

HIGH FIDELITY®

and musical america

MAY 1974 \$1.25
08398

- LAB TEST REPORTS
- SAE Mk. XXXIB power amplifier
- Magnavox MAX-15, Model SE-2510 speaker system
- Scintrex Supra headset
- Harman-Kardon 800+ receiver
- Pickering PST-1 stylus-replacement timer

Masterful Windbag: The Recordings of Max Reger

Should
You
Buy a
Manual
Turntable
Or a
Changer
?

MARACORR882BRITZZ E MAY 75
T CORBIN
8826 BRIERLY RD
WASHINGTON DC 20015

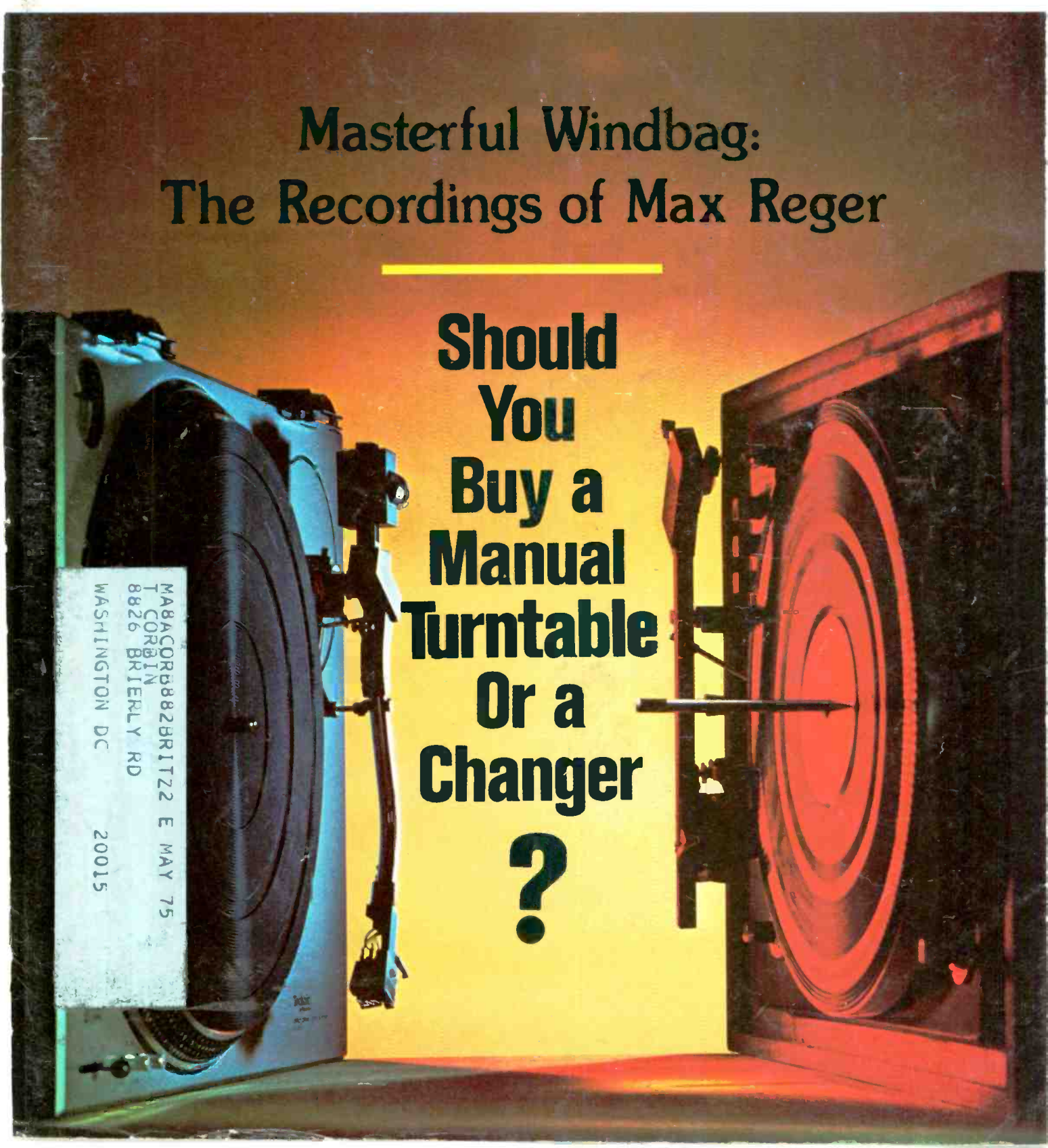

Fisher '14' series built-in CD-4.

acknowledged to be the state-of-the-art in 4-channel records. Keeping the signals separate throughout the recording and playback process makes possible superior channel separation and higher fidelity than any other disc systems achieve.

So Fisher, realizing the viability of the CD-4 system, and the increasing availability of program material in that format, has incorporated a Fisher-quality CD-4 encoder into the '14' series.

You can have Fisher with or without.

If you buy a Fisher '14' series receiver, you get CD-4 built in. If you buy an '04X' series receiver, you can still have the CD-4 built-in, if

you want it you decide anytime within a year after you make your purchase. Just return your '04X' receiver to a Fisher factory-authorized service center, and they will install it for you. The total cost of your receiver plus the decoder will not exceed what you would have paid for the equivalent '14' series receiver.

So it's up to you. Which do you prefer? A receiver that leaves room for improvement? Or one that does not?

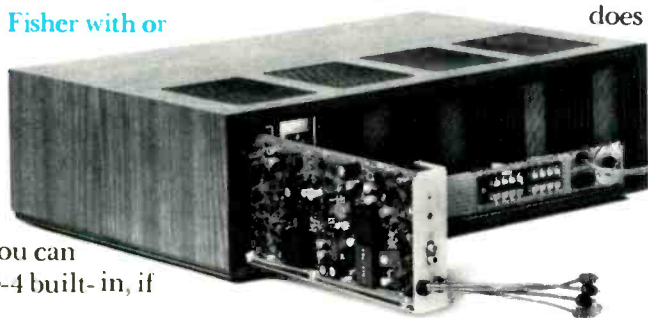

Free! \$5 value! With every Fisher '14' series receiver, you get a free 4-channel record, produced especially for Fisher by Enoch Light and Project 3. One side is encoded by the CD-4 process, the other is SQ-encoded. Selections include compositions by the Beatles, Rogers and Hammerstein, and Cole Porter.

If you buy a Fisher '04X' series receiver, you get the record free when you have your CD-4 demodulator installed.

Important specifications of the Fisher '14' and '04X' series Studio-Standard receivers.

	514	504X	414	404X	314	304X
Price:	\$749.95	\$649.95	\$649.95	\$549.95	\$549.95	\$449.95
Power, stereo, total continuous power (rms) into 8 ohms, 20 Hz to 20,000 Hz, all channels driven:	180 Watts	180 Watts	88 Watts	88 Watts	76 Watts	76 Watts
Power, 4-channel, total continuous power (rms) into 8 ohms, 20 Hz to 20,000 Hz, all channels driven:	128 Watts	128 Watts	88 Watts	88 Watts	60 Watts	60 Watts
Total harmonic distortion at rated output, 8 ohms, 20 Hz to 20,000 Hz:	0.5%	0.5%	0.5%	0.5%	0.5%	0.5%
IHF-FM usable sensitivity:	1.8 uV	1.8 uV	1.8 uV	1.8 uV	1.8 uV	1.8 uV
FM mono harmonic distortion, 400 Hz, 100% modulation:	0.2%	0.2%	0.2%	0.2%	0.2%	0.2%
Capture ratio (IHF at 1 mV):	1.2 dB	1.2 dB	1.2 dB	1.2 dB	1.2 dB	1.2 dB
Alternate channel selectivity (IHF method):	60 dB	60 dB	60 dB	60 dB	60 dB	60 dB

The Fisher Studio-Standard.

Free \$2 value! Write for your free copy of The Fisher Handbook! This entirely new, revised edition of the famous Fisher reference guide to high fidelity, stereo and 4-channel is a magnificent 68-page book. Fisher Radio, HF5, Box 1001, Long Island City, N.Y. 11101.

Introducing the receivers with

There's no paradox. On page 1 of this magazine, you see the new Fisher '14' series 4-channel receivers, with built-in CD-4 disc demodulator.

On the front-cover flap of this magazine, you see the new Fisher '04X' series 4-channel receivers, without the CD-4 built in. But with room for it, in the cabinet. The two series' of receivers are otherwise identical.

A general description of the new receivers.

If you read any of the rave reviews on the predecessor of the '14' receivers, the Fisher '04' line, you have an excellent idea of what the new models can do. The performance specifications are identical. Which means they are sensational.

Power to spare, in stereo and in 4-channel.

Fisher was probably the first manufacturer seriously to tackle the problem of 2-channel power versus 4-channel power. The concept of "strapped" amplifiers is a Fisher engineering feature of extreme importance. In all three of the Fisher '14' receivers, turning a control on the front panel lets you move from full 4-channel operation to stereo with twice or even more than twice the power per channel.

And even the lowest-powered unit, the 314, delivers 76 watts total RMS across the bandwidth of 20 Hz to 20kHz, into an 8-ohm load, in stereo. That's enough clean power to drive four bookshelf speakers at concert volume without clipping. The 414, measured the same way, delivers 88 watts RMS, while the 514 is a real powerhouse, with 180

watts RMS, enough to drive two sets of four Fisher top-of-the-line speakers at full volume in large rooms — that's a lot of power!

The controls: Very simple, and very flexible.

Besides all the controls you expect, Fisher includes a few you don't expect on every receiver in the '14' series.

The joystick is one. It's a sophisticated version of the old-fashioned balance controls — instead of two knobs, one of which balances the front left or right, the joystick gives you more precision with only *one* control. Move it to the left, get more sound on the left. Move it up or down, get more sound in front or back. Simple, yet extremely precise.

Most receivers have bass and treble controls, though possibly not of the same quality as the Baxandall controls Fisher employs. But in addition, the Fisher 414, 404X, 514 and 504X incorporate a midrange control that permits modification of the midrange frequencies as well. Another example of Fisher's flexibility.

The FM tuner section.

All the new Fisher receivers achieve the outstanding sensitivity figure of 1.8 microvolts, which permits them to bring in extremely weak signals without distortion. But they also are extremely selective (alternate channel selectivity, 60 dB),

which allows them to pick up a weak signal without distortion from a nearby station that happens to be stronger.

Among the reasons for the superiority of the Fisher FM section are dual-gate MOSFETS for high amplification with low noise, a ladder-type ceramic filter that passes the relevant information and rejects interference, and a multiplex decoder based on the phase-locked-loop (PLL) principle that's largely responsible for the 38 dB channel separation.

The AM section.

Fisher has never neglected the importance of AM reception. It has been our goal to insure that the '14' series is capable of reproducing an AM signal as cleanly as an FM mono signal. The AM input stage provides high sensitivity without overload susceptibility. The IF section includes High-Q filters that make the Fisher AM section extremely selective.

4-channel. All the ways.

4-channel is here to stay. But in what form? The answer is, to an owner of a new Fisher receiver, that it doesn't matter. The Fisher '14' series is equipped to handle everything. Discrete from tape. Any matrix system, SQ or otherwise. And the '14' receivers have a CD-4 decoder built in. So you're

completely covered no matter what kind of program material you like, no matter which format you prefer.

The CD-4 disc demodulator.

The CD-4 disc is generally





These new 4-channel receivers leave room for improvement.

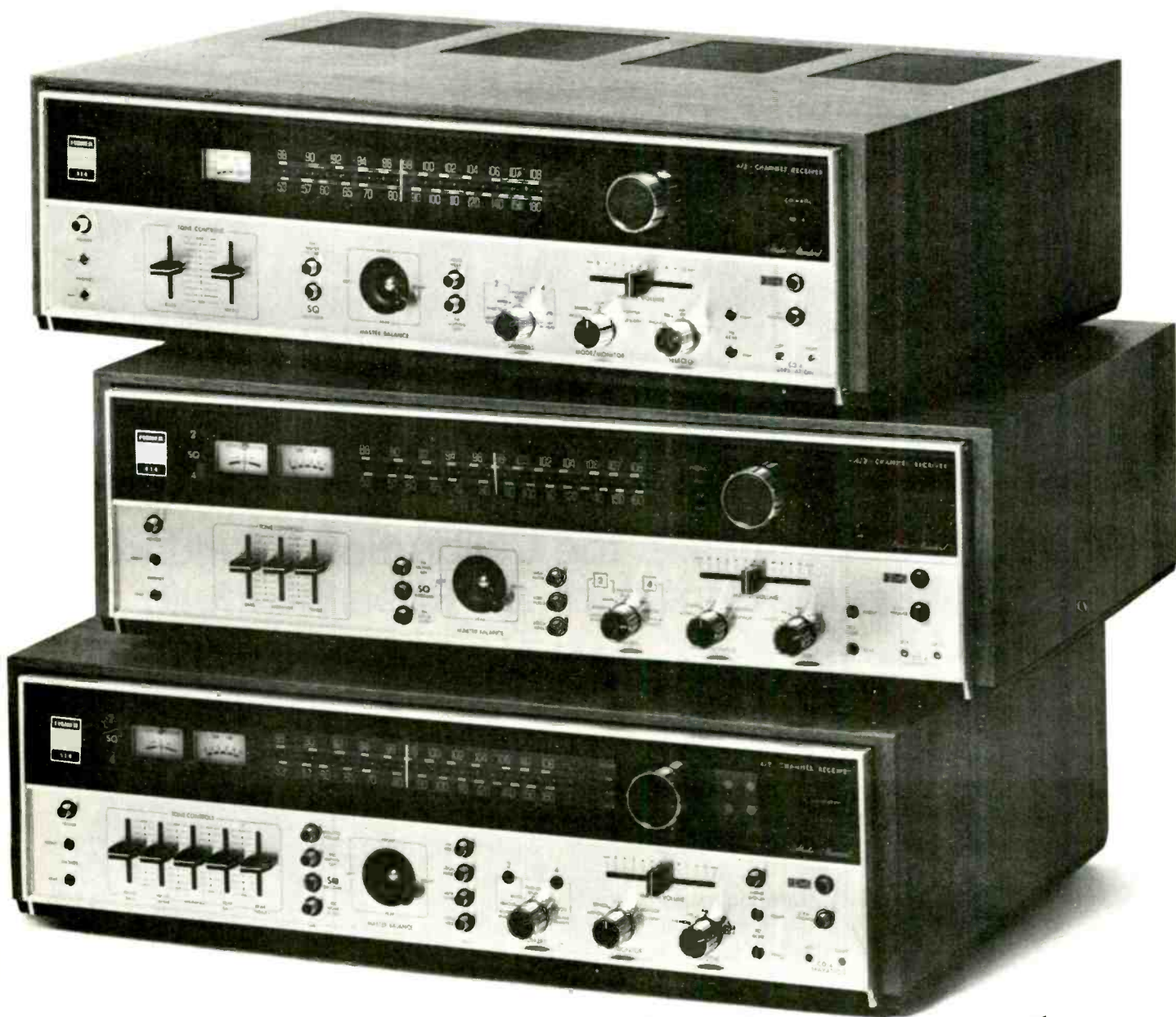

These new 4-channel receivers leave no room for improvement.

Stanton.

Benchmark for an Industry.

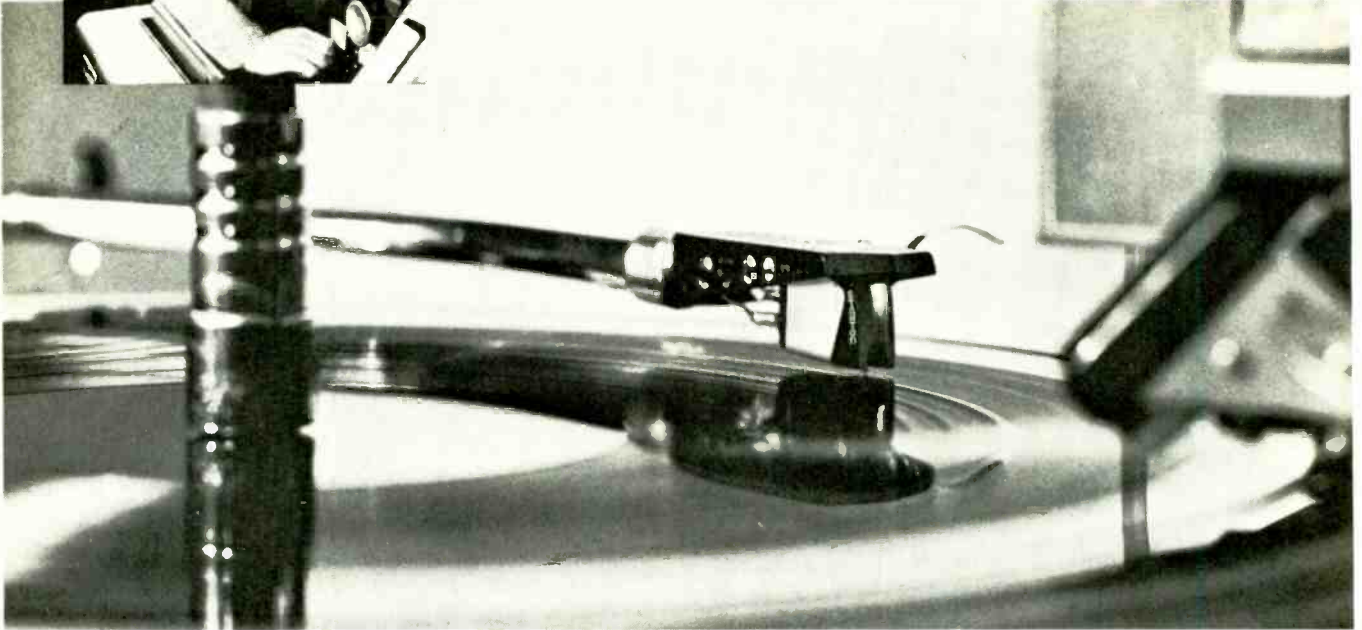

Stanton's 681 Series is the Calibration Standard to recording engineers such as Robert Ludwig.

Whatever the requirements for recording and playback, Stanton's Series 681 cartridges are the Calibration Standard. And there is a 681 model engineered specifically for each of these critical applications. That's why Stanton is truly the Benchmark for the industry.

The Stanton 681A—For Cutting Head Calibration. With Stanton's Model 681A, cutting heads can be accurately calibrated with the cartridge, for it has been primarily designed as a calibration standard in recording system checkouts. Frequency response is factory calibrated to the most rigid tolerances and the flattest possible response is assured for precise alignment of recording channels.



The Stanton 681EE—for Critical Listening. Stanton's Model 681EE is designed for low-distortion tracking with minimum stylus force, regardless of the recorded velocity or the distance of the groove from the disc center. High compliance, low mass and low pressure assure perfect safety even on irreplaceable records.

All Stanton Calibration Standard cartridges are guaranteed to meet the specifications with exacting limits. Their warranty comes packed with each unit—the calibration test results for that individual cartridge.

For complete information and specifications write Stanton Magnetics, Inc., Terminal Drive, Plainview, L.I., New York.



All Stanton cartridges are designed for use with all two- and four-channel matrix derived compatible systems.

CIRCLE 27 ON READER-SERVICE CARD

May 1974
VOL. 24 NO. 5

HIGH FIDELITY

and musical america

Manual or Automatic?

See page 33.



Has his time come?
See page 53.



Revolution by mail. See page 65.

music and musicians	
Edward Greenfield ELGAR BY BOULT, BARENBOIM, AND DANNY KAYE Behind the scenes in London	16
John Rockwell MAX REGER: WINDBAG OR PROPHET? A discography of the composer's music	53
Gene Lees THE HOME-GROWN RECORD LABEL Artist-originated mail-order record businesses may spark a revolution	65
audio and video	
TOO HOT TO HANDLE	22
NEWS AND VIEWS	27
Cultural revulsion . . . Chromium dioxide wins over a holdout	
EQUIPMENT IN THE NEWS	28
Larry Zide, Michael Marcus MANUAL VS. AUTOMATIC TURNTABLES How do you decide which to buy?	33
DIRECTORY OF HIGH-PERFORMANCE TURNTABLES	37
EQUIPMENT REPORTS	
Harman-Kardon 800+ receiver	
Magnavox MAX-15, Model SE-2510 speaker system	
SAE Mk. XXXIB power amplifier	
Scintrex Supra headset	
Pickering Model PST-1 stylus timing gauge	
record reviews	
Robert Long FOUR-CHANNEL DISCS AND TAPES All about SQ . . . What's left when pop groups split?	70
Abram Chipman MAHLER: A PSYCHOMUSICAL VIEW Four recordings spur speculation on what made Mahler tick	73
Robert C. Marsh TIPPETT: A COMMUNICATING COMPOSER His Third Symphony and <i>Knot Garden</i> show that modern music can be accessible	76
John S. Wilson CLASSIC JAZZ SURVEYED A Smithsonian collection offers an ideal view of an American art	78
CLASSICAL	
Fischer-Dieskau as conductor . . . The spectacular Heinz Holliger	81
LIGHTER SIDE	
Chi Coltrane . . . The Firesign Theater . . . Frank Loesser revisited	110
JAZZ	
Luis Russell . . . Flip Phillips . . . Upper Mississippi Jazz Band	114
R. D. Darrell THE TAPE DECK Grand piano parade . . . Multiflavored popsicals	122
etc.	
LETTERS	
Tebaldi and Corelli fans to the barricades . . . What is obsolete?	6
PRODUCT INFORMATION	18
An "at-home" shopping service	105
ADVERTISING INDEX	104

Lpbi High Fidelity and Musical America are published monthly by Billboard Publications, Inc., at 1 Astor Plaza, New York, New York 10036. Copyright © 1974 by Billboard Publications, Inc. The design and contents of High Fidelity and Musical America are fully protected by copyright and must not be reproduced in any manner. Application to mail at second-class postage paid at New York, New York and at additional mailing offices. Yearly subscription in the U.S.A. and Possessions \$14; elsewhere \$15. Subscription including Concert Artists' Directors \$20 in U.S.A. elsewhere \$21. Single copy \$1.25. Indexed in Reader's Guide to Periodical Literature. Change of address notices and undelivered copies (form 3579) should be sent to High Fidelity and Musical America, Subscription Department, P.O. Box 14156, Cincinnati, Ohio 45214. Please state both old and new address when requesting change.

Current and back copies of High Fidelity and High Fidelity and Musical America are available on microfilm from University Microfilms, Ann Arbor, Michigan 48106. Microfiche copies of these magazines (1973 forward) are available through Bell & Howell Micro Photo Division, Old Mansfield Road, Wooster, Ohio 44691.

Maxell's 60-minute Giveaway.

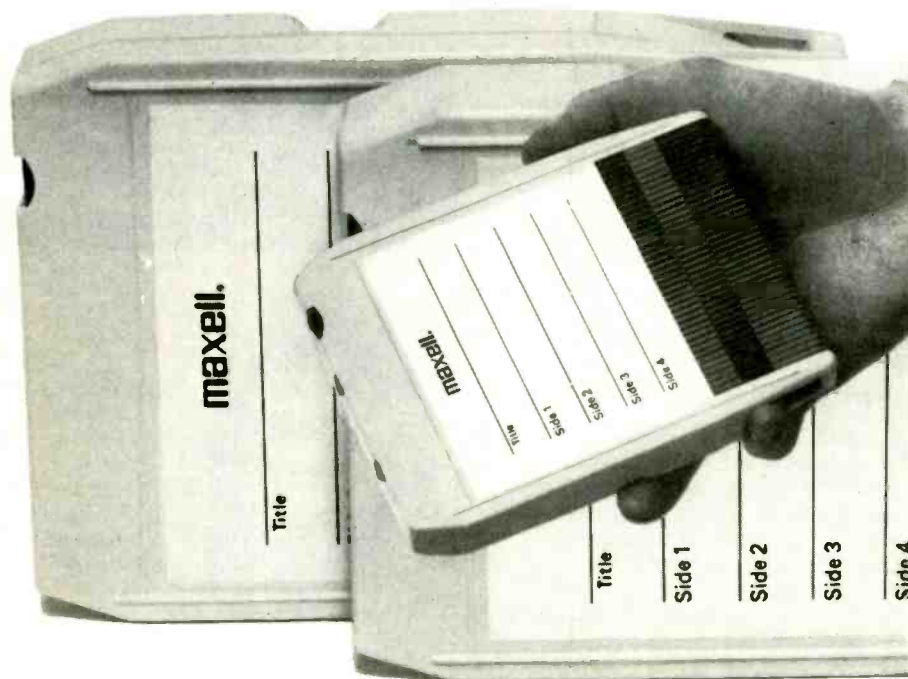

To a real audio buff, the only thing better than a beautiful bargain is a great giveaway.

And we've got one for you. We'll give you a Maxell 8-track 60-minute tape cartridge free just for buying two 80-minute cartridges.

Over the years, Maxell has developed a reputation for consistent quality and balance unsurpassed in both laboratory tests and home listening. We even developed the ideal cartridge shell to keep the sound pure and free of complications.

So find out for yourself about Maxell's fine, consistent quality and smooth running tapes and pick up your free 8-track tape. Your Maxell freebee could turn out to be the happiest hour you've ever listened to!

maxell®

The answer to all your tape needs.

Maxell Corporation of America, 130 West Commercial Avenue, Moonachie, New Jersey 07074.

CIRCLE 22 ON READER-SERVICE CARD

LEONARD MARCUS
Editor

NORMAN EISENBERG
Executive Editor

WAYNE ARMENTROUT
Managing Editor

KENNETH FURIE
Music Editor

ROBERT LONG
Audio-Video Editor

SHIRLEY FLEMING
Editor, Musical America Section

REBECCA ABBOTT
Copy Editor

VIOLA MATSON
Assistant Editor

WILLIAM TYNAN
Special Projects Editor

ROY LINDSTROM
Art Director

ROBERT MADDOCKS
Associate Art Director

MORGAN AMES
ROYAL S. BROWN
R. D. DARRELL
PETER G. DAVIS
HENRY EDWARDS
ALFRED FRANKENSTEIN
HARRIS GOLDSMITH
DAVID HAMILTON
DALE HARRIS
MIKE JAHN
PAUL HENRY LANG
GENE LEES
ROBERT C. MARSH
H. C. ROBBINS LANDON
Contributing Editors

STANLEY BINDER
Circulation Manager

CLAIRE N. EDDINGS
Associate Publisher and
Director of Advertising Sales

WARREN B. SYER
Publisher

Cover photo: Roy Lindstrom

ADVERTISING

Main Office: Claire N. Eddings, The Publishing House, Great Barrington, Mass. 01230. Telephone: 413-528-1300.

New York: 1515 Broadway (1 Astor Plaza), New York, N. Y. 10036. Telephone: 212-764-7365. Seymour Resnick, Eastern Adv. Mgr.

New England: The Publishing House, Great Barrington, Mass. 01230. Telephone: 413-528-1300.

Chicago: Billboard Publications, Inc., 150 North Wacker Dr., Chicago, Ill. 60606. Telephone: 312-236-9818. Leonard Levine.

Los Angeles: Billboard Publications, Inc., 9000 Sunset Blvd., Los Angeles, Calif. 90069. Telephone: 213-273-7040. Andrew Spanberger.

Nashville: Billboard Publications, Inc., 1719 West End Ave., Nashville, Tenn. 37203. Telephone: 615-329-3925. Robert Kendall.

London: 7 Carnaby St., London W. 1, England. Telephone: (01) 437-8090. Andre de Vekey.

Tokyo: Japan Advertising Communications, Inc., New Ginza Bldg., 7-3-13 Ginza, Chuo-Ku, Tokyo 104, Japan. Telephone: (03) 571-8748. Shigeru Kobayashi, president.



CIRCLE 46 ON READER-SERVICE CARD →

Our most expensive turntable has direct drive. So does our least expensive.

When Technics introduced direct drive, we set new standards for turntable performance. That's why we use direct drive exclusively in all Technics turntables.

No other system measures up to direct drive. Wow and flutter are less than 0.03% WRMS. And rumble is down to -65dB (DIN A) and -70dB (DIN B).

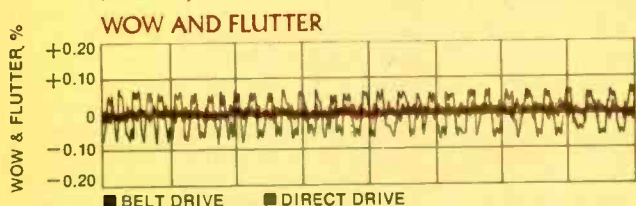

Our DC motor has no noise- or static-producing brushes and virtually none of the hum normally found in AC motors. It reaches playing speed in half a revolution and has electronic speed control that prevents speed changes due to line fluctuations.

All Technics turntables have illuminated stroboscopes, cast aluminum platters and variable pitch controls. The SL-1200 also has a precision tone arm, viscous damped cueing and low-capacitance 4-channel phono cables.

So does the SL-1100A but with a heavier platter, bigger motor and longer tone arm.

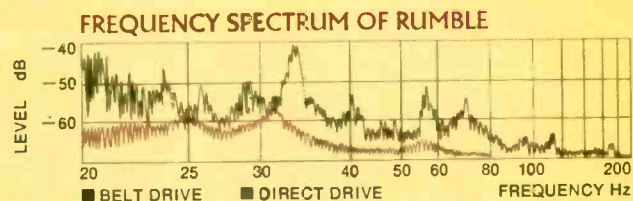

And the SP-10 is for those who insist on choosing their own tone arm.

No matter which Technics turntable you choose, you get the finest drive system that money can buy. But don't take our word for it. Read the reviews.* And you'll agree.

The concept is simple. The execution is precise. The performance is outstanding. The name is Technics.

*SP-10: Audio, 8/71; Stereo Review, 9/71.
SL-1100A: Stereo Review, 7/73; High Fidelity, 9/73.

200 PARK AVE., N.Y., N.Y. 10017 FOR YOUR NEAREST AUTHORIZED TECHNICS DEALER, CALL TOLL FREE 800 447-4700. IN ILLINOIS, 800 322-4400.

Technics

by Panasonic



letters

Take That Back, D.H.!

David Hamilton's reviews may read well but, for many listeners, simply do not convey adequately the critic's job—that is, to objectively and constructively criticize a new record release ("clearly a concession to failing powers" on Mr. Hamilton's part).

If neither Renata Tebaldi nor Franco Corelli manage to convey one bit of conviction in the "Great Opera Duets" record [February 1974], it may be because of Mr. Hamilton's "somnolent" ears. Granted the singers cannot do what they could fifteen years ago, but they both manage some beautiful phrases and lovely tone (especially in the Zandonai duet on Miss Tebaldi's part) and generally make this record a happy event. There is much beautiful singing on this record, which Mr. Hamilton so conveniently fails to mention in his razor-sharp review.

Mr. Hamilton says that to many ears this will be taken as great singing. There is great singing here and on many other records he has slaughtered. Unfortunately Mr. Hamilton's review will be taken as a real criticism, rather than the biased, irrelevant, and inconsequential piece of self-indulgent silliness it really is. Too often this type of review leaves the reader "wallowing in a swamp" of questions about what a record really sounds like.

I for one am glad I bought the record to hear a decent, convicted, authoritative rendition of these beautiful duets. Unfortunately HIGH FIDELITY reviews are "reduced to two-a-day vaudeville."

Roger Quigley
Cleveland Heights, Ohio

The author's invidious attack against these two great voices cannot be justified. How anyone writing for an esteemed magazine could use the terms "two-a-day vaudeville" or "wallowing in a tonal swamp" when reviewing this record is beyond me. I found the recording to be enjoyable and a must for any fan of these two artists.

The author who wishes that "self-criticism were as common as self-esteem" should apply the same reasoning to himself.

Carmen Verdi
Livingston, N.J.

The music editor replies: When a Willie Mays finally, if belatedly, retires, his legion fans breathe a sigh of relief. Instead of watching him embarrass himself whenever he steps on the field, we can again savor the wealth of memories of him as perhaps the greatest all-around ball player of our time. In baseball, as in opera, there is room for sentiment, but no fan would seriously suggest that this man who could no longer hit, field, or run was the real Willie Mays. Operatic standards, it would appear, are more flexible. But who does Mme. Tebaldi the greater disservice: those who appreciate her work from the years when the voice was unimpaired and under control (of which, fortunately, we have ample recorded documentation) or those who pretend that her current singing can measure up to those standards?

The Russian Best-Records List

In your "Best Records of the Year" [Decem-



Renata Tebaldi
Measuring up to what standards?

ber 1973], Mr. Marcus states that the Russian list of records submitted for consideration was disqualified because "every one was a Melodiya recording."

As an avid connoisseur of contemporary Soviet music, I am curious to know just why the Soviet nominations were disqualified *en bloc*. It certainly could not be because of the unavailability of these records in America, as two of your winners are unavailable locally. The only reason that comes readily to mind is that Melodiya Records is a branch of Mezhdunarodnaya Kniga, which in turn is a cultural arm of the Soviet government. If the disqualification was for this reason, it seems unfair, since record companies in socialist countries are ipso facto public. It would be a shame to deprive the music-loving public of a wider exposure to some of the very fine music being written and recorded in socialist countries simply because of the economic policies of these countries.

William E. Oylar
St. Paul, Minn.

Mr. Marcus replies: The economic policies of socialist countries had nothing to do with our acceptance or rejection of the lists submitted by critics from these countries, as witness the unquestioned lists submitted by critics from such places as Czechoslovakia and Yugoslavia. Rather, it was the unbiased critical competence of the anonymous Soviet nomination that was doubted. All the members of our jury and preselection committee are internationally respected critics with a broad knowledge of internationally released recordings. A critic who

ANSWERS TO "HOW CLEAR IS YOUR NOSTALGIA?"

Here are the answers to the quiz on the 1930s that appeared on page 73 of the April HIGH FIDELITY:

1. The instrument known as "the Ameche" was the telephone, because Don Ameche played the title role in the movie *The Story of Alexander Graham Bell*.
2. Mickey Rooney played Thomas Edison as a boy in *Young Tom Edison*, and Spencer Tracy played Edison as an adult in *Edison the Man*.
3. Besides being known by just one name, Rubinoff and Evelyn had in common the fact that both were popular violinists, one a radio personality, the other, with "Her Magic Violin," a featured soloist with the Phil Spitalny All-Girl Orchestra.
4. The nine-year-old boy who conducted the NBC Symphony at the 1939-40 New York World's Fair was Lorin Maazel, now the music director of the Cleveland Orchestra.
5. The tenor who introduced Gershwin's *Love Walked In* was Kenny Baker, a regular on the Jack Benny Show. Benny's invariable opening remark was, "Jello again."
6. The World War II antitank weapon that was named for a musical instrument was the bazooka, a country-music instrument popularized by Bob Burns.
7. The female singer of the Chamber Music Society of Lower Basin Street who later gained fame as a regular on the Eddie Cantor Show was Dinah Shore.
8. The two female leads in the original

production of Gershwin's *Girl Crazy* were Ethel Merman and Ginger Rogers.

9. The Moss Hart/Kurt Weill/Ira Gershwin show that starred Victor Mature and Gertrude Lawrence and introduced Danny Kaye to Broadway was *Lady in the Dark*.

10. The Jerome Kern musical that featured *Smoke Gets in Your Eyes* and the hitherto unknown Bob Hope was *Roberta*.

11. The radio programs and the music associated with them match up as follows: "The Lone Ranger"—Liszt's *Les Preludes* (it was the intermission theme; the opening theme was, of course, Rossini's *William Tell Overture*); "I Love a Mystery"—Sibelius' *Valse Triste*; "Stella Dallas"—Glover's *Rose of Tralee*; "Sgt. Preston of the Yukon"—Reznicsek's *Donna Diana Overture*; "Green Hornet"—Rimsky-Korsakov's *Flight of the Bumblebee*; "Bell Telephone Hour"—*If I Could Tell You*; "Lux Radio Theater"—Tchaikovsky's *Romeo and Juliet*; "The Shadow"—Saint-Saëns's *Omphale's Spinning Wheel*; "Mercury Theater"—Tchaikovsky's Piano Concerto No. 1; "Longines Symphonette"—Beethoven's *Moonlight Sonata*; "Escape"—Mussorgsky's *Night on Bald Mountain*; "The Big Story"—R. Strauss's *Ein Heldenleben*; "Sherlock Holmes"—Bruch's *Scottish Fantasia*; "Lorenzo Jones"—Denza's *Funiculi Funicula*; "Bachelor's Children"—Herbert's *Ah, Sweet Mystery of Life*; "Big Sister"—Drigo's *Valse Bluette*.

"COMPLIMENTS OF A FRIEND"

Anonymity is fine. Sometimes.

But when a company like ours has been a leader in its field for 37 years, one begins to wonder whether being anonymous is all that good for business. So, after mulling it over, we've decided to shoot for a little visibility among you who have known the products we sell (Garrard turntables, B·I·C Venturi speakers, to name two) but not our company name.

British Industries Co. will henceforth be known as B·I·C INTERNATIONAL™ (pronounce it "bee eye see" please, not "bic") and will be identified by this logo. 

We hasten to add that while we believe it is good business to change our name, we don't intend to change our ways.

We will continue to be innovators in the component field. We will continue to emphasize honesty, fair dealing, and all those other business virtues that mean so much when you're laying out several hundred dollars for a piece of equipment.

So remember us. B·I·C INTERNATIONAL. The name stands for more today than ever in our history. And as the man said, "you ain't seen nothin' yet."



TEAC

PRODUCT OF JAPAN

TEAC

TEAC 3300S

POWER
REEL
TAPE

MCC
LIMIT

REC

STOP

PULSE

A TEAC tape deck isn't a tape deck.



A TEAC reel-to-reel deck is a whole nother thing. It is a creative tool. A partner in the creative process itself.

Every member of the TEAC reel-to-reel family is designed to expand your imagination and enhance your creativity. From our classic 2300S with its reliable 3-motor, 3-head transport system to our 4-channel 3340S with its 8 input jacks and Simul-Sync[®] that lets you overdub, sweeten, echo, cross-echo and stack tracks — there's a TEAC in the family whose creative configuration best suits your particular creative bag.

Our 3300S is a semi-professional 1/4-track, 7½ — 3¾ ips, 10½ inch reel deck. Our 3300S-2T is a 2-track version of the 3300S with speeds of 15 and 7½ ips. Both have a "running splice" feature that enables you to record directly from playback.

Our 4300 with adjustable bias, two-position level meter and automatic reverse circuitry, our 5300 with center capstan drive, DC reel motors, dual-scale VU meters and plug-in electronic boards, our 5500 with dual-function Dolby* circuitry are examples of TEAC creative engineering in the service of creative use. And they all offer complete remote control capability.

Think of your TEAC as an extension of yourself. Then open your head and explore your personal world of sound.

You'll be surprised at the beauty that's there.

Or maybe you won't be.

It's you, it's you.

TEAC[®]

The leader. Always has been.

*Dolby is a trademark of Dolby Laboratories, Inc.

TEAC Corporation of America — Headquarters: Dept. A-17A, 7733 Telegraph Road, Montebello, California 90640 — TEAC offices in principal cities in the United States, Canada, Europe, Mexico and Japan.

©TEAC 1973

CIRCLE 45 ON READER-SERVICE CARD

knew only the albums recorded in his country would ordinarily not be invited to participate in the HIGH FIDELITY/Montreux Awards. None of us, however, was familiar with Russian record critics: we simply took a chance that the Soviets could come up with a person of unqualified open-mindedness toward, and knowledge of, the international recording scene. Unfortunately they couldn't, or at least didn't. If a Dutch critic nominated only Philips recordings, or a German critic only Karajan performances, we would also question his competence to participate in the world's only international record awards.

Our Kindhearted Readers

Several months ago I sent you an inquiry about where I might find an Ampex Micro-90

cassette player. You answered my questions with dispatch, and I didn't give the matter much more thought until a large portion of my letter appeared in your "Too Hot to Handle" column. Before long I began receiving letters addressed to me via your offices. Some were from dealers with an item they felt might serve my purpose: a couple were from private parties telling me about the player's twin that had been out under a different make; and one was from a person I'll just call Lou.

There are a lot of clichés about music being a common language or bond between people. Lou has to be a personification, and more, of that bond. He not only gave me many specifics about similar machines but said he had in his possession an unused model of the Ampex's twin and would be very pleased if I would ac-

cept it as a gift, "from one stranger to another." Needless to say, I took him up on his offer.

A stranger? How nice this world would be if it were filled with Lous and the kind of heart he has—or just a few more here and there to help ease our troubled old globe through these trying times. Thank you for running my letter and forwarding the replies, and thanks to all who took the time to answer my letter. I hope it does your heart as much good as it did mine to find out you have readers such as Lou.

Donald G. Gaedy
St. Cloud, Minn.

We can't of course guarantee to forward readers' letters, but we try to do so when a useful purpose will be served. In this case it was—Mr. Gaedy, a quadriplegic, required a cassette player with multiple changer. We too thank the many readers who responded.

Ives's Early Work

In his thoughtful and cogent review of Zubin Mehta's London recording of Ives's Symphony No. 1 [February 1974], Robert P. Morgan makes a somewhat misleading statement in describing the work as "in every sense a student work." True enough. Ives produced this initial essay in the symphonic genre under the tutorial aegis of composer Horatio Parker while the former was a Yale student. But unlike most comparable examples (Stravinsky's youthful Symphony in E flat comes to mind), the work was perhaps unique in that its composer had already written a small body of his more experimental music, either before or contemporaneously with this symphony, outside of Academe. Those ten amazing psalms for chorus, with or without organ or other instrumental accompaniment, for example, or at least some of the polytonal and polyrhythmic *Harvest Home Chorales* will serve for the argument.

One must also take into account that Ives, according to his biographers Henry and Sidney Cowell, was compelled by Parker to curb some of his more avant-garde tendencies, so this symphony further represents a departure from most examples of student work in that its "style" is an imposed one. What Morgan calls "pastiche" in most composers at the outset of their careers is a result of their not having found a manner of their own, and thus quite willingly they follow predecessors as models. Ives's case is entirely different: He unwillingly subjected himself to his teacher's own "academicism" in order not to fail a college course! That the First Symphony is such a viable piece in the face of these obstacles is the real proof of the Ives genius.

Gordon C. Cyr
Towson State College
Baltimore, Md.

Obsolescence Revisited

The colloquy between Messrs. Bailey and Marsh ["Two Views of Obsolescence," Letters, October 1973] was interesting, albeit in the end no debate. For better or worse, the word "obsolete" connotes "unworthy," and Mr. Bailey's letter protesting categorization of older recordings as such seems justly prompted. Mr. Marsh explained his use of the term properly enough.

I would ask only whether a recording per se can be obsolete. Surely the technology that

"On musical material we judge the Interface:A to be unusually clean and smooth..."

HIGH FIDELITY February, 1974

"...the Interface:A can deliver a level of undistorted bass far superior to that of any other speaker of its size that we have heard."

STEREO REVIEW March, 1974

"The Interface:A is, simply, a great speaker system."

STEREO & HI-FI TIMES Winter, 1974



Interface: A™

\$400/pair, suggested retail including equalizer.

The complete reviews cited above, our own comments on Interface:A, plus a list of dealers are all in a packet of facts we have waiting for you. Send today.

Electro-Voice® ELECTRO-VOICE, INC., Dept. 544H a **Gulton**
619 Cecil St., Buchanan, Mich. 49107 COMPANY

CIRCLE 12 ON READER-SERVICE CARD

Nakamichi 1000
used to be the world's
only 3-head cassette
deck with quality
and performance
comparable to
professional 15 ips.
reel-to-reel machines.



Now there's another. **Nakamichi 700**

That's right... only *two* cassette decks available today parallel the performance and reliability of professional 15 ips. reel-to-reel machines... and Nakamichi has them *both!*

Nakamichi 1000—the world's most expensive cassette deck—designed for rack mounting, offers instantaneous off-the-tape monitoring; large peak-level meters; built-in user-adjustable phase-sensing azimuth alignment beacon for record head; dual-motor drive system including a DC servomotor driving dual capstans and equipped with speed vernier; Tri-Tracer 3-head configuration featuring specially designed recording and playback heads; two complete

noise reduction systems (Dolby B® and DNL); 3-point sound pickup; peak limiter; instant-acting jam proof device; solenoid action feather-touch controls with timing-logic system—everything you'd expect at \$1100.

The surprise is how much of these outstanding features are shared by the new Nakamichi 700. Like frequency response 35-20,000 Hz \pm 3 dB; wow & flutter less than 0.10% (WTD Peak); better than 60 dB signal to noise ratio (WTD at 3% distortion); total harmonic distortion less than 2.0% (at 1 KHz, 0 dB). A lot of deck for \$690.

For complete information on these unique Tri-Tracer 3-head Cassette Systems, write...



HEARING IS
BELIEVING

NAKAMICHI RESEARCH (U.S.A.) INC. 220 Westbury Ave., Carle Place, N.Y. 11514 • (516) 333-5440
West Coast Office • 1101 Colorado Ave., Santa Monica, Calif. 90404

®Dolby® is a Trade Mark of Dolby Laboratories, Inc.

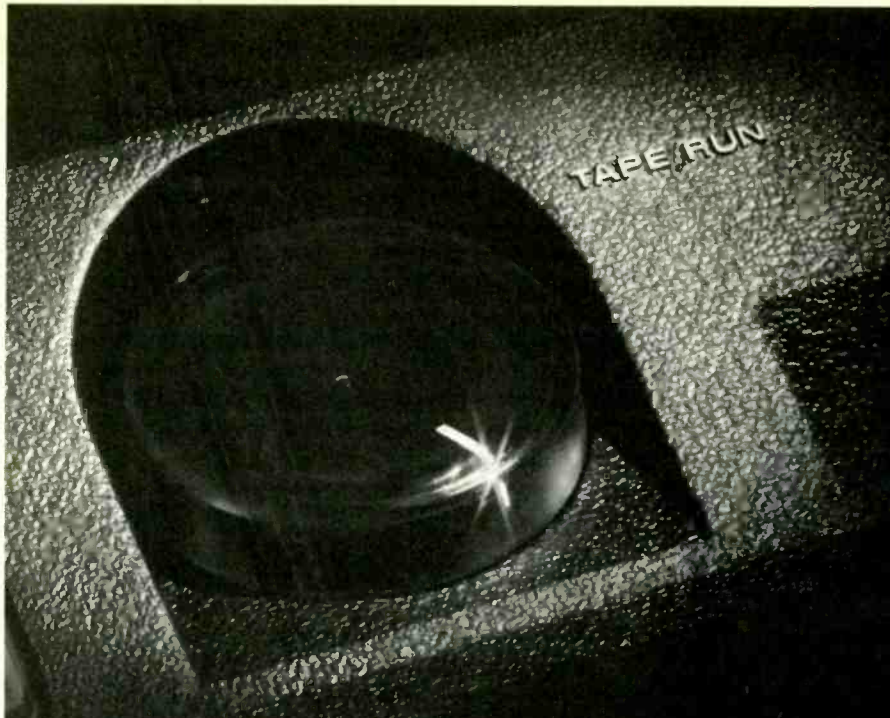

introducing the
**Dokorder
MK-50**
with DOLBY-B*
the stereo cassette deck
with a new sense of direction

DOKORDER moves in new directions with this outstanding state-of-the-art cassette deck. A Tape Scan Indicator shows the direction the tape is moving and, in conjunction with the 3-digit tape counter and Cue and Review Switches, makes it exceptionally easy to locate desired selections instantly. The super-hard Molybdenum (MBD) PLAY/RECORD head delivers outstanding fidelity and increased frequency response (30-18k Hz). And the Dolby-B noise reduction system achieves exceptional signal-to-noise characteristics (better than 60 dB). It's the finest cassette deck you could choose for reel-to-reel quality and professional performance. *Dolby is a trademark of Dolby Laboratories, Inc.

For complete information, visit your nearest Dokorder Dealer, or write . . .

Dokorder Inc.® 11264 Playa Court, Culver City, Calif. 90230



CIRCLE 9 ON READER-SERVICE CARD

produced a recording of twenty years ago is obsolete by today's standards; but do we consider a photograph taken in the 1800s obsolete? The caption beneath the picture of Toscanini that accompanied the Bailey letter and Marsh reply asks, "How much difference do sonics make?" Obviously an enormous difference; if we could neatly divorce sonic and musical values (though I'm not sure how), I'd likely prefer a given performance in the newest rather than older sound. But there is more to "sonics" than up-to-date technology.

When Mr. Marsh insists that a record made in the 1950s can be compared "only musically" with one today, I think he overstates. I can receive great enjoyment from the sound on some of the very Mercury Chicago Symphony reissues to which he refers. Oh sure, the frequency response, dynamic range, and all the rest are less than today's average, but the unique ringing brass on some of those reissues provides a special, quite *sonic* pleasure. And the realistic hall ambience of those recordings is very much a sonic consideration.

A recording of Nellie Melba may reveal something of her interpretive art while masking her sound. The same cannot be said of the recorded Flagstad sound in the *Tristan* recording referred to by Mr. Bailey. Her matchless tonal opulence would have been better served by the best of today's recordings, but much of it is on the Angel set (EL 3588)—so much in fact that no subsequently recorded Isolde approaches it, despite better technology.

Naturally standards for evaluating recordings must change as technology develops; but the total sonic experience is the result not only of recording technology but also of acoustic factors, halls, and the tonal values of the performers—quite aside from their artistic felicities. I'm sure Mr. Marsh knows all this, but it deserves more emphasis in reviews of recordings.

Garry D. Whitlow
Hollywood, Calif.

I was amazed at Mr. Marsh's reply concerning "obsolescence." How could he state so categorically that recordings made in the Fifties can be compared only musically and not technically with present-day ones? I would like Mr. Marsh to hear Toscanini's recording of Sibelius' *Finlandia* and tell me what is wrong with its frequency response, dynamics, clarity, naturalness, and balance. In fact, this recording captures precisely the conductor's work, whereas in a modern recording there is an ever-present danger of going astray with the many microphones and "mixing" controls. In Toscanini's time it was Toscanini who did the mixing, and what a great "mixer" he was. Monophonic techniques had particular advantages and cannot be labeled with the repellent word "obsolete."

Raymond Falcón
Santurce, Puerto Rico

I must to some extent defend Mr. Bailey's viewpoint. Mr. Marsh disagreed with Harris Goldsmith because, as Mr. Bailey notes, the latter (presumably in his May 1973 review of the Solti Beethoven Ninth) "failed to indicate that Toscanini's old recording of the Ninth is the equivalent of an older-model automobile." In fact, though, Mr. Goldsmith had clearly stated that "London's reproduction makes one aware how recording techniques

Listen to a professional who listened to the AR-5

6 *I was immediately struck by its superb mid-range to high end smoothness and broad dispersion... the AR-5's bass line is solid and supremely clean, very deep... had a room-filling size to it, this is of course, a function of the excellent high frequency dispersion characteristics... if you like your music loud, you will doubly appreciate the AR-5. It is downright cheerful about accepting large amounts of power.*

LARRY ZIDE
IN AMERICAN RECORD GUIDE

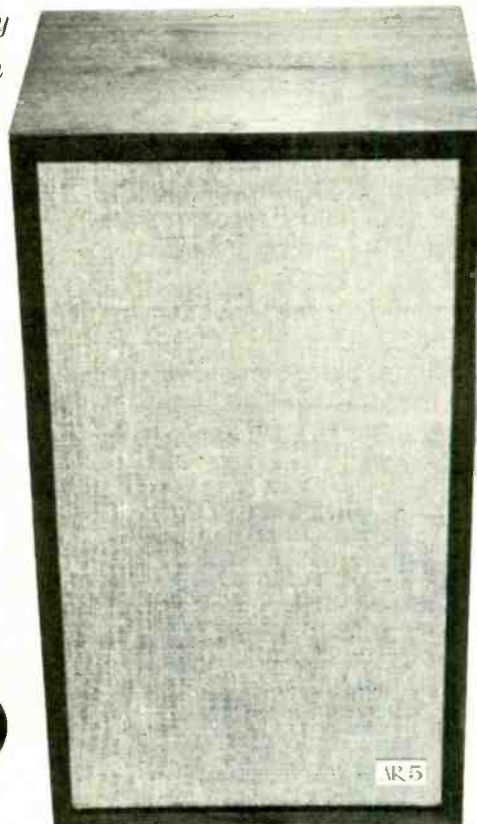

We think you will agree with the professionals. The AR-5 is an unusual speaker system that delivers magnificently balanced sound with a minimum of distortion in the bass, mid-range and high frequencies. This is made possible by several AR advances in materials technology. The cone of the 10" woofer, for example, is molded by a new low vacuum process that greatly reduces the tendency to coloration heard on conventional cones of paper or polystyrene. At the cone's outer edge is a new suspension of urethane polymer that achieves a very low distortion of low frequencies. The hemispheric dome mid-range and tweeter are identical to those found in the industry standard AR-3a. The price, only \$199. For more detailed information, please write.

ACOUSTIC RESEARCH
10 AMERICAN DRIVE
NORWOOD, MASS. 02062

Please send details on the AR-5 and the full line of AR speaker systems.

NAME

ADDRESS

STATE

CITY

ZIP



CIRCLE 1 ON READER-SERVICE CARD

From here



to hear

With Superex Stereophones, you've got the best seat in Philharmonic Hall. You're in the control room at every recording session. And you can change seats simply by changing the volume.

Transport yourself to the center of the brass section, or see what it feels like to sit under the cymbals.

The Superex PEP 79 will carry you there. According to Stereo Review, "... though one of the lowest-price electrostatic headsets we know of, sounds about as good as the best and most expensive ones we've tested thus far — and that is no small achievement." Write for complete report.

You'll have a pair of Superex Stereophones with a 10-22,000 Hz. frequency response, a handsome console that works off any amplifier, and a one year guarantee.



PEP-79
Sugg. Retail Price \$85.00



Superex Stereophones. Feel what you hear.

For Free Literature Write:
Superex Electronics Corp., Dept. FT, 151 Ludlow St., Yonkers, N.Y. 10705.

have progressed since the fine high fidelity of the Fifties." Exactly how strong a statement along these lines would satisfy Mr. Marsh? Like Mr. Bailey, I own only the Toscanini and Furtwängler Ninths and consider the merits of the performances sufficient to make up for the technical superiority of any more recent performance.

In the same May issue appeared a review of Furtwängler's 1943 Beethoven Seventh. It was with some trepidation, due to David Hamilton's lukewarm reaction, that I finally ordered a copy. To my surprise, the recording turned out to be one of the best Turnabout Furtwängler issues to date. No doubt the "pseudostereo" detracts somewhat, but the recording is remarkably clear and free from noise. I already own the noisy *Pastoral*, the Fifth (with a low-level first movement, as Schubert's *Unfinished* is on the same side), the somewhat hissy Fourth and similar *Eroica*. To think that I was nearly discouraged from purchasing a recording technically superior to all of these! If your reviewers must, then let them stress "technical obsolescence." But please do not let them steer us away from the better early recordings, even if they are only "worthy of specialist attention."

Mark W. Kluge
Urbana, Ill.

She's Been Around

I was delighted to read Henry Edwards' perceptive review of Etta James' latest album [December 1973]. However, Miss James made her debut long before 1960. In fact, she made her first rhythm-and-blues hit, *Dance with Me, Henry*, back in 1954.

Though she hasn't received due credit, Miss James was one of the first and still is one of the leading ladies of soul as indicated by her new release.

Reginald Roberts
Knoxville, Tenn.

High Fidelity, May 1974, Vol. 24, No. 5. Published monthly by Billboard Publications, Inc. Chairman: R. H. STEGEMAN; President: W. D. LITTLEFORD; Vice Presidents: MAYNARD REUTER, Sales; JOEL NOVAK, Circulation; JULES PEREL, American Artist Group; WARREN B. SYER, Consumer Publications; DAVID LUPPERT, Controller; MORT NASATIR, International Operations; HAL B. COOK, Treasurer; LAWRENCE GATTO, Secretary; JOHN ROSS, President, Whitney Publications; CHARLES WHITNEY, President, Music Labo (joint venture); BEN OKANO, Publications, New York; *American Artist*, *The Architectural Forum*, *Gift & Tableware Reporter*, *Industrial Design*, *Interiors*, *Merchandising Week*, *Modern Photography*, *Photo Weekly*, *VidNews*, *Watson-Guphill Publications*, *Whitney Library of Design*, Great Barrington, Ma.; *High Fidelity*, *Musical America*, *Stereo*, *Musical America Directory of the Performing Arts*, *Buyer's Guide to the World of Tape*, *Consumer's Guide to Four-Channel Sound*, *High Fidelity's Test Reports*; Los Angeles: *Billboard*, Nashville, *Amusement Business*; London: *Music Week*, *Record Radio Mirror*, *World Radio-TV Handbook*, *How to Listen to the World*; Tokyo: *Music Labo*.

High Fidelity/Musical America. Edition published monthly. Member Audit Bureau of Circulations.

Editorial correspondence should be addressed to The Editor, High Fidelity, Great Barrington, Mass. 01230. Editorial contributions will be welcomed. Payment for articles accepted will be arranged prior to publication. Unsolicited manuscripts should be accompanied by return postage.

Subscriptions should be addressed to High Fidelity, 2160 Patterson St., Cincinnati, Ohio 45214. Subscription rates: High Fidelity/Musical America: In the U.S.A. and its Possessions, 1 year \$14; elsewhere, 1 year \$15. National and other editions published monthly: In the U.S.A. and its Possessions, 1 year \$7.95. Subscription rates for all other countries available on request.

Change of address notices and undelivered copies (Form 3579) should be addressed to High Fidelity, Subscription Fulfillment Dept., P.O. Box 14156, Cincinnati, Ohio 45214.



By Jupiter! the sound comes at you from all directions.

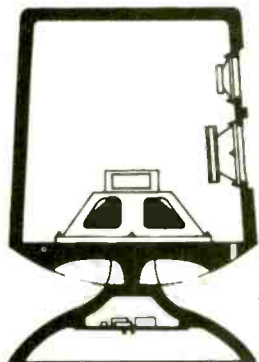

Empire's unique Jupiter cylinder produces the kind of sound no conventional box speaker can deliver. Our all-around sound is simply phenomenal — it radiates in all directions: front, rear, left and right.

The Jupiter's perfect three-way system* uses Empire's heavy 12 inch down facing woofer for bass you can feel as well as hear, a powerful midrange for crisp, clear alto and

voice tones, and a lightweight ultrasonic tweeter with wide angle dispersion. The power of the Jupiter 6500 speaker is awesome — it can deliver an impressive performance without overload, burnout or strain.

Best of all, the virtually indestructible Jupiter enclosure is made of a new space-age acoustic material with a marproof surface, making it ideal for today's casual living.

*Jupiter speakers are completely weatherproofed for indoor or outdoor listening.

Empire's new Jupiter 6500 Speaker list price \$149.95. Available at better hi-fi dealers. For your free "Empire Guide to Sound Design" write:
EMPIRE SCIENTIFIC CORP.,
Garden City, New York 11530.

Mfd. U.S.A.

EMPIRE 

CIRCLE NO. 98 ON READER SERVICE CARD

The first NEW amplifier design since



the ORIGINAL Super Amp

You remember the first super power amplifier - the Crown DC300. Well, most of its competitors are still using those six year old circuit designs pioneered by Crown. Most every amp but Crown's new **DC300A** - a totally redesigned amplifier inside and out. Frankly, the DC300A is not created for the hi fi mass market, but for demanding commercial and professional applications. However, we know there are discerning audiophiles, perhaps like yourself, who can appreciate the difference.

The new DC300A has double the number of output transistors, effectively twice the muscle of the old DC300 for driving multi-speaker systems. Each channel has eight 150-watt devices for 1200 watts of transistor dissipation per channel. Advanced electronic output protection permits the DC300A to drive the toughest speaker loads at higher outputs before going into protection, and even then there are no annoying flyback pulse noises or DC fuses to blow.

The new DC300A has unprecedented signal purity. IM and harmonic distortion ratings are .05%, although typically below .025%. Hum and noise rating is 110dB below 150 watts, while typically -122dB. The difference in increased listening comfort is impressive.

Although totally new, the DC300A has inherited some important traits from its predecessor:

PRICE — still under \$700

WARRANTY — three years on all parts, labor and round-trip shipping

POWER RATING — 150 w/ch continuous at 8 ohms; power at clip-point typically 190 w/ch at 8 ohms, 340 w/ch at 4 ohms, 500 w/ch at 2.5 ohms, or plug in two parts for 600 watts continuous mono power at 8 ohms.

There are many new super-power amplifiers. But when you buy a Crown DC300A, you're buying more than just an amp. You're buying the Crown company — a professional audio equipment manufacturer with a 26-year reputation for solid quality and lasting value. There are thousands of Crown amps in the field still working to their original specifications, and still outperforming most new amps. Visit your Crown dealer to hear the difference. For detailed product data, write Crown International, Box 1000, Elkhart, Indiana, 46514.



CROWN

CIRCLE 7 ON READER-SERVICE CARD

behind the scenes



Sir Adrian Boult and Elgar's daughter Mrs. Carice Blake discuss the composer's work during a recording session.

Elgar Conducted by Barenboim, Boult—and Kaye?

LONDON

A sort of hijacking of the conductor's podium took place during one of Daniel Barenboim's recording sessions at the EMI studios. The culprit was another Danny, who had come as a visitor to see Barenboim conducting Elgar's *Pomp and Circumstance* Marches for Columbia. Producer Paul Myers and the engineers, alert at the controls, set the tape rolling as soon as Maestro Danny Kaye started the London Philharmonic on *Pomp and Circumstance* No. 2. It was fortunate that they did, for to everyone's amazement the famous parodist of conductors past and present persevered to the end of the piece.

"It was a cracking performance. We hope to use it," commented Myers enthusiastically, though he has not yet indicated where.

The Barenboim version of the five marches will be coupled with the *Cockaigne* Overture (another piece that has attracted unexpected celebrities to the podium) and two pieces from *The Crown of India*.

That is only a fraction of Columbia's

massive Elgar recording program with Barenboim and the LPO, who had previously done the *Second Symphony*. In six three-hour sessions Barenboim managed to complete the *First Symphony* (some fifty minutes long) and the "symphonic study" *Falstaff* (over half an hour). He had the advantage of conducting the orchestra in both works prior to the sessions, at a series of concerts in London and outside. As an Elgarian myself, I was fascinated to note that, while his view of the *Second Symphony* had been expansive to the point of waywardness, these readings were tauter, with tempos on the fast side.

Don Giovanni (continued). As I reported in March, Barenboim's recording of Mozart's *Don Giovanni* for EMI was delayed initially by bass Roger Soyer's serious throat infection. Subsequently producer Suvi Raj Grubb had managed to record a large part of the opera even without a Don, but again the project was foiled by a sore throat—this time Helen Donath's. She was unable to come to London to sing the rest of her role as Zerlina, which means that some numbers still need to be completed, notably the duet "*Là ci darem la mano*."

The aim now is to finish the delayed

**HIGH
FIDELITY** and

MAY 1974

musical america

Martin Mayer on
musical strikes

Cantometrics—
an anthropological
breakthrough?



Musician of the month:
Kiri Te Kanawa

An Open Letter to the General Manager of the Metropolitan Opera

Dear Schuyler Chapin:

These are difficult days for the Met and those who run it, so MUSICAL AMERICA would like to send along some words of sympathy and reinforcement.

The accountants have done their arithmetic and the financial forecast is dark. Opera concerts in the parks are out, the mini-Met has gone, the 1975/76 season is to be cut by four weeks. Some office and backstage staff have been let go, and the unions have been put on notice that the Metropolitan can no longer contemplate offering its employees a paid fifty-two-week working year.

More. Your music director has quit. Rafael Kubelik, whose appointment was announced with such fanfare two years ago, now feels there is insufficient money to enable him to carry out his "artistic ideals." (To our mind there is something a little less than admirable about this statement of resignation: the water is rising in the scuppers, but—sorry, fellers—I cannot stay to help you at the pumps.) Kubelik will be back to conduct, however, if not to give his wise counsel: and that is perhaps all to the good.

It would be natural enough to despair at such a time but your courage should be buoyed by the knowledge that since mid-October your company has been performing at memorably high levels of quality. Despite all the troubles, the house has offered a string of superior performances in a distinguished repertory. You have given *Les Troyens* and *Tristan and Otello*, a fine *Hoffmann*, a historic first production of *I vespri siciliani*, splendid revivals of *Boccanegra* and *Der Rosenkavalier*; *Götterdämmerung* is still to come at the time we go to press. We have had a lion's share of the world's great singers: Sutherland and Nilsson and Caballé and Horne, Pavarotti and Domingo and Vickers. We have had good men in the pit: James Levine and Sixten Ehrling for Verdi, Leinsdorf for *Tristan*, Kubelik for Berlioz, Böhm for Richard Strauss. Signor What-not is mercifully absent, and Herr Doktor Thingummy not in evidence. The orchestra has rarely sounded better, the chorus has often excelled itself, the stage machinery has worked well.

This is a hard-won achievement, and you must not allow the money-men to dilute it. The Board must be told that it is *your* job to run the opera season, to maintain the standard and to tell *them* what it costs; it is their job to find the money. Money must not be wasted, naturally enough, but it is no part of the Board's work to decree how many horn-players are required for *Tristan* or to insist that young Whatsisname can sing Alberich just as well as that other German. These things you should be absolutely firm about.

Lincoln Center is ten years old now. It cost something over \$200 million to build, much of the sum coming from Rockefeller coffers. But Lincoln Center has changed the property values of all the West Side in its vicinity: people have made billions out of its presence. Should they not pay, if only to make sure that the golden eggs keep coming? If property values have risen five-fold as a consequence of the existence of Lincoln Center and what is done there, surely one-tenth of that gain might be taken away and applied to the feeding of the goose? That would solve every budget problem in sight.

With all honor to Chicago and San Francisco, it is a fact that the only opera company in the United States approaching the stature of a national institution is the Metropolitan. To allow its repertory or its quality to decline would be a national, not merely a local disgrace. And for what? The lack of, say, six million dollars a year to meet the gross deficit, or a million or so after all the gifts are in?

Please tell your Board, good Schuyler Chapin, about the rocket that NASA tried out on February 11. It flew off from Cape Kennedy and wasn't acting right, so the man at the control panel pressed the 'destruct' button and the thing blew itself up, at a cost of twenty million dollars.

So here's hoping that you and all about you keep their courage high and their sense of proportion keen. More power to you.

Sincerely,
The Editors

Letters

Directory: corrections, additions

SIR:

On Page 139 of your yearly Directory, David Schiffman's report states that Thomas Booth is Musical Director of Artists Internationale. This is not a fact. Mr. Booth, a most gifted and talented artist, is employed by Artists Internationale in the capacity of a conductor. The entire artistic directorship is under Marguerite Ruffino. We would appreciate a retraction of the statement as we find it damaging due to the fact that we have other conductors in our employ and will employ other conductors in the future.

Margaret M. Connor
Company Manager
Artists Internationale
Providence, R.I.

SIR:

In your 1974 Directory issue, in the North American Artists Managements reports, the following was omitted:

Dina Bader Associates is now agent in the United States and Canada for Alexandra Hunt, whose appearances as Marie in *Wozzeck* include debuts at La Scala Milan, (German premiere) and Hamburg. The noted soprano's Katya in *Katya Kabanova* was critically acclaimed at Wexford and York festivals and she has been invited to repeat this role with the Prague Opera during their 1975-76 season. Miss Hunt returns to the U.S. for appearances with the Philadelphia Orchestra in Penderecki's *Passion According to St. Luke*.

Contralto Eunice Alberts' festival appearances at Saratoga include a complete staged production of *La Vida Breve*, and she sings Princess Ahkrossimova in Prokofiev's *War and Peace* with the Opera Company of Boston. Baritone Timothy Nolen sings in *Peter Grimes* and *La Bohème* during San Francisco's fall season. Molly Stark, who has appeared with Clarion Concerts and the Little Orchestra Society, has been highly commended for her Mimi in *La Bohème*.

Linda Anderson is no longer under our management. During the past

Continued on page MA-4

Leonard Marcus *Editorial Director*
Shirley Fleming *Editor*
Susan A. Elliott *Managing Editor*
Claire N. Eddings *Assoc. Pub.,
Dir., Adv. Sales*
Stanley Binder *Circulation Dir.*
Warren B. Syer *Publisher*

Contributing editors:

Charles B. Fowler, *education*
Jacqueline Maskey, *dance*
John Rockwell, *new music*
Patrick J. Smith, *book reviews*
Dorle J. Soria, *personalities*

contents

- MA-2** Letters
- MA-4** Artist Life
Dorle J. Soria
- MA-7** Here & There
- MA-8** Kiri Te Kanawa
Dorle J. Soria
- MA-10** The Dance
Jacqueline Maskey
- MA-12** What's New?
John Rockwell
- MA-14** On Education
Charles B. Fowler
- MA-18** The Strikes
and The Future
Martin Mayer
- MA-22** The Metropolitan Opera
George Movshon
- MA-24** Summer Festivals, part 3
- MA-26** Debuts & Reappearances
- MA-37** Book Reviews
Patrick J. Smith, editor

Cover photo: Shirley Fleming

HIGH FIDELITY

musical america

highlights of may

- SATURDAY 4** The Minnesota Opera give the premiere of *The Newest Opera in the World*, an improvisation in which the audience participates.
- MONDAY 6** An Evening with Pierre Boulez at New York's Whitney Museum: he directs a program of his own music, with commentary and audience discussion.
- WEDNESDAY 8** Prokofiev's *War and Peace* is presented by Sarah Caldwell's Opera Company of Boston; this is its first fully staged production in the United States.
- The Baltimore Symphony plays the premiere of George Rochberg's *Imago Mundi*, commissioned by the orchestra; Sergiu Comissiona conducts.
- MONDAY 13** Aaron Copland is guest conductor of the Phoenix Symphony in a program including his *Billy the Kid* Suite and excerpts from *The Tender Land*.
- SATURDAY 18** A gala production of *Turandot* is mounted by the Monte Carlo Opera to celebrate the 25th anniversary of Prince Ranier's assumption to the throne. Gabriella Tucci is Liù.

Advertising Sales Office: 1 Astor Plaza, New York, N.Y. 10036. Telephone (212) 764-7300.

season, the Minnesota Opera Company has been represented in Europe by our management; the organization is not among our special attractions.

Dina Bader
Dina Bader Associates
New York, N.Y.

Mozart fils

SIR:

In the February issue of *MUSICAL AMERICA*, I note that a "Highlight of February," cited on page 3, was the world premiere of Franz Xavier Mozart's Concerto for Piano in E flat, performed by Gary Graffman and the Cleveland Orchestra on Thursday, the 28th.

May I bring to your attention that Mr. Graffman, conductor Leon Fleisher, and the Annapolis Symphony Orchestra gave the first American performance of this work on Sunday, January 27, in Annapolis.

The world premiere, of course, took place in Lemberg in 1818 with the composer as soloist. We in the Annapolis-Baltimore-Washington area are proud that Messrs. Graffman and Fleisher gave us the first American presentation of the Concerto.

Jane Young Davis
Annapolis, Md.

In reply:

We are sorry for the error and never meant to slight the excellent Annapolis Symphony Orchestra and its distinguished conductor, Leon Fleisher.

Mrs. Davis is indeed correct about the fact that the world premiere of the F. X. Mozart Piano Concerto in E flat took place in Lemberg, December 7, 1818. In addition, the composer subsequently played the concerto frequently on his Grand Tour of Europe which he made during the following three years. Further, the last movement of the concerto was published and performed separately by F. X. Mozart as a *Rondo pour le Piano-forte*.

The first performance in Cleveland took place February 28, with subsequent performances March 1 and 2, when Mr. Graffman was guest soloist with the Cleveland Orchestra.

Audrey Michaels
Press Representative
for Gary Graffman

artist life

DORLE J. SORIA

HENRY-LOUIS DE LA GRANGE has written—is still writing—a definitive life of Mahler [see page MA-37]. Critics have called the first volume "a monumental work" (Harold Schonberg, *New York Times*), "The most distinguished biography of the year" (Paul Hume, *Washington Post*), a book which "could do for Mahler what Newman did for Wagner" (*Los Angeles Times*), "one of the first monuments of the new world-era" (Karlheinz Stockhausen—yes!—in his introduction). Volume I, almost a thousand pages including appendices and notes, covers the first forty years of Mahler's life up to his marriage to Alma Mahler. The second volume, covering the last decade and the turbulent years with the New York Philharmonic and the Ladies of the Board, will be published the spring of next year.

Who is this dedicated man who, for the past twenty years, has devoted himself to what has been called a "veritable Everest of scholarly exhumation"? He says: "I am not German nor Austrian nor Jewish but that has not made me, as Glenn Gould wrote, a model of 'impeccable objectivity.' I was never 'objective.' I was totally committed. Mahler is closer to me than anyone in my own life. He never

disappointed me. He had great big faults but never small faults. I couldn't write a book about Richard Strauss, for instance, because he had petty faults, faults about money. Not Mahler. I am always happy to be in his company. I know all my efforts until the end of my life will be devoted to him."

But, after the biography, what? He will do a complete edition of the letters of the violinist Natalie Bauer-Lechner, that paragon of unrequited love who was Mahler's confidante, diarist, Boswell. He will do a book of the complete Mahler letters. "I already have about three thousand of which only some nine hundred have been published in German. And in the second volume of the biography, I will publish an appendix of material I have found since finishing the first one. For example, the Mahler memoirs of the Hamburg critic Ferdinand Pfohl have only now been published. I used to think I might do a book on Weber and one on Italian opera. But now I know I will do none of these things. I now realize I will spend the rest of my life with Mahler. I am a one-person. I am very faithful in love." Do you identify yourself with him, we asked. He answered quickly: "No. No. That would be immodest. He was a genius."

Henry-Louis de La Grange

He was born in France on May 26, 1924, a Gemini oddly enough, considering his single-track life. "Anyway, I was never able to plot my stars because my mother doesn't know what time I was born. She says: 'After four children do you think I kept my eyes on the clock?' I have three older sisters."

His mother, an American, was Emily Sloane, whose grandfather founded the famous Fifth Avenue furniture store. On his father's side he is French. His great-great-grandmother was born in Martiniqne, a first cousin to Empress Josephine. When Napoleon became Emperor he brought the former to France but, on the way, she was captured by English pirates. "They took her to London where she had a wonderful time going to balls. She was furious when Napoleon ransomed her and married her to Prince von Arenberg, whom she detested. They say she locked her door to him the night

of her wedding and said, 'The day Napoleon falls I will leave you.' She did, and married my great-great-grandfather, Marquis de Chaumont-Quitry. That was the name of my paternal grandmother, who always talked to me about Napoleon." We asked if that was why he had a home in Corsica. "No. Napoleon is not much liked in Corsica. He was one Corsican who never went back. The Corsicans did not forgive him."

His paternal grandfather had ties with this country. He had at one time gone to California and bought a gold mine, still called the La Grange mine. His father, Baron Amaury de La Grange (Henry-Louis uses his title only in private life), was a pioneer in aviation, a French Senator who was a cabinet minister in the Reynaud government. In 1915, when he came here to work out international air agreements for the French government, he met his wife. "It was at the home of Mrs. Chanler, wife of the composer Theodore Chanler." During the Thirties they often returned to the States and, when in Washington, stayed at the White House because of Emily de La Grange's long friendship with Franklin and Eleanor Roosevelt. "In 1940, just before the fall of France, my father was sent by Reynaud to buy American planes. It was too late." Later he was arrested and deported but, in his absence, a newspaper of which he was board president, *Le Nord Maritime* of Dunquerque, continued to publish. When he returned, he was condemned and fined a symbolic franc. "My father was guiltless. He suffered greatly from this injustice and would never ask for amnesty." After his death Henry-Louis and his mother had his name officially cleared. The family chateau in the north, near the Belgian border, is now an aviation school named after the Baron Amaury de La Grange.

Henry-Louis' first schooling was in Paris; his secondary schooling at the Lycée Française in New York. As a boy he had wanted to be an archaeologist. He lived to reconstruct, not a temple, but a man, a musician. But he was fifteen before he discovered music. "I was given a batch of recordings." He ticked them off. The Mozart Clarinet Concerto with Reginald Kell. Landowska playing the *Well-tempered Clavier*. The Schubert Fourth conducted by Barbirolli. Cortot play-

ing the Schumann *Carnaval* and *Kreisleriana*. "My sister studied with Cortot. I used to hear her practising in the next room. Music came to me by osmosis. It percolated through the wall into my subconscious. Years later, when I would hear a rarely played work like the Weber Second Sonata, it would be familiar. My sister then had practiced it. But my love for music really came from recordings and listening to radio stations like WQXR. I would say ninety-nine percent of my musical knowledge came from records, one percent from concerts. I am always listening to music. If I don't have my daily dose I am starved."

He went back to France in 1941; his parents had preceded him. He left on an American Export Line ship for Lisbon, accompanied by a huge crate of two hundred 78-rpm records. In France he attended the University of Aix-en-Provence (Greek and Latin among his studies) and the Sorbonne. After the war he returned to this country, ostensibly—his mother's wish—to study business administration, a mission honored in the breach. He attended Yale for two terms and took music courses under musicologist Leo Schrade and pianist Bruce Simonds, then dean of the School of Music.

Mahler discovered

"In 1945 I heard Bruno Walter conduct the Mahler Fourth. I was always a *conformiste*. I was appalled. How can you put a soprano solo in the finale? All those sleighbells and those verses about asparagus and fishes! It was ridiculous." Two months later he heard the Mahler Fifth. "The trumpet announcing the theme of the opening Funeral March movement impressed me. Otherwise I was not convinced. I thought, Mahler must have been insane. The critic Adorno has said that 'Mahler's music is an insult to the bourgeois establishment.' In those days I was the establishment. I was sure of what was good and what was not good. I only liked things like the last Beethoven quartets. I was a little suspicious of all opera, except maybe *Figaro* or *Don Giovanni* or *Pelléas*. Wagner I found a bit boring. I was deeply offended by Mahler. Yet . . . two weeks later . . . I bought my first Mahler record. It was the Fourth with Bruno Walter and

Desi Halban, who is the daughter of Selma Kurz, the singer with whom Mahler was once in love. William Ritter, the French-Swiss critic, wrote that when he first heard the Fourth he was 'at once bewitched, flabbergasted, and horrified.' For me, too, it started as a love-hate thing, the beginning of a lifelong love affair."

In 1947 Princess Topazia Caetani, whom he had met in the States, asked him to be a witness at her marriage in Vevey, Switzerland, to conductor Igor Markevitch. "There Igor said to me: 'You must go to Nadia Boulanger and study.'" He worked with the great teacher five years—counter-

SEWANE E

Summer Music Center

Chamber Music
Orchestra
Private Study
Artist Faculty
Weekend Concerts
Festival

JUNE 21 - JULY 28

Write: Martha McCrory, director
Sewanee Summer Music Center
Sewanee, Tennessee 37375

Aston Magna

BAROQUE MUSIC AND DANCE



Great Barrington, Massachusetts

School:

June 8-30, 1974

Concerts:

June 9, 15&16, 22&23, 29&30

ALBERT FULLER
Artistic Director

WRITE:

Aston Magna Foundation for Music, Inc.
333 West 70th St., New York, N.Y. 10023

point, harmony, etc.—and studied piano with Yvonne Lefebvre. At the Boulanger studio he met the young and the famous. He mentioned Lipatti. “A bit too polite for my tastes. One wondered what he really meant.” He clarified the remark in his polite way: “One gains time by being outspoken.”

He decided he could never be a concert pianist and started to write about music. Through his mother, who knew Mary Ellis Peltz, then editor of the Metropolitan *Opera News*, he wrote three articles for the magazine, including pieces on *Manon* and *Carmen*, both of which he knew only from recordings and scores. In Paris he worked for some ten years for the weekly *Arts*. “The first critic was Jacques Bourgeois. He sent me to all the piano recitals and the bad concerts and to the opera. He wasn’t interested in opera, which was fortunate for me.” He also started writing for *Disques* and from time to time sent special reports to the *Herald Tribune*, the *New York Times*, the *Saturday Review*, and *Musical America*.

He began his Mahler opus in 1954. He had planned to do a short monograph on the composer and started to track down dispersed manuscripts and to look up Mahler’s contemporaries. His interest grew and the monograph became the monument. Fortunately he had the time, the temperament, the patience, and the means to accomplish the task he had set himself. He learned German “like a dead language.” Though bilingual, he wrote the book in his mother tongue, French, despite the fact that he received no encouragement in France. Even now, with the first volume published in the United States, Great Britain, and Germany, there is no talk of a French edition. “When I began my work Mahler was almost unknown in France. They called him the Meyerbeer of the symphony. He was considered a composer under a curse because they thought his musical borrowings and quotations were proof of creative impotence. As for French music publishing, it is still in its infancy.”

He was helped by many people and much luck, he said. “For instance, Alan Rich was in Europe when I was starting and he told me of a young man in Vienna called Peter Riethus who had a passion to find old and out-of-print books, an antiqua-

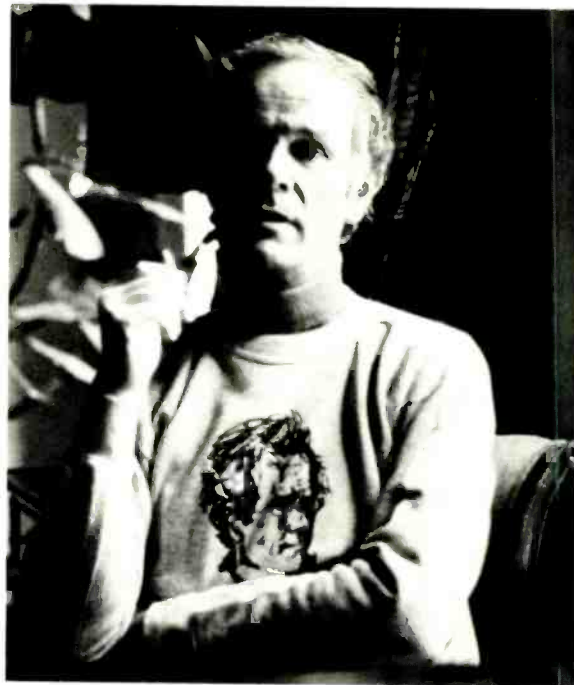

Henry-Louis de La Grange, in non-hair shirt

rian researcher. Over the years Peter has assisted me tirelessly, following every scent in every place Mahler ever set foot.” Great finds were the notebooks of Natalie Bauer-Lechner, the chance to copy the love letters Mahler wrote to the singer Anna von Mildenburg preserved in the Vienna National Library, to photograph unpublished letters in the possession of Alfred Rosé, professor of music at the University of Western Ontario. Rosé is the son of Mahler’s sister Justine who had married Arnold Rosé, concertmaster of the Vienna Philharmonic and founder of the Rosé Quartet. He knew Alma Mahler Werfel before her death. Later her daughter Anna gave him access to her mother’s original manuscript of her life with Mahler which contained passages she later suppressed, unpublished letters, and excerpts from her private diary. La Grange says that Alma, for her own reasons, drew a picture of Mahler as a morbid hypochondriac, an impotent man, “the image which Visconti took as his inspiration for the character in his *Death in Venice* film.” He will right that image.

Corsica

Henry-Louis de La Grange has a home in Paris, a pied-à-terre in Vevey near his friend Topazia Caetani, and a house in Corsica. His Paris rooms are filled with Mahler manuscripts and souvenirs, a copy of the

Rodin bust of the composer, his last baton given the author by Alma Mahler, and an enormous library augmented by the Cortot library which he bought after the pianist’s death. Cortot had read most of the French manuscript of the Mahler book and had made “many useful suggestions.”

But Corsica is where the Mahler opus was written. “My father’s side is from Normandy and Lorraine and my mother’s background is Scotch and English and I love the Mediterranean like someone whose blood is Nordic.” He first came to Corsica in 1950 and bought “a wee house” from Prince Youssoupoff. In 1961 he found a sixteenth-century monastery which later had been turned into a stronghold during the wars between France and Corsica. On the northwest coast the monastery, “like a Sleeping Beauty,” slumbered at the foot of 2,000-foot mountain, trees and vineyards around, the sea below. In the village above, Monte Maggiore, a character was born who modeled himself on the original play of *Don Giovanni*. He lived the life of the Don, and raped his own sister, according to La Grange. The monastery was put in order. “I expected to find religious objects. All I found were cannon balls and handcuffs.” There, in the Couvent Alziprato, Henry-Louis de La Grange lived with Mahler.

But not always with Mahler. The

Continued on page MA-40

The **National Endowment for the Arts** has established a program of individual fellowship grants for composers, librettists, and translators. To date, one hundred twenty-five individuals have received grants. For information regarding application, write the Office of Music Programs, National Endowment for the Arts, Washington, D.C. 20506. . . . The National Opera Institute has awarded sixty-three young professional singers grants of \$5,000 each towards the advancement of their careers.

The new ten-million-dollar **Ambassador Auditorium** on the Pasadena campus of Ambassador College opened April 7 with an exclusive engagement of the Vienna Symphony conducted by music director Carl Maria Guilini. . . . The **Cleveland Orchestra** will tour Japan this month, giving twelve concerts over a two-week period. . . . **Kazimierz Kord** guest-conducted the Toronto Symphony on its recent four-week, sixteen-concert European tour.

The **Texas Opera Theater** was created last January by the Houston Grand Opera to serve residencies of eastern Texas. Stage director is David Alden; music director is Robert Jones, assistant conductor of the Santa Fe Opera. . . . The finals of the Amato Opera Circle's sixth annual Opera Scholarship Competition will be held on May 19 at the Plaza Hotel in New York City. Those interested in attending should write the Amato Opera Circle, 319 Bowery, New York, New York 10003.

Premieres

The world premiere of the full orchestral version of **Charles Ives's** *Three Places in New England* was performed by the Yale Symphony and pianist John Kirkpatrick in New Haven last February. . . . **Alan Hovanes's** *Mainur* Symphony received its world premiere at Texas Tech University in January as part of the school's annual Symposium of Contemporary Music. The work was commissioned by Texas Tech's International Center for Arid and Semi-Arid Land Studies. . . . The Bowling Green (Ohio) State University School of Music premiered

here & there

Wallace E. DePue's opera *Dr. Jekyll and Mr. Hyde* in April. . . . **Ned Rorem's** *Little Prayers*, a symphonic-choral work, was premiered in April by the Sioux Falls (Iowa) Symphony and choral groups from Colleges of Mid-America (ten liberal arts, church-related colleges in South Dakota and Iowa), who commissioned the work.

Summer prospects

The **Oberlin Music Theater** will reopen this summer after a dark '73 season due to financial difficulties. Producer/director David Bamberger is planning productions of *Madama Butterfly*, *Così Fan Tutte* and *The Fantastiks*. . . . An anonymous stock gift worth \$40,000 will enable the **Ca-brillo College Festival** to establish a music camp in 1975.

Personalities

Rafael Kubelik has resigned as music director of the Metropolitan Opera, effective last February. [See editorial, page MA-2.] . . . **Louise Talma** and **Alexander Tcherepnin** have been elected to the National Institute of Arts and Letters. Miss Talma, a composer, is the first woman to be elected to the music department in the Institute's history. . . . The **New York Brass Quintet** participated in the Eleventh Annual Symposium of Contemporary Music for Brass last February at Georgia State University. In addition to a workshop and concert, they served as judges in selecting a participating composer to receive \$500 commission. . . . **Julian Patrick** makes debuts with three Canadian orchestras this spring—the Atlantic Symphony, Hamilton Philharmonic, and Vancouver Symphony—in the baritone solo part of Orff's *Carmina Burana*. He will also sing at the Cincinnati Summer Opera. . . . After a performance of *Le Rossignol* for RAI-Rome, soprano **Jeanette Scovotti** made her Italian stage debut at the new opera

house in Turin singing Olympia in *Les Contes D'Hoffmann*.

Appointments

Sir Rudolf Bing, recently appointed director of Community-College Cultural Affairs at Brooklyn College, has been elected to the board of directors of Columbia Artists Management. . . . Former assistant professor at the University of Minnesota **Peter J. Schoenbach** has been named dean and administrative coordinator of the Curtis Institute of Music, Philadelphia. . . . **William Schuman** is the new chairman of the board of the MacDowell Colony, the retreat for artists, composers, and writers located in Peterborough, N.H. . . . **Niklaus Wyss** has been appointed resident conductor of the San Francisco Symphony for the 1974-75 season. Since 1970 he has served as assistant conductor. . . . **Gillian Weir**, English organist, has been appointed to the faculty of Cambridge University.

Awards

The **Symphony of the New World** has been awarded a grant of \$25,000 from the Exxon Corporation "because of its pioneering task of bringing blacks and other minorities into the mainstream of American symphony music." . . . Curtis Institute graduate **Andre Michel Schub** has won first prize in the 1974 Naumburg Piano Competition held last February in New York City. . . . Twenty-three-year-old pianist **Adrienne Shannon** and twenty-one-year-old tenor **Donald Woodrow** were the first place winners in the Hamilton (Ontario) Philharmonic Young Artists' Competition last February. . . . **Jane E. Brockman** is the first woman to receive the Sigvald Thompson Composition Award for her *Eventail for Orchestra*. The competition is sponsored by the Fargo-Moorhead Symphony of North Dakota. . . . Pianists **Alan Ball** of

Salt Lake City and **Ki-Ae Kim** of San Francisco are first and second place winners in the sixteenth annual Young Artists Awards regional competition held last January in Fresno, California.

Competitions

The **West Virginia Arts and Humanities Council** has initiated a competitive commissioning program, open to composers who are state residents. Deadline for application is May 1. For information, write Jim Andrews, West Virginia Arts and Humanities Council, State Office Building #6, Room B-531, 1900 Washington Street E., Charleston, West Virginia 25305. . . . July 19 is the deadline for application to the **Twenty-First International Singing Competition at 's-Hertogenbosch**. For information write Secretariat, Stichting 's-Hertogenbosch Muziekstad, Townhall, 's-Hertogenbosch, The Netherlands. . . . Composers of all nationalities are eligible to enter the **Queen Marie-José Prize for Musical Composition** competition. Deadline for submission of works is May 31. For information address the Contest Secretariat or Radio Suisse Romande, Studio de Geneve, 66, Bd Carl-Vogt, 1211 Geneve 8, Switzerland. . . . April 20 is the deadline for application to the **Rossanna M. Enlow Young Artists Awards Competition**. Residents of Indiana, Illinois, and Kentucky should address the competition at the Evansville Philharmonic Office, P.O. Box 84, Evansville, Indiana, 47701. . . . For information regarding the **Young Musicians Foundation 1974 National Competition** for string players, pianists, vocalists, and composers, write the Foundation, 914 So. Robertson Boulevard, Los Angeles, Cal. 90035. Deadline for most categories is May 1. . . . The Festival of Flanders is sponsoring the **4th International Harpsichord Competition** for harpsichordists born after December 31, 1941. Write to the Festival Secretariat, C. Mansionstraat 30, B 8000 Brugge, Belgium. Application deadline is May 1.

Obituary

Benjamin Steinberg, founder of the Symphony of the New World, died on January 29. He was fifty-eight.

musician of the month

KIRI TE KANAWA

ON A MID-FEBRUARY afternoon she came in, tall, strikingly handsome, wearing a large-brimmed white panama hat with a pheasant-feather band and a white dress under her fur coat. The hat was a present from the mother of her friend Flicka (Frederica) von Stade, after whom she calls it her "Sarah hat." Her brown hair hung in a pony tail beneath that hat, her enormous brown eyes seemed to swim in a luminous white sea, her soft skin was sun-burn color with a rosy cast, her mouth large and friendly; there were pearls in her ears. This was Kiri Te Kanawa, an exotic name the opera world is fast learning to pronounce, with the accent on the Ka. The soprano from New Zealand first made news in London when, on the first of December 1971, virtually unknown, she sang the Countess in *The Marriage of Figaro* at Covent Garden and had sensational reviews. On February 9, 1974, she made news in New York. On three hours' notice, she sang Desdemona at the Metropolitan, anticipating by a month her official debut in the role.

She was born in the farm-and-fishing port of Gisborne, at the foot of mountains, on the east coast of New Zealand's North Island, which is warmer than its South Island because it is closer to the equator. "My father is Maori, my mother white," she says. For those people who don't quite know who the Maoris are, we stop for brief identification. The people of New Zealand, a self-governed nation of the British Commonwealth, are predominantly of British descent. However, about eight percent of the population is Maori, a Polynesian-descended race which reached New Zealand over six centuries ago after ocean voyages—twice as long as that of Columbus—sailing in canoes by sun and stars from the South Pacific. They have been called "the Vikings of the Sunrise." When we were in Auckland we saw in the marvelous Maori Museum a Maori war canoe, eighty-five feet long, its hull cut by jade adzes from a single trunk, its prow a masterpiece of carving. The Maoris are now integrated with the Caucasian population on a basis of complete equality. Many of New Zealand's business, political, and professional leaders are Maori. Kiri Te Kanawa says it has been an advantage for her to have a Maori name.

She was called Kiri, which means "bell," a happy omen for her future. Te means "the." She has an ancestor, a chief called Te Kanawa, about whom she says there are many legends. "Because he was so good, because he could do everything better than anyone else, he was ousted from his tribe. He formed his own and became its chief." She observed: "The more important you become the more vulnerable you are."

Kiri was an only child in a warm, close-knit family. Her father, now retired, was a contractor who installed petrol tanks. Her mother, who died two years ago, was the power



behind her career. "At three I sang songs like "Daisy, Daisy, give me your answer true" or "I'll be your sweetheart" and as a child I was always asked to entertain people. I was not temperamental but I was sick-shy. I would say 'No, I won't' and my mother would say 'I'll speak to you when everybody goes.' She frightened me into singing. I was not an extroverted child. You have to learn to be extroverted."

When she was eleven the family moved to the big city, to Auckland. They were Catholic, and Kiri was educated in Catholic schools. When she was sixteen she started regular singing lessons from Sister Mary Leo at St. Mary's. "She had no method or anything, just a way of bringing the voice out."

She is an outdoor girl. "When I was a child I had a shadow on a lung and I took up archery to expand my chest. I've never had anything wrong since." During school days she played basketball. "I was the best goalie of the year one year." She loves swimming and water skiing. Her affinity for the water is natural—she is a Pisces born March 6. "I am mad about water. Every time I see it I want to dive into it."

During her teens Kiri entered every available music competition. In New Zealand contests are held annually in various cities and singers try for entrance into the vari-

ous "classes" such as art song, Lieder, national song, and the special song of the year. Those admitted are entitled to compete for the aria prize, which is the big prize. "Sometimes people would complain about me because I would repeat the same song in another class. But I always believed in singing songs which suited me. If it's good, sing it twice. By 'good' I mean songs which make a splash." She also won prizes—money as well as cups—in radio competitions and, in Australia, came out second in Sydney and first in Melbourne in the *Sun*-sponsored aria competition. During this period she sang in night clubs, for weddings, and special occasions, and did some "stupid recordings" of Maori and folk songs. "But I wouldn't sign a contract. Five years then seemed like an eternity. Even six months seemed forever." Now she worries about not being overbooked in 1977.

In 1966, with a grant from the New Zealand Arts Council for four years' study at the London Opera Centre, she set off with her mother with free passage on a ship of the Chandris Line. It took twenty-three days to reach England, with stops at Miami and Cristobal, Panama. They arrived with six trunks, no friends, no place to stay. "I wanted to go straight back. I'm a nesting-type person. But mother stayed with me the first nine months."

Why had she decided to become an opera singer, rather than a concert singer? "I rather fancied myself as an actress and I liked to hide behind things like wigs and costumes and the role." At the Opera Centre she was trained and coached in repertoire, acting, movement, fencing, languages and "I found this marvelous teacher, Mme. Vera Rosza, who gave me a whole new way of singing. I wouldn't do without her."

In 1969, after a number of professional engagements while she was still a student, she returned home to sing the title role of *Carmen* with the New Zealand Opera (her voice was lower then). That same year she auditioned for Covent Garden. Among other things she sang the Countess' arias. The management offered her a contract, including the role of the Countess. "I think the world exploded with my happiness." She made her debut at the Royal Opera as a Flower Maiden in *Parsifal*. The title role was sung by Jon Vickers, who was to be the Otello at her unexpected Metropolitan debut. "He terrified me—I had such respect for him." Afterwards he said: "You should have been more seductive. All I saw were your frightened eyes."

In February 1971 she began to learn the role of the Countess—from her voice teacher, from the Italian coach at Covent Garden, from the opera's music director Colin Davis, from its stage director John Copley. Ten months later she sang it. Critic Andrew Porter called her "such a Countess as I have never heard before." Critic Peter Heyworth wrote "Covent Garden here has a pearl of great price."

Kiri Te Kanawa's American debut had come the summer before, at Santa Fe, where she tested the Countess role. In the autumn of 1972, after her London triumph, she repeated it at the San Francisco Opera, where she "brought the house down." Further roles at Covent Garden in 1973 were *Carmen*, and *Amelia* in *Simon Boccanegra*, in which she was hailed by editor Harold Rosenthal of *Opera* as "a revelation, Verdi singing on the highest level." In the summer of 1973 she was at Glyndebourne, again singing the Countess. In 1973 she also won the Drogheda-Mayer Fellowship of the Royal Opera, as a result of which

she went to Mantua in Italy for a month of study.

She was to have made her Metropolitan debut as *Desdemona* March 7. But on the morning of February 9, three hours before the Saturday matinee, with its accompanying and important broadcast, Kiri Te Kanawa received an unexpected telephone call. Teresa Stratas, scheduled for the season's first *Otello*, was ill. Miss Te Kanawa had to replace her. The *New York Times* said, "she won the audience from the beginning and did not lose it." The *Post* said, "her large, full, easily produced soprano opens up on the top like a luscious rose." The *New Yorker* said, "she seemed born to play the lovely and too trustful Venetian lady." Kiri Te Kanawa said: "I never stopped being nervous until after the fourth act. But all along Jon Vickers kept encouraging me. He made me feel like a wee babe being taken care of."

Next? This spring at Covent Garden *Desdemona* and *Micaela*; this summer Glyndebourne, the Countess once more. Then a three-week holiday followed by an Australian tour with the New Zealand Orchestra and a return to Covent Garden to sing *Marguerite* in a new production of *Faust*. 1975: *Elvira* in *Don Giovanni* at the Metropolitan in January, *Elvira* at the Paris Opera in February; later, eight *Bohèmes* with the Scottish Opera; October 1975, *Simon Boccanegra* in San Francisco; also opera recordings and ... "But I can't keep track," said the singer.

Kiri Te Kanawa is married to an Australian mining engineer, Desmond Park, blond, even-tempered, her exact opposite. "I met him on a blind date in Piccadilly Circus. My mother had warned me against blind dates. This was my first and my last. It was not love at first sight. I was engaged to someone else in New Zealand at the time. But we were married three months later."

They live about twenty miles outside of London in a house with grounds where there is a willow tree and a silver birch. Kiri grows vegetables and flowers and is building an extension to the house for her father to live in. She hopes eventually they will also have a flat in London near the opera.

She and her husband are parted too much, she says. He travels to Canada, to Georgia, to Australia. Her career keeps her more and more on the move. "The best holiday we can have is to stay home. That's divine." There she likes to sew, "Curtains and lamp shades and things." For exercise she bicycles—"I picked it up riding through the park in San Francisco"—and she will play golf with her father; her husband plays squash. She has a cat named Cobber, which she describes as a "lilac-point Siamese." She says: "I didn't use to read but I am an insomniac and I decided to read English history at night as a remedy. I thought all those dates and lists of kings would be so boring that I couldn't stay awake. Instead I became fascinated. Now I must find something really boring to put me to sleep."

"We never go out weekends and hate going to parties. When we are at a cocktail party Des and I get in one corner and talk to each other. We have so little chance to be together. If he is stranded at one end of a room and I am at the other we find ourselves looking at each other, desperately signaling for escape." She is a private person and doesn't like being questioned. She is only now getting used to interviews. "At a party I hate people who ask me what I do. Sometimes I say 'I work in a factory.' If they say 'where?' I say 'in the market' and if they say 'what do you

Continued on page MA-40

the dance

JACQUELINE MASKEY

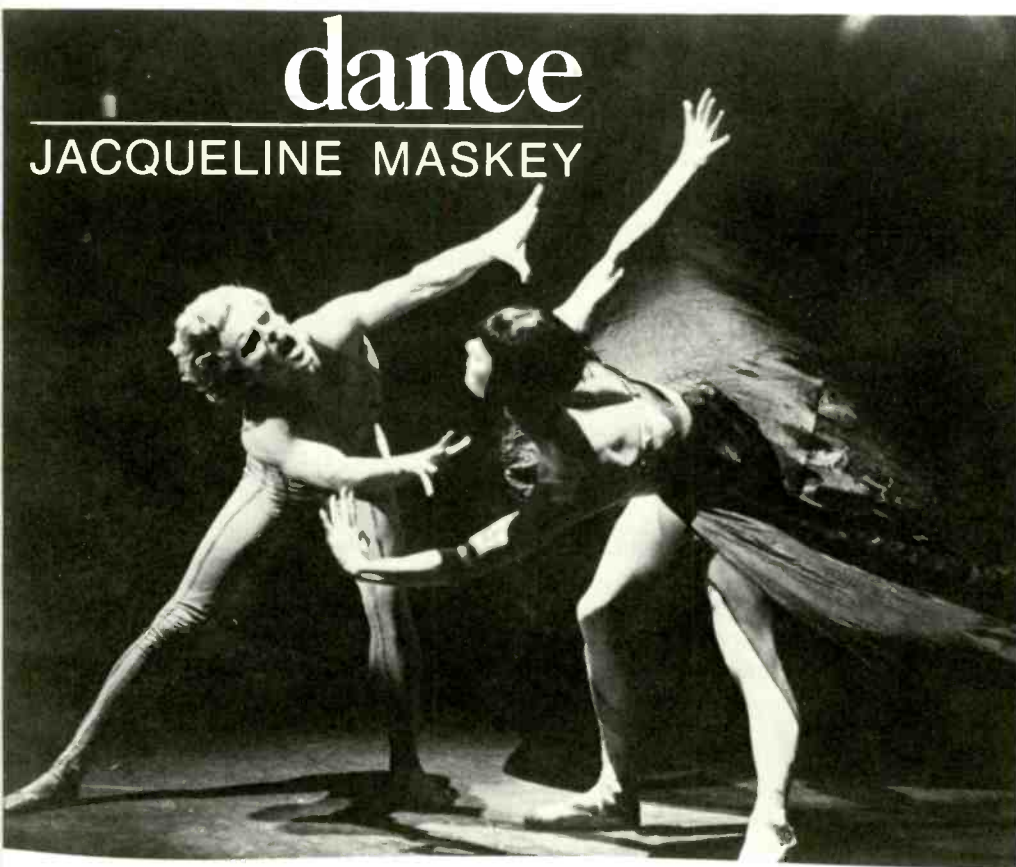

Karin von Aroldingen and John Clifford in Balanchine's *Porte et un soupir*

THE ADMINISTRATION of the New York City Ballet must have been scurrying about like squirrels for a good part of December and January, coping with (1) a strike by the dancers of the company which lopped off four weeks of the winter season (November 13–February 17), including irreplaceable rehearsal time and a number of performances of the profitable and popular *Nutcracker*; (2) the absence-due-to-injury of both Violette Verdy and Patricia McBride; (3) a grumbling subscription public which seldom got to see the programs it had bought tickets for, due to the juggling of programs and dancers necessitated by (1) and (2). No premieres were cancelled, but that was because very little had been planned in the way of new works (although the tantalizing rumor that Balanchine would mount a full-length *Coppélia* [Delibes] for the company's Saratoga '74 season turned out to be true). The only entirely new piece was Balanchine's *Variations pour une porte et un soupir* (Variations for a Door and a Sigh); the second, Jerome Robbins' *Four Bagatelles*, had been

premiered at a Production Fund benefit in May 1973.

"Porte et un soupir"

For *Porte et un soupir* Balanchine worked with a score—in the program designated a "sonority"—by Pierre Henry who, with Pierre Schaeffer, was in the 1950s much involved with the experiments of the Paris-based French Radio's *Groupe de Recherches* in the fabrication of what is now known as *musique-concrète*. In brief, the score is a metrically controlled arrangement of manipulated sounds, which in their raw or "natural" state suggest agitated breathing, the nerve-scraping creak of a wooden door, and the striking of the rim of a glass by a rubber mallet. Unlike Maurice Béjart, who abdicated as choreographer when he used the score in 1965 and allowed the dancers to improvise the choreography, Balanchine exercises complete control, choosing fourteen out of Henry's twenty-five variations on his first theme and making out of them a *pas de deux*, designed in creep-camp by Rouben Ter-Arutunian.

Balanchine uses his dancers impersonally. The male, powdery gray from heels to hair, moves unsteadily, sometimes spasmodically, suggesting protest undermined by dwindling strength: he flaps at the feet of the female like a landed fish. She, an enameled, red-lipped goddess-mannequin, moves as if programmed, stiffly, unblinkingly, with an attitude of mechanical menace. When the male finally succumbs it is in a dive through the legs of the female into a billowing black limbo. What is accomplished is a little horror story in which the protagonists can, if one is inclined to metaphor, be considered as Man and Death.

Porte et un soupir exerts a kind of fascination for approximately two-thirds of its length. But when the choreography involves the female, pushing and prodding her voluminous skirt into big black balloons like a manic laundress, its tension slackens like a loosened wire and only recovers itself during the ballet's final moments. The skirt, by the way, is something of a temptation as a plaything: it functions as both costume and décor since it extends from the dancer's waist over the full area of the stage and is lifted when necessary into huge peaks by five invisible pulleys.

The dancers themselves, John Clifford and Karin von Aroldingen, are quite remarkable in the style and discipline of their performances. As for the ballet, put it in the category of novelty; that is, a piece which as a new work provides a necessary fillip to a season but which fades from view when that function is accomplished.

"Four Bagatelles"

In contrast, Jerome Robbins' *Four Bagatelles* is fresh as a new leaf and sturdy as a sequoia. I expect to be encountering it—and with pleasure—for some time to come. The structure of *Four Bagatelles* (Beethoven's, played with becoming modesty by pianist Jerry Zimmerman) is that of the classical *pas de deux*: adagio, male variation, female variation, coda. Very neatly it figures to one section per bagatelle. The feeling of the choreography is much akin to *Dances at a Gathering*; there is an air of mutual concern and compatibility between the two dancers which is more companionable than lover-like; the vocabulary is classical, lightly laced

with folk references; the choreography is technically taxing and the partnering allotted to the man complex, but the dancers (Gelsey Kirkland and Helgi Tomasson) soften the shock of virtuosity with an irresistible and cosy charm. Miss Kirkland and Mr. Tomasson are absolute perfection, providing one of the few examples of flawless performing which I saw during the entire winter ballet season.

ABT: "Three Essays"

Meanwhile, back at the New York City Center, American Ballet Theatre was in the process of producing its own novelty, *Three Essays* by Lar Lubovitch, aptly set to Charles Ives's *Second Orchestral Set*. I don't expect this one to last either, but for some irrational reason I feel that Lubovitch should not be abandoned by ABT. At least he is not a mechanical step-maker, but his ideas seem to take an unsatisfactory form in their struggle from rehearsal room to stage. They are interesting failures. They do, nonetheless, have moments which stick in the mind. *Three Essays* has one such—a World War I soldier (Ian Horvath), seemingly nailed to the ground, miming twisted images of

horror and pain. Other remembered moments are a young man (Warren Conover), barely beyond the groping, infantile stage, being quite literally enwrapped in the folds of the Stars and Stripes; a village Romeo and Juliet (Christine Sarry and Clark Tippet) caught up in a procession of townspeople, joyously sprinkling Old Glory (Marie Johansson) with confetti. What Lubovitch seems to be questioning in *Three Essays* is patriotism as a positive value, but he has not yet found a satisfactory form in which to express his social concerns.

ABT also staged a revival of the Balanchine/Stravinsky *Apollo*, chiefly under the supervision of the Stuttgart Ballet's Heinz Clauss, with an assist here and there by Barbara Fallis and André Eglevsky. Without Balanchine's direction it is an *Apollo* of impure pedigree, but it comes off surprisingly well. Almost everybody gets a shot at the title role—Jonas Kage, Michael Denard, Ivan Nagy. Of the three, Denard seemed the most in command of the part, due perhaps to his having performed it previously at the Paris Opéra. He looked handsome, seemed well rehearsed, and his lack of stamina was efficiently disguised by his well-paced performance. Cynthia Gregory was simulta-

neously a cool, sexy, and impeccable Terpsichore; Natalia Makarova in the same role exhibited a ravishing action but seemed baffled by the part. Deborah Dobson's Calliope was overshadowed by the sleek and voluptuous dancing of Martine van Hamel as Polyhymnia.

There are, however, in this production of *Apollo*, one or two moments which caused some opening-night giggles: the finger-to-finger confrontation of Apollo and Terpsichore at the beginning of their *pas de deux* (which in the ABT setting manages to look like a test of motor coordination) and the swaddled Apollo's entrance. This is accomplished dead-center on a plucked chord from the orchestra. It seems badly timed and makes the leader of the Muses resemble a bulky letter falling bumpily through a mail slot.

A Note of Interest: Eliot Feld, late of his own American Ballet Company and, before that, of ABT, has announced the formation of a new company, the Eliot Feld Ballet. Funded by The Rockefeller Foundation and, hopefully, the New York State Council on the Arts, the 12-14 member troupe will make its New York debut in early June, an event which will be covered in these pages. △



Robbins' *Four Bagatelles*: Gelsey Kirkland and Helgi Tomasson are absolute perfection



Charlemagne Palestine

MINIMALISM may or may not be a dead issue in the visual arts, but it is very much alive in music. Composers have been turning out pieces in which nothing much seems to be happening since the early years of this century. But the current spate of minimalist music probably dates from the Fifties, when John Cage and then La Monte Young began producing works with a determinedly austere level of recognizable content. Today, a whole slew of composers—in New York and throughout the country and the world—can be legitimately called minimalists.

Explorations of Charlemagne

Charlemagne Palestine, a young New Yorker who has worked in Southern California, is a good case in illustrating what this kind of music can mean. In a recent concert at the Kitchen, in lower Manhattan, Palestine sat raptly before a Steinway grand in dim if theatrically designed

what's new?

JOHN ROCKWELL

lighting. Almost in a trance, he began to alternate chords in the middle of the keyboard. He did this—with breaks every forty-five minutes—for two and a half hours (the piece was meant to go on for four, actually, but in a fit of displeasure reminiscent of Garrick Ohlsson, Palestine broke things off with a complaint about the action and tone of the Steinway and a paeon to Boesendorfer). Such variety as there was came about through changes in speed, the kinds of chords played and the way they were arpeggiated, the rhythmic relation between the two hands, the dynamic level and the amount of sustaining pedal. The idea of the piece is that both performer and audience will attain a “somnambulistic state,” in Palestine’s words. The composer-performer chooses his chords and plays them in such a way that he can perceive and then reinforce the subtlest of overtones, and the audience is meant to attain a similar state of communion with those distant, elu-

sive, ringing overtones. Obviously the effect of the piece, even within its curtailed time-span, must have been affected by Palestine’s unhappiness about the piano (he was also upset about other aspects of the evening as well, and told the audience all about it in detail before the performance began). Still, one could hear what he had in mind, and on its own minimalist terms it worked.

Palestine’s is hardly an isolated instance of such music. A film-maker and composer named Phill Niblock composes music that consists of taped instrumental sounds (sometimes with a live musician playing obbligato on the same instrument that is on tape) stretched out mournfully over long time periods and altered coloristically by electronic means in subtle, fascinating ways. A Japanese composer, Yoshimasa Wada, presented a two-hour concert of his music for long, Tibetan-like “pipe horns,” as he called them, up to twenty feet in length. Wada and his three helpers

(one of them being Garrett List, a trombonist and composer who had also played in Niblock's pieces) blew steadily and insistently into his horns throughout the entire performance, producing a low, sad, distant drone, mostly separated simply at the fifth or octave, with some microtonal drifting around those centers. And—apart from the visual effect of a cavernous loft space dimly illuminated, the mysterious sight of the horns stretched out along the floor, and the huddled forms of the audience scattered about the room—that was that.

Under water & underground

Max Neuhaus, the former avant-garde percussionist, is also a minimalist. His under-water piece that he has taken around the country—using eight or ten water-driven whistles that can only be heard if you are submerged in the same swimming pool in which they are installed—is a case in point, with its pleasantly steady-state, reedy little sounds. Neuhaus currently has another installation at a subway station in Brooklyn, consisting of the stereo alternation of similarly piping sounds for the delectation of the everyday commuters (if they notice it at all), but I haven't heard that one myself.

Paul DeMarinis, a young San Francisco Bay area composer who has worked with Robert Ashley and Terry Riley at Mills College in Oakland, has a piece called *The Pygmy Gamelan* that he brought to New York recently. At the WBAI Free Music Store, the piece consisted of four separate little systems, each of which emitted tiny sounds vaguely reminiscent of both a faraway gamelan and an African thumb piano. Each system produced five pitches in a fixed rhythmic pattern, although some variance in their order could be introduced by the listener, either directly, through touch pads (DeMarinis currently works at the Donald Buchla synthesizer plant in Berkeley, and Buchla has preferred touch pads over keyboards in his products), or indirectly through the electrical energy produced by the human body and picked up by antennas attached to the systems.

Slightly further afield, Young and his wife, Marian Zazeela, continue to produce music that may be called minimal, since it lasts for hours and

generally consists of the endless repetition of a few fixed, chanted notes over a drone base. But actually Young has begun to reintroduce a structural element into his music (however minimal the structure itself may be). And the music of such composers as Riley, Steve Reich, Tom Johnson, and Philip Glass is even more obviously determined by structural considerations, even if they still sound austere and non-eventful to the average musician or listener.

The capacity to offend

It is this unintended capacity to offend the conventional musician that binds these otherwise disparate composers together for analytical purposes. The actual sounds of the music described above—and that by numerous other composers who didn't happen to perform in New York in recent months, but who can still very definitely be called minimalists—is very different. But the music shares a simplicity of aesthetic, and demands a similar attitude of acquiescence from its audiences.

Traditional Western music, especially since the codification of the tonal system, has presupposed the existence of a clearly argued, linear form. Many musicians who have been trained to think of music this way begin to have real trouble with much of the music written after the turn of this century, when conventional notions of harmony and form began to go by the boards. Others have managed to stretch their tastes to appreciate those composers—the serialists included—whose ancestry can be traced back along the continuum: composers who still think logically and formally, and who still pay heed to the assumption that the conscious complexity of musical thought can somehow be equated with value.

For that kind of musical sensibility, minimalist music sounds insulting and primitive. All such people can hear is the boring, repetitive sameness of it: the reaction is absolutely identical to the art traditionalist, years ago, who looked blankly at a new Picasso or Pollock and dismissed it with the notion that a six-year-old child could do as well.

What the minimalists are doing is assuming a whole different sort of sensibility on the part of their audiences. It is a sensibility rooted in the

Orientalism that has permeated Western art for the past hundred years, a sensibility presupposing a quiescent, meditative appreciation of simplicity, and the ability to discern a smaller, subtler world of complexity within the apparently simple. There is an obvious mysticism to all of this—the world in a grain of sand. But Palestine's fascination with overtones, for instance, is unquestionably a real one. The overtones are there, and now composers are beginning to step back and devote whole pieces to celebrating their existence.

The threat

In one sense, of course, this does indeed represent a rejection of not only the Western musical tradition, but of the whole Western notion of logic, order, and rationality. As such it is part of a much larger counterculture movement that is backing off from the Faustian assumptions that underlie our culture, and suggesting something else instead. Those committed to traditional Western art and societal assumptions are right to regard this music, and the life-style behind it, as a threat.

But things needn't necessarily be conceived in such antagonistic terms. Oriental minimalism is but one tendency in the art and life of today's vanguard, not an all-exclusive alternative. And in fact, the recent work of composers like Young, Riley, Reich, and Glass, with its newly reawakened concern for structure, can be looked on as a retreat from the anarchistic abyss welcomed so enthusiastically by Cage. The fact that the musical traditionalists are so divorced from this aspect of the music of their times that they can't appreciate such a development is lamentable, but not irreparable: critics have been dense about the music of their own time before, and they are dense still.

It will be interesting to look back in twenty or thirty years at the minimalist music of today. Perhaps it will seem then like a necessary polemical extreme, a needed clearing out of the clutter of an outmoded tradition before the development of a newly structured kind of music. More likely, in the happy welter of multiple styles that more and more characterizes today's composers, it will persist as a charming enclave in the house of music. △

on education

CHARLES B. FOWLER

MUSIC LOVERS, TEACHERS, AND STUDENTS: Take note. Hidden away on the twelfth floor of an old apartment building on Ninety-eighth Street in New York is a group of dedicated musicians, anthropologists, and scientists who have been pursuing the most intense and thorough cross-cultural study of the world's ethnic music ever undertaken. For eleven years, under the sponsorship of Columbia University's Department of Anthropology, Alan Lomax, the major collector of America's folk song, has guided a study that may alter how we listen to music, think about it, and even how we teach it. Pouring over hundreds of tapes and recordings of the primitive musics of the world collected from every possible source (the Russian government sent tapes of Siberian tribal music), Lomax and his associates have probed the essence of these sounds, charting, with the help of a computer, the similarities and differences over a wide range of characteristics and, at the same time, relating these characteristics to the life-styles of the human species.

Their findings are extensive and significant on many levels. They have determined, for example, that song-style is one of the most telling indexes of the life-style of a people. Singing, so far as we know, is a universal human trait found in all known cultures. "The chief function of song," Lomax has written, "is to express the shared feelings and mold the joint activities of some human community. It is to be expected, therefore, that the content of the sung communication should be social rather than individual, normative rather than particular." Lomax and his as-

sociates have now provided the first statistical confirmation that as people live, so do they sing.

The fact that song, one of the most elusive of artistic creations, matches culture and depicts society, gives the study of music a new and human significance. Up to the present time scholars such as Curt Sachs have alluded to, and even provided some scattered examples of, the possible relationships between patterns of expressive behavior and patterns of social and cultural structure. But they have never been able to make clear and certain how art and society might affect one another and vary together. Lomax, for the first time, has literally mapped music with culture and provided evidence of absolute correlation.

Lomax has called his method Cantometrics—canto for song, metric for measure; song as a measure of man; or the measure of song. By applying these measures to a sample of songs from every continent and every kind of culture, Lomax and his staff have shown that every people has developed a style perfectly appropriate to their cultural and social needs. Thus, every music is an important human creative discovery, with its own intrinsic values and creative potentials. The Cantometrics method leads the listener to these essential patterns by a training system entirely incorporated into tapes. The tapes are designed to show people how to listen to the songs of other cultures and where to find the key to unfamiliar kinds of music. They teach by using excerpts of authentic native performances, encompassing a brief but representative survey of the whole world of music-making.

One cannot listen to these tapes without gaining an understanding of and affection for the varied creative patterns of the human race. One necessarily comes away from them with a higher regard for the great achievement that folk music represents. The sum total of man's life-styles provides alternatives across the huge spectrum of human behavior that can reveal and help to eliminate our tendency toward what might be called "Eurocentrism." The preference and special status we accord European social and aesthetic practices can be reevaluated when viewed from the perspective of other cultures. In this sense Lomax has attained a life-long aim, for he has finally offered to all people in crystallized form the truly remarkable nature of man's indigenous musics.

Lomax's achievement is an outgrowth and extension of the work of his father. John Lomax was America's first folklorist. He went into the field, listened, notated, and published the songs of the people years before anyone else. His first folksong collection, the first in this country, appeared in 1902. Interestingly, it contains an introduction by Theodore Roosevelt. Alan, following his father's cue, was the first to use the recording machine and tape in the field. Probably half to two-thirds of the folk songs everybody knows came out of his and his father's work, songs like *Tom Dooley*, *Sweet Betsy from Pike*, *House of the Rising Sun*.

Alan started in the field with his father in 1933, and when he found recording companies unsympathetic and unwilling to reproduce folk music, he took to the airwaves, performing the music himself. His weekly C.B.S. "School of the Air" broadcasts initiated a folk song revival. "The next phase," Lomax recounts, "was to introduce the folk singers themselves." And so he did: Woody Guthrie, Burl Ives, Josh White, The Golden Gate Quartet,

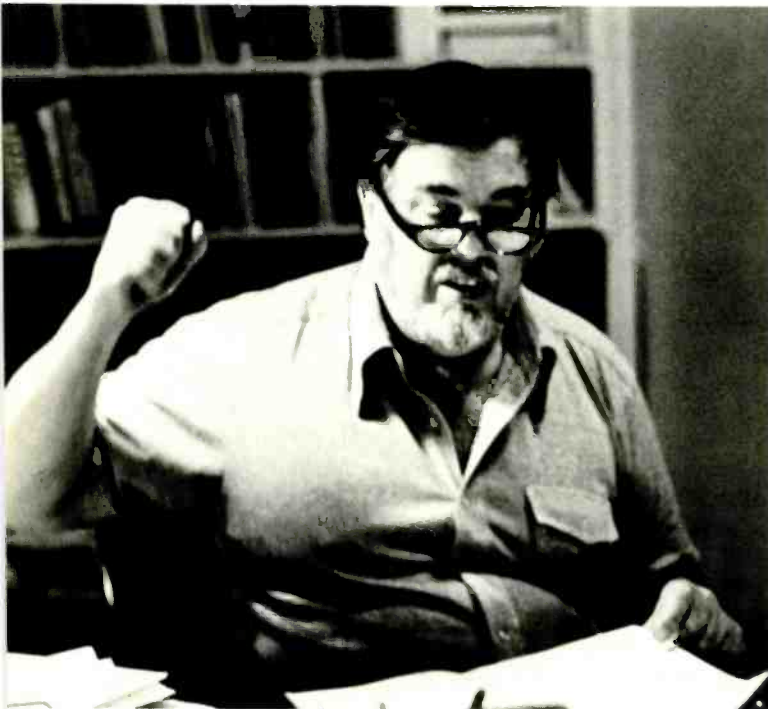

Alan Lomax, in New York office, drives home a point

Alan Lomax's "Cantometrics" links song style to life style

*Among far-flung
folk musicians,
Spanish children with
homemade instruments*



Pete Seeger, and Aunt Molly Jackson to name a few.

During the '50s, others were on the trail, flooding libraries with tapes made in the field. But the music was still far from accepted. Most city musicians saw folk music largely as raw material which they could develop, improve, or ignore. Their European training blinded them to the realization that every folk song tradition is a complex, balanced structure. Alan's *Midnight Special*, a series of Town Hall folk performances, opened the eyes of the New York concert audiences. Determined to bring legitimacy to the folk tradition and equal acceptance to the folk artist, he compiled albums of field recordings. Issued by the Library of Congress in the '30s, these albums were the first of their kind and soon were imitated all over the world.

By the end of the '50s there were tens of thousands of recordings in the archives. Anthropologists and ethnomusicologists had scoured the tribal cultures of the world, collecting descriptive data of every kind, including music. By then Lomax was asking bigger questions. What did this vast collection of primitive sounds represent? What did it mean? He began to view these recorded resources of human sound as a vast reservoir of communication. How does one people's musical communication differ from another's? What were the musical continuities among cultures? Were all the systems interconnected? Whereas anthropologists, musicologists, and ethnomusicologists centered their investigations on one, or at most a few cultures, Lomax's study was inevitably cross-cultural.

How then should he approach this mountainous preserve of human musical communication? While his colleagues in the social sciences preached the uniqueness of cultures, often to the exclusion of possible interconnections, Lomax, who also respected cultural individ-

ualism that characterized the great musical families of mankind, sought a way through to the universals.

In the early '60s, together with Victor Grauer, a musicologist who is at present professor of music at the University of Pittsburgh, Lomax began to devote full time to the problem. With the help of a pilot grant from the Rockefeller Foundation and then an extended grant from the Institute of Mental Health (interested in expressive behavior as a part of mental well-being), and from the National Science Foundation, Lomax and Grauer developed the "cantometric" system. First, Lomax and associates assembled a vast collection of recordings of primitive music from around the world. Then with the help of the now-famous jazzman Roswell Rudd and a staff of eight to ten people, they "charted" the characteristics of some four thousand songs representing four hundred cultures—a sample of all mankind's song.

Lomax was convinced that musicologists and ethnomusicologists had generally made a basic error in their studies of the music of these various cultures. They had attempted to write this music down and even analyze it within the confines of our Western system of musical theory.

His years of listening to tapes from all over the globe told him that such an approach would not suffice. There were standards of performance style that reached beyond the conventional analysis of melody, rhythm, harmony, and form. He felt that music was fundamentally an aural and social link between performers and audience. Noting down the complex melodic and rhythmic patterns of Asian and African music, in a system invented to transmit European patterns, was not enough. The ear easily distin-



Bessie Jones of the Georgia Sea Islands sings songs indigenous to the Southern coast

guished many stable traits of performance by which styles could be typified and which notation omits or distorts. Here the recordings themselves are superior to written scores, no matter how meticulous. Clearly, systematic language to handle the whole aural message, contained in the tape, was needed.

Cantometrics is thus a totally aural system which approaches the music of other cultures solely through what the listener hears in recorded performances. It is not dependent upon any knowledge of native language, exotic scale systems, esoteric rhythmic and contrapuntal devices, or the reading by sight of notated musical examples. The cantometric system is therefore readily accessible to any listener as a means of attaining a broad and thorough perspective of music from outside his own culture. The use of this approach permits the listener to view this music in the aural tradition that is indigenous to it.

After a decade of study, the team of ethnologists, linguists, music analysts, programmers, and statisticians did, indeed, identify certain musical "universals." They discovered them, but not where you might expect. The universal aspects reside in the characteristics of music itself and the way these characteristics relate to life-style. Every tribe, for example, incorporates some type or organization in its music-making. This first parameter, or characteristic—the organization of the singing group—spans nine basic possibilities: 1. Solo, accompanied or not. 2. Two or more solo singers alternating, so that one person is heard at a time. 3. Social unison in which all the participants sing the same melody and text together all the way through a performance. 4. Uncoordinated group performance where individuals appear to be singing totally

different material at the same time, or where they give the impression of singing the same general melody or rhythm, but differ radically on details. 5. Simple alternation, leader-chorus, with a perceptible, if slight pause between the two parts. 6. Simple alternation, chorus-chorus, where two groups of two or more singers interact with a slight pause between sections. 7. Overlap, solo-chorus, in which no pause can be heard between the alternation. 8. Overlap, chorus-chorus, with no pause between the alternation. 9. Interlock, where the group is divided into two or more parts that are coordinated rhythmically and melodically. The training tape demonstrating this parameter provides verbal descriptions coupled with musical examples, followed by a brief "test" that permits the listener to see how well he can distinguish the various types of organization. What was new and exciting—aside from the systematizing for convenient study—was the perception that the social relation of members of a singing group was a fundamental aspect of the society itself. Not only this, but the parameter provided a way of finding a relation between the music and the society from which it came.

Some kind of social organization is incorporated in all human music-making. One might well react, "So what?" Yet if this fact is a substantiation of the obvious, the systematic study of the various types of musical organization has turned out to be a way of understanding many human activities. Most music-making and dancing are the result of teamwork. Lomax's study had convinced him that a principal function of music and dance is to augment the solidarity of a group. They function somehow to enhance a sense of communality. This had been theory. Now there was hard data showing that the favored choral

organization differed radically from society to society. The communication of song about social organization could now be sought.

Using the data from Murdock's *Ethnographic Atlas*, which describes the world's peoples in terms of their main social attributes, Lomax and his collaborator, Conrad Arensberg, looked for relationships between life-style and musical style in hundreds of cultures. Their computer output produced a discovery important to both musicians and social scientists. They found that the models of chorus organization were paralled in activities all through culture—in dance, in conversation, at work, even in government. Diffusely organized, individualistic cultures favored ragged choruses and solo performances. Cultures dependent for their livelihood on coordinated group effort tended to sing and dance cohesively.

Singing together in simple unison, where the leader's part is inconspicuous and the whole group conforms to the same text and tune through whole evenings of song, is typical of small, settled tribal groups, where males dominate the ritual life. Here everyone knows and conforms to common customs. Chiefs function largely as community discussion leaders. In these situations of community conformity, social unison in singing is the rule. Unison is the most efficient way of unifying joint activity, as military men all know, and as the peace marchers demonstrated with their massed chants of "peace now."

Antiphony occurs in more advanced political settings, as among the Zulus of Africa, who had a system of kinship. There the whole tribe, thousands strong, might assemble around some hill where the king was enthroned, and give rhythmic assent to his proclamations. This formula of alternation between leader and chorus mirrors the relation between a powerful chief or king and his council, where he speaks and the council says "yea!" The same pattern was important in the music of American

blacks, particularly during that period when the church, with its dominant male leader, was the central organization in the black community and the preacher was the community head.

What Lomax calls the interlocked style of social organization within the singing group represents equality. Each person functions as an individual, yet all perform in a cooperative, coordinated way. This leaderless style occurs frequently among cultures that do not have authoritarian leaders. The style aligns itself with the very simplest of political organizations, where there often is no leader role at all. African Pygmies and Bushmen, who live the life of simple gatherers, are accomplished vocal polyphonists. Their songs reflect the harmonious internal balance of their culture, where each individual is relatively free of dominance by any other individual and where a person can operate independently and can express his feelings when and as he pleases. These people frequently sing five or six different parts simultaneously, changing leadership and shifting parts at will. Because, however, the bonds of affection between members of the community are so strong, both their community life and their musical performances are extremely cohesive. The result is a music of great flexibility and at the same time great integration. "The African collecting bands, which depend on the women's knowledge of where seeds and berries are ripe, stand at the bottom of the social stability scales we have devised," Lomax says, "yet in actual interaction, they can achieve a level of varied synchrony in song and dance unmatched in other cultures."

Although Lomax seldom makes analogies to our own present-day music, it would appear that our preference for highly coordinated group choral performance, in this case with clear leadership, might also find its roots in our current social, political, and economic systems of interlocked dependence and our reliance on administrative guidance. Symphony orchestras, marching bands, the ballet, and other massive demonstrations of multileveled coordination can be viewed as reinforcing our industrial-managerial system, with its complex tables of organization.

Solo song, of course, occurs in all cultures. However, Cantometrics finds it most frequent where individual enterprise is essential in food getting. Thus solo is favored by hunters, shepherds, ploughmen, and business enterprisers, who often work alone, but not so much by collectors and early farmers, who work in groups. The great rise of solo virtuosity came with the plough and the irrigation system and with political centralization where large tracts of land could be exploited by single individuals. Specialists in all kinds of crafts developed in these early urban societies, and alongside of them, specialists in music and composition. Thus, the individual emerges in song as he emerges in society. In performance of song, people remind themselves of the kind of community from which they come and its level of achievement. In this sense, then, song reinforces the dominant social patterns of society.

But we have just briefly examined one of Lomax's parameters. There are thirty-seven in all, of which ten are significant enough to distinguish any culture and its music. Next month we will explore some of the other parameters of primitive music, how Cantometrics can further the understanding of other cultures, and the ramifications of Lomax's research for education. \triangle



A people's singer of Kazakhstan, USSR

THE STRIKES

and THE FUTURE

by martin mayer

Nearly two generations have passed since Dr. Walter Cannon wrote on the principles of homeostasis, the fact that an organism lives not in the air around it but in its bloodstream, which is maintained at a proper chemical mix through automatic responses engineered by the central nervous system. The chemical input to the bloodstream produces a behavioral output. In the case of an external event perceived as a threat to the organism, the behavioral output was described by Dr. Cannon as a "fight or flight" reflex. In fall, 1973, the four largest New York musical performance institutions became sufficiently terrified of their apparent future that they reacted like organisms. Three of them fought: the New York Philharmonic and New York City Opera and the New York City Ballet. The fourth, the Metropolitan Opera, having nobody to fight, began twitching ominously with the precursors of flight. Fall has yielded to winter, and now spring; the strikes are history; but the institutions have not regained a balanced chemistry. They all look pretty sick.

The strikes that afflicted the New York musical world were not like most other strikes; the demands that precipitated them were made not by the workers but by the management. Over the course of the preceding decade, the arts unions had gained unprecedented concessions. Salaries of musicians in orchestras in the New York area had more than doubled in the ten years, in part through the growth of the number of weeks of work guaranteed by the union contract, in part through improvements in the weekly salary. The argument that a man simply could not feed his children on an orchestra player's salary had given way to the basic statement of I. Philip Sipser, the lawyer who represents most of the major orchestra chapters in the American Federation of Musicians, that "the average scale of seventeen thousand dollars a year in our top five orchestras is so disproportionate to what we pay the top doctors and lawyers and ballplayers." And scale, of course, is the minimum: the average salary of players at the Philharmonic and the Metropolitan is over \$20,000. In New York, where schoolteachers with eight years' experience get more than \$20,000 a year regardless of their talent, there can be no question that the orchestra musicians are underpaid on any rational supply schedule of talent/training/scarcity of skills. But the Bengladesh appeal, fashionable and not unwarranted in the early 1960s, no longer applied in labor-management negotiations.

The acceleration of improvements in musicians' wages

and working conditions can be traced back to the mid-1960s, when the orchestra players, after a long war, wrenched away from the American Federation of Musicians the right to represent themselves in negotiations with their employers. The AFofM leadership had been interested mostly in the pop and broadcast areas, and had regarded the local symphonies as charities that generously gave employment to union musicians. Not infrequently, leaders of union locals sat on the symphony boards. As Philip Hart put it in his book *Orpheus in the New World*, "they often listened with considerable sympathy to the pleas of financial hardship which symphony boards and managers put forth . . . settling for modest increments in salary and small improvements in working conditions." Adding injury to insult, orchestra members in the old



Demonstrators for New York City Opera

days did not have the right to vote on the contract terms their union had negotiated for them: once the local made an agreement, they were stuck.

The end of colonialism came in three stages: first the orchestra members were allowed to send nonparticipating observers to the negotiating sessions (ca. 1960), then they were accorded the right to ratify or reject a contract negotiated on their behalf (ca. 1965), and finally they were permitted to handle the negotiations themselves, up to and including their own choice of a lawyer to represent them. (Even today, however, some matters may be settled over the heads of the men: Cleveland Local 4 of the AFofM extended the Cleveland Orchestra's contract to cover the weeks of an Australian tour at the beginning of this season without consulting the players.) The first contract in New York negotiated *by* rather than *for* the members of an orchestra was that of the New York Philharmonic in 1967.

"These orchestra groups are probably the most democratic union groups you'll find anywhere," says Ralph Mendelson, a gravely militant violist who was a leader of the Philharmonic's orchestra committee from its inception, and since 1970 has been chairman of the International Conference of Symphony and Opera Musicians (ICSOM), a sort of self-governing Bantustan on the territory of the AFofM. "These are real town meetings. It's not a situation where a handful of people will lead everybody else around by the nose. Committees are elected every year, and it's difficult to get people to serve two years in a row. You hope that in a contract year you'll have at least one person with negotiating experience." (Under these circumstances, one must have a little sympathy with the Cleveland AFofM local that signed to permit the Austra-

lian tour: in a democratic nexus with inexperienced leadership there was sure to be a faction that would—mistakenly—demand that the tour be held hostage to force gains for the new contract. But tours are much more important to the players who make them than they are to the board members who must raise some extra money to pay for them.) The result necessarily is a laundry list of new contract demands—salaries, pensions, welfare, vacations, reductions in the number of services per week, shorter rehearsals, extra pay for recording sessions, greater payment for and more beneficial definitions of overtime, security not merely against dismissal but also against relegation to a less prestigious chair in a section, better *per diem* and fewer services on tours, etc., ad infinitum. In each negotiation the demands recur, and slowly but surely more and more expensive provisions appear in contracts. The most important, unquestionably, has been the extension of what was once a "season" of varying duration to year-round employment, though in fact there is as yet no audience demand for year-round performance.

By 1973, the financial situation at the New York institutions seemed genuinely perilous to their directors. Both the New York Philharmonic and the Metropolitan Opera will have to use revenues from subscriptions to next season's performances to pay the bills this spring and summer, and the New York City Center is \$2.7 million in debt. "And it's added to every month," says Martin Segal, the actuary and pension consultant who has become (thank God) the chairman of that institution's finance committee, the first man on that board since Morton Baum to have a consuming curiosity about what really goes on. "There comes a point when your vendors become impatient."

The event that triggered the 1973 demands by the arts managements was the Metropolitan Opera contract of 1972, in which the late Goeran Gentele and Schuyler Chapin, babes in these woods, agreed to various apparently minor contract modifications (new definitions of what constitutes overtime, and the like) that are now costing the Met hundreds of thousands of dollars a year. Probably in concert, though nobody would admit it (they did use the same lawyer as their negotiator), the New York Philharmonic and the City Center managements decided that this year the negotiations would have to be fought on their ground rather than on the union's ground.

The Philharmonic opened negotiations with the presentation of a statistical study by its then manager, Helen Thompson, formerly executive director of the American Symphony Orchestra League, proving that the men should not get a penny of increased salary in a year when the cost of living was rising 8%. And the City Center came to the New York City Opera orchestra with a demand that eleven weeks for which the men had been guaranteed work, over and above the City Opera's normal season, must be removed from the contract. If the Opera could continue its tour presentations in Los Angeles and Washington, fine, the men would continue to get some of those extra weeks (in the previous year management had been able to use only seven of the eleven for which it had to pay); if it couldn't arrange future tours, the men would be out of luck.

The City Opera strike began September 1. On September 20, the day the New York Philharmonic contract ex-



outside State Theater: fighting back

pired, Lincoln Center (headed by the man who is also board chairman of the Philharmonic) announced receipt of a gift variously estimated at six to ten million dollars, to endow the maintenance of Philharmonic Hall, the name of which would be changed to Avery Fisher Hall. The gift had been so structured that none of the money could ever be used by the orchestra to pay musicians. By then management had indeed made a money offer to the men—\$10 a week in the first year. Though one should never underestimate the possibility of thoughtlessness in the actions of part-time boards of directors of cultural institutions, it is hard not to sympathize with the players who believed that the gift had been announced as and when it was announced for the purpose of goading them to strike.

The New York Philharmonic was on strike for ten weeks; the New York City Opera for three; and then the New York City Ballet went out in a complicated strike which saw the ballet dancers as the active ingredient, demanding a firm commitment for the season, which the management couldn't give because there was no contract with the musicians. Chicago, too, suffered a four-week strike this year, and Denver was out for two weeks. The only reason the Newark-based New Jersey Symphony did not have a strike was that both the union and the budget were in a state of collapse: the union accepted a contract which reduced the orchestra's budget from \$1.8 million to \$1.1 million, the length of the season by thirteen weeks, and the annual scale minimum for members of the orchestra from \$7,560 to \$4,830. "In addition to the proposed reduction," the orchestra committee reported in a news note for *Senza Sordino*, ICSOM's official publication, "the management required a schedule clause which allows them to make schedule changes without notice. No non-monetary concessions were made by management to allow musicians to find additional outside employment in order to support themselves and their families. This statement is issued with regret."

Any scorecard on this year's negotiations and strikes must be a matter of opinion. It is probably true enough to say that unions outside the New York area did reasonably well (St. Louis, without a strike, did spectacularly well, gaining in effect an increase of more than 20% the first year, close to 50% over three years); unions in the New York area did poorly. The City Opera orchestra had to agree to a reduction in their pay for weeks not worked (though the number of feather-bedding weeks was not changed); and the wage increases gained by the Philharmonic will not bail the men out of their losses from striking until the third year of the contract (though there are significant gains in health insurance and pension provisions, and in the third year an above-scale guarantee to the string sections, assuring every string player at least \$400 a week). The Orchestra Committee submitted this final Philharmonic management offer to the men without a recommendation; the contract carried by only 69 to 35.

Labor-management relations in the musical arts have become increasingly unfriendly in the last decade, and the experiences of last fall are not likely to improve them. "There are a good many men in this orchestra twenty years," Ralph Mendelson says with satisfaction, "who had grown up with the idea that there were a bunch of father figures up there on the Board, who would take care of them. That attitude is now gone." While working with

Rudolf Bing on his memoirs, this reporter read through years of memoranda exchanged between management and the orchestra committee at the Metropolitan Opera with relation to members of the orchestra whom the conductors wished to see depart. In the 1950s, the players were willing to arrive at their own artistic judgment of the man's performance, and could accept the dismissal of a colleague for failure to maintain standards; by the later 1960s, every attempt at a dismissal was a grievance to be prosecuted by the union. The contract Gentile signed guaranteed that the Met would not even attempt to dismiss any musician on artistic grounds for four years. "That's what I cannot understand," says John White, associate manager of the City Opera. "They say it makes a great difference how good an orchestra you have, and we agree. Then they turn around and show us a different opinion of themselves by insisting that we retain a player everyone knows is not up to his job."

At the symphony orchestras, the extension of the season and the virtual disappearance of the permanent resident conductor have placed severe additional burdens on the players, who must now in fact assume much of the day-to-day responsibility for the maintenance of performing standards. It was one thing for management to insist on an exclusive prerogative in the choice of guest conductors when the transient presence on the podium was merely a brief interruption in the sequence of appearances by the music director, but something else when the orchestra has to play most of the time under a visiting baton. Chicago was Reiner's orchestra—Cleveland was Szell's, Boston was Munch's, San Francisco was Monteux's—in a way that only the Philadelphia is now Ormandy's. Given greater responsibilities, the men not unreasonably ask greater authority, especially in the choice of guest conductors.

And there is of course the advertised anomie of the orchestral musician, who feels his identity submerged into a group, his individual artistry extinguished by the need to accept the dictation of a leader whose omniscience is always assumed but not always demonstrable. Phil Sipser sees the musicians' attitudes as part of a more general "white collar revolution. We represent the doctors in the hospitals as well as Local 1199 [the hospital, hotel and restaurant workers' union]. Everywhere you see this discovery by semi-executives of what union power can do."

Sipser has suggested elsewhere that unionism in the orchestras could evolve into a cooperative form of organization, like that of the European orchestras. Harold Lawrence, the new manager of the Philharmonic, was for some years manager of the London Symphony Orchestra, which is a cooperative; he doubts strongly that it can be done. "The English musician thinks of himself as a freelance. His income-tax status lies in Schedule D, 'self-employed person.' The member of the London Symphony Orchestra agrees to accept any engagement offered him at least twenty-eight days before the date, unless he is excused by the release committee, but he does not think of himself as part of a contract orchestra. The New York Philharmonic has seven weeks' paid vacation, a health and welfare plan, a pension plan, and extra pay for any services beyond eight a week. Rehearsals are two and a half hours long, except that a sectional rehearsal on a double-rehearsal day—Wednesday—cannot be more than

Continued after High Fidelity page 106

Here's your **FREE**

HIGH FIDELITY

“at home” shopping service!



It's easy! All you do is use the Reader Service card at right . . .

HIGH FIDELITY's Reader Service Department will take it from there. It's as simple as 1, 2, 3!

1 Just circle the number on the card that matches the number below the ad or editorial mention that interests you.

You'll also find the key numbers for advertised products in the Advertiser's Index.

2 Then type or print your name and address. Don't forget your zip code, it's important!

3 Drop the card into the mail. No postage is needed if mailed in the United States.

You'll receive literature, colorful brochures and specifications about the products that interest you . . . free and without obligation!

Subscribe today by filling out the subscription order card on the reverse side of this page.

First Class
Permit No. 111
Cincinnati, Ohio

BUSINESS REPLY MAIL

No postage stamp necessary if mailed in the United States

Postage will be paid by—

HIGH FIDELITY

Subscription Dept. 74
P.O. Box 14156
Cincinnati, Ohio 45214



1	2	3	4	5	6	7	8	9	10	11	12	13	14	15
16	17	18	19	20	21	22	23	24	25	26	27	28	29	30
31	32	33	34	35	36	37	38	39	40	41	42	43	44	45
46	47	48	49	50	51	52	53	54	55	56	57	58	59	60
61	62	63	64	65	66	67	68	69	70	71	72	73	74	75
76	77	78	79	80	81	82	83	84	85	86	87	88	89	90
91	92	93	94	95	96	97	98	99	100	101	102	103	104	105
106	107	108	109	110	111	112	113	114	115	116	117	118	119	120
121	122	123	124	125	126	127	128	129	130	131	132	133	134	135
136	137	138	139	140	141	142	143	144	145	146	147	148	149	150
151	152	153	154	155	156	157	158	159	160	161	162	163	164	165

Please circle #165 for information about the High Fidelity Annuals.

NAME _____

ADDRESS _____

CITY _____ STATE _____ ZIP _____

I am a subscriber I am not a subscriber

5 6 7 8

USE THIS POSTAGE-FREE CARD TO

DOUBLE

**YOUR LISTENING
AND READING ENJOYMENT**

Now you can enjoy
the best in both musical
worlds — in one colorful magazine:
HIGH FIDELITY/MUSICAL AMERICA.



SUBSCRIPTION ORDER FORM

- Please enter a one year subscription to HIGH FIDELITY/MUSICAL AMERICA in my name. I'll receive 12 issues of HIGH FIDELITY, plus about 32 pages per issue of news and reviews of important musical happenings throughout the world — concert, opera, etc. — for only \$14.
- Please enter my subscription to HIGH FIDELITY only. I want to take advantage of your special offer of 15 issues for only \$9.47.
 - New Subscription
 - Renewal
 - Payment enclosed
 - Bill me

Name _____

Address _____

City _____ State _____ Zip Code _____

For postage outside U.S.A., Possessions: Add \$1.00 for HIGH FIDELITY/MUSICAL AMERICA subscription (12 months); add \$2.00 for HIGH FIDELITY subscription (15 months).

5 6 7 8

First Class
Permit No. 111
Cincinnati, Ohio

BUSINESS REPLY MAIL
No postage stamp necessary if mailed in the United States

Postage will be paid by—

HIGH FIDELITY

Reader Service 74
P.O. Box 14306
Annex Station
Cincinnati, Ohio 45214



For the full story of music and music makers today, be sure to include MUSICAL AMERICA as part of your HIGH FIDELITY subscription!

In 40 sparkling pages, MUSICAL AMERICA covers the live musical scene *completely*. You'll get news, reviews and reports of important musical events all over the world — written by critics who know the score and how to write about it with wit as well as authority. You'll meet today's outstanding conductors, composers and performers... learn how they work and live... what they think and say about music — and about each other.

MUSICAL AMERICA adds a new dimension to HIGH FIDELITY — and to your enjoyment of music. Use the postage-free card to start copies coming your way regularly.

(MUSICAL AMERICA is available only by subscription... and only with HIGH FIDELITY. It is not sold on newsstands. Another important reason for you to use the subscription card now.)

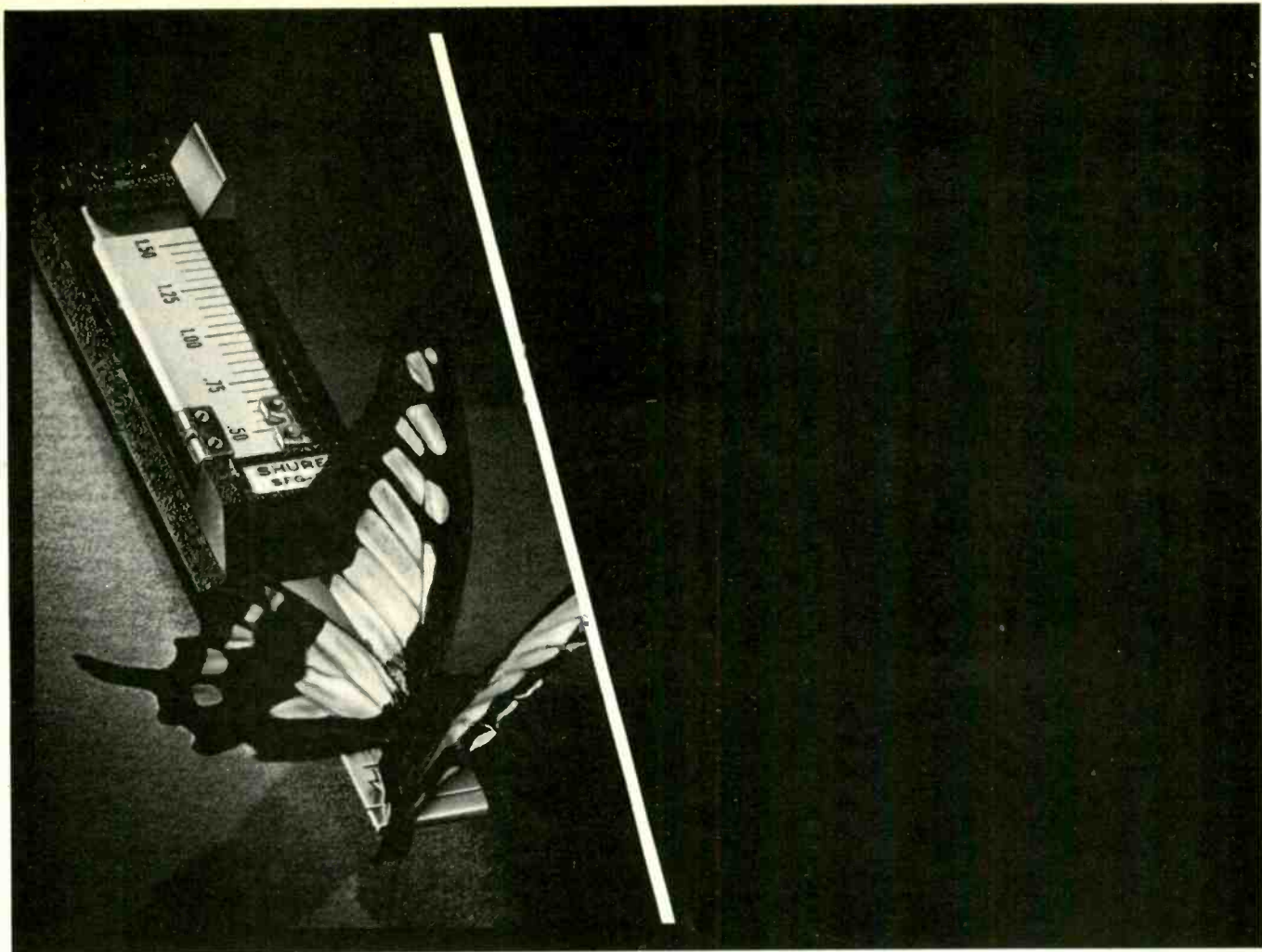

Weight watcher par excellence.



The same Shure development group that created the *Super-Track "Plus" V-15 Type III* cartridge has perfected a reliable, simple, low-cost stylus force gauge that meets the needs of the dedicated discophile. It's designed to operate in the $\frac{1}{2}$ to 3 gram range, and is accurate within $\frac{1}{10}$ th of a gram in the critical $\frac{1}{2}$ to $1\frac{1}{2}$ gram range—the force most widely used with today's better turntables and cartridges. It will enable you to accurately adjust the tracking force for maximum trackability while protecting *all* your records. Cost? Only \$4.95—just about the price of one good stereo disc.

Shure Brothers Inc.
222 Hartrey Ave., Evanston, Ill. 60204
In Canada: A. C. Simmonds & Sons, Limited



project in May. Not that delay has in any way reduced Barenboim's keenness. Grubb was particularly delighted with the fire and intensity of the final scene, in which the Don's disappearance down to hell was a challenge to all concerned—Soyer, Sir Geraint Evans as Leporello (at last recording a part for which he has long been renowned on the stage), Peter Lagger as the Commendatore, and Heather Harper as Elvira. The rest of the cast includes Antigone Sgourda as Anna and Alberto Rinaldi as Masetto. As in Barenboim's many other Mozart records for EMI, the orchestra is the English Chamber Orchestra.

Grubb, Barenboim's regular producer over the years, has officially retired from EMI but continues to do work on contract. As so often in that sort of situation, he finds himself busier than ever. When I spoke to him, he was about to depart for Paris to record for EMI Barenboim's performance of the Fauré Requiem with the Orchestre de Paris and soloists Sheila Armstrong and Dietrich Fischer-Dieskau.

Out-of-the-Way Elgar. While Barenboim conducts the basic Elgar, Sir Adrian Boult has been recording such rarities as *Polonia* and *Carillon*—both occasional pieces from the period of World War I—and items from the oratorio *Caerulacus*.

Boult, by the way, was one of the two conductors who took part in the EMI seventy-fifth-birthday concert at the Royal Festival Hall, the other being André Previn. As on record (see my March report), they gave the Mozart C minor Piano Concerto, K. 491, with Previn playing and Boult conducting the LSO—all of this supervised by a monster model, ten times life-size, of Nipper, the HMV dog, looking into his horn gramophone.

Shostakovich Cycle Continues. Previn's recording program has included Britten's *Sinfonia da Requiem* (a work he recorded with the St. Louis Symphony for Columbia at the beginning of his serious conducting career) and more Soviet music, Shostakovich's Sixth Symphony and Prokofiev's *Lieutenant Kijé* Suite. His measured tempos for the Shostakovich will make it impossible to squeeze the work onto one disc side—thus the *Kijé* is a half-side filler.

At the Shostakovich sessions, Previn reminded me that this was one of the works he included in the LSO's American tour early in 1973. It had taken ten months to get around to recording the work—too long an interval, he felt, particularly since it involved some twenty different players who had to be rehearsed afresh, but with the LSO that was easily done. It is not only the long

first movement that Previn takes unusually slowly; his tempo for the central scherzo is on the slow side too. But then the finale goes hell for leather. At one point the timpanist has a virtuoso ostinato to cope with, and everyone was fascinated when what sounded to Previn rhythmically precise came out fractionally wrong on tape. In the end, rather than relying on his own ear, he had to take the word of producer Christopher Bishop that absolute unanimity had been achieved.

Earlier last year Previn recorded Beethoven's Fifth Symphony, not a work with which he has so far been associated in Britain. Now he has done the Seventh as well, and we can look forward to a fair sprinkling of standard classics among the more exotic works that have generally made up his recorded repertory. His next complete ballet recording will be the Tchaikovsky *Sleeping Beauty*.

Ashkenazy Futures. Previn has also been conducting a series of Prokofiev piano-concerto recordings with Vladimir Ashkenazy for Decca/London. The very first sessions were held up when Previn was ill, but the delay was ultimately turned to advantage: The sessions for the First and Third Concertos came immediately after a series of live performances in London and elsewhere.

The Prokofiev is one of the many long-term Ashkenazy projects Decca has in hand. He has been continuing his Beethoven violin-sonata series with Itzhak Perlman (most recently the *Kreutzer*, in Kingsway Hall) and his Beethoven piano-sonata series with *Les Adieux*.

Offbeat British Projects. Recent recordings of British music include a coupling, sponsored by the British Arts Council, of the music of Thea Musgrave, a composer whose works have blossomed richly in the last ten years. She conducted the Scottish National Orchestra in her horn concerto, with Barry Tuckwell as soloist, while Alexander Gibson conducted the virtuoso *Concerto for Orchestra*. The results will appear on the Argo label.

Even more offbeat is the recording, also for Argo, of Constant Lambert's massive piano sonata—incidentally following Previn's recently made recording of Lambert's *Rio Grande*. The idiom of the sonata is similar to that of the choral work, with Cuban rhythms and Twenties jazz overtones consistently beguiling the ear. The pianist is Rhonda Gillespie, whose nerve and ability to convey tension seem excellently suited to recording. At my suggestion she even added an item to her Lambert offering: the tiny *Elegiac Blues*, written in memory of the Twenties blues singer Florence Mills, a charming piece that Miss Gillespie warmed to at once. The disc coupling will be the piano sonata of Sir Arthur Bliss.

EDWARD GREENFIELD

STR's

NEWEST
SPEAKER

will blow you away

WITH ITS:

Front-loaded 12 in. woofer with an 8 lb. induced field magnet* in a ducted port enclosure; 3 piezoelectric tweeters and transmission line midrange

After listening to SIGMA 1 you'll know why we say "STR gives you more sound for your money"

Frequency Response
20 - 20 KHz ± 3 dB

Power Handling
120 watts (rms)

Weight
80 lbs.

Dimensions
15½" x 15½" x 32"

*Patented high efficiency limited field magnet requires less power for optimum response, yet can handle auditorium size loads



SIGMA 1
\$299.00

SOUND TECHNOLOGY RESEARCH
3516 LAGRANDE BOULEVARD
SACRAMENTO, CA 95823
916 / 422-0440

DEALER INQUIRIES INVITED FOR THIS AND OTHER FINE STR PRODUCTS

CIRCLE 39 ON READER-SERVICE CARD

The New Vestigal Arm by Transcriptors

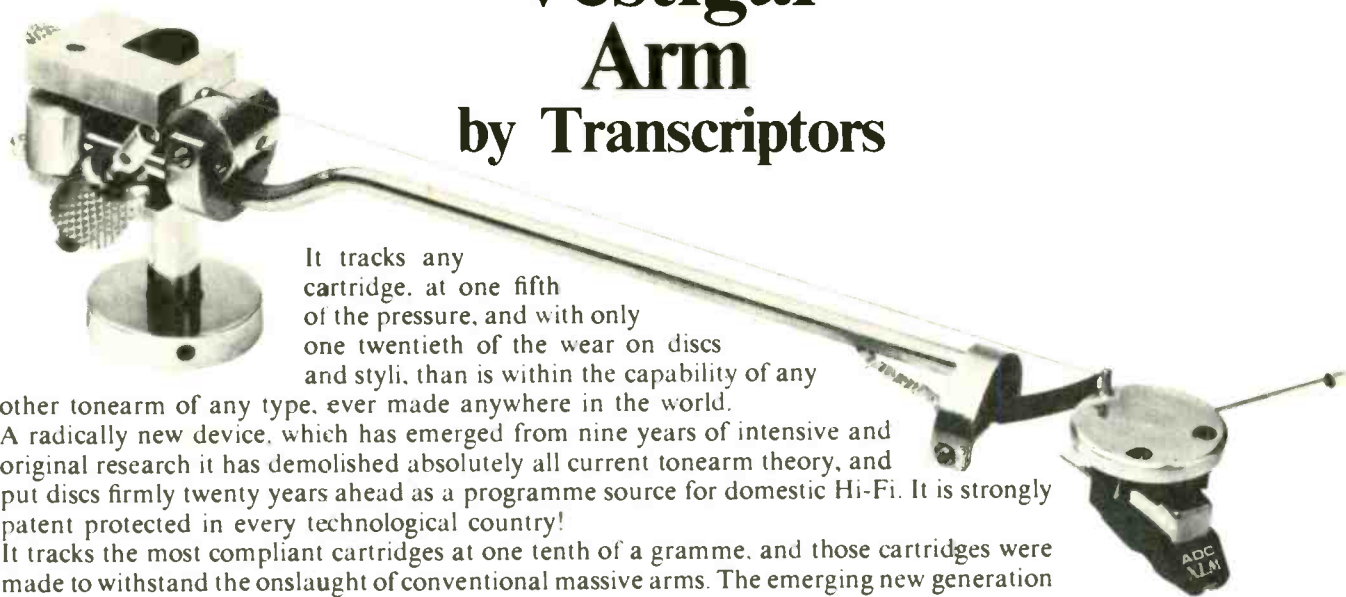

It tracks any cartridge, at one fifth of the pressure, and with only one twentieth of the wear on discs and styli, than is within the capability of any

other tonearm of any type, ever made anywhere in the world.

A radically new device, which has emerged from nine years of intensive and original research it has demolished absolutely all current tonearm theory, and put discs firmly twenty years ahead as a programme source for domestic Hi-Fi. It is strongly patent protected in every technological country!

It tracks the most compliant cartridges at one tenth of a gramme, and those cartridges were made to withstand the onslaught of conventional massive arms. The emerging new generation cartridges will do far still better in this arm.

In the world of self respecting Hi-Fi, all other disc playing systems, are hopelessly outdated, all other arms hopelessly massive, destructive and wasteful.

SPECIFICATION	Best low mass conventional arm or parallel tracking arm, with best cartridge	Vestigal arm, with best cartridge	Perfect arm
Actual moving mass	Best 180 grammes in all planes	37.5 grammes horizontal	Zero Mass
Inertia (Effective mass) with cartridge	Best 11 grammes in all planes (often twice this figure)	6 grammes horizontal 1 gramme vertical	Zero inertia
Tracking pressure	Best 1 1/4 grammes on selection of highly modulated discs	Best one tenth of a gramme on selection of highly modulated discs	Zero
System resonance	2-30 C. P. S. System resonance within large air moving frequencies, resulting in distortion and feedback	over 180 C. P. S. System resonance well outside large air moving frequencies no distortion or feedback	over 30,000 C.P.S.
Disc wear	Severe degeneration of discs after 15 playings, no longer Hi-Fi after 35 playings	Degeneration of discs at least forty times less, due to low inertia and tracking force.	No wear

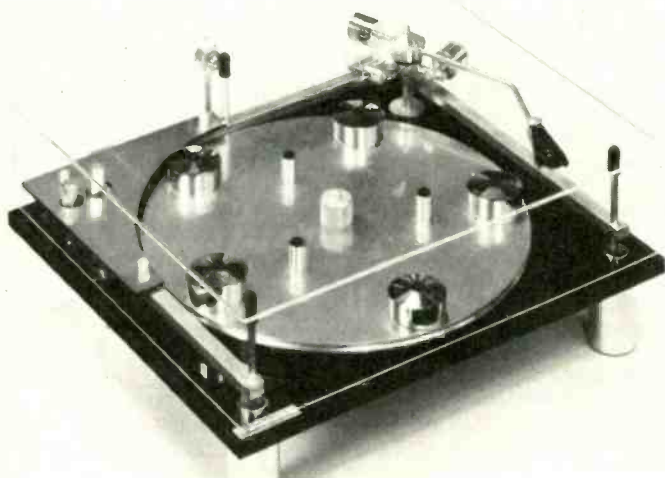

The VESTIGAL ARM is now standard on the fine TRANSCRIPTOR range of turntables, made in Ireland. These turntables are the acknowledged leaders in Europe. Incomparable performance is coupled with such outstanding design that TRANSCRIPTOR turntables are on permanent exhibition in most European design centers and in your own Museum of Modern Art in New York.

TRANSCRIPTORS are now in New York offering sales and service for all their products.

Please send for brochure.

TRANSCRIPTORS

509 5th Avenue, New York, N.Y. 10017 Tel: (212) 687-0890

CIRCLE 47 ON READER-SERVICE CARD



too hot to handle

At Sam Goody's record store the cashier removes a corner of the plastic wrap and dates each record jacket so they can allow refunds only within a designated period after the purchase. The store manager assures me that, since only a corner is removed, I can be sure there's a "factory fresh record" (his words) inside. But I bought one record on which the corner of the wrap had previously been removed and upon opening it at home found that it had been badly scratched. Your readers should be warned to look for these previously marked jackets.—Edward C. Wachs, Lodi, N.J.

A friend of mine bought a Columbia set and found that someone had doodled in the booklet that came inside, even though the set still had its outer shrinkwrap intact. How is this possible?—Edward T. Foley, Lee, Mass.

We wouldn't be willing to say this was the case with either of your complaints, but it is possible for a dealer to rewrap records when they're returned. The shrink wrap equipment is not very expensive, and we've even seen manufacturer ads pitching it for just this use. Obviously if the dealer has the choice of getting his money back on returned records (by sending them back to the record company) or making a profit on them (by reselling them), he'll be tempted to do the latter. Unfortunately we know of no way you can distinguish between factory shrinkwrapping and the dealer variety. And even at the factory mistakes could happen. For example, say that the Columbia set had been returned as defective. Columbia could have taken new records and packed them in the old box with the old booklet, not realizing that the booklet had been (willfully) damaged.

As a collector of older recordings I have many mono open-reel tapes, made on my Sony 355, with different program material on each track. My stereo receiver—a Lafayette LR-1000—has a mode knob with positions for left-only and right-only mono so that I can play tapes. But I'm thinking of purchasing a quadraphonic receiver and am interested in getting this feature. Do any four-channel receivers have it?—Andrew Frakol, Redwood City, Calif.

Probably some do, though we've checked a dozen of the fancier models without finding one, and even some stereo models have only one mono mode position, combining left and right channels. In terms of the more common equipment formats, your problem is peculiar to open-reel tapes. Discs, FM, cassettes, and even eight-track tape cartridges are designed in such a way that mono signals automatically will appear

on both channels of a stereo system. Receiver designers therefore tend to think of the problem as being one for the tape-deck designer to solve and see left-only and right-only mono positions as an inexpensive frill that can be omitted with impunity. And most open-reel decks capable of recording independently on the two channels do provide some way of playing them independently. If your deck doesn't and the receiver you would like to buy lacks the switching, you would have to adopt some expedient like disconnecting the interconnect cable in one channel or using the receiver's balance control to kill all but one speaker. Admittedly the mode controls on quadraphonic equipment are getting to be very complex, but we'd like to see the one-channel-only mono feature retained for another reason as well: to simplify TV-sound hookups, an application of high fidelity that seems to be overlooked by most system owners.

Your equipment report on the Pioneer TX-9100 tuner [December 1973] made no comment on the quality and performance of the AM section, though your report on the Nikko STA-5010 receiver in the same issue rated the AM performance as very good. Does this mean that the AM section in the Pioneer is not as good as that in the Nikko? I know that not too many people are concerned about AM performance, but where I live the only full-time classical music station is AM.—Keith J. Webster, Salt Lake City, Utah.

I have the Heath AJ-1510 FM tuner and am looking for a high-quality AM tuner to use in the same system. Does such a thing exist?—Lester L. Munn Jr., Madison, Wis. We don't get that much in the way of FM broadcasts. I think you should pay more attention to AM.—John R. Williams, El Paso, Tex.

One of our editors comments that in the last year he's seen as much reader mail dealing with AM (other than shortwave) as he had in perhaps the previous five years put together. It could be that the decline in FM programming of classical music in general and live concerts in particular—a decline to fewer than one classical FM station per state—has finally become critical to consumer attitudes toward equipment. The announcement of several FM-only super-tuners (Sony and Sequerra come to mind) dramatizes a certain disparity between the ideal world and the real one. Not that AM sections, when they're included in stereo components, are often poorly designed. Most provide minimum interference (as long as the signal strength is reasonably good), minimum distortion, and better fre-

quency response than most AM stations broadcast. For that reason we have not been asking the lab to test AM sections and have felt little need to comment on them in our reports—particularly where (as in the Pioneer report) there is a great deal that should be said about other features of the design. It is our impression, though we have not compared them side-by-side, that the AM reception of the Pioneer tuner is at least as good as that of the Nikko tuner. We would expect it to be excellent in a high-end tuner but not necessarily in a receiver of modest price and hence went out of our way to mention the Nikko's performance. But where high fidelity AM sections (as opposed to those in shortwave or communications receivers) fall down for readers in areas like Salt Lake and El Paso is in pulling in clear signals from distant stations—in other words, in selectivity and sensitivity, which are at a premium for this use. Selectivity even works against high fidelity since high selectivity to some extent implies limited frequency response. The McKay Dymek AM-3—the only real (and present) hi-fi AM-only tuner we're aware of (see Equipment in the News in this issue)—gets around the selectivity-vs.-bandwidth problem by providing "sharp" and "broad" tuning buttons and gets around the similar sensitivity-vs.-overload problem by providing "distant" and "local" buttons. Of course no matter how good the AM tuner is, an A/B comparison of the same program on normal AM and FM signals should make FM the winner hands down. FM has better inherent bandwidth and greater noise suppression going for it. But several factors mitigate against FM in practice. Where the listener had no strong local signals carrying broadcasts he wants to hear, he will appreciate AM's ability to "reach" farther; stereo broadcasting introduces extra noise and distortion into FM particularly on a station of marginal signal strength; and many broadcasters are throwing away the advantages of FM through excessive signal limiting, sloppy equipment maintenance, and so on. So if AM is to be taken seriously as a high fidelity medium it will be largely by default.

Playing my Akai GX-365D tape deck at 3 1/4 ips through a Marantz 2245 receiver and Imperial 7 speakers, quiet passages sound unbelievably distorted at high volume levels. I gather a Dolby B system is what I need. What unit would do the job best?—Ray Hackett, Middletown, Conn.

If distortion really is your problem, no Dolby unit will do the job, and we'd suggest you hustle your Akai off to the repair shop if the distortion is as bad as you imply. If what you're hearing is noise, rather than distortion, then Dolby B certainly will help. Performance of the Dolby units on the market varies much less than their features. The under-\$100 models will allow you to record or to play Dolby recordings, but not to monitor from a separate playback head while you record. The fanciest models may include quadraphonic options, mike preamps, mixing options, and special switching for listening to—and/or recording—Dolby-processed FM broadcasts. To choose the "best" you'll have to evaluate each of these features in terms of your own needs and predilections.

The gyroscopic gimbal suspension of the Dual 1218 and 1229 tonearms is the best known scientific means for balancing a precision instrument in all planes.

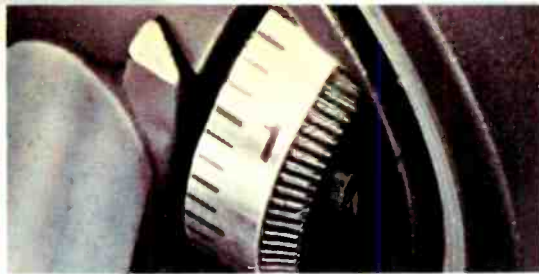
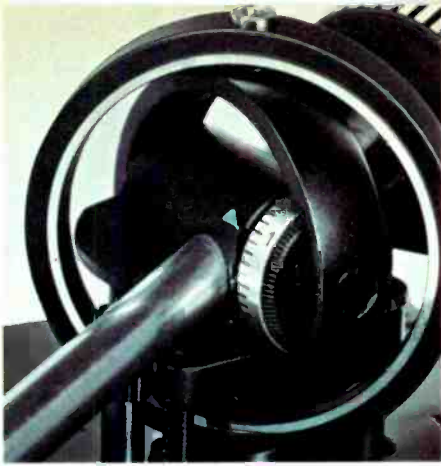

In all Dual models, stylus pressure is applied around the pivot, maintaining perfect dynamic balance of the tonearm.

Separate anti-skating calibrations for conical and elliptical styli achieve perfect tracking balance in each wall of the stereo groove.

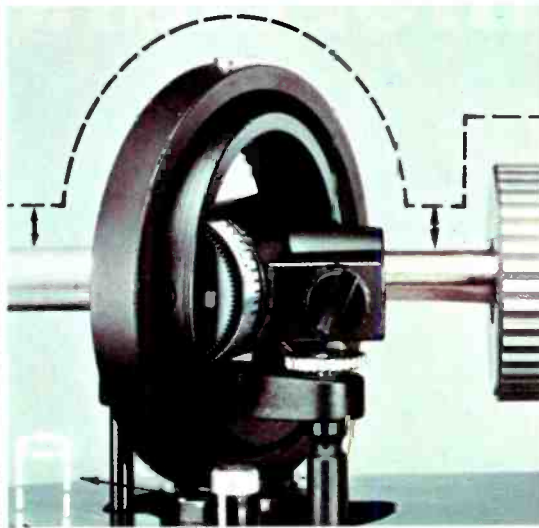

The 1218 and 1229 tonearms track records at the original cutting angle. The 1229 tonearm parallels single record, moves up for changer stack. A similar adjustment is in the 1218's cartridge housing.

Some of the reasons why other turntables don't perform quite like a Dual.

Because of the wide acceptance and acclaim Dual has earned over the years, especially among audio experts, many Dual innovations have understandably turned up on competitive turntables.

Still, to copy a Dual feature is one thing. To achieve Dual performance and reliability is quite another matter. A few examples will illustrate our point.

True, twin-ring gimbal.

The 1229 and 1218 tonearms are centered and balanced within two concentric rings, and pivoted around their respective axes.

Vertical bearing friction is specified at 0.007 gram, and every Dual gimbal is hand-assembled and tested with special gauges to assure that every unit will meet this specification.

Only by maintaining this kind of tolerance can tonearm calibrations for stylus pressure and anti-skating be set with perfect accuracy.

Tracking perpendicular to record.

The CD-4 record is the latest and perhaps the most critical application of the need for identical tracking pressure

on each side wall of the groove.

This is best achieved by a tonearm that is perfectly balanced in all planes, with stylus pressure applied internally, around the pivot and perpendicular to the record. All Dual tonearms do this.

Perfect concentricity assured.

The rotor of every Dual motor is dynamically balanced in all planes of motion. Each motor pulley and drive wheel is also individually examined with special instruments to assure perfect concentricity.

Any residual vibration within the motor is isolated from the chassis by a three-point damped suspension.

Finally, every assembled Dual chassis is "tuned"

to a resonant frequency below 10 Hz.

The best guarantee.

Despite all these precision features and refinements, Dual turntables are ruggedly built and don't have to be babied. Which is why your Dual comes with a full year guarantee.

With all this — performance is still what counts. So we suggest you visit your franchised United Audio dealer to see for yourself that only a Dual performs precisely like a Dual.

United Audio Products, Inc.,
120 So. Columbus Ave., Mt. Vernon,
N.Y. 10553

Dual[®]



Dual 1219, \$154.95

Dual 1218, \$189.95

Dual 1214, \$119.95

Dual 1229, \$259.95

United Audio is exclusive U.S. distributor for Dual.

first came the word...



And then there was music. And then came Sony tape recorders to capture the words and music with perfect fidelity. Right from the start, Sony has always been first with the best, the newest and the broadest

selection of tape recording equipment in the world. Sony tape recorders, Sony accessories, Sony microphones, Sony recording tape. We could go on and on and on. We are. **SONY**. Ask anyone.

Brought to you by **SUPERSCOPE**



In the beginning there was folded horn bass reflex acoustics suspension.

And now BIC VENTURI

For about 40 years, speaker designers have been juggling the characteristics they wanted from speakers: Compact size, high efficiency, high power-handling, and deep ranging, pure, clean, gut-reaction bass.

They tried folded horns: efficient, clean, good power-handling, but too large for most homes, quite expensive. They tried the bass reflex: Efficient, compact, but limited by uneven, one-note bass. Ditto the labyrinth, but far less efficient.

Today's favorite, the acoustic suspension: Compact, smooth, deep ranging bass. But inefficient (requiring costly, high-powered amplifiers) and limited dynamic range.

A virtue here, a virtue there -- but all with corresponding compromises.

Ironically, the principle that combines these objectives into one compact cabinet has been around for some 180 years: The VENTURI principle of fluid motion transformation, reapplied in a form better suited to acoustics (patents pend). Our simplified diagram shows how the scientifically formulated VENTURI coupled path functions as a step-up transformer. Up to 140 times more bass energy comes from the duct as comes directly from the woofer. And bass is reinforced broadly over the low frequency spectrum, not at a single "tuned" frequency.

The BIC VENTURI coupled path also operates as an acoustic, low pass filter, cleansing harmonics and distortion components from the bass waves. So, the bass not only goes down further and is louder, it's cleaner and more natural. And requires hundreds percent less amplifier power than other speakers of comparable size and performance. Yet, even though BIC VENTURI need less amplifier power, they can handle more. This new principle eliminates compromises in cone, suspension and magnetic design to "match" cabinet characteristics.

Above the woofer, you can see our mid-range. To match the exceptional high efficiency of the bass section, we had to invent a new horn, combining two different types of flare, conical and exponential, BICONEX™ (pats pend). It provides wide, smooth dispersion in both horizontal and

vertical planes, so placement in the home won't be critical. BICONEX covers the full midrange to well beyond 15,000 Hz without crossover network interruptions, for distortion-free, smooth response.

Our super tweeter handles just a half octave from 15,000 to over 23,000 Hz. While you can't hear single frequency tones in that range, the accuracy of musical "timbre" depends upon those frequencies being added in proper proportion to the complex tones you do hear. An important subtlety.

Because you hear less bass and treble at low and moderate levels, we built a DYNAMIC TONAL COMPENSATION circuit (patents pending)

into the speaker. It

adjusts speaker frequency response as sound pressure output changes, automatically. Amplifier "loudness contour" controls can't do that. Result: aurally "flat" musical reproduction always, regardless of volume control settings.

Our Formula 2 is the most efficient speaker system of its size, yet can be used with amplifiers rated up to 75 watts per channel! Formula 4 has deeper bass and can be used with amplifiers up to 100 watts. Formula 6, the most efficient, will handle 125 watts. Hear them at franchised BIC VENTURI dealers. Or write for brochure:

B·I·C INTERNATIONAL, Westbury, N.Y. 11590,
a div. of Avnet, Inc. Canada: C.W. Pointon, Ont.



Cultural Revulsion, or the Case of the Viennese Revisionists

Beethoven, Mozart, and Schubert are all bourgeois capitalist composers whose works are devoid of meaning for the proletariat. That's what the Chinese are saying in a surprising turnabout from last year, when they officially sponsored visits by the London Philharmonic Orchestra, the Vienna Philharmonic, and the Philadelphia Orchestra. (See review of the Philadelphia's recording of the *Yellow River Concerto*, a work the orchestra brought back from China, page 107).

Recent articles in the Chinese Communist party paper *Jenmin Jih Pao* specifically attack the three composers, while condemning "blind worship" of Western music in general. "Numbered works" receive particular scorn in an article bearing the headline "Works of Music Without Titles Don't Reflect the Class Spirit." It states, "If we go on like this . . . uncritically introducing these things to our youth . . . where will our young people be led?"

It depicts Beethoven as a "German capitalist musician," comparing his *Tempest Sonata* with Shakespeare's play of the same name, "which propagates the capitalist theory of human nature." Another writer interprets Schubert's *Unfinished Symphony* as an expression of gloom produced by oppression of the petite bourgeoisie by the Austrian feudal rulers. And Mozart's



Beethoven—
Is The Battle Symphony better than the Ninth?

works "cannot stand comparison" with the Chinese composition *White-Haired Girl*, the paper says.

Recommended listening includes the Chinese work *The Sun Rises*, which "glorifies the Red sun of Chairman Mao Tse-tung and the Chinese Communist party in the hearts of the Chinese people." Dismissing the idea that music is a common language transcending national boundaries, the paper says that, like all other forms of art, it must be an instrument for class struggle.

While we might take exception to the specific examples cited in the Chinese publication, we must applaud any artistic movement that is struggling to retain some class in music.

Et Tu, 3M?

3M, which has clung tenaciously to its iron-oxide-only Scotch cassette-tape line, finally is going to chromium dioxide. Its new line of C-45, C-60, C-90, and C-120 cassettes should be generally available by the time you read this.

The company will handle all the manufacturing but is using the chromium dioxide particles under a licensing agreement with E.I. Du Pont de Nemours—the developer and holder of the patent on the chromium dioxide formulation and the licensor of all chrome tape manufacturers. 3M says its Posi-Trak backing, first introduced in its High Energy ferric tapes, will be used on the Scotch chrome line.

The decision to add chromium dioxide was based on dealer reports of increasing customer demand for a chrome cassette and on the company's belief that bias and equalization switches on cassette decks now are sufficiently standardized to allow predictable performance, even when a chrome cassette is recorded on one machine and played on another. The company contends that formerly many bias and equalization settings compromised between the requirements of low-noise ferric tapes and those of chrome, using equalization alone for compensation; and at first few manufacturers adopted the new record/play equalization that makes the most of chrome's inherently "hotter" high end.

In contrast to some other tape companies, 3M is not promoting its chromium dioxide cassette over its ferric oxide lines. True to 3M's long-standing dictum that its best ferric tapes already offer the performance of

chrome without its special bias and/or equalization requirements, a spokesman says: "Chromium dioxide occupies the same plane as our top-of-the-line iron oxide Scotch High Energy tape. Basically, if a person has paid an extra \$30 or so for a chrome switch on his cassette deck and wants to use it, we now have a tape for him."

CIRCLE 157 ON READER-SERVICE CARD

For Want of a Resistor

With alarming frequency over the last year or two we have been told that this or that new model had not reached production because one or more key parts were back-ordered from a supplier. Transistors, capacitors, resistors—all sorts of small but critical electronic "ingredients"—may take six months (sometimes as much as eighteen months) for delivery to an equipment manufacturer.

To meet new product needs some companies are reportedly diverting circuit components originally intended for dealers' repair stocks, meaning that even if you can buy the unit you want, you may have trouble getting it fixed. If the dealer can't get the parts, there may be a long wait in the shop for your ailing equipment.

Small dealers may find it more difficult to satisfy customer repair orders than larger ones, who can cannibalize parts from a greater number of nonfunctioning sets. Normally these sets would be returned to the manufacturers for credit, but dealers may figure that customer service is worth more than what they'll lose by not returning the equipment.

There are some signs that the situation is easing,

though perhaps that is because equipment manufacturers are learning to plan farther ahead than they used to. But delays because of parts shortages probably will be with us for some time.

More Dolby on 8-Track

Earlier this year Ampex Music Division began offering Dolbyized cartridge albums on a selected basis, further chipping away the old audio industry truism that nobody who buys 8-track is interested in Dolby. (Columbia began Dolby processing last year; see N&V, November 1973.)

Initial releases are limited mainly to classical and easy-listening titles, and Ampex says it has no plans at this time to Dolbyize all its 8-track releases. The company adds, "We will incorporate the Dolby system where the products will gain significant improvement from the process."

Coincidental to Ampex's move, Wollensak and Superscope both have begun distributing Dolbyized 8-track cartridge models—the first such units available.

One Cassette Motor Too Many?

The evolution of cassette tape equipment from simple voice recording devices to audiophile status included the adoption of many open-reel features. For example the single drive motor gave way to three motors. Now a Woodside, New York manufacturer of cassette transports says three motors are one too many.

The Amilon Corp. is among the companies offering two-motor systems with one reel motor and one capstan

motor. The company says this design is "functionally superior," arguing that in three-motor systems, where a motor is permanently attached to each reel hub as well as the capstan, the tape must pull the rotor of the unused reel motor. Stronger open-reel tape will tolerate this, the company says, but cassette tape may stretch and slip at the capstan. Amilon's system uses a single reel motor to drive both hubs, powering only the hub onto which the tape is winding and optimizing hold-back tension, as needed, on the other.

While we haven't heard any specific complaints from owners of three-motor cassette units and have encountered no tape damage attributable to excessive feed-hub drag in the three-motor gear we've used, Amilon's claim does raise a question: Do we assume too glibly that what's great in one format will be good in all?

Pops Tops

What kind of music and equipment do car stereo system owners prefer? Two companies (GRT Corp. and Pioneer Electronics of America) found some surprising results in a recent survey of some 2,390 car stereo buyers.

So-called top-40 music was preferred by 61% of the respondents, as compared to easy listening (8%), r & b (7%), country and western (4%), and classical (2%). What surprised everyone about the overwhelming top-40 preference was the educational level of the respondents—more than 50% had college degrees, with 7% having postgraduate degrees. The assumption had been that people with this level of education would purchase car tape units to get away from the top-40 sameness of most AM and FM stations.

The survey also showed 8-track units favored over cassettes for automobile use, 54 to 14%, with 21% interested in quadriphonic cartridge models.

equipment in the news



Cassette deck with "automatic program finder"

Sharp is offering its first Dolby cassette deck. The RT-480 features an automatic program finder that locates the beginning of musical selections in either fast-wind mode by stopping at the blank spots between selections. The tape-selector switch has positions for chromium dioxide, low-noise, and "normal" oxides. Other features include full automatic shutoff in all modes just before the tape runs out, and top-panel jacks for

headphones (a stereo plug) and mikes (RCA pin jacks). A dust cover is included in the \$240 price.

CIRCLE 152 ON READER-SERVICE CARD



Marantz's top four-channel amp

The newest addition to the broad Marantz line of amplifiers is the Model 4140. Designed as a stereo/quad unit, it is rated at 25 watts of continuous power per channel in four-channel operation and at 70 watts per channel when bridged for stereo. Like all Marantz quadriphonic units it incorporates a unique "pouch" for an optional SQ decoder. In addition, a Vari-matrix dimen-

sion control allows altering of the separation when decoding other matrixed sources or when simulating four-channel from two-channel sources. The unit has traditional Marantz styling and includes controls for loudness, high filter, and two tape/source monitors. A mid-range tone control is provided; a remote four-channel "joystick" balance control is available. The unit costs \$549.95; an optional walnut cabinet costs \$32.50.

CIRCLE 146 ON READER-SERVICE CARD



Energizer restores lost frequencies

Pro Line Electronics, Inc., of Phoenix,

KLH is well into its second decade of manufacturing extraordinary high performance loudspeakers that don't cost an extraordinary amount of money. We've kept costs down by making every loudspeaker ourselves. And by selling a staggering number of them.

In short, we've had a lot of practice.
And that's perfect for you.

For now you can own a pair of our new Model Thirty-One loudspeakers for just \$89.95†. Think of it. Two superb sounding full-range loudspeakers at a price you might consider fair for just one! A pair of Thirty-Ones deliver a truly inordinate amount of sound for their modest size. You can drive them to big listening levels

with virtually any decent amplifier or receiver. They're handsome, featuring a new sculptured acoustically transparent foam grille. Rugged. And best of all, incredibly inexpensive. With the money you save, you might even trade-up to a better turntable or receiver, perhaps even get into quadraphonic sound. The Thirty-Ones can help make it happen. A pair is at your KLH dealer now. Listen to them soon. We're sure you'll agree that no one has ever offered you a better value in sound.

And we've had a lot of practice.

For more technical information, write to KLH Research and Development, 30 Cross Street, Cambridge, Mass. 02139. Or visit your KLH dealer.

What does it take to make an important new loudspeaker and sell it for \$89.95[†] a pair?

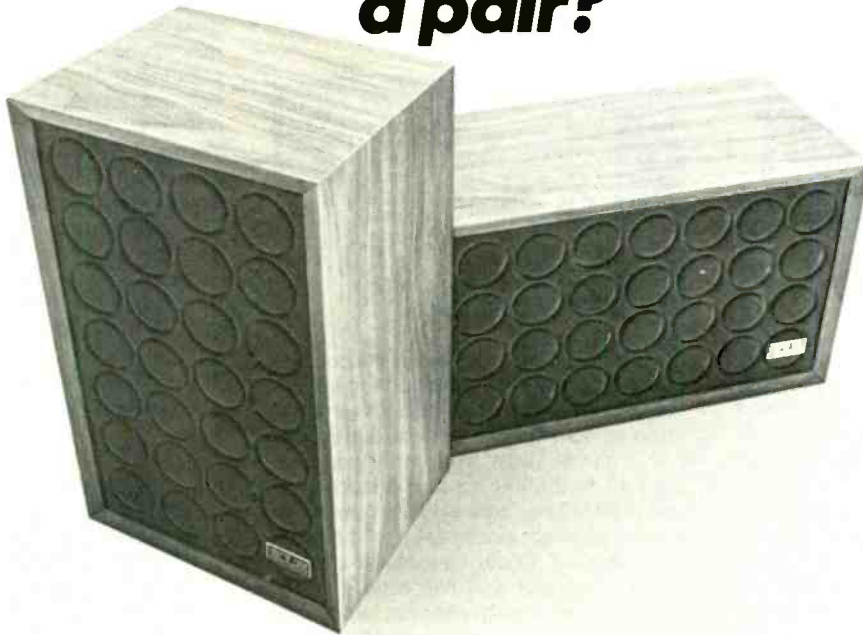

Practice. A whole lot of practice!



KLH RESEARCH AND DEVELOPMENT CORP.
30 Cross St., Cambridge, Mass. 02139

†Suggested retail prices—slightly higher in the South and West.

CIRCLE 21 ON READER-SERVICE CARD

Arizona, is a new name in the high fidelity field. Its Model 201 frequency energizer is designed to improve on conventional tone controls or equalizers in solving the problems of high- and low-frequency rolloff inherent in speaker response, room absorption, and so on. The compact unit provides six low-frequency boost positions in 3-dB steps up to 18 dB and a choice of six high-frequency contours. Basic response is specified as flat within 1/4 dB from 20 to 20,000 Hz with less than 0.5 per cent THD at any frequency across the range and at 0.5-volt continuous output, for a 90-dB S/N ratio. A tape/source monitor switch is provided so that the unit can be connected to the tape jacks of a receiver or integrated amp and the tape equipment outboarded from the energizer, which costs \$89.95.

CIRCLE 147 ON READER-SERVICE CARD



Slim-line Dolby open-reel deck begins new Teac series

The Model 5500 Dolby deck from Teac is the first in a new series of slim-styled open-reel models with DC motors. Most of the features of the previous Model 4300 have been retained in both the 5500 and the 5300, also introduced recently. The key changes are a Dolby circuit in the 5500 and the direct servo-controlled DC drive system in both units. Dolby features include recording with simultaneous decoded tape monitoring, FM decoding, direct copying of Dolby-encoded tapes, and calibration oscillator. A foil-sensing system allows auto reverse in playback. The unit has Permaflux heads for play, reverse play, record, and erase. Other features are IC logic controls; two-step pinch-roller action, which allows partial retraction during pause and therefore almost instantaneous start-up; separate bias and equalization switches; a meter switch for matching the meter scale to tape characteristics; complete remote control; and "memory" indicators for setting predetermining levels. The 5500 costs \$899.50.

CIRCLE 153 ON READER-SERVICE CARD

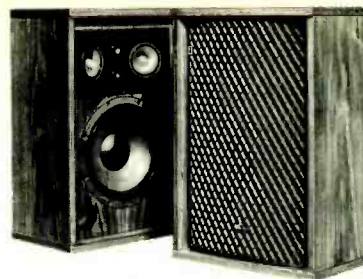

A wide-dispersion speaker from Sansui

The Sansui SP-1700 speaker system has been designed around two 4-inch midrange drivers and two 2-inch cone tweeters placed at angles in the cabinet to increase their dispersion. The 12-inch woofer is inherently unresponsive to high frequencies, according to Sansui, obviating conventional crossover parts that inhibit good damping. A three-step control is provided for the tweeters and midrange drivers. Response is stated as 30 to 20,000 Hz, with crossovers at 700 and 6,500 Hz. The duct bass-reflex design can handle 70 watts, the company says, and is enclosed in a natural walnut cabinet. The SP-1700 costs \$180.95.

CIRCLE 148 ON READER-SERVICE CARD



Sony adds low-cost amplifier

Sony continues to broaden its components line with the introduction of the TA-1066 amplifier. This budget model is rated at 15 watts of continuous power per channel, with frequency response from 40 to 20,000 Hz and distortion at less than 0.8 per cent at rated power. An automatic-reset circuit breaker protects the speakers. Features include a front-panel aux input and two tape monitor circuits. Both conventional and DIN tape connections are provided. The price is \$149.50.

CIRCLE 149 ON READER-SERVICE CARD



Frequency dividing networks offered

Two electronic frequency dividing networks have been added to JBL's Professional Series. The 5231 (\$165) is for

single-channel use and the 5232 (\$198) for dual-channel use with bi-amplification or tri-amplification. Crossover frequencies are determined by inserting printed circuit cards into each channel's circuitry. Cards are available for 250, 500, and 800 Hz, and 1.2 and 5 kHz; blank cards cost \$15. Performance is rated at less than 0.5 per cent THD and greater than 90 dB S/N. Features include a high-frequency shelving control and a 12-dB per octave filter slope.

CIRCLE 150 ON READER-SERVICE CARD



A high fidelity AM-only tuner

The McKay Dymek Co. of California has introduced an AM-only tuner that, to the best of our knowledge, is unique. The AM-3 is designed to rectify everything you always disliked about AM reception. The key controls are for "broad" and "sharp" bandwidth/selectivity and for "local" and "distant" sensitivity. With distant settings, sensitivity is rated at 3 microvolts for bare minimum (10 dB) quieting (nothing to rave about in FM, but impressive for AM). The "sharp" button selects a 3-kHz bandwidth, while "broad" opens the bandwidth to 8.7 kHz. Output circuitry includes a sharp notch filter tuned to 10 kHz to attenuate adjacent-channel heterodyne whistles. And the antenna input circuit incorporates adjustable rejection of signals interfering in the IF stage. The AM-3 costs \$255 and is available with a specially designed frequency-matching AM antenna (DA-3) for an additional \$127.

CIRCLE 151 ON READER-SERVICE CARD

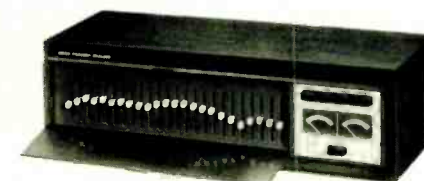

Frequency equalizer added by BSR

BSR has introduced the FEW-3, its third frequency equalizer. This model covers twelve octaves with a separate control for each octave in each channel. VU meters are provided for each channel. Distortion is rated at less than 0.007 per cent and S/N ratio at 80 dB. The circuitry allows equalization during recording. A translucent flip-down front panel protects the frequency level settings. The price of the unit had not been announced at press time.

CIRCLE 155 ON READER-SERVICE CARD

AT THE TIME OF WRITING THERE IS NO OTHER RECEIVER LIKE THIS IN THE WORLD.

This Harman/Kardon 800+ multichannel receiver can handle every kind of monaural, stereo, and four-channel system on the market today, and in the foreseeable future.

It has a CD-4 discrete system built in. Not the standard, off-the-shelf system everyone else uses. This we designed ourselves. It's more efficient, more compact, and it sounds better than anything else made.

The 800+ also has a matrix system. Built in. Also using a new circuitry design. And although we designed it for SQ, it will, in fact, play all current matrix systems.

In the quadraphonic mode, the 800+ delivers an amazing 22 watts per channel. And it delivers them throughout the entire audible spectrum of 20Hz to 20KHz.

If you hate to see your stereo records lying idle, turn the mode selector to 'Enhanced Stereo'.



A unique phase-shift network launches your stereo record library over again with a completely new sound.

The 800+ has Harman/Kardon's traditional ultra-wideband circuitry. And as a result, the best phase linearity, square wave response and, many say, the best sound in the business.

We've always cared most about that. It's nice to have bench test numbers to back up our sound story, but in the end you buy a receiver to listen to music not math.

The Harman/Kardon 800+ comes from a good blood line.

Twenty years ago we produced a receiver that was also like no other in the world.

The first one.

harman/kardon

Harman/Kardon Inc., 55 Ames Court, Plainville, N.Y. 11803, U.S.A. Also available in Canada.
CIRCLE 14 ON READER-SERVICE CARD

This year only 1200 perfectionists will satisfy their pursuit for excellence.

The new Ferrograph Super Seven takes its place alongside the finest high fidelity components in the world. Admittedly, it's not for everyone. Just the limited few who are able to recognize and appreciate its unexcelled capability for professional performance in the home.

The Super Seven achieves new heights in innovative tape recording with more than thirty advanced features including:

Exclusive variable speed wind and rewind—10½-inch reels—3 speeds: 1⅞, 3¾, 7½ ips or 3¾, 7½, 15 ips—Dolby B (on request with either speed configuration)—professional electronic editing—

instant slur-free starts in record/playback—bias adjustment on front deck—pushbutton tape/source comparison—bias reading and tape track transfer.

The choice of professional broadcasters and musical perfectionists the world over, Ferrograph Super Seven is not merely the best of its kind—it's the only one of its kind.

A visit to your Ferrograph dealer will convince you. Or write to: Elpa Marketing Industries, Inc., New Hyde Park, New York 11040 / 7301 East Evans Road, Scottsdale, Arizona 85260.



New Super Seven Ferrograph
Total versatility with tape.



by Larry Zide and Michael Marcus

Should You Buy a Manual or an Automatic Turntable?

If today's record changers are so good and so convenient, what are the advantages of a manual turntable?

ONCE AGAIN WE address ourselves to the perennial question: Which is better, a manual turntable or an automatic changer? While we would like to put this argument to rest, we may only fan the fires of controversy. But we can, at least, shed some light on the operative factors that will determine your own personal answer to that question.

Let's begin with some definitions. The simple terms *manual* and *automatic* no longer have clear meaning. There are several types of turntable systems available. The first and simplest is the separate component system that consists of a turntable platter and drive, tone arm, and phono cartridge, each of which can come from a different manufacturer (though all can be from the same one of course). Whether or not the turntable is supplied with a tone arm already mounted, the product is a *manual turntable*; that is, the tone arm and cartridge must be set down manually at the lead-in groove and (usually) removed and returned manually to the at-rest position at the end of play.

At the other end of the spectrum are the changers. But that word *changer* often has been construed as something inferior, and it now is absolute dogma among advertising and public-relations people that any changer selling for more than \$35 must be called an "automatic turntable" or an "automatic transcription turntable" (why not an "electromagnetically engineered music sequencer and retrieval system"?)—but never a changer.

Now a number of manufacturers have added automatic features to what used to be called a manual

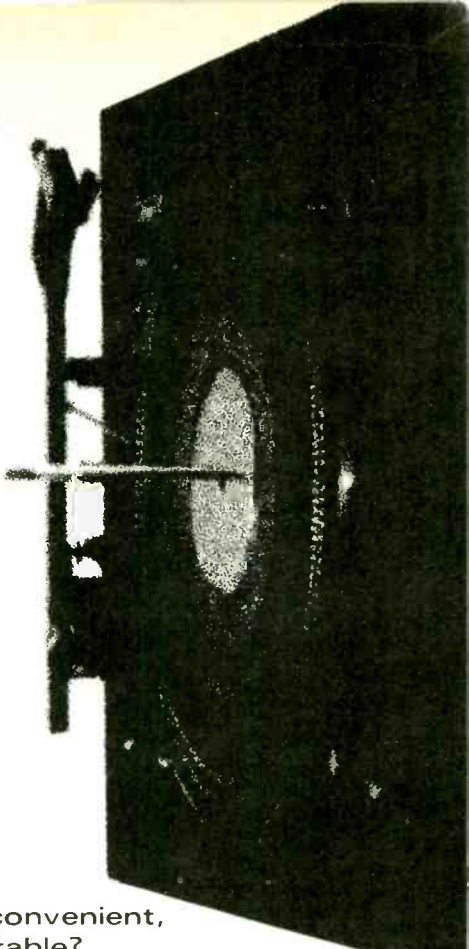

and sold as an integrated system—a turntable and arm on a base. The system may find the opening groove of the record by itself (on command), play the record, and at the conclusion raise the arm and return it to rest, shutting off the system. In short this manual behaves like a changer except that it doesn't change records. It is, in fact, an automatic turntable, although that term already had been pre-empted by the changer manufacturers. There are, of course, *degrees* of automation available; what one manufacturer calls an automatic another may consider a manual with special features.

So here is the terminology we'll be using for the remainder of this article. The separate component system—platter, tone arm, etc.—is a *single-play manual*. It doesn't matter whether you buy tone arm and platter separately or the manufacturer has pre-assembled them for you. If there is automatic cueing and shutoff, the system becomes a *single-play automatic*. If it can also play a succession of records without manual intervention, we can call it a *multiple-play automatic*—or a *changer*. So much for semantics.

Man vs. Machine vs. Music

Few contemporary audiophiles will dispute that transistors are better than tubes, that a printed circuit is better than a hand-wired chassis, or that stereo is preferable to mono. But the "old" manual turntable has never really lost its place in the sun

despite the popularity and genuine quality of today's record changers, and single-play equipment is more plentiful and more popular than ever.

Proponents of manual turntables are almost reduced to tears—or perhaps ironic laughter—by the thought that any music lover would risk the life of a beloved recording and suffer untold sonic misery by choosing the cushy convenience of mechanized disc switching. The automated opposition says that the manual manipulators are ignorant, stuffy old snobs; that the conservative approach might have been justified thirty, ten, or even five years ago, but that the modern changer actually handles records more gently than even the steadiest of hands; and that any difference in performance between a good manual and a good changer exists only in the oscilloscope or in the head, not in the ear.

Manufacturers' research sheds some interesting light on the buying habits of their customers. Most purchasers seem to decide whether to buy a manual or a changer before entering the store and are not swayed in this respect by the audio salesman.

While a majority of the purchasers of manuals seem to feel that changers as a group are inferior to manuals, advertisements for manuals seldom if ever try to build on this feeling by exposing the "evils" of changers. They just talk about motors and arms. And the changer ads, in turn, hardly ever mention the most obvious advantage of a record changer: You can relax—or entertain—with non-stop music without having to flip the disc or turn off the motor when the music is finished. Maybe it's an obvious advantage, but it's a big one and not the kind of thing advertising agencies usually ignore. You may have noticed that before a manufacturer has a picture taken to help sell one of his "automatic turntables," he generally incapacitates it as a changer by unceremoniously yanking off the deft six-inch automatic spindle and substituting an impotent little one-inch stub to further the manual masquerade.

Some statistics make it look as though consumers are being tricked into buying changers that they think are manuals. Thus perhaps as many as one-third of the purchasers of respected and expensive changers—selling in the price range of many manuals—never use them with a stack of records. And only one changer in twenty-five is used as a changer at least ninety per cent of the time, according to some data.

Of course these people *aren't* fooled; they know what they're buying. They choose a changer primarily to have a machine that cues the tone arm and shuts itself off. What these people really want is a single-play automatic turntable; they either didn't know such a thing exists or couldn't find one to suit their needs and budget. Further data seem to confirm this: In a check of one group of music lovers who had replaced their changers with a man-

ual model, only five per cent are said to miss the stack loading, but more than half miss the other automated functions.

Simplicity has great appeal. Many people believe that changers are too complex to give good results. And the interrelation of man and machine does in fact play a big part in the choice of a record player.

Manuals appeal, for example, to those who fundamentally mistrust machines. ("Index fingers were made before arm-cycling cam-and-lever systems.") They also appeal to anyone who wants to be master of his own phonographic fate, so to speak, by mating separate tone arms and turntables. The parts matchers can't hear the difference, but they feel better knowing they're *involved*. Then, too, music is pleasure; and the puritanical instinct makes us think we must labor to be worthy of pleasure. We've all been taught that the things we appreciate most are those for which we work hardest. Perhaps some users "jes' don't hanker after them new-fangled contraptions." Closely related to this attitude is the back-to-nature bit: Euell Gibbons, natural food, and bicycling. The success of the ultra-simple AR turntable may be related to these values, though its relatively low cost surely helps. Thorens is another no-nonsense brand that has been with us for years, as has Empire.

Snob appeal is very important. While you don't have to spend \$400 on a manual, you *can*. Professionals, the ads say, use manuals. Play disc jockey; win fame, fortune, and women. You never see a manual turntable in a console stereo, and everyone knows how lousy *they* are.

And, of course, there's something almost universally sensuous about the engraved top plate on the Technics SL-1100, the wood base on the Pioneer PL-61, the hefty platter on the Sony PS-2251, and the fresh-from-the-drag-strip tone arms on all three. Even simple manuals can be very sexy. The tone arm on the Philips GA-212 is spare and elegant, and it has those incredible illuminated cat's eye speed-change buttons that are so sensitive they can be activated by a trained flea. At the other extreme, Rabco's separate, motor-driven radial arm (its integrated turntable/arm has been withdrawn) is among the most glamorous pieces of hi-fi gadgetry ever offered—to say nothing of the perfectionism implicit in its tangent tracking. The nipple-studded Transcriptors "platter" is one of the most individual. Some of the newer designs seem even more sophisticated: the Beogram 4000 (not yet offered in this country) and units expected from Janszen and SSI (both of which are included in the accompanying table on the basis of advance information supplied by the manufacturers). Also off the drawing board by the time you read this should be a design of sophisticated simplicity from Win Laboratories using a dual-motor drive system

(claimed to make wow and rumble factors in its conventional idler drive largely self-canceling) and a wooden tone arm of unusual design.

But in considering the ways in which manuals—or at least single-play equipment—can appeal to the prospective purchaser, and the hang-ups and clichés that go with that appeal, don't forget that this equipment generally has real merit. That's the thinking man's reason for choosing it. Is it also the listening man's reason? Thereby hangs a technical tale.

Changer Performance

In the ongoing debate about technical differences between single-play and multiple-play systems, the question to be answered is: How does the multiple-play feature influence performance? It once was a rule of thumb that stacking records is harmful to them: They grind against each other and thus become scratched and worn. Certainly this used to be true. But modern records all have raised edge beads and center labels, so they do not touch in the groove area at all. Stacking today's records does not harm them—unless they are allowed to sit atop the changer spindle for inordinate lengths of time, gathering dust and warps.

But does playing by the stack get the finest sound from the grooves? Let's assume the changer drive develops enough platter torque so that the maximum stack still has no effect on turntable speed or flutter. This is easily achieved in modern designs. But when the arm/cartridge combination plays the records, it is tracking each one in the growing stack at a progressively changing vertical tracking angle. Most record changers are designed so that the third or fourth record in the stack is perfectly tracked, thus creating some error at other stack heights but avoiding severe errors on the first or sixth record.

The changes in vertical tracking error as a good changer plays a stack are certainly documented, and test records often will reveal differences in distortion as the angle changes. But there is a serious question whether these measurable phenomena are *audible*. Again, most records are played in the single-play mode even on changers. If vertical tracking angle is optimized for the third record, rather than the first, performance in the single-play mode is less than optimum to this extent. Some of the best changers, however, have a cartridge or arm adjustment by which you can change the vertical tracking angle to optimum for single play. Garrard and Elac do it by adjusting the angle of the cartridge in its mount; Dual has a mechanism to raise the arm pivot and compensate for the higher stylus position atop the stack.

In early changer designs there also was a problem of vertical tracking *force*. The highly nonlinear springs that were used to apply tracking force did

not apply the same force at the top of a record stack as they did in playing the first record. As we will show, this no longer is a significant problem.

What happens to the changer when you remove the long spindle, and replace it with the stub, for single-play operation? It becomes, in effect, a single-play automatic; the turntable now can be compared to single-play manual systems on a point-for-point basis.

Turntable Drive Systems

There are three kinds of systems used for driving turntable platters. The first type, used on all multiple-play and some single-play units, is the high-speed motor driving an intermediate idler, which in turn presses against the platter's edge. This system permits speed change by using different motor-shaft diameters and positioning the idler so it will contact the portion with the appropriate diameter. And if the individual portions are angled slightly (that is, made slightly conical instead of cylindrical), the idler can be moved up and down, varying the effective shaft diameter and achieving vernier speed "tuning."

The second system is belt drive. In this approach, a belt from the motor shaft drives the platter by simply going around it. The designer calculates dimensions so that the small high-speed shaft of the motor drives the large-diameter platter at the correct speed. Speed can be changed by shifting the belt from one pulley on the motor shaft to another of different diameter, but it also can be changed by altering the speed of the motor. The first method is mechanical while the second is electrical, but they can be equally convenient. Gross vernier speed changes are not easily accomplished with a manual belt-shift system but are simple with electrically controlled motors. Past attempts at marketing belt-driven changers have not been very successful, though some automatic features are beginning to appear on belt-driven units, as the table shows.

The third system—and the newest—is direct drive. In this system, special and relatively sophisticated electronically controlled motors of AC or DC designs are used. The motor's shaft, in effect, terminates in the spindle at the top of the turntable platter; the motor and the platter turn as a unit and therefore at exactly the same speed, with the platter acting as the motor's flywheel. The platter has some flywheel effect in any turntable system, of course; the big advantage of direct drive lies in its obviating intervening belts and idlers. Direct-drive turntable systems are available as manual or automatic single-play models, but none are changers.

Changers all use the idler system because the modern spindle for changing records requires under-platter operating parts that reach the spindle where it extends downward through the center of

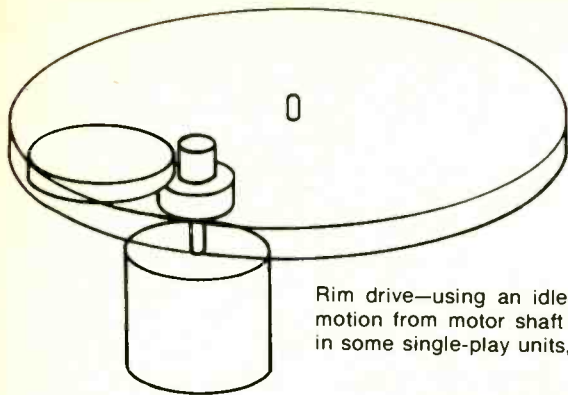

Rim drive—using an idler wheel to transmit motion from motor shaft to platter—is found in some single-play units, all changers.

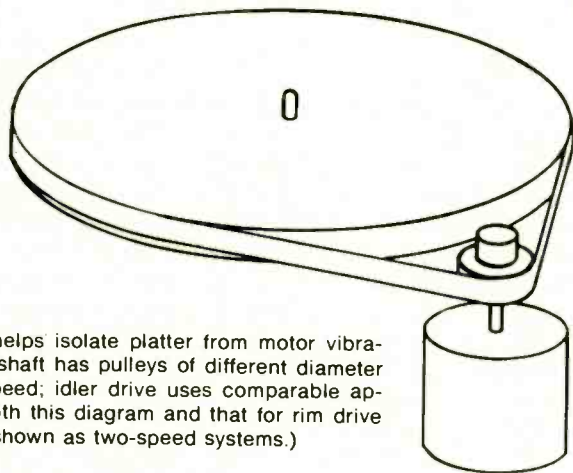

Belt drive helps isolate platter from motor vibration. Drive shaft has pulleys of different diameter for each speed; idler drive uses comparable approach. (Both this diagram and that for rim drive above are shown as two-speed systems.)

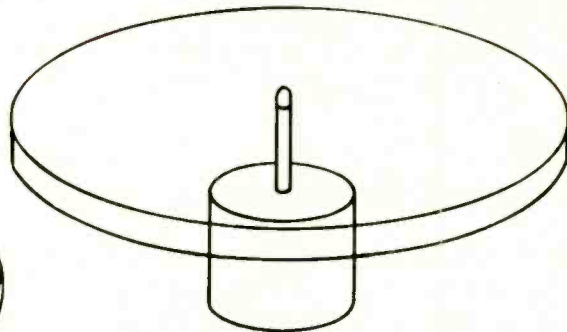

Most recent—and most sophisticated—is direct drive. Platter is connected directly to motor shaft and both turn together. Speed of motor itself must be changed to alter playing speed; control is electrical rather than mechanical.

the platter. This can be managed in a belt-driven system, but so far we've seen no attempt at it with direct drive since the motor shaft is directly under the center of the platter, leaving no ready access for spindle linkages.

Flutter and rumble are problems associated with platter-and-drive operation. Manufacturers' specs for the recently introduced direct-drive systems suggest—and initial tests seem to confirm—that they are setting new standards for low flutter and rumble. Good belt and idler systems seem to be on a par with each other in terms of best available performance. Both have achieved such good levels that further improvement as realized by the new designs is largely academic in practice. You just can't hear better performance than the already-inaudible rumble capability of many of today's best single-play and multiple-play systems. The same is true of flutter. There is probably more flutter to be heard in the tape master from which the disc was cut than in the turntable that is playing it.

Still, there *are* qualitative differences. Good single-play systems use bearings superior to the kind available to multiple-play systems. A unit designed only for single-play operation can run on a single large-surface ball bearing, whereas a changer must run on a number of smaller bearings in a circular ball race that must be outside the diameter reserved for the changer spindle. One would expect greater durability from the single bearing. And since the bearing will last longer, the

system using it will—all else being equal—maintain its performance longer. Of course, both idlers and belts need periodic replacement since they wear and become deformed or deteriorated with age. Direct-drive systems suffer none of these ills.

The Tone Arm

In tone arm design today, only two systems of achieving tracking force are used. In one, the arm is balanced longitudinally (front-to-back, like a seesaw) and sometimes laterally (side-to-side, like a tightrope walker) and then tension is dialed on a spring that pulls the arm and stylus down against the grooves. In the other system, no spring is used, but the arm is first balanced and then a small calibrated weight is used to unbalance it for the requisite tracking force. Terms like "statically balanced" and "dynamically balanced," though frequently used in advertising, are both obscure and inexact; we'll avoid them.

A properly designed modern spring system, particularly if it is the clock-spring type mounted exactly at the fulcrum, is sufficiently linear in operation so that there is no measurable difference in tracking force between the first and last records of a stack. This is the kind of arm that manufacturers like to show in use upside down—for those who are willing to glue their records onto the platter.

Continued on page 41

Manual Single-Play Turntables

Manufacturer (Distributor)	Model	Price	Motor type/ Drive system	Tone arm	Antiskating	Built-in strobe	Vernier adjust.	Speeds	Cartridge	Base	Dust cover	Comments
Acoustic Research	XA	99.95	Belt drive	*				2		*	*	Tracking-force gauge supplied.
	XB	109.95	Belt drive	*				2		*	*	Similar to model XA, but includes cueing lever.
Connoisseur (Hervic Electronics, Inc.)	BD/2 Mk.IV	139.95	Synchronous/ Belt drive	*	*			2		*	*	Hydraulic cueing; VTF gauge, lubricant, belt dressing included.
Empire	598 III	399.95	Synchronous/ Belt drive	*	*	*	6%	2	*1	*	*	(1) Empire 4000D/III four-channel cartridge with "4-Dimensional" stylus. Includes cueing control with record light.
Hitachi	PS-33	249.95	Synchronous/ Belt drive	*	*			2	*	*	*	Lateral balance control.
JVC	VL-5	109.95	Synchronous/ Belt drive	*	*			2		*	*	End-of-disc arm-up function.
Lenco (Benjamin Elec. Sound Co.)	L-75	149.50	Induction/ Idler	*	*			4 ¹		*	*	(1) Continuously variable speeds from 30 to 88 rpm.
	L-85	249.50	16-pole synchronous/ Belt drive	*	*	*	6%	2		*	*	Electronic shutoff and arm-lift.
	L-78	179.50	Induction/ Idler	*	*			4 ¹		*	*	(1) Continuously variable speeds from 30 to 88 rpm. Includes electronic shutoff and arm-lift.
Philips	GA-212	179.50	DC servo/ Belt drive	*	*	*	6%	2		*	*	Motor shuts off at end of disc.
Pioneer	PL-12D	99.95	4-pole synchronous/ Belt drive	*	*			2		*	*	Stylus-overhang adjust. Low capacitance leads for CD-4 cartridges.
	PL-51	249.95	DC servo/ Direct drive	*	*	*	4%	2		*	*	Low capacitance leads for CD-4 cartridges.
	PL-61	299.95	DC servo/ Belt drive	*	*	*	4%	2		*	*	Arm-height adjust. Built-in turntable level.
QRK	12/C	199.50	Synchronous/ Direct drive					3 ¹				(1) Includes 78 rpm. Shelf base, \$24.95.
	16/S	250.00	Synchronous/ Direct drive					3 ¹				Similar to Model 12/C, except has 16-inch platter. (1) Includes 78 rpm. Shelf base, \$29.50.
Rek-O-Kut	CVS-12	169.50	Synchronous/ Direct drive					4 ¹				(1) Continuously variable speeds between 16 and 100 rpm. Shelf Base, \$24.95.
	CVS-12S	255.00	Synchronous/ Direct drive	*1				4 ²	*3	*		(1) Model S320. (2) Continuously variable speeds between 16 and 100 rpm. (3) Model F-3.
	B12-71	199.50	Synchronous/ Direct drive					3 ¹				(1) Includes 78 rpm.
Sanyo	TP-805A	Under 200.00	Synchronous/ Belt drive	*	*			2		*	*	Automatic arm return.
Sony	PS-2251	349.50	AC servo/ Direct drive	*	*	*	8%	2		*	*	
	PS-1100	109.50	4-pole induction/ Belt drive	*				2	*1	*	*	(1) Magnetic cartridge, 0.5-mil spherical stylus. Automatic arm return.
	PS-5550	249.50	Synchronous/ Belt drive	*	*	*	8%	2		*	*	Automatic arm return.

Manufacturer (Distributor)	Model	Price	Motor type/ Drive system	Tone arm	Antiskating	Built-in strobe	Vernier adjust.	Speeds	Cartridge	Base	Dust cover	Comments
Technics by Panasonic	SL-1200	279.95	DC/ Direct drive	*	*	*	10%	2	*	*	*	Stylus-overhang adjustment.
	SL-1100A	359.95	DC/ Direct drive	*	*	*	10%	2	*	*	*	Similar to Model SL-1200 except larger motor, slightly heavier platter, slightly greater pivot-to-stylus distance for lower tracking-angle error. Base, \$29.95.
	SP-10	419.95	DC/ Direct drive			*	4%	2			*	Base, \$49.95. Dust cover, \$29.95.
Thorens (Elpa Marketing)	Mark II Series TD-125	280.00	Electronically-controlled, 16-pole synch/ Belt drive			*	4%	3 ¹			*	(1) Includes 16 rpm. Base, \$17.50. Dust covers, \$17.50 and \$35.
	Mark II Series TD-125AB	400.00	Same as above	*	*	*	4%	3		*	*	Identical to Model TD-125, except includes tone arm and base.
	TD-160C	250.00	16-pole synchronous	*				2		*	*	
Toshiba	SR-40E	199.95	16-pole synchronous/ Belt drive	*	*			2	* ¹	*	*	(1) IC cartridge C-300FA, 0.7 mil spherical carborundum stylus N-300C. Includes built-in preamp. No VTF adjustment.
	SR-80	299.95	16-pole synchronous/ Belt drive	*	*			2	* ¹	*	*	(1) Model C-402S electret condenser cartridge, Model N-402SD 0.5-mil spherical diamond stylus. Built-in preamp.
	SR-50	449.95	DC servo/ Belt drive	*	*			2	* ¹	*	*	(1) Model C-100P photoelectric cartridge, Model N-100E 0.3 by 0.8 mil diamond elliptical stylus. Built-in preamp.
Transcriptor (Audiophile Imports)	Hydraulic Reference	475.00 ¹	Synchronous/ Belt drive	* ²	*	*	10%	2 ³		*	*	(1) Includes stylus brush. Available without tone arm, brush for \$360. (2) Non-integrated, pivoted, silicone-damped tone arm with removable lightweight shell. (3) 78 and 16 rpm optional. Record sweep brush and stylus brush, \$17.95 each.
Win Labs	Lab	150.00	Synchronous/ Idler	*				1 ¹		*	*	(1) 33 rpm only. Two-motor drive. Auto start and stop; manual cue. Dust cover optional.

Automated Single-Play Turntables

Manufacturer (Distributor)	Model	Price	Motor type/ Drive system	Tone arm	Antiskating	Built-in strobe	Vernier adjust.	Speeds	Cartridge	Base	Dust cover	Comments
Bang & Olufsen	Beogram 3000	265.00	Belt drive	*		*	6%	2	* ¹	*	*	(1) SF-12 elliptical.
Dual (United Audio Products, Inc.)	701	399.95	Direct drive	*	*	*	16%	2		*	*	Stylus-overhang adjustment. Two mechanical anti-resonance filters in counter-balance housing.

Note: All tone arms are integrated, pivoted models, unless otherwise stated.

All models have VTF (Vertical Tracking Force) adjustments, unless otherwise noted.

Vernier adjustment shows total range (6% = ±3%).

"2" speeds means 33 and 45 rpm; third speed specified in comments; "4" means 78, 45, 33, and 16 rpm.

Radial tone arms obviate need for antiskating adjustment.

Manufacturer (Distributor)	Model	Price	Motor type/ Drive system	Tone arm	Antiskating	Built-in strobe	Vernier adjust.	Speeds	Cartridge	Base	Dust cover	Comments
JansZen	Hydrostatic	500.00	DC servo/ Belt drive	*1	*			4 ²	*	*	*	(1) Integrated, radial tone arm. (2) Continuously variable speed from 0 to 99 rpm. Air-supported turntable platter.
Panasonic	SL-750	159.95	Induction/ Idler drive	*1	*			3 ²	*3	*	*	(1) Integrated, radial tone arm. (2) Includes 78 rpm. (3) Model EPC-451C semiconductor cartridge with "Quadratip" stylus. Iron turntable.
	SL-850	199.95	Induction/ Idler drive	*1	*			3 ²	*3	*	*	(1) Integrated, articulated tone arm. (2) Includes 78 rpm. (3) EPC-450C-II cartridge with "Quadratip" stylus. Die-cast turntable.
Philips	GA-209	349.50	DC servo/ Belt drive	*	*	*	6%	2		*	*	Placing disc on platter automatically starts unit, selects speed, initiates play. Automatic arm return and shutoff. Capacitance switching activates cueing.
Pioneer	PL-A35	149.95	4-pole synchronous/ Belt drive ¹	*	*			2		*	*	(1) Separate motor for tone arm. Low-capacitance leads for CD-4 cartridges.
Sansui	SR-212	149.95	4-pole synchronous/ Belt drive	*	*			2		*	*	Automatic arm return. Bi-directional damped cueing.
Sony	PS-5520	159.50	Synchronous/ Belt drive	*	*			2		*	*	
Sound Systems International	MM-3000	325.00	Synchronous	*1				2		*	*	(1) Integrated radial tone arm.
Yamaha	YP-700 ¹	239.95 ¹	Synchronous/ Belt drive	*	*			2	*2	*	*	(1) In June YP-700 will be offered with minor cosmetic changes and without cartridge for about \$200. (2) Audio-Technica AT-12 cartridge with 0.7 mil spherical stylus. Includes stylus-overhang adjustment, lateral tone arm balance. Auto Return/Mute System mutes audio at end of disc, lifts arm, and returns to rest, shuts power off; audio muted until stylus touches lead-in groove. Oil, two screwdrivers, record-cleaning pad, dust cover cleaner, 45-rpm adapter, and tweezers supplied.

Automatic Multiple-Play Changers

Manufacturer (Distributor)	Model	Price	Synchronous Motor	Tone arm	Antiskating	Built-in strobe	Vernier adjust.	Speeds	Cartridge	Base	Dust cover	Comments
BSR	710/X	149.95	*	*	*	*1	6%	2	*2	*	*	(1) Strobe center; disc supplied. (2) Shure M91E cartridge, elliptical stylus. Six-disc capacity.
	810/X	199.95	*	*	*	*	6%	2	*1	*	*	(1) Shure M91ED cartridge, elliptical stylus. Similar to Model 710/X except heavier platter, different tone arm pivot.
Dual (United Audio Products, Inc.)	1214	119.95		*			12%	3 ¹				(1) Includes 78 rpm. Six-disc capacity. Factory-set antiskating. Stylus overhang adjustment. Base, \$9.95 and \$13.95. Dust cover, \$12.95. Combination base and dust cover, \$44.95.

Manufacturer (Distributor)	Model	Price	Synchronous Motor	Tone arm	Antiskating	Built-in strobe	Vernier adjust.	Speeds	Cartridge	Base	Dust cover	Comments
Elac (Benjamin Electronic Sound Co.)	1216	154.95		*	*		12%	3 ¹				(1) Includes 78 rpm. Same capacity and options as Model 1214.
	1218	189.95	*	*	*		12%	3 ¹				(1) Includes 78 rpm. Same capacity and options as Model 1214. Stylus overhang adjust. 10 $\frac{1}{2}$ -in. cast platter.
	1229	259.95	*	*	*	*	12%	3 ¹				(1) Includes 78 rpm. Six-disc capacity. 12-in. cast platter. Base, \$15.95. Dust cover, \$44.95. Combination base and dust cover, \$44.95.
	Miracord 625	125.95		*	*			4				Ten-disc capacity. Base, \$16.50. Dust cover, \$7.50.
	Miracord 760	199.95		*	*	*	6%	3 ¹				(1) Includes 78 rpm. Base, \$17.50. Dust cover, \$13.95.
Garrard (British Industries Co.)	Miracord 50H Mk II	239.50	*	*	*		6%	3 ¹				(1) Includes 78 rpm.
	Miracord 770H	280.00	*	*	* ¹	6%	3 ¹					(1) Digital strobe readout. Built-in stylus timer. Vertical tracking angle adjusts for one or eight discs.
	Model 82	119.95		*	*			3 ¹				(1) Includes 78 rpm. Vertical tracking angle adjusts to 15 degrees for one or three discs. Bases, Model B-2, \$7.95, Model WB-2MkII, \$19.95. Dust cover, Model D-2, \$7.95. Six-disc capacity.
	Zero 92	169.95		* ¹	*			3 ²				(1) Articulated tone arm. (2) Includes 78 rpm. Tracking-angle adjustment, options same as Model 82.
Glenburn/McDonald	Zero 100C	209.95		* ¹	*	*	6%	3 ²				(1) Articulated tone arm. (2) Includes 78 rpm. Tracking-angle adjustment, options same as Model 82.
	2155S	54.50	*	*	*			4				Six-disc capacity.
	2155	102.45	*	*	*			4	* ¹	*	*	(1) Shure M75E cartridge with elliptical stylus. Six-disc capacity.
Perpetuum-Ebner (Impro Industries)	2155WB	111.90	*	*	*			4	*	*	*	Identical to Model 2155, except includes walnut base.
	3012	109.95		*	*		12%	3 ¹				(1) Includes 78 rpm. Six-disc capacity. Stylus overhang adjustment. Automatic disc-size scanner prevents tone arm from descending to platter unless a disc is on it. Base, Model BW-30, \$13.95. Dust cover, Model DC-15, \$12.95.
	3015	149.95		*	*		12%	3 ¹				(1) Includes 78 rpm. Similar options and features as Model 3012, except has dynamically balanced cast platter.
Realistic	3060	195.00	*	*	*		12%	3 ¹				(1) Includes 78 rpm. Similar options and features to Model 3015, except has separate spherical and elliptical antiskating scales.
	LAB-36A	79.95	*	*	*			3 ¹	* ²	*		(1) Includes 78 rpm. (2) Realistic/Shure R27E cartridge with elliptical stylus. Six-disc capacity. Spherical and elliptical antiskating scales.
	Realistic Miracord 40C	134.50	*	*	*			4	*	*		Similar cartridge and features to Model LAB-36A, except pushbutton controls, die-cast platter, 4-pole motor.
	Realistic/Miracord 45	164.95	*	*	*			4	* ¹	*		(1) R-700E Realistic/Shure cartridge with elliptical stylus. Similar to Model 40C, except single-phase asynchronous motor.

Continued from page 36

The springless arm requires careful leveling of the turntable system since it has only gravity to aid it in its work. A spring arm is relatively immune to gravity and thus requires no critical leveling (though it probably is a good idea so turntable bearings wear evenly over the years). Both types of arms are to be found on single-play and multiple-play systems and result in equal performance on both theoretical and practical grounds. The better changers (Miracord, PE, Dual, Garrard, and so on) have well-designed spring systems; most good manuals (Thorens et al.) use weights, with many of the arms bearing a notable resemblance to the "classic" SME separate arm in this respect.

But, some readers will say, "I have put the same cartridge in a good changer arm and in a super-duper manual arm, and it sounded better in the manual arm." If so, it is coincidental. Modern high-compliance cartridges depend heavily on the resonant frequency that is developed between cartridge and arm. If that frequency is in the critical area that conforms to the cartridge's needs, it will track beautifully. But if it is wrong, there will be some mistracking, particularly of warped records. (What record is *really* flat?) In short it will sound bad. The cartridge's resonance as realized in that particular arm is a function of their combined mass along with the compliance characteristic of the cartridge. So it is entirely possible that a given cartridge may sound better in a changer than it does in a manual. Either way, a single cartridge certainly can sound significantly different in different arms.

For this reason, the designer has an advantage when he knows which cartridge will be used with the arm. That in the Beogram 3000, for example, is specifically designed for the B&O SP-12. A number of changers (BSR, Glenburn, Radio Shack) are offered with preselected cartridges from another manufacturer. The Toshiba turntables in the accompanying table are sold with the company's relatively esoteric cartridges and can therefore be engineered for them. Sony and Pioneer are among the Japanese manufacturers that originally included cartridges with their (relatively expensive) turntables but—presumably in response to the American preference for picking one's own—generally have discontinued the practice in this country.

Almost all of the available arms are of the conventional, pivoted type, which has the inherent (if largely theoretical) disadvantage of altering effective lateral tracking angle as the stylus moves from the lead-in groove toward the label. While most pivoted arms are well engineered to minimize lateral tracking-angle error, the tangent-tracking (or radial) arms are designed to eliminate it altogether. And not only do they keep the stylus always exactly parallel to the groove, but they also eliminate the skating force that is inherent in pivoted-arm de-

signs. The articulated arm, first introduced in current models by Garrard, has a conventional pivot (and hence develops skating force) but is provided with a second pivot at the pickup head; a mechanical linkage alters the so-called offset angle at this second pivot during record play to correct the lateral tracking angle continuously from one end of the record side to the other.

Antiskating

There is hardly a tone arm left without antiskating compensation. Advertising copy has stressed its benefits, implying special importance among arm features. It is not our purpose to debunk the concept; there *is* value to antiskating compensation. But with modern light-tracking cartridges the skating effect is minimized, so the antiskating compensation must be judiciously applied. It is easier to apply too much antiskating than too little. Manufacturers often are vague in their instructions since stylus force and stylus contact diameter both affect the degree of skating that needs compensation. While this may sound almost heretical, you might omit antiskating compensation with cartridges that track at 1 gram or less. Instead, increase the tracking force by twenty-five per cent (to 1.25 grams if tracking normally is at 1 gram); loss of groove contact due to the skating effect will disappear, and any additional record-wear factors will be insignificant.

When All Is Said . . .

So which *is* better, a changer or a single-play turntable? It is obvious that you must first define "better." If you mean better sound, we would suggest that modern top-flight changers sound as good as the best manual systems so long as cartridge/arm incompatibility problems don't affect the performance.

Naturally, if you want to play music for hours on uninterrupted end, only a changer will do. But if you don't expect to use music as a sort of audible decor, a single-play system will suffice.

If durability and trouble-free performance are paramount, no doubt you should choose a single-play manual. The changer is likely to be less durable than a manual, but there is no reason to believe that a modern top-grade changer isn't durable enough for average home use.

There always will be dedicated audiophiles who *must* have the very best. The perfectionist still may want to make his own choice of platter, arm, and cartridge and assemble them into a viable system. But the days are long since past when this was the *only* route to a fine record-playing system. ■

Introducing a small miracle

Miracles, even small ones, are hard to believe. We know.

When we first introduced our small 404 speaker some years ago, believers were hard to find. Today, our credibility is really being challenged. The new XT-6 is so good that even the people who know ADC's "small box, big sound" achievements find it incredible.

But it's true. This book-sized bantam outperforms anything its size. And rivals enclosures many times its size and price.

How do we do it? With a unique combination of cone structure, magnet force and coil configuration, for one thing; they interact to let a small woofer pump out a staggering amount of bass. Handle as much power as any standard-sized room requires. And keep distortion at a minimum.

Granted, the XT-6 has its limitations. It won't shake timbers. And it won't project massive sound into huge rooms. But in typical apartments, the ADC XT-6, at under \$60, gives you more sound per dollar than any other bookshelf speaker on the market.

The specifications will confirm the technical capabilities of the XT-6. But we suggest you go to your dealer and listen... Even if you don't believe in miracles, the XT-6 will give you something to think about.

XT-6 SPECIFICATIONS

NOMINAL IMPEDANCE:	6 ohms
RESPONSE:	45Hz to 20 KHz \pm 3dB in average listening room.
HIGH FREQUENCY DRIVER:	2 1/2" viscous impregnated cone tweeter with 1 1/2" Dia. effective radiating surface.
LOW FREQUENCY DRIVER:	6" with high compliance, soft suspension and viscous coated cone.
CROSSOVER FREQUENCY:	2000Hz Nominal.
HIGH FREQUENCY LEVEL CONTROL:	When in "treble down" condition tweeter level is pivoted from the crossover point to approximately 3dB down at 10kHz.
ENCLOSURE:	Walnut finish air-tight cabinet. 12 1/4"H x 7 1/4"W x 8 1/2"D. Filled with sound absorbent material.
POWER REQUIREMENTS:	10 watts RMS power output per channel.
PRICE:	\$ 58.00



ADC XT-6 SPEAKERS
-the insider's choice.

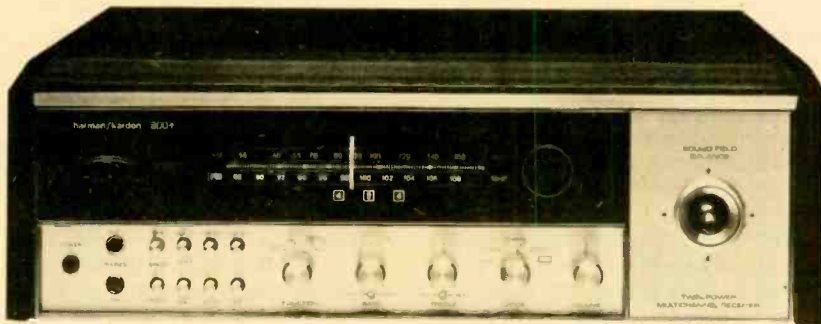

Harman-Kardon's All-Purpose Receiver

The Equipment: Harman-Kardon 800+, an AM/FM 2- and 4-channel receiver with built-in SQ decoder and CD-4 demodulator, in wood case. Dimensions: 18 by 5 $\frac{1}{4}$ by approx. 15 inches. Price: \$599.95. Warranty: two years parts and labor. Manufacturer: Harman-Kardon, Inc., 55 Ames Ct., Plainview, N.Y. 11803.

Comment: This is a highly unusual receiver. While its design gives it a broad range of capabilities, and does so without making the controls excessively complex, the complexities of the 800+ make it relatively difficult to set up—let alone describe. Let's take it section-by-section, rather than knob-by-knob.

The tuning panel has a single meter that shows channel centering for FM, signal strength for AM. The function switch has positions for both mono and mono/stereo FM reception. (We preferred the mono position on the mode switch to the mono-FM function position for weak stereo signals, since the former does not disable the stereo indicator next to the tuning meter and therefore gives notice that a multiplex carrier is present should we want to go back to stereo.)

On the back panel are screwdriver FM controls for stereo threshold (which the lab set for a quieting of 30 dB for its FM tests) and muting; there is a muting on/off button on the front panel. (Muting always is turned off in testing FM tuner sections.) One position of the function switch is marked "discrete FM/aux 1." Assuming that the FCC gives us an approved discrete broadcast method, the now-usual FM-multiplex output (a pin jack) on the back panel can be used to feed an appropriate quadriphonic multiplex unit and its outputs fed to the aux 1 connections on the back panel. Hence the aux 1 switch position already is marked for that use.

Screwdriver antenna connections on the back panel provide for 300-ohm FM lead-in and external AM antenna. There is a built-in adjustable loopstick for AM,

and Harman-Kardon throws in a length of wire for use as an external FM antenna, having found that this solution is as satisfactory as the bulkier but no more efficient twinlead dipole normally included with FM receivers and tuners.

CBS Labs' measurements of the FM section show it to be about average for a middle-priced receiver. Its most spectacular characteristic is the mono response curve—flat within only $\frac{1}{4}$ dB to well beyond 15 kHz. Also striking is the degree to which stereo quieting and distortion performance matches mono for signal strengths of 50 microvolts and above. We flatter ourselves that our tests of stereo performance in this respect may have encouraged such a design; all too many stereo tuners and receivers though they may achieve better mono quieting than the 800+, require more than 50 microvolts of signal strength to do so and even then can't match in stereo the performance on mono signals.

The phono preamp section has a somewhat surprising response curve. It is reasonably flat out to about 15 kHz and then rolls off rapidly—like typical response curves for FM-tuner sections. And the similarity appears to be more than skin-deep since in both cases the roll-off is, we assume, intended to prevent interference between audio frequencies and the higher frequencies associated with the multiplexed carrier signal. CD-4 Quadradiscs contain such a signal, of course, and we have noted similar high-end rolloffs in demodulators we have examined in the past. (See "HF Compares Columbia's and RCA's Four-Channel Disc Systems," January 1974.)

Another feature of the phono preamp that is occasioned by CD-4 is the pair of knurled "separation" controls on the back panel. Like the high-end rolloff, they affect all signals through the phono preamp, no matter what cartridge or operating mode is chosen. They behave like sensitivity controls for each channel

REPORT POLICY

Equipment reports are based on laboratory measurements and controlled listening tests. Unless otherwise noted, test data and measurements are obtained by CBS Laboratories, Stamford, Connecticut, a division of Columbia Broadcasting System, Inc., one of the nation's leading research organizations. The choice of equipment to be tested rests with the editors of HIGH FIDELITY. Manufacturers are not permitted to read reports in advance of publication, and no report, or portion thereof, may be reproduced for any purpose or in any form without written permission of the publisher. All reports should be construed as applying to the specific samples tested; neither HIGH FIDELITY nor CBS Laboratories assumes responsibility for product performance or quality.

(to match baseband-signal levels to those from the difference-signal detector in CD-4 reproduction) with a range from virtually zero output up to very high sensitivity. The lab tested the section first in the conventional way, with these controls at maximum. The resulting sensitivity figure (0.5 millivolts) is well beyond the range of most other equipment, however, and beyond the needs of conventional cartridges. Furthermore, the maximum setting inhibits dynamic range. So the lab next chose a setting that would give a 2.5-millivolt sensitivity as comparable to competing equipment and yielding phono-signal levels more consistent with other program levels. Signal-to-noise figures are shown for both settings. That for the 2.5-mV setting is good; though that for the maximum setting is not as good, the point is fairly academic since we wouldn't expect most users to want or need so much phono gain.

A further concomitant of these controls is that S/N ratios in playing SQ records will be affected to some extent by the settings chosen in optimizing for CD-4, using the disc that Harman-Kardon supplies for the purpose. As readers of our April test-report section will remember we are exploring new questions raised by our latest tests of CD-4 demodulator sections. A lab report on the quadriphonic portion of the 800+ will appear as soon as we have more answers.

The matrix section—which can be used in decoding (or simulating quadriphonics) from broadcasts and tapes, as well as discs, of course—includes two mode positions for SQ and one for simulation from stereo sources. With non-SQ matrixed material—QS/RM or early E-V Stereo-4—any of these positions can be used, though we preferred the SQ-2 position for this purpose and the SQ-1 position for SQ. The difference is that some front left-right separation (which is kept at a maximum in SQ) is sacrificed in the SQ-2 position in favor of

more front-to-back separation. This makes the SQ-2 position conform more closely to the basic QS and E-V matrices themselves.

The mode-indicator lights just below the tuning dial respond to all these positions in a fascinating way. There are lights for (in order across the faceplate) 1, 4, 2, 4, and CD-4. With the mode switch at its extreme left position (mono) only the 1 lights. At the next position (stereo) only the 2 lights. For SQ-1 and SQ-2 the lights show () (4)(2)(4)(), suggesting that four channels have been matrixed to two and recovered as four (the so-called 4-2-4 system). In the simulator position ("enhanced stereo") the first 4 disappears, leaving the display with () () (2)(4)(). And in the CD-4/discrete position the lights show () (4)() (4)(). So in any mode the display is a graphic and quasimathematical description of the process in use.

The CD-4 light appears only when a Quadradisc carrier is present. The CD-4/discrete position of the mode switch also is used for all discrete inputs, including aux-1/discrete-FM, aux 2, and tape-monitor-1. The first two are chosen with their respective positions of the function-control knob; the monitor 1 function has its own pushbutton. There actually are two four-channel sets of back-panel tape-recording outputs. If a second quadriphonic recorder is used, its output may be connected to aux 1 or aux 2. In addition, there is a stereo set of inputs and outputs, also with its own front-panel pushbutton and marked Dolby/tape-monitor-2. Conceivably one might use an outboard Dolby B unit connected to this set of jacks simply to decode Dolby FM broadcasts, but a number of Dolby tape units now offer switching so they can be used for that purpose as well as for tape noise reduction. A stereo tape deck can also be connected to the four-channel outputs and will record matrixed material without decoding (that is, all tape outputs are ahead of the matrix-decoder portion of the circuitry); the back-channel outputs are driven only in recording from discrete sources. You can even use the 800+ with three tape recorders (though Harman-Kardon's unusually comprehensive and graphic manual doesn't cover this) by connecting the input of no. 1 to tape out 1 and its output to tape monitor 1 (both of which are quadriphonic sets), the input of no. 2 to the quadriphonic set of jacks for tape out 2 and its output to either of the aux inputs (again all quadriphonic), and no. 3 to the Dolby/tape-2 connections, which are stereo pairs.

Other features of the control section include pushbuttons for high and low filters and one for loudness compensation; bass and treble knobs, both with separate friction-clutched sections for front and back channels; and a volume knob. The balance control is the "joy stick" type and is located at the extreme right of the front panel.

Two more pushbuttons control the speakers—main and remote—allowing you to use either, both, or neither of the quadriphonic sets of speakers for which screw-driver terminals are supplied on the back panel. The

Harman-Kardon 800+ Additional Data

Tuner Section			
Capture ratio		1.5 dB	
Alternate-channel selectivity		55 dB	
S/N ratio		73 dB	
THD	Mono	L ch	R ch
80 Hz	0.35%	0.38%	0.46%
1 kHz	0.31%	0.39%	0.32%
10 kHz	0.40%	6.9%	7.7%
IM distortion		0.33%	
19-kHz pilot		-37.5 dB	
38-kHz subcarrier		-46 dB	
Amplifier Section			
Damping factor		40	
Input characteristics (for 50 watts output)			
	Sensitivity	S/N ratio	
phono (max. input)*	0.5 mV	55 dB	
phono (typical)*	2.5 mV	63 dB	
aux 1, 2	160 mV	83 dB	
tape 1, 2	160 mV	83 dB	
*See text			

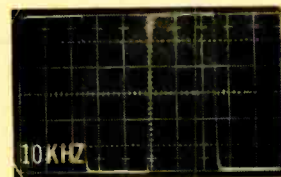

Square-wave response

stereo headphone jacks (one for the front channels and one for the back) next to the speaker pushbuttons are live at all times.

So are the back-channel connections for the selected set of speakers, even with mono or stereo program ma-

terial, which is fed to both front and back amps on each side. This is true, however, only when a "stereo/4-ch" switch on the back panel is in the four-channel position, as it is on the as-delivered receiver. If you want maximum per-channel power for stereo operation, you must

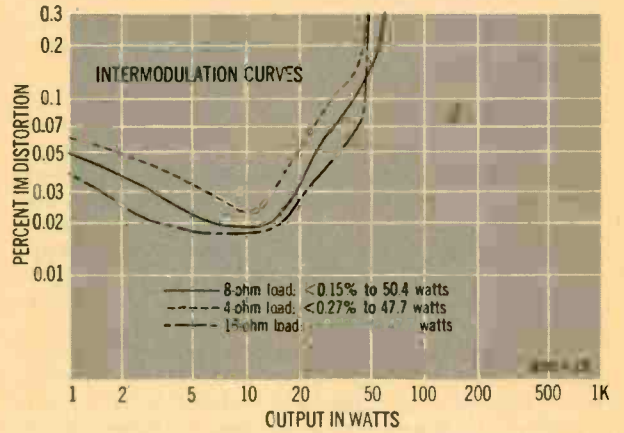
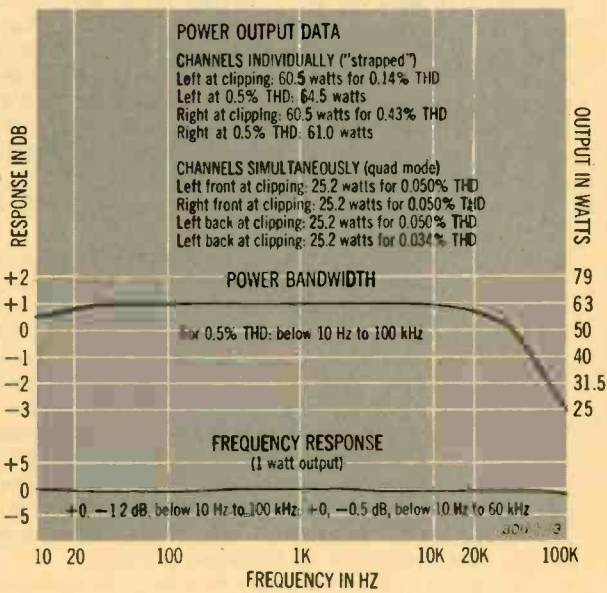
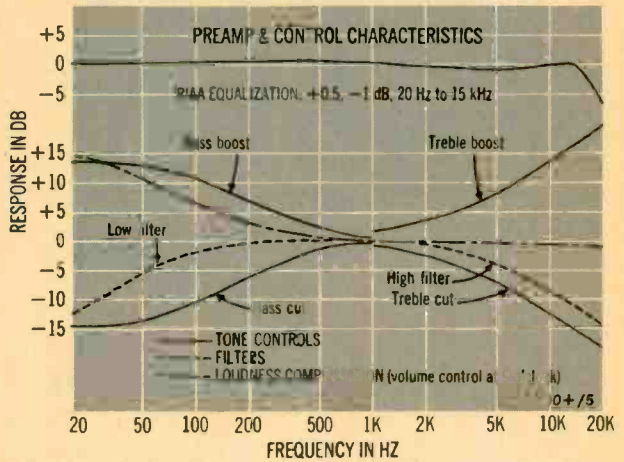
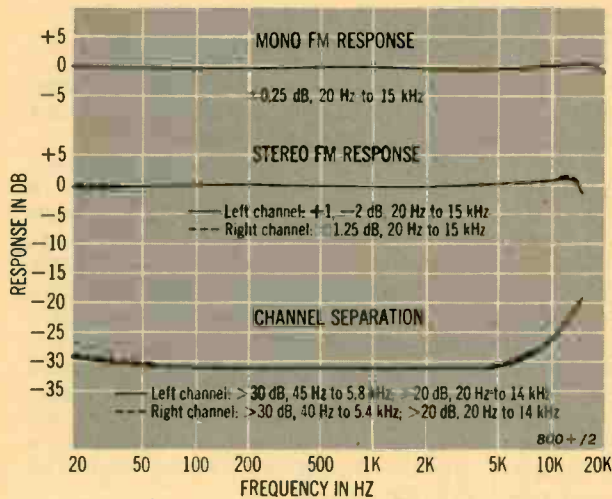
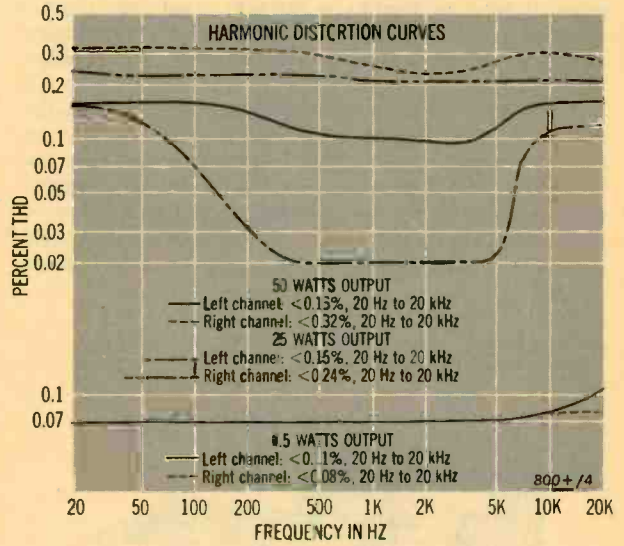
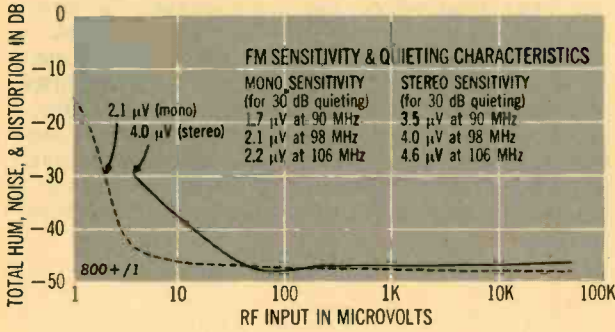

loosen the screw holding a sheet-metal "latch" on this switch before you can convert to "strapped" operation. H-K warns that this should be done only with the unit turned off and that the latch should be replaced as soon as the switch is in the desired position. If the switch is moved while the receiver is operating, damage can result. (Another cautionary note that must be heeded to prevent damage: Don't use the 800+ with any equipment—some speaker-switching boxes or electrostatic headphones, for example—that requires a common-ground power hookup.)

In the strapped stereo mode the back speakers are incapacitated no matter what the program source, of course. As the lab data show, the receiver delivers better than its rated 50 watts per channel when strapped and close to 25 watts per channel in quadraphonic operation. Like that in most other H-K products, the amplifier design includes two power supplies—one for each

channel or pair of channels, depending on the operation mode. Distortion, which was measured in the strapped mode, is comfortably below H-K's specs, and the response and bandwidth of the amplifier are exceptionally wide-range.

A lot of thought obviously has gone into the design of the 800+, and the multitude of features and capabilities that have resulted do not come cheap. To have achieved this much in a \$600 receiver is a considerable accomplishment. And though the unit is a complex one, some of its internal complexity contributes markedly to simplicity of operation. The joy-stick balance control, for example, is an improvement in this respect over the multiple balance knobs of some quadraphonic receivers and is moreover unusually smooth and precise in its operation. The 800+ is both a good value and a pleasure to use.

CIRCLE 144 ON READER-SERVICE CARD



Magnavox's Max Speaker

The Equipment: Magnavox MAX-15, Model SE-2510, a floor-standing speaker system in wood enclosure. Dimensions: 20¼ by 29 by 15¼ inches. Price: \$449.95 per pair. Warranty: two years parts and labor. Manufacturer: The Magnavox Co., 345 Park Ave., New York, N.Y. 10022.

Comment: As long-term readers of these columns know, we have often been disappointed with Magnavox products in the past. Like many other manufacturers traditionally offering a broad range of popular home-entertainment products, it has produced units that come on like high fidelity components but don't really cut the mustard on close examination. We can't say that about the MAX-15, the top model in Magnavox's current loud-speaker line.

It is a three-way system using a 15-inch woofer, a domed 2-inch midrange driver, and a 2-inch tweeter with a phenolic ring design that Magnavox credits with exceptional dispersion characteristics. These drivers,

plus three-position (-3, 0, +3) midrange and treble controls, are hidden behind an easily removable sculptured-foam grille. There is a small handle at the top of the grille to simplify removal for access to the controls. Leads are connected to color-coded binding posts on a small recessed panel at the back of the enclosure.

The MAX-15 is a true 8-ohm speaker: At bass resonance (about 45 Hz) the impedance rises to less than 16 ohms, dropping to 8 ohms at the rating point (just below 100 Hz) and remaining between 8 and 16 ohms through the rest of the audible range. And because of its size it is fairly efficient for a sealed-enclosure system, requiring 4.0 watts of input to produce 94 dB at 1 meter on axis. It handles up to 100 watts of continuous tone (at 300 Hz) before exceeding distortion limits and will handle pulses to 225 watts, for outputs of 110.5 and 117 dB respectively. Its dynamic range therefore is good. Any good amplifier—and today that phrase generally implies a rated power of at least 25 watts per channel—should be appropriate for driving the speakers.

Our first impression of the sound was that the MAX-15 is a little bass-shy considering its over-all size and large woofer. Perhaps we were expecting a Magnavox speaker to display a failing common in the speakers built into consoles: the substitution of "boom" for true bass. MAX-15 has neither the severe doubling nor the exaggerated bass resonance that we call boom. And although deep bass is not particularly prominent in the MAX-15, the fundamental holds up well to below 40 Hz. (As with any speaker, position in the room will influence the bass you hear; bass is reinforced by a corner placement.)

Though the bass is good, the over-all sound is a little on the bright side. This appears to be due more to a certain roughness in the midrange and highs than to a superabundance of highs as such. This property of the design prompted comments by our listening panel ranging from "a little extra zing" to "slightly edgy at the top." The extreme top actually drops off quite rapidly above about 13 kHz, though up to that point the sound is very well dispersed. Test tones even in the upper midrange are not quite as prominent at 90 degrees off axis as they are from anywhere in front of the speaker, but at any normal listening position we found the highs quite evenly distributed right up to beyond 13 kHz.

The two controls on the MAX-15 make a small but per-

ceptible change in the balance of the sound. That for the midrange increases output by less than 1 dB below about 4 kHz while decreasing it by about 1½ dB in the same range, with respect to the "normal" setting. At higher frequencies it makes somewhat more alteration of the characteristics, approximating above 10 kHz the values implied by its +3 and -3 markings. The control for the highs introduces a change of a little over 3 dB each way in the range from about 3.5 to 6 kHz; from 10 kHz up the +3 setting raises output by almost 3 dB but the -3 setting does very little. (Of course the level is not literally raised at the +3 setting—it is simply less attenuated than at the normal setting.)

Since the behavior of these controls is a little irregu-

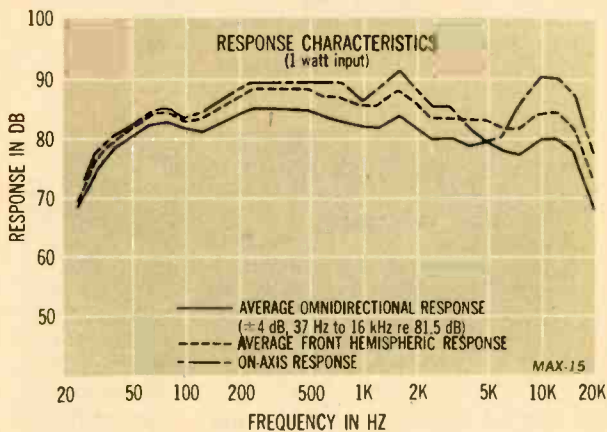

lar, we sometimes found that a change in setting did not produce quite the expected change in sound. In general we preferred the normal settings on good, wide-range program material or the +3 settings of both controls if the program material lacked sparkle. We finally settled on the normal settings, using our preamp's treble control to boost the highs slightly as occasion demanded.

While we can't honestly say that the MAX-15 is truly exceptional in either sound or in value, it is certainly a good product—and better on both counts than some we have seen from companies considering themselves among the leaders in high-performance components.

CIRCLE 141 ON READER-SERVICE CARD

Magnavox MAX-15 Harmonic Distortion*

Output Level (dB)	Frequency			
	80 Hz		300 Hz	
	% 2nd	% 3rd	% 2nd	% 3rd
70	0.45	0.60	0.55	0.62
75	0.50	0.60	0.50	0.62
80	0.75	0.90	0.50	0.78
85	1.6	0.70	0.50	0.85
90	3.2	0.30	0.60	0.93
95	5.5	1.1	0.95	1.1
100	10	2.1	1.9	1.5

*Distortion data are taken on all tested speakers until distortion exceeds the 10 per cent level or the speaker produces the spurious output known as buzzing, whichever occurs first.

Newest SAE Amp Is a Superb Job



The Equipment: SAE Mk. XXXIB, a power amplifier in metal case. Dimensions: 15 by 5 by 8¼ inches. Price: \$275; optional walnut case, \$33. Warranty: five years parts and labor. Manufacturer: Scientific Audio Electronics, Inc., P. O. Box 60271, Terminal Annex, Los Angeles, Calif. 90060.

Comment: The Mk. XXXIB (or the 31B, if you're unused to reading dates on copyrights and cornerstones) is one of SAE's newest group of matching components, which also includes the Mk. XXX preamp. The Mk. XXXIB is rated—very conservatively, as it turns out—at 50 watts per channel and 0.1 per cent THD. It is relatively compact for an amplifier of its description and has a front panel that is elegant in its simplicity: A rectangular blue pilot light and identifying lettering are the only "decora-

tions" on its surface, which is anodized a pale gold color. On the back panel are a stereo pair of pin jacks for the inputs plus color-coded output binding posts that will accept banana plugs or spade lugs as well as plain stripped leads for speaker hookup. Outside of the fuse holder and AC cord, that's it.

When we say that the power spec is conservative, we mean that it could have been stated in ways that would result in higher numbers (for example the approximately 70 watts per channel that CBS Labs measured at clipping) or, conversely, that its performance is better than the printed specs. A prime example of the latter is the harmonic-distortion graph. All the curves not only are well below SAE's 0.1-per cent rating but also are so low that they meet almost precisely its rating for the Mk. XXX preamp: "less than 0.03 per cent, 20 Hz to 20 kHz; typical performance, 0.015 per cent." The most startling

thing about these curves, however, is their uniformity at all power levels. Most amps can do well (though seldom this well) at half power. Most full-power curves show some rise in distortion at the frequency extremes; most 1/100-power curves show higher distortion at all frequencies. Yet all three sets of curves for the Mk. XXXIB are virtually interchangeable, indicating that harmonic distortion remains extremely low over an extremely wide operating range.

This, in turn, means that the amplifier must be driven beyond this operating range—must be abused, in fact—in order to produce the rated 0.1 per cent THD (to say nothing of 0.5 per cent) for the conventional power-bandwidth tests. While the amp will handle short-duration peaks at these levels, it is not designed for steady-state signals, needed to make the measurements, at these levels and at high frequencies. Actually the lab had no problem with the 0.1 per cent curve in the audio range; but at higher frequencies there were signs of overheating, and the lab restricted its tests to brief bursts of signal. The -3-dB reading of 60 kHz is therefore only an approximate measurement.

Driving the amp into even greater distortion means driving it harder, of course. So the lab checked only two points (1 kHz and 10 kHz) on the 0.5 per cent curve, confirming the relative "lie" of the two curves without attempting to fill in the whole 0.5 per cent curve itself. The curves confirm that the amp is capable of delivering about 70 watts at 0.1 per cent THD at all audio frequencies, on a short-term basis at least. And it would appear to be capable of 76 watts at 0.5 per cent on the same basis and at the same frequencies. (SAE assures us, incidentally, that the Mk. XXXIB's protective circuitry will prevent damage to the amp itself even if it overheats, though minor parts can be damaged by prolonged supersonic oscillator tones at these levels.)

According to SAE's published figures, the IM distortion should be less than 0.1 per cent and typically less than 0.025 per cent. Actual values (for an 8-ohm load) are well below both figures right up to the 50-watt power rating. IM is, as usual, higher into 4 ohms. The lab, using a different measurement technique, did not confirm SAE's damping-factor spec (over 150), but at 123 it must be counted as very high by any standard.

How does all this sound? In a word, superb. The individual characteristics of any good amp are far less noticeable, of course, than those of speakers and the program material, which vary over a wider range and include imperfections that are far more striking than the amp's. This is, then, one of those amps that simply seem to "disappear" with normal program material and give an ultra-clean, unfettered account of even the finest signal sources.

CIRCLE 142 ON READER-SERVICE CARD

SAE Mk. XXX IB Amp Additional Data

Damping factor	123
Input characteristics (for 50 watts output)	
Sensitivity	1.18 V
S/N ratio	104.5 dB

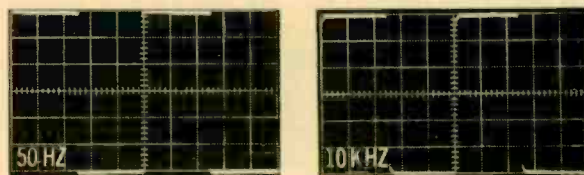
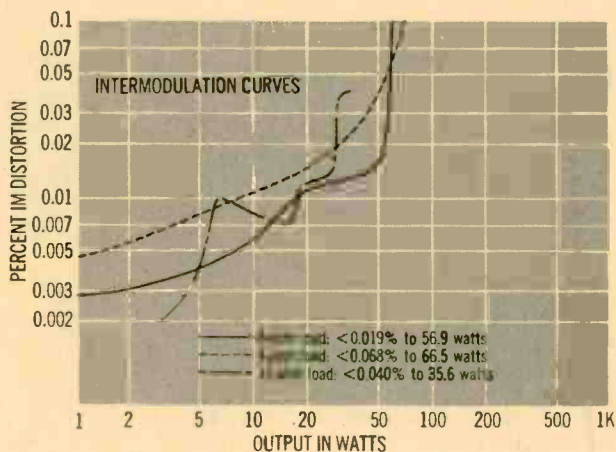
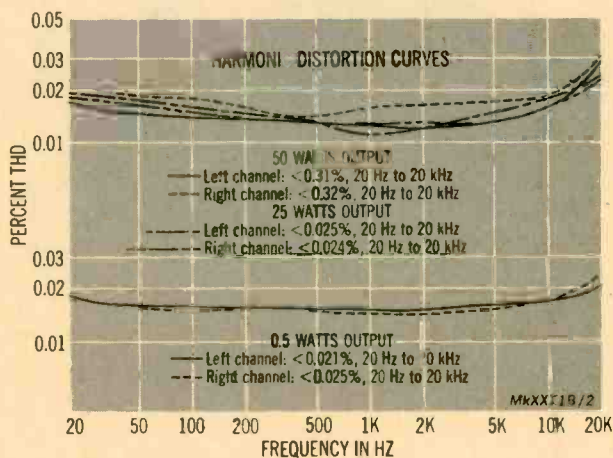
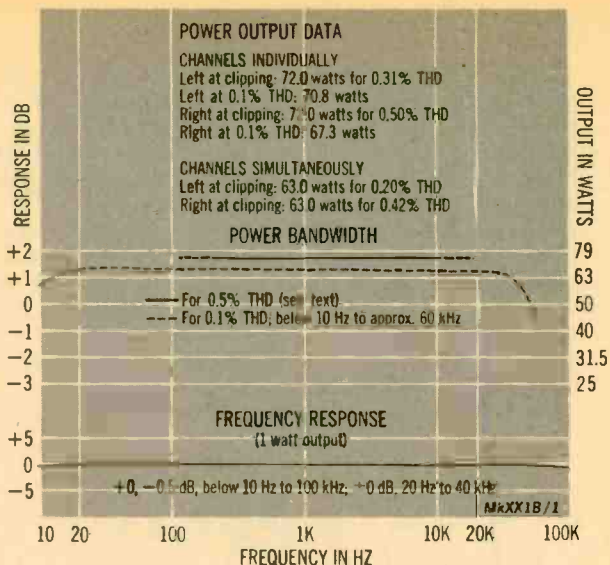

Square-wave response

A Further Look at the BGW 500R

While our February-issue report on BGW's 500R power amplifier was favorable, and the lab data indicated that the unit met its specifications within normal tolerances, it appears that it could have (and should have) done better but for a contact failure in a relay used in the power supply section. We understand that the socket containing this contact is being replaced with one of a different design to prevent this sort of failure—which would be difficult for a purchaser to detect since the amp still performs well in spite of it. Here is what BGW has to say:

Our test reports show substantially different findings in the areas of maximum power output, distortion at full power and damping factor. These differences could not be attributed to different power rating methods but are most likely due to a malfunctioning start-up circuit.

BGW Systems guarantees a minimum of 200 watts per channel average continuous sine-wave power output. We have never had a unit that did not produce at least 215 watts per channel. The only logical explanation would therefore relate to the turn-on circuit. This portion of the amplifier's circuitry consists of a transistor time-delay circuit, a relay, and a large power resistor. When power is applied to the unit the power resistor, which is in series with the power line, serves to limit

the turn-on surge. After a delay of about one second the relay pulls in and shorts out the resistor. The relay also is used to connect the speakers after the delay interval, thus providing transient-free switching. The type of relay used is a plug-in unit that mates with a printed circuit-board socket. We have experienced a few failures of this socket, and if this were the case it could result in operation at reduced power level. Under these conditions our calculations of maximum power output come very close to CBS Labs' measured data.

Under normal conditions, the distortion at 200 watts would be almost identical to the distortion at 100 watts. Our data at 200 watts is almost the same as that published in the review at 100 watts. The damping factor would also be much higher.

BGW's phrase, "test report" refers to their checkout of the test sample before forwarding it to CBS Labs. A comparison of their figures with ours [in brackets] for the key measurements in question turn up the following discrepancies:

1. Output at clipping into 8 ohms with both channels driven, 231 watts per channel for 0.2% THD. [CBS Labs measured 171 watts for 0.06% THD.]
2. Full-power (200-watt) harmonic distortion, 0.03% or better to 10 kHz. [Our data ran as high as about 0.4% in the extreme bass.]
3. Damping factor, ultra-high—approximately 1,000. [The lab measured a moderately high 40.]

Featherweight Scintrex Headphones



The Equipment: Scintrex Supra, a foam-cushioned on-the-ear stereo headset. Price: \$29.95. Warranty: one year parts and labor. Manufacturer: Scintrex Audio Division, Amherst Industrial Park, Tonawanda, N.Y. 14150.

Comment: The Scintrex headphone line is, of course, the direct descendant of the Sharpe headsets that have been among the "standard" high fidelity brands for years, the parent company's name (Scintrex) having replaced that of the erstwhile Sharpe Audio Division only recently on the headsets themselves. This latest model bears a resemblance to past models in the neat styling and excellent finish of the parts, but it is so trim in design and so light (just over four ounces, excluding the cable) that you might make the mistake of dismissing it as a communications—as opposed to high fidelity—model.

Part of the trimness comes from its being Scintrex's first model to rest on the ears, rather than surround them with a compliant "seal." The virtues of this sort of design have been argued (both ways) in our pages before. Models that, like the Supra, deliver their sound through a foam pad that rests *on* the ears generally are lighter and to that extent more comfortable. But the big difference is in sonic isolation; they provide relatively little attenuation of ambient sounds. If you want to shut out the noises around you in favor of the music, you probably will prefer the surround type. Some listeners find the sense of isolation rather fatiguing and prefer models like the Supra unless ambient sounds are distractingly loud.

Generally speaking, there is another price that must be paid for the lightness and comfort of a model like the Supra: the difficulty of getting really full bass response without a positive coupling to the ear. You may want to add some bass boost (via the tone controls or loudness compensation of your stereo system) to give a little more fullness to the sound; but the Supra, like other models of the type, can produce a good deal of doubling if driven too hard at the low end.

The sound is very smooth in the midrange, though there is some prominence to the "presence" range (around 2 kHz). At higher frequencies (around 10 kHz) it is not quite as smooth and rolls off toward inaudibility around 14 kHz. The over-all sound is well balanced and highly listenable—among the best we've heard in this price range over the years despite the emphasis on the midrange. If you want more sound at the frequency extremes, you probably will want the bulkier conventional type of headset; and if you want it with no sacrifice in

over-all smoothness, you probably should plan on spending more for it.

On unpacking the Supra, incidentally, we were pleased but startled to find a little card telling us that the headphone plug conforms to the IHF standard for channel wiring: The tip element of the plug is for the left signal and the ring element for the right. (Actually the earpieces are unmarked for channel orientation, but it is generally assumed that most users, being right-handed, will prefer to have the cord on the left.) The reason we were pleased was that manufacturers of both headphones and electronics have consistently ignored past attempts to standardize headphone plugs and jacks in this respect. We were startled because the IHF has not officially offered this standard to the industry yet. We hope it does, and we hope that the portion of the industry (approximately half at our last check) that is doing otherwise will follow Scintrex' lead.

CIRCLE 143 ON READER-SERVICE CARD

Pickering Lets You Know When to Change Styli



The Equipment: Pickering Model PST-1 stylus timing gauge. Dimensions: 1½ by 2 inches; height depends on use of spacers. Price: \$13.95. Warranty: one year parts and labor; battery, six months. Manufacturer: Pickering & Co., Inc., 101 Sunnyside Blvd., Plainview, N.Y. 11803.

Comment: The purpose of this clever little gadget is quite simple: to provide a timer that will operate only while your cartridge is in use and therefore indicate how much actual wear the stylus has been subjected to. Its gauge looks rather like a thermometer but actually is a mercury coulometer powered by a small mercury cell. Voltage from the cell is turned on and off by a button-like switch that stands atop the PST-1; when the unit is positioned and its height adjusted so that this switch presses against the underside of the tone arm, the coulometer will register only the time during which the arm is removed from its at-rest position—in other words, only the time spent in playing records.

To simplify this positioning, the PST-1 is designed with snap-on spacer elements at the base that give it a height range—from the turntable's top plate to the underside of the arm in its at-rest position—of 1 to 1½ inches. Note that if the height of your arm is adjustable, it may pose extra problems of switch-height adjustment. In our experience, however, most users set the height in one position and leave it there.

At one side of the PST-1 is the gauge. The element is packed separately and snaps on over a color-coded scale (green for okay, or less than 200 hours of use; yellow to indicate that microscope inspection, and possibly replacement, is due, or between 200 and 500 hours; and pink for order-a-new-stylus, or 500 to 1,000 hours), which can be positioned so that its zero calibration falls under a tiny mercury dot in the gauge element.

When all this is done and the PST-1 is fixed in place with small stickers supplied by Pickering, the tone arm will push down the switch on top of the PST-1 and disconnect the mercury cell from the gauge until a record is played. As long as the arm is removed from the switch the mercury dot will move very slowly upward. It takes 100 hours for the dot to move from one scale calibration to the next—about 1/16 of an inch.

When the stylus has been replaced, the entire element can be unplugged and reversed; the mercury dot's direction of travel is determined by the polarity of the voltage acting on it, which is reversed when the element is plugged in in the opposite position. Adjust the scale, and you're back in business with the new stylus.

Our sample has been going several months now without a battery change, which necessitates replacement (for \$2.00) at the factory. Pickering says the battery should last for a minimum 5,000 hours (approximately continuous use during its six-month guarantee period) and last longer, of course, with less frequent use.

It is admittedly very difficult to keep an accurate record of actual playing time so that you know without microscopic examination when replacement time has come—or at least know when it is time to examine the stylus under the microscope. (Of course diamond styli can be chipped, and any signs of abnormal record wear or distortion should be your cue to have the stylus inspected, whatever the gauge may say.) If, like most people, you regularly use a single cartridge, the PST-1 can either save you many needless trips to the microscope or—more probably—save you needless record wear. (When it has saved three LPs it will have paid for itself.) And even if you're a multiple-pickup listener, you can buy a gauge for each, set aside one element for each pickup, and plug them into the PST-1 accordingly when you change shells. If you're that fussy about cartridges, we'd expect you to be equally fussy about styli.

CIRCLE 145 ON READER-SERVICE CARD

Are we really number four?



A recent survey by a leading audio magazine found Sherwood in fourth place among all stereo receivers, in terms of the "brand bought most last year."

This report both pleased and confused us. Since we barely showed up in previous annual tallies, the evidence of sudden fame and popularity was certainly welcome.

Unfortunately, it didn't make any statistical sense. After all, we're the people who make this gear, and we ought to know how many units we put together in a year's time, and we promise you that the total doesn't even approach what the giants are doing.

Maybe there was another message in that score.

So we reviewed the survey a

little more closely, and remembered that it was a *subscriber* survey, meaning that it automatically did not include the large general mass market for high fidelity equipment, where most of the big volume is.

In other words, the survey was biased, in favor of the sophisticated, expert, deeply involved audio enthusiast: the man who takes his listening seriously.

Among *this* specialized group, Sherwood registered a fourth place position.

Which would make sense statistically, since the numbers are smaller.

And on a performance-per-dollar basis as well, since the standards are higher.

S7200

"Best Buy" (a leading consumer testing publication)

Amplifier output (RMS, 8 Ohms, both channels driven): 40 + 40 watts @ 1 KHz; 32 + 32 watts, 20-20 KHz

Distortion at rated output: less than 0.7%

Power bandwidth: 12-35 KHz

FM sensitivity (IHF): 1.8 μ v

FM selectivity: 60 dB

FM distortion (mono): 0.25%

Capture ratio: 1.9 dB

Price: \$359.95



Sherwood

The word is getting around.

HOW TO MOVE YOUR TAPE RECORDING TECHNOLOGY AHEAD OF THE BROADCASTERS

A quartz crystal controlled three speed drive capstan, relay-less, large scale integrated circuit (L.S.I.) controlled triple motor tape transport, plus photo-electric and motion-sensing tape protection arrangements – put the Revox A700 into a class by itself.

A host of further technological features combine to make the Revox A700, in our opinion, the most desirable tape recorder ever built.

See it at your Revox Professional Equipment Dealer. Try the faultless tape handling. Explore the comprehensive mixing and audio control facilities. On top of all this examine minutely the precision of the detailed construction – something Willi Studer is already world famous for – but now executed so well it's breathtaking.

Some day soon, the recording and broadcasting industries will share its technology!

Discover the new Revox A700



the standard setter
in magnetic tape
recording now at your
Revox Professional
Equipment Dealer

REVOX

Revox Corporation in U.S.A.: 155 Michael Drive, Syosset, NY 11791 and 3637 Cahuenga Blvd West, Hollywood, California 90068
Revox in England: C. E. Hammond & Co. Ltd., Lamb House, Church Street, Chiswick, London W4 2PB
Revox Sales and Service in Canada. For other countries: Revox International, Regensdorf 8105ZH Althardstrasse 146, Switzerland.

by John Rockwell

"He hasn't been heretofore thought of as a composer of hip head music, but there have been less likely candidates."

Max Reger: Windbag or Prophet?



THE MAX REGER centenary year is now safely behind us, and it can't be said that the American musical world overextended itself to honor the occasion. The majority of the major performing institutions, record companies and media managed blissfully to ignore it altogether, in fact. Reger remains for most people a composer not quite obscure enough to qualify for romantic revival yet hardly ever heard. His reputation is as a purveyor of glutinous prolixity.

Those who admire his music might suggest that he is a victim of an anti-Teutonic bias in the Anglo-American sensibility. In the late nineteenth century, American musical tastes were dominated by things Germanic. But then a reaction set in. For us today the modern spirit is characterized by a French model. Combined with a revived national predilection for pragmatism, we almost unconsciously exalt clarity and concision as our standard in all things.

Reger stands as a challenge to that aesthetic. His works are long and thickly clotted with notes. At least they aren't weighed down with the sort of bombastic quasi-philosophical pretensions that afflict the music of his more programmatically inspired contemporaries. But in conjunction with that whole line of Germanic post-Romantics—from Bruckner and Mahler through Pfitzner to such as Schmidt—Reger stands condemned before the tribunal of Anglo-American taste as a windbag. Yet all isn't necessarily lost. Mahler, reviled not so long ago, is the latest rage. Bruckner's day may be coming soon, and Pfitzner's *Palestrina* is now available from DG. Then, who knows, maybe Regerphilia!

Even in his homeland, Reger's reputation has al-

ways been a bit ambiguous. From the first he found himself under fire from both the conservatives and the progressives—and the same is true today, worldwide. The former are put off by his sprawling forms and his continuously chromatic harmonies; the latter object to his love for archaic models and his refusal to follow through to the atonal consequences of his chromaticism. Paul Rosenfeld, the progressive American critic of the interwar period, complained that Reger's photograph "was like a swollen, myopic beetle with thick lips and sullen expression, crouching on an organ bench. There is something repulsive as well as pedantic in this art. His works are stereotyped, stale terribly quickly. . . . They are like mathematical problems and solutions, sheer brain-spun and unlyrical. . . ."

But there have been significant pro-Reger voices too. Rudolf Serkin has long been a champion of his music and used to insist on playing the F minor Piano Concerto with a frequency that appalled symphony conductors and subscribers. Tovey, Hindemith and Schoenberg were all supporters of his work, and the distinguished German critic Hans Heinz Stuckenschmidt, best known for his advocacy of contemporary music, has written warmly on Reger's behalf.

Reger's personality, career and art were torn—or enlivened—by dichotomies. He was a Bavarian living in a nationalistic German empire dominated by the Prussian north. He was a Catholic strongly attracted to Protestant chorales (and married to a Protestant). He was a man of high, stern ideals given to coarse peasant humor and extravagant displays of rudeness. (His enemies used to say that in trying to emulate Beethoven he compensated for a lack of talent by exaggerating Beethoven's grace-

lessness. And to a hostile critic in Munich he wrote: "I am sitting in the smallest room of my house. I have your review before me. In a moment it will be behind me.") The dichotomies are reflected in his music itself and in reactions to it.

Reger was born on March 19, 1873, in a small northern Bavarian town. His principal early teacher was the musicologist Hugo Riemann. From 1901 until his death of heart failure in 1916 he based himself in Munich, Leipzig, Meiningen, and Jena, where he was continuously active as a pianist, organist, conductor, and teacher as well as the composer of hundreds of works. The opus numbers go up to 147, but many of them contain multiple pieces (the fifty-three chorale preludes, Op. 67; the sixty songs, Op. 76); many of them are long in comparison with works with similar titles by other composers (the fifty-minute *Sinfonietta*); and there are works without opus numbers.

The principal tension in his music is between highly traditional (if grandly expanded) formal structures and opulent chromaticism—a prime explanation for the diversity of reactions to it. Reger was in the forefront of what might be called the neo-Romantic, neoclassical revival. Although he had been profoundly affected by his first experiences at Bayreuth in 1888, he chose in his own music to side with the partisans of Brahms and, like Brahms, to abjure opera and the symphonic poem and to concentrate instead on "abstract" music based on classical and preclassical forms. But he went even further back than Brahms, who had concentrated on Beethovenian models. Reger never wrote a symphony, and his classical sonatas are relatively few. Instead, his love was the baroque and such supposedly lesser forms as the variations and the Lied. In his return to the baroque—which was of course a far, romanticized cry from our present-day "authentic" baroque revival—Reger prefigured the twentieth-century German neoclassicism that found expression in Busoni and Richard Strauss and only later, under some influence from France, in Hindemith and the 1920s modernists.

Yet if his formal antiquarianism might have pleased the conservatives, his harmonies definitely did not. Reger's tonal world approaches that of *Verklärte Nacht* and that whole post-*Tristan* era in which traditional diatonicism was having every leg systematically knocked out from under it. In fact, Reger's reliance on simple, strong structures was clearly his way of shoring himself up against the implications of his chromaticism. Schoenberg, too, used forms unrelated to the implications of his harmonies before he gave himself over completely to serialism, and even then he clung to older notions of rhythm and shape. Had Reger lived into the 1920s, he might have resolved his tensions. His last years show a certain "Mozartean" tendency in the direction of a new clarity, yet in that period he produced some of his most nearly "atonal" works.

Today, one might think it possible to get beyond

the prejudices of the past (we have our own prejudices against the music of *today* to worry about). The dragon of neo-Romantic pomposity should long since have been slain, and our modern sensibility shows signs once again of turning toward the expression of emotion and luxuriousness in music. Reger's craftsmanship and ingenuity have never been in question. Now, it may be possible to appreciate the extended, meandering evolutions of his pieces without imposing on them criteria that he never meant to be used. Of course Reger's works lack concision and clearly argued form. What they have instead, at their best, is an almost mystical, hypnotic power to lure you into the flow. If you can appreciate the modulatory twists and embellishments for themselves and not in relation to some far-distant classical harmonic grid plan, then this music may take on a whole new allure. Reger hasn't been heretofore thought of as a composer of hip head music, but there have been less likely candidates.

The Recordings

Reger is reasonably well represented in the German record catalogue, but not all of those recordings have found their way across the ocean. Some, such as Fischer-Dieskau's collection of twenty-one songs and Böhm's excellent mono-only account of the important *Mozart Variations*, Op. 132, are out of print even there. Others, including Anton Heiller's sampling of the organ music, are simply not available here.

Of those that can be bought in this country, hardly any are discs easily found in local record stores. For the most part, the choice is between expensive imports at a record specialty shop (if you have one in your town at all) or by mail, from the Musical Heritage Society. That worthy company has more than thirty-five Reger records in its catalogue, culled from various European projects that began several years ago and that will continue long past the centenary year. (MHS records are generally pressed, packaged, and annotated in exemplary fashion, but there is a curiosity about the notes for some of the company's Reger discs, by one Mark Gantt: Mr. Gantt blithely swipes the same extended passage from *Grove's Dictionary* in record after record; one wonders how many other, less obvious sources he stole from.)

Other than that, the home-grown product has produced slim centenary pickings indeed. Vox has put out two Vox Boxes optimistically labeled "The Complete Chamber Music, Volumes I and II," but has no immediate plans for any further releases. Columbia has issued a performance of the Op. 139 Violin Sonata, along with a reissue of the Op. 116 Cello Sonata. Orion and Mark Educational Recordings have come up with relatively obscure discs. There is a BASF release, apparently recorded

here, if you want to stretch the domestic category a bit. Otherwise, nothing—at least nothing devoted specifically to Reger, although an occasional short piece crops up on a recital record.

In looking over all those records on which Reger appears exclusively or significantly then, one finds some gaping lacunae. The song literature is especially undernourished. The orchestral works, few enough in number, are mostly to be heard in aged and/or ultimately undistinguished readings. As a rule, the performing heavyweights have avoided Reger; what we have are conscientious efforts in medium-fi by honorable second-raters.

Reger himself recorded some of his piano and organ music on Welte player instruments. The piano rolls can be sampled on a Telefunken disc of composers playing their music; a whole record devoted to the organ music was reissued this year on Da-Capo. As a listening experience it has its limits: For technical reasons the pieces chosen are snippets of a generally slow and simply registered sort. But if those in search of a real sampling of Reger's organ music will be disappointed, these Welte excerpts do provide an insight into the composer's own way of playing his music.

Just how much of an insight is a matter of controversy. To the extent that Welte playbacks today can be trusted, it would seem that Reger interpreted his music slowly—slower than many of his own metronome markings—and with a good deal of expressive rubato. It's like today's Bruckner style: if you think Bruckner rambled on and needs the sort of tightening up that conductors of the George Szell sort inflict on him, then you will enjoy some of the recent, mechanistically baroque recorded performances of Reger's music. If your taste runs to the Furtwängler-Karajan-Klemperer school of Bruckner conducting, however, you may find that such modern Reger playing minimizes the overtly mystical strengths of his music.

Organ Music

Reger's organ music has been justly prized as his finest contribution. You have to have a taste for late-Romantic organ reveries—the Franck-Widor-Vierne syndrome—to appreciate it fully. These are, for all their obeisance to the baroque, sweeping, highly colored, improvisational rhapsodies.

The fantasias based on Lutheran chorales are the choice of the lot, and Wilhelm Krumbach's richly recorded set on Eurodisc is the best example of a weighty, romantic style among the recent releases. This is playing in the Knappertsbusch tradition—a bit lacking in surface intensity perhaps, but full of the kind of *Innigkeit* Reger so desperately needs. Werner Jacob's two four-record sets on MHS are certainly worthy performances and provide the most extensive available survey of this music. Jacob plays on six different organs, and they all tend

The Organ Recordings

H Max Reger Plays His Own Organ Works. Reger, Welte player-organ. DACAP0 C 053 28925 \$6.98 (originally issued on LP on GERMAN COLUMBIA C80 666).

Fugue in G major, Op. 56, No. 3; Organ Mass, Op. 59; Benedictus, No. 9; Melodia, Op. 59, No. 11; Canzona, Op. 65, No. 9; Chorale Preludes, Op. 67: Nos. 20, 23, 33, 45, 50, and 52; Moment musical, Op. 69, No. 4; Romance, Op. 80, No. 8; Prelude, Op. 85, No. 3.

Chorale Fantasias. Wilhelm Krumbach, organ. [Rolf Benecke, prod.] EURODISC 86 489 XIX, \$27.92 (four discs).

Chorale Fantasias: on Ein' feste Burg, Op. 27; on Freu' dich sehr, o meine Seele, Op. 30; on Wie schon leucht' uns der Morgenstern, Op. 40, No. 1; on Straf' mich nicht mit deinem Zorn, Op. 40, No. 2; on Alle Menschen müssen sterben, Op. 52, No. 1; on Wachtel auf, ruft uns die Stimme, Op. 52, No. 2; on Halleluja! Gott zu loben, Op. 52, No. 3. Te Deum, in A minor, Op. 59, No. 12. Chorale Preludes, Op. 79b: Nos. 1, 4, 6, and 9.

B Selected Organ Works, Vols. 1 and 2. Werner Jacob, organ. MUSICAL HERITAGE MHS 1563/66 and MHS 1567/70, \$11.96 each four-disc set (available by mail from society at 1991 Broadway, New York, N.Y. 10023).

VOL I: Chorale Fantasias: Op. 27; Op. 40, Nos. 1 and 2; Op. 52, No. 2. Fantasia and Fugue on B-A-C-H, Op. 46. Symphonic Fantasia and Fugue, Op. 57 (*Inferno Phantasia*). Pieces, Op. 59: No. 7, Kyrie eleison, in E minor; No. 8, Gloria in excelsis, in D; No. 9, Benedictus in D flat. Introduction and Passacaglia, in F minor. Op. 63, Nos. 5 and 6. Canzone in E flat, Op. 65, No. 9. Variations and Fugue on an Original Theme, in F sharp minor, Op. 73. Chorale Preludes, Op. 79b: Nos. 4-6. Fantasia and Fugue, in D minor, Op. 135b. VOL II: Fantasia and Fugue, in C minor, Op. 29. Chorale Fantasias: Op. 30; Op. 52, Nos. 1 and 3. Sonatas: No. 1, in F sharp minor, Op. 33; No. 2, in D minor, Op. 60. Chorale Preludes, Op. 67, Nos. 3 and 5. Introduction, Passacaglia, and Fugue, in E minor, Op. 127. Toccata, Basso ostinato, and Fugue, in D minor, Op. 129, Nos. 1, 6, and 2. Introduction and Passacaglia, in D minor.

B Fantasia and Fugue on B-A-C-H, Op. 46; Introduction and Passacaglia in D minor; Suite in G minor, Op. 92. Heinz Lohmann, organ. MUSICAL HERITAGE SOCIETY MHS 1463, \$3.49.

B Variations and Fugue, Op. 73; Fantasia and Fugue, Op. 29. Heinz Lohmann, organ. MUSICAL HERITAGE SOCIETY MHS 1510, \$3.49.

B Thirty Chorale Preludes, Op. 135a. Heinz Lohmann, organ. MUSICAL HERITAGE SOCIETY MHS 1464, \$3.49.

Introduction, Variations and Fugue, Op. 73; Fantasia and Fugue on B-A-C-H, Op. 46; Seven Pieces, Op. 145: Funeral Ode, No. 1. Rosalinde Haas, organ. TELEFUNKEN SAT 22519 \$6.98.

Introduction, Variations and Fugue, Op. 73; Toccata and Fugue in A minor, Op. 80b; Organ Mass, Op. 59: Benedictus and Melodia, Nos. 9 and 11. Robert Noehren, organ. LYRICHORD 7121, \$5.98.

Organ Mass, Op. 59: Toccata and Fugue, Nos. 5 and 6; Chorale Fantasia, Op. 40, No. 2. Simon Preston, organ. ARGO ZRG 5420, \$5.95 (with REUBKE: Sonata on the 94th Psalm).

to a baroque sort of sound, light and cleanly voiced; in conjunction with his prevailingly quick, nonrhetorical style, they seem a little prosaic in spots, but that shouldn't put off the curious.

Heinz Lohmann is apparently engaged in a project to record all of Reger's organ music in Germany. His style and sound fall between Krumbach and Jacob—a little pedantic here and there, but nothing serious to complain about.

Rosalinde Haas's disc might serve as a good single-record introduction to Reger's organ music: Modern in spirit, it is still played with drama and

intensity, and the recorded sound is superb. The sound on Robert Noehren's record is more dated, though still functional; the interpretations sound idiomatic and serviceable, if not overflowing with individuality. Simon Preston's offering of two of Reger's pieces, made ten years ago, has as its virtues good sound and clean-lined modern performances. The disadvantages are a surprisingly poor pressing, no band break between the two Reger works, and a non-Reger coupling (which is of course an advantage if you want the Reubke).

Piano Music

Reger's piano music lacks the coloristic allure of his organ pieces and hence has had a tougher reception from the critics. His more grandiose piano efforts command respect for the sheer tenacity with which they attempt to approximate organ sonorities, often as not bringing in a second piano or pianist for reinforcement.

The *Bach* and *Beethoven* variations, Op. 81 and Op. 86 respectively, have been widely admired. The former, for solo piano, is attractively presented by Dieter Zechlin on a recent Eurodisc (coupled with some rather inconclusive snippets from the late *Träume am Kamin*, Op. 143). The latter, for two pianos, is even more persuasively advocated on an older MHS record by the Kontarsky brothers, paired with the more austere and in some ways even more fascinating Introduction, Passacaglia, and Fugue, Op. 96. (The very fact that these two champions of the avant-garde are advocating Reger is itself of interest.) The Kontarskys can also be heard in the *Variations and Fugue on a Theme of Mozart*, Op. 132a—another most appealing piece, although here one might prefer the orchestral version, of which this is a reduction by the composer. The *Mozart* Variations are coupled with the jolly *Telemann* Variations and Fugue for solo piano, Op. 134, in a workaday performance by Hugo Steurer.

Aus meinem Tagebuch, Op. 82, is a set of abstract salon pieces that takes three discs to encompass. If you like Grieg and other music of the genre and aren't put off by the Bach-ish dust that settles over it all, you may find it quite charming. Richard Laugs's performance on MHS presents a fine case for it.

Two other MHS discs, devoted to the early Op. 9 Waltz-Capriccios, the Op. 11 Waltzes, twenty Op. 10a German Dances, and six Op. 22 Waltzes, prove less successful. The music has its intermittent charms to be sure, but the young Reger hadn't yet learned his trade, and these determinedly light efforts sound simplistic and studious. The excellent four-hand piano team of Karl-Heinz and Michael Schlüter is heard to better advantage on yet another MHS record of three middle-period works, the first two light and the last serious; of the piano

The Piano Recordings

Variations and Fugue on a Theme by Bach, Op. 81; *Träume am Kamin*, Op. 143, Nos. 1, 3, 4, 7, and 10. Dieter Zechlin, piano. EURODISC 86 474 KK, \$6.98.

B Variations and Fugue in B flat major on a Theme of Beethoven, Op. 86; Introduction, Passacaglia, and Fugue in B minor, Op. 96. Alfons and Aloys Kontarsky, pianos. MUSICAL HERITAGE SOCIETY MHS 1292, \$3.49.

B Variations and Fugue on a Theme of Telemann, Op. 134. Hugo Steurer, piano. Variations and Fugue on a Theme of Mozart, Op. 132a. Alfons and Aloys Kontarsky, pianos. MUSICAL HERITAGE SOCIETY MHS 1268, \$3.49.

B *Aus meinem Tagebuch*, Op. 82. Richard Laugs, piano. MUSICAL HERITAGE SOCIETY MHS 1620/22, \$8.97 (three discs).

B Waltz-Capriccios, Op. 9. Karl-Heinz and Michael Schlüter, piano four hands. Waltzes, Op. 11. Richard Laugs, piano. MUSICAL HERITAGE SOCIETY MHS 1619, \$3.49.

B Twenty German Dances, Op. 10a; Six Waltzes, Op. 22. Karl-Heinz and Michael Schlüter, piano four hands. MUSICAL HERITAGE SOCIETY MHS 1618, \$3.49.

B Pièces pittoresques, Op. 34; Six Burlesques, Op. 58; Six Pieces, Op. 94. Karl-Heinz and Michael Schlüter, piano four hands. MUSICAL HERITAGE SOCIETY MHS 1487, \$3.49.

Pièces pittoresques, Op. 34; Six Waltzes, Op. 22; Six Pieces, Op. 94. Sharon Gunderson and Jo Ann Smith, piano four hands. ORION ORS 73130, \$5.98.

discs, this or the Kontarskys on MHS 1292 would be the best place to start. The selection offered by Sharon Gunderson and Jo Ann Smith on Orion is duplicated on two MHS albums by the Schlüters, who surpass the California women in liveliness of both interpretation and recorded sound.

Chamber Music

Reger wrote a full range of chamber music, and the best introduction to it that one can buy domestically in the average record store is probably the Vox Box devoted to the five string quartets. His quartets are all products of his maturity, and all of them are worth hearing. The Fourth is the most widely admired, the Third is fascinating for its range and length, and the Fifth marks an appealing return to the simpler style that characterized many of the composer's final works. The Reger Quartet, the performers on the Vox set, is a first-rate German ensemble that dispatches these pieces in a lean and generally sensitive, effective manner.

The Heutling Quartet's version of Op. 121 is interesting in its slower, more rhetorical approach, but that approach might work better in the middle quartets than it does in Op. 121. In any case, the imported disc is prohibitively expensive. It not only has to compete with a budget set, but it also spreads

Op. 121 over a whole disc (the piece is admittedly some fifty minutes long, but Vox squeezes another quartet onto the second side). The Pfeiffer Quartet's pairing of Op. 54, No. 2, with the unusual, otherwise unrecorded Op. 64 Piano Quintet is a good one: somewhat distantly recorded perhaps, but slower and more pointedly played than the Reger Quartet's style and still never lacking in forward momentum.

One's only hesitation about recommending the Vox Box to those in search of a complete set of the quartets is the availability in Europe of three DG discs by the Drolé Quartet that also encompass the five Reger quartets and offer the best performances of all—taut, tight, and masterful.

The other Vox Box can also be warmly recom-

mended. The two flute-violin-violata serenades (which also exist in optional versions in which the flute is replaced by a second violin) are sister works to the two string trios; both Op. 77 and Op. 141 contain one of each. All four works tend toward Reger's least portentous, Mozartean style, and they are pleasingly complemented by the four short pieces from Op. 131 for two violins. Op. 131 consists of fifteen short pieces in a deliberately baroque style for unaccompanied string instruments, and the canons and fugues have a real charm to them if you are susceptible to that sort of charm. The set is rounded out with the ingratiating Op. 146 Clarinet Quintet, a very late work of genuine lyrical appeal.

Being attractive works, the serenades and string trios have attracted attractive performances. The

The Chamber Music Recordings

- B** The Complete Chamber Music, Vol. 1. Aurèle Nicolet, flute; Susanne Lautenbacher and Geörg Egger, violins; Ulrich Koch, viola; String Trio Bel Arte; Bel Arte Ensemble. Vox SVBX 586, \$9.95 (three discs).

Serenades for Flute, Violin and Viola in D major, Op. 77a, and G major, Op. 141a; Canons and Fugues in the Old Style, for two violins, Op. 131b, Nos. 1-3; String Trios in A minor, Op. 77b, and D minor, Op. 141b; Quintet for Clarinet and Strings in A major, Op. 146; Allegro for Two Violins in A major, Op. 121.

- B** The Complete Chamber Music, Vol. 2. Reger Quartet. Vox SVBX 587, \$9.95 (three discs). String Quartets: No. 1 in G minor, Op. 54, No. 1; No. 2 in A major, Op. 54, No. 2; No. 3 in D minor, Op. 74; No. 4 in E flat major, Op. 109; No. 5 in F sharp minor, Op. 121.

String Quartet No. 5. Heutling Quartet. [Gerd Berg, prod.] ODEON C063-29097, \$6.98.

- B** Piano Quintet in C minor, Op. 64; String Quartet No. 2. Peter Schmalfluss, piano; Pfeiffer Quartet. MUSICAL HERITAGE SOCIETY MHS 1378, \$3.49.

Serenades, Opp. 77a and 141a. John Wion, flute; Stanley Ritchie, violin; Laurance Fader, viola. [Jerry Bruck, prod.] LYRICHORD LLST 7217, \$5.98.

- B** Serenade, Op. 141a; Allegretto grazioso for flute and piano; Clarinet Sonata in B flat major, Op. 107. Werner Richter, flute; Sandor Karolyi, violin; Hans Eurich, viola; Wendelin Gärtner, clarinet; Richard Laugs, piano. MUSICAL HERITAGE SOCIETY MHS 1329, \$3.49.

- B** Serenade, Op. 77a; String Trio, Op. 141b. Werner Richter, flute; Sandor Karolyi, violin; Hans Eurich, viola; Uwe Zipperling, cello. MUSICAL HERITAGE SOCIETY MHS 1353, \$3.49.

String Trios, Opp. 77b and 141b. New String Trio, New York. BASF KBB 21642, \$5.98.

String Trio, Op. 77b. Philharmonische Solisten Berlin. ODEON C053-28000, \$6.98 (with HINDEMITH: String Trio, Op. 34).

- B** String Sextet in F major, Op. 118. Wührer String Sextet. MUSICAL HERITAGE SOCIETY MHS 1402, \$3.49.

- B** Trio in E minor, Op. 102. Sandor Karolyi, violin; Uwe Zipperling, cello; Werner Hopstock, piano. MUSICAL HERITAGE SOCIETY MHS 1321, \$3.49.

- B** Trio in B minor, Op. 2; Three Suites for solo viola, Op. 131d. Philipp Nägele, violin; Ernst

Wallfisch, viola; Lory Wallfisch, piano. MUSICAL HERITAGE SOCIETY MHS 1389, \$3.49.

- B** Sonatas in A flat, Op. 49, No. 1, and F minor, Op. 49, No. 2. Dieter Klöcker, clarinet; Werner Genuit, piano. MUSICAL HERITAGE SOCIETY MHS 1521, \$3.49.

Sonatas, Op. 49, No. 1, and Op. 107. Herbert Tichman, clarinet; Ruth Tichman, piano. MARK EDUCATIONAL RECORDINGS MMF 3366, \$5.98.

- R** Sonata in C minor, Op. 139. Pina Camirelli, violin; Rudolf Serkin, piano. [Mischa Schneider, prod.] Sontata in A minor, Op. 116. Schneider, cello; Peter Serkin, piano. [Thomas Z. Shepard, prod.] COLUMBIA M 32221, \$5.98 (Op. 116 originally issued on MS-6891 in 1966).

- B** Sonata in F sharp minor, Op. 84; Suite in A minor, Op. 103a. Stanley Weiner, violin; Giselle de Moulin, piano. MUSICAL HERITAGE SOCIETY MHS 1667, \$3.49.

- B** Little Sonata in D minor, Op. 103b, No. 1; Sonata, Op. 139. Stanley Weiner, violin; Giselle de Moulin, piano. MUSICAL HERITAGE SOCIETY MHS 1500, \$3.49.

- B** Sonatas in C major, Op. 72; A major, Op. 103b, No. 2. Sandor Karolyi, violin; Suzanne Godefroid, piano. MUSICAL HERITAGE SOCIETY MHS 1726 \$3.49.

- B** Four Sonatas, Op. 42. Stanley Weiner, violin. MUSICAL HERITAGE SOCIETY MHS 1719, \$3.49.

- B** Seven Sonatas, Op. 91. Philipp Nägele, violin. MUSICAL HERITAGE SOCIETY MHS 1697 and 1741, \$3.49 each.

- B** Preludes and Fugues, Op. 131a. Sandor Karolyi, violin. MUSICAL HERITAGE SOCIETY MHS 1698, \$3.49.

- B** Sonatas in F minor, Op. 5; G minor, Op. 28; F major, Op. 78; A minor, Op. 116. Ludwig Hoelscher, cello; Karl Heinz Lautner, piano. MUSICAL HERITAGE SOCIETY MHS 1360/1391, \$5.98 (two discs).

- B** Sonatas, Opp. 5, 28, 78, and 116. Gerhard Mantel, cello; Erika Frieser, piano. MUSICAL HERITAGE SOCIETY MHS 1752 and 1765, \$3.49 each.

- B** Three Suites, Op. 131c. Zoltan Racz, cello. MUSICAL HERITAGE SOCIETY MHS 1465, \$3.49.

Lyrichord disc of the two serenades is brightly played and recorded, if noisily pressed. MHS offers good, occasionally soulful but echoicly recorded and slightly damp versions of the two serenades. MHS 1329 couples Op. 141a with the short Allegretto grazioso and the Op. 107 Clarinet Sonata. The latter is an appealing enough piece, if you like the clarinet, and is less under Brahms's shadow than the two earlier Op. 49 Clarinet Sonatas; it receives an idiomatic performance here. MHS 1353 couples the Op. 77a Serenade with the Op. 141b String Trio in a good if slightly stolid, Germanic performance.

The BASF pairing of the two string trios is an attractive offering, more intensely performed and closely recorded than its competition and—one is happy to report with a BASF release—cleanly and noiselessly pressed. Vox probably is still the best buy, although the best performance of either of the string trios can be heard on Odeon, with members of the Berlin Philharmonic sailing through Op. 77b with a richness of tone and finesse of style that easily surpasses all the others; the coupling is not Reger, but the Hindemith Op. 34 String Trio.

The Op. 118 String Sextet is an entirely different kind of chamber music. Instead of grace and charm (admittedly Regerian grace and charm, but still . . .), we have here chamber music pushed to its expressive limits, both in terms of tone and part-writing. Sextets can sound like orchestral sketches, especially in Reger's hands, and here the tonality is extended, too. After this, Reger's "Mozartean" late period was really the only alternative to a forthright plunge into atonality. The Wührer String Sextet makes a decent case for the piece in rather wiry recorded sound.

Reger wrote two piano trios. Op. 102, in E minor, derives from the same period as the String Sextet and is a similarly sweeping, impassioned effort. It receives a performance typical of MHS's Reger series on 1321: idiomatic, decently recorded, and just a little prosaic. The Piano Trio in B minor, Op. 2, similarly performed on MHS 1389, replaces the more frequently used cello with a viola and is clearly indebted to Brahms.

Reger's ties with the older master are even more apparent in the first two Clarinet Sonatas, Op. 49, written in direct imitation of Brahms's two sonatas for that combination. They sound a little stale, if still pleasant enough, in their MHS incarnations. The version of Op. 49, No. 1, and the third sonata, Op. 107, on Mark Educational Recordings is a little more edgy in tone and less idiomatic in approach, and its virtues are hardly such that it's worth special-ordering the record.

Reger wrote extensively for solo string instruments, with or without piano accompaniment, and a remarkably large number of his works of this sort are available on record—again, mostly on MHS. But the first disc that must be mentioned is the

Marlboro pairing of the Op. 139 Violin Sonata with the Op. 116 Cello Sonata. As it happens, the former receives a better performance than the latter. But the former's intense excellence is such that—along with a few other items in the current Reger discography—it makes one wonder what the composer's reputation would be if more top-notch artists interested themselves in his music. The worthy but unknown toilers in the fields of Regeriana who are responsible for most of the available recorded performances must be thanked, of course, but almost by definition they aren't advocating this music as well as they could. That said, one hastens to add that the MHS performances stand up well enough on their own terms.

As a general rule, Reger's music for violin or cello and piano pays homage to Brahms and the classical tradition as filtered through a Romantic sensibility: the works for unaccompanied string instruments, on the other hand, harken back to Bach. But within those categories there is a good deal of variety, from the full-blown drama of the Opp. 72, 84, and 139 Sonatas to the more domestic, self-contained charms of the Op. 103b Little Sonata. And there are exceptions, too: the Op. 103a Suite simultaneously enjoys piano accompaniment and a baroque inspiration. The solo pieces will strike some as too intermittently (pervasively?) academic in their determined Bach-ishness. But, like the organ music, it is possible to sink comfortably into this music and just let it flow over you.

MHS's various string players all have their virtues, although the company's conscientiousness might seem to approach the manic in its release of two directly competing sets of the cello sonatas. I haven't heard the first record (1752) in the more recent collection (it wasn't available at the time of this writing). But oddly enough, the versions by Ludwig Hoelscher and Karl Heinz Lautner, who got there first, sound richer and more secure. (A Dover record of three of the Op. 91 unaccompanied sonatas, listed in Schwann, is out of print.)

Choral Music

Reger's best-known choral music dates from relatively late in his life, and it is effective stuff, although some of the more chromatic a cappella pieces require an exactitude of pitch rivaling that needed for Gesualdo. Pitch precision is what distinguishes the N.C.V.R. Ensemble's disc of the Op. 110 three Motets on MHS; this is hardly the smoothest or most ingratiating choral tone imaginable, but the accuracy is very good indeed.

The Swedish group's performances for Odeon make use of a bigger, more adult-sounding ensemble and a vaster ambience. The first side, devoted to the *Geistliche Gesänge* and one of the Op. 110 Motets, is quite successful in a churchy kind of

The Choral Recordings

B Motets, Op. 110, Nos. 1, 2, and 3. N.C.V.R. Vocal Ensemble, Hilversum, Marinus Voorberg, cond. MUSICAL HERITAGE SOCIETY MHS 1519, \$3.49.

Geistliche Gesänge, Op. 138; Motets, Op. 110: Nos. 2 and 3. Stockholm Radio Chorus, Eric Ericson, cond. [Gerd Berg, prod.] EMI ODEON C 063 29081, \$6.98.

Der Einsiedler, Op. 144a. Max van Egmond, baritone; Junge Kantorei; Berlin Symphony Orchestra, Joacim Martini, cond. TELEFUNKEN SLT 43114 B, \$6.98.

Geistliche Gesänge, Op. 138: Nos. 3, 5, and 8; Twenty Responsories: Nos. 1, 5, and 8; Palmsonntagmorgen, Ostermotette; Requiem. Op. 144b.

way; the second side, with another motet, was recorded live in 1968 and sounds too murky and muddled.

The Telefunken album is the best of this bunch, combining a nice mixture of works with excellent sound and fresh and devoted performances.

Orchestral Music

The orchestral music offers some of Reger's most appealing accomplishments, in that the Brahmsian instrumentation provides a coloristic variety lacking in some of the other pieces. His most widely heard orchestral book in this country is the Op. 114 Piano Concerto, because of Serkin's dogged efforts in its behalf. Serkin's own first-rate performance on Columbia, with Ormandy and the Philadelphians, is out of print and unavailable on Columbia's special-order list as well. But the reissued version from 1958 on Electrola with Erik Then-Bergh and Hans Rosbaud is worthy competition, and any lover of sprawling, tuneful, late-Romantic symphonies with solo instrument obligato should find it worth investigating. The more recent East German account of the concerto—the East Germans have been far more assiduous about recording Reger's orchestral scores than anybody else—is better recorded but slacker than the Electrola disc.

Joseph Keilberth's versions of the *Hiller* and *Mozart* Variations and the Ballet Suite is probably still the best place to begin an exploration of this part of Reger's *oeuvre*. The sound is a little dated now, particularly the *Hiller* Variations in electronic stereo, but Keilberth's performances remain authoritative ones in their relaxed way.

The two-disc Eurodisc collection of orchestral music offers an alternate version of the Ballet Suite, equally convincing interpretively and more brightly recorded. The Concerto in the Old Style is perhaps not so important a work as the two sets of variations, but it has its real charms nonetheless. The venerable Bongartz's performances of the *Sinfonietta* in the two-record set and the *Mozart* Variations (rather stingily offered without a coupling)

are even more relaxed than Keilberth's Reger, and a little sloppy besides. Their palpable affection for the music comes through winningly, though.

In the Four Tone Poems after Böcklin, one of Reger's few excursions into program music, the bulk of the score is so softly and uncharacteristically Impressionistic that Bongartz's geniality proves a positive blessing. The Berlioz coupling might strike Americans as eccentric, but it indicates how close Reger is to the warhorse repertory in Germany.

Hopefully a major conductor and orchestra will turn their attentions to these pieces; a new account of the boisterous *Hiller* Variations is especially needed.

The Orchestral Recordings

R Concerto for Piano and Orchestra in F minor, Op. 114. Erik Then-Bergh, piano; Southwest German Radio Orchestra, Hans Rosbaud, cond. EMI ODEON C 053-28929, \$6.98 (originally issued from ELECTROLA E 80439 in 1958).

Concerto, Op. 114. Amaceus Webersinke, piano; Dresden Philharmonic, Günther Herbig, cond. EURODISC 86 475 KK, \$6.98.

Variations and Fugue in E major on a Theme of Hiller, Op. 100. Hamburg Philharmonic State Orchestra, Joseph Keilberth, cond. Variations and Fugue in A major on a Theme of Mozart, Op. 132; Ballet Suite, Op. 130. Bamberg Symphony, Keilberth, cond. TELEFUNKEN TK 14520/1-2, \$13.98 (two discs).

Sinfonietta in A major, Op. 90; Concerto in the Old Style, in F, Op. 123; Ballet Suite, Op. 130; Günter Siering, violin, (in Op. 90); Karl Suske and Heinz Schunk, violins (in the Op. 123); Dresden Philharmonic Orchestra, Heinz Bongartz, cond. (in Op. 90); Staatskapelle Berlin, Otmar Sutner, cond. (in Opp. 123 and 130). EURODISC 86 535 XEK, \$13.98 (two discs).

Variations and Fugue on a Theme of Mozart, Op. 132. Sächsische Staatskapelle, Dresden, Heinz Bongartz, cond. EURODISC 80 276 LK, \$6.98.

Four Tone Poems after Arnold Böcklin, Op. 128. Walter Harwich, violin; Dresden Philharmonic Orchestra, Heinz Bongartz, cond. EURODISC 85 125 KK, \$6.98 (with BERLIOZ: Roman Carnival Overture; La damnation de Faust: Rakoczy March; Ballet of the Sylphs; Minuet of the Will-o'-the-Wisps).

There is much to be done, but one has to admit that there are significantly more Reger records to be had now (precisely seventy-one, at the time of this writing) than there were at the start of the centenary year. If the American record industry didn't honor itself in terms of self-sponsored recordings, then at least Musical Heritage Society went a long way to restore that honor by its ceaseless flow of repackaged German imports.

Max Reger's time can't really be said to have come—a MHS annotator's casual references to a Reger "vogue" in this country seem premature at best. But at least the current slew of available material may help the open-minded reassess him in terms of his accomplishments rather than his dubious, daunting reputation. ■

Fidelity.

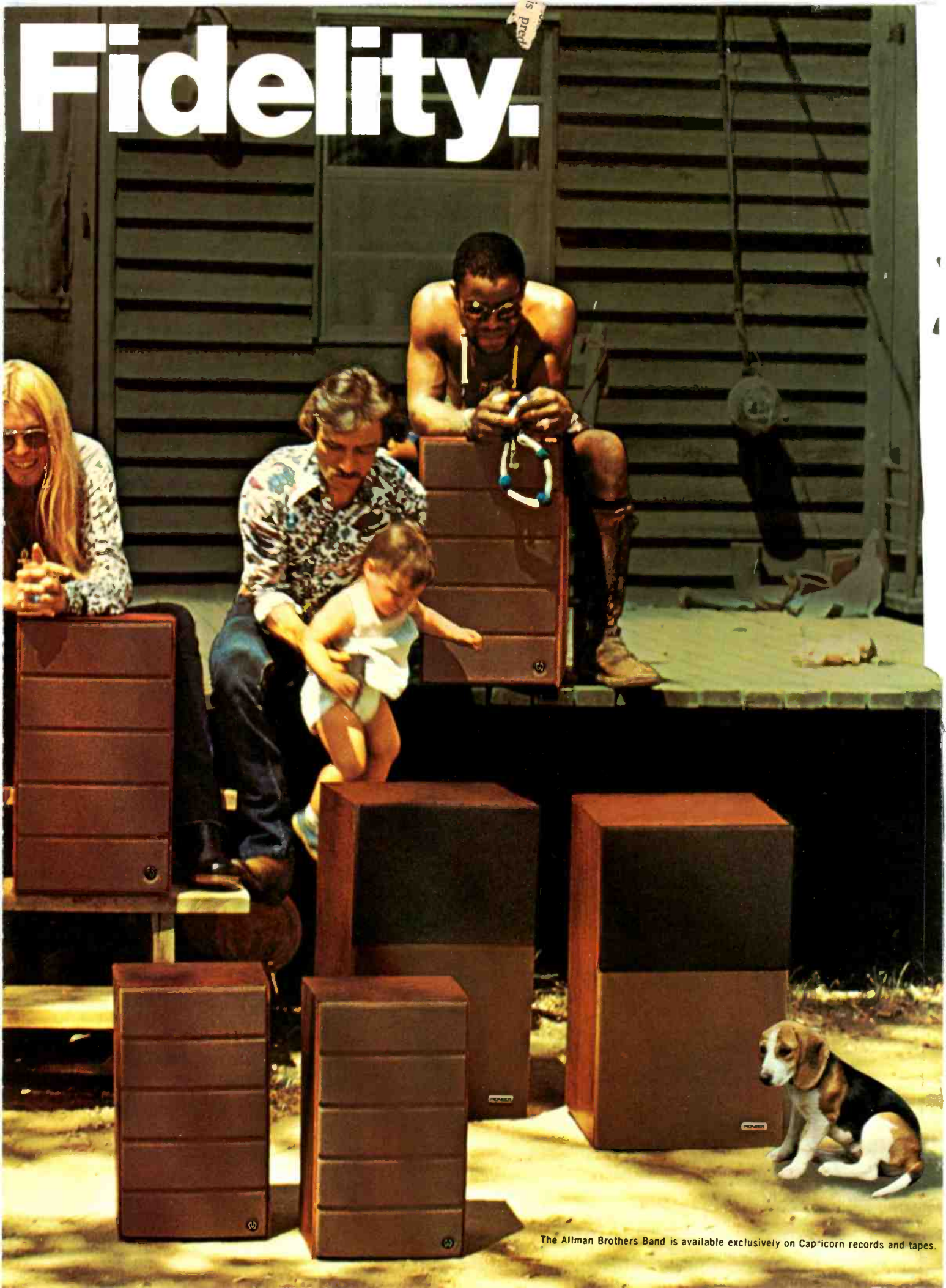

The Allman Brothers Band is available exclusively on Capricorn records and tapes.

The Allman Brothers Band has a great new sound...



Pioneer High



More than anything else, the Allman Brothers Band are musicians. Accomplished, sophisticated musicians whose blues-rooted improvisations have carried them to the top of their field.

Musicians, not rock stars. Their success doesn't depend on sequins or serpents, or make-up, or put-on showmanship. Instead, they innovate. And they stake their fame on their music.

As musicians, the Allman Brothers Band prefer the sound of Pioneer speakers. They prefer Pioneer speakers because of their clarity and overall sound quality. They prefer Pioneer speakers because they reproduce the sound of an original performance without adding coloration, hyped-up bass or artificial brilliance. They prefer Pioneer speakers because exactly what goes in is exactly what comes out.

With Pioneer speakers, the Allman Brothers sound right to the Allman Brothers. It's that simple.

Pioneer makes a variety of speakers to match any hi-fi system. Speakers that are consistent in their clarity, sound quality and ability to exactly reproduce the sound of an original performance. Speakers that vary because people vary, hi-fi systems vary, room acoustics vary, budgets vary and tastes vary.

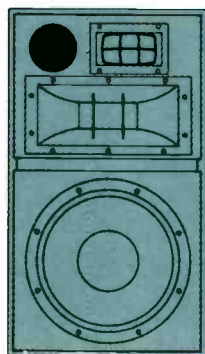

R-700

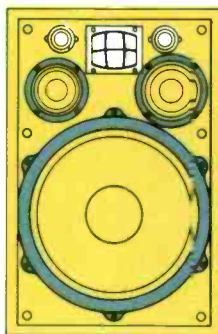

CS-99A

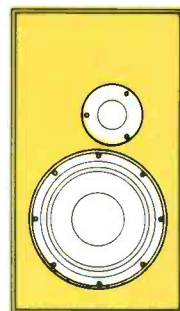

PROJECT 100

Series R

Series R speakers are designed for the individual who demands the finest in styling, design and sound. Styling and design as contemporary as the state of the art. And sound as contemporary as a live performance.

Series R speakers bring new life to live performances. And truly live performances to your listening room. Their high efficiency, extreme accuracy and zero coloration have been equally praised by artists, engineers, critics and musicians.

All of the Series R speakers — R700, R500 and R300 — deliver the true vibrancy of a live performance. In an untouched, uncolored and unusually natural way.

Project Series

Project Series speakers are designed to deliver maximum performance per dollar in a contemporary bookshelf design. Smallest of the three, the Project 60 is an extremely efficient speaker system that delivers a surprisingly high sound level from moderately powered receivers and amplifiers. It is perfect for smaller hi-fi systems. And equally well suited for 4-channel systems — since many of the new 4-channel receivers and amplifiers have less power per channel than their stereo counterparts.

Project 80 and 100 speaker systems use their air suspension design to deliver a beautiful natural

sound. Their superb bass response can effortlessly reproduce the lowest of lows with minimal distortion and uncanny accuracy. Their dome tweeters provide exceptionally wide dispersion and highs of unsurpassed clarity.

CS Series

There is a myth about speakers that handsome cabinets hide inferior sound. Fortunately, it need not be the case.

If you seriously demand the acoustic quality of custom cabinetry along with powerfully smooth sound, the CS series speakers will be your first choice. Their sound is precise and natural. And their craftsmanship is a reflection of an almost bygone era.

The air suspension design of the

CS series speakers help to provide the quality of sound that is the hallmark of Pioneer engineering excellence. From the compact 2-way 2-speaker CS-44 to the 4-way 6-speaker CS-63DX, Pioneer CS series speakers offer a combination of superb sound reproduction and custom-crafted cabinetry.

There are 12 different speakers in the Pioneer line. There are six different musicians in the Allman Brothers Band. Different people have different needs and different tastes. Even the Allman Brothers. But they agree that Pioneer speakers deliver the best sound available.

Pioneer speakers are part of a complete line of Pioneer audio components — components preferred by the Allman Brothers Band. A fact you might consider when you make your own selection.

U. S. Pioneer Electronics Corp.
75 Oxford Drive, Moonachie,
New Jersey 07074.
West: 13300 S. Estrella, Los Angeles,
Cal. 90248 / Midwest: 1500
Greenleaf, Elk Grove Village, Ill.
60007 / Canada: S. H. Parker Co.

Model	Type	Maximum Input Power	Size (HxWxD)	Price
R-700	12" 3-way	75 watts	26"x15"x14"	\$229.95*
R-500	10" 3-way	60 watts	24"x14"x12"	159.95*
R-300	10" 2-way	40 watts	23"x13"x11"	119.95*
PROJ. 100	10" 2-way	35 watts	23"x13"x10 1/2"	129.95
PROJ. 80	10" 2-way	30 watts	20 3/4"x11 3/4"x11"	99.95
PROJ. 60	8" 2-way	20 watts	18 1/2"x10 5/8"x8 1/2"	79.95
CS-63DX	15" 4-way	80 watts	28"x19"x13"	269.95
CS-99A	15" 5-way	100 watts	25"x16"x11"	229.95
CS-A700	12" 3-way	60 watts	26"x15"x12"	189.95
CS-A500	10" 3-way	50 watts	22"x13"x12"	149.95
CS-66	10" 3-way	40 watts	22"x12"x12"	119.95
CS-44	8" 2-way	25 watts	19"x11"x9"	74.95

*Fair Trade resale price where applicable.

PIONEER
when you want something better

CIRCLE 48 ON READER-SERVICE CARD

\$179⁹⁵

for a Thorens?



\$179⁹⁵

for a Thorens!

You've always expected the unexpected from Thorens. And now you get it for only \$179.95.

Despite its modest price, the new Thorens TD-165C is a Thorens in every sense of the word. Completely integrated with a new Thorens tonearm, dust cover and walnut base, it features a double 16-pole synchronous motor, precision cueing control, dynamically balanced six pound, 12-inch platter, anti-skating control,

plus the many refinements that are the foundation of Thorens' reputation for the world's finest transcription turntables. And of course, with Thorens the last thing you have to think about is quality. We thought of it first.

Elpa Marketing Industries, Inc.,
New Hyde Park, N.Y. 11040
7301 E. Evans Rd.,
Scottsdale, Ariz. 85260

THORENS

CIRCLE 13 ON READER-SERVICE CARD

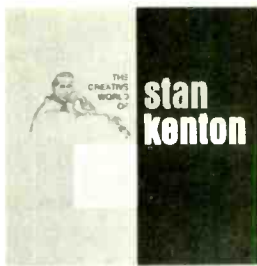

by Gene Lees

The Home-Grown Record Label



The growing trend among performers to found their own mail-order record-production companies may start a small revolution in the record industry.

WITHIN THE PAST two or three years, a curious and potentially important movement has sprung up in the American record industry: the do-it-yourself label, owned and operated by the artist—sometimes literally from a basement—and using mail order as the primary means of reaching the public.

The movement is small as yet—nothing for the big dinosaur companies to worry about. But it is a gutsy little thing, defiant and quick, like a small mammal, and full of the warm blood of anger at the majors.

Records have been sold by mail for some time. Mail order, in fact, made the Reader's Digest into one of the biggest record companies in the world. That label is of course dedicated largely to nostalgia, as are Time-Life Records and Dynamic House/Tele House. Reader's Digest and Time-Life have taken on classical projects from time to time (the huge Beethoven series from DG and the complete Solti *Ring* from London). Also in the classical field, direct-mail sales have made the Musical Heri-

tage Society into another of the world's most successful record operations.

This phenomenon has not gone unnoticed by the majors. Hence the flood of television advertising for direct-mail purchase of records by Eddy Arnold, Elvis Presley, and the late Nat King Cole, as well as interminable packages of rock and country hits.

The movement that concerns us here is a separate thing, since it is run by the artists and is in effect a parting of the ways with the standard patterns of record distribution and sale. It involves some important names in American music, such as Stan Kenton, George Shearing, Marian McPartland, Bobby Hackett, Yank Lawson, and Carla Bley. Indeed, since there is no central source of information about the movement, it is difficult to determine just how big it has grown and how many people are involved.

It is motivated by many things, not the least of which is the widespread suspicion, and in some

cases certainty, that many labels have been playing games with royalty figures for years. But a more important factor is the desire, the need, the passion to circumvent the big labels, the paid-off disc jockeys, the ill-educated young program directors who are debasing the quality of American radio, and the great barn-like record stores pounding with rock, splattered with posters, and crowded with bin-browsers, and get their music to that large minority of the audience that is blessed with selective taste. The big companies and the big stores are no longer interested in that audience, and this has produced frustration in both artists and listeners.

One of the biggest operations set up in response to these conditions is Kenton's, and he is a key figure in the movement. The six-foot, five-inch and graying Kenton has emerged in the last decade as the magnificent fool of American music—one of its genuine prophets. He has always had uncanny foresight, and he has persisted in his direction even when record executives were saying he must be retarded to go on. And he has won.

Kenton was one of the figures whose albums in the 1940s—along with those of Nat Cole, Johnny Mercer, Peggy Lee, and others—helped build upstart little Capitol Records into a major. After the company was acquired by EMI of England and became, as its switchboard operators would tell you when you called the Hollywood office, “the home of the Beatles,” interest in Kenton and his music evaporated. Stubbornly, Kenton went on; after long argument he acquired from the company the rights to his old albums. He promptly began reissuing them on his newly organized Creative World label.

In the meantime, he was consolidating his penetration of the universities. He had for years been giving freely of his time and prodigious energies to the big-band movement that still flourishes in the high schools and universities of the U.S. (It is estimated that there are between eight thousand and ten thousand of these big “stage bands” in the schools.) With years of effort as a teacher and counselor, Kenton had become a hero to countless musically minded youngsters. They were the foundation of the audience for his band, which has remained determinedly modern, utilizing such composers of the new generation as Baltimore's Hank Levy. Kenton's music had moved on, but at the same time he wanted his older albums kept available for both their musical and historical value.

He began distributing cards during his concert appearances. Anyone who returned a card to his company was promptly put on Kenton's mailing list and began receiving a regular newsletter about the band's activities, the available older albums, and the new ones he was making, including the widely acclaimed Redlands University concert album. Today Kenton has forty of his albums available, and his mailing list is approaching 150,000

names, with about 25,000 of them bearing European addresses.

The biggest album sale he's had so far is about thirty thousand—chicken feed, by the standards of the rack jobbers. But it must be remembered that he gets the full retail price for an album. (Indeed, the sale at retail price is part of this do-it-yourself movement's appeal to artists.)

Kenton's staff of six, which works out of an office on Robertson Boulevard in Los Angeles, is headed by Bob Curnow, his a&r chief, general manager, and vice president. Under Curnow, the operation has expanded until now Creative World has thirty albums by artists other than Kenton—among them Maynard Ferguson, Clark Terry (who has himself just set up Etoile Records), Charlie Barnet, Bill Holman, Laurindo Almeida, and John Van Ohlen, the former Kenton drummer who now has his own quartet.

Creative World, in its newsletter, regularly prints plugs for the other artists who have gone the same route as Kenton. One of these is George Shearing, whose Sheba label has issued seven albums (including one by the magnificent Joe Williams) in the last two years. The operation is housed in a storefront office in North Hollywood. It is run by Shearing's quick and imaginative wife Trixie and his business-minded daughter Wendy. Its mailing list of ten thousand is on computer cards organized by ZIP code. In addition to direct-mail subscribers, the records are sold to and through thirty-three record shops throughout the country, and more keep writing to the Shearings every week.

The operation is doing well. “I saw a financial projection,” Trixie said, “that says a record company can be expected to lose money in its first two years of operation. If it is going to succeed, it will break even in the third year and then go into profit. We're right on schedule. Of course, during the first two years, we had all the expense of making those first seven albums. Now we'll recoup.”

Most of Shearing's earlier albums were, like Kenton's, on Capitol. They are simply unavailable to the public today, despite persistent requests from fans. Indeed, Sheba has been getting checks in the mail for the Capitol product and simply sends them back. The Shearings are in litigation with Capitol, and one of the bones of contention is the rights to those older albums. They wish to reissue them on their own label, as Kenton has reissued his.

Pianist Marian McPartland is another who has moved into mail order and, like Kenton, she finds herself recording artists other than herself. She's done albums with the New England pianist Dave McKenna and Teddy Wilson and another with her ex-husband, the Chicago-school cornetist Jimmy McPartland. She has also acquired the rights to a duet piano album she made with the late Bud Powell, one of the germinal figures in modern American music, and she's devoted her newest album to



One of the prime movers in the home-grown record movement, Stan Kenton organized his Creative World label when EMI/Capitol decided that it was "the home of the Beatles."

the music of Alec Wilder, another of the master musicians whose work has been assiduously ignored by the majors in recent years.

"I couldn't go on the way things were," Ms. McPartland said. "I haven't recorded for Capitol since 1954, and I'm still getting statements saying that I'm in the red! Yet they won't reissue the albums.

"There are days when having your own company is ghastly. But I'm glad I did it. At least I know I'm getting an honest count, and I know where all the records are going. I have records available for the disc jockeys, and I feel we are all doing a service for the people who want our music and can't get it in the record stores."

In New York City, the Jazz Composers Orchestra Association is devoted to the work of avant-garde jazz people, including Mike Mantler, Cecil Taylor, Don Cherry, Roswell Rudd, Pharoah Saunders, and Larry Coryell. It has issued a three-record set of *Elevator Over the Hill*, a multimedia opera by composer Carla Bley. JCOA also distributes records by European companies whose musical philosophies accord with its own.

Strada East is another interesting New York operation. Each musician produces his own record, and the company distributes it. Strada East has at least fifteen albums by New York jazzmen such as Cecil Payne, Kenny Dorham, Clifford Jordan, and the late Wynton Kelly.

Cornetist Bobby Hackett has organized his own label, Hyannis Port Records. And two years ago, at the age of ninety, pianist Eubie Blake set up his own label to market his records, both old and new. Singer/pianist Blossom Dearie has gone the do-it-yourself road, as have pianist Mary Lou Williams and singer Jo Stafford. (Women's Lib may make in-

terested note of the number of women involved in this defiance of the majors.)

Miss Stafford and her husband, composer/arranger Paul Weston, got into mail order almost by accident and partly because of this magazine. Miss Stafford is, of course, one of the great singers in the history of American popular music. But beneath her self-possessed perfect-pitch exterior lies the soul of a prankster, and a few years ago she and her husband made several classic comic albums by the fictional and dreadful pianist-and-singer team Jonathan and Darlene Edwards. The records had been an underground success for years with musicians and the hipper listeners, but they became unavailable. When the Westons acquired the rights to one of them, they had no idea how to market it. I suggested mail order and wrote a column for *HIGH FIDELITY* about the album, giving a box number where readers could send for it. So many readers responded that the couple were hard pressed to fill the orders.

In any event, the Westons perceived the writing on the wall, and they have acquired the rights to all of Miss Stafford's older—and, of course, more serious—albums from Columbia. They are now getting set up to issue them on their own label.

The most successful operation of all is Rod McKuen's. McKuen had been shoved from pillar to post by record companies for years before starting his Stanyan venture, and his success has been built largely on mail order. This is an important thing to note. Most of the other mail operations have involved works by artists already known but who had come to be ignored by the major labels. McKuen's is the only important career that was built virtually from the ground up on mail order.

Today Stanyan Records has 113 LPs on the market. They include new works (some in quad) commissioned by the company and older masters picked up from other labels. McKuen has albums by Ellis Larkins, Noel Coward, Cleo Laine, Jo Stafford, Jacques Brel, Leo Ferre, and Chris Connor. "Everybody told me Chris Connor wouldn't sell," McKuen said. "She's sold very well."

The company has a Christmas album by Sir Malcolm Sargent—the last thing he recorded before he died—that is scheduled for release in September. There's another album called "Electric Music To Freak Your Friends and Break Your Lease," and McKuen has issued newly recorded quad performances of the scores from *For Whom the Bell Tolls* and *Spellbound*. All of the albums, purchased by mail, sell for \$4.00 or \$4.50. "I think record companies charge too much for albums," McKuen said flatly.

"As a matter of fact," the tall blond singer/songwriter continued, "the record companies have done something really bad. You know, I like all kinds of music, so long as it's good. And it upsets me that people such as Jo Stafford, Tony Bennett, Rose-

mary Clooney, and Doris Day built Columbia records in the popular music field only to find themselves ignored by them.

"The record industry has a larger dollar volume of business per annum than any other form of entertainment—movies or television or the stage. But it could be two to three times as big if the companies would get their priorities straight. They simply can't afford to ignore certain audiences. There is a large audience out there for Chris Connor. I've proved it."

McKuen's mail operation has become so successful that he has had to purchase a large building on Santa Monica Boulevard in Los Angeles to house it. Working from a mailing list of 65,000, he puts out a thirty-five-page magazine four times a year to apprise his readers of his own activities and those of the other performers whose albums the company handles. He also prints the addresses of the other artists who have gone into mail order. "I think we've all got to help each other," he said.

The system is mixed: McKuen operates through two distributors, and a great many stores now carry his product. The biggest seller he's had—one of his own albums—did well over 200,000 copies, and today he claims to have the second largest mail-order record business in the U.S. (Columbia is the largest), ahead of RCA and Capitol.

It would seem obvious that all of these enterprises should join forces for mutual advantage. "I have been arguing for a long time that there should be an association of some kind," said Trixie Shearing.

Kenton too thinks there ought to be a co-operative. Thus far it hasn't happened, perhaps because the movement is too new.

But another factor is the infantilism that is common among artists. Some of the people involved in the movement clutch their carefully accumulated mailing lists like a poker hand that contains four aces, although a pooling of lists might be expected to increase everyone's sales. "Let's face it," Kenton said, "there's a lot of paranoia in our business. But you can understand why people feel that way. So many of them have been cheated over the years, in one way or another."

Thus far the various little companies co-operate to this extent: In their flyers to subscribers, they print the names and addresses of the other artists who are in mail order.

Whether the movement will eventually coalesce remains to be seen. But there is a great deal of intelligent talent involved in these operations, and if the movement ever does achieve maturity, it might well turn into a powerful and even revolutionary force in American music. ●

Home-Grown Records—Where to Get Them

Here is a partial list of the do-it-yourself record labels owned or controlled by artists. Most of these companies print newsletters, and anyone wishing to buy records from their catalogues should write directly to them for their lists.

STAN KENTON
Creative World
Box 35126
Los Angeles, Calif. 90035

MURRAY MCEACHERN
Archives Records
Box 723
Mentone, Calif. 92359

FOUR FRESHMEN
870 Woodley Ave.
Sepulveda, Calif. 91343

YANK LAWSON, BOB HAGGART,
AND THE WORLD'S GREATEST
JAZZ BAND
c/o Bud Hellewell
157 W. 57th St.
New York, N.Y.

MARIAN MCPARTLAND
Halcyon Records
P.O. Box 4255
Grand Central Station
New York, N.Y. 10017

PAUL WESTON & JO STAFFORD
LSM Industries
Box 3168
Los Angeles, Calif. 90028

JAZZ COMPOSERS ORCHESTRA
ASSOCIATION
6 W. 95th St.
New York, N.Y. 10024

STRADA EAST
463 West St.
Suite 1020
New York, N.Y.

JIM CULLUM AND THE HAPPY
JAZZ BAND
P.O. Box 66
San Antonio, Texas 78291
(The catalogue includes two
albums by Earl Hines.)

EUBIE BLAKE MUSIC
284-A Stuyvesant Ave.
Brooklyn, N.Y. 11221

GEORGE SHEARING
Sheba Records
P.O. Box 2120
North Hollywood, Calif.
91602

THE BOBBY HACKETT 4
Hyannis Port Record Co.
Box 337
Hyannis Port, Mass. 02647

BLOSSOM DEARIE
Daffodil Records
P.O. Box 522
Radio City Station
New York, N.Y. 10019

ROD MCKUEN
Stanyan Records
Box 2783
Hollywood, Calif.

AKAI's 4-Channel Challenge

We challenge any other manufacturer in the world to surpass the performance of AKAI's new 4-channel component combination. You can pay more. But you can't buy better.

Here they are.

First is AKAI's new AS-980 4-channel receiver. Endowed with sophisticated features for unparalleled performance. Sensitive and powerful, the AS-980 provides a continuous output of 120W (3C x 4). Plus 4 separate 4-channel modes: Discrete SQ, RM, and built-in CD-4 with individual separation controls ... It's everything you'd expect AKAI's *ultimate* receiver to be.

Unequaled reproduction quality is yours with AKAI's new GX-28CD-SS. It's a fully discrete 4-channel tape deck that's also 2-channel compatible. The utilization of 4 individual heads—including AKAI's exclusive GX glass and crystal heads (dust free and virtually wear free)—and 3 superbly engineered and balanced motors make this unit the professional 4-channel tape deck for recording and playback.

Together, these units are AKAI's unbeatable 4-channel challenge—providing professional 4-channel capabilities that no other equipment combination can match.

Both the AS-980 receiver and the GX-28CD-SS tape deck are available at your nearest AKAI Dealer. Whenever you're ready to make that ultimate step up. That's AKAI's 4-channel challenge.



FREE! AKAI includes with the purchase of any tape recorder, BASF low-noise, hi-output reel-to-reel tape or 3-track cartridge, or Chromdioxid™ cassette. Up to \$18.00 retail value. (Offer good only in continental U.S.)

From

AKAI™

The Innovators

1071

AKAI America, Ltd. / 2139 E. Del Amo Blvd., Compton, California 90220

4-channel discs/tapes

BY ROBERT LONG

Squandering Vinyl? Glance quickly over this column before you begin reading it. Every one of the discs mentioned is quad-encoded by Columbia's SQ process. There are a number of reasons for it, but it certainly reflects the continuing massive effort by the forces of SQ to get maximum exposure for their product.

I sometimes receive two or even three copies of SQ discs, but often find it difficult or impossible to obtain copies of "available" CD-4 or QS releases. And much of the SQ material I receive never gets into this column. There's nothing *wrong* with Percy Faith or Lynn Anderson—or Elvis, for that matter—but unless their recordings have something material to contribute to quad as a topic I see no reason to take up space with them, paper being as scarce as vinyl (perhaps scarcer) these days. The point is that despite the shortage—and given the chronic rumors of severe difficulties in the CD-4 camp because of the shortage—Columbia and its licensees apparently find the publicizing of SQ recordings high on their priorities lists.

Some of their products are high on mine too. With so much being issued in SQ these days, most of the ideas (good and bad) that bear on the directions quad is taking are embodied in SQ matrix jobs. That doesn't mean that what is happening can't and won't be embodied in other forms of quad. Perhaps quad will someday be an all-SQ affair, but—this column notwithstanding—that day hasn't come yet.

End of the Bookends. I used to like the Mamas and the Papas—really like them. Then they split up, and Mama Cass went on to make a record called "Make Your Own Kind of Music." The trouble was you couldn't tell what her kind of music was. On that disc she demonstrated professionalism in a number of styles; gone was the unique and consistent musical approach that had made the M&P so attractive.

I think the same thing has happened to Simon and Garfunkel. Each has gone off (successfully) on his own, of course. "There Goes Rhymin' Simon" (Columbia CQ 32280, \$6.98) and Art Garfunkel's "Angel Clare" (Columbia CQ 31474, \$6.98) are among their independent products. Both are very pleasant, professional jobs; neither has any distinct individuality. Paul Simon, particularly, displays his versatility in a number of standard pop styles without supplying much of his own.

Symptomatic of this, perhaps, is the use of quad on both discs. It has become

a convention of quad—at least, chez Columbia—that when you're recording a big star like Liza Minnelli or Barbra Streisand, you float the voice in a miasma of quadriphonics. That's what Columbia has done again here. There are plenty of pretty quad effects, but they add up to a slick professionalism rather than a sense of real communication through sound.

For Medievalists and Others. I've had the immense pleasure of hearing medieval church music performed in medieval churches—from a small Romanesque chapel in Spoleto to the vastness of Westminster and Wells—and looked forward to "*Las Cantigas du Sancta Maria*" (Vanguard VSQ 30019, \$6.98) as an evocation of those experiences. No way! The sound is lovely, but it's patently a studio job with just a tastefully suggestive use of echo—particularly in the narrator's voice tracks—to give a touch of liveness.

The cantigas in question come from the court of Alfonso X of Castile and León and celebrate both the Blessed Virgin and Alfonso's pretensions to the mantle of Holy Roman Emperor. The performing group, the Waverly Consort, is new to me. It does fine work, very much in the tradition of the recently disbanded New York Pro Musica, and the structure of this presentation strongly suggests the Pro Musica's *Play of Daniel*—the medieval work I heard on tour in Europe.

Quad could do a magnificent self-service in recording such a performance, real cathedral acoustics (at their best) being what they are. In the meantime the far more intimate ambience of the cantigas disc is very charming in its own—relatively artificial—way.

The Put-on as Art Form. Columbia has come up with another of its would-be classical shockers in "E. Power Biggs Plays Scott Joplin on the Pedal Harpsichord" (Columbia MQ 32495, \$6.98). Okay, so you associate Biggs with the organ and Joplin with the upright piano; the unusual juxtapositions are amusing but no big deal. The record is pleasant to listen to—which "Monster Concert," for example, wasn't particularly—but I don't understand why it was chosen for a quad issue.

Biggs is said (by the people at Columbia) to be a big quad booster, and that may be part of the reason. Quad is said (by lots of people) to be the way of the future, and that may be another. But quad adds very little to a project that is

more amusing than distinguished. The harpsichord is kept front and center (there is, thanks be, no attempt to move the instrument's various registers into separate channels, for instance), and the back channels are used for ambience fill-in. But it seems like a lot of fuss for a relatively unrewarding end.

A Feeling for Space. When quadriphonics first came out, it was assumed that pops in general and rock in particular would take to it like the proverbial duck to water. But the way in which a typical pops/rock recording is built up on multitrack tape seems to have worked against—rather than toward—this end in many cases. The successive layers of sound just don't gel into a cohesive aural image; though you can hear the *musical* relationship between the tracks that have been mixed together, they seem to have no particular spatial relationship. They're together in time, but that's it.

Two exceptions among the discs that are before me at the moment are "360 Degrees of Billy Paul" (Philadelphia International ZQ 31793, \$5.98) and Lee Michaels' "Nice Day for Something" (Columbia CQ 32275, \$6.98). Neither makes any great contribution to quadriphonics as such, but the sound does hang together.

An interesting study in this property is the Herbie Hancock disc "Sextant" (Columbia CQ 32212, \$6.98). From the cover art I assume it is intended to be African rock (if there is such a thing), though my (WASP) ears detect certain elements reminiscent of the old Jazz at the Philharmonic albums.

One reason, surely, is the group's use of extended numbers; there are only three on the disc, with *Hornets* filling all twenty minutes of Side 2. The best of the JATP (mono) albums developed a great sense of tension by building on short phrases that, through repetition by a single instrument and interplay between instruments, suggested the group's (eventually successful) search for a musical route through the forest, so to speak. You felt that each of the musicians had participated in the adventure—and you along with them.

But the sound in Hancock's *Hornets* is so un-together (in the sense of creating a single space continuum in which all of the musicians are co-participating) that it suggests the exact reverse: musicians using related material but going their own musical and spatial ways with it. *Rain Dance* on Side 1 is far better in this respect, though I personally would rather listen to the more succinct expressions of an Edgard Varèse or Harry Partch. I'm glad to see a rock group experimenting like this with longer forms, but I don't think the content here really justifies extended treatment. ●

Do-it-yourself Shopping Guide to 4-Channel Receivers



**The Heathkit AR-2020.
Spec for spec, dollar for dollar,
it's today's
best 4-channel value.
And you can prove it!**

All that glitters isn't gold in today's crowded and often confused 4-channel market. Fancy styling, galaxies of gleaming knobs, and impressive-sounding specifications taken out of context are no indication of the performance you can really expect for the dollars you spend on a 4-channel receiver.

So we're putting our specs and our price where our mouth is . . . and letting you be the judge. Clip out this do-it-yourself rating chart, take it with you on your next 4-channel shopping trip, and jot down the *equivalent* specs (be sure they are based on the same parameters) and prices of your favorite receivers in the spaces provided.

We're so sure of your conclusions, we'll say no more. Except this — if you're skittish about building this receiver because you've never built a kit . . . forget it! The AR-2020 was designed for you . . . with simple, clear check-by-step instructions that assure success.

Grab your scissors, and start shopping!

**See it at your nearest
Heathkit Electronic Center . . . or send for FREE catalog**

HEATHKIT ELECTRONIC CENTERS —
Units of Schlumberger Products Corporation
Retail prices slightly higher.

ARIZ.: Phoenix; CALIF.: Anaheim, El Cerrito, Los Angeles, Pomona, Redwood City, San Diego (La Mesa), Woodland Hills; COLO.: Denver; CONN.: Hartford (Avon); FLA.: Miami (Hialeah), Tampa; GA.: Atlanta; ILL.: Chicago, Downers Grove; IND.: Indianapolis; KANSAS: Kansas City (Mission); KY.: Louisville; LA.: New Orleans (Kenner); MD.: Baltimore, Rockville; MASS.: Boston (Wellesley); MICH.: Detroit; MINN.: Minneapolis (Hopkins); MO.: St. Louis; NEB.: Omaha; N.J.: Fair Lawn; N.Y.: Buffalo (Amherst), New York City, Jericho, L.I., Rochester, White Plains; OHIO: Cincinnati (Woodlawn), Cleveland, Columbus; PA.: Philadelphia, Pittsburgh; R.I.: Providence (Warwick); TEXAS: Dallas, Houston; WASH.: Seattle; WIS.: Milwaukee.



		AR-2020	Brand A	Brand B	Brand C
FM TUNER (Stereo) IHF STANDARDS	Frequency Response	±1 dB 20 to 15,000 Hz			
	Sensitivity (IHF)	2 μV			
	Selectivity (IHF)	60 dB			
	Capture Ratio	2 dB			
	Channel Separation	40 dB typical			
AM TUNER (Mono)	Sensitivity	100 μV per meter			
	Selectivity	40 dB (altern. chan.)			
AMPLIFIER SECTION	Total Music Power (IHF) all channels driven	100 watts (8 ohms); 120 watts (4 ohms)			
	Music Power (IHF) output per channel with all channels driven	25W (8 ohms) 30W (4 ohms)			
	Continuous (RMS) power output per channel with all channels driven	15W (8 ohms) 20W (4 ohms)			
	Full Power Bandwidth for constant 0.5% THD	5 Hz to 30 kHz			
	Frequency Response (1W level)	±1 db, 7 Hz to 50 kHz; ±3 dB, 5 Hz to 70 kHz			
	Harmonic Distortion at 15W output per channel	less than .05% from 20 Hz to 20 kHz; less than .25% at 1000 Hz at 1W output			
	IM Distortion at 15W output per channel	less than .05% using 60 & 6000 Hz mixed 4:1; less than .25% at 1W output			
PRICE	249.95*				

NOTE: A separate 4-channel amplifier version of the AR-2020 is available at just 179.95*



Heath Company, Dept. 8-5
Benton Harbor, Michigan 49022

Please send FREE Heathkit Catalog.

Name _____

Address _____

City _____ State _____ Zip _____

*Mail order prices; F.O.B. factory.

HF-284

CIRCLE 15 ON READER-SERVICE CARD



They're talking about Capitol 2 recording tape.

Musicians, high-fidelity perfectionists, music lovers of all sorts, are talking about Capitol 2, the world's best iron-oxide tape.

Cassette users rave about the frequency response (20-22,000 Hz), the backcoating that makes the cassette jamproof, and the new package (Stak-Pak™) that ends cassette clutter.

Everyone's giving the Stak-Pak special mention. Probably because it's without a doubt the world's ultimate cassette storage method. Stak-Paks come with two Capitol 2 cassettes, and they slide or snap together to form a tiny chest of drawers, each with its own two labels.

Reel-to-reel bugs get excited about being able to buy a tape that's as good as the best tape the recording studios themselves use.

And 8-track cartridge people are delirious with the Capitol 2 Audiopak® High Output/Low Noise cartridge, already a standard of the music industry. It's even available in a newly engineered 100-minute playing time.

Visit your favorite tape store, and try the new Capitol 2 tape. So that the next time your friends start talking about tape, you'll have something significant to add to the conversation.



Capitol 2™
Gets the good sounds right.

Cassettes/Cartridges/Reel Tape
© 1973 Audio Devices, Inc., a Capitol Industries Co., Glenbrook, Conn. 06906.

CIRCLE 5 ON READER-SERVICE CARD

**the new
releases**



Mahler's death mask

Mahler: A Psychomusical View

Four releases by Haitink, Horenstein, and Morris survey Mahler's career—from *Das klagende Lied* to the complete(d) Tenth Symphony.

by Abram Chipman

THOUGH THE MAHLER recording boom has subsided (could it have maintained its former pace?), I am not inclined to worry that his popularity has crested. His universal appeal in an era of thermonuclear shadows and Freudian illumination lies in his unmistakable articulation of the most repressed and denied aspects of human experience. The most primitive terror, the most heartrending grief and yearning are portrayed in his scores with a tonal imagination as pictorial as the canvases of Bosch or Brueghel.

In their overt (literary) and covert (musical) content, alongside the circumstances of their composition, the four works in this current crop of releases afford us a psychobiography of Mahler focused around the profoundly important area of his relationship to women. The young Gustav was very close to his mother, who believed fervently in him. Yet there was deprivation in the family background, due to grinding poverty, the too many and

too closely spaced siblings, and the wearying toll of his parents' oppressive marriage. Tragic deaths came to two of his brothers—one only nine months his junior and thus (at least subconsciously) a hated interloper into the blissful paradise of early infancy, the other considered by Gustav to be a greater composer than himself.

And so behold the "Op. 1" cantata, *Das klagende Lied*! The fairy tale of fratricide and punishment must surely have been chosen for "overdetermined" reasons, just as Mahler's later deletion of the first of its three parts (in which the murder of the younger brother in rivalry over the hand of a beautiful queen is so vividly depicted) must have been motivated more by irrational guilt than by musical flaws.

A full generation later, behold the Fourth Symphony

Dr. Chipman, familiar to HF readers as a critic, is by profession a clinical psychologist.



Mahler continued

(1900), palpably an island of serenity in the turbulent seas of its creator's life. Some concern more subliminal than attainment of the coveted directorship of the Vienna Opera must account for its bucolic tenderness, its cherubic and radiant benignity. The soprano gives us the answer in the finale, singing a folklore text about a child's vision of heaven as a place where everyone has enough food, cooked and served by the female saints (but note, ominously, that it's Peter, Luke, Herod, and John who slaughter the innocent animals for the feast!).

The events of the next seven years led Mahler to the edge of despair and self-mortification: the stormy marriage (in 1902, the year of the Fifth Symphony), with family and career demands constantly vying for his energies; the death of a daughter from scarlet fever (after his wife, Alma, had accused him of tempting the fates by composing the *Kindertotenlieder*); the rupture with the Viennese musical establishment; and, finally, the discovery of his own terminal heart condition. So after the hammer blows of the Sixth Symphony and the nocturnal demons of the Seventh, there could only come (and only as a temporary interlude) the Eighth—that Faustian paradox, that incredibly overreaching fusion of cantata, opera, and symphony, that glorification of “victory gained by repentance.” In this luxuriant affirmation of endless creative renewal, one almost imagines Mahler saying, “I have not really lost a daughter, I have given birth from my mind to a thousand performers on one stage!”

Theatrically and musically, this is a work of astonishing genius, vitality, and sensuality. Clinically, it is like a delusional transformation of all guilt, grief, frustration, and suffering into their polar opposites—that narcissistic omnipotence that we all preserve deep within us from the period of life when, as the text to the almost orgasmically exultant final pages of the symphony puts it, “the newly arrived is scarcely conscious of itself. . . . The new life, so much does it resemble the sacred host . . . steps forth in the first flush of youth! . . . The love of long ago, now free from stain, is returning. . . . The ever-womanly draws us heavenward!” Thus, in the midst of staggering personal loss and marital woes, did Mahler succeed in producing a euphoric vision of rebirth, rejuvenation, fertility, and union with “the eternal feminine.”

But as surely as day gives way to night and mania to depression, did the brilliantly defensive posture crumble—in the Ninth Symphony and *Das Lied von der Erde*—before the ultimate confrontation with his warded-off heartache. At this point, the composer consulted Freud and was reportedly given a brief (and ostensibly curative) treatise on his own Oedipus complex.

Back then to the drawing board for the Tenth, an unfinished symphony whose full sketches have been posthumously realized by several men. What a complete five-movement performance lets us hear is that Mahler attempted to conclude his life with a series of flashbacks to his various creative stages and a final reconciliation with conventional tonality and with human love. The opening Adagio (still oft performed by itself) picks up

where the Ninth leaves off, carrying ultrachromaticism to the early Schoenbergian dissolution of tonality; Scherzo I peeks back at the *Knaben Wunderhorn* period via paraphrases in its trio of the song *Verlorene Müh'*; Purgatorio recalls the middle period, suggesting to this hearer the general ambience of the Sixth Symphony's scherzo; Scherzo II echoes the more recently written *Das Lied*, specifically the opening tenor song; the finale sums up the above cyclically before resolving into the most unambivalently Romantic music Mahler ever wrote. With vows of loyalty to Alma inscribed over the pages of the manuscript, he writes closing passages that suggest the epilogue of Strauss's *Heldenleben*. Before his creative energies gave out completely, then, Mahler “went home again” to the nineteenth century in gratitude to his own “hero's helpmate.”

Bernard Haitink, like readers of this review, may or may not accept such theories of Mahler's unconscious motivations. The Dutch conductor *has* elected to omit from his recording of *Das klagende Lied* the once-suppressed (but now available for performance) opening section, *Waldmärchen*.

In an interview last year, Haitink expressed to me the view that “Mahler left out that part for good [presumably musical] reasons. . . . One of the dangers of the gramophone is, because everything is recorded now, we want to record things which not without reason are never played. . . .” I now regret I did not ask further what he thought the “good” reasons were, for Haitink is clearly no slavish follower of the notion that composers' last thoughts are always best, as witness the choice of editions for his recordings of Bruckner's Third and Eighth Symphonies.

For the complete *Das klagende Lied*, there is no recorded alternative to the two-disc Boulez set (with the Adagio from the Tenth Symphony). If we accept the validity of presenting only Parts II and III—the sections that describe the discovery of, and retribution for, the murder—the choice is between the new Philips and the 1967 Angel editions.

Haitink and Wyn Morris are somewhat leisurely in Part II, *Der Spielmann* (with a dash more rhythmic snap from the former), and less ferocious than Boulez in Part III, the *Hochzeitsstück*. Haitink's Concertgebouw and Morris' New Philharmonia are both great orchestras, but there is an added Mahlerian tint in the Amsterdam tonal canvas.

The Delysé/Angel engineers put the off-stage wedding band too close for real atmosphere; Philips goes to the opposite extreme and makes the players seem not only outside the Concertgebouw but possibly down the street in the Rijksmuseum! Angel has the advantage of Jack Diether's exhaustive annotations and Morris' lateral division of first and second violins (the impact of which becomes apparent about ninety seconds into Side 1).

Also, Angel's Andor Kaposy is a more secure and mellow tenor than Philips' Hollweg. On the other hand, the new version has the better of it where the ladies are concerned, since Harper manages a more chilling glissando at the culminating “*Ach, leide!*” than did Teresa Zylis-Gara and Procter shades her words with more mystery and wonderment than did Anna Reynolds. It's a coin toss all the way.

Horenstein's Fourth Symphony, new to the domestic catalogue, is a shade more vivid sonically in the new

Monitor edition than in the English Classics for Pleasure original. The excellence of the interpretation will surprise nobody. Horenstein's over-all approach is one of austere dignity, marked by conservative tempos in general (though the scherzo is more measured than average), a firm hand on the unfolding of long-breathed lines (rhythmic caprice and emotional distension of phrases are avoided), and a meticulous observance of glissandos and other explicit Romanticisms (e.g., the "*sehr zurückhalten*" at eleven after No. 24 in the first movement, which others have inaccurately rejected as a Mengelberg mannerism).

Margaret Price's work in the finale has poise and inwardness, and her blend with the flute at No. 2 is as consummately artistic as her rhythm between Nos. 14 and 15 ("*Cäcilia mit ihren Verwandten...*"). I am impressed with the forwardness of bassoon and horn details in many places and delighted that the conductor made this recording with the LPO—the Fourth is one Mahler score I've always wanted to hear played by an orchestra that Beecham built.

If there are any lingering doubts that this is easily the finest of the budget-priced versions, then Horenstein's use of the 1963 Critical Edition ought to dispel them. Of the three competitors making use of the C.E. (Haitink, Kubelik, Abravanel), it is the Czech maestro who shares top honors with Horenstein. Kubelik's fresh, flexible, guileless interpretation has a rustic flavor aided by the Bavarian orchestra's slight tonal edginess (a deficit elsewhere in DG's cycle). If you don't require the C.E. (and the differences are admittedly slight), then it's off to the races with Klemperer (Angel S 35829), Szell (Columbia MS 6833), Kletzki (Seraphim S 60105), and Reiner (RCA LSC 2364). Historically priceless and interpretively unique (in their own ways) are the readings of Walter (Odyssey 32 16 0026) and Mengelberg (Turnabout TV 4425).

The Horenstein Fourth was his last commercial recording of Mahler. Many grateful collectors will at the same time continue to hope that air checks of some concert performances can be shaken loose. (Unicorn is preparing a Mahler Sixth from Stockholm for release.)

The young Welshman Wyn Morris has been working his way through the Mahler literature with a variety of orchestras and for a variety of labels. His *Symphony of a Thousand* with a pickup orchestra of players from London's vast instrumental pool was released in England last year on a limited-distribution basis, and it is especially welcome on RCA because of its price tag. You might, unfortunately, have to go through more than one copy to get a playable pressing; the first two review copies had one of Dynaflex's most monumental vertical warps yet!

The inconvenience will be well worthwhile, though, if you like the Eighth presented with all the breadth and weight it can take. I imagine a Furtwängler performance would have sounded something like this—not only in the periodic lapses of ensemble and rhythmic control, but also in the sustained, unhurried sense of rich, glowing ecstasy. Recorded balances are usually appropriate, though there is an occasional sore thumb like the larger-than-life piano between Nos. 111 and 112 of Part II.

Particularly outstanding in terms of individual contributions are the violin soloist in Part I (where the affinity of the music to Delius at No. 20 has never been more apparent) and bass Gwynne Howell in the role of Pater

Profundis. The remaining soloists are a reasonable bunch, with Raymond Myers a light-timbered baritone who bites his consonants a bit hard, tenor John Mitchinson the clear weak link, soprano Joyce Barker good save for squeezed tones in her upper register, and mezzo Joyce Blackham suffering from an insufficiently supported lower range. Morris himself makes few major tactical errors, being more prone to eschew an indicated gear change rather than tamper with speeds on his own.

The engineering is perhaps the best combination of depth and directionality the work has had on discs, with a finely differentiated spread between the two choruses. I am bothered by the break after Side 2 (four before No. 77), in which two notes of a cruelly interrupted phrase are repeated on Side 3 (shades of 78 rpm!). It happens that the same absurdity occurs on Solti's Eighth.

Of the Morris album's half-dozen predecessors still available, three Eighths reluctantly can be eliminated from serious consideration: the Mitropoulos/Everest (not genuine stereo in a score that so badly needs contemporary audio technology); the Bernstein/Columbia (a recording both hard and diffuse, whose essential Dionysian spirit has been equally well realized in the Solti album); and the Kubelik/DG (an exciting recording which contains at least one incomparable solo performance—Fischer-Dieskau's—but which is of insufficient orchestral elegance and was made in an acoustic where everything seems right on top of the listener).

Solti/London, the most widely acclaimed edition, is a well-executed, brightly recorded, overpoweringly zealous and personalized interpretation. Solti wraps himself up in pretzels of expressive phrasings and rubato that make the music a series of loosely connected, though very voluptuous, events. Abravanel/Vanguard, RCA's direct low-price rival, was the first technically adequate Eighth; a decade later it still sounds uncommonly fine, with a warmth and immediacy that haven't been superseded and an honest, workmanlike, not-so-charismatic but fully professional performance typical of the underrated Utah Mahler cycle (due for completion later this year).

My own first choice is Haitink/Philips, where the reading and sonic production maintain an Olympian perspective on the work's totality (at the cost, some would argue, of individual effects) and taut propulsiveness and musicianly integrity from the podium allow the music to speak for itself. This offering has generally decent singing, glorious playing, and engineering that stresses depth more than bite.

A propos the Tenth, I will not attempt to argue the "morality" of completing a dead composer's sketches. The symphony we hear on the new Philips album (and its predecessor on Columbia) is an admittedly "conjectural" execution of Mahler's briefly noted intentions, but it does, as I have noted, indicate the directions in which his creative discourse was moving at the time he left this earth. I would count it a tragic loss, indeed, to be denied the knowledge of how his lifelong psychic and aesthetic struggles were resolving themselves at that point.

One can only be grateful, therefore, for the dedicated (and authentic-sounding) efforts of Deryck Cooke, his many allies, and even his as-yet-unrecorded rivals for bringing to the light of day the four-stave sketches of the movements Mahler did not fully orchestrate. The first Cooke score, which was given its premiere over the BBC

by Berthold Goldschmidt in 1960, was missing many bars in the two scherzos. It was, nonetheless, a very hot item in the "tape underground" during the ensuing years (even with various Rube Goldberg touches dubbed in by others) until the discovery of additional manuscript material and the lifting of Alma Mahler's embargo on further performances led to a second (complete) scoring by the brilliant and persistent Englishman. That version received its 1965 American premiere (and a recording debut for the five-movement Tenth) under Ormandy. The third and final Cooke performing realization, now recorded by Morris on Philips, represents his afterthoughts on, and sharpening of, what was already an idiomatic Mahlerian sound. This final Cooke revision is due for publication by AMP later this year. The latest orchestration sounds a bit more penetrating in its clarity—crisper and drier with more made of wind and string contrasts.

Morris' reading probes deeper into the expressive substance of the Tenth than did Ormandy's. The slow outer movements, more broadly paced, have a valedictory intensity next to which the Philadelphians seem glib and feverish. In the first scherzo, the new rendition is both peppier and more flexibly molded. The second scherzo finds the American orchestra showing off its bold and terrifying brass sound, but the English ensemble is victorious in the wittier, more finely chiaroscuroed, woodwinds.

Philips' recording, less aggressive at the frequency extremes than Columbia's, is fuller and mellower, revealing more wind detail (or has Cooke "cleaned up" the textures at crucial points?). Again I find Morris' left-right violin deployment exceedingly effective, the more so since he also places his violas on the left, where they pen-

trate through the texture more clearly than in the usual stage-right position. Both Columbia and Philips have spread the Tenth somewhat extravagantly over four sides.

MAHLER: Das klagende Lied (two-part version). Heather Harper, soprano; Norma Procter, alto; Werner Hollweg, tenor; Netherlands Radio Chorus; Concertgebouw Orchestra of Amsterdam, Bernard Haitink, cond. PHILIPS 6500 587, \$6.98.

B MAHLER: Symphony No. 4, in G. Margaret Price, soprano; London Philharmonic Orchestra, Jascha Horenstein, cond. MONITOR MCS 2141, \$2.98.

B MAHLER: Symphony No. 8, in E flat (*Symphony of a Thousand*). Joyce Barker, Elizabeth Simon, and Norma Burrowes, sopranos; Joyce Blackham and Alfreda Hodgson, mezzos; John Mitchinson, tenor; Raymond Myers, baritone; Gwynne Howell, bass; Orpington Junior Singers; Highgate School Choir; Finchley Children's Music Group; Ambrosian Singers; New Philharmonia Chorus; Bruckner-Mahler Choir of London; Symphonica of London, Wyn Morris, cond. [Isabella Wallich, prod.] RCA RED SEAL CRL 2-0359, \$6.98 (two discs). Tape: ● CRS 2-0359, \$7.95; ●● CRK 2-0359, \$7.95.

MAHLER: Symphony No. 10, in F sharp (finally revised full-length performing version by Deryck Cooke). New Philharmonia Orchestra, Wyn Morris, cond. [Gavin Barrett, prod.] PHILIPS 6700 067, \$13.96 (two discs).

Comparisons—Das klagende Lied:
 Boulez / London Symphony (complete) Col. M2 30061
 Morris / New Philharmonia (Parts II and III only) Ang. S 36504
Comparison—Symphony No. 4:
 Kubelik / Bavarian Radio Symphony (Critical Edition) DG 139 339
Comparisons—Symphony No. 8:
 Abravanel / Utah Symphony Van. SRV 276 / 7 SD
 Haitink / Concertgebouw Orchestra Phl. 6700 049
 Solti / Chicago Symphony Lon. OSA 1295
Comparison—Symphony No. 10 (complete):
 Ormandy / Philadelphia Orchestra Col. M2S 735

Tippett: A Composer Who Communicates

Philips offers his vital,
richly imagined Third Symphony
and the more rarefied opera
The Knot Garden.

by Robert C. Marsh

SIR MICHAEL TIPPETT, at sixty-nine one of the three dominant personages (along with Walton and Britten) in contemporary British music, made a cometlike turn on an American orbit in February and March—conducting, lecturing, or simply being there when one or another of his works was played. The two recordings considered here were released to coincide with his trip and the premieres of the works in this country.

The Boston Symphony, under guest conductor Colin Davis, performed the Third Symphony on February 15 and took it to New York the following week. On March 7 Tippett himself conducted the score with the Chicago Symphony and joined Stephen Bishop in a performance of the piano concerto.

The first production in the U.S. of any Tippett opera took place February 22 in Evanston, Illinois, where a student cast from Northwestern University presented *The Knot Garden* with Bernard Rubenstein the conductor and Robert Gay the producer. Northwestern became interested in acquiring the manuscript of the opera for its burgeoning music archive in 1971—the year after the Covent Garden premiere of the score. The idea of a performance came up during the negotiations, and according to Northwestern's music librarian, Don Roberts, "Sir Michael was fascinated with the idea of a student production. He agreed with us that students could be able to portray the emotions of the opera's characters as well as, or even better than, some professional performers."

The thesis is interesting. The fact that it was advanced



Jill Gomez, Raimund Herincx, and Sir Michael Tippett discuss a point during *The Knot Garden* recording sessions.

and considered without prejudice is a key to Tippett's way of looking at things. Among his British peers he stands out as the most independent thinker and socially involved artist. Walton began as an angry young man but ceased to bother the Establishment when, in middle life, the war brought his nationalism to the fore. When English composers start writing coronation marches, you know they're not going to trouble anyone again. Britten's Britain often seems a humanistic abstraction from the present, filled with literary rather than social realities, and even his *War Requiem* lacks any great sense of immediacy.

Tippett, on the other hand, is very much a part of today, and as both man and artist he is clearly allied not with the Col. Blimps who might be his contemporaries, but with younger and more liberated generations. He likes America, especially the West. He sees this country as a projection and development of much that is central to Britain in terms of a new land rather than as a colonial possession manqué. "It is an extension of the whole of ourselves," he has commented. Indeed, with his strong, angular features and searching eyes, you might easily imagine him on horseback, his gaze fixed beyond the rolling Colorado plains to the shining mountains.

The Third Symphony thus is not English music, but international music. I would predict considerable success for it throughout the world, and its present series of performances in the U.S. deserves to open the way to its assimilation into the repertory.

What Tippett has faced, and most successfully, is the fundamental problem of organizing a large-scale symphonic movement without making use of key relations, which were, of course, the musical glue that gave structural integrity to sonata form. As he tells it, "The first idea of the work came during a concert of contemporary music . . . in Edinburgh in 1965. I lost touch with the music being played and began to muse on how much of contemporary music seemed quite motionless; without movement of harmony, pulse, or melody. And I considered how I did not conceive of any personal use for such motionless music (within a symphonic work) unless contrasted with some other music in a polarity. New names in my own jargon for an archetypal polarity of this kind came to mind: Arrest and Movement."

The symphony is in two parts, the first of which contains five "arrests and movements" that grow "proportionately longer and longer. And after a final 'argument,' when they sound together, the music comes to a full stop and goes into the motionless music proper as referred to before." Movement is introduced by the low strings in a

passage that, for Tippett, suggests *Moby-Dick* and the play of whales (others will find different images, if images are required), and in this vein the movement ends. In fact, what Tippett has done here is combine in one movement dramatic materials that usually make up the opening and slow movements of a conventional symphony, and he has done so in one of the most successful pieces of sustained orchestral writing of the past twenty-five years.

The second part of the work begins with a scherzlike section, after which the orchestra bursts forth with an outrageous parody of the "terror fanfare" that opens the final movement of the Beethoven Ninth Symphony. What follows, however, is not Schiller's Romantic optimism, but Tippett's cool humanism. Warm, friendly bodies here and now concern him more than a Big Daddy in the Sky, and the piece becomes, as he sees it, a "Song of the Body" with a certain kinship to Mahler's *Song of the Earth*, but in blues style. The structural principle of Part I is sustained, with blues representing movement and the contrasting arrest being found in the intervening breaks.

The four songs are a slow blues (equivalent to Mahler's first two songs), a fast blues (a parallel of Mahler's third song), a moderate blues as a counterpart to Mahler's No. 4, and a fast song ("a dramatic scena") equivalent to the fifth part of Mahler's cycle, *The Drunkard in Spring*. But Tippett ends here, on a note of detumescence and hope: "We sense a huge compassionate power/To heal/To love." Mahler's protagonist, wearing *Weltschmerz* like a somber mantle, goes off to the mountains to die.

In the U.S. we are beginning to see what the consequences are when artists and intellectuals become increasingly part of the academic establishment, are put through what William James called "the pedantification process," and have their vision shifted from the large world about them to the small world of academic fashion and foibles. Tippett has done time in academe, but he has resisted its lures to isolation, most of all the lure that he address himself only to a parochial minority. In England, thank God, composers are still composers, not professors, and junior theory instructors do not have to pretend to be creative artists to survive in the rat race.

It is difficult to imagine anything as vital as this Third Symphony being written in the U.S. today, because there is really no one around to write this kind of music. It's completely at odds with what the academics are doing. It's richly imaginative, beautifully scored, filled with good ideas. Most of all, it communicates. People are going to understand it, like it, and respond to it as a work of art from our own day (the first performance was in June 1972) that tells us something of value in terms we readily comprehend. It's probably not going to be long before we get the word from Princeton that it's no good, but until then (and afterwards, if you think for yourself) it proves a most rewarding musical experience. Davis' performance, as you would expect, is excellent. Miss Harper has real affinity for the songs, and she projects both the music and the words with a sense of complete involvement.

Simply because it is an opera, *The Knot Garden* will reach fewer people than the symphony, and no matter. It's a less powerful work. (The title comes from Elizabethan horticulture—a knot garden was usually made of tightly clipped box hedges in a complex, formal pattern.)

Tippett allows himself to be overly bound in symbolism. The English have never recovered from Shakespeare any more than the Germans have from Goethe, but the long running analogue between the action in *The Knot Garden* and *The Tempest* appears at times to hinder rather than assist character and plot development. For me, the central weakness of the work is that the characters are all multileveled symbols—thus the action consists of symbolic interplay on one or another level. The red-blooded stuff of character and deed is largely missing. Some of the symbolism, moreover, is rather heavy-handed; Dov, a homosexual, becomes Ariel the fairy, for example. Come on. This is an opera set in modern Britain. It calls for a greater sense of present realities.

Another problem is that the opera really is too short: two acts of about a half-hour each, and one of some twenty minutes. Single acts of Wagner take longer than this, and Tippett denies himself what Wagner gave himself generously, the time needed for the exposition of ideas and the full delineation of his dramatic personages. This is needed in an opera that is more about finding identity than anything else.

Thus in *The Knot Garden* a great deal happens very quickly. We are introduced to seven people and their problems, and as the work ends they have formed alliances and, presumably, see the solution of their difficulties. But on a first hearing, especially, it is quite possible to be vague about what happened. Of course the advantage of the recording is that it makes an instant replay possible. Here the question is simply one's willingness to explore further. Those who think of opera in terms of Puccini are not likely to bother. Those who are concerned with opera in this century will be interested.

“Classic Jazz” —an Adventurous, Revealing Survey

The Smithsonian's six-disc
set offers an ideal sampling
for new collectors—and
some surprises for veterans.

by John S. Wilson

For one thing, the score has an ample measure of fine vocal writing, some effective long numbers (dare we call them arias?), and a fair share of well-written duos and ensembles.

Tippett uses an orchestra well. The Third Symphony is filled with effective touches in scoring, especially for percussion, and *The Knot Garden* abounds in bright and unexpected sounds, such as the electric guitar. Davis conducts the opera with a true sense of mastery and affection, and he has a cast that should satisfy all expectations. Yvonne Minton and Raimund Herincx are the estranged couple in their mid-thirties around whom the drama revolves. Jill Gomez bring a fresh and lovely voice to the role of Flora, their ward. Robert Tear is Dov, and Thomas Carey, Mel; both cope admirably with unrewarding roles. Josephine Barstow sings the least real of the characters, Flora's sister Denise. Thomas Hemsley is Mangus, an analyst turned magician. Everybody turns up in the big ensemble number that closes Act I, and listening to that, perhaps, is the quickest and easiest way to find whether *The Knot Garden* is for you.

A study score of the Third Symphony and vocal score of *The Knot Garden* are available from Belwin Mills.

TIPPETT: Symphony No. 3. Heather Harper, soprano; London Symphony Orchestra, Colin Davis, cond. [Erik Smith, prod.] PHILIPS 6500 662, \$6.98.

TIPPETT: *The Knot Garden*.

Thea	Yvonne Minton (ms)	Dov	Robert Tear (t)
Mangus	Thomas Hemsley (b)	Mel	Thomas Carey (b)
Flora	Jill Gomez (s)	Faber	Raimund Herincx (b)
Denise	Josephine Barstow (s)		

Orchestra of the Royal Opera House, Covent Garden, Colin Davis, cond. [Erik Smith, prod.] PHILIPS 6700 063, \$13.96 (two discs).

PUTTING TOGETHER a definitive collection of jazz records has occupied the fantasies of jazz fans for years. It remained largely fantasy, primarily because record companies have until recently jealously guarded the purity of the recordings to which they own the rights, refusing to allow them to be mixed with other companies' records. About twenty years ago, before the major companies assumed such a rigid stance, Folkways assembled an eleven-disc set, drawn from a variety of labels, which traced developments to about 1950. Although reproduced from 78s not always in pristine condition, that collection served its purpose then; but as a jazz overview, it is long out of date.

Now the Smithsonian Institution has managed to win the cooperation of the companies that own the rights to practically everything necessary for a definitive survey. The result is this remarkable six-disc “Smithsonian Collection of Classic Jazz”—remarkable not only for the official participation of a wide range of major and minor labels but also for the skill with which Martin Williams, director of the Smithsonian's jazz program, has chosen the contents. Without allowing the set to become heavy with overly familiar material, he has covered the full sweep from Scott Joplin to John Coltrane with recordings that are “classics.”

It is quite often an adventurous, revealing survey, even for one who considers himself familiar with the territory.



Duke Ellington



Count Basie



Charlie Parker



Thelonious Monk



Louis Armstrong

For example, to come across Duke Ellington's 1941 recording of *Blue Serge*, a piece that has not received as much attention as many of the other superb recordings in that flood of creativity that hit him in 1940 and 1941, forces the realization that this rich period of Ellingtonia has even more depth than superficial memory is apt to acknowledge.

Williams begins with ragtime and the blues—Joplin, Robert Johnson, and Bessie Smith—and then builds his collection around several key figures: Jelly Roll Morton, Louis Armstrong, Duke Ellington, Count Basie, Lester Young, Charlie Parker, and Thelonious Monk. En route, of course, many other musicians and singers are represented, but these seven form the spine of the work. They are the ones on whom Williams focuses, both in his choice of records and in the concise, clearly organized history included in the handsome, forty-six-page booklet that comes with the set. He also has written a helpfully explicit piece on how to listen to jazz—more specifically, how to listen to these records—along with extensive and sometimes refreshingly acerbic notes on each recording.

Inevitably the choices for such a collection are wide open to argument. But Williams has made his selections so perceptively and—allowing for an occasional performance included despite its flaws—has managed to find records that are so representative of the musicians at their best that one must recognize the over-all excellence of the finished product.

He is particularly discerning in his choice of records by singers. It would be hard to go wrong with Billie Holiday and Bessie Smith (although Fred Longshaw's reed organ is a bit of a drag on Bessie Smith's *St. Louis Blues*), but Ella Fitzgerald and Sarah Vaughan are quirky enough to make an apt choice difficult. Williams has managed to show them both at the very peak of their unique powers, doing them much more justice than they sometimes do themselves in personal appearances.

Some of the artists receive more attention than seems really necessary: Despite the very obvious merits of the eight Louis Armstrong, eight Ellington, five Charlie Parker, and six Thelonious Monk tracks, these might have been condensed to allow for a little more Earl Hines (heard only peripherally with Armstrong on *West*

End Blues and *Weather Bird*), Fats Waller (one unaccompanied piano solo), or Charles Mingus. Some eyebrows will be raised over the omission of Benny Goodman's orchestra. Instead Williams shows us where the Goodman band came from by reproducing Fletcher Henderson's *Wrappin' It Up*. It might have been instructive to have paired it with the Goodman version of the same arrangement—much as the Goodman Trio's *Body and Soul* is followed by Coleman Hawkins' version, a fascinating juxtaposition. And where is Mary Lou Williams? The set contains not a note by the greatest woman instrumentalist in jazz.

Williams has solved potentially prickly problems by including Cecil Taylor in a selection that is relatively brief and assimilable and by suggesting the essential qualities of Don Byas and Dexter Gordon with single examples. However, Ben Webster is reduced to a few bars on Ellington's *Blue Serge*.

Obviously, it would take more than six LPs to do the subject full justice, but these are all records that any jazz collector would want. The transfers are excellent (aside from the jerkiness in the Scott Joplin piano roll that gets the set off to a shaky start) and the annotation is both helpful and provocative. The set provides a foundation for a jazz collection that can be developed in whatever direction the collector finds appealing.

B **THE SMITHSONIAN COLLECTION OF CLASSIC JAZZ.** Scott Joplin, Jelly Roll Morton, Robert Johnson, Bessie Smith, King Oliver, Sidney Bechet, James P. Johnson, Louis Armstrong, Bix Beiderbecke, Fletcher Henderson, Bennie Moten, Fats Waller, Meade Lux Lewis, Benny Goodman, Coleman Hawkins, Billie Holiday, Ella Fitzgerald, Art Tatum, Jimmie Lunceford, Gene Krupa, Roy Eldridge, Benny Carter, Lionel Hampton, Count Basie, Charley Christian, Lester Young, Duke Ellington, Don Byas, Dizzy Gillespie, Charlie Parker, Erroll Garner, Bud Powell, Sarah Vaughan, Lennie Tristano, Miles Davis, Tadd Dameron, Dexter Gordon, Thelonious Monk, Sonny Rollins, Modern Jazz Quartet, Charles Mingus, Cecil Taylor, Ornette Coleman, John Coltrane, and others. SMITHSONIAN Classic Jazz, \$21.50 (six discs, postpaid, available from Classic Jazz, Box 14196, Washington, D.C. 20044).

HIGH FIDELITY

CLASSIFIED

1515 Broadway, New York, N.Y. 10036
Phone: (212) 764-7300

CLASSIFIED RATES: 1-time \$1.20 per word per issue, minimum \$12. 6 consecutive issues—\$1.10 per word per issue. 12 consecutive issues—\$1.00 per word per issue. Words in caps—10¢ extra each.

Box Numbers: \$1.00 additional per insertion to cover cost of handling and forwarding mail. Count 10 extra words for box number and address.

DISPLAY CLASSIFIED AND DISCOUNTS: 1 inch by 1 column—\$200. 2 inch by 1 column—\$400. 3 inch by 1 column—\$600. 5% discount 6 consecutive issues. 10% discount 12 consecutive issues. Deadline is two months prior to publication date. Full payment must accompany All copy for classified ads.

for sale

AR, KLH, ADVENT, DYNACO, RECTILINEAR, ADC OWNERS—Our electronic equalizer gives your speakers an octave of new bass, plus three broadband tone controls. Three reviews, literature from **NORMAN LABORATORIES**, 2280 Industrial Boulevard, Norman, Oklahoma 73069.

RARE ROMANTIC PIANO SCORES—Moscheles, Henselt, Herz, Litolff, Scharwenka, Scriabin, etc. Free catalog. **MUSIC TREASURE PUBLICATIONS**, 620 Ft. Washington Ave., 1-F, New York, N.Y. 10040.

SONY, RCA, Heathkit, Stereo and Electronic Equipment. Fantastic bargains, moving sellout. Must dispose entire hobbyshop. \$15.00 RCA stereo cartridge recorder. For catalog send \$1.00 to 127 Park View, Apt. 207, Los Angeles, California 90057.

HOW TO SAVE MONEY safely, buying components/recorders. Prominent reviewer lists models, pitfalls, 20 pages. \$1.03. U.S. Audio Testing Laboratories, Inc. Box 1570 LICNY, 11101.

BUILD YOUR OWN SPEAKERS AND SAVE UP TO 50%. You can assemble your own high quality, multi-element stereo speakers in a few hours and save up to half the cost of comparable speakers. Send for our free 32-page catalog of speaker kits, raw speakers and accessories. **SPEAKERLAB**, Dept. HF2, 5500-35th N.E., Seattle, WA 98105.

miscellaneous

SLEEP-LEARNING—HYPNOTISM! TAPES, RECORDS, books, equipment. Also Alpha Brainwave Feedback devices. Free catalog. Autosuggestion, Box 24-F, Olympia, Washington 98501.

DIAMOND NEEDLES and Stereo Cartridges at Discount prices for Shure, Pickering, Stanton, Empire, Grado and ADC. Send for free catalog. All merchandise brand new and factory sealed. **LYLE CARTRIDGES**, Dept. H, Box 69, Kensington Station, Brooklyn, New York 11218.

Stereo Components, Appliances, low quotes. \$1.00 for catalog. Defa Electronics, 2209 B'Way, N.Y., N.Y. 10024. (212) 874-0900.

HIGH FIDELITY'S TEST REPORTS—Over 175 currently available audio products. Tests, analyses, prices. Send \$2.25, Includes 30¢ postage & handling, to High Fidelity's Test Reports, Box HF, 2160 Patterson St., Cincinnati, Ohio 45214.

Protect your records Poly sleeves for jackets 6¢ Roundbottom inner sleeves 5¢ Poly lined paper sleeves 12¢ White jackets 27¢ Postage \$1.00. Record Supply House, Hillburn, New York 10931.

Free Opera Catalog. Opera Recorder, 862, E 51 St. F. Brooklyn, N.Y. 11203.

ORIGINAL OLD RADIO SHOWS! Thousands available. Six hours only \$9.00! Catalogue \$2.00 (Refundable). Radio Vault, Box 9032-F, Wyoming, Michigan 49509.

QUICK READING KIT \$2.95. Doubles reading speed while you read normally. Quick Read DEPT. B, Box 5002, Oakland, Cal. 94605.

"WAR-PEACE"/MELODIYA \$4.50, limited! FREE lists SSAE. Harrison, 311 Park Ave., Monroe, La. 71201.

services

RENT 4-TRACK OPEN REEL TAPES—ALL MAJOR labels—3,000 different—free brochure. Stereo-Parll, 57 St. James Drive, Santa Rosa, Cal. 95401.

RECORD, TAPE, CASSETTE COPIES made (one or more) also complete record production and demos from your tapes. Request brochure. Trutone Records, Box 830, Dept. H, Saddle Brook, N.J. 07662 (201) 868-9332.

new equipment for sale

DON'T PAY THE HIGH MAIL ORDER PRICES. THIEVES WAREHOUSE OF TAMPA, 1531 SOUTH DALE MABRY, TAMPA, FLORIDA 33609.

DON'T PAY THE HIGH MAIL ORDER PRICES. THIEVES WAREHOUSE IS COMING TO YOUR AREA. FRANCHISES AVAILABLE. THIEVES WAREHOUSE, P.O. BOX 8057, PENSACOLA, FLORIDA 32505.

LISTEN TO TV THROUGH YOUR STEREO WITH TELEDAPTER!



Works with any television and stereo no wiring—just takes a minute to plug in. Now enjoy all TV programming with a full new sound. Complete and ready to use with instructions. Send \$2.00 for C.O.D. or \$16.95 for PPD. (Cash, check, or master charge #). To: **RHODES AND CO. P.O. Box 817, Hendersonville, Tennessee 37075.** 10 day money back guarantee. Dealer inquire invited.

35% to 55% DISCOUNT on Professional Guitars, Amplifiers, P.A. Systems. Free Catalog. Carvin, Escondido, Calif. 92029.

"BUY DIRECT FROM ENGLAND. Save Money! B & O, Cambridge, Decca, Goldring, Gold Speakers, Jordan-Watts, KEF, Leak, Lowther, Ortofon, Revox, Rogers, SME, Tandberg, Transcriptors, Wharfedale. Price and shipping list free or send \$3 bills to include literature airport. Goodwins, 7 The Broadway, Wood Green, London, N.22. 6DU. Phone 888 0077. Visitors Welcome."

AUDIO COMPONENTS at guaranteed lowest prices. Specializing in PIONEER, SANSUI, AR, MARANTZ and SONY. Write for prices on over 50 brands including color televisions and musical instruments, DISCOUNT SOUND, P.O. Box 6346, Washington, D.C. 20015.

tapes & records

"HARD TO GET" RECORDS—ALL SPEEDS, RECORD Exchange, 842 Seventh Avenue, New York, N.Y. 10019.

SCOTCH RECORDING TAPE, LOWEST PRICES, TAPE CENTER, Box 4305C, Washington, D.C. 20012.

Basf, Memorex, Scotch, TDK, Reels, Cassette, 8-tracks. Lowest Prices. S & S Audio, P.O. Box 523, Skokie, Ill. 60076.

FREE 200-PAGE CATALOG 1,400 New Stereo Recordings. Renaissance, Baroque, Classical, Romantic, Modern Music. Not sold in stores. Not listed in Schwann's. Highest quality! Budget label prices! Available only by mail. **MUSICAL HERITAGE SOCIETY**, Box 932 HF, New York, N.Y. 10023.

EVERYTHING ON OPEN REEL! Prerecorded classical/popular tapes. Latest releases. Dolby Quad. 96-page catalogue \$1. Barclay-Crocker, Room 857H, 11 Broadway, NYC 10004.

Cut-out records. Huge Stock. All new. No catalog. Lesco, 2205 Marylane, Broomall, Pa., 19008

LIVE OPERA, CONCERTO, SYMPHONIC, TAPE BARGAINS, \$3.50—(REELS & CASSETTES), BOX 1101, WOODHAVEN, NEW YORK 11421.

SOUNDTRACKS, Lowest Prices. Catalog: 25 cents. Write: Hi Fi, Box 715, Florissant, MO 63033

FREE Movie Classics Soundtrack Catalog. Wilson, 823 Timberlane, Gallon, Ohio 44833.

SOUND TRACK-RECORD-ALBUMS—MAIL AUCTION—FREE LIST—Whalon, 2321-C-Hill, Redondo Beach, Calif. 90278.

RARE SOUNDTRACKS, SHOWS AND PERSONALITY RECORDINGS—Reasonable prices. Large new catalog free. Robert Hiott, Box 440471, Miami, Florida 33144.

CAPITOL STACK-PAKS. Blank cassettes, cartridges, reels. Discount prices. Lawson's, Box 510H, Livermore, Calif. 94550.

TAPES Important Singers, conductors, instrumentalists in live performance. Emphasis on Superior sound. Catalogues. Good Sound Associates, POB 489, Dept. F, Planetarium Station, N.Y., N.Y. 10024.

RARE OPERA, symphonic music on tape. Historic performances. European, domestic. Free catalogue. Underhill, Belpport, N.Y. 11713.

IMPORTS: Jazz, Classical LP's, 8 Tr., Cassettes all languages 3 catalogues 50¢ each. Refundable. Nostalgia, films and show catalogue 25¢. Refundable. Howards International (H) 61-25 98th St., Rego Park, N.Y. 11374.

LIVE OPERA PERFORMANCES ON OPEN REEL TAPES. Incredible performances, 1926-74. Catalog. MR. TAPE, Box 138, Murray Hill Station, N.Y.C. 10016.

YESTERDAY LIVES! LP's Of Great Jazz, BIG Bands. Radio Shows from 1930s to '50s. Send 10¢ for catalog to: Tulip Records, P.O. Box 3155, San Rafael, Calif. 94902.

OPERA TAPES—DISCS OPEN REEL AND CASSETTES—historical performances of last 40 years—Unbelievable treasure and rarities—ALSO LP RECORDS. Ed Rosen, Box 97, Freeport, N.Y. 11520.

Golden Age Radio—your best source for radio tapes. Box 25215-J, Portland, Oregon 97225.

FILM-STAGE SOUNDTRACKS. Large free list. A. Lutsky, Box 557342, Miami, Fla. 33155.

RADIO PROGRAMS ON CASSETTES. Catalogue 50¢. MB/JB Enterprises, P.O. 724, Spencer, Iowa 51301.

Old radio programs on tape. Thousands available. Six hours. \$8.00. Catalogue, 25¢. Nostalgic Radio, Box 292, Peoria, IL 61601.

JAZZ—Personalities—Soundtracks & O.C. Auction Lists From: Ray Macknic, 16114 Napa St., Sepulveda, Calif. 91343, U.S.A.

WHOLESALE PRICES C A S S E T T E S				
PLAIN WHITE CASSETTE LABELS, NORELCO CASSETTE CLEANERS, PAPER MAILER BOXES—HOLDS NORELCO-TYPE PLASTIC BOX, FAMOUS BRAND CASSETTES				
"LIKE NEW" 10% METAL OR FIBERGLASS REELS. SEND FOR OPEN REEL AND CASSETTE DISCOUNT CATALOG				
	QUANTITY	1-9	10-99	100
CASSETTE LABELS (PLAIN WHITE)		03	02	15
NORELCO CASSETTE CLEANER		55	50	35
NORELCO PAPER MAILER BOXES		03	025	022
10% FIBERGLASS REELS, USED		50	40	35
10% METAL NAB HOLE, USED		1.00	1.00	.90
*PLUS POSTAGE BY WEIGHT AND ZONE				
SAXITONE TAPE SALES				
1776 COLUMBIA ROAD, N.W., WASHINGTON, DC 20009				

SHOW ALBUMS—Rare, out-of-print LP's. 52-page list 50¢. Broadway/Hollywood Recordings, Georgetown, CT 06829.

SOUNDTRACKS. Large free catalog. STAR-49, Box 850, Arroyo Grande, CA 93420.

QUADRAPHONIC RECORDS AND TAPES—ALL labels, over 500 titles—at discount prices! For your free illustrated copy of the world's most complete quad catalog, write: **SOUND CONCEPTS**, 2713 West Radan, Dept. B5, Peoria, Illinois 61604.

1930-1962 RADIO PROGRAMS, REELS, \$1.00 HOUR! CASSETTES, \$2.00 Hour! Catalog, \$1.00. AM Treasures, Box 192W, Babylon, N.Y. 11702.

L.P. COLLECTION FOR SALE—8,000 Records, Private Party—Jazz Dance Bands, Light Orch., Vocals, free lists sent on Requested Artists. Brian O'Flaherty, P.O. Box 5892, San Francisco, Calif. 94101.

5000 RECORDS! ALL RARE/OUT-OF-PRINT. Soundtracks, Shows, Personality, Jazz, TV, Comedy, Spoken. MOST COMPLETE LISTING AVAILABLE. 105 page catalogue \$2.00. Refundable. Check/MO To: Records Revived, Dept. A, POB 15008, San Francisco, CA. 94115.

wanted to buy

CASH FOR UNWANTED STEREO LPS AND PRERECORDED TAPES. Reder. 81 Forshay Road, Monsey, New York 10952.

situations wanted

AUDIO DISKMASTERING ENGINEER SALESMAN with solid audio background seeks permanent career, studio/sales position in N.Y./N.J. area. Salary negotiable. Box 2004, High Fidelity, One Astor Plaza, New York, N.Y. 10036.

classical

reviewed by

ROYAL S. BROWN
 ABRAM CHIPMAN
 R. D. DARRELL
 PETER G. DAVIS
 SHIRLEY FLEMING
 ALFRED FRANKENSTEIN
 KENNETH FURIE
 CLIFFORD F. GILMORE
 HARRIS GOLDSMITH
 DAVID HAMILTON
 DALE S. HARRIS
 PHILIP HART
 PAUL HENRY LANG
 ANDREA MCMAHON
 ROBERT C. MARSH
 ROBERT P. MORGAN
 ANDREW PORTER
 H. C. ROBBINS LONDON
 JOHN ROCKWELL
 SUSAN THIEMANN SOMMER



Alfred Brendel
A second chance at Beethoven.

BACH: Complete Lute Works. Narciso Yepes, lute. [Heinz Wildhagen, prod.] ARCHIV 2708 030, \$15.96 (two discs).

Suites: in G minor, S. 995; in E minor, S. 996; in C minor, S. 997; in E, S. 1006a. Prelude, Fugue, and Allegro, in E flat, S. 998. Prelude in C minor, S. 999. Fugue in G minor, S. 1000.

Bach's works for lute, seven in all, are presented here in their first integral recording—the redoubtable Narciso Yepes having set about that task with a hefty theorbo-lute of fourteen sets of strings, including four drone sets in the bass.

No one seems to know exactly how many lute works Bach may have written or transcribed, but the scholarly guess is that these seven comprise the great proportion, if not the whole of the output. They are well documented: Three are in the composer's own hand, the rest in manuscript copies by reassuringly authentic contemporary composers or performers. Four pieces are lute originals, three are transcriptions (of the Fifth Suite for solo cello, the Third Partita for solo violin, and the Fugue from the First Sonata for solo violin).

It is good to have these works all under one roof, though I don't necessarily recommend taking them at a single sitting. Perhaps because of Yepes' somewhat dogged scholarlyness, perhaps because this particular instrument is less capable of color variety than the concert guitar to which we are accustomed, the set strikes me as an honorable reference work rather than an unadulterated musical delight.

In the final analysis, Yepes—always an artist of integrity and seriousness—lacks the elegance and the power to beguile that are so marked in several of his brother artists on lute and guitar. Nor does he manage to create that sense of inexorable beat that pulses through a movement like a life-rhythm that only God could stop. Even at his own high level of technical accomplishment he sometimes scrambles a bit, and he is often breathless in phrasing. To counter that, he is very effective in certain individual movements: The C minor Prelude sets forth its ostinato bass with irrefu-

table authority, the Gigue of the C minor Suite swings along quite happily, the Sarabande from the Cello Suite is magisterial.

It is enlightening to hear, in the transcribed works, how Bach added supporting lines in the lute version as a new harmonic underpinning and sometimes a new suggestion of polyphony. There's much to be learned here, and Yepes, in his professorial fashion, lays it all out before us intelligently and clearly. S.F.

BARTÓK: Choral Works—See Janáček: Works for Male Chorus.

BEETHOVEN: Sonatas for Piano: No. 7, in D, Op. 10, No. 3; No. 14, in C sharp minor, Op. 27, No. 2 (*Moonlight*); No. 25, in G, Op. 79. Alfred Brendel, piano. PHILIPS 6500 417, \$6.98.

Brendel has been re-recording much of his former Vox repertoire for Philips. Some of his recent work offers a distinct improvement (the two Liszt concertos are slimmed-down conceptions, with much better orchestral accompaniments) and some a decided step backward (the four Schubert impromptus on Philips are fussy and mannered, without the athletic spontaneity and naturalness of the older versions). These Beethoven sonatas, however, are pretty much the same as before: decent, sometimes even distinguished conceptions, but a trifle bourgeois and metrically tight-lipped.

The first movement of Op. 10, No. 3, seems a bit closer to the requisite presto, although the older version was perfectly acceptable in tempo. The Largo is broodingly, and satisfactorily, paced; the scherzo and rondo are sunny and temperate. The humidity, though, is rather high for Beethoven: I would prefer less sustaining pedal and a bolder, firmer piano sonority.

In the *Moonlight's* opening Adagio sostenuto, this sort of misty, half-shadow tone painting is more appropriate. Brendel keeps that movement moving along briskly and happily refuses to make too much of the interplay of straight sixteenth notes against triplets. The

Allegretto, on the other hand, is too namby-pamby, while the finale suffers slightly from some lily-gilding allargandos at cadences (the early recording was less exaggerated but otherwise almost identical).

The charming, lightweight Op. 79 lacks the requisite sparkle and playfulness. This slowly paced, squarely serious playing takes all the fun out of the piece.

The sound is firmer and less tinny than Vox's, but the surfaces of my copy were well below the Philips norm. H.G.

B **BRAMMS:** Sonatas for Clarinet and Piano: in F minor, Op. 120, No. 1; in E flat, Op. 120, No. 2. Harold Wright, clarinet; Harris Goldsmith, piano. MUSICAL HERITAGE MHS 1496, \$3.49 [from CROSSROADS 22 16 0142, 1968] (Musical Heritage Society, 1991 Broadway, New York, N.Y. 10023).

R **BRAMMS:** Sonatas for Clarinet and Piano: in F minor, Op. 120, No. 1; in E flat, Op. 120, No. 2. Mitchell Lurie, clarinet; Leona Lurie, piano. [Peter Christ, prod.] CRYSTAL S 301, \$5.98.

Brahms's two clarinet sonatas, written in 1894 when the composer was in his last years and producing some of his most beautiful and distinctive music, rank among the finest works in wind literature. It was thus a surprise to discover that, before the appearance of these two recent releases, they were available only in Vox's three-disc set (SVBX 578) of all the Brahms chamber works featuring clarinet (the two sonatas; the trio for clarinet, cello, and piano; and the clarinet quintet). Curiously, both sonatas were available in the "alternate" viola versions (played by Walter Trampler on RCA LSC 2933), and there is even a Stern recording of No. 2 in Brahms's own arrangement for violin. But the works were originally conceived for clarinet, and only in the clarinet version do they seem to attain their definitive character. Thus Brahms enthusiasts should be pleased to have them readily available in two different readings.

The two, however, are not of equal distinction. The Wright/Goldsmith version seems superior in virtually every regard. There is more variety of color in the instruments, a more relaxed and flexible projection of the larger contours of the piece, and a clearer delineation of individual elements within the total texture. Particularly in this last respect, credit should go to Harris Goldsmith—well known to readers of these pages—whose rendering of the frequently complex piano part is a model of clarity and musicality. Clarinetist Harold Wright also plays beautifully throughout, with remarkable control of his instrument and a sure sense of line.

Explanation of symbols

Classical:

- B** Budget
- H** Historical
- R** Reissue

Recorded tape:

- Open Reel
- 8-Track Cartridge
- Cassette

The Lurie team, on the other hand, is hampered by a somewhat wooden approach to the rhythmic side of the music: Each beat seems to give way only reluctantly to the next, an impression that is compounded by sluggish tempos. The opening of the slow movement of the Second Sonata, for example—which should seem to be suspended in space, gradually revolving over the slowly changing harmonic foundation—appears so firmly anchored as to be frozen. Moreover, there are simply some careless lapses: e.g., one cannot hear the third in the final chord of the first movement of No. 2.

I might have reacted less negatively to the Lurie recording, I suspect, if I had not listened to it in conjunction with the Wright/Goldsmith offering, which is one of the better recordings of chamber music for wind instrument to have come my way in some time. The two players work together with an unusual combination of independence and cooperation. The recorded sound is good throughout (much better than Crystal's, which is too distant in quality and is particularly unclear in the lower register), and Goldsmith's liner notes are both informative and entertaining.

R.P.M.

BRITTEN: Diversions on a Theme, for Piano Left Hand and Orchestra. **LADERMAN:** Concerto for Orchestra. Leon Fleisher, piano (in the Britten); Baltimore Symphony Orchestra, Sergiu Comissiona, cond. DESTO DC 7168, \$5.98.

The Britten is a youthful work, composed in 1940. It is beautifully tuneful, ingenious in its variations (which bear such titles as Romance, Chorale, Nocturne, Badinerie, Toccata, and Tarantella), entirely academic and orthodox in its idiom, and instantly charming. How long that charm may last remains to be seen. Music that seduces you at once rarely has much staying power, for all the brilliance and sensitivity a Fleisher and a Comissiona may put into its performance.

Ezra Laderman's *Concerto for Orchestra*, on the other side, neither charms nor seduces. It is a big, noble, powerful piece, placing sections of the orchestra in high relief as it storms grandly on its way. The jacket notes suggest that Laderman has been challenged by those (including the writer of these lines) who have been asking if the symphony orchestra hasn't become an obsolete institution, creatively speaking. Well, we can relax now. Laderman's concerto proves, in the deathless phrase of Don Marquis' cat, that there's a dance in the old girl yet.

A.F.

BRUCKNER: Symphony No. 8, in C minor (ed. Nowak and Klemperer). New Philharmonia Orchestra, Otto Klemperer, cond. ANGEL SB 3799, \$11.98 (two discs).

Comparisons:

Szell/Cleveland (Nowak ed.)
Haitink/Concertgebouw (Haas ed.)

Col. M2 30070
Phi. 6700 020

I approached this recording, Klemperer's last, with high hopes. While his Angel Bruckner Nos. 6, 7, and 9 are marred by flaccid rhythm, loose ensemble control, distant and ill-balanced recording, or all three, his Nos. 4 and 5 are splendid achievements. A third unqualified winner would have evened the score.

To be sure, this set is beautifully recorded

(and illustrated). EMI has captured a warm, solidly glowing sonority that few of its previous Bruckner efforts (the Fifth is a notable exception) have approached. The conductor's unwavering loyalty to the left-right violin seating arrangement (now that he's gone, only Rafael Kubelik and Wyn Morris keep *that* faith) pays considerable dividends.

Though the work's opening section is taken at a rather measured clip for an Allegro moderato, I can accept the resulting repose and grandeur as quite becoming to the music, without the bombast or fussiness others have brought (e.g., Karajan on his deleted Angel version). Indeed, there is some ravishingly lovely solo playing (horns, for example), but the oboe at bar 146 is hard-pressed to shape a smooth legato line at Klemperer's speed. As the movement progresses, the waning physical control from the podium is increasingly exposed—in the unclear voice leading at L and in the shaky co-ordination of horns and strings and then of flute and trumpets around N.

The Scherzo will shock many hearers. It isn't all *that* ponderous. Szell's is only marginally faster, after all, but the Cleveland performance has a gnarled rhythmic tension, a cutting and snarling brassiness, that is sadly lacking in this dyspeptic and feeble rendition. The huge slow movement is kept aloft by Klemperer's forward-pushing pulse (somewhat nervously, rather than tautly), but minor blemishes of attack occur anyhow and there is a passage of utter confusion three or four measures before U.

It seems pointless to criticize the finale because it simply isn't all there—literally! No fewer than 222 of its 709 measures have been excised in two separate chunks without any explicit (or deducible) rationale. Klemperer *does* rely mainly on the Nowak edition, which follows Bruckner's final acceptance of many cuts urged on him by others, but these even more drastic deletions omit a good bit of essential development, the initial cyclical reprise of the first movement's principal motif, and some gorgeous choralelike passages.

The Bruckner Eighth buyer can have the



Otto Klemperer
Missing on the finale.

best of both worlds: Szell's monumental yet classically terse (!) treatment of the untruncated Nowak edition, and Haitink's warmly lyrical and flexibly molded one of the Haas edition (which restores a few cuts that Bruckner reluctantly sanctioned). Now that the 1887 score has been published and performed, we can even hope for a recording of the very different original version.

A.C.

COPLAND: Appalachian Spring (suite from original version). Columbia Chamber Orchestra, Aaron Copland, cond. [Andrew Kazdin, prod.] COLUMBIA M 32736, \$5.98 (with seven-inch rehearsal disc). Tape: MA 32736, \$6.98; ●● MT 32736, \$6.98. Quadriphonic: MQ 32736 (SQ-encoded disc), \$6.98; MAQ 32736 (Q-8 cartridge), \$7.98.

COPLAND: Sonata for Violin and Piano; Duo for Flute and Piano; Nonet for Strings. Isaac Stern, violin (in the sonata); Elaine Shaffer, flute (in the duo); Aaron Copland, piano (in the sonata and duo); Columbia Chamber Ensemble, Aaron Copland, cond. (in the nonet). COLUMBIA M 32737, \$5.98.

When Aaron Copland spent a year composing a ballet score for Martha Graham, he imagined it a labor of love, one of those projects animated by inner necessity rather than by hardheaded appraisal of the most profitable way to spend one's time. But virtue, as we are told, has its rewards: the suite that Copland drew from his "Ballet for Martha" became one of the most popular of contemporary orchestral works. However, the original ballet version, for thirteen instruments (flute, clarinet, bassoon, piano, double string quartet, and contrabass), long remained reserved for Miss Graham's exclusive use. Recently the composer prepared a concert version using the original scoring, and he recorded it last spring with a group of crack New York players—a lovely performance, surely now the preferred way to hear this genial score.

Only in one respect does the content of this new suite differ from that of the familiar full-orchestra version: A very striking episode, full of ominous resonances, has been restored preceding the final variation on the Shaker tune. This is most welcome: for one thing, it's good Copland, and for another, it provides valuable contrast to the prevailing pastoral tone of the familiar music. In effect, it gives us—horizontally, so to speak—something like the variety that the range of full orchestral dynamics affords "vertically" in the standard suite. Something of the composer's attitude towards (and affection for) *Appalachian Spring* is further afforded by the little bonus record of rehearsal snippets.

Not long before *Appalachian Spring*, Copland composed a violin sonata in a similarly lyric vein. There hasn't been a first-rate recording of this around in quite awhile, so I'm sorry to report that the new Stern-Copland version doesn't hit the bull's-eye. The noted virtuoso's style—the intense tone, the juicy portamentos—is at odds with the open harmonic color and the springy rhythms. Often, too, his poising and balancing of the phrases is relatively noncommittal. The piano part is, of course, in secure hands, but given the distribution of material, it is the violin that determines the over-all character of the performance; though expert, this isn't quite right.

Written in 1971, the duo for flute and piano



Aaron Copland—stating his views of his own works.

also recalls *Appalachian Spring*—in fact, it draws upon sketch material from the period of the earlier work, and the opening, a slowly building solo flute line, so much suggests the mood of the ballet that one is inclined to think “Appalachian Syrinx.” But a different kind of harmonic shading builds up, and none of the three movements head in quite the directions they would have a quarter-century earlier. A retrospective work, but so assured, varied, and masterful that it is sure to be a staple of the flautist’s repertory. The late Elaine Shaffer played the premiere (at a concert in memory of William Kincaid, whose friends and pupils commissioned the piece). She is not at quite her tonal best here, but the spirit is right, and the composer’s vital work at the piano helps a great deal.

The nonet, composed in 1960, was recorded in 1962 and has thus been sitting in the Columbia icebox for a dozen years. This is one of the most original of Copland’s later works, the solemn harmonies of the opening touching (from quite a different direction) on an expressive region not far from Strauss’s *Metamorphosen*, then expanding to lyricism and vivacity before returning to the original character. The rich sonorities of the unusual ensemble (three each of violins, violas, and cellos) are, alas, not well transmitted by the thick, bass-heavy sound on this disc; a bass cut and treble boost help, but cannot alleviate the congestion that too often swallows up important subsidiary lines. A shame, for the nonet deserves the very best. D.H.

DEBUSSY: Songs, Bernard Kruysen, baritone; Noël Lee, piano. TELEFUNKEN SAT 22540, \$5.98.

Trois chansons de France; Fêtes galantes, second series; Trois poèmes de Stéphane Mallarmé, Le Promenoir des deux amants; Noël des enfants qui n’ont plus de maisons; Trois ballades de François Villon.

The first song in this recital could almost serve as a caricature of French vocal art of the present day: What one hears is an insubstantial baritone voice, dry in tone and ridden with vibrato. Matters clear up immediately, however, and anyone who does get beyond *Le temps a laissé son manteau* will be rewarded by a sensitive and illuminating account of all the songs composed by Debussy from 1904 to

1915, when he wrote his last one, the strange *Christmas Carol for Children Who Have Lost Their Homes*. Bernard Kruysen does not have distinguished vocal material to work with, but by the second of the *Chansons de France* he manages to cope effectively with all of Debussy’s technical demands. He even summons an unexpected burst of power for the first and third Villon ballads.

But Kruysen’s great virtues are interpretive. What he does with his voice is to use it for the ends of poetry. He brings these superb and haunting songs unerringly to life. He enunciates the text with distinction, employing an astonishingly wide variety of colors and timbres to suggest meanings, situations, moods, atmospheres. Debussy is the great poet of the flux of emotions, and Kruysen does not make the mistake of trying to dramatize these songs. He sees that they are mostly reveries, and he but glances at the implied characterizations. *Colloque sentimental* is shadowy, elusive, half numb in feeling. The vague, excited vision of *Les Ingénus*, the first of the *Fêtes galantes*, is crowned by a reverberant climax in the final line, a climax created by Kruysen’s subtle emphasis of two words: “*Que noire âme depuis ce temps tremble et s’étonne.*”

Yet Kruysen is not all moonlight and pot-pourri. He can be witty and ironic, as in the second of the Mallarmé songs or the final Villon ballad. He is, in brief, a noteworthy artist. We have, in any case, reached a stage in our culture when simply to hear the French language properly pronounced and enunciated is by itself an aesthetic experience. To this gift Kruysen adds a considerable musical talent.

Noël Lee is a superb pianist. Debussy’s piano parts are just as important as the vocal line, and Lee does them full justice. There are texts but no translations. The four-line “*Envoi*” of the last Villon ballad has not been printed, though Kruysen, of course, sings it. D.S.H.

DVOŘÁK: Sextet for Strings, in A, Op. 48; Quintet for Strings, No. 3, in E flat, Op. 97. Members of the Vienna Octet. LONDON STEREO TREASURY STS 15242, \$2.98.

Comparison—sextet:
Berlin Philharmonic Octet

Phi. 839 754

Comparison—quintet:
Trampler, Budapest Quartet

Col. MS 6952

Thirteen years separate the composition of these two works, and in that time Dvořák learned a good deal. Not to disparage too greatly the Sextet, Op. 48—it was, after all, the first chamber work of Dvořák to be performed outside his own country, thanks to Joseph Joachim, who thought highly enough of it to introduce it to Berlin in 1879. It was, too, the first work in which Dvořák employed two characteristic Czech dances, the dumka and the furiant. Still, to our ears it may sound a little thin; the developments are textbook affairs, the phrases are a bit too carefully balanced and too often repeated, and the composer tends to make a little bit go an awfully long way. The Vienna performance is perfectly presentable but not quite on a level with that of the Berlin Octet members, who manage more lift and flexibility in the dumka movement and a more sensitive balance of instruments in the finale, making the listener better aware of the contours of the music.

The Op. 97 Quintet—more full-blooded, varied, and well-knit than the sextet—is one of the triumvirate of “American” works along with the *New World* Symphony and the Quartet in F, Op. 96. It was written after the composer got away from the big-city bustle of New York and took refuge among his compatriots at the Czech settlement in Spillville, Iowa, during the summer holidays of 1893. He and a group of Indians (invariably called “Red Indians” in the reference books) made each other’s acquaintance that summer, and while nobody has recorded what the Indians thought of Dvořák, he seems to have been fascinated by them. Much is made of their influence on the quintet, and it would be hard not to hear the tom-tom beat in the scherzo. But the prevailing folkish quality of the themes is too indigenously Dvořák to require Red Indian explanation; the work as a whole has a tunefulness and a beguiling rhythmic sway that stem directly from his early, innate sensitivity to his own national heritage. Here, it is translated into American terms, but the roots of the style reach back across the Atlantic. Another marked aspect of the quintet is its persistent darkness in instrumentation, thanks to some remarkable and beautiful viola solos.

The Vienna performance is on a par with the Budapest, give or take a few points on either side. The Budapest achieves more variety of color through subtle shifts in instrumental balance (*vide* the *Larghetto*), but the Vienna’s more easygoing rhythm in the finale avoids the almost unpleasant spastic jerkiness of the other version. All in all, the Vienna disc—both sides of it—will give a great deal of pleasure. S.F.

FRANCK: Sonata for Violin and Piano, in A. **SZYMANOWSKI:** Mythes, Op. 30. Wanda Wilkomirska, violin; Antonio Barbosa, piano. CONNOISSEUR SOCIETY CSQ 2050, \$5.98 (SQ-encoded disc).

Comparison—Franck:
Stern, Zaklin

Col. MS 6139

Miss Wilkomirska, as this recording demonstrates, is a violinist with more than one string to her bow. The first recording of hers that came to my attention was a businesslike, musicianly, quite austere reading of Bach’s Solo Violin Sonata No. 1 and Partita No. 2 (re-

viewed in October 1973 issue). On the basis of it, one would not have guessed that Franck's sonata or Szymanowski's hothouse visions would play to her strengths—or, rather, she to theirs. But you can't judge a lady by her Bach; it seems, and here Miss Wilkomirska reveals the other side of her artistry: high-powered, impassioned, volatile, verging on the purple at moments, abrim with spirit.

What remains from the Bach demonstration is brains. For even though there is occasionally, for my taste, too much heart-on-sleeve in the Franck (specifically, a great deal of rubato in the first movement, much use of portamento in the second), the logic of her approach is clear. The over-all shape of each movement is beautifully mapped out, and climaxes are impressive and well placed.

The violinist is fully abetted in this combination of heat and intelligence by Antonio Barbosa, who contributes luxuriant playing. In the Allegro the two of them soar and push forward on waves of melodic power; in the finale they set out on their canonic way with appropriate serenity and coolness.

If you own the old Stern/Zakin recording of the Franck, you will not need to replace it, for that version—more patrician, more subtle, boasting Stern's own special power of articulation, and recorded with greater delineation and clarity—is still a prize. But the new disc is welcome on its own terms.

The Szymanowski *Mythes* provide a compelling glimpse into the overheated, feverish fantasy of that intriguing musical mind. The moods of the *Mythes* ("three poems for violin and piano") vary from opium-scented languor to near hysteria, and Wilkomirska and Barbosa keep pace all the way, with a sense of abandon. Any whiff of stiffness or calculation would have been the kiss of death to these pieces. Wilkomirska lets Szymanowski flower like a tropical plant. S.F.

HANDEL: Alcina: Suite—See Mozart: Symphony No. 39.

HELLER: Piano Works. Gerhard Puchelt, piano. [Robert F. Commagere, prod.] GENESIS GS 1040, \$5.98.

Promenades d'un solitaire, Op. 78; *Valse-réverles*, Op. 122; *Nocturne in G*, Op. 103; *Tarantella No. 1*, in E minor, Op. 53; *Variations on a Theme by Beethoven* (33), Op. 130.

Stephen Heller (1813-88) was a contemporary of the great Romantic masters, but there was nothing in this modest and likable man of the heaven-storming passions and ambitions of his brethren. He was a miniaturist who at most wrote little cycles of pieces like the *Solitary Rambles* recorded here. The title of one of his small pieces, *Tour Around My Room*, symbolically indicates his musical horizon.

If I am permitted an obvious pun, this music seems to be the result of rambling over the keyboard. It is attractively written for the instrument, and though here and there poetic, reminding one of the minor Schumann, it has little substance and tends to be diffuse. The variations on Beethoven's theme are surprisingly inventive and interesting; it is amusing to watch how ingeniously Heller manages to convert snatches from the Fifth and Ninth Symphonies to his purpose.

Pianist Gerhard Puchelt is a bit pussy-footed, often too subdued; he breaks chords and deflates phrase endings, nor is his pedal-

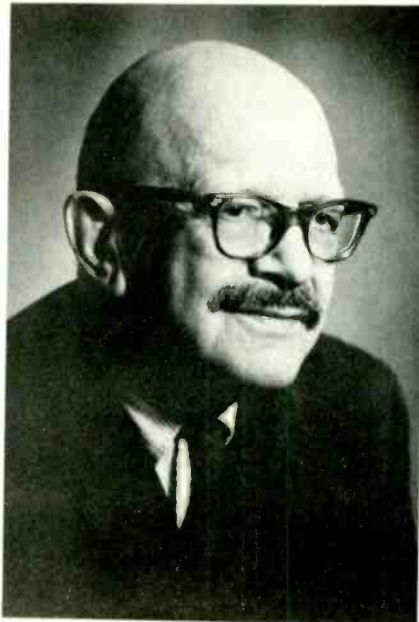

Andrew Imbrie

Making a quick but strong impression.

ing anything to write home about. However, at least some of these shortcomings must be due to the poor and noisy recording. P.H.L.

B **IMBRIE:** Dandelion Wine. **ROCHBERG:** Trio for Violin, Cello, and Piano. **WAXMAN:** Trio for Oboe, Clarinet, and Bassoon. Kees Kooper and Alvin Rogers, violins; Richard Maximoff, viola; Fred Sherry, cello; Bert Lucarelli, oboe; Arthur Bloom, clarinet; Donald MacCourt, bassoon; Mary Louise Boehm, piano. TURNABOUT TV-S 34520, \$2.98.

Two of the three pieces recorded here—the two trios by George Rochberg and Donald Waxman—are extended works, almost twenty minutes in duration; ironically it is the third work, Andrew Imbrie's brief, poignant *Dandelion Wine*, that to my mind makes the strongest impression.

Scored for six instruments, the work makes a remarkably full and varied effect despite its less-than-five-minute duration. Imbrie has attempted to mirror musically the quality of reminiscence explored by Ray Bradbury in his novel of the same title and has succeeded beautifully. Moreover, he does this not by quoting well-known music (always an easy way to evoke memories), but purely by supplying new musical contexts for his own material, first stated at the beginning of the work. It is a fascinating piece, characterized by considerable rhythmic vitality and unexpected motivic correspondences, as well as an unusually colorful instrumental surface. The sectional formal structure is, without ever seeming predictable, a model of clarity.

Also impressive is George Rochberg's 1964 trio, his last twelve-tone work. (He has since gone on to compose in a sort of post-Ivesian style.) At first hearing it seems rather forbidding, but as its over-all shape becomes more familiar it assumes an arrestingly individual character. Especially notable is the textural arrangement: Each instrument has an extended solo section, and the alternation of these with

ensemble sections delineates the formal growth of the piece. Even in the ensemble sections, however, there is a marked degree of instrumental isolation, the over-all line seeming to emerge not from a simultaneous mixture of the three parts but from the passing of material from one part to another. Only at the end—in a climactic section that serves to tie together the composition—is there any significant degree of instrumental interaction.

Donald Waxman's trio for oboe, clarinet, and bassoon is a light piece written in the French manner, with a particularly strong nod to the sort of "popular" style fostered by *Les Six*. The tunes are catchy and the forms simple; indeed, the whole thing would be oppressively bland were it not for Waxman's ability to upset the underlying rhythmic symmetries. Even so, one eventually tires of the constant sequential motivic repetitions and the somewhat strained effort at "cuteness."

R.P.M.

B **JANÁČEK:** Works for Male Chorus. Moravian Teachers' Choir, Antonín Tučapský, cond. NONESUCH H 71288, \$2.98 [from SUPRAPHON 1 12 0878, 1972].

The Soldier's Lot; Our Birch Tree; The Evening Witch; Leave-Taking; Czech Legions; The Wandering Madman; Schoolmaster Haltar; Maryčka Magdonova; Seventy Thousand.

BARTÓK: Choral Works. Male Choir of the Hungarian People's Army, Zoltán Vásárhelyi, cond.; Slovak Philharmonic Choir, Miklós Szabó, cond. [András Székely and Jenő Szijjártó, prod.] HUNGAROTON LPX 11519, \$6.98.

Four Old Hungarian Folksongs; Slovak Folksongs; Four Slovak Folksongs; Hungarian Folksongs; Székely Songs; From Olden Times.

Janáček's choral music formed a major part of his output, particularly during those long years when recognition eluded him. Even today, it is not well known outside Czechoslovakia, principally because of the language problem and the extreme difficulties of translation due to the composer's characteristic fidelity to the speech rhythms of his native Moravia. Thus this record, the only one of this repertory domestically available [the original imported version was reviewed in October 1972], assumes great documentary significance. But it is far more than just a document: This is a great and unique disc, containing as it does music as inspired as any Janáček ever wrote.

Anyone who responds to the operas and the Slavonic Mass must hear this record—or at least its second side. The first four of the five items on Side 1 date from 1893-1904. While they have their indisputable charms, they remain closer to a folk idiom than the more ambitious creations of Janáček's later years. The last three numbers on Side 2 consist of settings of ballads by Petr Bezruč, a pseudonym for a socially conscious nationalist who sought to arouse resentment against the Hapsburgs with his depictions of the lives of Silesian miners and humble patriots. Janáček's songs, composed between 1905 and 1909 and later revised, are cantata-like in their intensity of expression and their originality and complexity of form.

Czech Legions (1918), which concludes Side 1, is another dramatic portrayal, this time of patriotic joy at the role played by Czech soldiers in defeating the Austrians and winning national independence for Czechoslovakia.

But the most extraordinary of all these extraordinary pieces is *The Wandering Madman*, which begins Side 2.

The last decade of Janáček's life (he died in 1928) saw him mostly preoccupied with the works by which we know him best today. But he found time in 1922 to translate a poem by Rabindranath Tagore, the Bengali poet, and to set it for male chorus and soloists. The result is one of the experimental masterpieces of twentieth-century choral music.

The performances here, all a cappella, are first-rate and constitute a valuable documentation of their own. The Moravian Teachers' Choir was founded in 1903, and Tučapský is only its third leader, dating back in an unbroken chain. Janáček wrote many of his choral pieces for this choir, and Tučapský and his singers clearly have the music in their bones.

Kodály is better known than Bartók for choral music, and the present record, while a valuable part of the invaluable Bartók series nearing completion on Hungaroton, is not as striking as the Nonesuch Janáček disc. Resonantly sung and recorded by the Hungarian and Slovak choirs, Bartók's music sounds just a little bland next to Janáček's; Bartók clearly saved his experimentation for other forms. Still, on its own, more overtly folksy terms, this is extremely attractive, expertly crafted music, and no one interested in the composer will want to pass it up.

Lavish notes and texts for both records. J.R.

LADERMAN: Concerto for Orchestra—See Britten: Diversions on a Theme.

LISZT: Hungarian Rhapsodies (19); Spanish Rhapsody. Roberto Szidon, piano. [Rainer Brock, prod.] DEUTSCHE GRAMMOPHON 2709 044, \$23.94 (three discs).

B LISZT: Hungarian Rhapsodies (19). Louis Kentner, piano. VOX SVBX 5452, \$9.95 (three discs).

Both of these anthologies are satisfactory without being irresistible. Kentner's playing with Deutsche Grammophon's processing would have come closer to my ideal (especially at Vox's lower price), but that is a problem for an a&r man, not a reviewer.

In general, this is a study in the differences between the old and new order of piano playing. Kentner, a long-time "specialiszt," has a big, freewheeling, but always musical approach to music and instrument. He commands a solid, bronze sonority and phrases with rhetorical expansiveness. He uses the sustaining pedal rather lavishly at times and is often more concerned with an over-all effect than with specific details.

He has lived with this music for many years, which proves both an asset and a liability. On the positive side, his interpretations have a big line, a grand manner, an unassailable authority. At its best, his playing is warm, organic in phrasing—in short, musically aware in matters of style and differentiation. On the other hand, a certain freshness is occasionally missing; Kentner, like many long-standing practitioners of this repertoire, sometimes succumbs to clichés of "tradition." In the *brillante* sections of No. 2, for example, he over-exaggerates his tempo manipulation.

The young South American Szidon belongs to the more modern school. Like Kentner, he too has a big technique, but he too sometimes



Leos Janáček

Choral music as inspired as any he wrote.

gets a bit flurried in articulation. Szidon's phrasing is considerably more tightly coiled, not nearly so expansive or concerned with the larger elements of form. He is apt to think in smaller bits, and his playing often eschews rhetoric. Many listeners will find his clipped, urgent style utterly refreshing in the introductions to Nos. 2 and 6. He is far from metronomic, and in No. 11 his interpretation is even more pulled about than Kentner's.

Szidon's sound is always geared toward brilliance, and he is often scintillating in passages that call for champagne-like sparkle. On the other hand, fortissimos can—and usually do—sound tacky and brittle. Heard in small doses, his pianism falls prettily on the ear; after a while, a certain sameness and superficiality become increasingly evident.

The last three rhapsodies tell the important story. Kentner is aware that these late-period essays are very special. He perceives their experimental qualities and treats them accordingly: The opening of No. 17 is played like the opening of *Funérailles*; the short No. 18 becomes a veritable *Czardas macabre*; and No. 19—sunnier and less cryptic than its immediate predecessors—emerges with its contemplative introspection intact. Szidon merely sees further opportunities for glitter and display. His playing is never vulgar, but it tends to be bland in characterization.

The DG album is beautifully reproduced, and the discs are silent. Vox's sound for Kentner varies: At its best, the piano tone is clean and warm; at other times it blasts, and some sides of my copy suffer from noisy pressing. Vox's annotations are concise and to the point. DG's, far more elaborate, are informative—barring some unusually offensive public relations puffery for the star. H.G.

MARTINU: Etudes and Polkas; Borová. Josef Hála, piano. [Jaroslav Krček, prod.] SUPRAPHON 1 11 1104, \$6.98.

Hoo boy! It's been some time since I've heard such an exhausting display of pianistic patache, either from a composer or from a per-

former. I mean, when Martinu calls something an etude, he means business. Not only does he put the pianist through the usual fiendish passage work—from the perpetual-mobile triplets of the Etude in A in Book I to the incredibly fast runs in the Etude in C from Book II—he also fills these pieces with constant strong accentuations which, combined with frequent blocks of chordal complexities, often produce an effect of utter exhilaration.

Yes, but does all this have any musical value? Absolutely. To begin with, these pieces are totally identifiable with their composer, whether in the alternation between the dominantly major harmonies and the characteristic Martinu dissonances; in the distinctive Bohemian overtones; or in the rhythmic momentum that few composers can establish as well as Martinu can at his best, which he is in these works.

There is, of course, a strong difference between the style of the seven Czech dances of *Borová*, written in Paris in 1929, and of the etudes and polkas, composed in the U.S. in 1945. The former tend to be somewhat simpler and more subdued than the latter and often manifest a more acerbic harmonic idiom. But even in the midst of the spectacular fireworks of many of the etudes, Martinu comes up with some surprisingly subtle and intriguing writing, such as in the quiet and rather nervous opening of the Polka in A (almost a march at the beginning) of Book III.

I'm sure my delight in these works, which should come as a revelation to anybody with the slightest interest in piano literature, is due partly to the enthusiastic and unbelievably energetic performances by Josef Hála. If ever a performer totally identified with a work of music, Hála does so here—with such obvious gusto and abandon that his phenomenal accuracy seems all the more amazing. Even in the quieter, less showy pieces, his playing pulses with a latent vitality which he never overstates.

The piano sound has been fairly well recorded by Supraphon in spite of some shrillness, a generally hollow quality, and on my copy, a less than great pressing. But it would take much more than this to detract from my enjoyment of the disc. And why in the world do these compositions—none of them lasting much over two minutes—not reach the recital hall more often? R.S.B.

MESSIAEN: Visions de l'Amen. Peter Serkin and Yuji Takahashi, pianos. [Max Wilcox, prod.] RCA RED SEAL ARL 1-0363, \$5.98.

Comparison:
Ogdon, Lucas

Argo ZRG 665

Much of the uniqueness of Messiaen's *Visions de l'Amen* lies in the symbolic roles given to the two pianos. In his notes to the score (translated on the album jacket), Messiaen states that each piano part was written with a specific style in mind: The first part is more cerebral, more difficult technically, more abstract, while the second has a more emotional, thematic orientation. Besides this, it is also obvious that the composer had in mind the pianistic capacities of his wife, Yvonne Loriod, and himself—they premiered the work in 1943.

The work itself, then, impresses not as an interplay between two instruments occasionally blending to form a super-piano sound, but rather as a constant play of oppositions based around such traditional, quasi-mythical

polarities as male-female, heaven-earth, ecstasy-agony, and creation-judgment day. Throughout the seven "visions," each piano maintains an almost total independence from the other, and only rarely do they merge to form a literal unity otherwise suggested by a total sound that is obviously much more than the sum of its two opposing component parts. All of this is contained within a musical temporality that, instead of moving linearly, expands in all directions through the nondevelopmental but frequent repetition, within each "vision," of certain thematic, harmonic, and rhythmic cells. And a kind of cosmic cyclism is implied through the return in the final vision of the dissonant seventh chords heard throughout the first.

The Messiaens' version (on Vega 8509A) and this performance of the *Visions de l'Amen* by Peter Serkin and Yuji Takahashi are certainly the best available. Much of the character of the *Visions* depends on the constant changes in accentuation, dynamics, and tempo that are indicated quite precisely in the score but that call for much more than the literal interpretation that often dulls the generally soulless performance by John Ogdon and Brenda Lucas. What both Serkin—surely one of the most sensitive and technically capable pianists around, young or old—and Takahashi bring to this music is an apparently instinctive identification with the dynamic pulse hidden behind the notes and the frequent indications in the score. In an amazingly coordinated effort, they produce a kaleidoscopic flood of sonority whose impassioned intensity almost matches that of the Messiaen-Loriöd rendition while avoiding the latter's occasionally frenetic excesses.

The basic recorded sound far surpasses the other recordings: From the exceedingly resonant bass tones to the precisely defined and sharp highs, the piano sound has been perfectly conceived for the piece. But the extreme dynamic ranges of the *Visions* make it almost impossible to record without some distortion, and I am afraid this RCA disc has more than its share at moments (not to mention some wicked pre- and post-echo), especially on the second side. And I would have thought that the *Visions* could benefit from much more extreme stereo separation than is used here. From a spot right around dead center, the second-piano part, which tends to dominate to begin with, constantly overwhelms the first-piano part, which is pushed over to the left. I might add that the breaks between the bands are longer (about fifteen seconds) than any I've ever heard.

R.S.B.

MINKUS: *Don Quixote*: excerpts (arr. Lanchbery). Elizabethan Trust Melbourne Orchestra, John Lanchbery, cond. [Brian Culverhouse, prod.] ANGEL S 37008, \$5.98.

Rudolf Nureyev has devoted a lot of his energies to refurbishing the heritage of nineteenth-century ballet. He has especially concerned himself with works by the choreographer Marius Petipa (1819-1910): the *Corsaire* pas de deux, the Kingdom of Shades scene from *La Bayadère* Act IV, Act III of *Raymonda*, and the full-length *Sleeping Beauty* and *Don Quixote*.

The latter was first performed at the Bolshoi Theater, Moscow, in 1869 but does not survive in its original form. Petipa himself revised it for a St. Petersburg production two years later



Eleanor Steber and Richard Tucker—the Met's *Fiordiligi* and *Ferrando* in 1952.

and in 1900, when he was an old man, supervised a reworking of the choreography by Alexander Gorsky. This version was designed to bring the ballet closer in spirit to Cervantes. What that seems to have entailed is the introduction of a certain amount of realism in the *mise-en-scène*. Further efforts in this direction were made at the Bolshoi in 1940, when amendments in the choreography were undertaken by Goleizovsky and Zakharov.

Petipa's choreography was not the only constituent of *Don Quixote* to be continually changed during these years. At every stage the music of Ludwig Minkus (1827-1890) underwent patching, rearranging, and supplantation. Dispensing with early twentieth-century realism and acknowledging that the connection with Cervantes was purely nominal, Nureyev devised a production that went back to Petipa and preserved as much of his choreography as possible. For this purpose Nureyev commissioned John Lanchbery to rehabilitate what survived of the original music. Somewhat more than half of the result is represented on the present recording, taken from the soundtrack of the highly successful film made in 1973 by the Australian Ballet.

Lanchbery provided him with a very good basis for his production. Minkus' music is essentially melodic, and though the tunes are not very distinguished in themselves they are mostly wonderfully buoyant and therefore perfect for nineteenth-century classical dance forms. They also display a lot of rhythmic variety. But it cannot be said that what Lanchbery had done with them is particularly authentic. As heard here the orchestration is pure Hollywood, the sort of thing you'd expect to enjoy behind the titles of, say, *Yolanda and the Thief*, Richard Bonyng's performance of Kitri's solo from the Act III pas de deux in his "The Art of the Ballerina" (London CSA 2213) makes an interesting comparison, since it preserves what sounds like the original orchestration: lightly scored strings, a few woodwinds, and occasional triangle.

Lanchbery's version is something of a hodgepodge. Apart from unmistakable echoes of Delibes (*Coppélia*), Chabrier (*España*), and

Falla (*El Sombrero de tres picos*), the first number in the score—a very un-Minkus-like piece—also turns up in Lanchbery's music for the ballet film *The Tales of Beatrix Potter*. And though in the absence of authentic scores it is hard to be certain about this, the Dryad Queen's solo from Act II is probably by Riccardo Drigo (1846-1930). It is featured, at any rate, in the Drigo pas de deux interpolated in 1899 into Adolphe Adam's *Le Corsaire*.

None of the foregoing diminishes the interest of this new recording, which at the very least is valuable for its relationship to Nureyev. Lanchbery, moreover, is a superb ballet conductor. Only Robert Irving of the New York City Ballet has a finer rhythmic sense. Lanchbery's accelerando in Kitri's solo is masterly.

In any case, for the balletomane, inauthentic Minkus is better than none at all. Apart from Bonyng's *Don Quixote* pas de deux (which includes two sections omitted from Lanchbery's recording) and a pas de deux from *La Bayadère* in the same album, I know of only one other selection of this composer's music on disc: the pas de deux from *Paquita* on Bonyng's "Pas de Deux" (London CS 6418). Ludwig (or Léon, as he was known in Russia) Minkus, a Vienna-borr Pole who became staff ballet composer first in Moscow, then in St. Petersburg, has a genuine place in ballet history, especially through his collaboration with Petipa. What one hears in the theater today of his *Bayadère* and *Paquita* and his collaboration with Delibes on *La Source* makes one eager to hear more. My first suggestion would be a complete *Bayadère* from Bonyng.

D.S.H.

M **MOZART:** *Così fan tutte* (sung in English).

R Fiordiligi Eleanor Steber (s)
Dorabella Blanche Thebom (ms)
Despina Roberta Peters (s)
Ferrando Richard Tucker (t)
Guglielmo Frank Guarrera (b)
Don Alfonso Lorenzo Alvaró (bs)

Metropolitan Opera Chorus and Orchestra, Fritz Stiedry, cond. ODYSSEY Y3 32670, \$8.94

we're number one

well over 500,000 happy owners

have heeded the strongest recommendations of

- leading consumer testing organizations
- hi fi magazine reviewers
- consumer buying guides
- music critics
- perfectionist audio evaluating publications
- and enthusiastic friends

that the Dynaco A-25 is the extraordinary sound value in loudspeaker systems. "Best Buy" is heard over and over. The A-25 is surprisingly close to perfection, and it's well below \$100.

The key is naturalness. It can be delicate or incisive, mellow or brilliant, subtle or potent—whatever the music demands. That's why the critics have been so unanimous and enthusiastic in their praise. And why the A-25 is the most popular quality speaker system in the world!

The coupon will bring several of these complete reviews, plus full specifications. Most important, insist on hearing the A-25 at your Dynaco dealer. Don't be switched. You'll find Dynaco properly demonstrated by the dealers who care.

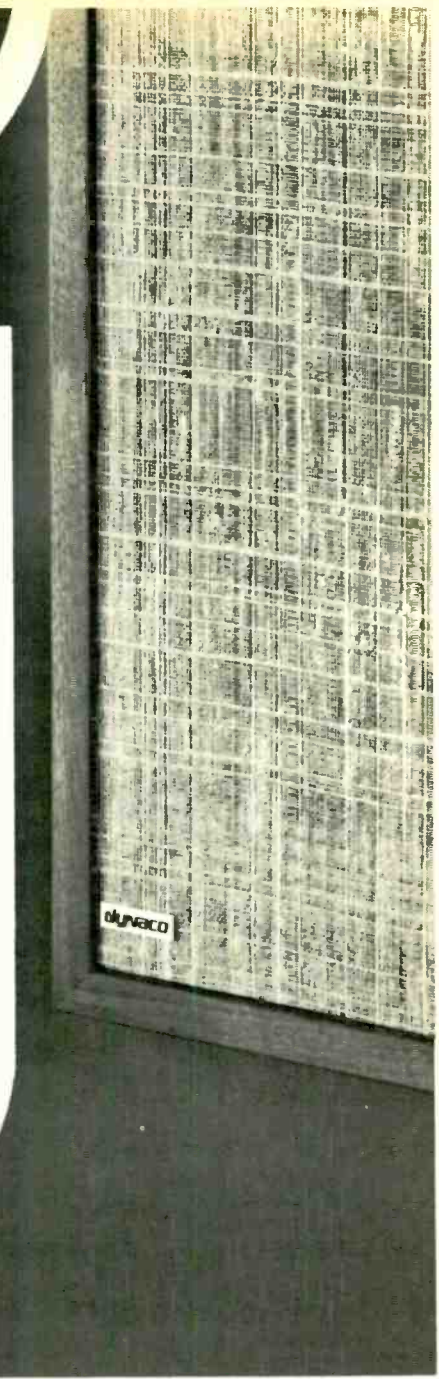

dynaco inc.

Division of Tyco Laboratories
3060 Jefferson St., Phila., Pa. 19121

Also available in Canada from
DYNACO OF CANADA, LTD.

Gentlemen: Please send your new full color Dynaco catalog of speakers and components.

Name _____

Address _____

City _____ State _____ Zip _____

HFS

CIRCLE 10 ON READER-SERVICE CARD

(three discs, mono) [from COLUMBIA SL 122, recorded June 1952].

B STRAUSS, J.: Die Fledermaus (sung in English).

R Rosalinda	Ljuba Welitsch (s)
Adele	Lily Pons (s)
Oriofsky	Martha Lipton (ms)
Eisenstein	Charles Kulmann (t)
Alfred	Richard Tucker (t)
Dr. Falke	John Brownlee (b)
Frank	Clifford Harvuot (b)
Dr. Blind	Paul Franke (t)

Metropolitan Opera Chorus and Orchestra, Eugene Ormandy, cond. ODYSSEY Y2 32666, \$5.96 (two discs, mono) [from COLUMBIA SL 108, recorded December 1950 and January 1951].

As far as the Metropolitan Opera is concerned, opera in translation now seems to be a moribund issue (or perhaps I should say "opera in English translation," for we still have *Don Carlo* instead of *Don Carlos* and newly have *I Vespri siciliani* instead of *Les Vêpres siciliennes*). Last season, Tchaikovsky's *Queen of Spades* reverted to Russian (the first time a complete performance had ever been sung at the Met in that language), while the Martin translation of *Così*, heard on the 1952 recording, gave way to Da Ponte's original even earlier.

Now a case can certainly be made that our leading international opera house should perform operas in their original languages. At least when it is functioning as an international house, that is: on occasion, one can hear predominantly or exclusively American casts struggling painfully with the original dialogue of Mozart's *Zauberflöte*, pleasing neither German speakers nor non-German-speakers. But the reverse is plainly audible when Pons and Welitsch have a go at *Fledermaus*.

Whatever the pros and cons with respect to the Met, however, there is surely a place for opera in translation at some levels of our musical society (it does seem to me, for example, that the New York City Opera, a predominantly native company, should be offering far more in the way of vernacular alternatives to its next-door neighbor's original-language productions). And even on records, a case can be made, but a lot depends on the specific translation. *Odyssey's* reissue program has now turned up two representative examples from the early years of the Bing regime, and they point up some of the tasks and travails of the operatic translator.

Howard Dietz's lyrics for *Fledermaus*, along with Garson Kanin's dialogue (the latter not included in the recording), represent what must be called the "Broadway musical" approach. On a certain level of craftsmanship, they are well made, full of zippy internal rhymes and sharply (if sometimes wrongly) rhymed words, fair gags, and some (obviously intentional) hoary old chestnuts. But they create significant problems.

For one thing, they are too "busy"—all the cleverness (and also the habit of fitting fresh verses to what in the German are merely repetitions) puts too much of a verbal load on the music. The original lyrics of Haffner and Genée are not dense in this way; graceful and sentimental, they are an excuse for Johann Strauss. (Basically, the Viennese operetta is a framework for dance music to insinuate itself into a variety of lightly conceived theatrical situations and, at its best, to make these situations seem entertaining and beautiful.) In the Met version, Strauss's music is turned into an



Ljuba Welitsch as Rosalinda
Awash in a sea of accents.

excuse for Dietz's lyrics to show off; they call attention to themselves rather than to the music. (The American musical comedy places a greater emphasis on verbal wit, and in any case the close collaboration—often, identity—of composer and lyricist guarantees a fair balance of the two elements.)

Beyond this, there is a failure of tone, of style. Strauss's music is genuinely and un-faillingly elegant. The original text, if rarely elegant, is certainly never vulgar. Dietz is sometimes vulgar and often corny. In the *Czardas*, Rosalinde's bogus Hungarian countess expresses her pseudo-homesickness in abstract, artistic terms: the landscape, the music. Dietz transmutes this into clichés of *Saturday Evening Post* down-on-the-farm nostalgia: "The mean hills/That you used to try to climb—/The stream where you can wade again—/The orchard you can raid again," and the countess' bare feet are showing in Oriofsky's ballroom, a social as well as a theatrical gaffe. (In performance, all this becomes even more muddled, for Welitsch sings as if the English words meant the same as the original German!) In all of this, Vienna has been lost altogether; the nature of the sentiment that animates the original, especially in the second-act "*Brüderlein*" ensemble, has been fatally altered.

One could cite many other specific instances where Dietz has spoiled the phrasing of musical lines or imposed a leer on the original thought. But these two failings are really fundamental: verbal density and style can be quite as basic considerations as literal meaning and "singability," although they are less frequently discussed. Only when we have translations sensitive to these dimensions can opera in English translation stand on its own feet.

The Metropolitan performance is hard to judge independently of the adaptation; often, the better the singing and diction, the harder it is to take the totality. In fact, except for Pons and Welitsch, everyone is pretty comprehensible. Brownlee's British pronunciations stick

out, and Welitsch sounds as if she's been accepting coaching from both sides of the Atlantic—"caant" for "cant," but "ahnt" for "aunt." Lipton and Tucker do the most distinguished singing; Welitsch sounds well too, but her extravagance, her tendency to rush the beat, her diction, and Dietz's words all add up to a fairly grotesque caricature. As for Pons, were I to have a singing French maid about the house, she would have to phrase better than this, and the accent is quite extraordinarily opaque. Much as one admires Kulmann's musicianship, his nasal tone does not figure a plausible Eisenstein.

One out-and-out musical horror is perpetrated in the "Champagne" ensemble, with each verse bodily lifted a semitone above the previous one. The ballet music is omitted in favor of *Rosen aus dem Süden*, played with a noisy brio more suitable for *The Stars and Stripes Forever*, although the orchestra is otherwise fairly ruly, the choice of tempos usually reasonable. The enclosed libretto gives all the omitted dialogue but fails to indicate several "standard" cuts made in the musical numbers.

The Martin translation of *Così* aims, happily, at something other than a Broadway level of wit. Like Dietz, the Martins tend to replace Mozart's repetitions of Da Ponte's original words with fresh "translations," thereby making extra demands on the listener's attention. The tone is not bad; in "*Non siate ritrosi*," when Guglielmo affirms, "We're strong and athletic, Romantic, poetic," the choice of the second adjective belies the appropriateness of the fourth, and there are other infelicities sprinkled about. But it sings well, and everyone in this cast has come to terms with it except Alvary—and even he is perfectly clear in the recitatives; in sustained singing, his vowels are untrustworthy.

All in all, I rather enjoyed coming back to this performance (which is, I believe, the only major Mozart opera ever recorded in America), not least for the really beautiful singing of Tucker—accurate, spirited, warmly phrased, and elegantly "spoken." Steber is also a pleasure for her strong musical impulses (especially in terms of rhythmic address), vocal freedom, and generosity of feeling. Her ensemble with Thebom is exceptional, but the latter's good qualities are undermined by unreliable intonation. Guarrera and Alvary are vocally sound, although the latter, probably for linguistic reasons, fails to project much of Alfonso's irony. He and Peters—a lively Despina—are the only non-original-cast singers here, replacing Brownlee and Patrice Munsel; they both became standard alternates during the four-season run of the original revival.

Stiedry is something less than the most spirited Mozartean to be heard on records, and his orchestra is evidently not yet fully at home in the score. Still, he surely deserves credit for the general consistency of style here, an essential part of the production's success. As in the house, Nos. 7 (the Duetto "*Al fato dan legge*"), 24 (Ferrando's "*Ah, lo veggio*"), 27 (Ferrando's "*Tradito, schernito*"), and 28 (Dorabella's "*E amore un laurancello*") are omitted entirely, and there are several other substantive cuts (a wrenching one in "*Fra gli amplessi*") as well as the usual nibblings at the recitatives. None of this is indicated in the libretto, which also varies in minor details from what is sung.

On my copy, a finished pressing, Sides 5 and 6 were reversed; although the matrix numbers are in correct order, the music is not. D.H.

B **MOZART:** Quartets for Strings, Nos. 14–19. Hungarian Quartet. Vox SVBX 589, \$9.95. (three discs).

Quartets: No. 14, in G, K. 387; No. 15, in D minor, K. 421; No. 16, in E flat, K. 428; No. 17, in B flat, K. 458 (*The Hunt*); No. 18, in A, K. 464; No. 19, in C, K. 465 (*Dissolant*).

Between December 1782 and January 1785 Mozart composed these six works, dedicating them to his old and respected friend Josef Haydn. There is little doubt that Haydn recognized their worth, for he cheered up papa Leopold Mozart (who was always prepared to think that Wolfgang was sure to come to a bad end) by hailing Mozart *filis* as "the greatest composer known to me." He could hardly have been more generous. His traditional title, father of the string quartet, was justified, and yet none of the Haydn quartets surpass these for craftsmanship, content, or the sheer beauty of their sustained invention. Superlatives are never entirely trustworthy, but this is probably the greatest chamber music of the eighteenth century.

The present set is one of those rare events, a genuine gilt-edge bargain. The Hungarian Quartet has this music fully assimilated and projects it with all the zest and rhythm and melodic grace the composer requires. These are recordings with the finish and felicity, the consistency of insight, that come from many performances and true mastery of the material.

The recorded sound grows on you. It may seem a little harsh at first, but after a time its sense of immediacy, the presence that is projected by the firm bite of bow on string, becomes a further source of satisfaction.

But the real pleasure is the price. There are no better performances currently in print, and this album gives you the entire series for less than the price of two of the rival discs. There is thus no excuse for anyone lacking this music or missing the many satisfactions it can provide year after year. R.C.M.

R **MOZART:** Symphonies: No. 39, in E flat, K. 543; No. 40, in G minor, K. 550. London Symphony Orchestra, Colin Davis, cond. PHILIPS 6500 559, \$6.98 [from 900 036, 1963].

H **MOZART:** Symphony No. 39, in E flat, K. 543; Three German Dances. **SCHUBERT:** Rosamunde (incidental music), D. 797; Die Zauberharfe Overture, D. 644; Andante.

HANDEL: Alcina: Suite. Berlin State Opera Orchestra (in Mozart K. 543), Berlin Philharmonic Orchestra (in the remaining works), Erich Kleiber, cond. Rococo 2048, \$6.95 [recorded in the 1920s and 1930s] (Rococo Records, P.O. Box 175, Station K, Toronto 12, Ont., Canada).

Davis first recorded the Mozart No. 39 with the London Sinfonia in a performance still available in this country on Victrola VICS 1378, coupled with No. 29. This current disc is a European-pressed reissue of a later domestically pressed Philips record of the mid-Sixties.

The disc immediately regains its place in the upper reaches of the lists for both symphonies.

The interpretations balance lyricism and intensity admirably, as well as the sometimes contradictory demands of personality and idiomatic fidelity to Mozart style. The Victrola No. 39 is still a most worthy version, especially considering its budget price, but the Philips performance surpasses it in quality of playing, naturalness of recorded sound, and comprehensiveness of repeats (the Victrola doesn't take the first-movement repeat). Davis is generally generous about repeats on the Philips disc, although in No. 40 he doesn't match Britten (London CS 6598), who takes every blessed one.

The Kleiber No. 39 is a historical document. These performances were recorded in the late 1920s or early 1930s before Kleiber emigrated (for political rather than racial reasons). The recording, considering that these 78s were made in the early years of the electrical era, is satisfyingly natural and lifelike, and the Rococo transfers have been handled smoothly. As it happened, Kleiber redid K. 543 after the war, on an Amadeo record that also included a (different) clutch of *German Dances* and that used to be available in this country. The (mono) sound was better, of course, but the orchestra—the Cologne Radio Symphony—wasn't as good as the Berlin State Opera ensemble was when Kleiber directed the company. And the Rococo disc has a documentary value that the Amadeo version couldn't touch—as an instance of one of the great Mozarteans of our century in his glory days as a luminary of Weimar Republic culture in Berlin.

The performances of all the works here re-

The Black Composers Series: A Historic First.

Of all the hundreds of thousands of discs issued to date, there have been just a small handful devoted to black composers.

The Black Composers Series fills this gap in our musical heritage, presenting the first anthology of symphonic music written by blacks. The whole series has been recorded under the supervision of the brilliant young black conductor Paul Freeman, with the great symphony orchestras of London and Detroit.

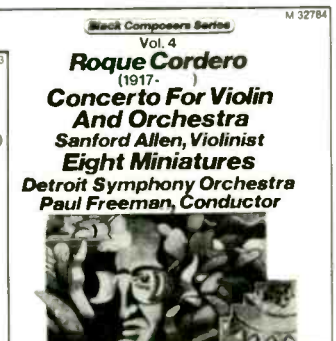
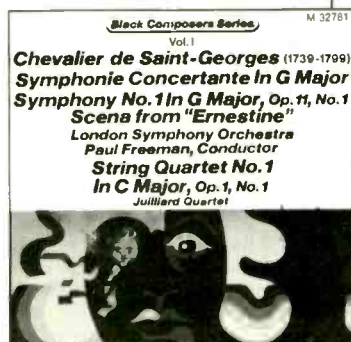

The Black Composers Series.
An important undertaking.
On Columbia Records

veal Kleiber's characteristically balanced, sane musicianship, expressive yet never melodramatic. The use of a harpsichord for the continuo in the Handel suggests that he was ahead of his time in musicological matters.

J.R.

MOZART: Die Zauberflöte.

Sarastro	Kurt Moll (bs)
Tamino	Peter Schreier (t)
Queen of the Night	Edda Moser (s)
Pamina	Anneliese Rothenberger (s)
Papageno	Walter Berry (b)
Papagena	Olivera Miljakovic (s)
The Speaker	Theo Adam (bs-b)
First Lady	Leonore Kirschstein (s)
Second Lady	Ilse Gramatzki (ms)
Third Lady	Brigitte Fassbaender (ms)
Monostatos	Wili Brokmeier (t)
Priests: Armed Men	Wilfried Badorek (t)
	Gunter Wewel (bs)
First Boy	Walter Gampert (s)
Second Boy	Peter Hinterreiter (ms)
Third Boy	Andreas Stein (a)

Bavarian State Opera Chorus and Orchestra, Wolfgang Sawallisch, cond. [Helmut Storzjohann, prod.] ANGEL SCL 3807, \$17.98 (three discs).

Comparisons:

Klemperer/Philharmonic	Ang. SCL 3651
Bohm/Berlin Philharmonic	DG 2709 017
Solti/Vienna Philharmonic	Lon. OSA 1397

In Germany, this is the first and only *Magic Flute* in quadraphonic sound. Over here, in two-channel stereo only, it must stand on its merits simply as a performance. Nevertheless, the question of sonics looms large for us too.

Whether or not the process of converting four channels to two has affected balances, textures, and dynamics is hard to tell, yet what we have here is frequently unbalanced, thick in sound, and uncomfortably recorded. Throughout the orchestra sounds far too resonant; inner voices are hard to make out; murkiness impedes the music's progress. Sometimes a singer is obliterated, as Pamina is by Tamino and the two Armed Men in the pages that immediately precede the trials. The flute solo with which Tamino is presumed to accompany his singing of "*Wie stark ist nicht dein Zauberton*" is much closer to us than the singer is: one hears the flautist's every breath. Monostatos' aria, marked *sempre pianissimo*, is far too loudly recorded. It should be like something overheard.

Part of the trouble, especially where balances are concerned, may stem from Sawallisch's conducting. He seems intent upon a no-nonsense approach. His manner is heavy. From the overture onward he presses forward in a fast, even headlong, manner that allows little room for nuance, light and shade, or any of the details that in musical performance bring the dramatic situations to life. He makes hardly anything, for example, of the various changes of mood in the music for the Three Ladies that opens the opera, failing to allow room for the humor of their rivalry over Tamino.

In general Sawallisch sacrifices variety of pace to a scarcely modified briskness. The first-act quintet is a case in point. He diminishes the mysterious beauty that invades the music at the mention of the Three Boys by playing down the change in tempo from allegro to andante and by failing to observe the *sotto voce* marking. There are similar problems in the second-act quintet, which like so much of the music in this recording goes at a fearsome clip. In some places Sawallisch's manner pays dividends, a good example of this being the scene of Papageno's attempted suicide, which,



Wolfgang Sawallisch—keeping *Die Zauberflöte* moving.

often dawdled over and therefore sentimentalized, is here refreshingly vigorous. But on the whole this is a singularly unmagical *Flute*.

Sawallisch's cast, the sort you would likely encounter during the annual Munich Festival, is good. Anneliese Rothenberger is a touching Pamina, sensitive and technically well schooled, though her rather soubretish voice is becoming unpliant. Edda Moser is a very effective Queen of the Night—cool, unflustered, equal to all Mozart's demands. Her instrumental timbre restricts her expressiveness in the *maestoso* section of her first aria, but in the staccatos of her second aria she creates an astonishing effect by matching the woodwinds in exactness of rhythm and intonation.

Though Peter Schreier has a rather dry and throaty voice, his musicianship—his care for phrasing, shading, rhythmic inflection, and the enunciation of the text—results in a performance I find very satisfying. Walter Berry is much less vocally assured than he used to be ("*Bei Männern*" is not at all easy for him now), but he is an accomplished singing actor all the same and the personality he projects is very sunny and direct.

Kurt Moll has a beautiful voice and can negotiate Sarastro's music without effort. The precipitous downward intervals of a tenth hold no terrors for him. What he lacks, however, is eloquence—a noble sense of line and an awareness of the interdependence of text and melody. Apart from a squally First Lady, the other singers are entirely adequate.

In many ways this is the best cast on records. Rothenberger, Moser, and Moll, while not perfect, nevertheless outclass their rivals. Schreier, though not as beautiful to listen to as Wunderlich on DG, is a finer musician. Berry is bettered only by his own earlier performance on Angel.

Moreover, all the other sets have serious drawbacks in casting. London has in Lorengar an intolerably flutery Pamina, in Hermann Prey a Papageno of disconcerting sophistication, in Cristina Deutekom a Queen of the Night who, once she gets up among the ledger lines, always seems on the point of yodeling, in Martti Talvela a Sarastro who for all his vocal magnificence doesn't sing in tune and can't manage legato. The earlier Angel has in Gottlob Frick a woefully insufficient Sarastro, in Gundula Janowitz a wan, fluty Pamina, in Elisabeth Schwarzkopf a maddeningly arch First Lady. It also has no dialogue. DG has in Fischer-Dieskau an unsympathetically disingenuous Papageno, in Roberta Peters a

Queen of the Night who sounds like Kathryn Grayson, and in Evelyn Lear a Pamina who, though intelligent, reveals a debilitating lack of ease at the top of the voice.

But in the last resort these are not crucial considerations. *Zauberflöte* is one of those operas for which the conductor is the chief determinant of success. For me Solti (London) never finds a convincing flow for this music. He stops and then starts again; some numbers sound right, others questionable; nothing coheres into a comprehensible musical statement. In this respect his version compares unfavorably with Böhm's DG performance. Some of his tempos plod—e.g., the *Bildnisarie*, the Queen of the Night's first aria, the opening of the first-act finale, the second quintet. Yet a single conception shapes the entire performance. Everything is bathed in geniality, elegance, and grace. Böhm shows a loving regard for nuance. His characters have room to express their individuality. The first quintet is as ravishingly presented as anything I know on records.

Otto Klemperer is even better. A successful Klemperer performance—his *Fidelio*, *Figaro*, *Zauberflöte*—makes you realize that there are times when slowness means not lack of speed, but rightness of tempo. When Klemperer is on form no one can hold the listener with greater conviction. He makes everything sound inevitable. In his *Zauberflöte*, his attention to the details of phrasing and of dynamics produces a feeling of intimacy and solicitude. This is a very warm view of the opera. It is at the same time a majestic one. While according Papageno and Papagena (and the Third Lady too) their proper due, he is able to incorporate them without trouble into Mozart's sublime vision. In Klemperer's hands the awesome solemnity of Sarastro's realm partakes of the human as much as of the divine. Despite the lack of dialogue, this is a performance I would not wish to be without.

Sawallisch's recording, like Böhm's and Solti's, contains a sensibly abridged quantity of dialogue. It omits appoggiaturas, as do the others except Solti's. A short duet of doubtful authenticity (it is included in the Peters vocal score) has been inserted into the second act between the priests' duet and the quintet: the unfamiliar music is of moderate interest. After Angel's recent improvement, these pressings are a great disappointment. There is also some pre-echo throughout and a startling amount of echo at the very end, where the chorus resounds unnervingly across the vault of heaven.

Libretto/translation in a booklet that devotes a lot of space to the advantages of quadraphonic sound!
D.S.H.

MYSLIVEČEK: Abramo ed Isacco. Gianfranca Ostini and Jana Jonášová, sopranos; Anna Viganoni, alto; Choichiro Tahara, tenor; Gianni Maffeo, baritone; Czech Philharmonic Chorus; Prague Chamber Orchestra, Peter Maag, cond. SUPRAPHON 1 12 1021/2, \$13.96 (two discs).

Josef Mysliveček (1737-81), a native of Prague, was a famous and successful composer of Italian operas and a good deal of other music. Italy, where he was known as "il divino Boemo" (they could not pronounce his name anyway), was at his feet, and invitations came from all the musical capitals of Europe. The young Mozart esteemed him and recommended to his sister that she learn Mysliveček's sonatas by heart. Reporting home, Mozart also said that "all Munich talks about his oratorio *Abramo ed Isacco*."

Are we again rediscovering an unjustly forgotten master? I am afraid not. Even so, at times it is devilishly difficult to distinguish him from the great Italo-Germans, and such numbers as Isaac's fine aria "*Madre, Amico*," could easily pass as early Mozart. (As a matter of fact, when this oratorio was discovered in 1928, it was so taken.)

The Neapolitan tone and style are pervasive in *Abramo ed Isacco*, but stylistically the work is somewhat schizophrenic. Mysliveček holds fast to the old baroque scheme, complete with castrato and da capo aria (the work is indistinguishable from an *opera seria*), but the idiom itself is preclassical, like that of Christian Bach and the young Mozart. His vocal writing, his sense for a truly Italianate setting remind one of Hasse; indeed, everything is here except one important thing—genius.

Thus while this is a most interesting and valuable recording for study purposes, one that will be welcome in classrooms (we know so little about the history of earlier opera), it is not something that we would often put on the turntable for sheer enjoyment. Yes, there are several very fine arias and two attractive, if brief, choruses, but in order to reach them we must submit to endless and rather perfunctory secco recitatives.

The performance is handicapped by poor recording technique. The sound is either too open or too evanescent. I am sure that the two sopranos, Gianfranca Ostini and Jana Jonášová, are better singers than they sound here; in the high register their voices are shrill—so are the violins. But Anna Viganoni is hooty in the fortes, and tenor Tahara's colorless voice is in constant peril above the staff. The only voice that comes across warmly and authoritatively is Gianni Maffeo's baritone (he was heard recently as the Schaunard of Karajan's *Bohème*).

The orchestra is a bit nondescript, the victim of too much monitoring; the chorus is good. Except for Maffeo, there is little temperament exhibited in the performance, and that includes Peter Maag, a conductor who has often distinguished himself in numerous recordings. Well, perhaps it is the uncertainty of dealing with music that has all the earmarks, technique, and symbols of a great and familiar style but has not the comforting and convincing expression of a positive personality.
P.H.L.

PENDERECKI: *Utrenja*. Delfina Ambroziak and Stefania Woytowicz, sopranos; Krystyna Szczepanska, mezzo; Kazimierz Pustelak, tenor; Włodzimierz Denysenko and Bernard Ladysz, baritones; Boris Carmeli and Peter Lagger, basses; Pioneer Choir; Warsaw National Philharmonic Chorus and Symphony Orchestra, Andrzej Markowski, cond. PHILIPS 6700 065, \$13.96 (two discs).

Comparison—Part I only:
Ormandy/Philadelphia Orch. RCA LSC 3180

Krzysztof Penderecki's *Utrenja* is the sequel to his *St. Luke Passion* and brings to a close the composer's monumental work (total duration: c. three hours) dealing with the last days of Christ on earth. *Utrenja* is itself divided into two sections, each of which constitutes an independent unit comparable to the Passion: *The Entombment of Christ*, which is related to the Easter Saturday service and deals with the descent from the cross and the burial of Christ; and *The Resurrection of Christ*, related to the Easter Sunday service dealing with His ascent into heaven. (I say "related," because the works do not adhere strictly to the liturgical text, nor are they intended for performance as part of a service.) Part I of *Utrenja* was completed in 1969 and has been performed several times as a separate work and recorded by the Philadelphia Orchestra under Eugene Ormandy. Part II was not completed until 1971, and this new two-record set marks its first recorded appearance, here presented as part of the complete *Utrenja*. (The *St. Luke Passion* is available in two recordings, Victrola VICS 6015 and Philips 802 771/2.)

The most immediately discernible characteristic of *The Resurrection* which distinguishes it from its predecessors is the greater reliance on percussive elements, which play a dominant role throughout much of the work. This is by no means confined to the percussion section proper, but affects the chorus as well, which is limited to nonpitched sounds—speaking, hissing, shouting, etc.—during extended sections.

Interestingly, however, there is also much more purely triadic writing than before. In the *Passion*, the triad was used exclusively for purposes of cadential punctuation, being limited to occasional, isolated appearances that seemed largely arbitrary in effect and that, to my mind, constituted one of the weakest aspects of that work. But in *The Entombment*, the chorus is occasionally heard performing fragments of triadically chordal music which emerge from their surroundings and form a sort of separate layer of the piece; and in *The Resurrection*, these have been further developed to become one of the work's most important components. Indeed, the sharp contrast afforded by playing off these triadic sections against the percussive sections is characteristic throughout. The role of the soloists, already diminished in *The Entombment* as compared with the *Passion*, is here further reduced; even when the soloists are heard, they are virtually always singing in ensemble with one another, rather than alone.

There is no question that *Utrenja* is a deeply felt work, and it is one that has considerable immediate impact. This impact, however, depends to a large degree upon purely dramatic associations, rather than innately musical ones; and although Penderecki's achievement in holding together, on any terms, a work of this scope and ambition should not be minimized, I do find that its effects begin to diminish as one becomes more familiar with the



Baker Sings Schubert

"She has a voice for all seasons of the heart... devastating in its sheer beauty of sound and purity."
—Newsweek

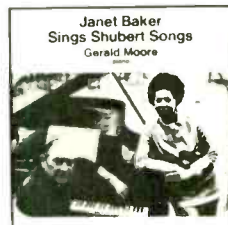

SIB-6083 (27 songs—on 2 LPs)

MAHLER

The Youth's Magic Horn S-36380
Kindertotenlieder;
Songs of a Wayfarer S-36465
The Five Rückert Songs
(with Elgar: Sea Pictures) S-36796

BERLIOZ

Les Nuits d'été
(with Ravel: Shéhérazade) S-36505
The Trojans—Final Scenes;
The Death of Cleopatra S-36695
The Damnation of Faust SCL-3758

DELIUS

Songs of Sunset, Cynara,
An Arabesque S-36603

ELGAR

The Dream of Gerontius SB-3660
Sea Pictures (with Mahler:
Rückert Songs) S-36796

Duets & Songs

An Evening of Duets by Purcell,
Schumann, Mendelssohn, others
(with Fischer-Dieskau) S-36712
A Treasury of English Songs
by Britten, Vaughan Williams,
Dowland, others S-36456

Janet Baker
In the Angel tradition of recording
the great artists of our time.



CIRCLE 2 ON READER-SERVICE CARD

score. There is only so much one can do with the kind of massive, undifferentiated cluster textures that are so prevalent in the work, and the reliance on older musical styles (i.e., the triadic sections), while effective as a dramatic foil and beautifully handled by the composer, is hardly a basic solution to the compositional problem Penderecki has set himself.

The performance under Andrzej Markowski is very good. Part I is more transparent than in the Philadelphia version (this kind of music is not Ormandy's forte), and the whole work holds together surprisingly well. Soloists (who do not remain completely the same for the two parts), chorus, and orchestra all seem equally at home with the music. A handsome four-language booklet containing the complete text is included. R.P.M.



PERI: Euridice.

La Tragedia; Venere: Proserpina

Euridice	Adele Bonay (ms)
Orfeo	Nerina Santini (s)
Arcetro	Rodolfo Farolfi (t)
Tirsi; Aminta	Gastone Sarti (b)
Dafne	Franco Ghitti (t)
Ninta	Elena Barcis (s)
Pastor	Karla Schlean (s)
Plutone	Adolfo Filistad (t)
Caronte	Federico Davia (bs)
	Giuseppe Donadoni (bs)

Milan Polyphonic Chorus; I Solisti di Milano, Angelo Ephrikian, cond. TELEFUNKEN SAWT 9603/4, \$11.96 (two discs) [from MUSICAL HERITAGE OR 344/5, recorded in the early 1960s].

Historians still squabble about the primacy of the first opera. Was it Peri's *Euridice* or Caccini's setting of the same story? Or perhaps

Marco da Gagliano or Emilio de' Cavalieri might qualify for a prior claim. Everyone agrees however that it was Monteverdi's *Orfeo* in 1607 that really set the new form on its feet. Although many elements in the early opera developed out of the pastoral play, mythology was its first topic, and what myth could be more suitable for a musical drama than the story of Orpheus the singer and his search for his lost bride?

Rinuccini's libretto for Peri is neither as complex nor as strong as Striggio's *Orfeo* for Monteverdi, but it is competently drawn within the outlines of the pastoral format. The story is somewhat condensed. After a prologue sung by Tragedy, we join the nymphs and shepherds celebrating the marriage of Orfeo and Euridice. The principals appear separately and then a nymph, Dafne, comes to Orfeo with the tragic news of his wife's sudden death. At his request Venus escorts Orfeo to the underworld where he pleads with Pluto and Proserpina for his bride's return. His wish is granted, the spirits bid him adieu, and the couple return in the last scene to the general rejoicing of the assembled nymphs and shepherds. This arrangement gives Orfeo only one real scene in the underworld, while in Monteverdi's work the hero must first sing Charon asleep, then convince Pluto of his case, and finally suffer and be rescued from a second loss when he disobeys the command and looks back at the following Euridice. The emphasis in Peri's opera lies more heavily on pastoral scenes and leaves much of the drama to be narrated second-hand by Arcetro, a companion of Orfeo.

Musically too Peri's *Euridice* lacks the splendid set numbers that are so exciting in

Orfeo, although the hero's address to the spirits "Fineste piagge" and his radiant apostrophe to his bride are moving and memorable. The vocal setting may be described as recitative, but Peri's characters do not sing the dry patter of the eighteenth century but a beautifully fluid melodic line sensitive to the spirit of the character and the demands of the poetry. There are plenty of opportunities for dance and spectacle—the first and last scenes, the chorus of spirits, Orfeo's departure with Venus, no doubt in an elaborate stage machine, and his return. All this surely delighted the Florentines in 1600 as much as it did when *Euridice* was revived there in 1961.

This recording of the opera, however, is very curious. The singing by a largely unknown cast varies from assured to very shaky; the realization of the accompaniment with its strange additional countermelodies is anachronistic. Even more striking is the wildly uneven quality of the sound. Levels that jump inexplicably from soft to loud and hokey stereo that makes the characters leap unaccountably from stage left to right in the midst of their speeches make listening uncomfortable. Telefunken, whose Das alte Werk series is usually meticulously documented, supplies suspiciously little information about the production. A little research reveals that this recording is at least a decade old. First released in 1962 or '63 by Amadeo in Italy, this version of *Euridice* was picked up by the Musical Heritage Society around 1967 and is still in their catalogue. Except for the general subordination of the accompaniment on the Telefunken label, which permits Peri's vocal line to stand out in relief as it should, the MHS package, which includes an English translation with the libretto and far better notes, is a much better buy at \$3.50 a disc.

So much has happened in the last ten years to enrich the repertoire of early opera on disc. Three Monteverdi operas and two by Cavalli are now available, and more may be on the way—the New York Pro Musica's popular production of Gagliano's *Dafne*, for instance. Peri's *Euridice* is not just a curiosity but a work of beauty and imagination. It deserves a new recording; alas this is not it. S.T.S.

selecting a hi fi speaker

Confused by the rapidly growing
number of loudspeaker brands?

Before you invest, write for
our FREE Booklet to
help you make a
valid listening
judgment.

**BOZAK,
INC.**
P.O. BOX 1166
DARIEN, CONN.
06820 (DEP'T. "H")

Gentlemen:
Send a copy of your new FREE Booklet,
"Evaluating a Loudspeaker System."

NAME _____

ADDRESS _____

CITY _____ STATE _____ ZIP _____



Bozak

INC.

Our 25th Year of
Loudspeaker Design
and Manufacture

PROKOFIEV: Concertos for Piano and Orchestra: No. 2, in G minor, Op. 16; No. 3, in C, Op. 26. Jorge Bolet, piano; Nürnberg Symphony Orchestra, Ainslee Cox, cond. GENESIS GS 1021, \$5.98.

PROKOFIEV: Concertos for Piano and Orchestra: No. 2, in G minor, Op. 16; No. 3, in C, Op. 26. Gabriel Tacchino, piano; Luxemburg Racio Orchestra, Louis de Froment, cond. CANDIDE CE 31075, \$3.98.

Comparison—No. 2:
Henriot, Munch/Boston Sym. Victrol. VICS 1071
Comparisons—No. 3:
Graffman, Szell/Cleveland Orch. Co. MS 6925
Katchen, Ansermet/Suisse Romande Ev. 3297

These concertos prove good disc mates. No. 2 is as massive and knotty as No. 3 is frail and transparent. The former's brusque anger is an apt foil for the latter's wistful bitterness. Though both were written during Prokofiev's pre-Parisian years, No. 3 has something of the cafe-society urbanity to contrast with the almost bleakly rural landscape of No. 2. I regard the pair as the Russian master's most substantial contribution to the literature for piano and orchestra.

The *Candide* disc has in its favor a lower price tag, quieter surfaces (*Genesis*' are afflicted by heavy rumble), and a relatively superior orchestra. Though the Luxemburgers boast no world-rank virtuosity, their playing—effortful and tonally arid though it be—is several minor-league pennants ahead of the grossly understaffed, off-tune, barely together German ensemble. The brief pair of middle movements in No. 2 is all the sampling you will need to hear what I mean. Whatever Mastersingers remain in Nürnberg have obviously not taken up instruments!

Score the following points for *Genesis*, however: a recording of greater depth, color, and instrumental definition, and a soloist/conductor team more involved in the spirit of the music and more willing—despite the ragged forces backing them up—to take risks to convey that spirit. I have no objection to anything that Tacchino and Froment do with the scores: they just are a neutral force, collaborating in a smooth, straightforward, and pleasant pair of readings of no great spark or profile. Bolet, on the other hand, has a special identification with at least part of this repertory: He gave the disc premiere of the *Second Concerto* in 1953 on Remington. Fortunately, he has lost none of the sweep and power he brought then, and his technique remains commanding enough to project the blunt savagery of his current, basically similar conception. Cox (who was Stokowski's associate with the *American Symphony*) is *au courant* with the idiom, and he and Bolet also work together flexibly in the Third. Their interpretation has solid authority and a modicum of feline grace, provided you can make allowances for the orchestral execution.

Despite the attractiveness of the coupling, there are better recordings of both concertos. Of the two other *Seconds* remaining in the catalogue (both, it happens, from the *Boston Symphony*), I prefer the more mercurial and exotically colored one of Henriot-Schweitzer and Munch. Among the legions of recorded Thirds, the patrician rectitude, crispness, and polished ferocity of Graffman and Szell are in an easily commanding position. My personal favorite is the late Julius Katchen's first recording (with Ansermet's magically shaded accompaniment): this London mono classic has been reissued in "electronic stereo" by Everest. A.C.

PROKOFIEV: *Romeo and Juliet*, Op. 64: excerpts. Rotterdam Philharmonic Orchestra, Edo de Waart, cond. PHILIPS 6500 640, \$6.98.

Edo de Waart, one of the winners of the Dimitri Mitropoulos conducting competition in 1964, is developing into one of the more interesting young conductors around. Having heard him conduct Wagner and Mozart opera in Santa Fe and the Chicago Symphony Orchestra at Ravinia, I have looked forward to his recordings, which now include music by Rachmaninoff, Gershwin, and Haydn (in addition to his work with the Netherlands Wind Ensemble). This is his first recording with the Rotterdam Philharmonic, of which he has been principal conductor since 1967.

Despite the fact that his orchestra is not the equal of the London Symphony or the Cleveland Orchestra, his account of these excerpts from Prokofiev's great ballet compares well with the interpretations of André Previn and Lorin Maazel, whose recordings of the com-

plete *Romeo and Juliet* (Angel SCL 3802 and London CSA 2312 respectively) I reviewed in December 1973. He has a fine feeling for the Prokofiev style and a strong sense of rhythm.

For those interested in just a third of the score, this record is an excellent choice. It includes four of seven selections from the first suite, extracted by the composer from the complete score, and all of the second suite. Prokofiev arranged the suites without regard for the narrative sequence of the ballet: De Waart, however, presents his excerpts in an order that roughly follows the original. Thus he offers in effect a capsule version, but I suspect that anyone who really appreciates this extraordinary music will want one or the other of the superb complete versions. P.H.

RACHMANINOFF: Concertos for Piano and Orchestra (4); Rhapsody on a Theme of Paganini, Op. 43. Agustin Anievas, piano; New Philharmonia Orchestra, Rafael Frühbeck de Burgos (in Opp. 1 and 40), Moshe Atzmon (in Opp. 18 and 43), and Aldo Ceccato (in Cp. 30), cond. [Suvi Raj Grubb, prod.] ANGEL SCB 3801, \$11.98 (three discs) [Opp. 18 and 43: from SERAPHIM S 60091, 1969].

Concertos: No. 1, in F sharp minor, Op. 1; No. 2, in C minor, Op. 18; No. 3, in D minor, Op. 30; No. 4, in G minor, Op. 40.

RACHMANINOFF: Concerto for Piano and Orchestra, No. 3, in D minor, Op. 30. Rafael Orozco, piano; Royal Philharmonic Orchestra, Edo de Waart, cond. PHILIPS 6500 540, \$6.98.

Comparison—Concerto No. 1: Rachmaninoff, Ormandy/Philadelphia RCA ARM 3-0296
Comparison—Concerto No. 2: Rachmaninoff, Stokowski/Philadelphia RCA ARM 3-0260 (1924), ARM 3-0296 (1929)
Comparisons—Concerto No. 3: Mogilevsky, Kondrashin/Moscow Phil. Ang. SR 40226
Rachmaninoff, Ormandy/Philadelphia RCA ARM 3-0296
Comparisons—Concerto No. 4: Michelangeli, Gracis/Philharmonia Ang. S 35567
Rachmaninoff, Ormandy/Philadelphia RCA ARM 3-0296

Excellent orchestral and technical work abounds on these Rachmaninoff centennial discs, but for all the lavish trappings they remind me of a gala birthday party without the



Agustin Anievas
Solid but bland Rachmaninoff.

guest of honor. Rachmaninoff, a pianistic giant of unique qualities, tailored his music especially to his gifts. Few of the younger pianists have succeeded in recapturing the glint and scintillation that give the writing its characteristic profile.

Anievas has a solid style and an agreeably expansive sound. But time and again, momentum is dissipated by a relaxation of tempo and tension, an instinctive desire to strive for expansiveness and comfort at all cost. He is, to be sure, an honorable musician and a superb craftsman, but his completely homogenized pianism has a bland uniformity of texture and color from top to bottom.

The *First Concerto* comes off very well. For one thing, this ardently youthful, Romantic score suffers less than the others from Anievas' constraint. For another, the strong, direct solo playing is ideally backed by rich-sounding, highly detailed orchestral playing, and the reproduction is both brilliant in definition and spaciouly impactful. It may be heresy, but I honestly enjoyed this performance more than Rachmaninoff's own (which is, alas, a brittle, inferior example of recorded sound even when judged by its own vintage-1939-40 standards).

Anievas' versions of the *Second Concerto* and *Paganini Rhapsody* were released before on a Seraphim disc (S 60091). Certain details in the concerto performance continue to bother me. At the very opening, for example, it seems to me misplaced purism to play the large spanning chords without even the slightest arpeggiation. Rachmaninoff certainly had large enough hands to span these stretches easily (note the ease with which he negotiated similar hurdles in his recording of Schumann's *Carnaval*, RCA ARM 3-0294), but chose, for musical reasons, to play the first note in the left hand slightly before the rest. Anievas executes the passage exactly as written, and it sounds curiously static and unfulfilled. I also find the brass fanfare ushering in the development section constrained, both metrically and dynamically (how grand it sounds on the Rachmaninoff/Stokowski recordings, and also on the Giesecking/Mengelberg "private" recording). Finally, the quasi-glissando cadenzas in the finale are here rather shapeless and ineffective. (I wonder why so few performers heed the composer's way of retaining the bass notes for longer than their noted time value.) Otherwise, the rather brisk tempos serve the music well, and I find Moshe Atzmon's rather ascetic, intellectualized conducting—unidiomatic though it is—quite individualistic. Certainly he gets some incisive articulation from his forces at the beginning of the third movement.

The *Paganini Rhapsody* is similarly robust, but this work really needs more splash and color. The recorded sound on this new Angel pressing is excellently bright and realistic, far above what I recall from the older Seraphim disc.

The *Third Concerto* gets off to a tentative start with a tempo that plods along phlegmatically—Giesecking-like deliberation without any of the Giesecking profile and angularity. The second subject is also limp and shapeless, the development section without "spin" and energy. The whole performance, in fact, is lacking in any sort of audacity or scintillation. Who needs a cautious Rachmaninoff Third?

The Orozco/De Waart Philips version of the same piece (also part of a complete cycle, available in Europe but not here) is a bit tougher and firmer, but generally shares vir-

Two Schubert Symphonies by a Talented Newcomer

by John Rockwell

Unlike some of the singers who have wandered onto the podium of late, Dietrich Fischer-Dieskau really has something to say. Even those who find his Lieder-singing self-conscious must recognize his expertise as a Schubertian, the mixture of love and knowledge that he brings to that composer's music, and his scrupulous attention to detail. All of those attributes are on hand in this debut recording as a conductor, without of course the specifically vocal mannerisms that have bothered his critics.

Both of these performances are marked by relatively uncontroversial tempos coupled with a quite unusual attention to details, particularly details of phrasing. At its best, during most of the *Unfinished*, this can work very well indeed. There is a slight preciousness about some of it, especially when Fischer-Dieskau chooses to interpret Schubert's controversial arrowheads as diminuendos rather than accents (as in the final pages of the Fifth). On the whole, the grander Eighth succumbs to his treatment more comfortably than the more innocent Fifth (in which, incidentally, he takes the second-movement repeat—a real rarity).

As far as Fischer-Dieskau's longer-range conducting ventures are concerned (he has already announced a worldwide tour in his new capacity), one record does not a career make. Some technical

inexperience can perhaps be detected in a lesser attention paid to minutiae of balance and articulation, especially string articulation. On the other hand, this is certainly a creditable "debut"—it is at the very least fascinating to hear, which is more than you can say about most records of any sort. In the old days, one might have grumbled about the disappearance of the apprentice system, the need to work your way up slowly, the need to master a broad repertory, etc. But for better or worse this is a new musical world. Fischer-Dieskau has certainly had a chance to observe many conductors at close range, he is an intelligent man, and he knows the music. Perhaps conducting careers these days can be made with the mastery of a narrow repertory coupled with imagination and the moxie to command sufficient rehearsal time to lift the interpretation and execution above the live and re-recorded ordinary (Boulez, after all, came late to conducting, too, and still has a narrow repertory in relation to the great conductors of the past). One imagines one has heard far from the last of conductor Fischer-Dieskau.

SCHUBERT: Symphonies: No. 5, in B flat, D. 485; No. 8, in B minor, D. 759 (*Unfinished*). New Philharmonia Orchestra, Dietrich Fischer-Dieskau, cond. [Svi Raj Grubb, prod.] ANGEL S 36965, \$5.98.

tues and defects with the Anievas/Ceccato. On the good side are spacious, detailed sound that gives forth the orchestral climaxes without strain or congestion, a cool-headed accompaniment from De Waart, with great clarity and finesse, and clean-fingered solo work (basically more spiky and percussive than Anievas', but in a way also more incisive and appropriate for this overlush score). And like Anievas, Orozco opts for the thick, alternative first-movement cadenza, and offers the music in a complete version (Rachmaninoff, in later years, sanctioned cuts and so recorded the piece himself). Alas, this performance is also rather soft-centered and tentative, without a true conviction and start-to-finish concept. The Mogilevsky/Kondrashin version towers over the modern competition. And, of course, there is the Horowitz/Reiner mono edition, if RCA ever chooses to recirculate it. Rachmaninoff's own performance, aside from a brilliant first movement, is severely cut, rather perfunctorily played, and very poorly (opaquely) reproduced.

Anievas turns in a workmanlike account of the Fourth Concerto, the least popular, and his collaboration with Frühbeck de Burgos is both congenial and richly recorded. But with the brilliant Michelangeli version, in remarkably effective icy, neoclassical style, and Rachmaninoff's own interpretation, serviceably reproduced, the newest addition may be regarded as superfluous. Angel offers three records for the price of two, but that still represents a per-disc increase over the Seraphim

rates asked for the same performances of Opp. 18 and 43. H.G.

RACHMANINOFF: Symphony No. 1, in D minor, Op. 13. Orchestre de la Suisse Romande, Walter Weller, cond. LONDON CS 6803, \$5.98.

Comparisons:
Sanderling/Leningrad Phil. Ev. 3218
Svetlanov/U.S.S.R. Sym. Mel./Ang. SR 40084
Ormandy/Philadelphia Orch. Col. MS 6986

Rachmaninoff's First Symphony must lie between the rather extreme pronouncements about it. No reasonable listener would share Cesar Cui's original verdict that it is worthy of first prize at "a conservatory in hell"! Yet, with all due respect, Robert Simpson's belief that this is the finest symphony of Rachmaninoff, perhaps even of any post-Tchaikovsky Russian, is equally hard to swallow.

There is much unevenness here. Things get off to a fertile start in the opening—that characteristically suave clarinet tune over a smartly turned ostinato accompaniment. But the contrasting lyrical material is, it must be faced, undistinguished. The scherzo's one good idea (and it *is* mighty good) defies development. The slow movement is pleasant, but how much more the composer ultimately learned about how to spin a passionate cantabile! The best thing about the finale is the quasicyclic transformation of the early clarinet tune and the ubiquitous Dies Irae. The worst is that brass fanfare when the composer bids the mu-

sic to become "marziale." In sum, such a piece is a major yardstick by which to measure the progressive growth of this multiply creative artist. The Second Symphony is a vast improvement, the Third vaster still.

None of the recordings known to me is "the best." Of the versions in print, Sanderling leads a taut and sparkingly colored reading with the great Leningrad Philharmonic but in aging sonics whose "stereophony" is the product of Everest's mixers rather than Melodiya's microphones. The later Russian edition under Svetlanov suffers crude playing in spots and overmonitored climaxes, but it is a vivid and flexible account of the music, warmly affable and driving in equal measure. The creamy sound of Ormandy's Philadelphians is gorgeous in an overbearing way; the virtuosic but rather loud rendition does not wear too well on repeated hearings, but it does "sell" the music plenty hard.

Weller gives full attention to such subtleties as the marginal differentiations among the speeds of the Larghetto. Gradations of piano and pianissimo are scrupulously heeded in many places, and if the big outbursts are inclined to shyness, I attribute that to limited lung power on the part of the Suisse Romande band. Weller is careful to maintain steady speeds, aware perhaps of the structural looseness of the music, but he may have sacrificed some conviction by refusing to bend and swoon where indicated. The Geneva players produce a drier sound than the Leningraders or Philadelphians, but they are cleaner and

more accurate than the U.S.S.R. Symphony for Svetlanov.

London's sound is crisp and lean, honestly balanced; the disc is attractively pressed and packaged. Incidentally, Weller has recorded a Rachmaninoff Second with the London Philharmonic, already released overseas. A.C.

B **RAFF:** Symphony No. 5, in E, Op. 177 (*Lenore*). London Philharmonic Orchestra, Bernard Herrmann, cond. [Gavin Barratt, prod.] NONESUCH H 71287, \$2.98.

There are now two of Raff's eleven symphonies in the domestic catalogue: the Third (*Im Walde*) on Candide CE 31063, and the present Fifth. Raff played an interesting role in mid-nineteenth-century central-European musical life, as both a popular composer of his day and as a leading pedagogue (he was director of the Frankfurt Conservatory from 1877 until his death in 1882, and one of his pupils was Edward MacDowell). Raff owed both his popularity then and his neglect now to the same thing, one suspects: his deliberate eclecticism. At the time, his ability to combine the abstract symphonic language of the Viennese school with the programmatic imagination and a safe dollop of the musical adventure-someness of the Liszt-Wagner camp enabled him to win the whole middle ground of musical taste. But once a later public had come to accept the innovations of the radicals and the craftsmanship of the Brahmsians, Raff's compromises began to sound like a simple lack of personality.

But all that may be a bit harsh on the man. If the Romantic revivalists are right in their argument that the principal cause for the neglect of these many worthy, forgotten works has been a neoclassical reaction against the whole idiom of musical Romanticism, then there may be a place for a composer like Raff after all. Certainly the Fifth Symphony is an ingratiating work, expertly put together and deftly recalling almost any major nineteenth-century composer you can think of at one point or another along the line. The four movements deal in a generally programmatic way with the antecedents and events of a popular ballad of the day by Gottfried August Bürger, in which Lenore is carried off on a horse by Death for blasphemous remarks uttered during her grief over the loss of her soldier-beloved, Wilhelm. Raff's symphony works its way through three movements to the finale, the actual ride, in which the frightened girl clings to the mysterious rider as his steed gallops through a plethora of supernatural apparitions. It reminds one of both the ride to hell in Berlioz' *Damnation of Faust* and Kafka's *Country Doctor*, and both Berlioz and Kafka, in their different media, were far more successful in conjuring up the horror of the occasion than the blander, safer Raff. But the earlier three movements have a less pretentious charm to them, and Raff's artistic personality is more suited to providing attractive musical statements of their sentiments.

Herrmann's performance sounds completely devoted and convincing. This performance has been available in import shops for a couple of years on the British Unicorn label, and while one welcomes its wider availability at a budget price, and appreciates Nonesuch's pressing, packaging, and annotations, one

does regret Nonesuch's failure to make use of the surrealist Fuseli *Nightmare* portrait of a spectral horse that graced the Unicorn jacket—one case in which a record's musical contents, however worthy, were surpassed in artistry by its cover. J.R.

RESPIGHI: Pini di Roma—See Recitals and Miscellany: The Yellow River Concerto.

ROCHBERG: Trio for Violin, Cello, and Piano—See Imbrie: Dandelion Wine.

SCHUBERT: Rosamunde: excerpts—See Mozart: Symphony No. 39.

SCHUBERT: Vocal Trios. Ely Ameling, soprano (in D. 930 and 666); Horst Laubenthal, tenor (in D. 37, 277, 366, 441, 88, and 148); Peter Schreier, tenor (in D. 930, 37, 277, 441, 88, and 148); Dietrich Fischer-Dieskau, baritone; Gerald Moore, piano. [Cord Garben, prod.] DEUTSCHE GRAMMOPHON 2530 361, \$7.98.

Der Hochzeitsbraten, D. 930. Die Advokaten, D. 37. Punschlied, D. 277. Cantate zum Geburtstag des Sängers Johann Michael Vogl, D. 666. Cantate zur 50jährigen Jubelfeier Saliaris, D. 441. Verschwunden sind die Schmerzen, D. 88. Trinklied, D. 148.

On the evidence of this disc, Deutsche Grammophon's project of recording the Complete Practically Everything Starring Dietrich Fischer-Dieskau is reaching a point of diminishing returns. Some of these pieces are pretty



what is a JR-200M to an audiophile ?

Sound is to the audiophile what salt is to pepper, diamond's to a girl, or an oasis to a desert. Each has a most important relationship. That's why an audiophile, a real sound expert prefers TRUSONIC JR-200M's magnificent studio quality reproduction. Clean, undistorted sound from this 12" 3-way speaker system again demonstrates the incomparable electronic technology of TRUSONIC. THE PRICE? You can pay twice as much, but you won't find a better studio quality system. Write TRUSONIC for complete information on JR-200M.

Just a few of JR-200M's impressive engineering features are 12" woofer for distortion-free low frequency bass performance 5" mid-range speaker for clean voice and horn reproduction, and a horn-loaded dome radiator tweeter for high frequency. A carefully engineered crossover network, plus individual level controls to adjust midrange and tweeter sound independently, are included. Size is: 24" x 15 1/4" x 12" deep. Finish: Hand-rubbed oil finish, Walnut veneer.

NET \$149.95

TRUSONIC
1100 E. Franklin Street
Huntington, Indiana 46750

Export: Morhan Exporting Co.
270-78 Newton Rd.
Plainview, N.Y. 11803

CIRCLE 49 ON READER-SERVICE CARD

thin stuff indeed, music that Schubert wrote for private use. Such social music doesn't often stand up well in "grand" performances, particularly when a group of soloists with less than ideally blended voices have a go at it—these things should be sung by friends for friends, not embalmed on disc. What's more, *Die Advokaten* is not even by Schubert and shows it: he merely altered a piece by one Anton Fischer (1778–1808) and did not, at age fifteen, turn dross into gold.

For my money the interesting tracks here are two in number: *Die Hochzeitsbräuten*, an 1827 comic trio about a young couple poaching a rabbit for their wedding dinner (the game warden frees them when he is invited to the feast), and the clearly heartfelt cantata in honor of Vogl, the celebrated tenor of the Schubert circle. The Salieri cantata—or, rather, one movement thereof, DG's musicologists apparently having lost the other two in the editorial swamps—is also a capable piece of work.

As noted, these singers don't blend very well in ensemble work (D. 88, an unaccompanied canon for the three men, is decidedly unsecure), but the solo bits are reasonably done and Gerald Moore's fingers are still limber. Texts and translations are provided on an insert, while the double-fold sleeve contains a lavish four-color catalogue of DG records.

D.H.

SCHUMANN: Piano Works, Vol. 1. Karl Engel, piano. TELEFUNKEN SKA 25 082, \$23.92 (four discs).

Abegg Variations, Op. 1; Papillons, Op. 2; Intermezzi, Op. 4; Impromptus, Op. 5; Davidsbündertänze, Op. 6; Allegro in B flat minor, Op. 8; Carnaval, Op. 9; Symphonic Etudes, Op. 13; Noveletten, Op. 21; Posthumous Variations.

Although this project originates in France (the recordings were made by Valois and licensed to Telefunken), this is Schumann *auf Deutsch*.

On the whole, this is admirable playing, even though it doesn't always reveal every aspect of Schumann's kaleidoscopic personality. Engel is an extremely serious—one might even say incorruptible—musician. Generally he is at his best in the pieces that balance genial charm and orderly classicism in equal measure. *Papillons*, for example, is severely played, and yet its touching wit and nimble delicacy are touchingly conveyed. Engel similarly holds together the salonish writing of the *Abegg Variations* without sacrificing their color and charm. In the *intermezzos*, a firm rhythmic pulse is nevertheless pliant enough to admit all sorts of lilting, expressive details.

The *Davidsbündler* are finely conceived: Engel's playing of these eighteen pieces has color, structural integrity, and a finely honed, low-keyed intensity. Like Murray Perahia, in his recent outstanding Columbia debut record (M 32299), Engel underplays some of their athleticism and reckless passion in favor of a chiseled symmetry (certainly a valid approach); even more than Perahia he follows most of the little changes in Schumann's second edition.

Engel plays the later versions of the *Impromptus on a Theme by Clara Wieck*, Op. 5,

and the *Symphonic Etudes*, Op. 13, but incorporates two impromptu-variations from the earlier version of Op. 5 and all five posthumously published variations from Op. 13. He plays the latter magnificently well—in a more melting, expansive style than the more direct, tough-skinned *echt* Op. 13. Perhaps that is why he chooses to keep the posthumous studies as an appendix rather than interspersing them into the body of the work as Cortot, for instance, used to do.

Engel fares less brilliantly when dash, flair, and splashy exuberance are supposed to carry the day. The B minor *Allegro* is solidly but rather cautiously played. The finger work doesn't scintillate, and the rhythm seems correct rather than dynamic. Similarly, the first two *novelettes* are a trifle sedate, and the trio section of No. 1 in F is finicky and slow-footed. How Richter used to make these pieces soar! Engel does better in the long F sharp minor *Novelette* but even there seems to be loath to really take wing.

Even at his least convincing, he proves to be a scrupulous and perceptive interpreter. Though *Carnaval*, to cite an important example, never really comes to life, Engel nonetheless observes several vital and usually ignored directions: *Chopin* is for once taken at the prescribed *agitato*; *Aveu* has the requisite bass accents that give the little cameo suitable contour.

On the basis of what I have heard of Jörg Demus' Schumann cycle for Musical Heritage Society, I tend to prefer Engel—a bigger, more forthright sort of player. Demus plays many of

“Hey...what do you want for under \$100?”

If you're looking for the best combination of features, performance and value . . . look no further. Glenburn delivers just that.

The features . . .

- Tone arm damping in manual and automatic modes . . . up and down
- Tone arm height and stylus pressure finger adjustments . . . no tools required
- Automatic tone arm lock
- Cartridge and dust cover and base standard . . . Nothing else to buy.

The performance . . .

- Lowest tripping and tracking forces available under \$100
- Largest turntable bearing in the industry
- Exclusive uni-planar mechanism . . . results in smoother, quieter turntables by putting most moving parts on a single plane.

And, the value . . .

All these unsurpassed features and improved performance available in four great new automatic turntables . . . All priced under \$100. Prove it to yourself. At your nearest Glenburn Dealer. He'll help you choose a Glenburn automatic turntable to fit your needs as well as your pocketbook.

Sometimes you have to pay a little less to get a lot more.



G GLENBURN better by design

787 Susquehanna Ave., Franklin Lakes, N.J. 07417 (201) 891-8250

CIRCLE 51 ON READER-SERVICE CARD

1081



If Bach were alive today, he'd be recording on "Scotch" brand recording tape.

It's been said it would take a present-day copyist seventy years just to *copy* all the music Bach composed.

So, next time you record something take a hint from the master. Use "Scotch" brand—the Master Tape.

The quantity of his work is staggering. But so is the quality.

And *that's* what made Bach the pro he was.

And that's why, if he were recording today, he'd be recording on "Scotch" brand recording tape. Just like the pros in today's music business.

After all, nearly 80% of all master recording studios use "Scotch" brand.



"Scotch" is a Registered Trademark of 3M Co.

The Master Tape.

the miniatures with ravishing refinement, but then he attacks the rhythmic nerve center of some of the more heroic works, causing them to writhe, contort, and lose power. Engel is perhaps a shade less "sensitive" and even sometimes stolid, but a certain robustness always comes to the fore.

The boxed album is beautifully presented, with an essay on Schumann's piano pieces that will continue in the forthcoming volumes. The discs are solidly reproduced, and the imported pressings are a joy. I look forward to hearing the balance of Engel's cycle. H.G.

STRAUSS, J.: Die Fledermaus—See Mozart: Così fan tutte.

SYMANOWSKI: Mythes—See Franck: Sonata for Violin and Piano.

TCHAIKOVSKY: Swan Lake, Op. 20. Netherlands Radio Symphony Orchestra, Anatole Fistoulari, cond. [Raymond Few, prod.] LONDON

PHASE-4 2SPC 21101/3, \$11.96 (three discs). Tape: ●● D 66607, \$14.95.

TCHAIKOVSKY: Swan Lake, Op. 20 (soundtrack of the Kirov Ballet Company film). Leningrad Philharmonic Orchestra, V. Fegomov, cond. WESTMINSTER GOLD WGS 8248, \$5.96 (two discs).

Comparison—six sides:
Rozhdestvensky/Moscow Radio Sym. Mel./Ang. SRC 4106

Comparisons—four sides:
Ansermet/Suisse Romande Lon. CSA 2204
Lanchbery/Unitel film track Ang. SB 3706

These first multidisc versions of *Swan Lake* to appear since my April 1970 detailed charting of its long-muddied waters perpetuate the old confusions over the accuracy of any recorded performance's claims to completeness. As specialists in this ballet have learned the hard way, there are Orwellian possibilities of versions being not only less, but *more* than "complete."

A handy rule of thumb is that all four-sided editions *must* be incomplete (although some, like the present Fegomov and earlier Lanch-

bery sets, may indeed represent everything in the film soundtracks from which they have been drawn). The long-standard complete score demands six disc sides (as in the original mono of the pioneering Dorati version for Mercury), while some more recent six-sided sets—Fayer's for MK (now OP), Rozhdestvensky's, and now Fistoulari's—are *more* than complete, incorporating a seven-and-a-half-minute Act III pas de deux rescued from the original 1877 production. (This section was omitted from the better-known Petipa/Drigo revision used in the 1895 revival, being replaced by the familiar *Black Swan* pas de deux, No. 5 in the Jurgenson/Broude Brothers orchestral score and which originally belonged in Act I.)

But stage and recorded performances all go their own ways when it comes to including—or more often excluding—the four Petipa/Drigo interpolations, three of which are transcriptions of Tchaikovsky Op. 72 piano pieces, and the fourth a polka presumably by Drigo himself.

If you're one of us fanatical discographers and you still have my chart, you may want to

Heinz Holliger—Spectacular Indeed! by Robert P. Morgan

One of the most interesting and important developments in recent music has been the appearance of performers who devote themselves not only to playing new compositions, but also to expanding the possibilities of their instruments: people like violinist Paul Zukofsky, trombonist Vinko Globokar, and soprano Cathy Berberian, all of whom have worked with various composers and have become well-known through their recordings.

Probably the most important factor prompting this development was, curiously, electronic music, which began to appear in the 1950s and presented the composer with a considerably enlarged spectrum of timbral possibilities. At first the electronic medium may have appeared to render instrumental performance—at least in respect to new music—a thing of the past; in actuality, it led to a desire to develop the capacities of traditional instruments to meet the compositional criteria evolving out of the electronic experience. Frequently this led to a "misplaying" of the instrument in traditional terms, such as overblowing a wind instrument to achieve a new timbre or a multiphonic combination (i.e., the sounding of more than one note at a time), and shouting, whispering, screeching, and the like in the case of vocal music.

The result has been the appearance of a growing group of musicians whose techniques are largely—but by no means exclusively—geared to a new instrumental language. They are the "virtuosi" of contemporary music, soloists who can take their place in a long tradition of virtuoso playing associated with the history of Western music since the Renaissance.

Without question, one of the greatest of their number is oboist Heinz Holliger. Holliger has mastered his instrument, in both traditional and contemporary terms, in a consummate manner, and he is gifted with an unusual

degree of musical sensitivity and understanding. This release, devoted entirely to pieces written during the 1960s, should help to establish him as one of the great instrumental soloists of the modern period.

Of the six pieces, Berio's *Sequenza VII* for solo oboe is the most recent (1969) and offers by far the best demonstration of the use of new sonic resources on the oboe. Berio requests, for example, as many as six different fingerings for a single pitch, each of which produces its own distinct timbre. He also calls for various multiphonic combinations, as well as a wide range of overblowing techniques, double trills, and micro-intervals. The entire piece is organized around a central pitch (B a seventh above middle C) which appears as a sort of pedal throughout—both literally, in the form of an electronically produced pitch that sounds softly from beginning to end and is intended to lend a slight resonance to the oboe; and figuratively, embedded in the oboe line itself, which keeps referring to this pitch while building diversions from and around it but alluding to it frequently enough so the listener retains it in his ear as a kind of echo of the "real" pedal.

The work is, above all, a showpiece for the performer, and Holliger projects it with masterly control and a fine sense of over-all shape and pacing. Interestingly, his performance lasts about half again as long as would a "literal" reading of Berio's score: there are no aleatory aspects to the piece whatever, but the area left open to the performer's interpretation is considerably broader than in, say, nineteenth-century virtuoso music. It is difficult to imagine the work being played at Berio's tempo without a significant loss in clarity, although Holliger is certainly more deliberate than would be absolutely necessary. Still, his reading is entirely convincing on its terms. My only real complaint is that the prerecorded

pedal is for some reason cut off just before the oboe's final, "cadential." B, despite the composer's explicit request that it sound throughout.

The five other pieces—none written later than 1966—make more conventional use of the oboe. The most distinctive is the oldest, Klaus Huber's *Noctes intelligibilis lucis*, a delicate, muted dialogue for oboe and harpsichord. The mosaiclike structure, in which formal components reflect one another like kaleidoscopic mirrors, evolves out of two subdued, though elegant, instrumental layers that interact in the manner of a carefully controlled improvisation.

Also impressive are Hans-Ulrich Lehmann's *Spiele* for flute and harp and Holliger's own trio for oboe (doubling English horn), viola, and harp. Both offer interesting examples of the use of harp—nominally a diatonic instrument—in a highly chromatic musical context. The works by Niccolò Castiglioni and Ernst Křenek are also effectively written but strike me as less individual. The performances by the other instrumentalists are all excellent, if somewhat overshadowed by Holliger's brilliant playing.

There is much to enjoy and marvel at on this disc. I hope we may now look forward to a Holliger disc containing more radical examples of his extremely transformed acoustical image, such as Globokar's *Discours III* and Stockhausen's *Solo*, with which he has created a considerable stir in European new-music circles.

THE SPECTACULAR HEINZ HOLLIGER. Heinz Holliger, oboe and English horn. PHILIPS 6500 202, \$6.98.

BERIO: *Sequenza VII*. **CASTIGLIONI:** Trio for Oboe/English Horn, Viola, and Harp (with Serge Collot, viola, Ursula Holliger, harp). **HUBER:** *Noctes intelligibilis lucis* (with Jürg Wyttenbach, harpsichord). **KŘENEK:** Vier Stücke, for Oboe and Piano (with Wyttenbach). **LEHMANN:** *Spiele* (with Ursula Holliger, harp).

The Sansui SR-212.

Fine music on a platter.



Put your favorite record on the large 12" aluminum platter of the new Sansui SR-212 automatic return turntable and you will be pleased with the results. You'll be pleased with the ease of operation. A cueing control that lets you place the arm at any point on the disc and go "automatic" from there. You'll be pleased with the reliability and rugged construction of the SR-212's belt-driven full size platter powered by a 4-pole synchronous motor.

You'll be pleased by the statically balanced S-shaped arm and anti-skate features. You'll be pleased by the solid stability assured by Sansui's multiple point suspension system. You'll be pleased by Sansui's added features of handsome wood base and hinged dust cover. And, most of all, you'll be pleased by the reasonable price that goes with this new Sansui turntable. Hear it at your nearest franchised Sansui dealer

Sansui

SANSUI ELECTRONICS CORP. Woodside, New York 11377 • Gardena, California 90247
SANSUI ELECTRIC CO., LTD., Tokyo, Japan • SANSUI AUDIO EUROPE S.A., Antwerp, Belgium

The best automatic you can buy is also the hardest to get.

Making the best automatic turntable simply takes us longer. Longer to machine our 12-inch non-ferrous turntable on a lathe. Longer to dynamically balance it. Longer to precision-machine our operating cam, made of die-cast metal rather than ordinary plastic.

ELAC is more concerned with making it right than making it fast. And that's one of the reasons our Miracord 50H Mark II is harder to get than some others.

Another reason is what we put into it. For example, let's take turntable speed. We have a speed-setting control and a built-in stroboscope for accurate setting. But so do several other good automatics. What makes ours unique is the type of motor we use to maintain speed accuracy no matter what. It's called a hysteresis synchronous motor, and until now you could get one only in professional manual turntables made to broadcast standards. We use it in the 50H Mark II for precisely that reason: it maintains speed to professional standards with virtually no regard for fluctuations in line voltage. In tests, voltage variations of more than 20% up or down failed to affect our turntable speed.

This same locked-in accuracy is maintained even in the face of loads up to ten records. There's a simple way to prove this for yourself. Go to your dealer and ask to see the 50H Mark II. Put on a stack of records and set the speed by means of the illuminated strobe. Now watch it carefully as each record plays. You'll see that the speed returns to dead-on accuracy for each record.

How tough a test is this? Try it on other automatics.

You'll find that their strobes will quickly develop the jitters.

Another professional feature is our unique push-button control system. Certainly, it's more pleasant to press one button than to push several levers. But we didn't design them just for convenience. We did it to avoid that inevitable initial shock other systems cause every time you start a record, resulting in arm movement and possible record damage.

Of course, even if that initial shock did occur, the arm of the 50H Mark II wouldn't be thrown by it. Because it happens to be balanced in all planes. It also has a unique method for matching anti-skating with stylus pressure and a cartridge overhang adjustment which reduces distortion and record wear.

There are many more reasons why this automatic retains its accuracy so long. And takes so much longer to make. They're all described in detail in our brochure on all the ELAC turntables... yours for the asking.

One more thing. Suppose you become convinced and want a 50H Mark II. Will you be able to find one? Well, you may have to check two or three dealers. But although the 50H Mark II may be hard to get, it's far from impossible.

ELAC Products, Benjamin Electronic Sound Company, Farmingdale, New York 11735.

MIRACORD 50 H Mark II



ELAC You can't rush craftsmanship.

note that the new Fistoulari version has the same contents and sequence of the Rozhdestvensky version except that it inserts, just before the last two scenes, the Petipa/Drigo Interpolation II (a transcription of Tchaikovsky's *Valse-bagatelle*, Op. 72, No. 11). The Fegomov Russian film score is roughly like the Lanchbery Viennese film score in its arbitrary omissions and resequencing, and it is further handicapped by substantial cuts in seven of the selections it does include. As far as content is concerned, it is interesting mainly for its inclusion of Interpolations I (a transcription of Tchaikovsky's Op. 72, No. 12, *L'Espiegle*—the French equivalent of *Eulenspiegel*, i.e., a rogue or jester) and IV (the polka).

But what about the new sets' actual performances and recording qualities, exasperated nondiscographers must be screaming. I'm sorry you insist on asking.

The once-esteemed Fistoulari seems to have become more crotchety, rather than mellow, with the passing years. He is still authoritatively assured, but his concert-style reading is too often hard-pressed and heavy-handed. Worse, it seldom *sounds* attractive. And since it's hard to believe that Phase-4 technology and an engineer of Arthur Bannister's caliber could be responsible for so many harsh or coarse moments, I must presume the Netherlands Radio Symphony to be at fault. Yet when even the solo violin passages by so redoubtable a virtuoso as Ruggiero Ricci come off excessively sticky-toned and more than life-size, perhaps the buck should pass all the way to producer Few.

The Kirov company's *Swan Lake* film (choreographed by Konstantin Sergeev and starring Yelena Yevteyeva and John Markovsky) has not, to my knowledge, been shown in this country. Conductor Fegomov's name is a new one to me, but he demonstrates sure stylistic insights into Tchaikovsky's music. What he does play here is mostly done very well indeed—in an idiomatic balletic rather than a concert presentation. He and his Leningrad musicians are fatally handicapped, however, by extremely strange, often bodiless or hollow-toned sonics. Either the original (optical?) film recording was miserably poor or (more likely) a number of things went wildly wrong in the transfer to the Melodiya/Celebria master tape from which the present—mechanically first-rate—Westminster Gold discs stem.

If you're seeking a more-than-complete *Swan Lake*, the preferred choice is still Rozhdestvensky's for Melodiya/Angel. If you want the most "danceable" reading, the preferred choice is Lanchbery's for Angel (although Fegomov's might well have beaten that out, given even acceptable sound). If you want the best sound—sound that does justice to Tchaikovsky's kaleidoscopic tonal colorings and resplendent sonorities—the 1959 Ansermet/London and 1967 Lanchbery/Angel sets remain as magnificently impressive as ever, but they have been surpassed in airy expansiveness (in stereo no less than in quadriphony) by the recent, regrettably only two-sided, Ormandy/Philadelphia suite (RCA ARD 1-0169). R.D.D.

USSACHEVSKY: *Three Scenes from the Creation*; *Missa brevis*. Macalester College Chamber Chorus, Ian Morton, cond. (in the *Creation* Prologue). Jo Ann Otley, soprano (in *Missa*); University of Utah Chorus (in the



The Kirov Ballet in *Swan Lake*—the score from the film is idiomatic but hollow.

Creation Interlude and Epilogue and *Missa*); members of the Utah Symphony Orchestra (in *Missa*), Newell Weight, cond. [Carter Harman and Vladimir Ussachevsky, prod.] COMPOSERS RECORDINGS SD 297, \$5.95.

Three Scenes from the Creation is obviously intended to be the big bowwow, but the lesser work, the *Missa brevis*, runs away with the show. Unlike the music on which Ussachevsky's reputation largely rests, this work does not use any electronic material. It is for solo soprano, chorus, and ten brass instruments. The choral and instrumental sonorities are beautifully handled, sometimes recalling Ussachevsky's upbringing in the Russian Orthodox church. The movements are deftly shaped, and the whole thing has elegant and eloquent proportions. Newell Weight, the conductor, can be as happy with the recorded interpretation as Ussachevsky with the work.

In *Three Scenes from the Creation* there is much electronic modification of the choral voices and an electronic accompaniment. There are three movements: a Prologue in Akkadian, an Interlude in English translated from the Akkadian, and an Epilogue on a poem by the English writer Kathleen Raine. We are given no text and practically no information about the text; it's all a mystery, and the lack of intelligibility often makes the vocal writing seem labored. The electronic effects are good theater. A.F.

WAGNER: *Siegfried Idyll*; *Wesendonck Lieder*. Naděžda Kniplová, soprano (in *Lieder*); Czech Philharmonic Orchestra, Zdeněk Košler, cond. [Eduard Herzog, prod.] SUPRAPHON 1 12 1136, \$6.98.

Naděžda Kniplová is a Czech soprano with some reputation in the Wagnerian literature (she is the Brunnhilde of the Swarovsky *Ring* cycle on Westminster Gold). Whether her performance of the *Wesendonck* Songs appeals to you will depend on how much you value sheer tonal splendor, for she hasn't much: The sound is rather a "squeezed" one, produced with a certain amount of tremolo but very accurately tuned. On the other hand, these readings are very well conceived, the phrases gra-

ciously shaped, the words sensitively uttered if a bit oddly pronounced. Unfortunately, some of the dotted rhythms are slighted, and *Strehle still!* rather ponderously accented. Still, I prefer this approach to the more proclamatory one often favored; the orchestral setting of the songs has rarely sounded so intimate and personal.

The Czech Philharmonic does well in the songs, but somewhat less so in the overside *Idyll*, where the winds let us down—a shame, for the string playing is rich and satisfying. Good sound; liner notes, mostly biographical, in stiff English; a text leaflet giving the German originals only. D.H.

WAXMAN: *Trio for Oboe, Clarinet, and Bassoon*—See Imbrie: *Dandelion Wine*.

recitals and miscellany

FRENCH COMPOSERS CONDUCT THEIR OWN MUSIC, VOL. 1. ROCOCO 2038, \$6.95 (Rococo Records, Box 175, Station K, Toronto 12, Ont., Canada). HONEGGER: *Pacific 231*; *Pastorale d'été*. SCHMITT: *Reflets d'Allemagne*, Op. 28; Nos. 7 and 8. D'INDY: *Le Camp de Wallenstein*, Op. 12. No. 1. RABAUD: *La Procession nocturne*, Op. 6.

The two most appealing items on this disc, consisting of material taken from French 78s probably made in the late 1920s, are the Honegger-conducted *Pacific 231* and *Pastorale d'été*. As in his interpretation of his *King David*, Honegger showed in these old recordings a perfect ability to communicate the deepest meanings of his compositions to an orchestra. Although the extremely tubby sound makes it difficult to pick up much of what is going on, the *Pacific 231* performance obviously has a rhythmic urgency and a taut, lean, modernistic precision that can be heard on no other recordings. But Honegger proves just as effective in bringing out the warm, nostalgic, and occasionally archaic lyricism of the subdued *Pastorale d'été*.



Jug End in the Berkshires

1200 Acre Year 'Round Resort
For
Care-Free Vacations

The most fun-loving place you have ever been. There are 35 Sports and activities from which to choose (from water volley ball—pool enclosed and heated in winter—to 18 Holes of Mountain Golf to bike riding on our scenic country roads). Three of our five courts covered by a heated "Bubble" so you can play tennis year 'round. 185 types of accommodations. Brochure & Welcome Guide FREE.

For Tension-Free Conventions

Each year well over 200 organizations and Major Firms hold Productive Meetings, Conventions, Seminars, Outings, year 'round Training Programs, and Conferences in our complete Resort atmosphere. Complete Meeting facilities with 12 Function Rooms accommodating up to 350. Phone today, or send for our unique file folder describing our excellent meeting and recreational facilities. Andre J. Bergerson, Vice President Marketing and Sales.

Jug End in the Berkshires

Box No. 689 Dept. HF
So. Egremont, Mass. 01258
Phone 413/528-0434
N.Y.C. (FREE) 212/757-8950
A.C. 516, 914, Collect 212/686-3565
A.C. 617 Call Collect—617/227-0663
From anywhere in U.S.A.
Toll FREE 800/327-3384

None of the other three works offers the interest of the Honegger, even though, unlike the Honegger, no modern recordings exist for any of them. Vincent d'Indy's *Camp de Wallenstein*, the first part of a "symphonic trilogy" intended to be a "preface and musical commentary" for three poems by Schiller, is characterized by frequent and rather awkward shifts in the rhythmic flow, a fair amount of pseudo-Wagnerian bombast, and even a fugue *manqué* that falls to pieces after traversing a few measures of inappropriately neo-baroque meanderings. As a tone poem, Henri Rabaud's moody *Procession nocturne*, based on a poem inspired by part of the Faust legend (the work was once recorded for Columbia by Mitropoulos), remains much more within the framework of traditional French tone painting. But here again, the presence of Wagner (this time of the *Tristan* ilk) makes itself felt in an almost painfully obvious manner. And though the two waltzes from Florent Schmitt's *Reflets d'Allemagne*, originally a waltz suite for four-hand piano, may turn toward Vienna instead of Bayreuth, the results, if somewhat ingratiating, are hardly more original.

Except for the Rabaud piece, which contains some abrupt jumps, these LP transfers were done with exceptional skill and smoothness. The D'Indy and Schmitt works, by the way, are followed by short "vocal autographs" spoken (in French) by the composers. R.S.B.

ENDRE GRANAT: Violin Recital. Endre Granat, violin; Erwin Herbst, piano. ORION ORS 73128, \$5.98.

YSAÏE: Sonatas for Solo Violin, Op. 27, No. 3, in D minor; No. 5, in G. **CAMPO:** Sonata for Violin and Piano. **DE LA VEGA:** Tangents for Violin and Tape.

Endre Granat, a Hungarian on the faculty of California State University at Northridge, is a splendid violinist, and he knows how to assemble a recital program that is fresh, challenging, and—not incidentally—shows off his technical and musical accomplishments to the utmost.

The Ysaÿe sonatas for unaccompanied violin (there are six of them) turn up on live concert programs with more and more frequency, but there are no recordings in the catalogue and there should be. Now the oversight is at least partially remedied, and record collectors can hear for themselves some of Ysaÿe's very respectable compositional efforts. No. 3 starts out as a free-flowing, improvisational essay that never veers into bad taste and goes on to exploit a wealth of the fiddle figurations the instrument was made for. No. 5 is weaker, or at least more uneven: Its impressionistic, dream-haunted opening goes smoothly enough, but eventually the piece turns into something of a finger and bowing exercise. Never mind. These works will appeal to and entertain anyone interested in violin literature, and Granat has a winning, spontaneous way with them. He can get as much variety of color into a single phrase as any violinist I've heard, but there is never a sense of overdoing it.

The Frank Campo sonata for violin and piano (1959) is a kind of Everyman's "modern music" piece. The violin by turns sings a slightly sour but nevertheless melodious song or moves ahead at a disjunct trot. It is all pleasantly astringent. The piano, however, is way underrecorded, and the interplay between the two instruments doesn't come forth as strongly as it might.

Aurelio de la Vega's *Tangents* for violin and

tape is, we are told, a close relative of *Para-Tangents* for trumpet and tape, written at the same time (1973). The tape (left speaker, very distinct) takes an aggressive role, with a goodly amount of splat and blast, dive-bomber effect, and chirp and splutter, but all held down well below the threshold of pain. The violin starts out in a relatively tender vein and proceeds to take on more of the tape's fierce temperament. Some very telling colors and timbres are achieved in the course of this confrontation, and even fleeting bits of humor, as when one instrument whips off a phrase that is the mirror image of the other's. It is a credit to Granat that while the listener is absorbed in sorting out these sounds he forgets how much skill is required of the violinist in creating them. Granat has it, and to spare.

S.F.

JOSEF HOFMANN: The British Recordings. Josef Hofmann, piano. INTERNATIONAL PIANO LIBRARY IPL 110, \$7.00 [recorded 1904 and 1935] (International Piano Library, 215 W. 91st St., New York, N.Y. 10024).

G&T recordings (1904) **CHOPIN:** Polonaise No. 3, in A, Op. 40, No. 1. **MENDELSSOHN:** Songs Without Words: No. 3, Hunting Song, Op. 19, No. 3; No. 30, Spring Song, Op. 62, No. 6. **SCHUBERT-LISZT:** Der Erkonig. **SCHUBERT-TAUSIG:** Marches militaires. *Unreleased HMV recordings (1935):* **BEETHOVEN:** Sonata No. 18, in E flat, Op. 31, No. 3; Scherzo. **CHOPIN:** Nocturne No. 5, in F sharp, Op. 15, No. 2; Waltz No. 5, in A flat, Op. 42. **CHOPIN-LISZT:** Chants polonais: No. 1, The Maiden's Wish, Op. 74, No. 1; No. 5, My joys, Op. 74, No. 12.

Hofmann expressed great interest in sound reproduction during the years of its infancy. His 1904 recordings, reissued here, demonstrate the musician's cooperation: Their sound is astonishing for the time—in fact, not much worse than the "norm" of Hofmann recordings, which ironically are execrably bad on the whole (coming as most of them do from amateur transcriptions of public concerts). The quality is even more impressive when one realizes the typical piano sound from turn-of-the-century discs (e.g., the terrific wow and muddy distortion of the 1903 Pugno items).

The other side of this limited edition, however, is a real prize for Hofmanniacs: These hitherto unreleased 1935 items (IPL's contract prevents them from mentioning HMV by name) are the only records Hofmann ever made that had his wholehearted approval. Their sound is magnificently full and mellow—prewar British engineering at its best—and exquisitely dubbed by IPL. And what a difference good piano tone makes! For the first time, I can begin to hear what all the fuss was about: This is, indeed, a major artist at work.

Hofmann recorded some of these same selections elsewhere, and it is fascinating to note how differently he plays them here. The Chopin F sharp Nocturne, for example, is given a broad, lyrical, expansive re-creation with only occasional signs (e.g., in the chromatic runs) of the trivialization heard in the much faster, glibber 1938 performance on Victrola VIC 1550. The Chopin A flat Waltz and the Chopin-Liszt *Maiden's Wish* were also included on that Victrola disc, in test pressings made in America just a few months before those now at hand. The full, luscious, resonant British verisimilitude of the piano automatically puts these new performances way out in front, but it is evident that Hofmann also plays with greater flexibility and sensitivity.

Only the Beethoven movement falls below acceptable standards. This is, in many re-

spects. "woodwind" writing (e.g., the bass oboe certainly resembles a bassoon part), and Hofmann's fast, rhythmically untidy account misses both the charm and the poise of the piece. But on the whole, this is fleet, singing, aristocratic pianism, and I doubt that there will ever be another Hofmann disc so fully recommendable. H.G.

THE SPECTACULAR HEINZ HOLLIGER. For a review of this recording, see page 98.

LAWRENCE JOHNSON: Guitar Recital. Lawrence Johnson, guitar. CLASSIC RECORDINGS FOR GUITAR CRG 1, \$5.00 (CRG Records, 153 Wellington Ave., Rochester, N.Y. 14611).

SOR: Sonata in C minor, Op. 25; Sicilienne, Op. 33; VI-vace, Op. 34 **BACH:** Suite for Lute, No. 3; Prelude and Fugue **DA MILANO:** Fantasia in E minor **DUARTE:** Prelude No. 1, Op. 13.

SPANISH GUITAR MUSIC. Santiago Navascués, guitar. [Teije van Geest, prod.] EURODISC 86 852 KK, \$6.98.

SOR: Sonata in C, Op. 22 **VILLA LOBOS:** Preludes, No. 1, in E minor; No. 2, in C minor; No. 3, in A minor; No. 4, in E minor; No. 5, in D.

Lawrence Johnson bills his recital as consisting entirely of works previously unrecorded, and while this sounds like a dangerous claim, neither my memory nor the Schwann catalogue is comprehensive enough to corroborate or refute. The Sor sonata is typically broad in gesture and romantic in inclination; the short Duarte prelude is a pleasantly melodious and easy-going piece; the remainder of the program holds no surprises. Johnson is an honest performer who, however, lacks the finesse that we have come to expect of concert guitarists. He is hampered by a thin, metallic tone and by an excessive amount of left-hand buzz and scratch when shifting.

The "Spanish Guitar Music" disc by Santiago Navascués (one side of which is devoted to that well-known Spaniard, Villa Lobos) is something I would advise you to stay away from. The performances are heavy-handed, laborious, and rhythmically lumpy. S.F.

SUSANN McDONALD PLAYS THE ROMANTIC HARP. Susann McDonald, harp. [Harold L. Powell, prod.] KLAVIER KS 525, \$5.98.

FAURÉ: Impromptu, Op. 86; Une Châtelaine en sa tour, Op. 110 **GODEFROID:** Etude de concert, in E flat minor, Op. 193; Romance **HASSELMANS:** Will-o'-the-Wisp **PIERNE:** Impromptu caprice, Op. 9 **RENIÉ:** Danse des lutins **SALZEDO:** Variations on a Theme in Ancient Style; Chanson dans la nuit **TOURNIER:** Feerie; Vers la source du bois; Les Annesses grises sur la route d'El-Azib.

One of the most outstanding attributes of Susann McDonald's extraordinary talent and depth as a harpist is her ability to integrate even the most ornate filigree work into the musical context of the piece she is playing. In the Renié *Danse des lutins*, for example, she maintains a marvelous rhythmic pulse throughout all the characteristic harp ornamentation, enhancing the lightness intended by the composer. Furthermore, McDonald's articulation in the almost constant passage-work of some of the pieces is so perfectly smooth and utterly clear that, were it not for the profound sensitivity of the interpretations, one would be tempted to wonder whether such sounds could be made by human fingers. Note, for example, the gossamer, pianissimo fourth variation of the Salzedo *Variations on a Theme in Ancient Style*.

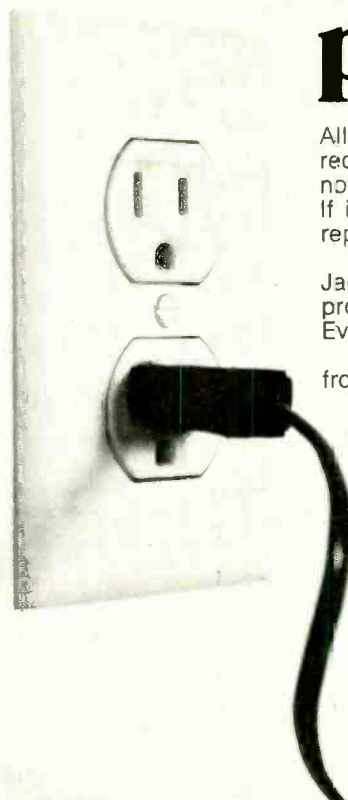

plugged

All Electrostatic speakers require AC. If a speaker does not, it is not electrostatic. If it is not electrostatic, it's not reproducing all that it should.

Janszen. Electrostatic in every product we manufacture. Every product.

from 119.95

**JANSZEN
ELECTROSTATIC**

a division of
ELECTRONIC INDUSTRIES INC.
7516 42nd Ave. No.
Minneapolis, Minnesota 55427

CIRCLE 20 ON READER-SERVICE CARD

Who Says Audiophile Components have to be Expensive?

No one really says so, but most people think so. The SAE Mark XXX Stereo Preamplifier and Mark XXXIB Stereo Power Amplifier offer the highest engineering excellence and quality parts available at a moderate price.

To find out what makes these units the most sought after components, fill out the coupon and mail today.



SAE
*Components
for the
Connoisseur*

SAE, Inc., Electronics Division (574)
P.O. Box 60271, Terminal Annex, Dept. HF-54
Los Angeles, California 90060

Gentlemen:

Please rush free information on the Mark XXX and Mark XXXIB by return mail.

Name

Address

City State Zip

CIRCLE 34 ON READER-SERVICE CARD

ADVERTISING INDEX

Key No.	Page No.
1	Acoustic Research, Inc. 13
	Akai America, Ltd. 69
2	Angel Records 91
	Audio Dynamics Corp. 42
3	Audio Warehouse 114
	Bozak 92
	B I C International 7
4	British Industries 26
5	Capitol Tape 72
6	Carston Studios 121
	Classified Ads 80
	Columbia Records 89
7	Crown International 16
8	District Sound 114
	Dixie Hi-Fi Wholesalers 121
9	Dokorder Inc. 12
17	Dual 23
10	Dynaco, Inc. 87
11	Elac Products, Benjamin Electronic Sound Co. 100
12	Electro-Voice, Inc. 10
13	Elpa Marketing Industries, Inc. 64
	Elpa Marketing Industries, Inc. 32
98	Empire Scientific Corp. 15
	Ferrograph 32
	Fisher Radio Cover II, 1
51	Glenburn Inc. 96
	GTE Sylvania 120
14	Harman / Kardon 31
15	Heath Co. 71
16	Icelandic Airlines 108
18	Illinois Audio 113
19	International Hi-Fi Distributors 114
20	Janszen Electrostatic Jug End 103
	Jug End 102
36	Kenwood Cover IV
21	KLH Research & Development Corp. 29
30	Koss Corp. 118
43	Marantz Co., Inc. Cover III
22	Maxell Corp. of America 4
23	McIntosh Laboratory 107
24	Midwest Hi-Fi 116
25	Nakamichi Research (U.S.A.) Inc. 11
26	Nova Audio 116
29	Rabsons 119
31	Radio Shack 109
	Revox Corp. 52
32	Sansui Electronics Corp. 99
33	Sansui Electronics Corp. 117
34	Scientific Audio Electronics, Inc. 103
35	Scientific Audio Electronics, Inc. 107
37	Sherwood Electronic Laboratories 51
38	Shure Brothers Inc. 19
54	Sony / Superscope, Inc. 24, 25
39	Sound Technology Research 20
27	Stanton Magnetics, Inc. 2
40	Stereo Corp. of America 121
41	Stereo Wholesalers 119
42	Superex Electronics Corp. 14
44	TDK Electronics Corp. 115
45	Teac Corp. of America 8, 9
46	Technics by Panasonic 5
13	Thorens 64
	3 M Company 97
47	Transcriptors 21
49	Trusonic 95
17	United Audio 23
48	U. S. Pioneer Electronics Corp. 60, 63
4	Venturi 26

The works recorded here, mostly of the en-core-piece genre, are of little purely musical consequence. As it happens, however, the compositions by such harp virtuosos as Carlos Salzedo, Henriette Renié, and Alphonse Hasselmans offer more interest than the vignettes by Fauré and Pierné, who had more success combining the harp with other instruments, although the Fauré *Châtelaine en sa tour* is quite lovely. The Pierné *Impromptu caprice*, on the other hand, has a rather unidiomatic heaviness to it. But absolutely nothing on this disc grates, and it is worth listening to from start to finish not only because of McDonald's stunning artistry, but also because of the beautifully clear, realistic, and—dare I say—limpid recorded sound. R.S.B.

R THE CHRISTOPHER PARKENING ALBUM. Christopher Parkening, guitar. [Patti Laursen, prod.] ANGEL S 36069, \$5.98 [from various originals]. Tape: **8X** S 36069, \$7.98; **4XS** 36069, \$7.98.

ALBÉNIZ: Rumores de la Caleta (Malagueña); Leyenda. **TÁRREGA:** Capricho arabe (Serenata); Estudio brillante. **VILLA LOBOS:** Etude No. 1, in E minor. **ANON:** Romance. **BACH:** Well-Tempered Clavier, Book I: Preludes Nos. 1 and 6; Suite for Cello, No. 3; Courante; Sonata for Violin, No. 1: Fugue; Jesu, Joy of Man's Desiring.

Grow old along with me, guitar fanciers. If you remember as well as I do the debut albums of Christopher Parkening, you will probably be as unprepared as I was to realize that they were five long years ago. But I will wager one thing: If you heard that pair of albums you *do* remember them, for they were not the kind of thing that comes along every day. Parkening is an amazing instrumentalist, capable of miracles of color. Under his fingers the music ebbs and flows, pounces hard or flies off in feathery wisps, moves in and out of sunshine and shadow. He plays Bach clavier transcriptions with far more coloration than is available to a harpsichordist or clavichordist, but he does it with so strong a sense of architecture and such innate good taste that we begrudge him not at all the appropriation of this great music for his own domain. And he can invest a work like Tárrega's *Estudio brillante* with a vitality and joy that might surprise even the composer. In short, he is in the fullest sense a re-creative artist, whose rich musical imagination is fully matched by technical prowess.

Angel calls this disc "a collection of [Parkening's] concert favorites" but leaves us to deduce for ourselves (from germ-sized print on the jacket, advertising earlier albums) that all the selections have been previously released. For shame. Luckily, Parkening is worth hearing over again. S.F.

ROMANTIC HORN CONCERTOS. Hermann Baumann, horn; Vienna Symphony Orchestra, Dietfried Bernet, cond. BASF KMB 20834, \$5.98.

SCHUMANN: Konzertstück for Four Horns and Orchestra, in F, Op. 86. **SCHÖECK:** Concerto for Horn and String Orchestra, in D minor, Op. 65. **WEBER:** Concertino for Horn and Orchestra, in E minor, Op. 45.

The use of wind instruments as principals in the concerto has a rich history with an interesting alternation of preferences. During the baroque the oboe was the favorite among the woodwinds; the horn was not employed as a solo instrument, but the trumpet had a special place because of the developed art of playing

in the highest register (called clarino playing) where the chromatic scale was available. The rococo loved the flute because of its elegance and fluency in executing ornaments; the Romantics added the highly expressive clarinet and a "new" instrument, the valve-operated—and hence chromatic—horn. The clarinet became very popular, but horn concertos are few.

The Schumann piece on this release is "a curiosity" (in Schumann's own words), a composition of slight intrinsic value, though some of the sonorities are pleasant enough. The writing is so gauche and difficult that an extra horn was employed for this recording to ease the quartet's burden. The performance is very good.

Othmar Schoeck (1886–1957) is one of those unexportable Germanic composers, like Reger, who may mean a lot to their devotees at home but turn on mighty few abroad. One soon gets tired of the meandering, contourless melodic line that just goes on and on.

Weber's concertino offers a refreshing change. Here is a composer whose trifles are more attractive than many others' major works. This piece, composed in 1806 and revised ten years later, is still for the valveless natural horn, demanding extraordinary virtuosity even when played on a modern instrument. Hermann Baumann supplies this virtuosity to a dazzling degree. Weber could handle the horn as could no one else in his time, but the concerto form was another matter; in fact this is a sort of operatic potpourri with some absolutely stunning effects. This carefree light music may be slapped together, but it surely puts the Schoeck to shame. P.H.L.

ELEANOR STEBER LIVE AT THE CONTINENTAL BATHS—See Kiri Te Kanawa Sings.

B KIRI TE KANAWA SINGS. Kiri Te Kanawa, soprano; chorus and orchestra, Oswald Cheesman, cond. WESTMINSTER GOLD WGS 8233, \$2.98.

BENOFF: Havah nagilah. **BERNSTEIN:** West Side Story: I Feel Pretty; One Hand, One Heart. **BIZET:** Carmen: Habanera. **DRAKE:** I Believe. **FAIN:** Love Is a Many-Splendored Thing. **GERSHWIN:** Porgy and Bess: Summertime. **KERN:** Showboat: Bill. **LARA:** Granada. **LECUNA:** Malagueña. **RODGERS:** The Sound of Music: My Favorite Things; Climb Ev'ry Mountain.

ELEANOR STEBER LIVE AT THE CONTINENTAL BATHS. Eleanor Steber, soprano; Joseph Rabb, violin; Edwin Bilcliffe, piano. [Joseph Habig, prod.] RCA RED SEAL ARL 1-0436, \$5.98.

CHARPENTIER: Louise: Depuis le jour. **KREISLER:** The King Steps Out; Stars in My Eyes. **LEHAR:** Die lustige Witwe: Villalied, Lippen schweigen (in English). **MASSENET:** Manon: Gavotte. **MOZART:** Idomeneo: Zeffiretti lusignieri. Così fan tutte: Temerari. . . Come scoglio (in English). Die Zauberflöte: Ach, ich fühl's. **PUCCINI:** La Bohème: Musetta's Waltz. Tosca: Vissi d'arte. **SIECZYNSKI:** Wien, du Stadt meiner Träume.

On this pair of discs from exotic shores—New Zealand and New York's Continental Baths—we hear the old giving way, just in time, to the new.

If you don't know about the Baths, I won't try to explain it. But however amusing Ms. Steber's gala "black towel" appearance (October 4, 1973) may have been, the disc thereof is a (deliberate) grotesquerie. Not that the voice is unlistenable: The usable range is impressive, and for whole phrases at a stretch the vibrato is sufficiently controlled to allow real authority (e.g., the opening of Musetta's

two hours long. In 45 work weeks, the Philharmonic has 360 services. The London Symphony in its last financial year played 562 three-hour working sessions, and only 42 of them were concerts sponsored by the orchestra itself. Men *do* sign up for the BBC Orchestra because they like the stability of a contract, but then they find they can't stand rehearsing in the same place all the time, playing at Maida Vale for an invited audience. The Wanderlust is in the blood of the British musician; it's an entirely different psychology." Diplomatically, Lawrence does not point out that for three-fifths as many services as his London counterpart, the New York Philharmonic player makes more than twice as much money.

"I don't want to make any representation that I know any of the answers," says Phil Siper. "I would like to say I know something about it, but after thirty-four negotiations I have to say I don't." Schuyler Chapin, looking forward to negotiations in which the Met will insist on cutting at least four weeks off the fifty-two-week contract, says glumly, "The answer may be that there isn't any answer." To meet the obligations incurred in their new contracts, the New York Philharmonic must raise annual contributions of at least \$2 million a year and the Chicago Symphony probably needs \$3 million a year—more than either has ever been able to raise before. They can of course stay alive by pledging and then expending the endowment funds raised with the Ford Foundation matching grants program of 1966, which are released from legal restrictions in 1976—but the end of that process is asphyxiation by a deficit not even a government would assume.

Meanwhile, the City Center situation is truly desperate. It is hard to be sympathetic with Richard Johnson of the New York City Opera orchestra committee when he writes scornfully, "It is evident that the Board simply doesn't want to raise more money, and has decided to put a stop to the improvement of conditions which musicians rightfully demand." There is no reason to believe that the City Center board *can* raise more money. "How can we prove that we mean it?" Martin Segal inquires. "By closing the house and going bankrupt?" Siper says regretfully, "There isn't going to be any substantial new infusion of private money."

Shortly before he left the leadership of AGMA for a teaching post at UCLA, Hy Faine wrote a paper suggesting that the basis of collective bargaining between artists' unions and non-profit performing institutions was all wrong. They were not and should not consider themselves adversaries; instead, they should operate as allies against a common "enemy," the government. Any solution to what William Baumol and William Bowen of Princeton have called "the economic dilemma of the performing arts" must come from government grants.

The prospects in this direction are brighter than they have ever been before. Whatever has been cut in other areas of the federal budget, the Nixon Administration has been sympathetic to the needs of the arts: this year's requested appropriation is \$300 million, more than seven times what it was seven years ago. It is hard to get much of this money into New York, which many Congressmen consider a seat of irreligion, subversion, and un-American ideas; but even the drippings from that size budget will provide some nourishment. And the city can count on a reasonable share of the \$30 million the state government

has budgeted for its own Council on the Arts.

To date, both the National Endowment for the Arts and the State Council have talked like foundations, in terms of "seed money," "innovation," "three-year cut-offs," "special-purpose grants" and such. Unlike the British Arts Council, which routinely sets aside most of its grant for the support of the central arts institutions, they have not wished to consider themselves mere conduits from the public treasury to established organizations. "But we really went through the sound barrier without knowing it in 1970," says Eric Larrabee, executive director of the New York State Council, "with the funding of the three upstate symphonies—Buffalo, Syracuse, Rochester. All three were dead broke, in hock to the banks, their credit exhausted, and the Council decided to fund them to the extent of their deficits. We were still programed for foundation talk, but we found our discourse having less and less to do with what we were doing." This year's request to the state legislature calls for half of the grant to the Council to be spent on what the bill labels "primary cultural resources."

What the government will want in return is by no means clear. The least that can be expected is a demand for the right to appoint some members of the board of any institution that is a major beneficiary of government funds. If the unions begin to do too well in their negotiations with managements that are the recipients of substantial tax monies, one can anticipate a rather frightening insistence on approval of the budget of arts institutions by some government agency. People who cannot pay their own way are always less free than people who can. But the strikes of the fall were a demonstration that without government help the arts face a future of bitter discord and decline. Near-universal recognition of this unhappy truth—by labor, management and government—is the only real benefit anyone gained from the costs and pain of last fall. The immediately appropriate response is neither fight nor flight, but an anguished hanging on. △



The youngest protester

THE METROPOLITAN OPERA



Caballé in I vespri siciliani: the house held breathless

I vespri siciliani

Of the fifteen thousand or so performances of opera given at the Metropolitan in its ninety-one seasons, nearly one-third have come from the pen of Giuseppe Verdi. The old man and the Met have done remarkably well by each other over the years, so well indeed that the company manifestly owes the composer an occasional expedition into one of his lesser works; and regularly carries out this obligation. At times these ventures have brought both house and man unforeseen profit, for previously ill-considered scores like *Don Carlo* and *Simon Boccanegra* have been found fully worthy of incorporation in the front line of the repertory. Though that is not likely to happen with *I vespri siciliani*, given its premiere at the Met on January 31, the enterprise does honor to all concerned. The company now possesses viable and contemporary productions of the complete middle/late Verdi canon, from *Rigoletto* to *Falstaff*, in addition to three or four of the earlier works. Over a span of five years or so, the assiduous Verdi-collector should thus

be able to attend sixteen of his twenty-six operas. There are few other cities in the world where that would be possible.

Vespri has always been a problem opera, a reflection of the composer's disenchantment with the circumstances of the Paris commission of 1855. Confined by the five-act tradition of the Opéra, fobbed off by Scribe and Duveyrier with a libretto originally cobbled for Donizetti, the result was a dark and harsh theater piece with a lumpy and bumpy score, in which the ratio of gold to base matter was far below the composer's proven capacity. Nevertheless there are substantial nuggets: an incomparable aria for basso, a tenor aria of the first water, and one no less worthy for baritone, two luxurious extended melodies for the soprano, and much powerful ensemble-writing. The plot centers upon a thirteenth-century nationalist uprising by Sicilian patriots against their French oppressors, in which the young Sicilian hero Arrigo turns out (by one of those bolts of coincidence that seem to strike in opera and nowhere else) to be the son of the French commander. The heroine

(Elena) is a noblewoman committed to the Sicilian cause. To complete the quartet of principals we have Procida, a ruthless and unidimensional partisan leader. The opera ends with the locals massacring the French soldiers on stage, the signal for their attack having been the church bell sounding for the wedding of Arrigo and Elena.

Productions of *Vespri* on other stages have emphasized its period color and southern geography, but this is decidedly not the approach of producer John Dexter or designer Josef Svoboda in the new Metropolitan version. This is a monochrome production, its modular set dominated by a vast row of steps reaching from floor level to photographic infinity, the light beating down on the action from above. A few massive architectural elements convert town square to governor's patio to prison interior to church façade. Upon this severe frame Dexter moves both principals and crowd with fluid precision. Jan Skalicky's costumes also are colorless to the point of drabness, a few bold designs distinguishing Sicilians from Frenchmen. The effect is geometric, confining, oppressive—and there was talk in the lobbies at intermission of the Bayreuth style, and whether it was appropriate to a Meyerbeerian grand opera. I cannot say I liked it all, but I certainly admired the work of Dexter and Svoboda for its combination of boldness with economy, its internal consistency, its ingenuity. Certainly there is no trace of the old mindless Met opulence, the splash of money in place of skill—and for that one is thankful. Yet it has also to be conceded that *Vespri* is gloomy and severe enough in its action and music to have warranted a little more visual relief than producer and designers were apparently willing to supply.

The stark tableaux may also have helped to camouflage certain theatrical shortcomings on the part of the main performers, all of them accomplished singers, none of them outstanding actors. Montserrat Caballé fitted well into the general scheme, her customary semaphoric style of gesture (when it's not ten of two then it's twenty past eight) mitigated by the visual weight of the scenery. Vocally, the Spanish lady was having a superlative evening, holding the house breathless with her matchless

purity of tone and her command of the half-voice. In the prison scene she negotiated the precipitous descent from a high B down through more than an octave during "*Ah, parli a un core,*" spinning a gleaming *pianissimo* filament as only she can. The house exploded with cheers, sustained them for a seeming eternity until the diva finally raised a restraining hand to the audience and the scene went on. If she was not quite vivacious enough in "*Merce, dilette amiche*" (the pre-nuptial Bolero in the final scene) Miss Caballé nonetheless provided throughout the kind of controlled, masterly singing of which legends are made.

Not quite so happily cast was her partner, Nicolai Gedda, in the hero's role. Normally a singer of the utmost reliability, he seemed on this occasion to be forcing his voice, even in the normally brilliant high range that he possesses so notably. The terminal B natural in "*Giorno di pianto*" was not a happy sound. Nevertheless, Arrigo has a great deal of work to do in this opera, and Mr. Gedda did much of it very well indeed.

Sherrill Milnes placed his ample baritone and strong physique at the disposal of the role of Monforte, French captain and Arrigo's father. He looked good, moved with restraint (something he doesn't always do), and for the most part sounded in firm control. But, and I am not alone in noting it, some of the bloom has vanished from the low and middle register of late. Perhaps the prescription is a less demanding schedule of performances and a more careful selection of therapeutic roles: his is too valuable a voice to lose.

Powerful and sonorously secure was Justino Diaz, who gave full weight to Procida's famous aria "*O tu Palermo.*" It is good to have him back in the house, and in such fine condition. The role of Procida permits its portrayer to offer little more than cardboard villainy, but he did that as well as possible.

This strong quartet of famous singers was firmly supported by the Met's able team of comprimarios, of whom Cynthia Munzer, Nico Castel, and Andrij Dobriansky deserve special mention. The chorus, newly challenged by unfamiliar music and newly trained in it, proved in every way estimable. So did the orchestra.

My admiration for James Levine's excellence as a Verdi conductor this

night reached a new plateau. He sometimes drives things rather hard for singers, taking a "symphonic" view of such operas as *Otello*. That approach would have done damage here, for it would have emphasized the raw and rhythmically angular aspects of Verdi's writing. Instead Levine gave us every possible lyrical value that could be drawn from the music, emphasizing the long melodic lines wherever they could be found. To have done this without loss of tension or sonority is the mark of a notable intelligence and a cultivated ear. Levine has both.

I vespri siciliani, as given at the Met, has a number of small cuts and one big one: the extended "Four Seasons" ballet has been eliminated. Even so, it makes for a long and (given the production style) fairly severe evening. Nevertheless, there is a great deal to both the work and to this controversial production, more than enough to reward those willing to dig into unfamiliar Verdi with a questing and open-minded spirit.

Tristan und Isolde

Not since Flagstad and Leider has there been an Isolde to compare with Birgit Nilsson. She has been singing the part for more than fifteen years, in every major opera house. Not since Melchior and Lorenz (and maybe Vinay on a great night) has there been a Tristan to compare with Jon Vickers. He first took up the role three years ago and carefully rations the number of Tristan engagements he accepts.

So the great coup for present-day Wagnerites has been to catch the two giants together, under the same roof, in a performance of Wagner's love story. The first chance to do that came in Europe last summer, during a single offering at the Orange Festival, conducted by Karl Böhm. Since then Nilsson has partnered other tenors, Vickers other sopranos. It follows that the merest hint that both would be together at the Met for the *Tristan* of January was enough to sell out the house weeks in advance, by mail-order. The ticket-holders were not disappointed. Few asked for their money back. They were present at an unforgettable, red-letter night, an account of the opera in which the two principal roles were for once in superb balance, each artist secure and strong and joining with the other on a

basis of equality. That was a phenomenon unequaled in my twenty-two previous hearings of the opera.

It was not, to be a little ruthless about matters, one of Nilsson's greatest nights—though even middle-notch Nilsson is more than you'll get from anyone else. There were a few rough patches in the first act and some insecurity of pitch at the beginning of the *Liebeshod*. But she did some beautiful, feminine singing in the second Act and brought the steel into play precisely where it was needed. The serene beauty of the blend is still in my ears.

Vickers was a Tristan to dream about. The firm, always musical, indisputably manly voice, caressing Wagner's cadences, spinning the long and cruel lines (as I have always hoped to hear them sung) was the realization of a search that has lasted two decades. I can at last banish from the aural memory a dozen less worthy aspirants, replacing all their efforts with the noble and sonorous music that Vickers has given us.

Both artists took on a positive charge from the ambient electricity in the house, for it was an audience predisposed to make a historic performance. The radiations touched William Dooley too, for his Kurwe-

Continued on page MA-36



Nilsson: today's greatest Isolde

CALIFORNIA

MUSIC AT THE VINEYARDS. Saratoga, June 22–August 25. Sandor Salgo, music director. Scheduled performing groups include the Festival Wind Ensemble, the San Francisco Vineyard Ensemble with soloist Stuart Canin, and the Los Angeles String Quartet in the performance of a world premiere.

MASSACHUSETTS

COLLEGE LIGHT OPERA COMPANY. Falmouth, July 2–August 31. Robert A. Haslun, general manager. The season schedule includes operetta and Broadway classics performed by a company of college students from various schools throughout the country. Performances are held in the Highfield Theater.

MINNESOTA

CARLETON SUMMER MUSIC FESTIVAL. Northfield, June 14–18. William Wells, director. The first annual Carlton College Festival will present the Philidor Trio in concert, workshops, and master classes. Works to be performed by the festival chorale and orchestra include Crumb's *Ancient Voices of Children* and Purcell's *The Fairy Queen*.

NEW HAMPSHIRE

NEW HAMPSHIRE MUSIC FESTIVAL. Center Harbor, July 7–August 17. Thomas Nee, musical director. The season includes children's concerts, three weekly chamber concerts, the festival orchestra with soloists, a week of opera, and the festival chorus under Joel O. Johnson's direction.

NEW MEXICO

SANTE FE CHAMBER MUSIC FESTIVAL. Santa Fe, June 30–August 4. Artists returning to the festival's second season will be cellist Claus Adam, violist John Graham, pianist and founder Alicia Schachter, and violist Eudice Shapiro. New to the program are flutist Frank Bowen, oboist Darrell Randall, and the Arriaga quartet. All concerts are held on Sundays at 6 pm.

SANATA FE OPERA. Santa Fe, July 5–August 24. John Crosby, general director. Operas scheduled this sea-

FESTIVALS, PART III

Herewith the final segment of our survey of summer music-making

son are *La Bohème*, *The Magic Flute*, Offenbach's *La Grande Duchesse de Grolstein*, Berg's *Lulu*, and the American premiere of Cavalli's *L'Egisto*.

NEW YORK

CHAUTAUQUA FESTIVAL. Chautauqua, June 27–August 25. Oscar E. Remick, president and program director. Guest artists participating in Chautauqua's centennial season will be Boris Brott, Everett Lee, Marilyn Horne, Leonard Rose, Earl Wild, Natalie Hinderas, Claudette Sorel, Bunyan Webb, George Shearing, and Clara Siegel. Special events include the world premiere of Seymour Barab's *Philip Marshall*, a joint recital by Richard Tucker and Robert Merrill, Virgil Fox and the Revelation Lights, and the National Band of New Zealand.

PENNSYLVANIA

TEMPLE UNIVERSITY MUSIC FESTIVAL AND INSTITUTE. Ambler, June 28–August 11. David Stone, artistic director. Joining the in-residence Pittsburgh Symphony will be Phyllis Curtin, Earl Wild, Eileen Farrell, Nikolais Dance Company, Moiseyev Dance Company, Mignon Dunn and Richard Cassily in Bizet's *Carmen*, Yehudi Menuhin, New York Chamber Soloists, Alicia De Larrocha, Philipp Hirshhorn, Alfred Brendel, Jaime Laredo, and John Alexander. There will also be folk and ethnic concerts by local groups and international

groups on tour under the auspices of the Smithsonian Institution.

RHODE ISLAND

RHODE ISLAND BACH FESTIVAL. Providence, May 7–10. Ronald Morris, guest conductor. In addition to a performance of the *Passion According to Saint Matthew*, there will be a special cantata evening and instrumental evening. Soloists appearing with the Rhode Island Civic Choral and Orchestra will be Carole Bogard, John Aler, Rose Taylor, Timothy Holley, and Robert Van Valenberg.

TEXAS

SOUTHERN METHODIST UNIVERSITY SUMMER SEMINARS. Dallas, June 3–August 3. Eugene Bonelli, chairman. The schedule includes a choral conducting symposium with Lloyd Pfautsch, the annual Big D Music Camp with Clarence Sawhill, guitar workshop with Robert Guthrie, piano workshop with Lynn Freeman Olson and Thom David Mason, international organ-harpsichord seminar with Jean Guillou and Isolde Ahlgrimm, piano masterclasses with David Bar-Illan, the Dallas Symphony, masterclasses in voice with Thomas Hayward, and the tenth annual music education workshop.

VERMONT

MOZART FESTIVAL. Burlington, July 21–August 3. Melvin Kaplan, festival director; William Metcalfe, Mozart

Institute director. In conjunction with the University of Vermont music department, the first annual Mozart Festival will be held for the study (Mozart Institute) and performance of Mozart's works. Guest artists will be the New York Chamber Soloists and the Fine Arts Quartet. The University Choral union will be conducted by Dr. James Chapman.

VIRGINIA

WOLF TRAP FARM FOR THE PERFORMING ARTS. Vienna, June 17-September 9. John M. Ludwig, general director. The opening week of the festival will feature Metropolitan Opera performances of *Carmen*, *Don Giovanni*, *Turandot*, *Der Rosenkavalier*, and *Madama Butterfly*. Soloists will be Marilyn Horne, James McCracken, John Reardon, Lucine Amara, Thomas Stewart, Evelyn Lear, Roberta Peters, Teresa Zylis-Gara, Franco Corelli, Walter Berry, Judith Blegen, Rosalind Elias, Pilar Lorengar, John Alexander. Conductors will be Henry Lewis (*Carmen*), Max Rudolf (*Don Giovanni*), Gabor Otvös (*Turandot*), Jan Behr (*Madama Butterfly*). Additional performances at Wolf Trap will be symphonic, chamber, band, choral, jazz, folk, pop, and dance.

WASHINGTON

TAMARACK MUSIC FESTIVAL. Cheney and Spokane. June 24-July 6, Donald Thulean, artistic director; Wendal Jones, executive director. Appearing with the Spokane Symphony will be pianist Garrick Ohlson, French hornist Charles Kavaloski, and the Modern Jazz Quartet. Workshops by visiting artists and the High School Creative Arts Session will be held at Eastern Washington State College; major concerts will be held at Expo '74.

WISCONSIN

PENINSULA MUSIC FESTIVAL. Fish Creek, August 10-24. Thor Johnson, music director. Featured soloists are pianists Leonard Pennario, Eugene List, Robert Silverman, and Mary Sauer; others include Carrol Glenn, violinist; Teresa Seidl, soprano; Brad Lieble, baritone, and soprano Patricia Brooks of the New York City Opera. The annual Bach concert is August 14.

STRATFORD MUSIC FESTIVAL

Stratford, Ontario, Canada
June 27-September 1, 1974

RAFFI ARMENIAN, Music Director • **STUART KNUSSEN**, Music Administrator

OPERA *The Medium, The Summoning of Everyman*

OPERETTA *La Vie Parisienne* (performed in English)

CONCERTS Maureen Forrester, John Lill, Trio di Trieste, Barry Tuckwell, Michael Tilson-Thomas and the Buffalo Philharmonic Orchestra, et al.

MASTER-CLASSES Maureen Forrester (Lied interpretation), Stuart Knussen (double bass), Ray Still (oboe)

Write or phone for brochure:
Stratford, Ontario, Canada
tel.: (519) 271-4040



KÄBI LARETEI, pianist

- Has performed with Georg Solti, Antal Dorati, Sixten Ehrhng, Charles Munch, Karl Münchinger, Dean Dixon, and Robert Craft.

- Has been hailed by composers Igor Stravinsky and Paul Hindemith.

BENN CLAY MANAGEMENT 200 Park Avenue, Suite 303 East, New York, N.Y. 10017 — (212) YU 6-2515

ORGANS

RODGERS

The Rodgers Organ Company,
Builders of the world's most authentically voiced electronic organ
and exclusive representative for

ORGANS

Ruffatti

Fratelli Ruffatti of Padua, Italy,
World's most distinguished pipe organ builders

ORGANS

For free information, write: **RODGERS ORGAN COMPANY**
Department AB, Hillsboro, Oregon 97123

debuts & reappearances

BATON ROUGE

Baton Rouge Sym.: Korn premiere

Peter Jona Korn was on hand to receive a standing ovation when the Baton Rouge Symphony performed his Concerto for Violin and Orchestra on January 16, with Peter Paul Fuchs conducting and the young violin virtuoso Zina Schiff as soloist. This exciting new work received its United States premiere performance and won its approval before a large and enthusiastic audience. It is difficult to determine how much excitement was generated by the composition itself, by the virtuosity of Miss Schiff, or by the orchestra. All in all it was an impressive combination.

Korn combines many of the compositional techniques of the twentieth century with modal, nationalistic tunes, punctuated by a strong rhythmic drive. All of these techniques he uses in a personal manner that creates a strong aura of Romanticism. This three-movement work, alternating moods of excitement and tranquility, uses various timbres to create moods. The solo passages leap out from climaxes created by strong, dissonant rhythmic motives, or they glide out of sparse textures that are limpid and rhapsodic. In the last movement an awesome final climax was reached by the "piling-up" of a four-note rhythmic motif. Miss Schiff, obviously in accord with the composer's style and intent, enhanced the first U.S. hearing of this work with her dazzling technique and her devoted attention to the score.

ALDRICH ADKINS

CHICAGO

Chicago Sym. (Ajmone-Marsan)

Guido Ajmone-Marsan, the twenty-six-year-old Italian who won the first (so far, the only) Sir Georg

Solti Conducting Competition here last season, reaped one of his rewards the second week in January when he directed the Chicago Symphony Orchestra in its first subscription set of the new year. The slender, wiry leader, whose podium manner recalls that of the younger Ozawa, rekindled doubts as to the validity of contests for aspiring maestros. To the onlooker, Ajmone-Marsan's baton technique might have seemed convincing. It evidently didn't convince the Chicago instrumentalists, who slid into sloppy attacks, wrong notes, and even bad intonation during a program of music by Weber, Rachmaninoff and Walton.

In Weber's Overture to *Euryanthe*, the conductor tried to be a symphonic dramatist, but ended up with a manic reading in which furiously fast sections bore no relation to super slow ones. Pianist Gary Graffman lent dignity and elegance to the solo lines in Rachmaninoff's *Rhapsody on a Theme of Paganini*. Ajmone-Marsan, however, refused to listen to Graffman's tempos and took off at his own paces, leaving the badly balanced orchestra foundering somewhere in the middle. Sir William Walton's First Symphony, which received its first American performance in Chicago in 1936 under Sir Hamilton Harty's baton, suffered from rhythmically flaccid direction. More than anything, this work needs rhythmic and kinetic drive. It got, instead, mushy articulation, careless treatment of dynamics, and formal incongruity.

KAREN MONSON

Chicago Sym.: Karlins premiere

M. William Karlins, a member of the Northwestern University music faculty, claims the singular if in some ways dubious distinction of being the only living American represented on the subscription programs of the Chicago Symphony's eighty-third year. His *Concert Music No. 5*, which received its premiere last December 20,

was arranged for and presided over by associate conductor Henry Mazer. The eleven-minute work, dedicated to the memory of the composer's mother, augments the usual contingent of symphony players with three saxophones and extra percussion. The six connected parts of *Concert Music* compare and contrast the sounds of the orchestra's various sections, which stay almost snobbishly segregated. Through a lengthy *accelerando*, brass, winds, strings, and percussion engage in separate games of musical tag with lively, harmonically derived lines of imitation.

Concert Music No. 5 reaches a ringing climax, then fades into a minute-long neo-romantic epilogue for oboes and English horn supported placidly by the strings. The engaging effect of the new opus was well set off by Mozart's *Coronation Piano Concerto* (with Jean Bernard Pommier) and Shostakovich's 15th Symphony (in its Chicago premiere), which completed the program.

K.M.

DALLAS

Ginastera premiere: Quartet No. 3

On February 4, Dallas was the site of the premiere of Alberto Ginastera's new Quartet No. 3 for Soprano and Strings. The piece was commissioned seven years ago by the Dallas Chamber Music Society (which provides the city with some of its best evenings of music making) and the Fine Arts Division of the Dallas Public Library. The commission was a memorial to the late critic of the *Dallas Morning News*, John Rosenfield, who died in the fall of 1966. The performers on this occasion were Benita Valente and the Juilliard String Quartet.

In many ways this latest work is virtually a summary of the reasons why Ginastera persists as one of the major voices in contemporary music. The quartet communicates strongly and unerringly. In it, Ginastera

thinks and acts dramatically, even theatrically, to establish moods, conjure atmospheres, involve a listener. It is not by chance that the Third Quartet includes poetry and a singer, for Ginastera's finest writing has been triggered by words, by the capacity of the human voice to give life to thoughts. Beyond this, he has a rare feeling for using a voice to expressive ends; he understands the power and possibilities in singing as few others do today. Benjamin Britten and Michael Tippett come quickest to mind as his peers in this regard.

The Third Quartet employs poems by Juan Ramon Jimenez (a sensual ode to music and, later, what strikes me as a further paean to the art), Federico Garcia Lorca (in praise of physical love), and Rafael Alberti (a stark meditation on death). Taken as a whole, the two poems on music seem to form a parenthesis about the two essentials of life—loving and dying. The poems are used in four of the work's five movements (the second movement, a quasi-scherzo, is all instrumental), and the vocal settings are intensely lyrical with sung and spoken lines interspersed. Taken as a whole, the piece is very sequential in design—form and organization are present, of course, but the architectural feeling is loose, even improvisatory.

The quartet's moods are many and varied, from the emptiness of the opening—a section of cold, hard beauty—to the nightmarish whispers and outcries of the scherzo, the warm sensuality of the third movement (literally and figuratively the heart of the piece), the violence of the commentary on death, and a return to the original stance. It is a quartet only in its instrumentation and in a highly personal sense. But such is the way in composition today; traditional formal designations—quartet, sonata, symphony—are tags now which identify music only in the most general terms. There is nothing wrong with this; it is an evolutionary factor which bespeaks the freedom of action and expression possible in our time. In the case of the Ginastera, we have an expression of penetrating originality and a compelling dimension of design.

I cannot say with any degree of authority, after one hearing, how well the Juilliard Quartet and Miss Valente served Ginastera, but I do not

AIX^{en} Provence July 10-31

FESTIVAL INTERNATIONAL D'ART LYRIQUE

Operas: MOZART: Schauspieldirektor-Pergolèse: Serva Padrona
3 new productions VERDI: Luisa Miller
12 performances MOZART: Clemenza di Tito

Concerts: E. AMELING • M. CABALLE • P. LORENGAR
 B. NILSSON • E. SCHWARZKOPF • T. TROYANOS
 J. VEASEY • S. BURROWS • H. CUENOD
 G. SOUZAY • E. TAPPY

Conductors: J.C. CASADESUS • C. DAVIS • A. EREDE • A. LOMBARD
 G. MASINI • L.v. MATAVIC • M. PLASSON • K. REDEL

Orchestras: Orch. de Paris • Orch. O.R.T.F. • Orch. Monte-Carlo
 Orch. Opera du Rhin • Orch. "Pro Arte"

Reservations: Festival Office, Palais Archevêché 13.100 Aix-en-Provence
 Cable: Festivalaix • Phone: 26-34-82

U.S. Agencies: Mayfair Travel Service 119 W. 57 St., N.Y. 10019
 Study Abroad Inc. 250 W. 57 St., N.Y. 10019



**festival
 estival
 de paris**

Directors:
**Jean Louis Petit
 Bernard Bonaldi**

Apply for information:
**5 Place des Ternes
 75017 Paris**

PARIS SUMMER FESTIVAL

- INTERNATIONAL MUSIC CRITIC'S COMPETITION
- INTERNATIONAL GUITAR COURSE
- HARPSICHORD FORUM
- 70 EVENTS
 (Concerts, ballets etc. . . .)

July 15—September 23, 1974

SAMUEL MARGOLIS

Teacher of **ROBERT MERRILL**, leading baritone Metropolitan Opera (his only voice teacher), **JEROME HINES**, leading bass Metropolitan Opera, as well as many other leading singers of the Metropolitan Opera.
 205 West 57th Street, N.Y.C.
 COLUMBUS 5-9155

**next month in
 musical america**

Conrad L. Osborne on
 a "new thing" in
 opera production
 Houston's "Seagull"

hesitate to say that they thoroughly convinced and involved me. And there is no doubt how superbly the Quartet filled with life the Mozart Quartet K. 548 and the Brahms First Quartet which flanked the evening's premiere.

JOHN ARDOIN

LOS ANGELES

L.A. Phil.: Berio, Berberian

The Los Angeles Philharmonic promised three contemporary B's and the U.S. premiere of Luciano Berio's *Folk Songs* (1964) in its orchestral arrangement (1973). But nothing was so easy as the promising. Guest conductor Berio and French pianist Michel Beroff arrived onstage at L.A.'s Dorothy Chandler Pavilion as planned, Thursday night, January 31. Avant-garde soprano Cathy Berberian, plagued by the flu, did not. The substitute for Miss Berberian and *Folk Songs*? Nothing less than an old B—Bach's first *Brandenburg Concerto*—hastily assembled in a performance of elephantine weight and haphazard ensemble. Finally, two nights later in Pasadena's Civic Auditorium, Miss Berberian and *Folk Songs* supplanted Bach.

There is, thankfully, no loss of intimacy in Berio's new, larger accompanimental arrangement. Its major gain will probably be in the acquisition of the symphony-oriented audience. Its principal musical advantage seems to be the reinforcement of interludes and the more conclusive drawing together of such diverse items as the spare *Black Is the Color*, the hearty Armenian *Loosin yelav*, the mournful Sardinian *Motettu di tristura* and the whimsical Azerbaijan *Love Song*. Although lacking her customary technical flexibility, Miss Berberian met the eleven songs' coloristic and dramatic challenges head-on, her quick changes from straight-voiced innocence to coloratura coquetry to chest-toned boldness most convincing.

Elsewhere in both concerts, Bartók's Second Concerto displayed Beroff's dazzling pianism; Bruno Maderna's gently pointillistic *Serenata No. 2* (1955) memorialized the late composer (originally scheduled to conduct this engagement); and Berio's and Maderna's *Divertimento* (1957) offset Maderna's brass-

stabbed *Dark Rapture Crawl* and Berio's *Scat Rag* and *Rhumba-Ramble*.

MELODY PETERSON

U.C.L.A.: "Scarlet Mill"

Thanks to the enterprising Opera Theater of the University of California at Los Angeles, composer Eugene Zador's *The Scarlet Mill* made its first West Coast appearances, February 6, 7, and 9 in UCLA's Schoenberg Hall. Based on Ferenc Molnar's *Varos Malom*, *Mill* is set in hell where an appropriately malevolent Professor attempts to hasten the corruption of mankind by means of a new-fangled invention (the mill of the title). George Jelinek's English libretto sets a swift, sardonic first-act pace as the Professor and his devilish accomplices search for an honest man. Act II, however, lacks the same verbal punch, exchanging much of its wit for moralizing as the machine's first victim, Janos, faces the temptress puppet Mara, a quartet of her demonic companions, and presto-chango, Sin. As the libretto goes, so goes the opera. In Act I, Zador provides incisive musical interplay for the conspirators and a fascinating introductory scene for the purposefully changeable Mara. In Act II, the composer's rich harmonies and felicitous, folk-tinged melodies continue. Their impact is lessened, however, by the shift of dramatic focus from colorful villains to a hero so noble he's boring.

In the performance of February 9, baritone Bill Miller offered a clear-voiced, credibly boyish Janos; Alma Piazza turned a honeyed soprano to marvelous seductive purpose as Mara; tenor Robert Mazarrella mixed vocal flint and superb diction for a commanding Professor; and soprano Judy Mazarrella issued a serviceable Ilonka (Janos' wife). Bill King's sets—smoke-belching mill, high-rise Satan's throne and all—were neatly tailored to a modest stage. Gail Bixby's costumes bespoke magic and malice in clean-lined, sometimes-sparkly, red-gray-black combinations. John Hall's stage direction proved inventive and thoroughly efficient. In the pit, Zador's music—string-rich and gilt-edged with cimbalom—received the expert ministrations of conductor Jan Popper and a very responsive American Youth Symphony. M.P.

MILWAUKEE

Milwaukee Sym: Moevs premiere

From modern America's heartland to eighteenth-century Austria, music's boundaries of time and culture are bridged in Robert Moevs's *Main-Travelled Roads*, which received its premiere here on February 9 by the Milwaukee Symphony Orchestra. The work was commissioned by the Wisconsin American Revolution Bicentennial Commission and the orchestra's Women's League.

Moevs (pronounced Maves), who teaches at Rutgers University, is a native of La Crosse, Wisconsin, and he borrowed his title from a collection of stories called *Main-Travelled Roads* by another Midwesterner, Hamlin Garland (1860-1940), who spent much of his own youth in the La Crosse area. However, the pathways that primarily concern Moevs here are neither literary nor geographical, but musical. Today's composers, he believes, have wandered from the great highways built up from Haydn and Beethoven. They have cut themselves off on byways that can lead only to a dead end.

So *Main-Travelled Roads*, which actually picks up the thread of three *Symphonic Pieces* that Moevs wrote for the Cleveland Orchestra in the Fifties, aims at a reconciliation between tradition and currency. "What better medium is there to establish this rapprochement," Moevs asks, "than the symphony orchestra?" In its ten-minute course, *Roads* bows to Haydn with a characteristic adagio introduction, which gives way to a brightly paced, if rather freely spun, sonata form. To this traditional shape is applied a modern dress highlighting serialized patterns woven from material common to both eras—the diminished seventh chord.

Conductor Kenneth Schermerhorn gave this outwardly contrived scheme a sympathetic realization. Moevs's agile handling of large orchestral forces carried one's attention along on a sparkling variety of sonorities when, even in this brief space, his musical invention fell into question. But the composer's coloristic gift is undeniable, and in that he was well served by the Milwaukee Symphony's polished execution.

LAWRENCE B. JOHNSON

NEW YORK

Boehm Quintette

American composers have almost by themselves created a body of literature for the woodwind quintet. The Boehm Quintette, named after the great inventor and perfecter of woodwind instruments, appropriately devoted its 1974 Carnegie Recital Hall series to American music. Their too sparsely attended concert on January 21 featured those conspicuous stylistic traits of "American" music: tonal or nontonal neoclassicism with its fugatos and bouncy polyrhythms. Of the quintets by Alvin Elter, Bernhard Heiden, Michael Colgrass, and David Diamond, the last two broke most successfully with the stereotyped American woodwind quintet.

Diamond's first-class work, dating from 1958, displayed both humor and profundity, but always great dignity. Clear and interesting textures permitted rhythmically differentiated musical materials to be heard; it had lots of breathing space. One secret of success in writing for this difficult medium seems to be putting in enough rests! Michael Colgrass, the Boston-based composer, achieved notoriety first from his skill in handling percussion instruments. We can see this influence in his fine *Woodwind Quintet* (1962). He stresses the effect that the sound conglomerate of the five woodwinds can produce, rather than emphasizing the instruments' individual characters through melodic writing. The piece was refreshingly unquintetlike, bearing the marks of Colgrass's twittering, nervous, non-linear style.

As soloists, the members of the Boehm are not spectacularly distinguished. But the group played with fine ensemble, though sometimes at the expense of a suave over-all tone and more subtle dynamic shading. Most apparent and much appreciated, however, was the obvious dedication they showed to the music they chose, a trait too often neglected in many performances of contemporary music these days. BRUCE SAYLOR

Bronx Opera: "Albert Herring"

For its most recent production, the Bronx Opera Company chose Brit-

Continued on next page

22nd ANNUAL PENINSULA MUSIC FESTIVAL

DR. THOR JOHNSON, MUSICAL DIRECTOR-CONDUCTOR

August 10-24, 1974—Fish Creek, Wisconsin

Symphony Orchestra with soloists:

Pianists: Leonard Penario, Eugene List, Robert Silverman, Mary Sauer; Sopranos: Patricia Brookes, Teresa Seidl; Violin, Carroll Glenn; Baritone, L. Brad Liebl; Harpsichord, George Lucktenberg.

Information and tickets address:

Peninsula Music Festival, Ephraim, Wi. 54211

The Mannes College of Music

John Goldmark, *President*
David Tcimpidis, *Dean*

157 East 74th Street, New York, N.Y. 10021



(212) 737-0700

Bachelor of Science Degree • Bachelor of Music Degree
Diploma • Post Graduate Diploma

Extension Division • Opera Workshop

The Mannes Preparatory School (ages 4-18)

Full and partial scholarships available

catalog upon request

Rachel, La Cubana (NET Opera)



Hans Werner Henze has been, in recent years especially, something of an enigma. His conversion to religion (Marxism) has been looked on with some suspicion, and informed opinion seems thoroughly divided as to whether he is an opportunistic lightweight or a major composer—more divided than with any other composer.

On the evidence of *Rachel, La Cubana*, a ninety-minute "vaudeville with music" commissioned for the WNET Opera Theater (it was shown on the PBS network March 4), the former group would have the case, for *Rachel, La Cubana* is a thudding dud.

It should be said that executive producer Peter Herman Adler and his WNET Opera Theater company are to be congratulated on their policy of commissioning works, for it is all too easy to revive the classics; and every commissioned work is not going to be successful. But *Rachel's* failure stands all the more glaring in the company of Henze's *The Young Lord* or *El Cimarrón*, which, whatever their faults, are works of far greater artistic worth.

The story, according to librettist Hans Magnus Enzensberger, is "a portrait of a republic and society turned vaudeville" that "questions the function of art in our society." It is told as the flashback memories of a three-bit concert-hall singer in Cuba, recollecting with embroidered detail her colorful past, while outside the shuttered windows of her apartment Fidel and the New Order take over. What these memories are, unfortunately, are quite predictable—it's the old femme fatale melodrama: the lovers, the broken hearts, the glitter, the fading of the career, and the final life in fantasy, as remembered (by us) from numberless B films. But here all is turned nasty, for Enzensberger has a Message. *Rachel's Fate*, he indicates, is owing not to her lesser talents but to the fact that she has been used by a tawdry and exploitive society, and her over-

Continued on next page

adulation by critics is designed as an opiate to keep the people's mind off the cancerous ills of Society. "If you drool, that's Art," Enzensberger has his Critic say.

Lying behind this, of course, is the notion that True Art must be a tool of the struggling masses, and all Art that is not is exploitive and useless fantasy. The point of view is doctrinaire Lenin, and its working-out in terms of *Rachel, La Cubana* standard agit-prop nonsense, complete with a "Greek" chorus (less Greek than Brechtian) which comments at intervals, the obese plutocrat-Senator out of George Grosz who dies (predictably) of apoplectic rage, and the penultimate scene in which the ephemeral Rachel sings her hit song "My Foolish Dream" to her adorers, oblivious to the fact that Havana is in revolt. Grosz and Brecht should not be invoked, for their talents for invention, rage, and satiric thrust (not to mention compassion) were miles beyond Enzensberger's poster art, and indeed it is sad to see Enzensberger, himself a poet and librettist of some note (*El Cimarrón*), descend to such twaddle. In the world of Brecht and Solzhenitzyn, *Rachel, La Cubana* is as meaningless an exercise as the tinsel it seeks to combat.

Henze's contribution is close to musical bankruptcy (I fervently hope because he was less than inspired by the material). It is consciously rinky-dink, in keeping with the vaudeville nature of the piece, with simple, repeated bass lines over which he spins professional counterpoint. That is not its weakness. Its weakness lies in its pathetic predictability, which at every turn invokes not Cuba but hand-me-downs from the 1920s German music hall of Kurt Weill. Nadirs of musical thought are repeatedly reached: in a scene involving the appearance of Halley's Comet over Havana, Henze's response is to use the opening measures of the *Moonlight Sonata* as harmonic ground bass; and the very last scene resurrects, so help me, the hurricane straight from *Mahagonny* with a whooshing apocalypse straight from Sergeant Pepper.

In part, the very style of the piece, which is drenched in campishness, means that there is critical ambiguity: many of the lyrics are deliberately banal, as is some of the music, presumably to reflect the music-hall atmosphere. There are also obvious touches, such as having Rachel, in one sequence, resemble the Dietrich of *The Blue Angel*, throatiness, man's clothes and all. This ambiguity, lacking the wit, precision, and deftness that redeems camp, is allied with stolid didacticism. A contempt for nostalgia and a complete lack of sympathy for any of the characters (with the possible exception of *El Cimarrón*) infuses the whole work.

The production was television oriented and quite fluid, using cross-cuts for irony and variety (Rachel singing her love songs to the cabaret mob while her lover pines away in his room), and Rouben Ter-Arutunian provided properly outsized "Cuban" sets and costumes, as if all Rachel's recollections were theatrically remembered. Lili Darvas played the speaking role of the old Rachel; young Rachel was well handled by Lee Venora (although even here the ambiguity operated: Venora doesn't have the fiery passion necessary to make the "femme fatale" character believable—why would critics and lovers go so crazy over her?—but maybe composer and librettist deliberately wanted "just a good singer" in order to grind in the bogus nature of the response). Alan Titus tripled as a portion of her various lovers. Henze himself conducted. PATRICK J. SMITH

ten's *Albert Herring*. That was both an act of courage and a gesture of self-confidence on the part of a small company which, since its inception in 1967, has stuck pretty much to standard repertory. It also served to illustrate the particular advantages a smaller company, performing in a smaller auditorium, enjoys when it presents the kind of opera intended for such circumstances. *Albert Herring* abounds—overabounds, perhaps—with "action" music whose functional aspect gets lost if one is not constantly abreast of the stage action, a problem

that must have been serious for people upstairs watching the recent New York City Opera production, but which vanished in the more intimate confines of the Hunter College Playhouse where the Bronx company gave weekend performances on January 11 and 12.

Since part of the company's function is to provide experience for a large number of singers, each production has two casts. Assuming that the January 11 cast measured up to the one I heard next day, the company is having rather good luck in its recruit-

ment of talent. As Albert, James Wilson gave a warm portrayal of the timid greengrocer who, in the space of one intoxicating May night, cuts loose from his mother's apron strings. And there was excellent singing by Eleanor Wold as the overbearing mother, Randolph Riscoll and Anita Gatti as the lovers who spike Albert's punch and send him reeling down the primrose path; DeNice Jensen as the puritanical Lady Billows; and her claque of sanctimonious friends played by Patricia Schraden, Peter Schroeder, Brian Donohue, and David Anchel. Under the direction of Louis Galterio, the cast worked constantly and convincingly as a dramatic ensemble, nobody ever slipping into buffoonery.

Michael Spierman was the expert conductor, as he has been since the time that he founded the Bronx Opera. Among the New York area's thirty-odd bush league companies, the Bronx group seems the most firmly established, enjoying such immediate advantages as a substantial-sized pit orchestra in place of the usual piano, and financial support from state and local sources.

Those advantages are traceable to the resourcefulness of the company's founder-director. The pit players, it turns out, are members of the Bronx Symphony—and Spierman, it turns out, just happens to be the symphony's maestro. Much of the financial support comes from the local board of education, a connection doubtless facilitated by Spierman's position on the Hunter College faculty. The Bronx Opera Company, in short, has what every opera company big or small dreams of having—a leader equally adept at music and business. JACK HIEMENZ



Bronx
Opera's
Albert
Herring:
convincing



Rounseville and Venora in Henze's TV vaudeville opera, *Rachel, La Cubana*

cause slavery and imprisonment have become the central concern of Hans Werner Henze's work since that time of conversion when he forswore the extravagantly sensual world of post-Straussian German opera—the world of *Lulu* and the sex-ridden *Bassarids*—and gave himself wholly to a kind of musical theater whose primary function is to awaken us to the realities of revolutionary socialism.

Henze sees slavery as the pervasive condition of capitalist society. Sometimes it comes right down to the nitty-gritty of actual chains, as in *Prison Song*, written a year after *El Cimarrón* and based on a poem by Ho Chi Minh called *The Leg-Irons*, which tells how “each night the irons devour the legs of the people” and wonders at the strangeness of “people rushing in to place their legs in irons.” Slavery can also take such various shapes as the young intellectual in *Natasha Ungeheuer* who finds his involvement in capitalism's sensual blandishments a barrier to revolutionary activism, or the vaudeville performer in *Rachel, La Cubana* whose absorption in her “art” is presented as no more worthy than

Brooklyn Academy: “El Cimarrón”

The first time you hear the harsh abrasive sound of chains in *El Cimarrón*, which had to wait until last December 29 for its New York premiere, the effect is virtually magical. Were Hans Werner Henze to be the purveyor of graceless, spiritless, socialist agitprop that his detractors insist he indeed has become, his introduction of chains into *El Cimarrón*'s sparse sonic network would have been predictable, and should have occurred at that point in the text where the African-descended Cuban Esteban Montejo, recalling his early years as a slave, tells how his first attempt at escape, at age ten, got him a beating with a chain—a beating that even now, in his 104th year, he can still

feel. This would have been the obvious place for Henze, so-called seeker of simplistic effects, to have introduced the sound of chains. Instead, he waits until the following section, where Esteban, describing the daily routine at the sugar plantation, tells how “Every morning at half-past four the overseer rang the Ave Maria.” Then comes the rasping commentary of the chains, like a cadence. Further on we are told how at the end of a workday, “They rang the prayer bell”—and once again we hear the chain's lashing mockery.

Ave Marias, prayer bells, chains. The church in *El Cimarrón* is seen just as the church in Luis Bunuel's films—as a tool of capitalist oppression, and the point is put over with a ghoulish humor miles away from the simplicity of agitprop, far closer to the overheated decadence of Berg's *Lulu*. Only once more, in the next section, *Flight*, are the chains put to use: they rattle when Esteban, determining to break for freedom, feels a burning rage; and they are hurled crashing to the floor as he tells of smashing a rock into the overseer's face.

That, so far as actual use is concerned, is *El Cimarrón*'s total use of chains: hardly thirty seconds in a work lasting nearly an hour and a half. And yet, as you leave the theater, it is the chains you most remember—not merely because of their shock value, but more, I suspect, be-





MUSIC EXPERIENCE

1974

Western Reserve Academy
Hudson, Ohio 44236

William Appling, Director

— for high school music students, admission by audition

Six weeks of concentrated music study in conjunction with the Blossom Festival season of The Cleveland Orchestra

Private Lessons: Taught by members of The Cleveland Orchestra and faculty members of the Oberlin Conservatory, Cleveland Institute of Music and the Firestone Conservatory

Ensemble Participation: Orchestra or chorus

Chamber Music Study: Coached by professional musicians

Classroom Study: Music theory and literature

Blossom Music Center: Attendance at all festival concerts and some rehearsals

Visiting Artists: Opportunity to meet and talk with prominent performers and conductors such as: Robert Shaw, Seth McCoy, Alice Parker, Aldo Ceccato, Andre Watts, Claude Frank, Penelope Jensen, Louis Lane, and Lorin Maazel

Dates: July 10 through August 21, 1974

Place: Students live and study on the campus of Western Reserve Academy, a private preparatory school in the village of Hudson, Ohio

Cost: Tuition of \$735 covers all costs for resident students

Scholarship assistance is available

For further information write to: David W. Judkins
Assistant to the Director
Summer Music Experience
Tomlinson Hall
10900 Euclid Avenue
Cleveland, Ohio 44106

or call: (216) 791-0642

her activities as courtesan.

Above all, Henze is fascinated by the slavery of musicians; in interviews he will angrily cite the example of Bach writing pleading letters to his patrons to bolster his contention that the history of musicians has been the history of lackies. That conviction is the root of the kind of dramatic music he has now taken up in place of opera—something he calls “action music,” in which the musicians themselves are part of the dramatic action.

What it comes down to, perhaps, is a reversal of that cliché in decadent theater where the people onstage are so involved in self-gratification that they have no interest in what's happening in the world outside. To cite *Lulu* again, there's a recurring joke where somebody dashes in to tell of the outbreak of revolution in Paris, news that goes virtually unheard by the other characters. Henze has taken that theatrical convention and turned it inside out. Now it's the revolution that is stage center, with the forces working against it out in the periphery, more often than not represented by the musicians. Hence the three musicians in *El Cimarrón* will simulate the evil spirits who terrify Esteban in the forest; a glissando on a marimba becomes a deluded cry of liberation; and a harmonica comes to represent the invading Yanks. In the twelfth section, *The Battle of Mal Tiempo*, the instrumentalists are directed to become actors, to make battle noises, to engage in highly animated choreography.

The “action music” concept in *El Cimarrón* isn't nearly as highly developed as it was to become in *Natasha*; nonetheless, *El Cimarrón* is probably Henze's most successful experiment in this form. How lamentable that so important and effective a work, first presented in 1970, had to wait until now to be heard in the New York area. Its appearance was part of the Festival of Modern Combos put on at the Brooklyn Academy of Music under the auspices of Lukas Foss and the Brooklyn Philharmonia, an orgy of small-ensemble modern works which began at 6:30 and extended beyond midnight. Baritone Julius Eastman, who has become one of contemporary music's more formidable specialists, handled the narrator part to a fare-thee-well, and the expert instrumentalists were Eberhard Blum, flute, Stuart Fox, guitar, and Dennis

Kahle, percussion. Christopher Keane wrote the superb translation.

JACK HIEMENZ

Cleveland Orch.: “Elektra”

It is always instructive to hear a leading symphony orchestra take on an operatic score, especially when the ensemble is as distinguished—and as remote from the opera pit—as the Cleveland Orchestra. At Carnegie Hall on February 4 Lorin Maazel led his redoubtable musicians in as keen and tense a re-creation as I can remember of the music of *Elektra*. The precision of the string-playing, the bloom on the brasses, the luxuriant total blend, all these are attributes that are only rarely available to opera audiences. Some of the quality must derive, I am sure, from the very unfamiliarity of the music and the need to solve, perhaps for the first time, technical problems that are long familiar to the opera-house instrumentalist; the resulting tension is a valuable and positive element. From whatever genesis, the Cleveland *Elektra* proved to be a brilliantly colored, magnificently realized account of the score, with sonorities and contrasts new to my knowledge of the music. It was no less distinguished vocally.

The great excitement centered upon the return of Astrid Varnay, whose association with this opera is unforgotten by those who heard her at the Metropolitan in 1952 or in New York concert performances of 1949 (under Mitropoulos) and 1964 (under Steinberg). On those occasions she sang the title role, but now she was appearing in the mezzo-soprano part of Klytemnestra, in music that Strauss wrote most ably to display the neurotic and corrupt soul of Agamemnon's faithless widow. She delivered a most striking musical and dramatic characterization of a haunted and possessed woman.

The warmth with which Astrid Varnay was welcomed back, the command she displayed of her assignment, did nothing to detract from the achievement of Ursula Schroeder-Feinen, who sang *Elektra*. This singer is familiar from a few Met performances as Chrysothemis and the *Siegfried* Brünnhilde, in all of which she has impressed. To hear her now in this fiendishly demanding music, delivering Strauss's thrusting lines at full force, with total musical control

and conviction, is to realize that we have among us a major force in the next decade of opera. Of all those who aspire to Nilsson's mantle she is the most persuasive candidate.

To sing the role of Chrysothemis, Maazel chose Roberta Knie, an Oklahoma City girl now making a name in European opera houses. It was a happy piece of casting, for Miss Knie showed a big voice with admirable tone and a sure sense of the Strauss style. In Graz and elsewhere she sings big dramatic parts—*Salome*, *Desdemona*, *Senta*—and it is good to know in New York that such talent is awaiting us.

Nor were the principal men less impressive. Kenneth Riegel, who made his name at the New York City Opera and did very well as Iopas in *Les Troyens* at the Met, did a sterling job as Aegisthus; and a Belgian baritone, Jose van Dam, sang Orest with firm tone and full authority.

The Cleveland Orchestra took a little trouble with presentation, and the results were in every way worth it. The hall and stage were darkened, all save the desk lights. The players then moved from either side into an illuminated zone to the left and right of the conductor; this made for logical grouping and a modicum of physical action. Since the appearance of the male cast in white tie and tails would have destroyed the atmosphere, the men were persuaded to put on black turtleneck sweaters to go with their black trousers—all to good effect. The women were attired in simple long-skirted dresses of harmonizing colors. Maazel conducted from an elevated high chair, darkened so as to offer no distraction from the singers. There was a total blackout at the closing chord. All this contributed to verisimilitude, to a feeling that we were present at something more than a concert, if not quite a performance in the opera house. It is no bad model for other producers of other such events. GEORGE MOVSHON

Juilliard Ensemble (Dufallo)

A number of problems as well as solutions of the musical avant-garde in the 1920s and in our own time came to mind at a concert of New York premieres at the Juilliard Theater, January 16. Richard Dufallo led the Juilliard Ensemble, a fine group of the school's young professionals, in

works by Erik Satie and Kurt Weill, and by Karlheinz Stockhausen, R. Murray Schafer, and William Albright.

Satie's vanguard notion that music, like wallpaper, could be made from the most banal materials and nondirectional construction seems to have been more important in theory than in practice. His *Cinema* is film music written in 1924 to accompany René Clair's brilliantly funny twenty-five-minute masterpiece of Dada. The film, shown during the performance, had all the carefully camouflaged structure and sense of progression that Satie's pale excuse for music lacked. Bar after bar of unadorned um-pah and other vapid mechanics seemed almost deliberately to eschew musical interest. In any case, the music was easily forgotten, the film heartily enjoyed.

Kurt Weill's Concerto for Violin and Wind Orchestra, Op. 12, showed much different and enduring avant-garde tendencies. It dates from 1924 when the young composer studied in Berlin with Ferruccio Busoni, an important figure for both neo-classicism and dodecaphony. The concerto's sober atonal idiom, marked by a clean contrapuntal texture, occasionally admits intrusions of those dance-hall elements that so fascinated Berg and Stravinsky during the same period. Twenty-year-old Mark Kaplan, a Leventritt winner and Juilliard student, played the solo part with astonishing suavity.

Karlheinz Stockhausen's *Stop* (1964-65) was not surprisingly the most convincing piece on the program's second half; this marked its U.S. premiere. Stockhausen, at the front of the avant-garde movement through the early Sixties, has always stressed compositional idea and overall form with each new work, while never becoming slave to a particular device or stylistic fad. Thus, while *Stop* has aleatory elements along with standard contemporary procedures, all is subjugated to his powerful if sometimes unbearably egocentric personality. *The Geography of Eros*, an aria for soprano and chamber orchestra by the Canadian composer R. Murray Schafer, was appealingly lyrical, and owed much to Berio's *Circle*. A nice touch was prerecording snatches of the singer's part which made the fine soprano Nadine Herman seem to accompany herself with

her own voice. William Albright illustrated the adage that when contemporary music can be categorized and labeled "avant-garde" it is already old hat. Albright's intensely boring *Marginal Worlds* seemed like a compendium of every tired cliché of the last ten years, without the imprint of a strong character.

With more concerts of this scope and interest, Juilliard should at last take a leading responsibility in officially encouraging its students to play the music of our time. With its tremendous resources of talented composers and performers, the school could become an important force in this country's continuing avant-garde.

BRUCE SAYLOR

N.Y. Phil., Janis (Slatkin)

Last-minute illness continues to plague the performing arts. For the second week in a row, beginning with its subscription concert of January 10, the New York Philharmonic was forced to find a substitute conductor for an indisposed Riccardo Muti. The week before, Erich Leinsdorf had filled in. This time it was the youthful Leonard Slatkin, son of a well-known musical family, who mounted the podium in Avery Fisher Hall.

The program was that announced for Muti: Berlioz's *Waverly Overture*, Beethoven's Third Piano Concerto with Byron Janis as soloist, and Prokofiev's Symphony No. 5. Only as accompanist to Janis' nervous and erratic Beethoven did Slatkin reveal a talent that may flower into something more convincing than it appeared on this occasion. Piano and orchestra dovetailed with precision, tempos set by the soloist were sustained by the orchestra, and the hot and cold, taut and slack contrasts which the pianist introduced in excess were faithfully matched by the larger ensemble.

If the *Waverly Overture* provided no real measure of Slatkin's strengths and weaknesses, the Prokofiev did. When the spirit was martial, with a big climax in the offing, everything was brisk and efficient. In between, however, the conductor was at a loss to know what to do. Limited in his technique, with very little independence of the left hand, he was unable to do much more than beat time and keep things going until the next Big Moment.

In a pinch, therefore, a reasonable pinch of a conductor. But the Philharmonic, and the Philharmonic's audiences—even that rude Thursday night crowd which leaves before the end—deserve better.

ARTHUR SATZ



The great pianist: from the socks up

Arthur Rubinstein, piano

A 1950 advertisement for RCA Victor in the Carnegie Hall program described the teenage boy at an Arthur Rubinstein recital who exclaimed, "Boy, he plays from the socks up!" That youth must be pushing middle age by now but the truth of his words continue to ring—loud and clear: Rubinstein at age eighty-eight still plays from the socks up.

The description is a remarkably apt one, in a sense even more so now than then: Rubinstein's style, always robust, has become more and more bass oriented and structurally solid. And his phenomenal artistry is a continuing compendium of human warmth, pianistic brilliance, ruddy good health, and sublime perception. Both in playing and in the direct simplicity of his platform decorum, Rubinstein exudes life affirmation and dynamic flair.

In the old days there were quibbles (some from this reviewer) that Rubinstein's interpretations sometimes lacked depth. Those objections no longer hold: some artists mellow with time, but Rubinstein has also deepened. His all-Chopin program at Avery Fisher Hall on January 13 was really in the nature of a miracle. The B flat minor Scherzo was full of pomp and stride—spaciously conceived, singingly delivered. The three Preludes from Op. 28 (No. 1 in C, No. 23 in F, and No. 8 in F sharp minor) had

remarkable vision and serenity. Rubinstein, through choice rather than necessity, plays them much more deliberately than he did on his old recording, grasping these immortal miniatures each in a single celestial breath. No one in my experience has discovered and conveyed so much nature in these pieces. The D flat Nocturne was lithe and impassioned, the great B minor Sonata, Op. 58, full of rich elaboration. Rubinstein's way with the piece on this occasion was rather improvisatory, but always maintained a goal. The Largo in particular was a glorious paradigm of how to cope with time and space. Rubinstein has truly extraordinary inner rhythm, but he never merely plays "in time." He began this movement moderately, broadened perceptibly just before the unexpected enharmonic modulation, waited even longer than the new slow tempo indicated, and then picked up for the principal, nocturnelike melody. The effect was that of airborne simplicity, never contrivance. A wily old wizard was at work.

The F minor Ballade unfolded like an epic and three of the four Etudes which followed were charged with drama and nuance. If there have been more masterful accounts of the *Revolutionary* (Op. 10, No. 12) and C sharp minor (Op. 10, No. 4) in any of our concert halls of late, they have escaped my notice. It was a novel idea to program only a single Mazurka, the tragic C minor, Op. 56, No. 3, in solitary grandeur. Once again, Rubinstein's statement was an epical vocal declamation. The A flat *Heroic* Polonaise, Op. 53 is, of course, a popular favorite and Rubinstein's incomparable reading of it is one of the world's great institutions. It is as much his piece as it is Chopin's, and his playing of it this Sunday afternoon was as stirring as ever. The response, needless to say, was tumultuous, and for encores the generous pianist offered a memorably inflected C sharp minor Waltz; a genial, songful, earthy Mendelssohn's *Spinning Song*, a surging account of the C sharp minor Scherzo, Op. 39.

Candor compels me to note a miniscule flaw or two in Rubinstein's technique—some slightly smudgy passagework in the *moto perpetuo* Scherzo of the Sonata, an occasional tiny memory hesitation. For some reason, passages for the left hand

seemed to give the veteran no trouble at all, while those in the right were fractionally less fluent. I mention these quibbles only to disarm the skeptics. The fact is that Rubinstein is musically better than ever and in close to top form pianistically. He is, by any reckoning, still a titan who commands oceans of sonority, an incomparably mellow tone, and facility to burn.

HARRIS GOLDSMITH

PROVIDENCE

R.I. Civic Chorale: Dvořák

According to report, Antonin Dvořák's dramatic cantata, *The Spectre's Bride*, was performed just once in this country (1886, Milwaukee) before the Rhode Island Civic Chorale and Orchestra gave it in late January. On two grounds it is easy to understand this neglect: the sparsity of performances of any but well-known Dvořák pieces until the '60s revival, and the lack of interest in demonology themes as found in the K. J. Erben text until the same relative period. Who gave a fig for a lonely maiden visited by her deceased suitor and taken to wed in a graveyard? Otherwise, inattention to *The Spectre's Bride* is curious. It is a lovely, musically logical work, rich in characteristic Dvořák. It abounds in expressive arias and duets for the heroine and her living-dead lover, the choral passages with narrator are dramatically paced as the pair race across icy fens, and it does not want from a trace of Slavonic dance.

Civic Chorale, whose founding music director, Louis Pichierri, died about two years ago, has a keen-minded young guest conductor for the current season. He is Ronald Morris. It was he who chose the cantata as well as another rarity, William Vincent Wallace's opera, *Maritana*, to be sung later in concert form. Morris' podium style is intense, but precise rather than expansive. The approach exacted a superior tonal performance from the chorus of some sixty voices and the fifty-two-piece orchestra. Soloists—soprano Karen Altman, tenor Neil Shicoff, and bass-baritone Vern Shinall—needed greater heft vocally to be heard through much of the lower string and wind writing. It was well to know the plot beforehand. An English translation by Troutbeck was largely abandoned because of

bowdlerisms. In its place George Kent, a Brown University graduate student in Slavic studies, made a new literal version which then was versified by committee. Here was the major flaw. Neither chorus nor soloists had clear diction for the most part. But for all that, this opportunity to hear yet another radiant work by Dvořák was extremely welcome and rewarding.

EDWIN SAFFORD

RENO

Nevada Opera: Busoni's "Faust"

Gambling is not new in Nevada. What was new on January 25, in Reno, was an operatic gamble by the audacious six-year-old Nevada Opera Company when it presented the American premiere of *Doktor Faust* by Ferruccio Busoni, the story based on the old German puppet show, with twentieth-century music.

The company won over the odds with a commendable and courageous production of an opera with heroic demands. If not brilliant, the performance had a professional gloss and was better than adequate. It won the respect of a large audience which included music critics and visitors from various parts of the country. Director-conductor Ted Puffer achieved admirable artistic results, which showed his long and careful planning. Disappointing, however, was the cast's inadequate projection of the words, despite the use of English translation by Ted and Deena Puffer.

The leading principals were baritone Daniel Sullivan (San Francisco Opera) as Doktor Faust and tenor Ted Rowland (Nevada Opera) as Mephistopheles, both with fine voices and considerable dramatic vigor. Supporting principals were guest artists Charles Koehn (Milwaukee Sky-light Opera Theater and Florentine Opera), basso, and Richard Wagner (West Coast opera companies), baritone, both eminently satisfactory, and soprano Janet Winston (Nevada Opera) as the wayward Duchess. The other soloists, the well-trained chorus, the augmented orchestra, and the sensitive ballet were all satisfactorily integrated.

Deceptively simple and beautifully effective unit sets, with superb lighting, were created by David Agress (Nevada Opera) and technical ad-

viser was Philip Eisenberg (San Francisco Opera). Special effects of realistic sorcery included shooting stars, flaring flames, fog-enveloped appearances and disappearances, which enhanced the supernatural atmosphere necessary to the story.

The music, admittedly distinguished, was demanding, taxing, and heavily dissonant. A scarcity of relieving arias and a strong tendency toward musical monotony, however, created a somewhat depressing grayness of emotional tone. Dramatically, the story abounded in symbolism, sin, sorrow, and anguish, at times confusing. It is a stunning, gothic statement about punishment and retribution.

The young company and Mr. Puffer well deserved the bravos.

PEARL A. PETERSON

SAN ANTONIO

San Antonio Sym.: "Figaro"

The Symphony Society has put on operas in San Antonio for thirty years, and this year the change was made from "festival" to "season." Rather than having one performance of four operas over two consecutive weekends, the season offers two performances (Friday and Sunday matinee) of three operas, with the productions separated by several weeks. The season opened with the Corbett Foundation's *Marriage of Figaro* February 1 and 3. This production was conceived by James De Blasis for the 1972 Cincinnati Summer Opera, of which he is manager. Since its premiere, it has been to Wolf Trap, Hartford, San Diego, and Fort Worth.

Norman Treigle had the name role, while his protégé, Michael Devlin, was the Count. Despite the association, the San Antonio performances were only the second time they have been together in these roles on stage. The first was in Fort Worth. Devlin dramatized the Count's elegance and brutal jealousy very well, and his third-act aria was vocalized with grand sweep. Treigle's basso was in top form, and his Figaro matched the Count, scheme for scheme.

The women were also excellent. The richness and melting *pianissimos* of Carol Neblett's Countess reminded many opera buffs of the young Schwarzkopf. Kay Creed, as Cheru-

bino, almost brought the house down; she is an irresistible stage personality. Barbara Daniels didn't bring the largest soprano voice ever to Susanna's part, but she paced her long role intelligently.

San Antonio Symphony music director Victor Alessandro conducted. His judgements were always right on the musical mark, and his balancing of the ensembles was sensitive. The orchestra played with a keen ear to Mozart's uncanny instrumental commentary on what was transpiring onstage. The Corbett Foundation's production uses the Ruth and Thomas Martin translation, juiced up now and then with American colloquialisms. I liked the clarity of De Blasis' stage direction, though his slapstick brought audience laughter that occasionally covered the music. But *Figaro* had two very good days here.

ROBERT PINCUS

URBANA

U. of Ill.: "Rip Van Winkle"

Before I heard the American Music Group's revival of George Bristow's *Rip Van Winkle* February 2 at the University of Illinois in Urbana, I thought I knew pretty much how the music would sound. There would be a supernatural scene in the Catskills when the tipping Dutchman was put into his twenty-year sleep, giving the composer a chance for spooky horns and melodramatics similar to Weber's *Der Freischütz*. Afterward, the up-country folk would be treated much like those in Rossini's *William Tell*. Bristow, who composed this first American opera on an American subject in 1855, had probably heard both of those works when they arrived in Manhattan, where he was the first concertmaster of the New York Philharmonic. By my reasoning, he would imitate them.

Was I ever wrong. *Rip Van Winkle's* musical parent—and some of the melodies are so similar as to suggest piracy—is, of all unlikely possibilities, Donizetti's *The Daughter of the Regiment*.

How can this be? Answer: In J. H. Wainwright's libretto—reconstructed in 1878 by J. W. Shannon and edited for the Group by Paul Rapoport—the old man has a daughter who becomes a vivandiere, as they say, for the Rev-



Ven Stade and Stilwell in *Ulisse*

olutionary Army. This gives her a chance to sing brilliant coloratura from atop a convenient cannon, warn her beloved Captain Edward that his life is endangered, and save the life of the villain when the soldiers drag him from his battlefield hiding place. The invented love affair gives *Rip* both a soprano and a lyric tenor to occupy the audience's time while baritone Rip is snoring in *Sleepy Hollow*, and their duets contain the most substantial and tuneful music in the score.

When it opened September 27, 1855, at Niblo's Theater in New York, it outdrew the local Italian opera company at the box office and ran for four weeks. The American Music Group's campus production treated the music with respect, though it had neither the soloists nor the orchestra to do the score full justice. The Group and its talented director, Neely Bruce, must nevertheless be praised for undertaking a revival of this historically important curio.

THOMAS WILLIS

WASHINGTON

Morzeverdi's "Ulisse"

Morzeverdi's next-to-last opera, *Il Ritorno d'Ulisse in Patria*, is no *Poppea*, either musically or dramatically, but there is enough fine music in it, plus a good if lengthy retelling of the final

chapters of the *Odyssey*, to justify performance. *Il Ritorno* is closer to the world of the seventeenth-century opera than *Poppea*, because it involves several scenes with the gods and a good deal of the "spectacular," both of which were common in the early days of opera. Its long, declamatory set pieces and comic relief are typical of the form of the time, but Monteverdi's musical skill lifts the characters from the ordinary to the special. Penelope's opening arioso, with its reiterated "Return, Ulysses!", is masterful, as is Ulysses' opening declamation, and the individualization of Penelope's three lovers is excellent. The final duet, when Ulysses is recognized and accepted by Penelope, makes a marvelous contrast with Monteverdi's last duet, for *Poppea*: this one idealized love, the other idealized passion.

The Opera Society of Washington production (January 18), at the Kennedy Center, utilized the Raymond Leppard version of the score, prepared for Glyndebourne in 1972. I am glad that I did not see the Glyndebourne *Ulisse* before seeing this one, for it has gained the reputation of being one of the great productions of recent times (Peter Hall directed). This one could hardly compete, but on its own terms it was a very good rendition. It lacked distinction in the secondary cast, but included all the spectacular elements (gods descending from the clouds, ships being turned into rocks, and the splendid scene of Ulysses slaying the suitors with his bow and arrows), with some good sets by Douglas W. Schmidt and costumes by Jane Greenwood. Ian Strasfogel provided straightforward, if hardly inventive, direction. The opera was somewhat cut from the Leppard version (itself shorter than the original), but could have been cut further, less because of Monteverdi's inadequacies than because of the singers'.

The Penelope was Frederica von Stade, and if she is a bit young for the role (a switch from usual operatic practice!), she brought it to life with the noble resignation and intensity of her acting and vocalism. The Kennedy Center Opera House is especially well suited to her voice, since most words can be heard, and her subtle coloring of the words, plus her evenly produced voice and effortless legato, bring out at every measure the

riches inherent, but easily dissipated, in the role. She is also one of the very few American girls who knows how to carry herself with dignity onstage, an apparently trivial asset but in fact one which makes a great deal of difference, particularly in early opera. Richard Stilwell, as Ulysses, was also excellent, both as to diction and acting, although his voice possesses a certain bleaty quality.

The rest of the large cast ranged from good (Donald Gramm as Neptune, a role in fact a little low for his voice), to acceptable, to inaudible (Carmen Balthrop's Minerva), but it is fair to say that there was a gulf between the two principals and the others, partly owing to vocal deficiencies and partly owing to the difficulty of singing the long lines Monteverdi demands. Singers are simply not trained for lengthy, inflected phrases in which color is shaped rather than forced in; those singers who do specialize in this type of vocalism tend to whiteness and constriction of voice, two qualities at odds with the music. Alexander Gibson conducted with exactitude and sympathy. P.J.S.

THE METROPOLITAN OPERA

Continued from page MA-23

nal was much superior to an earlier reading. Paul Plishka gave a majestic and generously voiced account of Mark's monologue and Michele Vilma, a French mezzo-soprano making her house debut, rallied from an indifferent performance in Act I to provide an admirable reading of Brangaene's long-lined solos during Act II.

Erich Leinsdorf delivered another lean, tight, tense performance of the score, one in which the orchestra too seemed to take fire and heart from the prevailing ardor of the audience.

The Everding/Schneider-Siemssen production remains hauntingly beautiful, as apt and evocative a visual frame for a Wagner story as I ever expect to see.

Il Barbiere di Siviglia

The Metropolitan Opera chose Christmas night to bring *Il Barbiere di Siviglia* back to the repertory, which meant that numbers of children (whose families presumably take their festive dinner in the middle of the day) got the benefit of a night-

time outing and an exposure to the opera most suitable of all for the initiation of the young. What more could one ask for this purpose than the story of a young nobleman adopting successive disguises to capture a lovely girl from the clutches of an old lecher out for her money, the hero abetted by a breezy barber, the old grouch attended by a venal music teacher of comic appearance—and all set to some of the most bubbling and vivacious music ever written?

There was joy for many of the older customers too, for in this happy atmosphere the Met acquired a new star, in the person of Frederica von Stade. She has played smaller parts here before and last year won high praise for her portrayals of Cherubino in Paris and Glyndebourne. Miss von Stade is an American mezzo-soprano of silken voice and consummate physical grace, whose view of Rosina is both subtle and gently aristocratic. This young lady is no virago, not even a saucy minx, but a gentlewoman of character and charm. No less apt was her singing (of the original mezzo-soprano scoring intended by Rossini for this role), which demonstrated confident ease in the coloratura work and skillful control of the melodic line. Of all the new singers at the Met in recent seasons, and they have been many and talented, Miss von Stade gives most strongly the intimations of "star quality."

As her suitor on this occasion, Luigi Alva generated some agreeable and temperamentally apt singing, and he always looks like a handsome young hero. Figaro was taken by Dominic Cossa (new to the role at the Met) and seemed underplayed and undersung, though all that this fine baritone does is in good taste. Fernando Corena (Bartolo) was fighting off a cold and omitted "*A un dottore*" in the second act; but his normally robust sense of comedy seemed also afflicted. Ezio Flagello brought very little ingenuity (and not very much sonority either) to the role of Basilio. Cynthia Munzer sang Berta for the first time and did well in her principal moment of glory, the Act III aria.

John Pritchard, also new to the opera here, led nimbly and shaped the music well but did not sufficiently lift the spirits: many of the kiddies were asleep before the last curtain came down. △

book reviews

Patrick J. Smith, Editor

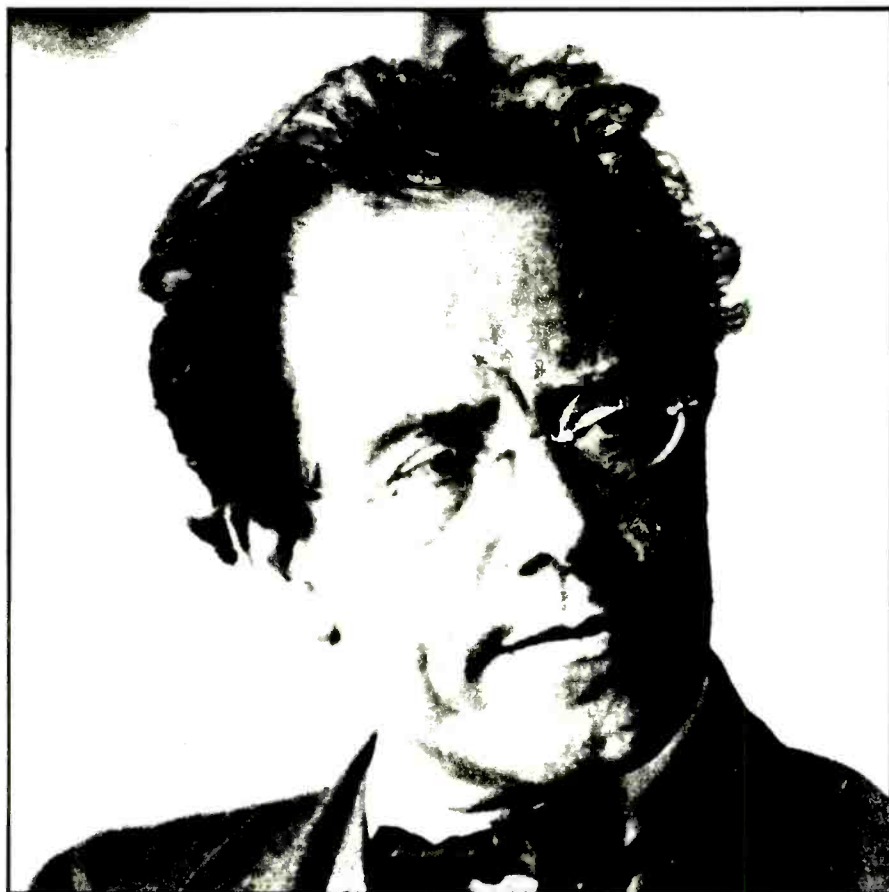

MAHLER (Volume I), by Henry-Louis de la Grange. Doubleday, \$17.50.

THIS MONUMENTAL work, which will doubtless become the standard biography of Gustav Mahler for some time to come, takes the composer-conductor-impresario's life from his beginnings to 1902, just prior to his marriage to Alma Schindler. To say that it is exhaustive would be a commonplace—seven hundred pages of text, another hundred and thirty of appendices (which include detailed discussions of the works written up to 1902, with attention paid to the variants [the *Blumine* movement of the First Symphony, the discarded Part I of *Das Klagenide Lied*]), and over a hundred more of notes, many of them absorbing. Exhaustive but not exhaust-

ing—if taken in not-too-large doses—for, despite the rather rocky prose (attributable to the author or to the translation from French to English?), it is a fascinating book, and I believe in some ways a unique biography not likely to be duplicated soon. It is fascinating for a variety of reasons.

First, the subject itself is first-rate material for writing. Mahler was no wall-flower composer, who worked in his garret and led an uneventful existence. He was, rather, a man of the world, caught up in the world, whose tremendous energies and whose tremendous inner opposing forces led to all sorts of clashes. He was, moreover, not only a composer—indeed, during his lifetime he was considered only tertiarily a composer—but a conductor and an impresario, and each of

these lives involved constant warfare with bureaucrats, singers, orchestras, which were only compounded when he tried in addition to present his music to the public. Further, his inner insecurities, stemming from his Jewishness in an anti-Semitic society and his rampant idealism about music coupled with an almost desperate need for approval, led him to enter the very arenas that would rebuff him, which in turn made him drive himself all the harder, become even more arrogant and, inevitably, fall prey to a hundred psychosomatic illnesses which plagued his life and doubtless caused his early burning out. And, to top it all, these inner conflicts found their way directly into his music. Small wonder that Gustav Mahler is the favorite composer of the psychiatrists and has become almost a paradigm for our Age of Anxiety.

Second, the very restlessness of his existence, which (in the present volume) included stays in Prague, Hamburg, and Vienna among many other cities, and contact with a good number of the composers, conductors, singers and critics of the time, makes for a variegated panorama of artistic life of the nineteenth century unequalled by any other composer. Finally, the entrance of the beautiful and mercurial Alma Schindler, herself a complex character who was to cause Mahler such joy and grief, gives this book a magnificent coda, leading to the second volume, with its great personal tragedies, the American escape, and the final, fevered years. It is a life story that no novelist could have envisioned, not even a Dostoyevsky. One comes away shaken and amazed.

The achievement of de la Grange is commensurate with his subject. His strengths as a biographer lie not only in his exhaustive research, but even more in his judiciousness: in a life which can easily become the basis for all sorts of readings-into and amateur psychoanalyzing, he has maintained a balance and a judgment that is exemplary. He does not shirk the facts and he does not gloss them, but constantly strives for an understanding within the context of the time and of Mahler's own conflicts. Many will feel that there is too much in the book, for de la Grange gives long quotes from letters and expatiates at length on the lives of people with whom Mahler came into close

contact. But it is essential to his approach, and essential to our understanding of the man and his music.

But what I feel is unique and most valuable about the biography is less its subject and its treatment than the depth and range of its societal picture. Apparently de la Grange, who has spent years on research, had the resources to be able to use a battery of helpers, who culled every imaginable scrap of Mahler information from all over Europe. Without a guiding hand, however, this mass of minutiae would have overwhelmed the reader. Yet, as de la Grange handles it, the immense amount of detail becomes a powerful force, so that what we are presented with is at once a personal biography and a sociological document: a look at musical life in Europe at the end of the nineteenth century.

Two aspects of this detailed panorama are worth singling out. One is the picture of concert and opera life. Opera houses were run on a basis roughly similar to those today, but there were distinct differences, the primary one being in the number of conductors employed. A major opera house had two or three regular conductors who were expected to take on all but one or two of the repertory operas. This meant, since the seasonal repertory was about thirty operas, that each would take ten or more. Thus Mahler, while trying to run his company, was also in the pit nightly, and during the day rehearsing works and coaching new singers. It was a grueling schedule. De la Grange's insistence on including details not only as to which opera was played but how much of it, what was added, what was "new" (often Wagner had never been heard complete until Mahler's insistence), Mahler's own additions and compilations (most notable in his "reconstruction" of Weber's *Die Drei Pintos*) is immensely valuable. We are given not simply the bones but the flesh and blood: we can understand why so many artists and administrators succumbed to the forces of inertia, laziness, and complacency that would inevitably result from these burdens. Thus the development of the *stagione* concept of opera production becomes a logical outgrowth, as does Wagner's escape to Bayreuth and Toscanini's insistence on conformity to the printed score. Ernest Newman's Wagner biography contains a good deal of this kind of de-

tail, but nowhere near so much as de la Grange's.

The second important aspect is the revelation of musical criticism in the nineteenth century. I know of no other book that has ever attempted such an in-depth examination. De la Grange must have dug out every review of every Mahler performance, and he gives not one but a selection of reviews of the major events. As a critic himself, de la Grange is naturally interested in the subject, and his wealth of information on the specific critics in each city and their special viewpoints (not only conservative versus modern but those who trumpet anti-Semitism masked as criticism) brings the period to vibrant life. (It also demonstrates that mediocrity and lack of vision are not confined to any single age.) Here as elsewhere, this expansion of scope from the main subject to the surrounding society serves to make the book much more than a biography. If Mahler had not been so interesting a person, this richness might have led to his being swallowed by the age in which he lived (a fate which partly overtook Saint-Saëns in a biography). But his personal force and inner conflicts ensure that we never for a moment lose sight of him.

I cannot too highly recommend this biography, even to those who are not particularly fond of Mahler's music. Reading it is as good an introduction as I know not only to the life of a complex, tortured creative artist on various levels (like Karajan after him, he even staged as well as conducted opera), but to musical life in the later nineteenth century. Quibbles there will be—there are numerous small errors, inevitable in a book this size, and de la Grange is not afraid to make judgments on which Mahlerians disagree—but the achievement is immense. I hope the final volume will not be long delayed.

PARTICK J. SMITH

THE NEW YORK CITY BALLET,
by Lincoln Kirstein. Alfred A. Knopf, \$25.

LINCOLN KIRSTEIN'S new book, *The New York City Ballet*, his first since the monumental *Movement and Metaphor* (1970), is really two books in one. It is most overtly a handsome photo-album extravagantly designed (somewhat *over-designed*, in fact), approximately the size and price of a small

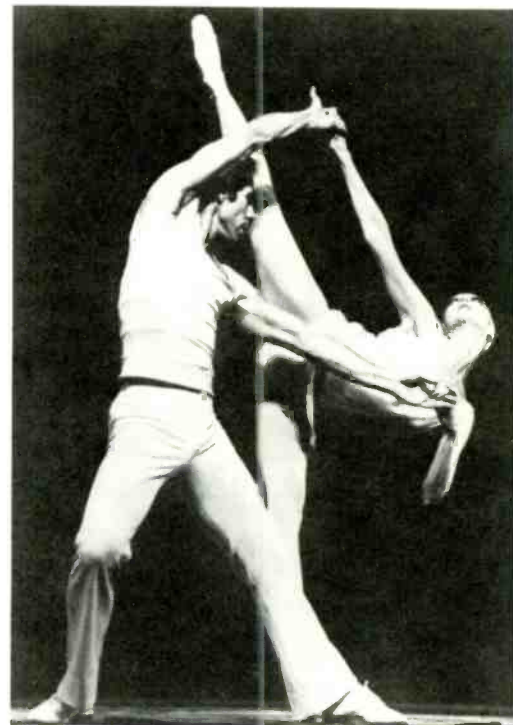

Anthony Blum, *Allegra Ken'*, in a photograph from Kirstein volume

end-table. The photographs which illustrate it—more than 450 of them, the majority in black and white, with a few reproduced (not very successfully) in color—are by George Platt Lynes and Martha Swope. The two represent different approaches to picture taking as well as different eras in the New York City Ballet's history. Lynes, who photographed the company from its earliest days as the American Ballet through its various manifestations as Ballet Caravan, Ballet Society and, ultimately, the New York City Ballet, worked in the studio with elaborate lighting set-ups and George Balanchine's help in grouping the dancers. Devotedly, he even allowed Balanchine to click the shutter upon occasion. His recordings are almost Keatsian portraits—marble men and maidens, forever young. In contrast, Swope, a relatively inexperienced photographer when she began snapping the company in the middle '50s, produces pictures that have an in-performance immediacy and which improve technically as she goes along. This, then, is an almost continuous history of the company, overlooking a small gap in the '50s between Lynes's unfortunately early death and Kirstein's employment of Swope as official company photographer.

It is accompanied by a text which

is another kind of history. In form it is a chronological selection of brief paragraphs from an imaginary diary, each entry commented upon at length, retrospectively. The time span is from April 1912: Rochester, New York ("Ma took us to the Lyceum. We sat in Uncle Mart's box. Red and gold; everything, red and gold.") to January 1973: New York ("Conference with Madame Karinska, Rouben Ter-Arutunian, and Balanchine over the *Birds of America*, anticipating bicentennial celebrations of 1975-76."). What it represents is a brief account of Kirstein's artistic education linked with key events in the founding, development, and support of one of the world's major cultural organizations.

Kirstein came by his vocation only gradually. Already infatuated with the theater at the age of six, a victim of what Cocteau called "the red-and-

establishment of the traditional classical ballet in America.

Much of Kirstein's material about that odyssey is familiar (there was a 1953 volume, also called *The New York City Ballet*, authored by Anatole Chujoy with Kirstein's cooperation), but his accounting of it here is more personal than usual. Influential figures emerge—Pavel Tchelitchev, A. Everett Austin, Jr., Muriel Draper, Virgil Thomson, Frances Hawkins, Alice Pleydell-Bouverie; and Kirstein is at pains to acknowledge the loyal staff which for many years has served both him and Balanchine. There is even some comment on the mysterious Vladimir Dimitriew, without whose prodding Balanchine might have remained in Europe—with, one can wonder, what effect on the history of ballet in America?

This is not definitive history—perhaps Kirstein is too close to the company to write one—but it is a volume no balletomane will want to be without. JACQUELINE MASKEY

MARTHA GRAHAM: A BIOGRAPHY, by Don McDonagh, Prager, \$10.95.

UNBELIEVABLY, Don McDonagh's *Martha Graham* is the first full-length biography (I exclude the Leroy Leatherman *Martha Graham, Portrait of the Lady as an Artist* because of its limited scope) of a woman who through sheer creativity and longevity has been a dominant figure in American modern dance for the past several decades. In terms of influence and achievement she has often been placed triptych-fashion with Stravinsky and Picasso as the great innovators in twentieth-century art. Yet pull open any library catalogue drawer: yards of cards on the painter and composer, a pitiful inch's worth on the dancer-choreographer.

Part of this is due to the evanescence of her art—no canvas or score to refer to; part is due to Graham herself. Until quite recently she would allow no one to dance her roles, and many of them have faded in oblivion. She extended the same right of domain over her life: she or no one. And so for years it was rumored that she was working on an autobiography. Mentioned were the letters which she wrote weekly to her mother; the close, unruptured relationship between the two guaranteed a rich primary source. Then, of course, there was the

correspondence with Louis Horst, for many years her professional colleague, musical director, emotional prop. The revelation that both bodies of material had been destroyed at Graham's behest came as a bewildering shock; to some of us it was an act of willful vandalism.

McDonagh makes do without these precious assets. He traces Graham's personal history from her Pennsylvania birth in 1894 through her California adolescence to her first intensive dance training at Denishawn, the Los Angeles school directed by Ruth St. Denis and Ted Shawn. By 1923 the Denishawn phase is over and Graham is on her own in New York, dancing in the Greenwich Village Follies, then teaching at the Eastman School of Music in Rochester. Graham realizes that she must perform her own dances, not other people's, and that she must find a form of dance expression totally her own. It is a conviction reinforced by Horst, also a defector from Denishawn, now a staunch support to Graham, a believer in her genius. It is not a genius of the precocious sort; Graham is thirty-two at the time of her first independent New York concert, and it is not until 1929 with



Cris Alexander

Martha Graham in Deaths and Entrances

gold disease," he was at Harvard in the 1920s and instrumental in the founding of the literary magazine *Hound and Horn* and in the Harvard Society for Contemporary Art. Traveling abroad, the last seasons of the Diaghilev Ballets Russes stirred him, but his unfocused ambitions were finally crystallized by George Balanchine's ballets, particularly *Apollo* and those created for the short-lived Les Ballets 1933. At twenty-six he persuaded the young Russian to come to the land of Ginger Rogers and join him in a great enterprise: the

musical america Monthly Directory

KEEP YOUR NAME BEFORE YOUR PUBLIC . . . at very little cost: One inch is only \$189 for 12 monthly issues plus the important MUSICAL AMERICA Annual Artist Directory. A half-inch listing, available only to teachers, coaches, and accompanists, costs only \$99. Send copy and order to: Mrs. Claire N. Eddings, High Fidelity/Musical America, Publishing House, Great Barrington, Mass. 01230.



DALCROZE SCHOOL OF MUSIC

"Combining the best features of European and American Education."
Complete Music Curriculum—Artist Faculty
DALCROZE TEACHER'S CERTIFICATE COURSE
161 East 73rd St., N.Y., N.Y. 10021 TR 9-0316
Dr. Hilda M. Schuster, Dir. — The only authorized Dalcroze Teachers Training School in the Americas.

JUNE BURGESS

VOICE

All phases of Vocal Instruction
Fac. American Academy of Dramatic Arts
Ansonia Hotel NYSTA-NATS SU 7-3300
73rd & Broadway (Apt. 10-112)

MARIENKA MICHNA

PIANO

Concert Pianist—Teacher
Opera Coach — Accompanist
Hotel Ansonia, Bway. & 73 St., N.Y.C.

Heretic that the style based upon her movement principles of contraction and release is made manifest. *Heretic*, danced by Graham and a small company of women, looks "... gaunt, tense, and forceful ...". It is definitely not Denishawn; it is a declaration of independence.

After the breakthrough year of 1929 Graham went on to extend her dance vocabulary, consolidate her technical innovations, and create a body of dance works which, as a contribution to the art of theatrical dance, is unequalled by any woman, unexcelled by any man. Her dance was richly rooted: in the religious impulses of the Indians of the American Southwest (*Primitive Mysteries*, *El Penitente*), in modern Jungian psychology (*Dark Meadow*), in Greek myth (*Cave of the Heart*, *Night Journey*, *Clytemnestra*), in the interior life of the woman artist (*Letter to the World*).

Graham's life, as woman and artist, has been abundant in achievement, conflict, emotional turbulence, and it should have been of riveting interest to read about. In McDonagh's hands it is not. He has done the drudge-work of biographical research with patience and perseverance, sifting through piles of newspapers, scrapbooks, tour itineraries; conducting taped interviews with relatives, friends, patrons, and professional colleagues of Graham's from Israel to California; compiling (with Leighton Kerner) a complete chronology of her work which includes the chief dancers, composers, designers of sets, costumes, and lighting for each piece. He has also attempted to describe major Graham works such as *Primitive Mysteries*, *American Document*, and *Letter to the World*, for which task he has no great gift (Lincoln Kirstein in an essay on Graham once wrote, "... to write about Martha Graham's dances would be only interesting if the writer was the equivalent of his subject."). McDonagh's prose is more reportorial than evocative; Graham, to whom as artist and person no one was indifferent, loses a great deal in McDonagh's translation. One is grateful that a couple of Merle Armitage's salty and profane comments are quoted verbatim. There is not enough in this book of the seasoning which direct quotation can supply. What is lacking in McDonagh's textual treatment is indicated in an ex-

cerpt from one of his taped interviews with Gertrude Shurr, teacher and former Graham company member, published in its original question-and-answer form in the periodical *Ballet Review*. In its few pages it has the liveliness, flavor, and emotional immediacy lacking in McDonagh's careful abstractions from contemporary interviews. In one area, however, McDonagh makes a real contribution: he makes clear that Graham did not go it alone and that the support—practical, emotional, financial—of Horst, Martha Hill, Erik Hawkins, Bethsabée de Rothschild, and others were important factors in the triumphs of this remarkable woman.

J.M.

KIRI TE KANAWA

Continued from page MA-9

do there?" I say 'I'm on an assembly line'. Just when they decided to leave me alone—oh spit!—somebody recognizes me and spoils it all!"

"But I love giving parties for my friends—the people we most like to be with, a tightly knit group. I have Sunday luncheon sit-ins. You know, plates on your lap, out on the lawn if the weather's good. We drink and eat and I have a joint of some kind. I don't mean what you call a 'joint' here," she laughed.

Being a descendant of a Maori chieftain is no handicap, rather the reverse, says the soprano. But her name can cause confusion. Last year at Covent Garden Siepi kept asking "where is Kanawa?" He had expected her to be Japanese.

"Maoris have great pride," admits Kiri Te Kanawa. "Sometimes it's in the way. It won't let me give in. And, when somebody gets in my hair, my deep-rooted anger comes to the surface. Normally I am really a pleasant person but sometimes I get my Maori up. That's what I call my pride. Then my husband will say quietly: 'Drop your pride. Get on with the job.' Sometimes he is difficult," she explained in loving exasperation. "When I want to hit him he asks me if I want a cup of tea!"

How will she manage the prima donna career which is beginning to engulf her life? "I will take a break every six months, three to four weeks. I will allow myself a week after each opera. I will not do consecutive performances. I do not do modern operas. I look after myself very well."△

ARTIST LIFE

Continued from page MA-6

writer is, as the French press says, *sportif*. He climbs mountains ("Corsica's high mountains are a well-kept secret") and he goes skin-diving, as deep as 180 feet down. "I have fished coral and have taken lobsters with my own hands." And he bottles his own wine, about fifty thousand bottles a year, half sold in France, the other half to tourists in Corsica. "They are among the three quality wines in Corsica—a red rosé and a white wine." The label is called *Domaine d'Alziprato*. It was designed by the artist and stage designer Leonor Fini (the last thing she did some years ago was the Paris Opera *Tannhäuser*) who also lives in Corsica, but in an unrestored convent. She chose a faun for the label and so it could not be called *Couvent d'Alziprato*. "One can't associate a faun with a monastery."

Henry-Louis de La Grange also presents small festivals during the summer in a ruined, roofless church and in the village square. Richter, who likes fishing and swimming, has appeared and this summer a play is planned in addition to concerts, one of the latter, it is hoped, by Janet Baker. "Nothing happens in Corsica. These are great events."

Before returning home La Grange heard Mahler performances, appeared on television with Boulez, gave newspaper and radio interviews, lectured, was wined and dined. He enjoyed it. "I could talk about Mahler all day long," he says. And he does, and he is never boring.

We saw, in a Paris magazine, a photograph of him wearing a T-shirt with a picture of Mahler on the front. He had gotten it, he said, from the Mahler Society of California. He has several and likes to wear them. Mahler is no hair-shirt for him.

The choreographer Maurice Béjart, after reading the Mahler biography, wrote to compliment Henry-Louis de La Grange on his enormous research and knowledge but, above all, "the love." He said that on the frontispiece it should be written: "*Was mir die Liebe erzählt*." What love told me. He elaborated in French: "*Tant la vie, qui n'est qu'amour, est présent à chaque page*." To such an extent life, which is only love, is present on every page. △

Waltz). But under these circumstances, the demanding program ("Come scoglio"?) is ludicrously out of reach. The packaging makes it clear that this record is a joke, but on whom? Neither Ms. Steber nor the demonstrative audience nor RCA shows any signs of embarrassment. No matter: the listener's will do for all.

Since Ms. Te Kanawa's earlier-than-scheduled Met debut in February was a broadcast *Otello*, she is already familiar to many American operaphiles. Improbable though the Westminster Gold program looks, this disc—one of an apparently large number made for the New Zealand Kiwi label—shows dazzlingly why the young soprano has conquered London and New York with such ease. The voice, of ample if not overwhelming size, is one of the most ravishing sounds I have heard. Her scale is seamless; and since she sings dead on pitch, the narrow vibrato makes possible a haunting tonal purity. She can color the voice considerably, and she realizes the mood of any kind of text with astonishing musical rightness (frequently making material sound much better than it is). Listen to her light, buoyant *I Feel Pretty*; her dark, intense *Climb Ev'ry Mountain*; her sultry, soulful *Summertime*.

Ms. Te Kanawa's European recordings include Mozart's *Exsultate, jubilate* with Colin Davis for Philips; we will soon hear her as the Elvira of Davis' *Don Giovanni* (made, alas, before her triumphant Covent Garden appearances in the part). But if the other Kiwi discs are on the level of this one, I hope Westminster Gold can release them as well. This recital should hold its own alongside what one expects will be a very long series of major-label recordings. K.F.

THE YELLOW RIVER CONCERTO AND OTHER SHOWPIECES PLAYED ON THE HISTORIC CHINA TOUR. Daniel Epstein, piano (in the concerto); Philadelphia Orchestra, Eugene Ormandy, cond. [Max Wilcox (in *Pini di Roma*) and Joseph Habig (in the remaining works), prod.] RCA RED SEAL ARL 1-0415, \$5.98. Tape: ● ARS 1-0415, \$6.95; ●● ARK 1-0415, \$6.95.

CENTRAL PHILHARMONIC SOCIETY OF THE PEOPLE'S REPUBLIC OF CHINA: The Yellow River Concerto. **TRAD:** San Pei (Chinese workers' and peasants' march, arr. William Smith and Jesse Taynton). **SOUSA:** The Stars and Stripes Forever. **RESPIGHI:** Pini di Roma.

Well, here it is—the famous *Yellow River* Concerto, the first musical composition from mainland China to be performed, and now recorded, in this country.

The concerto was written some ten years ago by a committee of composers of the Central Philharmonic Society of the People's Republic of China, although it evidently is based on an earlier work. *The Yellow River* Cantata, written in the 1940s by Hsien Hsing-Lai "to deify Mao Tse-tung's war against the Japanese." The Yellow River is apparently a symbol of the Chinese nation, and "the concerto praises the courage and fighting spirit of the country."

As is well known, the Philadelphia Orchestra and Eugene Ormandy were invited to visit the People's Republic in the fall of 1973 and were requested to play the concerto there with the Chinese pianist Yin Cheng-chung. In anticipation of this tour, they gave the Western Hemisphere premiere of the work at Saratoga Springs, New York, with the young American pianist Daniel Epstein as soloist.

Since its premiere the concerto has been an

FREE McIntosh CATALOG and FM DIRECTORY

Get all the newest and latest information on the new McIntosh Solid State equipment in the McIntosh catalog. In addition you will receive an FM station directory that covers all of North America.



MX 113

FM/FM STEREO - AM TUNER AND PREAMPLIFIER

SEND TODAY!

McIntosh Laboratory, Inc.
East Side Station P.O. Box 96
Binghamton, N.Y. 13904

NAME _____

ADDRESS _____

CITY _____ STATE _____ ZIP _____

If you are in a hurry for your catalog please send the coupon to McIntosh. For non rush service send the *Reader Service Card* to the magazine.

CIRCLE 23 ON READER-SERVICE CARD

SAE

The most respected name in electronics introduces state-of-the-art loudspeakers.

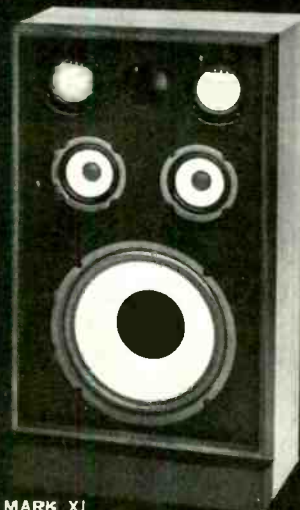

MARK X Dynamic Transducer Three-way Speaker System, utilizing four drivers (1—12", 1—5" 2—2"), with low and mid-frequency control. Oiled walnut.

MARK XI Dynamic Transducer Three-way Speaker System, utilizing seven drivers (1—12", 2—5" 4—2"), with low, mid and high frequency control. Oiled walnut.

MARK XII Solid State Electrostatic Transducer, three panel array of electrostatic elements, 1—12" low frequency driver, 1—5" driver, for lower mid-frequencies, electronic protection circuit, with low, mid and high frequency control. Oiled walnut.

MARK XIV Solid State Electrostatic Transducer, six panel array of electrostatic elements, 1—12" low frequency driver, 2—5" mid-frequency drivers, with low, mid and high frequency control. Oiled walnut or rosewood.

MARK XI

Scientific Audio Electronics, Inc.
Acoustics Division
P.O. Box 60271 Terminal Annex, Dept. A-34
Los Angeles, California 90060

Please send comprehensive data on SAE state-of-the-art loudspeakers.

Name _____

Address _____

City _____ State _____ Zip _____

Components for the Connoisseur

CIRCLE 35 ON READER-SERVICE CARD

object of considerable interest. As the first "new-Chinese" work to be heard here, it could not help but attract attention, and there are aspects of the composition that make it seem to Westerners a special curiosity. Foremost, perhaps, is the fact that it is the work of a "committee" rather than of an individual. According to the American composer Chou Wen-chung (in an interview that appeared in a recent issue of the *Contemporary Music Newsletter*), this practice first came about in the period immediately following the Cultural Revolution, when composers were urged to work jointly in trying to create a new kind of concert music capable of speaking directly to the people, of educating them, and of working as a catalyst for social change. Thus everything depends upon the public's reaction, and frequently pieces are revised several times in

accord with these reactions. Although normally only one or two composers work on a composition at one time (in "consultation" with a larger group, however), Chou states that "after that someone else would be called in to revise or edit if necessary. In fact, they seem to be constantly refining their compositions to the point where, by the time a work is completed, certainly a large number of people would be involved." What we are dealing with, then, is truly a "collective" composition.

Even more surprising, however, is the musical style of *The Yellow River Concerto*, which is uncompromisingly "European" in all of its essential aspects; more specifically, it is very close to the sort of "popularized" style of concert music favored around the turn of the century. Rachmaninoff comes most readily to mind, although there are also brief hints of

others—e.g., Tchaikovsky and Dvořák. But everything is watered down as much as possible, simplified to the point where the closest parallel is really those movie scores that present a sort of "reduction" of the styles in question, leaving in essence little more than a series of pretty tunes garnished with very elaborate orchestration. There is virtually no thematic or harmonic development of any kind in the concerto, the only exception being in the last movement, where there is actually a full-scale tonal modulation—a very simple one to be sure, but the only thing of its type in the entire work.

There are admittedly some allusions to indigenous elements. Occasionally two Chinese instruments (a bamboo flute and a kind of lute) are heard in the otherwise standard orchestra, and there are some quotations of folk songs. Oddly, however, the latter give the effect of those orientalisms one finds, for example, in Puccini: occasional pentatonic passages superficially pasted over a basically diatonic, functionally harmonic structure. As a consequence, the listener has the impression of hearing a Western piece with surface oriental ornamentation rather than a Chinese work betraying Western influences.

Finally, a great deal of emphasis is placed on the virtuosic piano part, which seems very odd when one considers the desire to subordinate all "individualistic" qualities. There are several flashy cadenzas, none of which seem to have any real formal function—the music simply pauses momentarily at a convenient cadential point so that the piano can indulge in various kinds of passagework before the real matter (the pretty tunes) is taken up again.

Washington critic Paul Hume described the concerto as "a first cousin to the *Warsaw Concerto*"—not a bad characterization if one ignores the cultural dislocation in the one case. It is a showy work, not without its effects perhaps, but with very little real substance. As one might expect in a piece so patently imitative (and of a "dead" style at that), it communicates an impression of pronounced artificiality. Indeed, considered from a purely artistic point of view (which I realize was probably totally irrelevant to those who created it), it would seem to be the worst imaginable argument for the political system it represents.

The performance by Ormandy and the Philadelphia Orchestra is excellent (this is the kind of thing they can really dig into), although there are more than a few gaffes in the difficult piano part. This would seem to suggest that the recording was made in some haste—undoubtedly in order to take advantage of the current Chinese craze—as these could easily have been edited out.

The remaining time on the disc is filled up with other works that were performed with particular acclaim on the tour. Completing the first side is a Westernized orchestration of *San Pei*, a Chinese workers' and peasants' march (according to a review in the *People's Daily*, Peking, "the Chinese audience was deeply moved by this familiar melody"), and a slapdash version of *The Stars and Stripes Forever*. The reverse side contains a fine performance of Respighi's *Pines of Rome* (Gilbert Johnson's lovely trumpet solo in the second section deserves special mention). The Philadelphians do this work about as well as anyone, but those primarily interested in the Respighi would be better advised to get the orchestra's older version on Columbia (M 30829), where it is coupled with the *Fountains of Rome*. R.P.M.



Next time you plan a trip to Europe, make sure you visit the unique country.

Where can you find: Europe's largest waterfalls?
Europe's blondest blondes?
Europe's highest geysers?
Europe's greatest glaciers?

And where can you find moonlike craters where the astronauts trained? More volcanos than anywhere else on earth? Historic landmarks of the world's oldest continuous parliament? Celebrations marking Europe's youngest republic?

The answer to all of these questions is—ICELAND. Next time you plan a trip to Europe, make sure you visit Iceland.

The only thing it may cost you is time well spent. Because you'll save enough money on Icelandic's lowest jet fares to Luxembourg to pay for your stopover in Iceland. Or, you can hop over from New York or Chicago for longer tours. See an erupting volcano. Take a cross-country pony trek.

Next time you plan a trip to Europe, ask your travel agent about Icelandic Airlines. Or phone Icelandic Airlines, for folders about Iceland and lowest jet fares to Europe. In New York State, phone (212) 757-8585. Elsewhere in U.S., phone (800) 555-1212 for local toll free number.

CIRCLE 16 ON READER-SERVICE CARD

Leave it to Realistic® to create...



a beautiful receiver at a down-to-earth price!

You want a new receiver. One combining top technology, features, looks. But you're not about to pay the price of an overpowered monster to get it. What you really want is Realistic's STA-80. With direct-coupled, fully protected output. Flat 20-20,000 Hz audio response. FET/IC tuner with crystal filtering on FM and AM, 300- and 75-ohm inputs, dual metering, FM muting. Glide-Path™ volume/balance controls. Perfect loudness.™ Walnut case. And more! Sensible 82-watt power ± 1 dB (48 watts RMS) — we don't create monsters. U. L. listed. #31-2046.

The STA-80.

249⁹⁵

Very down to earth.

Save \$44.40 on an STA-80 System

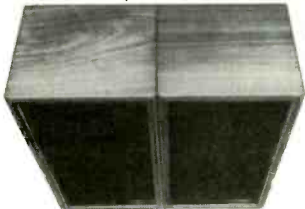

Optimus-2 floor or shelf speaker systems. Each regularly **69.95**

STA-80 AM/FM Stereo Receiver. Reg. **249.95**



LAB-24B with Realistic/Shure cartridge, base. Reg. **64.50**



Complete System **409⁹⁵**

REALISTIC at Radio Shack®

A Tandy Corporation Company

402



FREE 1974 CATALOG
AT 2000 RADIO SHACK STORES
OR MAIL THIS COUPON

180 Pages — Full Color! Hi-Fi, CB, Kit, Recorders, Antennas, Parts, More!

Name _____ Apt. # _____

Street _____

City _____ State _____ Zip

MAIL TO: Radio Shack, P. O. Box 1052, Fort Worth, Texas 76107

Retail prices may vary at individual stores.

the lighter side

reviewed by

MORGAN AMES
ROYAL S. BROWN
R.D. DARRELL
HENRY EDWARDS
KENNETH FURIE
MIKE JAHN
JOHN ROCKWELL
JOHN S. WILSON

*** PAUL WILLIAMS: Here Comes Inspiration.** Paul Williams, vocals and songs; orchestra arranged by Ken Ascher. *Born to Fly; Driftwood; If We Could Still Be Friends*; nine more. [Kenny Ascher, prod.] A&M SP 3606, \$6.98. Tape: ●● 8T 3606, \$7.98; ●● CS 3606, \$7.98.

Paul Williams is easy to love, with his flow, his clowning, and his tenderness. While many a lesser songwriter marks his songs with various kinds of misery, Williams signs his work with a celebration of life and love. Which is not to say that he cannot and does not write downers that will put you away. But his essence shines best when he is reflecting what is best, that special sweetness we all feel and lose and feel again. Williams pours it into such songs as *That's Enough for Me* ("I smile to think of you and me, you and I, and how our pleasure makes me cry"); *I Never Had It So Good*; *I Won't Last a Day Without You*.

In this album, he puts those warm protective feelings into a touching song called *You and Me Against the World* (music by Kenny Ascher). *What Would They Say* is a beauty that was written for a TV drama last season. The show was good, but the song will outlive it: You can't sign a TV show.

No doubt about it. Paul Williams is hot. Just as everyone scrambled to record Bacharach/David songs a few years back, now they scramble for Williams' work, and such is the magic that hits appear left and right (mostly left). But it is probably true that Williams, with his rough-weave voice and odd pronunciations, is still the best expresser of his own material. To prove the point he includes a couple of songs already famous from other versions: *Rainy Days and Mondays* (the Carpenters) and *That's What Friends Are For* (B. J. Thomas).

This is the first Paul Williams album I have been able to love wholeheartedly. It is more musical, romantic. Much of the credit goes to his recent conductor/arranger/collaborator, Kenny Ascher. I first knew of him as Woody Herman's piano player several years ago in New York, and he looked about eighteen then. The Herman band is a famous place for young musicians to build their chops, on their way—unfortunately for Woody—to someplace else. Ascher has emerged not just as a superb pianist but also as a simply beautiful arranger/orchestrator. I suspect that Williams has been looking for someone like him for some time. The two wrote several songs together for this set, including the single release *Inspiration* (a nice tune I can't seem to care about).

Ascher and Williams seem to have a deep-

ening influence on each other. But then Williams is equally successful with most of his collaborators—Roger Nichols (*Rainy Days and Mondays*), Ron Davies (*In the Beginning*), for example. *Dream Away* was written with film composer John Williams for the film *The Man Who Loved Cat Dancing*, in which it was not heard for some reason. The two Williamses collaborated again recently on songs for the film *Cinderella Liberty* (not included but available in the soundtrack album).

It has been a pleasure to watch this man's career take flight. If poetry or sheer likability were measured in inches, Paul Williams would show up twenty feet tall. M.A.

*** CHI COLTRANE: Let It Ride.** Chi Coltrane, vocals and piano; rhythm, strings, synthesizer, horns, and vocal accompaniment. *Hallelujah; Let It Ride; Shortenin' Bread*; seven more. [Chi Coltrane, prod.] COLUMBIA KC 32463, \$5.98. Tape: ●● CA 32463, \$6.98; ●● CT 32463, \$6.98.

Here's a ripsnorting female vocalist/composer/producer whose performances are nothing less than searing. "Let It Ride" is dedicated to rock-and-roll basics; it has been created in the spirit of fun—and fun it is. I defy anyone to resist Coltrane's *Hallelujah*, a joyous stomp that would be at home inside a Bessemer furnace. Powerful, too, is the album's title tune, which just may make Chi a nationwide name. *Fly-Away Blackbird* is an electric gospel blues in which she gleefully competes with three backup singers (including the superlative Merry Clayton) and devastates them all, an easy feat for a performer with fist-clenched intensity and Grade-A lung power.

There's nothing profound about this disc, nothing at all. But who ever said that a wallop had to possess hidden meanings? H.E.

HARRY CHAPIN: Short Stories. Harry Chapin, vocals and guitar; vocal and instrumental accompaniment. *Short Stories; WOLD; Changes*; seven more. [Paul Leka, prod.] ELEKTRA EKS 75065, \$5.98. Tape: ●● ET 85065, \$6.98; ●● TC 55065, \$6.98.

Harry Chapin's songs always have been short stories, the best known of them being his hit record *Taxi*. With the title of this, his newest LP, he admits it. The songs in this album are gently stated observations of the this-and-that aspect of life. They are understated, whereas Chapin has in the past been guilty of the opposite. Best are *WOLD*, a poignant little piece about a disc jockey, and *Changes*, a symbolic work wherein a declining singer is used to exemplify declining confidence in old idols.

The recording seems a bit flat, with Chapin's voice buried somewhat. A singer who wants his words to be taken seriously should pay more attention to the prominence of his voice in the recording. Yet this is a minor fault, and on the whole Chapin's newest album is a good one. M.J.

LEO SAYER: Silverbird. Leo Sayer, vocals; Russ Ballard and Max Chetwyn, guitars; Dave Wintor, bass; Dave Courtney, piano; Mike Giles, Henry Spinetti, and Bob Henrit, drums; strings accompaniment. *Innocent Bystander; The Show Must Go On; The Dancer;*

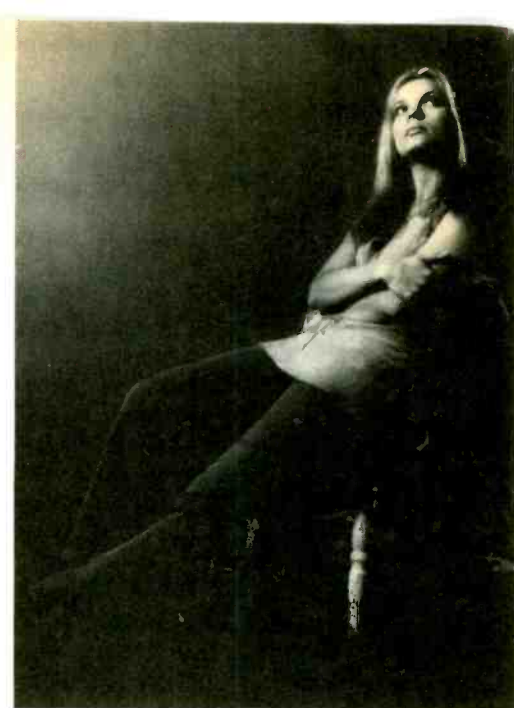

Chi Coltrane
Fist-clenched intensity.

Tomorrow; seven more. [Adam Faith and Dave Courtney, prod.] CHRYSALIS BS 2738, \$5.98. Tape: ●● M 82738, \$6.97; ●● M 52738, \$6.97.

Leo Sayer first came to prominence as the writer (along with Dave Courtney, who composed the music) of eight of the ten songs on Roger Daltrey's recent solo album. That push by Daltrey has been enough to propel Sayer to prominence as a performer on his own and to call attention to the Sayer-Courtney songwriting team, which provides all the material for this. Sayer's debut album.

It is an impressive debut. Sayer has kicked around the British pop-music scene enough to have acquired a genuinely eclectic style, from blues to music hall to ballad. He wears a clown costume and makeup for his current act, but this isn't so much a glitter phenomenon as a (slightly cloying, to my taste) poetic statement. But the Sayer-Courtney songs have an undeniable touch of freshness to them, and Sayer's singing—despite occasional instances of lush overarrangement on this disc—is compelling. J.R.

GRACE SLICK: Manhole. Grace Slick, lyrics and vocals; David Freiberg, Paul Kantner, David Crosby et al., vocals; rhythm accompaniment; orchestra arranged by Steven Schuster. *Jay; It's Only Music; Epic*; three more. [Grace Slick, David Freiberg, and Paul Kantner, prod.] GRUNT BFL 1-0347, \$5.98.

A Grace Slick review uses up a lot of energy. She does not come out to meet us; we must journey into her space without a road map and

Explanation of symbols

***** exceptional recording

Recorded tape:

●● Open Reel

● 8-Track Cartridge

●● Cassette

perceive as we will. This is Miss Slick's reality; this is how records are made and why.

I admire Grace Slick in a careful way, as I would admire a gifted Martian—from a distance. She makes these periodic musical statements from San Francisco with her friends, especially Paul Kantner and David Freiberg. Miss Slick is rarely a hit-maker, but she must have a following, because I have been getting these albums for years from Grunt Records, distributed by RCA.

Side 1 of the set is made up primarily of a work entitled *Theme from the Movie Manhole*, featuring a large orchestra arranged by Steven Schuster (who receives credit as a coproducer along with Keith Grant and the three producers listed). No information is given about the film *Manhole* except that the title "tune" was written by Miss Slick and published by her company. The words to this piece go on for days, stream-of-consciousness style. The orchestrated music is as massive and slow-moving as a bureaucracy. Pompous. People have been trying for years to reproduce the brilliance of the original Moody Blues album of six or seven years ago. It rarely comes off.

Side 2 opens with a bloodcurdling scream like nothing I have ever heard in my life. It just hangs there. A cheap shot for attention? It works disturbingly well, followed by a song, *Come Again? Toucan*, with music by Freiberg and lyric by Grace.

It is time to mention the large folder that accompanies the album, a journal from Slickworld with newspaper blurbs and handwritten axioms such as "Its [sic] a hardy tool [sic] who blames his musicians on his faults." The folder also includes lyrics to the songs, except that the printed words don't match the singing. Cute, Grace.

Better Lying Down is the only tune that expresses a specific idea: "She don't recognize you standing up; you know she thinks you look better lying down." This simple, horny blues, wonderfully sung with only a honky-tonk piano for accompaniment, is a relief from all the complexities.

When I see a title like *Epic (#38)*, I figure the writer (Kantner) never focused in on anything. The piece rambles forever with exquisite self-importance.

Grace Slick's charm is not that she is off-beat, but that she is fearless. She has a point of view and sells it hard. She is also what she was from the beginning, since the Jefferson Airplane days of the White Rabbit: a strong and original singer. M.A.



THE FIRESIGN THEATRE PRESENTS THE TALE OF THE GIANT RAT OF SUMATRA.

The Firesign Theatre: Phil Austin, Peter Bergman, David Ossman, and Philip Proctor. *An Outrageously Disgusting Disguise; Pickles down the Rat Hole*; four more. [The Firesign Theatre, prod.] COLUMBIA KC 32730, \$5.98.

The Firesign Theatre is a four-man comedy group that performs via the long-playing record. It made its name first in 1967 with "Waiting for the Electrician or Someone like Him," a classic recording, like this one on Columbia. That debut was bizarre, very funny, and often frightening—imagine the Marx Brothers directed by Federico Fellini.

A number of LPs have been issued since, and the newest is the best of them. It too is bi-

zarre and funny—not as substantial as the first, perhaps, but that album would be difficult to top. The basic idea of "Giant Rat of Sumatra" is to poke fun at the speech and behavior patterns of Victorian-era British adventurers, the old chums mucking about the jungle. There also is some business about Prohibition Chicago gangsters. The entire LP doesn't make a great deal of sense, but that's unimportant. It's fun to listen to as ludicrous scene follows ludicrous scene, and if it isn't logical, neither is life. M.J.

AMON DÜÜL II: Vive la Trance. Amon Düül II, all instrumentation. *A Morning Excuse; Fly United; Jalousie*; eight more. [Olaf Kübler and Amon Düül II, prod.] UNITED ARTISTS UA-LA 198F, \$6.98.

Rumored to be Germany's answer to the Grateful Dead, Amon Düül II is instead a most peculiar rock band with a great many avant-garde pretensions. Nevertheless, "Vive la Trance" does show promise at the outset. The album begins with *A Morning Excuse*, a combination of chirping and squawking sound effects, an insinuating, repetitive, haunting rhythm line, nonsensical lyrics sung in English, a few four-letter words, and a choir that sounds like a gaggle of Tiny Tims on the first day of the winter thaw. The result is admittedly interesting.

Intriguing too is *Mozambique*, which could have been lifted whole from an old Debra Paget movie. Jungle rhythms throb for more than seven long minutes, another example of the group's peculiarity. By the time one gets to *Apocalyptic Bore*, a selection devoted to exploiting the spacy sounds of the theremin, one has become bored by the precious studio tricks Amon Düül II has doggedly employed.

So many of the more precocious artifacts of one culture fail when placed in the context of another culture, and this band does not seem to be an exception. "Vive la Trance" may earn itself a cult of American devotees, but it's not an item with built-in popular appeal. H.E.

SUZI QUATRO. Suzi Quatro, vocals and bass; Len Tuckey, guitar; Alastair McKenzie, key-

boards; Dave Neal, drums. *48 Crash; Glycerine Queen; I Wanna Be Your Man; Can the Can*; seven more. [Mike Chapman and Nicky Chinn, prod.] BELL 1302, \$5.98.

Suzi Quatro is a young lady from Detroit who dresses in leather suits that zip down in front to the nether regions and who is working very hard in London to become a rock-and-roll star. She has already enjoyed several British singles successes, although at the time of this writing she hadn't yet cracked the American charts. This is her first album, and in a winningly old-fashioned, adolescently sexual way, it is an irresistible charmer.

Miss Quatro has a piping, teenage-ish soprano of unjudgeable quality. She is overdubbed with herself so many times that she sounds like an all-girl chorus lost in an echo chamber. But the effect is appropriate for the AM-oriented, no-nonsense rock offered here, and it doesn't in any way obscure the engaging, infectious rock-and-roll style she brings to her singing. The material (mostly by Miss Quatro and her lead guitarists or by the producers of the album) varies in quality, but most of it is clever, insistent pop music, the kind that sticks in your head without making you feel guilty about it. If her stage act equals her work on this disc and approximates the image she projects, she just might overcome the rock audience's prejudice against female hard rockers and make it big. J.R.

COMMANDER CODY AND HIS LOST PLANET

AIRMEN: Live from Deep in the Heart of Texas. Lance Dickerson, percussion; Commander Cody, keyboards; John Tichy and Andy Stein, horns; Billy C. Farlow, Bill Kirchen, Bruce Barlow, and Bobby Black, strings. *Introduction; Armadillo Stomp; Good Rockin' Tonite*; eleven more. [Steve Jarvis, prod.] PARAMOUNT PAS 1017, \$5.98.

This disc, recorded live at the Armadillo World Headquarters in Austin, Texas, finds Commander Cody playing to an enthusiastic audience that delivers enough screams to make all but the most hardy musicians flee the stage. It's difficult to figure out what all this hysteria is about. Commander Cody and His



The Firesign Theatre—as illogical as life.

Lost Planet Airmen, an amiable band with a distinct country-and-western sound, just doesn't have the pizzazz to generate this mad-dened response. For example, the performance of the jolly *Armadillo Stomp*, highlighted by a twanging country fiddle, is professional—as are all Commander Cody performances—and the number is invigorating, but it is hardly a blockbuster.

Neither is *I'm Coming Home*. Good playing abounds, but the tune could not be called a grabber. In fact, every rendition sounds almost the same by the time one has reached the second side of the disc. Side 2 does, however, offer two highlights: the toe-tapper *Diggy Diggy Lo*, irresistible no matter who performs it, and the Lieber-Stoller *Riot in Cell Block No. 9*, given a thoroughly witty rendition. These two numbers demonstrate that Commander Cody, when it wants to, can get a little variety into its performance. H.E.

* **OZARK MOUNTAIN DAREDEVILS.** Steve Cash, John Dillon, Randle Chowning, Larry Lee, Buddy Brayfield, and Michael "Supe" Granda, vocals, guitars, keyboards, fiddles, harps, percussion, and drums. *Spaceship Orion; Beauty in the River; Colorado Song*; seven more. [David Anderle and Glyn Johns, prod.] A&M SP 4411, \$5.98. Tape: ● 8T 4411, \$6.98; ●● CS 4411, \$6.98.

This album has a feeling—which is what all new bands search for. Players get together, talk their talk, play their music, and then wait to see if it all comes together in a way that has a feeling. If it does, the band tends to make it. If the feel is faked, the group tends to fade, break up, and regroup elsewhere, looking for the magic.

The Ozark Mountain Daredevils have a real friendly feeling. All six are excellent players, but these days, who isn't? More important than basic indispensable competence is their naturalness, so that ability is not the big deal.

The musicians all sing well, and most of them are front-line songwriters in the way that Crosby/Stills/Nash/Young were equally fine writers when they were a group (no other similarity). According to the bio, all members contribute to each track. I tend to believe it.

Much of the album's good feeling may be related to the easygoing production values of David Anderle and Glyn Johns. The two British producers came over to spend time with the Daredevils in their large house in the woods of the Ozarks. Much of the music originates there, though the band went to London to record.

Ozarks or not, this is a sophisticated if earthbound group. Randle Chowning, who plays several guitars and harp, sang and wrote my favorite track, a haunting ballad called *Road to Glory*. *Within Without* is sad and honest, written well by Larry Lee (vocals, drums, percussion, guitar). I have a weakness for bare, simple ballads, but the Daredevils are equally good on high-energy songs such as *If You Wanna Get to Heaven* by Steve Cash and John Dillon and *Chicken Train* by Cash.

The Ozark Mountain Daredevils do not sound like The Band, but they feel as good as The Band. I wish them all dazzling success and hope they never sell off that priceless hidden house in the woods. M.A.



The New (?) Dylan

by Mike Jahn

The titles tell the story: Bob Dylan has released another batch of love songs. All are recent original compositions, and all are at least competent. Several of them—such as *On a Night like This*, *Hazel*, and *Going, Going, Gone*—are superb love songs but still love songs. One doesn't want to make a stand against declarations of love, but there is hardly a category of song that is more overpopulated. With a dozen or more albums of like material released each week, who needs to hear it from Bob Dylan?

Dylan making this album reminds me of

Marlon Brando playing that role in *Teahouse of the August Moon*: not bad, but there were three billion Orientals who could have done it as well or better. And most importantly, we know the old boy is worth more than that.

Dylan was worth more than that at one time. His odd voice is perfect for the songs on his three epic Columbia albums, "Bringing It All Back Home," "Highway 61 Revisited," and "Blonde on Blonde." His nasal tones match well the bitter, sardonic material. But seven years have passed since the release of the last-mentioned of that trio, and Dylan has churned out, for the most part, a steady stream of pleasant but superficial love songs. He has tried to make his voice deeper in order to carry it off, but it hasn't helped. Dylan still sounds as foolish singing *Hazel* as would Frank Sinatra singing *Subterranean Homesick Blues*.

Most critics and, apparently, most fans have waited patiently for seven years, making excuses. One of the more recent excuses is that "Dylan doesn't really mean it, he's putting everyone on." If this is the case, he should press a private edition for use as a valentine card and not release the album to the public. I am among those who are tired of waiting for Dylan to regain his old stature. Perhaps he cannot and is content to spend the rest of his life tending his real-estate holdings and releasing the musical equivalent of Grade B movies. If so, it's sad indeed.

BOB DYLAN: Planet Waves Bob Dylan, vocals, guitar, and harmonica; vocal and instrumental accompaniment. *On a Night like This; Going, Going, Gone; Tough Mama; Hazel; Something There Is About You; Forever Young; Dirge: You Angel You; Never Say Good-by; Wedding Song*. ASYLUM 7E 1003, \$6.98. Tape ● ET 1003, \$7.98; ●● EC 1003, \$7.98.

* **JAMES GRIFFIN:** Breakin' Up Is Easy. James Griffin, vocals; rhythm, strings, keyboards, and vocal accompaniment. *Breakin' Up Is Easy; Someday; Love You Till the Cows Come Home*; seven more. [James Griffin and Robb Royer, prod.] POLYDOR PD 6018, \$5.98.

Along with David Gates, James Griffin was founder of that much-loved, extremely popular, middle-of-the-road rock ensemble Bread. After Gates began creating superhits for the group, however, Griffin felt he was being denied the opportunity to express himself creatively within the successful format. And when Bread did not record Griffin's *Love You Till the Cows Come Home* as it had promised, James packed up his guitar and moved to another label as solo artist.

You could be sure that his debut would be the most powerful and versatile creation he could offer, and the composer/performer/producer/instrumentalist has not failed in his attempt to go it alone.

"Breakin' Up Is Easy" is a melodious demonstration of Griffin's talents in conjunction with an assortment of musicians dedicated

enough to him to allow him to shine. These musicians include ex-Bread members Mike Botts and Larry Knechtel, the Section's rhythm section, Lee Sklar and Russ Kunkel; and Mike Iseberg, who utilizes both the synthesizer and mellotron to produce alternately spare and lush strings effects.

All this musicianship comes together on the album's title tune, an emotive number with a soaring set of musical lines from Iseberg and a gritty Griffin vocal. Other highlights include the rollicking blues tune that Bread rejected and the tender *Father and Son*, in which the rock tune becomes a quiet ballad and then reverts back to its punchy rock format. Leaning towards the gentle side, Griffin also presents a sweet-voiced *You'll Get Along*, the folk-oriented *Going Back to Boston*, and *Love You to Light the Way*, a tune arranged with a stirring, anthemlike conclusion.

Welcome, James Griffin.

H.E.

JEREMY STEIG: Monium. Jeremy Steig, bass flute; Eddie Gomez, bass; Ray Mantilla, congas and timbals; Marty Morell, drums. *Mason Land Express; Bluesdom; Djinn Djinn; Space Maiden; Monium; Dream Passage*.

[Jeremy Steig, prod.] COLUMBIA KC 32579, \$5.98.

Jeremy Steig is a young flautist who has for over a decade been a leader of the avant-garde jazz flute. He has toyed with rock, as he toys with Latin percussion on this album, a good one. Steig is equally comfortable playing a soft, arhythmic melody such as *Space Maiden* and an up-tempo, nearly frantic raver like *Monium*, the title tune. I don't care for his habit of making the sound of his breath nearly as prominent as the tone it causes in the instrument, but that is my only quibble. M.J.

theater and film

RAISIN. Original Broadway cast recording. Music by Judd Woldin; lyrics by Robert Brittan; Joe Morton, Virginia Capers, Ernestine Jackson, Robert Jackson, et al., vocals; Howard A. Roberts, cond. [Thomas Z. Shepard, prod.] COLUMBIA KS 32754, \$6.98. Tape: ● KSA 32754, \$7.98; ●● KST 32754, \$7.98.

GIGI. Original Broadway cast recording. Music by Frederick Loewe; lyrics by Alan Jay Lerner; Karin Wolfe, Daniel Massey, Alfred Drake, Maria Karnilova, et al., vocals; Ross Reimuller, cond. [Joe Reisman, prod.] RCA ABL 1-0404, \$6.98. Tape: ● ABS 1-0404, \$7.95; ●● ABK 1-0404, \$7.95.

Lorraine Hansberry's moving play *Raisin in the Sun*, about a black family's hopes of using a \$10,000 inheritance to gain the dignity they have been denied in the ghetto of Chicago's South Side, did not seem a likely candidate for adaptation as a musical. And the Judd Woldin/Robert Brittan score for *Raisin* does not always improve on what Miss Hansberry was able to do with words alone. But that extra potential in the combination of words and music makes itself felt often enough to justify this new version.

Still, it is the dialogue that gives even this musical version much of its power (a reversal of the customary relationship of book and score), and the score alone does not have the momentum to carry and set the songs in the theater. Fortunately, several of the performers are singing actors who project with such immediate strength that they can establish in a few bars of a song a characterization that is constantly in development on-stage. Joe Morton is consistently brilliant in this respect, and he is able to color his songs with the varying levels of frustration that are a key element in them. In the same way, Robert Jackson and Virginia Capers create instant cameos with *Alaiyo* and *Measure the Valleys*. But the subtle powers and skill of Ernestine Jackson are obscured on the recording, except for the warmth that pervades *Whose Little Angry Man*.

While *Raisin* seems to succeed in spite of itself, the stage version of *Gigi* fails in spite of its success as a film. Granted, the Alan Jay Lerner/Frederick Loewe film score was an all too transparent rerun of their phenomenally successful stage production of *My Fair Lady*. It had some charm and color and the helpful personality of Maurice Chevalier. Somehow, in this Broadway cast recording, the color has faded and the charm is cloying. The compos-

ers have written three new songs for the stage version which add nothing to it, and if it were not for the very capable presence of Alfred Drake this adaptation would have scarcely anything to commend it. J.S.W.

THE DEVIL IN MISS JONES. Original motion-picture soundtrack recording. Composed by Alden Schuman. Linda November, vocal; Frank Owens, piano; Peter De Angelis and Roy Straigs, cond. [Alden and Earl Schuman, prod.] JANUS JLS 3059, \$5.98.

Well, here you have it, ladies and gentlemen, a historic first: a soundtrack album for a genuine hard-core porno flick. I'm not sure what would be appropriate as music to-do-what-they-do-in-this-film by, but certainly the Francis Lai-cum-Erik Satie-cum-Roger Williams sounds devised by Alden Schuman to accompany the goings on come as a bit of a surprise. It is the kind of music you expect to hear behind aerial pan shots of two flower children sitting on a mountaintop contemplating each other's yoghurt.

What is really incongruous is that the music almost never reaches a climax. Schuman's basic technique is a simple, hypnotic, vamp-till-ready, one-two alternation between two keys (frequently major-minor), plus some pretty hammy piano playing (no doubt the fault of the arrangers) over which he spins various simple themes that keep repeating—and repeating. For all this, there is no denying the wistful prettiness of some of the music, and the ballad *I'm Comin' Home* (sung as the heroine commits suicide at the opening of the film) is definitely effective. Although the music wears very thin very fast and is not particularly well played or recorded, I can think of worse things to play as background music for a party. Especially certain kinds of parties. R.S.B.

CASABLANCA: CLASSIC FILM SCORES FOR HUMPHREY BOGART. National Philharmonic Orchestra, Charles Gerhardt, cond. [George Korngold, prod.] RCA RED SEAL ARL 1-0422, \$5.98. Tape: ● ARS 1-0422, \$6.95; ●● ARK 1-0422, \$6.95.

STEINER: Casablanca; Passage to Marseille; The Treasure of the Sierra Madre; The Big Sleep; The Caine Mutiny; Virginia City, Key Largo. **WALKMAN:** To Have and Have Not; The Two Mrs. Carrolls. **HOLLANDER:** Sabrina. **YOUNG:** The Left Hand of God. **ROZSA:** Sahara.

If any actor deserves to have a record devoted to him, it is Humphrey Bogart. Bogart's screen presence was projected so strongly that this presence in itself has become a paradigm of sorts. And thus, in the midst of the convoluted anarchy of certain recent films, actors such as Belmondo and Trintignant have on occasion not just played their roles but have, in fact, played Bogart playing their roles.

But I'm not sure I see the logic in devoting music albums to film stars rather than to composers. What this Bogart release nets for the most part is still more Max Steiner: and what with the ho-hum prospect of a *Gone with the Wind* from RCA, the Steiner ship seems ready to sink beneath the weight of all that eternally heroic, major-key optimism. Little could be more innocuous than the *Caine Mutiny* march or the *Virginia City* music included here. And if *Casablanca* starts off with an immensely impressive bang and a flourish, it loses steam at an alarming rate when it starts playing around

SAVE!

MONEY • TIME • FREIGHT

QUALITY STEREO EQUIPMENT AT LOWEST PRICES.

YOUR REQUEST FOR QUOTATION RETURNED SAME DAY.

FACTORY SEALED CARTONS—GUARANTEED AND INSURED.

SAVE ON NAME BRANDS LIKE:
A.D.C. KLH
A.R. SHURE
DYNACO KOSS
FISHER SONY

AND MORE THAN 50 OTHERS

BUY THE MODERN WAY

BY MAIL—FROM

ia

illinois audio

Department 217H

12 E. Delaware Place

Chicago, Illinois 60611

312-664-0020

CIRCLE 18 ON READER-SERVICE CARD

HUGE SAVINGS ON FAMOUS BRAND STEREO COMPONENTS

DISCOUNTS

ON NATIONALLY ADVERTISED

TURNTABLES • CARTRIDGES

COMPACTS • RECEIVERS

AMPLIFIERS • TAPE RECORDERS

Wholesale Prices! Audio Warehouse Sales, one of the Capitol's largest stereo wholesalers will fill and deliver all your mail orders promptly in factory sealed cartons, at prices that will amaze you.

Write for quote on Famous Brand, Stereo Components. We guarantee satisfaction.

AUDIO

WAREHOUSE SALES
3310 NEW YORK AVE. N.E.
WASHINGTON, D.C. 20002
(202) 832-1616

CIRCLE 3 ON READER-SERVICE CARD

DISCOUNTS

WASH. D.C.
HAS NO FAIR
TRADE
LAWS!

ON STEREO COMPONENTS

PLEASE REQUEST
Prices for your choice of
Changers, Receivers, Tape
Recorders, Speakers, etc.

PROMPT DELIVERY
IN FACTORY
SEALED
CARTONS.

DISTRICT SOUND INC.

2316 Rhode Island Ave. N.E.
Washington, D.C. 20018
202-832-1900

CIRCLE 8 ON READER-SERVICE CARD

BIG DISCOUNTS

STEREO COMPONENTS

Largest selection of top name
brands... try us and see

It's worth a call
(301) 488-9600

INTERNATIONAL
MUSIC
DISTRIBUTORS

6330 Frankford Ave.
Baltimore, Md 21206

All mail answered within 24 hours

Phone Daily 9 AM to 9 PM
Saturday 9 AM to 4 PM
Phone (301) 488-9600

CIRCLE 19 ON READER-SERVICE CARD

with the *Marseillaise*. As *Time Goes By*, and *Deutschland über Alles*. *The Treasure of the Sierra Madre* has a good deal more depth to it, and I found many of the understated *Key Largo* excerpts a pleasant relief. But even in the latter, the mawkish milking of some of the themes considerably waters down the over-all dramatic effect.

More welcome are the all-too-brief selections from scores by the much-neglected Franz Waxman. Although these selections contain many of the tics that can be heard in the Steiner scores, their rhythmic inventiveness, their harmonic complexity, and their frequently unpredictable shifts of direction broaden their musical and emotional impact miles beyond any of the Steiner heard on this album. A typical Waxman touch, for instance, can be heard in the *Martinique* section of *To Have and Have Not*, in which a strange timpani ostinato offers a highly original alternative to the pseudo-exotica that fills so many of the Steiner scores. Miklós Rózsa's sweeping title theme for *Sahara* abounds in the tense melodic patterns, the frequent strettos, and the modulations typical of the composer, and it is most welcome here. I also liked the poignant, hymnlike love theme Victor Young wrote for *The Left Hand of God*. But the fifth-generation Viennese one-two-threes of Frederick Hollander's watery score for *Sabrina* rankle beyond belief. I can think of a dozen Bogart films (*The African Queen*, for starters) with better scores.

As usual, the recorded sound for this "Classic Film Scores" release is spectacular, and Gerhardt conducts the pieces creditably, in spite of a horrible cello solo in *The Two Mrs. Carrrolls* and some other miscues. I can only hope that RCA will make it worth sitting through "Max Steiner Rides Again" by bringing out the Bernard Herrmann and Miklós Rózsa albums—scheduled to follow the *Gone* (again) with the *Wind* disc—with all due haste.

R.S.B.



FRANK LOESSER REVISITED. Compiled and produced by Ben Bagley under the auspices of David Wilke. Gloria Swanson, Rhonda Fleming, Johnny Desmond et al., vocals; musical direction by Dick Hyman. *Let's Get Lost; Pleasures and Palaces; Why Fight the Feeling*; thirteen more. PAINTED SMILES 1359, \$5.98 (Painted Smiles Records, 1860 Broadway, New York, N.Y. 10023).

Ben Bagley was into nostalgia before it was "in," even before it was called camp (remember camp?). He owns a special pocket of the record and theater world, a sphere where no one else can touch his work. By God-knows-what means, he has managed to finance and bring off at least fifteen albums of tributes to obscure works of famous composers such as Cole Porter and Gershwin and, now, Frank Loesser. He has a way of throwing in surprises: In this set, Gloria Swanson makes her singing debut!

Even better than Bagley's albums are his liner notes—intimate, flowing, funny, real. These happened to be written just after the death of his beloved cat, Butch, who has often been mentioned. Melancholia pervades but does not overwhelm Bagley's basic whimsy and fine madness.

Frank Loesser is one of my all-time favorites. Ben's too. It was Loesser who once

backed Bagley's *Littlest Review* because it featured the songs of Vernon Duke, a composer he admired greatly. Loesser knew he'd never see a dime. Bagley: "Frank Loesser was not a greedy man. He gave almost as much back to the American musical as he received from it... and he used to refer to me as 'that crazy kid with talent.'"

The album begins with Rhonda Fleming and Les Boys singing *Kiss the Boys Good-by*, the "title song from the Paramount motion picture which introduced Mary Martin to a basically uninterested movie-going audience."

Three-Cornered Tune, sung by the inestimable Blossom Dearie, is for me the highlight of the album. Bagley: "This really is a rare find. It was written for Isabel Bigley, Sam Levene, and Robert Alda to sing in *Gyps and Dolls*, dropped from the show out of town, and reinstated under the title *Fugue for Tin Horns*, with new lyric and new tempo." The tune is immediately recognizable, but this early version is fascinating, with all three parts of the fugue sung elegantly by Miss Dearie.

Margaret Whiting gives us *I Wish I Didn't Love You So*, from *Perils of Pauline* and once introduced by Betty Hutton (who knew?). Johnny Desmond steps up jauntily for *Dancing on a Dime*, and Rhonda returns for a heart-felt *Where Are You Now That I Need You* (1949), Madeline Kahn, young leading lady of *Paper Moon* and *Blazing Saddles*, performs in her unique way on *Rumble Rumble Rumble*.

Gloria Swanson is charming in her singing debut, *They're Either Too Young or Too Old*. She sounds as if she should know.

Bibi Osterwald lends her crackling energy to *Hamlet and Murder, He Says*. Finally Margaret Whiting does a simple version of the classic *Spring Will Be a Little Late This Year*, introduced by Deanna Durbin in Universal's *Christmas Holiday*. Bagley: "I never felt the meaning of the lyrics completely until the death of that cat. I'd always considered him, as I told you before, a 'tender friend,' but I have a recurring nightmare where I'm searching for him in empty buildings... My subconscious, you see, is telling me that he was more than just a constant companion. He was my baby! If this grief is difficult for any of you to understand and you say to yourself, 'Oh well, it was only a cat,' then I would appreciate it if you would return this record."

Bagley shares himself—no apologies. I like him for it, and I find his albums irresistible.

If you cannot find this album in your record store, you may order it directly from Bagley at the address given above. M.A.

jazz

THE SMITHSONIAN COLLECTION OF CLASSIC JAZZ. For a feature review of this album, see page 78.



FLIP PHILLIPS: Flip in Florida. Flip Phillips, tenor saxophone and bass clarinet; Tom Howard, piano; Eddie Schwager, bass; Pete Helman, drums. *Sweet Georgia Brown; Miss Thing; Nuages*; seven more. ONYX 214, \$5.98.

If Flip Phillips is remembered primarily for

CIRCLE 44 ON READER-SERVICE CARD →



anatomy of the total performers

If you take apart one of TDK's new Dynamic-series cassettes, you might think it looks pretty simple. Five screws. Two hubs. A length of tape. Two rollers. Two cassette shell halves. A few other parts. What's so complicated about that?

Plenty! Unlike open reel tape, a tape cassette becomes an integral part of your recorder. Not just electromagnetically, but also mechanically. So in addition to good sound reproduction capabilities, a cassette must be an absolutely precise mechanism.

It took years of research, development and testing to produce the present-day TDK cassette. The result is a unique combination of superior electromagnetic characteristics and mechanical precision that make TDK cassettes completely compatible with any cassette recorder. And it permits them to deliver total sound reproduction and mechanical performance unequalled by any other cassette you can buy today.

Take the tape, for example. TDK cassette tapes are coated with exclusive formulations of ferric oxide powders in special binders, using proprietary TDK methods which result in the most desirable electromagnetic characteristics. Not just full-range frequency response and high-end sensitivity, but the proper balance of all the other characteristics essential to the faithful reproduction of "real-life" sound. Like high MOL (Maximum output level). Broad dynamic range. Wide bias tolerance. High signal-to-noise ratio. Low modulation and bias noise. Low print-through. Good erasability.

The housing is precision-molded of high-impact styrene. The transport mechanism uses tapered and flanged rollers with stainless steel pins, all-felt pressure pad, silicone-impregnated liners, and two-point hub clamps. Features first introduced by TDK. And all parts are manufactured to extremely fine tolerances to assure trouble-free operation and to

resist jamming, stretching, warping and tangling.

What does all this mean to you? Just that when you record on one of TDK's new Dynamic-series "total performer" cassettes, you can be sure of getting everything! All the highs and lows. All the important harmonics, overtones and transient phenomena. All the natural richness, fullness and warmth of the original performance. Plus reliable, trouble-free mechanical operation.

So look for TDK's total performers at quality sound shops everywhere. For sound you feel as well as hear, discover the dynamic world of TDK!

the new dynamic world of

TDK

TDK ELECTRONICS CORP.
755 Eastgate Boulevard, Garden City, New York 11530

NOVA AUDIO

The Brightest Super Star
In Stereo Today

At Last!

- MAIL ORDER
- Plus —
- SERVICE
- Plus —
- FINANCING
- Plus —
- TOP MAJOR BRANDS

Nationwide Financing
Also Bank Americard & Mastercharge
We carry all the Fair Trade Brands
Whenever Possible these makes
are quoted 'in Systems'
We quote on ALL Major Brands
Large complete inventory on
everything we sell

We provide our own
Factory Authorized Service on
everything we sell

YOU CAN TRUST US!

Write for our price and quotations on
complete systems or individual
items. Whatever your needs,
we'll fill them and SAVE you money,
time and worry!

Box 542, 2940 A Prosperity Ave.
Fairfax, VA 22030
(703) 280-4500

CIRCLE 26 ON READER-SERVICE CARD



Free!

New 14th
Edition of
the Midwest
Hifi Catalog!

Save on stereo!

Buy direct from us, and you save
money with our high-volume prices
on more than 100 name brands.
Order from the branch nearest you.

Midwest Hifi Wholesale

& MAIL ORDER DIVISION
2455b Wisconsin Ave.
Downers Grove, Ill 60515
3309 E. J W Carpenter Frwy.
Irving, Tex 75062

HF

NAME

ADDRESS

CITY/STATE

ZIP

CIRCLE 24 ON READER-SERVICE CARD

his endless blasting and honking through *Perdido* with Norman Granz's "Jazz at the Philharmonic" troupes, he has been done an injustice. Of course, Phillips had established himself as a strong, driving saxophonist with Woody Herman's band in the mid-Forties before he joined the JATP entourage, but with Herman he was playing as one element in an orchestra filled with brilliant, individualistic soloists, rather than as the exhibitionist he became with JATP.

Since he left JATP in 1954, Phillips has been based in Florida, and this set, recorded in 1963, shows what the jazz world has been missing by his absence from a broader scene. This is straight, clean, joyous swing, propelled by a vital rhythm section, with Phillips varying between astutely phrased, flowing solos that almost revel in his memories of Lester Young (one of his best performances is a very loving bit of Lesteriana called *I Remember Lester*) and easy, relaxed ballads that reveal a warm, beautifully controlled tone. He has also taken up the bass clarinet, which he plays with a notable lack of the grumpiness that often comes out of this instrument in jazz settings. His three associates—Tom Howard, Eddie Schwaiger, and Pete Helman—are excellent on their own as well as a closely knit accompanying group.

This is unpretentious, beautifully balanced, and skillfully played swing-style (but not Swing Era) jazz, the likes of which is rarely heard these days. J.S.W.



UPPER MISSISSIPPI JAZZ BAND: Red, Hot, and Blue. Bruce Allard, trumpet and violin; Art Katzman, trombone; Dick Ramberg; clarinet; Butch Thompson, piano; Reuben Ristrom, banjo; Bob Andrews, bass; Tom Andrews, drums. *Blue Turning Grey over You; My Honey's Lovin' Arms; Birth of the Blues*; seven more. UMJB S 80-583, \$5.50 (Upper Mississippi Jazz Band, 4215 22nd Ave. S., Minneapolis, Minn. 55407).

The unexpected freshness and individuality shown by the Upper Mississippi Jazz Band on its first record—unexpected in view of the tendency of most such traditional or Dixieland bands to adhere to trite formulas—is not only maintained in the group's second disc but is even more open and free-flowing.

A key figure in achieving this is Bruce Allard, who provides an easy but positive lead trumpet for the ensembles as well as a variety of pungent solos, both open and muted, and who plays violin with a swinging skill that combines traces of Stéphane Grappelli and Ray Nance. Butch Thompson, a pianist who seems at times a reincarnation of Jelly Roll Morton, mixes his Mortonisms with a bright, stomping manner that is essentially his own. He also shows an interesting capability as a composer on *Ecuadorian Memories*, a jaunty, folksy piece that takes on an unusual piquancy with the traces of Jelly Roll that trickle through the echoes of Ecuador. The other sidemen would be standouts in most traditional groups, but it is indicative of the over-all quality of this band's playing that they seem merely acceptable next to Allard and Thompson.

The choice of material is not exactly inspired, but even on such well-worn pieces as

Panama and *Just a Closer Walk with Thee* this band finds fresh, interesting, individual things to do. J.S.W.



LUIS RUSSELL: And His Louisiana Swing Orchestra. Various groups including Bob Shoffner, Bill Coleman, Red Allen, Louis Metcalfe, Gus Aiken, and Leonard Davis, trumpets; Preston Jackson, J. C. Higginbotham, and Jimmy Archey, trombones; Albert Nicholas, Barney Bigard, Charlie Holmes, Teddy Hill, and Greely Walton, reeds; Luis Russell, piano; Johnny St. Cyr, banjo; Bill Johnson, guitar; Bill Moore, tuba; Pops Foster, bass; Paul Barbarin, drums. *Call of the Freaks; Jersey Lightning; Louisiana Swing*; twenty-seven more. COLUMBIA KG 32338, \$6.98 (two discs) [recorded 1926-34].

This collection may come as an exciting shock to a lot of people who thought they were reasonably knowledgeable jazz followers. From the formative big-band days of the late Twenties the familiar names are Fletcher Henderson, Duke Ellington, McKinney's Cotton Pickers, Bennie Moten, Earl Hines—not only because they were celebrated at the time but because also these are the bands that have been reissued most frequently on LP. Luis Russell's orchestra has, until now, received very little attention on reissues, and after hearing this set one can only wonder why.

At its peak, this was one of the greatest of the big jazz bands, focused on three brilliant young soloists—J. C. Higginbotham (trombone), Red Allen (trumpet), and Charlie Holmes (alto saxophone)—and with a rhythm section driven by a ground-breaking bassist, Pops Foster. The sweeping power of Higginbotham's remarkably brash, swaggering trombone attack brings a fresh, exultant sound on every piece in the set except those records from what might be termed the prologue and epilogue to Russell's career as a band leader—four 1926 recordings with men drawn from King Oliver's band and six made in 1934.

The rest are Russell's band of 1929 and 1930, with Charlie Holmes playing alto solos that are dead ringers for Johnny Hodges' work at that time and Red Allen adding his commanding trumpet in the fall of 1929. Foster came in on bass at the same time, and the resulting transformation of the rhythm section is startling. Like Fletcher Henderson, Russell was a modest piano soloist and his arrangements were simple and direct, which was the best kind of display for his brilliant soloists.

Frank Driggs, who produced the set, has written a long, informative biographical essay on Russell. The soloists on each selection are identified and personnel lists and a bibliography are included, but for some reason one essential bit of information—dates of the recordings—has been omitted. J.S.W.

BUDDY RICH: The Roar of '74. Charlie Davis, Larry Hall, Greg Hopkins, and John Hoffman, trumpets; Alan Kaplan, Keith O'Quinn, and John Leys, trombones; Joe Romano, Bob Martin, Pat La Barbera, Bob Crea, and John Laws, saxophones; Buddy Budson, piano; Joe Beck, guitar; Tony Levin, bass; Jimmy Maeulen and Sam Woodyard, percussion; Buddy Rich, drums. *Big Mac; Senator Sam;*

CIRCLE 33 ON READER-SERVICE CARD →

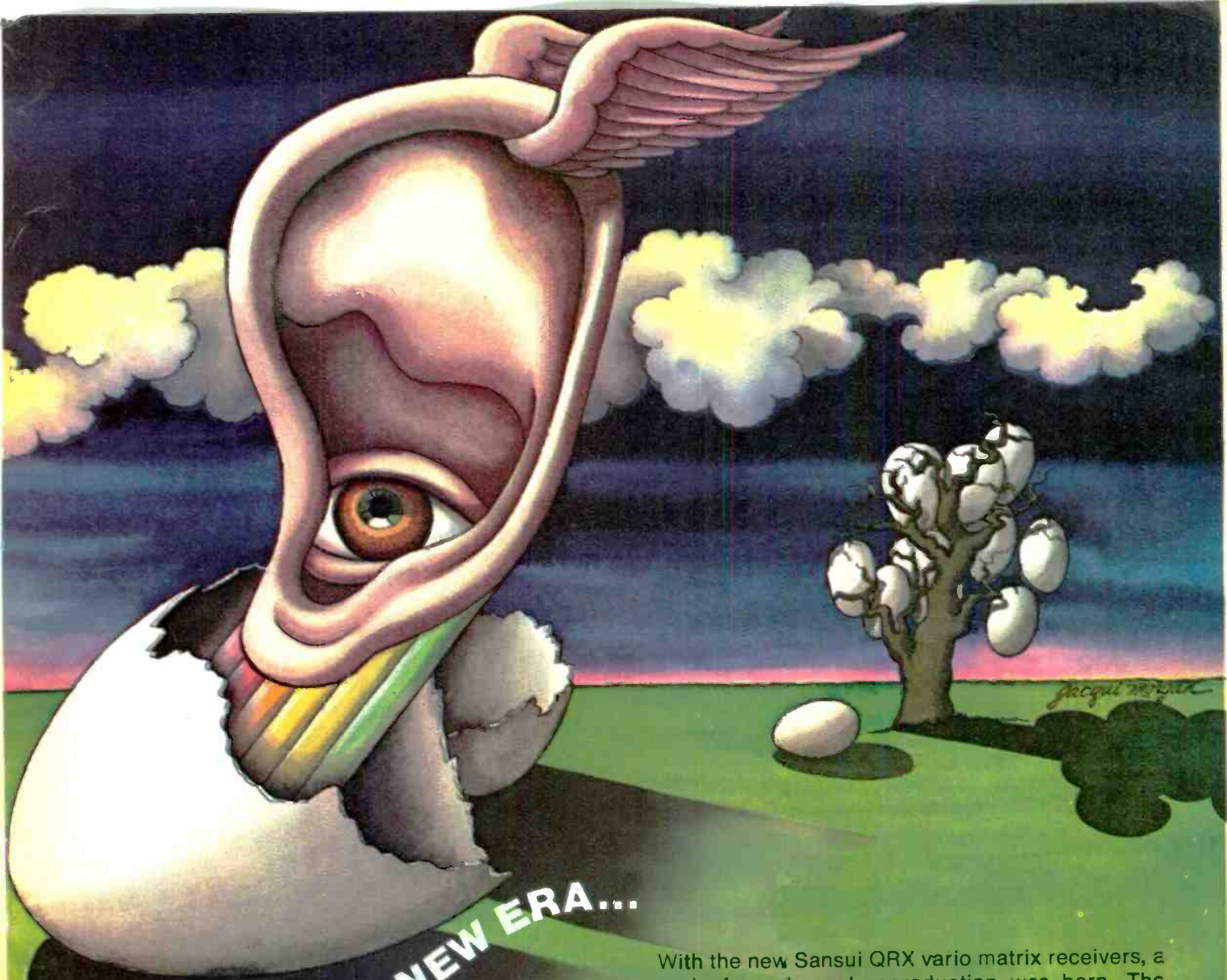

BIRTH OF A NEW ERA...

With the new Sansui QRX vario matrix receivers, a new era in four channel reproduction was born. The QRX-5500 allows for total control of the most breathtaking four channel sound ever produced. Only Sansui's QS vario matrix circuitry gives you true QS four channel, synthesized four channel from a two channel source, and SQ with true fidelity. The QRX-5500 also handles discrete sources such as demodulated CD-4 and discrete tape. *Hear the new age of sound at your franchised Sansui dealer.*



QS
REGULAR MATRIX

Sansui

SANSUI ELECTRONICS CORP.

Woodside, New York 11377 • Gardena, California 90247

SANSUI ELECTRIC CO., LTD., Tokyo, Japan

SANSUI AUDIO EUROPE S. A., Antwerp, Belgium • ELECTRONIC DISTRIBUTORS (Canada) Vancouver 9, B.C.

**A breathtaking performance
deserves a breathtaking
performance.**

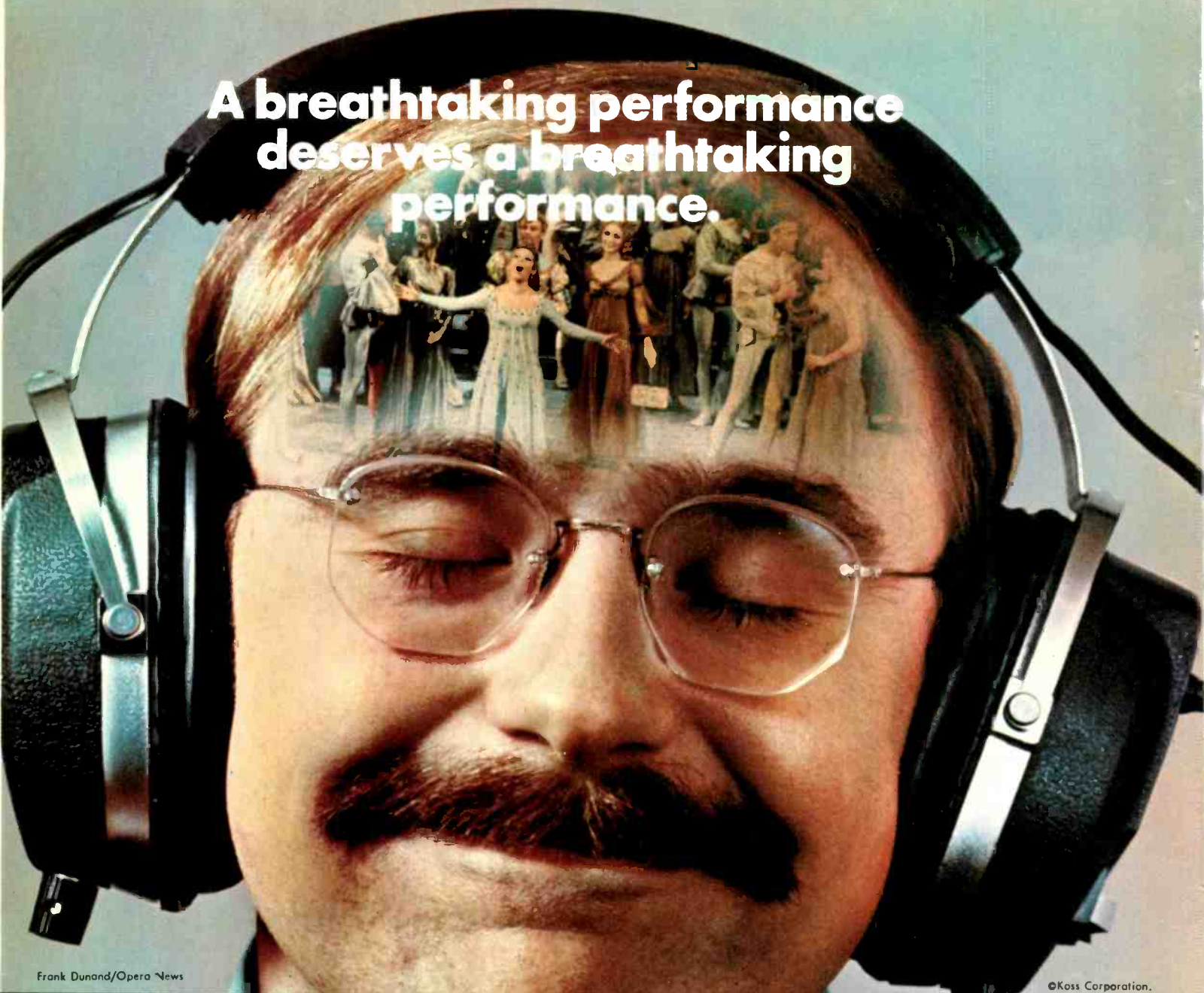

Frank Dunand/Opera News

©Koss Corporation.

Slip on a pair of Koss K2+2 Quadrafones® and slip into the closest thing to a live performance you'll ever hear. Because unlike speakers, the Koss K2-2 mixes all four channels in your head instead of on the walls of your living room. So what you'll hear is a 4-channel sound so breathtaking, you'll feel the deepest bass all the way down to your toes and the highest highs running up and down your spine.

And because all Koss

Quadrafones feature volume-balance controls on each ear cup, you'll have any seat at the opera at your fingertips. A twist of your fingers will put you front row center one minute and in the middle of the opera house the next. And all without moving from the comfort of your easy chair.

But even more importantly, Koss has added a 2-channel to 4-channel selector switch on the



left ear cup. In the 4-channel position, two 1½-inch dynamic driver elements in each ear cup deliver breathtaking quadraphonic sound from either matrix or discrete systems. In the 2-channel position, both drivers in each ear cup are connected in parallel for an unparalleled sound of 2-channel stereo. Either way, the switch to Koss Quadrafones is worth it.

Ask your Audio

Specialist for a live demonstration. Or write for our free full-color catalog, c/o Virginia Lamm. The Sound of Koss Quadrafones will take your breath away, but the price won't . . . from \$45 to \$85.

Koss K2+2 Quadrafones



KOSS QUADRAFONES®
from the people who invented Stereophones.

Koss Corporation, 4129 N. Port Washington Ave., Milwaukee, Wisconsin 53212 Koss S.r.l., Via dei Valtorta, 2120127, Milor, Italy.

CIRCLE 30 ON READER-SERVICE CARD

Prelude to a Kiss; five more. GROOVE MERCHANT 528, \$4.98.

Buddy Rich's band seems to be rising above that early period in its career when everything it played was more or less a buildup to its *West Side Story* medley or one of the other long concerto-type pieces that featured Rich's drumming.

On this disc the emphasis is on the driving power and vitality of the band as a whole, rather than on Rich himself (there is relatively little solo drumming), and on the extraordinarily gutsy book that the band is building up. The emphasis is on relentless, driving power, a tactic that produces explosive, jubilant jazz when it works but comes out as empty blare when it doesn't. It succeeds more often than it fails, thanks to exceptionally clean but loose section reading and solos—primarily by tenor saxophonist Pat La Barbera—that flow like a mountain torrent. Greg Hopkins' *Nuttville*, John La Barbera's *Backwoods Sideman*, a tremendous jazz hoedown, and Don Menza's *Time Check* are the main power here, while Hopkins' richly voiced arrangement of *Prelude to a Kiss* and Ernie Wilkins' slinky blues, *Senator Sam*, create the change of pace necessary to keep the disc from flying completely off the turntable. J.S.W.



RUBY BRAFF-GEORGE BARNES QUARTET. Ruby Braff, cornet; George Barnes and Wayne Wright, guitars; John Guiffrida, bass. *Our Love Is Here to Stay*; *Liza*; *Oh, That Kiss*; seven more. CHIAROSCURO 121, \$5.98.

After playing a distinctively mellow and imaginative cornet for more than twenty years, Ruby Braff has finally found a musical setting that not only is ideal for his lyrical style but also has that rare and difficult-to-achieve element in jazz—an individual sound. The quartet that Braff has organized with George Barnes (cornet, two guitars, and bass) made its debut last summer at the Newport Jazz Festival, serving as an opening act for a reunion of the original Benny Goodman Quartet. The audience had come to hear Goodman, Gene Krupa, Teddy Wilson, and Lionel Hampton, but the Braff-Barnes Quartet won them over immediately and, in the view of many listeners, took the honors of the evening.

This is the quartet's first recording, and it is a close reflection of the performance it gave that night. The unison blend of Barnes's electric guitar and Braff's cornet, open and muted, and their crisp phrasing provide the basis for the sound that gives the group its identity. Beyond this ensemble effect, the solos also benefit from the interesting backing of strings (no drums), which often creates a suggestion of the Quintet of the Hot Club of France.

Braff has rarely played with such relaxed charm as he does on *Looking at You*, one of Cole Porter's less frequently heard tunes, and a Don Redman song originally recorded in 1928 by Louis Armstrong, *Nobody Else but You*. Ruby also shows that those lovely lines that pour out on his solos can be channeled into an equally lovely composition, *With Time to Love*. Barnes's bright guitar lines add a balancing sparkle, although his solos tend toward flashiness.

Tightly knit groups are a rarity in jazz these days when long, loose-lined performances are the custom. So, for its rarity as well as its

warmth and beauty, this record is doubly welcome. J.S.W.

in brief

THE HUES CORPORATION: Freedom for the Stallion. RCA APL 1-0323, \$5.98.

The only thing that matters in a new group is that it should have a sound that is human. Most new groups don't. If a group is human, it is distinguishable from the Great Competent Majority. The Hues Corporation sounds like real people you could get to know. They sing very well too—warm and clear and rich. Their material is equally interesting and fitting. The album is beautifully produced by John Florez, who is probably largely responsible for the clarity of its sound. Arrangers include Gene Page and Perry Botkin, with vocal arrangements by Wally Holmes and the group. Hues already has a successful single, *Freedom for the Stallion*, and gets my best-debut-of-the-month award, which you can trade in for a quart of milk if you have a dollar in change as well. M.A.

DR. HOOK AND THE MEDICINE SHOW: Belly Up. COLUMBIA KC 32270, \$5.98.

To be perfectly frank about it, Dr. Hook, which has built its peculiar reputation by performing with total glee the raunchy and loathsome songs of Shel Silverstein, does offer up some perfectly charming Silverstein songs on this collection. Unfortunately, there is enough of the loathsome Silverstein on this disc to still leave a bad taste in one's mouth. H.E.

GLADYS KNIGHT & THE PIPS: Anthology. MOWTOWN M 79252, \$5.98.

For more than twenty years Gladys Knight & the Pips have been making rhythmic, gospel-tinged music sparked by Gladys' searing, soulful vocals. "Anthology" includes fifteen of the act's most popular hits, including *I Heard It Through the Grapevine* and *Neither One of Us (Wants to Be the First to Say Good-by)*. Gladys Knight & the Pips fans: rejoice! H.E.

LINDA RONSTADT: Different Drum. CAPITOL ST 11269, \$5.98. Tape: 8XT 11269, \$6.98.

Linda Ronstadt has gone over to Asylum, and Capitol has put out a "greatest hits" collection from her days on that label. What makes it worth getting, even for those who own her three Capitol discs, is that half the material comes from her days as lead singer with the Stone Poneys—material that is mostly out of print or hard to get. Miss Ronstadt is still looking for a personal style. But she does so many kinds of songs well, and she has such a superb soprano, that she has won a fanatical army of fans even without a style. This record helps explain why. J.R.

CLIFFORD T. WARD: Home Thoughts. CHARISMA SD 6061, \$5.98. Tape: TP 6061, \$6.97; CS 6061, \$6.97.

Ward is an extremely sweet-sounding singer/writer/pianist who also teaches school in England. He is heartbreaking on *Home Thoughts from Abroad* and *Where's It Going to End*. Other songs get a bit hung up in college-ese. Side 1 throws quite a bit of commercialism at him, and his essence is lost. We can pray that Ward has some kind of blind luck in this busi-

R
A
B
S
O
N
S

RELIABILITY . . . Rabsons means reliability. Over 68 years of experience.

AUDIO SPECIALISTS . . . Our staff at Rabsons are all knowledgeable audio specialists. Personal service has been a byword for over 68 years.

BEST PRICES! . . . Our prices are really wholesale, actually lower than discount. Requests for quotes are immediately given.

SATISFACTION . . . Is guaranteed. All merchandise brand new in factory sealed cartons, shipped double-packed, fully insured from our warehouse.

OUTSTANDING VALUE . . . As one of America's largest mail order houses we pass our volume and buying power along to you.

NATIONALLY ADVERTISED BRANDS . . . We carry over 60 brands.

SAVE MONEY NOW! Write us now or even better, come down and see for yourself . . .

RABSONS

119 W. 57 ST.
N.Y.C., N.Y. 10019
Tel. (212) 338-2268

68 years

CIRCLE 29 ON READER-SERVICE CARD

Great Listening Pleasure Doesn't Come Cheap. . . Or Does It?

Yes, it does! We're one of the country's largest Mail Order Houses of Stereo Equipment and components. We pass our volume buying power right along to you.

Stereo Wholesalers

*WRITE OR PHONE FOR QUOTATIONS AND OUR LATEST FREE CATALOG
7A Aylesbury Road
Timonium, Md. 21093 • 301,252-6880

CIRCLE 41 ON READER-SERVICE CARD

CHECK OUR SPECS BEFORE YOU BUY THEIR 4 CHANNEL RECEIVER.

	Sylvania	Pioneer	Sansui	Fisher	Harman-Kardon	Marantz
Model	RQ 3748					
Continuous (RMS) Power ¹						
4 channels Stereo Bridge	50Wx4 125Wx2					
THD at rated output	<0.5%					
IM Distortion at rated output	<0.5%					
FM IHF Sensitivity	1.9 μ v					
50 db signal to noise ratio	2.8 μ v					
Capture Ratio	1.5db					
Price	\$549.95 ²					

¹All power measurements taken at 120 volts/60 cycles, 8 ohms, 20Hz-20kHz, all channels driven simultaneously.
²Manufacturer's suggested list price which may be higher in some areas.

If you're in the market for four channel, you already know you've got to spend a good bit of cash for a receiver. So it'd be a good idea to spend a good bit of time checking specs on everything available just to make sure you get the most for your money.

To make your search a little easier, we've prepared the blank comparison chart above with spaces for some of the best-known brands and most important specs. Just take it with you to the store, fill it in, and you'll be able to tell at a glance what you get for what you pay.

We took the liberty of filling in the Sylvania column with specs for our RQ3748 four channel receiver. We did it because we know we're not the best-known name in four channel, and we didn't want you to overlook us for that reason.

Because we think the RQ3748's specs are really worth remembering.

50 watts of RMS power per channel at 8 ohms, 20-20kHz, with all four channels driven. 125 watts perchannel in stereo bridge mode. A THD and IM of less than 0.5% at rated output. An FM sensitivity of 1.9 microvolts. A discrete four channel receiver with

matrix capabilities so you can use either type of quadraphonic material. And much, much more.³

We can offer so much because we have so much experience. We were one of the first in the audio field. And now we're applying all our knowledge, all our engineering skill to four channel.

Once you've proven to yourself which receiver has the best specs, move on down to that last line in the chart and compare Sylvania's price with all the others. Find out which one gives the most for your money.

We feel pretty confident you'll discover that the best-known names aren't necessarily your best buy.

³So much more that it won't all fit here. So send us a stamped, self-addressed envelope and we'll send you a four-page brochure on our four channel receivers.



GTE SYLVANIA

Sylvania Entertainment
Products Group, Batavia, N.Y.



SAVE MONEY NOW!! As one of America's largest wholesale distributors, our buying volume has kept our prices the lowest. We pass the savings on to you.



TERRIFIC... Equipment at terrific prices. We carry over 60 major brands, all factory sealed cartons, fully warranted, shipped from our warehouse fully insured.



OUTSTANDING VALUE... We are proud of the fact that we offer the best value anywhere in this industry.



PRICES... Ours are the lowest of the low, write us now for a lowest of the low quote.

STOP OVERPAYING FOR AUDIO EQUIP.

Write us today — or better yet come down and see for yourself. "We're taking the High Price out of Hi-Fi!"

STEREO CORPORATION of AMERICA

Dept. H.F. — 2122 Utica Ave.
Brooklyn, N.Y. 11234
Tel. (212) 338-0263

In L.I. 1180 NEMPSTEAD TPK., UNIONDALE

CIRCLE 40 ON READER-SERVICE CARD

Now you can enjoy your antique records on a modern sound system!



It's easy! And it's all explained in a big 9-page "How To" article available in reprint form from HIGH FIDELITY. You'll also receive a bonus 85.71 to 70.59 rpm strobe disc to set your turntable speed.

It's simple! Written in lucid step-by-step fashion, this reprint quickly enables you to listen to (and tape) your antique 78 rpm records. Here are a few of the subjects covered—

- Adjusting your turntable to antique record speeds.
- Picking the right stylus for your 78's.
- Playing odd size records on your changer.
- Converting your stereo pickup for vertical discs.

And this complete reprint, including pickup wiring diagrams and your bonus strobe disc is only \$1. Supplies are limited, so fill out the coupon below and send it with your check or money order to:

HIGH FIDELITY Magazine Dept. OR
The Publishing House
Great Barrington, Mass. 01230

Please send me my "How to Play Old Records on New Equipment" reprint, plus my bonus strobe disc. Enclosed is \$1.

Name _____
Address _____
City & State _____ Zip _____

ness, unlikely as that would be, because he is an authentically elegant and unusual talent.

M.A.

STEPHEN COHN, MOTOWN M 789V1, \$5.98. This debut disc may not reek of profundity, but it certainly does possess plenty of charm. Cohn is one of the rare young artists with legitimate potential.

H.E.

THE CLANCY BROTHERS WITH LOU KILLEN: Greatest Hits. VANGUARD VSD 53/54, \$5.98 (two discs).

This latest addition to Vanguard's "twofer" series contains some of the Clancy Brothers' best-known songs in new versions recorded in June 1973.

M.J.

ESTHER PHILLIPS: Black-Eyed Blues. KUDU KU 14, \$5.98.

These understated r&b performances range over material that includes the Paul Webster-Duke Ellington *I Got It Bad and That Ain't Good* and the Joe Cocker-Chris Stainton *Black-Eyed Blues*. They are the very model of restraint and do not develop an overwhelming intensity until Leonard Feather's *You Could Have Had Me, Baby*. All of this simmering without the pot boiling over ultimately can weary one a bit.

H.E.

YES: Tales from Topographic Oceans. ATLANTIC SD 2-908, \$9.98 (two discs). Tape: ● TP 908, \$9.97; ●● CS 908, \$9.97.

Here is the latest from Yes, one of the leaders in the burgeoning field of sci-fi/acid-downer/distended blues rock. You've probably heard it and seen it all before: the same mind-blowing cover, the same mystical ramblings inside the jacket, the same spacy improvisations on the records themselves. Yes is undeniably clever and skillful in what it does, and lots of people apparently like the group a good deal. But if you want profundity in your music, there are better places to find it.

J.R.

DARYL HALL/JOHN OATES: Atlant Abandoned Luncheonette. ATLANTIC SD 7269, \$5.98.

This sweet-voiced duo not only creates a gentle brand of folk-style music but also offers up, on occasion, a moody, intense musical line that is as surprising as it is gripping.

H.E.

HENRY GROSS, A&M 4416, \$5.98.

An interesting twenty-two-year-old ex-member of Sha Na Na, Gross is nothing like that group: He's high-voiced and high-energized, very musical. His songs are immature, but he has lots of time to mellow. Keep your eye on him.

M.A.

JACKIE JACKSON, MOTOWN M 785V1, \$5.98. This enchanting album from another one of America's First Family of R&B, the Jacksons, finds Jackie and his engaging falsetto matching with glee the achievements of other Jackson Five members, Jermaine and Michael.

H.E.

HOYT AXTON: Life Machine. A&M 3604, \$6.98.

Hoyt Axton has never sounded richer, deeper, warmer. An ex-folker, he has not quite made the transition into pop music, but he's gotten a damn sight closer than most of his old pals.

M.A.

DISCOUNTS

HI-FI SYSTEMS COMPONENTS

- KITS • COMPACTS
- TUNERS • AMPLIFIERS
- RECEIVERS • TURNTABLES
- SPEAKERS • TAPE RECORDERS

- Franchised Distributors for over 70 mfrs.
- Largest selection in the country
- Full manufacturers warranty protection
- Only brand new, factory sealed components
- Fast, fully insured shipments
- Double-boxed cartons where possible
- Same day reply to your inquiry
- Extra savings on complete systems
- Lowest possible prices

WRITE FOR OUR QUOTE AND SPECIALS BULLETIN VISIT OUR NEW MODERN WAREHOUSE FREE AMPLE PARKING AT PREMISES



146 OLD BROOKFIELD RD. (NORTH)
DANBURY, CT. 06810
DANBURY, CT. (203) 744-6421
N. Y. CITY (212) 369-6212

CIRCLE 6 ON READER-SERVICE CARD

DIXIE SAVE ON Brand Name Audio Components BY MAIL

Write Today for Our FREE Wholesale Audio Catalog

DIXIE, one of the largest stereo wholesalers, fills all your orders promptly. At prices actually LOWER than "Discounters". See our exciting Wholesale Price Catalog, or write for quotes. Choose the famous brand stereo equipment and accessories you desire. Everything shipped factory sealed.



DIXIE HI-FI WHOLESALE

5600 Second St., N. E., Washington, D. C. 20011
Phone: 1-202-635-4900

Please rush me your FREE Wholesale Audio Catalog and complete information. I understand there is no obligation.

Please Check Your Music Preference: (1 only)

Rock Classical Country

Name _____
Address _____
City _____
State _____ Zip _____ HF-5

the tape deck

BY R.D. DARRELL

Grand Piano Parade. I wonder how many audiophiles remember when it was generally believed that the piano was the hardest of all instruments to record. Today we know that belief was only partially correct. The main difficulty was in properly *reproducing* piano recordings. And it is only in relatively recent years that there has been widespread availability of first-rate playback equipment—with rock-steady speed and minimal transient-distortion characteristics—to assure natural piano-tone reproduction in home listening rooms. As if in response to the new potentials, we have a considerable number of extraordinarily gifted young recording pianists to follow (they never can replace) the Grand Old Masters, only a precious few of whom remain active.

So it is richly satisfying to hail what quite possibly is not only the finest major piano-concerto recording achievement to date but also the epiphany-representation of my own favorite in the new generation of virtuoso pianists, Vladimir Ashkenazy. His many notable earlier contributions (mainly to the Romantic and modern repertoires) are now crowned by an integral set of the five Beethoven concertos in which he and Solti, with the Chicago Symphony, fuse their incalculable talents to perfection (London/Ampex W 480270, two Dolby 7½-ips reels, \$23.95; also D 10270, two Dolby cassettes, \$14.95). Playing and recording are superb, yet for me this set is most treasurable for its music-makers' infectious relish for what they are doing. I won't discard my long-preferred Fleisher/Szell set (currently OP on tape) of the Beethoven five, but it now must take second place in my esteem. (Collectors of like minds will also want a kind of encore solo program in which Ashkenazy plays Chopin's B flat Sonata and four shorter pieces with comparably contagious zest before a live audience: London/Ampex M 10262, L 480262; Dolby cassette, \$6.95, and Dolby 7½-ips reel, \$7.95.)

Another major achievement is the burlier Russian giant Emil Gilels' set of the two Brahms concertos with Jochum and the Berlin Philharmonic (DG/Ampex D 47064, two Dolby 7½-ips reels, \$14.95). Here the approach is more overtly Olympian, deliberate, even grandiose, and the recording may seem unduly dark and weighty on first aural encounter. But as one becomes accustomed to it, the sonic lucidities are unmistakable, and one is swept along by

the mighty musical floods that Brahms himself must have hoped for. Here again the best earlier sets—those of Serkin and Rubinstein in particular—will not be forgotten, but they no longer command undisputed top ranking.

In two smaller-scaled Dolby cassette programs we can hear a controversial young pianist in some of his easier-to-take moments and a master demonstrating both the icy and radiant aspects of his Janus-like interpretive personality. The former is that Peck's Bad Boy of the keyboard, Glenn Gould, with Volume 1 of the Bach *French Suites*, Nos. 1 through 4 (Columbia MT 32347, \$6.98). For all their idiosyncrasies, such as obsessive *sotto voce* ululations, the performances are buoyantly vivacious and brightly and lightly recorded. The latter is the great Horowitz, no less deft than ever but so coolly objective in Beethoven's *Moonlight* Sonata that this might be a computerized interpretation. It's only in four Schubert impromptus—D. 899, Nos. 2 and 4; D. 935, Nos. 1 and 2—that digital precision is vitalized by true poetic feeling (Columbia MT 32342 and MA 32342 cartridge, \$6.98 each).

Assorted Popsicals. There's no more penny candy, but crude color and taste appeals are the main ingredients of today's commercial campaigns to seduce youngsters into augmenting their pop and rock snacks with a few synthetic "classical" vitamins. One of the more ingenious approaches is to rescore pop hit tunes anachronistically, as in "The Baroque Connection: Today's Standards in the Style of Handel and Vivaldi" (Angel 8XS/4XS 37000, eight-track cartridge or cassette, \$7.98 each). It's very well played and recorded by the Paris Opera Orchestra under Michel Ganot. Some of the ten selections are unimaginative—Ye Olde Antique Shoppe wares, but a few—like the passacaglian treatment of *Here's to You* and of producer Paul de Senneville's original *Romantica Strings*—may amuse even serious-minded connoisseurs.

I doubt that you'll find any real musical—as distinct from sonic—interest in two more ambitious programs featuring familiar classics gussied up in mod rags. Al Stewart's "Museum of Modern Brass" is handicapped even sonically by its often thin-toned trumpet timbres. But "Stolen Goods: Gems Lifted from the Masters," despite its accreditation to an "outrageous Dr. Teleny's Incredible Plugged-In Orchestra," is not dominated by its Moog synthesizer or other electronic instruments. And despite its mostly hackneyed arrangements with wordless chorus and inconclusive fade-outs, there are occasional moments when Bach, Handel, and Chopin in motley have a certain horrid fascination. These

recordings are available on RCA/Stereotape ERP 1-0032 (Stewart) and ERP 1-0015 (Teleny), 7½-ips reels, \$7.95 each; Q-reel editions from Stereotape, and Q-8 cartridges from RCA.

Musicassette Capsules. Tape connoisseurs who refuse to accept the heretical notion that cassettes can even come close to competing technically with open reels may have their conviction shaken by listening—via first-rate playback means—to four recent exemplars of the state-of-the-cassette-art at its best (\$6.95 or \$6.98 each; alternate eight-track cartridge editions of the DG and Columbia examples; alternate Ampex Dolby open-reel editions of the DG and London examples).

• Two of the last non-Dolby Deutsche Grammophon cassettes are outstanding, both orchestral and technically. One is Barenboim's Bruckner Fourth (*Romantic*) Symphony with the Chicagoans (3300 328), which perhaps is not as eloquent interpretively as Haitink's Philips/Ampex reel version, but which is more magnificent sonically, probably more still in the DG/Ampex Dolby reel edition (L 43336). The other is the Karajan Weber-overture program (*Der Freischütz, Ruler of the Spirits, Oberon, Euryanthe, Abu Hassan, Peter Schmall*), in which the maestro's mannerisms are minimized and his and the Berlin Philharmonic's executant crafts are maximized (3300 294).

• Not even so fervent a Czechophile as I will claim that Dvořák's tone poems rank among his supreme masterpieces. But surely I can't be the only listener who is utterly entranced by the scoring felicities of *The Water-Goblin*, Op. 107, and *The Noonday Witch*, Op. 108 (London/Ampex M 10268, Dolby). These tape firsts are combined here with reissues of the *Hussites* and *My Home* Overtures (originally fillers in the Dvořák-symphony series) in glowing recordings of the late István Kertész's delectably lilting, as well as idiomatically authoritative, performances with the London Symphony Orchestra.

• Since reviewers as well as laymen have their often inexplicable idiosyncrasies of personal taste, I'm not ashamed to confess that I must be wrong (unless everyone else is out of step) in evaluating Rheinberger's Organ Concertos, Opp. 137 and 177. The current Romantic revival probably accounts for their first recorded representation and perhaps for the seemingly unanimous praise my colleagues have heaped on the performances of E. Power Biggs, with the Columbia Symphony under Peress, and on Columbia's luscious recording (MT 32297, Dolby; Q-8 MAQ 32297). The praise may be deserved, but I'm consistently excruciatingly bored. ●

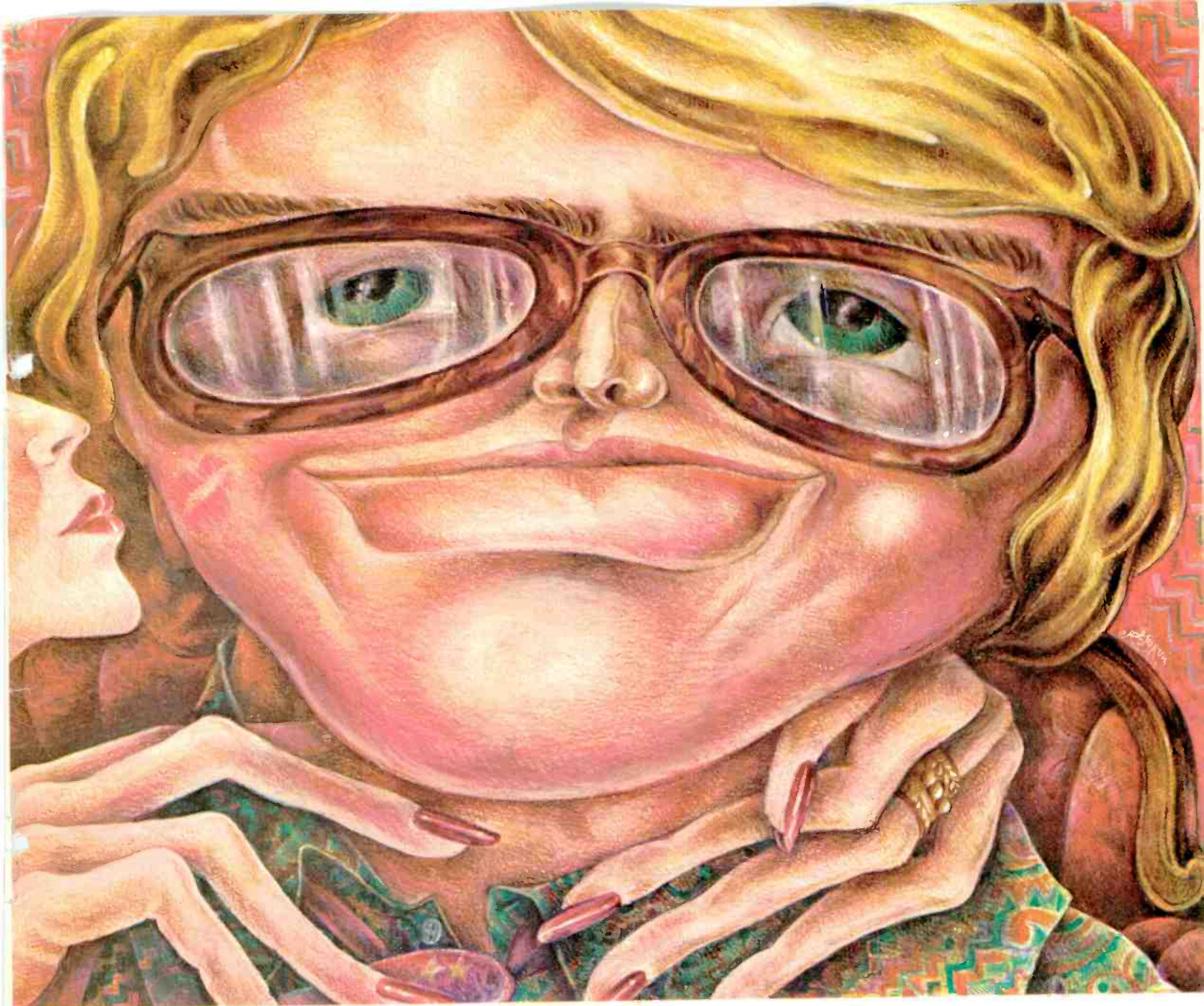

Separation saved our marriage thanks to Marantz speakers.

"Where's the flute Henry?" my wife complained constantly. I was about ready to leave her. Then we saw a Marantz dealer. He told us that separation of sound is a true test of a speaker system. He suggested we put Marantz and other popular speakers to the test by listening to a familiar recording so we'd be able to hear for ourselves that it's the speaker and not the recording that makes the difference. Oh, what a difference Marantz made! What we thought were two oboes were clearly an oboe and a flute. And that barbershop quartet...well, they're really a quintet.

The proof is in the listening. And that's where Marantz design concepts come into play. The transducers in Marantz speaker systems are engineered to handle an abundance of continuous power, so you get distortion-free

sounds that are as pleasing as a nibble on the ear.

We bought the Marantz Imperial 5G Two Way Speaker for just \$99. Perfect for our budget and it delivers fine sound separation even with minimum power equipment. And there are five other quality Marantz speaker models starting as low as \$59 and all are available with the new Marantz acoustically transparent foam grill.

Whatever your power and budget requirements, keep this in mind. Marantz speaker systems are built by the people who make the most respected stereo and 4-channel equipment in the world.

To find out how much better they sound go to your nearest Marantz dealer and listen.

marantz®
We sound better.



BIG NEWS from **KENWOOD**

introducing the New Top-of-the-Line Receivers

BIGGER Performance
BIGGER Power
BIGGER Size

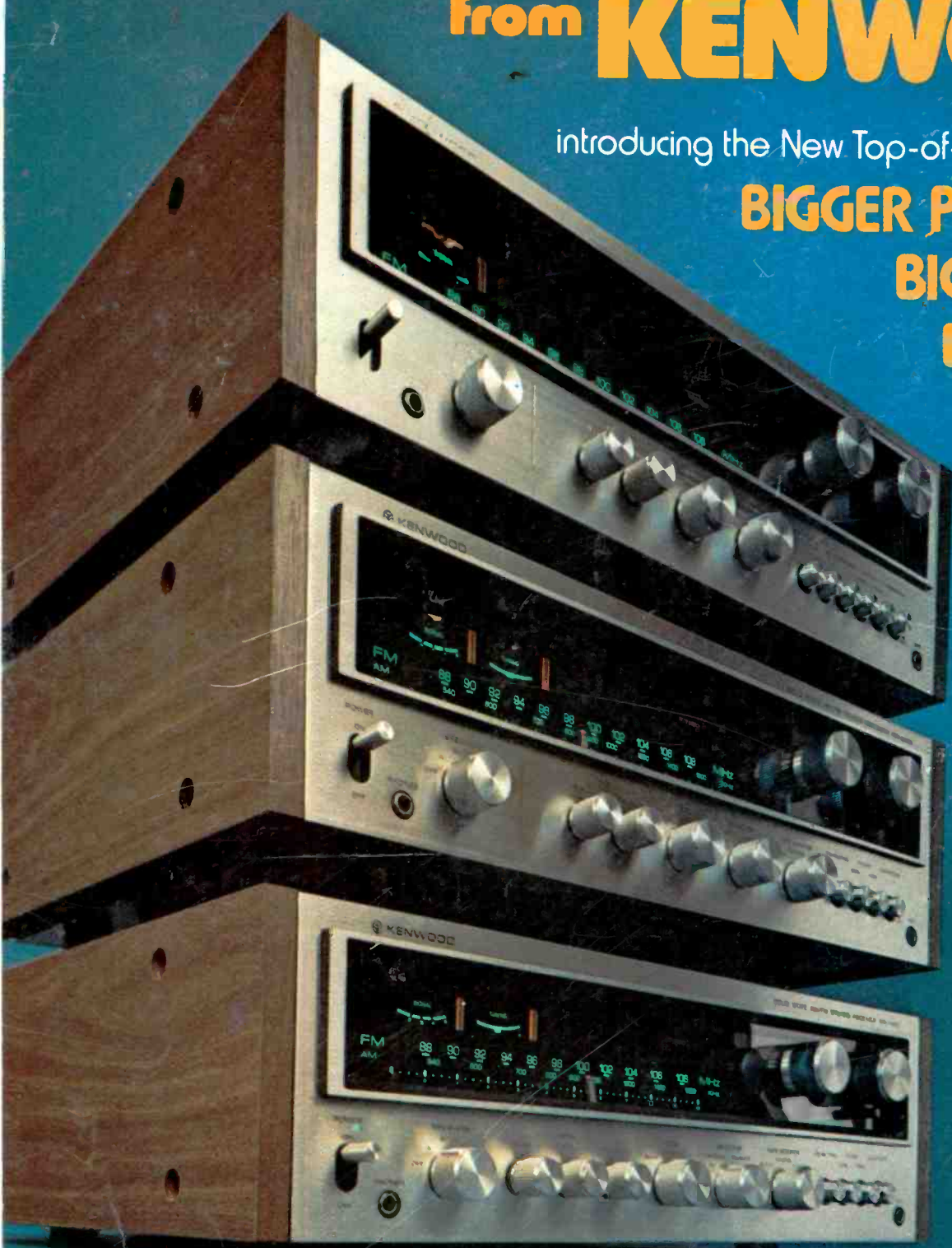

KR-5400
STEREO RECEIVER
35 RMS Watts per
Channel (8 Ohms,
20-20k Hz) ■ Direct
Coupling ■ Dual Tape
System ■ Phase-Lock-
Loop MPX

KR-6400
STEREO RECEIVER
45 RMS Watts per
Channel (8 Ohms,
20-20k Hz) ■ Direct
Coupling ■ Tape-Through
Circuit ■ Phase-Lock-
Loop MPX

KR-7400
STEREO RECEIVER
63 RMS Watts per
Channel (8 Ohms,
20-20k Hz) ■ Direct
Coupling ■ Tape-Through
Circuit ■ Phase-Lock-
Loop MPX

For Bigger-Than-Ever Stereo Enjoyment, write for
All the Big News on the new KENWOOD Receivers.

the sound approach to quality
 **KENWOOD**

15777 So. Broadway, Gardena, Calif. 90248
72-02 Fifty-first Ave., Woodside, N. Y. 11377
In Canada: Mag.asonic Canada, Ltd.

CIRCLE 36 ON READER-SERVICE CARD