

HIGH FIDELITY

JULY 1971 75¢

LAB TEST REPORTS

Tannoy's omni speakers

PE 2040 changer

Altec Lansing music center

Ortofon/Martin cartridge system

Nikko STA-1101 receiver

LIBRARY OF CONGRESS
PHOTODUPLICATION SERVICE
5101 MARSHFIELD DRIVE
FLEXCITY, MARYLAND 21754
413332

What Consumer's Magazine's Special Guide to Stereo Controls

What they do...
How they do it...

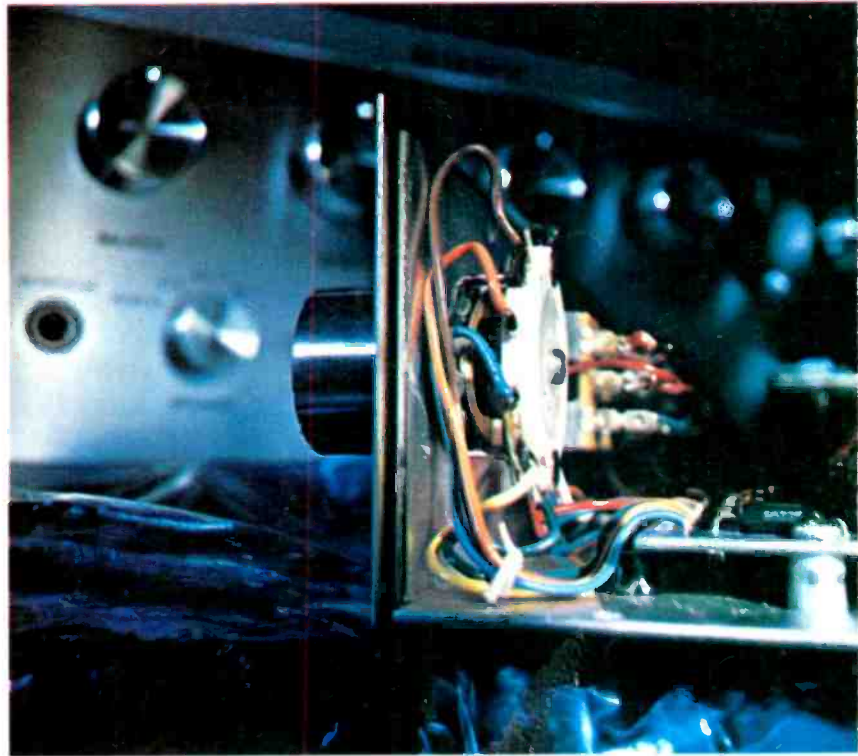

The Musician As Political Activist



e, but not *very* expensive, r. The Fisher 601.



The Fisher CP-100

switch to activate a special circuit that lets you create 4 channels out of 2-channel material. The circuit extracts ambient information from the channels that you otherwise couldn't hear, and feeds it into the two rear channels. This information, which represents the sum of the reflected signals from the original recording source, enhances the stereo effect. The result is as close as you can get to true 4-channel sound, without actually starting with four separate signals.

So now you can hear your entire library of stereo LP's, tapes, and even FM-stereo broadcasts in 4-channel. And even more important, Fisher's 2+2 matrix system will let you play the various different stereo records and tapes that have been encoded with 4-channel information for playback on a 4-channel system. Of course, if for some reason you shouldn't want the 4-channel effect,

you can still play your stereo records in stereo, and your mono source material in mono.

Speaking of sound sources, meet the Fisher CP-100.

The CP-100 is the ideal source of real 4-channel. For many reasons. It plays 8-track cartridges with several 4-channel programs on each cartridge. And there's quite a repertoire of cartridges available, from rock through pop to classical. (The CP-100 also plays the standard 8-track stereo cartridges.)

And the CP-100 is the only cartridge player built to Fisher standards. Wow and flutter are extremely low. Frequency response is 50 to 12,000 Hz, which compares favorably even with open-reel machines. And the CP-100 is extremely versatile. It will play one program after another, repeat one program as long as you want, or you can skip to

whatever you want to hear. The cost? Only \$169.95.

Plug the CP-100 into the 601, hook up four good speakers, and you're ready to listen to a 4-channel stereo system that's expensive, but not as expensive as it sounds.

Shown at right: four Fisher XP-7B speakers.

Fisher XP-7B speakers go beautifully with the new Fisher 601. The reason they sound so smooth is that they're 4-way systems, each with a massive 12-inch woofer, two 5 3/4-inch drivers (each assigned a different section of the midrange), and a pair of 3-inch wide-dispersion cone tweeters. At \$159.95 each, the XP-7B's aren't even expensive.

stereo receiver. The Fisher 701.



The 701 is a true 4-channel AM/FM stereo receiver with 250 watts of power, push-button electronic tuning *without moving parts* (from the front panel or by remote control), toroidal filters on FM and other ultra-sophisticated electronics. In addition to being the most advanced piece of 4-channel equipment you can buy, it's also a sensationally fine receiver for conventional 2-channel stereo. Not to mention mono. \$699.95.

The Fisher 
We invented high fidelity.

Introducing our expensive 4-channel receiver



Last year, Fisher brought out the world's first true 4-channel receiver, the Fisher 701.

Now, you have to understand that a true 4-channel receiver requires nearly twice the electronics of an equally good 2-channel receiver.

And since the 701 was to be the world's *first* 4-channel receiver, we pulled out all the stops when we designed it. Which resulted in a piece of equipment that was *very* expensive. Incredibly good, but very expensive.

But now we think it's time to bring out a top-quality 4-channel receiver that more people can afford. One that doesn't cost a lot more than the best 2-channel receivers. So we're introducing the Fisher 601 4-channel AM/FM receiver.

Meet the Fisher 601. \$599.95.

Even though the 601 is not the top of the Fisher 4-channel line, it's a no-

compromise piece of equipment.

It's got everything: power, sensitivity, versatility, and wonderfully clean 4-channel sound. (We think 4-channel is as much of an improvement over 2-channel as 2-channel was over mono.)

200 watts is a lot of power.

The Fisher 601 has 200 watts of clean power. It's fully capable of driving two sets of speakers—four main, four remote. And it will drive them at concert levels with no sign of strain.

The FM tuner section has 1.8 microvolts sensitivity, which is on a par with the tuners in the finest 2-channel receivers Fisher makes. You'll get clear reception on stations that non-Fisher tuners pick up as static.

A full complement of controls.

The new 601 receiver is equipped with bass and treble controls, of course.

They're of the Baxandall variety, which is a little more expensive than the kind other makers like to use. But they're also better. (They leave the midrange alone while you adjust the bass or treble.)

A muting switch quiets the noise between FM stations. There's a high filter so you can cut out unwanted high frequencies on the front channels, if you choose. There's a balance control, loudness contour and tape monitoring switches for front and rear channels.

Of course, the 601 has controls for mode, selecting speakers, and selecting a sound source. And the front and rear-channel volume controls slide like professional sound-studio faders.

The Fisher 2+2 matrix system. 4 channels out of 2.

Not only does the Fisher 601 give you fantastic sound with true 4-channel program material, it also incorporates a



Only 25¢! \$2 value! Send for your copy of The Fisher Handbook, a fact-filled 80-page guide to high fidelity. This full-color reference book also includes complete information on all Fisher stereo components. Enclose 25¢ for handling and postage.*

Fisher Radio, Dept. HF-7, P.O. Box 1367
Long Island City, N.Y. 11101

Name _____

Address _____

City _____

State _____

Zip _____

*Please glue or tape coin on picture of handbook above

0107711

Our very expensive 4-channel



**Real 4-channel
stereo is expensive.**

**But now
it doesn't have to be
very expensive.**

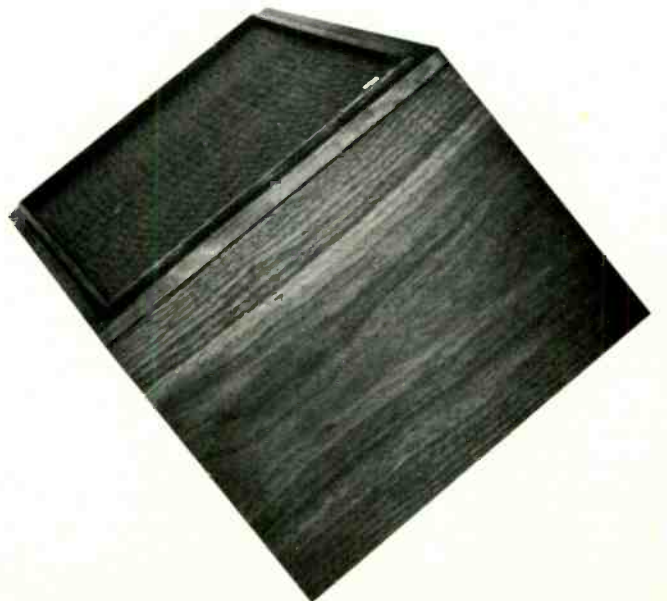
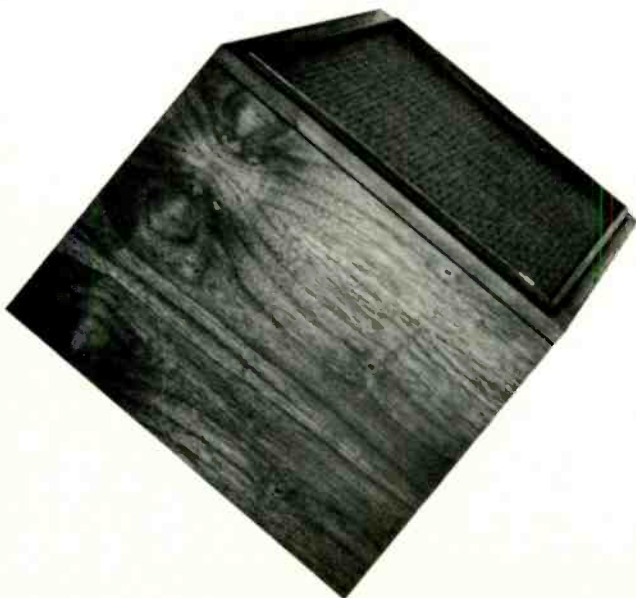
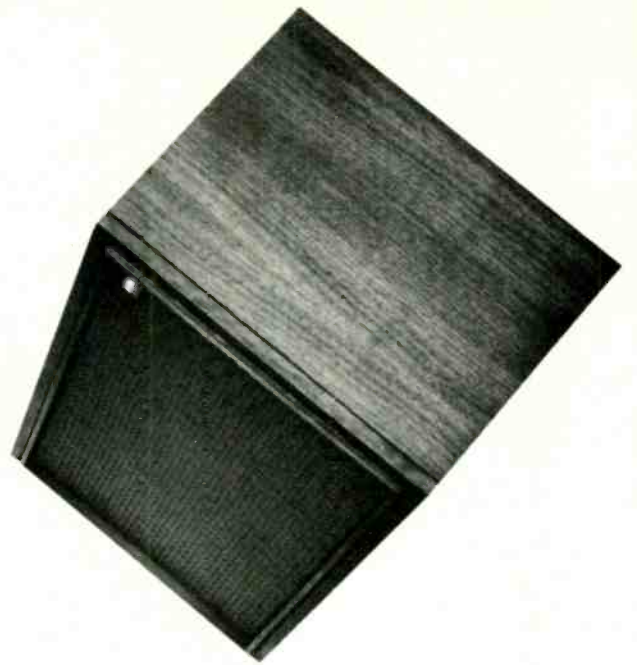
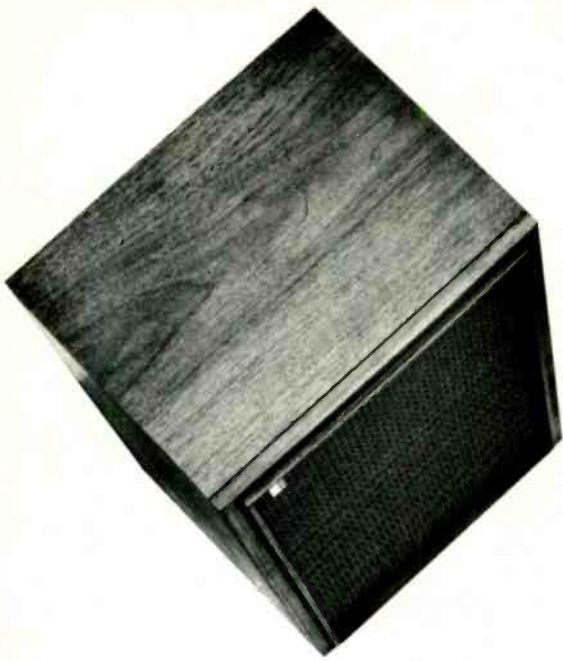

The History Savers at work.



David Hall and Sam Sanders discuss a fine point.

Deep inside a building at New York's Lincoln Center for the Performing Arts, recorded history is being recorded again. At the Rodgers and Hammerstein Archives of Recorded Sound, technician Sam Sanders is busy continually transcribing all sorts of old recordings, transcriptions and acetates. Not only will there then be a more permanent record of this valuable material, but access to it is made easy through a sophisticated catalogue system, by which interested persons can hear material that was otherwise unavailable.

The Rodgers and Hammerstein Archives of Recorded Sound are part of the New York Public Library, Research Library of the Performing Arts, and encompass virtually the entire history of recorded sound. But to get these early (and often irreplaceable) discs onto tape wasn't easy. Because until the recording industry established its own standards, playing speeds, groove widths and depths were widely varied.

Stanton engineers worked closely with Archive Head David Hall and engineer Sam Sanders

when the Archive Preservation Laboratory was being set up. Standard Stanton 681 cartridge bodies were chosen for their superior reproduction characteristics. However, some 30 different stylus types had to be prepared to give the tape transfer operation the variety needed to match the various old groove specifications. Each was hand-made by Stanton engineers to fit a particular disc's requirements. So when Sam Sanders begins the careful disc-to-tape transfer, he must first match the stylus to the record. Both microscope and trial-and-error techniques must be often used together. But one of the special styli will enable every last bit of material to be extracted from these recorded rarities.

It goes without saying that a company willing to take such care in helping to preserve recorded history must also be interested in superior reproduction of today's high fidelity pressings. Which is one reason why Stanton cartridges remain the choice of professionals the world over.

For an informative brochure about our professional-quality cartridges, write to Stanton Magnetics, Inc., Terminal Drive, Plainview, N.Y. 11803.



HIGH FIDELITY MAGAZINE

July 1971
VOL. 21 NO. 7

HIGH FIDELITY

music and musicians

Leonard Marcus THE CALLEY RECORDS 4
A letter from the Editor

Christa Ludwig SPEAKING OF RECORDS 27
A singer's choice

Charles Fisher vs. Paul Henry Lang THE TAMERLANO CONTROVERSY 18
Pros and cons of Handel's operatic style

William Zakariasen MUSICIAN AS ACTIVIST 50
Music and politics can be an explosive mixture

John McClure IGOR FYODOROVITCH STRAVINSKY 20
A remembrance

audio and video

TOO HOT TO HANDLE 28
HF answers your more incisive questions

NEWS AND VIEWS 32
Stereo-4: the box score

EQUIPMENT IN THE NEWS 34
The latest in audio gear

EQUIPMENT REPORTS 41

Elpa PE 2040 automatic turntable . . . Nikko STA-1101 receiver
Ortofon SL-15/MP235 cartridge . . . Tannoy Orbitus-1 speaker system
Altec Lansing 911A stereo compact

Leonard Feldman WHAT'S BEHIND THE KNOB? 56
A layman's guide to audio controls

Robert Long FOUR-CHANNEL DISCS—1971 64
Several systems, none yet standard

Leonard Marcus FOUR-CHANNEL DISCS—1904 65
A unique system for royalty

recordings

FEATURE REVIEWS 67

A Rachmaninoff eruption
The St. Matthew Passion on original instruments
An ideal Pierrot Lunaire

CLASSICAL REVIEWS 72

Heifetz on television . . . Youthful genius and the BSO

IN BRIEF 100

Capsule wrap-ups of new releases

R. D. Darrell THE TAPE DECK 102
Dolbyized cassettes: foreign and domestic

POP REVIEWS 104

Colombier's musical adventure . . . Liberace love festival

JAZZ REVIEWS 110

Ellington in church . . . The complete Jelly Roll Morton

etc.

LETTERS TO THE EDITOR 8

Our anniversary issue . . . A stamp for Kreisler

PRODUCT INFORMATION 15

An "at home" shopping service 97

ADVERTISING INDEX 96



What did they do? See page 50.

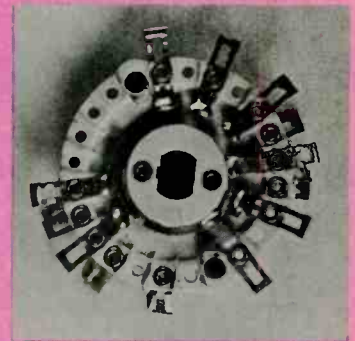

What does this do? See page 56.

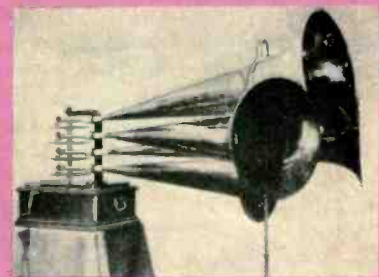

Did this do anything? See page 64.



Published at Great Barrington, Mass. 01230 by Billboard Publications, Inc.
Copyright © 1971 by Billboard Publications, Inc. The design and contents of High Fidelity Magazine are fully protected by copyright and must not be reproduced in any manner. Second-class postage paid at Great Barrington and at additional mailing offices. Authorized as second-class mail by the Post Office Department, Ottawa and for payment of postage in cash. High Fidelity/Musical America Edition is published monthly. Subscription in the U.S.A. and its Possessions, \$14; elsewhere, \$15. Subscription including Concert Artist Directory published in December, \$20 in the U.S.A. and its Possessions, elsewhere, \$21. Regular issues \$1.25 a copy. National and other editions published monthly. Subscription in the U.S.A. and its Possessions, \$7.95. Subscription rates for all other countries available on request. Regular issues 75¢ a copy. Indexed in the Reader's Guide to Periodical Literature. Current and back copies of High Fidelity and High Fidelity/Musical America available on microfilm from University Microfilms, Ann Arbor, Michigan 48106. Change of address notices and undelivered copies (Form 3579) should be addressed to High Fidelity, Subscription Department, P.O. Box 14156, Cincinnati, Ohio 45214. Please state both old and new addresses when requesting a change.

The Calley Records

DEAR READER:

Unfortunately, the Calley verdict was not controversial. When only nine per cent of the people (according to a *Newsweek* poll) approve the verdict, and opposition spans the political spectrum from Bella Abzug to Lester Maddox, you don't have a controversy, you have a definition of contemporary American culture. Somewhere along the line the old American ethic that a man is responsible for his own actions has been subverted. We are now to hold either that when others share responsibility in a crime its perpetrator is innocent, or that the shooting of defenseless civilians (or POWs for that matter) *under custody and in the protection of a capturing force* is no crime. In either case, we would have to disavow both the Nuremberg Trials and the Geneva Convention. I for one was proud to be an American the day the court-martial jury determined in effect that we bind ourselves to the same moral code we bound the Nazis to, and which made retroactive the previously questionable moral foundation of Nuremberg—that it established a minimum level of tolerance for international misbehavior and was not simply a ritual revenge upon defeated enemies.

Since the overwhelming majority of Americans apparently felt otherwise, it was only to be expected that some record companies would now take their turn to make a killing. Empathy for Calley's predicament could be converted into cash if the lieutenant were transformed into a hero through song. I have no quarrel with political music. As William Zakariassen's article in this issue makes clear, musicians and their music have long been involved in political activism. From time immemorial, balladeers have romanticized outlaws. And certainly in our own time the antiestablishmentarians have had more than their share of activist music. But what degree of avarice must one have to be able to glorify a baby-murderer who happened to get caught?

A quick-acting one, at least. In what must have been the fastest marketing of a news-oriented recording since Pope Paul VI visited America, pro-Calley discs flooded record stores. Within days of the verdict, Plantation Records and Royal American Records had each brought out *Battle Hymn of Lt. Calley*. To the tune of *Battle Hymn of the Republic*, we learn about the little boy playing soldier with a "wooden sword in one hand and an American flag in the other" who grew up but "never let go of the flag." "I'm just another soldier," he sings, who "tried to do my duty," but "they" have "made me out a villain." Within a week one of the recordings had jumped into *Billboard's* "top 100" chart at number 41 and the other was "bubbling under" at 114. A third record, *Morning in My Lai* (which I haven't heard), was issued almost immediately, and a week later came *Indictment of a Nation* from Westpark Records. *Indictment*, despite its title, is another glorification of the young officer whose "friends all called him 'Rusty'" and whose constant rejoinder is "Sir, I'll do my best," all to the background of *America and Battle Hymn of the Republic*.

Now steps in Stan Gortikov, the head of Capitol Records. While unknown artists were used on the above-mentioned discs, Capitol had cut *Battle Hymn of Lt. Calley* with country star Tex Ritter. Imagine the money to be made there! But Gortikov stopped the release. Executive censorship of artistic expression? No more so than Mercury's decision to bar dope-promoting songs. Rather, the record industry had come up with a man of moral sensitivity who refused to let his company benefit from the unspeakable—if still expressible. "If we want to glorify a war hero," he explained, "let's find somebody other than Lt. Calley."

My choice, right now, would be Stan Gortikov.

Next month, in a **SPECIAL TAPE ISSUE**, we will point out **9 CASSETTE SOUND-SPECTACULARS**, discuss **THE DOLBY BOOM**, describe the **ADVANTAGES AND LIMITATIONS OF CASSETTES, 8-TRACK, AND OPEN-REEL**, examine **THE NEW TAPE FORMULATIONS**, and much more. And in **AIDA'S CREATOR** you will read the incredible story of, no not Amonasro, or Verdi, but the archaeologist-turned-pasha Auguste Edouard Ferdinand François Mariette. Who?

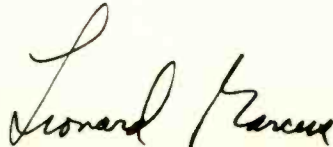

LEONARD MARCUS
Editor

NORMAN EISENBERG
Audio-Video Editor

PETER G. DAVIS
Music Editor

SHIRLEY FLEMING
Editor, Musical America Section

ROBERT LONG
Associate Audio-Video Editor

EDITH CARTER
Associate Editor

SHEILA SCHULTZ
Assistant Editor

ROY LINDSTROM
Art Director

ROBERT MADDOCKS
Associate Art Director

RUTH W. DUNTON
Production Editor

MORGAN AMES
R. D. DARRELL
ALFRED FRANKENSTEIN
HARRIS GOLDSMITH
DAVID HAMILTON
PAUL HENRY LANG
GENE LEES
ROBERT C. MARSH
GEORGE MOVSHON
H. C. ROBBINS LONDON
Contributing Editors

MILTON GORBULEW
Circulation Director

STANLEY BINDER
Circulation Manager

CLAIRE N. EDDINGS
Assistant Publisher and
Director of Advertising Sales

WARREN B. SYER
Publisher

ADVERTISING

Main Office: Claire N. Eddings, The Publishing House, Great Barrington, Mass. 01230. Telephone: 413-528-1300.

New York: 165 W. 46th St., New York, N.Y. 10036. Telephone: 212-757-2800. Seymour Resnick, Eastern Adv. Mgr., Charlotte Gilbert; Steven R. Twomey.

Chicago: Billboard Publications, Inc., 150 North Wacker Dr., Chicago, Ill. 60606. Telephone: 312-236-9818. Leonard Levine.

Los Angeles: Billboard Publications, Inc., 9000 Sunset Blvd., Los Angeles, Calif. 90069. Telephone: 213-273-1555. Andrew Spanberger.

Nashville: Billboard Publications, Inc., 1719 West End Ave., Nashville, Tenn. 37203. Telephone: 615-329-3925. Robert Kendall.

London: 7 Carnaby St., London W.1, England. Telephone: (01) 437-8090. Andre de Vekey.

Frankfurt/Main: Eschersheimer Landstrasse 69, Frankfurt/Main, West Germany. Telephone (0611) 590805-6. Walter B. Rios.

Milan: Piazzale Loreto 9, Milan 20131, Italy. Telephone: 28.29.158. Germano Ruscitto.

Tokyo: Japan Trade Service, Ltd., Ikejiri 3-1-1-1008, Setagaya-ku, Tokyo, Japan. Telephone: 413-2871. Kanji Suzuki.

Out of the Research that Produced the 901

BOSE brings you the Second **DIRECT/REFLECTING[®] Speaker System**



The BOSE 901*

DIRECT/REFLECTING[®] Speaker System

THE 12 YEARS OF RESEARCH

Twelve years of research into physical acoustics and psychoacoustics produced this unconventional speaker that has met with unprecedented success. Copies of the Audio Engineering Society paper, by Dr. A. G. Bose, describing this research, are available from BOSE Corp. for fifty cents.

THE RAVE REVIEWS

The 901 is the most highly reviewed speaker on the market, regardless of size or price. Circle number **5** on your reader service card for reprints of the reviews.

THE SOUND OF THE 901

Ask your franchised BOSE dealer for an A-B comparison with the best conventional speakers he carries, regardless of their size or price. You will only appreciate why we make this request after you have made the experiment.

The BOSE 501*

DIRECT/REFLECTING[®] Speaker System

THE DESIGN GOAL

Our objective was to produce a speaker in the \$125 price range that would audibly outperform all speakers costing less than the 901.

THE DESIGN APPROACH

We preserved as many of the features of the 901 as possible to produce a speaker that sells for \$124.80.

Circle No. 6 for information on the design of the BOSE 501.

THE PERFORMANCE

You are the judge. If we have succeeded in our design goals, the result will be obvious to you when you A-B the 501 with any speaker selling for less than the 901.

"You can hear the difference now."

BOSE[®]

Natick, Massachusetts 01760

Circle # 5 for information on the BOSE 901

Circle # 6 for information on the BOSE 501

*Covered by patent rights
issued or applied for

FREE... Any 3 Stereo LPs or

WITH NO OBLIGATION

66764 ELTON JOHN
Tumbleweed Connection
Uni LP, 8TR, CASS

66826 BOBBY SHERMAN
Portrait of Bobby
Metro LP, 8TR, CASS

65797 GABOR SZABO
Blowin' Some Old Smoke
Budda LP, 8TR, CASS

Counts as 2 records

Counts as 2 records

75002 JACKSON 5
Maybe Tomorrow
Motow LP, 8TR, CASS

41213 JESUS CHRIST SUPERSTAR
(2 record set)
Decca LP, 8TR, CASS

33184 DIONNE WARWICK
Very Dionne
Scept LP, 8TR, CASS

68023 WOODSTOCK TWO
(2 record set)
Cotil LP, 8TR, CASS



67517 THREE DOG NIGHT
Golden Biscuits
Dunbi LP, 8TR, CASS

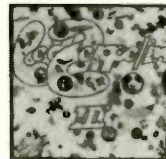

42780 LED ZEPPELIN III
Atlan LP, 8TR, CASS



37833 ROD MCKUEN
In The Beginning
Sunse LP, 8TR



43871 STATLER BROS
Bed of Roses
Mercur LP, 8TR, CASS



42988 ROGER WILIAMS
Love Story
Kapp LP, 8TR, CASS



68030 CROSBY STILLS NASH & YOUNG
Four Way Street
(2 record set)
Atlan LP, 8TR, CASS



50506 BUFFY SAINTE-MARIE
Wanna Be A Ballerina
Vangu LP, 8TR, CASS

21597 RIMSKY-KORSAKOV
Scheherazade
Yorks LP, 8TR, CASS

33093 IAN & SYLVIA
Greatest Hits
(2 record set)
Vangu LP, 8TR, CASS

44765 SHIRLEY BASSEY
Is Really Something
UniAr LP, 8TR, CASS

21551 BEETHOVEN
Piano Sonatas
Yorks LP, 8TR, CASS

42986 ROGER WILIAMS
Golden Hits Vol. II
Kapp LP, 8TR, CASS

42665 CROSBY STILLS & NASH
Atlan LP, 8TR, CASS

32882 JOAN BAEZ
Joan Baez 5
Vangu LP, 8TR, CASS

Compare and see!

33182 SUSAN SINGS
SESAME STREET SONGS
Scept LP, 8TR, CASS

41217 BERT KAEMPFER
Orange Colored Sky
Decca LP, 8TR, CASS

30618 DIANA ROSS
Motow LP, 8TR, CASS

48800 B. B. KING
Live At Cook County Jail
ABC LP, 8TR, CASS

43870 MELBA MOORE
Look What You're Doing
Mercur LP, 8TR, CASS

68019 EMERSON, LAKE & PALMER
Cotil LP, 8TR, CASS

39089 5th DIMENSION
Greatest Hits
SouCi LP, 8TR, CASS

38368 VENTURES 10th
Anniversary Album
(2 record set) Liber LP

21633 RED ARMY ENSEMBLE
Yorks LP, 8TR, CASS

38373 IKE & TINA TURNER
Workin' Together
Liber LP, 8TR, CASS

33099 PDQ BACH
Stoned Guest
Vangu LP, 8TR, CASS

16595 VIRGIL FOX
Bach at the Fillmore
Decca LP, 8TR, CASS

See for yourself why over 1 1/2 million record and tape collectors paid \$5 to join Record Club of America when other record or tape clubs would have accepted them free.

	Citadel Record Club (as adv. in TV Guide Oct. 3, 1970)	Columbia Stereo Tape Cartridge Service (as adv. in Esquire Nov. 1970)	Capital Record Club (as adv. in Look Jan. 26, 1971)	Columbia Record Club (as adv. in Playboy Feb. 1971)	RCA Stereo 8 Tape Club (as adv. in Esquire Oct. 1970)	RECORD CLUB OF AMERICA
CAN YOU CHOOSE FROM ALL LABELS' LPs OR TAPES, INCLUDING CARTRIDGE AND CASSETTE TAPES?	NO	NO	NO	NO	NO	YES! Choose any LP or tape on any label! No exceptions! Over 300 different manufacturers including Capitol, Columbia, RCA, Angel, London, etc.
MUST YOU BUY A "MINIMUM" NUMBER OF RECORDS OR TAPES? HOW MANY?	12	12	12	10	6	NONE! No obligations! No yearly quota! Take as many, as few, or nothing at all if you so decide!
HOW MUCH MUST YOU SPEND TO FULFILL YOUR LEGAL OBLIGATION?	\$59.76 to \$71.75	\$83.76 to \$95.40	\$59.76 to \$71.76	\$49.80 to \$59.80	\$41.70 to \$47.70	ZERO DOLLARS You don't have to spend a penny—because you're not "legally obligated" to buy even a single record or tape!
CAN YOU BUY ANY RECORD OR TAPE YOU WANT AT A DISCOUNT?	NO	NO	NO	NO	NO	ALWAYS! Your discount up to 79% OFF. Guaranteed never less than a third! No exceptions!
DO YOU EVER RECEIVE UNORDERED RECORDS OR TAPES?	YES	YES	YES	YES	YES	NEVER! There are no cards which you must return. Only the records and tapes you want are sent—and only when you ask us to send them.
HOW LONG MUST YOU WAIT FOR SELECTIONS TO ARRIVE?	5 to 6 weeks	5 to 6 weeks	5 to 6 weeks	5 to 6 weeks	5 to 6 weeks	NO LONG WAITS! Your order processed same day received. No shipping on cycle.

TYPICAL "EXTRA DISCOUNT" SALE

\$4.98 LPs average as low as \$1.96
\$5.98 LPs average as low as \$2.25
\$6.98 LPs average as low as \$2.56

Savings of 63% or more from recent Club sales up to \$4.42 per LP. Start these giant savings now... not after you fulfill your obligation like the other clubs.

	Label	List Price	Average Club Price
Andy Williams—Love Story	Colum	5.98	2.25
Anne Murray	Capit	5.98	2.25
Ed Ames—This Is	RCA	6.98	2.56
2001—A Space Odyssey	MGM	6.98	2.56
Mary Travers—Mary	WarBr	4.98	1.96
Creedence Clearwater Revival—Pendulum	Fanta	4.98	1.96
Miles Davis—Bitches Brew	Colum	5.98	2.25
Love Story—Soundtrack	Param	5.98	2.25
Perry Como—It's Impossible	RCA	5.98	2.25
Bloodrock—3	Capit	5.98	2.25
Santana—Abraxas	Colum	5.98	2.25
Worst of Jefferson Airplane	RCA	5.98	2.25

RECORD CLUB OF AMERICA—The World's Largest Record and Tape Club

CIRCLE 35 ON READER-SERVICE CARD

Any 1 Tape or Cartridge or Cassette Shown Here Worth up to \$20.94

TO BUY ANYTHING EVER!

Yes, take your pick of these great hits right now! Choose any 3 Stereo LPs (worth up to \$20.94) or any 1 Stereo Tape (cartridge or cassette, worth up to \$13.96) FREE... as your welcome gift from Record Club of America when you join at the low lifetime membership fee of \$5.00. You can defer your selection of FREE items and choose from an expanded list later if you can't find 3 LPs or 1 Tape here. We make this amazing offer to introduce you to the only record and tape club offering guaranteed discounts of 33 1/3% to 79% on all labels—with no obligation or commitment to buy anything ever. As a member of this one-of-a-kind club you will be able to order any record or tape commercially available, on every label—including all musical preferences. No automatic shipments, no cards to return. We ship only what you order. Moneyback guarantee if not satisfied.



66738 NEIL DIAMOND Tap Root Manuscript Uni LP, 8TR, CASS



65793 BREWER & SHIPLEY Tarkio KamSu LP, 8TR, CASS



38376 CANNED HEAT 'N JOHN LEE HOOKER (2 record set) Liber LP



42784 STEPHEN STILL'S Atlan LP, 8TR, CASS



66709 ORSON WELLES Begatting of the President Media LP



65784 MELANIE Leftover Wine Budda LP, 8TR, CASS



21537 TCHAIKOVSKY 1812 Overture Yorks LP, 8TR, CASS



41152 WHD Tommy (2 record set) Decca LP, 8TR, CASS



33185 JOSEPH & THE AMAZING TECHNICOLOR DREAMCOAT Scept LP, 8TR, CASS



33183 B. J. THOMAS Most of All Scept LP, 8TR, CASS



67519 STEPPENWOLF Gold Dunhi LP, 8TR, CASS



33092 BEST OF BUFFY SAINT-MARIE (2 record set) Vangu LP, 8TR, CASS



44746 DUKE ELLINGTON-TDN 70th Birthday Concert (2 record set) SolSt LP



33179 DIONNE WARWICK I'll Never Fall in Love Again Scept LP, 8TR, CASS

44726 FERRANTE & TEICHER 10th Anniversary Album (2 record set) UniAr LP

28082 GREGORIAN CHANT TREASURY Yorks LP, 8TR, CASS

33134 B. J. THOMAS Greatest Hits Vol. 1 Scept LP, 8TR, CASS

65775 VERY BEST OF LOVIN' SPOONFUL KamSu LP, 8TR, CASS

33065 JOAN BAEZ David's Album Vangu LP, 8TR, CASS

44757 BEST OF GORDON LIGHTFOOT UniAr LP, 8TR, CASS

42911 MAN OF LA MANCHA Original Cast Kapp LP, 8TR, CASS

65796 CAL TJADER Tjader-Ade Budda LP, 8TR, CASS

44753 TRAFFIC John Barleycorn Must Die UniAr LP, 8TR, CASS

NOW YOU CAN CHARGE IT, TOO!

AT LAST A RECORD AND TAPE CLUB WITH NO "OBLIGATIONS"—ONLY BENEFITS!

Ordinary record and tape clubs make you choose from a few labels—usually their own! They make you buy up to 12 records or tapes a year—usually at list price—to fulfill your obligation. And if you forget to return their monthly card—they send you an item you don't want and a bill for \$4.98, \$5.98, \$6.98, or \$7.98! In effect, you may be charged almost double for your records and tapes.

BUT RECORD CLUB OF AMERICA ENDS ALL THAT!

We're the largest all-label record and tape club in the world. Choose any LP or tape (cartridges and cassettes), including new releases. No exceptions! Take as many, or as few, or no selections at all if you so decide. Discounts are GUARANTEED AS HIGH AS 79% OFF! You always save at least 33 1/3%. You get best sellers for as low as 99¢.

NO AUTOMATIC SHIPMENTS

With our Club there are no cards which you must return to prevent shipment of unwanted LPs or tapes (which you would have to return at your own expense if you have failed to send written notice not to ship). We send only what you order.

HOW CAN WE BREAK ALL RECORD AND TAPE CLUB RULES?

We are the only major record and tape club NOT OWNED...NOT CONTROLLED...NOT SUBSIDIZED by any record or tape manufacturer anywhere. Therefore, we are not obliged by company policy to push any one label. Nor are we prevented by distribution commitments from offering the very newest LPs and tapes.

SPECIAL INTRODUCTORY MEMBERSHIP OFFER Join RECORD CLUB OF AMERICA now and take advantage of this special Introductory Membership Offer. Choose any 3 LPs or any 1 tape shown here (worth up to \$20.94) and mail coupon with check or money order for \$5.00 membership fee (a small handling and mailing fee for your free

LPs or tapes will be sent later). If you can't find 3 LPs or 1 tape here, you can defer your selection and choose from expanded list later. This entitles you to LIFETIME MEMBERSHIP—and you never pay another club fee. Your savings have already more than made up for the nominal membership fee.

NOW YOU CAN CHARGE IT

If you prefer, you may charge your membership to one of your credit cards. We honor four different plans. Check your preference and fill-in your account number on the coupon.

LOOK WHAT YOU GET

- **FREE Lifetime Membership Card**—guarantees you brand new LPs and tapes at discounts up to 79%... Never less than 1/3 off.
- **FREE Giant Master LP and Tape Catalog**—lists all readily available LPs and tapes (cartridges and cassettes) of all labels (including foreign)... all musical categories.
- **FREE Disc and Tape Guide**—The Club's own Magazine, and special Club sale announcements which regularly bring you news of just-issued new releases and "extra discount" specials.
- **FREE ANY 3 Stereo LPs or any 1 Tape** shown here (worth up to \$20.94) with absolutely no obligation to buy anything ever!

GUARANTEED INSTANT SERVICE

All LPs and tapes ordered by members are shipped same day received (orders from the Master Catalog may take a few days longer). ALL RECORDS AND TAPES GUARANTEED—factory new and completely satisfactory or replacements will be made without question.

MONEY BACK GUARANTEE

If you aren't absolutely delighted with our discounts (up to 79%)—return items within 10 days and membership fee will be returned AT ONCE! Join over one and one-half million budget-wise record and tape collectors now.



RECORD CLUB OF AMERICA

CLUB HEADQUARTERS
YORK, PENNSYLVANIA 17405 X910S

Yes—Rush me a lifetime Membership Card, Free Giant Master LP & Tape Catalog, and Disc & Tape Guide at this Special Membership Offer. Also send me the 3 FREE LPs or 1 FREE tape which I have indicated below (with a bill for a small mailing and handling charge). I enclose my \$5.00 lifetime membership fee. This entitles me to buy any LPs or tapes at discounts up to 79%, plus a small mailing and handling charge. I am not obligated to buy any records or tapes—no yearly quota. If not completely delighted I may return items above within 10 days for immediate refund of membership fee.

3 FREE LPs

or 1 FREE TAPE

8 track
 cassette

or Defer Selection—send expanded list.

Mr. _____
Mrs. _____
Miss _____

Address _____

City _____ State _____ Zip _____

All Servicemen write Soc. Sec. # _____

CHARGE IT to my credit card. I am charging my \$5.00 membership (mailing and handling fee for each FREE LP and tape selected will be added).

Check one: Diners Club Master Charge
 American Express BankAmericard

Acct. # _____ Expiration Date _____

Signature _____

Canadians: mail coupon to above address. Orders to be serviced from Canada.

© RECORD CLUB OF AMERICA 1971 52

RECORD CLUB OF AMERICA—The World's Lowest Priced Record and Tape Club

CIRCLE 35 ON READER-SERVICE CARD

Living outdoors?



Bring your music with you with the Bozak *bard*

The perennial favorite of outdoor music lovers is Bozak's famous Bard — the wide-range all-weather music system.

Much imitated for over a decade, the Bard is distinguished by its —

- rugged waterproof construction
- year-round usefulness
- handsome appearance
- and above all, its incomparable musical reproduction

The Bard is unsurpassed for tonal richness and for intimate, personal sound. It is marked by a total absence of "tinny" common to so many outdoor speakers. Every component — from the wide-range B-800 driver to the modern hemispheric steel enclosure — is designed specifically for full, natural sound reproduction outdoors. (Frequency response 50-10,000 Hz; impedance 8 ohms; power handling capacity 30 watts program; diameter 18"; height 21".)

For superb outdoor music the year round, enjoy The Bard.



P.O. Box 1166 • Darien, Connecticut 06820

Overseas Export: Elpa Marketing Industries, Inc.
New Hyde Park, New York 11040 U.S.A.

letters

Our April Anniversary Issue

With more than sixteen years of HIGH FIDELITY back issues resting on a closet shelf, it seemed inappropriate to let your twentieth anniversary pass without extending congratulations.

I literally grew up with your magazine at my side and it would be difficult to guess how many enjoyable hours your publication has provided. Thank you for a superior job and my best wishes for your continued success and prosperity.

David A. Williams
Promotion Manager,
WNDU/WNDU-TV
South Bend, Ind.

May I compliment you on your fine Twentieth Anniversary Issue. My continuing interest in both music and high fidelity dates from your first issue in 1951, when as an impressionable fourteen-year-old I realized that the old family radio was not giving out all one might wish. Most of your technical articles have faded from my memory, along with my custom-built 20-watt Williamson amplifier, my Rek-o-Kut turntable, and an enormous bass reflex enclosure. What remains, however, is the nostalgic memory of your reviews over the years, especially the early discographies.

In response to your article "The Story of an Idea," I'd like to know what happened to some of the critics whose reviews I followed so closely. For example, what became of C. G. Burke? I remember his reviews disappearing from your pages in the late Fifties. And J. F. Indcox — is there still a "Music Box" on Main Street in Great Barrington? And what about David Randolph, Paul Affelder, and Ray Ericson?

Watching the growth of high fidelity and stereophonic sound over the past twenty years through the pages of HIGH FIDELITY has been quite an experience. I hope you're around for another twenty years so my son can enjoy the same.

Ronald H. McDonald
Syracuse, N.Y.

Here is a brief updating on the activities of a few of HF's former critics. C.G. Burke lives in retirement in upper New York State; he's well on in years and since he no longer drives a car, is not able to visit the Publishing House. Jack Indcox still lives in Great Barrington. Though he has given up the storefront on Main Street, he continues to sell records to a limited group of collectors. David Randolph is still very active in the musical world as a lecturer and director of the Masterwork Chorus. Paul Affelder's freelance musical writing continues apace and Ray Ericson is now music editor of the New York Times.

In his perceptive survey of pop music during the Sixties, Gene Lees made some brilliant observations but also some questionable ones. First, I am sure that few would agree with Mr. Lees that the decade's music was, in general, poor. Rather, it was a time when

anyone who thought he had something musical to say, regardless of talent, was given the opportunity. But natural selection applies to music as well as to biology, and only the fittest survive. By that criterion, the music of the Sixties is so far the best of the century.

Second, Mr. Lees continues to insist on a causal relationship between rock music and the drug culture. Actually, the drug scene was a logical outgrowth of the despair that characterized the entire decade—the record companies were not offering a cop-out when they said that their product was simply a reflection of the times.

What caused this despair? Mr. Lees hinted at it when he viewed the music of the early Sixties in terms of the hope generated by the Kennedy administration. President Kennedy's assassination generated a shock that was felt through our whole culture. Despair and unrest naturally followed and brought with them all their cultural "reflections": the electric guitar, long hair, psychedelia, LSD, etc. The Beatles, the cultural harbingers of the Sixties, became established in America less than one month after the assassination, at a time when someone or something was needed to lead American youth (and the youth of the world) through the shattered dreams. The entire Beatle output was an almost logical development, from *I Want to Hold Your Hand* through *Lucy in the Sky* to their inevitable breakup.

If anyone wants to know where pop music is heading in the Seventies, they should consider the most recent cultural shocks, the deaths of Jimi Hendrix and Janis Joplin. The drug scene has worn itself out because, instead of offering consolation, it has brought even more despair. It has proven to be a cop-out. The recent changes in pop music reflect this dissatisfaction with the drug experience. The highly individual statements by such people as James Taylor (whom Mr. Lees wrongly considers as characteristic of the Sixties) and the Beatles indicate a more down-to-earth trend in pop music. Jesus-rock foretells a restoration of religious values. Let's hope for the best.

Wayne Bergen
Elmhurst, N.Y.

The reappearance of Gene Lees in the April issue was cause for jubilation. It has seemed months since you've printed one of his engaging little essays about his culture heroes, Spiro Agnew and Art Linkletter, and meanwhile I've been forced to turn to the "Letters" column for my moral education. It just hasn't been the same. I mean, sure Leonard Marcus and all those super-earnest philosophy profs out in Nebraska were laying it on us (oh, were they laying it on us!) about how demon drugs obscure the real and true appreciation of music, which only they can know, and that was terrific stuff. Just terrific.

But the moral tone began to get a little ambiguous when Marcus confessed that he isn't especially turned on by the sound of music anyway (preferring silent score-reading) and that gunshots and women's screams are the sounds that he really digs at the visceral

A large gorilla is the central figure of the advertisement, holding a Sherwood S-7300 AM/FM stereo receiver. The gorilla is shown from the chest up, looking towards the camera with a slight smile. The receiver is a dark wood-grain cabinet with a silver faceplate. It features a green LED display in the center, several control knobs and buttons, and a volume knob on the right side. The gorilla's right hand is resting on the top of the receiver, and its left hand is near the bottom. The background is a plain, light-colored wall.

THERE WAS A MISSING LINK IN OUR LINE, TOO

Actually we found there was something missing in everyone's line. No one had a really high powered, high styled receiver for a reasonable price.

And you asked for one. So we did the only human thing. We built the S-7300 AM/FM stereo receiver. The Missing Link.

The S-7300 has 160 watts (IHF) – 42 + 42 watts R. M. S. at 8 ohms, both channels driven, with only 0.6% distortion. Plus, solid state ceramic FM IF filtering and 1.8 μ v FM sensitivity. We included inputs for *two* phonos plus

mikes, and, provision for up to *four* tape recorders. There are illuminated selector indicators, and one special feature: an oiled walnut cabinet at no extra charge.

Normally, it costs up to \$400 to get all these features. But we wanted a truly evolutionary receiver.

So we priced the S-7300 at just \$319.95.

It's priced just above our best selling S-7100, just below our top-rated S-8900. But in the \$300 price range, no other receiver has more power, features and styling than our new S-7300.

Ask your audio man to demonstrate our Missing Link. The evolutionary S-7300 AM/FM stereo receiver.

Or, write us for complete specifications. Sherwood Electronic Laboratories, Dept. A, 4300 N. California Ave., Chicago, Ill. 60618.

**SHERWOOD
SOUNDS EXPENSIVE**

Our new PL-12A stereo turntable. Incomparable at \$89.95

Quality and versatility gave their price. Now they cost less. For only \$89.95, including walnut base, dust cover and cartridge, you can own the new Pioneer PL-12A 2-speed stereo turntable.

At this low price no other turntable includes all these quality features: 4-pole, belt-driven, hysteresis synchronous motor... meticulously balanced tonearm...

interchangeable high compliance magnetic cartridge... feather light tracking force... polished diamond stylus... oiled damped cueing... 12" dynamically balanced die-cast platter... anti-skating control... hinged dust cover... walnut case... simplified operation... 33 $\frac{1}{3}$ -45 rpm

speeds, and much more. See your franchised Pioneer dealer for an exciting demonstration.

U.S. Pioneer Electronics Corp.,
178 Commerce Rd., Carlstadt,
New Jersey 07072.

 **PIONEER®**



level. So who do you trust? I mean, my mother warned me about people like that when she warned me about drugs!

And then I turned to page 69 and found that good old Gene was back again. What I like about Gene is that he's so reliable. If he secretly hates music and prefers the snap of black leather, you can be sure he'll never come out and say so in print. And best of all, nobody puts anything over on him. If a young person smiles, Gene can always see the snarl underneath. Somebody says "love," and old Gene never misses the overtones of "hate" echoing around it. They say "life" and he hears "death" every time. Nobody fools old Gene.

And what a grasp of history and sociology! Gene is the audiophile's Edmund Burke. Who would have thought that you could pick up a magazine about records and amplifiers and stuff and find the whole decade of the Sixties put together for you in a page and a half? Heavy!

The only thing I missed was that he didn't say a word about the cancellation of the Lawrence Welk Show. Maybe next month, Gene?

George R. Paterson
Chicago, Ill.

I have rarely witnessed such pompous, pretentious ego-tripping as the April letters concerning the music/drug question. With the exception of Craig Stacey's correspondence (which came close to the mark), the letters are wasted space in a magazine that needs more space. Gary Ralph, for example, insists upon an intellectual approach to music listening: never permit simplicity to creep into art. I will listen to this pap when Mr. Ralph writes something that will make me dislike *Bohème* (I am very fond of *Wozzeck* but damn if I cannot enjoy *Bohème* also).

Unfortunately, among all these people pronouncing the last word on music listening, the worst offender is Leonard Marcus. Not only does he suggest that he *knows* what approach to take to get the most out of music (a rather clinical means), but in an offensive, snobbish little paragraph reveals how he, unlike most mortals, is one of the elite, the great Master Score Reader. He forgets that music came before notation. I would love to see how well Professor Marcus could read every bit of Carter's Piano Concerto projected page by page on a screen with pages changing at full tempo.

If I seem harsh, perhaps it is because I feel that vain boasts and silly pretense have little to do with artistic communication. I certainly do not know how I listen to music or why it moves me, and I don't really want to know. Let music happen and do what it will to you. At the risk of sounding presumptuous myself, I feel that people who can express the mysteries of music so simplistically are missing the point themselves.

The rest of the issue was splendid, however, especially Gene Lees's inspired comments.

Alan Klein
Pittsburgh, Pa.

I noticed with interest the April 1971 issue which discusses the Great Recordings of the past twenty years.

On the list were Ansermet's performance of Falla's *El sombrero de tres picos* (formerly

on London) and the Beecham versions of Haydn's *Salomon* symphonies (formerly on Angel). We are happy to announce that within the next four to six months, both will be re-released on the Everest label.

In the same issue, Peter G. Davis ["Repeat Performance"] pointed out that Ernest Ansermet was in all likelihood the conductor of Bloch's *Schelomo* as well as *A Voice in the Wilderness* on Everest 3284—not the composer as noted on the jacket. London, which originally released this disc, supplied us with the incorrect credit; only after releasing the record did we discover that Ansermet was in fact the conductor and London apologized for their error. In the near future we will correct the labeling.

Bernard C. Solomon
President
Everest Records
Los Angeles, Calif.

Peter G. Davis senses correctly [April 1971] that the incorrectly labeled Arensky "Fantasy" which he reviewed on Turnabout 34345 is in fact the composer's Piano Concerto, Op. 2 and is now so listed in Schwann. The only recording of the one-movement Fantasy is on Soviet MK D-16581-2 with Nikolaeva and Fedoseyev. Your correspondent must take credit for advising Turnabout and Schwann of the error some months ago.

Saul Kruger
Silver Springs, Md.

A Stamp for Kreisler

Recently at a spa near Lucerne, I happened to see a poster announcing a semiprofessional performance of Fritz Kreisler's operetta *Sissy*. I intended to see it but found, to my disappointment, that it was sold out.

This brought back to me a project that I have been carrying in the back of my mind for several years now, one of those good intentions one never carries out; to initiate some action that would cause the Austrian postal authorities to honor our beloved Fritz Kreisler's memory by issuing a stamp commemorating the centenary of his birth in 1975, only four years away. That this has not already been done is a source of amazement to me. How could it be that a unique figure like Kreisler—whose name evokes so much that was a part of Austria and Vienna, the composer of *Caprice viennois*, of *Liebesleid* and *Liebesfreud*, the incomparable violinist with that Viennese lilt—should have been forgotten by those who make decisions in the philatelic field?

Although I am not a philatelist myself, I know how all countries, especially those concerned with the tourist industry, are on the lookout for symbols that help to create the "image" of what they set out to propagandize. I am thinking of the French stamp series of the great French painters, of Hungary's utilization of Bartók's prestige, and so on. Is there anything more natural than that Austria should stress the fact of the great Kreisler's *Oesterreichertum*?

Knowing a thing or two about bureaucratic red tape, I decided not to approach the authorities myself. Instead, I decided that your magazine with its international readership and prestige could achieve the result much more effectively. After all, the gramo-

NEW, TRANSPARENT AND BEAUTIFUL.



ADC's brand new 450A is a "high transparency" speaker system for the perfectionist who wants to own the best bookshelf system money can buy.

This two-way system avoids the use of complex crossover networks and the resultant phase distortion. By enabling the majority of the audio spectrum to be radiated by the high frequency unit, we achieve essentially a "single point source". The low frequency driver is then left to do the demanding but uncomplicated job of reproducing the low and basically non-directional portion of the audio spectrum.

The result is an extremely transparent true-to-life bookshelf speaker system you must hear to appreciate.

ADC 450A SPECIFICATIONS

Type . . . Full-sized bookshelf.
Cabinet . . . Oiled Walnut.
Dimensions . . . 25" H x 14" W
x 12 $\frac{3}{8}$ " D.
Weight . . . 50 lbs. each.
Frequency Response . . . 25 Hz to 30
kHz \pm 3 dB (measured in average
listening room).
Speakers (2) . . . $\frac{3}{4}$ " "point source"
wide range tweeter and 12" high
compliance woofer.
Nominal Impedance . . . 6 ohms (for
optimum performance from
transistorized amplifiers).
Power Required . . . 10 watts RMS
minimum.
Price . . . \$165 (suggested resale).



AUDIO FOR AUDIOPHILES

CIRCLE 9 ON READER-SERVICE CARD

RABCO

Gives you a choice —

TWO straight line servo - driven phono arms.

The moderately priced ST-4 turntable and mechanical servo arm

- Synchronous motor at the turntable for constant speed
- Electric-motor cueing and end-of-record arm lift

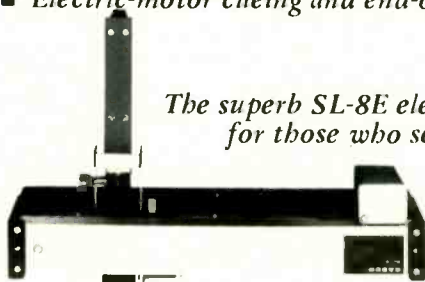

The superb SL-8E electric servo arm for those who seek the ultimate

ST-4 Combination \$159.00
Optional Two-Piece Cover \$15.00
SL-8E arm \$169.00

MAKERS OF THE ONLY SERVO DRIVEN STRAIGHT LINE ARM

RABCO 11937 TECH ROAD
SILVER SPRING, MARYLAND 20904

CIRCLE 33 ON READER-SERVICE CARD

What started out as a romance in Los Angeles...

A salesman in Los Angeles recommended a Concord receiver to a couple from Phoenix, the couple from Phoenix told their lawyer in Colorado Springs, the lawyer from Colorado Springs told an oil man from Tulsa, the oil man from Tulsa told his lodge brother from Peoria, the lodge brother from Peoria told a druggist from Cleveland, the druggist from Cleveland told a truck driver from Philadelphia, the truck driver from Philadelphia told his stock broker from New York, and the stock broker from New York loved the Concord stereo receiver.

...has ended up as a love affair in New York!

And this is the reason for the love affair. The Concord Mark 20, AM-FM stereo receiver is 300 watts* of beauty. It can deliver enough distortion-free power to fill an auditorium. Or it can whisper sweetly. Solid state circuitry utilizing field-effect transistors and integrated circuits provides maximum station-pulling power, superb performance on records, tapes and broadcasts. A tuning meter for FM, signal strength meter for AM, provide pinpoint tuning. And it has all of



*total power at 4 ohms single channel driven ± 1 dB

the audiophile controls—tape monitoring, speaker selector switch, stereo headphone jack, loudness contour controls, calibrated slide pots for tone, balance and volume, interstation muting and automatic stereo switching. All of this wonderful performance is wrapped up in a handsome solid-walnut cabinet with a back-lit, smoke-black plexiglas front panel. The price is under \$300. Other Mark Series receivers starting at under \$200 for Mark 10, under \$240 for Mark 12

Concord Mark Series Receivers

Concord Electronics Corp., 1935 Armacost Avenue, Los Angeles, Calif. 90025. A Subsidiary of Ehrenreich Photo-Optical Industries, Inc. 

CIRCLE 13 ON READER-SERVICE CARD

phone industry and all that the gramophone means to music owes a debt to Fritz Kreisler who, along with Caruso and perhaps Mischa Elman and Wilhelm Backhaus, was one of the principal artisans of the gramophone's emergence as a major factor in music.

Joseph Szigeti
Clarens, Switzerland

The Image of Delius

While perusing HIGH FIDELITY's April issue, my heart jumped for joy when I came across the full-page review of Angel Records' new Delius *Appalachian Brigg Fair* release, but after reading what Donal Henahan had to say my joy turned to disappointment.

I'm a concert cellist with a profound love of Delius' music, and I always approach the subject of this great composer with keen interest. Mr. Henahan's attitude is condescending and rather offensive when he uses phrases such as "seriously addicted Delians," "folky tunes," "allowing for the inevitable purple patches," "harmonic *gouache*," "Hollywoodish climax."

He also points out that "some practical reason also may explain his [Barbirolli's] elimination of the choral part for three measures (at ten bars before letter v), though it is not obvious." Upon checking the recording with my score, the tenors made their entrance exactly as indicated at ten bars before letter v, with nothing eliminated. Something definitely is obvious.

I don't want to be a nitpicker, but I think it is a sad indictment of the current trend in our concert halls that this sublime and supremely beautiful music is almost totally neglected. Delius is music's nature poet incarnate, mystic visionary, peace lover, true humanitarian, an Aquarian in this age of Aquarius. If ever the world needed to understand this great man's message, it is now. Let us by all means, with honor and respect, do what we can to encourage a greater understanding.

David Everhart
New York, N. Y.

Magical Flute

I would like to take strong exception to Paul Henry Lang's review of the new London/Solti *Magic Flute* [April 1971].

The most exciting aspect of this recording is, to me, the utterly fresh perspective employed in approaching a work and a composer whose visionary potential is so often neglected in performance. From the excitement and dynamism of the orchestral treatment, its dramatic emphasis and unity, to the sublime effect obtained by using male instead of female sopranos as the three boys, everything about this recording contributes to what is virtually a complete revitalization of this most vital of operas.

While Mr. Lang seemed to have shared my opinion of these particulars, it seems to me that he did not respond to their freshness and vibrancy, but rather to an incidental conformity with his standards of execution. Confronted with something truly imaginative, like Cristina Deutekom's breathtaking and unearthly Queen, all Mr. Lang could manage was to whip out his pharisaic metronome and pick vocal nits, never realizing that what rubbed him the wrong way was not the inter-

Introducing Memorex Recording Tape. The tape that can shatter glass.

New Memorex Tape can shatter glass because it records and plays back with exacting precision. Memorex Tape records every note, every pitch, every harmonic, every nuance of music, then plays them back the same way they sounded live.

Quite a claim.

Quite a tape.

We found a singer who could maintain the pitch necessary to shatter glass and projected his voice with enough volume to vibrate a glass to its shatter point. At the same time, we recorded that pitch on Memorex Tape.

Then we played our tape back.

Bam! Shattered glass.

Memorex has increased tape sensitivity, increased high-frequency response, and improved signal-to-noise ratio so much, that now you can record your favorite music and play it back the same way it sounded live.

You'll hear.

MEMOREX Recording Tape
Reproduction so true it can shatter glass.



Incidentally, our cassette tape also shatters glass.

© 1970, MEMOREX CORPORATION

These long playing cartridges will outperform any long playing records you own.



Here are two exciting stereo cartridges that barely touch your records, yet track them like radar, at forces so low that your records will be good as new after years of use.

1000ZE/X "Measurement Standard" — Tracks as low as 0.1 gram in laboratory playback arms. List Price—\$99.95.

Each 1000ZE/X and 999VE/X cartridge is individually adjusted to have a flat frequency response within ± 1 dB from 20-20,000 Hz. Stereo separation is better than 35 dB at 1 K Hz and remains 25 dB or better all the way out to 20,000 Hz. Overall frequency response a phenomenal 4-40,000 Hz. There are no electrical or mechanical peaks and total

IM distortion at the standard 3.54 cm/sec groove velocity does not exceed .05% at any frequency within the full spectrum. Uses a .2 x .7 mil hand polished miniature diamond for exceptional low mass.

999VE/X "Professional" — Recommended tracking force $\frac{1}{4}$ to $1\frac{1}{4}$ grams. List Price—\$79.95.

Write for your free copy of "1971 Guide to Sound Design," Empire Scientific Corp., 1055 Stewart Avenue, Garden City, N.Y. 11530.

EMPIRE



CIRCLE 21 ON READER-SERVICE CARD

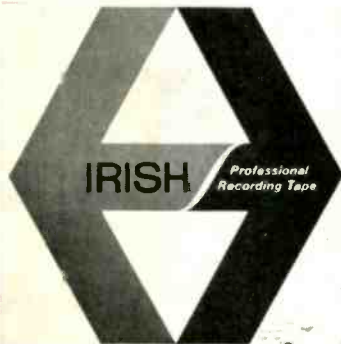

here are the facts:

We've been making premium quality tape for over 25 years. That's know-how! Irish is a professional quality 20-25M cycle wide range—low noise tape. No hiss, no distortion. Just sharp, clear, dynamic sound reproduction. We include, at no extra cost, 30" color-coded leader, trailer and reversing strip. Every good tape should have it. A leatherette "library" binding is also included for handsome storage and easy identification.

Irish is available in reel and cassette sizes as well as video tape. Try Irish just once. One test will prove to you that Irish is the finest quality tape money can buy or your money back!

Irish Tape

270-78 NEWTOWN RD.
PLAINVIEW, N.Y. 11803
EXPORT: MORHAN EXPORTING CORP.

CIRCLE 25 ON READER-SERVICE CARD

pretation's lack of "temperament" but its unfamiliarity.

While conservatism of this sort has historically done little damage—to true artists, that is, who invariably react to a lack of popular acceptance by withdrawing deeper into their creative sources—the same unfortunately cannot be said of a recording company whose product must sell if it is to survive. Surely London's management should be encouraged in their innovative policies in this time of cheapening products and tastes. We know only too well the profitable alternatives that can be taken.

Michael Newman
Flushing, N.Y.

Much Ado About Reger

I have been reading record reviews by Clifford F. Gilmore for some time now and have always been impressed by his enlightened and articulate criticism. His review of the Telefunken recording of the Reger organ works in the March issue, therefore, gives me the impression that he was either not quite serious or not quite sober when he wrote it!

As an organist, I am—unfortunately—more than casually familiar with the works reviewed. To describe Reger's music as "intricately contrapuntal" implies a conception of polyphony that is, to say the least, rather quaint. Reger's "polyphony" is a sham, intended to give the impression of melodic independence in music conceived entirely in the late or, rather, hyperromantic idiom of the turn of the century. Seen from our vantage point, Reger's output is, like that of so many of his contemporaries, a frantic and futile attempt to stem the tide of a rapidly declining musical culture. Those who see in him genius, or a synthesis of Bach and Brahms, only betray their inability to see behind a façade. Where Bach and Brahms wrote profoundly, Reger wrote pompously; where they wrote forcefully, he wrote loudly; where they wrote dramatically, he wrote hysterically.

Stravinsky once described Reger's music as being "As repulsive as the man himself," but Shakespeare unwittingly described it better than anyone else 300 years before it was written: there is in Reger's music, indeed, much ado about nothing.

Richard Siggins
Hamburg, Germany

High Fidelity, July 1971, Vol. 21, No. 7. Published monthly by Billboard Publications, Inc., publisher of Stereo, Stereo International, Modern Photography, American Artist, Billboard, Vend, Amusement Business, Merchandising Week, Photo Weekly, Gift & Tableware Reporter, Record Retailer, Record Mirror, Discografia Internazionale, World Radio TV Handbook.

High Fidelity/Musical America. Edition published monthly. Member Audit Bureau of Circulations.

Editorial correspondence should be addressed to The Editor, High Fidelity, Great Barrington, Mass. 01230. Editorial contributions will be welcomed. Payment for articles accepted will be arranged prior to publication. Unsolicited manuscripts should be accompanied by return postage.

Subscriptions should be addressed to High Fidelity, 2160 Patterson St., Cincinnati, Ohio 45214. Subscription rates: High Fidelity/Musical America: In the U.S.A. and its Possessions, 1 year \$14; elsewhere, 1 year \$15. National and other editions published monthly: In the U.S.A. and its Possessions, 1 year \$7.95. Subscription rates for all other countries available on request.

Change of address notices and undelivered copies (Form 3579) should be addressed to High Fidelity, Subscription Fulfillment Dept., P.O. Box 14156, Cincinnati, Ohio 45214.

WHY

AREN'T YOU LISTENING TO THE 2 EXTRA CHANNELS IN YOUR STEREO RECORDS, TAPES, AND FM BROADCASTS?

There is four channel material already present on your stereo records, tapes and FM broadcasts but, you are only listening to two of them. Add the Lafayette Dynaquad* 4-Channel Adapter to your present stereo receiver or amplifier (such as the Lafayette LR-1500TA or LA-125TA) and two additional speakers and you will experience the dramatic difference of four channel sound NOW!

During a stereo recording session, the microphone picks up two types of sounds: direct and reflected, both of which are always included on a stereo recording. When playing back stereo records, tapes, and FM broadcasts in a conventional 2-channel stereo system, the reflected sounds are masked by the louder direct sounds coming from each of the two front speakers. The great importance is that reflected sounds create the depth and spatial breadth one associates with a performance given in a concert hall rather than in the downstairs closet! The Lafayette Dynaquad recovers and separates a substantial amount of this reflected sound from the direct sound. This is not produced artificially as in the case of reverberation units, and synthesizers. The result is a dramatic new sound

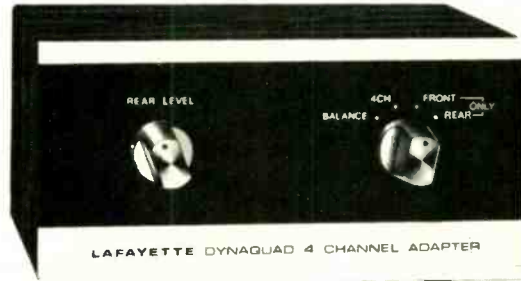

dimension to all existing stereo program sources without the need for any additional amplifiers!

So . . . why listen to only two channels when you can hear music the way it was meant to be heard with FOUR CHANNEL STEREO by LAFAYETTE? Price \$29.95!!!

*Exclusive Licensee of Dynaco

The RENOWNED LR-1500TA Ideal match for new 4-channel sound!

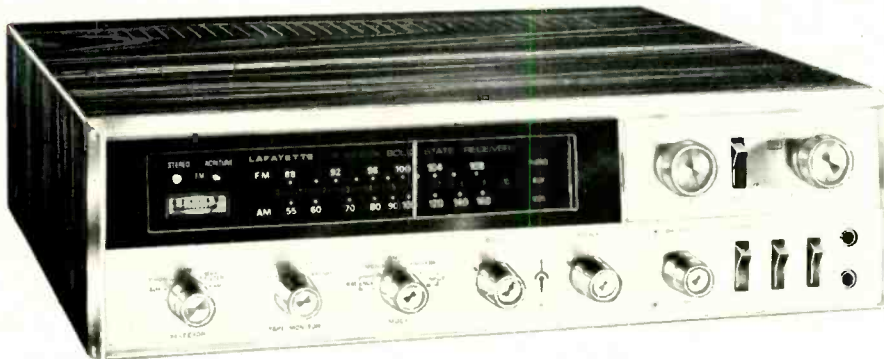

"High performance and an abundance of features . . . an excellent buy on today's market."

High Fidelity

"We found the performance of the LR-1500TA FM tuner to be excellent in all respects . . . The LR-1500TA is a lot of receiver for the money."

Stereo Review

The perfect matchmate for the Lafayette Dynaquad Adapter. Widely acclaimed by critics and consumers alike, the Lafayette LR-1500TA 240 watt AM/FM stereo receiver combines excellence in design, performance and operating convenience with the latest advances in solid-state circuitry. Four Integrated Circuits and five Field Effect Transistors in the FM front end assure you of pulling in the weak stations as well as the strong with noise-free clarity and tonal purity. "Acritune," our precision tuning circuit, activates a light on the front panel when your station is perfectly tuned, and Computer-Matic®, our

exclusive overload protection circuit, insures against amplifier damage. In addition, the LR-1500TA features a complete set of automatic and manual controls such as automatic FM stereo/mono switching, interstation muting circuit to silence the receiver when you're tuning between stations, an illuminated D'Arsonval signal strength meter, front and rear panel tape output jacks, direct tape monitor switch, and a dual system speaker switch which permits you to enjoy stereo in one or two rooms separately or simultaneously. Price \$299.95!!!

LAFAYETTE®

LAFAYETTE RADIO ELECTRONICS CORP., DEPT. 19071, BOX 10, SYOSSET, N.Y. 11791



Write Today For Your Big
FREE 1972 Catalog.
468 Pages!

Send me FREE Lafayette Catalog 720		19071
Name.....		
Address.....		
City.....		
State.....		Zip.....

CIRCLE 29 ON READER-SERVICE CARD



Fisher vs. Lang

Long Live the Little Knife

I feel that Paul Henry Lang's review of our recording of the opera *Tamerlano* [May 1971]—an important and brilliant addition to the Handel discography—is an incredibly superficial and capricious concoction of bias and faulty scholarship.

Mr. Lang's first theme is to disparage the whole effort because he lacks the imagination to accept mezzo-sopranos in Handel's castrato roles, even though Handel in his operas wrote twenty-six male roles for women singers. Most critics accept the mezzo compromise, and the opera public certainly expects women to sing Orfeo, Cherubino, and Octavian.

In *Tamerlano* the "male" mezzo voices are effectively contrasted with each other and with the female roles. But Mr. Lang quips: "how can you tell them apart in a fast-moving recitative?" Well, Mr. Lang, since you are not fluent in Italian, which I will prove, you must do what you did with the five low men's voices in the recent DGG *Giulio Cesare*: you pay attention! You find fault with the Italian of our mezzos (which is quite good) but you ignore tenor Young's habitual un-Italian glottal stopping in cases like *unico/avanzo*. On Side 1 alone of *Giulio Cesare* you ignored twenty-six incorrect vowels (including "Chay-zareh" for "Chez-areh"), five incorrect single consonants, and ten wrong double consonants. Italian "quotations" in your book (*George Frideric Handel*) do not restore my confidence; I find at random *canto* for *cantate*, *dissentite* for *senti*, *si* for *se*, *compresso* for *amplesso*, and *offere* for *offese*.

According to this double standard it seems that the Italian does not matter so long as the castrato roles are transposed for men—in *Giulio Cesare*, for instance, Mr. Lang says "the results are felicitous" even while admitting that Fischer-Dieskau could not handle the coloratura at all. Mr. Lang's book actually advises removing excessive rousades and ornaments when transposing so that men can manage. The very essence of rage arias like Caesar's "*Al lampo dell'armi*" and *Tamerlano*'s "*A dispetto*" is the frenzy of three or four consecutive allegro bars in sixteenth notes. Today these can be sung brilliantly by women, at original pitches: it is difficult to conceive what would be left of them after Mr. Lang's "competent editing" for men. Transposing Handel's vocal line down an octave perverts—and inverts—the harmonic



Charles P. Fisher

architecture of his often deceptively simple, transparent orchestration. Accompaniments and countermelodies are trampled or marooned and the voice gets mired in the bass. Retouching as endorsed by Mr. Lang merely aggravates the vandalism.

His opinion of the recitative in *Tamerlano* as compared to that in *Giulio Cesare* seems to be the result of his anti-mezzo bias. He is bored by it: although it is "fast-moving" he finds it "fuzzy" and lacking in dramatic timing. This is strangely at odds with the opinion of Winton Dean, author of *Handel and the Opera Seria*, who in a recent letter wrote, "The recitative is conspicuously good—far

better than in any other Handel recording..." *Stereo Review*'s Bernard Jacobson writes "...in the recitatives... there is none of that pious mooning about what is unsuitable enough in Handel oratorio, and quite unconscionable in opera. Instead, we are swept along, as we should be, by the passionate intensity of the action." This double standard seems confirmed in Mr. Lang's book: explaining the function of recitative in Handel opera he writes on p. 158, "the *dramatic expression* was left to the recitative"; on p. 160, "the *emotion-free* and often perfunctory recitatives restore the temporal continuity." (Italics are mine.)

When facts do not suit Mr. Lang, he bends them. He is entitled to dislike Killebrew's voice, but attacking her style, recitative delivery, and technique (all of which are widely admired—see Jacobson) because he would have preferred a baritone is dubious journalism. A reader hearing "*A dispetto*" or "*Vuò dar pace*" might well wonder if Mr. Lang listened to them.

If one thing more than another has proliferated in the LP era it is the appreciation and knowledge of baroque performance practices; yet Mr. Lang is flatly opposed to vocal embellishment. He praises the unadorned da capos in *Giulio Cesare* for showing that Handel's great melodies "easily bear literal repetition," and he represents that ornamenting a Handel aria is a wild improvisational excursion for which no modern singer is trained. Nonsense! As in baroque instrumental music, it is a matter of decorating a tune without obscuring it—with turns, trills, slides, divisions, and so forth. The assertion that today's singers, unlike string, wind, and keyboard players, are incapable of this is preposterous. Of course, Handel's great tunes bear literal repetition, but they respond gracefully to the modest and stylish embellishment added in *Tamerlano*. The pettish abuse it drew from Mr. Lang is pure spleen.

He ventures out on another limb and it breaks. He argues that Asteria, the youthful, initially naive daughter-figure, should have been sung by a dramatic soprano, finding our singer "at a disadvantage when pitted against the heavy mezzos;" as in the duet with Andronicus. Well nothing in the entire recording is more obviously right than the exquisite balance of quality and dynamics between

**"When facts do
not suit Mr. Lang,
he bends them."**

Bogard and Steffan in this piece. Mr. Lang misunderstands the magnificent aria "*Cor il padre*" (another misquote, for "*Cor di padre*")—as well as the entire role—or he would not call for a dramatic soprano in this young girl's sorrowful affirmation of filial devotion and rejected love, while tacitly approving the extremes of fiery desperation and grief in her "*Mirami, io quella son*" and "*Padre amato*." Francesca Cuzzoni sang the role for Handel, as well as Cleopatra and Rodelinda, both of whom are more worldly than Asteria; to call them dramatic soprano roles would be incongruous.

Mr. Lang is finally trapped in a glaring error. He says that in the opera's final *coro* "the

top part, marked by Handel 'soprano,' i.e., Asteria, was allotted to one of the mezzos so that with her powerful voice the treble would prevail!" Mr. Lang, in Handel's autograph the top part is marked "Dotti," and the others "Senesino," "Pacini," and "Boschi," respectively. Dotti sang Irene for Handel, and Irene the treble for us. As a Handel expert you should also know that characters disabled at the ends of operas are not usually recalled to sing the *coro*: this one has *no* Cuzzoni and *no* Borosini (Bajazet).

This is not all: Mr. Lang had another strange lapse in contrasting Bajazet's "*Figlia mia*" with his death scene; the former is actually the centerpiece of the latter. Through

another score-reading error he accused us of improperly silencing the harpsichord where the score is in fact marked "*senza cembalo*."

There are seven other abusive inanities in the review which, having little or no basis in fact, reveal more about the author than the recording. Through all his distortion and misrepresentation there emerges a pattern of hostility for which I cannot imagine a wholesome motive.

This is a distressing exception to HIGH FIDELITY's high standard of journalism.

Charles P. Fisher

President

Cambridge Records, Inc.

Wellesley, Mass.

It is regrettable that an occasional individual is unable to separate legitimate disagreement with a critic from personal insult and innuendo. Mr. Fisher categorically rates his company's recordings as "brilliant and important," and imputes my contrary opinion to "unwholesome motives," a "pattern of hostility," etc. (At least two other generally unfavorable reviews, by the way, have already appeared in reputable American publications.) In fact, I am always happy to see a new Handel recording, and would have much preferred to praise this one. My judgment was fairly made on the basis of a not inconsiderable musical experience. I began my training in one of the great opera houses in Europe, first in the orchestra, then as *répétiteur* rehearsing many of the great singers of that day, and I know something about singing. But though I called the *Tamerlano* production "a valiant effort... done with dedication," Mr. Fisher is resentful because I found DGG's *Giulio Cesare* a better executed job, so he throws the book at me. Apparently I have been thoroughly researched for past malfeasance: Mr. Fisher even read my book on Handel. Too bad that all he got out of 700 pages, besides a couple of quotes nicely lifted out of context, was a half-dozen obvious mechanical errors, already corrected for the next printing.

But all this is of little importance. What is really at issue is the profound dilemma that stands in the way of the revival of baroque opera: *Urtext* vs. the living theater. DGG faced it squarely; Cambridge took the easy way out. (Incidentally, it is rather small of Mr. Fisher to make snide remarks about the competing company just because they were favorably reviewed.) Leaving aside the vituperation, Mr. Fisher's sole argument against my advocacy of men for the castrato parts is that Handel himself substituted women when the pampered and expensive *evirati* were not available. He seems ignorant of the well-known fact that Handel was a ruthless impresario, willing to butcher his own scores for expediency. Since eighteenth-century operas were custom made for a particular theater and a particular group of singers, whenever the production shifted to another city radical changes were made based on practicality. Furthermore, since Handel was running an Italian opera house he never questioned the prevailing Italian conventions.



Paul Henry Lang

To the Italian public of his time only one thing mattered in opera: superlative singing, and it was willing to put up with every absurdity to get it. "Long live the little knife," the audience thundered when the castrato came through with a good performance. This could be tolerated in the usual Neapolitan type of opera, but the use of castratos and, even more, of female singers in male roles, becomes instantly untenable when the composer presents not faceless types but recognizable individuals, when he characterizes in music. Handel had the true dramatic instinct

“... the paper
tolerates more than
the ear.”

—and power—and though he unfortunately often bowed to the conventions, he did so only as to framework and technical means; his characters are not puppets. In Handel's oratorios, essentially operas but no longer governed by the rules of the *opera seria*, the use of the castrato or of women in men's roles is exceptional. Mr. Fisher's citing of Cherubino and Octavian in favor of his thesis only shows his innocence in matters of operatic dramaturgy. Cherubino is a youngster just past puberty (Strauss patently modeled his Octavian on Cherubino) and Mozart deliberately created this delicious borderline situation by giving the role to a mezzo. As to Gluck, he rewrote *Orfeo* for a tenor; that we stick to the Italian version (bowdlerized at that) just shows a similar lack of understanding.

Only two or three decades ago, almost no performer, conductor or producer would pay any attention to musicologists; we were trying to communicate our findings, but were ridiculed. (Sir Thomas Beecham made a real sport out of this.) Then musicology was discovered by the lay fraternity and taken even more solemnly and rigidly than by its professional practitioners. However, once the research has been done, the correct score and the ground rules for performance established, the scholar must yield to the performing artist. This is far more than a simple exchange of roles, for the historian deals with the past, the performer with the present; the paper tolerates much more than the ear. DGG has a pride of musicologists in its pay; unlike laymen, they understand that we can never exactly reconstruct, only approximate, this long-departed music. They know that intelligent adjustment is necessary, especially in the case of operatic music. The castrato both as an institution and as a stylistic norm is gone forever; we compromise willy-nilly. When a castrato role is allotted to a woman, far from remaining faithful to Handel's conception, we ruin it. We substitute for the castrato's white, neutral voice one that is warm, colorful, and *feminine*. The substitution of a tenor or a baritone is less false, and need not hurt the score at all. I reiterate that strict adherence to the *Urtext*, even where physically possible, is not the answer to the problems of the living theater. About the similarly misunderstood question of embellishments, some other time.

Paul Henry Lang

Oranienbaum 1882



New York City 1971

Igor Fyodorovitch Stravinsky

by John McClure

Director of Masterworks, Columbia Records

MAY 1966. After the final session of *Perséphone*, I drove Stravinsky home, small-talking our way along Sunset Boulevard, propelled by our fatigue and the vision of a Chivas Regal at the other end. During our ceremonial toasts and desultory plans for tying up the loose ends of the U.S. recording project which had occupied us for eight years, I became increasingly depressed.

He seemed so frail that by the time I left I was overwhelmingly convinced that I had seen him alive for the last time. As I drove slowly down Wetherly Drive tears forced me to pull over. So this was how it would end. I phoned my wife to share my feelings. I was inconsolable, and as a dozen meetings in the next four years proved, entirely mistaken.

However, this incident, melodramatic as it was, seemed a bellwether for our few remaining recording collaborations and marked roughly the beginning of the terrible roller-coaster years of strokes, recoveries, embolisms, hospitals, miraculous rallies, pneumonia, and the cruel fatigue and heartbreaking vigils that Vera Stravinsky and Robert Craft were to undergo.

These travails, signaling an end to our professional encounters in the studio, altered our relationship in other ways. Towering under me as he did by a full foot, the impact of his talent and personality was at times like a physical blow. By accepting me into the "family" he mitigated both my awe and the age gap of forty-seven years between us, thus making it possible for me to function.

Now all this was changed perforce. There was no professional or personal contribution I could make to deflect these crises. Each time he returned miraculously from death's border, a bit less man, a bit more myth, I would undergo another withdrawal exercise, progressively insulating myself from the real loss when it would finally come. In this sense, my private mourning has extended over the past three years.

But who is the public Stravinsky that we must now mourn ceremonially? Is he simply the sum of the parts? St. Petersburg. Rimsky-Korsakov. Diaghilev. Panache. *Firebird*. Paris. Picasso. *Petrushka*. Nijinsky. Cigarette holder. *Sacre*. Riot. *Histoire*. Neoclassicism. *Pulcinella*. Beret. *Symphony of Psalms*. Hollywood. Money. *Fan-*

tasia. Balanchine. *The Rake*. Robert Craft. Scotch. Schoenberg. Conversations. Serialism. Invective. Illness. *That Stravinsky?*

Or, Mr. Twentieth-Century Music. Acerb. Professional. Rich. Hot-tempered. Doctorphile. Conductorphobe: "What most people call interpretation, I call bad habits." Collector of prominent friends. Maker of famous enemies. Scourge of critics: "Music means nothing." Artificer of brittle neoclassic ballets: "I compose with a stopwatch." A facade as glinty and off-putting as Salvador Dali's. *That Stravinsky?*

Or, "Oh, yeah. *That Firebird* is pretty, but I can't stand that noisy piece he wrote for Walt Disney." *That Stravinsky?*

Yes, all those Stravinskys and many thousands more. Being public property, each person's Stravinsky will be mourned in his own way. Even the word "mourn" is perhaps inappropriate. Neither Stravinsky nor his two classmates at Seminal High School of Art, Class of 1910—James Joyce and Pablo Picasso—worked overly hard at leaving a mournable image. Lovability is OK for politicians and doomed young poets, but is not chic for avant-garde artists, steady in their orbits, thriving on rejection. These three giants dominating a half century of art were too engrossed in projecting new slides on our aesthetic scrim to concern themselves with positive PR for the man in the street.

More important than public grief, I.S. would emphasize, is for some of his less popular offspring to receive a fair hearing and the popularity that is their due. Why not the *Symphony in Three Movements*, *Oedipus*. *The Rake's Progress*, *Apollo*, *Requiem Canticles*? A slow public misled by slower critics. This would trigger the adrenalin, the flashing eyes, the deep voice. "Jone [sic], tell me please, has X ever looked at my violin concerto? I doubt he could even play it!" Annoying omissions and aggravations, but fortunately no lost sleep over his musical hegemony.

Now the ghost will be bobbing and weaving accusingly over my sleep like *Petrushka's* ghost, summoning hidden Stravinsky tears not shed. The last heartbreaking images of an active, avid intelligence trapped inside a racked and deteriorating body, communication gradually fading. Now the offspring will carry on. *Pace*.

AKAI products available

from JULY 1, 1971

AKAI has continued to supply for the past 20 years some of the world's highest quality audio-video products. It was AKAI that developed the world's first Cross-Field Head, the GX (glass and crystal ferrite) Head which is guaranteed for 150,000 hours of service life, and the world's lightest portable 1/4-inch tape video tape recorder.

These are the result of AKAI's extensive research, rich experience and ultra-precision processing techniques necessary for the assembly and manufacture of various components. See the following pages for some of AKAI's representative products.

Audio & Video
AKAI

AKAI AMERICA, LTD.
 2139 East Ciel Amo Boulevard/Compton,
 California 90220 (213) 537-3880

Manufacturer
AKAI ELECTRIC CO., LTD.
 P.O. Box 21, Tokyo International Airport, Japan



the GX generation

150,000 hours service life!
Dust free/Wear free/
Preeminent recording



GX-365D



GX-220D



GX-280D

AKAI's GX-365D, GX-280D and GX-220D have formed a new GX generation. All three decks boast the AKAI-developed GX (glass and crystal ferrite) Head which is the first of its kind in the world. In conventional heads, tape dust and wear greatly reduce sound quality. But our GX Head is "dust free", "wear free" and guaranteed for over 150,000 hours of service life! In case this head should become faulty before 150,000 hours of use, it will be replaced free of charge. AKAI engineers were successful in focusing the magnetic bias field of the GX Head so that the influence of the bias is drastically lessened. And greater frequency response was obtained because an ideal gap width and gap depth were developed and ultra-precision processing techniques were used in the manufacture of this head.

GX-365D Professional Stereo Tape Deck

Features 3 heads, world's only automatic continuous reverse (Reverse-O-Matic), sensing tape reverse, automatic volume control (Compute-O-Matic), magnetic brake, one hysteresis synchronous 3-speed motor for capstan drive and two eddy-current outer-rotor motors for supply and take-up reel drive, and automatic stop/shut off.

GX-280D Stereo Tape Deck

Features 3 heads, one 2-speed servo-control outer-rotor motor for direct capstan drive and two eddy-current outer-rotor motors for supply and take-up reel drive, sensing tape automatic continuous reverse, automatic stop/shut off, and pause button with lock. The two 7-inch reels can be completely covered with an optional plastic dust cover.

GX-220D Stereo Tape Deck

Features 3 heads, automatic continuous reverse with sensing tape, and 3 speeds. The two 7-inch reels can be completely covered with an optional plastic dust cover.

AKAI's GX-365, GX-280 and GX-220 Stereo Tape Recorders are also available.

Audio & Video

AKAI

AKAI AMERICA, LTD.
2139 East Del Amo Boulevard/Compton,
California 90220 (213) 537-3880

Manufacturer
AKAI ELECTRIC CO., LTD.
P. O. Box 21, Tokyo International Airport, Japan

AKAI products will be available in the U.S.A.
CIRCLE 3 ON READER-SERVICE CARD

from July 1, 1971

4channel/2channel

top choices for the new world of sound



1730 SS



1730 D-SS/AA-6100

An entirely new world of sound has been created by AKAI's electronics engineers who have developed a new and sophisticated line of 4-channel surround stereo equipment. Included in this line are the exciting **1730-SS 4-Channel/2-Channel Stereo Tape Recorder** and the **1730D-SS 4-Channel/2-Channel Stereo Tape Deck**. With either system, you're completely surrounded in sound with four speakers... left and right in front, and left and right in the rear. This system gives you a real "sense of presence", the feeling of being exactly in the middle of a live performance. Both models are designed to be used for not only 4-channel stereo but also 2-channel stereo as well.

The 1730-SS, equipped with four built-in pre-amplifiers, two built-in main amplifiers, and two monitor speakers, is designed for amazing versatility. It can be used not only as a complete 2-channel stereo tape recorder, but also as an exciting 4-channel stereo tape recorder by simply adding an extra pair of AKAI speakers to your existing 2-channel stereo amplifier/speaker system.

The 1730D-SS is perfectly matched with AKAI's exclusive **AA-6100 Solid State 4-Channel System Pre-Main Amplifier**. This amplifier has 80W music power for dynamic 4-channel stereo sound and accommodates both 4-channel and 2-channel stereo operation.

Cross over to 4-channel stereo and enjoy the multidimensional sounds no 2-channel system can ever achieve.

Audio & Video

AKAI

AKAI AMERICA, LTD.
2139 East Del Amo Boulevard/Compton,
California 90220 (213) 537-3880
Manufacturer
AKAI ELECTRIC CO., LTD.
P.O. Box 21, Tokyo International Airport, Japan

AKAI products will be available in the U.S.A.
CIRCLE 3 ON READER-SERVICE CARD

from July 1, 1971

revolutionary precision versatile



CR-80 D/CR-80 T



1-micron gap head
cartridge/
tuner combination



CS-50 D

Revolutionary... precision... versatile... these are the maxims that guide AKAI at all times in its quest for the best. No matter which AKAI product you choose, it's sure to be revolutionary, precision-made, and the best in its class.

CS-50D Cassette Stereo Tape Deck

This is a masterpiece, incorporating the world's first "INVERT-O-MATIC" mechanism which makes possible automatic reverse recording. This revolutionary cassette tape deck automatically stops after two full hours of hi-fi stereo recording with AKAI's C-120 cassette tape. The "INVERT-O-MATIC" mechanism also makes possible automatic continuous reverse playback for as long as you like. Instant manual reverse can also be effected.

CR-80D 8-Track Cartridge Stereo Tape Deck

This sensational cartridge tape deck puts you in the professional recording class. It boasts a precision-designed 1-micron gap head, for superb frequency response, that makes the difference between ordinary and highest quality performances. The CR-80D also incorporates

fast forward control, automatic stop, continuous play button, and many other outstanding features.

CR-80T 8-Track Cartridge Stereo Tape Recorder/Tuner

With this versatile tape recorder you can make direct recordings on cartridges from FM and AM broadcasts. It not only has a built-in tuner but also phono jacks for recording directly from turntables. And it can be used for a convenient public address system as well. The CR-80T also boasts a 1-micron gap head for extra wide frequency response, fast forward control, automatic stop control, and continuous play button.

AKAI's CS-50 Cassette Stereo Tape Recorder and CR-80 8-Track Cartridge Stereo Tape Recorder are also available.

Audio & Video

AKAI

AKAI AMERICA, LTD.
2139 East Del Amo Boulevard/Compton,
California 90220 (213) 537-3880
Manufacturer
AKAI ELECTRIC CO., LTD.
P. O. Box 21, Tokyo International Airport, Japan

AKAI products will be available in the U.S.A. **from July 1, 1971**
CIRCLE 3 ON READER-SERVICE CARD

24 hours

is recording continuous recording contin



X-330

AKAI's X-330 Stereo Tape Recorder is the ultimate for those who seek highest sound quality for long hours. This multi-purpose tape recorder incorporates precision-processed professional mechanisms of ultra-durability. The Cross-Field Head incorporated in the X-330 is AKAI's unique recording head that gives you true sound reproduction. This exclusive and world-patented head has created a sensation in the tape recorder world by offering one of the widest recording ranges available today. And high fidelity recording can be attained even at the very slow speed of 1-7/8 ips.

Our X-330 is strictly for the professionals. With the use of 10-1/2-inch reels, the maximum continuous recording time is 24 hours monaural and 12 hours stereo.

Continuous playback can be performed as long as you like with its automatic continuous reverse. This tape recorder also boasts sensing tape continuous reverse, manual reverse, 4 heads, 3 motors, 3 speeds, automatic stop/shut off, and magnetic brake. AKAI's X-330D Stereo Tape Deck is also available.

Other AKAI products incorporating its unique Cross-Field Head include the M-10 Stereo Tape Recorder and the X-200D Stereo Tape Deck. The M-10 features 3 heads, 3 motors, 3 speeds, automatic continuous reverse with sensing tape, manual reverse, automatic stop/shut off, and instant stop control. The X-200D features 3 heads, 3 motors, 3 speeds, automatic continuous reverse with sensing tape, manual reverse, auto-

matic stop/shut off, instant stop control, and solid state pre-amplifier with two integrated circuits.

Audio & Video

AKAI

AKAI AMERICA, LTD.
2139 East Del Amo Boulevard/Compton,
California 90220 (213) 537-3880

Manufacturer
AKAI ELECTRIC CO., LTD.
P.O. Box 21, Tokyo International Airport, Japan

AKAI products will be available in the U.S.A. **from July 1, 1971**

CIRCLE 3 ON READER-SERVICE CARD

...designed for audiophiles



AA-6300

AA-6600/AA-8500

SW-170A

AKAI offers amplifiers and speakers of uncompromising standards. If you're planning a high performance audio system, it'll be worth more than your time to look into AKAI's amplifiers and speakers designed for audiophiles.

AKAI's high performance AA-8500 Solid State AM/FM Multiplex Stereo Tuner Amplifier has a total music power of 240W and incorporates a field effect transistor and integrated circuits to assure high FM tuner performance. Pre and main amplifiers can be separated, enabling the use of multichannel amplifiers. Frequency response is 20 to 50,000Hz (-3dB) and S/N ratio is better than 80dB (Aux.).

The AA-6600 and AA-6300 Solid State AM/FM Multiplex Stereo Tuner Amplifiers are also designed for versatility and extra-sensitivity to produce the strength and delicacy of every pitch of sound when connected with your high quality audio equipment.

AKAI's numerous hi-fi stereo speaker systems are designed to fit different situations and appeal to different tastes. Shown on this page are three widely different systems. The SW-170A is a 5-way, 6-speaker system with a 15" linear travel piston edge woofer. The SW-125 is a 3-way, 3-speaker system with a 10" linear travel piston edge woofer. And the SW-35 is a "jet stream" speaker system which has a 5-1/4" flange speaker with a linear travel piston edge. The cabinet produces a "jet stream" flow of unbelievably clear bass sound equivalent to large-sized speaker systems. There's an AKAI speaker system for any need. Listen to our speaker systems at any of our authorized dealers. You'll quickly notice the difference.

Service and maintenance facilities are available in the U.S.A. Write to us for a list of AKAI service shops

I'm interested in AKAI's audio and video equipment. Please send me free literature. H.F.-7

Name _____

Title _____

Address _____

Phone _____

City _____

State _____ Zip _____

Audio & Video



AKAI AMERICA, LTD.
2139 East Del Amo Boulevard/Compton,
California 90220 (213) 537-3880

Manufacturer
AKAI ELECTRIC CO., LTD.
P.O. Box 21, Tokyo International Airport, Japan

AKAI products will be available in the U.S.A. from July 1, 1971
CIRCLE 3 ON READER-SERVICE CARD

speaking of records



A Singer's Choice by Christa Ludwig

LISTENING TO RECORDS is a problem for any musician who constantly jet-hops the continents. Only when I settle for a period of time in New York or Vienna do I have a chance to hear something other than my own voice and those of my colleagues in rehearsals and performances. Actually, I listen to vocal records only on very special occasions. For instance, I love to lie comfortably in a hot bath with Act III of *Tristan* on the phonograph—the live Bayreuth performance on Deutsche Grammophon (2713 001) with Karl Böhm conducting. The aging voice of Wolfgang Windgassen is so right for the music of *Tristan* in his dying moments—so incredibly poignant and beautiful.

Not long ago I happened to hear a recording of Wagner's *Wesendank* Lieder on the radio, but I didn't know who was singing. After the performance I learned that it was Marilyn Horne who gave such wonderful meaning to the words through her pronunciation and phrasing (London OS 26147). I sing this music, so I know. Also I am dazzled by her "*Mira, o Norma*" with Joan Sutherland in London's complete *Norma* recording (OSA 1394). Although these nineteenth-century Italian operas are not part of my tradition, I do love the first Callas *Norma* (Seraphim IC 6037, mono), especially her "*Casta diva*." And when I was pregnant I listened only to her *Tosca* (Angel 3508, mono)—don't ask me why!

Of the older singers, I have long admired Frida Leider's singing of Donna Anna's vengeance aria, "*Or sai chi l'onore*" from *Don Giovanni* (Eterna 745, mono) and Rosa Ponselle on the now deleted Camden "Art of Rosa Ponselle" or the Victrola recital reissue with arias from *Norma*, *Aida*, etc. (VIC 1507, mono). She is a real paradigm for singers, so healthy was her technique and vocal sound. When I prepare to sing Bizet's *Carmen*, my inspiration is always the incomparable Conchita Supervia, whose Odeon disc of *Carmen* excerpts is unfortunately now unavailable.

One of the most remarkable Lieder interpretations I have ever heard is Elisabeth Schwarzkopf's *Gretchen am Spinnrade* (Angel 35022, mono): here she seems as if she were hypnotized by a snake. There are so many other great recordings: Hans Hotter's unforgettable *Winterreise* cycle of Schubert (Seraphim IC 6051, mono), Dietrich Fischer-Dieskau's special way with *In der Fremde* from Schumann's *Liederkreis* (Angel S 36266), and an old 78 I have of Elisabeth Schumann singing Schubert's *Der Nussbaum*. As for my own records, I enjoy recording and the possibility of repeating a passage until it is the way I want it. Although I never find much time to listen to myself, I do like the disc of Strauss duets with Walter [Berry] on Victrola VICS 1269—perhaps because I don't sing the role of Elektra and we did the Recognition Scene. I can't go to that opera because I cry from beginning to end.

In the orchestra repertory, I would say that my tastes reflect my German-Austrian background, for more than anything I love all the Beethoven and Bruckner symphonies—despite a recent article in *Der Spiegel* chastising us for using Beethoven as a substitute for church! When I come home after a mediocre Beethoven concert, I immediately run to my shelves and dig out Furtwängler's *Eroica* or Fifth Symphony (both available on Seraphim IC 6018, mono, with the Seventh). I also have the nine symphonies conducted by Toscanini with the NBC Symphony (Victrola VIC 8000, mono), because the contrast with Furtwängler in temperament and tempos is extraordinary.

Bruckner opens the heavens to me. His orchestra was made for stereo—yet this music also impresses me by its simplicity. For the Bruckner Eighth and Ninth Symphonies I prefer Herbert von Karajan's interpretations with the Berlin Philharmonic (Angel S 3576 and DGG 139011)—while I also have Klemperer's recordings of the Fourth, Fifth, Sixth, and

Seventh (Angel S 36245, S 3709, S 36271, and S 3626, respectively). I am also eagerly awaiting Karl Böhm's recording of the entire nine which is due to appear on DGG before long. Brahms is a problem for me and I have not yet found the key: he is complicated and the symphonies confuse me. But for his beautiful, ethereal *Deutsches Requiem* I will again choose Karajan on DGG (2707 018) with Gundula Janowitz, Eberhard Wächter, and the Berlin Philharmonic. Bach has only recently come into my life. When I studied the piano, I hated Bach and for years I did not listen to any of his music. Then I began to sing his oratorios and passions. I now love Bach, particularly the unaccompanied works—for instance, Nathan Milstein's performance of the chaconne from his deleted Capitol recording of the Partita No. 2 and the solo cello suites by Janos Starker on Mercury (SR 3 9016).

As for pianists, my heroes are Dinu Lipatti and Vladimir Horowitz, especially the latter in that brilliant performance of the Tchaikovsky First Piano Concerto with Toscanini (Victor LM 2319, mono)—it is also very rewarding to compare this fiery reading with the more stately version of Sviatoslav Richter and Karajan (DGG 138822). Also I could not be without Horowitz' unforgettable *Pictures at an Exhibition* from his Carnegie Hall recital (RCA Red Seal LM 2357, mono). There are several recordings by Lipatti which have a valued place in my library, including his Chopin waltzes (*Odyssey* 32 16 0058) and his Bach/Mozart/Schubert/Chopin last recital on Angel 3556, mono.

In the area of contemporary music I am drawn to György Ligeti, who I think is the successor to Bartók—and particularly to his *Atmosphères* as conducted by Bernstein with the New York Philharmonic on Columbia (MS 6733). Just recently I bought a recording for my son, Wolfgang, of the soundtrack from *2001: A Space Odyssey* (MGM S 1E13ST)—it's quite a heady experience to leap from Ligeti to Richard Strauss's mighty *Also sprach Zarathustra* and then to Johann Strauss's *Blue Danube*.

On my nonclassical shelves I have everything from Eileen Farrell's *I've Got a Right to Sing the Blues* to Sammy Davis singing *I've Gotta Be Me* and some Streisand albums. And I'm crazy about Danny Kaye's children's songs, particularly *Mommy, Gimme a Drink of Water* and *I Love Old People*—probably because I can listen to them with my son. We also have a recording of *What is Jazz?* with Bernstein—no longer in Columbia's catalogue, but one of Wolfi's favorites. Bernstein explains that to be a blues singer you must sing a little bit flat. Once when Wolfi and I were at a concert given by another singer, he whispered to me, "She would be a great blues singer." ●



too hot to handle

I have bought a Shure V-15 Type II Improved pickup, but your review [May 1970] says it will only perform up to design specs with "a shunted capacitance of 400 to 500 pF," which may or may not be provided by the leads and the preamp. How can a neophyte—and there are many of us—determine the capacitance of the cartridge leads and associated preamp circuitry? And how would you add compensation?—Harry J. DeLaney, Ottawa, Canada.

It's very difficult to determine the capacitance you've already got. The leads from tone arm to preamplifier generally run about 200 pF—less on an arm like the SME, which has relatively short, low-capacitance cables, and sometimes higher on inexpensive equipment using cheap cable. Shure tells us that the input capacitances of preamps they have checked in this respect vary around a median value of about 100 pF. So chances are that a typical system will run just a little shy of the ideal 450-pF figure. The difference probably won't be audible, so most users simply don't worry about it. If you're a worrier, you could write to the manufacturers of both your arm or turntable system and your preamp or receiver in the hope that they can supply capacitance figures. (On the preamp, particularly, you may be out of luck.) Let's say the two figures add up to only 150 pF. You would then want to add 300-pF capacitors between hot and ground leads in each channel to obtain an ideal match. The easiest place to do this usually is at the terminals where the separate wires from the arm are connected to the shielded cables that carry the signal on to the preamp. Incidentally discussions such as this may become academic before long. Until recently the input capacitance of preamps was of little importance; but the new super-compliant pickups are making it more critical and Shure is not alone in designing for the 400-to-500-pF input capacitance range. Consequently preamp manufacturers have every reason to design circuitry accordingly so that the electronics will make the most of state-of-the-art pickups.

When KFAC in Los Angeles broadcast a trial run of quadraphonic sound they wrote and talked about it as though the desired result was to make you sit right in the middle of the orchestra—instead of the middle of the hall, the basic idea of four-channel sound as I understood it. I wrote the station about this big difference and got a reply saying, "As described by the manufacturers of four-channel tape material (RCA and Vanguard), their microphone placement was such as to create the effect of the listener being in the middle of the orchestra. (Surround Sound is the

Vanguard trademark for their process.) We, therefore, followed the same procedure on the placement of our microphones at the Museum for the Roger Wagner live portion." Is this right? Who wants to listen as if he were in the middle of the orchestra?—W. R. Augur, Claremont, Calif.

Your correspondent of KFAC either hasn't read the literature carefully, or he's oversimplifying in order to give you a quick and easy answer. You're right in believing that the original thrust of four-channel sound was toward the re-creation of hall sound or "ambiance" rather than the musician's-ear perspective implied by KFAC. Even Vanguard's original description of Surround Sound hinged on the capturing of the reverberant field within the concert hall and the reproduction of its acoustics in the home. But some of the tapes in the initial Vanguard release (particularly the Buffy Sainte-Marie) took a much less "natural" approach and laid the groundwork for the surround-and-conquer technique that has become all but standard in subsequent four-channel releases, which tend to make basic program information come from all sides of the listener. This plan may be appropriate for rock music, for example, but not, we agree, for most concert fare. The impetus behind most of the recent quadraphonic recordings seems to be a swelling desire to demonstrate that sounds can be placed wherever the producer wants them.

I have a Scott LT-112B tuner, which I built from the kit. Some of the more distant stations I would like to receive sound excessively noisy when I listen in stereo, though the sound is fine in mono. I've checked the tuner's alignment, using the built-in meter and following the procedures specified in the manual, but without improvement. Do I need a bench alignment, an adjustment elsewhere in the circuit, or a new tuner?—William G. Styn, Wheaton, Md. With one sample of our acquaintance, the LT-112B came in at about 2.5 microvolts sensitivity when aligned by its builder using only the front-panel meter. A bench alignment subsequently improved the figure to about 2 microvolts: not a big change, but enough to show that bench alignment can do a better job. And assuming no malfunction elsewhere, these figures demonstrate that buying a new tuner probably won't net you much, if any, gain in sensitivity. Try borrowing a new unit with a good sensitivity rating and using it in your system. If it improves significantly your LT-112B probably needs a trip to the repair shop. Weak stations become noisier when you switch to stereo on any tuner of course; the difference is intrinsic to the stereo broadcast process. So if you want quieter reception of

these broadcasts, the logical point of attack might be your antenna, about which you say nothing. If you have one of the garden-variety jobs we'd suggest a high-gain model with a rotator.

I seldom see anything about the EVR (photographic) and SelectaVision (holographic) home video cartridges in your magazine any more. How come?—Richard Witolski, Port Chester, N.Y.

EVR costs have inched upward since its initial announcement by CBS and it appears to have priced itself out of the home market for the moment. Recent publicity from CBS—aimed at the education market—seems to support this view. RCA apparently has run into unforeseen technical problems with its proposed holographic system; it now says that the name SelectaVision may be used to cover any audio/visual system that RCA adopts for marketing and that the holographic system per se is probably at least five years away in terms of marketability.

Being in Viet Nam I have run across many new names in stereo equipment—particularly Akai and Dokorder. I haven't read anything in your magazine concerning these companies. How can I find out about the reliability of their products?—Sgt. E. Pinto, Jr., APO, San Francisco, Calif.

At present only by reading reports published in those areas (including Europe) where the products are sold. Very soon, however, the full line of Akai products is expected to be in the U.S. now that the company has set up American offices, and we undoubtedly will begin to review them here.

Why do stereo equipment manufacturers persist in power operating requirements of 117 volts when residential electric power is supplied at 110 volts? Won't the deficiency in the supply harm the equipment—or at least compromise its performance?—D. R. Williamson, Chester, Pa.

You're being too literal, D. R. House current is nominally standardized at 120 volts, although it can and does vary from time to time and from place to place. Designations of 110, 115, 117, and so on are intended only to distinguish a unit's power requirements from radically different supplies—the 220 volts (also nominal) used for electric stoves and similar utility circuits for example. If supply voltage is critical for an intended use—say, in X-ray work or photographic color printing—voltage regulation must be built into the equipment. But it is not critical in stereo components: even the induction motors in many record changers and tape recorders should suffer only modest speed changes from a rise or drop of 5 volts or so in the supply. Don't worry about it.

AR[®], JBL[®], Altec-Lansing[®], Bozak[®] lovers take heart...

there's a Heathkit[®] Speaker made just for you.



(A) New AS-103... the highly praised AR-3a in low cost kit form. Uses the three Acoustic Research AR-3a drivers in a sealed acoustic suspension enclosure. 12" woofer provides crisp, clean bass down to the limits of hearing... special hemispherical dome midrange & tweeter, combined with a precisely-engineered crossover network, deliver the clean, transparent AR sound. Separate level controls for midrange & tweeter. 4 ohms. Luxurious oiled walnut cabinet 25" H x 14" W x 11 $\frac{3}{4}$ " D. 68 lbs. **\$189.95***

(B) New AS-102... an outstanding 3-way system with famous Bozak speakers. A 12" woofer, 6" midrange and two 2 $\frac{1}{2}$ " tweeters in an infinite baffle design offer clean, natural response to well beyond audibility on both ends of the audio spectrum. An 8 ohm, medium efficiency system; handles up to 50 watts. Complete with a beautifully designed and finished factory assembled Mediterranean cabinet... measures 29 $\frac{5}{8}$ " H x 27 $\frac{3}{4}$ " W x 19 $\frac{7}{8}$ " D. Finished in pecan veneers & hardwoods. 114 lbs. **\$259.95***

(C) Heath AS-48... featuring custom-designed JBL speakers. Two custom-designed JBL speakers in a classic, one-piece pecan finish damped reflex, tube-ported cabinet deliver extraordinary bookshelf performance. Special 14" woofer delivers crisp, pure bass you can feel as well as hear; clean, lifelike highs come from the 2" JBL direct radiator. Three-position high frequency level control. 8 ohms. Handles up to 50 watts. Measures 14" H x 23 $\frac{1}{2}$ " W x 12" D. 57 lbs. **\$184.95***

(D) Heath AS-38... a medium-priced, efficient system with famous JBL speakers. The 12" JBL woofer produces rich, full-bodied bass down to the limits of hearing; 2" direct radiator tweeter delivers clean, natural highs to beyond audibility. Handles up to 40 watts program material. 8 ohms. High frequency level control. Assembled, air-tight walnut veneer cabinet, damped reflex, tube-ported. Measures 14" H x 23 $\frac{1}{2}$ " W x 11 $\frac{3}{4}$ " D. 49 lbs. **\$154.95***

(E) New Heath AS-101... a superb 2-way system with Altec-Lansing speakers. A remarkable 2-way bass reflex system incorporating a high compliance 15" woofer and high frequency sectoral horn to bring you extremely faithful reproduction throughout the audio range. A high efficiency 8 ohm system capable of handling up to 50 watts. High frequency level control. Luxurious Mediterranean styled cabinet measures 29 $\frac{5}{8}$ " H x 27 $\frac{3}{4}$ " W x 19 $\frac{7}{8}$ " D; finished in rich pecan veneers and hardwoods. 128 lbs. **\$259.95***

HEATH COMPANY, Dept. 8-7 Benton Harbor, Michigan 49022		 <small>a Schlumberger Company</small>
<input type="checkbox"/> Enclosed is \$_____ , plus shipping.		
Please send model (s) _____		
<input type="checkbox"/> Please send FREE Heathkit Catalog.		<input type="checkbox"/> Please send Credit Application.
Name _____		
Address _____		
City _____ State _____ Zip _____		
*Mail order prices; F.O.B. factory. Prices & specifications subject to change without notice. HF-247		

CIRCLE 24 ON READER-SERVICE CARD

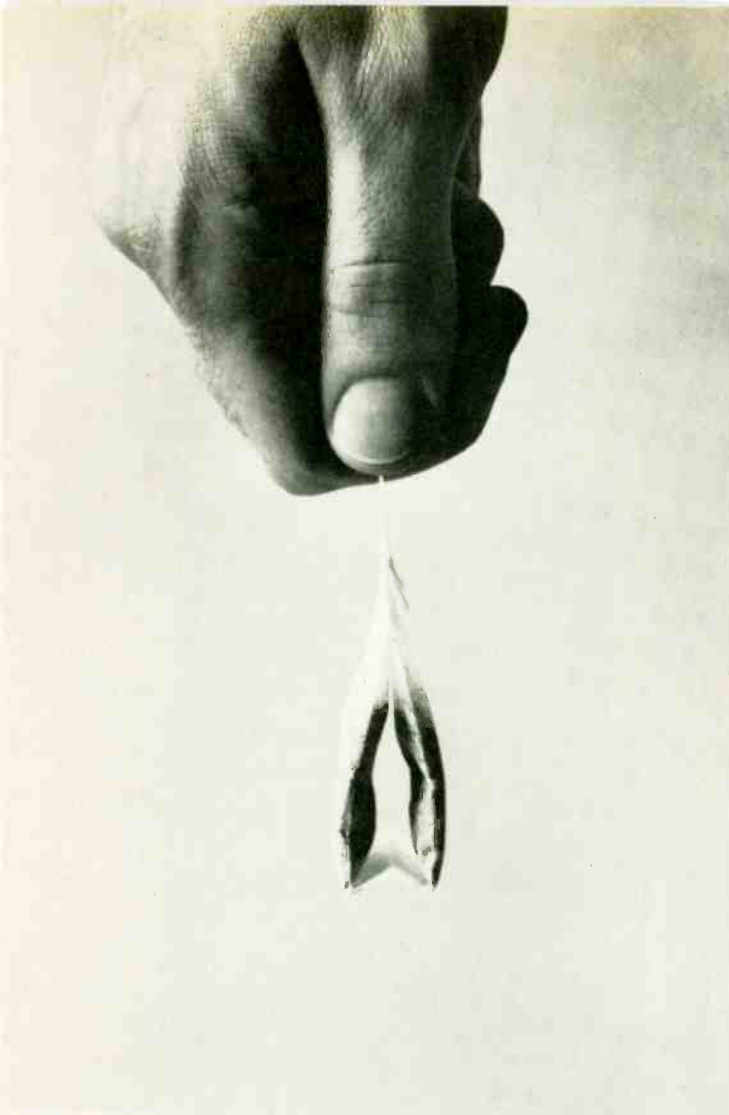

Our new receiver incorporates an advanced engineering concept made famous by a leading tea bag.

Not long ago, the tea people demonstrated that it was possible to increase the performance of a tea bag simply by changing its fundamental structure.

A similar approach has given birth to a whole new line of stereo receivers, the first of which is here now: the Harman-Kardon 930.

The 930 is the first receiver ever built with twin power. Unlike every other receiver, it has two separate power supplies—two separate transformers, two separate rectifier circuits and two separate filter sections.

To really appreciate what this means, you have to hear it in action.

Let's say you're listening to an orchestra through a conventional receiver. Suddenly a stirring bass passage comes along—a protracted organ chord for example.

To reproduce all that bass, a huge amount of electrical power is required. In conventional stereo receivers, both amplifiers pull that power from a common source. The amplifiers begin struggling for whatever they can get. The result is a loss in *acoustical* power—and a debilitating interaction between the two amplifiers.

This can't happen with the 930. The demand for power is just as frantic. But the amplifiers, each with its own power source, have no trouble meeting these demands. Each supplies the needed power without affecting the other. No fuzziness or veiled effect.

The result is virtually distortionless sound—not just at 1,000 Hz, where even ordinary receivers do fairly well, but throughout the entire frequency spectrum. Total harmonic distortion remains below 0.5% from 20 Hz to 20,000 Hz (at full rated output, 45/45 watts RMS, both channels driven simultaneously into 8 ohms). The distortion curve isn't a curve. You can draw it with a straight edge.

Because of twin power, the 930 offers remarkable square wave response: less than 5% tilt at 20 Hz; rise time is less than 2 microseconds.

But there's more to a receiver than amplifiers and power sources. The 930 also offers a tuner every bit as sophisticated as the rest of the system—and quite a few other things we'd like to tell you about.

Write to us and we will: Harman-Kardon, Inc., 55 Ames Court, Plainview, New York 11803. **The Harman-Kardon 930.**

The first receiver with twin power.

harman kardon

A subsidiary of Jervis Corporation



4-channel sound

Stereo-4: The Box Score

Electro-Voice has released some facts and figures to document the acceptance of its Stereo-4 compatible 2/4-channel sound process now that the E-V Model 7445 encoder has become available. The way things go these days, the figures are sure to be out of date by the time you read them; but they illustrate the rapidity with which Stereo-4 is making itself felt—or rather heard.

To begin with, E-V lists twenty-six FM stations broadcasting Stereo-4 sound:

California: KBIG-FM, Los Angeles
KMET, Los Angeles
KPEN, Mountain View
KSAN, San Francisco
KVEZ, San Mateo
Colorado: KLIR-FM, Denver
District of Columbia: WASH, Washington
Florida: WPEX-FM, Pensacola
Illinois: WCLR, Chicago
WFMT, Chicago
Massachusetts: WCRB-FM, Waltham

Michigan: WKNR-FM, Dearborn
Minnesota: WLOL-FM, Minneapolis
Missouri: KMBR-FM, Kansas City
New Jersey: WDHA-FM, Dover
New York: WNEW-FM, New York
WNYC-FM, New York
WRFM, New York
WZOW-FM, Utica
Ohio: WHFD, Archbold
Texas: KWXI, Fort Worth
Tennessee: WLAC, Nashville
Utah: KSL-FM, Salt Lake City
Virginia: WRNL-FM, Richmond
WBCI, Williamsburg
Washington: KIRO-FM, Seattle

Then there are the recording studios presently set up with the encoding equipment: four of them in New York City and one each in Chicago and Hollywood. And there are five record labels already producing Stereo-4 discs for the consumer market: Crest, Crewe, Ovation, Project 3, and Radnor.

Tape Duplication: A Hot New Process?

Tape, we are told by those who make it, is the medium of the future. Well and good; but as sales figures prove, we haven't stopped buying discs just because pre-recorded tapes are available. Cost is a major reason. Consistency of the finished product is another.

One LP per minute is considered a pretty poor output even for a manual press these days, and the records it produces are virtually identical. In tape duplication an average production rate of one copy a minute would be considered excellent in most cases, but that might require making a dozen or more copies simultaneously. And with that many "slave" units to co-ordinate, maintain, and feed, it's easy to overlook a level that's a few dB too high here, or an excessive number of dropouts there. Unlike records, tapes don't lend themselves to visual inspection.

The search for alternative, more efficient methods of tape duplication has been going on since the advent of prerecorded tapes some twenty years ago. The simplest expedient—increasing transport speed—entails extra problems of equalization (made even more complex if the copy is to be Dolbyized) and of bandwidth in the electronics and heads of the system. If only some system could be devised comparable to the high-speed printing of movie film—that is, one in which the content is transferred directly, without intervening signal recovery and re-recording. *(Continued on page 34)*



Present (perhaps temporary?) state of the art: Ampex says this \$10,000 stereo cassette duplication system, which drives both master and copies at 75 inches per second, is "five times faster than any previous cassette duplicator."

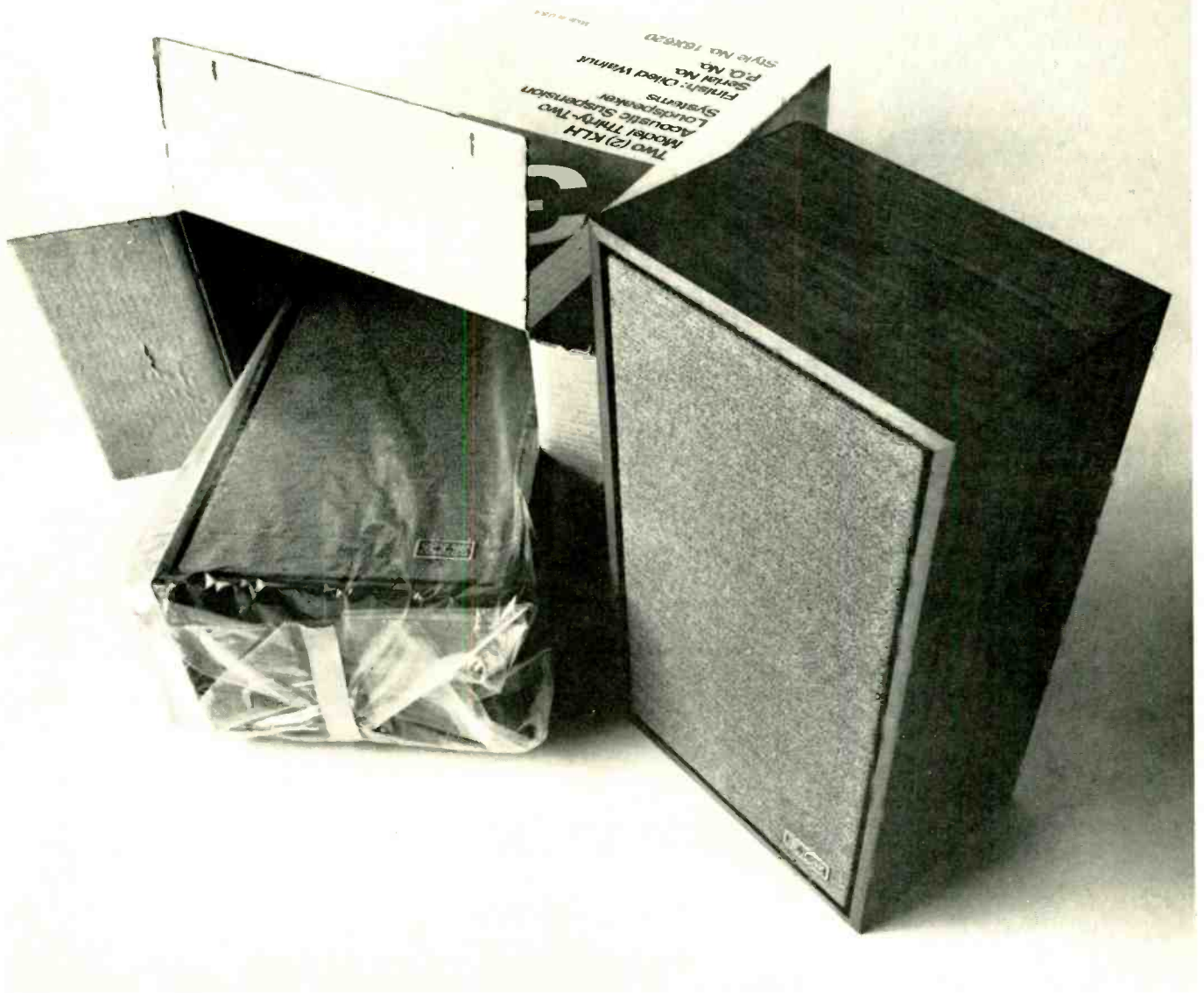

The \$95 Misunderstanding.

It seems there's been some confusion about the price that appeared in our first ad for the new KLH Model Thirty-Two loudspeakers. To clear up any misunderstanding, the price is, indeed, \$95 the pair (\$47.50 each).†

If you're wondering how we could make a KLH loudspeaker for \$47.50, it's really quite simple.

We had two choices.

Either we could make a fair speaker and a lot of profit. Or we could make a lot of speaker and a fair profit.

We chose the latter. We always do. That's why KLH speakers sound like KLH speakers.

Of course our Model Thirty-Two won't deliver as

much bass response as, say, our Model Seventeen. But the basic listening quality of the new KLH Thirty-Two is superb by any standard. In fact, we'll match the Thirty-Two against any speaker in its price class: even against most speakers costing twice its price. For when it comes to making reasonably-priced speakers that deliver an inordinate amount of sound, that's really what KLH is all about.

And about that, there can be no misunderstanding.

For more information on the Model Thirty-Two, write to KLH Research and Development, 30 Cross St., Cambridge, Mass. 02139. Or visit your KLH dealer.

†Suggested retail price. Slightly higher in the west.
*A trademark of The Singer Company

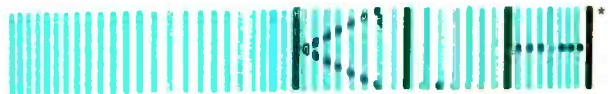

KLH RESEARCH AND DEVELOPMENT
A Division of The Singer Company

Well, Du Pont has developed such a system for use with Crolyn tapes; and other, apparently comparable, systems are in the works. The Du Pont process relies on the "Curie temperature" of the magnetic coating—the temperature at which the coating loses its ability to retain magnetization much the way that ice loses its physical shape when it is warmed above the melting point.

A blank tape, heated above its Curie point, is brought in physical contact with a master tape and then cooled rapidly. (The master tape will suffer erasure only if its own temperature is allowed to creep up close to the Curie point.) The heated copy will assume the magnetic pattern of the master with which it is in contact, and the cooling "freezes" this pattern, making a permanent copy—barring subsequent erasure of course.

Since the duplication speed is basically unrelated to playback speed—it can take place at any rate the heating and cooling equipment can manage—the process makes a strong bid to break what has been a major barrier to the promised ascendancy of tape.

Harry and the Pirates

The Harry Fox Agency has been conducting a notably successful campaign on behalf of its music-publisher clients to bring suit against record pirates who have been absconding with hit tunes and producing copies, royalty-free, on the QT. Big profits can be made from such pirated editions. Aside from the royalties, the purveyors don't have to worry about original studio costs—easily in five figures for a present-day LP.

We were aware that piracy was a widespread abuse, of course; but we were not prepared for a recent statement by Albert Berman of the Fox Agency: "Bootleg recordings unbelievably now account for more than one third of the sales of recordings in the U.S. and produce illegitimate revenue into the hundreds of millions of dollars."

The report in which this statement appears goes into the details of one operation that the courts, following a Fox suit, have closed down. It reads like a scenario for *The Avengers*. Contacts with local dealers were handled by answering services and shipments were made by commercial airlines to avoid all person-to-person contact in the distribution process. (Remember what Mr. Steed must go through to find the *real* big boss?)

The description of the "home office" is particularly striking: "The Phoenix operation, doing business as the National Manufacturing Company, was located in a 17,200-square-foot modern facility in an industrial park. Private investigation had revealed that the plant previously had been located in lower California, but had moved to Phoenix when its location was uncovered . . . Five U.S. marshals confiscated the entire operation, which included approximately 150,000 tape cartridges, 17 winding machines, duplicating equipment, wrapping and labeling machines, and numerous other equipment. The highly organized plant had special areas for office work, maintenance, testing, quality control, labeling, shipping, and receiving—and even a kitchen and lounge area for the employees. It is estimated that the plant employed approximately 100 people in around-the-clock shifts."

No wonder the legitimate companies sometimes find it tough sailing.

equipment in the news

Digital tuner from SAE



In the new stereo FM tuner from Scientific Audio Electronics (better known as SAE) of Los Angeles, the stations are tuned in the usual way, using a rotating knob, but the tuned frequency appears on numerical display tubes via a crystal-controlled reference circuit. A miniature oscilloscope, rather than a meter, is used as a tuning aid, and it can be switched to show the radio-frequency signal (for center tuning, assessment of multipath interference, etc.), the audio output (for instance, to evaluate stereo separation), or an audio input from your preamp or tape recorder (for similar evaluation of non-FM signals). When the display selector is set to "audio" the scope will show output until the tuning knob is touched; then it will switch automatically to the RF as a tuning aid until the knob is released. The tuner costs \$950; its walnut case, \$30.

CIRCLE 147 ON READER-SERVICE CARD

Koss's Mephistophelian headphone

It's called the Red Devil, its model number is KRD-711, and it costs \$49.95. It's the newest Koss dynamic stereo headset, a lightweight (12-ounce) model with a 10-foot coiled cord and single-piece headband molded of flexible red polypropylene. The earpiece enclosures, too, are red—very red. That explains part of the name; as for the "Devil," that seems to be just for . . . well, just for the heck of it.

CIRCLE 148 ON READER-SERVICE CARD



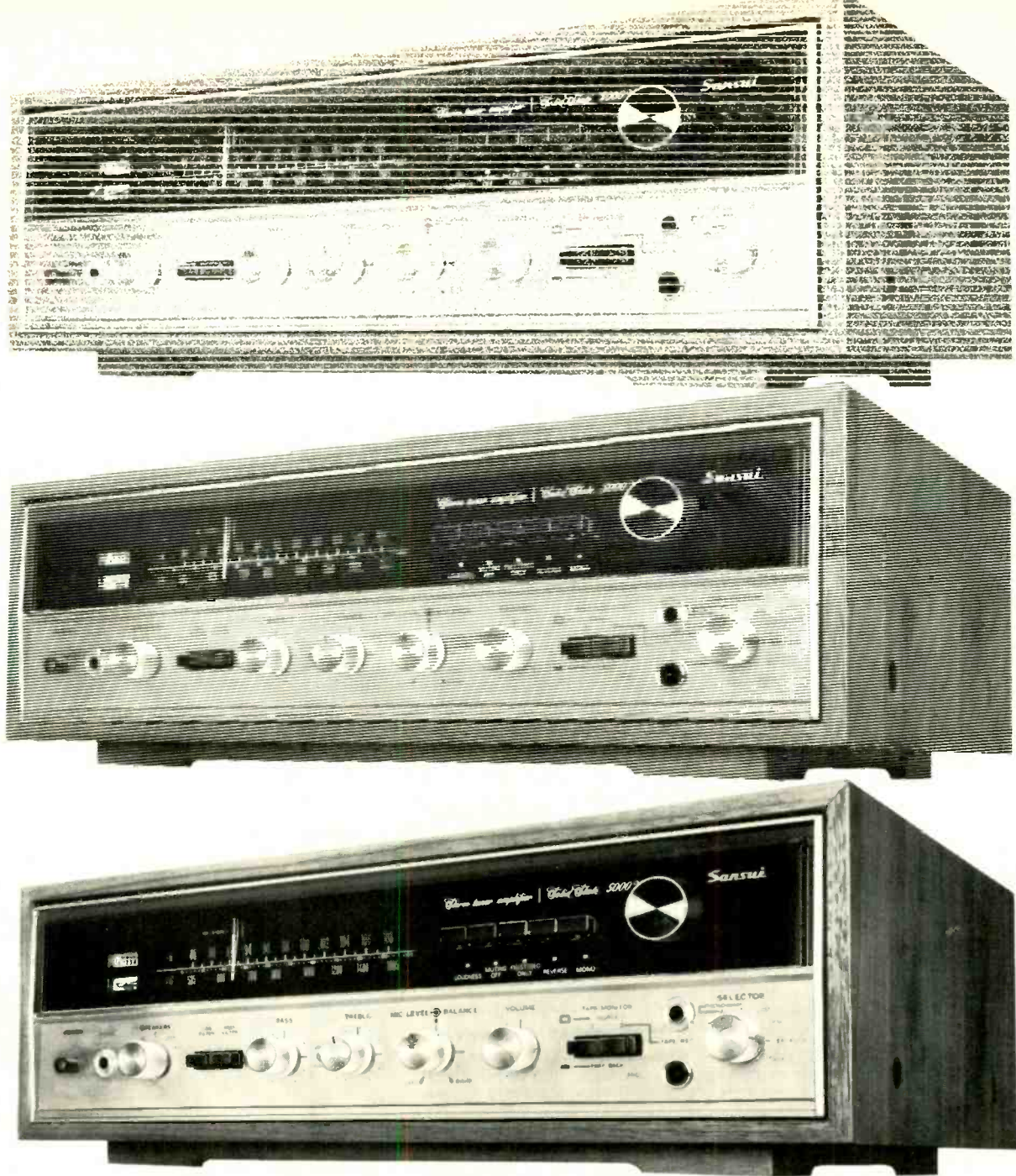

IF YOU RECOGNIZE THE LOOKS, YOU KNOW THE QUALITY

Sansui 5000 X AM/FM Multiplex Receiver

If you immediately think, "That's a Sansui", when you spot the distinctive styling, you know enough to assume it will also have sumptuous sound, velvety operating feel, fabulous specifications and deluxe features to match. And you're absolutely right.

Continuous power is 60 watts per channel at 8 ohms, by our own tough standard (or 200 watts of IHF music power). At a total harmonic distortion below 0.5%, not "under 1%." With IHF power bandwidth of 15 to 30,000 hz, not 20 to 20,000. FM sensitivity is 1.8 μ v IHF—and the sensitivity curve bends sharply beyond that point for real pickup power.

It's got a microphone input with its own control for blending in live voice and instrumental performance with disc, broadcast, tape or any other input. Tape in/out facilities for up to four decks. Exclusive stereo-only FM mode. Linear-tuning FM dial. Separable pre- and power amplifiers. Foolproof pushbutton speaker connectors . . . to mention just a few features. Of course it's a Sansui . . . \$399.95



SANSUI ELECTRONICS CORP.

Woodside, New York 11377 • Gardena, California 90274

SANSUI ELECTRIC CO., LTD., Tokyo, Japan • Sansui Audio Europe S. A., Antwerp, Belgium

CIRCLE 39 ON READER-SERVICE CARD

Power amplifier from Marantz

The Marantz Model 250 is designed to replace the Model 16, adding extra power and features at no additional cost, according to Super-scope (parent company of Marantz). The new model is rated at 125 watts continuous power per channel. Output level meters are switchable for two sensitivity ranges. The unit sells for \$495.

CIRCLE 150 ON READER-SERVICE CARD



Concord deck has bias switch, auto stop

The new Concord F-106E stereo cassette deck not only stops at the end of the cassette side, but disengages the drive mechanism—eliminating both tape tension and “flats” on the pinch roller due to capstan pressure when both are stationary. At the same time, push-buttons return automatically to the stop position, and a signal light indicates that the tape has run out. The bias switch adapts recording characteristics for either standard or the new “high-density” iron-oxide cassette tapes. Other features include pause control, noise filter, headphone monitoring, and VU meters. The F-106EB deck, supplied with patch cords, costs \$99.79; the F-106E, which also includes a remote-control switch, microphone, and one cassette, sells for \$119.79.

CIRCLE 149 ON READER-SERVICE CARD



New top integrated amp from Kenwood

Kenwood's KA-7002 amp, rated at 50 watts per channel continuous output power into 8-ohm loads, has a number of interesting features. One of the two phono inputs is switchable for extra-low-level cartridges (down to 0.06 mV). There are also two aux inputs and complete connections and switching for two tape decks. The tone-control system, in addition to the usual gain-or-loss treble and bass knobs, includes three-way switches providing two turnover points plus defeat for each. There is a null balance switch for setting channel balance exactly and switching for up to two pairs of speakers at a time out of a total of three pairs that may be connected to the set. Preamp out and main-amp in connections allow the unit to be used with special controls or in multi-amp systems. The KA-7002 costs \$299.95.

CIRCLE 153 ON READER-SERVICE CARD



Roberts glass-head reversing deck

The new Roberts GH-500D is an open-reel deck with automatic reverse in the playback mode. The erase head is conventional; record and playback heads are a new crystal ferrite and glass type. The new heads, described by Roberts as “virtually indestructible” because of their glass surfaces, employ a narrow gap with a “focused field.” Other features include an automatic level control system, magnetic braking, a pause/edit button with a remote control release, three-speed synchronous capstan motor, plus special facilities like input mixing and sound-on-sound. The GH-500D costs \$699.95.

CIRCLE 151 ON READER-SERVICE CARD

ZERO 100 is the newest, most advanced automatic turntable. The name stands for Zero Tracking Error—up to 160 times less than with any conventional tone arm—new freedom from distortion—new life for your records. This revolutionary Garrard unit, priced at \$189.50, was introduced with a special presentation booklet, bound into the June issue of this magazine. There are 12 explanatory pages, with clear illustrations and diagrams, valuable to anyone interested in fine record playing equipment. If you missed the insert last month, or would like a better copy, we'll be glad to send you one. The coupon is for your convenience.

CUT OUT AND MAIL



British Industries Company
Dept. AG271
Westbury, N. Y. 11590

Gentlemen: Please send me the Garrard Zero 100 presentation booklet.

Name _____

Address _____

City _____

State _____ Zip _____

British Industries Company, a division of Avnet, Inc.

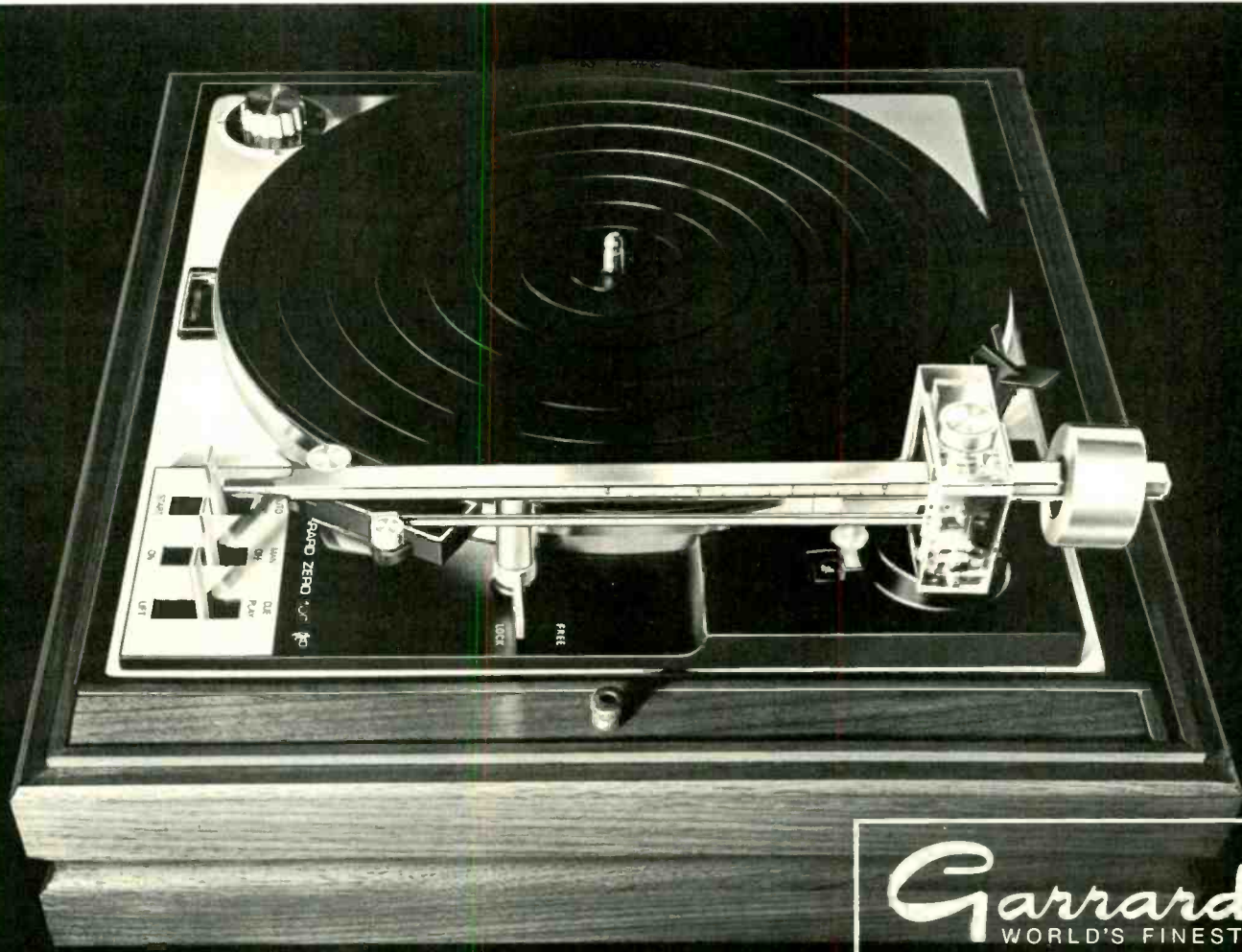

Garrard®

WORLD'S FINEST

Mfg. by Plessey Ltd.
Dist. by British Industries Co.

How high

From \$50*



SR-RF935—FM/Multiplex Converter Converts your AM car radio to an AM/FM multiplex radio in minutes. Automatic stereo switching. FM beacon light, tone and volume control to blend stereo broadcasting to perfection. Easily mounted under dash or almost anywhere in your car.



TU-108—AM/FM Multiplex Tuner Black-out dial, Vu meter, flywheel tuning. Stereo indicator light. AM antenna inside walnut-finished wood cabinet. Matching tuner for PM-158 and PM-403 amplifiers.



SR-207—Budget-priced Stereo Receiver 30 watts (IHF) power. FM sensitivity: 2.5 uV. Pre-amped for magnetic cartridge. Taps for X'tal phono, tape in/out.



PM-158 Amplifier Ideal for all uses. 20 watts music power (IHF). Pre-amped for magnetic cartridge, tape in and out, switched AC outlet. Up-front headphone jack. Walnut-finished wood cabinet.



T-391DK—8-track Record/Playback Deck Selector switch allows choice of programs to be recorded. Complete record or stop after program 1, 2, 3 or 4. Pause and F. F. control. A.L.C. recording system. Wow and flutter below 0.25% RMS. A perfect match for all Standard amplifiers and receivers.



PM-403 Amplifier 15/15 watts RMS both channels driven. Dual speaker system selector, tape monitor, loudness control and up-front headphone jack. Walnut-finished cabinet.

T-180DK—Stereo Cassette Record/Playback Deck Super dynamic noise suppression system. Bias switch for high fidelity tape and chromium dioxide tape. Automatic record level control. Automatic shut-off of AC or cassette. Wow and flutter below 0.2% RMS. Vu meter accurate to 2 dB at 0 Vu. Frequency response 30 to 15 KHz — 1dB.



CIRCLE 45 ON READER-SERVICE CARD

the fi?

You've seen stereo receivers selling for next-to-nothing. And others costing thousands. Two basic elements are largely responsible for the difference. The performance features. And the "niceties." Performance features include IHF sensitivity, S/N ratio, THD, frequency response, capture ratio and the like. All are important variables that alter both the sound and the price.

If you're on a budget, sound should be your *only* consideration. If the sky's the limit, it should be your *major* consideration. Standard's receivers all accentuate the sound. And some also provide the extras for those who want them. Whether you plan on spending \$50 or \$600 or something in between, we can offer you many sound reasons for choosing Standard. Write us for the name of your nearest Standard dealer. Then come in and hear us out.

*Prices may vary slightly in different locations.

SR STANDARD®

STANDARD RADIO CORP.
60-09 39th AVENUE, WOODSIDE, N.Y. 11377;
13518 SOUTH NORMANDIE AVENUE,
GARDENA, CALIF. 90249.

SR-500—Stereo Receiver IC for all audio stages, FET'd front end. 15/15 watts RMS (8 ohms). Dual speaker system selector, Hi filter, FM muting, tape monitor controls. Large tuning meter. Black-out dial face. Walnut-finished wood cabinet included.

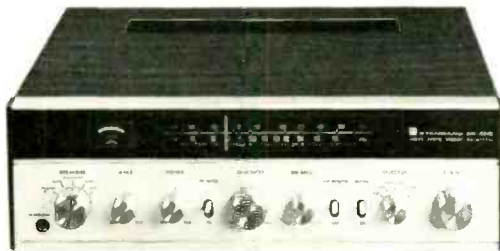

SR-A1000—Moderate-priced AM/FM Stereo Receiver 20/20 watts RMS (8 ohms). FM sensitivity: 2.5 uV. FET plus 4 IF stages double tuned. Rocker switch controls. Walnut-finished wood cabinet.



SR-1500 AM/FM Stereo Receiver 40/40 RMS (8 ohms) THD of less than 0.5%. FM sensitivity: 1.8 uV (IHF). Capture ratio: 1.5 dB. Separate pre and main amplifiers. Center tuning, signal strength meters, dual ganged stepped bass and treble controls. Handsome wood cabinet. Much more.



To \$600*



SR-4500 AM/FM Stereo Receiver 100/100 RMS (8 ohms). FM sensitivity: 1.5 uV. THD: less than 0.3% at rated output. Separate pre and main amplifiers, lever action controls for Hi and Low filters, tone cancel, loudness, tape monitor, FM muting, audio muting. Dubbing in and out, microphone jack and mixing control. Walnut-finished wood cabinet. Much more.

CIRCLE 45 ON READER-SERVICE CARD

NEW DYNACO QUADAPTOR®

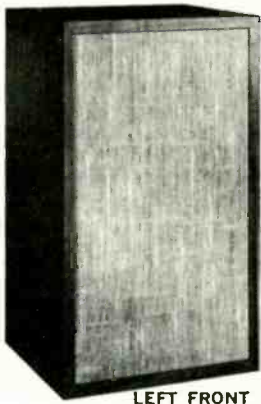

LEFT FRONT



Only
\$19.95 KIT
\$29.95 factory-
assembled

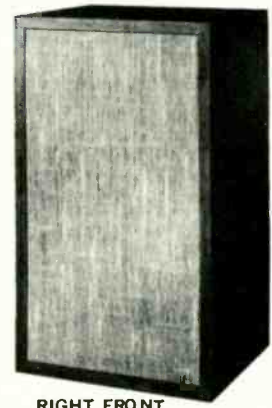

RIGHT FRONT

AND
TWO MORE SPEAKERS
CREATES

FOUR-DIMENSIONAL



SCA-80 (\$169.95 kit; \$249.95 assembled)

DYNAQUAD® STEREO

The new Dynaco Quadaptor® can be used with virtually any existing stereo receiver or amplifier. Dynaquad® four-dimensional stereo does not require an additional stereo amplifier . . . just two matched,

eight ohm speakers in back of the room. The four speakers are connected to the Quadaptor® which in turn is connected to the amplifier.

The Quadaptor® is not a synthesizer. Rather it reveals depth and concert-hall sound already on many of your present stereo recordings but not enjoyed due to the limitations of the conventional two-speaker stereo system. The manner in which the new two back speakers are

connected unmasks this hitherto hidden information to fully utilize everything that has been included on your recordings all along. Not only will the Quadaptor® give you four-dimensional stereo from your present recordings, but you can enjoy the same Dynaquad® stereo from your present FM stereo tuner too.

Best results are realized when the back eight ohm speakers have as constant an impedance as possible. The Dynaco A-25 (\$79.95 each) speakers were designed specifically to provide constant impedance. The Sterophile Magazine calls them "probably the best buy in high fidelity today."

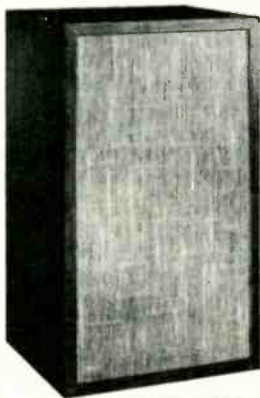

LEFT REAR

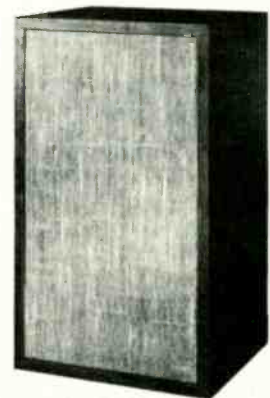

RIGHT REAR

Dynaco A-25 speakers (\$79.95 each—assembled only)

Send for literature or pick some up at your dealer where you can see and hear Dynaco equipment.

dynaco inc.

3060 JEFFERSON ST., PHILADELPHIA, PA. 19121
IN EUROPE WRITE: DYNACO A/S, HUMLUM, STRUER, DENMARK



Top-of-the-line Turntable at Less Than Top Cost

The Equipment: PE 2040, a three-speed automatic turntable with integral arm. Dimensions: chassis, 14 by 12 inches; clearance required above, 5 inches; below, 3½ inches. Price: \$145. Manufactured by Perpetuum Ebner of West Germany; distributed in the U.S. by Elpa Marketing Industries, Inc., New Hyde Park, N.Y. 11040.

Comment: The PE 2040 is now the top-of-the-line automatic turntable offered by Elpa. A three-speed model (33, 45, and 78 rpm), it is supplied with two spindles (long and short), and may be used in several ways depending on which spindle is inserted and how you operate the unit.

In automatic single play, using the short spindle, the arm will lift and cue a record automatically; at the end of the record the arm returns to its rest and the motor shuts off. In manual single play, the short spindle also is used, but this time you can cue by hand to any portion of the record. You also can use the built-in cueing device if you desire, and you can cue a nonrotating record and then start the turntable. During manual play you can stop the turntable manually whenever you want or use the main control lever to do so automatically. Or you can let the record play to its end, when the arm will return to its rest and the motor will shut itself off.

As an automatic changer, the PE 2040 will play up to eight records of the same diameter in sequence, shutting itself off at the end of the last record. An automatic sensing device determines the size of the first record and adjusts the arm for set-down in the lead-in groove of all the records in the pile. During this sequence you can interrupt the normal cycle to reject, or to repeat, a record. The repeat option also is available in single-play, as a one-time repeat or an indefinite repeat.

The 2040 uses a fairly heavy platter (a seven pound, six ounce nonferrous casting that is critically drilled out for good balance and flywheel effect) driven from

a four-pole induction motor via a stepped pulley. Operation is very quiet: the measured ARLR rumble figure of -56 dB is the best rumble figure we've yet had for PE turntables and one that compares favorably with other top-line automatics. Flutter is insignificant at an average value of 0.04 per cent. The vernier speed adjustment enables you to zero in on exact speeds at all three settings, using the strobe disc supplied with the unit. The tested range of this adjustment ran from -1 per cent to plus 5 per cent. Actually, the motor system is quite stable; if you set the 33-rpm speed to be exact, the variations at the other two speeds (even without using the vernier adjustment) are hardly worth worrying about, as indicated in the accompanying speed table.

The arm on the PE 2040 is a metal tubular model with negligible friction (less than 10 milligrams laterally and vertically). It requires only 0.4 gram to activate the automatic trip to the end of a record. Its resonance occurred at 6.5 Hz and showed an 11-dB rise. The arm is fitted with an adjustable rear counterweight for initial balance, and a separate adjustment for vertical tracking force. A third adjustment adds antiskating bias. The tracking force knob is calibrated from 0 to 6, and apparently these numbers represent generally about a half-gram more stylus force than is actually being applied. The following knob settings produced the indicated stylus force in grams, according to CBS Labs tests: for 1, 0.8 gram; for 2, 1.6 grams; for 3, 2.6 grams; for 4, 3.6 grams; for 5, 4.5 grams; for 6, 5.6 grams. Be that as it may, the arm will permit today's top-line pickups to track satisfactorily at their recommended stylus forces: for instance, the Shure V-15 Type II was used at 1.25 grams. The antiskating knob is calibrated from 0 to 10, with five subdivisions between each number, making a total of 100 possible settings in all. A table of values, included in the owner's booklet, explains the use of this knob; generally CBS Labs found that the recommended antiskating values were slightly but not

REPORT POLICY

Equipment reports are based on laboratory measurements and controlled listening tests. Unless otherwise noted, test data and measurements are obtained by CBS Laboratories, Stamford, Connecticut, a division of Columbia Broadcasting System, Inc., one of the nation's leading research organizations. The choice of equipment to be tested rests with the editors of HIGH FIDELITY. Manufacturers are not permitted to read reports in advance of publication, and no report, or portion thereof, may be reproduced for any purpose or in any form without written permission of the publisher. All reports should be construed as applying to the specific samples tested; neither HIGH FIDELITY nor CBS Laboratories assumes responsibility for product performance or quality.

significantly on the conservative side—that is, a bit low. You can, however, double-check antiskating (if the small values involved bother you) by a method also described in the owner's manual, using an unmodulated record.

The front end of the arm is offset to minimize lateral tracking angle error, and an adjustment of the platform on which a pickup is mounted in the arm shell permits further correction for stylus overhang. The shell also has a vertical angle adjustment (with a 5-degree range); CBS Labs found that the optimum vertical angle—i.e., the particular vertical angle of the cartridge being used—does indeed occur when the setting of this adjustment matches the record number playing in any given stack. However, since this is an automatic, a compromise setting corresponding to half the total number of records in a pile will produce zero error with respect to the middle record in a pile, and minimum error for all the other records in that pile—which is, of course, as it should be.

Other noteworthy features of the PE 2040 include its excellent cueing device; the pickup, when raised and lowered by the lever, returns to the same groove with no "side drift." The change cycle takes 18 sec-

onds, is very gentle on the records, and is silent, thanks to the built-in muting system.

The PE 2040 is supplied less base and cover which are available as optional accessories: the base, Model BV20, costs \$8; the dust cover, Model TX18/20, also lists for \$8. Properly mounted, the PE 2040 goes through its paces flawlessly, has a healthy immunity to the effects of external shock, and strikes us as an excellent automatic with advanced features, and a not-so-advanced price.

CIRCLE 144 ON READER-SERVICE CARD

PE 2040 Turntable Additional Data

Speed Setting (rpm)	Speed Accuracy*		
	105 VAC	120 VAC	127 VAC
33	0.1% slow	set exact	0.1% fast
45	0.4% fast	0.6% fast	0.7% fast
78	0.5% fast	0.6% fast	0.7% fast

*With reference to vernier adjusted for exact speed at 33 rpm. Absolute accuracy at all speeds also can be adjusted by the vernier speed control, using strobe disc supplied.

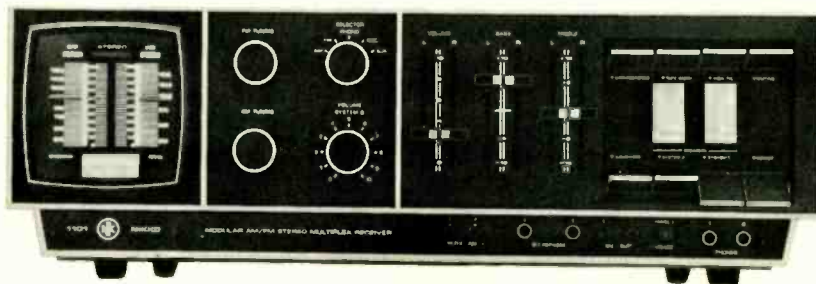

Receiver Offers Many Features

The Equipment: Nikko STA-1101, a stereo FM/AM receiver. Dimensions: 18½ by 6½ by 14¾ inches. List price: in black metal case, \$399.95; in walnut cabinet (as Model STA-1101W), \$419.95. Manufacturer; Nikko Electric Corp. of America, 5001 Lankershim Blvd., North Hollywood, Calif. 91601.

Comment: One of the most versatile—and certainly the most novel—receivers we've yet encountered, the Nikko STA-1101 combines a sensitive tuner with a medium-powered control amplifier. The set obviously has been designed to look different and it does, but its appearance serves a functional as well as a decorative purpose. The larger portion of the front panel is divided into four main areas: the first section contains the AM and FM tuning dials; the second, a group of rotary controls; the third, a group of sliding controls; the last section is given over to several lever switches and two meters. Yet another area, under the main front panel, contains additional controls and facilities that may be hidden behind a sliding panel.

Now for the details and some surprises: the AM and FM tuning dials are completely separate, and since each is controlled independently by its own tuning knob, you can tune a station on one and switch to the other

band and tune it without disturbing the previous tuning. This section is a cosmetic triumph: when you switch to AM, a maximum-strength tuning meter, the AM channel markings, and an adjacent logging scale all light up; these are intersected by a dial pointer in two-tone red, the brighter section catching the glow from the tuning dial; above the dial a blue rectangle glows; and above that the letters "AM" glow. When you switch to FM, the same tuning meter, the FM channel markings with their logging scale and their two-tone red pointer light up; a green rectangle glows above the dial; the letters "FM" glow above it; and if you are tuned to a stereo station, a long red rectangle lights up, and the word "stereo" comes on.

While this is all visually attractive and certainly unique, we wish the designers had also taken the trouble to provide a longer tuning dial—at least for FM—since tuning for a station with a set as sensitive as this one (which pulls in a large number of stations) is not particularly easy with a dial that allows only 1¾ inches of space between 88 and 108 MHz.

In addition to the FM and AM tuning knobs, part two of the front panel contains matching controls for signal selecting (AM, FM, phono, mike, and auxiliary), and for regulating the volume of a second or remote speaker

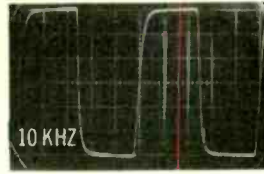

Square-wave response.

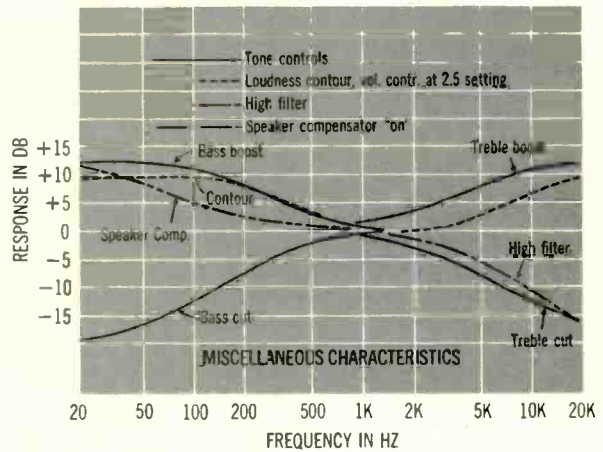
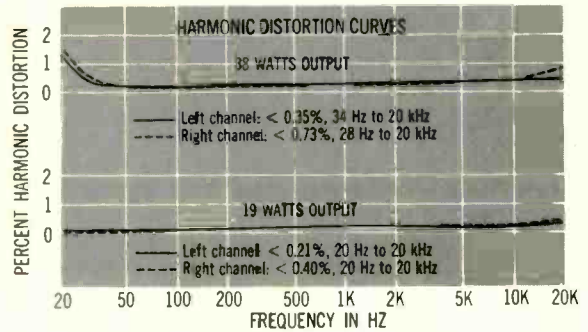
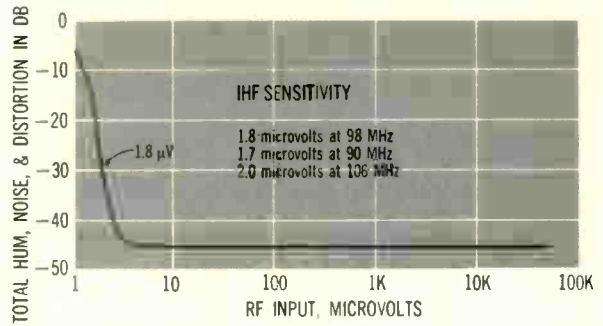
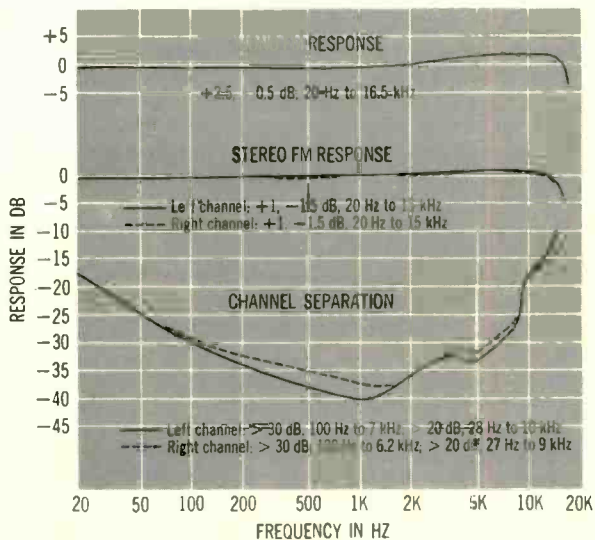
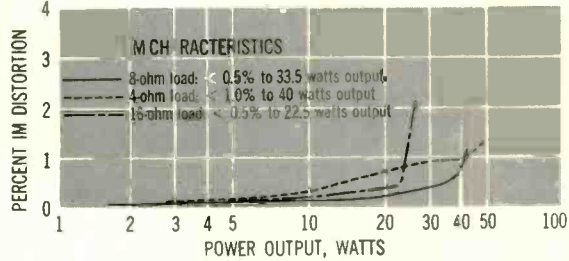
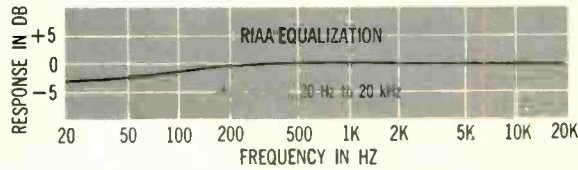
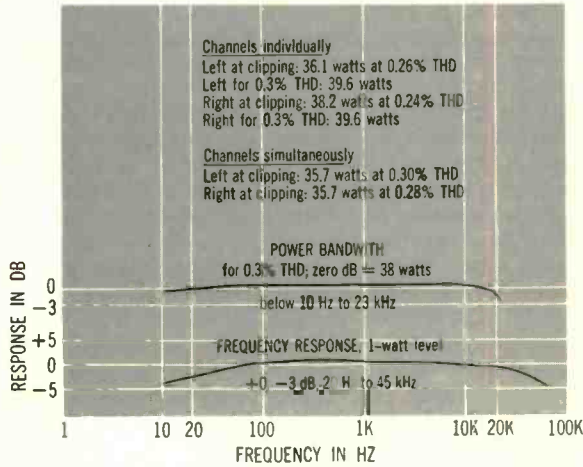

Nikko STA=1101 Receiver Additional Data

Tuner Section			
Capture ratio			2 dB
S/N ratio			74 dB
IM distortion			2%
THD	Mono	L ch	R ch
40 Hz	0.54%	1.4%	1.2%
400 Hz	0.54%	0.68%	0.95%
1 kHz	0.56%	0.56%	0.78%
19-kHz pilot			-62 dB
38-kHz subcarrier			-44 dB
Amplifier Section			
Damping factor			23
Input characteristics		Sensitivity	S/N
(for 38 watts output)	phono	4.5 mV	67 dB
	mlke	4.7 mV	67 dB
	aux	250 mV	87 dB

system (more of this later). The main volume control is part of the next group of slide switches. There are three pairs of sliders in all: blue for volume, yellow for bass, and red for treble. Each pair handles its own left and right channels independently so that you can adjust channel response individually or simultaneously. The volume sliders, in this arrangement, also serve as a channel balance adjustment. This control grouping is particularly well thought out and useful.

The top row of lever switches at the right end handle, in order, mono/stereo mode, tape monitor, high filter, and interstation muting (which operates on both AM and FM). The bottom row, from left to right, includes loudness contour, speaker system 2 selector, speaker system 1 selector, and power off/on.

The speaker selectors, in conjunction with suitable terminals at the rear of the set, permit operating either, both, or neither of two pairs of stereo speakers. The main volume control (blue sliders) set the output level of speaker system 1; this control also sets the threshold at which volume control 2 begins to have an effect on the sound level from speaker system 2. In other words, you get virtually no output from speaker system 2 unless the main volume control is set to a given level; then you can adjust speaker system 2 on its own control. This arrangement may sound complicated but it is quickly mastered. It also is quite useful in that it lets you operate each pair of stereo speakers at its own level. It thus permits running the added speakers for "center-fill" or "flankers" in the same room without the need to buy and insert L-pads for balancing the whole array. Finally, it permits accurate A/B testing of speakers, since you can readily balance their outputs so that both sound equally loud.

Another cosmetic touch at the right end of the panel is the pair of illuminated VU meters centered between the rows of lever switches. The VU meters merely monitor the amplifier's output (they are not tied into the tape-record feed or monitor circuits), a marginal function.

Across the bottom section, behind the sliding door, are additional controls: a pair of screw adjustments to set the VU meters for zero reading, a stereo pair of microphone (high-impedance dynamic) jacks, a stereo pair of recorder feed jacks, and two separate headphone jacks with an associated headphone level control. The first headphone jack is controlled by this level adjustment, while the second headphone jack is controlled by the main volume slider.

The front-panel recorder jacks permit several options. You can patch in a tape recorder here in addition to the recorder that may be connected at the rear and thereby, a) record without interruption an extra-long program by switching from one machine to the next, b) record on both machines simultaneously, or c) dub from one to the other. The headphone jacks, which are live at all times regardless of the position of either of the speaker selectors, may be used for tape monitoring and for general listening. Some additional decor notes: the meter adjust controls are blue; the headphone 1 level control is red; the lever switches are in grey and white; the front escutcheon itself is matte black framed in semi-glow silver stripping.

The rear of the set contains more features and more colors. There are three circuit-breaker buttons (red) for the left- and right-channel outputs and for the main AC power line. The speaker terminals are the push-to-insert type, with red for "hot" and black for "ground" connections. They are clearly marked for system 1 and 2 as well as for their respective right, left, and ground

hookups. Similar push-to-insert terminals are used for antenna connections: the AM pair are colored white and black; the FM pair are green. Provision is made for 300-ohm and 75-ohm FM antenna lead-in and for a long-wire AM antenna in case the built-in movable loopstick isn't adequate for AM reception. The increasingly popular "circuit interrupt" feature also is offered here in the form of a stereo pair of "preamp out" and "main in" jacks, connected normally by two jumper cables supplied—yellow for the left channel, red for the right. This feature, by the way, permits using the Nikko's preamp and power amp as separate entities—for instance, to patch in accessory devices such as room equalizers or reverb units or electronic crossovers. Another option found at the rear is a "speaker compensator" switch; when it is "on" it boosts the bass to compensate for bass-shy speaker systems. Its tonal effect (see accompanying graphs) is slightly different from either the loudness contour lift or the bass tone-control boost and while it may seem something of an electronic redundancy, it could serve a useful purpose in some playback systems. Input jacks at the rear include stereo pairs for tape monitor, magnetic phono, and an auxiliary (high-level) source. In addition there's the pair for feeding signals to a tape recorder, plus a DIN (5-pin) receptacle for European recorders that use a unitized cable for both record and playback hookup. Finally, there's the set's power cord and three convenience AC outlets, one of them switched.

The Nikko's internal circuitry employs many advanced design features including plug-in circuit boards that facilitate servicing. An FET demodulator in the AM section is said to be the world's first circuit of its type. A screw adjustment on the chassis permits operating the set on standard U.S. voltage or on the 220/240-volt AC lines found abroad.

The tuner section of the Nikko acquitted itself very well in CBS Labs' tests. IHF sensitivity was measured as 1.8 microvolts, and the sensitivity curve descends steeply, reaching a maximum quieting of -45.5 dB for only 7.5 microvolts of input signal. No front-end overload was encountered at higher input signal levels. In our cable-FM test, the set logged a healthy total of 49 stations of which 31 were deemed suitable for critical listening or off-the-air taping. The AM section, in listening tests, performed quite well in terms of the number of stations it received and their sound.

The amplifier portion of the Nikko shapes up as a competent medium-powered unit that should prove adequate for driving any available speaker system. The roll-off in the low end of the frequency response (down 3 dB at 20 Hz) isn't what we'd call "state of the art" but it's not terribly serious either, since distortion at normal listening levels remains very low, and the bass boost options can be used without increasing the distortion. Low-frequency square-wave response shows the effect of the bass roll-off; high-frequency square-wave response has fast rise-time and no ringing.

If the Nikko thus offers average performance, it certainly offers more than average in the way of features and styling. Its control system (especially the built-in level adjustment for the added speakers), its tape-recorder hookup options, its twin headphone jacks, the circuit-interrupt-and-patch feature, and the general circuit stability that permits running four loudspeakers and two headsets simultaneously all are commendable features which many a prospective owner will welcome in a receiver.

CIRCLE 141 ON READER-SERVICE CARD

Ortofon Adds A "Little Black Box"

The Equipment: Ortofon SL-15/MP 235, a moving-coil phono pickup with solid-state preamp. MP 235 preamp dimensions: 8½ by 2½ inches. List prices: \$150; SL-15 cartridge alone, \$90; MP 235 preamp alone, \$75. Manufacturer: Cartridge by Ortofon of Denmark; preamp by Martin Electronics of Kansas City, Mo.; distributed by Elpa Marketing Industries, Inc., Thorens Bldg., New Hyde Park, N.Y. 11040.

Comment: The Ortofon long ago established its fame internationally as one of the very best phono pickups. However, since it is a moving-coil design, its signal output is characteristically very low. To suit it for use with normal magnetic phono inputs (on preamps, integrated amps, or receivers) its designers at first built a tiny transformer directly into the cartridge body. A few years later, in order to decrease the cartridge's weight, Ortofon removed the transformer from the cartridge and made it available as an external accessory to be connected to the output of the cartridge. This option also enabled buyers to obtain only the cartridge for direct hookup to the very few preamps that had a special input to accommodate a moving-coil pickup without an intervening booster. Somewhere along the line, a few enthusiasts began talking about the desirability of doing away with the transformer altogether and replacing it with a solid-state device that would perform the same boosting function. A few solid-state "pre-preamps," as they came to be known, were built privately and experimentally. Their advocates insisted that the small increase in high-gain transistor noise was a small price to pay for the absence of transformer distortion and the improved clarity and firmness of sound that resulted when the Ortofon was used the new way. Thus, another "audio controversy." The anti-transformer crowd also pointed out, on obviously less debatable ground, that a pre-preamp would enable the Ortofon to be used with any preamp, amp, or receiver—and since the transformer already had been eliminated by Ortofon itself, the smaller and lighter pickup also would work correctly in any quality tone arm, including those on automatics.

The present Ortofon pickup system incorporates just such a pre-preamp in the form of the Martin MP 235, a small black box fitted with its own AC power cord and four phono jacks for left- and right-channel inputs and outputs. The MP 235 is connected to an AC source (preferably through a switched AC outlet, so that it turns on with the system); the cables from the tone arm connect to it, and additional cables run from it to the ordinary magnetic phono inputs on whatever equipment you're using.

And it does make a difference. Although the basic pickup is the same as the previous Ortofon we tested (see HF test report, November 1967), the new combination offers measurable and audible superiority. The most dramatic improvement is in distortion. The new system consistently shows harmonic and IM distortion figures that are twice to three times lower than in the past; in fact they are among the lowest yet measured for any phono pickup. For instance, the previous Ortofon showed, on the left channel, 2.5% THD at 1,000 Hz; the new version reads only 1.2%. In the former Ortofon, IM laterally and vertically was 3.5% and 5% respectively; in the present model, we read only 1.7% and 1.8%. Output voltage in the former model was found

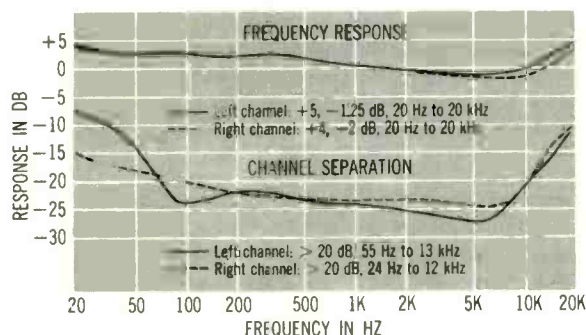
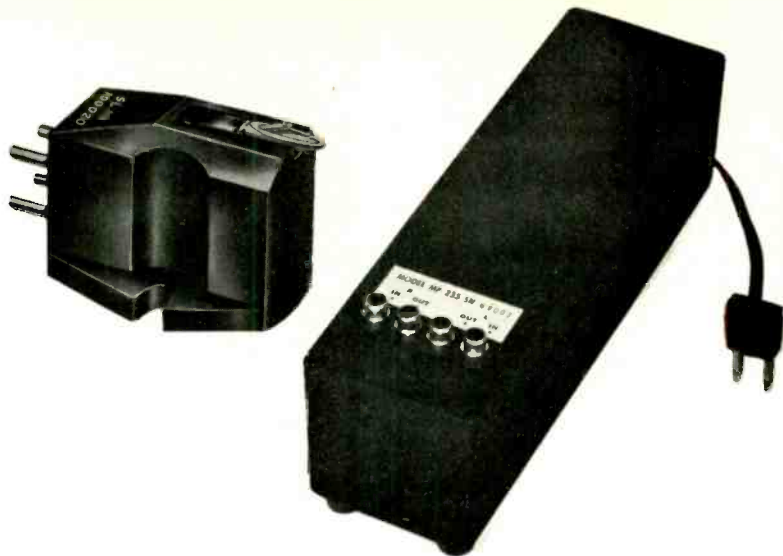

respectively (through the transformer); in the new model (through the MP 235) it is higher at 9.0 and 8.5 millivolts. In the opinion of our listening panel, these excellent characteristics outweigh the few dB of noise contributed by the MP 235.

Frequency response and channel separation characteristics are about the same in both versions. There are slight variations between both models but they add up to a standoff between the two. Either way, the Ortofon is a wide-range pickup with no peaks in the audible range, and a response that continues to beyond audibility. It is, in fact, one of the few pickups often used for laboratory tests that involve ultrasonics, including the checkout of test records and, more recently, experiments with four-channel discs that employ super-sonic subcarriers for two of the channels.

Such uses aside, the Ortofon is a very good cartridge for playing ordinary discs. Its two channels are very closely balanced, and its separation is adequate for a full stereo effect. It is not the lightest pickup available, although it is light enough. The minimum vertical tracking force it needed to track the torture test bands of the CBS test records was 1.25 grams; in normal use, a force of 1.5 grams was used. Its vertical angle, at 17 degrees, was very close to the 15-degree standard. Its resonance (in an SME arm) was clocked as a few dB at 11 Hz. Compliance was measured as 15 ($\times 10^6$ cm/dyne) laterally and vertically. The elliptical tip was found to be well formed to the dimensions of 0.2 by 0.6 mil. Listening to ordinary records with this new pickup system we got a sense of full tonality, very wide and clean frequency response, very wide dynamic range, and an excellent and firm stereo image. An ample, hum-free signal level also contributed to the pleasure. So while the debate over transistors vs. transformers continues, we'll enjoy the new Ortofon.

CIRCLE 142 ON READER-SERVICE CARD

Tannoy Debuts an Omni Speaker

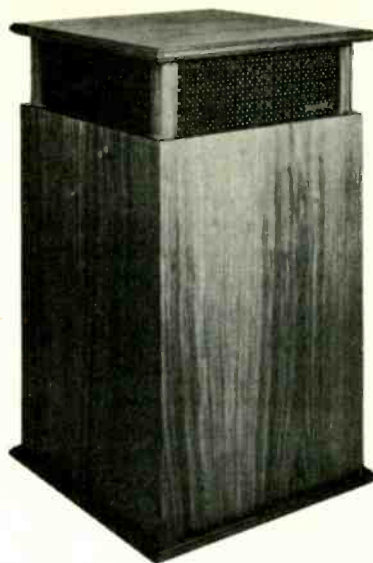

The Equipment: Tannoy Orbitus I, a full-range speaker system in enclosure. Dimensions: 29 by 17 by 17 inches. Price: \$245. Manufacturer: Tannoy Ltd. of England; USA branch, Tannoy (America) Ltd., 1756 Ocean Ave., Bohemia, N.Y. 11716.

Comment: Known here and abroad for many decades as a manufacturer of quality loudspeakers, Tannoy has now introduced its own version of the increasingly popular "omnidirectional" type of speaker system. It doesn't take much listening to discern that the new Orbitus I is right up there with the best.

A floor-standing model, the Orbitus I employs a specially modified version of Tannoy's 12-inch dual-concentric loudspeaker which, in other design configurations, has enjoyed a long and enviable history as one of the favored reproducers among serious audiophiles. The present version incorporates Tannoy's principle of a concentrically mounted high-frequency exponential horn tweeter, the curve of which blends into the shape of the larger surrounding woofer. Nominal crossover, provided by a network housed within the cabinet, is at 1,000 Hz. This dual driver faces upward and radiates against a curved deflector whose own shape follows that of the speakers; the sound is thus dispersed in a full circle and emerges from the four-sided grille surrounding the enclosure's top section. To better suit the speaker for the horizontal mounting this design entails, and at the same time achieve the stability and the compliance required for full response, both its surround material and its diaphragm suspension have been modified. A duct, terminating in an opening on the underside of the enclosure, permits the low-frequency section to function as a bass-reflex type.

In keeping with its omni design—which implies that it can be positioned virtually anywhere in a room and away from the traditional wall—the Orbitus I is finished (in walnut) on all four sides. Its top surface, also in walnut, could conceivably serve as a lamp stand. Connections are made to the underside of the enclosure via screw terminals marked for polarity. Here you'll also find two high-frequency controls: one, a four-step switch, sets the rate and degree of roll-off from about 2,500 Hz and upward; the other, a five-step switch, adjusts the amount of high-frequency energy radiated from about 1,000 Hz and upward. Between the two controls the system's response can be adjusted to suit a wide variety of room conditions. Having them on the bottom of the unit makes the initial installation adjustments inconvenient, but obviously the controls had to

be placed there to permit the cabinet to be finished on all four sides. Be that as it may, our tests show that the controls are effective and do the intended job. The measurements made at CBS Labs were taken with both controls set to their indicated "level" positions (minimum treble roll-off and maximum treble output). In subsequent listening tests using normal program material, most listeners opted for the "level" position of the roll-off control and one step below "level" on the energy control. The actual measured differences in the effect of the roll-off control averaged 1 dB for each step of the control up to about 7,500 Hz, then about 2 dB from here to 16,000 Hz, then 1 dB again out to 20,000 Hz. The level control produced an average steady 1-dB difference for each of its settings from 1,000 Hz to 20,000 Hz.

Rated impedance is 8 ohms; the measured impedance just beyond the characteristic bass rise was 7 ohms. This value rises generally across the audio range, averaging about 12 ohms and never going below 7. Tannoys are obviously perfectly safe to connect in pairs to the sometimes critical outputs of solid-state amplifiers or receivers. A fairly efficient reproducer, the Orbitus I can be used with any associated equipment. It required a minimum average power of 10.5 watts to produce an output of 94 dB. It also is a very robust system and could not be driven into significant distortion with an average power input of 257-watt pulses (514-watt peaks), a factor that also attests to its excellent dynamic range (the output at this level was measured as 108.2 dB—probably louder than, or certainly as loud as, what you'd hear in the first row at a concert hall). Indeed, at any listening level, the Orbitus I provides a full, clean response; we'd say it would do well in just about any type of room.

More good news about the Orbitus I is found in the frequency response curves reproduced here, which are definitely confirmed in listening tests. The average

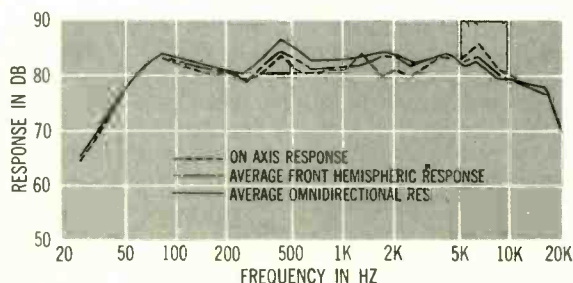

omnidirectional response is clocked as within plus or minus 6.5 dB from 39 Hz to 18,000 Hz, a very good measurement indeed. Across the broadest portion of the audible spectrum the response is very linear with no more than plus or minus 3 dB variation from 55 Hz to 10,000 Hz. On test tones, we found a slight doubling at 50 Hz, which did not increase as frequency was lowered. The system responded to tones as low as 25 Hz, albeit faintly and with increased doubling. In any event the Orbitus I certainly makes its claimed low-frequency response down to 30 Hz—and then some. Its high end is just as exemplary, with no sense of directivity all the way up the frequency band, and its response continues to beyond audibility with a slope beginning at about 15,000 Hz. White noise response sounded very smooth and extremely well distributed throughout the listening area.

On a wide variety of program material the Orbitus I pleased all who heard it. A pair playing stereo provides a beautifully spaced-out orchestral panorama, yet they retain the ability to locate instruments and sections. On solo material, the signal is nicely centered between

Tannoy Orbitus Harmonic Distortion*

Output Level (dB)	Frequency			
	80 Hz		300 Hz	
	% 2nd	% 3rd	% 2nd	% 3rd
70	0.2	0.15	0.15	0.35
75	0.18	0.25	0.1	0.38
80	0.2	0.3	0.12	0.43
85	0.3	0.75	0.18	0.58
90	0.6	0.85	0.2	0.71
95	3.0	1.1	0.25	0.83
100	5.0	2.0	0.45	0.8

*Distortion data is taken on all tested speakers until a level of 100 dB is reached, or distortion exceeds the 10-per-cent level, or the speaker produces the spurious output known as buzzing, whichever occurs first.

the two systems. Over-all, the effect is one of musical integrity and virtually no sonic coloration. These virtues always have characterized Tannoy systems; in the Orbitus I they are joined with yet another: the natural, easy "spread" and firmness of stereo image contributed by omnidirectionality.

CIRCLE 143 ON READER-SERVICE CARD

Tandberg 6000X: New S/N Figures

Tandberg has recently pointed out, and CBS Labs confirmed, that the Model 6000X tape recorder can be used in a manner that produces a more favorable signal-to-noise ratio on record/playback than hitherto understood and originally reported here (see Equipment Reports, December 1970). Instead of the 40 dB and 34 dB for left and right channels respectively, Tandberg claims much better figures: 57 and 58 dB.

The apparent discrepancy has to do with the Model 6000X's sensitivity which is greater than in most other brands. When tested in the usual way, i.e., taking advantage of the unit's full sensitivity with its gain "wide open," the S/N figures originally reported are what the unit produces. However, when more typical input signal levels are used for recording, such as 100 mV to 500mV, the Tandberg's S/N improves to the 57dB and 58 dB claimed for the unit.

So, a word of advice for owners of the Tandberg 6000X (in any of its versions) or the 3000X (the same deck with fewer features): you actually can get an improved S/N ratio when making your own recordings by not driving the inputs from very low-level signal sources. Make certain that your signal input levels fall within the 100- to 500-mV range, and you will produce extremely quiet tapes.

CIRCLE 146 ON READER-SERVICE CARD

True Components in Compact Form



The Equipment: Altec Lansing Model 911A Music Center (a stereo FM/AM receiver combined in the same case with a Garrard SL 95B record changer and Shure M-93E pickup). Dimensions: 19½ inches wide by 19½ inches deep (plus at least 1 inch allowance for heat sinks and connectors) by 7¼ inches high without dust cover 10¼ inches high with dust cover, but additional space must be allowed or removal). Price: \$499. Manufacturer: Altec Lansing Co., 1515 S. Manchester Ave., Anaheim, Calif. 92803.

Comment: Altec Lansing finally has done it—produced a stereo compact that cuts no corners in adapting high fidelity components to the stereo compact format. Nobody said it couldn't be done, of course; it's just that until now it hasn't been done quite this way: combining a top-quality receiver with a top-quality turntable and pickup, all of which are integrated not by the expediency of compromise, but by an attractive walnut wrap-around, period. The choice of loudspeakers is strictly up to the buyer, and these can be any that might be chosen for the Altec 714A receiver—that is, without

reference to any circuit limitations or special requirements just because the electronics are packaged together with a turntable. To put it another way, the parts that make up the 911A would be at home in a traditional separate component system: the Altec 714A stereo FM/AM receiver, the Garrard SL 95B turntable, and the Shure M-93E cartridge. Together they form a logical and harmonic ensemble, both in terms of technical performance and with respect to styling. The wood trim of the SL 95B, for example, makes it a particularly attractive model to combine with the wood case of the 911A.

The row of switches along the bottom of the front panel (from the left) control selection of FM, AM, phono, auxiliary input, and tape monitor; a high filter for noisy records or FM broadcasts; FM interstation muting (on/off); loudness compensation; mono/stereo mode; "volume range" (a switch that reduces output by 10 dB and can be used for background-level listening); and on/off switches for the two sets of speaker outputs. At the far right, beyond the headphone jack, is the power on/off switch. Above these switches are the FM/AM tuning dial (with its tuning meter and stereo indicator), sliders for volume, balance, treble and bass, and the tuning knob. On the back panel are the antenna connections (300-ohm twin-lead for FM, long-wire for AM), aux input, input and output for tape recorder, a center-channel output, speaker connections for main and remote pairs, and a convenience AC outlet. The controls for the record changer are, of course, all on its top plate and allow use as a full automatic changer, an automated single-play turntable (with automatic set-down and arm return), or a manual single-play unit.

We have reported already on the two major elements in the ensemble: the Garrard changer in January of this year and the Altec receiver in February. Lab tests proved both units to be excellent performers in all respects. In cable-FM tests, the receiver logged a record number of stations, thanks partly to its unusually fine capture ratio of 1.1 dB and excellent sensitivity of 1.9 microvolts. In such respects as distortion and signal-to-noise ratio, performance also was well above average. The power-amplifier section produced better than 44 watts per channel of continuous power for a total harmonic distortion rating of 0.5 per cent. In other words the unit is capable of delivering cleaner-than-average signals to two stereo pairs of speakers with power to spare even if speaker efficiency is on the low side.

The Shure cartridge used here is a medium-priced (\$40) Hi-Track model with an elliptical stylus of 0.4 x 0.7 mils. Other cartridges can of course be substituted if you want; the Garrard slip-in cartridge mount makes substitution unusually easy. In listening tests we could discern no differences between the SL 95B and M-93E as used in the Altec 911A and the separately available models.

There are some differences in the receiver section, however. The original Model 714A has two phono inputs; the 911A only the Garrard/Shure combination. The 714A has a local/distant FM sensitivity switch on the back panel and separate front-panel tuning meters for AM and FM; the 911A has no sensitivity switch and uses a single tuning meter, for center tuning on the FM band and for maximum signal strength on AM. The 714A has both switched and unswitched AC convenience outlets; the 911A but a single, switched outlet. The 714A has back-panel jumpers connecting preamp and power-amp stages; the 911A does not. And finally,

the 714A has a vertical front panel; that on the 911A is set at an angle.

Most of these changes strike us as consistent with the quasi-compact product concept. For instance, we doubt that buffs who demand two phono inputs would be attracted to the prepackaged format in the first place. The single tuning meter does everything the dual meters of the 714A are capable of. Such esoterica as room equalization or bi-amplification can be added to the 911A almost as easily as to the 714A by using the tape-monitor connections instead of the preamp/amp jumpers found on the latter version. Another wall outlet can be used instead of the unswitched convenience outlet of the 714A. And we found the angled front panel to be a distinct advantage.

The array of switches at the bottom, as we said in our report on the 714A, makes a handsome design. And by tilting the faceplate of the 911A toward the user, Altec has made it easier to identify these controls, particularly if the unit is installed at lower-than-eye level (the normal case, in our experience).

In sum, we are impressed by the 911A. It is an excellent choice in our opinion for the purchaser who wants true component high fidelity sound with minimum fuss and is eager (or at least willing) to forego the more esoteric complications.

CIRCLE 147 ON READER-SERVICE CARD

Teac A-1230 Addendum

FOR TAPE EDITORS ONLY: In our report on the Teac A-1230 open-reel tape deck (April 1971) there was considerable discussion on the operation of the unit's pause control. To recap: when the A-1230 is in the record mode "the pause control releases the drive puck and activates the tape lifters but does not stop the capstan motor nor switch off the heads." In playback its action is like that of the stop button.

As inveterate tape editors know, this action prevents use of the pause control in cueing up the tape to a precise edit point; and our report had mentioned a suggested modification that would keep the pause control from tripping the tape lifters. Teac subsequently has pointed out, however, that since a single solenoid operates both the tape lifters and the pinch roller on the A-1230, no simple modification will produce the desired result—namely, to free the tape from the drive system while keeping it in contact with the playback head.

Teac says, "We would like to suggest that for those audiophiles who wish to do splice editing there is a simple procedure that works very effectively with a little practice. Put the tape recorder in play, retract the pinch roller slightly with the thumb of the right hand, and move the tape by turning either reel. This will provide the ability to locate precise positions on the tape."

Some users might prefer an alternate procedure we mentioned in our report on the Teac A-6010U (April 1970): thread the tape on the wrong side of the capstan and then switch the deck into play. The rethreading takes a bit of care, to avoid damaging the tape, but it leaves both hands free to "rock" the two reels easily.

CIRCLE 145 ON READER-SERVICE CARD

REPORTS IN PROGRESS

Fisher 701 Receiver

Empire 598 Turntable

Do you ever wonder what happens to your records when you play them?

You should.

Chances are, your record collection is worth hundreds or even thousands of dollars. And some unhappy things might be happening to your records while you're enjoying the music.

To appreciate this, let us follow the stylus down into the grooves of your records.

Torture in the groove.

To the stylus, the record groove presents one long, torturous obstacle course. And the stylus must go through that groove without a trace that it's been there.

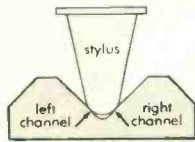

Stylus in groove. Record wear, if any, takes place where edges of stylus touch groove walls.

As the record rotates, the rapidly changing contours of both groove walls force the stylus to move up, down and sideways at great speeds.

Thus, when you hear the bass drum from the right-hand speaker, the right wall of the groove is causing the stylus to vibrate about thirty times a second. And when you hear the piccolo from the left speaker, the stylus is responding to the left wall about 15,000 times a second.

By some miracle, all these vibrations bring a full symphony orchestra right into your living room. That is, if all goes well. For there is an unequal match in the forces confronting each other.

Diamond vs. vinyl.

As you know, your records are made of a soft vinyl that has to contend with a diamond, the hardest substance known to man.

If the stylus can't respond to the rapidly changing contours of the groove, especially the hazardous peaks of the high frequencies, there's trouble.

Instead of going around the peaks, the stylus will simply lop them off. And with those little bits of vinyl go the high notes, the record and your investment.

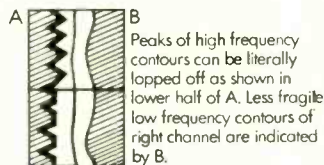

Peaks of high frequency contours can be literally lopped off as shown in lower half of A. Less fragile low frequency contours of right channel are indicated by B.

The tonearm to the rescue.

Actually, all this needn't happen. Your precious records can be preserved indefinitely. And sound as good as new every time you play them. It all depends on the tonearm, which is to the stylus as the surgeon's hand is to the scalpel.

There is a vast difference among tonearms. Some are little more than "sticks on a swivel." But the best ones are designed and engineered to a high degree of precision. For very important reasons.

Consider the simple movement of the tonearm from record edge to center, guided by the outer groove wall nudging the stylus along. The tonearm must be free to follow without resistance. This requires virtually friction-free pivots.

Another subtle but demanding aspect of tonearm performance is the need for equal tracking force on each groove wall. This setting ("anti-skating") calls for exquisite precision.

Some other factors that affect tonearm performance include its overall length (the longer the better), its dynamic balance, and the position of the cartridge in the tonearm head (affects tracking error).

Still more to consider.

And while the tonearm is performing all these functions, other things are going on.

For example, the record must be rotating at precisely the right speed, or pitch will be off. The motor must be quiet and free of vibration, or rumble will be added to the music. The platter must weigh enough to provide effective flywheel action to smooth out speed fluctuations. And, of course, the stylus must get to and from the groove as gently as possible.

A reassuring thought.

With all these considerations, it's good to know that Dual automatic turntables have for years impressed serious record lovers with every aspect of their precision performance. In fact, many professionals won't play their records on anything but a Dual.

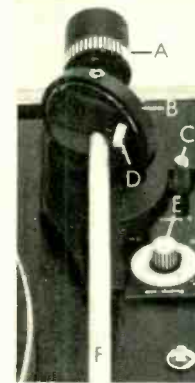

A precision tonearm like the Dual 1219's provides:

- A) Vernier-adjustable counterweight.
- B) Four-point gimbal suspension with near-frictionless pivot bearings.
- C) Setting to provide perfect tonearm angle for single play and changer modes.
- D) Direct-reading tracking force dial.
- E) Setting to equalize tracking force on each groove wall.
- F) 8-3/4" pivot to stylus.

If you would like to know more about tonearms, turntables and us, we'll send you some interesting literature that we didn't write. A booklet on what to look for in record playing equipment. And a series of independent test reports on Duals.

Better yet, visit any authorized United Audio dealer and ask for a demonstration.

At \$99.50 to \$175.00, Dual automatic turntables may seem expensive at first. But when you consider your present and future investment in records, they may begin to look inexpensive.

United Audio Products Inc., 120 So. Columbus Ave., Mt. Vernon, New York 10553.



CIRCLE 18 ON READER-SERVICE CARD

The Musician

by William Zakariasen

MUCH HAS BEEN WRITTEN of the role that music and musicians play in the world of politics. Arguments often erupt when this subject is brought into conversation, particularly when it involves the behavior of certain musicians during World War II. Throughout that period and for the five years following, an endless debate took place in journalistic circles between such unlikely combatants as Ernest Newman and Walter Winchell, and the picketing of suspect artists extended into the mid-Fifties—sometimes causing the cancellation of performances. The apology for these artists was usually a variation of Newman's theme: "The cobbler should stick to his last—therefore, art and politics don't mix." The fact is that the artist is always a part of history and is often, directly or indirectly, required to place his career, his reputation, sometimes even his life on the line.

The interrelationship of music and politics remains very much with us. Popular liberation movements are still expressed in popular song, and some of the composers and interpreters, such as Theodorakis, are in and out of jail. A Western Establishment composer, Hans Werner Henze, becomes converted to world revolution, and must therefore be content to hear much of his later music only on records—live, it might be far too dangerous, as was proven by the abortive premiere of his *The Raft of the Frigate "Medusa."* An Eastern Establishment performer, the cellist Mstislav Rostropovich, attacks Soviet Socialism in print when his nation's leading novelist, Alexander Solzhenytsin, is prevented by his government from accepting the Nobel Prize. Rostropovich is then prevented from fulfilling his American and Finnish commitments in early 1971.

In Greco-Roman times, the court musician was often used as a political instrument to viciously satirize forces growing too powerful. The Renaissance court jester often had to be both a composer and a performer. No doubt the prototype of Rigo-

Mr. Zakariasen, a former member of the Metropolitan Opera Chorus, is a frequent contributor to HIGH FIDELITY.

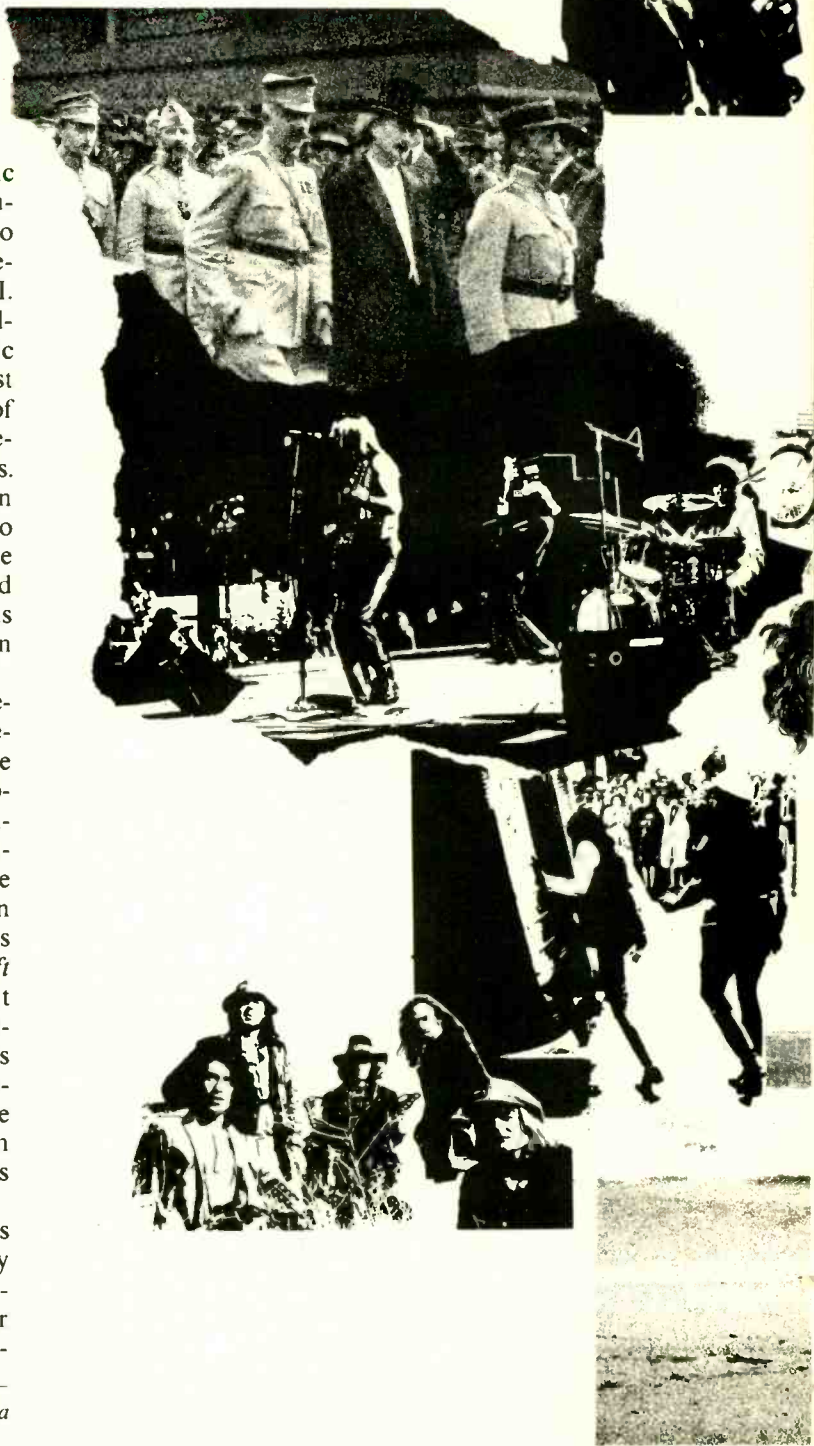

as Activist

Rostropovich

and Baez are following

a centuries-old
tradition.

letto knew his music—certainly in the sophisticated court of François I—and sang his insults to court factions as required. No doubt he met as ignominious an end for his efforts as does Rigoletto. Through the murder of Mary Stuart's court musician, David Rizzio, the history of Scotland took a fatal turn. Agostino Steffani, Handel's predecessor as court composer of the house of Hanover, was one of the most important opera composers of the seventeenth and eighteenth centuries. He was also a clever enough politician to assist several European thrones. Steffani's political genius was such that the Pope appointed him Bishop of Stiga and eventually Papal Prothonotary at Düsseldorf.

Like some of Shakespeare's plays, the operas of the Venetian baroque, commissioned as they were by rulers, were thinly disguised histories of the good guys who ruled and the bad guys they overthrew or would like to have overthrown. Monteverdi's *L'incoronazione di Poppea* is nothing less than a bloody musical comedy aimed at the Borgias, only recently overthrown. The countless operas and other musical "entertainments" during the reign of Louis XIV were designed mainly to project the dazzling wattage of the Sun King, who, like Nero, would often join in the performance.

The French Revolution caused many a musician to change his political allegiance, sometimes at a moment's notice. André Grétry, previously favored by the monarchy, found mugwumping quite simple. At the outbreak of the Revolution he allied himself with the mob, writing several revolutionary works, including the opera-ballet *La Rosière républicaine* (1793), based on tunes of the Terror such as *La Carmagnole* and *Ça ira*. Following this flag-waving piece, he carried a musical banner for every possible conqueror. The Directoire named streets after him; Napoleon gave him the Legion of Honor and appointed him head of the Paris Conservatory; Louis XVIII retired Grétry with a sizable pension and a country house formerly owned by Jean Jacques Rousseau.

In another case, Louis XVI commissioned from Luigi Cherubini the opera *Marguerite d'Anjou* as





David Rizzio (born: Turin, c. 1533; murdered: Scotland, 1566). Rizzio, a musician in the train of the Piedmontese ambassador to Scotland, was hired by Mary, Queen of Scots, who had need of a bass singer in her court. A royal favorite, he soon became Mary's *valet de chambre* and her secretary for correspondence with France, where she had been raised. The queen's marriage to her cousin, Darnley, took place in Rizzio's apartments, and Rizzio also became an adviser to Darnley. When Darnley asked Mary to give him the crown matrimonial, which would have assured his rank of king for life, Rizzio advised the queen against it. Darnley, who also may have been jealous of Rizzio's intimacy with his wife, plotted the musician's murder, which was carried out on March 9, 1566. Among the results of this act were Mary's escape from Holyrood Palace on the 11th and Darnley's own murder within the year—Mary was charged with complicity in this act twenty years later as she went into her own Elizabethan tragedy.

a musical antidote to popular unrest. The line "Great God, save our queen" appears at every turn. In later years Cherubini wrote a Requiem for Louis XVIII, but intervening times found him busy saving his own life and reputation. In 1796, at the opening of the Council of Five Hundred, Cherubini conducted his cantata praising the executioners of Louis XVI. During the Terror, he was forced by a mob of Jacobins to play *La Marseillaise* on a confiscated piano in the shadow of the guillotine.

La Marseillaise had a somewhat different effect on a somewhat greater composer—Hector Berlioz, a man not noted for his sympathy with the down-trodden poor. Rather he was like De Gaulle—a believer in the glory of France and of himself, period. During the 1830 Revolution, Berlioz ran into a confused crowd which was contemplating looting a museum. His French conscience aroused, he began singing *La Marseillaise*. No one joined in—they just stood there, until the third verse, when Berlioz roared, "Damn it, sing!" and they did, forgetting everything else. This experience resulted in his magnificent setting of the anthem—perhaps

the finest setting of its kind. Berlioz' preoccupation with *La gloire de la France* resulted in at least two more works commemorating that bloodless but eventually useless revolution: the Requiem and the *Grande symphonie funèbre et triomphale*. If Berlioz' music as a whole celebrated either the artist as anarchist, contemptuous of the people, or the glory of Napoleonic grandeur as it might have been, his heroic defiance of an undecided Parisian mob gave his life a moment of raw heroic activism. Berlioz the composer became Berlioz the humanist.

Verdi, whose humanistic life mirrors his music, served for a time as representative of his district in the first Italian Parliament despite his knowledge that plans for a truly democratic Italy had been betrayed. Verdi was as responsible as Garibaldi and Cavour for the creation of Italy as an independent nation. His operas were thinly disguised polemics against Austrian and Papal imperialism. *Nabucco's* Jews singing by the waters of Babylon were the Italians ruled from the Danube and the western side of the Tiber. Their choral cries for freedom, repeated in such works as *I Lombardi*, *Macbeth*, and *Ernani*—the first opera by a reputable composer in which the outlaw hero rejects the "system" in the attempt to bring himself and his people social justice—became the greatest collection of national anthems ever owned by a nation. Censors, slow-footed as they remain today, caught up with Verdi in time for *Stiffelio*, *Rigoletto*, and *Un Ballo in maschera*, forcing the composer to fake new, supposedly innocuous plots—but by then, Europe knew: the truth, by any other name, was still known as *Verdi*. Royalists took his cause as well, since the letters of his name coincidentally fit *their* rallying cry: "Vittorio Emmanuele Re D'Italia!"

Therefore, money and foreign intervention (to which Verdi paid halfhearted obeisance in one of his least inspired compositions, *Hymn of the Nations*) helped to create an independent, but not free Italy. The poor were still pariahs in the sight of the new king. In a square in Milan in 1867, when bloody rioting broke out between Royalists and Republicans, Verdi strode to the center of the carnage, raised his hands, and began to sing: "*Va, pensiero, sull' ali dorate*"—the chorus of Hebrew slaves in *Nabucco*—the piece of music that started it all. The mob joined in song and dispersed respectfully. Verdi lived on to compose and re-compose his greatest scores, all the while giving the bulk of his profits to such causes as the defeated French soldiers of the Franco-Prussian War, the Italian poor, who were always with him, and to the support of Casa Verdi, a home for retired musicians.

In those days of great political upheaval, the difference between Verdi and Wagner was simply this: Wagner loved "the people;" Verdi loved "people." Wagner's association with the anarchist Bakunin and the Communist Engels brought about his twelve-year exile after the 1848 Revolution. While

Wagner's nationalism was based upon the hope of reviving and unifying dormant forces, Verdi's nationalism was based on the desire for freedom from outside forces. Upon Wagner's return to a still divided Germany, he used his influence with one of its richest yet weakest kings to assure himself a dominant role in European life. But in point of fact, his extravagant artistic and personal budget helped lead to the downfall of the Bavarian monarchy.

The involvement of a musician in the fight for human rights began with Mozart. In *Entführung*, *Figaro*, *Don Giovanni*, and *Così fan tutte*, the comic, though often serious, events of the day are largely conquered by the soubrette soprano—Blonde, Susanna, Zerlina, and Despina. Each, with her plain talk and common sense, deflates authority and helps to create a better atmosphere for the downtrodden. Women's Liberation is indeed older in opera than in politics.

In embracing the Masonic order toward the end of his life, Mozart abandoned the liberation of woman in favor of liberation of all humanity. It took great courage for him, as well as for Schikaneder and his other associates, to perform *The Magic Flute* within the police-state atmosphere of 1791 Vienna. The Masons, whose secret rites upset the Establishment, were blamed for causing the French Revolution, and as a result, their ranks had become sadly decimated. Yet Mozart, a Catholic as well as a Mason, began the great finale of his opera with a Lutheran chorale, fully understanding its deep national significance. He used it as a musical bridge over the religious differences that had torn apart Central Europe. Schikaneder's deceptively innocuous libretto contained the following revolutionary sentiment:

Will he have the strength to endure the
ordeals which await him? He's only a
prince.
Much more than that—he is a man!

It is strange that *Zauberflöte* was not banned—perhaps the tyrannical Emperor Leopold guessed the impending death of Mozart. In truth, with Mozart's death, the Masonic order ceased—temporarily at least—to be of consequence in Austria. Its resurrection much later was as a conservative rather than as a liberal force.

A few days after Napoleon occupied Vienna in 1805, the first version of Beethoven's only opera, then called *Leonore*, was performed to a half-empty house. How the premiere of this strangely prophetic work could have occurred under these circumstances is indeed a puzzle. The libretto was based on a play by Jean-Nicolas Bouilly, a revolutionary who suffered under the Terror—like Beethoven, he embraced Bonaparte but later rejected him as the Judas of Europe. It was an act of courage to attempt *Leonore* in an occupied city, especially since half

her citizens were collaborators. It would have been an even greater act of courage had it been performed five years later, when the prophecy of Bouilly and Beethoven was coming true during the Peninsular War. "The Desired One" Don Fernando—Ferdinand VII—was returning to Spain to drive out the imperialist. Beethoven knew this as he triumphantly composed his final version of *Fidelio*—but he was doomed to disappointment, as he was by the promises of Napoleon. Ferdinand VII became, even in the eyes of present-day Spaniards, the worst ruler in their history. Goya warned his people through his acute depiction of the king's hypocritical glance in his numerous paintings. The only statue left of "The Desired One" lies as Ozymandias, half buried in a junk heap in the outskirts of Seville.

The humanist crisis of the Dreyfus Affair ripped France apart at the turn of this century. Zola, Clemenceau, and Anatole France at first found no supporters in the musical profession. It was expected that the conservatives Saint-Saëns and D'Indy would join the Establishment, but not the avant-gardists Debussy and Degas. Liberal support in the field of music came from a most unusual source—Norway's Edvard Grieg.



Ignace Jan Paderewski (born: Russian Podolia, 1860; died: New York, 1941). Possibly the most politically active musician of the century, pianist/composer Paderewski fought for the independence of Poland from Russia for many years before World War I. In 1919 he became the newly independent country's first prime minister and minister of foreign affairs, suppressing the various military factions that threatened national unity and obtaining from the Diet a national army. It was he who signed the Versailles Treaty for Poland. Long retired politically by June 1933, four months after Hitler had taken over Germany, Paderewski played a benefit concert in Paris for Jewish refugees. After the Nazi conquest of Poland, Paderewski became, in 1940, president of the Polish Parliament in Exile in Paris. His death in New York the following year occurred during a trip he undertook to promote the cause of Poland.

Grieg had been invited to conduct a concert of his own works in the Theatre Châtelet in September 1899. At this time—the crucial period of the Dreyfus Affair—he was at work on his cantata *Fred* (Peace), set to the works of his lifelong, though sometimes truculent, friend Bjørnstjerne Bjørnson. This cantata was scheduled for performance at the Paris World Exhibition in 1900. Grieg canceled the concert with a letter that ended: “Like all other non-Frenchmen, I am shocked at the injustice in your country and do not feel myself able to enter into any relation whatsoever with the French public.” The cantata was never finished, but Grieg eventually conducted a concert of his music in Paris in 1903, when the political climate was one of vindication for Dreyfus, who had not, however, yet been exonerated by the courts. The anti-Semites came to wreak vengeance on “the troll who defends his kind,” and created one of the most violent riots in musical history. But time had passed the rioters by. In the end Grieg—and Dreyfus—conquered. But only one critic reviewed Grieg’s concert favorably; he was from *Le Figaro* and his name was Gabriel Fauré.

The great nationalist composer of Finland is Jean Sibelius. The fatal year of 1899 saw the loss of Finnish autonomy to Tsarist Russia. Ready for the fray, Sibelius composed appropriate music for the tableaux which were to be part of the “Press Celebrations” that November. Each tableau depicted a scene from Finnish history or legend. It was the finale, however, which truly made Finnish history and legend. The living statues interpreted the tableau *Finland Awakes*, but no one could remain still for long. Sibelius’ music aroused the theater and the nation as no politician’s oratory could have done. This music was published under the title of *Suomi*—a word which made no sense to the Russians or their *Gauleiter* General Bobrikov. To the outside world it was *Finlandia*, and today remains the most stirring symphonic piece of musical patriotism yet written. Such works as Sibelius’ Second Symphony and his cantata *The Captive Queen* (all that is left of his attempt at opera) reminded the Finns of their national heritage. Five years later Sibelius wrote *In Memoriam*, a *Götterdämmerung*-scaled funeral march in memory of the young Finnish patriot, Eugen Schaumann, who assassinated the hated General Brobrikov in broad daylight.

Sibelius has been accused of being a “rightist” composer, and it is true that he, along with the vast majority of his people, welcomed aid from Germany in both world wars. Yet, if one studies history, Russia was Finland’s perpetual enemy—as Germany was Russia’s perpetual enemy. At the close of the First World War, remnants of the German army joined the Mannerheim division of the White army to fight against Bolshevik Russia in Finland. It was the only area in Russia’s last civil war where the Whites beat the Reds. If the Reds



Bob Fitch/Black Star

Joan Baez escorts her husband, David Harris, as he leaves for jail in 1969 after being sentenced to three years for refusing to submit to induction in the armed forces. The Harrises had long been anti-war activists and Baez’ “David’s Album,” released on Vanguard a month after the sentencing, was in effect a proclamation of their joint stance. Harris was released from jail this past March 15.

had won, there would be no Finland today—Sibelius cannot be blamed for the choice he made between two tyrannies.

The great musical movement in Tsarist Russia, despite its plethora of politically inspired operas by “The Five,” never got any composer in trouble, until Rimsky-Korsakov’s *Le Coq d’or*, which was thought to be a satiric comment on the fiasco of the Russo-Japanese War. This opera was banned until 1909, one year after its composer’s death. How the political implications of such operas as *Boris Godunov* could have flown over the heads of the Russian aristocracy seems beyond comprehension. Of course, the history of Russia itself seems beyond comprehension, culminating perhaps in the circumstances that prompted Rostropovich’s letter.

World War II drew lines in art as perhaps no other in history. In the long view it seemed that the easiest way out of an artist’s dilemma was defection to America—after all, we were, thanks to geography, destined to win. As early as World War I, two great musicians, Pablo Casals and Artur Schnabel, boycotted Germany. Casals went further, boycotting any nation that sported a totalitarian government, and any nation that supported that nation. Casals has returned to the U.S. despite our

recognition of the Franco regime, but he cannot bring himself to go back to Catalonia. To Casals, totalitarianism, whether from right or left, is an equal abomination. He has never played in Soviet Russia. On the other hand Rubinstein has played in many countries of totalitarian and anti-Semitic bent but not Germany.

World War II saw many musicians who gladly collaborated with totalitarianism—some are still with us. Others were forced to make a harder choice. Kirsten Flagstad was damned because she rejoined her husband in occupied Norway; Frida Leider was criticized because she refused to leave Germany with her Jewish husband. Both were eventually exonerated. Conductors such as Wilhelm Furtwängler and Karl Böhm performed “forbidden” works in a gamble between self-respect and collaboration, at times speaking out against the cancer that was destroying German art. Furtwängler, who steadfastly refused to conduct birthday concerts for Hitler, feigning illness each time, did conduct one birthday concert when informed the Führer was indisposed. The incriminating photo of Furtwängler on the podium and foxy Adolf in the front row has become evidence for those who do not care to find out the ameliorating facts. Like Furtwängler, Richard Strauss was fired from his job by the Nazis, and his intercepted letters to Stefan Zweig nearly cost him his life. Carl Orff has been accused of Nazism, yet his 1943 opera, *Die Kluge*, was as much a satire of Nazism as *Le Coq d’or* was of Tsarism. Arturo Toscanini refused to conduct in Nazi Germany, and events in his beloved Italy broke his heart. At first an enthusiastic supporter of Mussolini before his brand of socialism became “national,” Toscanini later rejected the tyrant. In 1928 Toscanini refused to conduct the Fascist hymn, *Giovinetza*, which was to have opened a concert, and thus was barred from the podium by the authorities. He still returned to his villa every summer for vacations and performances in Salzburg, but his frequent pronouncements to the foreign press against Mussolini and his Nazi ally caused his house arrest in the fall of 1937. The Italian underground finally succeeded in spirited the Maestro across the border to Switzerland, where he caught a plane that brought him to New York just in time for the first concert of the new NBC Symphony on Christmas night.

Ironically, and despite Ernest Newman’s thesis, it was often the completely apolitical musician who suffered most during the war. No conductor was more beloved by those who knew him than Willem Mengelberg, who singlehandedly brought the Netherlands into the mainstream of music, as well as bringing works by composers like Mahler, Strauss, Bartók, and Stravinsky to light for the first time. In his fifty years as conductor of the Concertgebouw, he gave concerts for millions of people, and if the Nazi occupation authorities numbered

among those millions, he didn’t care. He would play for anybody in the attempt to prove his thesis that “Only art, not politics, endures.” The Dutch people, loving him as they did, expected only the best from him, and thus, like Oedipus, he died in exile, bereft of every honor they bestowed upon him, in 1951. Time has forgiven or exonerated many music makers caught up on the wrong side during the war; Mengelberg was never exonerated during his lifetime, but Holland is holding a centennial festival in his honor this year.

Of all the tales of a musician laying down life for country or conscience, a special place must be given the Czech soprano Marie Podvalová. In Nazi-occupied Prague, staged operas in Czech were forbidden, particularly those by Bedřich Smetana that exalted Czech history (*Dalibor*, *The Brandenburgers in Bohemia*, and *Libuše*). In 1943 Podvalová aroused her colleagues to arrange a secret concert performance of *Libuše*, in defiance of the authorities. This opera tells the story of the legendary first queen of Bohemia, who founded a dynasty by marrying a peasant. Despite its simple tale, it is among the grandest of grand operas, containing monumental, yet tender music such as only Smetana could write. The final scene, after the wedding, is a long solo sung by the queen, who as if in a trance prophesies the future glories and terrors to befall her people. Her last phrase, taken up by the chorus (and often by the audience—I’ve seen it happen!), “*Ceský národ neskoná!*” is translated as “The Czech people will overcome!” No wonder this work was forbidden by the Occupation.

Hearing of the performance plans a bit too late, the Nazis proudly announced to the world press that they had allowed this performance to take place. The Czechs knew better and tried to convince their prima donna to call it off, but to no avail. At the conclusion of the work, performed as it was in street clothes, the audience could not help but join in the final chorus. During the applause, Marie Podvalová was quietly arrested and sentenced to two years’ internment in the concentration camp at Terezin. She managed to live through it, but to her this was not so important. Asked about it later, she said: “*Someone* had to do it.”

Arthur O’Shaughnessy, a member of the zoological department of the British Museum during the tumescent quietude of late Victorianism, left one poem, *Songs of a Worker*, which is remembered, but even *he* understood, as did Edward Elgar, who later set it to music. It begins:

We are the music-makers,
And we are the dreamers of dreams,
Wandering by lone sea-breakers,
And sitting by desolate streams;
World-losers and world-forsakers,
On whom the pale moon gleams;
Yet we are the movers and shakers
Of the world, forever, it seems. ●

What's Behind the Knob?

by Leonard Feldman

MANY STEREO ENTHUSIASTS regard an abundance of control knobs and switches as something of a status symbol. Others prefer only those controls deemed absolutely essential. Whatever your "knob-count" preference, I would like to present what to my knowledge is the first layman-clear picture of just what happens when a knob on a high fidelity component is turned or a switch is moved.

To begin with, there are only two fundamental actions that occur when any control is moved. One I call "signal amplitude division," the other is "signal turning on and off" or simply "switching." If you want to take an even more simplistic view, the first category of control action could loosely be termed switching, if, by definition, switching is also understood to mean "partial switching"—that is switching from a signal that is present in all its electrical amplitude to a smaller replica of the same electrical signal or vice versa.

Signal Amplitude Division

Even if you've never tried to read an electronic schematic diagram, the symbology used to represent controls which fall into this major category clearly suggests its function. In Fig. 1, the jagged line represents a resistor. What does it resist? Flow of current. The higher the resistance (expressed in ohms), the less current will flow through it when a given voltage is applied. This is the basis of the famed Ohm's Law (current equals voltage divided by resistance) taught in every high school physics class.

Now to make a fundamental point: in Fig. 1a, one end of a resistor is connected to the positive terminal of a 6-volt battery, and so its voltage or potential must also be 6 volts. And since the bottom of the resistor is connected to the ground or zero point, the voltage there must of course be zero. If we could carefully cut into the resistor at its midpoint, we would measure exactly 3 volts. At one quarter of the way up from the bottom, we would measure 1½ volts; three quarters of the way up, we'd get a reading of 4½ volts. And if the whole

surface of the resistor probe from bottom to top you could get any reading between 0 and 6 volts.

Musical programming amplified electronically consists of nothing but a complex arrangement of varying voltages. Unlike the battery voltage used in our explanation, the voltage alternates—it is an AC voltage. Unlike home AC power voltage, however, it is usually of much lower amplitude, and it alternates at all sorts of instantaneous rates (frequencies from 20 to 20,000 Hz) depending upon the instantaneous pitch of the musical note being amplified. For instance, if we were amplifying "middle A" on the piano, the voltage alternation would occur 440 times per second. From the standpoint of its function in "dropping" the voltage, the resistor behaves the same whether the voltage that appears across it is DC or AC. The voltage appearing at any point along the resistance is proportional to the ratio of that partial resistance compared to the whole resistance.

Now, suppose the resistor were built so that a sliding contact could touch it at any point along its resistive length. The schematic representation of this type of variable resistor is shown in Fig. 1b—the familiar "potentiometer" used in audio equip-

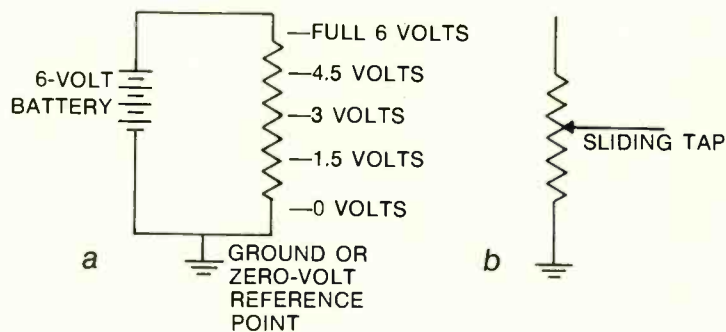

Fig. 1. A resistor (zigzag line) connected across a voltage source, as in a, develops or "drops" the full amount of voltage, of which various amounts may be tapped; b shows the symbol for a potentiometer, a resistor fitted with a slide or a rotator (symbolized by an arrow) that varies the amount of resistance in the circuit and consequently the amount of voltage picked off from it to feed to another circuit.



Fig. 2. The anatomy of a potentiometer (familiarily, a "pot"). At left, the complete device with its three connecting lugs and rotating shaft. The two end lugs get the full voltage since they are connected directly to the internal resistive element (see center photo). At right, the rotating member with its metallic wipers. One wiper contacts the resistive element at a particular point, depending on how the shaft is rotated. In this way the center lug becomes connected to the resistive element, and the point of connection—and hence the amount of resistance in the circuit—can be continuously varied at will.

ment for such functions as volume controls, tone controls, balance controls, and the like. Fig. 2 shows an actual single-section potentiometer, including an unusual view of it disassembled.

The schematic representation of the potentiometer in Fig. 2 is repeated in Fig. 3, this time with pictorial representations of a typical signal voltage applied to the "top" or "high" end of the potentiometer. A signal of such amplitude will appear smaller and smaller as the shaft and wiper contacts "pick off" less and less of it, as the shaft is rotated toward the "ground" or bottom end of the resistance, as shown by the series of waveform photos keyed to various points along the continuous resistance of Fig. 3. Of course, the amplitude of the waveform ultimately determines the "loudness" of the signal heard after it is retranslated from electrical energy to acoustical energy or sound. This, essentially, is how a volume control works.

A stereophonic amplifier is, in fact, two separate and distinct amplifiers. Its volume control must therefore be *two* separate volume controls, usually operated by a single knob on a single shaft. Fig. 4 shows such a control together with its schematic representation. The better the dual control, by the way, the more exactly the two commonly driven elements will select identical amounts of resistance at every point of rotation. If you have ever used a stereophonic amplifier in which the channels seem well balanced at *high* settings of volume, but tend to become unbalanced at low listening levels, it's due to the increasing discrepancy between the amounts of resistance picked off by the two elements as they recede further and further from the full signal amplitude. The ability of a dual control to pick off equal elements of resistance at all settings is known as its "tracking characteristic." A good dual control can maintain equality of signal picked off by the two sections within a very tight tolerance all the way from maximum loudness to inaudibility.

The familiar channel balance control is very

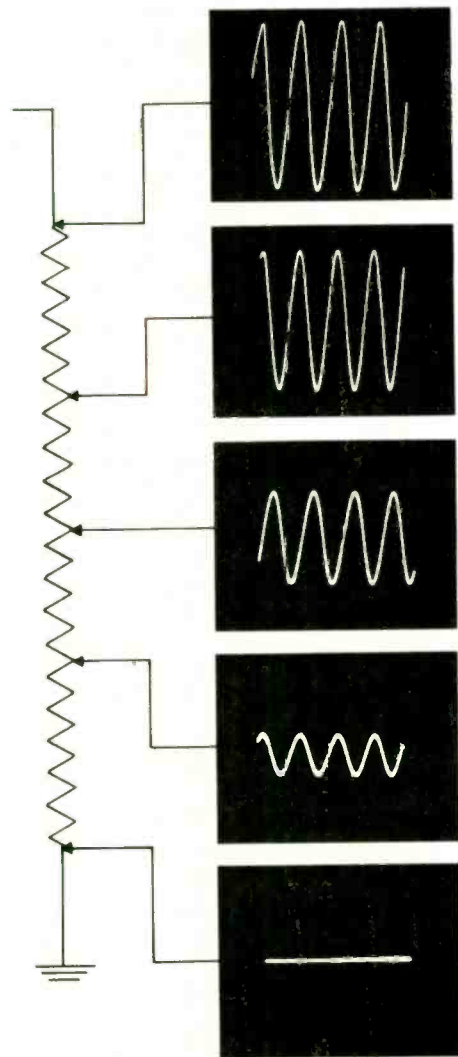

Fig. 3. Schematic of potentiometer showing signal amplitudes picked off by the sliding arm at various settings.

similar to a dual volume control except for the way in which it is hooked up (Fig. 5).

The very same types of rotary controls also are used to create tone-control circuits. These circuits employ an additional type of electrical component—the capacitor (once known as the “condenser”). A small capacitor tends to block the passage of bass tones while at the same time passing on higher tones with little or no diminution in amplitude. Figs. 6 and 7 illustrate schematically how this basic principle is used to create tone controls.

Several recent amplifiers and receivers are sporting a new type of control, in which vertical or horizontal movement of a knob accomplishes the same results previously achieved with rotation of a knob. The principle of variable resistance is still the same, however. A photo of a linear-motion or slide control is shown in Fig. 8.

Another form of dual control which you’ve probably seen has two knobs mounted on the same control shaft, yet each knob can be turned independently of the other. Such devices are often used for tone controls, in which the user is given the added flexibility of being able to adjust the tonal response of each stereo channel independently. Thus, the large, outer knob might control the bass response of the left channel while the smaller, concentrically mounted inner knob performs the same function for the right channel (see Fig. 9).

Signal Turning On and Off

The second major category of controls used in high fidelity equipment involves the turning on or off (switching) of signals. The schematic representation of some basic switches is shown in Fig. 10. When closed, a switch does nothing more than connect the ends of two wires. When open, it disconnects them. A non-audio use of this simple idea, which makes an important point about switching, is shown in Fig. 11.

Perhaps the most simply constructed switch is the so-called slide switch shown in Fig. 12. It is normally used for turning on and off such secondary functions as loudness contour, scratch filters, rumble filters, tape-monitor circuits, and the like.

If you can imagine several slide switches mounted side by side, equipped with plungers attached to the sliders with all plungers coming out towards you and parallel to the plane of the sliding action, you’re not too far from mentally constructing a multiple pushbutton switch bank. Mechanically, such pushbutton switches are a bit more sophisticated, since depressing one button usually requires that all other buttons automatically pop back out, but this action is accomplished by various springs, latching bars, and other mechanical niceties which need not concern us here. The important

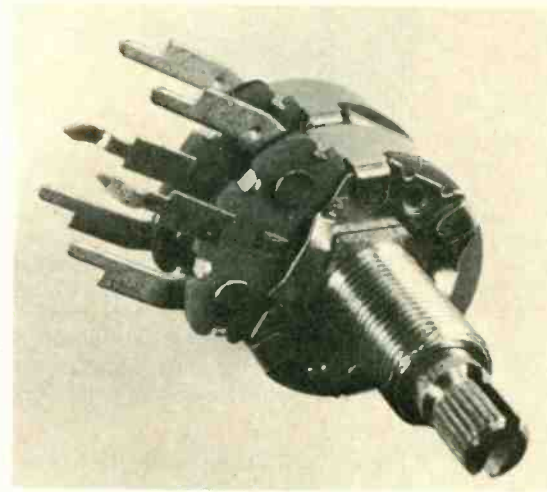
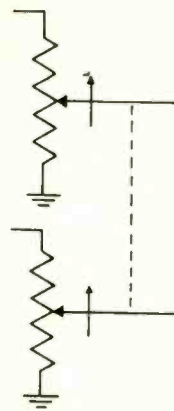

Fig. 4. A dual potentiometer is simply a pair of pots controlled by a common shaft. In the schematic representation the dotted line indicates that the sliders are ganged so that they move together as the shaft is rotated. The tiny arrows indicate the direction of the sliders for clockwise rotation of the shaft, in accordance with how the device is connected in a given circuit.

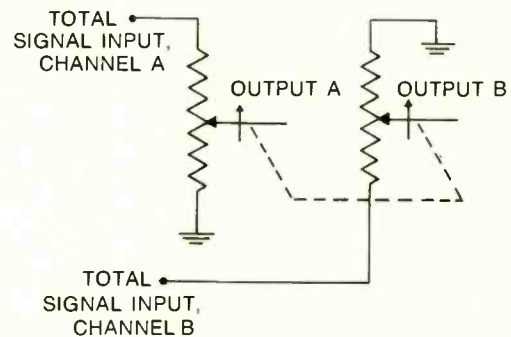

Fig. 5. A dual pot is connected in this manner to serve as a stereo channel balance control. Note that the sliders still travel together. However, the resistive elements (zigzag lines) are connected in opposite manner from each other: the upper end of one element is fed the total electrical signal with its lower end at ground or zero signal voltage, while the lower end of the other element is fed the total electrical signal of the other stereo channel, with its upper end at ground, or zero signal voltage. If both resistive elements are perfectly linear (equal change in resistance for each degree of shaft rotation), then rotating the shaft to its mid-point produces equal left channel and right channel voltages at the respective slider terminals. If the shaft is now rotated fully counterclockwise, the voltage appearing at the left-channel slider element will approach maximum. And that’s why your balance control is usually kept in exact physical and electrical center of rotation if you want equal levels of sound from each of your stereophonic speaker systems—or deliberately rotated off center if you want to raise or lower the level of one channel relative to the other.

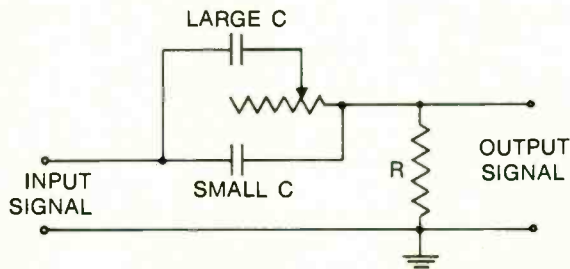

Fig. 6. This is how a pot can be wired into a circuit to serve as a "bass cut" tone control. Its slider is connected to a relatively large capacitor. If the slider arm is moved all the way to the right, all audio frequencies can pass directly through large C and thus will appear unattenuated across fixed resistor R. If, however, the slider is moved to the left, only the higher-frequency tones can pass through small C directly to resistor R. Lower frequencies must pass first through large C and thus through the total resistance of the potentiometer. It's as if the total amplitude of the low-frequency signals is now appearing across a very large resistor made up of both the potentiometer and fixed resistor R. Naturally, only a fraction of the amplitude will appear across R since much of it was dropped along the potentiometer. As a result, low-frequency tones appear at the output of the circuit diminished in level as compared with high-frequency tones. Thus, the "bass cut" effect.

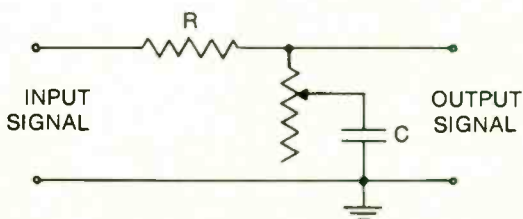

Fig. 7. A simple pot can be used for treble, or high-frequency, cut. When the slider arm of the pot is moved all the way up, high-frequency signals will flow through the small C right to ground—they are lost as far as the output is concerned. Low frequencies, on the other hand, cannot be "shorted to ground" by the small value of C, and so they do appear across the output unattenuated. Now, as the slider arm is moved downward, the previous "short circuit" (for high frequencies) is replaced by the finite, high resistance of the potentiometer itself, so all audio frequencies appear at the output with little or no attenuation if values of resistance and capacitance are chosen correctly. Most tone control circuits offer not only treble and bass cut, but also treble and bass boost. While more complex circuitry is used to achieve these double-acting control functions, the control used is invariably a potentiometer.

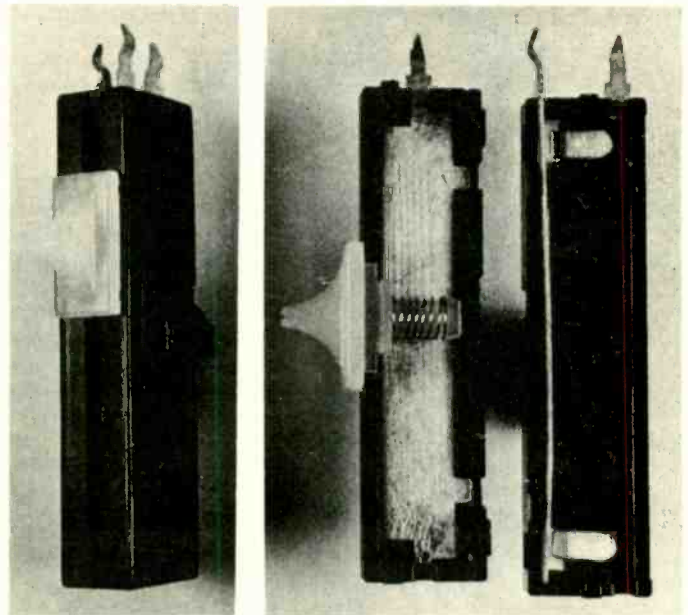

Fig. 8. Newest form of potentiometer uses linear, instead of rotary, motion. At left, the complete device; at right, disassembled showing the slider element and the fixed resistive element. Actually this form of control is closer in physical format to our schematic representation than the popular rotary controls, for here we have a slider that literally moves up and down or from side to side, just as it is shown schematically. Recent mechanical design breakthroughs have made this linear-motion control as simple to manufacture as its rotary predecessor and, psychologically, the listening public seems to favor "up for louder" or "down for softer" every bit as much as they were willing to accept "clockwise for louder" and "counterclockwise for softer"—so both forms of controls will probably be with us from now on.

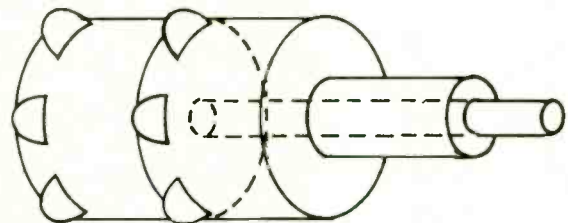

Fig. 9. Dual concentric potentiometer: each section is operated by its own shaft and control knob. Schematically, a dual-concentric pot is represented as simply two separate units. As a rule, the outer shaft is hollow and controls the slider of the front resistive element. The inner shaft is solid, passes through the outer shaft, and regulates the rear element slider. Often a friction clutch arrangement enables the user to rotate both shafts by turning either knob. Alternatively, you can keep one knob stationary with one hand while turning the other independently.

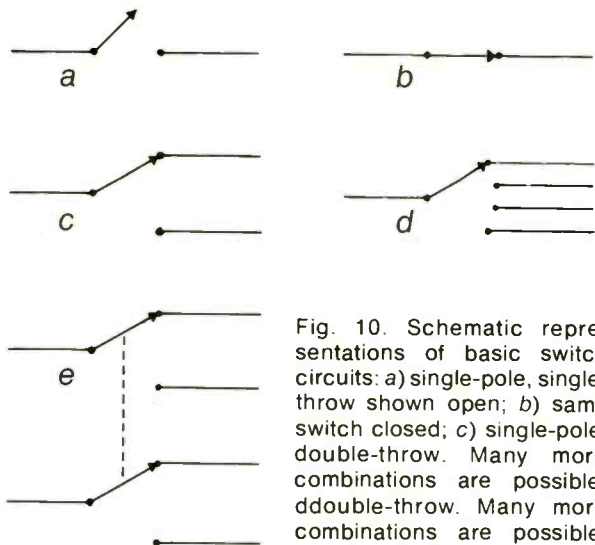

Fig. 10. Schematic representations of basic switch circuits: a) single-pole, single-throw shown open; b) same switch closed; c) single-pole, double-throw. Many more combinations are possible. d) double-throw. Many more combinations are possible. e) double-throw. Many more combinations are possible.

thing to remember is that a pushbutton switch does no more than any other kind of switch—it simply makes and breaks electrical contacts.

Often a switch element will be mated to a potentiometer used for a volume or tone control. A combination volume control/on-off switch is shown in Fig. 13. Electrically, the two functions are completely unrelated in that the “making” and “breaking” of the power-line connection has absolutely nothing to do with lowering or raising the volume of sound. Nevertheless, it is convenient to have the latter action take place when the shaft of the potentiometer is rotated completely counterclockwise so that the sound gets lower and lower and, finally, with a clicking sound, the whole equipment is turned off altogether. Schematically, the combination is often represented with a dotted line indicating a mechanical linkage between the rotation of the slider element of the resistor and the opening and closing of the rear switch section. Physically, it is quite simple to attach a little tab to the rotating shaft portion of a conventional potentiometer so that at one point in its circular travel it trips a spring-actuated switch element. The switch portion of such a combination is shown taken apart from its companion resistive element in Fig. 13. Yet another type of combination control is shown in Fig. 14.

Despite such intriguing combinations, most switches are used solely as switches. Names such as slide, rotary, lever, and pushbutton (to mention but a few) describe how the switching action is initiated by the user. The switching itself still consists of nothing more than the connecting or disconnecting of two wire ends, or multiples thereof. For instance, the simple rotation of a selector switch from, say, the AM radio position to the FM radio position may “make” and “break” some or all of the following circuit points in a single motion: 1. Disconnect the wire containing AM audio from the wire leading to the amplifier input. 2. Connect the wire containing FM radio to the same amplifier input.

Fig. 11. Quite apart from how they work, switches have long been a source of fascination in that they can be used to solve problems that are susceptible to “yes-no” analysis. The concept of switching, refined to a very high degree, is of course basic to computer design. On a more modest scale, which still demonstrates the logic of switching, is that perennial favorite: the problem of how to turn one light on or off from two separate positions.

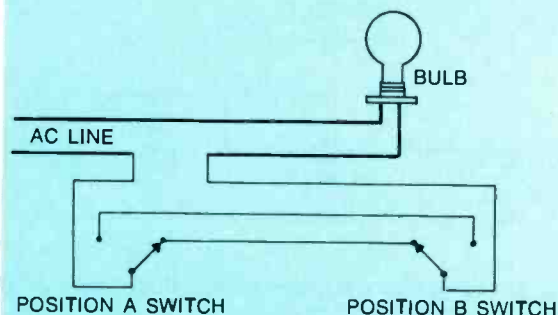

The correct wiring solves the problem simply and effectively. This basic principle of accomplishing as much as possible with the least complexity is germane to all switch-control arrangements, including those found in audio equipment.

3. Turn off operating voltage from the AM tuner section of the receiver.
4. Turn on operating voltage to the FM tuner section of the receiver.
5. Short out all unused signal wire ends (such as “phono,” “tape,” “aux” inputs, etc.) to ground, to prevent signal “leak-through.”
6. Open up previously shorted “FM” signal wire ends.

The most popular form of switch used to perform multifunctions such as those just mentioned is the rotary switch, available with any number of wafers or decks depending on what it must do. A single-deck switch capable of selecting one of several possible positions) such as AM, FM, phono, for example) and able to make or break several circuits in each of its positions is shown in Fig. 15. A multiple deck switch is shown in Fig. 16. The number of decks may be increased to three, four, or even more when enough switching functions are demanded. Each deck can have as many as eleven positions, spaced thirty degrees apart. Switches of this type can be designed to perform complex make-and-break circuits in virtually every combination of contacts imaginable and it is a “favorite sport” of many design engineers to see how much switching they can accomplish with the lowest number of contacts and decks.

The familiar stereo headphone jack now incorporated into virtually every stereophonic amplifier or receiver offers an example of a somewhat different kind of switching. Here, the switching action actually occurs when you insert the plug of your

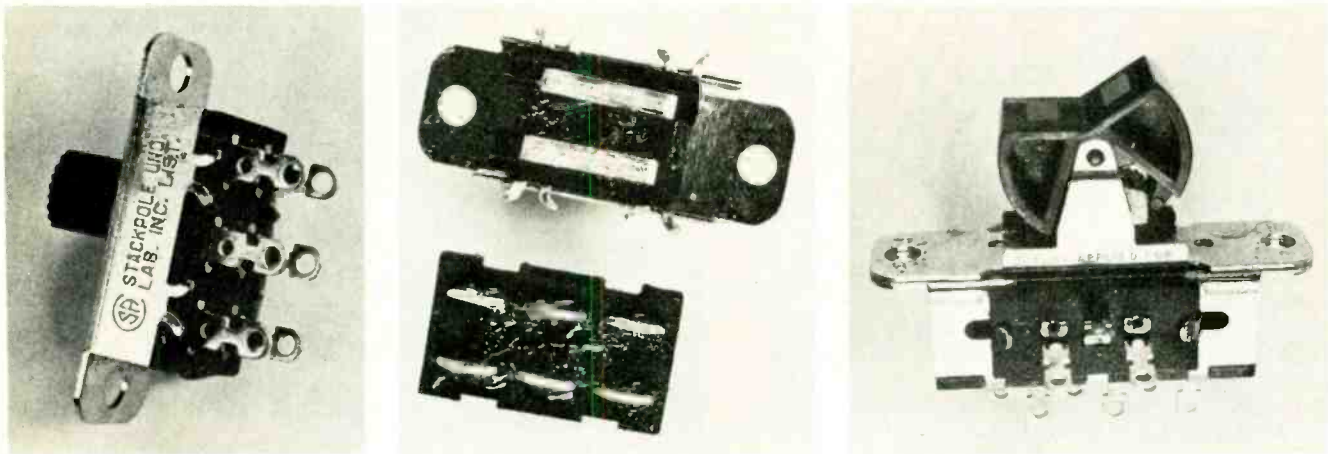

Fig. 12. A simple slide switch, outside and inside. The latter view reveals how it works: parallel metal contacts join the center terminals to a pair at either end, depending on which way you move the control slide above. By adding a plastic topping to the slide, switch manufacturers have dressed up the lowly slide switch and transformed it to the "rocker switch"—nicer to look at and easier to operate. This particular switch is a double-pole, double-throw type (see Fig. 10e).

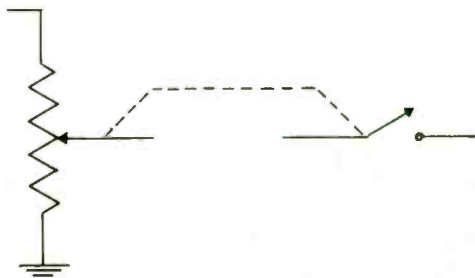

Fig. 13. Schematic symbol and photo of a potentiometer combined with an off/on switch, a device widely used as a combination power switch and volume (or tone) control. Closeup of internal section shows how switch works: when potentiometer shaft is turned to extreme counterclockwise position, a tab on the resistive element trips switch contacts (that familiar click you hear).

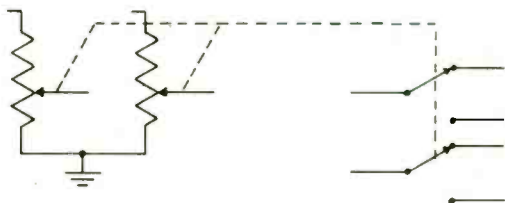
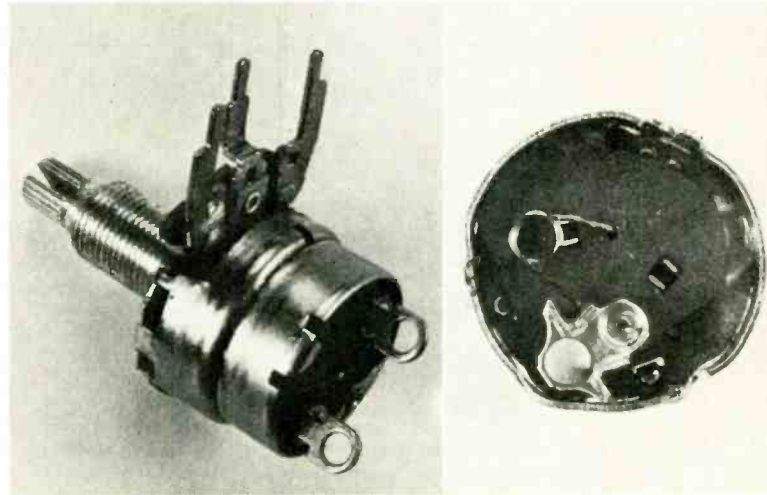
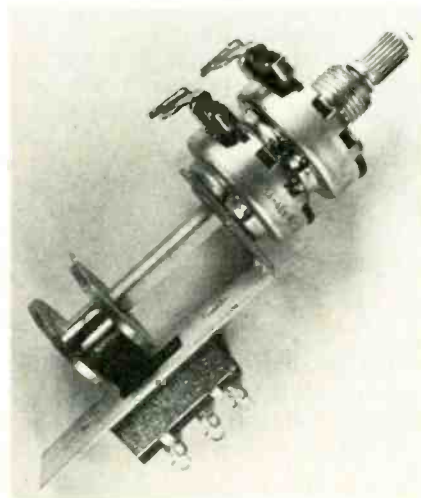

Fig. 14. A dual-ganged potentiometer may be combined with a slide switch in this manner. The pots are controlled by a common shaft that is hollow; through it a narrower shaft extends and terminates in the gripping device that moves the slide switch. This design often is used as a volume control combined with power off/on switch. Schematically, the combination in the photo is represented as a dual-ganged potentiometer in turn ganged with a double-pole, double-throw switch.



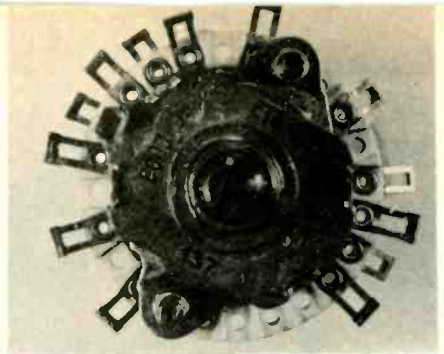
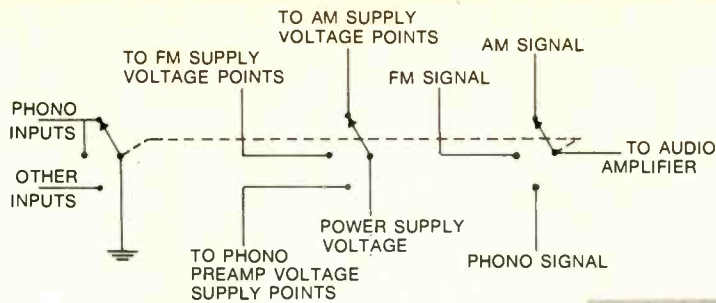
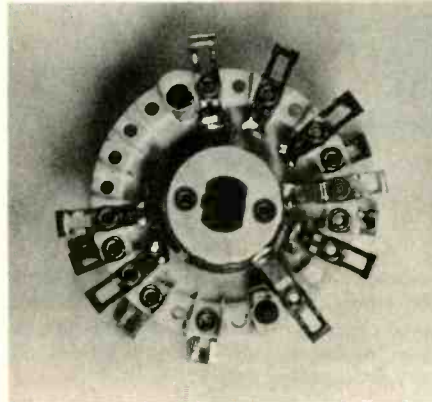

Fig. 15. How a three-pole, three-position switch might be used in an AM/FM receiver. Switch is shown in AM position: phono signal is grounded; power supply voltages are being fed to AM circuit points; AM signal is being fed to amplifier section. Keeping in mind that all three portions of the switch move together (the dotted line means they are ganged), you can trace the three simultaneous circuit actions for its other two positions. The photos show a closeup of the front and rear of a single wafer or deck of a rotary selector switch, such as might be used to accomplish the switching action just described. The outer rings of tabs or lugs serve as terminals for wires going off to parts of the set; they in turn are interconnected by metallic slides or "shorting members" that move into position as the shaft is rotated. A spring latch insures that the shaft will rotate in steps of exactly thirty degrees; mechanical stops at



the extremes of rotation limit the action of the switch to the number of positions intended by its designer.

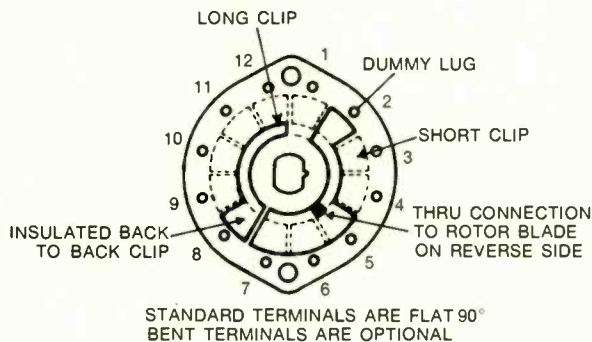
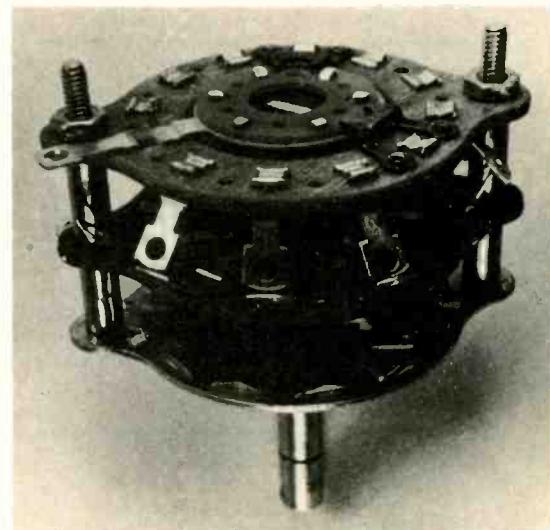

Fig. 16. The rotary selector switch is widely used in audio equipment. Its versatility—thanks to the number of decks it may include, not to mention the possible variations in size and shape of its contact slider and in the arrangement of its lugs—is virtually limitless. The drawing shown here (courtesy Centralab) is an actual sample worksheet used by design engineers to create new switching circuits. A variation of this type of switch is the lever switch: a long handle replaces the conventional knob to perform the same function.



stereo headset. The photo in Fig. 17 makes the action very clear.

A Special Case

The one control that generally does not fall into the two basic categories we have been discussing is the AM or FM tuning knob. It neither makes a signal greater nor smaller, nor does it switch a signal on and off in the conventional sense. Its function is

to tune your radio circuits so that they will respond only to a given radio frequency, be it AM or FM. A tuning circuit consists of a variable capacitor and a coil. From a control standpoint, the important item here is the variable capacitor which, as you rotate it, "tunes" the circuit that it forms with a fixed-value coil and thereby selects different incoming broadcast frequencies. This is shown symbolically, together with a close-up of an actual unit, in Fig. 18.

The odd thing about this widely employed tuning

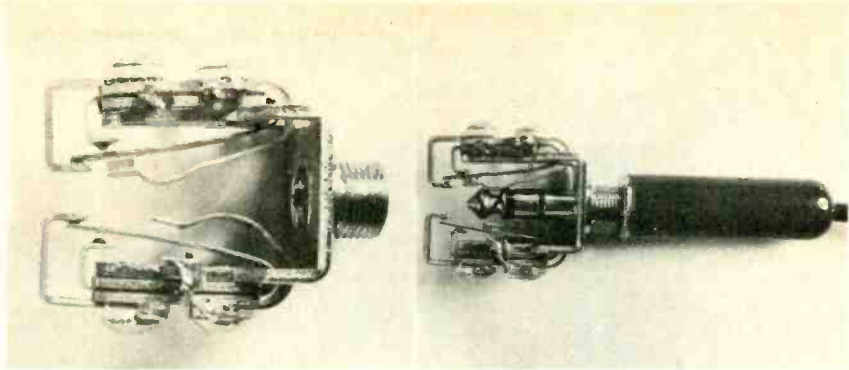
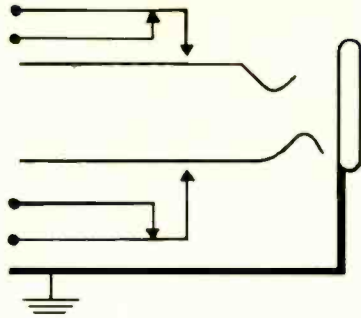

Fig. 17. Phone jacks are actually an ingenious form of switch, activated when the mating plug is inserted. Shown here is a stereo headphone jack, with and without the plug. As the plug is inserted, one set of contacts is "broken" (opened), while another set of contacts is "made" (closed). The contacts that are broken are those which connect the amplifier output to its speaker terminals; the contacts that are closed are those which connect the amplifier output to the shaft of the inserted plug. Note that the shaft itself is divided into three sections, separated by insulation. The forward two sections carry left and right channel signals; the rear section handles the ground connection. All contacts in the phone jack are under spring tension so that when the plug is removed, the original circuit hookup is automatically restored.

method is that it relies on a fairly crude mechanical effect (the close spacing of metal plates) to perform a very delicate electrical phenomenon (the precise adjustment of a variable circuit). Nonetheless, radio equipment of all types the world over employ just such a device to tune in stations and obviously it has proven eminently satisfactory.

But innovation rarely is absent from this field. Recently, some tuners have been introduced which do not rely on the mechanical interleaving of capacitor plates. Certain semiconductors, called diodes, behave like a capacitor when small voltages are applied to them. Furthermore, changing the voltage applied to these diodes actually changes their apparent capacitance. By utilizing the familiar potentiometer with DC voltage applied to its upper terminal, as shown in Fig. 19, the sliding arm of the potentiometer can pick off any amount of this voltage and apply it to the voltage-variable capacitance-diode and thereby tune an FM or AM set fully across its frequency band.

With such electronic sophistication taking hold in equipment design, my dictum that all control functions are a matter of either changing a voltage level or of switching in a "yes" or "no" fashion becomes truer than ever. This bit of intelligence will not make your equipment perform better, but it can at least give you a keener understanding of what goes on behind the controls as you operate them.

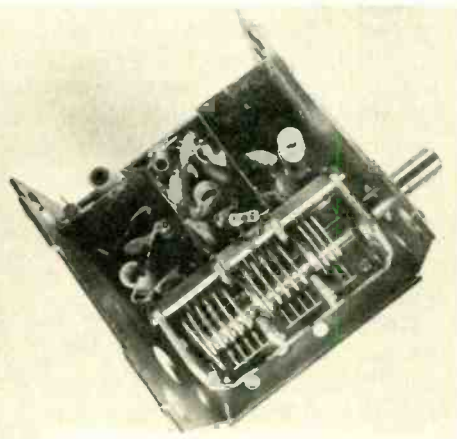
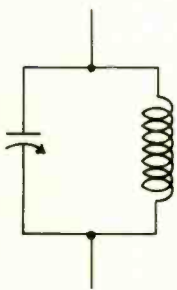

Fig. 18. Schematic representation and photo of a typical radio tuning circuit. The combined electrical action of capacitor and coil determines the frequency to which the circuit will respond, or becomes "tuned to." Theoretically, varying the value of either the capacitor or the coil will do the trick; for practical design reasons the capacitor became standardized years ago as the variable element and thus the control for the circuit. (The curved arrow in the schematic indicates the variable capacitor.) Increasing the value of capacitance lowers the tuned frequency; decreasing the value of capacitance raises the tuned frequency. Therefore, the knob you turn when tuning in a station (FM or AM) is linked—usually via a system made up of a shaft, dial string, pulleys, and drum—to a variable capacitor. Such a capacitor, of the electrical characteristics required for broadcast frequencies, consists of a group of stationary plates insulated from, but interleaved with, a group of movable plates. The more interleaved the plates become, the higher the capacitance and thus the lower the tuned frequency. At 88 MHz (the "low end" of the FM dial) the plates will be fully meshed, while at 108 MHz (the "high end" of the dial) the plates will be fully apart from each other.

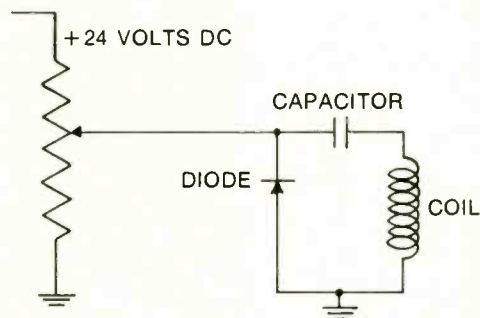

Fig. 19. Back to the pot. The newest form of radio-tuning circuit eliminates the venerable tuning capacitor (a fixed-value capacitor is used only for frequency stability), replacing it with a semiconductor device known as a diode in combination with a potentiometer. Varying the potentiometer applies different amounts of voltage to the diode, thereby tuning the circuit to different frequencies.

1971

Four Channels

by Robert Long

OVER THE LAST YEAR or so a number of companies have been actively—and more or less publicly—pursuing the means by which four-channel sound can be recorded on disc. Others doubtless have been working with less fanfare. All of the systems so far available for public scrutiny are described as compatible: the discs will play on existing stereo (or mono) equipment without sacrifice of basic program information. This is not to say that the sound necessarily will be as good as that on regular stereo discs.

A stereo disc can produce two virtually independent left and right channels because the two planes in which the pickup stylus moves to track such a record are at right angles to each other: a stylus moving in plane L in our diagram will produce no output in the right channel (plane R). Equal motion in the L and R planes will produce a mono signal (equal outputs to left and right speakers). The sound representing stylus motion in plane F, will

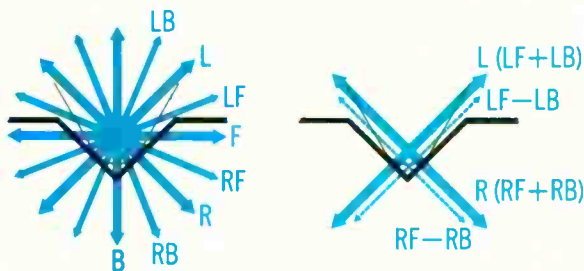

"PHANTOM" CHANNELS JVC MULTIPLEXED GROOVE
L-LEFT; R-RIGHT; F-FRONT; B-BACK; ETC.)

appear to come from the front. Other in-between signals can be simulated by combined motion in two planes, but these intermediate directions of stylus motion no longer are independent of each other. The smaller the angle between them, the greater the interaction. The "encoded" systems for cutting four-channel discs seek to control this interaction by adjusting amplitudes and phase relationships in the original signals that determine groove geometry.

Although exact operating data on some proposed four-channel disc systems still are guarded with a certain secrecy, basic principles are fairly well known. Here are the main contenders.

Stereo 4. The Feldman/Fixler system is best known and has resulted in the Electro-Voice encoder designed to combine (or matrix) the original

four channels into two for optimum recovery through the presently available EVX-4 decoder (or a comparable kit announced by Metrotec). Scheiber, who introduced an encoding system some time ago in conjunction with Advent, recently joined forces with E-V, and the parties involved agree that the two systems are fundamentally the same. Stereo 4 decoders are included in a new component line from Allied Radio Shack, and similar products are expected from other companies. Some of the smaller record companies have issued appropriately encoded discs.

Hafler/Dyna. These discs also can be reproduced via one of Hafler's four-channel speaker hookups (for instance via Dynaco's Quadaptor), the simplest and least expensive road to four-channel sound. The effect is similar to that with the EVX-4 but not identical—at least not with all recordings or all possible hookup configurations.

Sansui. An encoder using a somewhat different approach to phase juggling has just been announced; it will complement the Sansui SQ-1 four-channel synthesizer-decoder.

CBS. The darkest horse of all, this matrixed system involves relatively sophisticated control of phase relationships between channels. So far it has been demonstrated only to insiders.

JVC. The radically different approach taken by Victor of Japan places left and right (actually LF-plus-LR and RF-plus-RB for our purposes) information on the two groove walls in the usual way, then superimposes on each a supersonic subcarrier. These subcarriers are modulated, respectively, with LF-minus-LB and RF-minus-RB signals. Decoding is comparable to that in a stereo FM receiver. Since the two planes of groove modulation remain at right angles, the problem of channel separation is effectively solved, but the high subcarrier frequency requires exceptional frequency response (to about 50 kHz) in the playback cartridge and limits program content per side to some 20 minutes.

JVC discs can be played on normal stereo equipment but are not compatible in terms of four-channel sound with those of any other system. Proponents of encoding have refined recording techniques in recent months to improve the four-channel effect, but none has been entirely successful in matching the sense of space and directionality produced by the best of the JVC demos—which in those respects approximate the "discrete" four-channel tape systems.

on Discs



by Leonard Marcus

TODAY THE RECORDING FIELD vibrates to the sound of the future. Industry talk centers less around old repertoire than around the salvation promised by new formats. Whichever formats become permanent—quadriphony, video tape, cassettes, cartridges—when we look back on the early 1970s some twenty or so years hence, we will certainly see at least the implications of that era's home entertainment technology in today's apparent chaos. But if one were to pick a year that best foretold today from among the ninety-four years that mark the range of phonographic history, it would have to be 1904.

That was the year of the first double-sided record, issued by Odeon in Europe and first demonstrated at the Leipzig Fair that spring.

1904 was also the year of the first long-playing discs, issued by Neophone in London. The 78 rpm (one-sided) records could play up to ten minutes of music since they were twenty inches in diameter!

And it was the year of the first four-channel sound reproducing system. Four years earlier, at the 1900 Paris Exposition, the Columbia Phonograph Company had exhibited a three-track cylinder phonograph created by its Bridgeport, Connecticut plant manager, Thomas Hood Macdonald, the Peter Goldmark of his day. Three tracks were cut simultaneously and side by side along a cylinder, the cutting styli being powered through three horns. Playback was accomplished through the same three horns. Columbia called the apparatus its Multiplex Graphophone Grand. The "unique and marvelous instrument" cost \$1,000 and the first sale was to the Shah of Persia, who had it sent "together with thirty-two barrels of records to Batum on the shore of the Black Sea," according to

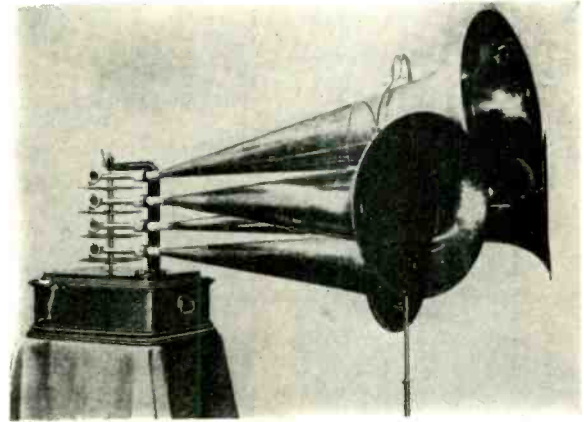

a Columbia copywriter, "whence the shipment was carried on the backs of dromedaries to far away Teheran with its great gold dome glistening in the sunlight!"

What was the purpose of this unique and marvelous gadget? Trinaural sound? Hardly. The horns were placed as close together as possible in order to lessen any distinction among the channels. But in those early pre-electric days, a great aesthetic obstacle was lack of volume. Three channels and three horns simply ensured that the music would bleat three times as loudly as it would through one horn.

A couple of years later the Bridgeport plant manager designed an even grander "multiplex" phonograph to be exhibited by Columbia in 1904 at the Louisiana Purchase Centennial Fair in St. Louis. Not only would there now be four styli playing four records through four horns, but the records would be discs—the new fad—rather than cylinders. In order to guarantee the greatest fidelity to the various segments of the frequency range, Macdonald installed horns of different sizes: one fifty-six-inch with a large bell; two of the same length but with smaller mouths; and, on the bottom, a forty-two-inch. As with the Multiplex Grand, a metal stand was supplied to support the horns; otherwise, of course, the whole thing would have toppled over.

Whatever happened to it? Nothing. It apparently was never put on the market. The problem of perfect synchronization proved beyond solution by 1904 technology, and the cost would have been beyond the capacity of most 1904 pocketbooks.

Simply put, the public was not ready for a four-channel playback system. Whether it is ready now remains to be seen. ●



You don't have a Horowitz album like it.



M 30464

For the first time in his career, Vladimir Horowitz has recorded a Rachmaninoff solo album.

The first side features his new recording of the Sonata in B-Flat Minor. It's some of Horowitz' most fiery and dynamic playing.

And on the other side are additional new recordings of five more Rachmaninoff pieces: Prelude in G-Sharp Minor, Moment Musical in B Minor, and three Etudes-Tableaux.

Horowitz' performances of these pieces possess all the lyricism and poetry of the composer. And of the artist himself.

Both sides have been recorded in concert at Carnegie Hall, Philadelphia's Academy of Music, and Constitution Hall in Washington, D.C.

But what's really special is what the music reflects: his close friendship with Sergei Rachmaninoff.



MS 7106*

MS 7264*

And listen to these three other fine performances by Vladimir Horowitz.
On Columbia Records

M2S 757* (A 2-record set)



Total Victory in the Bach Revolution

The Concentus Musicus' outstanding "original instrument" performance of the *St. Matthew Passion*.

by Clifford F. Gilmore

THIS IS THE first "original instrument" version of the *St. Matthew Passion*, but that's only one plus factor in a long list of qualities that make this the most outstanding Bach choral recording of the year, if not the decade. There are several first-rate groups who currently specialize in performances of early music on instruments of the period and in as historically accurate a manner as possible, but so far only Nikolaus Harnoncourt and the Concentus Musicus of Vienna have tackled the big choral works of Bach. The group first began attracting international attention with their recording of the *Brandenburg Concertos* back in 1965, then went on to raise quite a flurry of controversy with their absolutely unique, scaled-down, original-instrument version of the *St. John Passion* a year later. It's now just two years since their equally revolutionary recording of the B minor Mass renewed much of the same controversy (though that recording went on to win the Gold Medal of the HIGH FIDELITY/Montreux International Record Award), and

this *St. Matthew* will surely provoke many of the same arguments all over again. On the other hand, this approach to early music can hardly be called revolutionary any more, and according to my own private opinion poll, tastes have progressed quite a lot in the five years since that pace-setting *St. John* appeared; audiences are now much more ready to understand and accept Harnoncourt's outspoken iconoclasm. In addition, in terms of matching achievements to intentions, this *St. Matthew* seems to be Harnoncourt's most successful venture yet.

For those Rip van Winkles who have missed the discussions of the earlier recordings in the series, let me try to describe just what makes Harnoncourt's unique reading so important. The use of the instruments of Bach's time (or modern reproductions) is actually of less importance than many of the interpretive details, but it is a vital first step in establishing the internal balances that Bach heard and was writing for. Once the process is begun, it must be carried all the way: if you substitute an

eighteenth-century oboe for a modern one, it will be overpowered by a mass of today's violins with their steel E strings and brilliant regulation. Most theorists of the time agreed that one oboe would balance well with three or four violins, and these are the proportions on this recording: each of the two orchestras is made up of two oboes and six violins, with a viola, cello, violone, bassoon, and two flutes.

But far more important in producing the special "sound" of this performance is the manner in which the band of specialists plays. The strings, for example, use vibrato sparingly, almost as an ornamental device, and everybody involved articulates Bach's carefully indicated phrasings with utmost accuracy and distinctness. Bach, with characteristic attention to the minutest of details, has carefully drawn in slurs throughout the piece, typically over groups of two, three, or four notes; only rarely does a slur last more than one measure. The result here is a texture of quite astonishingly beautiful transparency and utter clarity of detail. If ever a piece of music demands this kind of clarity, it's the *St. Matthew* Passion, which is scored for two four-part choruses, a third *soprano in ripieno* choir, and two full orchestras, often all playing independent parts.

On both the *St. John* Passion and B minor Mass recordings the Concentus Musicus was joined by the boys and youths of the Vienna Choir Boys and the Viennensis Chorus. Inexplicably, they were passed by for this recording and instead we have choruses made up of boys from the Regensburg Cathedral Choir (sopranos) and the men of the King's College Choir, Cambridge (altos, tenors, and basses), directed by David Willcocks. Harnoncourt's over-all direction, however, is still most strongly felt and these choristers sing with every bit as much accuracy, purity, and sweetness of tone as the earlier Vienna group. I was fearful that the German diction from the Englishmen would not match that of the native German sopranos, but those fears were soon put to rest.

Many listeners will initially be surprised at the unusually brisk tempos of the opening chorus and of the chorale chorus which closes Part I. However, the extremely articulate phrasing and light textures make the quicker tempos acceptable, even desirable, and after the second hearing the logic and necessity—and effectiveness—of these tempos convinced me completely. Throughout the work the shorter dramatic choruses are sung with exquisite delicacy, grace, or intensity as the occasion requires. Only in the chorales are there a few disappointments: Willcocks/Harnoncourt (mis?)interpret the fermatas at the ends of phrases as holds in about half the chorales; in the others they make a full break at the end of each phrase, even when no pause is called for in the text.

At last we come to the soloists, and here again Harnoncourt has gone to the limit in providing exactly what Bach calls for. In the last of his several revisions Bach assigned every note in the *St. Matthew* Passion either to *Coro I* or *Coro II* or both, whether it be aria, recitative, chorus, or instrumental solo. The usual procedure nowadays is to employ two choruses, two orchestras, and one quartet of soloists for all the arias, plus a separate Evangelist, a Jesus, and perhaps additional soloists for the small roles of Judas, Peter, Pilate, etc., ignoring completely Bach's *Coro I* and *Coro II* assignments. Harnon-

court provides a quartet of soloists *each* for the two choirs, plus an additional bass for the role of Jesus. The two quartets then take all the small roles according to their voice and choir as well as their several arias. For instance, Max van Egmond (*Coro I*) sings two of the bass arias (as well as the roles of Judas, Peter, Pilate, and others) while Michael Schopper (*Coro II*) sings the other two. The recording engineers have followed through by channeling everything from *Coro I* through the left speaker and everything from *Coro II* through the right. For the antiphonal numbers this is an obvious procedure, but the employment of two complete sets of soloists (they are never called upon to sing together) and the engineers' insistence on keeping them separated, even when several consecutive numbers emanate from one chorus, seemed at first to be a rather pedantic extravagance. However, after two or three sides had gone by, the characters on the left and right began to take on very special spatial identities, and I began to get an inkling of the effect this work must have had in Bach's church with the two choirs (and their own soloists) on opposite sides of the building responding to one another and occasionally (in the chorales) joining together in unison. The work then took on an altogether new dramatic impact that, frankly, I had never before thought to look for.

The outstanding solo work in this performance is undoubtedly the Evangelist of Kurt Equiluz, now the finest *St. Matthew* Evangelist on records. He narrates the story as if he were telling it for the first time, with a fresh directness and simplicity and no wasted gestures or sentimental meanderings—though he can be tender or poignant or intense when the occasion warrants. His nimble reading would be an asset to any performance, but he seems particularly at home with Harnoncourt's similarly unsentimental reading. He also does a magnificent job with one of the two tenor arias, "*Ich will bei meinem Jesus wachen*." Nigel Rogers handles the other aria, "*Geduld*," with ease.

There have been more effective readings of the role of Jesus than Karl Ridderbusch's, although his is beautifully sung and in perfect accord with Harnoncourt's over-all view of the work. The other soloists have all been carefully chosen to match the requirements of their parts. Furthermore, they display an amazing unanimity of purpose in matters of style, such as ornamentation, which surprisingly is sparsely applied by the way. Special mention should also go to the (unidentified) boy from the Vienna Choir Boys who sings the soprano arias of *Coro I* with a quite spectacularly beautiful tone, and to countertenor Paul Esswood, who turns in tremendously moving readings of the "*Erbarme dich*" and the other alto arias of *Coro I*.

In sum, a well-nigh perfect realization of a masterpiece; a comparison with the many other available recordings would be meaningless since they are all birds of a distinctly different feather. By all means hear this one as soon as possible.

BACH: *St. Matthew* Passion, S. 244. Paul Esswood, Tom Sutcliffe, and James Bowman, countertenors; Kurt Equiluz, Evangelist and tenor I; Nigel Rogers, tenor II; Karl Ridderbusch, bass (Jesus); Max van Egmond, bass I; Michael Schopper, bass II; soloists of the Vienna Choir Boys; Regensburg Cathedral Boys Choir; King's College Choir, Cambridge (David Willcocks, cond.); Concentus Musicus, Nikolaus Harnoncourt, cond. Telefunken SAWT 9572/5, \$23.92 (four discs).

A Rachmaninoff Eruption by Harris Goldsmith

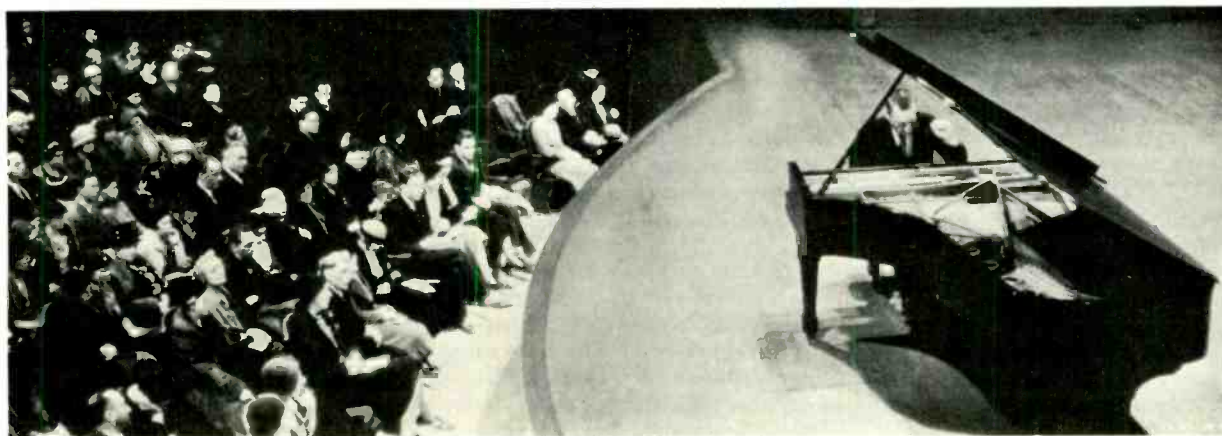

Horowitz, Weissenberg, Estrin, Ponti, and Bernette match their virtuosity against the composer's.

SERGEI RACHMANINOFF, like most great performer/composers, penned his piano music to suit his own very extraordinary digital technique. The D minor Concerto, for example, was written, frankly, as a vehicle for the virtuoso's first American tour in 1909, and most of the smaller *morceaux* undoubtedly were specifically tailored to be encores at solo recitals through the years. The worth of Rachmaninoff's *oeuvre* as music has been disputed in some quarters—there are still many who cannot abide the slithery chromatic density of the writing or its frequent diffuseness of form. There is no disputing Rachmaninoff's decisive and easily recognizable stylistic profile, however: this music abounds with kaleidoscopic, shifting rhythms, and passages of glittery complexity—few composers before him had written so many notes and yet intended so few of them to be actually heard. Yet, as many “simplifiers” have found out to their distress, it is virtually impossible to fake Rachmaninoff's passagework: every note must be played with impeccable and uncompromising accuracy if the requisite “swirl” is to be reproduced.

Understandably, a large portion of Rachmaninoff's music followed him to his reward, for few could match him in it. He did, of course, hear a few superb performances from certain colleagues and on these he bestowed his wholehearted blessings. The late Benno Moiseiwitsch was an “approved” re-creator, and when Rachmaninoff heard the young Vladimir Horowitz' brilliant exposition of the Third Concerto, he swore never to touch the work again (a vow he fortunately broke in 1939 when he gave posterity a heavily truncated recording). Horowitz, fortunately, is still very much with us, and in 1968 he played Rachmaninoff's rarely heard Second Piano Sonata honoring the twenty-fifth anniversary of the composer's death. This act of homage—taped at the concert—now appears on a splendid all-Rachmaninoff Columbia recording simultaneously with an unprecedented deluge of other new Rachmaninoff discs.

It is doubtful whether this stupendously difficult sonata will ever achieve the popularity of, say, the C minor

Concerto: the music tends to drown in its own complexity. To my ears it has the aesthetic and structural drawbacks of the D minor Concerto without that work's occasional irresistible melodic attraction. For all that, Horowitz makes one listen to the composition anew, and he “puts it over” splendidly. The very special demonic intensity of this remarkable performance is but one of the many qualities that give this very special artist a decided edge over even so fine a player as John Ogdon, who has recorded both of Rachmaninoff's sonatas for RCA. Horowitz also possesses a miraculous lyrical sense, and his wonderful diversity of texture and nuance couldn't be better suited to the music. The upside of this magnificent collection contains shorter works also taped “on location” to judge from the occasional cough or audience noise. In every instance, Horowitz' extra voltage and insight are manifest in innumerable ways. The G sharp minor Prelude is played with brooding intensity and a certain patrician detachment; the scampering Op. 33, No. 6 Etude has a quivering felicity that makes it seem almost faster than light itself; the Op. 39, No. 9 peals out with thunderous sonorities. One remarkable feature of Horowitz' Rachmaninoff impresses me anew: for all its magnificent singing lushness and color, the tone remains spare, limber, and even a mite *sec*. So much the better, for it eats its way into the music like lye into grease. The impactful reproduction, while not really beautiful (e.g., the recent Horowitz Schumann *Kreisleriana*), is thoroughly airy and lifelike.

Alexis Weissenberg's complete edition of the Rachmaninoff preludes for RCA shares some of Horowitz' pianistic virtues—the former Leventritt prize winner was obviously one of the young keyboard lions spawned under the Horowitz star in the '40s. One can praise the extreme power and electric clarity of Weissenberg's fingerwork, for in many ways he is a sensational pianist. Alas, he is also a sensationalistic one: quite often musical values are sacrificed here for outrageous extremes of tempo. The phrasing is often tortured and fragmentary, lacking simple melodic cogency and flow, and his rubato

is stilted. Dynamics (pianissimos especially) are frequently disregarded so that every note sounds with a definition that I am sure Rachmaninoff never intended. On the whole, Weissenberg's rendition of the Op. 32 preludes is far more successful than those of Opp. 3 or 23. The later pieces are more infused with velocity and neurosis. It is my hunch that Weissenberg is at his best when his fingers are kept busiest, and my suspicion is fully borne out by the evidence at hand. RCA's recording is extraordinary for its bite and tonal penetration, though the studio acoustics do not always flatter this controversial pianist's bloodless type of sonority.

Michael Ponti's Vox album is the first of Vox's projected integral edition of all the Rachmaninoff piano music. I have liked some of Ponti's earlier recordings (particularly his Moscheles, Henselt, and Moszowski) but am sorely disappointed with his work here. To be sure, this strong technician gives an admirable, unpretentious account of the variations on *La Follia* (mistakenly attributed to Corelli) and a relatively secure and unaffected one of the Op. 32 preludes. On the whole, though, Ponti shows precious little affinity for Rachmaninoff's style here. These are thuddy, perfunctory run-throughs, square-toed and stolid in phrasing, usually percussive and unsinging on top, and sometimes (as in the *Etudes Tableaux* and Op. 23 preludes) sloppily articulated. Vox's sonics are, moreover, quite unpleasantly metallic.

Morton Estrin's account of the thirteen Op. 32 preludes, on the other hand, is an honest, admirable affair. In a way, it's a shame that Connoisseur didn't have him record the Op. 23 works instead. The competition, less extreme in the earlier preludes, is just a bit too much for Estrin in Op. 32. On the whole he is a sensitive, clean-fingered player with an attractive sense for cogent, unfettered phrasing and a pleasing lyricism. As his nimble performances add up, however, a certain blandness and neutrality of temperament manifests itself. (I also felt his G sharp minor Prelude, Op. 32, No. 12 to be a shade too static and tentatively phrased.) Estrin, one might say, is caught between the extremes of Weissenberg's sometimes apropos driving brilliance and the more

diversified color and lyricism achieved by a Brazilian pianist Yara Bernette, who plays an assortment of Rachmaninoff preludes on a single Deutsche Grammophon disc. Miss Bernette's entry may not seem seriously competitive if completeness is desired; on closer scrutiny, her collection is very competitive indeed. For one thing, DGG has managed to squeeze all but No. 3 of the Op. 23 preludes onto a single side, and all but Nos. 11 and 13 of Op. 32 on the reverse, without in any way compromising their very beautiful sound quality. Such generosity, needless to say, would be of little concern if Miss Bernette's interpretations were undistinguished. Fortunately, she plays the pieces exquisitely. A very fine mistress of the keyboard, Miss Bernette sails into all the difficulties with perfect aplomb and without ever confusing pianism with egotism. Her basic sound has sheen and solidity, attractive coloristic variety, and a superb, singing clarity. She may not achieve such an avalanche of tone as Weissenberg does in the *appassionato* Op. 32, No. 6 and she may not take the more difficult alternatives in some of the Op. 32 pieces as both Weissenberg and Ponti do, but her playing is the most balanced of all. I suspect it will have the most staying power—except, of course, for those astounding performances by Richter, Horowitz, or the composer himself.

RACHMANINOFF: Preludes for Piano, Op. 23 (No. 3 omitted); Op. 32 (Nos. 11 and 13 omitted), Yara Bernette, piano. Deutsche Grammophon 2530 007, \$6.98.

RACHMANINOFF: Preludes for Piano, Op. 32. Morton Estrin, piano. Connoisseur Society, CS 2028, \$5.98.

RACHMANINOFF: *Etudes Tableaux*, Op. 33: No. 6; No. 2; *Etudes Tableaux*, Op. 39: No. 9; *Moment Musical*, Op. 16, No. 3; *Preludes for Piano*, Op. 32: No. 12; *Sonata for Piano*, No. 2, in B flat minor, Op. 36. Vladimir Horowitz, piano. Columbia M 30464, \$5.98.

RACHMANINOFF: *Etudes Tableaux*, Op. 33; *Etudes Tableaux*, Op. 39; *Fantasy Pieces*, Op. 3; *Preludes for Piano*, Op. 23; *Preludes for Piano*, Op. 32; *Variations on a Theme by Corelli*, Op. 42. Michael Ponti, piano. Vox SVBX 5456, \$9.95 (three discs).

RACHMANINOFF: *Preludes for Piano*, Op. 23; *Preludes for Piano*, Op. 32; *Fantasy Pieces*, Op. 3: No. 2. Alexis Weissenberg, piano. RCA Red Seal LSC 7069, \$11.96 (two discs).

The Fantasy World of Pierrot Lunaire

Nonesuch presents an ideal introduction to Schoenberg's seminal masterpiece.

by David Hamilton

THAT THERE ARE currently more recordings of Schoenberg's nearly sixty-year-old masterpiece in the catalogues than of, say, Schumann's *Frauenliebe und Leben* is a circumstance I take to be a sign of musical health. Not that there is anything wrong with *Frauenliebe*, after all; but *Pierrot* is one of those seminal works that stand at the portals of our century's music. As Charles Wuorinen observes in his notes for the new Nonesuch recording, "The art of every age contains a few works that we all must confront," and the echoes of composers' confrontations with *Pierrot* can be found resounding through the succeeding decades in vastly dissimilar works ranging from Berg's *Wozzeck* and Walton's *Façade* to Boulez' *Le Marteau sans maître* and Maxwell Davies' *Revelation and Fall*. The general public has been much slower to assimilate Schoenberg's score and its implications—no doubt in part because it doesn't fit easily into any of our conventional concert-hall formats; the forces required are unusual, and it turns up most frequently on "modern-



Jan DeGaetani

music" concerts rather than in conjunction with standard repertory. Whereas Stravinsky's *Sacre* and other path-breaking orchestral works are long since part of the general listening experience, *Pierrot* remains off the beaten path.

There are many facets to *Pierrot*, and the ten recordings we have had to date illuminate the score from distinctly different perspectives. The most substantial divergences hinge upon that imaginative yet controversial device, the *Sprechstimme* ("speaking voice"), the pitched declamation of text that Schoenberg first used in *Die glückliche Hand*, Op. 18. We have had recordings at both poles, speaking and singing. Ilona Steingruber, in a now deleted Vanguard recording, literally sang the voice part despite the composer's explicit declaration that this was incorrect, and Marie Therèse Escribano, on the new Turnabout disc, comes perilously close to doing the same thing. Erika Stiedry-Wagner, in a 1940 recording conducted by the composer himself, interpreted the notation with great freedom, and Schoenberg confirmed on other occasions that he approved of this performance.

Yet there is no doubt that musical coherence is aided if the notated pitches can be clearly projected, and many musicians would agree that Schoenberg had not clearly thought through all the problems posed by the technique; there are certainly anomalous spots in the score, where a strict rendering according to Schoenberg's instructions (both his verbal preface and his musical notation) can give contradictory, even ludicrous results. Among the currently available performances, that by Helga Pilarczyk and Pierre Boulez (Everest 3171) leans most pronouncedly towards speech. Like most dramatic sopranos, the German singer has a rather low-pitched speaking voice, and she tends to stay within the rather limited tessitura that a more or less natural speaking tone permits; thus, the two-and-a-half-octave notated range gets short shrift at the higher end. The result has some advantages, for it sounds "natural," avoiding the heavy expressionistic overtones, the "spooky" quality that many found in the Stiedry-Wagner performance.

Bethany Beardslee's performance with Robert Craft (Columbia M2S 679, the first volume of the apparently

abortive Schoenberg series) makes much more use of the lyrical possibilities of the voice, and the interpretation, though free, is always dramatically compelling, with a superb realization of *Der kranke Mond* (especially the troublesome final line); unfortunately, her less than idiomatic German pronunciation may constitute a drawback for some listeners. Alice Howland's sensitive reading (Concert-Disc CS 232) has always seemed to me on the pallid side, and Miss Escribano, aside from her tendency to sing, simply doesn't have the vocal thrust; her little-girl's sound cannot summon up the weight needed for the big dramatic pieces.

The remarkable thing about Jan DeGaetani's performance on the new Nonesuch disc is how close she has managed to stick to Schoenberg's instructions; this is not singing, yet a very high proportion of the pitches are made clear and the various pieces brilliantly and individually characterized. Miss DeGaetani has emerged in recent years as one of our best singers, and her interpretation of *Pierrot* is an exciting proof of her eminence.

Instrumentally, too, the new Nonesuch version is exceptionally distinguished for its qualities of ensemble and balance. In no other recording of the work do so many details come clear, even the fiendishly complex texture of *Der Mondfleck*, probably the most difficult number of the sequence, makes sense here (to be sure, Arthur Weisberg takes it more slowly than anyone else, but what good is the "correct" tempo if the result is a scramble?).

Indeed, my only complaint with this new recording is the matter of balance; the instruments are not in quite the same aural plane as the voice, and the total impact of the textures lacks the requisite immediacy. Fortunately, the sound is very clean, so that little is lost—but I recommend playing it at a slightly higher volume level than usual, so that the instrumental fabric stands out more clearly.

Certainly the new Nonesuch is the best *Pierrot* we have, and happily at a bargain price. I will not give away the old Schoenberg version, which has some extremely sensitive instrumental work as well as the unique authority of the composer's direction (and the participation of players long associated with *Pierrot*, including Edward Steuermann and Rudolf Kolesch; nor the Beardslee-Craft, still an enthralling interpretation with some very strong support from excellent players; nor the Pilarczyk-Boulez, a *sec* and almost chilly reading that illuminates what the composer/conductor finds fascinating about Schoenberg's masterpiece. But Weisberg and DeGaetani bring out both the wit and the fantasy of the score to a greater degree than anyone else.

Another factor that makes this recording an ideal introduction to *Pierrot*—and an obligatory purchase for Schoenbergians as well—is the inclusion of a brilliant translation of Hartleben's poetry by Robert Erich Wolf, perfectly evoking the *fin-de-siècle* extravagance of the poetry; in addition, there is the fine program note by Charles Wuorinen. By dismal contrast, Turnabout requires you to write in for a translation!

B **SCHOENBERG:** *Pierrot Lunaire*, Op. 21. Jan DeGaetani, voice; Contemporary Chamber Ensemble, Arthur Weisberg, cond. Nonesuch H 71251, \$2.98.

B **SCHOENBERG:** *Pierrot Lunaire*, Op. 21. Marie Therese Escribano, voice; instrumental ensemble, Friedrich Cerha, cond. Turnabout TVS 34315, \$2.98.

classical

reviewed by

ROYAL S. BROWN
R. D. DARRELL
PETER G. DAVIS
SHIRLEY FLEMING
ALFRED FRANKENSTEIN
CLIFFORD F. GILMORE
HARRIS GOLDSMITH
DAVID HAMILTON
PHILIP HART
DONAL J. HENAHAN
PAUL HENRY LANG
ROBERT C. MARSH
ROBERT P. MORGAN
GEORGE MOVSHON
H. C. ROBBINS LONDON
SUSAN THIEMANN SOMMER

BACH: Cantatas: No. 51, *Jauchzet Gott in allen Landen*; No. 199, *Mein Herze schwimmt im Blut*. Elly Ameling, soprano; Maurice André, trumpet (in No. 51); German Bach Soloists, Helmut Wanschermann, cond. Philips 6500 014, \$5.98.

Elly Ameling has given us in recent years many sparkling, poised, intelligent, and musical readings of various items from the concert and oratorio repertory. I, for one, highly praised her work on the London recordings with Münchinger of the *Christmas Oratorio*, the *Easter Oratorio*, and the *Magnificat*. Now on a new Philips disc she tackles *Jauchzet Gott*, which may be called the supreme trial piece for all those who would claim the title of Bach soprano par excellence. If she is not a complete success here, at least she comes as close to it as any of her recorded competition.

I recently waxed ecstatic over Carole Bogard's vocal and interpretive fireworks display on a Cambridge recording of this cantata, but the instrumental accompaniment there (Ghitalla's trumpet playing excepted) is miserably inadequate. Agnes Giebel is definitely in the running with a wonderfully restrained and elegant performance on Telefunken, but my favorite has been (and in some respects still is) Maria Stader's tremendously incisive and forceful reading with Karl Richter on an ancient (early stereo) Archive recording. Ameling misses some of the excitement that Stader and Richter offer, but it cannot be denied that she is in better control of the notes. She floats effortlessly through many of the long phrases that force Stader to gasp and lunge, and she has no difficulty articulating cleanly the torturous coloratura of the brisk opening movement and the very fast closing chorale and alleluia. Needless to say, Ameling's grasp

of the stylistic requirements is unsurpassed.

Cantata 199 is a lesser-known solo cantata (probably written in Weimar) whose sequence of four arias and recitatives progresses from a mood of profound remorse at the sinful state of the soul (adagio; solo oboe and strings) to one of tender confession (andante; strings). The catharsis is a remarkable chorale movement with viola obbligato, followed by a joyful (vivace) concluding aria in jig time which is reminiscent of Handel at his folksiest. Except for a dull but accurate viola player, Ameling et al. do a superb job with this cantata, easily surpassing the only competition, Stader's so-so reading with Helmut Müller-Brühl on None-such. C.F.G.



BACH: Harpsichord Works: Partita No. 2, in C minor, S. 826; Fantasias: in C minor, S. 906; in C minor, S. 919; Prelude, Fugue, and Allegro, in E flat, S. 998; Capriccio on the Departure of His Beloved Brother, S. 992. Wanda Landowska, harpsichord. RCA Victrola VIC 1594, \$2.98 (mono only) [S. 826, S. 906, and S. 992 from RCA Victor LM 2194, 1957; S. 998 and S. 919 from RCA Victor LM 1217, 1940s].

"The Landowska Collection of Harpsichord Music, Vol. 1" reads the promising inscription on this disc: Landowska recorded frequently for RCA so the series should be an extensive one. The first all-Bach program has been beautifully planned, with three extended but formally contrasted pieces separated by the two brief C minor fantasias. With so much musical variety in the hands of such an excitingly musical harpsichord player, this recital could hardly fail to impress. Landowska's command of Bach has rarely been surpassed by other harpsichordists—the magisterial sweep of the partita's *sinfonia*, the deliciously playful *postiglione* effects of the capriccio, or the passionate impetus of the S. 919 fantasia are all delivered with precise accents and masterful insight. The 1957 recordings still make an impressive sonic impact, and the earlier pieces are only marginally less well reproduced. P.G.D.

BACH: "Organ Works, Vol. I" Preludes, Fantasias, Toccatas, Fugues, Trio Sonatas. Helmut Walcha, organ (Schnitger Organ of St. Laurenskerk at Alkmaar, Silbermann Organ of the Church of Saint-Pierre-le-Jeune, Strasbourg). Archive 2722 002, \$36 (eight discs).

Helmut Walcha has been with us for quite a few years: his first recordings of Bach organ works began to appear during the last days of the 78-rpm era. Then between 1947 and 1952 Archive added to its LP catalogue some eighteen discs of Walcha playing almost all the organ works on the Schnitger organs at Cappel and at the St. Jakobi Church in Lübeck. With the advent of stereo, Walcha began the task of recording for a second time the complete

works on the magnificent Schnitger organ in the St. Laurenskerk at Alkmaar. The project was begun in 1956, but the bulk of the work was done in 1962, and these records began appearing in this country in or about 1964, as the older mono versions were withdrawn. After a hiatus of seven years, in 1969-70 Walcha decided to complete the unfinished stereo set, using however the Silbermann organ in the Strasbourg Church of Saint-Pierre-le-Jeune to record those works not previously recorded at Alkmaar. This handsomely produced eight-record box, then, consists of four and a half discs of material from Alkmaar, available in this country since the mid-Sixties in several different coupling formats, plus three and a half discs of brand new material from Strasbourg. Labeled "Vol. I," it contains almost all the preludes, fantasias, toccatas, fugues, and trio sonatas; in other words, all the organ works *not* based on a chorale. (In a couple of years we should see Vol. II, which promises to be even larger, containing all the chorale-based works.) What has been omitted from this first volume is primarily those works of which Bach's authorship is in doubt. For instance, absent are the eight "little" preludes and fugues, all of Vol. IX of the Peters edition which includes the so-called "jig" fugue, *Little Harmonic Labyrinth*, Pedal Exercise, the Aria in F, etc. In addition, none of the six concertos is included nor are any of the single-movement trios. To be sure, everything of substance is included on these eight discs, and some of the ditties omitted well deserve their excision.

A detailed description of each of the thirty-nine works here would be superfluous because Walcha's playing has remained remarkably consistent from his earliest mono recordings right up to 1970. His tempos are invariably moderate or slow, and his once highly praised metronomic regularity now sounds relentlessly square: even the improvisatory nature of the opening of the G minor *Fantasia* fails to sway him.

Archive's recording of the celebrated instrument at Alkmaar, even of those five pieces recorded in 1956, is extremely well done: the rückpositiv is recorded very close up, the rest of the organ further away, with just the right amount of warmth and large room reverberation. If Walcha had used the organ's generous supply of upper work more, rather than the masses of 8-ft. sound, the instrument would

Explanation of symbols

Classical:

- Budget
- Historical
- Reissue

Prerecorded tape:

- Open Reel
- 8-Track Cartridge
- Cassette

A film-maker talks about the V-M Professionals.

Joe Sedelmaier's prize-winning work appeared in film festivals in San Francisco, London, the Continent. His commercial TV work won awards in New York and Cannes. He sound-tested our new speakers.

"Let's open with pistol shots."

Good tone burst test. (He had recently recorded them, ricochets and all.) Shots came in quick succession, but the new speakers in our Professional series gave each a clean, whip-crack sound. We all flinched at the ricochets.

That's what good speakers are all about. Add nothing, leave nothing out. With ours, you hear the sound as recorded, not as interpreted by speakers.

"Let's try narration."

Model 93—Enclosure: airtight, infinite baffle. Speakers: 10" dynamic air suspension woofer with 4 lb. magnet, 28 Hz free air resonance; 4½" sealed back mid-range; 1" domed diaphragm, closed back tweeter. Frequency response: 37-22,000 Hz; 5 db ref 1000 Hz. System impedance: 8 ohms. Crossover: LC crossovers 12 db/octave; 1000 Hz, 5000 Hz. Power rating: 85 watts peak, 40 watts RMS. Separate mid-range and tweeter controls. Dimensions: 13½" h. x

23" w. x 11½" d. Weight: 41 lbs.

Voice, especially a mellifluous baritone, is an excellent speaker test. No "tubby" sound, no thump or boom, because our speakers have no peaks in the upper bass frequencies.

"How about a sound track?"

A marvelous test, because it had speaking voices, vocal and instrumental music, and sound simultaneously, all in different perspectives. All the layers emerged, undistorted, undiminished, balanced just as they were mixed.

We planned it that way. Our new Professional Model 93 uses a domed tweeter with superb transient response, beautiful dispersion, and extremely low distortion. Mid-range is half-roll surround, self-contained enclosure design. And the acoustic

23" w. x 11½" d. Weight: 41 lbs.

Model 91—Enclosure: Same as Model 93. Speakers: 8" dynamic air suspension woofer with 35 Hz free air resonance, 3" sealed back tweeter with low mass voice coil. Frequency response: 40-18,500 Hz. System impedance: 8 ohms. Crossover: LC crossover 12 db/octave, 1850 Hz. Power rating: 55 watts peak, 25 watts RMS. Individual tweeter control. Dimensions: 11¼" h. x 20" w. x 10" d. Weight: 28 lbs.

suspension woofer produces bass down to 30 Hz without doubling or distortion. The inductive-capacitive crossover network gives seamless transitions from lows to highs.

"Doesn't sound 'enclosed'."

Thank our computer. It worked out the best balance among the countless variables in speaker-enclosure systems.

If the Professionals can please a film-maker, musicians, recording engineers, sound technicians, people whose business is sound, we're confident they can make you very happy, too. For all the facts and figures, write: Professional Series, Dept. 74, P.O. Box 1247, Benton Harbor, Mich. 49022.

Made in Benton Harbor, Michigan by V·M Corporation.

 **V-M Corporation**



CIRCLE 52 ON READER-SERVICE CARD



She's
conquered
the world.
But her
heart
belongs
to Spain.

Soprano Victoria de los Angeles has explored virtually every musical corner of her homeland. She has dusted off manuscripts in cathedrals and castles to bring to life a musical heritage that dates back to the Middle Ages.

Happily, she has recorded that wealth for Angel, accompanied by authentic ancient instruments. She sings in original dialect, in a voice of almost instrumental purity. And each song glows with her love.

"She seems to save her freshest, sweetest, most feminine and subtly nuanced tonal coloring for the Spanish repertory. The performances are bewitching." (*High Fidelity*)

Her 7 albums of Spanish repertory may well be her most glorious.

Cantos de España (S-35937)

Songs of the Renaissance (SL-35888)

Songs of Andalusia (SL-36468)

Songs of Catalonia (S-36682)

Spanish/Sephardic Songs (S-36716)

Zarzuela Arias (S-36556)

20th Century Spanish Songs (S-35775)



CIRCLE 8 ON READER-SERVICE CARD

surely have sounded even better, as it does in E. Power Bigg's recordings. The Silbermann organ, used for the recordings made in 1969-70, has been subjected to numerous "resotations" over the years (carefully documented in the accompanying booklet) with the result that it sounds like no Silbermann of my acquaintance. It cannot compare in magnificence and dignity to the Schnitger at Alkmaar. It is, furthermore, fuzzily recorded.

In the words of the Dylan song, "The times, they are a'changin'!" and Helmut Walcha and his style of playing are now, at best *passé*. If you're shopping for a complete set of Bach organ works, the effort necessary to turn up either of Lionel Rogg's two separate eighteen-record sets will be well spent. C.F.G.

BACH: St. Matthew Passion, S. 244. Kurt Equiluz, tenor; Nigel Rogers, tenor; Karl Ridderbusch, bass; Max van Egmond, bass; Michael Schopper, bass; et al.; soloists of the Vienna Choir Boys; Regensburg Cathedral Boys Choir; King's College Choir, Cambridge; Concentus Musicus, Nikolaus Harnoncourt, cond. For a feature review of this recording, see page 67.

BACH, C.P.E.: Die Israeliten in der Wüste (The Israelites in the Desert). Sylvia Geszty and Catherine Gayer, sopranos; Ernst Häfliger, tenor; Hermann Prey, baritone; Chorus of the Berliner Singakademie; Radio Symphony of Berlin, Mathieu Lange, cond. Archive 2708 021, \$13.96 (two discs).

When Carl Philipp Emanuel Bach shook the dust of Frederick's court from his heels and removed to Hamburg in 1767 to take over Telemann's job, he found himself charged with the duty of providing music for no fewer than five churches. This necessitated a healthy amount of corner-cutting, and Carl Philipp borrowed right and left in patching together scores on what seems to have been perpetually a rush basis. Occasionally, however, he wrote works for broader consumption, destined for repeated church and/or concert performances both in Hamburg and beyond, and with these he took great pain and minted every phrase afresh. Such a composition is the 1769 oratorio (or cantata, as Karl Geiringer calls it), *The Israelites in the Desert*.

Heinz Becker, in the notes accompanying Archive's fine recording, describes this work as a link between the oratorios of Handel and the more secular pictorial essays on Biblical subjects by Haydn. I admire the designation for its historical tidiness, but it places *Israelites* in flattering company. C. P. E. Bach deliberately turned his back on the polyphony and textural complexity of J. S. Bach and the orchestral richness and vocal drama of Handel; and the neoprimitive, illustrative bent of Haydn represented another temperament and another age entirely. *Israelites* is stately, solid, and firmly unexciting. There is, to be sure, some character depiction in the cast: the two Israelite Women are the complainers on every tour; Aaron is the soothing, everything-is-going-to-be-all-right figure of reassurance; Moses is awesome, irritated, and commanding. Much of this comes through in the recitatives, which are extensive and which embody the most individually expressive writing in the score. But there is

not a line of counterpoint in the oratorio, and while the arias—particularly those for the two women—are limpid and flowing, there is little contrast among them. The showiest aria goes to the First Israelite Woman, sung by Sylvia Geszty with authority, vigorous projection, and a clarion-bright tone entirely appropriate; in a song of thanksgiving (No. 21) she negotiates the high coloratura with a flexibility that falls just a shade short of being totally easy. The next most impressive role is that of Moses, who in a song of jubilation (No. 18) wheels impressively through some florid passages of his own. Hermann Prey sings the part with a lift, a tonal focus, and a vocal thrust that are a joy to hear—all the more fortunate in that the one dramatic episode of the work falls to him, at the moment when the crowd of Israelites interrupts him repeatedly with interjections of despair (a pale reflection of "*Eilt, ihr angefocht'nen Seelen!*" from the *St. John Passion*), whereupon Moses strikes the rock and water pours forth. (Even Carl Philipp couldn't resist the running figuration of strings to illustrate this point, much as his father might have done.) Catherine Gayer, the Second Israelite Woman, is just sufficiently darker than Miss Geszty in vocal timbre to provide contrast and create an extra dimension of interest in their one duet. Ernst Häfliger's Aaron rings out with a fullness of tone and resilience of rhythm that do not desert him even in some exceptionally low-lying phrases. The Berlin Singakademie chorus renders its crowd-depiction willingly and with strength, and conductor Lange paces the music well. It is all pretty, but the really great oratorios leave it in the shade. S.F.

BEETHOVEN: Mass in C, Op. 86. Ely Ameling, soprano; Janet Baker, mezzo; Theo Altmeyer, tenor; Marius Rintzler, bass; New Philharmonia Chorus and Orchestra, Carlo Marla Giulini, cond. Angel S 36775, \$5.98.

If one includes the old Beecham version, there are now four LPs of the Beethoven Mass in C, a work scarcely known in America when I graduated from college a quarter of a century ago. Giulini certainly has, after Beecham, the best soloists, choir, and orchestra of the various versions. The recording is full-bodied and expertly balanced, and the performance is characterized by Giulini's usual precision, good tempos, and fine sense of taste.

If one distinguishing adjective were to differentiate his reading of the Mass from the others, it might be the suave elegance he brings to a work which can be subjected to scrutiny from various artistic aspects. There is no doubt that urbanity is one side of Beethoven's middle-period music which the biographers often choose to play down or even overlook (it is not part of the party-line "Titan" portrait). Possibly the Giulini approach is a little too sophisticated; it sometimes leaves one wondering if the conductor's balanced objectivity always does justice to the music. Certainly the work is relatively new to the British orchestra and choir, as is the whole wealth of late eighteenth- and early nineteenth-century Roman Catholic church music from Austria. Possibly one feels a certain lack of tradition, a lack of "identification" (as the saying goes nowadays) with the style.

To illustrate my point, listen to the rival

Woody Herman chose AR-2ax speaker systems for his listening at home. The sound of live music, be it rock or big band, is reproduced accurately on AR equipment.



The accuracy with which AR speaker systems reproduce music serves as a valuable tool for many notable musicians. Among the most notable is Woody Herman, whose big bands have long enjoyed great success. His secret seems to be an ability to stay in tune with the evolution of musical styles, as is documented by the Herd's latest recordings

on the Fantasy label. In spite of a schedule of more than 200 concerts every year, Mr. Herman can sometimes relax in the seclusion of his Hollywood home. Here, he listens to a high fidelity system consisting of an AR receiver, AR turntable with Shure V-15 type II cartridge, and a pair of AR-2ax speaker systems.

	ACOUSTIC RESEARCH, INC.
	24 Thorndike Street, Cambridge, Mass. 02141, Dept. HF7
Please send me a free copy of your illustrated catalog, as well as technical specifications and measured performance data for the AR-2ax speaker systems.	
Name _____	
Address _____	

version on Telefunken by Herbert Kegel with the Leipzig forces. Despite the Third Reich and the Communist government thereafter, there is a strong sense of tradition for this kind of church music in Protestant Leipzig: Haydn's and Mozart's Masses have always been performed at Leipzig, ever since the eighteenth century, and Beethoven's religious music has a long and distinguished history in Bach's city. This reviewer at any rate, feels that Herr Kegel with his Leipzig musicians may have come closer to the spirit of this problematical work than have the British musicians under Maestro Giulini. There may be other factors involved; it is hard to say (does the slightly quicker tempo of the Kyrie under Kegel seem less "seraphic," more businesslike, but also possibly more honest?). The sturdy Decca release is not really in the running, considering the formidable opposition of Beecham, Giulini, and Kegel, and as I had occasion to point out recently, the Beecham is now sounding its age. Others may find that Giulini's performance is more interesting than Kegel's: try them both, and see how different the approaches are, and yet how difficult it is to pinpoint what makes them so dissimilar. H.C.R.L.

BRAHMS: Sonatas for Violin and Piano: No. 1, in G, Op. 78; No. 2, in A, Op. 100; No. 3, in D minor, Op. 108. **MOZART:** Sonata for Violin and Piano, in B flat, K. 378. **LISZT:** Hungarian Rhapsody for Violin and Piano. Marshall Moss, violin; Adam Mekler, piano. Lizard C 20105, \$9.96 (two discs). Tape: ● M820105, \$6.95; ●● M520105, \$6.95.

"The problem with classical music is that most people view it as a dead phenomenon. Brahms, for example, made the same statements in his work about humanity and nature that you can hear in today's rock. The statement is the same, all that differs is the means of expression."

MARSHALL MOSS

"Right on. After all, Brahms grew up in a whorehouse..."

ADAM MEKLER

"Classical music, to most people is synonymous with sterility, with self-isolated cultureniks, and with the past."

ANON, ANNOTATOR OF BLURB
SENT WITH ALBUM

I didn't check out Brahms's background, but the performances on this Lizard album make me suspect that Moss and Mekler grew up in a Gypsy cafe! They are musicians of talent, but sound like a couple of gifted amateurs. The pianist has a lovely lilting keyboard style, a sense for color and line, a singing, liquid legato, a natural, though undisciplined, sense for phrasing. His bow-wielding accomplice draws a warm, gorgeously sensuous sonority from his instrument but is hopelessly addicted to slithering shifts and slides that would have made even the late Mischa Elman blush. In the Liszt *Hungarian Rhapsody* (billed as a World Premiere Recording) said flowery approach adds up to a groovy record. Brahms (whatever he did in his spare time) tended to be more discreet in his musical expression. And if any duo played Mozart like this in the concert hall, they would have to be stoned (in more ways than one).

What today's longhairs don't understand about longhair music is that there is a need for restraint and style. I don't want to be a sad sack, fellas, but leapin' Lizards, Brahms and Mozart are a different bag from Liszt (and from each other). I can enjoy some of this playing for its genuine feeling and spontaneity, and the recorded sound is rich and sonorous; but I sooner turn on to Szigeti and Petri or Szeryng and Rubinstein.

Dig?

H.G.

BRITTEN: The Prodigal Son, Op. 81. Peter Pears (t), Tempter/Abbott; Robert Tear (t), Younger Son; John Shirley-Quirk (b), Father; Brian Drake (b), Elder Son; English Opera Group and Orchestra, Benjamin Britten and Viola Tunnard, cond. London OSA 1164, \$5.98.

Britten's effort to resurrect the medieval liturgical music drama continues, and continues to interest. *Curlew River* and *The Burning Fiery Furnace* were the earlier works in this series of Parables for Church Performance, as he calls them. Now we have a recording of *The Prodigal Son*. First performed in 1968 at the Aldeburgh Festival, the third Parable has, like the others, a libretto by the poet William Plomer, a highly stylized theatrical manner, and enormously skilled use of minimal instrumental and vocal forces.

On this single disc, in an hour and eight minutes of music, Britten's retelling of the ancient story unfolds with economy and formal elegance. It opens and closes with plainchant processions, which serve as book ends for the story of the Prodigal's abandonment of home and Father, his revels and unhappy revelations in the big city, and his return to the forgiving family. Peter Pears, in the pivotal dual role of Tempter and Abbott, is convincingly insidious. The score requires the Tempter to sing in a "lively" but "smooth" manner, and when he is doing his seductive best he is accompanied by slithering music (double-bass glissandos on harmonics, with muted horn). There is a great deal of this kind of obvious, but effective, pictorialism: the "Voices Off" that sensuously beckon the Prodigal to the city's evil joys are boy sopranos, accompanied by glissandos on muted violas, with harp and organ contributing alluring harmonies.



Benjamin Britten conducts his third parable.

Thus, when the Prodigal leaves home and again when he heads back seeking forgiveness, his tread is marked by a rhythmically shaken gourd and a double-bass pizzicato. When the Parasites of the evil city swarm forward and surround the young man, the drums go into a jazzy dance. At various times, the score forces reminders of Stravinsky, *The Rake's Progress* and *L'Histoire du Soldat*, presenting parallels both in sound and story. But Britten's aim is clearly not to bring the Prodigal Son's tale up to date, as Stravinsky and others have tried to do, but to take us, the listeners, back to another, more pastoral time. Compared to a Nick Shadow, Peter Pears's Tempter is a cardboard devil, and is no doubt intended to be that—a stock figure from an old morality play. Giving the roles of the Abbott and the Tempter to one singer injects a certain irony and ambiguity into an otherwise rather flat narrative and Pears handles his dual character shrewdly, though he strains at his top F sharps and his one G, pianissimo, is a hollow squeak.

There is an odd interpolation in this recorded version that does not appear in the rehearsal score (for some reason, Faber has not yet published the official score), or in the published libretto. The opera is coming to a happy close, the Prodigal having been taken back, and the Abbott is unctuously explaining the moral to the congregation. Suddenly Pears reverts for a moment to the voice of the Tempter and exclaims shrilly: "Have you not seen me, did I not tempt him—craftily, craftily away?" The Devil, defeated, wants his momentary victory over Father and Son to be a matter of record. It makes a startling, theatrically effective moment, and though it might be difficult to manage in a staged performance, not unthinkable.

The Father is portrayed with proper baritone gravity by John Shirley-Quirk, and the Prodigal, the tenor Robert Tear, often sounds like a younger Pears, which is an effective bit of casting: the Tempter is supposed to be the tempted one's inner voice, urging him on to sin.

The hardworking Elder Son, whose provincialism and filial loyalty always make him far less attractive than the young wastrel, finds some dignity in the interpretation of Brian Drake, a baritone. For the rest, there are Servants, Parasites, Beggars, Young Servants, and Off-Stage Voices. Harlots are referred to but do not appear in this all-male production. At the U. S. premiere two years ago at the Caramoor Festival, the eight instrumentalists dressed as Lay Brothers and took part in the plainchant-accompanied processional and recessional that frame the opera. On the record, these comings and goings are enlivened by a stereo treatment that evokes a small church's ambience. One's only cavil about the recorded sound is the disconcerting prominence given at times to the double bass, which is positively seismic.

Now that we have the Three Parables, as well as the work that in a way set the stage for this series, *Noye's Fludde*, it is possible to see the dimensions of Britten's ambitions. Nowhere in his *Trittico* has he achieved, as some contend, a *Play of Daniel* for our time. *The Prodigal Son* is at best an unbodied echo, an aesthete's dream of olden days. But these little church operas do take some resonance from the medieval past and contribute a few sweet chimes of their own. *The Prodigal Son* has the marks of a minor master all over its

The either-or stereo from JVC

Model 4344 is the latest pacesetter from JVC. With more features, more versatility than any other compact in its field. You can enjoy either its superb FM stereo/AM receiver. Or your favorite albums on its 4-speed changer. Or 4-track cassettes on its built-in player. Or you can record your own stereo cassettes direct from the radio, or use its microphones (included) to record from any outside source. And you get all these great components in a beautiful wooden cabinet that can sit on a book-shelf.

But don't let its size fool you — JVC's 4344 is a real heavyweight. With 45 watts music power, 2-way speaker switching and matching air suspension speakers, illuminated function indicators, handsome blackout dial, separate bass and treble controls, FM-AFC switch. Even two VU meters to simplify recording, and more.

See the Model 4344 at your nearest JVC dealer today. Or write us direct for his address and color brochure.

JVC Catching On Fast

JVC America, Inc., 50-35, 56th Road, Maspeth, New York, N.Y. 11378



CIRCLE 26 ON READER-SERVICE CARD



**The
outdoor speaker
that doesn't sound
like one.**

Altec's 829A Patio Speaker.

Most outdoor speakers sound pretty bad. The result of too many design compromises, they end up hardly hi-fi.

But, Altec has built an outdoor speaker with a quality rivaling some of our indoor models.

The secret is our famous 755E 8" full-range speaker. It fits neatly into a one-cubic-foot enclosure of a durable, cocoa-brown weather-resistant material.

Less than 15" high, our Patio Speaker will serve as a portable unit, complete with its own stand, or may be mounted on walls or beneath eaves.

With a frequency response from 70 to 15,000 Hz and a 90° dispersion of high frequencies, the Patio Speaker will provide you with beautiful music for balmy summer evenings outdoors.

See it at your Altec dealers. Or write us for our catalog which also describes other Altec Lansing speaker systems, including the world's finest — "The Voice of the Theatre®" systems.



A QUALITY COMPANY OF LTV LING ALTEC, INC.
1515 S. Manchester Ave., Anaheim, Ca. 92803

CIRCLE 50 ON READER-SERVICE CARD

enameled surface. And it did drive at least one listener back to Luke 15:11-32. There may be more joy in heaven over that than over ninety-nine Elder Sons who know the parable too well to have to look it up. D.J.H.

BRUCKNER: Symphony No. 1, in C minor. Vienna Philharmonic Orchestra, Claudio Abbado, cond. London CS 6706, \$5.98.

There is an obvious parallel between the early symphonies of Bruckner and the early symphonies of Beethoven: in each case there is abundant anticipation of the greater works to come within a score that, quite on its own account, exhibits all the content and invention required to sustain interest.

The Bruckner First is the sort of work most conductors ignore and some adopt as a specialty. Otto Klemperer might be cited as an example; Abbado is another. In the recent past the work has been very active in the younger man's repertory throughout the world, and thus it is good to have his performance on records. It is a most interesting foil to the other available edition, that of Eugen Jochum, contrasting traditional Bruckner interpretation with a more Italianate, lyric-dramatic viewpoint. The complete Brucknerite will, I suspect, want both discs since each reveals its own special insights into the score. Younger listeners and those to whom Bruckner is still new territory are likely to respond most forcefully to Abbado's intensity, his fine ear for orchestral sonorities, and the propulsive, singing quality he brings to the music. R.C.M.

CHIHARA: Tree Music. Various instrumentalists. Composers Recordings CRI SD 269, \$5.95.

Paul Chihara is a young composer who teaches at UCLA and has a real genius for making music with tonal color. The present work consists of five separate pieces, each for a different instrument or combination of instruments. The first and last of them, to my taste, are the finest.

The first piece is called *Willow Willow* and is for bass flute, tuba, and percussion. The flute is handled in Oriental style, with low, breathy sounds and subtle bending of pitches; the tuba adds a delicate smoke; the timpani, vibraphone, suspended cymbal, and gong are handled with unprecedented beauty of tone, and the recording of the whole is just about the finest I have ever heard. Serenity, quietude, and long silences are also part of Chihara's tonal world, which relies very heavily on the virtuosity of his performers: in the case of *Willow Willow*, Harvey Sollberger, flutist; Herbert Price, tuba; and Kenneth Watson, Raymond des Roches, and Richard Fitz, percussionists.

The second piece in the series, *Logs*, is almost entirely a demonstration of virtuosity, that of the incredible string bass player, Bertram Turetzky. The jacket notes credit Turetzky with inventing new effects which he calls the "flutter finger," the "unbowed smear," the "pulled harmonic," the "handle gliss," the "woodknock," and the "flutter pizzicato." *Logs* seems to use them all and then some, and many of the sounds that emerge during the course of the piece cannot be con-

ceived as coming from the old doghouse; after a while, however, you've had enough.

Driftwood, for string quartet with two violas instead of two violins, is a pleasant piece, also full of fantastic effects but containing some strongly lyrical episodes too. It is played by the Philadelphia Quartet. *Branches*, for two bassoons and chromatically tuned drums, presents some marvelous work on the part of the percussionist, Watson; the drums toss the bassoons around like so many sticks in the wind even though one of the bassoonists is none other than Arthur Weisberg, the conductor of the Contemporary Chamber Ensemble; the other bassoonist is Donald MacCourt.

Last and longest of the five pieces is *Logs XVI*, which gets its numeral from the fact that the published recording is the sixteenth take that was made in an effort to capture completely the richness, subtlety, and drama of the sounds produced by Turetzky's bass along with the Moog and Buchla synthesizers. The effort involved was worth it; this work has a symphonic magnificence quite unlike the freely soloistic music of the preceding pieces and it ties everything together in a highly impressive and monumental way. The quality of the recording here—and indeed throughout the disc—is one of the finest things about this outstanding contribution to the literature of contemporary music. A.F.

HAYDN, M.: Concerto for Violin and Orchestra, in A—See Viotti: Concerto for Violin and Orchestra, No. 22, in A minor.

HOFFMEISTER: Duo for Violin and Viola, In G—See Mozart: Duos for Violin and Viola: in G, K. 423; in B flat, K. 424.

KODALY: Psalmus Hungaricus, Op. 13; The Peacock (folk-song setting); Peacock Variations. Lajos Kozma, tenor; Brighton Festival Chorus and Wandsworth School Boys' Choir (in the Psalm); London Symphony Chorus (in the folk-song setting); London Symphony Orchestra, Istvan Kertesz, cond. London OS 26186, \$5.98.

From the very first performances, Kodály's 1923 setting of Psalm 55 has been internationally recognized as one of the choral masterpieces of the twentieth century: a profoundly original work with only a slightly provocative post-echo of Delius' *Sea Drift* and pre-echo of Walton's *Belshazzar's Feast*. Yet from its first recording, over twenty years ago, most disc versions have been unsatisfactory either in performance or in their substitution of English or German for the original Hungarian text. I haven't heard the 1967 Mark-evitch/Hosfalvy version for Mercury, but I doubt that it possibly can match the idiomatic authenticity or even the magnificently robust stereo recording of the present version. The tenor soloist here may seem merely competent at first, but before long he achieves irresistible eloquence which, backed by thrillingly dramatic choral and orchestral sonics, endows the work with the full grandeur of the composer's inspired conception.

In comparison, the overside orchestral work of 1938-39 seems somewhat academi-

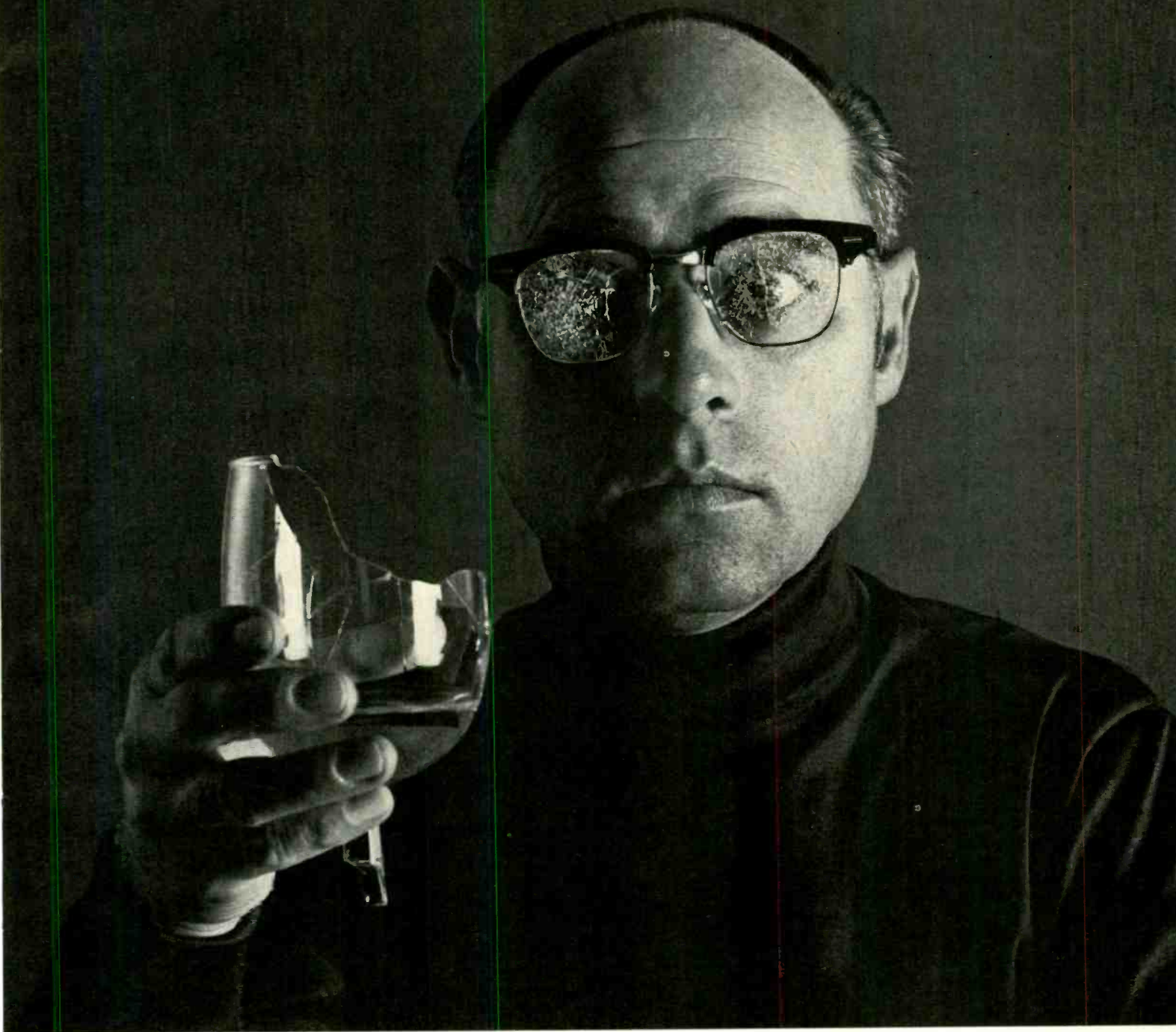

Introducing the Ampex Extended Frequency Cassette

Egad, what sound! What spectrum! What fidelity! At last, I can use the full range, the maximum frequency response of my magnificent stereo system. Yes, a medium to match my music. Absolutely smashing!

What's more, those clever rascals at Ampex have increased output with a smaller particle black oxide formula. They've reduced noise with super-smooth Ferrosheen® tape. They call it Extended Frequency. I call it marvelous. And, the packaging is so handsome it complements every piece of my fine equipment. Ah, quality sound with cassette convenience for just a bit more than two dollars each.

Ask your Ampex dealer to demonstrate the new Extended Frequency cassettes, another quality product in a full line of recording tapes; open reel, 8-track cartridges and standard cassettes.

But, don't wear your glasses.

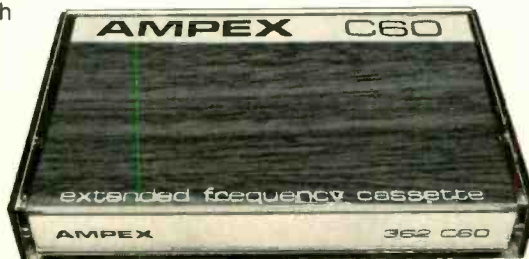

CIRCLE 7 ON READER-SERVICE CARD

AMPEX

Ampex Corporation
Magnetic Tape Division
401 Broadway,
Redwood City,
California 94063

cally contrived despite the skill with which its sixteen variations are constructed and the extraordinary coloristic imagination with which they are scored. Nevertheless, Kertesz not only plays the work with much more verve and conviction than any other conductor I know (including, most recently, Leinsdorf), but helpfully prefaces his performance with Kodály's simple, unaccompanied male-choral setting of the folk tune on which the variations are based. I'd be glad to see this practice followed in other recorded or concert performances of major works in variation form.

R.D.D.

LIADOV: From the Apocalypse, Op. 66; From Days of Old, Op. 21b; Baba Yaga, Op. 56; The Enchanted Lake, Op. 62; Kikimora, Op. 63; Eight Russian Folk Songs for Orchestra, Op. 58; A Musical Snuff-Box, Op. 32b. U.S.S.R. Symphony Orchestra, Yevgeny Svetlanov, cond. Melodiya/Angel SR 40159, \$5.98.

Poor Anatol Konstantinovich Liadov (1855–1914)—perhaps the most notorious example in all music history of a gifted composer who missed the boat. Liadov was Diaghilev's original choice to write the music for *The Fire-bird* ballet, a task he dithered with so long that it was given instead to a young, obscure student of Rimsky-Korsakov named Igor Stravinsky. Liadov's "laziness" in this and many other instances throughout his life may well have been the consequence of a psychological "block" or a too acute faculty of self-criticism. At any rate he wrote (or at least completed) relatively few, mostly small-scaled works. Indeed, the present program includes the major part of his *oeuvre* apart from piano pieces and songs. Yet every one is a miniature masterpiece of lyric fantasy and polished craftsmanship, with a kaleidoscopic palette of tone colors that Rimsky himself might have been proud to claim. The amusing little *Musical Snuff-Box*, originally for piano, is only a pops-encore trifle, to be sure. But the delectable settings of Russian folk songs are true gemlike genre pieces. They and the three little fairy tale tone pictures, Opp. 56, 62, and 63, long have been favorite recording choices by non-Russian, as well as Russian, conductors. The other two works, which have seldom been recorded, are likely to be new to most American listeners, but the somber fragments *From the Apocalypse* and balladlike *From Days of Old* are perhaps even more convincing demonstrations of Liadov's evocative and coloristic talents.

Ansermet and Szell, among others, have brought more poetry and tonal refinement to the familiar symphonic miniatures here, but Svetlanov's straightforward yet infectious zestful readings have the incomparable virtue of idiomatic authenticity, attractively enhanced by substantial recorded sonic qualities. A worthy, however belated, tribute to a quite unique music-maker, this Liadov program should be a delight for music-lovers seeking fare that's at once piquantly novel and easily digestible.

R.D.D.

LISZT: Hungarian Rhapsody for Violin and Piano—See Brahms: Sonatas for Violin and Piano.



A Mahler document from Jascha Horenstein.

B MAHLER: Symphony No. 3. Norma Proctor, contralto; Ambrosian Singers; Wardsworth School Boys' Choir; London Symphony Orchestra, Jascha Horenstein, cond. Nonesuch HB 73023, \$5.94 (two discs).

What is the role of the seventh recording of this music, especially when the preceding six are all of reasonably high quality? Several answers are possible. Anything by Horenstein these days immediately becomes a historic document of an important conductor long associated with this repertory. If that isn't sufficient, this Dolby-processed recording offers sound of demonstration quality. And the instrumental and vocal performances are on a very high level, both technically and interpretively. Most of all, for the economic man, the set is deliriously inexpensive, competitive in every way with the high-priced labels and not nearly so severe a drain on the budget. If the pocketbook pinches and Mahler beckons, no compromises are involved in making this your choice. (By the way, the eight-track master of this performance, mixed under the conductor's supervision, offers the promise of a four-track edition that ought to give the new format a real opportunity to show its advantages over dual-channel sound.)

Horenstein's greatest advantage in this music is that he knows how to give it the necessary thrust and movement and at the same time providing all the gracious stylistic felicities that are often sacrificed in a more propulsive musical approach. A little more romance is possible. Mahler assigned the solos in the third movement to a posthorn but here they are performed on what I take to be a B flat alto flugelhorn. They are well played (intonation on this instrument is more trustworthy), but the sound is rather too close to the microphone to suggest the distant mountain vistas that Mahler, I suspect, intended. I also object to a side break between the fourth and fifth movements; but nearly everyone is forced to present

an interruption at this point, even though it wrecks a great effect—the entry of the children's voices at the start of the angel chorus. (Kubelik's DGG edition, among the higher-priced sets, eliminates this break, as well as offering a remarkable realization of the music.)

The Mahler Third is one of the last great monuments of German Romanticism. Why it took so long to achieve popularity in this country will always be a mystery, but clearly the symphony is now here to stay. And in this edition it ought to reach many new listeners with the full radiance of its praise of love and nature.

R.C.M.

MAHLER: Symphony No. 7. Concertgebouw Orchestra, Bernard Haitink, cond. Philips 6700 036, \$11.96 (two discs).

MAHLER: Symphony No. 9. Concertgebouw Orchestra, Bernard Haitink, cond. Philips 6700 032, \$11.96 (two discs).

A complete edition of the Mahler symphonies from the Concertgebouw Orchestra, such as Philips is bringing us, has the historic significance of allowing us to hear this music from a body of players to whom the Mahler tradition has been a living entity for sixty-eight years. These things do get passed along in orchestras (ask any seasoned conductor on the international circuit). The fact that Mahler has been dead for sixty years does not diminish the fact that the Concertgebouw learned a good deal of his music from him directly and continued to play it for many years under one of his most dedicated advocates, Willem Mengelberg. Vienna is not the only Mahler town. Amsterdam is a rival of equal stature, and when we go there we are also going to a shrine and a source.

But if places and musical institutions can fill this role, so can people. The most interesting question raised by these albums is whether we should give first weight to a city and an orchestra with a Mahler tradition, now in the hands of a later generation, or to living musicians, such as Otto Klemperer, who knew Mahler as a contemporary and are thus primary rather than secondary sources of insight into his work. The interesting thing is that the recordings offer no clear-cut answer; indeed, the technical aspect of Philips vs. EMI engineering aesthetics is more to the point for many record buyers. The Concertgebouw discs have a greater degree of clarity, a much closer point of view, a higher sense of personal involvement with the orchestra than the Klemperer albums with their longer perspective and more resonant space. In something like the two *Nachmusik* sections of the Seventh, this lends atmosphere and enhances the mood (and Klemperer may well get more out of the music). But in the opening and closing movement of the Ninth, for example, the clean quality of the Philips sound adds greatly to an otherwise impressive performance that places Haitink in the front rank of the Mahler interpreters of his generation.

So let's be very pragmatic about the whole thing. On interpretive and technical grounds the Abravanel and Bernstein editions of the Seventh are now past their prime. If you want the work with maximum atmosphere, Klemperer provides it in a highly individual performance. If you want the best possible sound,

oh?

This is what people say when they hear the price of the Sony 6200

ah!

This is what people say when they hear the Sony 6200

The unusually high price of the new Sony 6200 receiver is a come-on. For once you know it, you can hardly resist the temptation to hear it perform and justify its lofty price. And once you hear it perform, you'll have to own this superb component.

The real joy of the 6200 lies in its performance. Balanced positive and negative power supplies permit direct coupling all the way through to the speakers for unusual clarity. There is power to spare by whatever measure: 360 IHF watts into 4 ohms. 70+70 watts *continuous* power into 8 ohms with both channels driven; a minimum of 60+60 at all frequencies from 20 to 20,000 Hz.

FM performance is equally distinguished. The FET front end raises the sensitivity to its theoretical limit (1.2 μV for 20 dB quieting; 1.8 μV IHF), while retaining the ability to handle strong local stations without overload and spurious response. Solid state i.f. filters ensure that the superb performance you hear today you'll enjoy many years later.

However, the true revelation of the 6200 is your own listening experience and the "ah" of your reaction to it. For many that "ah" will prevail over the "oh" engendered by its price. See it at your Sony dealer or write: Sony Corporation of America, 47-47 Van Dam Street, Long Island City, New York 11101.



New SONY® 6200 Stereo Receiver

Haitink provides it as the vehicle for a vigorous and effective statement of the music. (And if you're in no hurry, a Solti/Chicago Symphony edition is due to be on tape by the time you read this.)

In the case of the Ninth, where so many historic recordings exist, Haitink will appeal to those who prefer the work without heavy interpretive underlinings and overdramatized woes. This performance has great dignity, noble lyricism, and the first three movements stand on their own content rather than as anticipations of the finale. R.C.M.

MOZART: Divertimentos: In B flat, K. 287; in F, K. 138. English Chamber Orchestra, David Blum, cond. Cardinal VCS 10082. \$5.98.

The English Chamber Orchestra never disappoints; they are loyal professionals who play well under a variety of conductors. The horns are worth their weight in brass, the violins race with exciting unanimity, the usually inconspicuous violas are valued partners, and the basses are light and nimble. Blum knows the conductor's business, though he lacks the ultimate in refinement. The magnificent adagio in K. 287 requires more warmth and imaginative melodic inflection, but his strictness pays off in the fast movements where uninterrupted pace and élan are essential. The virtuosity Mozart demands in these light works is astonishing. Nowhere, not even in his last symphonies, does he drive the violins to such heights, nor demand such perilous horn passages. The indicated repeat in the first movement should have been observed; it would have assured a better perspective for the development section. Though "entertainment music," this movement is genuinely symphonic.

The second, earlier divertimento is really a little three-movement *sinfonia* in Christian Bach's Italian style. Everything sings here, and the accents are operatic. The work shows little thematic development, but it is genial, melodious, and the first movement has a remarkable sweep for a sixteen-year-old composer. The full and sonorous string writing in particular is admirable. The sound is excellent. P.H.L.

MOZART: Duos for Violin and Viola: in G, K. 423; in B flat, K. 424. **HOFFMEISTER:** Duo for Violin and Viola, in G. Arthur Grumiaux, violin; Arrigo Pelliccia, viola. Philips 839 747, \$5.98.

If there is a pair of pieces in the active repertory today that deserves to be called the String Player's Delight, it is surely Mozart's duos for violin and viola. Lives there a fiddler—or fiddle fancier—with an ear so callous that he does not rejoice in the invention, the sonorities, the twining interplay, the sheer happy bounce of these works? The present recording is, with one or two small reservations, good news, for Grumiaux and Pelliccia form a very poised partnership, and their musical purpose and technical accomplishment are without blemish. One of my reservations is hard to defend, I'll grant: it concerns the fact that when the viola is performing a merely accompanying role it drops to a fairly subdued level. An obviously rational maneuver, but I can't help wishing for a slightly darker viola color-

ing in some of those passages, and I would have favored Pelliccia putting himself more to the fore. He takes over with authority, though, when the ball is in his court.

At moments, particularly in the B flat Duo, the romantic temperature gets a little high: Grumiaux heats up a couple of shifts with a nineteenth-century portamento I could have done without, and the pronounced retard at the close of each variation in the finale seems to me to break the pace unduly. But these are minor matters. This is a disc that will make you feel good. And Franz Anton Hoffmeister, Mozart's publisher, keeps up a busy stir in his rather obvious but jolly and unoffending work. S.F.

B **MOZART:** Idomeneo. Sena Jurinac (s), Ilia; Lucille Udovick (s), Electra; Richard Lewis (t), Idomeneo; Léopold Simoneau (t), Idamante; William McAlpine (t), High Priest; James Milligan (b), Arbace; Hervey Alan (bs), Voice of Neptune; Chorus and Orchestra of the Glyndebourne Festival, John Pritchard, cond. Seraphim SIC 6070, \$8.94 (three discs) [from Angel 3574, 1958].

EMI's 1958 recording of *Idomeneo*, based on the 1956 Glyndebourne production and here issued in stereo for the first time, is a rather perplexing mixture of plus-and-minus qualities. There are two really outstanding performances—Sena Jurinac's exquisite Ilia and Léopold Simoneau's elegant Idamante—and at the modest budget price Seraphim's reissue might be recommended on the strength of their contributions alone.

The principal drawback is the heavy cutting: many recitatives are pruned away, most of the set numbers undergo internal surgery, and several arias are simply omitted altogether. *Idomeneo* may be a long and overly stately



Sena Jurinac—an exquisite Ilia in *Idomeneo*.

opera seria for impatient modern audiences, but such a ruthless abridgement badly falsifies Mozart's careful musical architecture. Furthermore, both Richard Lewis and Lucille Udovick lack the technique and vocal brilliance to do justice to their difficult roles. Philips' recent version, not absolutely complete but more sensibly edited, is a better balanced performance—thanks primarily to Colin Davis' poised conducting—although neither the Ilia nor Idamante match Seraphim's counterparts. The early stereo recording enhances the acoustic somewhat, but the sonics are still a trifle thin. P.G.D.

MOZART: Quartets for Flute and Strings: in D, K. 285; in A, K. 298; in G, K. 285a; in C, K. 285b. Jean-Pierre Rampal, flute; Isaac Stern, violin; Alexander Schneider, viola; Leonard Rose, cello. Columbia M 30233, \$5.98.

The most famous thing about the flute quartets is that they prompted Mozart to make the often quoted comment (in a letter to his father, February 14, 1778) that he couldn't stand the instrument. His fudging on the commission from the Dutch dilettante who was promised three flute concertos and four quartets (and got considerably less) seems to bear out the statement, but the music itself is perfectly palatable Mozart, and the flute writing in K. 285 is particularly idiomatic. (It is much less spectacular in K. 298.) The two half-works, K. 285a and 285b, are two movements each, and the problem of their identification makes a splendid historical muddle—the author of Columbia's album notes questions their authenticity, but Alfred Einstein seemed satisfied about K. 285a, at least in his introduction to the Hinrichsen edition of the score.

The present recording, in any case, gives us some superb flute playing and some lovely ensemble work—it is a measure of the company Rampal keeps here that in the adagio of K. 285, flute melody with pizzicato accompaniment throughout, it is actually the pizzicatos, in undulating, shapely waves, that impart the character of the movement. As you might predict, tempos are brisk—fine in the allegro of K. 285, which goes like clockwork, but creating a very highly charged finale indeed. In the remaining works, however, the tempos, combined with the unfailing rhythmic aplomb, seem entirely suitable. S.F.

MOZART: Sonata for Violin and Piano, in B flat, K. 378—See Brahms: Sonatas for Violin and Piano.

PADEREWSKI: Concerto for Piano and Orchestra, in A minor, Op. 17; Fantaisie polonaise for Piano and Orchestra, Op. 19. Earl Wild, piano; London Symphony Orchestra, Arthur Fiedler, cond. RCA Red Seal LSC 3190, \$5.98.

B **PADEREWSKI:** Concerto for Piano and Orchestra, in A minor, Op. 17. **RUBINSTEIN:** Konzertstück for Piano and Orchestra, Op. 113. Felicia Blumental, piano; Vienna Symphony Orchestra, Helmuth Froschauer, cond. Turnabout TVS 34387, \$2.98.

Until the dawn of the recording era, it was common for composer-pianists to be remem-



Record Your Own 8-Track Cartridges!

Add this stereo tape deck to your music system. Tape directly off-the-air, tape your favorite records; then play the cartridges in your car—or at home.



Illuminated Dual VU Meters for Professional Sounding Stereo Recordings

Record "Safety" Interlock —No Accidental Erasures

Four Illuminated Indicators for Program Identification

Concentric Independent Recording Level Controls

3-Way Function Switch
• Continuous Play of All 4 Programs
• Continuous Repeat of Any Program
• Automatic Cartridge Eject at End of Program 4

Pushbutton "Fast Forward" Finds Selections Quickly

Sold Only by Allied Radio Shack . . . The Realistic® TR-8

Our exclusive "automated recording studio." Set the controls, insert a cartridge, and forget it! Return 40-80 minutes later and your recordings are done. The cartridge even pops-out and the AC shuts off — automatically — easy as toast. Professionally calibrated stereo VU meters and a 30-15,000Hz audio response make you a recording "pro" in one easy lesson. There's even a light that tells you when a cartridge is not inserted properly. For making "live-action" voice recordings there are two mike inputs. Fully automatic playback too. Just push a button for non-stop stereo (continuous repeat of all 4 programs or of any one program) or eject/shut-off at the end of a cartridge. The luxurious walnut cabinet is included (which you expect from Realistic!). See how easy it is to record your own library of cartridges the low-cost way at the Allied Radio Shack store near you. Or order by mail — it costs no more.

159⁹⁵

At All Stores or Postpaid

Over 950 Stores Nationwide
See the Yellow Pages



FREE!
Parts & Accessory Catalog

ALLIED RADIO SHACK
A TANDY CORPORATION COMPANY
2725 W. 7th St.
Fort Worth, Texas 76107

Dept. HF-31

- Realistic TR-8 8-Track Deck @ 159.95
- Realistic MC-1000 Mikes @ 9.95 ea.
- Realistic 40-min. Blank Cartridges @ 1.99 ea.
- Realistic 80-min. Blank Cartridges @ 2.29 ea.
- FREE Parts & Accessory Catalog

Name (print) _____
 Street _____
 Apt. No. _____ Route No. _____ Box No. _____
 City _____ State _____ Zip _____

**BOTH
DIRECTION RECORDING**



BRING NEW LIFE TO YOUR SYSTEM

Dokorder 6020 is a Automatic Reversing tape deck tailored to the needs of sophisticated audiophiles. Exclusive Automatic Continuous Reverse, 3 motors, 4 heads. A quality deck for quality systems.

Dokorder®

AMERICAN DOKORDER

Box 2494 Main P.O. Culver City, Calif. 90230, U.S.A.

Authorized Agent for Military

ROYAL SOUND COMPANY INC.

409, North Main Street, Freeport, N.Y. 11520 U.S.A.

CIRCLE 14 ON READER-SERVICE CARD

84

bered more for their creative than for their re-creative gifts. This situation has held true even for those fortunate enough to leave posterity some mementos of their playing (Rachmaninoff and Prokofiev, to name two examples). Ignace Paderewski—save for the Minuet in G—is almost totally forgotten in his creative capacity; even as a pianist he is unjustly disparaged and most people remember him best as Poland's first prime minister! His only piano concerto dates from 1884 when the twenty-four-year-old musician was still studying with Leschetizky and only dreaming of a career as a pianist. The piece is a thoroughly competent and even enjoyable opus, even though it borrows heavily from Romanticism's complete bibliography. The orchestration is euphonious and the piano writing works well enough (more about that later).

Paderewski played his concerto often enough but never recorded it. Actually, though, he did vicariously take part in the work's disc debut by Jesús María Sanromá back in 1939. The jacket for the new RCA version documents that occasion by way of a photo which shows the white-haired composer—who had come to supervise the session—shaking hands with Arthur Fiedler. Alongside that photograph is another shot of the present soloist, Earl Wild, with Maestro Fiedler himself now very much the white-haired patriarch. Fiedler, as before, provides peppery support, sharply focusing every strand of instrumental sound and propelling the music forward with rather rapid tempos. But in so frankly a virtuoso affair, it is of course the soloist who comes first. Wild is a brilliant technician. He does his darnedest to "put the work over." He can crash thunderously, he can ripple over the keys effortlessly, he can scintillate with *affettuoso* delicacy. He does, indeed, do all of these things and also milks the lyrical pages for all they are worth (and they curiously sound less attractive for being treated so preciously).

Mr. Wild has also snazzed-up some of the passagework. I don't wish to imply puristic snobbery or even that such editing is reprehensible, but was it really necessary? Of the great keyboard virtuosos, Paderewski was probably one of the least virtuosic. Even so, his piano writing—even in 1884—was perfectly adequate to express his ideas. In the original, one or two runs fail to cut through the orchestration with incisive impact and a few other figurations sound slightly clumsy and opaque. For all that, the *Urtexi* has a certain modesty of means that tells us something about Paderewski's style, his assets and limitations. The fireworks of Wild's emendations lend a faceless brilliance to the music and tend to eradicate the individuality. The facelifting also reduces the distinctions that might have been drawn between the piano concerto and the later *Fantaisie polonaise*—which was written after Paderewski had become a world-beater (Wild touches up that work, too). In sum, the Wild/Fiedler production makes the music more immediately striking and accessible, but in the process, reduces it to a kind of anonymity.

Blumental, who recorded the Paderewski *Fantaisie polonaise* twice (once on an old London mono and once for Vox, with less happy orchestral support), now turns her attention to the concerto. From the outset

it is obvious that she approaches it as music rather than as a confectioner's delight. Her tempos are all a shade less precipitate than Wild's but quite brilliant enough. And she opts for a warmer-hued, more intimate approach. Her dynamic gradations may be more limited than Wild's, but the tone sings with more personal involvement. The Vienna Symphony, apart from a strident and thin sound or two, compares favorably with the suaver London Symphony, and Froschauer leads them with great gusto and spirit. At one point—the second theme of the finale—the Turnabout conductor actually surpasses Fiedler: that problematical episode, dubiously scored for brass chorale, can sound dangerously like a Gilbert & Sullivan reject when stated literally. Froschauer broadens it and minimizes the square-toed banality. There is, incidentally, yet another recording of the Concerto by Barbara Hesse-Bukowska and the Warsaw Philharmonic for the Polish Muza label (XL 0196). That performance, nearer to Blumental but a mite more brilliant and detached, is very much in the running. In terms of sound, though, Turnabout and RCA hold the edge (the Muza surfaces are rather noisy), and why pay import prices when the domestic alternatives are excellent?

Rubinstein's *Konzerstück* is a Weber-derived affair that verges on bombastic emptiness, and as you have undoubtedly surmised, I like the Paderewski *Fantaisie polonaise* considerably less than his concerto. H.G.

PAGANINI: Twenty-four Caprices for Solo Violin, Op. 1. Paul Zukofsky, violin. Cardinal VCS 10093/4. \$11.96 (two discs).

Paul Zukofsky is a formidably talented young violinist who first came upon the New York scene several seasons back with a three-concert series of contemporary violin music: his recordings since that time have concentrated on the likes of Penderecki, William Schuman, Mike Sahl, and J. K. Randall, but don't for a moment think that Zukofsky is a man to be pegged in any particular idiom. Don't think, either, that he is one to bring out a set of the Paganini Caprices just to prove that he can handle flying staccato, running passages in tenths, and left-hand pizzicato—that doesn't need proving. No, the purpose is more serious—a "rethinking" of the Caprices, stemming principally from the fact that Zukofsky feels that sheer speed has been too long emphasized. Seeking "moral support" for this view, he tells us in his album notes that he dug out a photocopy of the original manuscript from the publishers in Milan (G. Ricordi), and a Xerox copy of the first edition from the Library of Congress. And behold, enough discrepancies between the two warrant taking a second look at the whole opus. (Since the Caprices were among the few works to be published during the composer's lifetime, the question arises as to whether Paganini himself authorized any changes. I suppose we shall never know.) Specific details will be available when Zukofsky's own edition is published in the near future. Meanwhile, here are the fruits of his labor, some of it brilliant, some of it repugnant, none of it casual.

Zukofsky's ideas are strong medicine, and the strongest dose is offered in Caprice No. 6. "Why not," he remarks in the notes, "play this

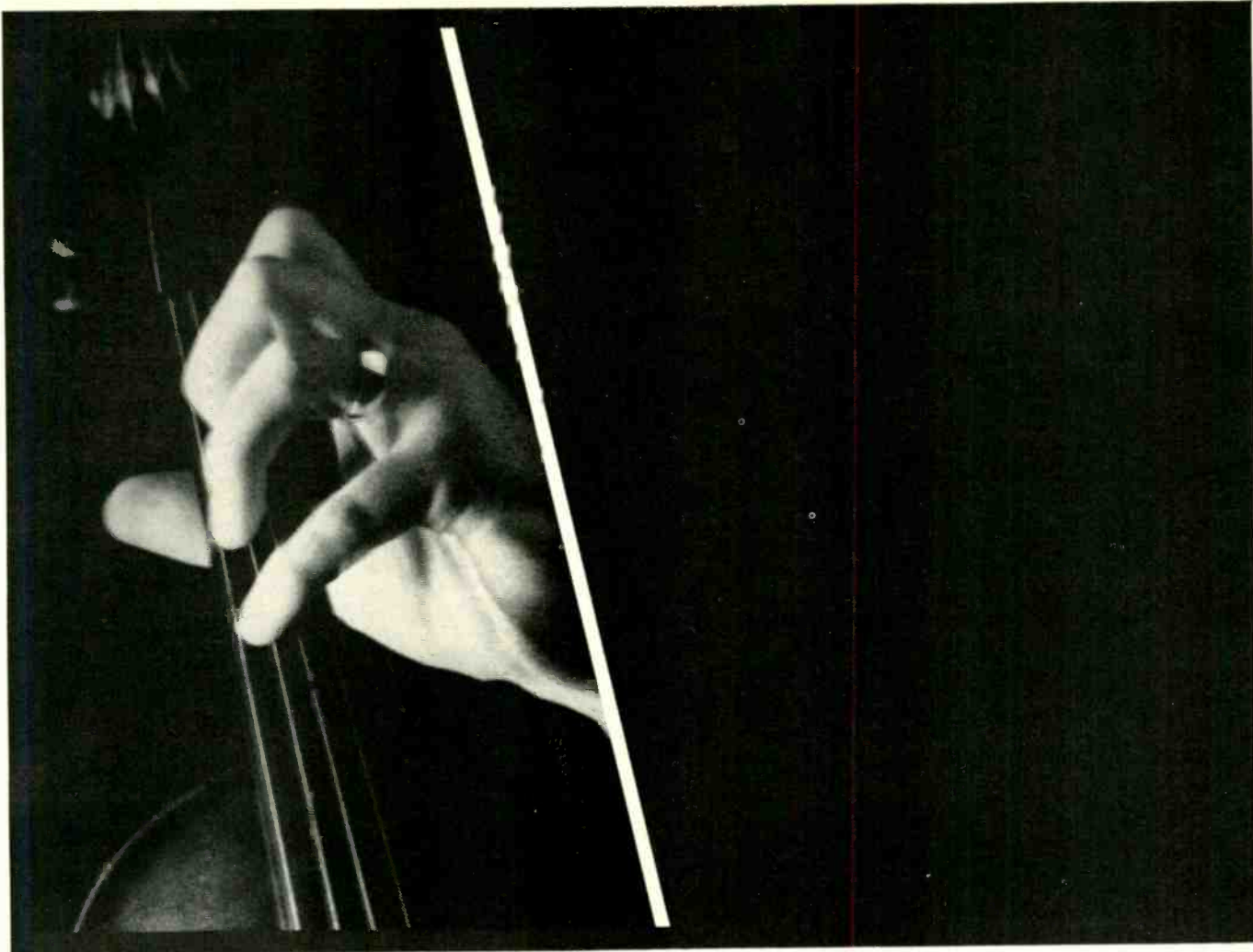

Second fiddle? Hardly.

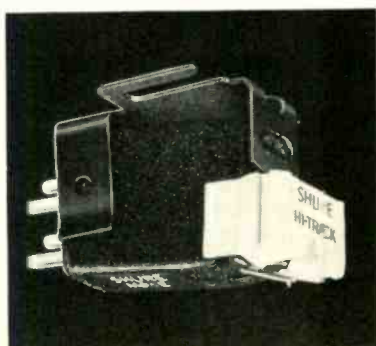

The Shure M91E cartridge cannot, alas, track as well as the incomparable V-15 Type II Improved, but then, no cartridge can. What the M91E can do is out-track everything else. Stereo Review (Feb., '69) said, "The listening quality of the Shure M91E was excellent . . . it virtually matched the performance of the V-15 Type II in its ability to track the highest recorded levels to be found on modern recordings." High Fidelity (July, '69) agreed: "Its sound is about as neutral and uncolored as any pickup we've auditioned; clean, smooth, well balanced across the range . . . a first class 'tracker.'" We at Shure agree. We ought to know, because we introduced the concept of trackability. The M91E for now (only \$49.95)—the V-15 Type II Improved later.

Shure Brothers Inc.,
222 Hartrey Ave., Evanston, Ill. 60204.





Paul Zukofsky—a Paganini/Schuman whiz kid.

flautando sul ponticello: emphasize upper partials (even let harmonic speak)? The question might be, rather, *why*? What emerges is a series of vaporous squeaks, whistles, and extraneous wails, adrift in a watery ambience of ambiguity wherein the melodic line is all but lost. It is a really extraordinary exhibition, and if a lesser man had undertaken it you would simply run for the exit. (And frankly, I haven't yet thought of a more attractive alternative. The piece lasts eight minutes and twelve seconds, and I counted every moment.)

The main thing on Zukofsky's mind, however, is tempo, and he slows down certain of the Caprices monumentally. They sound like works you never heard before. No. 8, for example, marked *maestoso*, opens with a four-measure passage of octaves: another violinist whose Caprices I admire takes eight seconds to play those four measures: Zukofsky takes twenty-eight. Truly, this is rethinking with a vengeance, and it characterizes Zukofsky's point of view. Essentially, he has stripped many of the Caprices of their traditional virtuoso glamour: often the pace is deliberate to the point of laboriousness (Nos. 2, 3, 7), often the melodic line is slighted for the sake of emphasis and articulation—the figuration in thirds of the No. 8, for example, explodes with tremendous individual impact, but the over-all line almost disintegrates under the impact.

The second thing on Zukofsky's mind is dynamic contrast—I do not mean the contrast of whole sections, but the extreme accentuation of punctuating notes or notes that outline melody such as occur in Nos. 4, 8, 11, 15, 19, all of which the violinist throws out like hand grenades. They utterly shatter the texture. I admire the ability to command such contrast, but I think the present instances verge on the grotesque.

But then there are the dazzling aspects of Zukofsky's accomplishment. Nothing to do with bowing or right-hand articulation is beyond his reach, and the occurrences of a real *presto* or *agitato* or *vivace* in Paganini's score is enough to send him skyrocketing—take as examples the clarity, precision, and bite of Nos. 5 and 10, the brilliant speed of No. 16, the breathtaking scales of No. 21. And he has ele-

gance and resilience of rhythm—they captivate the ear in No. 9, where his "imitation flute" is chaste enough to please the heart of Diana. But enough of chapter and verse. Try some of Zukofsky's strong medicine—it is quite a tonic. S.F.

PISTON: Symphony No. 2. **SCHUMAN:** Concerto for Violin and Orchestra. Paul Zukofsky, violin (in the Schuman); Boston Symphony Orchestra, Michael Tilson Thomas, cond. Deutsche Grammophon 2530 130, \$6.98. Tape: ●● L 3103, 7½ ips, \$6.98.

Two boy wonders of recent years team up here to provide a second time around for two American works of thirty years ago. The Piston comes off marvelously well, the Schuman rather less so.

People tend to dismiss Walter Piston as another academic composer, but his Second Symphony, written in 1942, proves that one can be a Harvard professor and a great creator of music as well. The symphony has everything, in generous measure, that its tradition requires: themes that appeal to the ear and command the respect of the mind, forms of the utmost clarity and logic, and a sense of drama in the building of proportions that confers dignity on rhetoric. This, in short, is a symphony to place alongside those of Ives and Vaughan Williams—the foremost works of their kind this century has produced.

William Schuman's Violin Concerto, composed in 1947 but revised in 1959, is in two large movements, each subdivided into several short sections. The slow sections are extremely effective, lyrical, and beautiful, but the fast sections often come embarrassingly close to the violin concertos of Prokofiev—and over and beyond that they contain a lot of mere fiddling. Zukofsky fiddles magnificently, to be sure, but one expects more musical justification for technical display than is offered here, especially from a composer of Schuman's stature.

The recordings are adequate but not especially remarkable. A.F.

RACHMANINOFF: Piano Works. For a feature review of recordings of Rachmaninoff's piano music played by Yara Bernette, Morton Estrin, Vladimir Horowitz, Michael Ponti, and Alexis Weissenberg, see page 69.

RUBINSTEIN: Konzertstück for Piano and Orchestra, Op. 113—See Paderewski: Concerto for Piano and Orchestra, in A minor, Op. 17.

SATIE: Les Pantins dansent; Tendrement; Ludions; Trois poèmes d'amour; Choses vues à droite et à gauche; Quatre petites mélodies; Prélude de la porte héroïque du ciel; Le Piège de Méduse. Mady Mesplé, soprano; Nicolai Gedda, tenor; Gabriel Bacqueler, baritone; Yan Pascal, violin; Aldo Ciccolini, piano; Pierre Bertin, Hubert Deschamps, Joseph-Marie Faluccci, and Marie Laurence, actors; Lamoureux Orchestra. Aldo Ciccolini, cond. Angel S 36713, \$5.98.

SATIE: Trois morceaux en forme de poire; Aperçus désagréables; En habit de cheval; Trois mélodies; Trois poèmes d'amour; Quatre petites mélodies; Ludions; Je te veux; La Diva de l'Empire; Tendrement; Choses vues à

droite et à gauche. Elaine Bonazzi, mezzo; Millard Taylor, violin; Frank Glazer and Richard Deas, piano. Candide CE 31041, \$3.98.

These two recordings—the umpteenth round in what seems to be an attempt to put on disc every note Satie ever wrote—offer, among other things, a selection of the composer's vocal music that has never been recorded. Although there is some overlapping between the two discs, the Candide release does include the important *Trois mélodies* (also available with Bernac on Odyssey) and the other two "popular" songs that go with *Tendrement*. The strengths of Satie's "art songs" lie in the texts, most of which are witty, absurdist vignettes by various authors, including Satie himself. One of the most amusing is the song *Danseuse*, in which Jean Cocteau, Satie's literary counterpart, compares a ballerina dancing with her hands curved above her head to a crab walking on its claws and "smiling from ear to ear." The best songs musically, however, are probably the *Ludions* and the *Trois mélodies*, which manifest many more of the typical Satie earmarks than a work such as the almost ascetic *Trois poèmes d'amour*. The other pieces will no doubt appeal either to those who dote on "camp" or to devotees of the music hall.

I cannot say that the singing on either record is particularly noteworthy. Even Nicolai Gedda, on the Angel recording, seems strained and uncomfortable, while some happy medium should be found between Mady Mesplé's wispy, almost nonexistent soprano on Angel and the rather heavy mezzo of Elaine Bonazzi, who performs all of the songs on the Candide disc. I will say, however, that Bonazzi, who is better recorded than Angel's singers, often does a splendid job in interpreting the various texts, and her characterization in the dialogues of *Daphnéo* are particularly effective.

One of the show-stoppers (included on both discs) is *Choses vues à droite et à gauche*, a three-part work for violin and piano which receives, if I am not mistaken, its double-recorded premiere here. After an opening "hypocritical chorale" (quite haunting in spite of itself), there is a "groping fugue" based on an amusing puerile theme, and finally an absolutely hysterical "muscular fantasy." Here Satie manages, within a very short space of time, to satirize many hackneyed tricks characteristic of "virtuoso" violin writing. For this composition, the performances by Pascal and Ciccolini on Angel are decidedly superior to the Taylor/Glazer version on Candide, although Taylor pulls off the humor of the "muscular fantasy" quite well. But Yan Pascal is obviously a violinist of considerable merit, and his teamwork with Ciccolini is nothing short of perfect. Furthermore, the Angel sound here is sharp and well defined; to my ears it is preferable to Candide's Dolbyized sonics which, for all their velvety smoothness, had me constantly running to the treble control on my amplifier.

The second side of the Angel recording is taken up with a complete performance of Satie's "lyric comedy," *Le Piège de Méduse*, which includes seven absolutely marvelous dances that are delightfully performed (with Ciccolini conducting) and sumptuously recorded. The play itself is, to my mind, an excellent and very funny piece of before-the-fact theater of the absurd, complete with a satire on traditional theatrical conventions and plots and a broadside attack on verbal logic. Furthermore, Satie, a devout Socialist, did not fail

If exceeding its performance claims makes a receiver great... the Scott 387 is about the greatest.



For months we've been telling you what a great performer the 387 AM-FM stereo receiver is. Now a respected independent test laboratory report* shows how conservative our performance claims really are:

Characteristic	Our Data Sheet Claims	H-H Lab Report
Continuous power (RMS) both channels driven	55 watts into 8 ohms 85 watts into 4 ohms	67 watts into 8 ohms 100 watts into 4 ohms
Harmonic distortion	0.5% at rated output	Below 0.1%, 1-60 watts Below 0.25%, 0.1-65 watts
IM distortion	0.5% at rated output	Well below 0.5%, 0.1-65 watts; under 0.5% from 25-20,000 Hz at 55 watts, and under 0.2% over most of that range

The report says the 387 has "one of the most powerful amplifiers ever offered in an integrated receiver". Add to this all the other innovative features such as Scott's exclusive "Perfectune" indicator, permanently aligned FET front end, full complementary output stage, solderless "tension wrap" connections, and you've got a receiver which is unsurpassed in the \$399 price class. Ask your Scott dealer for a demonstration of the 387 receiver today.

*Hirsch-Houck Lab report appearing in Electronics World, May, 1971

SCOTT[®]
where innovation is a tradition

H.H. Scott, Inc., 111 Powdermill Road Maynard, Massachusetts 01754

HEAD STRONG



The Ampex AX-50 stereo tape deck has three of the strongest heads money can buy. Deep-Gap heads made to last 10,000 hours, without variance in gap or frequency response. Which is about 10 times longer than regular heads. That's strong!

The AX-50 is also strong on capabilities. With a heavy-duty hysteresis synchronous motor. Direct tape monitor. Pause/edit control. Echo effect. Function programmer for sound-on-sound and sound-with-sound. Stereo headphone jack. Plus many more features you must see... and hear.

You need a strong deck to pick up today's heavy sounds. And the AX-50 is the strongest in its price range.

\$249.95
(Suggested retail price)

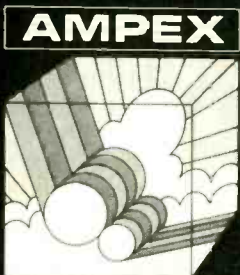

THE SOUND IDEA PEOPLE

CIRCLE 4 ON READER-SERVICE CARD

to include a bit of humorous social commentary: one of the best scenes occurs when Baton Medusa finally tames his servant, Polycarpe, by resigning from the Socialist "union" founded by the latter. In general the performance is quite good—Hubert Deschamps in particular is hilariously brutish in the role of Polycarpe. However, Pierre Bertin's hammy, whining Baron wears quite thin, all the more so since his voice, which dominates the "drama," never leaves the right speaker. It seems to me that one of the tenets of good Satie interpretation, musically or theatrically, is to "play it straight"—nobody embodies this principle better than pianist-conductor Ciccolini, who skillfully brings out the proper nuances at the proper moments and simply allows Satie to interpret himself.

A note should also be made of the Frank Glazer/Richard Deas performances of the four-hand piano music on the Candide release. Although their interpretations seem overly subtle and restrained at first, it all comes into focus upon subsequent hearings and consequently offers a fresh point of view on these oft recorded pieces. Candide does not supply texts or translations; purchasers of the Angel disc will be supplied with a text leaflet free of charge by writing to Angel Records Merchandising, 1750 North Vine, Los Angeles, California 90028. R.S.B.

SCARLATTI, A.: *Endimione e Cintia*. Reri Grist and Tatiana Troyanos, sopranos; Matthias Siedel, harpsichord; Hamburg State Symphony Orchestra, Matthias Lange, cond. Archive 2533 061, \$6.98.

To most discophiles Alessandro Scarlatti is the father of a famous son. While a good deal of Domenico Scarlatti's brilliant keyboard music is heard and recorded, of Alessandro's well over a hundred operas there is only an old mono version of his *Trionfo dell'onore*. Yes, there is perhaps also another cantata—out of six hundred—some arias, and a few instrumental pieces. This meager offering cannot even faintly bring home the fact that much of the great music written in the hundred years after the elder Scarlatti's death was influenced by this extraordinary composer.

The dividing line between cantata and serenata, the latter actually a small opera, is slight and often nonexistent. Baroque composers cut their operatic teeth on the cantata, which was very popular in the seventeenth and eighteenth centuries, and thousands were composed: Handel alone managed a round hundred of them. They ranged from the simple solo cantata with harpsichord continuo to virtual little operas with orchestra. A long cantata-serenata like *Endimione e Cintia* equals a whole act in a full-fledged opera. (Incidentally, some of Bach's secular cantatas belong in this category and were probably staged.) While it's only a drop in the bucket, this cantata gives a fair idea of Scarlatti's powers, of his exquisitely polished and pliable melody, of his dramatic accents, and of the forms and devices all of his successors considered mandatory. The work consists of a brief overture and a number of recitatives and arias in which the two singers alternate, though they also unite in some fine duets. The cantata is written for two sopranos, and the two singers are billed as such, but while Reri Grist is very much the true soprano, Tatiana Troyanos is

obviously a mezzo; however, she can climb upstairs very nicely. Just the same, it was a mistake to give Grist, who has a girlish, fresh high soprano, the role of the male lover, while Troyanos, whose voice is darker and heavier, sings the fair Cynthia. But both do very well, the orchestra is neat, the harpsichord is good, and the sound is excellent. P.H.L.

SCHOENBERG: *Pierrot Lunaire*, Op. 21. Jan DeGaetani, voice; Contemporary Chamber Ensemble, Arthur Weisberg, cond. (Nonesuch). Marie Therèse Escribano, voice; instrumental ensemble, Friedrich Cerha, cond. (Turnabout). For a feature review of these recordings, see page 70.

SCHUMAN: *Concerto for Violin and Orchestra*—See Piston: *Symphony No. 2*.

SCHUMANN: *Kreislariana*, Op. 16; *Romance in F sharp*, Op. 28, No. 2; *Sonata for Piano, No. 3, in G minor*, Op. 22. Walter Klien, piano. Turnabout TVS 34317, \$2.98.

This record is deceptively packaged but I doubt whether anyone will complain: the *Romance*, though fully noted on the label, is not mentioned anywhere on the jacket! The first thing one notices about Klien's Schumann is the lack of sensuality: it's a stark, sparsely pedaled sonority and the effect is emphasized by rather close-up recorded sound. Before long, the pianist convinces me that his approach is a just one. He presents this music in a manly, vibrant fashion—firm but tender, and full of direct, unaffected sentiment. Attention to all sorts of details is evident in each of the three performances. In the first section of *Kreislariana*, the offbeat accentuations and starkness remind me of Rudolf Serkin's approach to this composer. It is Germanic, to be sure, but never in the least rigid or unfeeling. Sometimes, as in that initial movement of *Kreislariana*, the new look is at first anything but soothing to ears jaded by innumerable standard "dreamy" interpretations, but Klien usually has the penetrating musicianship to make his divergent view convincing. He has a wonderful sense of rhythmic motion: rollicking vigor is decidedly preferable to sickly *affettuoso* in this problematical literature. Some of the slow sections move along freely but nonetheless somehow convey all their rapt stillness.

I think that the secret of Klien's success here is his ability to play *really* softly (an asset shared by Horowitz in his recent Columbia version of the *Kreislariana*). Another plus is Klien's extreme clarity of voicing. He has true digital independence, and the active (but not overactive) imagination to seek and coax these inner lines from the text. I also applaud Klien's meticulous attention to note values and internal timing (quite a different thing from his sense of good rhythm). He is, in short, a superbly good musician as well as an excellent piano player. The sonata and *Romance* fare equally well, and all three compositions are rendered with potency, fantasy, and an exquisitely controlled passion. Klien, by the way, plays the revised edition of the sonata.

Don't pass up this disc; it's a remarkable buy. H.G.

SCRIABIN: Sonatas for Piano: No. 3, in F sharp minor, Op. 23; No. 4, in F sharp, Op. 30; No. 6, in G, Op. 62; No. 10, in C, Op. 70; *Vers la flamme*, Op. 72. Ruth Laredo, piano. Connoisseur Society CS 2034, \$5.98.

Perhaps the most outstanding aspect of Ruth Laredo's second Scriabin disc is her brilliantly original interpretation of the Fourth Sonata. This short, two-movement work, one of the least known of the ten, represents a definite move toward the style of the later sonatas, particularly in its thematic and rhythmic structure. Since it is a transition work, however, the Fourth Sonata often eludes attempts to give it real shape or direction; here Laredo has, to my mind, succeeded better than any pianist I have ever heard in bringing out the over-all musical meaning of this piece. She yields with the music, so that instead of imposing external heavy-handed ideas, she allows Scriabin's elusive language to evolve naturally from measure to measure. This is not to say that Laredo has no interpretive ideas of her own: her playing of the repeated, upper-register chords in the *quietissimo* section of the first movement is both eerie and ethereal, while she imparts such rhythmic precision to the highly syncopated last movement that she creates an almost jazzlike impression.

Unlike the Fourth Sonata, there is little doubt about the direction of the Sixth which, like all the sonatas after the Fourth, has but one movement. This mystical, shimmering, quiescent vision exists wholly within its own harmonic language, which is constantly, obsessively defined and redefined through a perpetual give-and-take between chords, trills, and broken chords, interrupted occasionally by quasi melodies that seem like nostalgic reminiscences from the real world. For this piece Ruth Laredo has perfectly captured Scriabin's troubled mysticism—more so, in fact, than she did for the Seventh and Ninth Sonatas on her admirable earlier Scriabin disc. I will give a slight edge to Richter (MK 1582) for his more effective contrasts and his trills; but even this great pianist does not match Laredo's subtle pedaling and crystalline sonorities for the staccato chords at the end of the work.

Laredo's pedaling is not quite so successful in the Tenth Sonata. This, together with her rather indecisive trill-work, represents a definite weakness both here and in *Vers la flamme*. What really surprises me, however, is Laredo's rather restrained playing in the Third Sonata which, according to Faubion Bowers' somewhat precious liner notes, is her personal favorite. As the last of Scriabin's "first-period" sonatas, the Third would certainly seem to invite the sort of romantic flair manifested so beautifully on the pianist's previous recording. Yet she never attains any real feeling of contrast between loud and soft passages, especially in the first movement; indeed, there are more than a few dynamic markings she has inexplicably ignored. On the other hand, her impeccable attention to detail enormously enhances the already considerable interest of the music.

I strongly suspect that Laredo's intentions have not been served altogether faithfully by the recorded sound, which definitely lacks the incisiveness and vitality of the first Laredo/Scriabin release. Nonetheless, Ruth Laredo is one of the best Scriabin interpreters today.

A galaxy of stars in Opera, Ballet and Instrumental masterpieces on London's July release.

Saint-Saëns: SYMPHONY NO. 3 IN C MINOR FOR ORGAN AND ORCHESTRA

The Los Angeles Philharmonic Orchestra—Zubin Mehta—Anita Priest (organ)
CS-6680

Delibes: COPPÉLIA

L'Orchestre de la Suisse Romande—Richard Bonyngue
CSA-2229

**Schubert: SYMPHONY NO. 4 IN C MINOR ("Tragic")
SYMPHONY NO. 5 IN B FLAT MAJOR**

The Vienna Philharmonic Orchestra—Istvan Kertesz
CS-6682

HANDEL OVERTURES—Vol. 2

Semele; Julius Caesar; Faramondo; Judas Maccabeus; Radamisto; Arminio; Deidamia; Scipio; Belshazzar—The English Chamber Orchestra—Richard Bonyngue
CS-6711

Catalani: LA WALLY—Highlights

Renata Tebaldi, Mario del Monaco, Piero Cappuccilli, Justino Diaz—The Monte Carlo Opera Orchestra—Fausto Cleva
OS-26202

Delibes: LAKMÉ—Highlights

Joan Sutherland, Alain Vanzo, Gabriel Bacquier—The Monte Carlo Opera Orchestra—Richard Bonyngue
OS-26201

Verdi: LA TRAVIATA—Highlights

Pilar Lorengar, Giacomo Aragall, Dietrich Fischer-Dieskau—Orchestra of the Deutsche Oper, Berlin—Lorin Maazel
OS-26193

Cherubini: MEDEA—Highlights

Gwyneth Jones, Pilar Lorengar, Fiorenza Cossotto, Bruno Prevedi, Justino Diaz—Orchestra of L'Accademia Nazionale di Santa Cecilia, Rome—Lamberto Gardelli
OS-26184

**Schubert: FANTASIA IN C MAJOR (Op. 15) ("Wanderer")
IMPROMPTU IN E FLAT MINOR (D.946, No. 1)
IMPROMPTU IN E FLAT MAJOR (D.946, No. 2)**

Jean-Rodolphe Kars (piano)
CS-6714

**Beethoven: QUINTET IN C MAJOR (Op. 29)
SEXTET IN E FLAT MAJOR (Op. 81b)**

Members of The Vienna Octet
CS-6674

Now on London

R. Strauss: ARIADNE AUF NAXOS

Leonie Rysanek, Roberta Peters, Sena Jurinac, Jan Peerce—The Vienna Philharmonic Orchestra—Erich Leinsdorf
OSA-13100

LONDON
RECORDS

ALLIED RADIO SHACK ISSUES A
NEW
AND DIFFERENT CATALOG!

ELECTRONICS FROM A-Z
ANTENNAS
BATTERIES
CAPACITORS
DIODES
EDUCATIONAL KITS
FIBER OPTICS
BRILLE CLOTH
HI-FI SPEAKERS
IC'S · JACKS
KNOBS · L-PADS
MIKES · NEEDLES
OSCILLOSCOPE · P-BOXES
QUADRACS · RESISTORS
SEMICONDUCTORS
TELEPHONES
ULTRASONIC ALARMS
VHF ANTENNAS · WIRE
XENON STROBE LIGHT
"Y" ADAPTERS
ZENER DIODES
AND MUCH MORE!

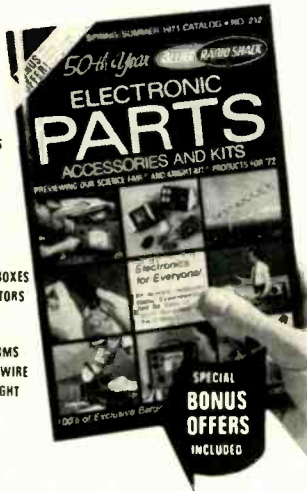

1000'S OF ITEMS,
100'S OF
EXCLUSIVES!

PREVIEWS OUR COMPLETE
SCIENCE FAIR® AND
KNIGHT-KIT® LINES FOR '72!

a valuable "FIRST EDITION"
...and it's **FREE!**

The new buying Guide for kit builders, Hams, hobbyists, do-it-yourselfers, "fix-it men"! Lists thousands of handy and wanted "little things" most stores don't stock. Like tubes and transistors, cables and plugs, adapters and antennas—you name it—the things that keep equipment working. Or make it work even better. Or DO MORE. If you own anything electronic or electrical, you need this catalog!

950 STORES NATIONWIDE!
EVERYTHING IN THIS BOOK
AVAILABLE FAST & EASY!

ALLIED RADIO SHACK Dept. HF-2
7275 W. 7th St., Fort Worth, Texas 76107

Send me your FREE Spring/Summer Cat. 212

Name (print) _____

Route No. _____ Box No. _____

Street _____ Apt. No. _____

City _____ State _____ Zip _____

and in spite of the more apparent flaws on this second release, I would not be without it.
R.S.B.

B SHOSTAKOVICH: Concerto for Piano, Trumpet, and String Orchestra, No. 1, in C minor, Op. 35; Concerto for Piano and Orchestra, No. 2, in F, Op. 102; Three Fantastic Dances, Op. 5. Ludovic Vaillant, trumpet (in Concerto No. 1); Dmitri Shostakovich, piano; French National Radio Orchestra, André Cluytens, cond. Seraphim 60161, \$2.98 (mono only).

Considering Shostakovich's early ambition to become a concert pianist, one would have expected the composer to make an important contribution to twentieth-century piano literature. In fact, however, nothing Shostakovich has written for piano—from the twenty-four preludes and fugues to the music recorded here—quite measures up to his works in other media. Nonetheless, the First Concerto is an enjoyable work, a fact largely due to its many skillfully communicated shades of humor—even the concerto's moments of lyricism and melancholy, especially in the second movement, seem to function primarily as a kind of acrid "tragic relief," while the comedy ranges from sarcasm (with its numerous near-quotes from other composers and its unpredictable false starts and endings) to outright hilarity.

As performed by Shostakovich in this 1957 recording, the concerto takes on an appropriate dryness that is only suggested on other recorded performances (and there have been quite a few). Shostakovich's brittle tone sets the piano off beautifully against the string orchestra and the solo trumpet, the latter adding an important and ingenious third shade of instrumental color to the work. The composer also plays with a good deal of verve and energy: he starts the first movement, for instance, at a somewhat slow tempo and gradually works up to an almost frenzied pace. Here, however, it must be said that Shostakovich does have a tendency to rush, as if he could not play the notes fast enough to suit himself. This has a detrimental effect, both on the soloist's technique, which is far from impeccable, and on the orchestra's ability to keep pace. However, the late André Cluytens provides an impressive accompaniment and the general spirit is so infectious that one can forgive the various technical slips on both sides.

Although the keynote of the Second Concerto is also humor, the work is almost totally lacking in the incisiveness of its more brilliant predecessor, and there is consequently little here to compensate for the juvenile treatment of the deliberately banal melodic material. Even the Rachmaninoff (cum Poulenc and Saint-Saëns) lyricism of the second movement and the rhythmic variety of the last strike one more as exercises in style than as sincere expressions. The performances have the same merits and drawbacks as those of the First Piano Concerto—this is a less finished rendition than the one by Shostakovich and the U.S.S.R. Radio Symphony conducted by Gauk (MK 201), but it has more depth, if such an adjective can be applied to this work.

The three attractive *Fantastic Dances* (now officially the composer's Op. 5 and not Op. 1) that fill out the second side are the pianistic

disaster of this recording. It is difficult to criticize a composer for interpretations of his own music, but I can see little justification in Shostakovich's monochromatic, monodynamic, and rhythmically flaccid execution of these expressive pieces. At any rate, the mono sound on this release is bright and nicely detailed—the fidelity is high, even if it is not stereo. This is, as far as I know, the only recording Shostakovich has made of his First Piano Concerto, and considering the special flavor the composer gives to what is perhaps his finest piano composition, this disc is therefore a must.

R.S.B.

SIBELIUS: Symphony No. 1, in E minor, Op. 39; Luonnotar, Op. 70. Phyllis Curtin, soprano (in *Luonnotar*); New York Philharmonic, Leonard Bernstein, cond. Columbia M 30232, \$5.98.

Bernstein's Sibelius First now appears in single-disc format. It remains an inspired but flawed performance; as I suggested in my discography of the Sibelius symphonies [May 1969], this reading was probably a brilliant accomplishment in actual concert, but the roughnesses of tone and ensemble show up more in the recorded presentation. What adds to the disc's interest is the filler on Side 2: a first domestic recording of the legendary (to Sibelians) *Luonnotar*. Written in 1913, between the Fourth and Fifth Symphonies, the eight-minute cantata deals with the creation of the heavens (*Luonnotar* is the mistress of the air in Finnish mythology). The work is rarely performed for several reasons. For one thing it has never been published and is available only in facsimile of Sibelius' manuscript (a friend was kind enough to lend me his facsimile of the facsimile). Secondly—and probably more to the point—the soprano part is excruciatingly difficult. With all its register leaps and almost atonal chromaticism, the vocal line is practically unsingable.

Rumor has it that Eva Turner and Elisabeth Schwarzkopf both made abortive attempts at recording the music and that the present Curtin/Bernstein effort (dating from 1965) very nearly joined those on the discard pile. Finally released, it makes a very interesting foil for the Gwyneth Jones/Antal Dorati/LSO version issued last year in England by HMV. It also is strikingly different from the live broadcast performance which directly preceded the recording session. At the public concert, Bernstein tended to race through the music at a bracing clip, leaving little room for plasticity, nuance, or even interpretation. The recorded version is still on the fast side, but is a bit more relaxed, inflected, and sensitive to mood. Phyllis Curtin, in turn, phrases with more involvement and rubato on the record, and offers a really savage interpretation, full of anguish and bleakness. To be sure, her singing is also full of strained chest tones, shrieking coloratura, and ambiguous pitches where precision most counts. It must also be admitted that Bernstein's interpretation still rather misses the serenity and introspection also inherent in the music. Jones and Dorati, by contrast, are much more on top of the notes technically. The British singer takes time (Dorati gives it to her) and is able to place each tone securely. In the long run, though Jones/Dorati miss some of the savagery, their subtler performance lets us hear more of what

is in the score. Since the coupling (*En Saga*, *Nightride and Sunrise*, and *The Oceanides*) conveniently offers a lot of rare Sibelius, I would have to give preference to the Dorati disc. Angel (or Seraphim) should by all means issue the record domestically. H.G.

B **STRAUSS, R.:** *Don Quixote*, Op. 35; *Der Rosenkavalier*: Waltzes (arr. Reiner). Antonio Janigro, cello; Milton Preves, viola (in the *Don Quixote*); Chicago Symphony Orchestra, Fritz Reiner, cond. RCA Victrola VICS 1561, \$2.98 [the *Don Quixote* from RCA Victor LSS 2384, 1959; the Waltzes from RCA Victor LSC 2112, 1957].

At its new budget price, Reiner's *Don Quixote* bids fair to be the preferred edition—unless the optimum in stereophonic reproduction is required, in which case Bernstein's recent Columbia disc gets the nod. The Chicago performance is typical of Reiner's distinguished Strauss series for RCA: superb balance of the complex orchestral texture, cool but expressive emotional temperatures, and an uncanny control of lyrical distention—especially in the Don's vision of his magical isle. Janigro's soft-grained cello lacks something of the orchestra's firmly fibrous tone, but both he and violist Preves are given an accurate middle-distance perspective by the engineers in this still fine-sounding record. The *Rosenkavalier* Waltzes make a pleasant filler, although Reiner's arrangement is all too obviously a patchwork job. P.G.D.

STRAUSS, R.: *Ein Heldenleben*, Op. 40. Concertgebouw Orchestra, Bernard Haitink, cond. Philips 6500 048, \$5.98.

Once more the Concertgebouw has chosen to record a work from its own history: *Heldenleben* was dedicated to the orchestra and its great father figure, conductor Willem Mengelberg. Many old-time collectors will still insist that Mengelberg's performance of this music as recorded more than forty years ago with the New York Philharmonic was the greatest ever heard. Haitink has the advantages of four decades of engineering progress, an orchestra that has the style of this music in its blood, and the conductorial authority to shape great rolling phrases, command hammer-blow attacks, and yet give full heed to the fact that some of the best writing in the score is to be found in the descriptive and atmospheric quieter pages.

The "critics" in that notorious satirical section of the score are unusually pleasant (are Amsterdam critics like that?), and Mme. Pauline Strauss, who clearly is the inspiration for the hero's lady, seems unusually sweet-tempered in the violin solos of Herman Krehbers. Indeed, for those who demand a performance drenched in every possible emotion and exploited for every possible effect, this version will probably seem understated on occasion. But rehearsals make it clear that Haitink's interpretation has great dignity. It wears well. It holds your respect. And if you want that kind of *Heldenleben*, in spacious, up-to-date sound, this is the clear-cut choice. R.C.M.

STRAUSS, R.: *Lieder*. Dietrich Fischer-Dieskau, baritone; Gerald Moore, piano. Odeon C 163-50043/51, \$53.72 (nine discs).

As an encore to their twenty-five-disc Schubert *Lieder* marathon, Dietrich Fischer-Dieskau and Gerald Moore have tackled the Strauss song repertory—a comparatively modest enterprise to be sure but one of almost equal documentary value. Although Strauss is considered one of the major German *Lieder* composers, recitalists invariably program the same fifteen to twenty "hits," while the rest of his 178 published songs remain virtually unknown. Fischer-Dieskau sings 134 of them here, bypassing those that are clearly intended for female interpreters, the orchestrally accompanied songs, and nineteen bits of juvenilia from the composer's teenage years. One item—*Erschaffen und Beleben*, Op. 87, No. 2 for bass—was omitted presumably out of simple discretion; the two-octave-plus range, the murderous leaps in the vocal line, and florid coloratura are virtually insurmountable (one wonders how the dedicatee, Michael Bohnen, faced up to this challenge).

Songs framed Strauss's creative career from the Christmas carol that he scrawled out for his parents at age six to the *Four Last Songs* nearly eighty years later. The majority of them were written by the turn of the century before opera claimed his attention, but even then he would often "mark time" while waiting for a libretto by dashing off a set of *Lieder*. The rather syrupy sentimentality of the most popular lyrics gives a very unfair picture of his achievement in this area—these early works

Kiss purple ear goodbye!

Amazing new Sony recording tapes keep your ear from being assaulted by "purple noise"—that irritating undercurrent of noise produced by ordinary tapes.

Sony's new Ultra High Fidelity (UHF) Cassettes and Low Noise, High Output (SLH-180) reel-to-reel recording tapes are the best money can buy.

And Sony tapes come in all configurations—open reel, cassette, 8-track—for every recorder, every application, all designed for incomparable performance.

So kiss purple ear goodbye forever. Get Sony recording tape—the very best—at your Sony/Superscope dealer.

SONY SUPERSCOPE

You never heard it so good®



CIRCLE 53 ON READER-SERVICE CARD

©1971 Superscope, Inc., 8154 Vineland Ave., Sun Valley, Calif.

are obviously the products of a young composer eager to gain acceptance in fashionable musical salons. Later on Strauss refined his art considerably as his technical facility and sense of declamation began to match the melodic invention and sensitive feeling for mood. There's no reason, aside from artistic laziness, to neglect such a profusion of lyrical beauty and characterful musical portraits.

Of course one finds a certain amount of dross here—Strauss had an annoying penchant for second-rate poets and sometimes he simply spins the notes out with compulsive absent-mindedness. Then, too, he will occasionally misunderstand the poem. *Befreit* (Freed) is a classic instance; the social-minded Richard Dehmel was ironically describing a divorce

proceeding here, while Strauss interprets the words as a kind of weepy death-bed parting. But the successes far outnumber the failures and anyone who listens to these discs is bound to gain a fresh perspective on Strauss's Lieder output.

One singer cannot hope to cope with the variety of vocal writing contained here: Strauss was notoriously partial to the soprano voice and even when the text does not specifically call for a woman one feels that he had a soprano in mind—many of the songs were in fact composed for his wife. This is a built-in handicap for Fischer-Dieskau despite his polished delivery and sophisticated artistry. Furthermore, such effusive outbursts as *Cäcilie*, *Frühlingsfeier*, and *Liebeshymnus* can only

make an effect in sheer vocal terms—all the subtlety in the world cannot disguise the need for a healthy, plush, flexible instrument. Fischer-Dieskau simply does not operate comfortably when a large, full-voiced gesture is required and he is often heard straining badly to fill out the line with sufficient tone. That said, one must admit that no other singer could probably handle all this material with such consistency, insight, and shrewdness. By turns puckish, sarcastic, ironic, pleading, down-in-the-mouth, the baritone provides an incredible interpretational tour de force. And there are many lovely vocal moments too, especially when Fischer-Dieskau spins out the sort of pearly legato *mezza voce* that he achieves in *Waldseligkeit*.

Strauss's accompaniments are frequently fiendishly difficult and Gerald Moore, who is also undoubtedly coming to much of this music for the first time in his long career, has a few rocky moments; but he is in superb form most of the way and there are innumerable deliciously turned phrases—I can't resist calling attention to the marvelous way in which he brings out the nibbling figure in the first of the *Krämerspiegel* songs as the "goat" of Bote and Bock grazes on the composer's hard-earned profits. The balance places the singer a bit too prominently in the foreground and the reverberant acoustic is not always ideal. Notes and texts are in German only. (Angel, by the way, has already issued the first of the nine records domestically—on S 36483—and present plans call for a disc-by-disc release over the next year or so.)

Flaws and all, this set is unquestionably a notable achievement, and no one interested in German Lieder should miss it. P.G.D.

TCHAIKOVSKY: Symphony No. 1, in G minor, Op. 13 (*Winter Dreams*). Boston Symphony Orchestra, Michael Tilson Thomas, cond. Deutsche Grammophon 2530 078, \$6.98. Tape: ●● Ampex L 3078, 7½ ips, \$7.95; ●● DGG 3300 107, \$6.95.

This is my first hearing of a DGG recording of the Boston Symphony and my first opportunity to study in some detail the work of Michael Tilson Thomas. I must confess that I am somewhat overwhelmed by both encounters. DGG's work in Boston has already been noted in these pages and I can only second any acclaim that this association has aroused for the fine sound engraved on DGG's customarily quiet discs. Thomas, for his part, may well be the most exciting new American conductor of his generation: here, at least, he shows a fiery imagination, a thrilling ability to project a long musical line, and a complete mastery of the conducting art far beyond mere promise.

In a sense, this record offers two demonstrations of youthful musical genius—in both composer and conductor. The symphony reveals premonitions not so much of Tchaikovsky as the highly original symphonist of the Fourth, Fifth, and Sixth, but a glimpse of the master composer of great ballet music. Notwithstanding the minor key of the First, or the connotations of its somber subtitle, the present work has little of the innovative structure, expressive intensity, and characteristic moodiness of the later symphonies; it does, however, contain a basic melodic fluency and rhythmic grace that not only served the composer well in

by Shirley Fleming

"Heifetz on Television"

It seems probable that opening diplomatic relations with Red China would be simplicity itself compared to making arrangements with Jascha Heifetz for the filming of an hour-long television feature on Jascha Heifetz. His personal reserve, his prickliness in business matters, his exacting demands on collaborators, his distaste for publicity are a legend in themselves. But somehow the wall was crossed and the Bell System produced "Heifetz" late last April for its NBC-TV Family Theater.

It was scarcely a family affair, and it certainly wasn't theater—there were only a few compromises for kiddies who couldn't sit up to the Chaconne, for instance—and of drama there was none. No peeps into private domain, unless you count a peep under the hood of the violinist's electric automobile; no glimpse into either of the Heifetz houses, in Los Angeles or at Malibu; no tour of the rare violin and bow collection; no reminiscences. Except for a rather terrifyingly high-voltage ping-pong game ("no matter what you do, you should do it well—better than somebody else, that in itself is something," intones the Heifetz voice during this shot), and except for a rather unconvincing moment or two of an outdoor lesson with a young French pupil—you can't tell me Heifetz would dilute the concentration of a violin lesson with sunshine and breeze and bugs—the program stuck largely to concertizing. It was done with dignity and taste, completely in keeping with its subject.

The focus on playing explains why there was nearly enough music to make up a fifty-minute recording—with the note that the Bruch *Scottish Fantasia* on RCA's disc is not the television performance, which was condensed (and performed with the French National Orchestra sans conductor), but an earlier recording made with the

New Symphony Orchestra of London under Malcolm Sargent. For those who did not watch the TV program the record will demonstrate what the rest of us saw, that the Heifetz phenomenon still exists unimpaired—the pitch razor-edged, the tone brilliance itself, the clarity of thought dazzling, the occasional arrogance intact (the blinding speed of the Mozart Rondo does not incline our thoughts to attributes of the composer). The Chaconne, made human by two doubtful notes and warmed by portamento here and there, is a marvel of lucidity in phrase and line and builds up in a crescendo of intensity that is formidable. And I guess *It Ain't Necessarily So* was necessarily there, a part of history as a Heifetz trademark.

The recording is more than a memento of the television show; the Chaconne and the beautiful performance of the interpolated Bruch see to that. And there is the bonus 7-inch disc included in the package, consisting of a snippet from Korngold's *Garden Scene*, the complete Rachmaninoff *Daisies*, and Heifetz himself philosophizing on various matters—including what is possibly his most famous personal characteristic, the unyielding format of the Great Stone Face.

"HEIFETZ ON TELEVISION:" BRUCH: Scottish Fantasia, Op. 46. **BACH:** Partita for Solo Violin, No. 2, in D minor, S. 1004: Chaconne. **MOZART:** Serenade No. 7, in D, K, 250: Rondo (arr. Kreisler). **DEBUSSY:** Preludes for Piano, Book 1: La Fille aux cheveux de lin (trans. Hartmann). **GERSHWIN:** Porgy and Bess: It Ain't Necessarily So (trans. Heifetz). Jascha Heifetz, violin; Brooks Smith, piano; New Symphony Orchestra of London, Sir Malcolm Sargent, cond. (in the Bruch). RCA Red Seal LSC 3205, \$5.98.

the last symphonies, but which he raised to high art in the ballet scores.

Thomas quite rightly makes no effort to inflate the score, but he never condescends to it. In fact, with superb élan and fluent sense of movement he projects far more musical delight than I have heard on any previously recorded version. He seems to share the balletic approach of Igor Stravinsky, who virtually "discovered" the early Tchaikovsky symphonies for the modern international audience, but he brings a much stronger sense of forward movement to the music than I recall from the late composer-conductor's performances of early Tchaikovsky.

Thomas' controlled enthusiasm for this music is reflected in a superbly responsive performance by the Boston Symphony: both for its soloist, notably Ralph Gomberg's lovely oboe tone in the slow movement, and for its ensemble precision and tonal finesse, this impresses me as one of the finest records, orchestral speaking, this great orchestra has made in some time. P.H.

VIOTTI: Concerto for Violin and Orchestra, No. 22, in A minor. **HAYDN, M.:** Concerto for Violin and Orchestra, in A. Arthur Grumiaux, violin; Concertgebouw Orchestra, Edo de Waart, cond. Philips 839757, \$5.98.

Giovanni Battista Viotti, often called the father of modern violin playing and so splendid a performer that he was courted on both sides of the English Channel, wrote twenty-nine violin concertos, of which only two (including this one) are to be found in the current catalogue. As a man he was, by all accounts, a gentle and noble soul, ill suited to dealing with the festering intrigues of Marie Antoinette's court, where he served nevertheless with considerable pride; and equally ill suited to the wine business, which he undertook in England after fleeing the French Revolution. The A minor concerto reflects something of this quality of character: it is a gentle, elegant work, melodic in a natural, free-breathing way, and reaching its apex in a lovely slow movement of fine filigree work—rendered with especial sweetness by Arthur Grumiaux. The dancing finale has its share of virtuosic display, but even this is restrained. Grumiaux matches this quality in his performance, which is self-possessed, refined, and boasting no special brilliance of tone. (It doesn't matter.) The Concertgebouw under De Waart is disciplined, precise, perfectly meshing with the soloist.

The same performance qualities are brought to bear on the Michael Haydn with equal justification, but that work is less individual: it is, in fact, quite Mozartean in figuration and balance of phrase—thoroughly pleasant, if not much more. S.F.

B **WAGNER:** Der fliegende Holländer: Wie aus der Ferne; Die Walküre: Act III, Scene 3. Birgit Nilsson, soprano; Hans Hotter, bass-baritone; Philharmonia Orchestra, Leopold Ludwig, cond. Seraphim S 60167, \$2.98 [from Angel S 35585, 1959].

In a sense this disc belongs to Hotter. The finale of *Die Walküre* reissued here is perhaps the best representation of his magnificent

We put a little more feature into each feature.



■ A Papst hysteresis synchronous motor with outer rotor for unvarying speed accuracy. ■ Precise stylus overhang adjustment with built-in gauge—no shifting, no guesswork, no templates. ■ Silicone-damped cueing in both automatic and manual play. ■ And, those exclusive light touch pushbuttons to make it easy to enjoy all those other wonderful 50H features \$175.00 at your hi-fi dealer. Benjamin Electronic Sound Corp., Farmingdale, N.Y. 11735, a division of Instrument Systems Corp. Available in Canada.

MIRACORD 50H

CIRCLE 11 ON READER-SERVICE CARD

QUAD®

For 20 years and throughout the world the trade mark QUAD has identified the high quality audio equipment made by this Company.

Because others are now seeking to use the name in other ways we have to make it clear that by itself or combined with other words or numerals, QUAD identifies only audio equipment, components and related goods of our manufacture or sponsorship.

All other use of QUAD in connection with such goods is either a misuse, abuse or infringement which must and will be prosecuted.

ACOUSTICAL MANUFACTURING CO. LTD.
HUNTINGDON, ENGLAND.

get the
**NEWS
FREE!**

The new McIntosh 36 page catalog gives you all the details on the new McIntosh solid state equipment. In addition, you'll receive absolutely free a complete up-to-date FM Station Directory.



**MC 2505
SOLID STATE POWER AMPLIFIER**

**FREE
SEND TODAY**

McIntosh

2 Chambers St., Dept. A-7
Binghamton, N.Y. 13903

Please Send FREE CATALOG and DIRECTORY

NAME _____
ADDRESS _____
CITY _____
STATE _____ ZIP _____

CIRCLE 31 ON READER-SERVICE CARD

Wotan on commercial discs—London's integral recording was made too late. Here is all the vocal authority, thrust, and majestic inflection that one remembers from his Bayreuth and Vienna performances of the Fifties. The *Dutchman* duet is marginally less perfect—this music demands the kind of evenly controlled legato singing that Hotter rarely commanded outside of his work in Lieder—but much of the brooding fanaticism of the doomed sailor comes across vividly.

Birgit Nilsson has grown tremendously since these sessions: the top is now much fuller at *mezza voce*, the tendency to sharp under pressure is no longer a problem, and her interpretations, especially of Brünnhilde, have deepened and developed to an extraordinary degree. The singing here, admirable though it may be in many respects, is primarily interesting as a reminder of a good artist before she became a great one. Ludwig's conducting is routine but solid, and the sound remains thoroughly contemporary. P.G.D.

recitals and miscellany

B "THE ART OF DENNIS BRAIN, VOL. 3:" MOZART: Divertimento No. 14, in B flat, K. 270. IBERT: Trois pièces brèves. JACOB: Sextet. Dennis Brain, horn; Gareth Morris, flute; Leonard Brain, oboe; Stephen Walters, clarinet; Cecil James, bassoon; George Malcolm, piano. Seraphim 60169, \$2.98 (mono only).

What sort of distended legend would we have made of Dennis Brain by now, do you suppose, if records of his live performances did not exist? The actual playing of Paganini and Liszt, that is to say, must have been far more interesting to musicians of their day than we can deduce from the opaque eulogies that make up the bulk of their written histories. But no speculation is necessary about why and how Dennis Brain churned up so much excitement in his day: in addition to his famous Mozart, Strauss, and Hindemith concerto recordings, we have this extraordinarily valuable Seraphim series, most of it concentrating on his performance as a chamber musician. Or perhaps it would be better to say *not* concentrating on his performance, since nothing documents more clearly than this BBC studio broadcast, taped just four days before his death in a sports car accident on September, 1, 1957, how a great solo artist should sound and act as an ensemble member.

After a few moments, while listening to the Gordon Jacob Sextet, one easily lets Brain and his horn slip into perspective. It is possible simply to enjoy Jacob's pleasant piece, with its skillful writing in a rather French style that suggests Milhaud or Poulenc much of the time, and, in the bustling finale, Prokofiev in his mock-*classique* manner. Here and even more particularly in the Ibert, Brain's characteristic technique could not be more apposite: the prominent tongue, the French-sounding attacks, the trumpetlike articulation, the hand-in-glove blending of tone with essentially dissimilar instruments. But ever and always one hears an ensemble, and a fine one, not Dennis Brain. Now and then one can

notice a slightly cracked tone from flute or oboe, a reminder of the radio source of this disc. But on the whole the performances measure up quite well with the best of their genre, and the sound, though mono, is clear and sharply detailed, a tribute to the BBC's technical routine and to EMI's lily-gilding specialists.

The Mozart Divertimento is a wind sextet originally for pairs of horns, oboes, and bassoons, heard here inexplicably but effectively arranged by Anthony Baines as a quintet for flute, oboe, clarinet, horn, and bassoon. It is garden-party fluff, but the fluff of genius, and completely delicious in this lithe, springing performance. D.J.H.

MONTSERRAT CABALLE: "Great Operatic Heroines!" VERDI: Otello: Willow Song; Ave Maria; Un Ballo in maschera: Ecco l'orrido campo. DONIZETTI: Anna Bolena: Piangete voi . . . Al dolce guidami. CHARPENTIER: Louise: Depuis le jour. PUCCINI: Tosca: Vissi d'arte. Montserrat Caballé, soprano; Barcelona Symphony Orchestra, Carlo Felice Cillario, cond. RCA Red Seal LSC 3209, \$5.98.

Considering RCA's previous Caballé recitals—each one a carefully planned collection devoted to one composer or style—this is a curious hodgepodge. Furthermore, the presentation is extremely sketchy: instead of a text/translation leaflet we are only given a rough précis of the arias. According to one RCA source, the material here was recorded about five years ago for a Spanish label, which might partially account for the *olla podrida* flavor.

Taking the five excerpts in order, we are first given Desdemona's scena (beginning at "*Mia madre aveva una povera ancella*," without Emilia's comments). Caballé's affinity for this music is unmistakable and the entire sequence draws out all her finest qualities. There is a compelling aura of hushed doom to the "*Salce*" refrain, the asides to Emilia are nicely differentiated, while the intonational purity in the "*Ave Maria*" is ravishing. Amelia's anguished gallows aria follows hard upon and here Caballé seems less comfortable. She pecks gingerly at the opening recitative, the melodic line is slack in the aria, and the melodramatic conclusion lacks sufficient vocal weight.

Side 2 opens with a bit of the final scene from *Anna Bolena*—the cavatina and a few interjections from the chorus. The dreamily elegiac recitative is again very much in Caballé's line and she catches Anna's gentle volubility here quite successfully. The aria itself is also gorgeously phrased, although the trills that form a vital component of the melodic line are only approximated.

Both the *Louise* and *Tosca* arias turned up on Caballé's new recitals for DGG and Angel respectively, and these later versions are clearly superior. The soprano has worked on her French pronunciation since recording this peculiarly inflected "*Depuis le jour*" and the DGG interpretation is also far less mannered. "*Vissi d'arte*" sounds much the same, although I can't imagine Caballé really singing the entire role.

Cillario's accompaniments are handsomely played and the closely miked engineering has considerable presence. A record primarily for the Caballé fan, I would say—unless you want to add one of the really great recorded versions of Desdemona's two arias to your collection. P.G.D.

For \$279 we give you engineering. For an extra \$20 we throw in some furniture.

To call the **Rectilinear III** a piece of engineering is a rather vigorous understatement.

The equipment reviewers of leading hi-fi and other technical publications have gone on record that there's nothing better than this \$279 floor-standing speaker system, regardless of type, size or price. (Reprints on request.)

But engineering is all you should expect when you buy this

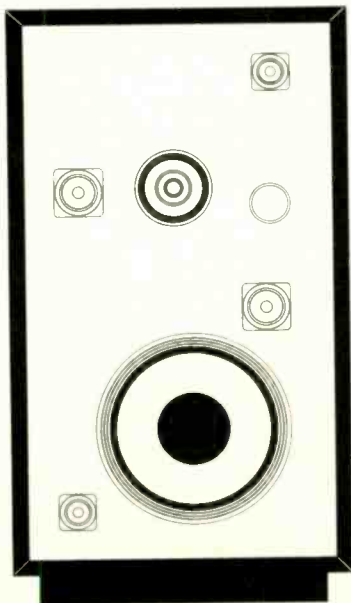

original version of the **Rectilinear III**. Its cabinet is 35" by 18" by 12" deep, handsome but utterly simple. For \$279, you get quality and taste but no frills.

However, if you're the last of the big-time spenders, you can now escape this austerity for an extra \$20. Because, for \$299, there's the stunning new lowboy version of the **Rectilinear III**, 28" by 22" by 12¼" deep, with a magnificent fretwork grille.

Mind you, the actual internal volume of the enclosure is the same in both versions. So are the

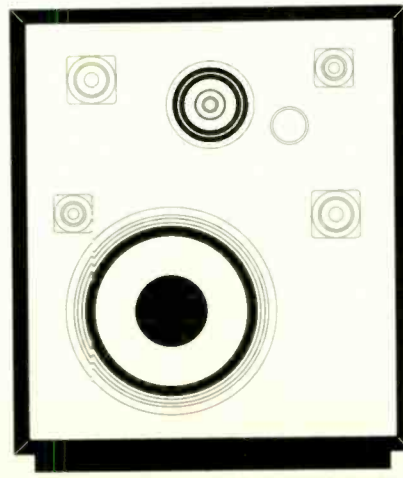

drivers and the crossover network. Only the cabinet styles and the dimensions are different. In the dark, you can't tell which **Rectilinear III** is which. They sound identical.

That's engineering.

(For more information, including detailed literature, see your audio dealer or write to Rectilinear Research Corp., 107 Bruckner Blvd., Bronx, N.Y. 10454. Canada: H. Roy Gray Co. Ltd., Markham, Ont. Overseas: Royal Sound Co., 409 N. Main St., Freeport, N.Y. 11520.)

Rectilinear III

CIRCLE 37 ON READER-SERVICE CARD

ADVERTISING INDEX

Key No.		Page No.
1	Acoustic Research, Inc.	75
	Acoustical Manufacturing Co., Ltd.	93
2	A.D.R. Audio	109
3	Akai Electric Co., Ltd.	21-26
	Allied Radio Shack	83, 90
50	Altec Lansing	78
4	Ampex Corp.	88
7	Ampex Tape Division	79
8	Angel Records	74
9	Audio Dynamics Corp.	11
10	Audio Sales	109
49	Audio Unlimited	111
11	Benjamin Electronic Sound Corp.	93
5	Bose Corp.	5
6	Bose Corp.	5
	Bozak	8
103	British Industries	37
12	Carston Studios	109
	Columbia Records	66
13	Concord Electronics Corp.	12
14	Denki Onkyo Co., Ltd.	84
15	District Sound, Inc.	106
16	Dixie Hi Fidelity Wholesalers	106
17	Downtown Audio, Inc.	108
	Dressner	106
18	Dual	49
19	Dynaco Inc.	40
20	Dynaco Inc.	105
21	Empire Scientific Corp.	14
22	Finney Company	108
	Fisher Radio	Cover II, 1
103	Garrard	37
30	Harman-Kardon, Inc.	30, 31
24	Heath Co.	29
25	Irish Tape	14
26	JVC America, Inc.	77
36	Kenwood	Cover IV
27	King Karol Records	111
28	KLH Research and Development	33
29	Lafayette Radio Electronics Corp.	17
23	London Records	89
31	McIntosh	94
42	Memorex Corp.	13
	Pioneer Electronics U.S.A. Corp.	10
33	Rabco	12
34	Rabsons-57 St., Inc.	111
35	Record Club of America	6, 7
	Record Mart	111
37	Rectilinear Research Corp.	95
38	Rek-O-Kut	112
39	Sansui Electronics Corp.	35
100	Scott, H. H., Inc.	87
	Scribner's, Charles, Sons	99
	SEE 70's	109
40	Sherwood Electronic Laboratories	9
41	Shure Brothers, Inc.	85
32	Sony Corp. of America	81
53	Sony/Superscope, Inc.	91
63	Sony/Superscope, Inc.	103
44	Sound Reproduction, Inc.	105
45	Standard Radio Corp.	38, 39
46	Stanton Magnetics, Inc.	2
47	Stereo Corp. of America	110
	Tape Timing Guide	106
67	Teac	Cover III
48	Toyo Radio Co.	107
18	United Audio Products, Inc.	49
52	VM Corp.	75
	Wyeth Press	110

DIETRICH FISCHER-DIESKAU: "Haydn and Mozart Rarities." **HAYDN:** Un cor si tenero; Spann' deine lange Ohren (from *La Vera costanza*) Terzi i vezzosi rai; Dice benissimo. **MOZART:** Männer suchen stets zu naschen; Ich möchte wohl der Kaiser sein; Nach der Welschen Art (from *La Finta giardiniera*); Mentre ti lascio, o figlia; Così dunque tradisci; Un bacio di mano; Hai già vinta la causa . . . Vedrò mentr'io sospiro (from *La Nozze di Figaro*). Dietrich Fischer-Dieskau, baritone; Vienna Haydn Orchestra, Reinhard Peters, cond. London OS 26182, \$5.98.

One thing about that insatiable Dieskau appetite for repertory: it brings about recordings that might well not have happened but for the fact that our versatile baritone has already recorded just about everything in the standard literature. The Haydn arias here—all but one of them composed for insertion in Esterházy performances of operas by other composers—are pleasant enough pieces, but in this juxtaposition with Mozart, one sees some of the reasons for the older man's relative lack of success as an opera composer. There is rarely much interpenetration between the vocal line and the orchestral fabric: although the latter's ritornello naturally presents the same material as the singer, it tends to run on, as if in response to the demands that Haydn the instrumental composer would place on his material rather than the economy and concision that Haydn the opera composer should be demanding. The vocal line too is primarily carpentry rather than melodic writing. Although the materials here are obviously of the later eighteenth century, the time scale is still that of the baroque.

The Mozart pieces are not all masterpieces, for that matter. We have the little arietta beloved of sopranos as a song entitled *Warnung* (Mozart actually completed only the vocal line and bass, plus a few orchestral details: the realization used here is by one Fürst, and seems stylistically unexceptionable); a tedious marching song with Turkish instrumentation; a *buffo* aria from an opera of 1775 (this and the aria from Haydn's *La Vera costanza* are sung in German, for obscure reasons); three fine insertion arias, two serious and one *buffo*; and finally a revision of the Count's aria from *Figaro*, apparently made for the same 1789 revival that gave rise to "*Un moto di gioia*," a soprano aria that replaced "*Venite, ingiunocchiatevi*." The revision was apparently to accommodate a Count strongest in the higher register, for it eliminates most of the lower notes in the fast section, keeping the singer above the staff most of the time; near the very end some material is rewritten, bypassing that troublesome measure of coloratura in triplets.

Some of these are curiosities, but the concert arias most definitely are not, and they have been very poorly represented in the catalogues (sopranos have recently done rather well by their share of this literature, but not tenors or basses). I have numerous reservations about the singing—its wearisome tendency to hammer on downbeats, exaggerated Italian vowels, patches of rough intonation, rhythmic fussiness, and the lack of true legato line—but I wouldn't wish to dissuade any admirer of Mozart from hearing these pieces. To my knowledge, only *Mentre ti lascio* is otherwise available, in a late Pinza recording (Odyssey 32 16 0335) which has more of the

appropriate vocal manner, although hardly the involvement and security of that singer's work in his more usual repertory.

The accompaniments are well executed, with a good deal of spirit. (By the way, can anyone tell me if this conductor is the same Reinhard Peters who once recorded Mozart violin sonatas with Charles Rosen, on a mid-Fifties London disc?). The advance pressing sent for review did not include packaging, but London will doubtless provide texts, translations, and background information. D.H.

ANDRE KOSTELANETZ: "And God Created Great Whales." **HOVHANESS:** "And God Created Great Whales." **SIBELIUS:** The Tempest: Incidental Music, Op. 109 (three excerpts). **SKALKOTTAS:** Three Greek Dances. **WEILL:** Die Dreigroschenoper: Mack the Knife. **GLINKA:** Jota Aragonesa. Orchestra, André Kostelanetz, cond. Columbia M 30390, \$5.98.

Whatever one may think of Kostelanetz as a conductor (and I've had some hard criticisms to make on occasion), he must be ranked among the most happily imaginative of program makers. Apart from the Glinka piece, familiar enough if by no means hackneyed, everything here has markedly novel appeal—so much, indeed, that even I am not going to quibble about some slight tonal coarseness. Even that recent hit, *Mack the Knife*, is spiced by the now rare use of the original scoring for theater orchestra. The Sibelius pieces (*The Mermaids*, *Miranda*, and *Caliban's Song*), while innocuous or inconsequential enough in themselves, haven't been available on records for some years. The three more striking and vital *Greek Dances* by the too short-lived and too little-known Skalkottas are currently available (along with nine more of the thirty-six he composed) in a 1957 Fantasy disc that is no sonic match for the vivid presence here.

But the prime feature of this program is the premiere recording of the Hovhaness work, originally commissioned by Kostelanetz and embodying the actual sounds of whales "singing." It's a very curious piece, like most of this distinctive composer's music, and magnetically fascinating even when it may not be completely satisfying. I rather doubt that the inclusion of the wails, whines, grunts, and blurps of whales is as aesthetically effective as the composer's strictly orchestral evocations of leviathans disporting themselves in calm and stormy seas. Just the same, the piece as a whole is surely one of the most provocatively "different"—without being aurally difficult or irritating—compositions in the whole contemporary repertory. R.D.D.

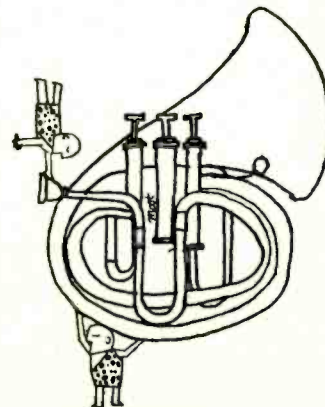

HIGH FIDELITY MAGAZINE

the recordings of



BEETHOVEN

To cap the 200th anniversary of Beethoven's birth, these critiques, originally published in *High Fidelity*—and now updated—cover all the available recordings of the works of the most popular of all classical composers.

CONTENTS:

Symphonies by Paul Henry Lang
Concertos by Harris Goldsmith
Other Orchestral Music by David Hamilton
Piano Music by Harris Goldsmith
String Quartets by Robert P. Morgan
Other Chamber Music by Robert C. Marsh
Fidelio and the Songs by George Movshon
Choral Music by H. C. Robbins Landon
\$6.95

At your bookstore or
write to *High Fidelity Magazine*
2160 Patterson Street, Cincinnati, Ohio 45214

Published by Charles Scribner's Sons
and The Wyeth Press

in brief

ARENSKY: Concerto for Piano with Orchestral Accompaniment, Op. 2; Trio for Violin, Cello, and Piano, in D minor, Op. 32. Maria Littauer, piano; György Terebesi, violin; Hannelore Michel, cello; Berlin Symphony Orchestra, Jörg Faerber, cond. Candide CE 31029, \$3.98.

I'll wager that the Heifetz/Piatigorsky/Pennario version of Arensky's trio (RCA LSC 2867) and Blumental's of the concerto (Turnabout TVS 34345) have already pre-empted the limited market for these attractive but faded period scores, but if not, I'll put in a plug for the new arrival. It seems to me that Maria Littauer is an altogether warmer and more spirited protagonist of the piano part in the trio than Pennario, and is better supported by the orchestra than Blumental in the concerto. Terebesi and Michel may not be Heifetz and Piatigorsky, but they are, in this work at least, undisputably fine instrumentalists in their own right and better chamber-music players. The strings sound unduly raspy on Candide's Dolbyized disc. Could it be that whoever did the mastering forgot to unstretch the signal on the tape? H.G.

BARTOK: Miraculous Mandarin; Suite. **PROKOFIEV:** Scythian Suite; The Love for Three Oranges; Suite. BBC Symphony Orchestra (in the Bartók); London Symphony Orchestra (in the Prokofiev); Antal Dorati cond. Mercury SR 90531, \$5.98.

This record has at least two shortcomings: Bartók's score for the *Miraculous Mandarin* is more successful in its complete form, notably as recorded by Solti on London; secondly, Dorati's rather unyielding and literal rhythmic drive as well as the orchestra's chilly tone do not really serve any of this music well. Though one of Bartók's less tender scores, there is more expressiveness in the *Mandarin* than Dorati evokes. Similarly there is more wit and relaxation in the Prokofiev suite than he projects. However, both orchestras play superbly. P.H.

BEETHOVEN: Christ am Oelberge, Op. 85. Cristina Deutekom, soprano; Nicolai Gedda, tenor; Hans Sotin, bass; Chorus of the Bonn State Theater; Bonn Philharmonic Chorus and Orchestra, Volker Wangerheim, cond. Angel S 36696, \$5.98.

Angel's new *Christ on the Mount of Olives* is the fourth current version of Beethoven's problematical, interesting, and occasionally gripping oratorio (Ormandy's performance on Columbia CMS 6841 is missing from Schwann although the disc was never officially deleted). There are many things to commend it: a serious, even dedicated approach to the score; Nicolai Gedda's profound reading of Christ; the solidly dependable choir and orchestra; the clear and well-balanced recording. What disturbs and disturbs badly is the fact that Cristina Deutekom is decidedly strained in the upper ranges of her voice and presses most uncomfortably when singing above G. The Ormandy version with Judith Raskin and Richard Lewis remains unsurpassed. H.C.R.L.

B **BEETHOVEN:** Trio for Violin, Cello, and Piano, No. 6, in B flat, Op. 97 ("Archduke"). Sandor Vegh, violin; Pablo Casals, cello; Mieczyslaw Horszowski, piano, Turnabout TVS 3441, \$2.98 [from Philips 900016, 1963].

These three distinguished musicians were decidedly having an off night when this live performance was taped at the Beethovenhaus in Bonn. One might pass the poor tonal balances, frequently ragged ensemble, and sour intonation had the interpretation some really blinding revelations to offer; but the deadly slow tempos rob the music of all vitality—the notes seem to be simply falling on the floor at random. It would have been far better to let this disc pass quietly into limbo. P.G.D.

B **BERLIOZ:** Symphonie fantastique, Op. 14. French National Radio Orchestra, Sir Thomas Beecham, cond. Seraphim S 60165, \$2.98.

This is *not* a reissue of Sir Thomas' *Fantastique* which used to be available domestically as Capitol G 7102. The unpredictable baronet, in the final years of his career, made separate mono and stereo versions of Berlioz' *Fantastique*, Franck's D minor, Brahms's Second, and Beethoven's Seventh. In the case of the present work, the two-channel account was consigned to domestic limbo; now that it has finally arrived, I can see why. On the whole, the mono was a much stronger performance. The rhythmic control was tighter, the phrasing sleeker and more assured, the engineering more forthright and forward in texture. On the newly released disc, the playing is sluggish and tentative (only one tiny detail represents an improvement: in the introductory phrases of the Witches' Sabbath, the wind instruments insert eerie glissandos that make one's hair stand on end). Of course, Beecham is Beecham, and there is much that is genuinely poetic and affecting even when he is below par. H.G.

CLAY: Ages Ago. Soloists, with piano, harmonium, and harp accompaniments; Frederick S. Roffman, cond. World Premiere Recording, \$7.98 (two discs). Available from Frederick S. Roffman, 230 Riverside Drive, New York, N.Y. 10025.

Here is a real curio. Frederic Clay was a contemporary of Arthur Sullivan and his once popular 1869 operatta, *Ages Ago*, predated the G & S series by about two years (it was, in fact, during a rehearsal of *Ages Ago* that Gilbert and Sullivan first met). Clay's music is not especially memorable, but Gilbert's libretto offers some fascinating glimpses of themes he was to develop later on. The living portrait gallery turns up again in *Ruddigore* of course, while the Gilbertian obsession with age—young, old, and middle—here receives its definite paradoxical working out. Given complete with dialogue, the performance is a rough-and-ready affair and the sound is distinctly homemade. Even so, confirmed G & S fans should give it a try. P.G.D.

COUPERIN: L'Apothéose de Lully. Eduard Melkus and Spiros Rantos, violins; Friedericke Schadner, flute; Bernhard Klebel, oboe; Johannes Koch, viola da gamba; Leo Carmaltz, bassoon; Huguette Dreyfus, harpsichord. Archive 2533 067, \$6.98.

This is refined playing by excellent instrumentalists; only in the slow pieces is there an occasional lack of variety. They refrain from overornamentation, which is praiseworthy; however, some of the trills and appoggiaturas are a trifle perfunctory. Curious how some of the finest musicians fail to integrate the ornaments with the melody. But this is a very good performance, made particularly interesting because instead of the usual cello they use the original gamba. First-class sound. P.H.L.

HANDEL: Water Music. English Chamber Orchestra, Raymond Leppard, cond. Philips 6500-047, \$5.98.

The combination of this fine orchestra with a conductor whose sense for balance and the demands of part writing is exceptionally acute usually results in superlative orchestral performance. This recording is no exception. We know that in order to achieve this extreme clarity Leppard occasionally meddles with the score, but whatever he does is musical. Perhaps the gorgeous air is a little sentimental, perhaps an allegro here and there is a little too brisk (though always impressively articulated), perhaps the staccatos in the first *Bourrée* are a bit Mendelssohnian, but everything is delight to the ear. Throughout the recording Leppard maintains a very pleasant intimate tone, rightly assuming that while this is outdoor music, it is not the "massive baroque" of the *Royal Fireworks Music*. Sound carries well over water and Handel never makes acoustic mistakes. I shall listen to this fine recording whenever I am tired of heavy-footed orchestral playing. P. H. L.

JOACHIM: Concerto for Violin and Orchestra, in D minor, Op. 11 ("In the Hungarian Style"). Charles Treger, violin; Louisville Orchestra, Jorge Mester, cond. Louisville LS 705, \$5.98.

Joseph Joachim (1831-1907) is remembered principally as a virtuoso violinist of uncompromising high ideals and for his friendship with Brahms. He composed a bit too, and this large-scale romantic concerto is considered his best work. The dark orchestral coloring and gypsy flavor suggests Brahms, but the harmonic idiom is closer to Schumann, while the solo writing has a touch of Lisztian deviltry. An eclectic work, in short, but an attractive one that certainly merits an occasional revival. Charles Treger easily surmounts the fiendish technical demands and makes fine capital of the music's soaring Hungarian lyricism. Mester and the orchestra give him respectable support, and the sound will do. P.G.D.

LALO: Concerto for Cello and Orchestra, in D Minor. **SAINT-SAENS:** Concerto for Cello and Orchestra, No. 1, in A minor, Op. 33. **FAURE:** Elégie for Cello and Orchestra, in C minor, Op. 24. Maurice Gendron, cello; Monte Carlo Opera Orchestra, Roberto Benzi, cond. Philips 6500 045, \$5.98.

In the April 1970 issue I commented enthusiastically on Leonard Rose's performances of these same three French works for cello and orchestra. Maurice Gendron's versions here have much to commend them for those interested in a more thoroughly French stylistic approach. Gendron does not bring the overpowering technical mastery that Rose lavishes on this music; his more intimate interpretation, lighter tone, and more restricted dynamic range, however, combine with an impressive range of tone color to produce extremely musical performances that are fully up to the requirements of the scores. The recording places the soloist considerably to the forefront of the sonic perspective, whereas Rose's sound was cradled and surrounded by the Philadelphia Orchestra. Moreover, the Monte Carlo orchestra is by no means in a class with the Philadelphia: though its solo woodwinds play with real distinction, the brass and strings are anemic and the over-all sound lacks real body. P.H.

MUSSORGSKY: Pictures at an Exhibition. **RACHMANINOFF:** Preludes: in G minor, Op. 23, No. 5; in G, Op. 32, No. 5; Etude Tableaux in B minor, Op. 39, No. 4. Viktor Yeresko, piano. Melodiya/Angel SR 40162, \$5.98.

I am quite agreeably taken with the present folio of *Pictures*. Viktor Yeresko plays the work on a broad scale: he is definitely the architect and muralist rather than the patrician master of the thumbnail sketch. He plays with basic strength and, as in the *Ballet of the Chicks in Their Shells*, with quite a lot of fanciful rubato phrasing. He doesn't quite achieve Richter's unbearable intensity of expression in *Catacombs*, nor that older pianist's obsessive frenzy in sections like *Baba Yaga*; but by ordinary standards, this is as moving and well played a *Pictures* as I've heard in quite a while. The Rachmaninoff selections are all well done too, with a particularly broad, massive G minor Prelude. The sound (as heard on an acetate reference copy) is bold, massive, and spacious. Excellent notes by our own Alfred Frankenstein. H.G.

NIELSEN: Symphony No. 4 ("Inextinguishable"). New York Philharmonic, Leonard Bernstein, cond. Columbia M 30293, \$5.98.

On the basis of his recordings of Nielsen's symphonies Three and Five, one would expect Bernstein's version of the Fourth to be the most energetic and compelling of the current offerings. Bernstein's grasp of the composer's ideas and orchestral idiom is one of those cases of nearly complete composer-conductor identification: it leads to performances that set standards for everyone else. No one else quite matches his skill in making this music move, in revealing how every thematic line has a pulse, how every dab or orchestral color is part of a total design. The Fourth is Nielsen's most often recorded symphony. If it's already a favorite of yours, you'll find ample discoveries in this performance. If you don't know it yet, opportunity is knocking loudly. R.C.M.

PERSICHELLI: Symphony No. 8. **RIEGGER:** Study in Sonority. Louisville Orchestra, Jorge Mester, cond. Louisville LS 706, \$5.98.

The Persichetti is a pleasant, tuneful, academic symphony, easy to listen to and easy to forget. The Riegger, however, is a masterpiece. It was composed in 1927 and is one of the first, if not the very first work in the modern literature to subdivide the string sections of an orchestra into many parts. It is for ten violins, or multiples of ten, and for violins only; but its polyphony is so eloquent, its color so strong, its phrasing so dynamic that a full string orchestra seems to be involved. *This piece has a profile; it really thrusts out at you, and you'll never forget it.* The performances are excellent and so is the sound. A.F.

RAVEL: Daphnis et Chloé: Suite No. 2; *Ma Mère l'Oye*: Suite; *La Valse*. Los Angeles Philharmonic Orchestra, Zubin Mehta, cond. London CS 6698, \$5.98.

Mehta's Ravel program is beautifully played and recorded, but his *Mother Goose* is interpretatively limp and prosaic in comparison with the 1969 Martinon version for RCA, and his *Valse*, while lusciously sensuous, tends to sag at times and be rushed at others. But in the familiar *Daphnis et Chloé* showpiece Mehta skillfully avoids the usual interpretative traps; he achieves a limpid freedom from tension in the first two sections and gives no feeling of haste in the exciting finale. If you haven't heard the Los Angeles Philharmonic (and its unspecified choral group) lately, you'll find this disc to be convincing proof of its current high executant stature. Certainly, I've never heard it sound better than it does here. R.D.D.

SCARLATTI, A.: Su le sponde del Tebro; *Endimione e Cintia* (excerpts). **TORELLI:** Concerto for Two Trumpets, Strings, and Continuo, in D; *Sonatas* (2) for Trumpet, Strings, and Continuo, in D; *Sinfonia* for Trumpet, Strings, and Continuo, in D. Barbara Schlick, soprano; Adolf Scherbaum, Stanislav Simek, trumpets; Scherbaum Baroque Ensemble. Deutsche Grammophon 2530 023, \$6.98.

If the Scarlatti cantata is what draws your attention to this record, I would suggest Carole Bogard's far more satisfactory reading on Cambridge CRS 2710. The DGG version is based on a "corrupt" text which, among other details, omits the second strophes of the three principal arias (DGG's playing time is fifteen minutes to Cambridge's twenty-four minutes). Besides, Miss Schlick can't hold a candle to Bogard's absolutely spectacular vocal fireworks. The two arias from *Endimione e Cintia* on the DGG disc are breathtakingly effective. Torelli's trumpet and orchestra pieces are delightfully vigorous, bouncy affairs in a Vivaldi style. Scherbaum is thoroughly dashing and his "Baroque Ensemble," five strings and harpsichord, play with clean-cut vigor and intensity. But a whole record side of unrelenting D major! C.F.G.

RUGGIERO RICCI: "Bravura!" **LOCATELLI:** The Harmonic Labyrinth, Op. 3, No. 12. **PAGANINI:** Variations: on "Nel cor piu non mi sento"; on "God Save the Queen"; on a Theme of Joseph Weigl. **ERNST:** Hungarian Airs, Op. 22; Variations on "The Last Rose of Summer." **VECSEY:** The Wind (Caprice No. 1). **WIENIAWSKI:** Variations on the Austrian National Anthem. Ruggiero Ricci, violin; Leon Pommers, piano. Decca DL 710172, \$5.98.

A trip through the funhouse with that now-extinct species, the violin virtuoso-composer. I loved every minute of it, including the really disgraceful ravishment of the Austrian National Anthem by Wieniawski and some things that ought not to have been done to *God Save the Queen*—even by Paganini. But if left-hand pizzicatos, running passages in double stops and double-stopped harmonics, catapulting across strings, etc., are your cup of tea, you will enjoy this recording. Ricci sails into all of it with gusto, grit, and flair. S.F.

the tape deck

BY R.D. DARRELL

Dolby: London and Elk Grove Village.

The progress of cassette Dolbyization has been proceeding slowly after its fast start earlier this year. Ampex has been releasing a considerable number of pop programs but relatively few classical tapes; of the latter only one has reached me for review. It's the one I wanted most, though, not only for its own exceptional artistic and technical merits but also as an index to American vs. British exploitation of Type-B Dolby technology. For this release (London cassette M 10238, \$6.95) is the Ampex processing of the same Boskovsky/Vienna Philharmonic 1970 New Year's Concert, "Vienna Imperial," I had heard earlier in an English Decca processing (SXC 6419, not on sale in this country) as well as in the London disc edition (CS 6641) which I reviewed last April—a program that warrants a treasured place in every Johann Strauss or Viennese music collection no matter what the medium or format.

Direct comparisons between discs and cassettes demonstrate once again that the best of the latter are a close match for their disc equivalents in every respect, including—with Dolbyized processing and playback—minimal surface noise. But A/B-ing the British and American cassette processings suggests that producers on this side of the Atlantic are not (in this particular case at least) taking full advantage of the new technique's potentials. The London/Ampex (Elk Grove Village, Illinois) production, while boasting first-rate technical quality, has been processed with a 6- to 8-dB lower modulation level than the British version. Unless the playback levels are equalized, the American version, for all its warmth and lucidity, will seem far less thrilling sonically; and if the levels are equalized, its noise-reduction characteristics will be far less dramatic.

The higher the modulation level the greater will be the risk of program-peak distortion, as every amateur as well as professional recorder knows. But the British engineers prove that their American colleagues have been too timid—here—to make use of an optimum high, yet still safe, modulation level. I hope that the lesson they teach in this case will be taken to heart, especially since the Ampex engineers proved earlier (on the B side of the "Mantovani in Concert" cassette program I discussed a couple of months ago) that they too are perfectly capable of handling distortion-free,

high-modulation levels. And I wish too that it weren't too much to hope that the English Decca (as well as the DGG and Philips) practice of providing cassette annotations would be emulated in London/Ampex releases. Even the brief notes in RCA Red Seal and Angel musicassettes are better than none at all. Now that cassettes can provide close technical as well as artistic competition for stereo discs, their higher cost certainly should cover the helpful inclusion of liner notes.

Rolling Rubinsteins Gather No Moss

—in my car, anyway, where every 8-track tape cartridge featuring the great Artur's pianism is more likely to be worn out by overuse. Heard more objectively at home, the same programs may raise at least minor quibbles over some executant or interpretative details, but even there Rubinstein's relish for what he plays is irresistibly infectious. And as a Good (traveling) Companion he's one of the most delightful, as well as the most rewarding, one can find anywhere.

He's in great form both in an anthology of earlier recordings, "The Chopin I Love" (RCA Red Seal 8-track R8S 1172, \$6.95) and a cartridge edition of his famous "Three Favorite Beethoven Sonatas" (RCA R8S 1173, \$6.95). Except for the G minor Ballade of 1959, the Chopin program comprises shorter works: three nocturnes; three waltzes; two polonaises; the Op. 33, No. 2 Mazurka; and the Fantasie-Impromptu, originally recorded in 1963-65 and still sounding as piquantly fresh and vital as ever.

The Beethoven favorites are predictably the *Moonlight*, *Pathétique*, and *Appassionata* sonatas of (I think) 1962-63, and they too sound as if they were Rubinstein's personal discoveries rather than warhorses long ridden to death. My only adverse criticism, applicable to both these releases, is that the RCA processors (generally the most careful of all 8-track cartridge producers) slip badly here where surface noise standards are concerned and in permitting adjacent channel spill-overs. Such defects are normally inaudible in carborne listening, to be sure, but they're unpleasantly evident in home audition—and in any case they're technically inexcusable.

There's considerable "spill" too in the recently released 1969 recordings of two long-time Rubinstein concerto favorites: the sparkling Saint-Saëns Second in G minor and Falla's atmospheric *Nights in the Gardens of Spain*, accompanied here

by the Philadelphians under Ormandy (RCA Red Seal 8-track R8S 1165, also cassette RK 1165, \$6.95 each). Saint-Saëns's romantic, frankly old-fashioned, but still exciting virtuoso work is ideal as an invigorating car companion, but annoying "breaks" as well as more spill-overs make the cassette edition preferable for home listening. In the fascinating Spanish masterpiece, however, neither edition is really satisfactory, even though Rubinstein himself is surely no less poetic here than in his memorable readings of old, and the orchestral playing, while perhaps a bit routine, is certainly not lacking in tonal beauty. But the music's magic is brutally dispelled by unconscionably close and realistically vivid recording.

In any case the Rubinstein solo programs best stand up to constant en-route repetition—and none of them are better than the very first Arturian cartridge sent me for review: the RCA Red Seal R8S 1071 Chopin waltzes. After some three and a half years of frequent (and consistently delightful) rehearsals, my copy was accidentally damaged—a relatively infrequent event nowadays, but one that does happen occasionally. Within a few weeks its absence became so achingly unbearable that I had to go out and buy a replacement. And when a reviewer digs up cash to pay for a recording, in any medium or format, he can make no more sincere recommendation of an indispensable work!

Back-Seat Romance. For travelers, or parkers, seeking environment-enhancement background music, there's a warmly colorful addition to Tutti Camarata's series of popularized bits and pieces from the classics. This "Magic of Borodin" program includes the expected *Polovisian Dances*, String Quartet *Nocturno* movement, and *In the Steppes of Central Asia*—but also the *Prince Igor* Overture and an orchestrated "Melody" from the String Quartet in D. There are of course more refined and authoritative readings of all these, but Camarata's enthusiasm is hard to resist and his first-rate British Orchestra is superbly recorded (London/Ampex 8-track M 95052, also cassette M 94052, \$6.95 each). There's likely to be even more mass-public appeal in an Ormandy anthology of earlier recordings starring "The Romantic Philadelphia Strings." These range from the same Borodin *Nocturno* through the Tchaikovsky *Andante cantabile*, Barber *Adagio*, Mascagni *Cavalleria Rusticana* Intermezzo, Massenet *Elégie* and *Thàis* Meditation, etc., to transcriptions of the *Londonderry Air* (by Harris) and MacDowell's *To a Wild Rose* (by Frost). Capsule comment: Juicy! (Columbia 8-track MA 30066, \$6.98.)

Sony presents three distinguished professional quality stereo tape decks for the serious hobbyist. Each of these Sony decks has been value-engineered to offer the greatest possible performance capability for the money. Your Sony/Superscope dealer will be glad to help you decide which instrument best suits your personal recording needs.

SONY SUPERSCOPE

You never heard it so good.®



the lighter side

reviewed by

MORGAN AMES

R. D. DARRELL

JOHN GABREE

JOHN S. WILSON

LIBERACE: Love and Music Festival—Live. Liberace, piano; orchestra. *Love Story; My Buddy; Nikki*; five more. Warner Bros. WS 1889, \$4.98. Tape: ● M 81889, \$6.95; ●● M 51889, \$6.95.

Years ago when I began reviewing, I was asked to do a Liberace album. On the cover was a color photo of Liberace in one of those incredible evening jackets, all sequins and beads. I listened to the mindless music and found nothing to say. So I reviewed his jacket.

Time passes. Eras and auras change. Liberace has become an institution, a charming and outrageous public personality. He has always had ten reasonably disciplined fingers at his pianistic disposal. The rest was a matter of taste. It made him a fortune.

This album, recorded live and in concert, reveals a different Liberace from his studio-made discs. Here he laughs and kids with his audience as easily as if they were in his living room sipping his best sherry. Once one views Liberace as a personality phenomenon rather than a musical one, all is well. Things that once drove one wild begin instead to charm. The first thing to realize is that the man is totally sincere. The second is that he is funny in his gentle, offbeat way, whether he's playing, talking, or showing off his jewelry. ("Well, look me over. I didn't get dressed like this to go unnoticed.")

About the music. It's better than any yet heard from Liberace. The surprisingly tasteful arrangements do a great deal to enhance his playing (particularly *We've Only Just Begun*). Unforgivably, the arranger is unlisted. Nor does Liberace give the arranger credit during the concert, though he does compliment the orchestra, whose string section is flat and whose horns are sluggish.

There is some stretching out in terms of program material here, which includes the above-mentioned Carpenters' hit; *Nikki* by Bacharach and David; *The Long and Winding Road* by Lennon-McCartney; and even the overture from Peter Townshend's rock opera *Tommy*. It seems that Liberace is one of many pre-rock era performers who has benefited from recent musical influences. Several pre-

dictable ditties are also included: *Over the Rainbow; My Buddy; Tea for Two*.

Liberace ends the concert as only Liberace can, with a song called *Ciao* ("Never say goodbye, say Ciao"). He wrote the song. He even sings it for the occasion. You've never heard such corn. Its ultimate charm lies in the fact that everyone leaves the hall with the feeling that Liberace wrote and sang it for him personally on this wonderfully personal evening.

This is a smiling album, and I finally get the message. Yeah, Liberace. M.A.

JOHN DENVER: Poems, Prayers & Promises. John Denver, vocals and guitar; rhythm accompaniment. *Let It Be; Junk; The Box; Fire and Rain; My Sweet Lady; Around and Around*; six more. RCA Victor LSP 4499, \$5.98.

CAROLE KING: Tapestry. Carole King, vocals and piano; rhythm accompaniment. *So Far Away; It's Too Late; Home Again; Beautiful; Where You Lead; Tapestry*; six more. Ode 70 SP 77009, \$4.98. Tape: ● 77009, \$6.95; ●● 77009, \$6.95.

These albums record the deepening abilities of two of the finest young singer/songwriters. With "Poems, Prayers & Promises" John Denver regains the stride he lost somewhat on his last couple of outings: the new disc includes some of his best writing. His songs, as always, would be too sentimental if they weren't so melodic and if he didn't deliver them so beautifully. His singing is more assured and he seems to have lost the need to show off—his worst fault in the past. He still has an unerring ability to find the most overrecorded songs when going outside his originals, this time offering *Let It Be* and *Fire and Rain*. But the whole works well enough to make such criticisms seem niggling.

Carole King's third album (she has released one previously under her own name and another using the group name City) finally begins to fulfill the promise that she has held out since the beginning of her performing career (her songwriting goes back to 1960). The City album (Ode 70 Z.12 44 012) was quite good and included at least two superb cuts; but her first solo album was muddled and confused, as if she couldn't decide which of several successful female singers to choose as a model. On "Tapestry" she seems to have found her groove.

At first glance, because her style grew out of the New York sound of the early '60s and because she plays piano, she resembles Laura Nyro, who works with the same material. However, King is a much less mannered performer than Nyro and her songs are more straightforward and less romantic. Most of these songs are new but she does dip back to past writing successes with *Will You Love Me Tomorrow?* and *(You Make Me Feel Like) A Natural Woman*. Her basic support of Danny Kootch, guitar, and Charles Larkey, bass, receives solid assistance from people like

James Taylor and reedman Curtis Amy. The record is also nicely packaged. Congratulations to all hands. J.G.

JOSEPH AND THE AMAZING TECHNICOLOR DREAMCOAT. Rock cantata by Andrew Lloyd Webber and Tim Rice for choir and orchestra; Andrew Lloyd Webber, arr.; Alan Doggett, cond. Scepter SPS 588, \$4.98.

Joseph and the Amazing Technicolor Dreamcoat was the first product of the collaboration between Andrew Lloyd Webber and Tim Rice that culminated in the fantastically successful *Jesus Christ, Superstar*. Written in 1967, *Joseph* is essentially a series of songs around a single story line, much the same as Peter Townshend's *Tommy* though not nearly as successful. There is the first faint glimmer of characterizations in the personages of Joseph and the Pharaoh, but for the most part the songs simply recount the Biblical story of Joseph in contemporary speech.

Tim Rice's work here already demonstrates considerable skill as a lyricist, but Webber's music is at best unmemorable and sometimes much less than that. The performance is so-so, uninspired, flat. Most of the time, the piece parodies various rock styles, only occasionally deliberately. The album is being given a big push by Scepter, hoping to make the most out of the popularity of *Superstar*—even the jacket cover resembles the sleeve on the opera, but I doubt that the album will interest any but pop historians. It was ignored by the public when it was released in Britain and rightly so. It's an amateur job. J.G.



Michel Colombier—a multicolored flight.

* **MICHEL COLOMBIER:** Wings. Composed, orchestrated, and conducted by Michel Colombier; lyrics by Paul Williams; Bill Medley, Lani Hall, Paul Williams, Herb Alpert, and Vemettya Royster, vocals. *Freedom and Fear; Thalassa; Earth*; seven more. A & M SPX 4281, \$5.98.

This adventurous album has been the source of much interested studio talk in Los Angeles

for nearly a year. It seems that A & M Records' owner/producer Herb Alpert met France's distinguished composer/conductor, Michel Colombier, while both were involved in a Tijuana Brass TV special a few years ago. The result of that meeting is this extensive project, labeled a "pop symphony."

The spine of the music was recorded in Paris, using a symphony orchestra of more than a hundred players. To this Colombier added a French pop orchestra of twenty-six men (including the noted jazz violinist, Jean Luc-Ponty). The tapes were then brought back to this country, where they were "sweetened" by a group of sixteen Los Angeles brass and woodwind players (including Kai Windling, Buddy Childers, and Tom Scott). A twenty-four-voice vocal chorus was also added in L.A., and finally, the five vocal soloists.

How's that for a massive undertaking? Enormous credit must be given to Herb Alpert, who produced the whole thing. Anybody can think big, but Alpert has the courage to put his money where his mouth is.

As for the album, it is not a "pop symphony," nor need it be weighted down with such a title. The album is a prism, a fantasy. It's a trip. The interesting lyrics are by Paul Williams, the fine young (twenty-one) writer who is responsible for the Carpenters' hit, *We've Only Just Begun*. The best of these songs tells of love still felt but on its way out. The beautiful bridge ends: "In the end it was good, God it was good." And later: "You are the song that the world should be singing!"

The vocal solos are spread among several artists, several moods. Bill Medley, formerly of the Righteous Brothers, sings the powerful *Freedom and Fear*. Strong as his singing is, he seems to lose the lyric. Vemettya Royster is regal and moving on *For Those Who Cannot Hear*. Paul Williams himself turns in the best vocal performance on *Doesn't Anybody Know?* Producer Alpert saved the best song for himself to sing (*All In All*) and who can blame him? He makes a friendly sound.

Colombier's orchestrations are vast and exciting: the sounds are so subtly placed that they are difficult to analyze. His understanding of American-style, large-orchestra pop music is impressive, and underneath it all is a fondness for jazz, a control of technique, and a deep urge to make romantic music.

This is a multicolored journey, full of spirit and skill, engineered with loving care by A & M's Larry Levine. It's the kind of disc that gets played from front to back without interruption on FM stations. May it remind the professionally frightened, stingy, and ulcerous among us that better vibrations are available and waiting. May it encourage the rest of us. M.A.

* **SLIM CRITCHLOW:** The Crooked Trails to Holbrook. Slim Critchlow, vocals and guitar. *The Last Wagon; Wild Buckaroo; Snag Tooth Sal; Whiskey Bill; Bucking Bronco; The Brazos River; Goodbye Old Paint; The Trusty Lariat*; ten more. Arhoolie 5007, \$5.98.

The term "country music" now almost exclusively applies to that variety of commercial music produced in Nashville. When earlier country music is thought of at all it is usually the earlier commercial styles of Bill Monroe's bluegrass, the Western swing of Bob Wills, or

the Carter Family. Country music as sung and played by real country folk for their own amusement and enjoyment has been virtually forgotten.

Slim Critchlow, who grew up in Utah and Oklahoma and was a singing cowboy of some fame in the Southwest in the 1930s, made this collection of eighteen cowboy and country songs just before he died in 1969. The songs were learned from a lifetime of listening to people sing. Most of the tunes were "made up" in the late 1800s by working cowboys, but a few "hand-written" songs are included. Mostly they recount daily events on the prairies—cattle drives, broncobusting, mule-teaming, eating, hunting, dying. Critchlow sings plainly and directly in a gentle, folk-singer's drawl, and supports himself with simple patterns on an eight-string guitar (the top two strings doubled). The album jacket is well designed and includes an autobiography and an introduction (history and glossary) for each song. For anyone interested in the history of the American West, this is a basic document. It is also a lot of fun. J.G.

* **CAREY BELL:** Blues Harp. Carey Bell, vocals and harmonica; rhythm accompaniment. *I'm Ready; I Cry So Much; Sad Dreams; Last Night; Come On Over Here*; five more. Delmark DS 622, \$4.98.

* **JUKE BOY BONNER:** The Struggle. Juke Boy Bonner, vocals, harmonica, and guitar; Alvin J. Simon, drums. *Railroad Tracks; Watch Your Buddies; I Got My Passport; I'm In the Big City; Running Shoes; Just a Blues*; six more. Arhoolie S 1045, \$5.98.

ARTHUR "BIG BOY" CRUDUP: Crudup's Mood. Arthur Crudup, vocals and guitar; rhythm accompaniment. *Crazy House Blues; Strictly a Woman; When I Lost My Baby; Any Old Way You Do; I Lost All I Had*; five more. Delmark DS 621, \$4.98.

JIMMY "FAST FINGERS" DAWKINS: Fast Fingers. Jimmy Dawkins, vocals and guitar; rhythm accompaniment. *I Wonder Why; Triple Trebles; Night Rock; Little Angel Child; Breaking Down*; five more. Delmark DS 623, \$4.98.

* **SLEEPY JOHN ESTES:** Electric Sleep. Sleepy John Estes, vocals and guitar; rhythm accompaniment. *I Ain't Gonna Sell It; Mae West; Laura Had a Dream; If the River Was Whiskey; Sweet Little Flower*; five more. Delmark DS 619, \$4.98.

The blues roll on, as the old song says, and this batch of new recordings proves it.

Carey Bell and Jimmy "Fast Fingers" Dawkins are both newcomers to records. Of the two, I find Bell considerably the more appealing as a vocalist. He has a hard-edged and exuberant voice that reminds me of James Cotton's, and his harp playing is mellow by comparison. Dawkins plays guitar on four of the cuts on Bell's album and they work very well together, but the two-guitar interplay by Eddie Taylor and Royal Johnson on the remaining tracks is more interesting. In any event this is a first-rate debut release.

There is no denying that Dawkins deserves his nickname and "Fast Fingers" offers a pretty fair sample of his work. His playing is cleaner than almost any Chicago blues guitarist you name. He sprays out short, sharp bursts of notes and though he sometimes lacks imagination in his solos, he is nearly a perfect support for a vocalist. His own singing is



**\$150
FOR A
\$600
TUNER?**

The Dynaco tuner you have been waiting for... it does *everything* a little bit better.

\$149.95 kit; \$249.95 assembled

Dynaco, Inc.

3060 Jefferson St., Philadelphia, Pa. 19121



CIRCLE 20 ON READER-SERVICE CARD

**WRITE FOR
QUOTATION**

FACTORY SEALED CARTONS
FRANCHISED DISTRIBUTOR
QUICK SHIPMENT

**WE GIVE
DISCOUNTS
ON HI-FI
COMPONENTS**

**SOUND
REPRODUCTION
INC.**

460 CENTRAL AVENUE
East Orange, New Jersey 07018
(201) 673-0600

CIRCLE 44 ON READER-SERVICE CARD

DISCOUNTS

WASH. D.C.
HAS NO FAIR
TRADE
LAWS!

ON STEREO COMPONENTS

PLEASE REQUEST
Prices for your choice of
Changers, Receivers, Tape
Recorders, Speakers, etc.

PROMPT DELIVERY
IN FACTORY
SEALED
CARTONS.

DISTRICT SOUND INC.

2312 Rhode Island Ave. N.E.
Washington, D.C. 20018
202-832-1900

CIRCLE 15 ON READER-SERVICE CARD

WANT TO REALLY



SAVE?

NATIONALLY ADVERTISED BRANDS!

- stereo components
- changers
- tape recorders & decks
- stereo tapes
- p.a. equipment
- radios and tv sets
- hi-fi accessories

FACTORY-SEALED COMPONENTS
SHIPPED PROMPTLY

SAVINGS YOU SEE!

Write for this month's EXTRA
discount Specials. Ask Al Kelly
for Quotes on Special Items!

DIXIE HI FIDELITY WHOLESALE

Our New Warehouse
10530 DETRICK AVENUE
Kensington, Maryland 20795
Phone: 301-933-7600

CIRCLE 16 ON READER-SERVICE CARD

HI-FI COMPONENTS TAPE RECORDERS

TAPES, ACCESSORIES
SLEEP LEARN KITS
MERITAPE

SAVE MONEY

- LOWEST PRICES
- INTEGRITY • SERVICE
- FRANCHISED DISTRIBUTORS

WRITE FOR OUR VERY LOW
PACKAGE QUOTATIONS
Nationally Advertised Brands
Factory Sealed Cartons

Write
for **FREE CATALOG**
Visit Our Showrooms

DRESSNER

1523-K JERICO TPKE.
NEW HYDE PARK, N. Y.
11040

New! STEREO Tape Timing Scale



If you've ever run out of tape in the last five minutes of an FM broadcast . . . or missed the tail end of an album, you're just the one to appreciate this exclusive new gauge.

You use it like a ruler. It measures off the time remaining on your tape at any of the three standard speeds and with standard tape thicknesses, on 4", 5", or 7" reels.

And it's yours for only \$1.

Fill out the coupon below, and send it, with your check or money order to:

STEREO Quarterly
Publishing House
Great Barrington, Mass 01230 HF-771

Please send me a STEREO Tape Timing Scale. Enclosed is \$1.

Name _____

Address _____

somewhat uninspired, although he gets off on a couple of these numbers. In general he seems to relate better to the harp/vocals/guitar situation of Bell's LP than to the guitar/vocals/piano/reeds here, but that may be because he isn't sharing the lead. (The review copy I received was badly warped, so be careful.)

Bell and Dawkins both turn up on Sleepy John Estes' new album (Bell also plays bass on one track) as part of a band that includes Sunnyland Slim on piano and Odie Payne III on drums backing the leader on vocals and guitar. Estes is one of the legendary old blues players who has usually been closer to Memphis' blues than Chicago's and to the country rather than the city. He shines in this novel context and the effect of the band may be enough to make this his best album (at least I know I am more likely to listen to it than to any of his others). I hope blues fans won't be turned off by the obvious steal from Muddy Waters' "Electric Mud" because if they are they'll miss a helluva good record.

Arthur Crudup was a big influence on the early Elvis Presley, so that gives you some idea of the quality of his approach. He has stayed pretty close to country blues throughout his career though his voice and playing sound quite "sophisticated." His earlier release on Delmark was something of a letdown because he didn't live up to his legend. But the new album is everything it promises to be. The bluesman he resembles most is Lonnie Johnson, but the comparison is inexact. Anyway, if you're looking for a nice, relaxed, vocal-oriented set, this is it. (Delmark has considerably improved its packaging and all of these albums are attractive, although Crudup's LP isn't improved by not having liner notes.)

Juke Boy Bonner, a Houston blues singer, guitar and harp player, enjoys considerable renown among serious blues fans. "The Struggle" is a chronicle of the life of a black in the "new urban South" which doesn't sound very much different from the old rural South. For example, *I Got My Passport* tells of Bonner's hassles with the civil bureaucracy over a trip to Europe. Another notable track—*Over Ten Years Ago*—tells about being down and out in Los Angeles. Bonner is first-rate on both his instruments and he has a fresh and expressive voice. An author's choice.

None but the biggest record retailers and a few specialty shops carry the products of the small labels and if you live outside the two or three biggest cities you may have trouble finding most of these releases. They can be ordered direct, however, from Delmark Records, 7 West Grand Street, Chicago, Illinois 60610; and Arhoolie Records, Box 9195, Berkeley, California 94709. Also, there is a new quarterly magazine devoted to this music called *Living Blues* (50 cents per issue, \$2 per year; 917 Dakin Street, Room 405, Chicago, Illinois 60613). Four issues so far. J.G.

* **JIMMY MCGRIFF & JUNIOR PARKER:** The Dudes Doin' Business. Junior Parker, vocals; Jimmy McGriff, organ; instrumental accompaniment. *Workin': Oh! Darling; Ain't That a Shame; A Losing Battle*; five more. Capitol ST 569, \$5.98.

JOHNNIE TAYLOR: One Step Beyond. Johnnie Taylor, vocals; rhythm and vocal accompaniment. *Time After Time; Party Life; Don't Take My Sunshine; A Fool Like Me*; four more. Stax STS 2030, \$4.98. Tape: ●● M 2030, \$6.95.

For people whose idea of soul music is some

True 4 Channel Sound

[\$42.50 per 20 watt channel]

There are several components on the market that you can take home and get true 4-channel sound out of today.

All are expensive.

Except ours.

We call ours QAUDIO.* It's an amplifier and player with 4 discrete channels. And we designed it primarily to play the new 8-track 4-channel cartridges.

But we also give it the capability of playing ordinary 8-track stereo cartridges, because there are a lot

more of them around today than there are 4-channel cartridges. And QAUDIO makes even ordinary stereo cartridges sound fuller and richer than they ever have before.

But of course it takes a specially recorded 4-channel cartridge to give you the real QAUDIO experience, and there's no point in trying to describe what *that's* like. It's simply something that has to be experienced.

And you can experience it today. QAUDIO is available now . . . and

at a price that's almost as unbelievable as the sound: \$169.95. (That's \$169.95 for a true 4-channel amplifier-player with 80 watts of total music power.) A QAUDIO unit for your car/boat is just \$129.95.

We'll be happy to send you the names of dealers near you demonstrating QAUDIO, together with a brochure describing it in detail.

Write to Toyo Radio Company of America, Inc., 1842B West 169th Street, Gardena, Calif. 90247.

QAUDIO
BY TOYO
 A SHOCKING EXPERIENCE IN SOUND

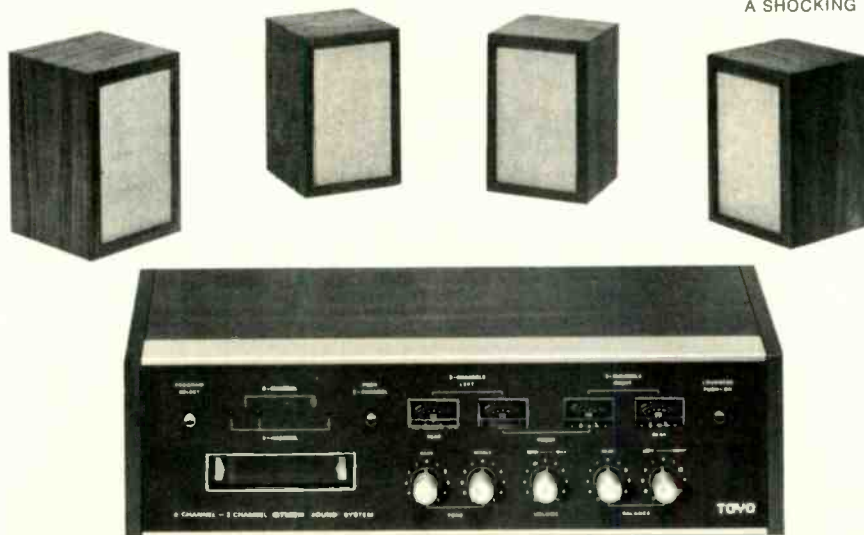

*PRONOUNCED "KWAH DIO". THE NAME QAUDIO IS BASED ON THE GENERIC "QUADRIPHONIC".

CIRCLE 48 ON READER-SERVICE CARD

**GET
MORE and BETTER
FM Stereo Multiplex
BROADCASTS**

WITH
FINCO
Award Winning FM Components

FM ANTENNA
Model FM-4G

\$28.50 list

FM BAND
PASS FILTER
Model 3007
\$7.30 list

FM INDCOR
AMPLIFIER
Model 65-7
\$24.95 list



Write Dept. HF-7 — for Catalog 20-213

THE FINNEY COMPANY
34 W. Interstate St., Bedford, Ohio 44146

CIRCLE 22 ON READER-SERVICE CARD

HEAR HERE

FOR THE UTMOST IN

DISCOUNTS

ON NATIONALLY
ADVERTISED

**HI-FI STEREO
COMPONENTS**

WRITE FOR OUR QUOTE

All Merchandise Shipped
Promptly Fully Insured From
Our Warehouse.

**DOWNTOWN
AUDIO, INC.**

17 WARREN ST.
NEW YORK, N.Y. 10007
267-3670-1-2

CIRCLE 17 ON READER-SERVICE CARD

sort of neotribal primitivism, these LPs should prove a pleasant surprise. The teaming of jazzman Jimmy McGriff and Junior Parker, whose sweet r & b vocal style has earned him the nickname "Honeydripper," is nothing short of inspired. Johnnie Taylor, who has developed over the past several years from a rough shouter into a sophisticated exponent of the Memphis sound, continues to refine and extend his style.

Taylor is an upbeat performer and even when dealing with unrequited love he can't quite hide his sense of humor. Pop music is basically a set of conventions and clichés that are given depth and feeling by a performer's interpretation. Taylor is unafraid to use soul conventions, including spoken introductions and gospel changes, and he is even willing to attack *Time After Time*, one of the all-time warhorses for r & b singers aspiring to a little class. On "One Step Beyond" everything works perfectly—the rhythm section, the horns, even the strings. If there is a flaw, it is that Taylor somewhat underestimates his audience, almost the way a Hollywood movie does. Taylor is entertaining, but there is a little less to chew on than there might have been.

Parker and McGriff don't make the same mistake. Although they do offer material that is chart-oriented—and Capitol would make a mistake if they did not release *Drownin' On Dry Land* and *It Ain't What'cha Got* as singles—the Dudes offer some of the most exacting and satisfying sides of the year. Whether they are into blues-based material, old pop tunes like *Ain't That a Shame*, or new ones like *Oh! Darling*, Parker is never less than elegant, and McGriff never falters with the perfect support. The band, arranged and conducted by Horace Ott, is solid throughout; in fact all hands, including McGriff, work unobtrusively to show Parker off to best advantage. A superb effort.

J.G.

PRISCILLA COOLIDGE: Gypsy Queen. Priscilla Coolidge, vocals; rhythm accompaniment. *On the Road; Let It Shine; Gypsy King; Salty Haze; "T" My "T"; Spring Rain*; five more. A & M SP 4297, \$4.98.

RON NAGLE: Bad Rice. Ron Nagle, piano and vocals; rhythm and instrumental accompaniment. *Frank's Store; Family Style; 61 Clay; Dolores; Party In L.A.*; six more. Warner Bros. 1902, \$4.98. Tape: ● M 81902, \$6.95; ● M 51902, \$6.95.

JERRY RIOPELLE. Jerry Riopelle, vocals; rhythm accompaniment. *She My Woman; Promenade; Elaine; To Tell the Truth; Devil's Song*; six more. Capitol ST 732, \$5.98.

* **CARLY SIMON.** Carly Simon, vocals; rhythm accompaniment. *Alone; One More Time; The Best Thing; Reunions; Just a Sinner*; five more. Elektra EKS 74082, \$4.98.

Despite declining record sales, especially of rock LPs, new first albums continue to proliferate.

Priscilla Coolidge is another studio back-up vocalist—like Donna Rhodes, Rita Coolidge, and Merry Clayton—who is attempting to make the move into the spotlight. It never quite seems to work, although "Gypsy Queen" is a somewhat more successful outing than its predecessors. For one thing, Priscilla Coolidge writes pretty good songs—in fact, on the whole they suit her better than the ones supplied her by outsiders. Also, the simple settings provided

by Booker T. Jones and company are imaginative and accomplished (e.g., the guitar work on *Long Rivers Flow*). It's good to see someone trying something original instead of dipping into the gospel bag once again. On the other hand, Coolidge's voice has a limited dynamic range and a quite unpleasant vibrato that can really become offensive on the slower numbers. Side 2 especially, where she is not singing her own songs, gets to be rather tiresome. Still, there is enough happening here to make this a worthy debut effort.

I can't pinpoint why I like the Ron Nagle album. The songs are quite good, it's true, but the elaborate arrangements sound muddy and Nagle's hard-edged voice (like Neil Young's) is not really pleasant to listen to. Nagle's piano is very appropriate to his purposes throughout the LP, however, and some of the solo work is quite good. The songs are really the album's strongest point, a couple of them rather political without being propagandistic, and most of them with sharp insights housed in pleasing musical settings. This sort of thing has been done before and better, of course—by Gary Wright and Dennis Linde to take two extremes—and I suspect that part of my reservations about Nagle would disappear if the production here were cleaner. What seem like muddy ideas may only be muddy engineering.

Jerry Riopelle seems to be just goofing off the styles of several well-known current faves—Randy Newman most obviously, but also Nilsson, J. Taylor, Sal Valentino, and Elton J.—and this release could be ignored except that there is some evidence of talent buried here. A few of the tracks might be thrown away, but most of them are good and Riopelle knows how to create effective albeit derivative settings for them. He also has good pipes and should he ever figure out where his head is he could develop into something.

Carly Simon is simply superb. Her post-rock style defies categorization and I won't try except to say that she meshes Broadway and cabaret, pop, rock, jazz, and country elements into a sound that is internally consistent and unmistakably her own. Her songwriting is varied and assured and several cuts could probably make it as singles if they got the right breaks. Her voice is lovely, clean, and strong, and she uses it skillfully to get across her moods and stories (she is so good that she nearly steals the show with that one song in the middle of Milos Forman's movie *Taking Off*). A first album of unusual quality. J.G.

DAVE MASON & CASS ELLIOT. Dave Mason, guitar and vocals; Cass Elliot, vocals; rhythm accompaniment. *Walk to the Point; Pleasing You; Next to You*; seven more. Blue Thumb BTS 8825, \$4.98. Tape: ● 8XW 8825, \$6.98; ●● 4XW 8825, \$6.98.

Out of high regard for both its artists, I wanted to love this album. Britain's Dave Mason, formerly of Traffic, is a formidable guitarist/singer/songwriter (he wrote Joe Cocker's hit, *Feelin' Alright*, plus his own hit, *Only You Know and I Know*).

If I recall correctly, Cass Elliot started out with a folk group called the Brandywine Singers and reached her zenith as a singer with the Mamas and Papas. After the disbanding of that milestone group, Mama Cass went out on her own. Strangely, she didn't identify with the rock element that made her famous nor with folk music where she began. Instead,

she gravitated toward the overripe world of standard popular music. She also shows up on TV shows with Andy Williams and Dean Martin, and on talk shows, cavorting with the entertainment world's old guard and revealing a comedic flair and sharp personality.

She has had a hit single, a pasty and flavorless version of *Dream a Little Dream of Me*. Her fans thought it was a put-on; it wasn't. Miss Elliot could have been—may still return to being—one of the most exciting of pop singers. All she has to do is open her mouth and really let go. Hearing that Mason and Cass Elliot had teamed up, I hoped that this would provide the catalyst to bring her out of her shell. It didn't happen.

Dave Mason is his own man, fully developed, self-contained, assured. His songs, singing, and playing are first-rate. The vocal arrangements are worked out carefully, often intricately. But while Mason's efforts emerge with a sense of spontaneity and pleasure. Miss Elliot sounds overrehearsed and in over her head. She does little but slow Mason down; her time and intonation are sluggish, and nothing he can do helps the case.

Most fine artists produce disappointing albums, but this one has proved to be particularly frustrating. M.A.

ALEX TAYLOR: With Friends and Neighbors. Alex Taylor, vocals; rhythm accompaniment. *Baby Ruth*; *All in Line*; *Southern Kids*; five more. Capricorn SD 860, \$4.98. Tape: M 8860, \$6.95; M 5560, \$6.95.

The Taylor-of-the-Month is Alex. There are five Taylors altogether: the first and most extraordinary is James, next came brother Livingston and then sister Kate. There is another brother, Hugh, who is not (yet?) seeking a musical career. But this month it's Alex.

My first impression was that Alex had the same appeal as brother James, but with less impact. Also, he is a bit more country-flavored than the others (he went to Macon, Georgia, to make this album).

This record grows more satisfying with repeated listening. Alex is comfortable in the milieu he has chosen. To be sure, he shares the infectious Taylor sound. He approaches songs straight on, finding an even keel and then settling in rhythmically in a way that is simultaneously loose and tight. He is perhaps less adventurous than James. It is too soon to tell if he shares his brother's magnetism, but my impression is that he does not share James's inner tension. If James is the fragile family thoroughbred, then Alex may be the family peacemaker—sturdy, relaxed, and warm.

Unlike his brothers, this performer neither writes nor plays guitar—at least not here. He simply sings, surrounding himself with a first-rate rhythm section. However, Alex shares the family attraction to meaningful material, no matter who writes it. The songs are excellent, including *Southbound*, by Gregg Allman and David Brown; *Take Out Some Insurance*, a country blues by Charles Singleton and Waldense Hall-Roosevelt; and two of James's songs, *Night Owl* and *Highway Song* (the latter not yet recorded by James).

The family is close-knit. James appears in the background here, and I thought I heard Kate as well. I am pleased that the family exists and is accessible to me. Alex is a welcome and worthwhile addition to the Taylor phenomenon. M.A.

**RECEIVERS
TUNERS
AMPLIFIERS** **TAPE
RECORDERS
DECKS**

LOW PRICES

ON FAMOUS BRAND
NATIONALLY ADVERTISED

STEREO COMPONENTS

FAST DELIVERY
FACTORY SEALED CARTONS
WRITE TODAY FOR OUR QUOTE

A. D. R. AUDIO

5200 CHILLUM PLACE N.W.
WASH., D.C. 20011
(202)
291-3000

**SPEAKERS
CARTRIDGES
COMPACTS** **ALL
STEREO
SYSTEMS**

CIRCLE 2 ON READER-SERVICE CARD

THE BEST
SHOW
IN New York IS

SIEE 70^s

SOUND ELECTRONICS EXHIBITS

- ★ Audio Seminars
- ★ Lectures
- ★ Equipment Demonstrations
- ★ Audio Counseling
- ★ Multi Media Entertainment

INTERNATIONAL HI-FI EXHIBIT
443 Park Ave. South at 30th St.
OPEN: Tues. thru Fri., 11-5:30
Sat., 11-4
Phone: 683-7721

CIRCLE 10 ON READER-SERVICE CARD

DISCOUNTS

HI-FI SYSTEMS COMPONENTS

KITS • COMPACTS
TUNERS • AMPLIFIERS
RECEIVERS • TURNTABLES
SPEAKERS • TAPE RECORDERS

- Franchised Distributors for over 70 mfrs.
- Largest selection in the country
- Full manufacturers warranty protection
- Only brand new, factory sealed components
- Fast, fully insured shipments
- Double-boxed cartons where possible
- Same day reply to your inquiry
- Extra savings on complete systems
- Lowest possible prices

WRITE FOR OUR QUOTE AND SPECIALS BULLETIN
VISIT OUR NEW MODERN SHOWROOM/WAREHOUSE
FREE AMPLE PARKING AT PREMISES

ARSTON *Stores*

146 OLD BROOKFIELD RD. (NORTH)
DANBURY, CT. 06810
DANBURY, CT. (203) 744-6421
N. Y. CITY (212) 369-6212

CIRCLE 12 ON READER-SERVICE CARD

WE CAN SELL FOR LESS

Nationally Advertised Brands

- Hi-Fi Stereo Components
- Tape Recorders
- Record Changers
- Home & Car Stereo Tapes
- Speaker Systems
- Radio & TV Sets
- Electronic Equipment

BRAND NEW AND FULLY GUARANTEED

WE CAN SAVE YOU MONEY

SEND: for FREE Listing
of 1000's of items...

LOWEST PRICES ANYWHERE!

• Factory Sealed Units • Fast Service •

AUDIO *Sales*

2745 ERIE BLVD. EAST
SYRACUSE, NEW YORK 13224

CIRCLE 10 ON READER-SERVICE CARD

Lowest of the LOW!

Shamelessly Low Prices...

As one of America's largest wholesale distributors, we're guilty of shamelessly low prices. Our buying volume has made our prices the lowest. We seriously doubt you can find one lower... and that we're proud of. What's more, at S.C.A. you can select from hundreds of NEW, Factory Sealed, Full Warrantee, Brand name, Hi-Fi Stereo components. If its in the Hi-Fi, Audio field... we have it!

Write for a lowest of the low quote... we're not ashamed.



STEREO CORPORATION OF AMERICA



2122 UTICA AVENUE, BROOKLYN, NEW YORK 11234 (212) 338-8555

CIRCLE 47 ON READER-SERVICE CARD

USE THIS FORM FOR CHANGE OF ADDRESS OR TO SUBSCRIBE

Please include a High Fidelity address label to insure prompt service whenever you write us about your subscription.

Mail to: High Fidelity
Subscription Service
P.O. Box 14156
Cincinnati, Ohio 45214

To subscribe mail this form with your payment, and check:

- new subscription
 renew my present subscription

Subscription rates in the United States, its Possessions and Canada 1 year, \$7.95; 2 years, \$14.90; 3 years, \$20. Subscription rates for all other countries available on request.

ATTACH LABEL HERE

CHANGE OF ADDRESS

If you're moving, please let us know six weeks before changing your address. Place magazine address label here, print your new address below. If you have a question about your subscription, place your magazine address label here and clip this form to your letter.

name _____

address _____

city _____

state _____

zip code _____

Now only \$1

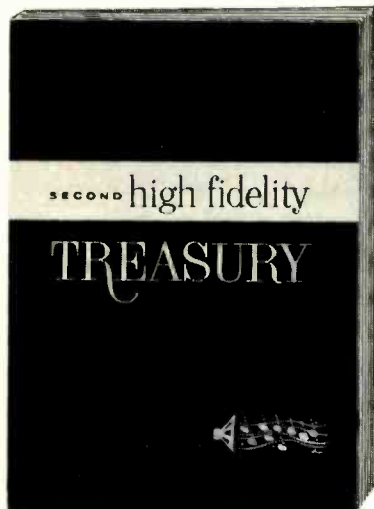

THE SECOND HIGH FIDELITY TREASURY brings you 28 top audio articles selected from *High Fidelity* and *Stereo Annuals*.

Here's a last chance to add them to your library—in book form that you can refer to again and again. They tell you just about everything you need to know for achieving satisfactory sound reproduction in your home, compatible with the price you wish to pay.

The TREASURY throws the spotlight on Amplifiers—Taping FM Stereo—Speakers—Past, Present and Future—Headphones—A Budget for Stereo—Room Acoustics—Keep It Playing!—The Origins of Psychoacoustics—New Trends in Stereo Kits—Can High Fidelity Be Measured?—A Guide to Stereo Shelving—Distortion—The Eternal Enigma—Pros and Cons of Wideband Response—Stereo Cartridges . . . and much more.

Illustrated paperback book of 132 pages measuring 6½ x 9½ inches, Copyright 1965 by Billboard Publications.

Originally \$2.50—now only \$1.00. Payment with order, please, but satisfaction guaranteed.

WYETH PRESS, 2160 Patterson Street, Cincinnati, Ohio 45214

I enclose \$1.00. Send me postpaid one copy of your Second HIGH FIDELITY TREASURY.

Name _____

Address _____

City _____

State & Zip _____

1586

jazz



DUKE ELLINGTON: Second Sacred Concert. Cat Anderson, Cootie Williams, Mercer Ellington, Herbie Jones, and Money Johnson, trumpets; Lawrence Brown, Buster Cooper, Chuck Connors, and Benny Green, trombones; Johnny Hodges, Harry Carney, Russell Procope, Paul Gonsalves, and Jimmy Hamilton, reeds; Duke Ellington, piano; Jeff Castleman, bass; Sam Woodyard and Steve Little, drums; Alice Babs, Tony Watkins, Devonne Gardner, Trish Turner, and Roscoe Gill, vocals; A.M.E. Mother Zion Church Choir; Choirs of St. Hilda's and St. Hugh's School; Central Connecticut State College Singers; the Frank Parker Singers. Fantasy 8407/8, \$5.98 (two discs).

Duke Ellington's second Sacred Concert, performed at New York's Cathedral Church of St. John the Divine in January 1968, seemed a notch or two above his first, despite occasional choral uncertainties. Yet it took three years for Ellington to find a label willing to release this recording. How could *any* record company, given the opportunity, *not* enrich its catalogue with a major work by a major composer definitively performed?

Fantasy Records has gotten all this and more: the recording also includes a performance of incredible brilliance by Alice Babs. This singer possesses a voice of amazing range and flexibility that seems to be in complete communion with the unusual and challenging music. Miss Babs's four appearances are the high spots of the recording—first in a lovely vocal parallel to Johnny Hodges' saxophone, followed quite logically by Hodges himself, who melts into an exquisite Ellington melody. She then vocalizes in a lyrical blues duet with Russell Procope's chalumeau clarinet, and later with the Duke's electric piano in a breathtaking bit of vocal agility; finally she leads a climactic ensemble magnificently.

In addition to Miss Babs, there are some choice matings of Ellington composition and Ellingtonian performance—the majesty of Harry Carney's declamatory baritone saxophone in the opening *Praise God*; the sinuous, growling trumpet of Cootie Williams in a musical portrait of Pastor John Gensel; the broad gusto of Lawrence Brown's trombone on *It's Freedom*; and the full, swinging spirit of the whole Ellington band.

The concert has its weak points, primarily in the choral recitatives which, lacking the Ellingtonian style of the instrumentalists or the spoken style of the Duke himself, become a drag. Similarly one misses the Duke's inimitable spoken introductions which form an essential colorful contribution to the live performance. And the vocal vehemence of Tony Watkins' full, juicy projection of every syllable of a lyric comes very close to caricature. But there is so much that is superbly right about this recording that these quibbles scarcely weigh in the balance. J.S.W.

JOHN W. "KNOCKY" PARKER: The Complete Piano Works of Jelly Roll Morton. Knocky Parker, piano, celeste, and barrel organ; Marvin Montgomery, banjo; Dick Brightwell or George

Pryor, bass; Ruth Brightwell or Harvey Kinder-
vater, drums. *Superior Rag*; *Wolverine Blues*;
King Porter Stomp; *Spanish Swat*; forty-four
more. Audiophile 102/5, \$19.95 (four discs).

On the face of it, this would appear to be a
landmark collection—all the compositions of
Jelly Roll Morton in one four-disc set, some
never before recorded, two tunes previously
unpublished and unrecorded. And they are
played by Knocky Parker, one of the more
eminent exponents of the Morton piano style
(in Leonard Feather's *Encyclopedia of Jazz*,
Parker lists Jelly Roll as his favorite musician).

There is no question that Parker can play
a Morton tune with full-flavored Morton fire,
vitality, and phrasing. Listen to him here on
Freakish, on *Troublesome Rag*, slinking
through the Spanish tinge of *The Crave* and
Creepy Feeling, swinging easily on *35th St.*
Blues, roaring through *Fingerbusting* at an
electrifying pace, or rolling through the mar-
velous, break-filled descending line of Mor-
ton's *Tribute to Bert Williams*.

Parker, however, has never been a particu-
larly consistent performer and uncertainty
plagues him on several selections in this set—
selections on which he stumbles or fumbles,
selections on which he gets into a plodding
attack that all but drives the piece into the
ground. If that were the only problem, the set
might balance out quite favorably since the
good performances are delightful and those
on which he is joined by Marvin Montgomery's
banjo are full of brightness and vitality.

But for some reason Parker has chosen to
play almost half the tunes on what sounds
like one of those barrel organs that grinds
around with merry-go-rounds—it is not identi-
fied in any of the sparse, uninformative written
material that comes with the discs. The sound
is absolutely ghastly and Parker seems to be
capable of only the heaviest, most lumbering
type of performances on it—about as far re-
moved from Morton's easy swing as one can
imagine. Worst of all, some of Morton's finest
tunes are put through this horrendous masher
—*The Pearls*, *Milenberg Joys*, *New Orleans*
Blues, *Wolverine Blues*, *Mr. Jelly Lord*, *Kansas*
City Stomps, *Wild Man Blues*, *Black Bottom*
Stomp. The list goes on and on and it's heart-
breaking—one entire side is devoted to this
lugubrious monster.

The only consolation is to turn to Side 2
of disc 104 which is all Parker-on-piano (with
the frequent support of Montgomery's banjo)
in a fine series of properly Mortonesque per-
formances of *Fickle Fay Creep*, *Fai Frances*,
Crazy Chord Rag, *Pep*, *Sweet Peter*, and *Sweet*
Substitute. If only the other seven sides had
measured up to this. J.S.W.



WORLD'S GREATEST JAZZ BAND: What's
New? Yank Lawson and Billy Butter-
field, trumpets; Vic Dickenson and Ed
Hubble, trombones; Bob Wilber and Bud
Freeman, saxophones; Ralph Sutton,
piano; Bob Haggart, bass; Gus John-
son, Jr., drums. *Dogtown Blues*; *My*
Inspiration; *Smile*; eight more. Atlantic
1582, \$5.98. Tape: ● M 81582, \$6.95;
● M 51852, \$6.95.

It has been a long, hard struggle—financially
and musically—for the World's Greatest Jazz
Band. But with this disc it has gotten over the
hump of musical identity and at the same time
it seems to have stopped being a financial
drain on its sponsor. Dick Gibson. One point

brought out by the two-and-a-half year effort
needed to get the band functioning is that not
even seemingly limitless funds, an all-star
line-up, and unflagging promotional energy
can produce a viable jazz band overnight. But
that's what the World's Greatest is now.

What comes through unmistakably on this
record for the first time is a distinctively in-
dividual musical personality. It is not the Bob
Crosby band. It is not an oversized Dixieland
band. The WGJB is itself—and the prime
evidence may be heard on several selections
here that might have emerged sounding like
the same old stuff, but they don't. *Bourbon*
Street Parade has become a Dixie chestnut
but the World's Greatest gives it a new, zestful
sound as the soloists emphasize their individu-
ality over the exultantly propulsive rhythm of
Ralph Sutton's rolling piano and Gus John-
son's quick-step drumming. Bud Freeman's
old showpiece, *The Eel*, takes on a new life
with a shouting big-band backing, and Billy
Butterfield's *What's New?* has a fresh adven-
turousness that makes it seem newly minted.

The band now plays contemporary material
—*Mercy, Mercy* and *Walk Him Up the*
Stairs—with a joyously natural drive that no
longer leaves the impression that they're read-
ing the arrangements through their bifocals.
The unique bite of Yank Lawson's muted
trumpet, Bob Wilber's lovely soprano saxo-
phone, Vic Dickenson's wry trombone com-
ments flow freely in and out of all the pieces,
weaving the musical fabric that has now
emerged as the vitalizing identity of this band.
J.S.W.

CHARLES MINGUS: Town Hall Concert. Johnny
Coles, trumpet; Eric Dolphy and Clifford Jordan,
reeds; Jaki Byard, piano; Charles Mingus, bass;
Dannie Richmond, drums. *So Long, Eric*; *Pray-*
ing with Eric. Fantasy JWS 9, \$4.98.

Despite its title, this disc has no connection
with the Mingus Town Hall concert released
several years ago on the United Artists label.
This new disc was recorded at the Tyrone
Guthrie Theater in Minneapolis, evidently at
least seven years ago (no other recording infor-
mation is given), since Mingus' quintet in-

RECORD MART Advertisement



Free mailing anywhere in USA, APO &
FPO for mail orders from world's
largest choice of records, tapes! The
low price of the record or tape is
all you pay. King Karol's prices low-
est, service fastest and inventory
largest—we have everything! For
FREE CATALOG write: King Karol
Records, Dept HF7, Box 629, Times
Sq. Sta., NYC 10036

CIRCLE 27 ON READER-SERVICE CARD

GET

LOWEST PRICES
FAST, FAST SERVICE
FACTORY SEALED CARTONS
FULLY INSURED SHIPMENTS
EXTRA SAVINGS ON PACKAGE DEALS

**AUDIO
UNLIMITED**

Serving Audio Enthusiasts
Since 1955
GIVES YOU
MORE FOR YOUR MONEY
Write For FREE Listing Today
SEND US YOUR LIST FOR
OUR AIR MAIL QUOTE TODAY
Visit Our Store Warehouse
CLOSED MONDAYS

**AUDIO
UNLIMITED, INC.**

396 Third Ave. (Nr. 28), N. Y.
N. Y. 10016 • (212) MU 2-3836-7-8

CIRCLE 49 ON READER-SERVICE CARD

THIS

OVER **66** YEARS
OF RELIABILITY

**IS WHY STEREO & HI-FI
BUYERS CAN BE SURE OF
SAVINGS
AT RABSONS**

At Rabsons Competitive Prices, Reliability and
Personal Service have been bywords for over
66 years.
It's so EASY and SAFE to deal with Rabsons.
As close as your telephone — as near as your
mailbox • Fast Air Mail Response on Quotation
Requests • Franchised Distributor for Hi Fi Lines
• All merchandise brand new in factory sealed
cartons, shipped double-packed, fully insured
promptly from our warehouse • Greater savings
on complete systems • Export packing • 220
Volts, 50 Cycle merchandising a specialty • Free
list of monthly specials.

**BEFORE YOU BUY GET A RABSONS
QUOTE... YOU'LL BE GLAD YOU DID!**

RABSONS 57 ST. INC.
113 West 57th Street, New York, N. Y. 10019
Tel. Area Code 212-247-0070

CIRCLE 34 ON READER-SERVICE CARD

ADVERTISING INDEX

is on page
96
in this issue.

Reader Service
cards appear on
pages 15 and 97.

REK-O-KUT



STANDARD OF
EXCELLENCE
IN
TURNTABLES
AND
TONEARMS

REK-O-KUT
COMPANY, INC.

1568 NORTH SIERRA VISTA, FRESNO,
CALIFORNIA 93703 • Phone 209 251-4213

A Subsidiary of CCA

CCA ELECTRONICS CORP.
716 JERSEY AVENUE, GLOUCESTER CITY,
NEW JERSEY 08030 • Phone 609 456-1716

CIRCLE 38 ON READER-SERVICE CARD

cludes Eric Dolphy, who died in 1964. The two long pieces that make up the disc are dedicated, in retrospect, to Dolphy and include samplings of his fascinating and very individual use of the bass clarinet and flute. Both selections are quintessential Mingus, filled with his hallmarks—the shifting tempos, passages of gorgeous melody, passages of mounting fury, the vocalized use of instruments.

At this time, Mingus' closeness to the Ellington idiom was particularly evident. It keeps rising out of the long *Praying with Eric*, which takes up the second side. The piece is a beautifully realized example of the Mingus concept, colored by Jaki Byard's all-encompassing piano, some marvelous drumming by Dannie Richmond, brilliant contributions by Dolphy, and rich, soulful bass work by Mingus himself.

J.S.W.

in brief

SKEETER DAVIS: Skeeter. RCA Victor LSP 4486, \$5.98. Tape: ● P8S 1694, \$6.95.

Skeeter Davis, whose little-girl voice is the most expressive in Victor's catalogue, bows with another excellent collection. One flaw: there are only ten tunes. J.G.

AL GREEN: Gets Next To You. Hi/London SHL 32062, \$4.98.

Al Green gives a very funky reading of standards like Roosevelt Sykes's *Driving Wheel*, pop tunes like the Doors's *Light My Fire*, and several r & b originals. There are only ten tunes. J.G.

B. B. KING: Live in Cook County Jail. ABC ABCS 723, \$4.98. Tape: ● GRT 8022-723, \$6.98; ●● 5022-723, \$6.98.

Blues-master B. B. King and band do their thing in jail. Standards and hits, but the show at the Regal (ABC 509) remains their best live album. J.G.

EDU LOBO. A & M SP 3035, \$4.98.

Many experts on Brazilian music, including Brazilians, feel that young Edu Lobo may be the most important talent of that country since Jobim. Lobo has written many of the best-known Brazilian songs, those whose names you can't remember. His guitar playing is vivid and urgent, yet beautifully controlled; his singing mournful and soft. The album is presented by countryman Sergio Mendes. Anything Edu Lobo does is excellent, including this disc. But I look forward to the next album, with fresher material and fuller scoring. M.A.

JOHNNY & JONIE MOSBY: Oh, Love Of Mine. Capitol ST 737, \$5.98.

One of c & w's most successful duos, the Mosbys favor traditional country over the contemporary variety, but their forceful presentation overcomes any limitations of material. There are only ten tunes. J.G.

TURLEY RICHARDS: Expressions. Warner Bros. S 1918, \$4.98. Tape: ● M8 1918, \$6.95; ●● M5 1918, \$6.95.

Warner Brothers has found another winner. Richards is one of those rare singers with so much natural musicality that his sound emerges with seeming effortlessness. He writes

with equal ease, bending toward earthy blues (*Virginia Woman*) or tunes with a folk-country feel. He's a knockout. Listen to him. M.A.

SIREN: Strange Locomotion. Elektra EKS 74087, \$4.98. Tape: ● 84087, \$6.98; ●● 54087, \$6.98.

Siren is a British version of Brownsville Station or the Flamin' Groovies. Good old-fashioned rock-and-roll. J.G.

JOE SOUTH: So The Seeds Are Growing. Capitol ST 637, \$5.98. Tape: ● 8XT 637, \$6.98; ●● 4XT 637, \$6.98.

Odd—people who like Neil Diamond and Ray Stevens tend to overlook Joe South. He is as good a songwriter and a better singer than either one. Only five of these tunes are South originals, though he also claims *Motherless Children* which is a black folk tune. There are only ten tunes. J.G.

CAT STEVENS: New Masters. Deram DES 18010, \$4.98.

Last month I offered an aside to the effect that "Mathew & Son," which was released several years ago, is still the best Cat Stevens album. Now there are two. Stevens' talent was rougher back then, but less pretentious, fresher, and more engaging too. J.G.

SWAMP DOGG: Rat On! Elektra EKS 74089, \$4.98. Tape: ● 84089, \$6.98; ●● 54089, \$6.98.

Swamp Dogg, a soul septet that is mostly somebody named Jerry Williams, Jr., is the band that toured the Army bases with the Jane Fonda/Donald Sutherland antiwar show. Overenthusiastic. J.G.

KATE TAYLOR: Sister Kate. Cotillion SD 9045, \$4.98.

With all the good talent around unrecorded and unlistened to, Kate and brother Alex get big buildups because they are related to James and Livingston. And for no other reason. J.G.

LILY TOMLIN: This is a Recording. Polydor 24 4055, \$4.98. Tape: ● 8F 4055, \$6.98; ●● CF 4055, \$6.98.

Laugh-In's Lily Tomlin deserves a prize for giving us the most bizarre characterization of the year—Ernestine, the telephone operator. If you can't give Miss Tomlin a prize, then buy this album, in which Ernestine goes through all her weird changes. M.A.

BILLY EDD WHEELER: Love. RCA Victor LSP 4491, \$5.98.

Billy Edd Wheeler was one of the first, with John D. Loudermilk and Roger Miller, of the new-wave Nashville songwriters. Included here is *Coal Tattoo*, one of his best early tunes. He is also a first-rate performer with a fine mellow voice. Now that he's with RCA he should reach the wide audience he deserves, though like everyone else he loses some of his individuality to the Victor formula. Ten tunes. J.G.

FARON YOUNG: Step Aside. Mercury SR 61337, \$4.98. Tape: ● MC8 61337, \$6.95; ●● MCR4 61337, \$6.95.

Faron Young, one of the most agreeable country vocalists, sings *Hello Darlin'*, *Gettin' Soft On You*, etc. backed up by Jerry Kennedy and the gang. Mercury likes to compromise at eleven cuts. J.G.

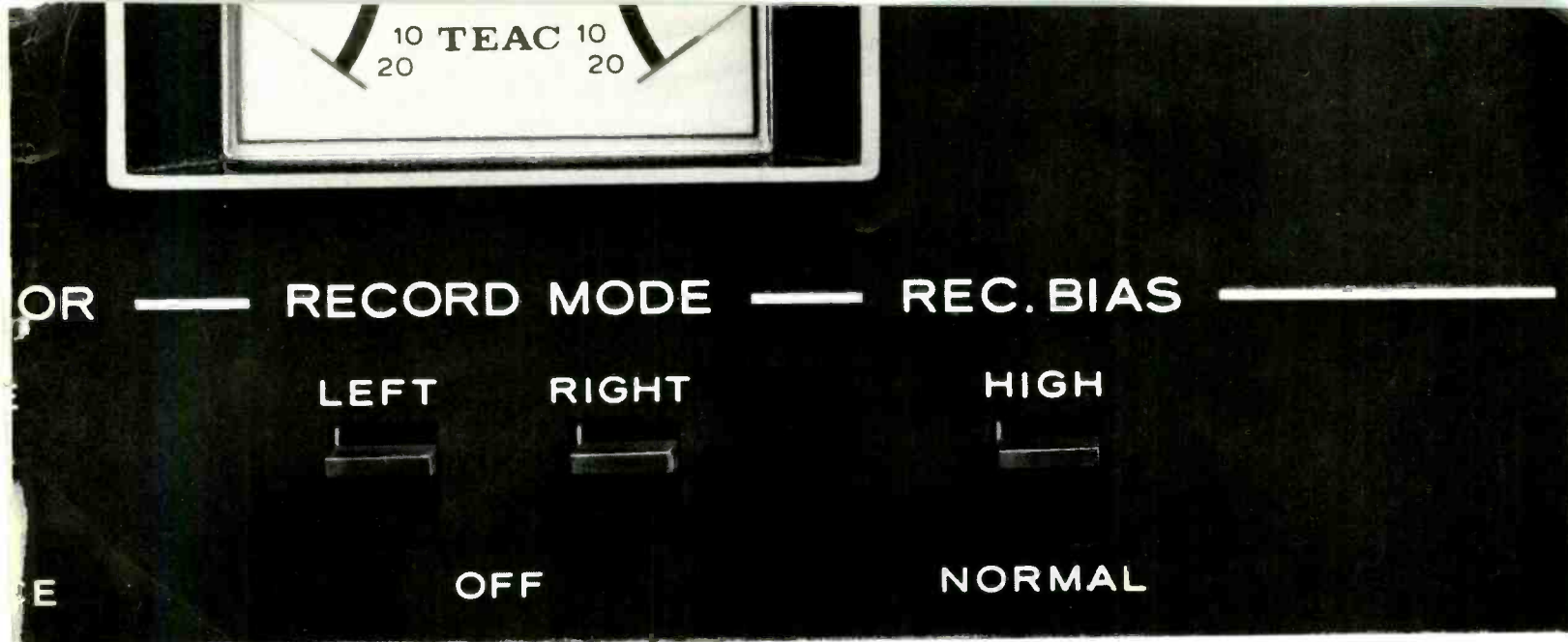

TEAC announces a current event: BiaTron.

It's the latest and greatest in dual capability: TEAC has incorporated a bias-current switch in the superlative A-1230 stereo deck. We call this feature BiaTron because it lets you choose the right bias for both standard and low-noise, high-output tapes.

The A-1230 has lots of other good news going for it, too. Like the remarkable Edi-Q Pause Control that lets you edit and cue the cleanest, click-free, pro-quality tapes while recording. And three precision motors: hysteresis-synchronous for capstan drive, eddy current types for turntable drive. TEAC constant-contact hyperbolic heads. And hair-trigger solenoid controls that make this one of the most humanly engineered decks to be found anywhere. No wonder it delivers this kind of high-performance characteristics: 30 to 22,000 Hz frequency response, 55 dB or better signal-to-noise ratio, 0.08% or less wow and flutter at 7½ ips.

Add to that such TEAC exclusives in a deck of this class as MIC

and LINE mixing, TAPE and SOURCE monitoring, turntable height adjustment, independent headphone monitoring with built-in volume control. And the price is a surprisingly low \$349.50.

Then to double your enjoyment, we added an auto-reverse mechanism to the A-1230, and called it the A-1250. This one is still a buy at \$449.50.

Whatever your choice, you can't help keeping current when you stay tuned to TEAC.



A-1250 AUTO-REVERSE STEREO TAPE DECK

A-1230 STEREO TAPE DECK

TEAC

TEAC Corporation of America, 2000 Colorado Avenue, Santa Monica, California 90404
 TEAC Corporation, 1-8-1 Nishi-shinjuku, Shinjuku-ku, Tokyo, Japan • TEAC EUROPE N.V., Kabelweg 45-47, Amsterdam-W.2, Holland
 In Canada: White Electronic Development Corp., Ltd. Toronto

CIRCLE 67 ON READER-SERVICE CARD



TUNE IN...FOR TOP PERFORMANCE

KENWOOD KT-7001

The NEWEST FM/AM STEREO TUNER
3-FET • 4-IC • XTAL FILTER

Frequency Linear-type 4-gang Variable Capacitor and 3 FETs FM Front-end results in excellent spurious and IM characteristics • Crystal Filter and 4 ICs FM IF Stages offer exceedingly sharp selectivity, capture ratio and stable high gain • Pushbutton Automatic MPX Filter eliminates noise components in the stereo sub-channel and improves SN ratio • FM Multipath Indication Circuit provides maximum multipath deflection • 2 step (10 μ S, 50 μ S) FM Audio Muting Circuit • New MPX Circuit offers greater stereo separation and extremely low IM Distortion • Low-noise FET and Ceramic Filter in IF Stage produce wide frequency and sharper selectivity in AM reception.

SPECIFICATIONS: FM Sensitivity (IHF): 1.5 μ V • FM Frequency Response: 20-15k Hz (+0, -1.5 dB)
 • FM Harmonic Distortion (at 400 Hz, 100% Mod.): Mono: less than 0.25%; Stereo: less than 0.5%
 • FM S/N Ratio (at 100% Mod.): better than 75 dB at 30 μ V input; better than 60 dB at 5 μ V input • FM Capture Ratio (IHF): 1 dB • FM Selectivity (Alt. Channel, IHF): better than 90 dB • FM Stereo Separation: better than 30 dB (20-15k Hz); better than 40 dB (300-10k Hz) • AM Sensitivity (IHF): 15 μ V • AM Selectivity: better than 30 dB • Dimensions: 16 $\frac{1}{4}$ " W, 5 $\frac{1}{8}$ " H, 11" D • Weight: 18 lbs. • Price: \$279.95 •

For complete specifications write...



KENWOOD

15777 So. Broadway, Gardena, Calif. 90248
72-02 Fifty-first Ave., Woodside, N.Y. 11377

CIRCLE 36 ON READER-SERVICE CARD