

HIGH FIDELITY

DECEMBER 1969 60¢

LAB TEST REPORTS

**ADC-25 Cartridge
Elpa PE 2018 Turntable
Sansui 4000 Receiver**

DEC.
1969



The 28 Best Classical Records of the Year

An International Jury Decides

plus Professional Hints for Amateur Tape Recordists

What's Available for the

HFDNQUINKEWHI*DZ640001L1089 02
DAVID J QUINLAN
KEWAUNEE HI SCH
KEWAUNEE WI 54216

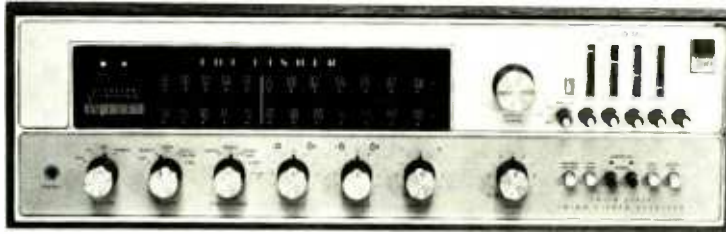

200 watts, the 500-TX.

gazine says this about Fisher Auto-
ock-in is flawless. That is, when the
s on a station it stops on the exact
t channel.
n is probably more accurate in
) center of (the) desired channel
omplished manually . . ."
ill pull in stations other receivers
ty is conservatively rated at 2.0 μ V.
ote control unit is included with the
an tune from all the way across

No job is too big for the mighty Fisher 500-TX AM/FM-stereo receiver. With 200 watts music power it will drive a three channel stereo system in any room, plus two remote channels, and still have watts to spare.

In addition, we've piled on the convenience features and made the 500-TX the most luxurious, most versatile, as well as the most sensitive receiver we've ever built.

The 500-TX features all the tuning conveniences found on our other receivers. There are four ways you can choose to tune FM. By Tune-O-Matic® Pushbutton Memory Tuning (as in the 250-TX). By AutoScan® (as in the 450-T). By optional remote control AutoScan®. And, of course, manually.

As for sensitivity and overall FM performance, we'll let the experts do the talking.

Audio Magazine:

"Usable sensitivity was everything we could have desired and limiting took place at a remarkable 1.5 μ V. Ultimate signal-to-noise ratio was 65 dB, as claimed. Stereo FM performance was excellent."

High Fidelity:

"Capture ratio is very high at 1.3 dB. In our cable FM test, the set logged a very high total of 57 stations."

The testers go on to sum up our biggest big job receiver this way.

Audio Magazine: "The Fisher 500-TX is a top-grade receiver whose performance might easily challenge that of even some of the better separate tuners and amplifiers . . . wonderful tuning convenience features . . . powerhouse of an amplifier . . . excellent transient response . . . truly 'big', clean sound."

High Fidelity: "The 500-TX is, at this writing, the top-of-the-line receiver from Fisher. It certainly strikes us as a top unit for any line."

\$449.95

for big, clean sound in the biggest as well as the smallest room in the house.

The Fisher®

The big job components.



50-TX.

power for most power at 8 ohms), 3 μV), and ease AM / FM-stereo best buy in its

specs and features:

5 dB.

kHz), 38 dB.

6.

Memory Tuning.

This allows you to preselect your five favorite FM stations, and then tune to any one at the touch of a button. Tuning is accomplished electronically, rather than mechanically, and is dead accurate center-of-channel each time. Of course, conventional flywheel tuning is also provided.

Muting. A front panel switch eliminates inter-station noise.

In addition, the 250-TX shares all the features we've listed for the Fisher 210-T.

If you can find a better receiver buy than the Fisher 250-TX, anywhere, we encourage you to grab it.

\$329.95

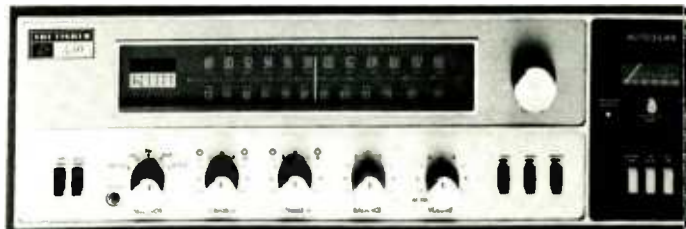

180 watts, the 450-T.

The new Fisher 450-T AM / FM-stereo receiver has many of the features of the famous 500-TX, at a somewhat lower price.

Most important, it delivers 180 watts music power into 8 ohm speaker systems. That's more than enough power to fill a big room with distortion-free sound, and drive a remote pair of speaker systems besides.

Also, the 450-T incorporates Fisher's exclusive AutoScan® electronic tuning system—the most accurate available in any receiver. Press one of the AutoScan® buttons and the next FM station on the dial is automatically tuned in, precisely to center-of-channel. Press the other button, and the entire dial is scanned automatically.

Audio Ma Scan®:

"Station I AutoScan stop 'center' of the

"AutoScan tuning to (the than can be a

The 450-T can't. Sensitiv

And a ren 450-T so you c

\$399.95

rs, big-bass speakers



15-inch woofer, the XP-9C.

This is the speaker that won the bass race. It's the first bookshelf-sized speaker system ever to incorporate a 15-inch woofer.

The four-way XP-9C delivers big, resounding bass in any room, any location. (No need to keep it in a corner or on the floor.)

A total of five crossovers at 500, 1200 and 5000 Hz.

\$199.95



12-inch woofer, the XP-12.

A slightly smaller consolette, the XP-12 is just as good looking, and nearly as big sounding as the XP-15B. (It uses a 12-inch woofer instead of a 15-inch woofer. Mid-range and treble drivers are identical, as are crossover points.)

\$219.95



15-inch woofer, the XP-15B.

The three-way XP-15B consolette will look as good as it will sound in your big room.

Big bass is provided by a 15-inch woofer.

To round out the sound, an ultra compliant 8-inch mid-range speaker and a 1½-inch hemispherical dome tweeter are utilized.

Crossovers at 400 and 2500 Hz. Three drivers.

\$289.95

*Also available with decorative fretwork grill, \$10 extra. (Model K instead of B.)

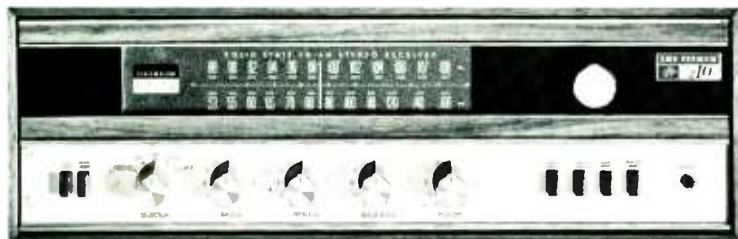

110 watts, the 210-T.

Even the least powerful Fisher receiver will drive a pair of average-to-low efficiency speakers in a mansion.

The Fisher 210-T AM/FM-stereo receiver delivers 110 watts music power into conventional 8 ohm speaker systems.

And despite its price, the 210-T is designed with the same sense of purpose as all Fisher components.

FM sensitivity is conservatively rated at 2.0 μ V.

The AM section is a special wide-band design that makes AM broadcasts sound comparable to FM-mono.

Stereo Beacon[®] automatically indicates whether the program you tune to is in stereo.

Baxandall tone controls allow you to boost lower bass and upper treble without adding distortion or affecting the mid-range.

Two sets of speaker systems can be hooked up to the 210-T, and you can listen to either set, or both sets, with individual switches.

Of course, there's a lot more we don't have room to list. All at the lowest price you can pay for a big-job receiver.

\$279.95



120 watts, the 250-TX

With more than enough applications (120 watts music power), outstanding FM sensitivity (2.0 μ V), and superb tuning, the Fisher 250-TX receiver is unquestionably the best in its price class.

It has all these important features: FM signal-to-noise ratio, 6 dB; FM stereo separation (at 1 kHz), 10 dB; Harmonic distortion, 0.5%; Hum and Noise, -90 dB. Tune-O-Matic[®] Pushbutton

Big-power receivers



10-inch woofer, the XP-60B.

A simple two-way, two speaker system, designed to reproduce the full frequency range smoothly.

The free-piston 10-inch woofer accurately reproduces all frequencies below 1000 Hz. The 3-inch wide dispersion mid-range/treble speaker handles everything between 1000 and 20,000 Hz.

\$79.95



12-inch woofer, the XP-66B.

The three-way XP 66B reproduces the entire frequency range cleanly and naturally, without skimping on bass.

It's the best value in bass, incorporating a 12-inch woofer instead of the 10-inch woofer you usually find in a speaker system at this price.

Crossovers at 500 and 1000 Hz.

Three drivers.

\$99.95*



12-inch woofer, the XP-7B.

In addition to superb, natural-sounding bass, the XP-7B four-way speaker system divides the mid-range into upper and lower and feeds each to its own acoustically isolated driver. Overall sound is clean and unstrained—a perfect match for your powerful receiver.

Crossovers at 350, 800 and 3500 Hz. Five drivers are used.

\$149.95*

For 1970 Fisher presents powerful receivers and oversized woofers,

The Fisher®



Mail this coupon
for your free copy of
The Fisher Handbook, 1970
edition. This reference guide
to hi-fi and stereo also
includes detailed information on all
Fisher components.

Fisher Radio
11-35 45th Road
Long Island City, N.Y. 11101

Name _____

Address _____

City _____ State _____ Zip _____

0112697

OVERSEAS AND CANADIAN RESIDENTS PLEASE WRITE TO
FISHER RADIO INTERNATIONAL, LONG ISLAND CITY, N.Y. 11101.
PRICES SLIGHTLY HIGHER IN THE FAR WEST.

CIRCLE 30 ON READER-SERVICE CARD

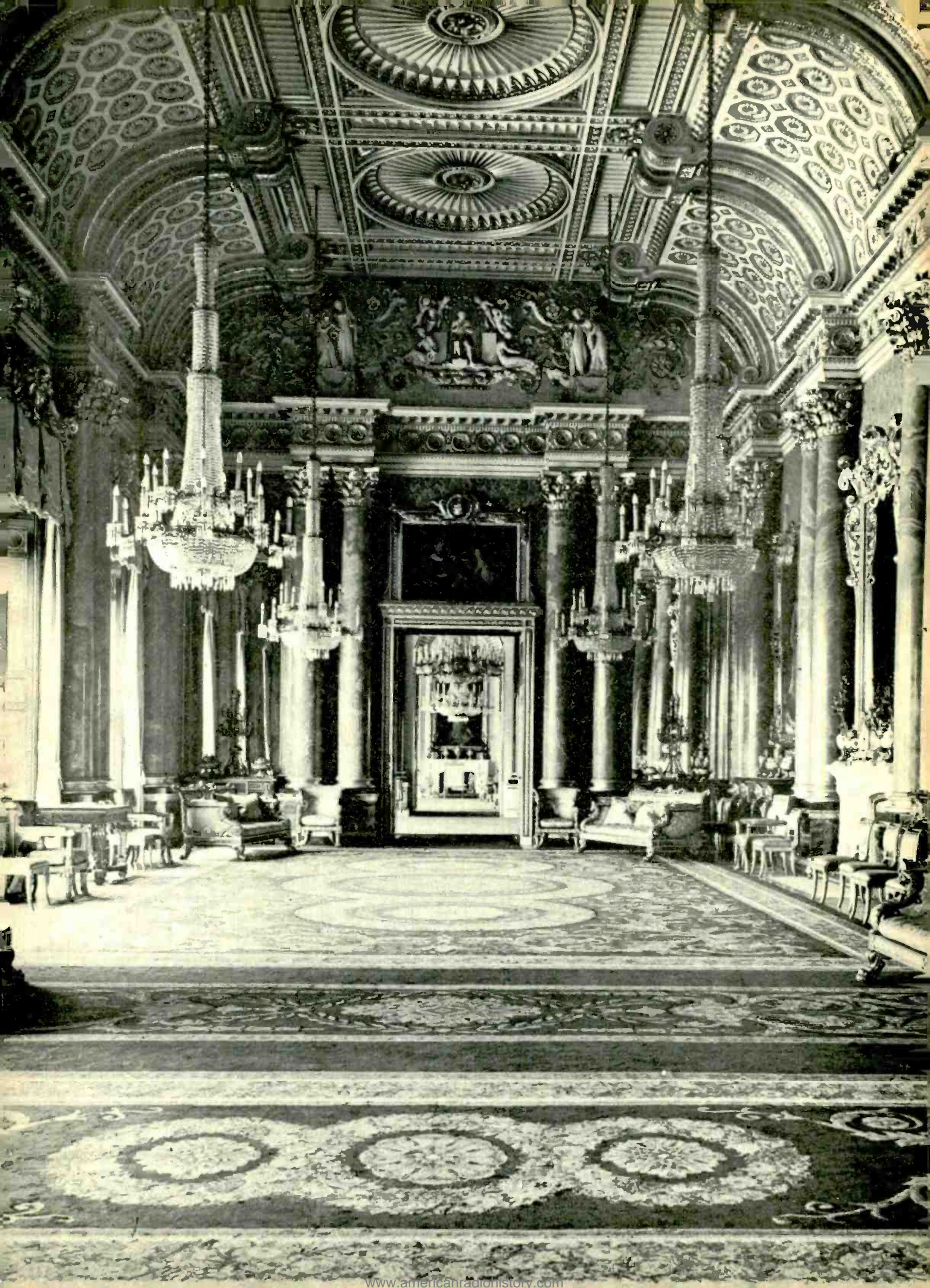

100% MUSIC POWER

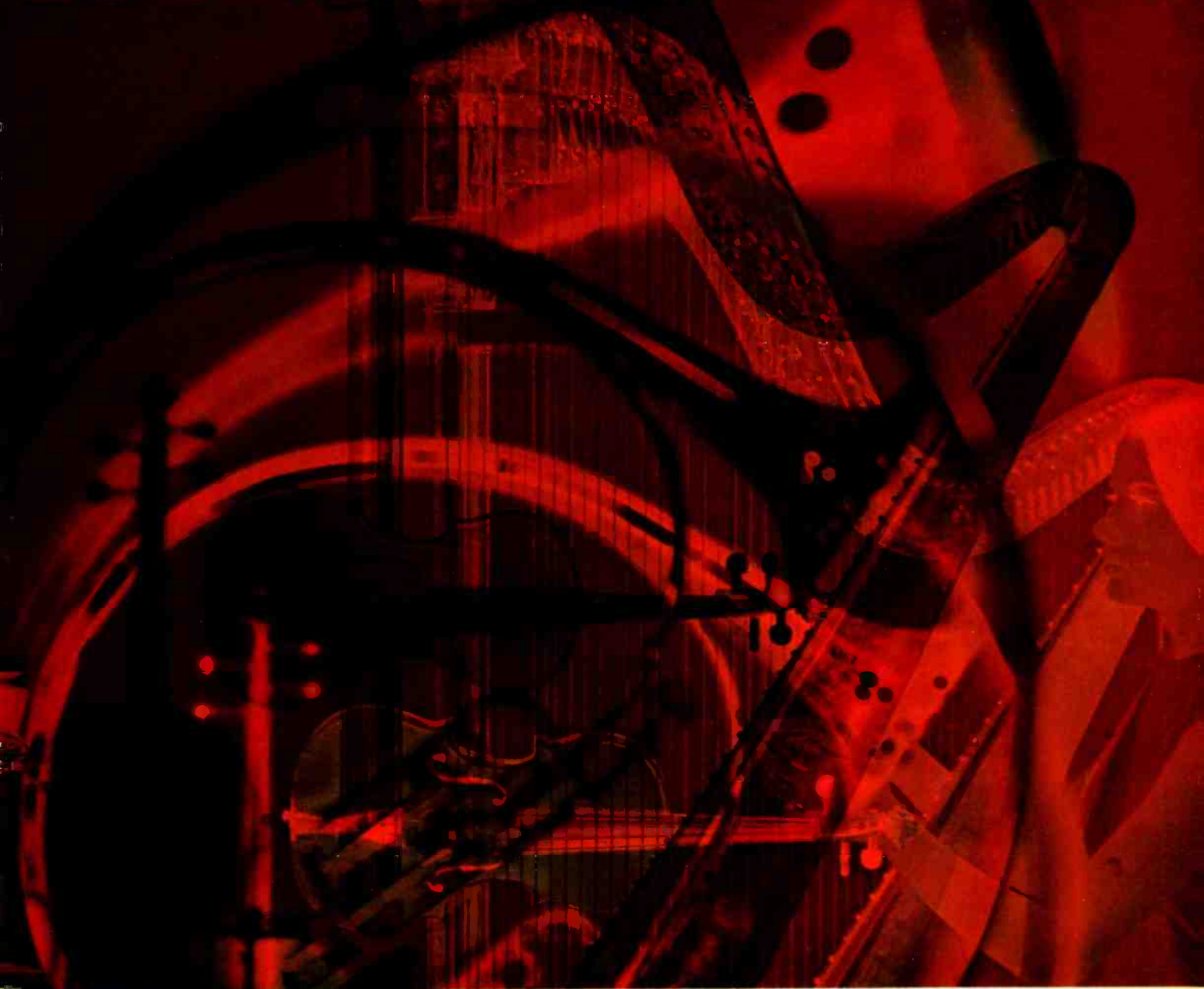

PHOTOGRAPH BY FRANZ EDSGA

With the Pickering XV-15 Cartridge You Get 100% Music Power— You Hear It All!

Only Pickering's XV-15 series of cartridges features 100% Music Power. With the Pickering, a harp sounds like a harp, a trumpet has the biting sound that you expect from a brass instrument, the flute has a rich romantic tone, the orchestra is the full-throated instrument the composer called for.

So choose Pickering—and make the enjoyment of 100% Music Power a part of your life.

PICKERING

FOR THOSE WHO CAN HEAR THE DIFFERENCE



THE NEW PICKERING XV-15/750E.
PREMIER MODEL OF THE XV-15 SERIES. TRACKS AT 1/2 TO 1 GRAM. DYNAMIC COUPLING FACTOR OF 750 FOR
USE IN FINEST TONEARMS. \$60.00. OTHER XV-15 CARTRIDGES FROM \$29.95. PICKERING & CO., PLAINVIEW, L.I., N.Y.

CIRCLE 49 ON READER-SERVICE CARD

HIGH FIDELITY / musical america

VOL. 19 NO. 12 DECEMBER 1969

music and musicians

- Leonard Marcus OUR BEETHOVEN YEAR 4 *A letter from the Editor*
- Paul Moor, Edward Greenfield
BEHIND THE SCENES: BERLIN AND LONDON 20 *A Karajan/Oistrakh/Rostropovich/Richter collaboration*
- Leonard Marcus THE BEST RECORDS OF THE YEAR 67 *An international jury decides*
- Robert P. Morgan
THE SCANDALOUS POLITICS OF HANS WERNER HENZE 106 *History of a nonmusical riot*
- Gene Lees YOU'RE GOING TO HEAR FROM HER 132 *Betty Jean Baker: a spectacular new talent*

audio and video

- TOO HOT TO HANDLE 50 *HF answers your more incisive questions*
- NEWS AND VIEWS 56 *Speakers, a speaker, and a four-channel deck*
- EQUIPMENT IN THE NEWS 60 *The latest in audio gear*
- Robert Long WHAT'S NEW IN STEREO KITS? 73 *A sophisticated system can be assembled from kits*
- Larry Zide
PROFESSIONAL HINTS FOR AMATEUR TAPE RECORDISTS 78 *Ways to utilize your recorder's full potential*
- EQUIPMENT REPORTS 85 *Sansui 4000 receiver
Audio Dynamics ADC-25 cartridge
Elpa PE-2018 automatic turntable
Fisher XP-7B speaker system*

recordings

- FEATURE REVIEWS 93 *Werther with De los Angeles and Gedda
Te Deum: a big sound from Berlioz
Toscanini rarities available at last*
- CLASSICAL REVIEWS 98 *The Beethoven concertos by Barenboim and Klemperer
Tannhäuser: a double role for Birgit Nilsson*
- Peter G. Davis REPEAT PERFORMANCE 130 *Jennie Tourel sings Offenbach . . . Böhm's Mozart*
- POP REVIEWS 134 *Those Wonderful Thirties . . . Theodore Bikel's New Day*
- JAZZ REVIEWS 142 *The provocative Gary Burton . . . Goodman rarities*
- R. D. Darrell THE TAPE DECK 160 *Cassettes from Columbia and RCA*

etc.

- LETTERS TO THE EDITOR 6 *Setting some records straight*
- PRODUCT INFORMATION 61
163 *An "at home" shopping service*
- ADVERTISING INDEX 162

musical america

Following page 164

Published at Great Barrington, Mass. 01230 by Billboard Publications, Inc. Copyright © 1969 by Billboard Publications, Inc. The design and contents of High Fidelity Magazine are fully protected by copyright and must not be reproduced in any manner. Second-class postage paid at Great Barrington and at additional mailing offices. Authorized as second-class mail by the Post Office Department, Ottawa and for payment of postage in cash. High Fidelity/Musical America Edition is published monthly. Subscription in the U.S.A. and its Possessions, \$12; elsewhere, \$13. Subscription including Concert Artist Directory published in December, \$17, in the U.S.A. and its Possessions elsewhere, \$18. Regular issues \$1.00 a copy, national and other editions published monthly. Subscription in the U.S.A. and its Possessions, \$7; elsewhere, \$8. Regular issues 60¢ a copy, indexed in the Reader's Guide to Periodical Literature. Current and back copies of High Fidelity and High Fidelity/Musical America available on microfilm from University Microfilms, Ann Arbor, Michigan 48106. Change of address notices and undelivered copies (Form 3579) should be addressed to High Fidelity, Subscription Department, 2160 Patterson Street, Cincinnati, Ohio 45214. Please state both old and new addresses when requesting a change.

Our Beethoven Year

DEAR READER:

December 16, 1970, is a full year away. But few musicians, musical organizations, or record companies are going to wait until the end of next year to celebrate Beethoven's bicentennial. Throughout 1970 performers will be giving special all-Beethoven concerts, recitals, cycles, series, and galas; record companies will be turning out an even greater volume of the composer's music than usual.

For HIGH FIDELITY, too, 1970 will be The Beethoven Year. As a major project, we will publish the most immense discography ever undertaken by any magazine: comparative critiques which will include every available Beethoven recording. In order to print all of it, we will have to spread our coverage over the months, beginning with George Movshon's **FIDELIO AND THE VOCAL MUSIC** in January. In fact, the bulk of HIGH FIDELITY's January issue will be devoted to Beethoven.

As I write this, I have been back in the United States from East Berlin only three days. My purpose on the other side of the Wall was—as I told the armed East German soldiers who demanded to know it before they would let me through—"Beethoven zu sehen." Perhaps they thought I meant a concert; at any rate, the answer seemed to satisfy them. But I was actually referring to something much more intriguing. As everyone knows, for a good part of his career Beethoven was deaf. Scholars are aware that, in order to converse, Beethoven resorted to "conversation books," in which his friends and colleagues (and often even Beethoven himself) had to write their part of the dialogue. Public rumor has it that these unique books have disappeared (they actually did vanish for several years after the war, as the result of an incredible robbery). Certainly, for most of the musical world, these mysterious documents are more legend than reality. (Would you believe that, with only minor exceptions, they were never published?)

I am delighted to report: that within the past few days I have held them in my hands; that well over a hundred are very much alive and in the care of an expert team of scholars headed by Dr. Karl-Heinz Köhler, Director of the Music Department of the Deutsche Staatsbibliothek in East Berlin (my first perusal of these books was in an inner sanctum of that library, where they covered the top of a grand piano); that they contain an incredible wealth of information about the times (imagine eavesdropping on intelligent conversationalists of the early 1800s discussing art, politics, girls, music, finances, personal problems—sometimes at the very moments of historic or dramatic events; then imagine that one of the participants is Beethoven!) and about the composer (did you know that Beethoven never learned to multiply?); and that in next month's issue we will show some of these pages for the first time in an article, by Director Köhler himself, on **BEETHOVEN'S CONVERSATION BOOKS**.

The January issue will also contain an eight-page photo section, in full color, devoted to **BEETHOVEN: AN ILLUSTRATED ESSAY** by contributing editor H. C. Robbins Landon. In it you will see one oil, recently rediscovered and never before published in color, portraying the thirtyish composer in the surprising role of a Viennese dandy.

Incidentally, did you know that the first comprehensive biography of Beethoven, originally published in German and now a classic, was written by a New Englander, the American Consul in Trieste? George Marek will tell you all about him in **BEETHOVEN'S AMERICAN BOSWELL: ALEXANDER WHEELOCK THAYER**. Our final January article will be a provocative essay by Jan Meyerowitz, **DO WE OVERESTIMATE BEETHOVEN?**

Leonard Marcus

LEONARD MARCUS
Editor

NORMAN EISENBERG
Audio-Video Editor

PETER G. DAVIS
Music Editor

SHIRLEY FLEMING
Editor, Musical America Section

EDITH CARTER
ROBERT LONG
SHEILA SCHULTZ
Associate Editors

ROY LINDSTROM
Art Director

ROBERT MADDOCKS
Associate Art Director

RUTH W. DUNTON
Production Editor

MORGAN AMES
R. D. DARRELL
ALFRED FRANKENSTEIN
HARRIS GOLDSMITH
DAVID HAMILTON
PAUL HENRY LANG
GENE LEES
GEORGE MOVSHON
H. C. ROBBINS LANDON
Contributing Editors

MILTON GORBULEW
Circulation Director

CLAIRE N. EDDINGS
Assistant Publisher and
Director of Advertising Sales

WARREN B. SYER
Publisher

ADVERTISING

Main Office: Claire N. Eddings, The Publishing House, Great Barrington, Mass. 01230. Telephone: 413-528-1300.

New York: 165 W. 46th St., New York, N. Y. 10036. Telephone: 212-757-2800. Seymour Resnick, Eastern Adv. Mgr.; Charlotte Gilbert; Leonard Levine. Classified Adv. Dept.: James Flatley.

Chicago: Billboard Publications, Inc., 188 W. Randolph St., Chicago, Ill. 60601. Telephone: 312-236-9818. Leonard Levine.

Los Angeles: Billboard Publications, Inc., 9000 Sunset Blvd., Los Angeles, Calif. 90069. Telephone: 213-273-1555. Andrew Spanberger.

Nashville: Billboard Publications, Inc., Baker Building, 1905 Broadway, Nashville, Tenn. 37203. Telephone: 615-244-1836. Robert Kendall.

London: 7 Carnaby St., London W.1. Telephone: 437-8090. Andre de Vekey.

Tokyo: Japan Trade Service, Ltd., Ikejiri 3-1-1-1008, Setagaya-ku, Tokyo, Japan. Telephone: 413-2871. Kanji Suzuki.

West Germany: 10 Neuhauss Str., Frankfurt/Main. Telephone: 595172. Walter B. Rios.

Take any seat in the house.

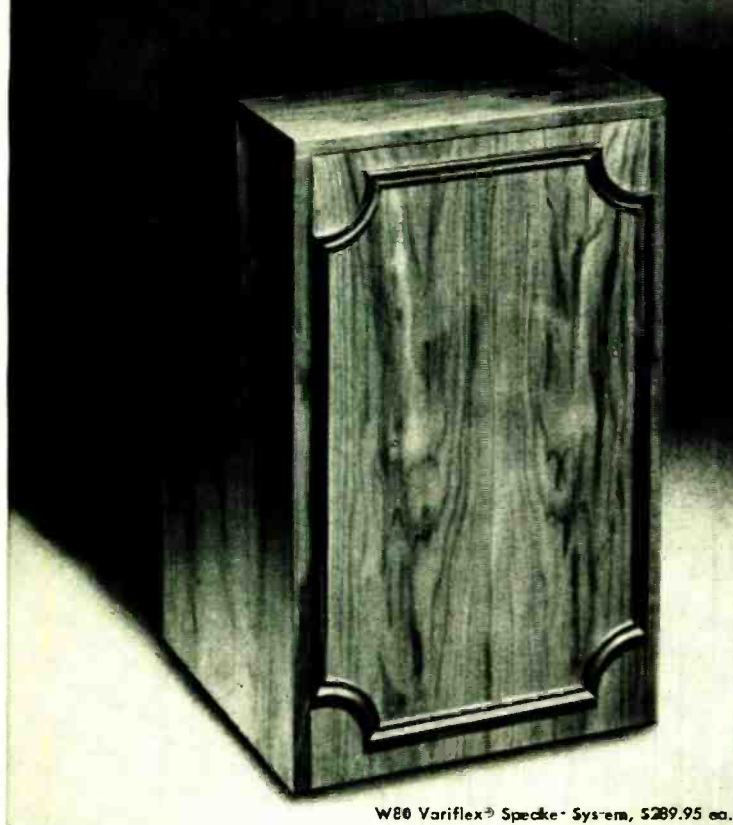

W80 Variflex® Speaker System, \$289.95 ea.

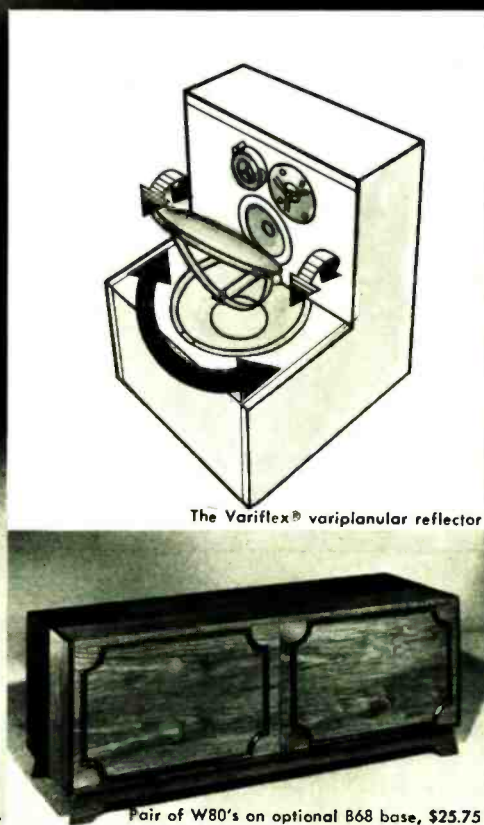

The Variflex® variplanular reflector

Pair of W80's on optional B68 base, \$25.75

Introducing—a most significant breakthrough in home stereo reproduction The WHARFEDALE Model W80 VARIFLEX® Speaker System This new concept completely eliminates the usual limitations involving speaker placement!

- The VARIFLEX requires no special spacing apart, or from a wall or above a floor.
- It can be used in pairs, anywhere in the room.
- Or, two W80 speakers can be used to form a single 56" console.
- VARIFLEX brings balanced stereo sound to the listener.
- Stereo perception is *preserved*, rather than splattered promiscuously by uncontrolled room acoustics or speaker elements.
- No need to disturb existing high fidelity systems. Does not require electronic equalizer.
- Exclusive sand-filled construction to eliminate undesirable enclosure resonances and coloration.
- Modest in size (only 17" x 17 1/4" x 29"), the W80 is truly fine furniture, attractively styled to enhance rooms of virtually any decor.

What is VARIFLEX?

Ordinary reflective and "omni" speaker systems have one thing in common: Sound dispersal is promiscuous and subject to acoustical phase distortions caused by the shape and furnishings of the room. Splattered sound, whether solely against a wall or through use of a conical reflector in the speaker enclosure, is *uncontrolled* sound. Hence, in the case of some types of systems, "optimum" spacing is recommended from a wall or above the floor. In other instances, sound is projected over a wide area, equally, from both speakers of a stereo pair. But, in this case the *levels* at which sounds of different frequencies arrive from both channels to a given point in the room are unequal and therefore *unbalanced*. In both instances, the distribution pattern of sound is fixed and therefore unable to accommodate

CIRCLE 101 ON READER-SERVICE CARD

the multitude of differences which exist between rooms.

The Wharfedale VARIFLEX employs a *variable* device which bends sound waves in a definite and controllable manner so as to form the particular sound distribution pattern *required* by room conditions and/or the listening and decor needs of the user. This variplanular reflector is capable of directing sound waves both in the vertical or horizontal planes, or any combination of these angles.

For full specifications on the W80 and all the Wharfedale systems, write Wharfedale, div. British Industries Co., Dept. HX29, Westbury, N.Y. 11590.

Wharfedale

ACHROMATIC SPEAKER SYSTEMS

When you're number one in tape recorders you don't make the number-two tape.

It costs a few pennies more. But Sony professional-quality recording tape makes a world of difference in how much better your recorder sounds—and keeps on sounding. That's because Sony tape is permanently lubricated by an exclusive Lubri-Cushion process. Plus, its extra-heavy Oxi-Coating won't shed or sliver. Sony tape is available in all sizes of reels and cassettes. And remember, Sony professional-quality recording tape is made by the world's most respected manufacturer of recording equipment.



You never heard it so good.

©1968 SUPERSCOPE, INC.

SONY SUPERSCOPE

Sun Valley, California 91352
CIRCLE 68 ON READER-SERVICE CARD

Letters

The Creative Reader

"A Plain and Easy Guide to Electronic Music" by Robert Ehle [August 1969] was one of the most fascinating articles I have had the pleasure to read in your magazine. The reason is obvious. Unlike most articles which describe, complement, or condemn the achievements (or failures) of composers, component manufacturers, etc., this article appealed to the creative talents of the reader. It is the best example of reader participation that I have seen in a national magazine. The same criterion holds true for the electronic music contest. I feel that an expanded and very detailed series of articles dealing with electronic music composition using home recorders would be highly appealing to a majority of HIGH FIDELITY readers. I recently purchased a Teac A6010, Akai X360D, and will soon acquire the KLH model Forty. I cannot wait until I have the time to put Mr. Ehle's suggestions to work.

Anthony Price
San Francisco, Calif.

Stolen Theater

If Donal Henahan wants to apply the metaphor "magic theater" to Luciano Berio's *Sinfonia* [August 1969], there is no reason why he should not, but there is every reason why he should have acknowledged its source—which is, in fact, from my work written in 1965, *Music for the Magic Theater*, commissioned by the Fromm Foundation and currently enjoying its own "underground" reputation among musicians. My title was taken, and with good reason, from the last chapter of Hermann Hesse's novel *Steppenwolf*.

If it were simply a coincidence or a vaguely refracted association coming *lontano* to Mr. Henahan's mind as he sat at the typewriter; if, in fact, Mr. Henahan were someone other than the very man who reviewed my work (*Musical Quarterly*, April 1967, Vol. LIII, No. 2, pp. 246-48), I would not bother to write. But he is, and it is interesting to observe how two years have improved his capacity for taking in a "disconcerting whole" (see *Musical Quarterly*, p. 247).

I am concluding, and rightly, I am convinced, that the metaphor was copped from my work—so why not say so? Berio wasn't shy about acknowledging his sources, so why was Mr. Henahan? If Berio has written a fine work which displays the same fundamental attitude toward existence as mine does, bravo for him. There is always room at the top.

What concerns me, however, is learning why Mr. Henahan did not make the connection.

George Rochberg
Newtown Square, Pa.

Mr. Henahan replies: I am afraid George Rochberg's complaint confuses me. The

metaphor was copped, not from his work, but from the same work from which he himself copped it, the final episode of Hesse's *Steppenwolf*, and for the same reasons. I admired Mr. Rochberg's work with reservations in my 1967 *Musical Quarterly* review, and while it may be that my capacity for taking in a "disconcerting whole" has improved, the point is that I found Berio's *Sinfonia* less disconcerting and more of a whole than I did Rochberg's earlier piece. I plead nothing but critical effrontery for this. I might add that to date I have not heard any complaints from James Joyce or his heirs about my copping of metaphors from *Finnegan's Wake* to illustrate a philosophical and artistic trend that, I believe, has been in existence a good many more years than Mr. Rochberg. However, as Mr. Rochberg says, "there is always room at the top," and I heartily welcome him and Mr. Berio to the company of Joyce, Ives, Cage, Vico, Heraclitus, and others who share the belief that "all things are steered by all."

Setting Some Records Straight

Searching for more detailed information on the Sousa Band recordings (Everest 3260) which I reviewed in the September issue, I have been helpfully steered by such knowledgeable historians as Philip L. Miller and Dr. A. F. R. Lawrence to the authority on Sousa's highly checkered recording career. This is James R. Smart, reference librarian in the Music Division of the Library of Congress, who has recently completed a Sousa Band discography for publication by the L.C. in the near future, and who has been able to compare most of the Everest re-recordings with their 78-rpm sources. In the following list of his identifications only two are "probables," and lack direct-comparison confirmation:

Washington Post: 28 May 1926 (electrical); Arthur Pryor, cond.; Victor 20191.

El Capitan: 15 June 1926 (electrical); Arthur Pryor, cond.; Victor 20191.

Hands Across the Sea: 1 July 1930 (electrical); The Victor Band, Rosario Bourdon, cond.; Victor 22940 (which credits the Sousa Band).

The Stars and Stripes Forever: 28 May 1926 (electrical); Arthur Pryor, cond.; Victor 20132.

The Thunderer: (probably) 21 October 1908 (acoustical); Walter B. Rogers, cond.; Victor 16151.

Fairest of the Fair: 28 May 1926 (electrical); Arthur Pryor, cond.; Victor 20132.

Under the Double Eagle: 20 October 1908 (acoustical); Walter B. Rogers, cond.; Victor 16960.

La Sorella: 27 December 1909 (acoustical); Walter B. Rogers, cond.; Victor 16523.

American Patrol: 28 December 1909

Continued on page 10



Erich Leinsdorf has directed symphony orchestras and opera companies all over the world. He uses AR high fidelity components for home listening.



Music Director of the Boston Symphony Orchestra, Erich Leinsdorf is intimately acquainted with the sound of the world's great orchestras and the concert halls in which they perform. His recorded performances with the Boston Symphony Orchestra on RCA Victor Red Seal Records, which now consist of nearly 80 works, represent a major contribution to the classical and contemporary recorded musical literature. For his private listening, Mr. Leinsdorf uses AR-3a speaker systems, an AR turntable and an AR amplifier.

Acoustic Research makes AR speaker systems, amplifiers and turntables. All are described in our catalog, obtainable for the asking.



Acoustic Research Inc.

24 Thorndike Street, Cambridge, Massachusetts 02141

Overseas Inquiries: Write to AR International at above address

CIRCLE 1 ON READER-SERVICE CARD

Only Marantz Has Butte.

What's a Marantz?

Any audio engineer or stereo hobbyist will tell you Marantz builds the world's finest high-fidelity components. And has for fifteen years.

This message, therefore, is not to engineers but to professional musicians, serious music-lovers, and beginning stereo hobbyists. We'd like to introduce you to Marantz.

Never Heard Of Marantz?

Until this year, the least-expensive Marantz stereo component you could buy cost \$300.00. And our FM tuner alone cost \$750.00! To own a Marantz, you either had to be moderately wealthy or willing to put beans on the table for awhile. But it was worth it. And a lot of experts thought so, too, because the word soon got around, and the products sold themselves.

What The Competition Said

The chief design engineer of a major competitor once said that no one even tries to compete with many of Marantz' sophisticated features; it would be just too expensive. Marantz designs its circuits the same way the aerospace industry designs missiles and jet planes—for utmost performance and reliability.

Butterworth Filters

You've probably never heard of Butterworth filters because no one else uses them besides Marantz. And the U.S. Military. Other manufacturers feel they can get by without them. And they can. Because their standards don't have to

measure up to Marantz'. Butterworth filters let you hear music more clearly, with less distortion, and, unlike their conventional I.F. coil or filter counterparts, they never need realignment. They help pull in distant FM stations and separate those right next to each other on the dial. Although Butterworths cost more, Marantz designed not one but four of them into their Model 18 receiver. You shouldn't settle for less.



Features, Not Gimmicks

The unique features of a Marantz component are there for only one purpose, to make possible the highest level of listening enjoyment.

That's why we put an oscilloscope in our best components.

An oscilloscope is kind of a TV tube. But instead of the Wednesday Night Movie, it shows you a green wavy line. An electronic picture of the incoming FM radio signal telling you exactly how to rotate your antenna for minimum multipath distortion (ghost signals) and



maximum signal strength (clarity) even from the weakest stations.

The "scope" also shows correct stereo phasing; that is, if the broadcasting transmitter or your other equipment is out of phase. And it lets you set up optimum stereo performance and reception to create a solid "wall" of sound.

Marantz also offers a different tuning experience because you rotate the actual tuning flywheel. This results in the smoothest, most precise tuning possible. And this Marantz-exclusive design requires considerably fewer moving parts than conventional systems used by other manufacturers. The benefits? Reduced friction, wear, and service problems. We call this patented feature "Gyro-Touch Tuning."

Built To Last

Marantz stereo components aren't built in the ordinary way. For example, instead of just soldering connections together with a soldering iron, Marantz uses a highly sophisticated waveflow soldering machine—the type demanded by the military. The result: perfect, failproof connections every time.

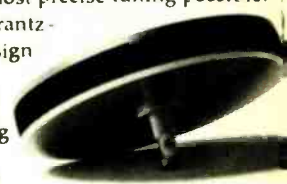

CIRCLE 53 ON READER-SERVICE CARD

HIGH FIDELITY MAGAZINE

worth Filters!

Even our printed circuit boards are a special type—glass epoxy—built to rigid



military specifications, ensuring ruggedness and dependability.

Marantz Power Ratings Are True

When someone tells you he has a "100-watt amplifier," ask him how the power was rated. Chances are his 100 watts will shrink to about 75 or 50 or perhaps even as few as 25. The reason is that most manufacturers of stereo amplifiers measure power by an inflated "peak power," or "IHF music dynamic power."

Marantz states its power as "RMS continuous power" because Marantz believes this is the only method of measurement that is a true, absolute, scientific indication of how much power your amplifier can put out continuously over the entire audible frequency range.

For example, if Marantz were to use the unscientific conventional method, our Model Sixteen 80-RMS-80 power amplifier could be rated as high as 320 watts per channel!

Moreover, you can depend on Marantz to perform. For example, the Marantz

Model 16 can be run all day at its full power rating without distortion (except for neighbors pounding on your wall). That's power. And that's Marantz.

Marantz Speaks Louder Than Words

In a way, it's a shame we have to get even semitechnical to explain in words what is best described in the medium of sound. For, after all, Marantz is for the listener. No matter what your choice in music, you want to hear it as closely as possible to the way it was performed.

In spite of what the ads say, you can't really "bring the concert hall into your home." For one thing, your listening room is too small. Its acoustics are different. And a true concert-hall sound level (in decibels) at home would deafen you.

What Marantz does, however, is create components that most closely recreate the sounds exactly as they were played by the musical performers. Components that consistently represent "where it's at" in stereo design. And no one gives you as much—in any price range—as Marantz.

Every Marantz Is Built The Same Way

Every Marantz component, regardless of price, is built with the same painstaking

craftsmanship and quality materials. That's why Marantz guarantees every instrument for three full years, parts and labor.

Now In All Price Ranges

Today, there is a demand for Marantz quality in other than very-high price ranges. A demand made by music-lovers who want the very best, no matter what their budgets. True, you can still invest \$2,000.00 in Marantz components, but now we have units starting as low as \$199. Though these lower-priced models do not have every unique Marantz feature, the quality of *all* models is the same. Marantz quality.

And quality is what Marantz is all about.

Hear For Yourself

So now that you *know* what makes a Marantz a Marantz, *hear* for yourself. Your local dealer will be pleased to give you a demonstration. Then let your ears make up your mind.



marantz®

©Marantz Co., Inc. 1969. A subsidiary of Superscope, Inc., P.O. Box 99A, Sun Valley, Calif. 91352. Send for free catalog. Illustrated above, Model 18. \$695.

**NOW... for the first time—a
quality ORTOFON Cartridge
as low as \$35.00!**

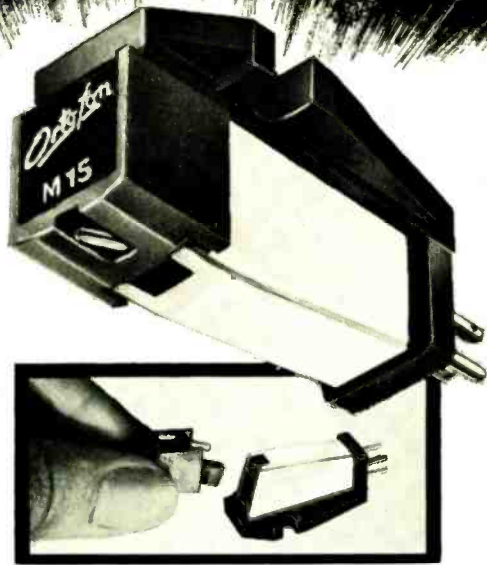

Introducing
ORTOFON M15 & MF15
Magneto-Dynamic Stereo Cartridges
with Interchangeable Styli

If you've ever wanted to own an Ortofon cartridge but thought it was beyond your budget, you'll welcome the new Ortofon cartridges M15 and MF15. Priced for everyone, yet they sacrifice none of the superb quality that is traditional with Ortofon cartridges and tonearms. Here is a new dimension to the state of the art in stereo reproduction.

Interchangeable Styli — These are the first Ortofon cartridges to offer the flexibility of interchangeable styli. The M15 plug-in stylus is ideally suited for use with professional transcription turntables and top quality automatics. The MF15 plug-in stylus was developed for automatic record changers. Available in elliptical or spherical stylus tips for both models.

Ultra-Lightweight — An incredible 0.4 milligram is the equivalent mass of the precision polished, natural diamond stylus tip — the lightest of any cartridge manufactured. Total cartridge weight is only five grams.

Universal Replacement — Both models are designed so they can be mounted in all standardized shells.

Matched to Most Amplifiers — Output impedance is ideal for direct connection to the latest amplifiers having an input impedance of 47K ohms. No external transformer is necessary.

Superb Tracking Force — The M15 tracks from ¾ to 3 grams, ideally at 1½ grams, while the MF15 tracks from 1 to 5 grams, ideally at 2 grams. Tracking angle is set for 15°.

Magneto-Dynamic Design—Capable of producing the most exacting performance from manual and automatic turntables.



M15 (Elliptical Stylus)...\$60.00; (Spherical Stylus)\$50.00
MF15 (Elliptical Stylus)...\$45.00; (Spherical Stylus)\$35.00



For additional details, see your Ortofon dealer, or write to:
ELPA MARKETING INDUSTRIES, INC.
New Hyde Park, N.Y. 11040

CIRCLE 26 ON READER-SERVICE CARD

LETTERS

Continued from page 6

(acoustical); Walter B. Rogers, cond.; Victor 16523.

Jack Tar: (probably) 21 October 1908 (acoustical); Walter B. Rogers, cond.; Victor 16151.

Mr. Smart's identifications not only correct Everest's partially accurate information which I quoted in my review, but also confirm the old suspicion that Sousa did *not* conduct "his" recording sessions. (Apparently there were only three acoustical and one electrical recording-session exceptions—none of which is represented by Everest.) More surprising to me is the fact that half of the Everest reissues have been transferred from early electrical recordings, since on first hearing these did not sound to me markedly clearer or stronger—in their present guises—than most of the acoustical recordings. (I had suspected that *The Thunderer* was of earlier vintage than any of the others, but two more apparently go just as far back.) And most startling of all is the crediting of the Victor Band's *Hands Across the Sea* to the "Sousa Band." Mr. Smart notes, however, that in this and one or two other instances where the Sousa label was applied to recordings by other organizations, the latter probably included many of Sousa's own bandmen.

Mr. Smart also provides the welcome information that a full-scale biography of Sousa by Paul Bierly of Columbus, Ohio is near completion. "Bierly," according to Mr. Smart, "probably knows more about the Sousa band than anyone, including the surviving band members."

R. D. Darrell
Stone Ridge, N.Y.

In his review "Dorothy Maynor—Songs and Arias" [August 1969] Conrad L. Osborne lumps in the orchestrations of Duparc's *Phidylé* and *L'Invitation au Voyage* with O'Connell's setting of "Now Let Every Tongue Adore Thee." Actually Duparc made the orchestration of his songs himself. Writing of *Phidylé* in his *The Songs of Henri Duparc*, Sydney Northcote thinks that "although it was not originally designed for orchestral accompaniment, the vibrant sensitivity of Duparc's musical concept is more effectively realized, perhaps, in the later orchestration."

Robert Rushmore
Sandisfield, Mass.

Effective Speaker Placement

After reading Mr. McIntyre's highly interesting article in your September issue ["Use Your Room to Enhance Your Stereo"], I felt compelled to write and thank him for enlightenment on the previously hazy subject of speaker placement. As I live in a mobile home with a living room measuring about 12' x 16', he can appreciate the problems I have had in the past. Thanks to some tips in the

Continued on page 12

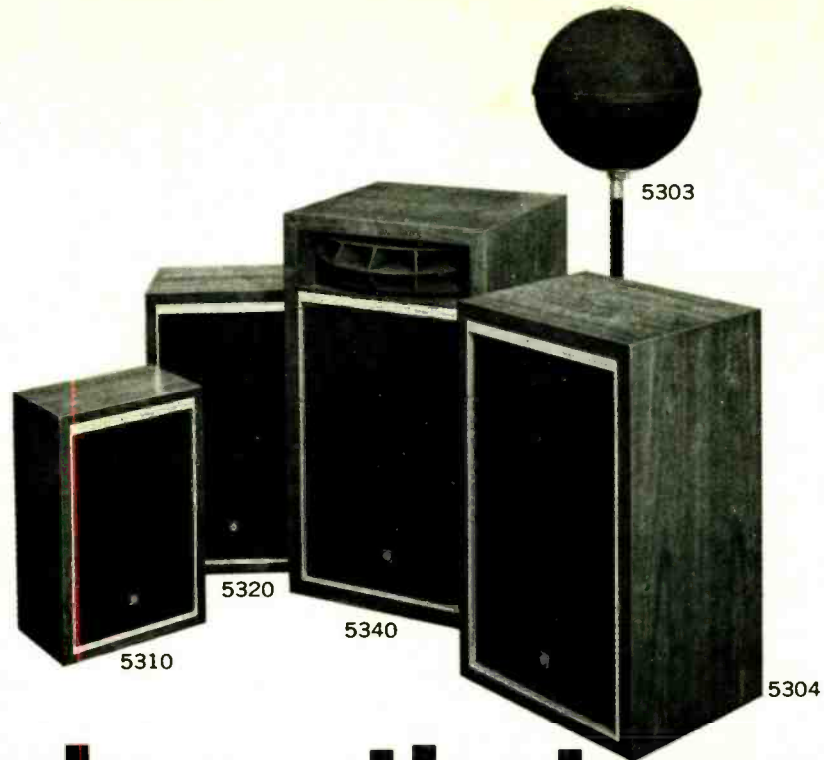

Speakers that speak for themselves from JVC

Hook 'em up and give a listen. They'll not only speak for themselves, they'll have something to say about the condition of your records and the quality of your stereo system.

And with JVC's 5303 omni-directional system, the message will be delivered with full stereo effect anywhere in the room. All 'round

features: four free edge woofers and four horn-type tweeters to handle up to 80 watts input from 20 to 20,000Hz. Gives you a full 360 degrees of sound diffusion. Just listen.

Check the other JVC systems, too. Models 5340 and 5304, powerful 4-way systems with multi-channel inputs. Handle 40 watts RMS and 80 watts peak. The 30 watt 5320 and 25 watt 5310 3-way book-shelf systems also deliver full range JVC-quality sound.

Get more information about JVC speakers and the name of the dealer handling JVC products in your area. Just drop us a line and we'll make the introduction.

5303 : \$199.95, 5304 : \$149.95, 5310 : \$69.95,
5320 : \$99.95, 5340 : \$229.95.



Catching On Fast

JVC

JVC America, Inc., 50-35, 56th Road, Maspeth, New York, N.Y. 11378 A Subsidiary of Victor Company of Japan, Limited, Tokyo, Japan

CIRCLE 40 ON READER-SERVICE CARD

The new **THORENS** TD-150 Mark II is the finest integrated transcription turntable ever made!

Aw, you say that about every **THORENS** turntable.



We can't blame anyone who's a bit skeptical about manufacturers' claims. But let's face it. Someone has to be best. You know the traditional quality of Thorens is undisputed. You know that Thorens has been a turntable innovator for the past 82 years. So when we say the new TD-150 Mark II is the best — you can believe it.

DRAMATICALLY NEW FEATURES:

Precision Cueing Synchronizer — Front positioned and isolated from the tonearm. Lowers the arm gently and precisely. Extends stylus life. Reduces record wear.

Anti-skate Control — No skip. No skate. No slide. Stations stylus precisely on both walls of groove.

Adjustable Low Mass Plug-in Shell — Adjusts to optimum playback stylus angle of 15°.

Tonearm Balance & Stylus Tracking Force Regulation — Perfect dynamic balance. One half gram adjustments to as low as 0.5 gram.

New Action Speed Glide Adjustment — Changes speed (33⅓ and 45 rpm) smoothly, rapidly without jolting stylus.

Other features: 12 inch, 7½ lb. precision balanced, non-magnetic platter eliminates wow and flutter . . . Unified suspension system suppresses rumble . . . Double synchronous motor for constant, precise speed.

Complete with tonearm and walnut base . . . Only \$125.00 (Suggestion: the new Ortofon M15 magneto-dynamic cartridge is the perfect complement.)



And here's what the critics say about . . . **THORENS TD-125 3-speed Transcription Turntable**

"All told, the TD-125 shapes up as the best three-speed manual (turntable) we've yet tested." High Fidelity (Sept. '69)

"The Thorens TD-125 is unquestionably one of the elite . . . It would be hard to imagine a unit that performs better." Stereo Review (Aug. '69)

Here are some of the novel design features that inspired this brilliant acclaim:

- Tonearm mounting incorporated in

- shock mounting of 8 lb. aluminum platter for rumble-free performance
- Low, low motor rotor speed of 250 rpm at 33⅓ rpm platter speed further decreases rumble
- Drive system isolated by shock mounting it independent of controls
- Dependable synchronous motor teamed with a Wien Bridge oscillator
- 3 speeds
- Self-lubricating platter bearings precision polished to ultra-fine tolerance
- Interchangeable tonearm mounting board for simple and inexpensive replacement
- Three year warranty
- TD-125 chassis — \$185.00; mounted in walnut base — \$200.00



For more details, see your Thorens dealer, or write to:
ELPA MARKETING INDUSTRIES, INC.
New Hyde Park, N.Y. 11040

CIRCLE 29 ON READER-SERVICE CARD

LETTERS

Continued from page 10

article, I now have my speakers, Jensen TF3a's, on a record cabinet and table about three feet off the floor with backs to the wooden walls and eight feet apart. I found an immediate improvement in the quality of the sound. Thank you again.

D. W. Rafferty
Jackson, Mich.

Order from Chaos

I was fascinated by David Hamilton's sensible and informative piece on cataloguing record collections in your September issue. In evolving my own system over the past ten years, I had to discover the hard way many of the principles and ideas that seem so logical and obvious as set forth by Mr. Hamilton.

R. C. Broadstone
Jackson Heights, N.Y.

The Classical Bag

From McClure on "The Classical Bag" and Ehle on do-it-yourself tape music ["Make Your Own Electronic Music," August 1969], I gather that the music of the future will be produced by teenyboppers who have graduated from kindergarten rhythm toys to the home electronic workshop. I'm glad I'm over thirty.

Paul Lewinson
Arlington, Va.

Neglect and Rediscovery

William Zakariassen's article in your August issue ["Born Losers"] reminded me once again of the record industry's neglect of that most interesting composer, Erich Wolfgang Korngold. Only his Violin Concerto is currently available on disc. Meanwhile his operas, *Die tote Stadt* and *Violanta*, along with his other symphonic and piano literature which cry out for today's stereophonic sound, lie dormant. Surely this composer, who was admired by Puccini, Mahler, and Richard Strauss, should not be forgotten. Why not let us have some modern music we might actually enjoy?

Charles Murootian
Paterson, N.J.

A word of praise for Seraphim. In a time when other budget lines are issuing such discs as Japanese Bach or exploiting fake stereo sound, or when the full-price labels push machine-age technicians in the name of mature artistry, it is truly gratifying to see the wealth Seraphim has given us thus far—in particular, their recent reissues of the Great Recordings of the Century series [see "The New Releases," October 1969]. What glorious performances! RCA and Columbia, to name only two companies, have vaults that are loaded with countless treasures. Can't they at least make some of them

Continued on page 16

CIRCLE 100 ON READER-SERVICE CARD →

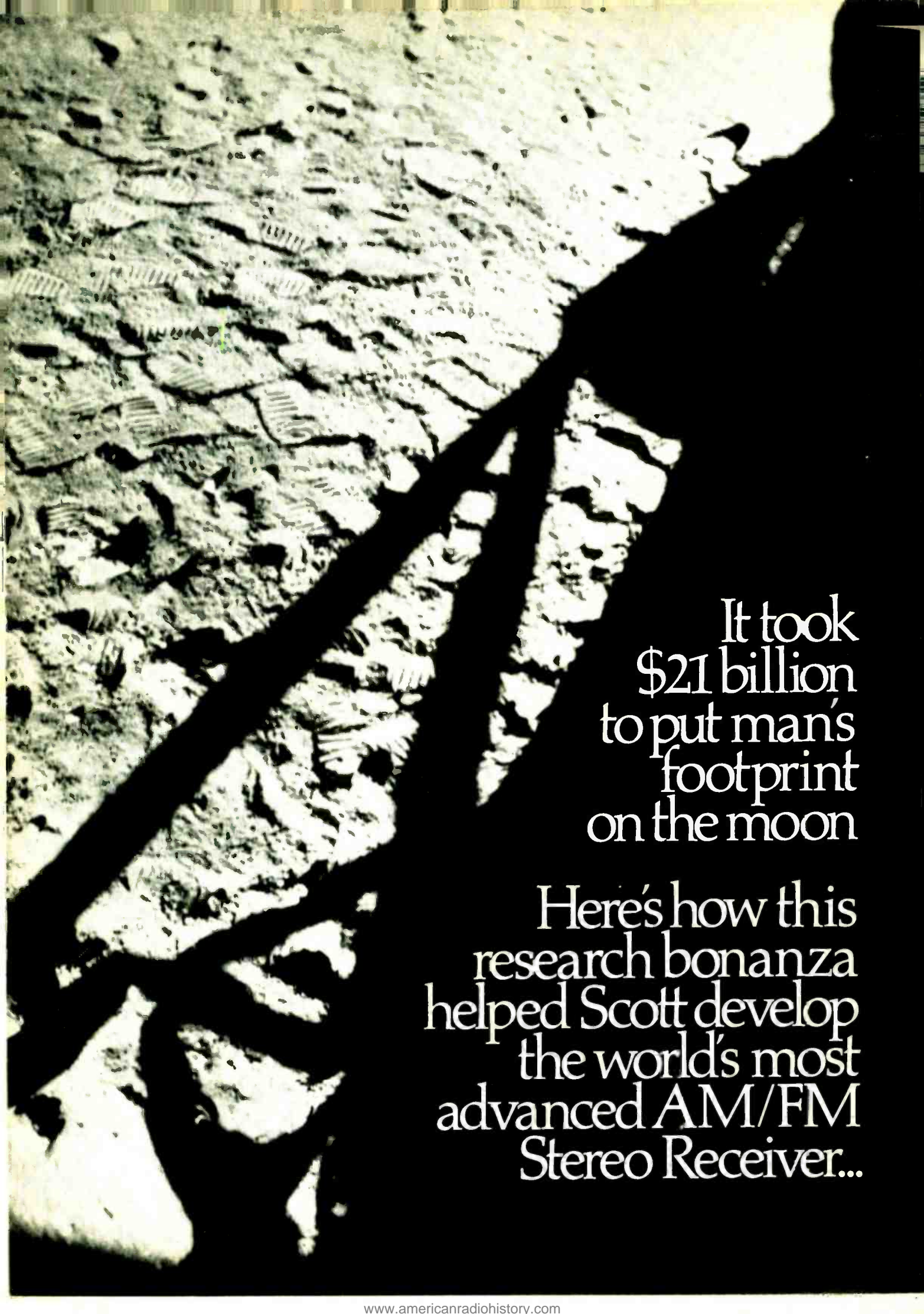

It took
\$21 billion
to put man's
footprint
on the moon

Here's how this
research bonanza
helped Scott develop
the world's most
advanced AM/FM
Stereo Receiver..



The new Nocturne Eight Twenty solid state receiver has 140 Watts of power and perhaps the most sophisticated FM stereo tuner ever built.

But it doesn't have an AM radio.

At \$299.95, we had to make a choice. So we made the one we thought you would make. We traded the AM radio for an inordinate amount of performance. For instance, the Eight Twenty has enough guts to drive four speaker systems flawlessly, without the slightest sign of strain. The amplifier is unlike any power output stage found in conventional stereo receivers. It employs wideband silicon transistors and a heavy duty power supply which extends the amplifier's response to below 5Hz and above 60,000Hz. This results in flawless reproduction

of all harmonics without phase and transient distortion. The output stage uses a quasi-complimentary symmetry design which insures accurate balance and symmetry at the clipping points. A high degree of feedback is used to keep distortion down and stability high. Harmonic distortion products are kept below 0.5% at full output across the audio spectrum of 20-20,000Hz. This insures unusually smooth and transparent sound.

**At \$299.95 we had to choose
between an AM radio
and better performance.
We left out the AM radio.**

CIRCLE 34 ON READER-SERVICE CARD

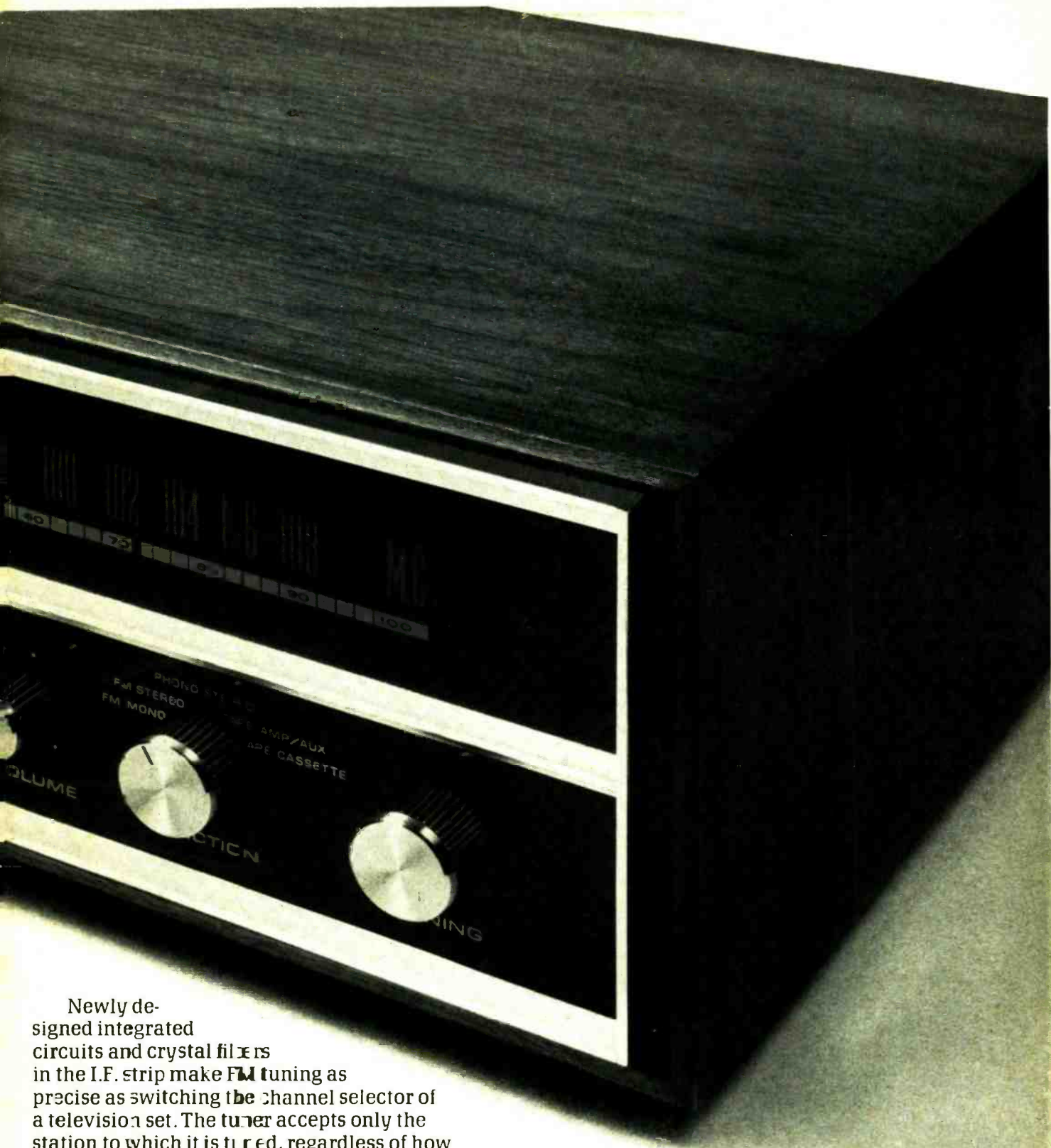

Newly designed integrated circuits and crystal filters in the I.F. strip make FM tuning as precise as switching the channel selector of a television set. The tuner accepts only the station to which it is tuned, regardless of how close an alternate or adjacent station may be. An FET front end coupled with a four ganged tuning capacitor assures unprecedented sensitivity and selectivity. Crossmodulation has been reduced to the vanishing point.

The new Harman-Kardon Nocturne Eight Twenty doesn't have an AM radio. But it has everything else you could possibly want in a receiver. And at an amazingly low price. Hear it soon at your Harman-Kardon dealer.

For more information, write: Harman-Kardon, Inc., Dept. HF-12, 55 Ames Court, Plainview, N.Y. 11803.

harman kardon

A subsidiary of Jervis Corporation

140 Watts, ± 1 db; 110 Watts, IHF

CIRCLE 34 ON READER-SERVICE CARD



BERLIN

A Dream Quartet For Beethoven

For anyone playing the wishful-thinking game of choosing ideal performers for certain works, it would require little imagination to hit upon Richter, Oistrakh, and Rostropovich as the soloists with Karajan and the Berlin Philharmonic for Beethoven's Triple Concerto. Anyone familiar with the intricacies and hard realities of the recording racket would require just as little imagination to think of the immediately obvious hindrances to such a bit of casting. DGG has both Karajan and the Berliners under exclusive contract. England's EMI has an agreement with Moscow on Soviet artists, but so has West Germany's Ariola—so where would that leave EMI's West German affiliate, Electrola? Richter has performed with Oistrakh and Rostropovich individually, but Oistrakh and Rostropovich have never played together, publicly or privately, and neither, obviously, have they ever formed a trio with Richter. Oistrakh has performed the Beethoven Triple with Oborin and Knushevitsky, but Richter and Rostropovich have never played it at all. Anyway, as everybody knows, Sviatoslav Richter *hates* to record—anything, under any circumstances—and several years ago he announced he would record no more at all, a decision he has adhered to, to the desolation of numerous recording executives. No, no—a lovely idea, such a dazzling constellation, but clearly quite out of the question to arrange.

And thus it came about that in mid-September, in West Berlin, the most prodigiously gifted (and highest priced) quartet of musicians brought together in many a moon joined forces in the Jesus-Christus-Kirche to record the Beethoven Triple with the Berlin Philharmonic—for EMI. When I asked an Electrola representative how they had managed to snaffle Karajan and his orchestra away from DGG, he froze in his tracks and said, "Now listen carefully. Gilels recorded the five Beethoven concertos with Szell and the Cleveland. EMI has Gilels, but Szell has some sort of DGG obligations—I *think*. Ariola will release the five piano concertos in Germany, so we get the Beethoven Triple. Clear?" "No," I said. He sped away.

Indian summer temperatures hung at about seventy degrees during the days of the Beethoven sessions, and all three soloists, like the orchestra, shucked their jackets before getting down to work. Richter retained a neatly knotted cravat, but Rostropovich wrenched his loose and Oistrakh removed his. An informant near

Continued on page 46



For the first time Rostropovich (right), Oistrakh (below), Richter, and Karajan (above) are brought together: a dazzling constellation of gifted musicians for the EMI recording of the Beethoven Triple Concerto.



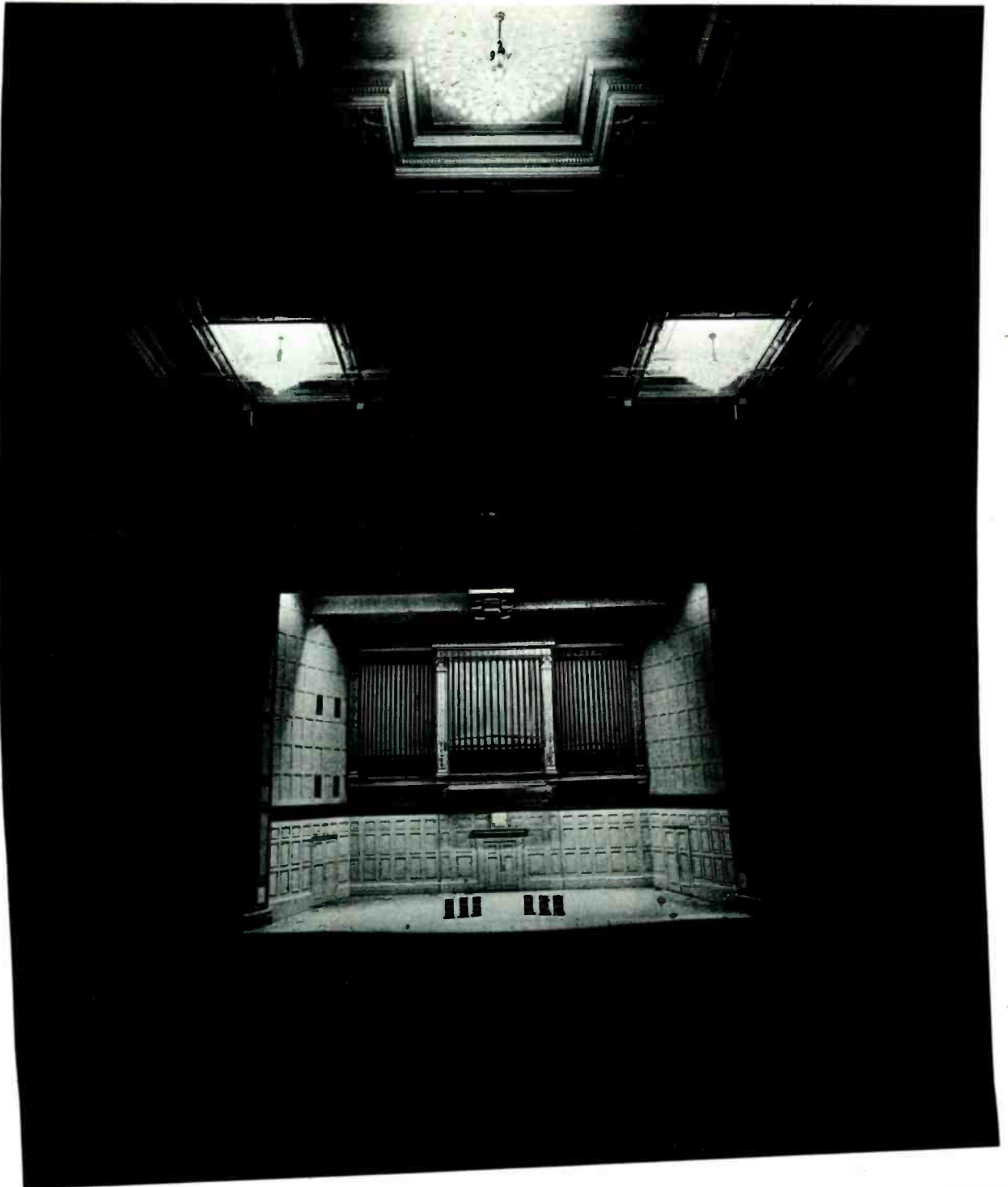

Acoustic Suspension

What is a loudspeaker?

In its simplest form, a loudspeaker consists of a metal frame with a cone of some softer material suspended from it. The frame also holds the electrical mechanism which moves the cone. When the cone is pushed forward and backward it produces waves in the air which we hear as sound waves. If the cone is made to move correctly, any sound may be produced or imitated exactly.

A major cause of distortion

There are limits to the accuracy with which a loudspeaker can be made to move, however. One of the most important limits of cone movement is the way it is attached to the frame. Since no mechanical suspension can stretch indefinitely, it restricts large movements of the cone and distorts the sounds these movements produce. Deep bass notes require the largest cone movements and it is these notes, if present at all, which are most distorted by conventional speaker systems. a

Applied physics; using air as a spring

The air in an enclosed space makes an almost perfect spring. It may be compressed to a small fraction of its normal volume; when the pressure is released, the air expands to fill this volume. In AR speaker systems, the suspension of the cone from the frame is made extremely loose; then the loudspeaker is mounted in a small, tightly sealed cabinet. The air in the cabinet, resting like a spring against the cone, makes a precise and nearly distortionless suspension. This design was originated by Acoustic Research in 1954 and named "acoustic suspension". b,c

Four advantages

The results of this technique are (a) very low distortion at low frequencies through acoustic rather than mechanical suspension; (b) extended bass response, essentially to the lower limit of human hearing; (c) conveniently small size because of the need for a small air volume behind the speaker cone; (d) simplicity and low cost.

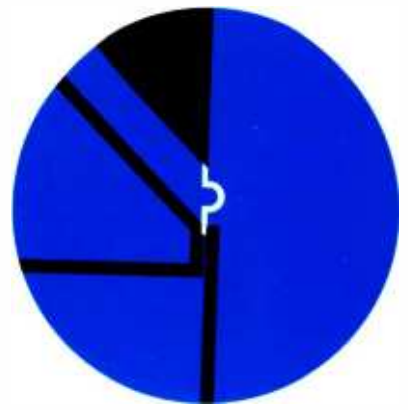
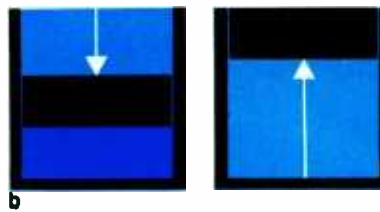
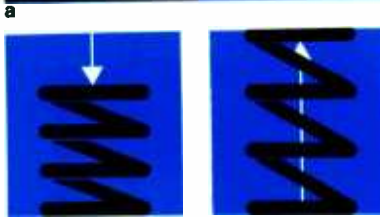
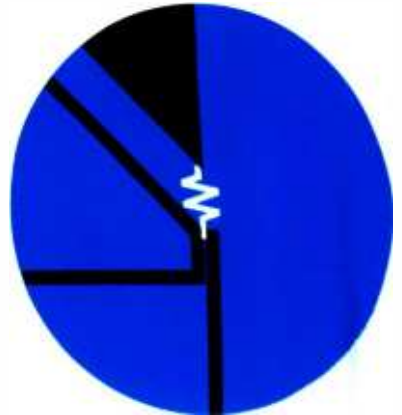

Hemispherical Dome Speakers

Sounds are usually mixtures

Musical sounds are complex; a single note played on the violin, for example, consists of at least half a dozen notes of different pitch and loudness, all sounding together. To reproduce the sound of a violin accurately, all of its tonal ingredients must be reproduced in exactly the right proportion.

Uneven distribution causes unnatural sound

Most loudspeakers radiate tones of different pitch into the room in different patterns. Generally, the higher the frequency of the tone, the more narrowly it is beamed forward. As a result, only part of the sound is heard in most of the room and often, in addition, the sound directly in front of the speaker is strident and harsh. Reflecting the sound from the walls helps such speakers somewhat, but also reduces high frequencies further by absorption. This defect, made even worse by the natural tendency of loudspeakers to decrease in output at very high frequencies, can only be corrected by the use of electronic equalization (fixed, built-in tone controls in the amplifier or in a separate circuit assembly). Such designs are severely dependent on the reflective characteristics of the listening room, in any case, which can hardly be anticipated by the manufacturer. a,b

A new kind of miniature loudspeaker

The narrowing beam of high frequencies is not a result of speaker design, as such, but rather follows from the size of the speaker and certain fundamental physical laws. An important innovation in AR speaker systems is the replacement of the conventional speaker cone by a tiny hemispherical dome in those speakers which are used for high-frequency reproduction. These domes, although smaller than the little loudspeakers

used in transistor radios, are driven by magnetic structures weighing as much as several pounds. Because of their small size and hemispherical shape, these units give even sound coverage at all audible frequencies in all directions, not only from side to side, but vertically as well. AR speaker systems sound the same standing on an end or on a side, whether heard directly in front or at an appreciable angle off-axis. c

Readers are invited to write to Acoustic Research for any technical or design information they wish to have. The design of AR speaker systems, in addition to descriptions in the patent literature, has been documented in numerous technical journals. Some of these papers are available as reprints from Acoustic Research, free upon request.

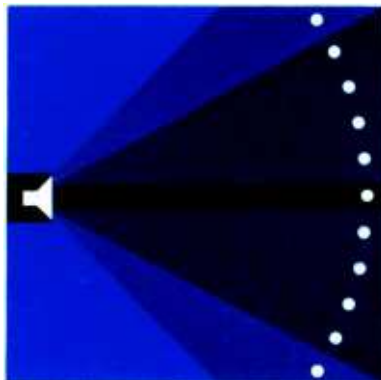

a

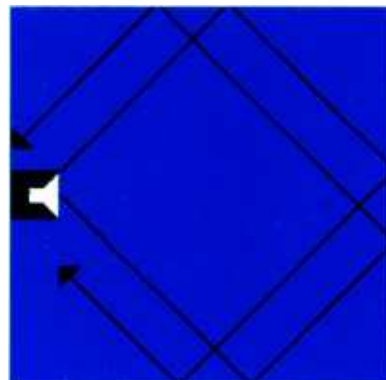

b

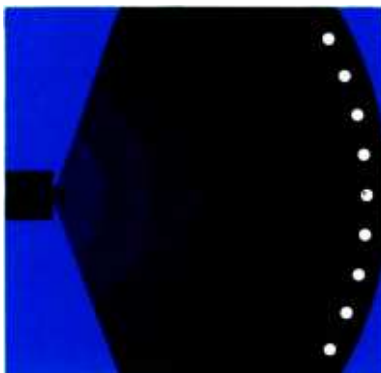

c

AR-3a Speaker Systems



Few musicians have achieved the international fame of conductor Herbert von Karajan. He has directed the major symphony orchestras and opera companies of the world in their own concert halls. At home in St. Moritz, and in his New York apartment he listens with AR speaker systems.

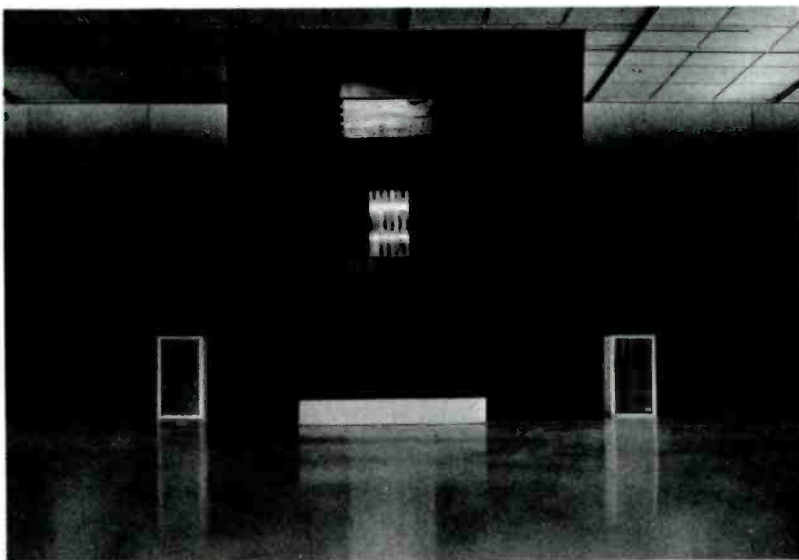

At Chicago's Museum of Contemporary Art, AR-3a and AR-4x speaker systems and AR amplifiers are used to present concerts of contemporary music to gallery visitors. The sculpture in the photograph is "Untitled" by Westermann.

The AR-3a is the best speaker system we know how to make.

It has been designed to reproduce music as accurately as present-day knowledge of acoustics and electronics permits. In addition to incorporating the 12-inch bass driver with which AR introduced its acoustic suspension systems to home listeners, the AR-3a was the first speaker system to use two miniature hemispherical speakers developed by AR to give better mid-range and high frequency response. The new miniature speakers offer an unprecedented degree of accuracy in their respective ranges.

The design of such small speakers — one is only ¾" in diameter — although technically difficult, allows the laws of physics to operate to the listener's advantage. While larger speakers must beam high frequencies straight forward, AR's hemispheres instead spread these frequencies through a wide angle, considerably improving the realism of music reproduction for listeners in all parts of the room.

Size: 14" x 25" x 1 1/8" deep.
 Weight: 53 lbs (24 kg).
 Recommended Amplifier Power: 25 watts r.m.s. per channel, minimum.
 Impedance: 4 ohms.
 Speaker Complement: 12" acoustic suspension woofer, 1 1/2" mid-range hemispherical dome, ¾" high-frequency hemispherical dome.
 Controls: Independent mid-range and high-frequency driver level controls.
 A technical data sheet is available.

The AR-3a is guaranteed for 5 years from date of purchase. See inside back cover for the AR guarantee.

AR-3a	
Glossy walnut, oiled walnut,	
cherry, oiled teak	\$250
Mahogany, birch	\$240
Unfinished pine (can be painted)	\$225
5% higher in West and Deep South.	

The AR-1W is the bass (woofer) section alone of the AR-3a, and the AR-3 was the forerunner of the AR-3a. Both systems are listed in the table on page 20.

"... the best speaker frequency response curve we have ever measured using our present test set-up ... virtually perfect dispersion at all frequencies ... AR speakers set new standards for low-distortion, low-frequency reproduction, and in our view have never been surpassed in this respect." *HiFi/Stereo Review*.

"On any material we fed to them, our pair of AR-3as responded neutrally, lending no coloration of their own to the sound ... the speakers sounded magnificent, filling the place with a lot of clean, musical sound and an excellent stereo image ... Our tests of the AR-3a simply confirm the manufacturer's design aims and claims for this system." *High Fidelity*.

"The harmonic distortion at bass frequencies was outstandingly low ... The high-frequency dispersion is the widest of any speaker we have tested ... a new high standard of performance at what must be considered a bargain price." *Audio*.



AR-5 Speaker Systems

An outdoor jazz concert in the sculpture garden of the Museum of Modern Art in New York. The museum uses its twelve AR-5 speaker systems to provide natural, undistorted amplification of the music for listeners distant from the musicians.

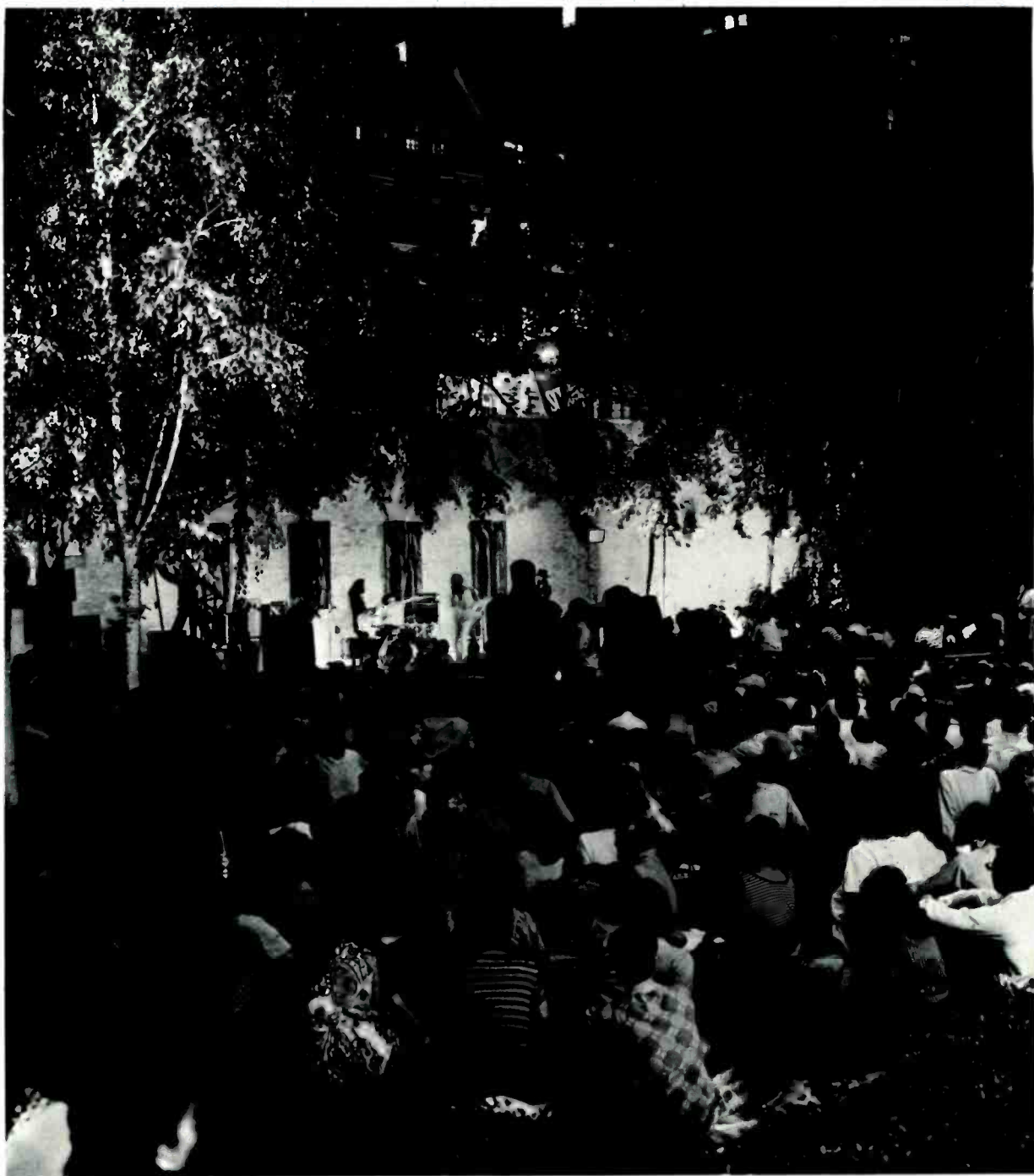

"I was immediately struck by its superb mid-range to high-end smoothness and broad dispersion . . . the AR-5's bass line is solid and supremely clean, very deep . . . had a room-filling size to it; this is, of course, a function of the excellent high-frequency dispersion characteristics . . . if you like your music loud, you will doubly appreciate the AR-5. It is downright cheerful about accepting large amounts of power." Larry Zide in *American Record Guide*.

"Its sound was unquestionably "AR" — which is to say that it had very clean, extended, low bass, exceptional dispersion of the higher frequencies, and an effortless, undistorted overall sound . . . [With level controls adjusted to the reviewer's preference] the sound quality of the AR-5 could then only be described as superb. We doubt that one could spot the differences between the AR-3a and the AR-5 on most program material." Julian Hirsch in *Stereo Review*.

The AR-5 is the newest of the AR acoustic suspension speaker systems. Inside it are the two hemispherical speakers of the AR-3a, which provide uniquely accurate mid-range and high-frequency reproduction, and a completely new 10-inch woofer. The main differences between the AR-3a and the AR-5 are that the bass response of the AR-3a extends approximately $\frac{1}{3}$ -octave lower, and the price of the AR-5 is about \$75 less.

The design of the AR-5, completed in 1968, incorporates several interesting advances in materials technology which help to make its performance possible. The cone of the woofer, for example, is molded by a new low-vacuum process developed for AR, which greatly reduces the tendency to coloration heard in conventional cones of paper or polystyrene. At the cone's outer edge is a new suspension of urethane polymer, which helps to achieve very low distortion at low frequencies. The AR-5, in fact, is one of today's most advanced speaker systems, combining AR's 15 years of experience with the newest processes and materials.

Size: 13½" x 24" x 11½" deep.
Weight: 39 lbs (17.8 kg).
Recommended Amplifier Power:
20 watts r.m.s. per channel, minimum.
Impedance: 8 ohms
Speaker Complement: 10" acoustic suspension woofer; 1½" mid-range hemispherical dome, ¾" high-frequency hemispherical dome.
Controls: Independent mid-range and high-frequency driver level controls.
A technical data sheet is available.

The AR-5 is guaranteed for 5 years from date of purchase. See inside back cover for the AR guarantee.

AR-5
Glossy walnut, oiled walnut,
cherry, oiled teak \$175
Mahogany, birch \$168
Unfinished pine (can be painted) \$156

5% higher in West and Deep South

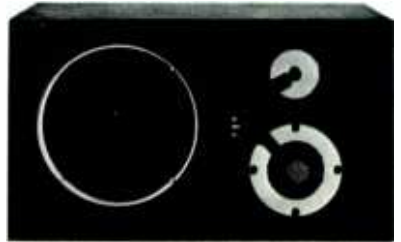
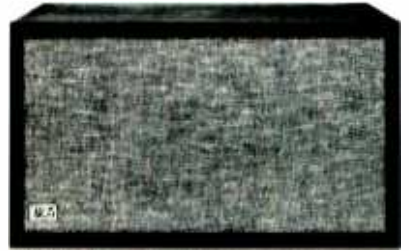

AR-4x Speaker Systems

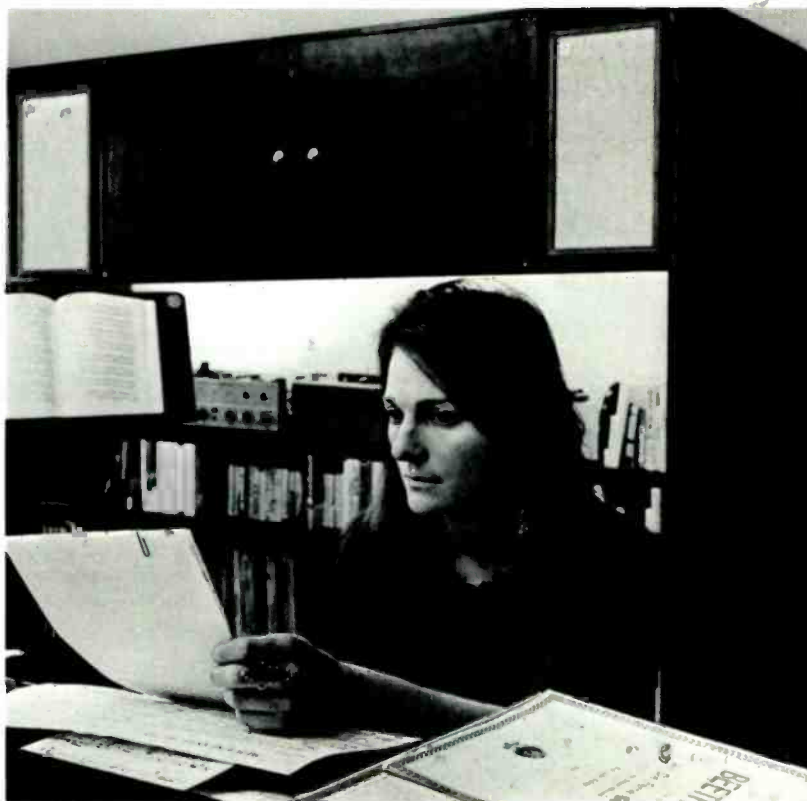

Singer Judy Collins' performances in concert and on Elektra Records are widely known and highly praised. The cabinet in the background contains her AR-4x speaker systems.

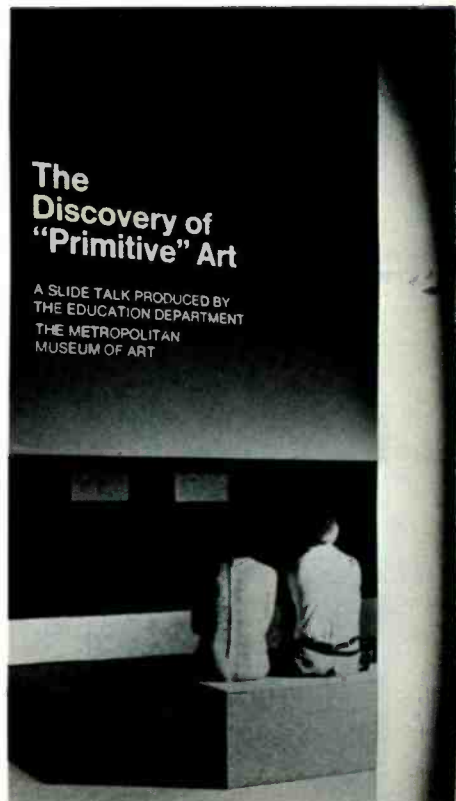

At the Metropolitan Museum of Art, AR speaker systems and amplifiers have been used in various exhibitions.

Acoustic Research Inc.

24 Thorndike Street
Cambridge, Massachusetts
02141

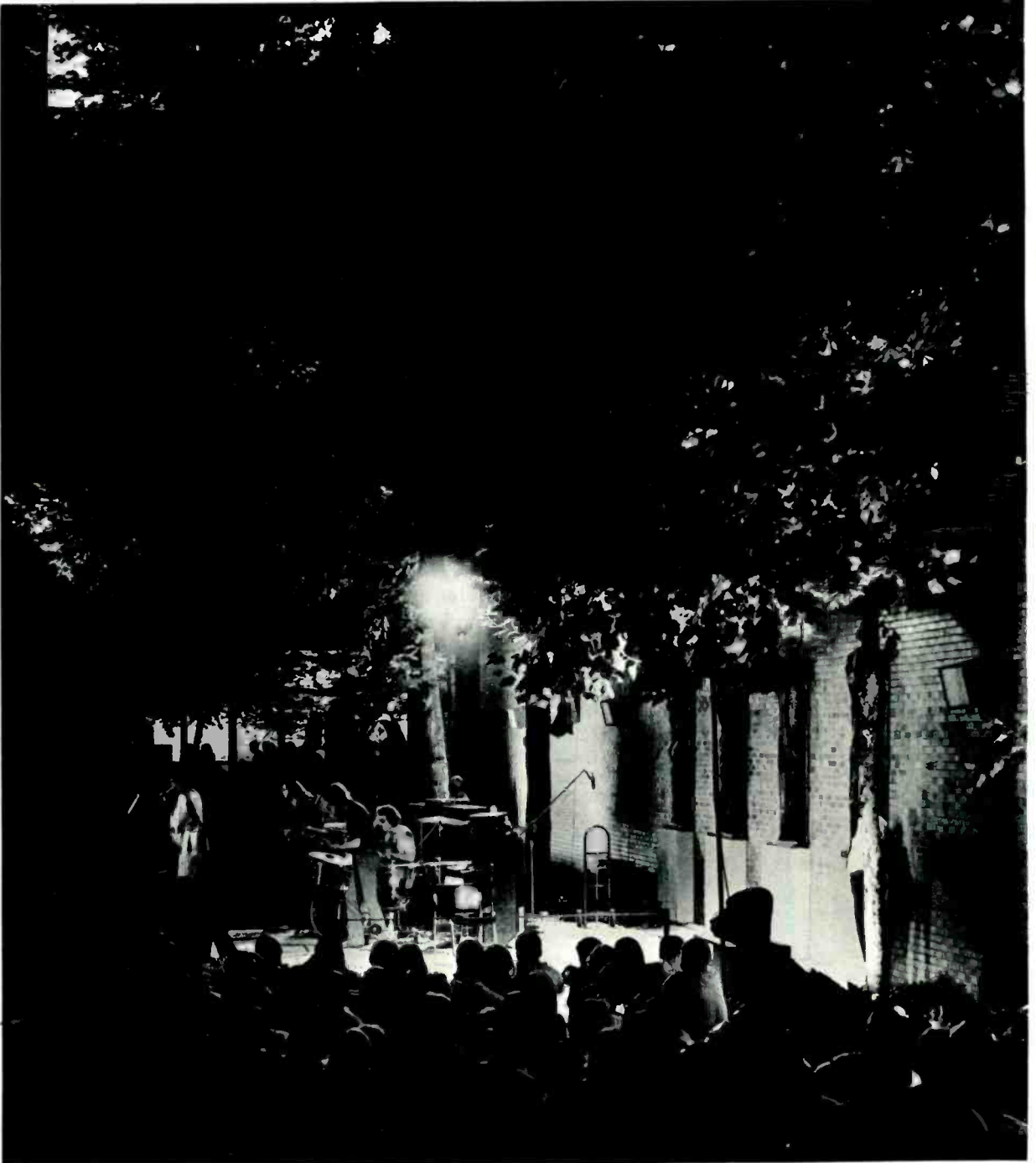

The Acoustic Research Contemporary Music Project

Advisers: Milton Babbitt, Elliott Carter, Aaron Copland, Gunther Schuller and Roger Sessions.
Director: David Epstein.

Beginning early in 1970, music by living American composers, many of whom have never before had their work broadcast or recorded, will be presented to listeners in a series of weekly broadcasts on many FM stations. The broadcasts, with commentary by Leo Treitler and informal interviews with many of the composers, will be produced by Acoustic Research and provided to the broadcast stations free of program charges. The records from which the music in the broadcasts is taken will be made available at a time to be announced, and will be manufactured in Europe especially for the project by Deutsche Grammophon GmbH. The cooperation of DG with the project makes possible sale of the records in the United States and Canada at \$2 each, and at a comparable price in other countries. After an initial period of distribution by AR, those recordings in greatest demand will be placed in the Deutsche Grammophon catalog for world-wide distribution.

A list of works to be performed during the first season, together with a list of those FM stations which have already asked to receive the transcriptions, is available by writing to ARCMP, 24 Thorndike St., Cambridge, Massachusetts 02141. Records will also be obtainable from the office of the new AR factory in Europe: Acoustic Research International n.v., Radiumweg 7, Amersfoort, Holland.

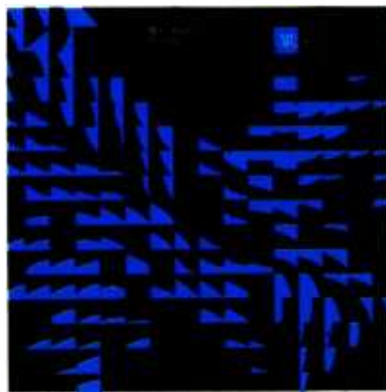

AR maintains two music rooms at which visitors are welcome to listen to their choice among new record releases and some selections AR has made, played on AR equipment. No sales are made at the music rooms, but AR personnel are there to answer any questions that visitors may have about AR equipment or music reproduction in general.

In New York City, a music room is located conveniently on the west balcony of Grand Central Station, off Vanderbilt Ave. at 43rd St. It is open from 10:00 a.m. to 6:30 p.m. on weekdays, 11:30 a.m. to 5:30 p.m. on Saturdays and Sundays.

In Cambridge, Massachusetts, there is a music room at 52 Brattle St., a short walk from Harvard Square. It is open from 4:00 p.m. to 10:00 p.m. on Monday, 12:00 noon to 10:00 p.m. Tuesday through Friday, and 10:00 a.m. to 10:00 p.m. on Saturday.

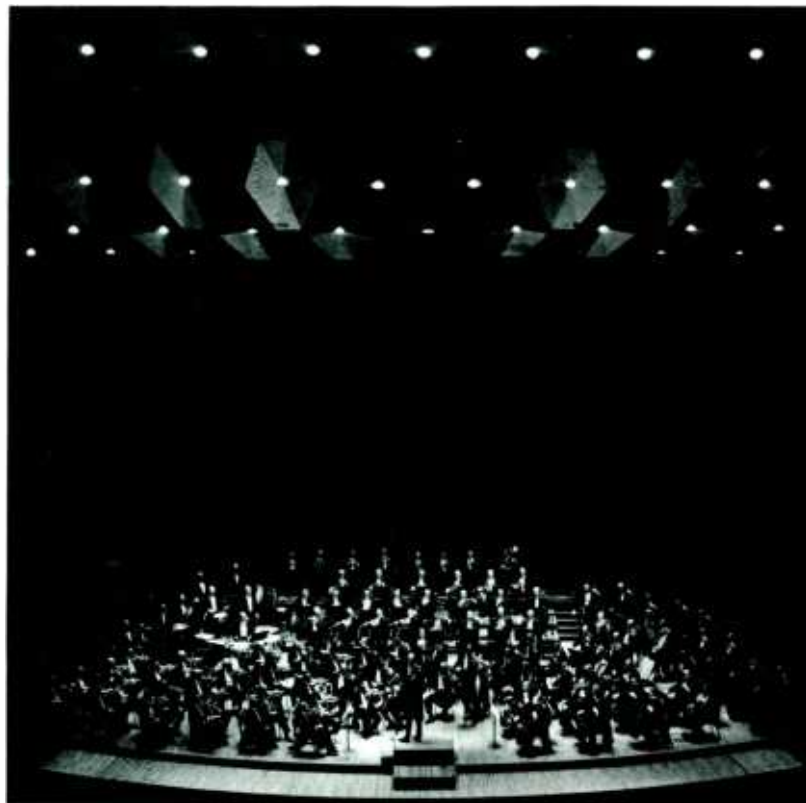

Above: the New York Philharmonic on the stage of Philharmonic Hall in New York's Lincoln Center. Some of the 4-channel tape recordings played at the AR Music Rooms are of performances by this orchestra, and reproduce the acoustics of Philharmonic Hall. Left: the AR Music Room in New York.

The special 4-channel recordings used in the demonstrations have been produced by Columbia Records, and include performances by a number of leading orchestras and soloists, rock groups and electronic music composers. Presented in the new 4-channel medium, these recordings, made in Philharmonic Hall in New York, St. Mark's Cathedral in Venice, the Cathedral of Toledo in Spain and other locations, display a realism that is surprising to nearly every listener who hears them. Other recording companies have also agreed to provide tapes for this demonstration, including Vanguard Records, the first company to release such recordings commercially.

Although designed for home use, AR speaker systems are often chosen for technical or professional applications because of their accuracy. They are used as monitors in the nation's leading FM broadcasting studios. Among recording companies which use AR speaker systems for auditing or monitoring are Angel Records, Connoisseur Society, Nonesuch Records, Vox Records, MGM Records, Polydor Records, Deutsche Gramophon and Vanguard Records. In addition to their obvious application in psychoacoustic studies, AR speaker systems have been used in physics laboratories studying Mössbauer effect, in computer laboratories to generate new types of displays, as adjuncts to sound synthesizers in electronic music centers, in environmental simulation studies and installations, and many other unusual uses. The AR staff welcomes inquiries regarding specialized use of AR speaker systems and other components.



At one of the world's leading medical schools, living heart sounds, amplified by an AR amplifier, are effectively reproduced for the class in a large lecture hall by four AR speaker systems. Almost all of the heartbeat signal is below 40 Hz.

Research on the directional hearing mechanisms of the ear and brain is carried out at Columbia University using AR-3a speaker systems and AR amplifiers.

"After years of rumor and waiting, the AR amplifier finally has appeared . . . [It] is, in our view, an unqualified success, a truly excellent and unimpeachable amplifier, the more outstanding for its comparatively low price . . . The unit, in fact, was tested at CBS Labs putting out 10 watts more than its rated power – and [even at 20% over its rated power] it either met or exceeded its specifications . . . The IM characteristics must be counted as the best we've ever seen . . . still running below a mere 0.2% at 100 watts output." *High Fidelity*.

"Our laboratory test showed that the AR amplifier is rated with great conservatism . . . IM distortion was of very low proportions. Into 4-ohm loads, the AR amplifier delivered a staggering 110 watts per channel at the clipping point (about 0.5% distortion) . . . it ranks among the very best available." *HiFi/Stereo Review*.

The AR amplifier is practically identical in performance to the amplifier section of the AR Receiver. The amplifier is available in two versions, one for 110-120 volts, 60 Hz, and the other for 110-240 volts, 50-60 Hz, usable almost anywhere in the world where alternating current is supplied.

<u>AR Amplifier in metal case</u>	<u>\$250</u>
Above, for 100, 120, 220, 240 volts, 50/60 Hz	<u>\$250</u>
Oiled walnut wood cover	<u>\$15</u>

Listed by Underwriters' Laboratories Inc.



AR speaker bases can be used where space limitations require mounting near the floor. Speakers standing directly on the floor tend to "boom"; the base raises an AR speaker system 11 inches above floor level, which helps to eliminate this problem. Bases are available either in unfinished birch, ready for staining, or solid walnut with oil finish; each base consists of two U-shaped pieces which fit together without screws. The bases are too large to be used with the AR-4x.

<u>AR Speaker Base</u>	<u>\$7.50 each</u>
------------------------	--------------------

Postpaid from AR



The earliest high-fidelity components were designed during the vacuum-tube era, and generally followed broadcasting practice in separating tuner, power amplifier, preamplifier and power supply, each circuit section on its own chassis. The characteristics of transistors, primarily their small size, cool operation and indefinite service life, permit the consolidation of all of the electronic circuitry needed in a high-fidelity system into one component, the receiver.

The AR Receiver was under development for some time. When the amplifier section was completed, several years ago, it was offered to the public as a separate component. *High Fidelity*, citing test reports from CBS Laboratories, stated, "It is, in our view, an unqualified success, a truly excellent and unimpeachable amplifier . . . [at 20% more than its rated power] it either met or exceeded its specifications . . . the IM [distortion] characteristics must be counted as the best we've ever seen . . ." *Stereo Review* called the amplifier's power "staggering", and added, "it ranks among the very best available."

The receiver has now been completed by the addition of the circuitry required for stereo FM broadcast reception which is in every respect the counterpart of the performance of the amplifier. The receiver circuit is all-silicon solid state; the most rigorous manufacturing and inspection techniques we know are used in its assembly. The receiver is guaranteed for 2 years; see the full AR guarantee on the inside back cover.

While no compromise is made with optimum performance, the AR receiver is lower in price than might be expected. This is because of the rational approach taken in its design. The AR Receiver is as sensitive, precise and powerful a unit as is ever likely to be needed in the home. In addition, it is one of the simplest to operate; as in the best of professional equipment, control functions have been limited to those which are actually needed.

Applicable IHF test standards are used for the following guaranteed performance specifications.

FM Section

Sensitivity: 2.0 microvolts or better (hush control "off"). Signal to noise ratio: 65 db, ASA "C" weighting (flat). Distortion: less than 0.5% IM or THD, mono or stereo. Frequency Response: 20 to 15,000 Hz, ±1 db, mono or stereo. Capture Ratio: 2 db or less. Separation: 35 db minimum at 50 Hz; 40 db minimum at 400 Hz; 30 db minimum at 10,000 Hz.

Control Amplifier Section

Power output (measured with both channels driven): 60 watts per channel RMS, 4Ω; 50 watts per channel RMS, 8Ω; 30 watts per channel RMS, 16Ω. Distortion (at any level up to and including full rated power): IM (60 and 7,000 Hz, 4:1), less than 0.25%; harmonic distortion, less than 0.5% from 20 Hz to 20,000 Hz. Distortion figures include preamplifier stages.

Switched input circuits: magnetic phono; tape playback; extra high-level input pair ("Special").

Outputs: tape record; 4-16Ω speakers; headphone jack on front panel; output to amplifier for center-channel or mono extension speakers.

Circuit Characteristics:

(FM) FET front end with 4-section variable capacitor; multisection crystal IF filter; IC (integrated circuit) IF amplifiers; automatic interstation noise suppression with defeat switch for very weak stations; automatic mono/stereo FM switching with stereo indicator light; low-distortion shunt multiplex detector; tuning meter. (Amplifier) DC driver clamping for clean overload recovery; idling power supply eliminates turn-on transient noises; bass and treble separately controlled for each channel; differential loudness compensation curves in bass control circuit; special null circuit permits exact balancing of stereo source material; stable under short-circuit of output terminals; line fuse, speaker fuses and self-resetting circuit breakers for full protection.

The AR receiver is guaranteed for 2 years from date of purchase. See inside back cover for the AR guarantee.

AR Receiver in metal case	
110-120 volts, 60 Hz	\$420
Oiled walnut wood cover	\$20

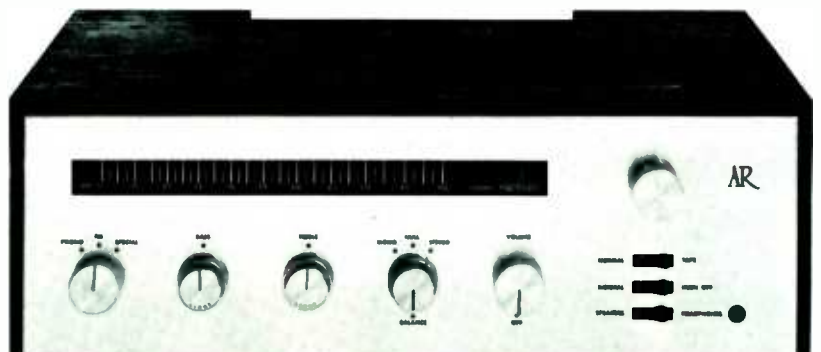

The AR Receiver

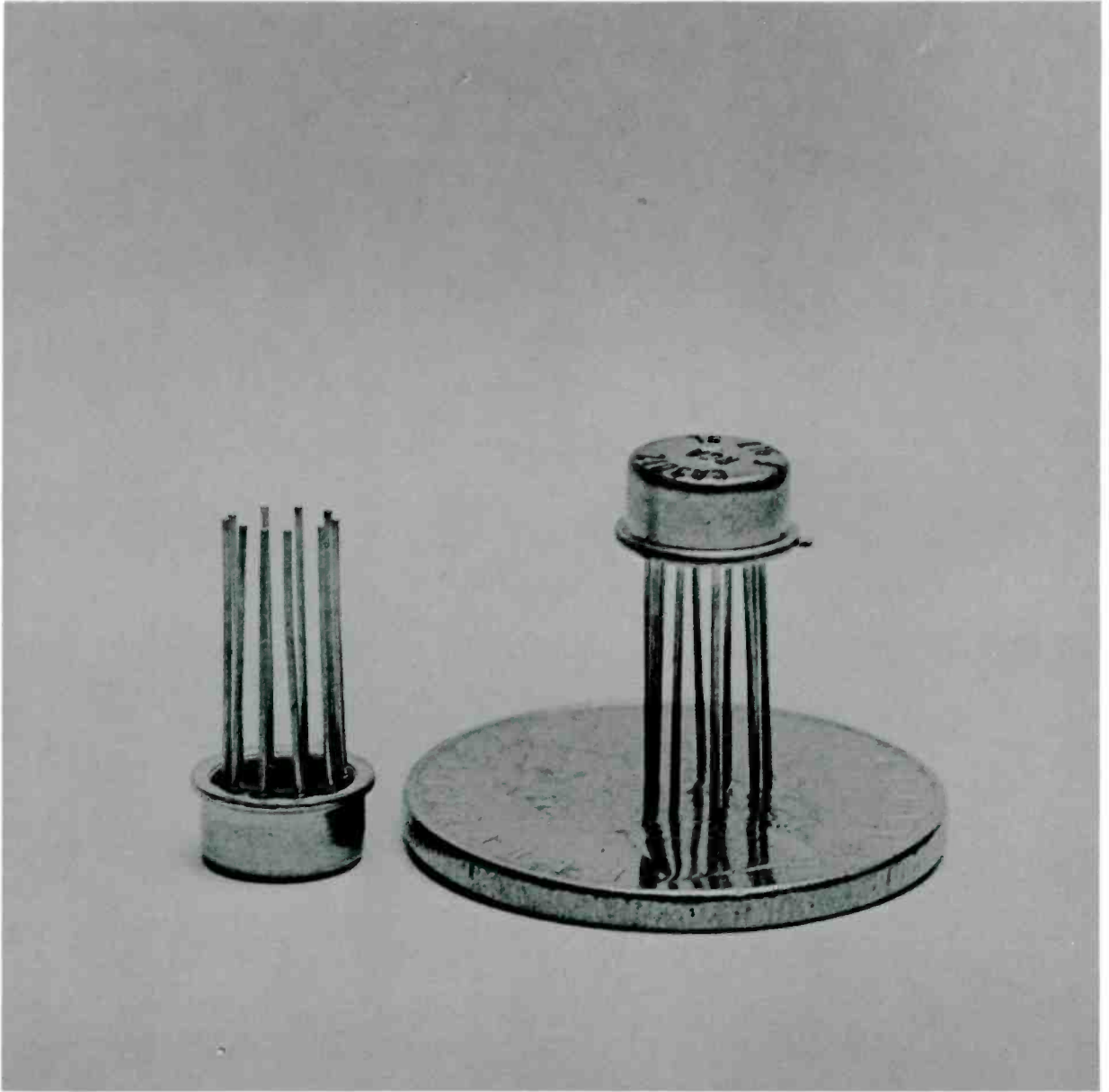

The electronic refinement of the AR receiver is exemplified by the two integrated circuit (IC) amplifiers used in its i.f. section. The two IC units, no larger than two peas, contain twenty transistors, fourteen diodes and twenty resistors.

Since its introduction, the AR turntable has had a profound effect upon both design and performance standards of home record-playing equipment, yet it remains alone in the field in the degree to which it combines broadcast equipment performance, completeness and convenience, simplicity of operation and low cost. The AR turntable meets all NAB specifications for broadcast studio turntables on wow, flutter, rumble and speed accuracy. Its miniature synchronous motor and belt drive make the AR turntable inaudible during operation.

The stability of the AR turntable is unusual; the top-plate may even be struck by vertical hammer blows without interrupting the music being played. The AR turntable is insensitive to floor vibrations or acoustic feedback. This gives its owners maximum freedom in placing the turntable where it will be most convenient, even close to the loudspeakers, if necessary.

AR turntables are supplied less cartridge.

Size: 12¾" x 16¾" x 5¼" high.
Weight: 13½ lbs (6.1 kg).

The AR turntable is guaranteed, as a condition of sale, to meet or exceed the specifications of the National Association of Broadcasters for broadcast equipment for wow, flutter, rumble and speed accuracy. A technical data sheet is available.

The AR turntable is guaranteed for 3 years from date of purchase. See inside back cover for complete description of the AR guarantee.

AR turntable for 110-120 volts,
60 cycles:

33½ rpm	\$84
33½ and 45 rpm	\$87
For 110/220 volts, 50/60 Hz	
33½ and 45 rpm	\$87

5% higher in West and Deep South.

Each AR turntable is supplied already mounted on an oiled walnut base, complete with transparent plastic dust cover, plug-in cartridge shell, cartridge mounting hardware and instructions, stylus pressure gauge, overhang adjustment guide, lubricating oil, color coded connecting cables for amplifier, screwdriver for tone arm counterbalance setting and cartridge installation, tone arm with internal adjustable viscous damping and 45 rpm center-hole adapter (2-speed versions only).

Accessories and spare parts:

Needle Force Gauge	\$1
Cartridge Shell	\$2
Turntable Pad	\$2
Dust Cover	\$3

One of each is supplied with the turntable; these prices are for additional parts bought separately.

"The three-year guarantee [like that for other AR products] . . . attests to the basic reliability of this turntable, whose performance is unsurpassed and is, at best, equaled by only two or three much higher-priced record players." Julian Hirsch in *HiFi/Stereo Review*.

"the lowest speed error . . . encountered in [fixed speed] turntables . . . no hint of rumble . . . silent and accurate operation." *High Fidelity*.

"It seems to me that once again they [AR] have executed a master stroke in putting on the market a turntable that we do not hesitate to describe as — the word is not too strong — revolutionary." C. Dartevelle in *Toute L'Electronique*.

"I have, in fact, only one criticism of the AR turntable and arm: it is greatly underpriced." Percy Wilson in *The Gramophone*.



The AR Turntable

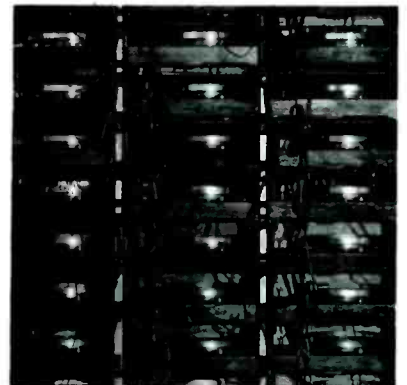
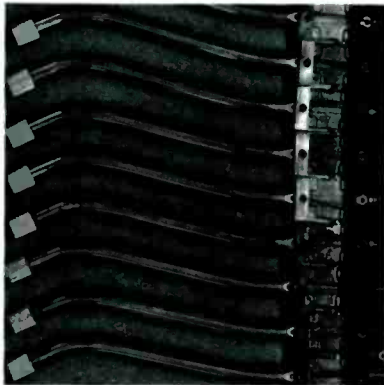

Executive conference room at the main U.S. Office of Angel Records. First pressings of new releases are checked with a system which includes an AR turntable, amplifier, and speaker systems.

Every part of every AR turntable is carefully inspected. Every AR turntable is run for several days before final inspection.



The AR-4x embodies the best performance per dollar that we have been able to build into a speaker system. Inside the AR-4x are an acoustic suspension woofer (a scaled-down version of the woofer used in other AR speaker systems) and a wide-dispersion cone tweeter for high frequencies. The speakers, enclosure and crossover network inside the AR-4x are built and tested to the same strict standards of craftsmanship and accuracy as apply to other AR speaker systems.

The AR-4x does not have as wide a frequency range as our other speakers, but in smoothness and uncolored musical quality it holds its own with any of them.

Size: 10" x 19" x 9" deep.
 Weight: 18½ lbs (8.4 kg).
 Recommended Amplifier Power: 15 watts r.m.s. per channel, minimum.
 Impedance: 8 ohms.
 Speaker Complements: 8" acoustic suspension woofer; 2½" wide-dispersion cone tweeter.
 Controls: High-frequency adjustment.
 A technical data sheet is available.

The AR-4x is guaranteed for 5 years from date of purchase. See inside back cover for the AR guarantee.

AR-4x	
Oiled walnut	\$63
Unfinished birch	\$63
Unfinished pine (can be painted)	\$57

5% higher in West and Deep South.

"There has been nothing like it, and the least I can write is that this speaker is astonishing . . . a model speaker in its class." *La Revue des Disques.*

"This [frequency response] would be remarkable for any speaker, and in our experience is unique for any speaker in the price class of the AR-4x . . . We know of no competitively priced speaker that can compare with it." *HiFi/Stereo Review.*

"To say that the AR-4 [forerunner of the AR-4x] is the best of this class would be to presume too much in the way of individual listener preference; it would perhaps be more to the point to say that we have heard nothing better, so far at least in this price class." *High Fidelity.*

"All in all, it is difficult to see how AR has achieved this performance at the price." *Modern Hi-Fi & Stereo Guide.*



**Because of their exceptional accuracy,
Acoustic Research speaker systems are usually
chosen for special scientific applications.**



One of the world's leading medical schools has recently solved a long-standing problem in its training of first-year students: how to enable a lecturer and hundreds of listeners to hear simultaneously the heart sounds of a living patient. Usable microphonic pickups exist; the difficulty arises because most of the sound in a heartbeat is in the range below 40 Hz. At these very low frequencies, even many speaker systems which seem to have "good bass" are unable to provide results comparable to those of a doctor's stethoscope. The stethoscope, simple as it is, couples the physician's ears directly to the patient's chest, and can, in principle, convey acoustic pulses near 0 Hz. It is this kind of extended low-frequency response which was needed, but individual listening devices were out of the question: they would not allow lecturer and students to hear and recognize the same abnormalities without ambiguity.

The problem was solved by the school's purchase of four standard full-range AR-1x speaker systems and an AR amplifier; the latter is used with all controls "flat". Despite the large size of the lecture hall, the heart sounds are clearly audible to all students, and levels can be produced which literally rattle the doors and windows of the amphitheater. Our best system for music reproduction is our AR-3a; it has the same low-frequency characteristics as the AR-1x, but includes our most accurate mid-range and high-frequency drivers also. Other AR speaker systems are described in the free AR catalog.



Acoustic Research Inc.

24 Thorndike Street, Cambridge, Massachusetts 02141

Acoustic Research International
Radiumweg 7, Amersfoort, Holland

CIRCLE 1 ON READER-SERVICE CARD

BEHIND THE SCENES

Continued from page 20

me in the choir loft, where Richter's and Oistrakh's wives also sat, told me toward the end of the afternoon session that Karajan had just donned his fourth light wool shirt of the day. Oistrakh looked oddly unfamiliar and *verfremdet* sitting down: his expansive corporation was almost Buddha-like. Richter put on and took off his heavy, black-rimmed glasses about a thousand times. Rostropovich, finishing a phrase with a decisive down-bow, would draw his elbows sharply back, his hands wide apart, like a wrestler about to grapple an adversary.

Will the three Soviet stars record any trios, now that they have finally got to-

gether? They decline to commit themselves, but they do indicate vaguely that they may do some trios live—in Moscow, of course. Richter's baleful attitude toward recording seems to have lessened in intensity, at least for the moment: before the end of the year, he said, he expected to join with Lorin Maazel and the Orchestre de Paris to record for Philips the Brahms Second, the Bartók Second, and the Ravel Left Hand.

Easily the most radiant face at the Berlin Beethoven sessions belonged to Konstantin Metaxas, once with DGG, now a Munich-based, free lance record producer. During a chat with him and Nina Dorlyak (Mrs. Richter), I asked Metaxas, a Moscow-born Greek, how long it had taken him to bring these sessions about. "Twelve years," he said, with almost

grim emphasis. "And this lovely lady"—he bowed to kiss Miss Dorlyak's hand—"gave me a great deal of indispensable assistance." Miss Dorlyak fingered her collar and smiled at the ground with deprecation. PAUL MOOR

LONDON

Caballe's Verdi—More Temperamental than Tenors

It was a hectic Verdian summer of recording in London—and much more so for the members of the New Philharmonia Orchestra. At one point the musicians were recording *Il Trovatore* at Walthamstow in the afternoons for RCA and then dashing twenty miles over to Watford to record the Verdi Requiem for EMI in the evening. Executives from both companies moaned that they were getting the worst of the deal. The surprising thing was how the orchestra thrived on such a steady diet of Verdi.

The situation was made even more tense when, only a few days before the *Trovatore* sessions were about to start, conductor William Steinberg had to withdraw. Zubin Mehta was signed up at once, but that meant sandwiching the whole opera into eleven sessions instead of the proposed fourteen. Richard Mohr, the RCA recording manager, explained how he just made it. Mehta was due to appear at the Queen Elizabeth Hall (as double-bass player in Schubert's *Trout* Quintet as well as conductor) on the Saturday afternoon immediately before his return to Los Angeles that night. From the concert he rushed straight to Walthamstow where the NPO was just finishing a session of lightweight French pieces under Antonio de Almeida. Mehta whizzed through a number of retakes that were needed for *Trovatore*, finishing off just before the tea break in the second session. After the break Almeida stepped in again to take up *Zampa*, *Bronze Horse*, and *Faust* where he had left off—a unique hybrid session. At 10 p.m., cool as a cucumber, Mehta caught his Los Angeles plane.

The situation was hardly less tense for EMI's Requiem sessions at Watford, where Sir John Barbirolli was conducting the players and chorus of the New Philharmonia, who know Giulini's interpretation far better than his. One of the early sessions was all but wasted, which created even more of a rush later on. Montserrat Caballé was making her first record under her new EMI contract, and naturally she wanted to be sure that all the results were to her taste. With only minutes to go in the penultimate session, she insisted on complicated tape changes and an immediate playback—all of which, as she said with great emphasis, was clearly spelled out in her precious contract.

Jon Vickers, the tenor for this Requiem recording and a singer who has himself been known to erupt, was equally explicit. "If I hear anyone from EMI say that *tenors* are temperamental," he snarled in great good humor. "I'm going

The world's first faultless headphones.

Audiophiles have always been aware that, at least theoretically, headphones are the ideal way to listen to reproduced music, particularly stereo.

We said theoretically. Because, in actual use, headphones have thus far been hampered by a number of practical disadvantages.

Fisher engineers have never believed that these disadvantages are insurmountable. But it took them until now to solve all the problems to their satisfaction.

The result is a pair of headphones called the Fisher HP-100 which can truly be considered the first commercially available model with all pluses and no minuses. Listening to them, or rather with them, is a new and different experience. The theoretical potential of headphones has finally been realized.

The comfort factor.

One of the main objections to conventional headphones is that they are uncomfortable. After wearing them for half an hour, the listener wants to go back to loudspeakers.

Excessive weight and unpleasant clamping of the head are only the lesser reason, although most headphones are certainly much too heavy and confining. More important is the uncanny isolation of the listener from the audible world around him, as though his head were encapsulated. This, of course, is due to the more or less airtight "cup" that fits over the entire ear, to provide close coupling of the acoustic cavity of the phone to the eardrum. Otherwise, with conventional headphones, there would be a serious loss of bass.

The Fisher HP-100 solves this problem in a highly imaginative way. The phones are not only extremely light but are also allowed to rest lightly against the ear on large, flat foam-rubber cushions, leaving the perimeter of the ear unconfined. The diaphragm of the driver is completely covered by the foam rubber and acoustically "sees" the thousands of tiny air bubbles in it, instead of a single cavity. This, combined with special acoustic delay slots in the back of the driver, maintains proper bass loading without the conventional airtight seal and its attendant discomforts.

As a result, wearing the HP-100 is as pleasant physically as listening to loudspeakers. In fact, to some people the



sound does not appear to originate in the phones but seems to come from a certain distance, as in loud-speaker listening, but with a much more pronounced stereo effect.

No more boominess.

Eliminating the single air cavity of conventional headphones also gets rid of another common fault: boomy bass. The low-frequency response of the Fisher HP-100 is amazingly smooth and is essentially flat down to 19 cycles, which is just about the low-end cutoff of the human ear.

As a matter of fact, the overall frequency response of the HP-100 is essentially uniform from 19 to 22,000 Hz, an unprecedented achievement due, in part, to the sophisticated driver design, which borrows from advanced microphone technology. It is, in effect, a reversed dynamic microphone with the coil driving the lightweight diaphragm, instead of vice versa.

Which brings us to another unique advantage of the HP-100.

Smooth treble response.

Nearly all headphones exhibit a certain roughness in their high-frequency response curve. Not the HP-100. The light microphone-type diaphragm provides completely smooth treble and superb transient response, so that the sound has the airy immediacy known only to owners of exceptionally fine tweeters.

Needless to say, distortion is non-existent at normal listening levels. The impedance of the HP-100 is compatible with all types of amplifiers and receivers. Power input for average listening levels is 2 milliwatts.

The phones are supplied with a fully adjustable vinyl-covered headband, velvet-soft, non-stick foam pads that are removable (and therefore washable!), and 8 feet of cable.

After reading all this, you will be prepared for an important listening experience when you first try the Fisher HP-100.

But you are not yet prepared for the price. Only \$34.95. Which may be, for the makers of the world's first faultless headphones, the greatest achievement of all.

The Fisher HP-100

FOR MORE INFORMATION, WRITE TO FISHER RADIO CORPORATION, INC., 11-35 45TH ROAD, LONG ISLAND CITY, N.Y. 11101. OVERSEAS AND CANADIAN RESIDENTS PLEASE WRITE TO FISHER RADIO INTERNATIONAL, INC., LONG ISLAND CITY, N.Y. 11101.

CIRCLE 30 ON READER-SERVICE CARD

Continued on page 48

CIRCLE 63 ON READER-SERVICE CARD →

The stereo tape system that has everything under control.

Stereo Control Center. Completely built-in. Consists of a stereo preamplifier and 20-watt music power stereo amplifier. Simply connect a stereo FM tuner, stereo turntable or record changer; flip the selector switch on the 230's control center panel—immediately you have the desired sound source for listening or recording.

Dual Full-Range Speaker System. Lid-integrated speakers may be separated up to 15 feet for full-dimensional stereo.

Three Speeds. 7½, 3¾, 1⅞ ips. Additional features: Four-track stereophonic and monophonic recording and playback. Seven-inch reel capacity. Stereo headphone jack. Pause control. Four-digit tape counter. Two VU meters. Two cardioid dynamic microphones. And more.

Nonmagnetizing Record Head. Head magnetization build-up—the most common cause of tape hiss—has been eliminated by an exclusive Sony circuit.

Automatic Sentinel Shut-off. Disconnects motor power only to tape mechanism at end of reel or when tape is not threaded, without disconnecting power to preamplifier and power amplifier.

Instant Tape Threading. Exclusive Sony Retractable pinch roller permits simple one-hand tape threading. An automatic tape lifter protects heads from wear during fast-forward and rewind operations.

Sony Model 230. Priced under \$249.50. Model 230CPW (same as 230 but with walnut case and two walnut speakers) priced under \$299.50. For your free copy of our latest tape-recorder catalog, please write to Mr. Phillips, Sony/Superscope, Inc., 8144 Vineland Avenue, Sun Valley, California 91352.

Noise-Suppressor Switch. Special filter eliminates undesirable hiss that may exist on older prerecorded tapes.

Vibration-Free Motor. An important new Sony development utilizing "floating" shock absorber action to isolate completely any motor vibration from the tape mechanism.

SONY SUPERSCOPE The Quality is Showing

You never heard it so good.

BEHIND THE SCENES

Continued from page 46

to brain them!" Despite all difficulties, Vickers was in high spirits, though the tone of his humor was not always appreciated by EMI's producers. Once he marched over to the pile of tape boxes in a corner of the control room, the fruits of two weeks' work. "What about putting a nice, big, powerful magnet by there?" he said gravely, and told a story of how a lawyer tucked a magnet into his brief case, arrived in court, and effectively wiped off the evidence from his opponents' tapes. Vickers then gymnastically tried out Caballé's crutches—the soprano was still recovering from the aftereffects of a recently broken leg. Clearly this was

an extra trial for Caballé during her exceptionally busy recording schedule as she finished off her RCA projects concurrently with her new EMI assignments. At the end of the Requiem sessions she leaned over to the EMI engineer who had been involved in quite a lot of extra work getting the tricky balances just right. "Thank you so much," she said, soulfully; after the fireworks the Caballé charm was working again at full intensity.

I almost expected to see her at the *Trovatore* sessions too, but there the Leonora was—predictably enough—Leontyne Price, with the exceptionally strong line-up of Fiorenza Cossotto, Plácido Domingo, and Sherrill Milnes. Cossotto was also working simultaneously on the EMI Requiem, but she had been able to plan her major sessions for each project

on different days. The other soloist in the Requiem with Caballé, Cossotto, and Vickers was the talented bass Ruggero Raimondi, who had a great success this year as Don Giovanni in the Glyndebourne production of Mozart's opera.

Vocal Rarities. Later in the season, after completing the Verdi Requiem for EMI, Caballé returned to the RCA camp at Walthamstow for a record of Donizetti rarities, including arias from *Fausta*, *Belisario*, *Parisina*, and *Torquato Tasso*. The London Symphony was conducted by Carlo Felice Cillario who directed Caballé's record of Rossini rarities. Handel's *Jephtha* was another offbeat item recorded this summer at Barking. Seymour Solomon was in charge of the sessions for Vanguard, with a cast including Maureen Forrester, Reiri Grist, Helen Watts, Alexander Young, and John Lawrenson with the English Chamber Orchestra under Johannes Somary. Last year very much the same team recorded Handel's *Theodora* in Conway Hall, a smaller studio than Barking, but this time Solomon was particularly anxious to have plenty of space, for he was proudly using his new quadraphonic stereo for the first time on an opera (or oratorio). Though the engineer, Bob Auger, tended to work with the two normal channels alone, it was possible at the flick of a switch to bring in the two rear speakers and be surrounded by Handel's music.

Maureen Forrester was particularly appreciative of the young, fifteen-year-old treble, Simon Woolf, who sang the Angel's aria, "Happy Iphis, shalt thou live," improvised cadenza and all. Master Simon is best known on record for his contribution to Mendelssohn's *Elijah* on Angel, and his self-confidence is daunting. His father has done more than anyone to promote his career—a point that Maureen Forrester took to heart; she explained that her own family was anything but complimentary when she first started making musical noises. "What a blessing to have musical relations!" The text is the Chrysander edition, virtually complete, with only two da capos omitted.

EDWARD GREENFIELD

uniCLUB

saves you more
on more of what you want!

RECORDS TAPES STEREO GEAR BOOKS



Here are 10 facts about uniCLUB. They are 10 reasons to clip the coupon and join now!

1. Any LP or tape on every U.S. or foreign label available. Columbia—Capitol—RCA—London & 350 more. No exceptions.
2. You save a minimum of 35% on LP's; 33% on tapes and 25% on books.

LP's LIST	uniCLUB
\$1.98	\$1.35
2.98	1.95
3.79/98	2.49
4.79/98	3.09
5.79/98	3.79

3. You can save even more by taking advantage of the regular extra discount "Specials." Save up to 80% off list price. Right now, for example, the entire RCA Red-Seal catalog is \$2.75 mono; \$3.25 stereo. The Vox \$4.98 series is \$1.75 mono and stereo.

4. Never a requirement to buy. No monthly "stop-order" forms to return. You receive just what you order.

5. LIFETIME MEMBERSHIP

The club membership fee is \$5. This is for lifetime privileges which are increasing all the time.

6. FREE CLUB MAGAZINE

Members regularly receive "uniGUIDE" advising them of the latest releases, recommended best-buys and extra discount "Specials." When you join you receive a free 300-page Schwann record catalog listing every available record and its price. You receive a free Harrison tape catalog if you specify.

7. FASTEST SERVICE ANYWHERE

Your orders are not only processed but shipped the same day we receive them. This unique service is possible because your orders are picked from an inventory of over 250,000 LP's & tapes. You get factory-new sealed albums and tapes only. Defects are fully returnable at no charge.

8. SAVE UP TO 50% ON STEREO GEAR

Individual components or complete systems—

9. BOOKS OF ALL PUBLISHERS

The Book Division—only uniCLUB has it—offers members at least 25% off on any book in print.* You get only original publishers' editions. uniGUIDE lists best-sellers, just-published works and book "Specials."

*Texts are reduced 10%.

10. FOUR CLUBS IN ONE

uniCLUB is really a time-saver. It makes joining many clubs unnecessary. Now you can buy all your records, tapes, auto-cartridges, books and stereo-gear from one convenient source. We hope you'll join today!

SAVE MONEY EVEN ON YOUR MEMBERSHIP FEE

Give gift memberships with full lifetime privileges for only \$2.50 each. Splitting the cost with one other person lowers cost to \$3.75; enrolling five at a time brings cost down to only \$3 each.

Send my Free Schwann catalog, order blanks & uniGUIDE by return mail. \$5 enclosed guarantees me:

1. LIFETIME MEMBERSHIP in uniCLUB
2. 35%-80% savings on LP albums, 1/3 off on tapes, 25% on books.
3. No requirements ever to buy anything. Nothing will ever be sent until I order it.

I must be delighted with uniCLUB or within 30 days I will let you know and receive a full refund.

uniCLUB Inc.

342 Madison Ave. HF-129
New York, N.Y. 10017

NAME _____
ADDRESS _____
CITY _____ STATE _____ ZIP _____

- Send gift memberships at \$2.50 each to names and addresses listed on attached sheet.
 I am also interested in pre-recorded tapes.

High Fidelity, December 1969. Vol. 19, No. 12. Published monthly by Billboard Publications, Inc., publisher of Billboard, Vend, Amusement Business, Merchandising Week, American Artist, and Modern Photography. High Fidelity/Musical America Edition published monthly. Member Audit Bureau of Circulations.

Editorial correspondence should be addressed to The Editor, High Fidelity, Great Barrington, Mass. 01230. Editorial contributions will be welcomed. Payment for articles accepted will be arranged prior to publication. Unsolicited manuscripts should be accompanied by return postage.

Subscriptions should be addressed to High Fidelity, 2160 Patterson St., Cincinnati, O. 45214. Subscription rates: High Fidelity/Musical America: In the U.S.A. and its Possessions, 1 year \$12; elsewhere, 1 year \$13. National and other editions published monthly: In the U.S.A. and its Possessions, 1 year \$7; elsewhere, 1 year \$8. Change of address notices and undelivered copies (Form 3579) should be addressed to High Fidelity, Subscription Fulfillment Dept., 2160 Patterson St., Cincinnati, Ohio 45214.

EXPERTS AGREE . . . THE DYNACO SPEAKER HAS THE BEST TRANSIENT RESPONSE.



DYNACO A-25
\$79.95

Dynaco introduced the A-25 loudspeaker system because of the great need for improved loudspeaker transient response.

How well did they succeed? Here's what two of the most respected publications say.

STEREO REVIEW, JUNE 1969

"... The tone-burst measurements also confirmed our listening tests . . . In the hundreds of tone-burst measurements we have made, we have found a few instances where a speaker was slightly better than this one at specific frequencies, but nothing we have tested had a better overall transient response."

"The excellent overall transient response of the Dynaco A-25 speaker system is shown by the tone-burst response photos at (left to right) 600, 2,000 and 10,000 Hz." (Stereo Review)

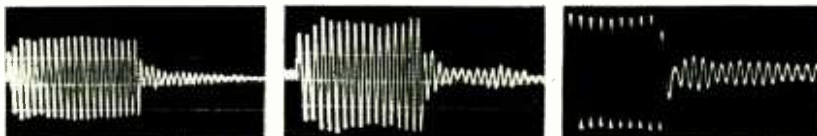

AUDIO, OCTOBER 1969

"... it was its outstanding transient response which really impressed us. Tone bursts throughout the meaningful frequency range showed up its excellence. In truth, the A-25 produced the finest tone-burst response of any speaker tested in this manner, regardless of price."

Send for literature or pick some up at your dealer where you can also hear the A-25

DYNACO INC.

3060 JEFFERSON ST., PHILA., PA. 19121
IN EUROPE WRITE: DYNACO A/S, HUMLUM, STRUER, DENMARK

CIRCLE 23 ON READER-SERVICE CARD



too hot to handle

You have warned against the use of anything less than "the best of arms" with the latest high-compliance cartridges. Is there nothing adequate in tone arms short of the lofty and expensive SME and the latest Ortofon arms for use with the Shure V-15 Type II, ADC 10E Mark II, and the like?—Ken Massey, Acton, Ind.

Separate arms aren't available today in as many varieties as in former years, to be sure. That's largely because of the popularity of the so-called automatic turntables, the best of which have arms that can do justice to the finest of cartridges. A number of Japanese manufacturers, some of whom are virtually unknown in this country, have announced separate arms. But they're usually all but nonexistent on dealers' shelves. If it is a separate arm you're looking for, and you don't want to pay SME, Ortofon, or Rabco prices, you'll be interested to know that the Empire 990 arm, part of the Troubador 598 integrated turntable described in "Equipment in the News" this month, is available separately at \$74.95.

New records all have, in addition to the regular printed jacket, an inner envelope of lightweight paper, sometimes with some sort of plastic liner. Is there any point in keeping the inner envelopes? I can see why they would be useful in handling the records in the factory, but they make just that much more work when taking out the record and putting it away.—W. R. Augur, Claremont, Calif.

Don't throw them away. The paper of the envelope, or the plastic of the liner has a much smoother surface than the board out of which the outer jacket is made, and will therefore have less tendency to retain grit that can scratch record surfaces.

In regard to the practice of wrapping tapes in aluminum foil and labeling them "Do not X-ray," you have stated that postal authorities deny that postal X-ray equipment could produce strong enough stray magnetic fields to erase a recorded tape. The fact is that X-rays themselves are responsible. A couple of seconds' exposure would probably erase a tape completely.—M. Dudakov, Melbourne, Australia.

How, or on the basis of what information, the idea that tapes can be erased in the mails first came about is lost in obscurity. A few seemingly legitimate cases have been brought to our attention, but most of the ink spilled on the

subject seems to represent purest speculation. The people at the 3M Company, makers of Scotch recording tape, receive this sort of letter too. In trying to determine whether X-ray equipment is to blame, they have subjected recorded tapes to "enough X-rays to kill a human" without finding any adverse affect on the recorded signal. (Sorry about that, Mr. Dudakov.) Their engineers also concur with the postal authorities we have quoted previously in this column: stray magnetic fields produced by postal X-ray equipment—used to check the contents of packages for customs purposes—are not nearly strong enough to erase tapes. So the mystery remains.

My cousin informed me that the manufacturer (Harman-Kardon) of his compact unit stated he could turn off the power to his unit while the stylus was on the disc, leave the stylus there overnight, then turn the power on the following morning and resume playing. It is my contention that leaving the needle on the disc in a stopped position will injure both the disc and the stylus. What is your opinion on this practice?—Spencer Neufeld, Cleveland, Ohio.

Harman-Kardon says it has never recommended such a practice in its instruction manuals. H-K's service department frowns on it, preferring that the "pause" or "cue" control, included on all current models, be used to lift the arm and pickup off a record. In addition to possible damage to disc or stylus, there is the question of damage to the changer, whose drive puck can become flattened if it is left engaged but stationary. One thing bothers us, though: we can't imagine why it is important to your cousin to leave the disc cued up all night long in the first place.

Is it possible for me to upgrade my present stereo system, consisting of a McIntosh model 230 integrated amplifier, an AR turntable with Shure Super-Track cartridge, and Bose 901 speakers? By upgrade I mean getting a really hearable difference. A local hi-fi dealer has told me that the only way to upgrade this system is to use tape for reproducing music. Is he right? If so, should I get cassette or open-reel tape equipment? Most of my listening involves symphonic music.—Leonard Schweitzer, Ft. Worth, Tex.

We can't tell what differences you can hear, but speaking generally, it is unlikely that startling improvements in the sound of records will

be evident—and the cost of realizing even a subtle improvement would be considerable—in the system you describe. Changing to tape will add a new dimension to the enjoyment of a stereo system but don't expect that it necessarily will add sonic quality, since tapes and tape recorders do vary in quality. The same might be said of FM. However, if you do go into tape, think in terms of open reel. The cassettes are very good for their format and slow speed, but cannot compete (not now and not in the foreseeable future in our opinion) against the best open-reel tapes or associated equipment. The advent of four-channel stereo, of course, means a potentially new dimension for any home music system. In our view, this development—at the quality level already represented by the system you now own—would constitute a far greater step upward in what you hear than subtle changes made in the two-channel system. So far, of course, the only four-channel program material announced has been on open-reel tape. And it's easier at the present time to convert an open-reel deck to four channels than it would be to do so with a cassette model. Of course, anything can happen in this particular area within the next six months that would change this.

How does the Dynaco A-25 compare with the KLH-17 speaker if both are driven by a 40-watt amplifier?—Thomas D. Benson, Jr., Hartford, Conn.

It's not certain whether your "40 watt amplifier" means a 20-watt or a 40-watt per-channel stereo amplifier. We also can't tell from your letter whether the rating, in either case, is for music power or for rms power. However, according to our tests of these two speakers, the \$70 KLH-17 and the \$80 Dynaco A-25 are very close indeed, but apparently the \$10 higher price tag gets you a jot more performance. The A25 responded down to about 30 Hz (with doubling); the Model 17 went down to below 40 Hz (with doubling). The A-25's high-end began dipping to inaudibility at about 15 kHz; the KLH-17 did so at 14 kHz. The A-25 is recommended for use with at least a 15-watt rms amplifier; the KLH needs only 10 watts rms. The A-25 can handle up to 60 watts rms; the KLH-17, up to 50 watts rms. Both speakers are smooth-sounding, honest reproducers; which one to get would depend on your budget and the actual rms power output of your amplifier or receiver.

A public hearing you won't forget.

Altec Lansing bookshelf speakers have the same quality that makes Altec sound systems the choice of most theatres, concert halls and motion picture studios. Just pick the pair that fits your budget. And hear them perform — unforgettably — at your franchised Altec dealer.



CORONA

\$85.50 each — high compliance 10" speaker with direct radiating tweeter for full range sound unmatched under \$100.

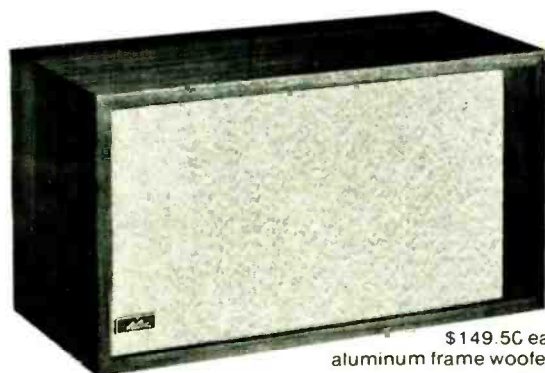

MADERA

\$149.50 each — heavy duty 10" cast aluminum frame woofer with a 10-pound magnetic structure and horn tweeter.

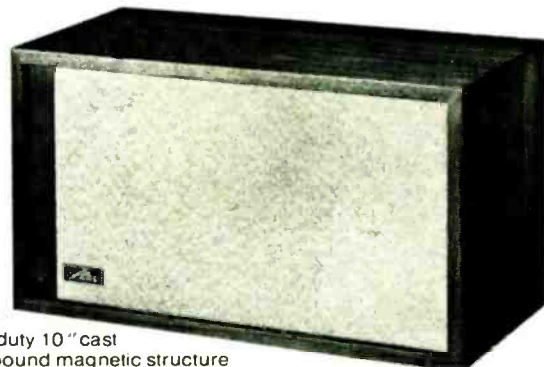

BOLERO

\$179.00 each — finest bookshelf speaker system made, at any price. Features exclusive fretwork grille. Precision engineered for full, rich sound.



For free catalog, write Altec Lansing, 1515 South Manchester Avenue, Anaheim, California 92803.

CIRCLE 3 ON READER-SERVICE CARD

This year, give the gift of music . . . with the

The World's Finest Medium Power Stereo Receiver . . . Designed In The Tradition Of The Famous Heathkit AR-15 . . . Advanced Field Effect Transistor And Integrated Circuit Design . . . Modular Plug-In Circuit Boards . . . Exciting New Styling Concepts

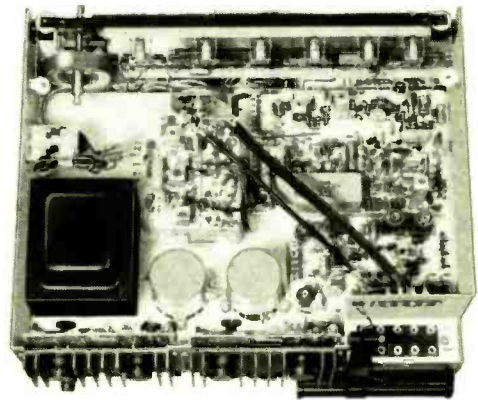
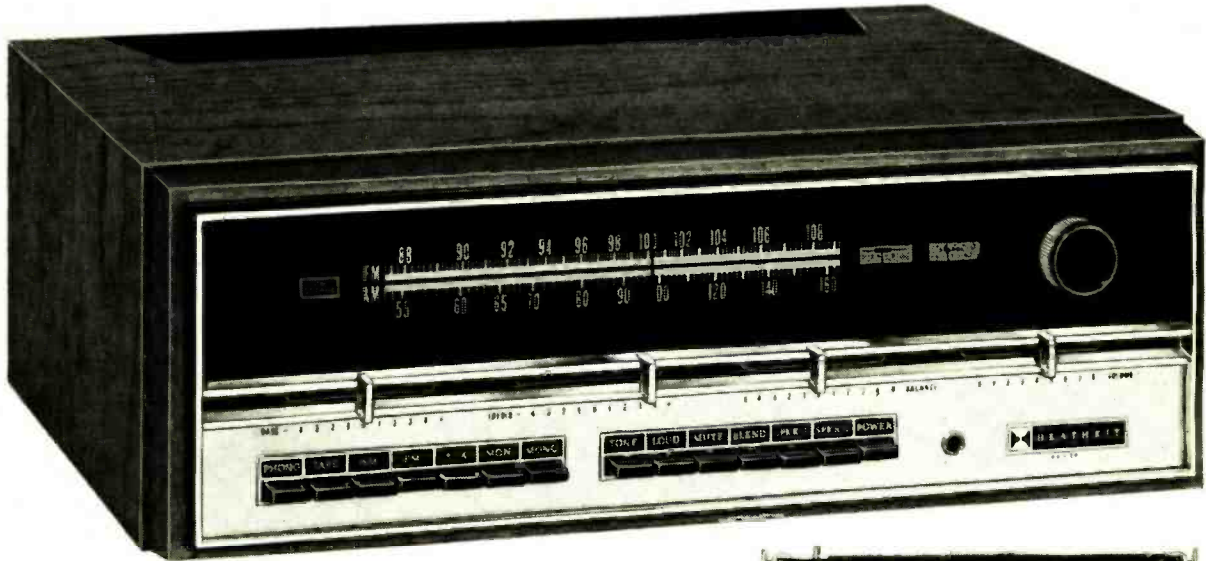

"Black Magic" Panel Lighting

When not in use, the new AR-29 remains quietly distinctive . . . its impressive midnight black and chrome face reveals no dial or scale marking. A gentle press of the pushbutton power switch and the dial and scale markings appear. The "black magic" is in the unique dual tinted acrylic panel design.

- All solid-state design . . . 65 silicon transistors, 42 diodes & 4 IC's containing another 124 transistors and 40 diodes.
- Assembled, aligned FET tuning unit . . . hypersensitive, free from overload.
- Computer designed L-C filter . . . a new advance in circuitry; fix-tuned, sealed factory assembled unit never needs alignment, gives steep flat-topped bandpass for highest selectivity.
- Ball-bearing flywheel tuning . . . just spin across the dial to your favorite station.
- Plug-in circuit boards . . . a first in kits . . . easy to build modular design.
- Built-in test circuit . . . test probes and meters combine to give you in-progress checks and service capability anytime.
- Massive power supply . . . loafs along at 100 watts . . . protected.
- Integrated Circuits . . . compress most of the elaborate IF and multiplex circuitry into 4 tiny solid-state devices.
- Recessed inputs & outputs . . . the cabinet fits flat against a wall.
- External AM & FM antenna inputs for your option.
- Transformerless outputs . . . for lowest distortion and phase shift characteristics.
- Linear Action Controls . . . just push left or right to the setting you desire for Volume, Bass, Treble, and Balance.
- Directional AM Rod Antenna . . . maximum signal for your favorite station.

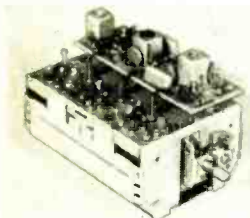

Field Effect Solid-State FM Tuner . . . preassembled & aligned, delivers high sensitivity, low cross modulation & no overloading. AM RF board atop.



Computer Designed L-C Filter . . . gives IF alternate channel selectivity of more than 70 dB, optimum separation & minimum distortion. A first in kits from Heath.

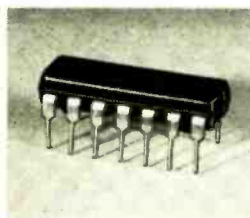

Integrated Circuit Multiplex . . . this single tiny IC contains 31 transistors, 30 resistors & 10 diodes performs four different functions.

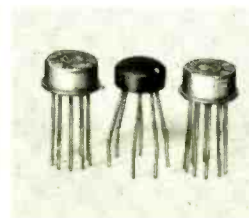

Three Integrated Circuits in FM IF amplifier for hard limiting, temperature stability and increased reliability. Contain a total of 25 transistors, 14 diodes, and 24 resistors.

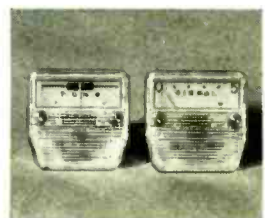

Two Calibrated Tuning Meters. Signal Strength meter indicates strongest signal . . . "Center Tune" puts you exactly on station frequency.

CIRCLE 36 ON READER-SERVICE CARD

new Heathkit® AR-29 Stereo FM Receiver

The New Heathkit AR-29 . . . 100 Watts Music Power Output . . . Remarkable FM Performance . . . High Fidelity AM Reception . . . Built-In Self-Servicing Capability . . . An Extraordinary Musical Instrument

• All solid-state circuitry with 65 transistors, 42 diodes and 4 Integrated Circuits • 100 watts music power output at 8 ohms • 7-60,000 Hz frequency response • Less than 0.25% Harmonic & 0.2% IM Distortion at full power output • Transformerless, Direct-coupled outputs with dissipation-limiting circuitry for output protection • AM-FM/FM-Stereo Tuner features ball-bearing inertia flywheel tuning • Advanced L-C Filter for greater than 70 dB selectivity and elimination of IF alignment forever • Preamsembled, factory-aligned FET FM Tuner for better than 1.8 uV sensitivity • Mute Control attenuates between-station noise on FM • Blend Control attenuates on-Stereo station noise on FM • SCA Filter • Linear Motion controls for Volume, Balance, Bass & Treble • Individually adjustable level controls for each channel of each input including tape monitor permits switching sources without annoying volume changes • Switches for 2 Separate Stereo speaker systems • Center speaker capability • Two front panel tuning meters for exact station selection • Stereo indicator light • Front panel stereo headphone jack • Swivel AM rod antenna for best signal pickup • 300 & 75 ohm FM antenna inputs • Tone Flat switch disables Bass & Treble controls for perfectly "flat" response • Massive, electronically regulated power supply • New Heath modular plug-in circuit board design speeds assembly, aids servicing • Circuit board-wiring harness construction for fast, enjoyable kit building

Another Design Leader. The new Heathkit AR-29 reflects a heritage of solid-state engineering experience that could only come from the designers of the world famous Heathkit AR-15. The result of a two year project to produce the finest medium-power stereo receiver ever conceived, the introduction of the AR-29 marks another milestone in receiver design.

New Performance Standards For Stereo Amplifiers. The AR-29 houses what is undeniably one of the finest stereo amplifiers in any receiver. It delivers a full 100 watts of IHF music power, 70 watts continuous . . . enough to drive even the most inefficient speakers. A massive, fully regulated and filtered power supply, 4 individually heat-sinked output transistors and the best IM and Harmonic Distortion specifications in the industry combine to give the cleanest, most life-like sound you'll ever hear.

Short-Circuit Protection . . . a dissipation-limiting circuit protects the outputs from damage, even with a short circuit condition.

Input Level Controls . . . for both channels of all inputs including tape monitor allow adjustment of levels so volume remains constant when switching sources.

Clean, Sensitive FM-Stereo Reception. The preassembled, prealigned FM tuner has 1.8 uV sensitivity for real station pulling power, using FET design for superior overload characteristics. A tiny Integrated Circuit performs four different functions in the Multiplex section to assure excellent stereo performance. Three IC's in the IF section provide superior AM rejection capability, hard limiting, temperature stability and greater reliability.

New Computer Designed 9-Pole L-C Filter . . . in the IF strip gives ideally shaped bandpass with greater than 70 dB selectivity, superior separation and eliminates IF alignment forever. High "Q" toroid design gives better performance than ever possible with transformer type multi-stage IF's or single crystals. An exclusive in kits from Heath.

New "Blend" Function . . . attenuates any on-station FM hiss and high frequency noise at the push of a button.

New "Mute" Function . . . attenuates between-station noise on FM without affecting sensitivity of the tuner . . . just touch a button.

AM That Sounds Like FM. Three Field Effect Transistors in the AM RF circuits provide superior sensitivity with large signal handling capability for really remarkable AM reception. And the built-in AM rod antenna swivels so you can orient it for best reception.

New Modular Plug-in Circuit Boards . . . make assembly faster, easier,

more enjoyable. And they snap out in seconds for faster service. Another first in kit design from Heath.

Exclusive Built-In Test Circuitry . . . means you not only assemble, test and align your new AR-29 a section at a time, but you can also service it if it's ever necessary—all without external test equipment. Test probes and meter are furnished at all times . . . just flip a switch to use. The manual includes comprehensive instructions on the use of this built-in capability.

Versatile Installation. The new Heathkit AR-29 can be installed a number of ways. Put it in a wall or equipment cabinet. Design and build your own cabinet. Or order the completely assembled AE-19 cabinet, finished in rich oiled pecan . . . measures only 17-11/16" W x 13 1/8" D x 6 3/8" H with feet.

Compare The New Heathkit AR-29 against anything in its power class . . . and be convinced that it is, indeed, the world's finest medium power receiver. Order yours now.

Kit AR-29 (less cabinet), 33 lbs. \$285.00
Assembled AE-19, cabinet, 10 lbs. \$19.95

AR-29 SPECIFICATIONS

AMPLIFIER SECTION: Dynamic Power Output Per Channel (Music Power Rating): 50 watts, 8 ohms*; 65 watts, 4 ohms; 30 watts, 16 ohms. Continuous Power Output Per Channel: 35 watts, 8 ohms*; 35 watts, 4 ohms; 25 watts, 16 ohms. Power Bandwidth For Constant 0.25% Total Harmonic Distortion: Less than 5 Hz to greater than 30 kHz. Frequency Response (1 Watt Level): —1 dB, 7 Hz to 60 kHz; —3 dB, 4 Hz to 100 kHz. Harmonic Distortion: Less than .25% from 20 Hz to 20 kHz @ 35 watts output; less than 0.1% @ 1000 Hz with 1 watt output. Intermodulation Distortion: Less than 0.2% with 35 watts output using 60 & 6000 Hz mixed 4:1. Less than 0.1% with 1 watt output. Output Damping Factor: Greater than 50. Input Sensitivity: Phono, 2.2 millivolts (overload 155 mV); Tape, 180 millivolts (greater than 10 V); Aux., 180 millivolts (greater than 10 V); Tape Mon., 180 millivolts (greater than 10 V). Hum And Noise: Phono, 10 millivolt reference; —65 dB. Tape and Aux., 0.25 volt reference; —75 dB. Minimum Volume: —90 dB. Channel Separation: Phono, 50 dB or better; Tape and Aux., 60 dB or better. Recommended Speaker Impedance: 4 ohm through 16 ohm. Tape Output Impedance: Approximately 50 ohm. Input Impedance: Phono, 49 K*; Aux., Tape, and Tape Mon., 100 K. Tape Output: 1 volt output with 0.2 volt input. TUNER (FM Section—Monophonic): Tuning Range: 88 to 108 MHz. Intermediate Frequency (IF): 10.7 MHz. Frequency Response: ±1 dB, 20-15,000 Hz. Antenna: Balanced input for external 300 ohm antenna. 75 ohm antenna input may be used between either FM antenna terminal and ground. Sensitivity: 1.8 uV or less*. Volume Sensitivity: Below measurable level*. Selectivity: Greater than 70 dB*. Image Rejection: 90 dB*. IF Rejection: 90 dB*. Capture Ratio: 1.5 dB*. AM Suppression: 50 dB*. Harmonic Distortion: 0.5% or less*. Intermodulation Distortion: 0.4% or less*. Hum And Noise: Greater than 60 dB*. Spurious Rejection: Greater than 90 dB*. FM SECTION—Stereo: Channel Separation: 40 dB min. at mid-frequencies; 30 dB min. at 50 Hz; 25 dB min. at 10 kHz; 20 dB min. at 15 kHz. Frequency Response: ±1 dB, 20-15,000 Hz. Harmonic Distortion: 0.5% or less at 1000 Hz with 100% modulation, 19 kHz and 38 kHz Suppression: 55 dB. SCA Suppression: 55 dB typical. AM SECTION: Tuning Range: 535 to 1620 kHz. Intermediate Frequency: 455 kHz. Sensitivity: Using external input, 30 uV at 600 kHz*, 20 uV at 1400 kHz*. Using rod antenna, 200 uV/meter at 600 kHz*, 300 uV/meter at 1400 kHz*. Selectivity: Greater than 40 dB alternate channel. AM Antenna: Adjustable built-in rod type. Connections for external antenna and ground on rear. Image Rejection: 60 dB @ 600 kHz*, 45 dB @ 1400 kHz*. IF Rejection: 50 dB*. Harmonic Distortion: Less than 2%*. Hum And Noise: 35 dB. CONTROLS AND SWITCHES: Front Panel: AM-FM TUNING: 535 to 1620 kHz & 88 to 108 MHz. SOURCE PUSH BUTTON SWITCHES: AM, FM, Phono, Tape, and Aux. VOLUME CONTROL: Dual linear motion (slider). BASS CONTROL: Dual linear motion (slider) for 18 dB boost & 10 dB cut at 20 Hz. TREBLE CONTROL: Dual linear motion (slider) for 14 dB boost and 16 dB cut at 20 kHz. BALANCE CONTROL: Dual linear motion (slider) which balances the right and left channel amplifiers for equal effective sound output from both speaker systems. NOTE: The following are push-button switches—in position being on: TONE FLAT SWITCH; SPEAKER SWITCH 1 AND 2; POWER SWITCH; MODE SWITCH; TAPE MONITOR SWITCH; BLEND SWITCH; LOUDNESS SWITCH; MUTE SWITCH. Bottom Plate: LEVEL CONTROLS: L and R (left and right channel) controls for Phono, AM, FM, Tape, Auxiliary and Tape Monitor. Rear Panel: CENTER CHANNEL SWITCH. OTHER CONTROLS AND SWITCHES: SEPARATION ADJUST CONTROL: 19 kHz and 38 kHz SWITCH, Normal Adjust positions; METER AND FUNCTION SWITCH, Norm/V (volts) and R (Resistance) positions; CENTER AND DEVIATION CONTROLS. GENERAL: AC Outlet Sockets: Two located on rear panel for power accessory equipment. One switched (350 watts max.) and one unswitched (350 watts max.). Power Requirements: 105-125 or 210-250 volts, 50/60 Hz AC; 34 watts idling (zero output) and 160 watts at full output with no load on accessory outlets. Dimensions: Overall—16 1/2" W x 5 1/4" H x 14 1/2" D. Mounting: AE-19 cabinet or custom mounting. Net Weight: 26.5 lbs.

*Rated IHF (Institute of High Fidelity) Standards.
**RIAA (Record Industry Association of America).

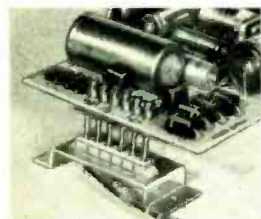

Plug-in Fiberglass Circuit Boards . . . mean quicker, more enjoyable assembly with less chance for error, easier servicing, and strong long life.

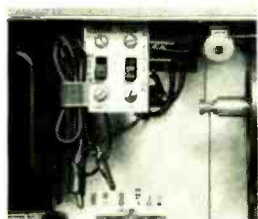

Built-in Test Circuitry for fast, precise initial set-up and servicing without external test equipment.

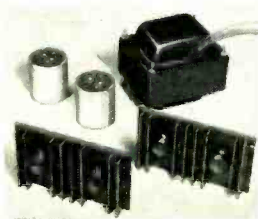

100 Watts Dynamic Music Power from massive regulated power supply and 4 heat-sinked transistors. Dissipation limiting circuitry protects it even with short circuits.



Built-in Adjustable AM Rod Antenna swivels so you can position it or best reception under all conditions.

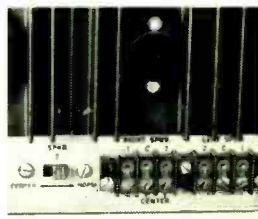

Switch Select Two Stereo Speaker Systems . . . both can be used simultaneously for stereo sound in two different locations . . . or you can switch in a "Center Channel" speaker for fill-in sound.

CIRCLE 36 ON READER-SERVICE CARD

Listen to the sounds of Christmas

Introducing The Heathkit "Component Credenza"



Component Quality Stereo In An Elegant Oak Console . . . \$299.95*

Lifting the spring-loaded hinged top reveals the heart of the AD-19 . . . the famous Heathkit AR-14 Receiver circuitry and the precision BSR 500A Automatic Turntable. A handy record storage compartment is in front.



• Combines all solid-state stereo FM tuner, amplifier, 4-speed automatic turntable with diamond stylus and two full-range, two-way speaker systems into a luxurious Mediterranean cabinet • 15 watts per channel music power output • Full range tone controls • Very low Harmonic and IM distortion • Excellent channel separation • Transformerless output circuit for minimum phase shift, wide response & low distortion • Electronically filtered power supply • Stereo headphone jack • Auxiliary input • Filtered tape output • Excellent FM tuner sensitivity & separation • Smooth flywheel tuning • Stereo indicator light • 4-stage IF • Automatic Frequency Control • SCA filter • Very low hum & noise • 300 ohm antenna input • High quality BSR McDonald 500A automatic turntable features low mass counterbalanced tubular aluminum tone arm • Comes complete with famous Shure diamond stylus magnetic cartridge • Plays all four speeds, manual or automatic • Vernier stylus pressure adjustment • Built-in Anti-Skate Control • Cue-Pause Controls • Automatic system power-turntable will turn complete system on & off • Two ducted port reflex two-way speaker systems give performance comparable to fine component-type separate speaker system • Excellent dispersion and separation • Each speaker system contains a 10" high compliance woofer & a specially damped 3-1/2" closed back tweeter • 60-16,000 Hz response • 2000 Hz crossover • Complete system housed in a magnificent factory assembled Mediterranean cabinet of beautiful oak veneers with solid oak trim • Easy assembly with the famous Heathkit Manual • The finest value anywhere in quality stereo consoles.

The Only Way To Get Component Performance Out Of A Console Is To Put Components In it . . . Heath Did, by combining the famous Heathkit AR-14 Stereo Receiver circuitry, BSR McDonald 500A Automatic Turntable and two full-range two-way speaker systems with a superbly crafted all wood cabinet of luxuriant oak. The result is the new Heathkit "Component Credenza" . . . the only alternative for those who appreciate both fine sound reproduction and craftsmanship in wood.

the components

Heathkit AR-14 Solid-State FM-Stereo Receiver . . . judged the finest medium power receiver available by leading consumer testing groups and high fidelity magazines. The amplifier portion delivers a solid 15 watts per channel music power . . . frequency response extends to 60,000 Hz, and Harmonic & IM Distortion are less than 1% at full output . . . assurance that the source and the sound are virtually identical. The tuner section features inertia flywheel tuning for smooth station selection, and a Stereo Indicator Light to tell you when the station is in stereo. The

assembled, aligned tuning unit will pull in stations you didn't know existed. A Phase Control allows adjustment for best stereo separation, and AFC puts an end to drift. Other features include a stereo headphone jack, an Auxiliary input and external antenna terminals.

BSR McDonald 500A 4-Speed Automatic Turntable . . . with features usually found only on very expensive units — Cueing/Pause control . . . Adjustable Anti-Skating . . . Stylus Pressure adjustment . . . Tubular aluminum tone arm with variable counter-balancing . . . comes complete with a famous Shure diamond stylus cartridge.

Two Speaker Systems . . . housed in tuned-port enclosures on either end of the oak cabinet. Each system has a 10" high-compliance woofer for deep, rich bass down to 60 Hz and a ring-damped 3 1/2" tweeter for crisp natural highs up to 16 kHz.

The Cabinet . . . designed in Mediterranean motif and flawlessly executed in rich, dark oak with a full furniture finish. A fine example of cabinet-making art, it is constructed entirely of wood, with no plastic or other material used. The panels are oak veneer on a solid wood base and all trim and decorative pieces are solid oak. Exceptionally well made . . . the cabinet alone weighs in excess of 100 pounds. The New "Component Credenza" . . . a remarkable integration of fine stereo components in a cabinet of singular design and beauty. Order yours now — it will make a fine Christmas present for your home.

Kit AD-19, 158 lbs. \$299.95*

AD-19 PARTIAL SPECIFICATIONS — FM SECTION: Tuning Range: 88-108 MHz. Sensitivity: 5 μ V. Hum & Noise: -45 dB, 1 watt reference. Capture Ratio: 4 dB. Audio Frequency Response: Monophonic, 0 to -3 dB; 35-15,000 Hz. Harmonic Distortion: 1% or less. Separation: 27 dB @ 1 kHz. **AMPLIFIER SECTION:** IHF Music Power Output: 15 watts per channel. Continuous Power Output: 10 watts per channel. Frequency Response: (1 watt) 50-60,000 Hz \pm 1 dB. Power Bandwidth: 12-90,000 Hz. Auxiliary Input Sensitivity: 300 mV. Auxiliary Input Impedance: 180 k ohms. Channel Separation: 45 dB or better @ 1 kHz. Total Harmonic Distortion: (at full output) Less than 1% from 12-60,000 Hz. Intermodulation Distortion: (at full output) Less than 1%. **SPEAKERS:** Frequency Response: 60-16,000 Hz. Crossover Frequency: 2 kHz. **AUTOMATIC TURNTABLE:** Type: BSR McDonald 500A. Speeds: 16-2/3, 33-1/3, 45 and 78 RPM. Record Size: 7, 10 or 12". Phono Cartridge: Type: Shure M71 Magnetic. Stylus: 6 mil spherical diamond. Tracking Pressure: 11 \pm 3 grams. **GENERAL:** Power Requirements: 105-125 or 210-250 VAC, 50-60 Hz, 32 watts idling, 65 watts full output, plus 7.5 watts for automatic turntable motor. Dimensions: 49 1/2" W x 27" H x 20 1/2" D.

CIRCLE 36 ON READER-SERVICE CARD

... with Heathkit® Stereo



Kit AR-15 Wired ARW-15
\$349.95* **\$540.00***
 (less cabinet) (less cabinet)



Kit AS-48
\$169.95*

Kit AR-14
\$119.95*
 (less cabinet)



Kit AD-27
\$179.95*

Kit AS-18
\$34.95*

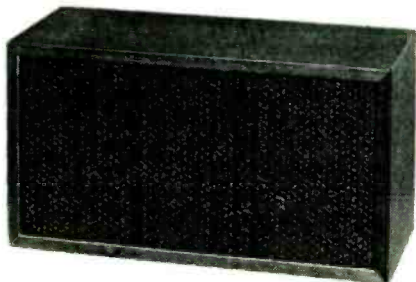

HEATHKIT AR-15 Deluxe Solid-State Receiver

The Heathkit AR-15 has been highly praised by every leading audio and electronics magazine, every major testing organization and thousands of owners as THE stereo receiver. Here's why. The powerful solid-state circuit delivers 150 watts of music power, 75 watts per channel, at ± 1 dB, 8 Hz to 40 kHz response. Harmonic & IM distortion are both less than 0.5% at full rated output. The world's most sensitive FM tuner includes these advanced design features ... Cascode 2-stage FET RF amplifier and an FET mixer for high overload capability, excellent cross modulation and image rejection ... Sensitivity of 1.8 μ V or better ... Harmonic & IM distortion both less than 0.5% ... Crystal Filters in the IF section give a selectivity of 70 dB under the most adverse conditions. Adjustable Phase Control for maximum separation ... elaborate noise operated squelch ... stereo only switch ... stereo indicator light ... two front panel stereo headphone jacks ... front panel input level controls, and much more. Easy circuit board construction. For the finest stereo receiver you can buy anywhere, order your AR-15 now. 34 lbs. Optional walnut cabinet, AE-16. 10 lbs... \$24.95*

HEATHKIT AS-48 High Efficiency System

Our Finest Heathkit System ... the new AS-48 with famous JBL® speakers. The specially constructed 14" woofer employs a 4" voice coil, 11½ pounds of magnet assembly and an inert, self-damping material to deliver clear, full-bodied bass down to 40 Hz. Crisp, open highs, up to 20 kHz come from the 2" direct radiator. LC-type crossover. The three position HF level control gives balance as you like it. All components are front mounted in the beautiful one-piece assembled pecan finish cabinet for easy construction. For very high performance stereo, order two of these amazing bookshelf systems today. 43 lbs.

HEATHKIT AR-14 FM Stereo Receiver

The AR-14 has been rated as the best value obtainable in a medium power stereo receiver ... and it's easy to see why. The all solid-state circuit delivers 30 watts music power from 15-50,000 Hz ... total distortion is less than 1% at full output. The AR-14 may be small, but its FM tuner section boasts high sensitivity, excellent selectivity and very low noise to give you FM stereo performance you will marvel at. Complete inputs and outputs, of course, for greatest system flexibility. Other features include stereo headphone jack, stereo indicator light and filtered outputs for beat-free taping. Make this amazing little receiver the heart of your new stereo system now. 18 lbs.

HEATHKIT AD-27 FM Stereo Compact

Heath engineers took the highly-rated AR-14 solid-state Stereo Receiver circuitry, matched it with the precision BSR McDonald 500A Automatic Turntable and put this quality component combination in a sliding tambour door walnut cabinet. Performance? The AD-27 delivers 30 watts music power ... full 15 watts per channel — enough to drive any reasonably efficient speaker system. Response is virtually flat from 12-60,000 Hz, and Harmonic & IM Distortion are both less than 1% at full output. Tandem Volume, Bass, Treble & Balance Controls give you full range command of the sound. Flick the rocker-type switch to select the FM stereo mode, and tune smoothly across the dial with the inertia flywheel tuning. You'll hear stations you didn't know existed, with a clarity and separation that will amaze you. An adjustable phasing control assures best separation always, and the automatic stereo indicator light comes on when the station is broadcasting in stereo. AFC eliminates drift too. The BSR McDonald 500A includes cueing/pause control, variable anti-skating adjustment, stylus pressure control, automatic system power and many other features usually found only on very expensive units. Includes a famous Shure diamond stylus stereo cartridge too. Add this handsomely-styled, top performing stereo compact to your home now. 41 lbs.

HEATHKIT AS-18 Miniature Speaker System

Miniature in size, but not in performance. This new Heathkit acoustic suspension system features two Electro-Voice® speakers ... a 6" woofer and a 2½" tweeter for 60 Hz to 20 kHz response. Handles 25 watts of program material. Adjustable high frequency balance control lets you adjust the sound to what you like. The 8¼" H x 15¼" W x 6¼" D walnut cabinet is protected by clear vinyl for lasting good looks. Pick a pair of these performers for stereo compacts. 16 lbs.



a Schlumberger company

HEATH COMPANY, Dept. 8-69
 Benton Harbor, Michigan 49022

Enclosed is \$ _____, plus shipping.

Please send model (s)

Please send FREE Heathkit Catalog. Please send Credit Application.

Name _____

Address _____

City _____

State _____

Zip _____

*Mail order prices; F.O.B. factory.

Prices & specifications subject to change without notice.

HF-231



NEW

FREE 1970 CATALOG!

Now with more kits, more color. Fully describes these along with over 300 kits for stereo/hi-fi, color TV, electronic organs, guitar amplifiers, amateur radio, marine, educational, CB, home & hobby. Mail coupon or write Heath Company, Benton Harbor, Michigan 49022.

CIRCLE 26 ON READER-SERVICE CARD

SPEAKERS and SPEAKERS

Even without a proper high fidelity show, New York has been getting a look at a succession of new products and a chance to hear the sort of things we have come to expect around show time. One week in September seemed to be devoted to loudspeakers—though loudspeakers were by no means the only newsworthy subject of the week. On Tuesday, September 16, AR demonstrated four-channel stereo in its Grand Central Station Music Room. That same night, Dr. Amar Bose talked before the local chapter of the Audio Engineering Society about speaker propagation and measurement. Then, on Friday, University Sound was in town to unveil its new line of speakers.

By now, regular readers of *HIGH FIDELITY* are sure to have read about the basics of four-channel reproduction—our September, October, and November issues all discussed the subject—and are aware that Acoustic Research is one of the prime movers in the many continuing experiments in the medium. For the demonstration, the new Telex/Viking Quad/Sonic Model 230 (see below) was used as the program source, playing tapes that included samples of the Vanguard Surround Stereo releases. The front channels were fed through the new AR receiver to the showroom's regular bank of AR speakers (AR-3a's were in use most of the time), while the rear channels were reproduced on a pair of AR-4s via the AR amplifier. Similar demonstrations continue in the New York Music Room and that in Cambridge, Mass. Both are open to the public, of course.

Dr. Bose's lecture (an appropriately professorial word, since he comes to loudspeaker manufacturing from the MIT faculty) was one of the best-attended AES meetings in years. Perhaps significantly, the member sitting next to our reporter commented that the only similar turnout in memory came to hear Ed Villchur of AR expound acoustic suspension speaker design over ten years ago. Dr. Bose's wit and warmth of personality, both solid assets in a public speaker, made compelling his description of the process by which the Bose speaker design emerged.

Newest in the University line of speaker systems—totaling some fifteen in all—are two floor models and two bookshelf types. Prices ranged from \$199.95 for the President, a floor model with a 12-inch coaxial driver and a 12-inch passive radiator, down to the El Dorado at \$49.95, the lowest-priced model offered by University.

The other two new models are the Vegas, a floor model with a 15-inch coaxial driver and a price of \$159.95, and the moderate-sized El Paso bookshelf model at \$59.95.

... AND FOUR-CHANNEL DECKS

The Telex/Viking deck used to play four-channel tapes at the AR demonstration mentioned above follows the Teac A-4010SRA (described in October 1969 in this column) to become the second model announced specifically for home use in playing the Vanguard Surround Stereo and similar tapes. Before giving particulars, let's explain that "Telex/Viking" designation. Telex (the headphone company) owns Viking (the tape recorder company), Magnecord (the other tape recorder company), and Phonola (the stereo-compact and portable company). Not surprisingly, the people who run things at Telex have decided to quit juggling four separate company identities and have begun weaning us over to thinking of all their products under the Telex name. But, just as a reminder, the name Viking also appears—albeit in a subsidiary position—on the new models.

The new four-channel consumer line is being called Quad/Sonic and consists of two versions each of two related models. The playback-only models are designated Model 230-QQ. Its transport version, which includes no electronics, is priced at \$550, and the deck model with four playback preamps goes for \$670.

The record/playback models, 230-QQRM, have staggered erase heads—one handles regular quarter-track stereo applications, both are used in recording four-channel materials—plus separate record and playback heads, both of them in-line designs. In the transport-only version, the Model 230-QQRM sells for \$626. The electronics available for it are, in the manufacturer's words, "truly professional." They include four record amplifiers each with two-channel mixing facilities, and true ASA-type VU meters—four independent playback preamps, headphone monitoring jacks, and so on. This most elaborate version of the 230 costs \$1,544.

The transports and electronics are designed for mounting in 19-inch equipment racks, though portable-style carrying cases are available as an accessory. Another option is remote controls.

CIRCLE 157 ON READER-SERVICE CARD

New Jensen Poses Question:

TWO SPEAKERS IN ONE?

The ingenious loudspeaker configuration that Jensen has taken as the basis of its new Stereo 1 system is bound to precipitate a good deal of comment. It is the only current speaker system that claims to produce stereo by the mid/side stereo principle. The fact that a single system produces stereo sound is not in itself unique. The JBL Paragon does that, for instance. But, whereas the

Paragon consists of two full-fledged speaker systems combined in one large cabinet, the Stereo 1 has no left and right speakers as such—only sum and difference speakers, the "mid" and "side" elements of mid/side stereo.

Here's how it works: the signal from a stereo amplifier is fed to four terminals on the back of the Stereo 1 cabinet. Behind these terminals is a matrixing network—a differential transformer setup that electrically takes the sum and difference of the two (left and right) signals that have been fed in. The sum of left and right

Continued on page 58

Indoors and out, Bozak quality is always the same.

Whether it be at the great summer music festivals or in your living room, Bozak speakers are your assurance of the ultimate in tonal quality and the faithful re-creation of all types of music.

From the new Tempo I to the incomparable Concert Grand — all are designed in accordance with the basic laws of physics without resorting to gimmickry or magical “breakthroughs” in the science of acoustics. Each uses the same Bozak designs, differing only in the number of speakers employed. Each is truly a fine musical instrument for the home.

Write today for a free catalog on the entire Bozak line . . . exquisite furniture styles, speaker components, speaker systems . . . the prerequisites for your own private music festival.



P.O. Box 1166 • Darien, Connecticut 06820

Overseas Export: Elpa Marketing Industries, Inc.
New Hyde Park, New York 11040 U.S.A.

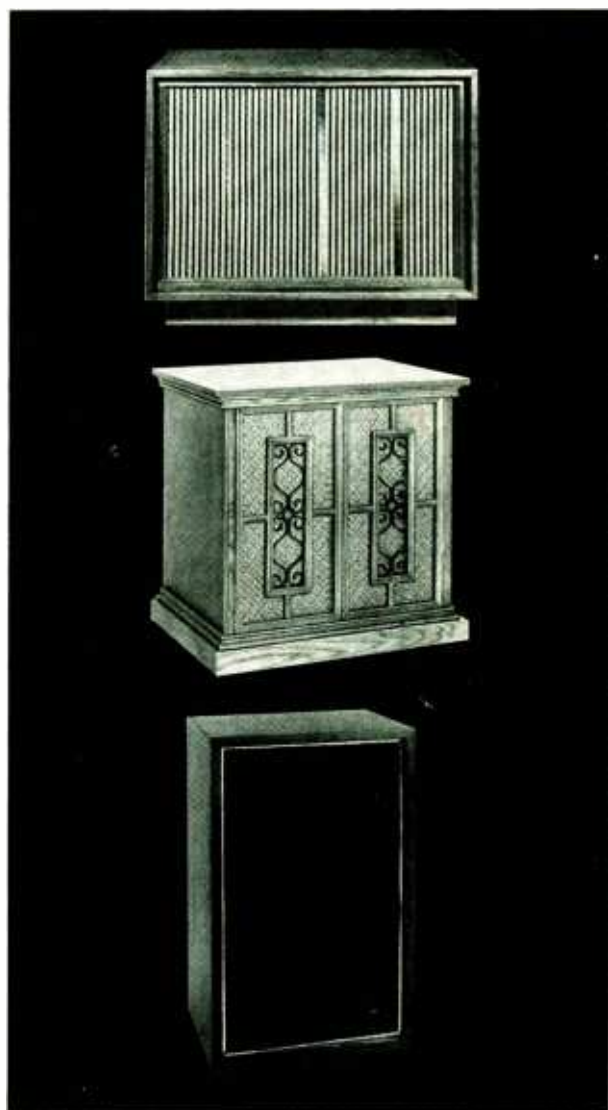
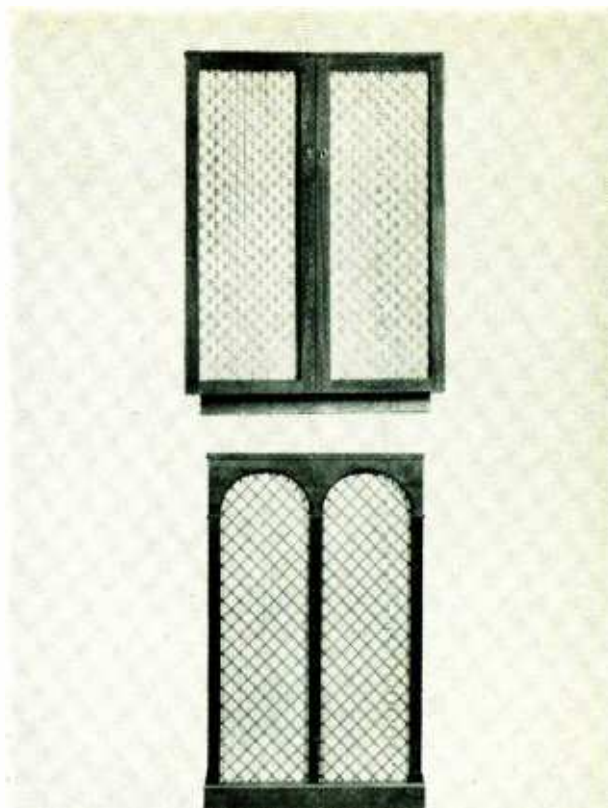

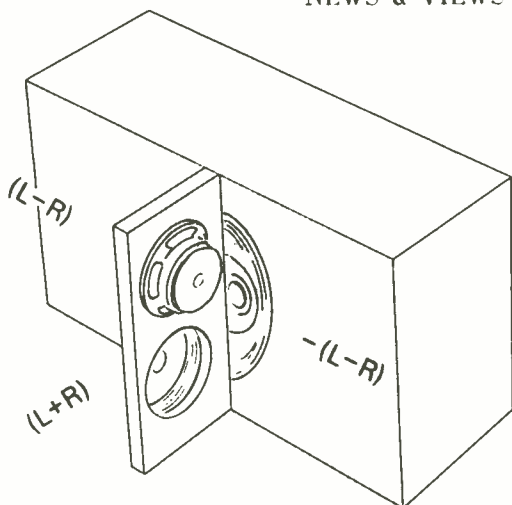

Grille cloth covers front and part of ends of Stereo 1, radiating "matrixed" sound as "sum" and "difference."

is, of course, a mono signal. And this mono signal is fed to a single, conventional, eight-inch acoustic suspension speaker system, which occupies roughly the back half of the Stereo 1's enclosure. The difference signal—left minus right—is fed to a pair of very unconventional speakers. They are mounted right in front of the eight-inch speaker on a vertical panel, whose edge is toward you as you face the system, without any additional baffling, but hidden by the grille cloth.

The sound coming from the three speakers recombines by a process Jensen calls acoustic matrixing to produce left-channel sound to the left of the enclosure, and right-channel sound to the right of the enclosure. Not that

the left channel cannot be heard from the right side of the enclosure—or vice versa. The stereo effect is audible in all directions, says Jensen, and is independent of any bouncing from walls or furniture.

By the same token, the Stereo 1 can't be expected to produce extreme, ping-pong stereo effects. As a Jensen spokesman put it, "M/S stereo is subtler than the extreme effects we used to play around with in the days when stereo was new; but the technique is responsible for some of the finest stereo sound you can get these days." Our initial hearing of the Stereo 1—at a press conference, which is not the best place to judge audio equipment—seemed to confirm that the system tends to differentiate sound sources without localizing them within the stereo image. Only when we are able to test the Stereo 1 in various rooms and with varying program material will we be able to say how typical of its performance the press demonstration was, of course.

Whatever its potential, don't think that the system makes your present stereo pair obsolete, however. Even the most enthusiastic of Jensen's representatives don't see the Stereo 1 as the speaker for all listeners. Instead, they will be selling it as an ingenious way to save space: to have stereo sound with only a single speaker enclosure of modest size (less than two cubic feet). And, at a list price of \$124.95, it will be competing with speakers whose price is modest, too.

Our question posed by the Stereo 1 is: how far can the concept be taken? By using larger drivers or multiple drivers with crossover networks, could M/S speakers be made to rival the best of those we're using today? Theoretically, the deep bass would not be needed in the difference channel since stereo difference information becomes negligible at the lowest frequencies. In that case, might it be possible to use electrostatic elements for the midrange and highs—similar to the Infinity Systems concept—with a large, double-sided electrostatic element for the difference driver? If you're willing to daydream a little, the possibilities seem endless.

CIRCLE 150 ON READER-SERVICE CARD

HOW'S YOUR JAPANESE?

Sansui has produced a record that will help you check the firm's electronic crossover system once it is hooked together. Using percussion instruments the record allows you to balance the two stereo channels one range at a time. White noise is presented on the disc as an aid to matching the speakers within each channel. Tests for phase and reversed channels are included.

All this fits on one side of the disc, whose reverse side is filled with musical selections recorded at 45 rpm. The disc is not for sale; it is given by Sansui to purchasers of the DC-5 crossover unit. But, while we hate to look a gift horse in the tongue, so to speak, there's one little catch. All the spoken material and almost the entire manual that accompanies the disc are in Japanese. Don't get us wrong, however: it's still a useful record. Particularly if you want to learn Japanese.

CIRCLE 158 ON READER-SERVICE CARD



WHO NEEDS SPECS?

How many pairs of eyes—bespectacled and otherwise—read in our September issue the statement that the Dynaco Stereo 80 basic amp can have its channels (each rated at 40 watts rms into 8 ohms) paralleled "for a total output of 80 ohms into 4 ohms for mono use"? The statement is nonsense, of course, unless you read "80

watts" instead of "80 ohms." Yet so intent are we on seeing what we expect to see—or perhaps so in need of new eyeglasses—that none of us picked up the error.

Nor did our readers, apparently, until one Joel Bieder of Forest Hills, N.Y., took us to task for it late in September. If HF meant what it said, he commented, "I am really behind in my knowledge of stereo." You may rest easily, Mr. Bieder; Ohn's Law has not been repealed. It was Murphy's Law that was operative in this case.

It takes nerve to ask \$1,000 for an FM/FM stereo receiver. Unless you have the stuff to back it up.

This is our SA-4000 stereo receiver. It costs \$1,000. But don't look for it at your Panasonic dealer yet. Because the first 25 units in existence have been snapped up by audio laboratories. They're ripping it apart to see how we created it.

For \$1,000, the SA-4000 better be something special. It is. How special? Try to tune it. You'll discover it's the first stereo receiver in history without a tuning knob. That's only for openers.

Nobody's ever combined the best pre-amp, the best power-amp, and best tuner into one unit before. This kind of ingenuity, creating a whole new generation of audio equipment, is commonplace at Panasonic.

It's happened 14,048 times, so far. That's how many patent rights and designs have come out of our 50 research and development labs. Where the hackles of 2,500 engineers and scientists go up when somebody says, "It can't be done." Many of the audio components they've created never existed just 3 years ago.

But the real key to quality is this:

Every component, from the tiniest transistor to our 36-inch woofer, is manufactured in one or another of our 80 factories. Tested, inspected, and quality controlled by 40,000 master technicians. That's why we're so absolutely certain of their compatibility. Their excellence. And their reliability.

Nobody makes audio equipment like Panasonic.

And this goes not only for our \$1,000 receiver. But our 4 other stereo receivers as well. The same imagination. The same rigid quality control. The same loving attention to detail is present in all our stereo receivers. They'll give you sound that'll knock your ear on its ear.

Our 4-track stereo tape decks are packed with little miracles of audio engineering. Every circuit is married to every transistor. To every component. That's love.

Speakers? Take your choice from 5 new Panasonic multi-speaker systems. Each set of woofers and tweeters is acoustically matched for

the purest sound. With a range wide enough to wake up an Airedale.

You've never heard stereo component systems like these before. Because nobody ever made them before. The speaker systems. The tape decks. They're all compatible with our \$1,000 receiver. And with our less expensive receivers.

Stop by any dealer we franchise to handle the Panasonic Audio Equipment line. If he doesn't have the \$1,000 unit in stock yet, lister to our less expensive models. They sound like a million.



PANASONIC

just slightly ahead of our time.

For your nearest Panasonic Audio Equipment dealer, write Panasonic, 201 Park Avenue, New York 10017.

equipment in the news



Empire designs for 0.1-gram tracking

That's one-tenth of a gram—not one gram. Empire's new Troubador Model 598 turntable-and-arm combination is designed with that figure in mind and, according to the company, exceeds every NAB spec for professional turntables into the bargain. It has other niceties too, like antiskating, automatic arm-lift at the end of the record, three-speed operation, fine pitch control, and a cueing light. The 598 sells for \$199.95; the base-and-cover combination for \$34.95. Empire's new 1000ZE cartridge, likewise designed so it can track at 0.1 gram and offering such specs as response within ± 1 dB from 20 to 20,000 Hz, and 35 dB of separation over much of the audible range, sells for \$99.95.

CIRCLE 156 ON READER-SERVICE CARD

New Wharfedale tunes to your room

In announcing a speaker system that might be classed among the omnidirectional designs, Wharfedale expounds the concept that promiscuous scattering of sound is to be avoided. Instead, the four-way Model W80 Variflex system contains a circular deflector on a universal mounting that can be positioned to aim midrange and highs, in almost any direction that will achieve the desired dispersion for a given placement in a given room, according to British Industries Company. Sound emerges at the rear of the speaker; the front is a solid panel. The enclosure walls are sand-filled, like those of other Wharfedale systems. The W80s sell for \$289.95 each; a floor stand that holds a pair of speakers in a console configuration sells for \$25.75.

CIRCLE 146 ON READER-SERVICE CARD



Sony offers moderate-priced AM/FM receiver

The Sony STR-6040 appears to be designed for installations where high-powered amplifiers will not be required but attractive specifications will be desirable nonetheless. That is to say that the STR-6040 uses circuit features such as ceramic IF filters to improve selectivity—listed at 70 dB by Sony—while power output is listed at 15 watts per channel rms into 8-ohm loads. The price of the STR-6040 is \$199.50.

CIRCLE 147 ON READER-SERVICE CARD

New cross-field model from Roberts

The Califone/Roberts division of Rheem Mfg. Co. has announced the Model 771X, a four-speed stereo model featuring the cross-field record/head configuration. Sound-on-sound recording is among the model's capabilities, and the built-in monitor system is rated by Roberts at 40 watts peak music power. The transport will accept reels up to seven inches. The price is \$329.95.

CIRCLE 149 ON READER-SERVICE CARD





Versatility that's surpassed only by performance

A new criterion of excellence in sound has arrived. The Pioneer SX-1500TD AM/FM multiplex stereo receiver was meticulously designed for the audio perfectionist. Its advanced design circuitry, incorporating an FET front end and IC's IF strip, offers an array of features for the ultimate in stereo performance. Music power is at a zenith of 180 watts, rated in compliance with the standards of the Institute of High Fidelity. Extremely versatile, it provides six sets of inputs. The pre and main amplifiers may be used independently. An exclusive highlight is

the unique facility for Dynamic Microphone Mixing which provides simultaneous recording with broadcast music... voice over music announcements... 5-position speaker selection for announcements over speakers in several locations. You can connect up to three different speaker systems. Complementing its magnificent sound reproduction is the subdued elegance of the hand rubbed, oiled walnut cabinet faced with brushed silver and jet. Hear the true sound of quality at your Pioneer dealer. Only \$399.95, including microphone.

 **PIONEER**

PIONEER ELECTRONICS U.S.A. CORPORATION, 140 Smith Street, Farmingdale, N. Y. 11735 • (516) 694-7720
West Coast: 1335 W. 134th Street, Gardena, Calif. 90249 - (213) 323-2374 & 321-1076 • In Canada: S. H. Parker Co., Prov. of Ontario

CIRCLE 52 ON READER-SERVICE CARD



The only record playback system
engineered for stereo cartridges
that can track as low as 0.1 gram.



NEW TROUBADOR MODEL 598

A turntable system designed exclusively for the new low-tracking-force cartridges that won't wear out your records, this unbelievable record playback device exceeds every National Association of Broadcasters specification for professional playback equipment.

1. This extraordinary Troubador system features the *Empire 990*—world's most perfect playback arm. Built to last with rugged precision foolproof adjustments. Arm friction measures a minute 1 milligram. A tone arm that applies no more drag than a feather held lightly against a record groove.
2. Arm fully stereo balanced—front as well as rear of pivots.
3. Sealed instrument ball-bearing races for horizontal as well as vertical motion.
4. Stylus force dialed with calibrated clock mainspring—more accurate than any commercially available pressure gauge.
5. Lowest fundamental resonance of any arm, an inaudible 6 Hz, makes it impossible to induce acoustic feedback in the system even when you turn up the gain and bass.

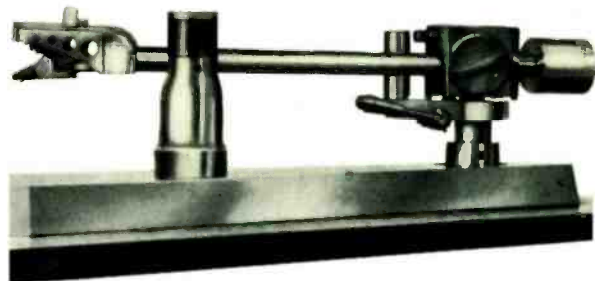

11. World's finest turntable motor, hysteresis synchronous type, self cooling, high torque with inside-out rotor; reaches full speed in less than 1/3 of a revolution and locks in on AC line frequency; maintains speed accuracy with zero error. Built-in strobe disc and pitch control.
12. Flexible belt drive precision ground to $\pm .0001$ in. tolerance.
13. 12-inch turntable platter and 4-inch thick balanced drive fly-wheel—most massive ever used in a home system.
14. Microhoned oilite bearings and lapped chrome steel shafts machined as individually matched pairs—no production-line tolerances.



6. Empire's exclusive Dyna Lift automatically lifts the arm off the record at the end of the music.
7. Micrometer calibrated anti-skating adjustment can be set exactly to match any operating force for conical or elliptical stylus. Eliminates uneven record or stylus wear.
8. Instant cartridge demount and interchange.
9. In-line stylus-to-pivot axis. No warp, wow or cosine-error distortion.
10. 5-wire circuit eliminates ground loops.



15. Lowest rumble of any turntable tested—90 DB (RRLL). Wow and flutter an almost unmeasurable .01%.
16. Customized record mat holds records by outer rim. The playing grooves never touch the mat on any size record.
17. Empire's exclusive pneumatic suspension combines pistons and stretched springs. You can dance, jump or rock without bouncing the stylus off the record. Tracks the world's finest cartridges as low as .1 gram.
18. Dead center cueing control—tone arm floats down or lifts up from a record surface bathed in light. Pick out the exact selection you want—even in a darkened room.

TECHNICAL SPECIFICATIONS

Empire 598 turntable
 3 Speeds—33 1/3, 45, 78 rpm
 Push-button power control
 Built-in 45 rpm spindle
 Overall dimensions (with base and dust cover): 17 1/2" W x 15 1/8" D x 8" H

Dimensions (without base and dust cover): Width 16", Depth 13 1/2"
 Height above mounting surface: 3 3/4"
 Depth required below base plate 3 1/2"
 Swiss ground gold finish



Troubador 598 playback system • \$99.95
(less base and cover.)
 Satin walnut base and plexiglass cover combination, \$34.95
 990 playback arm also available separately, \$74.95

EMPIRE

FOR A FREE FULL-COLOR CATALOG, WRITE: EMPIRE SCIENTIFIC CORP., 1055 STEWART AVE., GARDEN CITY, NEW YORK 11530.

CIRCLE NO. 28 ON READER SERVICE CARD
www.americanradiohistory.com

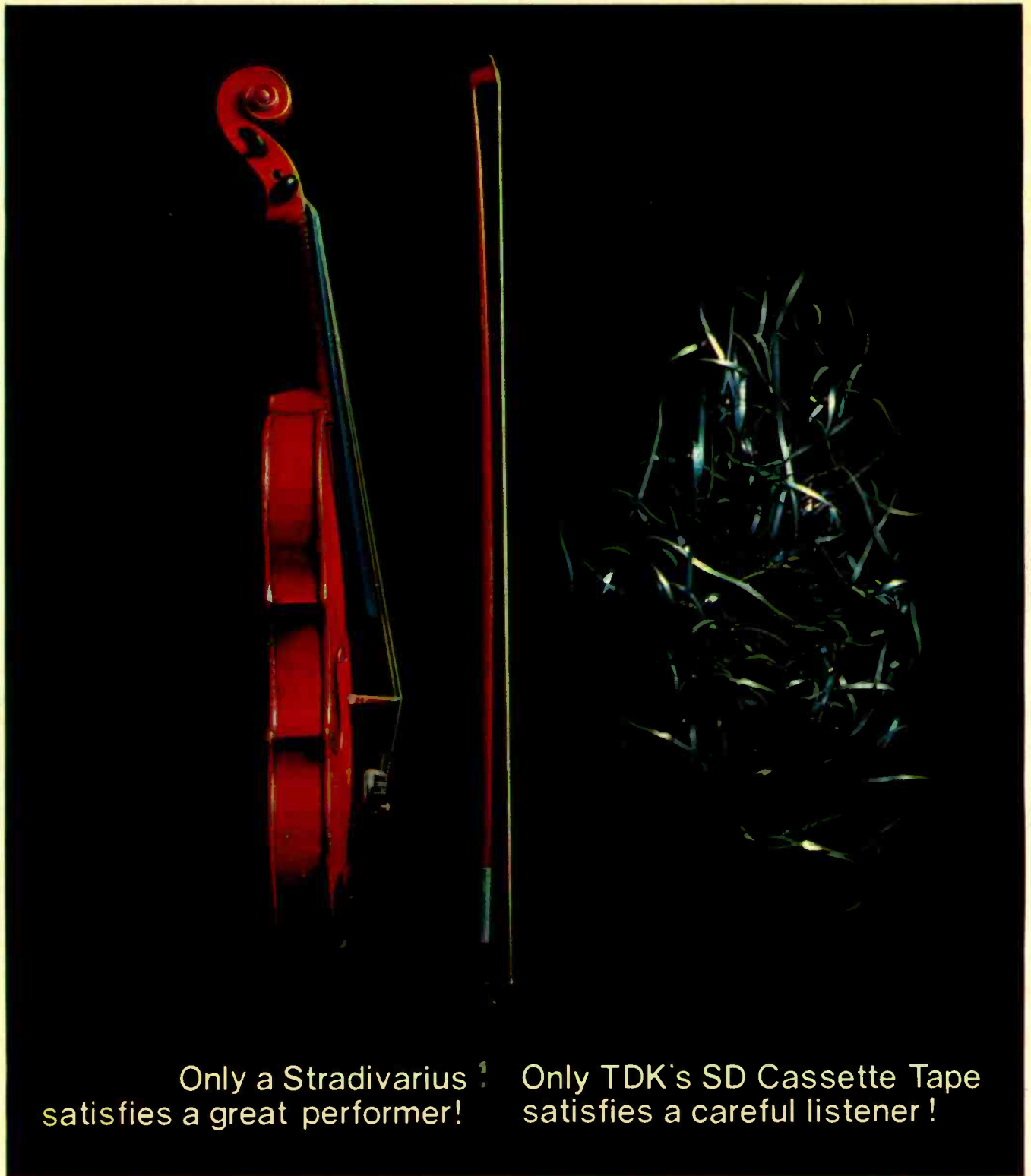

Only a Stradivarius
satisfies a great performer!

Only TDK's SD Cassette Tape
satisfies a careful listener!

Today, it's not only musicians who care about fine sound. That's why TDK has created its world-famous professional audio cassette tape: SD! For the first time, a cassette tape offers a truly significant improvement — the fantastic frequency range of 30 - 20,000Hz! Wide dynamic range. Excellent S/N ratio. Discover what exceptional sound SD cassettes deliver by using SD for your next FM Multiplex recording.

TDK CASSETTE

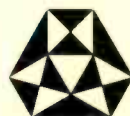

TDK ELECTRONICS CO., LTD.

2-14-6 Uchikanda, Chiyoda-ku, Tokyo Japan.
*For detailed information, write to.

TDK ELECTRONICS CORP

82 Wall Street, New York 10005 Phone:(212)425-7070
●LOS ANGELES Branch, 6151 W. Century Blvd. Los Angeles, California 90045 Phone:(213)670-5515
●CHICAGO Branch, 2906 West Peterson Avenue, Chicago, Illinois 60645 Phone:(312)973-1222

CIRCLE 75 ON READER-SERVICE CARD

speaking of records

By Leonard Marcus

The Best Records of the Year

An International Jury Decides

THE WEARY ELEGANCE of the old Swiss village of Montreux seems out of keeping with what one finds there. In Geneva, I was not too surprised that the first signs greeting me at the metropolis' airport took the form of four giant billboards, in as many languages, proclaiming that the automatic toothbrush most often recommended by American dentists was manufactured in Switzerland. But Montreux somehow seemed the wrong place to find window posters advertising a watch as one similar to those worn by the astronauts on the moon; to find even a few shiny hotels vying with the traditional faded-white gingerbread establishments; to hear Boulez' *Le Marteau sans Maître* in a gambling hall. No, Montreux seemed better exemplified by the visiting Poles, with their medieval costumes, playing fifes, *trompettes*, drums, and crumhorns in the local Chillon castle; by the Bach and Mozart that issued (at least during the festival season) from dress shops, watch repairers, and camera stores; by the window display of a full-sized violin, bow, and baton—all made entirely of chocolate.

GOLD PRIZE



BACH: Mass in B minor (Nikolaus Harnoncourt) Telefunken SKH 20.

This juxtaposition of the oldest and the newest was, to be sure, the ideal setting for my function in Montreux. I had been called there to preside over an international jury, which would determine the three best recordings issued, anywhere in the world, for the first time during the previous twelve months (actually between May 1, 1968, and April 30, 1969). And, after all, we were concerned with the ancient tradition of music in the most modern techniques of electronic reproduction. (As it turned out, we were also to select two of the earliest works under consideration, as well as the most recent.)

But how to choose the world's best records, even with so eminent a panel as assembled in Montreux? No one can possibly hear all the recordings issued annually in each country. A formidable task—but not impossible. We had the services of a remarkable Preselection Committee composed of the world's leading record reviewers and editors. Each Committee member (and juror) submitted a "Ten Best" list; there was but one stipulation: only recordings first issued, some-

SILVER PRIZE

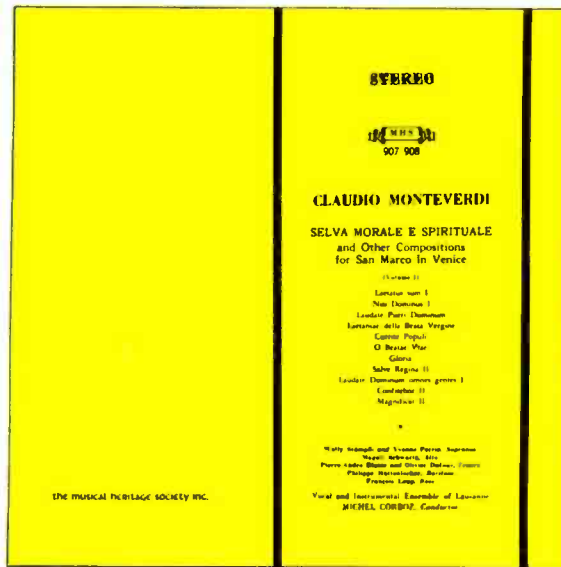

MONTEVERDI: Selva Morale (Michel Corboz) Musical Heritage Society MHS 907-08.

BRONZE PRIZE



BERIO: Sinfonia (Swingle Singers, Luciano Berio) Columbia MS 7268.

where, during the specified time limits would be considered. Leopold Stokowski's illuminating recording of Charles Ives's Fourth Symphony, for instance, had to be eliminated even though it received a considerable number of nominations from several European countries that first encountered it last year. On the other hand, Luciano Berio's extraordinary *Sinfonia*, which was to capture one of the three top prizes, at first seemed (to me) ineligible for this year's competition; it turned out, though, that the French legitimized that U.S.-produced recording from our New York Philharmonic by beating us to the punch, possibly because they are even more enthusiastic about the Swingle Singers than we are.

What does happen if a worthwhile recording is released in only one country just before the deadline, making it unlikely to receive enough preselection votes to get onto the final list of nominations, and at the same time barring it from the following year's award? To surmount this obstacle each juror



BEETHOVEN: The Five Piano Concertos (Daniel Barenboim, Otto Klemperer) Angel SD 3752.



WAGNER: The Flying Dutchman (Theo Adam, Anja Silja, Martti Talvela, Otto Klemperer) Angel SCL 3730.



BERLIOZ: Roméo et Juliette (Colin Davis) Philips PHS 2909.



WAGNER: Das Rheingold (Dietrich Fischer-Dieskau, Josephine Veasey, Gerhard Stolze, Herbert von Karajan) DGG 139 226-28.



CAVALLI: L'Ormindo (Raymond Leppard) Argo ZNF 8-10.



DVORAK: Symphony No. 7 (Zubin Mehta)
London CSA 2224.

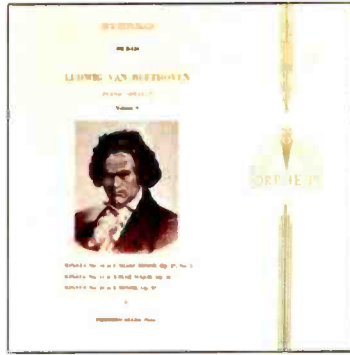

BEETHOVEN: Complete Piano Sonatas (Friedrich Gulda) Orpheus (Musical Heritage Society) ORB 116-26.



BERLIOZ: Requiem (Charles Munch)
DGG 139264-65.



ROSSINI: Rarities (Montserrat Caballé)
RCA Red Seal LSC 3015.

is given the option of adding one record to the list. Presumably if the late recording is that good, the juror from the country where it was issued will select it as his personal choice. All records are made available in Montreux, of course, for the jurors to listen and relisten to.

With so many awards being given to recordings, you may wonder why HIGH FIDELITY and the Montreux Music Festival established yet one more. That is precisely one of the main reasons: there are so many, each with its bias, that we didn't believe any of them. They are either nationally oriented (like the French Grands Prix du Disques), in which case a particular country seems to garner a disproportionate number of awards, or industry-sponsored (like the Grammy) in which case every company apparently has to get *some* prize to make its investment worthwhile. The HIGH FIDELITY/Montreux International Record Award last year became—and still remains—the only independent international record award in the world. We give only three prizes, and let the discs fall where they may.

Just look at this year's winners: nothing between the baroque and the 1960s; moreover, one of the albums (the Monteverdi) was yet to be released in the U.S. when we voted—and then it would not be widely distributed in record stores. The top prize



HINDEMITH: Die 7 Kammermusiken (various artists) Telefunken SLT 43110-12.



DONIZETTI: La Fille du Régiment (Joan Sutherland, Richard Bonyngé) London OSA 1273.



ROSSINI: Six Sonatas for String Orchestra (Claudio Scimone) Erato STU 70489-90 (no American record available at this writing).



MOZART: Le Nozze di Figaro (Hermann Prey, Edith Mathis, Gundula Janowitz, Dietrich Fischer-Dieskau, Karl Böhm) DGG 139276-79.



BRITTEN: Billy Budd (Peter Glossop, Peter Pears, Michael Langdon, John Shirley-Quirk, Benjamin Britten) London OSA 1390.



BEETHOVEN: The Five Middle Quartets (Guarneri Quartet) RCA Red Seal VCM 6415.



HONEGGER: Symphonies Nos. 3 and 4 (Ernest Ansermet) London CS 6616.



MENDELSSOHN: Elijah (Rafael Frühbeck de Burgos) Angel SC 3738.



GESUALDO: Madrigals (Angelo Ephrikian) Musical Heritage Society MHS 917-19.



BACH-CARLOS: Switched-On Bach (Walter Carlos) Columbia MS 7194.

went to one of the most controversial recordings to come out this year—as readers of this magazine are well aware. Or look at last year's awards: Strauss's *Elektra* (Decca/London) with Nilsson and Solti; Mahler's Sixth Symphony (Columbia) under Bernstein; and Busoni's Piano Concerto (Angel) with John Ogdon. Not only were the works written at almost exactly the same time (1903-8), but the records were all produced by Anglo-Saxon companies. No prizegivers in their right political or commercial minds would hand out such awards. It's simply that, in the opinion of incorruptible judges, these *were* the best records of their respective years.



DAVIES: Revelation and Fall (Mary Thomas, Peter Maxwell Davies) Angel S 36558.

The list of nominations was itself instructive. Of the five living composers represented two were British (Britten and Davies) and two Italian (Berio and Nono). Recordings of Monteverdi, Gesualdo, and Cavalli, all Italians of the late 1500s and 1600s, made the list as did the two contemporary Italians—but no standard repertory Italian (or French) opera was even proposed, unless you consider Donizetti's *La Fille du Régiment* a repertory piece. It was not a good year for non-Wagnerian opera. Also, Berlioz tied Beethoven as the best-represented composer (1969 was of course a "Berlioz year").



BERLIOZ: Les Nuits d'été (Janet Baker, Sir John Barbirolli) Angel S 36505.

You may be interested in my own

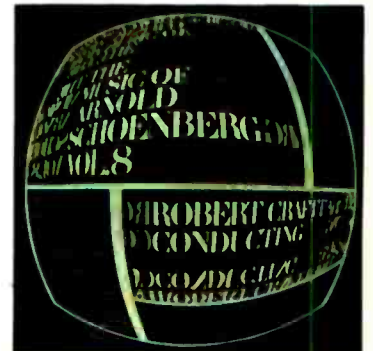

SCHOENBERG: Complete Works, Vol. 8 (Robert Craft) Columbia M2S 780.

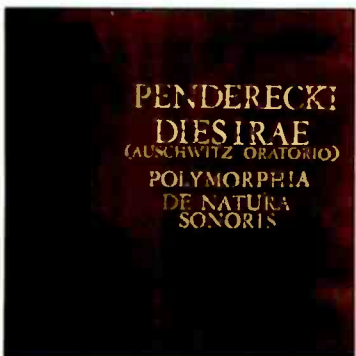

PENDERECKI: Dies Irae (Henrik Czyz) Philips PHS 900184.



NONO: La Fabbrica illuminata (Giulio Bertola) Wergo WER 60038 (no American record available at this writing).



BERLIOZ: Symphonie fantastique, Léo (Pierre Boulez) CBS 32 B1 0010.



Jean Schlemmer

Jury in secret session: the chair recognizes Prof. Blaukopf. From the professor's left, clockwise: Messrs. De Agostini, Pleijel, Lyons, Greenfield, Marcus, Mme. Nicole Hirsch-Klopfenstein (Secretary General), Messrs. Vojtech, Mann, Fierz, and Hofmann.

Jury

Leonard Marcus, HIGH FIDELITY, U.S.A., President
 Gabriele de Agostini, *La Suisse*, Switzerland
 *Luigi Bellingardi, RAI, Italy
 Kurt Blaukopf, *Hi-Fi Stereophonie*, Austria
 Gerold Fierz, *Neue Zürcher Zeitung*, Switzerland
 Edward Greenfield, *The Gramophone* and
The Guardian, England
 Michel Hofmann, *Diapason*, France
 James Lyons, *American Record Guide*, U.S.A.
 Carl-Heinz Mann, *Fono Forum* and
Hamburger Abendblatt, Germany
 Bengt Pleijel, *Musikrevy*, Sweden
 Ivan Vojtech, *Hudebni Rozhledy*, Czechoslovakia

* could not attend due to illness

Preselection Committee

Nicole Hirsch-Klopfenstein, Chairman
 Owen Anderson, *Music Journal*, U.S.A.
 William Anderson, *Stereo Review*, U.S.A.
 Karl Breh, *Hi-Fi Stereophonie*, Germany
 Edward Tatnall Canby, *Audio*, U.S.A.
 Jay Carr, *Detroit News*, U.S.A.
 Georges Cherière, *Diapason*, France
 Marcel Doisy, *La Revue des Disques*, Belgium
 Peter Gammond, *Audio Record Review*, England
 Ingo Harden, *Fono Forum*, Germany
 Paul Hume, *Washington Post*, U.S.A.
 Pierre Hugli, *Gazette de Lausanne*, Switzerland
 Robert Leslie, *Records & Recordings*, England
 Ornella Zanuso Mauri, *Discoteca*, Italy
 Martin Mayer, *Esquire*, U.S.A.
 Phillip Miller, former Chief, Music Division,
 N.Y. Public Library, U.S.A.
 Sylvie de Nussac, *L'Express*, France
 Edith Walker, *Harmonie*, France

Clemens Kalischer



At the presentation ceremonies: Prof. Blaukopf presents the Gold Award to Nikolaus Harnoncourt (left) and producer Wolf Erichson for their Bach B minor Mass.

vote, which should surprise nobody who read my monthly Letter in November. I opted for "Switched-On Bach." It didn't stand a chance.

There actually is a fourth prize: to a person who has contributed significantly over the years to the art of recording. Last year it was Stokowski; this year it was Walter Legge, former head of EMI, who more or less "discovered" for record buyers such luminaries as Maria Callas, Elisabeth Schwarzkopf, and Herbert von Karajan. As a matter of fact, it was Miss Schwarzkopf, alias Mrs. Legge, who presented the award to her husband.

In return for his honor, Mr. Legge offered a proposal to the world's

major record companies: combine your appropriate artists for at least operatic productions. This way if the companies agree that soprano X from company A is the best available Tosca, tenor Y from company B the best Cavaradossi, and baritone Z from company C the best Scarpia, that's whom they would use. As a result, fewer but better recordings would get made. Then, concluded Mr. Legge, let all the companies release the production and compete on the basis of the quality of the sound each can produce for it.

Fantasy? Perhaps, but from so impressive a source one wonders whether the artistic and financial merits do not

really outweigh the problems they seem bound to churn up.

Nikolaus Harnoncourt accepted the prize for his recording of Bach's B minor Mass, and Michel Corboz (one does not, "except in France," pronounce the z) not only accepted his award but signaled to an outer room for his singers, who entered the main hall to perform some Monteverdi. Neither Luciano Berio nor the Swingle Singers were able to attend the ceremonies, since, we were told, they were busy performing the *Sinfonia* elsewhere.

Too bad; I was hoping the Swingle Singers might perform at least part of the B minor Mass for us.

Clemens Kalischer



With his choir behind him, Michel Corboz listens happily as M. De Agostini prepares to present him with the Silver Award for his Monteverdi album.

Jean Schlemmer

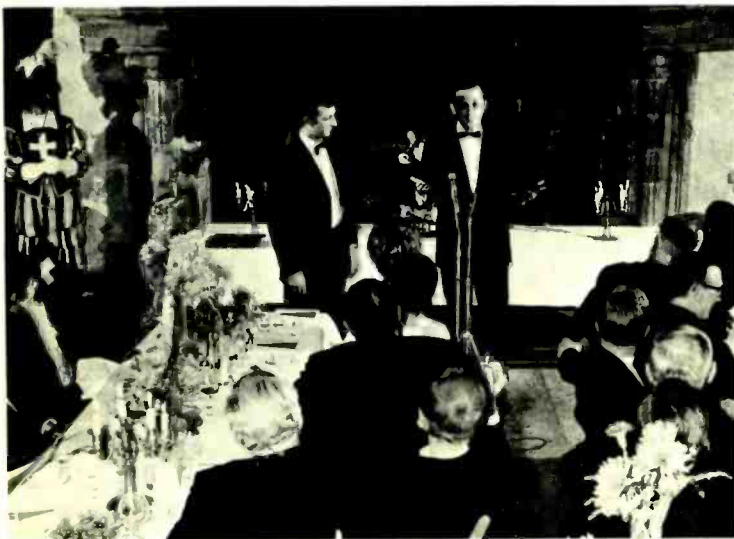

CBS representative Yves Helfenberger prepares to accept the Bronze Award for Luciano Berio and the Swingle Singers as Mr. Marcus concludes his remarks.

Clemens Kalischer



Walter Legge waits patiently for his wife, Elisabeth Schwarzkopf, to present him with a Diplôme d'Honneur.

What's New in Stereo Kits?

By ROBERT LONG

Some of the best equipment is available in do-it-yourself form

FRANKLY, I'M PREJUDICED. I try hard to look modest when my wife announces to guests that I built the stereo system myself (which isn't quite accurate, since the turntable and tape recorder were store-bought), but secretly I'm proud as all get out. Furthermore, I've enjoyed building every kit I've tried. And when something goes wrong, as it will sooner or later, you will find it an immense help to know just how the equipment was put together. So for me, kits are the only way to go stereo. Well, almost the only way.

There's a lot of first-rate equipment available in kit form. If anything, the average quality of the high fidelity electronic kits on the market has been climbing upward over the last few years. Cheap-and-dirty jobs, like the "powerful five-watt" amplifiers that once beckoned the way to stereo for an absolute minimum investment, have been falling into the oblivion they deserve. At the other extreme, some really impressive models have turned into best sellers among kits.

Take the case of Heath's AR-15 receiver, or its separate counterparts, the AJ-15 tuner and AA-15 amplifier. When the AR-15 first appeared, it raised a lot of eyebrows. Crystal IF filters? *Two* tuning meters? Integrated circuits? Technological window dressing, said the scoffers. And that price: almost \$350 in kit form and over \$500 wired. Nobody will buy it, they said; kits sell because people want to save money. When production samples started to reach the magazines, scoffing continued in spite of the AR-15's obvious quality. Too hard to build, they said.

The reviews said much the same thing, while praising the receiver's performance. But anyone who ordered an AR-15 during those early months of its availability knew who was having the last laugh, because Heath was back-ordered.

Actually, the AR-15 exemplified a tradition in

kits: it offered better-than-average equipment at a lower-than-average price. Continuing in this tradition, apparently, are two very new kit lines designed, according to their manufacturers, to the highest possible standards. One is Harman-Kardon's revived Citation series; the other is the new Stereo Age line about to be launched by Hegeman Laboratories, Inc. Parenthetically, it's interesting to note that Stu Hegeman of Hegeman Labs was the moving force behind the original Citation kits when he was connected with Harman-Kardon some years ago. Those were the early days of transistorized high fidelity, and circuits and companies were changing fast. The original Citation line didn't survive the instability of its times.

The new Citation line consists of two models in familiar format: the Models Eleven stereo preamp and Twelve stereo basic amp. The Hegeman Stereo Age line, using a somewhat different approach, takes its cue from studio control consoles. That is, the units will feature a modular design that permits custom tailoring for particular purposes. For instance, inputs can be equipped with preamp modules or used without them for high-level signal sources. The pre-amp modules themselves may be set for magnetic phono, tape-head, or mike inputs. By juggling these facilities, the switching elements that control them, and the power amps that they feed, the stereo enthusiast can achieve an unusual degree of flexibility. Provision for electronic crossover systems and center-channel amplification are also part of the scheme. Special systems for recording and playing back four-channel sound should be well within the capabilities of the Stereo Age line, though all four channels will not fit on a single front-panel assembly.

Another new line, bearing the Koss name, may be coming along soon. Koss, of course, has been the owner of Acoustech for several years, and the Koss/

A GUIDE TO STEREO KITS

Stereo Receivers

Manufacturer	Model	Type	(Output per Channel*)	Price
Allied Radio (Knight-kits)	KG-988	AM/FM	(25 watts)	\$179.95
Eico	3770	AM/FM	(20 watts)	189.95
	3570	FM	(20 watts)	169.95
Heath	AR-15	AM/FM	(50 watts)	339.95
	AR-29	FM	(35 watts)	285.00
	AR-13A	AM/FM	(20 watts)	189.95
	AR-14	FM	(10 watts)	114.95
Scott	LR-88	AM/FM	(32 watts)	299.95

Stereo Amplifiers and Preamps

Allied Radio (Knight-kits)	KG-865	Integrated	(34 watts)	69.95
Dynaco	Stereo 120	Basic amp	(60 watts)	159.95
	SCA-80	Integrated	(40 watts)	169.95
	Stereo 80	Basic amp	(40 watts)	119.95
	Stereo 70	Basic amp	(35 watts)	99.95
	SCA-35	Integrated	(17½ watts)	99.95
	Stereo 35	Basic amp	(17½ watts)	59.95
	PAT-4	Control preamp	—	89.95
	PAS-3X	Control preamp	—	69.95
Eico	3150	Integrated	(50 watts)	149.95
	3070	Integrated	(20 watts)	99.95
Harman-Kardon	Citation Eleven	Control preamp	—	199.95
	Citation Twelve	Basic amp	(60 watts)	199.95
Heath	AA-15	Integrated	(50 watts)	169.95
	AA-22	Integrated	(13 watts)	99.95
	AA-14	Integrated	(10 watts)	64.95
Hegeman Labs	HLA	Modular power supply/preamp/control unit	—	approx. 360.00
	HLB	Modular power amp/metering unit	(40 watts)	approx. 360.00
Scott	LK-60B	Integrated	(40 watts)	149.95

Stereo Tuners

Allied Radio (Knight-kits)	KG-796	AM/FM		\$ 69.95
Eico	3200	FM		99.95
Dynaco	FM-3	FM		99.95
Heath	AJ-15	FM		189.95
	AJ-33A	AM/FM		99.95
	AJ-14	FM		54.95
Scott	LT-112B-1	FM		149.95

Speaker Kits

Allied Radio	2370K	Bookshelf; three-way system		\$ 99.95
	2300CK	Bookshelf; three-way system		74.95
	2330AK	Bookshelf; three-way system		59.95
	3030BK	Bookshelf; three-way system		44.95
	3017K	Bookshelf; three-way system		34.95
Bozak	E-4000KM	Floor-standing enclosure; can be fitted with from 3 to 11 Bozak speakers in various configurations.		94.50
Heath	AS-48	Bookshelf; two-way system		169.95
	AS-10W	Bookshelf; two-way system		64.95
	AS-16	Bookshelf; two-way system		49.95
	AS-37	Bookshelf; two-way system		39.95

*Output power figures, which are based on manufacturers' ratings for rms power per channel into the most efficient loading conditions, are included only as a rough guide to the general class into which the equipment can be expected to fall. Since these ratings are measured in different ways and using different loading impedances, they are not strictly comparable from manufacturer to manufacturer.

Acoustech line of quality solid-state component kits was available until late this year. Some may still be available at a few dealers, though the line no longer is made. Koss now tells us that a complete redesign job is in the works, though it had been temporarily set aside during the development of the Koss electrostatic headphones. No details of the new line were available as we went to press, but we were given to understand that it should be announced in 1970.

Two new receivers are being offered this winter: Heath's AR-29 and Knight's KG-988. The KG-988—like all Knight kits, a product of Allied Radio—is an AM/FM job with features like multiple speaker switching, field-effect transistors in the FM front end, and so on. Its power output is rated at 50 watts total rms and the kit sells for \$179.95.

Heath's AR-29 retains a number of features found in the AR-15, but at a more modest price: \$285. Its power amp section is not as hefty as that of the AR-15 but it is quite respectable. IF filtering is handled by encapsulated coils and capacitors that—like crystal filters—need no alignment and, according to Heath, produce similar desirable bandpass characteristics. The AR-29 also features slider controls—the first we've heard of in a component kit.

The most recent models from Dynaco are the Stereo 80 power amplifier—which delivers 40 watts per channel, as the name implies—and its integrated amp counterpart, the SCA-80. Until these models appeared, Dyna's solid-state line consisted only of a 35-watt integrated amplified unit or its 120-watt power amp, which could be combined with the PAT-4 preamp. In tubed equipment the medium-power Stereo 70 basic amp and the PAS-3X preamp remain available, as do a number of tubed mono models that can be used to power center-channel speakers.

Some of the most attractive components kits around are not brand-new, however. Heath has a whole line of models that will fit just about any requirements and just about any budget. A few of the older tubed models still remain in the Heath catalogue, as an inexpensive way of rigging up a system for a playroom, for instance. These models, together with others from the Allied "Knight-Kit" line, Eico's "Cortina" models, and those from Scott and Dynaco, are listed in the accompanying guide.

If you are an avid reader of HIGH FIDELITY, you will recognize many old friends among the models represented. Some, like the Scott LT-112 tuner series and the Dynaco PAS-3X preamp, are among the true classics of high fidelity. Another is the Dynaco FM-3 tuner which, while it lacks all of the frills that have crept into tuner design in the years since it was introduced, still offers excellent listening at modest cost.

Another classic kit, surely, is the Bozak E-4000KM speaker system series. I say "series" because it represents a succession of kits that you can begin simply and add to a little at a time to upgrade the original version. The basic system consists of the enclosure itself plus a single woofer and a pair of tweeters, with crossover network and brightness control. It's perfectly usable just that way; but you can add, in

A GUIDE TO KIT MANUFACTURERS

Allied Radio Corp. 100 N. Western Ave. Chicago, Ill. 60680	Stereo components; test equipment; furniture; radios; electronic musical instruments; hobby kits; etc.
Audio Originals 546 S. Meridian Indianapolis, Ind. 46225	Furniture.
Barzilay Co. 16245 S. Broadway Gardena, Calif. 90247	Furniture.
R. T. Bozak Mfg. Co. P. O. Box 1166 Darien, Conn. 06820	Speaker systems.
Dynaco, Inc. 3060 Jefferson St. Philadelphia, Pa. 19121	Stereo and mono components.
Eico 283 Malta St. Brooklyn, N. Y. 11207	Stereo components; music-powered lighting equipment; test equipment
Harman-Kardon, Inc. 55 Ames Court Plainview, N.Y. 11803	Stereo components.
Heath Co. 305 Territorial Rd. Benton Harbor, Mich. 49023	Stereo and mono components; test equipment; color TV; electronic musical instruments; radios; etc.
Hegeman Laboratories 176 Linden Ave. Glen Ridge, N. J. 07028	Modular stereo components.
Koss Electronics, Inc. 2227 N. 31st St. Milwaukee, Wis. 53208	Stereo components expected in 1970.
Lafayette Radio Corp. 111 Jericho Turnpike Syosset, N. Y. 11791	Speaker enclosures and furniture; etc.
Music Associated 65 Glenwood Dr. Upper Montclair, N. J. 07043	SCA adapter.
S.C.A. Services Co. P. O. Box 209 Great Neck, N. Y. 11023	SCA adapter.
Schober Organ Corp. 43 West 61st St. New York, N. Y. 10023	Electronic musical instruments.
H. H. Scott, Inc. 111 Powder Mill Rd. Maynard, Mass. 01754	Stereo components.

succession, another pair of tweeters, a second woofer, four more tweeters, and a midrange with its crossover network and associated control.

There are other speaker kits on the market, right down to what one wag has dubbed the teeny-tinnies—little, low-cost systems that are handy for extension use even if they do not qualify as true high fidelity. Also in this class, perhaps, are the speaker enclosures designed for no particular speakers. No speaker will sound its best unless the enclosure is properly matched to it, of course; but if you have some extra speakers kicking around and want to put them to use for less-than-purist ears, an enclosure kit may do a fairly respectable job at low cost.

There are hosts of other items available in kit form too. For high fidelity purposes, the most important probably are the equipment cabinets. For instance, Barzilay's new Design X equipment cabinets, which feature sloping, high-visibility mounting surfaces for tape recorder and electronics, are among the most impressive pieces of audio furniture ever offered—kit or no. Barzilay and Furn-a-Kit have a number of equipment cabinet kits with matching speaker enclosures—though, again, optimum sonic results would presuppose that you use a driver array ideally suited to the enclosure. Some speaker manufacturers—Electro-Voice is one—will give you their recommendations for drivers if you write them specifying the type (bass reflex, infinite baffle, or whatever) and inside dimensions of the enclosure you are considering.

There is also a sneaky way out: buy an entire speaker system—an unfinished utility model would keep down the cost—small enough to slip inside the furniture maker's enclosure. Another way out is the Audio Originals approach. Its knockdown units have horizontal shelves to hold electronics, turntable, and records, and vertical openings at each end to hold typical acoustic-suspension speaker systems. The speakers can easily be angled or even removed for optimum sound distribution in the room.

Other furniture models, including some very inexpensive ones, are available from Lafayette and Allied. And Eico has the WE-78 compact enclosure that, for less than \$40, will hold a turntable and a Cortina receiver side by side.

Once upon a time, Eico also offered a tape recorder kit. So did Knight/Viking and Heath/Magnecord; but those days are gone. If you want to get into that kind of elaborate kit building, however, you can still take on electronic organs. Heath sells various Thomas models in kit form; Schober sells its line only as kits, and its newest model also can be ordered from Allied Radio. You also may want to tackle color TV; Heath lists several kit models.

Once you've built the basics of your stereo system, you may want to wander further afield. You can, for example, add an SCA adapter to pick up the background-music broadcasts that are multiplexed on some FM stations (in addition to the regular stereo signals). Kit adapters are available from at least two small companies in the New York area: S.C.A. Services Co. and Music Associated. Then you may want

test equipment to check out your equipment or aid in building more elaborate gear. Both Heath and Eico make full lines of test equipment in kit form. The Knight-Kit line also includes test gear. Or you may want to add music-powered "psychedelic" lighting. Eico's Sound n' Color line offers a variety of kits; some separate the sound into as many as four frequency bands to drive different color circuits. And, for add-on odds and ends, there are the so-called minikits, usually sold in blister or plastic packages through radio parts outlets.

Minikits are intended primarily for the experimenter hobbyist and usually consist of basic parts only. They contain nothing that could be called a front panel, so words like "styling" and "elegance" simply don't apply. But in the hour or two that it takes to construct even the most complex of minikits, you can slap together a basic preamp circuit or a monitor amp powerful enough to drive a transistor-radio speaker. If you like to fool around with audio, try looking into the Eicocraft line for starters. RCA, Radio Shack, and a number of other companies also put out comparable kits.

There are other accessory kits, too. The Koss/Knight KG-802 headphone kit—similar to the Koss SP-3XC, but costing a few dollars less as a kit—is one example. Once you get hooked on kit building you'll find that endless possibilities are open to you. For one thing, you'll start to consider little alterations in the equipment you build. Cabinetry is easiest to alter and most of us come to kit building with some experience in woodworking. Electronics may pose more of a problem. Outside of the Hege-man line, which is designed for special treatment, "customizing" may void the kit's warranty. So you'll want to be sure you know what you're doing and how the unit's warranty will be affected before you begin making changes.

The best way to learn is simply to begin building. Most high fidelity kits come with instructions that give you some insight into circuit functions while you build. Possibilities for circuit alterations are minimal, of course, when you're dealing with integrated circuits, prealigned subassemblies, and printed circuit boards. But basic changes are not recommended in any case. If you get deep into the guts, chances are you'll just louse up a good design job; so stick to those relatively superficial changes that will add flexibility and allow extra functions.

By way of example, take an Eico HF-20 tubed mono amplifier I built fifteen years ago. Two extra switches and a few additional wires gave me switchable input impedance on the phono preamp and a tape-recorder hookup that could be connected either before or after the tone controls—allowing either a "flat" or an "equalized" signal to be recorded. This amplifier is still in my living room today as the central element in a special equalization setup I use for copying old 78-rpm discs.

Whether or not you decide to throw yourself that far into kit building, "take it slow" is a motto you will do well to observe. There's no greater danger to the ultimate performance of the equipment you build

than trying to get the job done in a hurry or continuing to work after you have begun to tire. A second rule, almost as important, is to double-check everything, whether the instructions tell you to or not. No rechecking ever is wasted; it's a kind of insurance against blown transistors, odd noises or silences, and similar failures when you finally plug the AC cord into the wall.

If you've never tried anything of the sort before, you must first learn to solder. Most instruction manuals cover the fundamentals. Schober Organ even gives you a little practice kit that you can assemble and send in for comments by Schober's engineers. Once you pass that test, the company says, you can build any organ it makes. (You can, too; but organs are so complex that you mustn't assume yours necessarily will work when you first turn it on. Once again, you must take it slow and be prepared for lots and lots of double-checking before you're ready to zip off a Toccata and Fugue.)

For openers buy yourself a soldering pencil designed for work with transistors—Weller, Ungar, and several other companies make inexpensive models that are just right; and get some high-quality solder—one of the best is Ersin Multicore 16-gauge 60/40. That last figure means that the solder is composed of 60 per cent tin and 40 per cent lead. Other mixtures are available, but have higher flow temperatures and are not as well suited to circuit-board work where excessive heat can loosen the board's metal foil. By all means avoid solder with acid flux (most kits require that resin-flux solder be used if the warranty is to remain in force) and soldering "guns," which overheat quickly.

The next step is to buy an inexpensive kit to fool with. I started out with a two-transistor radio and did a poor job on it. But what I learned for the \$1.49 it cost me saved many dollars on the component I built next. Let's say you want to start out with a mike preamp made from a mini-kit. If so, buy two—they're inexpensive. Build the first one and look at all the things you did wrong. Then build the second one. The first one may work; but as you get used to handling the soldering iron, your solder joints will become trim and shiny, the "dressing" of the wires will be neater and show less evidence of iron burns. Now you will be ready for bigger game.

If you are doing a good job, the appearance of your wiring and soldering joints will not only be satisfying, it will be an index of quality in the finished equipment. Sloppy, wandering wires pick up hum, noise, and crosstalk. Dull, gray solder is a poor conductor and is mechanically weak; oversize solder joints threaten short circuits with neighboring leads—as does burned insulation, which may also be a sign of damage to whatever is beneath it.

And that's about it for basic guidelines. When you read the introductory matter in your kits' manuals—as you must, and carefully too if you're to do a good job of assembly—you'll pick up other pointers. When you're finished you can, like the fellow in the ad who caused them to laugh when he sat down at the piano, amaze your friends and delight their ears. In stereo.



This pilot model of the Citation Twelve basic amplifier, loaned to us by Harman-Kardon, suggests that production model may well turn out to be a classic.

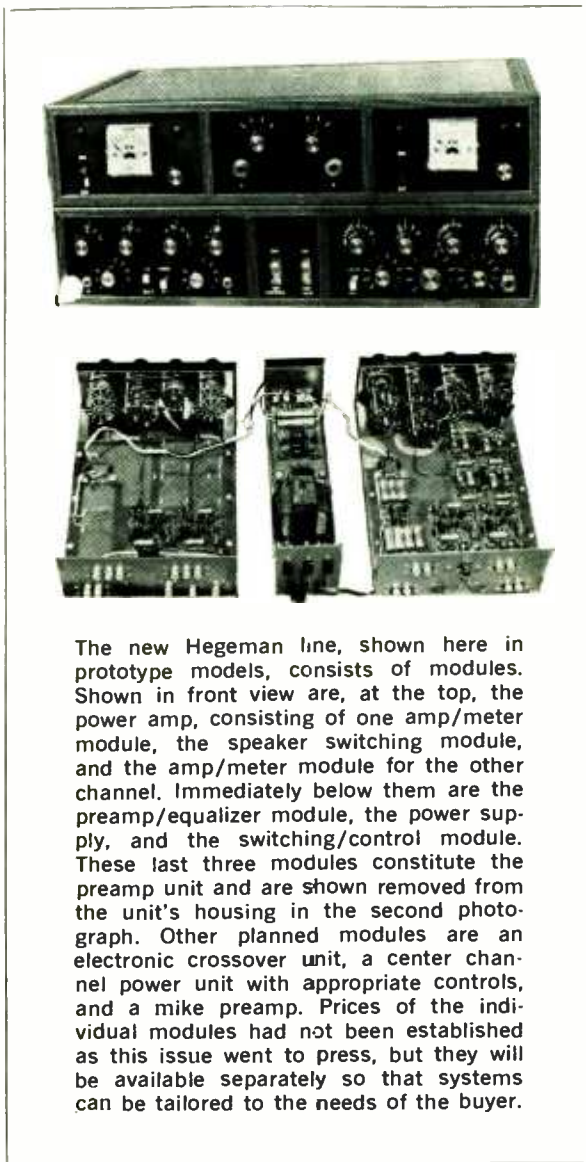

The new Hegeman line, shown here in prototype models, consists of modules. Shown in front view are, at the top, the power amp, consisting of one amp/meter module, the speaker switching module, and the amp/meter module for the other channel. Immediately below them are the preamp/equalizer module, the power supply, and the switching/control module. These last three modules constitute the preamp unit and are shown removed from the unit's housing in the second photograph. Other planned modules are an electronic crossover unit, a center channel power unit with appropriate controls, and a mike preamp. Prices of the individual modules had not been established as this issue went to press, but they will be available separately so that systems can be tailored to the needs of the buyer.

Professional Hints for Amateur Tape Recordists

By Larry Zide



PERHAPS THE MOST fundamental advice we can give to anyone using a tape recorder is that he take the time to read the instruction manual that comes with his machine. From cover to cover. To realize a recorder's full potential, you must get to know its working characteristics so well that using it becomes largely a matter of reflex action.

To begin with, it is obvious that while all tape recorders use tape, they do not use it in exactly the same way. Open-reel recorders run the tape from one (the supply) reel to another (the take-up) reel. Cassette recorders transfer the tape from a supply hub to a take-up hub, all enclosed within a plastic packet. Cartridge recorders move the tape in a closed loop which rewinds onto itself—also enclosed within a plastic container. Of all the classes of tape equipment, the open-reel machines offer the greatest versatility both in operation and in choice of tape. A cassette or cartridge machine trades that versatility for extreme convenience of use.

Only an open-reel recorder gives you a choice of tape speed. It is axiomatic that the fastest speed offers the highest over-all sonic quality—but at the highest cost in terms of the tape it uses. The highest speed you are likely to find on a quality home recorder is $7\frac{1}{2}$ ips (inches per second). At this speed you can expect, on many machines, close to a 20,000-Hz response curve, flat within a few dB. Other tape speeds divide the $7\frac{1}{2}$ ips by factors of two, so the next lower speeds are $3\frac{3}{4}$, $1\frac{7}{8}$, and $15/16$ ips. (Certain industrial and broadcast logging recorders run even slower.) Cassettes recorders run at $1\frac{7}{8}$ ips; closed-loop cartridge units (both 4-track and 8-track) at $3\frac{3}{4}$ ips.

Unless a recorder has special compensation built into it, you can figure that each reduction in speed will mean a loss of as much as one octave at the high end. And as speed is reduced, tape-motion irregularities may become more apparent.

The deductions to be made are obvious. When recording, use the highest speed possible consistent with the program material to be recorded, and the amount of tape at your command. If you are recording speech—which has a relatively limited frequency range—you probably will find that the lower speeds produce a quality that is indistinguishable from the higher speeds. Not so with music—which demands wider response ranges—though on the better machines you will be hard put to hear the difference between $7\frac{1}{2}$ and $3\frac{3}{4}$ ips.

Recording Levels

All tape recorders have some method of indicating the level of the signal that is being recorded onto the tape. Most machines use a meter (or meters for stereo recorders); some use one or two magic-eye tubes. Whichever type of indicator you have, its operation hinges on one concept: that of maximum allowable

Mr. Zide is editor of the engineering magazine db.

level, known as zero VU. The letters stand for volume unit—essentially the same as decibel (dB) but presumably standardized with respect to a specific signal reference level for tape. The magic eye is designed to indicate this zero level when it just closes—that is, when the two sides of its pattern just touch. The meter is supposed to indicate zero VU at the juncture of the red and black portions of its scale. When the sides of the eye overlap, or when the meter's needle travels into the red (plus VU) portion of the scale, an overload is indicated.

How accurate such an indication will be depends on both the quality of the indicator and the type of program material fed to it. The most inexpensive meters tend to exhibit vagaries of movement in one respect or another—what an engineer would call inferior ballistics. The meter's needle (unlike the electron beam in a magic eye) has mass and inertia. If it is driven too abruptly up the scale, when responding to a sudden peak in the signal, it will tend to overshoot and—momentarily, at least—read higher than it should. If its motion is excessively damped to control the overshoot, the needle may not have a chance to reach full indication of brief peaks before they are past.

Because of this ballistics problem, all meters represent a compromise. Professional meters, or "true VU" meters by engineering standards, are no exception. If your recorder has meters, it will pay you to observe their action closely, comparing visual overload indication against audible distortion as an aid to optimum meter settings for different sorts of program material and for various kinds of tape.

It must be understood that music has a dynamic range (the ratio of loudest to softest signal levels) which, at its greatest, may well exceed the capabilities of a tape recorder. A recording indicator enables you to record the signal at its maximum possible level short of overload and distortion so that you can take full advantage of the machine's limited dynamic range. This range, incidentally, approximately equals the record's signal-to-noise ratio. If, for instance, a recorder has a signal-to-noise ratio of 55 dB for a given recording level, it will run into overload and increased distortion when trying to capture the full range of 80 dB or more that a live orchestra might produce.

The zero indication on the meter tells you the maximum *sustained* signal that can be recorded on the tape without exceeding the tape's capability to hold a clean signal and produce distortion.

Note the emphasis on sustained. In contrast, an occasional instantaneous peak in the music that drives the meter beyond zero (and the meter may even be overshooting, as I've said) is no cause for concern. Of course, if the needle rises to beyond zero too often, it might be wise to back off a bit on the input level. On a calibrated meter, back off until average high volume is no more than about -2 VU. In fact, for most live recording I'd advise peaking between -5 and -2. This is particularly true if you are planning to combine speech and music. Because speech as we normally hear it is sustained but relatively

quiet in comparison to the peak sounds of an orchestra, it will seem unnaturally loud when it is combined with music recorded at the same peak level.

Setting levels is a high art among professionals. It is indeed worthwhile to practice with as many different sonic subjects as possible.

Recording with Microphones

A microphone, in a sense, is the reverse of a speaker—and, as such, is subject to all the variables that we accept as normal among speakers. More expensive mikes are likely to offer more versatility along with higher quality than inexpensive or original equipment mikes.

The first microphone specification you will probably encounter relates to its directionality—that is, the sensitivity pattern with which it accepts sounds impinging on it from various directions. Among the most common is the omnidirectional (or nondirectional) type that responds to sound more or less uniformly, no matter from which direction it comes. A good omni usually is fine for picking up over-all effects or for close-in miking. And it may cost less than a directional mike of equal quality.

Many directional mikes are called cardioids because their acceptance pattern resembles the mathematical cardioid or heart shape (referred to more accurately in German as a kidney shape). Cardioid mikes are most sensitive at the front. As a sound source moves to the side, the mike gradually becomes less responsive until, with the sound behind it, the mike produces almost no signal. Cardioids also may be called unidirectional (as opposed to omnidirectional) or simply directional (as opposed to nondirectional). But in recent years, there has been a proliferation of models even more narrowly directional than a true cardioid. Sometimes they are called hypercardioids. The most directional of all are the so-called shotgun mikes.

A directional microphone is extremely useful in some situations because it reduces response to spurious sounds—audience noise in the recording room, for instance, or the sound of traffic. A good cardioid, because it puts its sensitivity where the action is, makes an excellent choice for general use by the home recordist. However, you should approach ultradirectional mikes with some caution. If a mike's acceptance pattern is too restricted, its position becomes critical. If the source (a singer, for example) or the mike is free to move, the signal's level may fluctuate and—more important—its tonal characteristics may change with the motion.

Bidirectional (or figure-8) microphones are equally sensitive at front and back, but virtually unresponsive at the sides. Although they are valuable in the studio, you may find them awkward in most amateur recording situations. I don't recommend them as the first choice for most home recordists.

For a live recording session you will want to arrive early enough to experiment with mike placements and determine which locations will deliver

HOW NEEDLE BALLISTICS CAN AFFECT METER READINGS

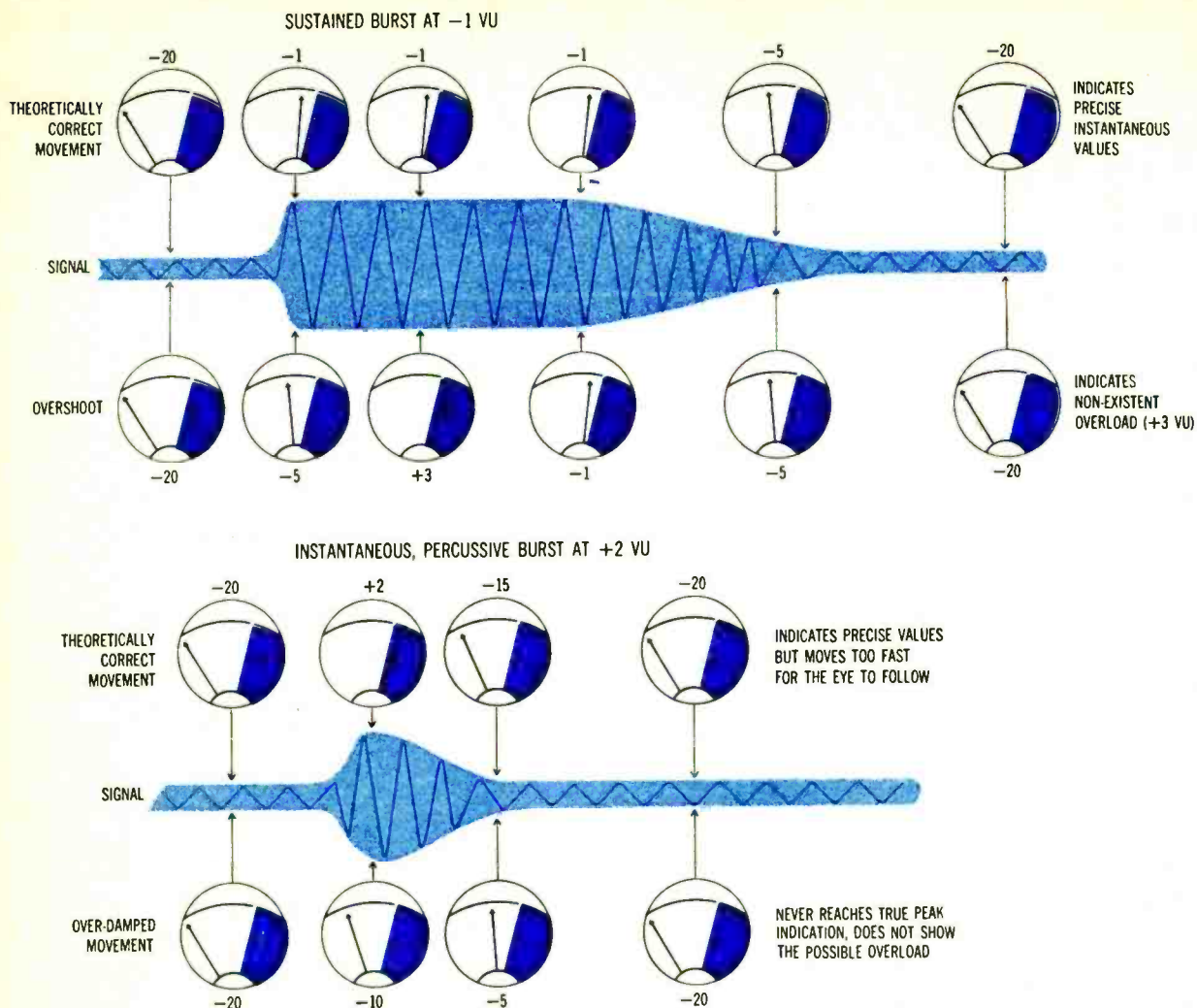

the best sound. You will also want to sample the loudest sounds your equipment will be asked to cope with, to determine gain settings in advance.

Recording From Other Sources

Broadcast material is protected by copyright and indeed is the property of the copyright owner. This means that off-the-air recordings must be made only for your personal use and not for commercial purposes.

Today's stereo amplifiers and receivers typically have a pair of tape output jacks. Standard phono cables should be run from these outlets to the auxiliary line or tuner inputs of your recorder. Then any material coming through your control center will automatically be fed to the recorder.

Don't overlook the possibility of recording from your television set. It will require a special audio take-off on the set—connected to one of the auxiliary inputs on the control unit—but some TV material can provide interesting listening. Often it's surprisingly high-quality audio. FM, TV, and AM stations carefully monitor the maximum audio signal they broadcast, as required by federal regulation. In addition, all stations use automatic limiters that prevent even an accidental excess in their signal output. Consequently the station will never surprise you with a sonic blast.

If you tune in the station a bit earlier than the broadcast you want to record, you will almost always be able to determine peak signal levels within a few minutes. Generally you will find that commercials do not hit peak levels any higher than those of music or speech, although their higher *average* loudness makes them seem louder.

At your first attempt to record stereo FM (multiplex) you may hear howling noises on the tape along with the program. The reason for the noise is that all tape recorders generate an ultrahigh-frequency bias signal that is put on the tape along with the recorded signal. At the same time, a stereo FM broadcast includes a 19-kHz pilot signal, used to trigger the stereo information circuits. The tuner doubles this 19-kHz signal to 38 kHz and should filter both signals from its output, but it may not always do so properly. If the tape recorder's bias oscillator produces too low a frequency, it can interact with the tuner's pilot signal—producing howls. Modern tape recorders, as a rule, have bias frequencies high enough to eliminate this problem. If you should encounter it, contact the manufacturer of your tape recorder and ask him for an input-filtering circuit to prevent the interference. The filter need not be expensive or difficult to procure.

Recorders with a pause control have a particular advantage in off-the-air recording. When announcements, station breaks, commercials, and the like come on, hit your pause control. This will save much

editing later. There is a danger though. If you are not quick enough when the program comes back on, you will lose a split second of the music.

A last consideration for off-the-air recording is timing. Tapes come in various thicknesses and lengths. Be sure you have enough tape to record all of the program you want. If you know that there will be station breaks between selections, you may be able to change tapes during such intervals, and thereby avoid having to use ultrathin long-play tapes with their attendant mechanical delicacy.

Making tapes from a previously recorded source is the easiest kind of recording. You have the program material fully under your control and you can "re-hearse" it until levels are perfect.

Except for the position of the selector switch, the setup with a component system would be exactly the same as that for recording a broadcast. With most automatic record players, you can simply start the tape recorder and cycle the automatic player. The same muting switch that prevents you from hearing the noises of the change cycle will prevent your recorder from hearing them too.

If you have a manual player, you can avoid the noises of cueing and stylus set-down by starting the recorder with its level control turned down. Then, once the stylus is in the lead-in grooves, bring up the control to the predetermined point.

With either a changer or manual player, you can add a bit of professionalism by fading down the record control smoothly as soon as the program is ended to eliminate the sound of the run-out groove. However, be sure to wait until the final echo of the music has died away before fading.

If you are taping a series of short selections from a number of discs, you may have to use the pause control much the same as you would for a broadcast. At the end of the first selection do not fade down. When the pickup reaches the spiral between selections on the disc, engage the pause control. Then check levels on the next selection, if necessary, and start the record playing at the end of the selection that precedes the one you want to record. When the pickup once again reaches the spiral between selections, release the pause control. The two selections you have thus dubbed will sound on your tape as though they had followed one another in the original recording, without the "dead" tape in between that you get when you fade down at the end of each number.

Tape Editing

If you are using a cassette or cartridge recorder, this section will prove somewhat academic. While there are splicers made for cassettes, you'll find that the narrower width and packaging of cassette tape make it relatively difficult to handle. Closed-loop tapes are, of course, wider—but splicing tape used on them will prevent correct cartridge feeding.

For open-reel tape, of course, there are any number of good splicers available. To make the splice, the two tape ends (usually cut at 45 degrees) are butted together, not overlapped. Then they are joined by a piece of splicing tape—available in rolls, or precut as ready-to-use splices—placed across the two butting ends. Note that special splicing tape must be used. Ordinary transparent tape is not suitable, since it has an adhesive that will ooze under the pressure of layers of tape on a reel, causing adjacent layers to stick to each other and gumming up your recorder's heads and guides.

Splicing tape is manufactured in several widths. The narrow (7/32-inch) width is intended for use parallel to the tape; wider splicing tape (1/2 and 3/4 inch are common) goes across the tape and must be trimmed off at each side. With either type, make very certain that no adhesive is exposed at the sides of the tape or between the tape ends. Position tape ends correctly, and trim carefully. To avoid overhang in using the wide splicing tapes it is common to trim *slightly* into each edge of the recording tape. But don't overdo it: you can easily cut into the signal of the outside tracks on a four-track tape.

Probably the most common practice among professional and advanced amateur tape editors alike is to use a good quality editing block and a *sharp* razor blade to make splices. Carelessly used, these devices will not produce perfectly matched butt ends in your splices, of course, but it is mechanically the simplest system available. Some of the more elaborate splicers tend to be somewhat cantankerous in operation. Most plastic editing blocks are to be avoided. If the molding is not sufficiently accurate, the block will not hold the tape flat and straight; in extreme cases, rough edges can even tear the tape.

Finding the correct point to make your cut on a recorded tape can be tricky. Most recorders will allow you to rock the tape by hand while you listen for the exact spot at which you want to make the cut. This will be right at the playback head. A mark should be made on the tape—but not on the head, of course—with a grease marking pencil. Then make your 45-degree cut at the mark.

An alternative method is to measure the distance from the 45-degree cutting groove on your splicing block to the end of the block and lay off the same measurement along the tape from the playback head toward the take-up reel. Place a marker—masking tape works well, since it can be altered if necessary—on the top plate of your recorder directly under the tape at this point.

Once you are cued up to the editing point on a tape, grasp it just beyond the marker and place it in the block, with your fingers at the end of the block. Done correctly, the editing point will fall on the 45-degree groove. But it may take some practice with the marker to get proper results.

In tight editing—that is, in the middle of continuous music or speech—splices will be most diffi-

cult to detect by ear if you cut on or just before the transient at the beginning of a sound—rather than at the end, which tends to trail away into room sound and ambient noise. Of course, the faster the tape speed, the easier the job. Words that take one second to utter will be spread over 7½ inches of tape at 7½-ips speed, but will be crowded into 1⅞ inches at 1⅞-ips speed.

When recording a tape you know will have to be edited, use your tape machine's numbered counter to index it for later revision. These counters, incidentally, do not indicate footage. They are usually driven by a belt from one of the reel turntables. The counters merely indicate the number of revolutions of that reel. If you remember your high school math, a reel turns faster when the diameter of the tape on it is small than when it is almost full. The counter is nonetheless an accurate tape index to the *unedited* portion of any particular reel. Once you shift the position in the reel of any given piece of tape, though, you alter the way the counter will measure it.

Many manufacturers of raw tape also supply leader—usually a white plastic or paper tape with no oxide coating. You should use a few feet of leader to protect the beginning and end of each reel.

One word of warning when editing quarter-track stereo or mono tape: you can't cut into it without cutting all four tracks, so don't edit one track if the other tracks are recorded. If you plan to edit, choose a blank tape and record in one direction only. Similarly, if you want to use leader tape between selections, the extra tracks must be left blank.

Basic Maintenance

Any piece of fine equipment should receive regular preventive maintenance. For a tape recorder, regular "pm" is fairly simple.

The magnetic coating on all tapes has a tendency to shed on the parts of the machine it touches—guides, tape heads, capstan, etc. Cleaning should be performed after every few reels of tape and certainly just before any important recording is to be made; otherwise the oxide build-up will surely cause high-frequency loss, distortion, and drop-outs. Many apparently malfunctioning machines that find their way to service shops need nothing more than a good head cleaning.

A cotton swab moistened (not sopping) with commercial head-cleaning fluid and brushed firmly across the heads and guides will do the job. Don't use carbon tetrachloride. Aside from the fact that its fumes are highly toxic, it is too good a solvent. It will not only dissolve the accumulated oxide and dirt, but will also attack the plastic resins that some manufacturers use to bond the layers of the head.

After a period of time, the succession of magnetic impulses going in and out of tape heads will leave a bit of magnetic residue. If it is not removed, it will affect all subsequent tapes played on the

partially magnetized machine: you will hear more tape hiss, and less very high frequencies.

It is easy to demagnetize your recorder. For less than \$10, you can buy a head demagnetizer (sometimes called a degausser) that will do the job. It should be applied to record and playback heads and tape guides. It is not necessary to demagnetize erase heads. One caution: be sure that the recorder's power switch is off during demagnetizing. The pulses induced in the tape heads by a demagnetizer might overload and damage recorder circuitry.

For best performance, of course, the tape heads must be perfectly aligned with the tape. Your instruction manual may contain information on head alignment. But don't attempt it unless you have the proper tools and experience.

The same may be said for bias adjustment. Many of the better tape recorders have some provision for the adjustment of recording bias. Adjustment alters bias current but not its frequency. Correct bias is a compromise, at best. The amount of bias affects the tape's signal-to-noise ratio, its distortion, and its high-frequency response. Bias can be set to favor one of these factors but can't be ideal for all of them simultaneously. The most common method of adjustment is to feed a 500-Hz signal into the recorder at its highest tape speed. While the signal is being recorded, set the bias to produce maximum output from the tape. (This is easier to achieve on a three-head machine that permits monitoring from the tape while recording.) Then increase the bias so that the output from the tape drops about 1 dB. This setting will provide the optimum compromise bias for the tape being used. Because the bias requirements of various kinds of tape differ, serious recordists should standardize on a single type of tape and leave their bias set for that type.

Sooner or later, most machines need lubrication. Your instruction manual is the only guide to follow. Since some recorders use permanently lubricated bearings, do not be alarmed if your manual says nothing on the subject. But if it does tell you to lubricate, follow instructions carefully. Avoid excessive oiling. Above all, take care not to get oil on rubber capstan and idler parts. If you do, use a swab soaked in alcohol and wipe the oil off immediately. Oil can rapidly decompose rubber parts.

If your machine uses pressure pads, you may have to replace or adjust them after a year or so. Again, your manual should be your guide.

A system malfunction calls for expert service. Check with the manufacturer for the best course of action. Remember that a proper regimen of preventive maintenance will postpone the day of malfunction for years. It really pays.

A final word on battery-powered recorders. A battery recorder is like any other except for its power source. All use batteries, but many can be operated from house current as well. Batteries have a habit of failing just when you need them most. So remember to check their condition before you start to record. If you are in doubt, carry extra batteries.

**Anyone who
wants the best,
and is worried about
spending an extra \$20,
ought to have
his ears examined.**



Look at what you're getting for the extra \$20.00.

The Papst hysteresis motor for reduced noise and rumble, unvarying speed accuracy. An exclusive feature of the Miracord 50H.

The cartridge insert with slotted lead screw for precise stylus overhang adjustment. Without this Miracord exclusive, your whole investment in a record-playing instrument could go down the drain. Because if the stylus overhang is incorrect, the finest cartridge will not track accurately.

The exclusive Miracord pushbuttons—the gentlest touch is all that's needed to put the 50H into automatic play (stacks of 10 or single records). Or you can start the turntable and play single records manually by simply lifting the arm and placing it on the record.

In addition to these exclusive features, the Miracord 50H offers a metal cam (not plastic) for greater reliability; piston-damped cueing; effective anti-skate; a dynamically balanced arm that tracks to 1/2 gram.

Finally, consider what the leading experts are saying about the Miracord 50H. That \$20 bill looks pretty tiny now, doesn't it? Miracord 50H less cartridge arm and base, \$159.50. The Miracord 620 (\$99.50) and the Miracord 630 (\$119.50) follow in the great tradition of the 50H. See what we mean at your hi-fi dealer. Benjamin Electronic Sound Corp., Farmingdale, N. Y. 11735. Available in Canada.

MIRACORD 50H
another quality product from BENJAMIN.

CIRCLE 8 ON READER-SERVICE CARD



Second to one...

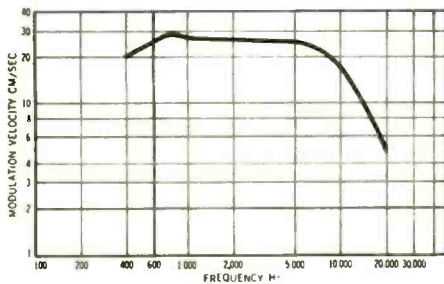

TRACKABILITY CHART FOR M91E

If it were not for the incomparable Shure V-15 Type II (IMPROVED) Super-Track, the Shure M91E Hi-Track would be equal or superior to any other phono cartridge in trackability . . . regardless of price! The astounding thing is that it costs from \$15.00 to \$50.00 less than its lesser counterparts. And, it features an exclusive "Easy-Mount" design in the bargain. Trade up to the M91E now, and to the V-15 Type II (IMPROVED) when your ship comes in. Elliptical Stylus. $\frac{3}{4}$ to $1\frac{1}{2}$ grams tracking. \$49.95. Other models with spherical styli, up to 3 grams tracking, as low as \$39.95.

SHURE

M91E HI-TRACK PHONO CARTRIDGE

© 1969, Shure Brothers Inc., 222 Hartrey Ave., Evanston, Illinois 60204
 CIRCLE 66 ON READER-SERVICE CARD

new equipment reports

THE CONSUMER'S GUIDE
TO HIGH FIDELITY EQUIPMENT

SANSUI RECEIVER DRIVES THREE SPEAKER SYSTEMS



THE EQUIPMENT: Sansui 4000, a stereo FM/AM receiver. Dimensions: 17 $\frac{3}{4}$ by 13 $\frac{1}{4}$ by 5 $\frac{1}{4}$ inches. Price: \$379.95. Manufacturer: Sansui Electric Co., Ltd., Tokyo; U.S. branch, Sansui Electronics Corp., 32-17 61st St., Woodside, N.Y. 11377.

COMMENT: High quality and high performance at a not-so-high price characterize the new Model 4000 receiver from Sansui. The set combines a very sensitive tuner with a husky and versatile amplifier in an attractively styled format. Its front panel features the blackout-type tuning dial that lights up only when FM or AM is chosen on the program selector knob. For other signal sources, the panel remains dark but the appropriate word (phono 1, phono 2, or auxiliary) lights up against the background. And lo! even the station-dial pointer changes color—red for FM, orange for AM. The generously proportioned station dial includes FM and AM channel markings plus a logging scale. FM tuning is aided by two meters—one for signal strength, the other for center-of-channel. The former meter also operates on AM. The legend "FM stereo" lights up whenever a stereo FM signal is tuned in. There's also a "protector" legend on the panel that lights up if a current-limiting circuit (in the power amp) has been activated to prevent the output transistors from becoming damaged. Just to the right of the tuning dial are two pushbuttons for interstation muting and for multiplex noise cancellation; to their right is the station tuning knob.

The lower portion of the panel contains controls common to both tuner and amplifier sections. At the lower left there's a power off/on pushbutton. Next to it is a stereo headphone jack, followed by an unusually versatile speaker selector control that lets you choose any of three stereo speaker systems, or a combination of system "A" simultaneously with system "B," or system "A" simultaneously with system "C." A final position mutes all the speakers. The headphone jack remains live at all times, by the way. Next in line are the high and low filter switches; bass and treble tone controls (dual concentric types that permit you to adjust bass and treble separately or

simultaneously on each channel, as you choose); a volume control; a channel balance knob; four more pushbuttons for loudness contour, channel reverse, mono/stereo mode, and tape monitor; and finally the input program selector with positions for phono 1, phono 2, AM, FM mono, FM automatic, and auxiliary.

The rear of the set contains the connectors for hooking up three pairs of stereo speaker systems, the inputs corresponding to the front-panel selector, plus tape-monitor inputs and tape-feed outputs. A European-type (DIN) connector enables hookup of foreign-made recorders, using the single 5-pin connector commonly found on such units. In addition to a built-in AM loopstick antenna, there are terminals for connecting a long-wire AM antenna. FM antenna terminals accommodate both 300-ohm and 75-ohm lead-in. A local/distant switch is provided. The speaker and the antenna connectors, by the way, are an unusual type: spring-loaded, press-to-connect holders that appear to be ruggedly made and easy to use. Two AC outlets, one switched, are provided. The left and right output channels are individually fused, and a third fuse protects the main power line. Yet another safety feature is the rear-panel output-level adjustment which you may use to limit the maximum signal fed to the speaker systems (the front-panel volume control then will regulate relative gain within that limited range). To determine the noise level at which the front-panel muting switch takes effect, there's a muting-threshold adjustment. Two grounding posts and the power cord complete the rear picture, but one additional control deserves mention: under the chassis cover-plate you'll find a voltage-selector plug that enables the set to be operated on eight different values of power-line voltage, from 100 VAC up to 250 VAC. This plug is preset to the value required for a given locale, but it assures that the equipment can be used anywhere in the world.

When you weigh all this versatility together with the Sansui's excellent performance as both tuner and amplifier, you must conclude that here is a really appealing set. FM sensitivity is among the very best yet measured, showing a rapidly descending, steep

REPORT POLICY

Equipment reports are based on laboratory measurements and controlled listening tests. Unless otherwise noted, test data and measurements are obtained by CBS Laboratories, Stamford, Connecticut, a division of Columbia Broadcasting System, Inc., one of the nation's leading research organizations. The choice of equipment to be tested rests with the editors of HIGH FIDELITY. Manufacturers are not permitted to read reports in advance of publication, and no report, or portion thereof, may be reproduced for any purpose or in any form without written permission of the publisher. All reports should be construed as applying to the specific samples tested; neither HIGH FIDELITY nor CBS Laboratories assumes responsibility for product performance or quality.

limiting curve that crosses the -30 dB (IHF standard) quieting line for 2 microvolts of input RF signal, reaches an impressive -50 dB of quieting for only 5.6 microvolts, and attains full quieting of -55 dB (one of the best figures yet seen in any FM set) for 25 microvolts. No overloading of the front end is evident for inputs up to 50,000 microvolts, and sensitivity remains constant within 0.1 microvolt across the FM band. These excellent figures are borne out in use-tests: hooked to our cable-FM system, the Sansui 4000 proved to be in the champion class, logging no less than fifty-seven stations, of which

forty-four were judged to be satisfactory for long-term critical listening or off-the-air taping. The set's capture ratio, at 1 dB, is about as good as you can get. Low distortion (both harmonic and IM) and high signal-to-noise ratio further contribute to the Sansui's superior FM performance.

Complementing the tuner section is a high-powered, low-distortion amplifier that offers clean, wide-range response and excellent stability. Its 45-watt power bandwidth, for rated distortion of 0.8%, is better than average for a receiver in this price class; indeed, most other performance characteristics are too. Fre-

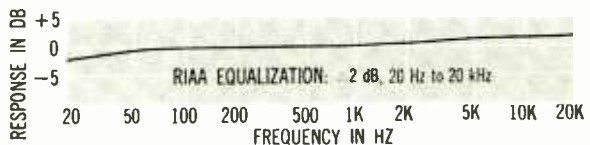
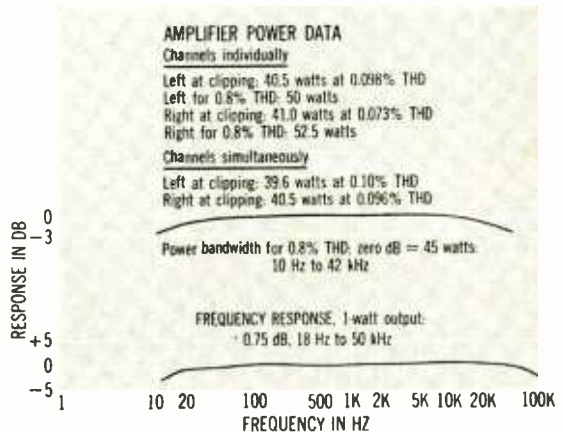
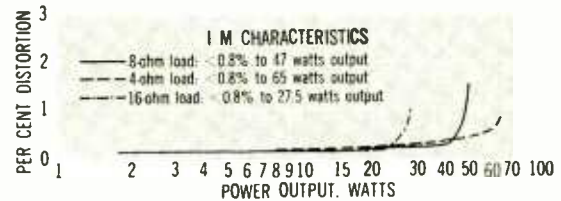
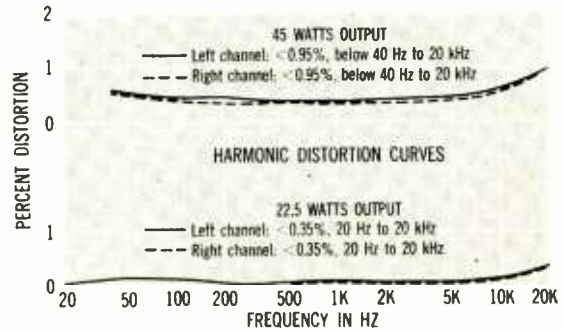
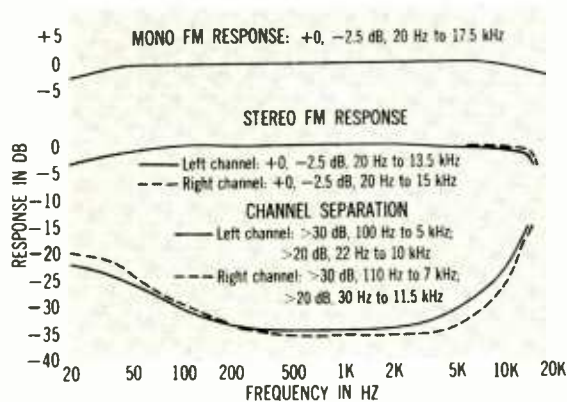
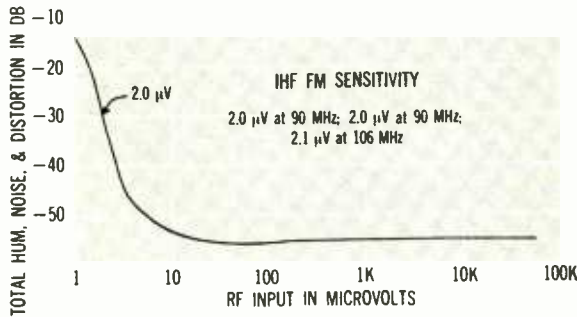

Sansui 4000		Additional Data	
Tuner Section			
Capture ratio	1 dB		
S/N ratio	68 dB		
IM distortion	0.20%		
THD	mono	l ch.	r ch.
40 Hz	0.26%	0.35%	1.0%
400 Hz	0.18%	0.66%	0.85%
1 kHz	0.20%	0.60%	0.45%
19-kHz pilot	-42 dB		
38-kHz subcarrier	-55 dB		
Amplifier Section			
Damping factor	40		
Input characteristics (for 45 watts output)	Sensitivity	S/N	
phono 1	2.6 mV	60 dB	
phono 2	2.7 mV	61 dB	
tope monitor	175 mV	87 dB	
aux	158 mV	71 dB	



Square-wave response

quency response is virtually a ruler-flat line from below 20 Hz to 50,000 Hz. IM distortion remains extremely low and linear at all three output impedances; harmonic distortion runs below rated levels across most of the band up to high-power outputs, and is virtually nonexistent at normal power demands. Signal-to-noise figures for all inputs are excellent. Low-frequency square-wave response shows a 45-degree tilt which indicates the normal roll-off in the subsonic bass commonly found in receivers; high-frequency square-wave response—with its fast rise

time and freedom from ringing—indicates excellent transient response and clean, well-aided middles and highs. The audible effect of this kind of response, combined with the set's very quiet operation, is a joy to hear. Finally, the owner's instruction manual, and a supplementary "quick-use" card, are well written and amply illustrated. The 4000 comes in its own metal case with four small feet; it may be placed "as is" on a shelf, or fitted into a suitable cut-out for custom installation.

CIRCLE 143 ON READER-SERVICE CARD



THE EQUIPMENT: PE-2018, a three-speed automatic turntable with integral tone arm. Dimensions: chassis, 13 $\frac{1}{8}$ by 10 $\frac{7}{8}$ inches; allow 3 $\frac{3}{4}$ inches clearance below and 5 inches above. Price: \$99.95. Manufactured by Perpetuum Ebner of West Germany; distributed in the U.S. by Elpa Marketing Industries, Inc., New Hyde Park, N. Y. 11040.

COMMENT: As compared to its predecessor, the PE-2020 (see HF reports, August 1968), the PE-2018 is somewhat smaller, lighter in weight, and offers three instead of four speeds, forgoing the 16-rpm option, but including 33, 45, and 78 rpm. The newer model also costs about \$30 less which, in view of its performance, makes it a very good buy indeed. The PE-2018 employs the same motor used to power the huskier job, and a similar arm which boasts a very effective built-in antiskating device and an adjustable vertical tracking angle. As in the earlier model, the new unit also features the stylus protector—a small rubber-tipped lever that rises up through the turntable base to sense the presence of a record. If it touches nothing, this lever will prevent the arm from moving.

The PE-2018 may be used as a stack-and-play automatic, as a single-play automatic, or as a single-play manual with or without automatic cueing. A repeat feature also enables you to play the same record repeatedly in either single-play or record-changer mode. The cueing control allows you to interrupt a record at any time and either resume playing at the point of interruption or at any other portion of the record. The arm, a low-mass and well-engineered metal tubular type, has provisions for balancing, stylus overhang, direct-dial stylus force, antiskating, and vertical tracking angle. The antiskating adjustment—once made as per instructions—is effective in equalizing stylus pressure against both walls of the record groove. The accuracy of the built-in stylus-force gauge was checked and found to yield the following results (first number is the actual setting on the dial, second number is the stylus force measured by the Lab): 0.5, 0.5; 1.0, 0.9; 1.5, 1.3; 2.0, 1.7; 3.0, 2.9; 4.0, 4.1; 5.0, 5.1. The automatic mechanism required a mere 0.3 gram to be tripped. Arm friction, laterally and vertically, was negligible. The changer mechanism performed satisfactorily and proved to be both quiet and gentle on the

A SMALLER AND LOWER PRICED PE TURNTABLE

records, although the complete recycling time was somewhat slow, taking 18 seconds.

Speed accuracy, for an automatic, was very good. A 33-rpm strobe disc, supplied with the unit, permits zeroing in on absolute speed for the 33-rpm setting. Thus adjusted, the Lab measured the degree of speed error for other settings and the results, shown in the accompanying table, are above average. And of course, using the vernier adjustment and an auxiliary strobe disc, the user can achieve absolute speed accuracy at any control setting. Flutter, at an average value of 0.08 per cent, was insignificant. Turntable rumble, by the ARLL standard, was clocked at -55 db, actually a dB quieter than in the costlier PE-2020. The platter weighed in at 4 pounds, 4 ounces—almost 7 pounds lighter than that used in the huskier unit, the platter in the PE-2018 obviously has a fair margin of power reserve which doubtless contributes to its quiet and smooth operation. Arm resonance showed a 6-dB rise at 8 Hz, which is well below any troublesome level.

The unique adjustment for vertical tracking angle is so engineered as to provide an optimum angle depending on the number of records stacked. For one record, this dial is set to number 1; for any number of records more than one, the dial may be set to provide optimum tracking angle for the center record in the pile, with the deviation from optimum varying no more than 50 per cent from bottom to top disc in the pile. This system, while it involves an extra effort on the user's part, is a definite advance over the fixed vertical angle customarily found in automatics.

The PE-2018 is supplied with prewired signal cables, an automatic spindle, a shorter manual spindle, and an adapter ring for single-play of 45-rpm doughnuts. The owner's instruction manual is clearly written and amply illustrated. Handsomely styled and smooth-running, it shapes up as a most competent job very worth serious consideration by anyone in the market for a new automatic player.

CIRCLE 141 ON READER-SERVICE CARD

Setting Speed (rpm)	Speed Accuracy (percentages fast or slow)*		
	105 VAC	120 VAC	127 VAC
33	0.2 s	set exact	0.1 f
45	0.1 f	0.5 f	0.7 f
78	1.2 s	0.8 s	0.5 s

*Measurements made with vernier speed control set for exact speed at 33 rpm using 120 volts AC, 60-Hz power line. Control may be adjusted by user for exact speed (i.e., zero error) at other settings and for varying power line voltages.

ADC'S THREE-STYLUS STEREO CARTRIDGE

THE EQUIPMENT: ADC-25, a stereo phono cartridge supplied with three styli (0.6-mil spherical, 0.3- by 0.7-mil elliptical, 0.3- by 0.9-mil elliptical). Price: \$100. Manufacturer: Audio Dynamics Corp., Pickett District Rd., New Milford, Conn. 06776.

COMMENT: Who needs three different styli for one cartridge? You may, depending on what kind of records you own and how fussy you are about playing them.

To begin with, the ADC-25 employs the "induced magnet" method of generating signals, introduced five years ago with its Point Four pickup. For an explanation of how it works, see the report on the Point Four (HF, October 1964), or write to ADC for its literature. Briefly, however, the induced magnet design can be credited with reducing the over-all mass of the moving system in a pickup and simultaneously with achieving very high stylus compliance. In fact, ADC—which has always been known for high compliance in its pickups—has outdone itself with the Model 25; its compliance, as measured by CBS Labs, was an unbelievable 120 ($\times 10^{-6}$ cm/dyne) laterally and an equally incredible 56 vertically. We know of no pickup that comes near these figures. This amount of compliance, combined with the unit's very low mass, enabled the Model 25 to track (in the SME arm) the demanding test bands 6 and 7 of CBS STR 120, and the glide tones on STR 100, at an unprecedented low stylus force of 0.25 gram. For playing normal commercial discs, the lab found that a mere 0.5 gram was ample.

This type of performance, combined with the three styli supplied with the cartridge, represents a bold and encouraging assault on the part of ADC against various forms of distortion which, in varying amounts, have been heard and complained about by many discriminating record collectors in recent years. According to ADC, the two sizes of elliptical tip are intended to provide a relatively higher or lower ride in the record groove depending on what portion of the groove already has been severely worn in past playings. No hard and fast rule can be laid down: the recommendation is to use that stylus which sounds best—on old and new records. The spherical stylus, ADC feels, is ideally suited for playing records whose inner grooves have been compensated during recording (ADC cites Dynagroove records as an example) inasmuch as such compensation is intended, ADC says, for spherical styli.

Admittedly, this is all somewhat elusive and hard to pin down in terms of individual recordings, the more so since RCA no longer states whether a particular release is indeed a Dynagroove or not. Moreover, the very question of what Dynagroove actually is cannot be that specifically defined. One (perhaps cynical) wag has suggested that Dynagroove is anything RCA says it is. On the other side, it also has been suggested with equal irreverence that here are these bright ADC engineers who have come up with a very fine cartridge but they can't agree on what size or type of stylus to fit into it, so they're giving us all three possibilities. Indeed, ADC's own literature asks the question: "Which stylus to use?" and answers it with: "In the final analysis, use the stylus which gives the best sound with the particular record being played." ADC also adds—and we believe it, on the basis of our own tests—that "no possible harm can be done to a record when using any of the Model 25 styli at a tracking pressure within the recommended range of 0.5 gram to 1.25 grams."

Of course, the idea of auditioning each record one

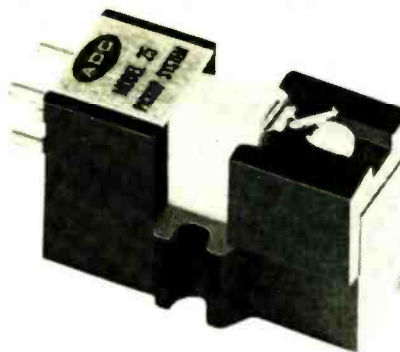

owns with three different styli, by way of settling on one tip for final listening, seems a bit much to expect of any but the most dedicated of "golden-ear" collectors, or of those who seriously dub treasured old discs onto tape. We wish we could come up with a final answer to the question of which stylus is best; but the results of our own tests indicate no clear winner.

What we did find was that with any of the styli, the ADC-25 is a superb, top-ranking pickup—albeit with some interesting differences observed among the three styli supplied. With each, output voltage on either

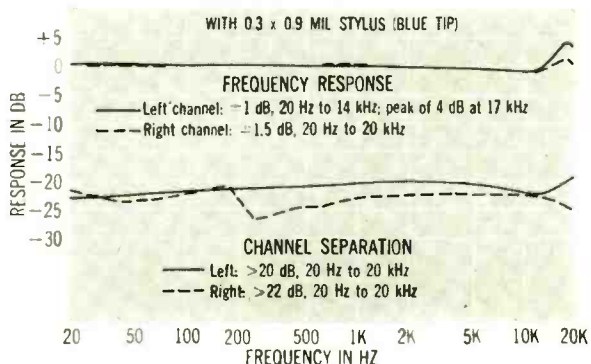
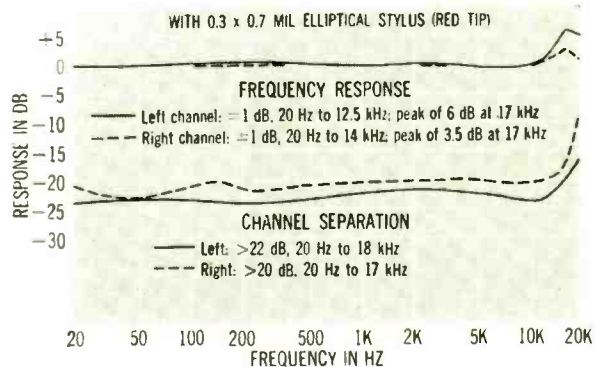
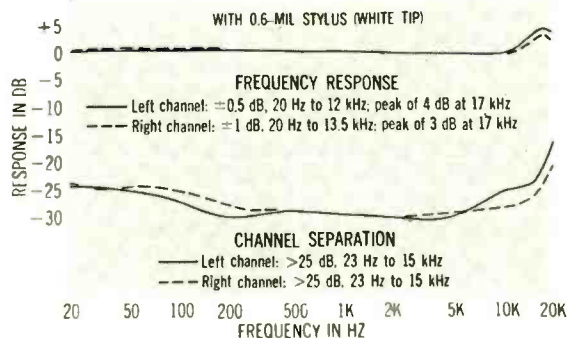

channel was measured to be exactly 3 millivolts; vertical angle, 20 degrees; low-frequency resonance, way down at 4.8 Hz (in the SME arm). Compliance, as already stated, was astonishingly high.

So much for similarities. As for differences, start with the frequency response curves for each of the styli. Note that across most of the audible range, response for any stylus is exemplary. However, at the very high end the 0.6-mil stylus had a maximum peak of 4 dB, and the 0.3 by 0.7 elliptical had a maximum peak of 6 dB. The 0.3 by 0.9 elliptical had a maximum peak of 4 dB, with one channel not peaking at all, but exhibiting the fabulous (for a cartridge) response of ± 1.5 dB from 20 Hz to 20,000 Hz. Clearly then, on frequency response, the largest elliptical is best.

But now look at channel separation. Again, all three styli show excellent separation characteristics, but the best belongs to the 0.6-mil spherical tip, with the two ellipticals sharing second place.

What about distortion? CBS Labs found that harmonic distortion was lowest for the 0.3 by 0.7 elliptical, higher for the 0.3 by 0.9 elliptical, and highest for the 0.6-mil spherical. By way of relating these amounts to other cartridges, we'd say that the 0.3 by 0.7-mil tip exhibited the lowest distortion yet encountered for a pickup; the larger elliptical had an aver-

age amount of distortion; the spherical tip had somewhat more than average distortion.

However, for IM distortion, the picture changes again. In this characteristic, the spherical tip was definitely superior to either elliptical, with the larger elliptical trailing the smaller by a decimal point or two. Just to see what would happen, the testers increased stylus force to 1 gram and remeasured IM distortion. You guessed it: the ranking changed again. Now—although the spherical tip still ran lowest—the two ellipticals changed place, with the larger one having a jot less distortion, although both ellipticals had much less distortion than before.

If, on the basis of all this testing, it is impossible to render a clear verdict as to which stylus is best, one thing does seem certain. Used in a high-quality arm within its recommended stylus-force range, and with correct bias force adjusted, the ADC-25—with any of its styli—will play your records with what is, at this state of the art, unsurpassed clarity and accuracy, and minimum groove wear. If you're still confused, look at it this way: \$100 gets you a pickup which, by virtue of its performance, is comparably priced with today's top models—especially when you consider that you're getting two "replacement styli" thrown in.

CIRCLE 142 ON READER-SERVICE CARD

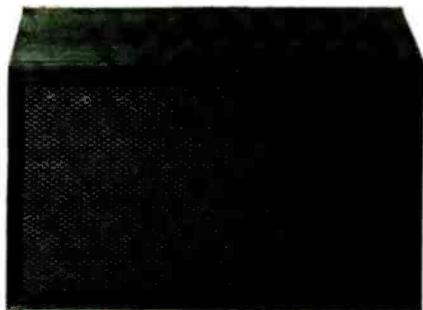

THE EQUIPMENT: Fisher XP-7B, a compact, full-range speaker system in enclosure. Dimensions: 14 by 12 by 24 $\frac{5}{8}$ inches. Price: \$149.95. Manufacturer: Fisher Radio Corp., 11-35 45th Rd., Long Island City, N. Y. 11101.

COMMENT: The Model XP-7B occupies a midway position in Fisher's speaker line. A four-way system, it embodies the sealed-box, direct-radiator design approach, utilizing a 12-inch woofer, two 5 $\frac{3}{4}$ -inch mid-range units (one covering the range from 350 to 800 Hz; the other covering frequencies from 800 Hz to 3,500 Hz), and a pair of 3-inch tweeters. The walnut enclosure, fronted with a canelike, nubby sort of grille, may be positioned vertically or horizontally. Connections at the rear are color-coded binding posts; there's also a three-step tweeter-level control with positions marked in plus, zero, and minus signs. Input impedance is 8 ohms.

After a period of listening we decided to leave the tweeter switch on its center or zero position (neither boosting nor attenuating the highs). Thus adjusted, the XP-7B provided clean, open, well-balanced sound throughout its range, which we estimated to extend from about 35 Hz to beyond audibility. The bass weakened (relative to higher tones) at 50 Hz but was still clean. Doubling started just below this frequency but did not increase significantly all the way down to 35 Hz, where the response just seemed to stop. Audible distortion, when the system was driven abnormally hard, sounded lower than average. Upward from

NEW BOOKSHELF SPEAKER SYSTEM FROM FISHER

the bass, response was extremely smooth and linear, with no objectionable peaks or dips. Dispersion was very good, too: a moderately directive effect became discernible just above 5 kHz but did not increase in severity until it reached 10 kHz, which bespeaks a very fine midrange presentation. Above 10 kHz tones narrowed in their perceptibility pattern, although 13.5 kHz was still audible slightly off axis. White noise response was very smooth and not too directive.

On program material, and installed in a very large room, the XP-7B pair projected a respectable amount of clean, wide-range sound that impressed listeners with its open and well-balanced quality. Strings sounded especially natural, and orchestral detail in general was well presented. At times, the very deepest bass heft seemed less than prominent—but this was only by comparison with three other systems costing considerably more than the XP-7B. In a smaller room, the XP-7B sounded better balanced and proved eminently listenable for long periods of time.

The XP-7B is more efficient than most air-suspension systems and can be driven to room-filling volume by amplifiers supplying as little as 5 watts (rms) per channel. It is rated for maximum power-handling capacity up to 30 watts (rms) or 50 watts (music power) per channel.

CIRCLE 144 ON READER-SERVICE CARD

REPORTS IN PROGRESS

Harman-Kardon CAD4
Cassette Recorder

Sony HP-465 Compact System

Columbia records announces a distinguished recording event.



Columbia celebrates the Beethoven Bicentennial with a special salute to the great master from Leonard Bernstein and the New York Philharmonic. The hailed contemporary conductor plays all nine of Beethoven's symphonies in this exciting specially priced 8-record set.

"When Leonard Bernstein is in the vein, he can bring to his readings of Beethoven an overwhelming dramatic dynamism and surge of human feeling. . . . One is swept into the world of Beethoven's own creative furies."—*Stereo Review*

D8S 815 (a specially priced 8-record set)

This year treat your friends to a musical Christmas. Leonard Bernstein does a lot more than just Beethoven on other multiple-record sets from Columbia.

On Columbia Records

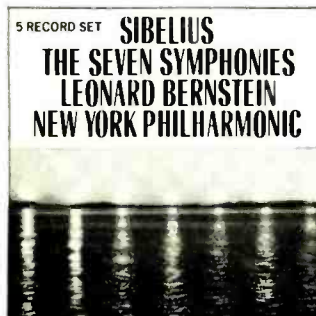

M5S 784 (a 5-record set)



D3S 725 (a specially priced 3-record set)

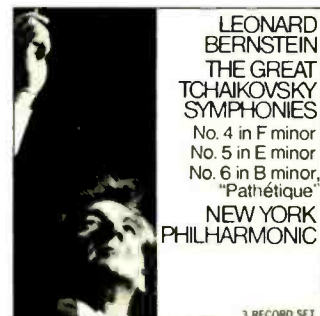

D3S 781 (a specially priced 3-record set)

© COLUMBIA MARCAS REG. PRINTED IN U.S.A.

CIRCLE 13 ON READER-SERVICE CARD

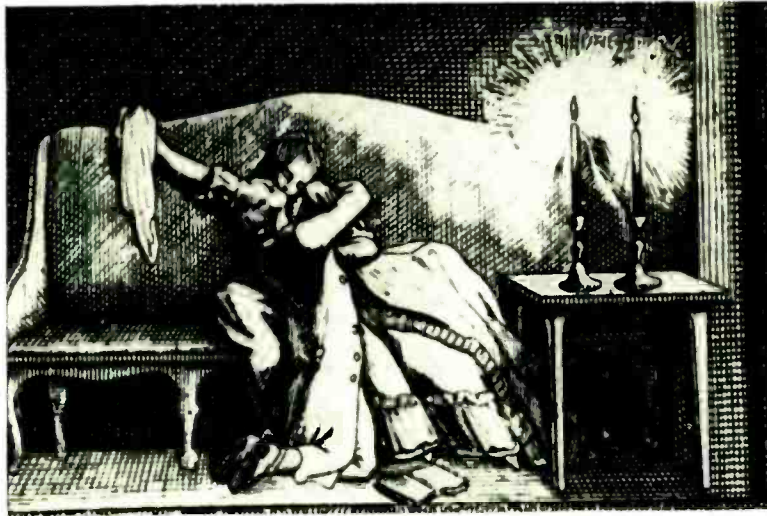

The Bettmann Archive

The Case for Massenet

Werther, sung with passion and skill by De los Angeles and Gedda

By George Movshon

A WARM WELCOME, please, for this honest, skilled, and passionate performance, the first complete *Werther* in stereo to reach the domestic catalogues.

Our swingeing and bitter times are far removed from the spirit of Jules Massenet, and it has long been the custom to patronize him, to scorn his music for its sweetness, and to call his concepts square. Yet he keeps coming back. Singers nag managers to revive him, for they know how good he makes them sound. And audiences still come to hear a good *Manon* or a *Werther* and show a mild interest in the less frequently performed Massenet operas: *Thaïs*, *Jongleur*, *Hérodiade*, and *Don Quichotte*. There were few complaints at Glyndebourne after the recent Michael Redgrave production of *Werther*, and some critics hold the 1968 New York City Opera *Manon* to be among the most satisfying operatic productions in town since the war.

How comes it that a fading and unfashionable composer hangs on to an audience in the teeth of the *Zeitgeist*? The short answer must be his professionalism, his sure knowledge of what works on stage and in the pit. Massenet paints with the primary emotions, but lays the colors sparingly on his canvas. He brings off big results with modest means, demanding no inflated orchestras or singers of superhuman accomplishment: any company of able and sensitive professionals can do the trick. At his best—and much of *Werther* finds him near the top of his creative capacity—he is hard to resist.

If the frank melodies of Massenet seem out of fashion today, then the bourgeois mores of Goethe's *Werther* appear positively paleolithic. Can anything be more archaic than the story of a poet who falls in love with

his friend's woman and, finding the situation "impossible," shoots himself? We order things differently today. But wait; there is Freudian gold to be mined in Goethe's hills, and one of the depth-psychology producers will get around to this side of *Werther* in time. Consider, for one thing, that when Werther decides to end it all, he borrows for the job . . . his rival's pistol. (How's that for a symbol, Sigmund?) It is hard to realize that the Werther cult once swept Western Europe, that Napoleon told Goethe he had read the book seven times, that artistic young men dressed up in Werther costumes (blue tail coats and yellow vests), and that scores of them committed suicide when jilted. But one may doubt that the character of Charlotte, Werther's beloved, ever inspired similar imitation on the part of young ladies. In Goethe's novel (but less so in Massenet's opera) she is inescapably a prig; and she deserves Thackeray's memorable description: "Charlotte, having seen his body/Borne before her on a shutter/Like a well-conducted person/Went on cutting bread-and-butter."

It takes both singing and acting to overcome such character deficiencies—which makes this a good moment to turn to one of the virtues of the recording under review: the warmly accomplished performance of Victoria de los Angeles as the heroine.

Charlotte is usually given to a mezzo-soprano but the scoring makes no great demands on the lower register. Emma Eames, Mary Garden, Geraldine Farrar, and Ninon Vallin—all sopranos—have succeeded in the role; so no particular novelty attaches to the De los Angeles casting. She proves ideal in the part, musically secure, verbally precise, shaping every phrase with scrupulous care but exacting just the right emotion at each point

Massenet *Continued*

in the score. She has a few less-than-perfect moments in the final death-scene duet with Werther, but these are minor blemishes; for the rest, it is hard to imagine a better presentation of Charlotte's music. The first act duet in the moonlight ("*Il faut nous separer*") is magically done; and by careful and sympathetic planning of the extended letter scene in Act III, Miss De los Angeles does much to rescue Charlotte's character dramatically, giving us a long look into her inner conflict and torment, and creating a credible human being. She is equally affecting in the next scene with sister Sophie and the "*Va, laisse-les couler*" ("*Air of Tears*") is most beautiful.

As the poet-lover, Nicolai Gedda registers one of his major triumphs. It is a part fashioned completely to his requirements: full of melodic opportunity, felicitously woven phrases, declarations of love and despair—and all of them in the French manner that he encompasses so purely and so well. The best-known aria in the score "*Pourquoi me reveiller?*" is taken rather faster than it would be if sung out of context, but it certainly sounds appropriate in the over-all fabric of the score. Gedda has sometimes been found to lack passion, but here he offers all of that quality that the role can take.

In the supporting parts, all is secure and well found. Mady Mesplé, a light soprano whose voice quality reminds me of Beverly Sills, does many striking things with the part of Sophie, Charlotte's fifteen-year-old sister. Baritone Soyer phrases and delivers Albert's music (he is Charlotte's fiancé, later her husband) with exemplary musicianship but sounds rather too old for the role: Albert, after all, is only twenty-five—two years older than Werther—but in this reading he is audibly a member of the next senior generation. The Bailiff's lines are well sung by Jean-Christophe Benoit and his friends Schmidt and Johann are just fine in their drinking song.

As far as I know, this is the first opera recording to be performed by the Orchestre Je Paris, a new and prestigious ensemble formed two or three years ago and led by Charles Munch until his death. It sounds splendid here, playing with a plushness of tone and precision of attack only rarely achieved in the past by French orchestras in opera performance, whether live or recorded. Georges Prêtre leads very capably, building the orchestral interludes, of which two are extended and important, with considerable splash; but he wisely (in this score) accommodates himself to the comfort of his singers during their big scenes—and everybody benefits.

The sound is rich and full-blooded, with conventional stereo balance; no movement of singers (unlike London's stereo operas) but a well-judged blend of voices with orchestra.

This release easily extinguishes all competition, but if you decide that three whole discs of *Werther* are too much, then try to locate RCA Victor LSC 2615, now deleted but possibly still to be found in some stores. This is a highlights-only single disc, very capably sung by Rosalind Elias, Cesare Valletti, and Gérard Souzay, with René Leibowitz conducting. Or else wait till Angel gets around to putting out a highlights record from this set.

MASSENET: *Werther*. Victoria de los Angeles (s), Charlotte; Mady Mesplé (s), Sophie; Nicolai Gedda (t), Werther; André Mallabrera (t), Schmidt; Roger Soyer (b), Albert; Jean-Christophe Benoit (b), The Bailiff; Christos Grigoriou (bs), Johann; Children's Chorus of the French Radio; Orchestre de Paris, Georges Prêtre cond. Angel SCL 3736, \$17.96 (three discs).

A Big Sound from Berlioz

Colin Davis' recording of the *Te Deum* is a triumph

By David Hamilton

IF THE *Roméo et Juliette* that formed the first installment of Colin Davis' Berlioz cycle for Philips was certainly welcome, the *Te Deum* that now follows is even more so. Among the earlier recordings of *Roméo*, it was possible to get a quite clear idea of what Berlioz was after, what kind of effect the piece should make. But the one and only previous version of the *Te Deum*, although conducted by that redoubtable Berliozian Sir Thomas Beecham, suffered under the handicap of a recording so "dim and shadowy," as Bernard Jacobson observed in these pages last spring, that "it is largely impossible to distinguish the text even when you have it in front of you." This was, in truth, the low point of Beecham's career with American Columbia—the actual recording having been done, however, by Philips engineers—and it was work of this quality that caused Beecham to return once again to EMI for the final years of his career.

Perhaps fittingly, it is now the Philips engineering staff who at last unveil the *Te Deum* in something close to its true sonic panoply. The achievement of this ideal was apparently not without its own difficulties; the sessions were originally planned for Westminster Cathedral in London, but the organ there proved to be wrongly tuned and everything had to be moved to another, much less resonant hall. According to a review in the British magazine *Records and Recording*, this condition was remedied in Holland by "playing back the master tapes in a large church." Mercifully, there is nothing artificial in the results; the sound is remarkably full and clear, with a wide dynamic range and splendidly impactful climaxes. What is more, this is one of the first American Philips releases to be imported directly from Europe, and is quite free of the quality problems that have constantly attended their local pressings.

To be sure, the tribulations endured by modern conductors and engineers in making the *Te Deum* broadly available are as nothing compared to those endured by the composer in bringing it to performance in the first place. With remarkable courage and self-confidence, he composed this grandiose conception (triple chorus and large orchestra) in 1849, on pure speculation—no commission, no shadow of a suitable occasion in

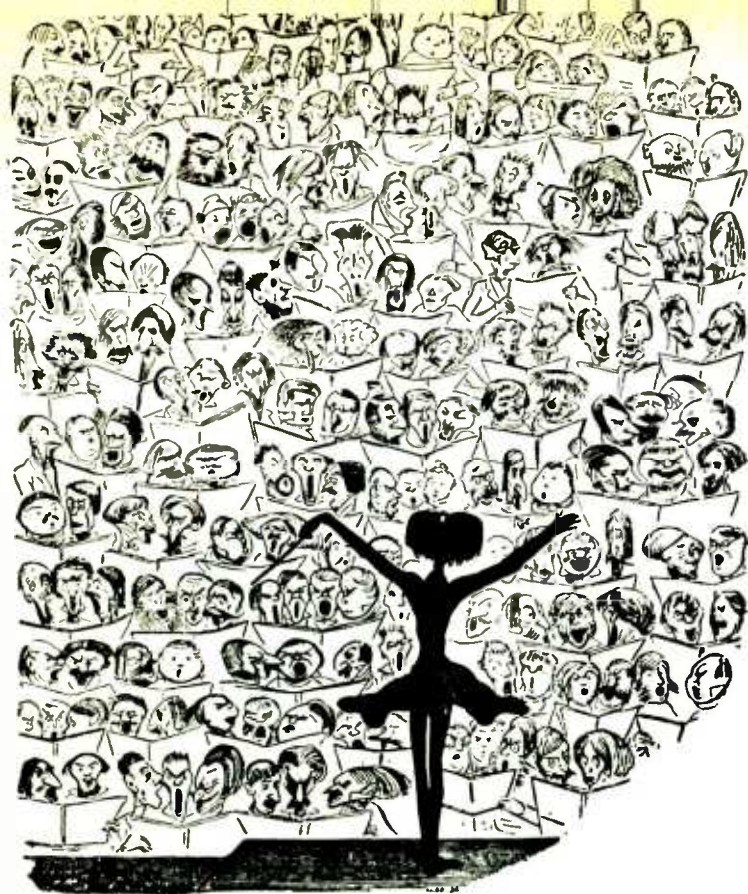

The Bettmann Archive

view. Hopes for performances in London, in Paris, in Weimar collapsed with depressing regularity. Not until 1855, six years after its completion, was Berlioz able to arrange a performance of the *Te Deum*, in connection with the Paris Exposition of that year. To Liszt he wrote that 950 performers took part in the premiere, although a Paris paper counted a grand total of 1,200 (two mixed choruses of 100 each, a children's chorus of 850, and 150 players in the orchestra). There is also some disagreement about the quality of the performance: the newspaper remarked on the imperfect ensemble, but Berlioz assured Liszt of "the most magnificent exactness . . . no mistakes, no waverings." Later, in a calmer frame of mind perhaps, he did concede that it "would have had even more effect in a building less large and resonant than the Church of St. Eustache."

Of course, as with Berlioz' other "architectural" works (the term is the composer's), magnitude for its own sake is hardly the point: the originality and variety of the structure, the pacing and scale of the contrasts are what make this music memorable. The massively proclamatory opening chords, alternating between organ and orchestra, not only state some fundamental harmonic facts, but also seem to be testing and defining the limits of the space to be filled. (Ideally, the organ should be at the opposite end of the nave from the orchestra—i.e., behind the listener; this type of antiphony is not yet realizable on records, of course, but the effect as presented here is still pretty fine.) From here, the organ launches a descending melodic figure whose outline serves as a sort of unifying thread to the whole work, above and beyond its more literal recurrences in the fugal opening movement.

Each of the six choral movements has its own special plan: the fugal *Te Deum*; the three-versed *Tibi omnes* (the text so structured by Berlioz, who was not averse to tampering with the liturgy for musical purposes), with its masterfully varied orchestrations of the *Sanctus* passage; the audacious *Dignare*, built on a series of pedal points that ascend by thirds to a distant key and then descend by a varied route with marvelously satisfying, if unconventional, sensation of resolution; the martial *Christe rex gloriae*, with its glittering pizzica-

tos at "*sedes in gloria*," and the sforzando dominant pedal notes that stave off the harmonic resolution until well after the opening theme returns, in order to prepare an even greater climax; the tenor solo of the *Te ergo quae sumus*, turning from minor to major for a coda in which the tenor extends and elaborates that descending scale figure; and finally the *Judex crederis*, where the elaborate modal theme is introduced on ominously rising scale steps and brought to constantly new and surprising culminations.

Two purely instrumental movements are published in the Berlioz collected edition but omitted here (as they were in Beecham's recording as well). A concluding March for the Presentation of the Colors, which adds an alto saxhorn and twelve (!) harps to what has been used before, should be a brave noise—but it is a ceremonial postlude to a religious service, and not really part of *Te Deum*. On the other hand, the *Praeludium* that fits between the *Tibi omnes* and the *Dignare* would be worth having, for it makes an important harmonic connection between these two movements. In a note to the score, Berlioz says that this piece must be omitted "if the *Te Deum* is performed neither as a Thanksgiving for victory nor for any other service of a military character." Because of its transitional function, this *Praeludium* can have no use other than in context, so I hope that the next recording of the *Te Deum* will make a point of including it. And it would be nice of Philips to give us the March later on, perhaps on a disc of Berlioz' ceremonial and public-square music.

With this exception, and barring a few uncertainties and scoops from the tenor soloist, there can be nothing but praise for Colin Davis' imposing and idiomatic performance. His sense for Berlioz' orchestral textures, long-breathed lines, and harmonic cruxes is always just and convincing, and the choruses and orchestra are both disciplined and enthusiastic—in short, a triumph.

While we wait for the next stage of Davis' cycle, Oiseau-Lyre (who has already contributed usefully to the catalogue of recorded Berlioz) offers some more novelties. Some of these are first recordings: the 1829 set of songs called *Irlande*, to texts by Thomas Moore (in French translation) and an 1848 song, *La Mort d'Ophélie*. Also included is *Le Trébuchet* (which we have had once before, on the duet record by Victoria de los Angeles and Dietrich Fischer-Dieskau, Angel 35963; the soprano-alto version offered by Oiseau-Lyre may be more authentic, but the Angel version is certainly more elegant), and the Easter chorale from *La Damnation de Faust* with piano accompaniment; this last seems rather pointless.

The Moore songs are a mixed bag, both in terms of medium (some are choral, one is a duet, and the rest are solos, mostly for tenor) and of quality. Indeed, a few are little more than salon music, but the *Elégie* is an effective piece, and most of the others quite listenable. The singing here is not especially smooth, and has been miked too closely, in a way that accentuates the roughness; nevertheless, it will serve the purpose.

Complete texts and translations are included with both records.

✓ **BERLIOZ: *Te Deum*, Op. 22.** Franco Tagliavini, tenor; Nicolas Kynaston, organ; Wandsworth School Boys' Choir; London Symphony Chorus and Orchestra, Colin Davis, cond. Philips SAL 3724, \$5.98.

BERLIOZ: *Irlande*, Op. 2; *Le Trébuchet*, Op. 13; *La Mort d'Ophélie*; *Chant de la fête de paques*. April Cantelo, soprano; Helen Watts, alto; Robert Tear, tenor; Richard Salter, bass; Viola Tunnard, piano; Monteverdi Choir, John Eliot Gardiner, cond. Oiseau-Lyre SOL 305, \$5.95.

By Harris Goldsmith

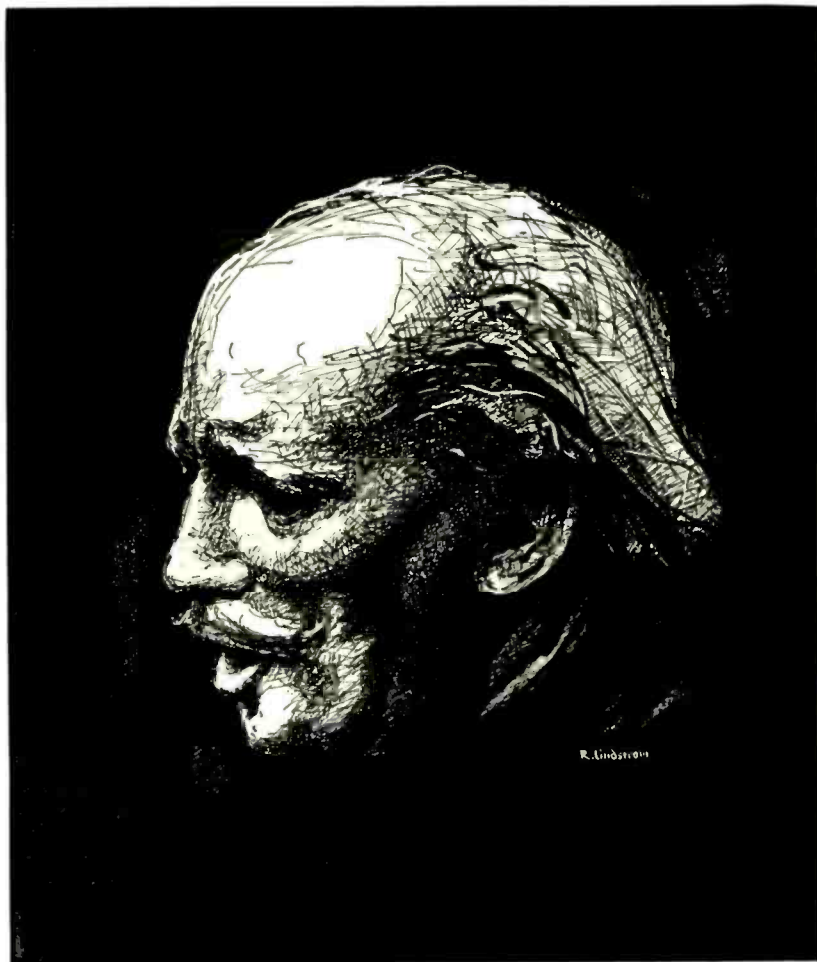

Toscanini Treasures

Legendary performances by the Maestro available at last

FOR THOSE FORTUNATE collectors with access to the extensive archives of Toscanini broadcast transcriptions and tapes from various world music centers, the genius of this great conductor looms far and beyond the comparative narrow confines of the recorded material that has so far been made available to the general public. Proselytizing critics in *HIGH FIDELITY* and other publications have long clamored for commercial pressings of these live-concert recordings. We have, in fact, succeeded in persuading RCA to issue such treasures as the great Philadelphia Schubert Ninth Symphony of 1941, the Berlioz *Roméo et Juliette*, the Serkin/Toscanini Beethoven Fourth Piano Concerto, and the fine five-disc memorial collection released two years ago in celebration of the Maestro's hundredth anniversary.

This bounty, while undoubtedly representing great progress, nonetheless only scratched the surface. Now, with the formation of the Arturo Toscanini Society,

Toscanini collectors will be able to hear at last some of the marvelous performances that have, up to now, been available only to a select few. The Society has already issued private pressings of some hitherto unreleased Toscanini performances. These discs are, in the strict sense, not for sale—you will not be able to buy any of these items from your local record dealer; they may be obtained only by members of the Toscanini Society. The annual dues are \$25, and anyone can join by simply writing to the address listed at the end of this review. In essence, then, the Arturo Toscanini Society may be regarded as one of the most exciting record clubs ever formed.

Uppermost among the Society's first four releases is the performance of the Brahms *German Requiem*. Toscanini's reading will come as a revelation to those who have never heard it. His approach is grim, terse, powerful. Furthermore, the Maestro completely shifts

the structural balance of the score with his surprising sequence of tempos. In general, he seems to understate those movements that other conductors bathe in genial sentimentality, and strengthen those most often subjected to speedy and inconstant tempos. The opening section, the soprano solo, and finale are prayerful, light, dry-eyed, and to the point. The second movement, on the other hand, goes at a slow, strictly disciplined tempo—the effect is like an almost unbearably ascetic and ferocious dirge. The giant fugato with brass and timpani punctuations of tremendous thrust and incisiveness, proceeds along similar lines. The soloists are good. Vivian della Chiesa is not the most rich-voiced or fluent soprano to grace the fifth movement solo, but she fits in well with the Maestro's tart, reflective outlook. Herbert Janssen's black, emotional bass-baritone is precisely what is needed for this music. The Westminster Choir is a bit opaque; the fact that English rather than German is used for this wartime (1943) broadcast performance neither adds to nor detracts from the tremendous emotional thrust of the interpretation—it is quite hard to hear words clearly anyway. The sound here is not particularly outstanding, but it is wholly adequate to convey the "nitty-gritty" of the statement. Indeed, the very grittiness of the tone often helps add abrasive fervor to this music-making.

I am a bit disappointed by the choice of the *Handel Variations* for Side 4 of this two-disc album. Brahms's *Haydn Variations*, as we all know, began life in the form of a duo keyboard work, but while the composer himself orchestrated that score this earlier set of solo-piano variations has been given a synthetic instrumental realization by the English composer Edmund Rubbra. Brahms's orchestral language tends towards the earthy and sober; Rubbra's, by contrast, verges on the showy and garish: all one needs is a narrator to turn the work into another *Young Person's Guide to the Orchestra*. Variation after variation fails to materialize in the way I imagine Brahms would have conceived it from his piano score. Be that as it may, Toscanini's performance (the world premiere of this transcription) is very beautifully played and full of tigerish, exciting dash. I do think, though, that something like the magnificent Schubert Second Symphony of 1938 would have been a far more substantial filler.

The two Haydn symphonies are played with earthy *élan* and admirable control. The performance of No. 88 comes from a 1938 broadcast and antedates the Maestro's commercial version (once available on RCA) by about two months. Here the playing is a bit swifter and more humorous, though the Largo is still quite noble and gravely paced. (Who said that Toscanini took everything too fast?) The *London* Symphony is more noteworthy in that it adds an important work to the Toscanini discography. It is said that the conductor was contemplating the release of this 1943 performance, but ultimately decided against it because he found the commercial RCA shellac set by the Edwin Fischer Chamber Orchestra preferable. That version, admittedly, was probably a more polished effort, but the directness and control (not to mention the momentum) of Toscanini's approach here provides an alternative statement well worth hearing. Toscanini's tempos sweep the listener along with whiplash, arrow-swift drive, yet manage to be warm, songful, and personable at the same time. The studio 8H sonics are quite warm and ingratiating in

both works, and the hiss from the acetates in Symphony No. 88 is not too obtrusive once the ear has adjusted. (Presumably, the engineer decided against filtering which might have resulted in the loss of high-frequency bite.)

Toscanini's only extant rendering of *Ein Heldenleben* with the NBC Symphony (he also performed it several times with the New York Philharmonic) turns out to be pretty true to form. It is a lean, intense reading, with a warmer and more incisive battle scene than Reiner's somewhat similar account, and less expansive and rhetorical than the famous old Mengelberg/New York Philharmonic performance of 1928. One finds all sorts of fine details here: the classically poised, really malicious-sounding chatter of the woodwinds in the "critics" section; the rich-toned, powerfully executed violin cadenzas by the superb Misha Mischakoff; the snakelike forward lashes of the big orchestral climaxes. The sound is quite rich and full-blooded too, well above the norm for 1941. In every way, Toscanini's is one of the truly great *Heldenleben*s to appear on disc. The 1939 performance of Salome's lurid dance is the only example we have of Toscanini conducting the operatic Richard Strauss. His reading is quite a bit more emotional and frenetic than Reiner's justly celebrated one, though the orchestral discipline in both instances is formidable.

A word about the transfers. Unlike RCA, the Toscanini Society evidently does not always have access to actual NBC acetates. Some of the originals of the performances issued on these initial discs, I suspect, were taken off the air on the best AM radios of the day. But as I am very familiar with all of these original tapes, I can testify that their mastering on these discs is uncannily faithful to the source. The Arturo Toscanini Society promises all sorts of goodies to its members in the near future: a new set of Beethoven symphonies, mostly from the golden Philharmonic days; the amazing BBC Symphony version of the Brahms Fourth which I recently mentioned in these columns; and other equally memorable documents. I, for one, would like to see high priority given to the exquisite Schumann Symphony No. 2 of 1941; the 1940 Sibelius Fourth and the Verdi Requiem (with Milanov, Castagna, Bjoerling, and Moscona); the Beethoven *Missa Solemnis* from the same year (with Kipnis replacing Moscona in the otherwise identical vocal line-up). The prospects of getting such material on records at long last is an exciting prospect for all phonophiles.

BRAHMS: A German Requiem, Op. 46; Variations on a Theme by Handel, Op. 24 (orch. Edmund Rubbra). Vivian della Chiesa, soprano; Herbert Janssen, bass-baritone; Westminster Choir; NBC Symphony Orchestra, Arturo Toscanini, cond. Arturo Toscanini Society ATS 1003/4 (two discs, mono only).

HAYDN: Symphonies: No. 88, in G; No. 104, in D ("London"). NBC Symphony Orchestra, Arturo Toscanini, cond. Arturo Toscanini Society ATS 1001 (mono only).

STRAUSS: Ein Heldenleben, Op. 40; Salome: Dance of the Seven Veils, Op. 54. NBC Symphony Orchestra, Arturo Toscanini, cond. Arturo Toscanini Society ATS 1002 (mono only).

Available from the Arturo Toscanini Society, 1206 Birge Ave., Dumas, Texas 79029.

classical

reviewed by

ROYAL S. BROWN
R. D. DARRELL
PETER G. DAVIS
SHIRLEY FLEMING
ALFRED FRANKENSTEIN
CLIFFORD F. GILMORE
HARRIS GOLDSMITH
DAVID HAMILTON
PHILIP HART
JACK HIEMENZ
PAUL HENRY LANG
STEVEN LOWE
ROBERT C. MARSH
ROBERT P. MORGAN
GEORGE MOVSHON
ROBERT W. SCHAAF
SUSAN THIEMANN SOMMER

BACH: Christmas Oratorio, S. 248. Agnes Giebel, soprano; Marga Höffgen, alto; Josef Traxel, tenor; Dietrich Fischer-Dieskau, baritone. Thomanerchor and Gewandhaus-Orchester (Leipzig), Kurt Thomas, cond. Seraphim SIC 6040, \$7.47 (three discs).

Thomas' introspective performance of the *Christmas Oratorio* emphasizes the lyrical and spiritual side of the music; his tempos are generally slower and more gentle than Münchinger's (London) or Richter's (Archive). Richter's fast-moving, extroverted, dramatic reading is tremendously exciting, while Münchinger strikes a golden mean with an equally lively performance but on a more tender, human level. Remarkably enough, all three very different approaches work in their own individual fashion and each is a thoroughly satisfying over-all achievement. An excellent tenor soloist as the Evangelist and a first-rate chorus are essential ingredients for this Oratorio. Josef Traxel, the Evangelist on the Thomas set, sings confidently, and movingly recounts the Christmas story. He is dramatically superior to his competition on London and Archive, though in terms of sheer gorgeous vocalism, the latter set's Fritz Wunderlich remains unapproachable. The boys and men of the Leipzig Thomanerchor sing with a very open and easy sound, contrasting sharply with the more covered and "pure" sound of typical English Cathedral boys. As for the other soloists, all three conductors were blessed with the cream from the crop of current Bach singers. Fischer-Dieskau is most outstanding on the Seraphim set; the taste and intelligence that he brings to his lieder and cantata recordings is everywhere apparent here: this is singing of incomparable elegance, either tender or majestic, depending on the music at hand. If London's Elly Ameling is today's best Bach soprano, then Seraphim's Agnes Giebel is at the very least a close second. The soprano and bass duet, "*Herr, dein Mitleid*" in Part III, is a beautiful example of a sensitive collaboration between two consummate musicians: both Giebel and Fischer-Dieskau toss off the carefully measured trills in thirds during this duet to perfection. The contralto soloists in all three versions are superb. Helen Watts (London), Christa Ludwig (Archive), and Marga Höffgen (Seraphim) all turn in rich and moving performances: Höffgen is particularly outstanding in the gentle lullaby from Part II, "*Schlafe, mein Liebster*."

For spectacularly sumptuous recorded sound the London set takes top honors, but the Odeon version was very nearly as rich, warm, and impressive. In the new Seraphim pressing, however, some of that warmth and richness has departed—the strings seem harder and more metallic and the trumpets speak with razor-edged brittleness. The clarity, spaciousness, and well-defined stereo placement remain, but the over-all sound is not as attractive as in the earlier pressing. All in all, though, collectors searching for a budget version of the *Christmas*

Oratorio are not likely to be disappointed by this performance. C.F.G.

BEETHOVEN: Concertos for Piano and Orchestra: No. 1, in C, Op. 15; No. 2, in B flat, Op. 19; No. 3, in C minor, Op. 37; No. 4, in G, Op. 58; No. 5, in E flat, Op. 73 ("Emperor"); Fantasia for Piano, Chorus, and Orchestra, in C minor, Op. 80. Daniel Barenboim, piano; New Philharmonia Chorus (in the Fantasia); New Philharmonia Orchestra, Otto Klemperer, cond. Angel SD 3752, \$23.92 (four discs).

It was an intriguing idea on the part of EMI/Angel to partner youth (Barenboim) with old age (Klemperer), in the Beethoven piano concertos, but the collaboration is, I'm afraid, beset with some rather severe problems. Both artists seem to favor slow tempos and this may possibly be regarded as a matter of taste (although it seems to me that in the earlier works especially—written to display the composer's own pianistic virtuosity—when Beethoven wrote *Allegro con brio*, he meant it). This leisurely view unfortunately is not sustained in the present performances. Take, for example, the opening tutti of the C minor Concerto: Klemperer starts broadly but after a few measures the backbone bends and the tempo becomes slower still—the music's life pulse simply drains away. The orchestral playing in the B flat Concerto is lethargic, clumsy, unpointed: in the first movement, the sluggish, lagging bass line and the unarticulated detail makes the going all that much heavier. Chords do not begin together, pizzicatos come too late, and other such mishaps are too legion to count. In sum, then, the podium support given to Barenboim, on a purely technical level, is scarcely a help to him.

I also find a basic interpretive discrepancy between the two protagonists. Despite their evident unanimity in matters of tempo, there is a yawning chasm that separates the yielding, sensuously romantic Barenboim and the didactic, stiff-jointed Klemperer. True, one occasionally feels a rapport between the two musicians—mostly in the slow movements (which are, in the main, the best things the new set has to offer)—but I sense now and then Barenboim, the conductor, giving the old man a wee bit of assistance. On the whole, the lack of real communication between the two shows up most injuriously in the Fourth Concerto.

Angel has put all five concertos plus

TAPE FORMAT KEY

The following symbols indicate the format of new releases available on prerecorded tape.

- OPEN REEL
- ☐ 4-TRACK CARTRIDGE
- ☐ 8-TRACK CARTRIDGE
- ☐ CASSETTE

CIRCLE 25 ON READER-SERVICE CARD →

We're Not Just In It For The Money

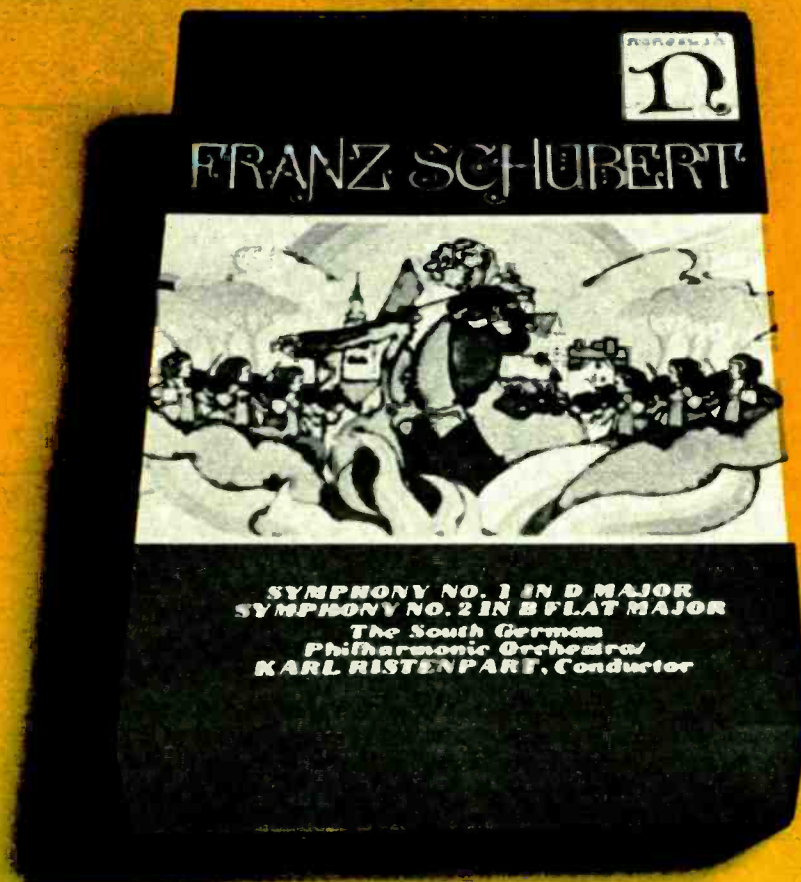

Nonesuch brought you the first moderate-priced classical album, better recording techniques, and award winning covers. Now Nonesuch offers you even more—**THE NONESUCH CASSETTE**—the very first budget priced classical cassette and as a special introductory offer for only \$2.50 you can listen to the magnificent sounds of Schubert's First & Second Symphonies. Available only direct from Nonesuch by mailing the coupon below.

The Nonesuch Cassette is also available in a wide-ranging unusual repertoire featuring the best of Baroque, Renaissance, Classical, and Modern at the regular low price of only \$4.95 (wherever records and tapes are sold).

So you see, we're not just in it for the money—Nonesuch thinks about you.

Please enclose check or money order (no cash or c.o.d.'s) and mail to:



**NONESUCH RECORDS, 1855 Broadway,
New York, New York 10023**

Gentlemen: Please send me _____ Schubert Nonesuch Cassette(s) at the special price of \$2.50 each. (New York State residents please add local sales tax.)

NAME (please print)

ADDRESS

CITY STATE ZIP CODE

Offer lasts until December 31, 1969. Good only on direct order to Nonesuch.

For catalogue, write to
NONESUCH RECORDS
1855 Broadway, New York, N. Y. 10023

the *Choral Fantasia* onto four records—a direct rival to the recent Columbia issue with Rudolf Serkin. This economical arrangement has necessitated scattering the music haphazardly over the disc sides, and my test-pressing acetates were arranged in automatic sequence—a further aggravation. The performances will doubtlessly appear as single discs in time, and taking that eventuality into account, here is a brief synopsis of the individual readings.

No. 1. One of the better performances in the set: here there is a reasonable meeting of minds. The Allegro of the first movement is slow, but it does boast a certain vigor and weight, accenting the lush aspects of the scoring in a rather interesting fashion. Barenboim plays his own discreet and moderately resourceful cadenza here, though in every other instance he opts for the standard ones by Beethoven. The Largo, taken really broadly as on the Schnabel and Kempff versions, has plenty of commitment, while the Rondo, weighty and robust rather than fierce (Serkin) or playful (Gieseeking), is effectively stated. Barenboim produces some lovely veiled tone with his judicious pedaling in the final cadenza.

No. 2. In contrast to the crude orchestral preamble, Barenboim's solo work here is in a "refined," light style—feathery and at times almost affectedly mincing: instead of the genuine playful quality achieved by both Schnabel and Fleisher, Barenboim merely sounds coy. The Rondo, fairly brisk, is on the right

track (despite an uncertainty of tempo at the very beginning), and once that ragged opening is out of the way, the Adagio is sensitively and expansively stated. The all-important long pedal marks are scrupulously observed at the movement's end.

No. 3. Here Barenboim suffers from an odious comparison with himself. His 1964 Westminster edition with Laszlo Somogyi and the Vienna State Opera Orchestra was taped when the pianist was merely another talented young artist trying to make good. It is far more elegantly wrought pianistically (on a slightly smaller scale perhaps) and better accompanied, though Somogyi's forces are a bit sparse. For all that, the Barenboim/Klemperer slow movement is memorably sustained, while the slow-paced rondo has a lilt, if not exactly a bounce.

No. 4. Some people maintain that the G major Concerto is the most difficult of the set and they may well be right. Certainly it is all very droopy and shapeless here. Barenboim contributes some sensitive colors and half-tints, but his unstructured, aimless phrasing and the prosaic orchestral work do not justify the slow tempo.

No. 5. One of the world's great pianists, having just returned from playing this work with the present conductor, spoke damningly of the "Klemperer" Concerto and illustrated his point by singing a ludicrously slow tempo for the first movement. I naturally supposed that some exaggeration was involved, but

find, now, there was not: the first movement here is a parody of the well-known Klemperer style. Aside from that, the performance is, on the whole, a solid and rather large-scaled presentation of the music. The conductor, incidentally, hews to the standard text in the bridge between the second and third movements: Szell (with Gilels and Fleisher) has the low strings begin their pizzicato one note later.

Choral Fantasia. Must Barenboim use so much pedal in his opening cadenza? He brought out the left hand triplets with telling clarity on his older Westminster version, but they are blurred here. On the whole, the new performance is more heroic and less thoughtful and delicate, though still admirably communicative. I prefer the sharper, leaner Somogyi leadership and the more compact choral and instrumental playing on the earlier edition.

In sum, then, the Barenboim/Klemperer cycle is a controversial and interesting one, but not really outstanding. To my mind, Beethoven requires more energy and discipline: perhaps others will disagree and find these interpretations more congenial than I do. H.G.

BEETHOVEN: Wellington's Victory, Op. 91; Marches: in D, WoO. 24; in C, WoO. 20; in B flat, WoO. 29; in F ("York March"), WoO. 18; in F, WoO. 19; Polonaise in D, WoO. 21; Ecossaise in D, WoO. 22. Berlin Philharmonic Orchestra, Herbert von Karajan, cond. (in Op.

WILL I HEAR THE DIFFERENCE?

If your turntable rumbles and wows . . . If your amplifiers put out only five watts at 10% distortion . . . If your speakers have a frequency range just good enough for speech . . . If your phono arm has the incorrect overhang required by the older record changers . . . If your cartridge requires a vertical force of a dozen grams to keep its stylus in the groove . . . And if your records have been torn and mutilated by that stylus — YOU ARE NOT LIKELY TO HEAR THE DIFFERENCE.

BUT If you own one of the many superb modern amplifiers . . . If your turntable produces no audible rumble or wow . . . If you have selected your speakers from the many excellent models available today . . . If your cartridge has a response that evenly covers the audible range of frequencies with little distortion . . . And if the recommended tracking force is of the order of one gram . . .

THEN You owe it to the engineers who designed your equipment, to the artists and technicians who produced your records and, above all, to yourself to . . .

LISTEN TO THE SL-8 and

**hear
the difference!**

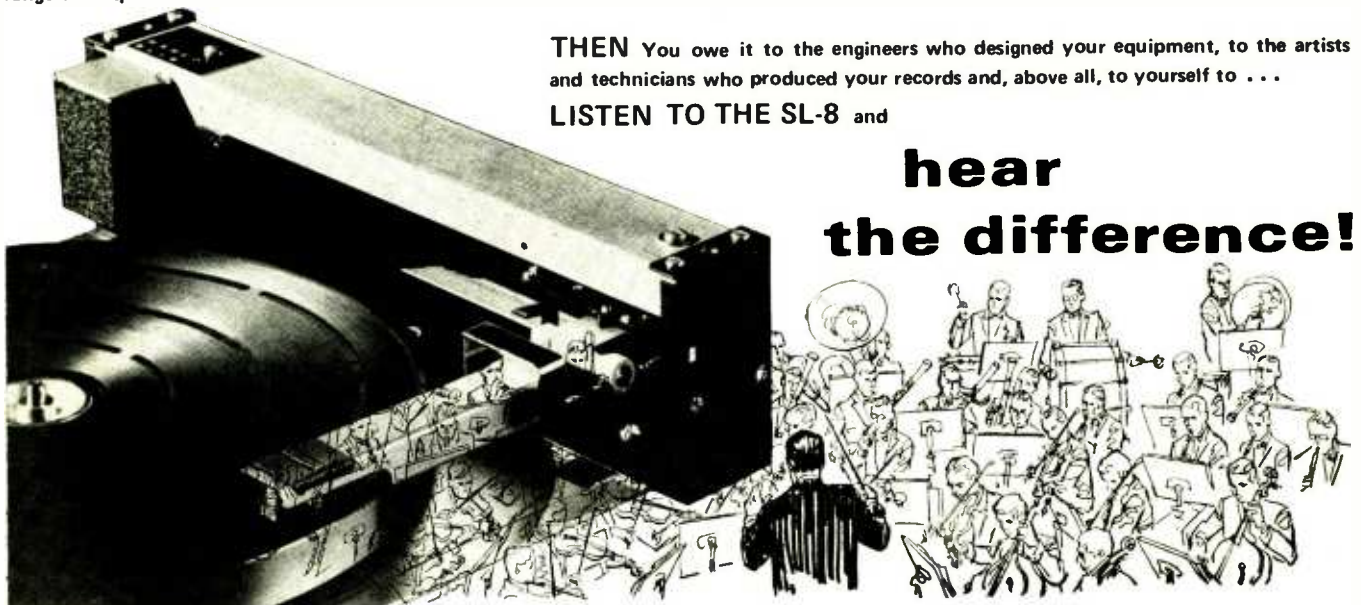

RABCO

MANUFACTURERS OF THE ONLY STRAIGHT LINE, SERVO DRIVEN PHONOGRAPH ARM.
11937 TECH ROAD, SILVER SPRING, MARYLAND 20904
CIRCLE 55 ON READER-SERVICE CARD

LONDON[®]
RECORDS

THE GIFT THAT IS A TRIBUTE TO YOUR GOOD TASTE

A few suggestions

R. Strauss: DER ROSENKAVALIER

with Régine Crespin, Yvonne Minton, Helen Donath, Manfred Jungwirth—The Vienna Philharmonic Orchestra — Georg Solti
OSA-1435

Kodály: HÁRY JÁNOS

with Peter Ustinov (Narrator) — Members of The Hungarian State Opera — The London Symphony Orchestra — Istvan Kertesz
OSA-1278

**R. Strauss: ALSO SPRACH
ZARATHÜSTRA**

The Los Angeles Philharmonic Orchestra — Zubin Mehta
CS-6609

**LUCIANO PAVAROTTI—VERDI &
DONIZETTI ARIAS**

Arias from Luisa Miller, I due Foscari, Un Ballo in Maschera, Macbeth, Lucia di Lammermoor, Il Duca d'Alba, La Favorita, Don Sebastiano
OS-26087

TEBALDI FESTIVAL

Arias from Tannhäuser, Lohengrin, Tristan und Isolde, Carmen, Samson et Dalila, Manon, Aida, La Bohème plus songs
OSA-1282

Verdi: LA TRAVIATA

with Pilar Lorengar, Giacomo Aragall, Dietrich Fischer-Dieskau — Orchestra of the Deutsche Oper, Berlin — Lorin Maazel
OSA-1279

**Zandonai: FRANCESCA DA RIMINI —
3 GREAT SCENES**

with Mario del Monaco, Magda Olivero — L'Orchestre National de L'Opéra de Monte Carlo — Nicola Rescigno
OS-26121

**JOAN SUTHERLAND—RICHARD
BONYNGE—RUSSIAN JEWELS**

Glière: Concerto for Coloratura and Orchestra; Concerto for Harp and Orchestra plus songs
Osian Ellis (harp) — The London Symphony Orchestra
OS-26110

Verdi: AIDA

with Leontyne Price, Jon Vickers, Rita Gorr, Robert Merrill, Giorgio Tozzi — Rome Opera House Orchestra — Georg Solti
OSA-1393

**VLADIMIR ASHKENAZY —
ITZHAK PERLMAN**

Franck: Sonata for Violin & Piano
Brahms: Trio for Violin, Horn & Piano
CS-6628

**IVAN DAVIS—THE ART OF THE
PIANO VIRTUOSO**

Selections by Liszt, Chopin, Moszkowski, Schumann, Liapunov, Rimsky-Korsakoff
CS-6637

Specially priced packages

**Wagner: DER RING DES
NIBELUNGEN**

Das Rheingold; Die Walküre; Siegfried; Götterdämmerung
plus John Culshaw's book "Ring Resounding"
RING 5

Dvořák: THE NINE SYMPHONIES

The London Symphony Orchestra — Istvan Kertesz
DVO 5-1

Stravinsky: THE FIREBIRD

and Rehearsal Record
L'Orchestre de la Suisse Romande — Ernest Ansermet
FBD-5-1

Tchaikovsky: THE SIX SYMPHONIES

The Vienna Philharmonic Orchestra — Lorin Maazel
TCH 5-1

Write to us for catalogs and brochures

London Records, Inc.
539 West 25th Street
New York, N.Y. 10001

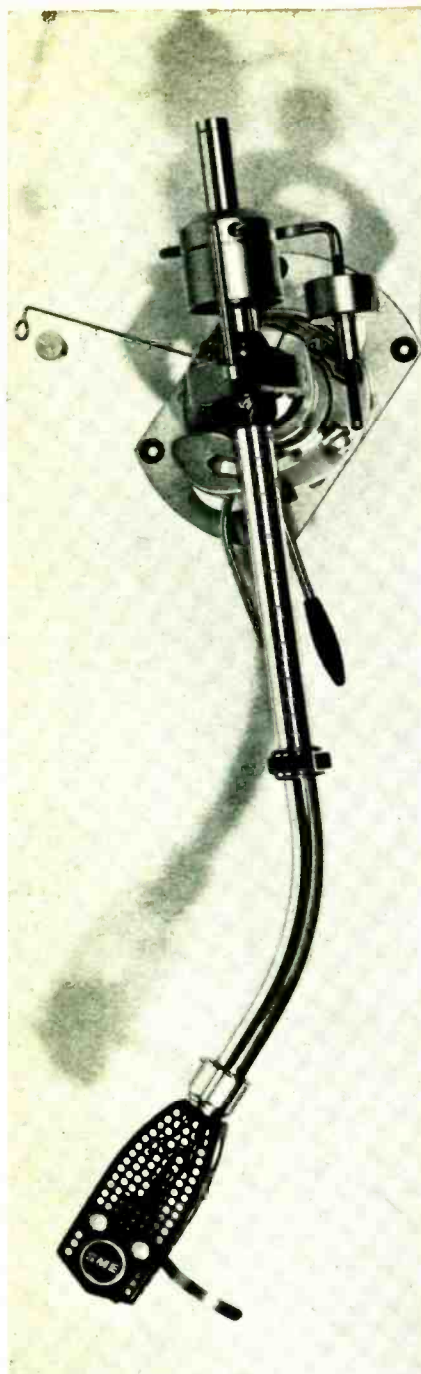

SHURE
SME

The best pick-up arm in the world

For details write to

SHURE BROTHERS INC.

222 Hartrey Ave., Evanston

Illinois 60204

CIRCLE 51 ON READER-SERVICE CARD

91); Winds of the Berlin Philharmonic (in Marches). Deutsche Grammophon 139045, \$5.98. Tape: ☉ 923105, \$6.95.

It will be interesting, during the coming Beethoven year, to see how many star conductors manage to resist temptation (or the blandishments of the record companies) with respect to that most trivial of Beethoveniana (or is it that most Beethovenian of trivia?), *Wellington's Victory*. The first to succumb is Karajan, who lines up with Dorati's Mercury version in espousing the cause of battlefield realism, replacing Beethoven's big drums with actual cannons, his ratchets with assorted small-arms fire. Both are well played—the Karajan with more finesse, the Dorati with more verve—but the noisy ordnance pretty well does in the (admittedly thin) musical content of the first part. Furthermore, in the new DGG, the orchestral sound is distant and muted here, suddenly becoming markedly more forward for the concluding "Victory Symphony."

The trouble with this approach, in any case, is that Beethoven knew perfectly well what he wanted; the ratchets he asked for give out a consistent sound, whereas the miscellaneous, highly articulative musketry proves constantly disruptive to the music. If you simply must have a recording of this piece (an improbable imperative, in my book), the Scherchen (Westminster) does let you hear whatever musical content Beethoven put into his exuberant potboiler, and even Scherchen's assorted eccentricities (wildly divergent tempos for the introductory marches, various exaggerated orchestral details) and unpolished playing don't get in the way as much as all that ordnance. (If it's ordnance you really want, the Dorati disc includes an extra band of it, unhampered by musical intervention.)

However, the comprehensive Beethoven collector may be drawn to the reverse of the new DGG—a group of five minor but not entirely trivial marches, plus an ecossaise and polonaise for wind band. The first piece, an 1816 march "für die grosse Wacht-Parade," is noisy and tedious, but the rest all display characteristic touches. Note that the last three marches are also available in smoother, snappier readings on Telefunken SLT 43104, a collection of Prussian military music; on this latter disc, the 1809 *York March* is performed with a rather catchy Trio from 1823. DGG's Berlin Philharmonic men don't play as smoothly as Telefunken's military band from Hamburg, but the results are certainly acceptable. D.H.

BERLIOZ: Te Deum, Op. 22. Franco Tagliavini, tenor; Wandsworth School Boys' Chorus; London Symphony Chorus and Orchestra, Colin Davis, cond.

BERICI: Irlanda, Op. 2; Le Trébuchet, Op. 13; La Mort d'Ophélie; Chant de la fête de paques. Various soloists; Monteverdi Choir, John Eliot Gardiner, cond. For a feature review of these recordings, see page 94.

BRAHMS: A German Requiem, Op. 46; Variations on a Theme by Handel, Op. 24 (orch. Rubbra). Soloists; Westminster Choir; NBC Symphony Orchestra, Arturo Toscanini, cond. For a feature review of this recording, see page 96.

BRAHMS: Zigeunerlieder, Op. 103; Three Quartets, Op. 31; Six Quartets, Op. 112. SCHUMANN: *Zigeunerleben, Op. 29, No. 3.* Martin Galling, piano; Gächinger Kantorei, Helmuth Rilling, cond. Nonesuch H 71228, \$2.98.

The title of this disc ("Gypsy Songs by Brahms and Schumann") seems a bit misleading. One may well wonder about Schumann's "gypsy songs" since he wrote only one, the third song of his Op. 29, entitled *Zigeunerleben*; and this short choral piece is the only music by Schumann on the disc. Unlike the gypsy songs of Brahms, it makes no attempt to evoke a gypsy musical style (it is only the text which is "gypsy"), and since it is not a particularly interesting piece in any case, one must turn to Brahms for the real meat of this set.

All of Brahms's *Zigeunerlieder* for choral ensemble with piano accompaniment are included here: the eleven songs of Op. 103 and the last four of the Six Quartets, Op. 112. These are pieces of admitted charm, although they are so simple in texture and structure (virtually all are essentially strophic in form) that I find that they do not lend themselves well to repeated listening. The songs used to fill out the disc, the Three Quartets, Op. 31 and the first two of Op. 112, are, to my mind, the most interesting of the lot (but then of course they're not gypsy!).

At any rate, this is all pleasant music and the performances are adequate if not really striking. It does seem a questionable idea, however, to have the quartets (which make up an entire side) sung by a chorus, as the pieces lose much of their intimacy in this setting. (For a comparison, listen to the recent recording of the quartets by the Gregg Smith Singers' soloists on Everest.) The sense of immediacy is further reduced by the fact that the singers seem to have been placed quite far away from the microphones. And why are the solo segments of the Schumann sung by full sections? Texts and translations are included.

R.P.M.

CHOPIN: Ballades: No. 3, in A flat, Op. 47; No. 4, in F minor, Op. 52; Polonaises: in F sharp minor, Op. 44; in A flat, Op. 53; Etudes: in G flat, Op. 10, No. 5; in G flat, Op. 25, No. 9; Berceuse, Op. 57; Three Ecossaises, Op. 72. Guiomar Novaes, piano. Cardinal VCS 10059, \$3.98.

This album contains some of Chopin's most popular piano music: with the exception of the three Ecossaises (written when the composer was only sixteen), each of these compositions represents a masterpiece of the type of characteristic piano piece that Chopin helped to bring

A Pride of Pianists



RCA

CIRCLE 58 ON READER-SERVICE CARD

THE TRUTH
about the complete line of
Electro-Voice[®]
HIGH FIDELITY
loudspeakers and electronics.

Over 50 different high fidelity products, including tuners, amplifiers, receivers, speaker systems, and component loudspeakers. Write today.



ELECTRO-VOICE, INC., Dept. 129411,
619 Cecil Street, Buchanan, Michigan 49107
Send my FREE product folder on the complete line of
Electro-Voice high fidelity components.

Name _____
Address _____
City _____ State _____ Zip _____

CIRCLE 24 ON READER-SERVICE CARD

THE TRUTH
about the
complete line of
Electro-Voice[®]
MICROPHONES

Capsule listings of over 85 microphones for recording, communications, sound reinforcement and radio-TV broadcasting. Send today for this helpful product folder.



ELECTRO-VOICE, INC., Dept. 129211,
619 Cecil Street, Buchanan, Michigan 49107
Send my free product folder on the complete line of
Electro-Voice microphones.

Name _____
Address _____
City _____ State _____ Zip _____

CIRCLE 33 ON READER-SERVICE CARD

to perfection in the first half of the nineteenth century. This music has always provided pianists with a strong temptation to exhibit their personal virtuosity, and it is one of the wonders of Mme. Novaes' playing that she manages to resist this temptation and still achieve a highly individual manner of interpretation. Eschewing pyrotechnics, she concentrates on purely musical matters: the poetic quality she manages to bring up from the work's core more than compensates for what is lost in surface excitement. The emphasis is always on the detail, and she frequently illuminates what may previously have seemed a minor aspect of the score, enabling it to take on a new and unexpected significance.

This quality of Novaes' playing is perhaps most apparent here in the performances of the two études. One is much less conscious of the music's technical difficulties (due in no small measure to the fact that she plays them so effortlessly) and more aware of the intimacy of these pieces and the underlying lyricism of their conception. But similar qualities are also to be found in her performances of the ballades and polonaises; and the wonderful simplicity with which she plays the Berceuse (how many would dare approach this piece with such disarming naïveté?) reveals it as a truly unique masterpiece. This is altogether a wonderful disc. R.P.M.

HANDEL: Music for the Royal Fireworks; Concerto for Double Woodwind Choirs, in B flat; Concerto for Solo Violin and Strings. Yehudi Menuhin, violin and cond.; Menuhin Festival Orchestra. Angel S 36604, \$5.98.

The *Fireworks* Suite is out-of-doors music that loses some of its effect when taken out of its natural habitat, but it falls pleasantly on the ear under any circumstances. Originally written for a whole carload of wind instruments—the king wanted nothing but “warlike” instruments—Handel later added strings to the score, and this recording presents the second version, with some editorial changes and additions (they don't hurt) by N. D. Boyling. This is fun music, by which I mean that it is pure pleasure to hear because of its heartiness and uninhibited enjoyment of the very existence of sound. And a glorious sound it is, by a man whose aural imagination and sense for euphony were outstanding. Menuhin is aware of the difference between the two versions and has due regard for the presence of the strings; one is always conscious of the guiding hand of a superior musician. Particularly delicate and minutely balanced are the episodes for solo instruments. This thoughtful and elegant performance is highly recommended, but if you want the original version and the full flavor of the big-band jamboree, as Londoners heard it in 1749 (though without the “101 brass cannon”), listen to Vanguard Everyman S 289, with Charles Mackerras conducting. The out-of-doors flavor is more pronounced here, and a piece like the

Bourrée, with everyone cutting loose, is capital entertainment that I personally prefer to the more refined version. Well, get both; they will turn a rainy day into sunshine. There is still another recording, by Appia and the Vienna Philharmonic (Vanguard Everyman SRV 115), which fascinates with its totally un-Handelian concept. Beautifully played and recorded with fancy changes in instrumentation, this *Fireworks* music sounds like a Viennese divertimento from Mozart's time—quite an experience.

The “Violin Concerto” is a Sonata a 5, an early work that is not quite licensed for operation, but it is pleasant and superbly well performed. This is a model of how a baroque concerto should be accompanied. Menuhin both plays and conducts his forces in a warm intimate performance; everything is clear, orchestra and solo completely integrated, and neither soloist nor orchestra tries to flatten the listener.

The Concerto a due cori (really a tre, because there are two wind choirs and a string body) is a *passiccio* made up of pieces culled from *Messiah*, *Belshazzar*, *Alexander Balus*, and other oratorios, and therefore nothing but a set of transcriptions—but what transcriptions! This is once more fun music, fun because of Handel's endless inventiveness in transforming the vocal pieces into instrumental ones. The playing is again superb and the sound excellent. P.H.L.

HAYDN: Symphonies: No. 88, in G; No. 104, in D (“London”). NBC Symphony Orchestra, Arturo Toscanini, cond. For a feature review of this recording, see page 96.

HINDEMITH: Cardillac. Leonore Kirschstein (s), Daughter; Elisabeth Söderström (s), Lady; Donald Grobe (t), Officer; Eberhard Katz (t), Cavalier; Dietrich Fischer-Dieskau (b), Cardillac; Karl Christian Kohn (bs), Gold Dealer; Willi Neff (bs), Leader of the Provost; Chorus of the West German Radio; Cologne Radio Symphony Orchestra, Joseph Keilberth, cond. Deutsche Grammophon 139435/36, \$11.96 (two discs).

Perhaps it's still too early to get a clear perspective on the music of Paul Hindemith. Most everyone agrees that he was one of the century's major composers, but the image he left at the time of his death six years ago is not an especially flattering one. His numerous American composition pupils remember a rather narrow-minded teacher who found the one bar in their student pieces that most resembled Hindemith and proceeded to remold the entire work accordingly. Concertgoers are familiar with a few smooth, cleverly contrived orchestral pieces (the *Mathis* Symphony, *Symphonic Metamorphoses*), as well as many others that are sheer academic note-spinning. Performers have tackled the myriad

Continued on page 108

There is only one Birgit Nilsson.

Except when there are two.



WAGNER: TANNHÄUSER
Windgassen, Fischer-Dieskau;
Deutsche Oper, Berlin, Chorus
& Orchestra; Otto Gerdes
139 284/7 (4 discs, boxed)

As in Deutsche Grammophon's new **TANNHÄUSER**. In this superlative recording, Nilsson sings both Venus and Elisabeth with a cast that includes Wolfgang Windgassen in the title role, Dietrich Fischer-Dieskau as Wolfram and Theo Adam as the Landgraf. Otto Gerdes leads the chorus and orchestra of the Deutsche Oper, Berlin.

Hear this incomparable artist in two more Deutsche Grammophon recordings.

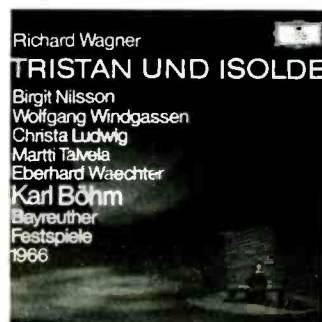

WAGNER: TRISTAN AND ISOLDE Ludwig, Windgassen, Waechter; Bayreuth Festival Chorus and Orchestra; Karl Böhm. 139 221/5 (5 discs, boxed)

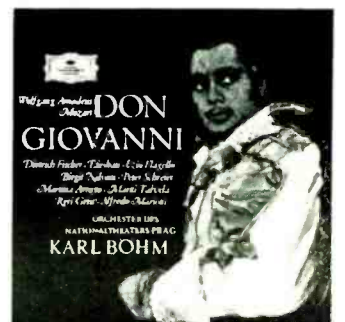

MOZART: DON GIOVANNI Arroyo, Grist, Fischer-Dieskau, Flagello, Talvela; Prague National Theatre Chorus and Orchestra; Karl Böhm. 139 260/3 (4 discs, boxed)

Deutsche Grammophon

DEUTSCHE GRAMMOPHON RECORDS ARE DISTRIBUTED IN THE USA BY POLYDOR INC.; IN CANADA BY POLYDOR RECORDS CANADA LTD.
CIRCLE 18 ON READER-SERVICE CARD

by Robert P. Morgan

The Scandalous Politics of Hans Werner Henze

THE HISTORY OF the abortive first performance of Hans Werner Henze's *Das Floss der Medusa* (*The Raft of Medusa*) has been so disputed in the press that it might be well to review the events surrounding its "premiere." Henze's recent interest in politics is well known: he has verbally announced his support of the radical left, and there was much attendant publicity when Rudi Dutschke, the Berlin student leader who was shot in a demonstration last year, stayed with Henze during his convalescence. Thus when Henze, commissioned to write a work for the North German Radio, dedicated his new composition to the memory of Che Guevara, its first performance became an event laden with political implications. The premiere, which was to take place in Hamburg on December 11, 1968, was attended not only by the usual wealthy patrons of such affairs but also by a healthy contingent from both the Hamburg and Berlin wings of the SDS. Shortly before the beginning of the concert, with the orchestra, chorus, and soloists already on the stage (but before the conductor—Henze himself—had appeared), a group of students attached a large portrait of Guevara to the conductor's podium. This was immediately torn down by an incensed Franz Reinholz, program director of the North German Radio. The students countered by putting up a poster praising Henze as a revolutionary and hoisting a red flag. By this time there was general bedlam in the hall. Members of the RIAS Chamber Chorus began to chant that they would not sing under a red flag and soon left the stage. The intensity of the demonstration increased until finally the police were called in (no one, incidentally, has admitted making the call); they burst into the hall and began pommeling, apparently more or less indiscriminately, the younger members of the audience. (Some embarrassment was caused by the fact that among those attacked was Ernst Schnabel, the librettist of *The Raft* and an employe of the Radio, who was thrown through a glass door, and finally put into jail for several hours.) Henze appeared and announced that the intervention of the police had made the presentation of his new work an impossibility, and then disappeared through a rear door.

Somehow it seems appropriate to the artistic tenor of our time that the musical scandal engendered by various premieres in the early twentieth century (the *Sacre du printemps* being the prime



Deutsche Grammophon/Adelmann

Composer Henze: spokesman for the new Left?

example) should be replaced by the political scandal of the nonpremiere in the Sixties. In an age which is no longer able to distinguish clearly between art and the commercial products of pop culture, it is perhaps inevitable that musical considerations can no longer play an important role in such affairs. Henze's music, after all, was never even heard on that occasion.

What if it had been? One can only wonder what the reaction of the SDS members would have been, assuming of course that they had bothered to listen. For the anomaly of the situation is that Henze, as a composer, is probably the foremost representative of the "establishment" to have emerged since the Second World War. And—irony of ironies—he has established this reputation in a genre which historically has maintained the closest associations with the social elite, whether monarchic or capitalistic: opera. Is this, then, the musical representative of today's radical left?

In search of an answer one is led to a consideration of the composition which caused the furor, now available (in what amounts to its true premiere—a further cultural symptom!) in a two-record set on Deutsche Grammophon, performed by the nonperformers of its nonpremiere. The work, subtitled an "*oratorio volgare e militare, in due parti*," is based on the infamous events following the shipwreck, in July 1816, of the *Medusa*, a French vessel on its way to Africa.

(The story is perhaps best known through the famous painting of the raft by Géricault.) The libretto recounts all the horrors of that tale: the occupation of all available lifeboats by the "important" members of the ship's party; the hasty construction of a raft for the 154 remaining members (including some women and children); the tying of the raft to the lifeboats so that it could be towed; the cutting of the ropes to the raft when those in the lifeboats realized they were making no headway (amounting to an execution of those on the raft); the agony of survival on board the raft; the gradual reduction of the number of living through thirst, starvation, and the elements; and finally the sighting of the raft by a ship when only a handful of survivors remained on board.

Henze and his librettist have organized the work spatially, placing the performers into three separate groups on the stage: the orchestra is located in the center, with those singers representing the living on the left and those representing the dead on the right. Each side is also represented by a soloist: the side of the living by Jean-Charles, the mulatto (familiar from Géricault's painting) who died only after the raft had been sighted, and the side of the dead by Death herself. The work opens with Death alone on the right; then the members of the choruses gradually pass from left to right as they move from the realm of the living to that of the dead. In the center before the orchestra is Charon, the ferryman, who narrates and thus serves as a guide through the story and who also conducts the transfer of the singers across the stage.

There are obviously distinct dramatic possibilities in this, and in some respects it seems to me that Henze has realized them effectively. His device of associating the dead with string instruments while the living are accompanied by winds and percussion works surprisingly well and avoids becoming overly schematic thanks to the fact that the two sides are frequently allowed to interact and that new combinations are constantly being created by the transfer of singers from one area to the other. But this highly ingenious dramatic framework seems largely undermined by the music itself, which appears to play an almost perfunctory role in the total structure. Written in Henze's eclectic, postromantic style, it has the quality of music turned out in great haste. The whole oratorio, in fact, has something of the character

of an endless recitative, a monotone punctuated only by occasional dramatic high points, achieved by such primitive means as the use of shouting in the chorus and the massing of percussion and winds in the orchestra. The only consistent lyrical element is to be found in the role of Death as she attempts to seduce the living to her side. As a result, the work is rather like a melodrama in which music is accorded a distinctly subsidiary role. Experienced on this level, it is admittedly not without a certain effect; but in terms of its musical substance, there is much to be desired.

This brings me back to the question raised previously about the significance of this piece in the light of the riot it precipitated. Is there anything in the work itself to account for its history? The answer clearly seems to be no. Its plea against the injustices of an outmoded political regime, symbolized by those in power on the Medusa, will draw scant dissent from even the most heartless right-winger. And with regard to its tonal content, the work can only be said to represent in the light of today's musical "culture" a sort of backwater, and one which in this instance seems suspiciously stagnant. Henze's relevance to the "cause," then, appears to be simply a matter of expediency. He has been adopted by the left as a well-known figure, capable of serving as a useful symbol and a valuable means for achieving publicity. (One is reminded on the other side of the fence of Madison Avenue's use—or misuse—of rock to lure "rebellious youth" back into the main stream of our consumer society.) It is thus the demonstration itself that counts and not the content of the work which supposedly triggered it. There are no issues, only actions.

Despite some ragged edges, the recorded performance is generally quite good, although I judge without benefit of a score. Fischer-Dieskau makes the most of the vocally ungratifying role of Jean-Charles, much of which is closer to speech than to song, and Edda Moser sings the role of Death quite beautifully. All three choruses are excellent, particularly the children (and here credit must be given to Henze, who rivals Benjamin Britten in his ability to write idiomatically for young voices). Charles Regnier, as the narrator Charon, is also most effective. The sound is fine and the spatial dispensation of the various performers comes over very well in stereo. Text and translation are included.

HENZE: Das Floss der Medusa. Edda Moser, soprano; Dietrich Fischer-Dieskau, baritone; Charles Regnier, narrator; RIAS Chamber Chorus; St. Nikolai Boys' Choir; Chorus and Orchestra of the North German Radio, Hans Werner Henze, cond. Deutsche Grammophon 139428/29, \$11.96 (two discs). Tape: ●● K9429, 7 1/2 ips, \$14.95 (double play).

Donizetti's 'Roberto Devereux' waited for Beverly Sills.



DONIZETTI: ROBERTO DEVEREUX (ELIZABETH & ESSEX)

Beverly Sills, Robert Ilosfalvy, Peter Glossop, Beverly Wolff. Royal Philharmonic Orchestra, Charles Mackerras, conductor. WST-323 (3-record set) Sugg. list price: \$17.94

Other great Westminster firsts:



BEVERLY SILLS
Bellini and Donizetti Heroines. Vienna Volksoper Orchestra. Jussi Jalas, conductor. WST-17143 Sugg. list price: \$5.98

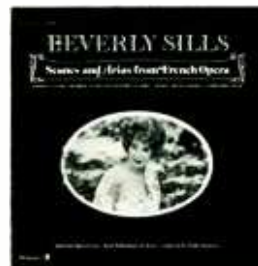

BEVERLY SILLS ARIAS AND SCENES FROM FRENCH OPERA.
Royal Philharmonic Orchestra & Chorus. Charles Mackerras, conductor. WST-17163 Sugg. list price \$5.98



TERESA STICH-RANDALL IN A GERMAN LIEDER RECITAL.
Robert Jones, piano. WST-17160 Sugg. list price: \$5.98



HANDEL: XERXES (COMPLETE)
Forrester, Popp, M. Miller, M. Tyler, Lehane, Priestman. WST-321 (3-record set) Sugg. list price: \$17.94



NORMAN TREIGLE
Operatic Heroes and Villains from Don Quixote and Mephisto. Vienna Volksoper Orchestra. Jussi Jalas, conductor. WST-17145 Sugg. list price: \$5.98



NORMAN TREIGLE IN ITALIAN, FRENCH & GERMAN ARIAS.
Vienna Radio Orchestra. Jussi Jalas, conductor. WST-17135 Sugg. list price: \$5.98

Write for complete catalog to:
Westminster Recording Co., Inc.
Dept. D, 1330 Avenue of Americas
New York, N.Y. 10019

Westminster



CIRCLE 2 ON READER-SERVICE CARD



**Solid State Power Amplifier
and Preamplifier**

The new McIntosh 36 page catalog gives you all the details on the new McIntosh solid state equipment. In addition, you'll receive absolutely free a complete up-to-date FM Station Directory.

SEND TODAY

McIntosh

McIntosh Lab. Inc.
2 Chambers St. Dept. A-12
Binghamton, N. Y. 13903

Send **FREE CATALOG** and **DIRECTORY**

NAME _____

ADDRESS _____

CITY _____

STATE _____ ZIP _____

CIRCLE 45 ON READER-SERVICE CARD

Hindemith sonatas for almost any instrumental combination you'd care to name—most of them far more fun to play than to hear (and such was the composer's intention). Some people may have even heard of the operas, reputed to be long, windy affairs that are more theoretical tracts than stage dramas.

While there is certainly a good deal of truth in all this, the picture is a lopsided one based primarily on Hindemith's postwar activities as composer/conductor/pedagogue and musical elder statesman. In the 1920s, Hindemith was considered something of a wide-eyed radical; his tense, dissonant, often severely objective contrapuntal style stood in startling and rather perplexing contrast to his preference for topics that ranged from the trivial to the luridly sensational. The four one-act operas belong to this period—*Mörder, Hoffnung der Frauen* (*Murder, the Hope of Women*, with a text by Oskar Kokoschka), *Das Nusch-Nuschi* (a musical play for Burmese marionettes), *Sancta Susanna*, and *Hin und Zurück* (*There and Back*)—as well as the ballet *Der Dämon* and the music for mechanical organ intended to accompany a "Felix the Cat" cartoon. Even many of his instrumental pieces, the sassy *Kammermusik* No. 1 (1922) for example, reflect Hindemith's predilection for giving his listeners a musical shock treatment.

Cardillac sums up early Hindemith in one compelling operatic package. The text is loosely based on an E.T.A. Hoffmann story. *Das Fräulein von Scudéri*, and Ferdinand Lion's three-act libretto is a model of taut, theatrical operatic construction. The story relates the final day in the life of Cardillac, a seventeenth-century Parisian goldsmith whose artistic genius is acclaimed by the entire city. Unfortunately, Cardillac cannot bear to part with his creations; whenever anyone buys a piece of his jewelry, he feels compelled to seek out the purchaser, murder him, and take back the precious stones. The townspeople, turned into an angry, hysterical mob by the series of mysterious murders, finally discover the truth from Cardillac's own lips and destroy him. Under the surface of this lodgerlike horror story, one can easily perceive that favorite Teutonic leitmotiv, the creative artist versus society—Hindemith took up this theme again on an even more ambitious level in both *Mathis der Maler* and *Die Harmonie der Welt*. Evidently the composer felt that his 1926 version of *Cardillac* was too entertaining and audiences might miss the deeper significance; he revised the opera drastically in 1952, adding many new words and additional music, hammering home the message in no uncertain terms. Much of the work's dramatic power was sacrificed in the process, though, and whenever *Cardillac* is staged (and since Hindemith's death the opera has been performed with increasing frequency), the early edition is invariably used.

Each scene is a self-contained musical unit, and, while the dramatic moods of the plot are cleverly delineated, the music

really leads an abstract life all its own. What makes it "work" in operatic terms seems to me to be the very ferocious intensity of the invention itself—a perfect mirror of Cardillac's own creative and destructive violence—and the composer's sure calculation of the theatrical effect. The final scene of Act I presents a typically Hindemithian solution to a tricky scenic problem. Lounging in her luxuriously appointed bedroom, a lady waits impatiently for her cavalier to arrive with a necklace by Cardillac. He enters, presents the jewelry, and begins to make passionate love; suddenly the masked goldsmith bursts into the room, stabs the cavalier in the neck, snatches the necklace, and escapes out the window. Curtain. For this scene of courtly gallantries, mounting passion, and swift murder, what does Hindemith write? A strict canon for two flutes over a light accompaniment—and it sounds absolutely right. The sensuous, twisting lines of the flutes followed by a vicious eruption from the full orchestra leaves no one in doubt about what is going on; yet the music could easily be taken out of context and simply entitled "Canon for Two Flutes and Orchestra"—who would guess the operatic origins? And so it goes throughout the score: the beautiful aria for Cardillac's daughter in Act II—a little triple concerto for violin, oboe, and horn with vocal obbligato—or the goldsmith's final confrontation with the mob, set as an elaborately worked-out theme and variations. Hindemith's own creative talents were working at peak intensity in this paradoxical opera—*Cardillac* is a fast-moving stage piece, bursting with superior musical ideas.

Crisp, precise, expressive orchestral playing is especially vital in this score, and the late Joseph Keilberth exercises taut control over his musicians. It's a brilliant performance and reproduced with impressive clarity by DGG's engineers. The chorus plays a large part in this opera and these important scenes also come across splendidly. Fischer-Dieskau dominates the cast; he vividly limns Cardillac's obsessed, fanatical character, and interprets the notes with his customary polished musicianship. Outstanding too is Elisabeth Söderström, insinuatingly sexy and musically letter-perfect in the relatively minor role of the amorous court lady. Donald Grobe does well as the impetuous officer in love with Cardillac's daughter; but Leonore Kirschstein disappoints here with her sluggish soprano and variable intonation. In general, though, the recording is admirably faithful to the spirit of the opera, an important and intriguing work by one of the twentieth century's major creative figures. P.G.D.

MAHLER: Symphonies No. 6, in A minor ("Tragic"); No. 10: Andante-Adagio. Orchestra of the Bavarian Radio, Rafael Kubelik, cond. Deutsche Grammophon 139341/42, \$11.96 (two discs). Tape: ●● K 9342, 7½ ips, \$11.95 (double play).

Mahler's *Tragic* Symphony has been re-

The second best thing about Victrola cartridges is their price.

First is their content.

The great classics performed by the most accomplished names in the musical world are now available on Victrola Stereo 8 Cartridge Tapes. Each is a musical masterpiece. Each is essential for any complete musical library.

In fact, you may be so happy about finding these works on Victrola Stereo 8, you may not notice that second best thing.

The low price. \$4.95*. That's why we've brought it to your attention.



RCA Victrola Stereo 8 Cartridge Tape

*Suggested list price.

CIRCLE 57 ON READER-SERVICE CARD

DECEMBER 1969

109

Christmas-time...
and the giving is
made easy.



Her voice is "about as beautiful as anything human can be." (*Atlantic*)
A treasury of her best performances.
Priced for giving (and for getting for yourself). Merry Christmas!
SCB-3754—3 stereo records

NEW!

Distinguished Solo Performances

**ARTIST in
RESIDENCE SERIES**



EUGENE ROUSSEAU
Indiana University

"... Mr. Rousseau has a huge dynamic range, a bagful of articulations and above all, intelligence and good judgement. . . . He has the genuine 'classical tone' . . ."

... New York Times

- # 1505 **JAMES PELLERITE, Flute
- # 1293 *PHILIP FARKAS, French Horn
- # 1601 **EUGENE ROUSSEAU, Saxophone
- # 1510 **JERRY SIRUCEK, Oboe
- # 1410 **HENRY CHAS. SMITH, Trombone
- # 1294 *LEONARD SHARROW, Bassoon
- # 1409 **OBERLIN FAC. WW. QUINTET
- # 1408 **WAYNE RAPIER, OBOE
- # 1244 *ROBERT WILLOUGHBY, Flute

And Many Others

FREE BROCHURE—LISTS ALL PROGRAMS
(Mono \$4.95—Stereo \$5.95)

**DEALERS-DISTRIBUTORS,
— PLEASE WRITE**

Coronet



RECORDING COMPANY
4971 North High Street
Columbus, Ohio 43214

CIRCLE 15 ON READER-SERVICE CARD

corded six times, twice in mono and, with the present release, four times in stereo. The key to the reviewer's problem is that, apart from any interpretive considerations, these six albums represent four different treatments of the text. Kubelik and Leonard Bernstein offer the same basic materials, the Erwin Ratz critical edition of 1963 with a fast-paced statement of the opening Allegro energico, ma non troppo and a double exposition. Erich Leinsdorf and Sir John Barbirolli offer somewhat slower, broader statements of the 1963 edition (especially this first movement) with the elimination of the repeat.

The two mono versions (both deleted) represented conductor-edited texts based on the final three of the five editions of Mahler's scores to appear in his lifetime. These differ from the present version in the reversed sequence of the two middle movements, the handling of the third hammer blow in the finale, and numerous details of orchestration. The performance of Charles Adler retains, in this context, some historic interest. That of Eduard Flipse may now be set aside. Finally one must note the publication by Eulenberg in 1968 of H. F. Redlich's edition of the 1906 *Originalfassung*. No recording exactly corresponds to this version, but it must be stressed that, in the main outlines, the 1963 edition more closely resembles the original 1906 text than Mahler's later revision. It would be interesting, however, if Georg Solti (who has a complete Mahler edition in the works) would give us Redlich's score rather than a fifth album of the Ratz.

In the face of these complications the idea of one "best" recording becomes even more ridiculous than usual. Those who have a strong preference for Barbirolli's slower-paced statements will not find the DGG set a rival for their affections. Kubelik's principal challenge is to Bernstein, and with warm and glowing sound and exquisitely sensitive treatment of both the animated passages and those of mystical introspection, the Czech maestro becomes a formidable opponent.

Technically, there is little contest. The Bavarian Orchestra seems surrounded by luminous space. The finest details of instrumentation (for example, the distant echoes of cowbells) project with exemplary clarity, yet one always retains an agreeable, concert-room perspective on the activities of a large orchestra. And the sound is so full and rich, so free of distortion! In contrast the Bernstein seems unduly compressed by its environment, less transparent in texture, and harsher in quality.

Interviewed in *Musical America* last January, William Steinberg struck a blow for practical musicology by reminding us that Mahler's hammer strokes do not project through the orchestration and, without some legerdemain, do not sound. Thus the difference between two strokes and three (Kubelik follows the revised score and provides only two) is really of slight importance in terms of the total effect. Kubelik gives you the sound Mahler wrote, and, like nearly everything else in the performance, it's authoritative and musically effective.

For me, the strongest feature of the Bernstein edition is the Scherzo, which is just a little more demonic and intense than Kubelik's performance. (Kubelik, however, offers a gloriously expansive and romantic account of the Andante.) In the first and final movements, the energy of Kubelik's leadership produces a remarkable sense of continuity that links the material into a powerful and unified musical structure.

The text of the Tenth Symphony played here is, of course, the old one, limited to the first movement of the work in its reconstructed form. This orchestration is almost entirely Mahler's work, and Kubelik plays it with the wisdom and eloquence he earlier displayed in the Symphony No. 9. R.C.M.

MAHLER: Symphony No. 7. New Philharmonia Orchestra, Otto Klemperer, cond. Angel SB 3740, \$11.96 (two discs).

Mahler was notorious for changing his mind on details of orchestration (rarely matters of basic structure) after his music had been engraved. Moreover, in the case of this Symphony (sometimes called *The Song of the Night*) he permitted more than 700 misprints to pass his eyes in preparing the 1909 edition. Thus a corrected version of No. 7 was one of the first items of business for the Mahler-Gesellschaft. This text appeared in 1960. Two years later Eulenberg issued the 1909 score corrected and edited by H. F. Redlich, who takes strong exception to the 1960 Gesellschaft revisions which Mahler might later have discarded, as he did with some of his second thoughts in the Symphony No. 6. According to Angel's notes, Klemperer follows the 1960 version. A recording of the 1962 Redlich text (further revised in 1965) would provide a welcome contrast.

The death of Bruno Walter denied us a complete Mahler edition from his hand (but then, Walter did not keep all nine symphonies in his active American repertory). But we have an encouraging start on a basic Mahler corpus from Klemperer, who, like Walter, brings unique qualifications of both musicianship and personal association to the performance of this music.

It is precisely a work such as the Seventh, with its five movement structure, its hour and forty minutes' playing time, and—most of all—its fluid thematic lines, that caused critics of the past to write so many silly things about Mahler's symphonies. The work must be unified by a conductor who sees how these elements fit together into a musical structure that permits movement and development within the over-all stylistic dimensions of the material.

All three of the stereo recordings of the score are musically commendable. The first to appear was Maurice Abravanel's, and it easily surpassed the mono editions that had preceded it. Then came the Bernstein, a tighter, more incisive performance that generally won critical preference. It remains an excellent al-

Fisher is ahead in the race for bass.

For a long time, the bookshelf speaker system with the "best" bass was the one with the most boom.

The fact is, most good bookshelf speakers today incorporate the acoustic suspension principle. Invariably, they can all deliver big bass in a corner, or on the floor. And, just as invariably, there'll be a lot of bass coloration, resonance, and overemphasis of certain bass frequencies.

Introducing the XP-9C.

At Fisher, we suspected that the first bookshelf system capable of solid, resounding bass outside of a corner or floor location would sound far cleaner than any other bookshelf speaker on the market.

We gave our engineers the assignment.

And they gave us the new Fisher XP-9C. The smallest speaker system ever to use a fifteen-inch acoustic suspension woofer.

This woofer, with its massive 12-pound Alnico magnet and extremely high compliance, has a free-air resonance of 10 Hz! And in its compact cabinet will produce natural-sounding bass to below 30 Hz. No doubling. No audible distortion.

For precise cone control, and greater power handling, our 15-inch woofer uses a 2½-inch voice coil.

Then, to insure a crisp mid-range, a pair of matched, 5-inch mid-range drivers take over at precisely 500 Hz. With their airtight enclosures they handle only those frequencies between 500 and 1,200 Hz, and can't interact with the bass.

The total effect is cleaner, more exact bass than any other bookshelf system can achieve, anywhere you choose to place the XP-9C's.



On to treble.

Naturally, there's more to the XP-9C than flawless bass.

A special hemispherical dome tweeter takes over from the lower mid-range drivers at 1,200 Hz. Then, starting at 5,000 Hz, a super tweeter reproduces all frequencies to the limits of audibility with outstanding clarity and presence.

Both tweeters use a soft dome with high internal damping to eliminate all

parasitic resonances. Crossovers are clean in every case, because we're using new sharp-cutoff (12-db per octave) networks. Bandpass filters (instead of conventional roll-off networks) assure that each speaker handles only those frequencies it can reproduce best.

Also (and some of our engineers believe, most important of all), the XP-9C has virtually eliminated boxy "speaker sound" by careful acoustic loading of the woofer; and putting it all in a cabinet constructed of non-resonant flake board, which eliminates the resonances found in plywood. Finally, the whole system is tightly sealed and filled with Acoustiglas® to provide a high degree of damping.

We challenge all comers.

We invite comparisons between the Fisher XP-9C and any other speaker system. Bookshelf, or floor standing.

Compare them for overall sound, of course. But pay special attention to the bass.

If you're a concert goer, and you know what real bass sounds like, you'll never be able to settle for one of the speakers that lost the race for bass.

(For more information, plus a free copy of the Fisher Handbook 1970 edition, an authoritative 72-page reference guide to hi-fi and stereo, use coupon on magazine's front cover flap.)

The Fisher XP-9C with 15-inch woofer.

FISHER RADIO., 11-35 45TH ROAD, LONG ISLAND CITY, N.Y. 11101.
OVERSEAS AND CANADIAN RESIDENTS PLEASE WRITE TO
FISHER RADIO INTERNATIONAL, INC.,
LONG ISLAND CITY, N.Y. 11101.

CIRCLE 30 ON READER-SERVICE CARD

Let Angel
help you wrap-up
Christmas.



"He is the noblest yet the most humane of all violinists." (Neville Cardus, *Manchester Guardian*)

A collector's treasury, priced for giving. Merry Christmas!
SCB-3727 —3 stereo records

WRITE FOR
QUOTATION

FACTORY SEALED CARTONS
FRANCHISED DISTRIBUTOR
QUICK SHIPMENT

WE GIVE
DISCOUNTS
ON HI-FI
COMPONENTS

SOUND
REPRODUCTION
INC.

460 CENTRAL AVENUE
East Orange, New Jersey 07018
(201) 673-0600

CIRCLE 69 ON READER-SERVICE CARD

bum, especially as a foil for the Klemperer, since the range of Mahler's work (for example, the Rondo Finale) is made clear by the manner in which it responds to different interpretive ideas.

The Klemperer set, for a start, is beautifully recorded, with rich, deeply colored sound that caresses the ears like velvet. As one might expect, it is more deliberate in pace than its rivals. Klemperer provides a superb sense of atmosphere: the shadow-scherzo, the night music, the shifting moods of the opening movement are all achieved with the kind of sympathy one would hope to encounter from one who knew Mahler and first studied this music in the year of its premiere. The most amazing thing is the way Klemperer suggests that the work is moving in a kind of cosmic time scheme all its own, paced by a master clock that runs independently of our hectic lives. Thus, as you listen to this performance, it seems, for 100 minutes or so, to enclose you within its own world of evocative sound, a world that echoes (especially in the night pictures) the world we may know, but remains a world transformed by imagination and high art, separate, remote, and complete within itself.

This sort of effect is the achievement one might expect from a musician of Klemperer's distinction. The result is a set worth acquiring, even if one has one of the older albums, and a performance that provides a unique introduction to this extraordinary score. R.C.M.

MANCINI: Beaver Valley—37; Dream of a Lifetime; Strings on Fire; Cameo for Violin; Drummers' Delight; The Ballerina's Dream; Speedy Gonzales. Philadelphia Pops Orchestra, Henry Mancini, cond. RCA Red Seal LSC 3106, \$5.98. Tape: ●● TR3 1006, 3¾ ips, \$6.95; ● RBS 1132, \$6.95.

If the a & r men at RCA are hoping to replace the Boston Pops, recently departed to DGG, with the newly formed Philadelphia Pops, they'll have to find better material than this. Musically, the record amounts to nil, and makes one wonder how Mancini made his reputation. As demonstrated here, his talent is limited to two kinds of pieces: one slow and moody à la *Moon River*, the other a fast, snappy number in the *Peter Gunn* vein. Occasionally, when he breaks away from these types as in *The Ballerina's Dream* or *Speedy Gonzales*, the result is downright embarrassing, resembling those dreadful novelty numbers that more proficient high school bands play to excess.

Such is the material on Side 2 of the disc, containing six short sketches designed to display the Philadelphia sound—unrecognizable here due to the slick, gimmicky engineering. Solo instruments are blown up larger than life, and the strings sound merely muddy rather than Philadelphia-rich—a typical Hollywood sound.

The featured work is *Beaver Valley—37*, an autobiographical suite depicting Mancini's teen-age experiences in Ali-

quippa, Pennsylvania. While the subject itself is of less than compelling interest, a movement like *Black Snow*, a musical protest on the evils of air pollution, simply invites disaster. Of the other two movements, only *The Sons of Italy* has any real life, although it suffers, as does the whole disc, from appallingly thin melodic invention.

One ray of sunshine amid the gloom: *The Ballerina's Dream* marks the debut of a new instrument, the piccolo in G, and it sounds gorgeous. But for the rest, expect the worst. R.W.S.

MASSENET: Werther. Victoria de los Angeles, Nicolai Gedda; Orchestre de Paris, Georges Pretre, cond. For a feature review of this recording, see page 93.

MESSIAEN: Poèmes pour Mi. Lise Arséguet, soprano; Olivier Messiaen, piano. Everest 3269, \$4.98.

The song-cycle *Poèmes pour Mi*, one of Olivier Messiaen's earliest works, is an excellent example of what I would call the composer's "Christian Surrealism." If these two terms seem contradictory, this same incongruity strikes one immediately upon listening to the nine *Poèmes*. The piano writing, with its endless (but subtly varied) repetitions and its constant flow of sensual, unresolved harmonies, creates the same impression of spaciousness found in Messiaen's later *Vingt regards sur l'Enfant Jésus*. The vocal line, on the other hand, remains fundamentally simple, moving more often into chant and vocalization than into true melody, while the text, written by Messiaen himself, ranges from the archetypal imagery characteristic of the Surrealists to Allelujahs and various borrowings from the Bible. For all this, the *Poèmes pour Mi* is one of Messiaen's most accessible works, strikingly beautiful in its cosmic simplicity and almost hypnotic in its musical effect.

This Everest release, taken uncredited from a French Harmonia Mundi recording, features the composer at the piano with Lise Arséguet (whose name is misspelled on the cover) doing the vocal part. Messiaen's playing is somewhat more percussive and dynamic than that of his chief keyboard interpreter, Yvonne Loriod (Mme. Messiaen). But the composer's rather brittle pianistic style is quite effective in delineating the accompaniment, and I cannot imagine a better performance. Although Miss Arséguet seems to strain on occasion and has a tendency to loose her vibrato in the quieter passages, her talents are admirably suited to the work. She has a remarkably clear voice and, even more importantly, obviously identifies with the texts, which are almost always quite easy to follow (although Everest might still have supplied a copy of the poems). The basic sound on the recording is likewise clear and well defined, but unfortunately somewhat marred by surface noise and distortion not present on the original mono-only Harmonia Mundi album. Although it is



16 10 0658

16 10 0132

16 10 0610

16 11 0092

16 10 0674

16 10 0776

Where All The Big Sounds Hide These Days.



16 10 0742

16 10 0748

16 10 0654

16 11 0104

16 10 0552

16 10 0612



16 10 0670

16 10 0692

16 10 0738

16 10 0744

16 10 0722

16 10 0718

Hear all the great hits on Columbia Stereo Cassettes

All albums also available in 8-track stereo tape cartridge and 4-track reel-to-reel tape

CIRCLE 13 ON READER-SERVICE CARD

© COLUMBIA MARCAS REG. PRINTED IN U.S.A.

not indicated as such on the album. Everest's "stereo" is obviously of the doctored (or medicated, if you prefer) variety, and the vocal line is split up in a bizarre manner; occasionally one has the feeling that two different sopranos are singing. However, this is a record well worth having—an excellent introduction to Messiaen for those unfamiliar with him and an invaluable addition to the collection of those who are devotees.

R.S.B.

MOONDOG: Theme; Stamping Ground; Symphonique #3; Symphonique #6; Minisym #1; Lament 1; Witch of Endor; Symphonique #1. Various instrumentalists; Moondog, cond. Columbia MS 7335, \$5.98.

Moondog is Louis Hardin, familiar to many New Yorkers as the blind man who stands on midtown street corners clad in Viking costume with spear in hand. If you ever caught sight of this picturesque figure and assumed that he was just another nut, you're wrong. Moondog is a man of learning and accomplishment, a poet and composer/musician of no small repute. Why he chooses to stand on street corners is his own business, and need not concern us. Why Columbia felt it necessary to devote a whole record to his works is a matter of concern, however. While the music is fun—and sometimes quite lovely in a Milhaud/Satiesque sort of way—it all seems rather limited in its emotional range; furthermore, each piece is

built on canonic or other similar repetitional devices. Twenty-eight minutes of this can become rather wearing.

I suspect that Columbia is trying to sell the disc as music of the lunatic fringe: the whole production, in fact, resembles their Harry Partch record of a few months back, even down to the color portrait on the unipac fold-out. Have we become so jaded that a thriving market really exists for this kind of thing? Heaven knows, there are enough rugged individuals writing real music.

R.W.S.

MOZART: "Opera and Concert Arias." *Le Nozze di Figaro:* Porgi amor; Deh vieni, non tardar. *Idomeneo:* Se il padre perdei. *Die Zauberflöte:* Ach, ich füh'l's. *Il Re pastore:* L'amerò sarò costante. *Ch'io mi scordi di te, K. 505.* *Bella mia fiamma, K. 528.* Leontyne Price, soprano; New Philharmonia Orchestra, Peter Herman Adler, cond. RCA Red Seal LSC 3113, \$5.98.

A puzzling record: at one extreme, a clean, secure, and forward-moving rendition of the *Re pastore* piece, unmarred by that nasty nineteenth-century cadenza we used to hear so often; at the other, a really unpleasant sing-songy reading of Susanna's aria that hasn't even solved the rather basic problem of how to handle the feminine phrase endings, which all sound like afterthoughts (not to mention the appoggiaturas that they demand but do not get).

In between, the *Zauberflöte* aria is also impressive, with the tone trimmed down to a pure, almost white sound, which negotiates the intricate line with a sure sense of destination. Elsewhere, there is some insecurity of intonation, particularly at the upper break; this shows up in three arias in E flat (K. 505, "Porgi amor," and the *Idomeneo* piece—who was the dunce that put these one after the other at the start of the record?), but oddly, not at all in the *Re pastore* piece, which is in the same key and lies right across that break. In *fioritura*, too, the singer is rarely completely accurate (e.g., the crucial upward run on "incoronar" at the end of "Deh vieni"), and such a piece as *Ch'io mi scordi di te* comes off poorly by comparison with Berganza's more incisive (both musically and verbally) performance.

Miss Price's espousal of the two concert arias wins her points in my book, at any rate; they are arguably among Mozart's greatest vocal works. It would have been nice to credit the pianist in K. 505 and the *Re pastore* violinist, however; they both work hard and to good effect.

There is enough fine singing on this record to make one feel entitled to expect still more; there are too many rough edges, in both voice and orchestra. Mr. Adler has one interesting idea about tempo, which he uses in both "Porgi amor" and "L'amerò," where he sets off the final phrases—which function as codas—by a gently slower speed. There isn't quite enough tempo contrast be-

Philips Classical Imports Arrive

The records everyone's been waiting for.

BERLIOZ: TE DEUM

Tagliavini, tenor: London Symphony Orchestra and Chorus / Davis—SAL 3724

SCHUMANN: CARNAVAL; FANTASY, OP. 17

Arrau, piano—SAL 3630

MAHLER: SYMPHONY NO. 2 "THE RESURRECTION"

Ameling, Heynis, Concertgebouw Orchestra / Haitink—802.884 / 85

PURCELL: SONG RECITAL

Patterson, tenor: Skeaping, viola da gamba; Beckett, harpsichord—SAL 3717

MENDELSSOHN: OCTET, OP. 20; WOLF: ITALIAN SERENADE; ROSSINI: SONATA A QUATTRO, NO. 3

I Musici—SAL 3640

WOLF: EXCERPTS FROM THE ITALIENISCHEN LIEDERBUCH

Souzay, baritone; Baldwin, piano—SAL 3661

MENDELSSOHN: SYMPHONIES NOS. 4 & 5

New Philharmonia Orchestra / Sawallisch—SAL 3727

BEETHOVEN: PIANO CONCERTO NO. 1; SONATA NO. 6

Arrau, piano, Concertgebouw Orchestra / Haitink—SAL 3712

BEETHOVEN: STRING QUARTETS, OP. 127 & 135

Quartetto Italiano—SAL 3703

DVORAK: STRING QUINTET, OP. 77; WALTZES

Berlin Philharmonic Octet—SAL 3688

C.P.E. BACH: FOUR SINFONIAS

English Chamber Orchestra / Leppard—SAL 3701

MUSIC FROM THE TIME OF CHRISTOPHER COLUMBUS

Musica Reservata—SAL 3697



FROM THE MERCURY FAMILY OF LABELS
MERCURY • PHILIPS • WORLD SERIES • WING

A Product of Mercury Record Productions, Inc. 35 East Wacker Drive, Chicago, Illinois 60601
A NORTH AMERICAN PHILIPS COMPANY

CIRCLE 46 ON READER-SERVICE CARD

A-1200U • Exclusive triple-motored drive system • 3 precision heads for instant off-the-tape monitoring • Mike-line mixing
• 4 independent amplifiers • Automatic tape lifter • All-pushbutton controls, automatic shutoff • Stereo echo for special sound effects

Ever see a sonic boom?

You're looking at our A-1200U tape deck. Most people would rather listen to it. Even though it's already started its own sonic boom. And no wonder: the A-1200U is our standard four-track model, with all the famous TEAC craftsmanship at an ear-boggling low cost. And plenty of unique features, like the popular ADD recording for simultaneous playback and recording on separate tracks. This is the machine that breaks the price barrier to your sound investment. Without breaking you.



TEAC

TEAC Corporation of America • 2000 Colorado Avenue • Santa Monica, California 90404

tween the two sections of K. 505, particularly given the extent to which both tempos are inflected—and the big ritard and *Luftpause* that precede the reprise in the slower part are unfortunate, leaving the pianist to plunk down a solitary and absurd high E flat upon resumption of the tempo.

No texts or translations; just a rather fervent liner note by Marcia Davenport. D.H.

RHEINBERGER: Der Stern von Bethlehem, Op. 164. Rita Streich, soprano; Dietrich Fischer-Dieskau, baritone; Chorus of the Bavarian Radio; Graunke Symphony Orchestra, Robert Heger, cond. Angel S 36565, \$5.98.

The pre-Christmas deluge of new albums almost always includes a number of off-beat seasonal items for those who wish a change of pace from the standard Yuletide fare. This year's surprise stocking gift is a curio indeed: a Christmas cantata composed in 1890 by Josef Rheinberger. Born in Liechtenstein in 1839, Rheinberger spent his entire adult life in Munich where he played an immensely active part in the city's musical life, composed profusely (nearly 200 opus numbers), taught organ and composition at the conservatory (his pupils included Humperdinck, Wolf-Ferrari, Furtwängler, and the physicist Max Planck), and died there in 1901. Although greatly respected in his day, Rheinberger is now a shadowy figure even in Germany: organists

will now and then resurrect one of his twenty sonatas for the instrument, but the rest of his voluminous output rarely comes off the library shelf into the concert hall.

The Star of Bethlehem is the last in a series of choral works set to text by the composer's wife, Fanny von Hoffnaass. Like many composer's wives past and present, Fanny was devoted to her husband and his career almost to the point of fanaticism. In addition to her literary contributions, she tended to Rheinberger's extensive correspondence, copied his music, and tirelessly encouraged his extreme musical conservatism in the face of that archradical and reprobate, Wagner. (For his part, Wagner once remarked that Rheinberger was a far superior composer to himself: whereas the latter composed punctually every day between five and six, Wagner said he could only work when he had an idea.) When Fanny died shortly after *The Star* had been completed, Rheinberger was so desolate that he could not bring himself to attend any performances of the work for the remaining years of his life.

Fanny would have wholeheartedly approved of *The Star*—even Brahms sounds dangerously left of center compared to this inoffensive, melodious, smoothly contrived cantata. Despite its facile veneer, there is something undeniably attractive about the unaffected, almost childlike wonder of both the text and music as the familiar Christmas story unfolds in nine well-contrasted sections. The opening chorus, a lovely little nature portrait, describes an expectant earth awaiting Christ's birth; we then meet the shepherds, hear the angels' announcement, follow the star to Bethlehem, see the holy family at the manger with the attendant wise men, and close with a chorus of "fulfillment" that recapitulates the opening music. Not one note jars in this comfortably conceived composition—the proportions are just right, the choral writing immaculate, and the little solos judiciously spaced. As a unifying device, Rheinberger uses a simple recurring four-note motto, symbolic of the star. Its rising octave span is curiously reminiscent of Richard Strauss, who undoubtedly heard a great deal of Rheinberger's music during his youth in Munich.

The performance is flawless. Heger never treats the music condescendingly but coaxes warm, affectionate playing and singing from his forces—the choral work in particular emerges with a captivating silken, mellow sheen. Streich's boyish soprano is perfectly suited to the wide-eyed innocence of her music and Fischer-Dieskau sings his few lines with as much thoughtful care as he would a Schubert song. The cool acoustic is most friendly to the work and the glowing performance. If it's honest, old-fashioned Christmas sentiment you're looking for, by all means give this modest but appealing score a try. P.G.D.

SCHUMANN: Zigeunerleben, Op. 29, No. 3—See Brahms: Zigeunerlieder, Op. 103.

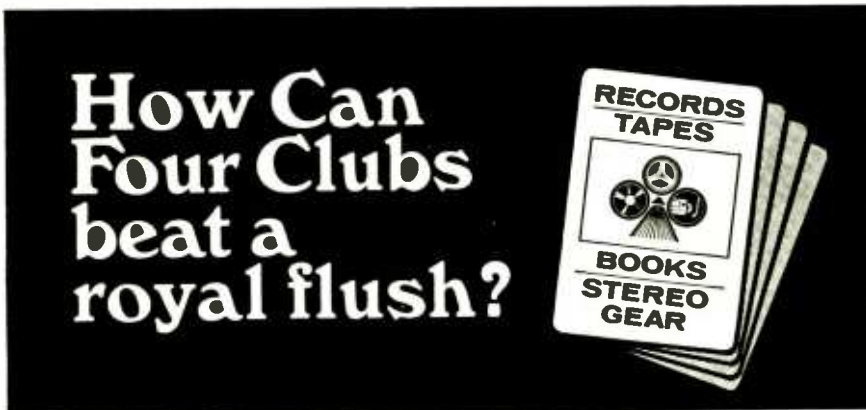

It can when the deal is with... Wadyakallus*

Every card player knows a royal flush is an unbeatable poker hand...but our club's 4 big clubs in one membership deal can beat it hands down when it comes to saving your money.

We've really stacked the deck in your favor: tape deck, that is. We offer savings up to 50% on Stereo equipment from all makers. We're prohibited from listing those nationally advertised brands. Write for our complete list of famous makers as well as a low quote on your Stereo needs.

QUALITY GUARANTEED! All records, tapes, books and equipment, of course, are BRAND NEW and FACTORY sealed. Your satisfaction is guaranteed.

MORE FOR YOUR MONEY! There are NO Membership Dues, No Annual Fees, No Minimum Orders, and Nothing will ever be shipped unless you order it. There are Tremendous Savings, Unlimited Selections, Extra Discount Specials, FREE Catalogs and Magazines, 4 Clubs in One Convenience and Fast Same Day Processing of Orders. The cost for all this and a lifetime of Membership Benefits is just \$5.00.

With all our cards on the table we think that's an unbeatable hand.

***Look for our new name and the winner (it may be you) in our next ad.**



If you ever wanted to buy RECORDS, TAPES, HI-FI-STEREO GEAR and BOOKS at substantial savings (25%-80%) with NO MINIMUM BUYING obligation, OUR CLUB IS FOR YOU. Your choice of every BOOK, RECORD and TAPE available is UNLIMITED. No need to be roped into choices pre-selected for you.

FREE SCHWANN Record Catalog is yours upon joining. It lists every LP available on every LABEL by category. Jazz, Folk, Classical. Popular and so on.

FREE HARRISON Tape Catalogs listing all available tapes, cartridges and cassettes are yours with our compliments. Both Catalogs are the undisputed recognized authorities in their field... A Must for every Music library.

FREE BOOK Supplements make book selection a snap... Select any book you wish: Fiction, non-fiction, historical, scientific, even valuable art books at 25% to 80% discount.

FREE Club Magazines keep you informed of New RECORDS, TAPES and BOOKS, NEW ARTISTS, what to watch for and offer valuable extra discount club specials.

Wadyakallus? HF-12

C/O SHIELD INTERNATIONAL CORP.
777 Third Avenue, New York, N.Y. 10017

Send my FREE SCHWANN catalog, my FREE HARRISON 4 or 8 track catalog, order blanks and FREE CLUB MAGAZINE by return mail. \$5 enclosed guarantees me:

- LIFETIME MEMBERSHIP
- 35%-80% savings on LP albums, 1/3 off on tapes, 25% on books.
- No requirement ever to buy anything. Nothing will ever be sent until I order it.

I must be delighted with the Club or within 30 days I will let you know and receive a full refund.

NAME _____

ADDRESS _____

CITY _____ STATE _____ ZIP _____

Send GIFT MEMBERSHIP at \$2.50 each to names and addresses listed on attached sheet.

I am interested in tapes 4 track and cassettes 8 track.

CHARGE PRIVILEGES AVAILABLE ON ALL PURCHASES

CIRCLE 64 ON READER-SERVICE CARD

The world's fastest bookshelf speaker.

That's not a joke. The new **Rectilinear X** is at least four times faster off the line than its closest competition. And you're not reading a drag-racing magazine.

But let's begin at the beginning.

A few months ago, we announced the **Rectilinear X** (that's a ten, not an ex) as the world's first high-fidelity loudspeaker. We explained that it was the first speaker system to pass a signal more or less unaltered, in the same sense as a minimally acceptable amplifier. (We didn't say, as a few people seemed to interpret us, that our new \$199 bookshelf speaker made all costlier systems obsolete. There will probably always be a need for larger, more expensive speakers for reasons of power, efficiency, versatility, special acoustical problems, etc. But not accuracy.)

What we want to point out in this ad is the specific reason for the superior accuracy of the **Rectilinear X** as a listening device.

Not the frequency response, although it happens to be beautifully flat and smooth. Nor the absence of harmonic distortion, although the 10-inch woofer with its one-inch linear travel won't distort a 50 Hz signal at 10 watts any more than a medium-priced stereo receiver. Nor even the transient response, although the exceptionally low-mass tweeter follows steep wave fronts with great alacrity.

No. The truth is that all of today's top speakers have reasonably smooth frequency response, low harmonic distortion and good transient response. And it would be utterly impossible to predict their individual sound quality or their relative ranking from these data alone.

However, as we have discovered, there is a measurable quantity that corresponds very closely to audible differences in speaker performance. *Time delay distortion*.

In our introductory advertising, we referred to this much-neglected criterion by the more specialized mathematical term of envelope delay distortion, a concept with many ramifications in network theory. A sophisticated ex-

planation would require a very involved discussion of loudspeaker phase response as distinct from amplitude response, but the basic idea is quite simple.

Sound waves travel through air at the rate of approximately 1135 feet per second (at room temperature). Therefore, if you're sitting let us say $11\frac{1}{3}$ feet from a speaker, you'd expect a signal to reach your ear one one-hundredth of a second (10 milliseconds) after the amplifier feeds it to the speaker terminals.

Not so. It will reach your ear more slowly.

It seems that speakers don't speak the instant they receive a command from the amplifier. Between the entry of the electrical signal and the exit of sound, there's a time delay. Not just a slow-down of the rate at which pressure amplitude builds up (i. e., transient response), but an actual moment of silence. Dead silence.

What's more, the length of this moment is frequency dependent. Generally speaking, lower frequencies are delayed longer than higher frequen-

cies. Which means that the low and high frequency components of a signal that enter a speaker at the same instant don't arrive at your ear at the same instant. There's a smearing effect. This accounts, in part, for the gutsy, canned sound of some popular speakers, which many people like although its bears no resemblance to live music.

Now, time delay distortion is least audible at low frequencies and becomes more and more obvious going up into the midrange. Woofers, with their massive moving parts and complex networks, are the worst offenders, so it becomes important to keep them out of the midrange. The only speaker system that goes all the way in this respect is the **Rectilinear X**.

Although the specially designed 10-inch woofer has remarkably little time delay to begin with, it's crossed over at 100 Hz to a 5-inch midrange driver with phenomenally low time delay distortion. Thus the entire midfrequency band has the benefit of minimum time delay. And you can hear it.

At 500 Hz, for example, the **Rectilinear X** has a time delay of less than 0.2 millisecond. By comparison, the top-of-the-line model of the most famous name in bookshelf speakers has a delay of approximately 0.8 millisecond at the same frequency, mainly because most of the output is still coming from the woofer. The **Rectilinear X** is literally faster off the start line.

Since no other speaker system cuts off the woofer at 100 Hz, and no moving-coil speaker is faster in the lower midrange than our 5-inch driver, the **Rectilinear X** is the world's speed king.

At which point we can't resist borrowing a phrase from the underground. "Speed kills." Our competition.

(For further information, see your audio dealer or write directly to Rectilinear Research Corporation, 30 Main Street, Brooklyn, N. Y. 11201.)

Rectilinear X

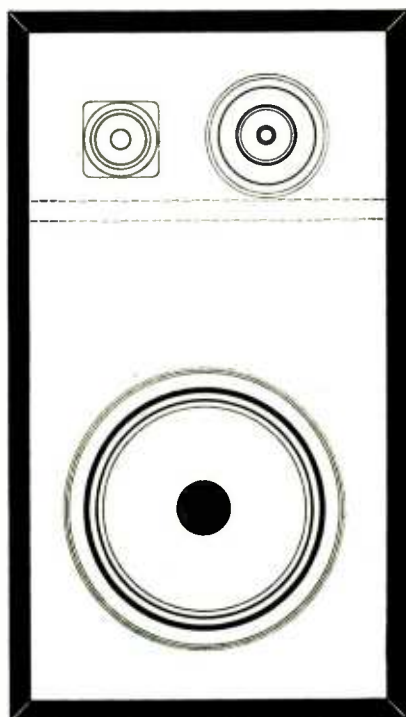

CIRCLE 59 ON READER-SERVICE CARD

STRAUSS, R.: Ein Heldenleben, Op. 40; Salome: Dance of the Seven Veils, Op. 54. NBC Symphony Orchestra, Arturo Toscanini, cond. For a feature review of this recording, see page 96.

cond. Deutsche Grammophon 139284/87, \$23.92 (four discs).

The arrival of a third stereo *Tannhäuser* serves to broaden the buyer's choice—and that is good. But it also complicates life for the reviewer (and that's bad) who presumably ought to be able to say, straight out, that such-and-such is the set to get. Now, with any opera as long and complex as this one, the variables mount in number and complexity. Back in HF of November 1966 Conrad L. Osborne did a thoroughgoing analysis of the *Tannhäuser* situation as it then stood; and things weren't simple even then. The new release is in some respects very good indeed, but in other important ones, it is not as good as the competi-

tion. So settle back. This is going to take a little time.

There are three important novel features about the new DGG issue, and these should be mentioned straight off, since they may settle things for you. First, if you value technology highly, then this is your set. No doubt at all about that. It has a fine, fully fleshed sound of the utmost polish and clarity, as good as DGG's best, which is saying a lot, and is far more impressive than either of the competing Angel and Philips issues. (For anyone who has pulled out the Osborne discography, I had better say right off that I am eliminating from consideration the earlier DGG set of 1950 conducted by Schroeder and also an early-Fifties recording conducted by Robert Heger, now listed in Schwann on the Vox, Urania, and Artia labels, some of them in rechanneled stereo.) The Philips set was made at Bayreuth in 1963 during live performances; the Angel issue was taped in Berlin in 1961. Both sets are quite good technically, but neither of them approaches the sonic excellence of the new DGG.

The German company is proverbially conservative when it comes to technical innovation, so it is something of a surprise to find that this release offers a new boldness in its stereo staging. For example, the Bacchantes in the Venusberg are microphoned alluringly in the middle distance; and in Act III, Wolfram comforts Elisabeth at stage right while the pilgrims are heard slowly approaching from the left. There are many similar touches, done with freedom and assurance, and (to my knowledge) for the first time in a DGG recording. These innovations may be due to the special insight possessed by the conductor of this performance, Otto Gerdes, who happens to be a DGG record producer himself and is therefore perhaps more flexible in such matters than other conductors. But whatever the reason, it is good to know that this company has started to make artistic use of the inherent resources of the stereo medium.

As a conductor, Mr. Gerdes is impressive. He emphasizes clarity, almost to a Boulezian degree, and avoids lush romantic bounce; he refines and slims down the orchestra line, allowing the inner voices their just due. His tempos are persuasive when he has the entire say-so—that is, in the orchestral passages and the ensembles. But Mr. Gerdes is far too permissive with his singers and bows too readily to the comfort of Nilsson, Windgassen, and Fischer-Dieskau; as a result, the over-all tension slackens and

NEW LP'S FROM POLAND



PRIZE WINNERS OF THE WIENIAWSKI VIOLIN COMPETITIONS vol. I

Side A

1. C. Saint-Saëns: Introduction and Rondo capriccioso mov. 1 and 2
2. A. Skriabin: Etude in B flat minor
3. H. Wieniawski: Scherzo—Tarentella op. 16
IGOR OJSTRACH—violin
Ina Kollegorskaja—piano

Side B

1. H. Wieniawski: Polonaise in D major
2. D. Shostakovich: 3 Preludes
3. H. Wieniawski: Caprice in A flat major No. 7
4. A. Andrzejewski: Burlesque
JULIAN SITKOWIECKI—violin
Ina Kollegorskaja—piano
5. K. Szymanowski: Dance from the ballet "The Highland Robbers"
WANDA WILKOMIRSKA—violin
Jadwiga Szamotulska—piano

"MUZA" XL 0385



POLISH PRE-ROMANTIC PIANO MUSIC

REGINA SMENDZIANKA—piano

Side A

- Michael Kleofos Oginsky (1765-1833)
Polonaise in B flat major
Five Dances for Piano: Tempo di Menuetto, Quadrille No. 1, Quadrille No. 2, Valse No. 1, Valse No. 2
Felix Janiewicz (1762-1848)
Andante con variazioni "Nel cor piu non mi sento"

Side B

- Franciszek Lessel (1780-1838)
Variations No. 1 Op. 15
Maria Szymanowska (1789-1831)
Nocturne in B flat major
Two Mazurkas
Polonaise in F minor
Etude in E major

"MUZA" XL 0355

OPERATIC OVERTURES—WARSAW PHILHARMONIC ORCHESTRA

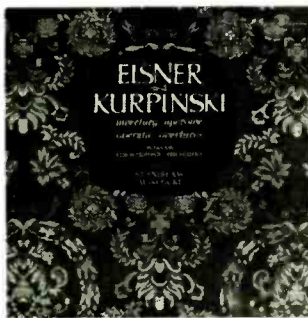

STANISLAW WISLOCKI, conductor
Karol Kurpinski (1785-1857)

Side A

- Overture to the Opera "TWO HUTS"
Overture to the Opera "THE RUINS OF BABYLON"
Overture to the Opera "CALMORA"

Side B

- Overture to the Opera "JADWIGA, QUEEN OF POLAND"
Jozef Elsner (1769-1854)
Overture to the Opera "LESZEK THE WHITE"
Overture to the Opera "SULTAN WAMPUM"

"MUZA" XL 0384

For information, orders:

POLISH RECORD CENTER OF AMERICA
3055 N. Milwaukee Ave.
Chicago, Ill. 60618

TORONTO MUSIC CENTRE
779-781 Queen St. W.
Toronto 3, Ont., Canada



CIRCLE 54 ON READER-SERVICE CARD

CIRCLE 22 ON READER-SERVICE CARD →

We suspect that the new Dual 1219 will get a warm reception from the independent testing labs. For the same reasons that they welcomed earlier Duals.

With so many similar audio products, equipment reviewers appreciate innovations. And Dual has traditionally obliged them.

The 1219 continues this tradition in many ways.

One of the 1219's features that sets it apart from all other automatics is the Mode Selector that shifts the entire tonearm base down for the single-play mode and moves it up for the multiple-play mode. The tonearm is thus able to track at the ideal 15° stylus angle whether playing one record or the middle record of a stack. (Instead of tilting down on single records.)

Another "first" is the 1219's tonearm suspension which is a true four-point ring-in-ring gyroscopic gimbal. The tonearm pivots vertically from an inner concentric ring which, in turn, pivots

horizontally from a fixed outer ring. The tonearm is centered within these rings and pivots on four identical needle bearings.

The 1219's anti-skating system is also noticeably different. It provides a separately calibrated scale for each stylus type, conical or elliptical. (Elliptical styli create more skating force than do conical styli.)

Another touch of Dual precision is the tonearm counterbalance. As it is rotated, there's a click for every hundredth-gram. (Makes balancing easier and faster, especially when interchanging cartridges of different weights.)

Several other features of the 1219 might be mentioned. The effective tonearm length is 8-3/4", longest of all automatic arms. The 12-inch platter is dynamically balanced and weighs 7 pounds. The cue control is damped in both directions, so the tonearm moves with equal delicacy, and without bounce whether you're raising or lowering it. And the motor combines high starting

torque with the absolute constancy of synchronous speed.

Although we can anticipate all the above features and refinements being welcomed by the testing labs, we don't presume to predict how they might be evaluated in terms of performance. Which, after all, is what really counts.

But reviews of earlier Duals have included terms like "superior, uncompromised performance" and "one of the finest record playing mechanisms I have used."

Reviews like these aren't easy to top, but if any automatic turntable can do it, we believe the 1219 can. Even though its price of \$159.50 may cause the reviewers to set their standards correspondingly high.

Until the reviews are published, we can only suggest that you write for our descriptive literature, or see the 1219 yourself at your dealer. Then write your own review.

United Audio Products, Inc.,
120 So. Columbus Ave., Mount Vernon,
New York 10553. **Dual**

The Dual 1219 should give the testing labs something new to talk about.



Easy shopping
from Angel.



"... he plays with ardor, power and musicianship." (Irv ng Kolodn, *Saturday Review*)

A Chopin treasury—6 polonaises, 14 waltzes, Sonatas No. 2 and 3. A collection to buy with pleasure and to give with joy. Merry Christmas!

SCB-3746 —3 stereo records

THIS

OVER **64** YEARS
OF RELIABILITY

IS WHY STEREO & HI-FI
BUYERS CAN BE SURE OF
SAVINGS
AT RABSONS

At Rabsons Competitive Prices, Reliability and Personal Service have been bywords for over 64 years

It's so EASY and SAFE to deal with Rabsons. Up to 36 months to pay on Easy Pay Plan - As close as your telephone — as near as your mailbox - Fast Air Mail Response on Quotation Requests - Franchised Distributor for Hi Fi Lines - All merchandise brand new in factory sealed cartons, shipped double-packed, fully insured promptly from our warehouse - Greater savings on complete systems - Export packing - 220 Volts, 50 Cycle merchandise a specialty - Free list of monthly specials.

BEFORE YOU BUY GET A RABSONS
QUOTE... YOU'LL BE GLAD YOU DID!

RABSONS

57 ST. INC.
119 West 57th Street, New York, N. Y. 10019
Tel. Area Code 212-247-0070

CIRCLE 56 ON READER-SERVICE CARD

**WE CAN
SELL FOR LESS**

Nationally Advertised Brands

- Hi-Fi Stereo Components
- Tape Recorders
- Record Changers
- Home & Car Stereo Tapes
- Speaker Systems
- Radio & TV Sets
- Electronic Equipment

BRAND NEW AND FULLY GUARANTEED

**WE CAN SAVE
YOU MONEY**

SEND: for FREE Listing
of 1000's of items...

LOWEST PRICES ANYWHERE!

• Factory Sealed Units • Fast Service

AUDIO
Sales
2745 ERIE BLVD. EAST
SYRACUSE, NEW YORK 13224

CIRCLE 6 ON READER SERVICE CARD

Why ?

DO THOUSANDS OF STEREO
ENTHUSIASTS BUY FROM
AUDIO UNLIMITED

It's Obvious!

- LOWEST PRICES
- FAST SERVICE
- FACTORY SEALED UNITS
- FULLY INSURED SHIPMENTS
- PACKAGE DEALS—SAVE MORE
- FRANCHISED DISTRIBUTORS

Write for **FREE Listing today**

**SEND US YOUR LIST
FOR OUR AIR MAIL
QUOTE TODAY**

Visit Our Store Warehouse
Closed Mondays

AUDIO unlimited, inc.
396-F Third Ave. (Nr. 28) N.Y., N.Y. 10016

the show runs down. Most specially is this true of Act III where, at the best of times, it is not easy to preserve the thrust through the successive largo and lento sequences: Tannhäuser's pilgrimage (the orchestral prelude), Wolfram's soliloquy, the return of the old pilgrims, Elisabeth's prayer, Wolfram's Evening Star invocation—all are broad and slow, and seem even slower through Gerdes' apparent complaisance to his singers. All the same, this is an important opera-conducting debut on records and one looks forward to more from the same source.

Mr. Gerdes has redoubtable competition from the conductors on the other two labels. For Angel, the late Franz Konwitschny conducted a mature and well-judged, if unexciting, performance. The Philips/Bayreuth set gets high-voltage leadership from Wolfgang Sawallisch and a generally fast range of tempos which (to my ears) is just what *Tannhäuser* needs.

The third new aspect of the DGG release (and it will be decisive for many listeners) is the casting of Birgit Nilsson as both Elisabeth and Venus. The experiment of using the same singer for both parts has been tried occasionally across the decades, and there is artistic justification for it: it is argued that each role is a separate aspect of Woman as she appears to Tannhäuser, that harlot and angel are really one. Whatever one feels about this theory, the requirement in opera, on records, and in the theater is for a sharp differentiation in the style and temperature of singing the two roles. And this we don't get in Miss Nilsson's recording: she just sounds like Birgit both times. There is not enough sex and by no means sufficient frustrated scorn in her Venus; and her Elisabeth, for all its wealth of beautiful tone and splendid technique, lacks femininity and simplicity.

One must redress this criticism by observing that no female voice in our time is more compelling and none more thrilling than Miss Nilsson's. Indeed, the sound she makes as she rides, glorious and high, above the ensembles is something to treasure. Nowhere is her singing less than very good indeed. But if you want to hear the languor of Venus, and her fury when scorned, then listen to Grace Bumbry in the Philips set: and if you seek a womanly and radiant Elisabeth, hear the delectable performance given by Elisabeth Grümmer on Angel. And these are values which a definitive recording of *Tannhäuser* cannot do without.

The title role here goes again to Wolfgang Windgassen, he of the leathery voice and the bleating manner. The performance he gives is much like his reading for Philips—certainly it is not worse than the 1963 effort—and one can give thanks that his voice has not further deteriorated in those six years. There is just nobody around to sing this music these days. The tonal center of gravity in the role of Tannhäuser is very high indeed, higher than Tristan or Siegfried; and some singers claim it is the most difficult *Heldentenor* part of all. Windgassen has all

TK-140X

200 WATT · FET · IC · FM/AM STEREO RECEIVER

**"KENWOOD'S BEST
RECEIVER TO DATE"**

HIGH FIDELITY, October, 1969



Read what HIGH FIDELITY has to say about KENWOOD's magnificent TK-140x, based on impartial tests conducted for the magazine by CBS Labs:

"In every respect the TK-140x is the best KENWOOD unit we've yet tested, offering as it does a high-sensitivity tuner combined with a low-distortion, high-powered amplifier, a generous roster of features and controls, and neat and attractive styling—all at a very competitive price."

ON FM SENSITIVITY: *"The tuner's sensitivity... is among the highest measured here."*

ON FM SELECTIVITY: *"In our cable FM-tap test, the set logged 50 stations, of which 41 were judged suitable for long-term critical listening and off-the-air taping. This mark compares favorably with that scored by some sets costing more..."*

ON TUNER DISTORTION: *"Distortion is low; capture ratio excellent; signal-to-noise very high."*

ON STEREO SEPARATION: *"Both stereo channels were closely balanced and amply separated."*

ON AMPLIFIER SECTION: *"The amplifier proved capable of furnishing power high and clean enough to drive any speaker system, including low-efficiency types, to full-room volumes without audible distortion or breakup. Distortion measured at normal listening levels remained virtually insignificant."*

IN SUMMARY: *This set, in sum, has a lot to offer and all of it strikes us as first-rate—the more so in view of its cost." \$349.95 including cabinet.*

VISIT YOUR NEAREST KENWOOD AUTHORIZED DEALER AND CONDUCT THE BEST TEST OF ALL—YOUR OWN "LISTENING TEST"!



15711 S. Broadway, Gardena, Calif. 90247 • 69-41 Calamus Ave., Woodside, N. Y. 11377
Exclusive Canadian Distr. — Perfect Mfg. & Supplies Corp. Ltd.

CIRCLE 41 ON READER-SERVICE CARD

More than a gift...
a compliment.



"... one of the supreme vocal artists of the century." (*High Fidelity*)
A deluxe treasury of his finest performances. Priced for giving. Merry Christmas!
SCB-3729—3 stereo records

Enjoy Relaxing Background
Music at Home with . . .
NO COMMERCIALS!

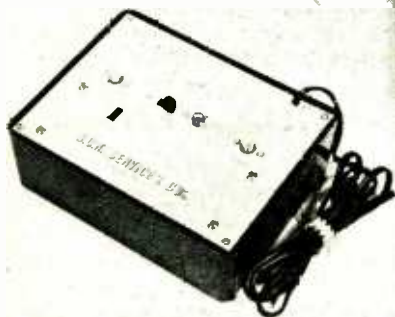

Size: 6½ x 5 x 2½

Our SCA-1 Decoder makes possible reception of this "private" musical programming, transmitted by nearly 400 FM stations around the country. YOUR FM tuner or receiver can recover this "hidden" music with the simple addition of an SCA-1. Hook-up in minutes—full instructions supplied. SCA-1 is self powered . . . uses all solid-state circuitry (FET's, IC's, NPN's). Works with any quality FM tuner or receiver.

Send check or m.o. for either . . .
SCA-1 (Wired, ready to use) \$64.50
SCA-1K (Kit, all needed parts) \$49.95
Etched, drilled P.C. Board plus special IC plus full construction plans \$12.50

One year parts guarantee
Free national SCA station list supplied with every order.
SOLD FOR HOME USE ONLY

SCA Services Co., Inc.

Box 601, Port Washington, N.Y. 11050
CIRCLE 62 ON READER-SERVICE CARD

the right ideas about the role, shapes the words and phrases like a master; the only thing that's wrong with it is the actual sound of the voice. But there is no point in going on: Windgassen, for all his tonal warts, was the only possible choice for DGG. Compared to Hans Hopf, Angel's tenor, he is Hyperion to a satyr.

Dietrich Fischer-Dieskau is the Wolfram for DGG, as he was for Angel in the 1961 set. He is even more mellifluous and sonorous here than he was eight years ago: a silken reading. Theo Adam is Landgraf Hermann and appears to be under some strain in his big scene, the so-called "Address" (which is not, as you might think, c/o The Schloss, Wartburg, Thuringia). He does not approach the solid authority of Gottlob Frick in the Angel set.

In other respects, the DGG edition is fully commendable: a fine chorus, most precise and sonorous; a very competent and obviously superior orchestra and excellent voices in the smaller roles. Caterina Alda's clear and plaintive singing of the Shepherd's song is a minor highlight.

One more quibble: why the Dresden version again, instead of the far richer and more exciting form of the Overture, Bacchanale, and Venusberg duet that Wagner wrote for the Paris production? Like its competitors, this new recording dodges between the two, but is basically Dresden. (Philips/Bayreuth has the Paris form of the Overture and Bacchanale, then ducks back to Dresden; Angel is nearly all Dresden.)

What we need is an integral recording of the Paris score, the one that represents Wagner's last thoughts on the subject of *Tannhäuser*. It means a little more work for the singers, but the results would more than justify the homework.

So there you are. If I had my druthers and could put together a dream *Tannhäuser* recording from all three sources, it would have Elisabeth Grümmer (Angel) as Elisabeth, Grace Bumbry (Philips) as Venus; the Landgraf would be Gottlob Frick (Angel); and Fischer-Dieskau (DGG) would sing Wolfram. Sawallisch (Philips) would conduct. It would certainly have the new DGG sound.

And if I really had my druthers, I'd go up to Valhalla (or down to the other place) and come back with a shining new tenor for *Tannhäuser*. G.M.

recitals & miscellany

BOSTON SYMPHONY CHAMBER PLAYERS: "Works for Chamber Ensemble." **SCHUBERT: Quintet for Strings, in A, Op. 114, D. 667 ("Trout").** **BRAHMS: Trio for Violin, Cello, and Piano, No. 1, in B, Op. 8.** **POULENC: Sextet for Piano and Woodwind Quintet.** **WEBERN: Concerto for Nine Instruments, Op. 24.**

MARTINU: Nonet. **DAHL: Duettino Concertante for Flute and Percussion.** Boston Symphony Chamber Players. RCA Red Seal LSC 6189, \$17.94 (three discs).

This three-record release raises a problem for both the reviewer and the prospective buyer: is the set to be judged as an entity or as six separate performances? Like the two earlier releases in this series, the BSCP's all-or-nothing package offers a balanced program suitable, if one so chooses, for a full evening of listening. The regular group of leading players from the Boston Symphony are joined here by the extraordinarily sensitive and musical American pianist Richard Goode. A first-rate chamber player, he blends well, aurally and temperamentally, with the Bostonians, and all the performances reveal excellent musicianship and careful attention to the special requirements of chamber music. Taken as a whole, then, this collection clearly provides a satisfying and enlarging musical experience for anyone interested in ensemble music.

However, when each work is approached individually, one begins to question the wisdom of such an omnibus assortment. Chamber music collectors will doubtless already own the familiar Schubert and Brahms works in versions that boast deeper musical perception and greater technical brilliance. Both Serkins, father and son, have given us more exciting readings of the *Trout* Quintet. Rudolf in a rather extroverted soloistic style on Columbia, and Peter in a more intimate collaboration on Vanguard. The same is true of the Brahms Trio: the Stern/Rose/Istomin version on Columbia offers greater virtuosity, and Suk, Starker, and Katchen gather for a beautifully integrated meeting of minds and spirit on London.

In the Poulenc Sextet, Mr. Goode and his Boston colleagues compete with Columbia's still sonically impressive performance by Poulenc himself and a group of proficient players from the Philadelphia Orchestra. A composer's own reading always merits attention, especially when, as in this case, he is an excellent performer as well. The difference between the two performances is very much a matter of Poulenc's "cooler" tone and his greater emphasis on wit and elegance, qualities that he also communicates to his colleagues.

Webern's Concerto, the shortest and technically most difficult work recorded here, comes off with highly impressive results. Not only do these musicians play the notes accurately and clearly, but they also succeed in conveying the melodic sense of Webern's febrile intensity with great musicality. A triumph for all concerned.

Dating from the composer's last years, Martinu's Nonet alternates Stravinskian neoclassicism with lush romanticism but never really reconciles the two styles. In some other music by this very uneven Czech composer the combination works, but not here. I fear, despite a good performance.

In Ingolf Dahl's delightful Duettino.

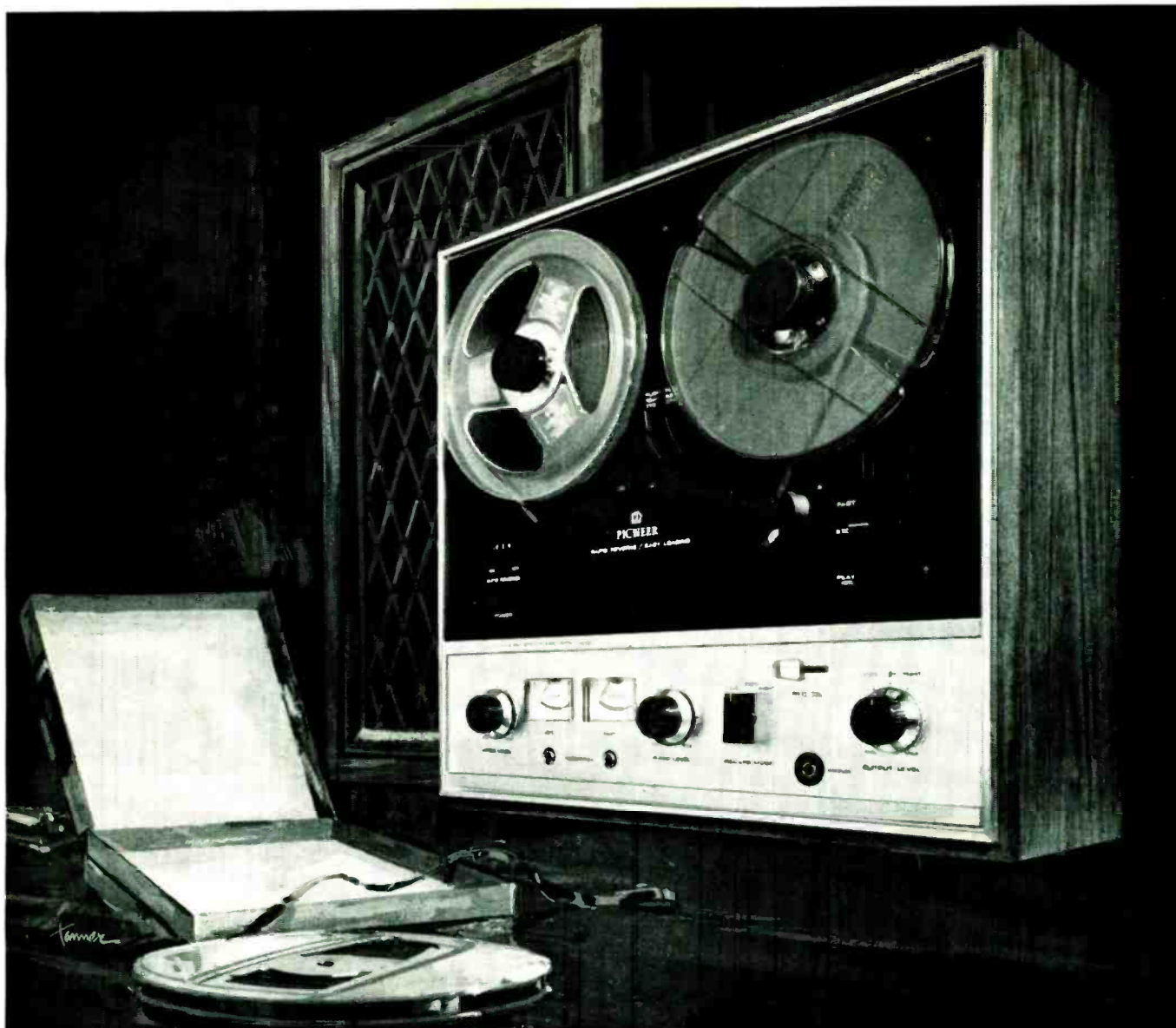

An Outperformer for the Tape Deck Set!

Tape recording has reached a new level of excellence with the new Pioneer T-600. These remarkable innovations tell the story. The ingenious auto-reverse unit offers the fastest automatic and pushbutton reverse playback and recording — less than a second. No more turning tape over . . . no more annoying recording interruptions. The dramatically different swing-in, swing-out pinch roller assures optimum tape pressure at all times — just right for flawless reproduction. Reel loading has been relegated to

a one hand operation, significantly reducing mounting and threading time and the possibility of torn or damaged tapes. Other features include: solid state circuitry; 4 heads; 4-track stereo & monaural Record/Playback; 2 VU meters; hysteresis synchronous motor; center capstan drive; headphone jack; automatic tape braking; push-button 4-digit counter, vertical or horizontal operation. Naturally, the quality is incomparable. It's a Pioneer Outperformer. Ask your Pioneer dealer for a demonstration. Only \$299.95 incl. dust cover.

 **PIONEER**®

PIONEER ELECTRONICS U.S.A. CORPORATION, 140 Smith Street, Farmingdale, N.Y. 11735 • (516) 694-7720
West Coast: 1335 W. 34th St. Gardena, Calif. 90248 (213) 323-2374 & 321-1076 • Canada: S. H. Parker Co., Prov. Ontario



CIRCLE 81 ON READER-SERVICE CARD

Angel has the gift
for making
people happy.



"One of that tiny elite . . . who are not
merely applauded but loved."
(High Fidelity)

A deluxe treasury, priced for giving
Merry Christmas!

SCB-3728 - 3 stereo records

GREATEST!

GREATEST SAVINGS
with the lowest prices
anywhere. Get our quote.

BEST!

BEST SELECTION of
hi-fi components and
photographic equipment
on the East Coast.

EASIEST!

EASIEST CREDIT!

Fast approvals for servicemen.

TRADE-INS WELCOME. FAST
QUOTES. Stereo components;
cartridge, cassette and reel
decks and recorders; pre-
recorded & blank tapes & acces-
sories; cameras; projectors;
darkroom supplies. Send for
catalog. Phone calls accepted
9 A.M. to 10 P.M.

INTERNATIONAL

**HI-FI
& CAMERA
EXCHANGE**

Bata Building,
Second Street
Belcamp, Md. 21017

Phone: 301-284-9675; 301-284-9856

CIRCLE 38 ON READER-SERVICE CARD

flutist Doriot Anthony Dwyer offers an extraordinary display of virtuosity, backed up by equally exciting percussion work by Everett Firth—a rare occasion when this kind of exposed percussion scoring makes musical sense. Serial in technique, the music plays and banters with its ideas in a thoroughly delightful fashion. Mr. Dahl, a distinguished teacher and composer long active in southern California, is to be congratulated for having carried off such a tricky conception; he's fortunate, too, in having it so superbly performed. RCA might be well advised to release the Webern and Dahl selections, on a single disc, coupled either with the Martinů and Poulenc or with other appropriate material from the BSCP's earlier releases. P.H.

**NICOLAI GEDDA: "Opera Recital." PUC-
CINI: La Bohème: Che gelida manina;
Manon Lescaut: Donna non vidi mai.
GOUNOD: Faust: Salut! Demeure chaste
et pure. MEYERBEER. L'Africaine: O
Paradis. PONCHIELLI: La Gioconda:
Cielo e mar. TCHAIKOVSKY: Eugene
Orégin: Lensky's Aria. VERDI: Aida:
Celeste Aida; Un Ballo in maschera:
Di' tu se fedele; Ma se m'è forza. PUC-
CINI: Tosca: Recondita armonia; E luce-
van le stelle; Turandot: Nessun dorma.
Nicolai Gedda, tenor; Royal Opera
House Orchestra, Covent Garden,
Giuseppe Patané, cond, Angel S 36623,
\$5.98.**

**NICOLAI GEDDA: "German Opera Ari-
as." MOZART: Die Zauberflöte: Dies
Bildnis. NICOLAI: Die lustigen Weiber
von Windsor: Horch, die Lerche singt.
FLOTOW: Martha: Ach! so fromm;
Alessandro Stradella: Jungfrau Maria.
GOLDMARK: Die Königin von Saba:
Magische Töne. BEETHOVEN: Fidelio:
Gott! welch' Dunkel hier. WEBER: Ob-
eron: Von Jugend auf; Vater! Hör mich.
WAGNER: Lohengrin: In fernem Land;
Mein lieber Schwan. Nicolai Gedda,
tenor; Bavarian State Opera Orchestra,
Heinrich Bender, cond. Angel S 36624,
\$5.98.**

It is rare among singers and almost un-
heard-of among tenors to find so cerebral
and well-organized a *persona* as that of
Nicolai Gedda. He is the thinking man's
tenor. He knows his own capacity, does
his homework and gets things right, keeps
an open mind about unfamiliar repertory,
enunciates accurately in at least six
languages, possesses a middle-sized voice
of sufficient natural beauty (with a big,
gleaming top register), and may be
counted upon to deliver solidly impres-
sive performances in a wide variety of
operatic roles—German, French, Italian,
and Russian.

The evidence for all these assertions is
to be had in this pair of recital discs:
you will not find a more sensitive version
of Lensky's aria from any contemporary
artist, Faust's cavatina is done with
matchless accomplishment, and the as-
sured elegance of the Third Act aria
from *Ballo* is a strong challenge to
memories of Bjoerling in this music.
There is great mastery in the German

recital too, and though you may prefer
Wunderlich in the Serenade from *Merry
Wives* (as I do) or Vickers as Florestan,
there is no denying that this is singing of
a high order.

The surprising thing is that a man
who does so many things so well should
choose to include here a number of over-
familiar arias in which he does not meet
the present-day competition: Gedda is
not comfortable in "*Celeste Aida*," is too
sentimental as Rodolfo, lacks the re-
quired passion to sing a memorable Ca-
varadossi. Nor is he sufficiently at ease
in the very exposed *Gioconda* aria. I
don't mean that these items are without
virtue; simply that they waste grooves
that Gedda could use much more valu-
ably.

He could, as an example, apply to
Italian or French opera the spirit of ad-
venture that led him to record (in the
second of these discs) two excerpts from
Weber's *Oberon*, "*Von Jugend auf*" and
Hoon's Prayer. The role of Hoon (which
I have never heard publicly performed)
is said to be among the most fiendishly
difficult parts in pre-Wagner German
opera, and certainly the first of these
songs makes powerful demands upon any
interpreter. Gedda does not meet the
challenge entirely, save in the lyrical mid-
section of the first aria and the Prayer,
both of which are superb; but a near-
miss in the role of Hoon is more valuable
than a dozen "*Recondita armonia*" bulls-
eyes.

So, bearing down, the first disc is
worth buying for the *Faust*, *Onegin*,
and *Ballo* arias; the second for a fine
"*Magische Töne*" in half-voice (a Caruso
favorite, this song), a well-shaped version
of the prayer from *Alessandro Stradella*
and a noble (if not completely satisfying)
revival of Hoon's music.

Both discs have proficient orchestral
accompaniments and excellent sound.
Full texts, translations, and notes. G.M.

**PAUL KUENTZ: "Royal Fanfares at
Versailles." DELALANDE: Symphonies
pour les soupers du Roy: 7th Suite:
Excerpts (9). CHARPENTIER, M.: Te
Deum: Prelude. LULLY: Pour le car-
rousel de Monseigneur, 1686: Airs (4).
PHILIDOR: March for Four Timpani.
FRANCOEUR: Symphonie du festin roy-
ale: Fourth Suite. Adolf Scherbaum and
Stanislav Simek, trumpets; Paul Kuentz
Chamber Orchestra, Paul Kuentz, cond.
Deutsche Grammophon 139431, \$5.98.
Tape: ●● L 9431, 7½ ips, \$7.95.**

Someone at DGG must have read Denis
Stevens' review (HF, September 1965),
which objected to the "tight" sound of
Paul Kuentz' Archive exploration of Del-
alande's Fourth Suite—supper music en-
ertainment for *le Roi-Soleil*, Louis XIV,
and his great-grandson Louis XV. Here
another DGG engineer, Harald Baudis,
working in an unspecified but obviously
spacious auditorium, achieves just the
thrilling live acoustical expansiveness that
this truly regal music demands for an
authentic re-creation of its original sonic
grandeur. Now imposingly ceremonial,

CIRCLE 67 ON READER-SERVICE CARD →

How to explain to your wife why you spent an extra \$400 for this stereo receiver.



There's no doubt about it. You can get a fine receiver for as little as \$200 or \$300. We know, we make them. But we also make a \$700 receiver. We know what goes into it. Once you know, you might be compelled to buy one and if you do, you might have to convince your wife about spending \$700 for a stereo receiver. So here's what you can tell her.

Point out that the 6120 is actually a bargain. It's sensitive (1.8 microvolts, IHF) so it pulls in stations that other receivers can't. As long as you are paying for the entire FM Band, you might as well get all of it. Prove it by letting her tune up and down the generous 8-inch tuning dial listening to station after station pop out. Show her how the two tuning meters help locate the strongest signal and the exact center of each channel for best reception.

She understands traffic jams, so tell her about the heavy traffic on today's broadcast bands. Stations are crowded together with little or no separation between them. Despite this, there's no interference from nearby stations with the 6120 and the one station you want to hear is the only one you'll hear. No other programs or unwanted noises. Adjacent channel selectivity, 100 dB.

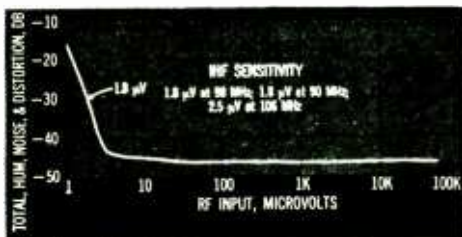

No wife likes noise. And noise is particularly annoying when combined with music. With the Sony 6120 noise and interference don't intrude upon the music. The 6120 delivers sound as clear and pure as possibly can be expected outside a concert hall. Purer, in fact, for she won't be putting up with audience noises, such as coughing and throat clearing. If she wants proof, mention a few of these specifications: signal-to-noise ratio, 70dB; rejection 90dB; i. f. and spurious image rejection, 100 dB each; and AM rejection 65 dB.

Now you can get a bit romantic. Turn on some moody background music, quietly. She'll relax. Now turn up the volume. Normally you'll be operating the 6120 at well below one watt. But just so it doesn't have to strain and distort when there's a crescendo passage, it has plenty of power in reserve (rated amplifier power 60 watts per channel into 8 ohms, both channels operating). The 6120 coasts along taking everything in stride from Beethoven to Berlioz, without distortion at any listening level (IM distortion 0.3% at rated output; 0.05% at one watt; harmonic distortion, 0.2% at rated output; 0.05% at one watt).

You're making progress. Now point out that the 6120 can capture the nuances in the music that are the result of harmonics and other subtleties that make music such a delightful experience. The 6120 can easily handle the audible sounds with none of the strain and distortion that a narrower hand would have to fight. It has more range than you'll ever need, from deepest basso profundo to the highest lyric soprano. The proof: Power bandwidth from 12 Hz to 70 Hz.



Time to begin your closing arguments. Point out all the pleasures of the SONY 6120-FM stereo and FM broadcasts, superb reproduction of records, tapes...only control she'll ever get involved with is the quick-action function selector. In the upper position, the tuner is connected; in the lower position, the record player; in the center, a knob selects microphone, tape head, phone 2, aux 1 and 2. You really don't have to go into detail on the 6120's many other conveniences. But, should your wife ask, you might mention the mode control with 7 positions and switches for low and high filters, loudness contour, tape monitor, FM mode (automatic stereo or stereo only) high blend and muting. The aux 2 input on the front panel accepts a stereo phono jack. It's useful for making a quick patch in of a tape recorder on playback, or any other high level signal source. For recording there's a front panel line-out jack. There's a headphone jack, speaker selector, treble and bass controls.

The rear panel has inputs corresponding to the front panel selector plus a duplicate set of aux 2 jacks, tape inputs and outputs,



and an additional tape recorder receptacle for 5-pin (European type) connections. A separate mixed left and right channel jack can be used to drive a mono amplifier, or to pipe music into another room. Maybe your wife won't understand the significance of all these conveniences, but she'll know she's getting something extra for her money.

It's time for your wife to audition the 6120. Try plugging a pair of stereo headphones into the front panel jack and mention how compatible the 6120 is. You can enjoy your 6120 while she can enjoy her favorite TV programs in the same room, without interruption.

Next, allay any doubts she might have. She might feel that while the 6120 sounds beautiful today, how will it sound 3 or 4 years from now? After all, her appliances wear out. Tell her about the "forever filter." The SONY solid-state IF filters (there are 8 of them) that preserve the high standard of performance in the 6120 for almost ever, since they cannot go out of alignment.

Now that you have demonstrated the performance capabilities of the 6120, show her how beautiful it is with oil-finish walnut cabinet, brushed aluminum paneling. Tell her it would take two of the finest components available today to equal the performance of the 6120, and they would cost considerably more. And take up more space, too. Finally, tell her it's Sony, made by those same people who make all of those wonderful things people have come to enjoy in both sight and sound. Now play her favorite musical composition. You've saved a happy marriage and become the proud owner of a new SONY 6120 FM/FM stereo receiver.

SONY Corporation of America, 47-47 Van Dam Street, Long Island City, N.Y. 11101

SONY® STR-6120



now piquantly light-footed, the present nine would be enough in themselves to re-establish the towering stature of that long-neglected French Master, Michel Richard Delalande (1657-1726). And this release warrants a third Best-of-the-Year gold medal (in addition to musical and technical awards) for its absorbingly informative jacket notes by the ensemble's harpsichordist, Olivier Alain.

The engineering award might be won simply for the dramatic authenticity of the varied timpani timbres (four drums) in the Philidor March. For that matter, two other short works on Side 1 also have been recorded before but surely never as well: an imposing Marc-Antoine Charpentier Prelude, now familiar as the

"Eurovision" TV signature theme; and Lully's spirited prelude and three dances for trumpets, oboes, and drums, composed for an out-of-doors royal carrousel, or tournament, in 1686.

Yet there is still more: the disc's overside transports us from the baroque to the rococo in what must be the first recording of a varied concert program for a royal banquet honoring the young Comte d'Artois, grandson of Louis XV and the future Charles X, in 1773. Especially valuable here is the new light thrown on François Francoeur (1698-1787), usually known nowadays for his violin pieces, but revealed in this music as a skilled orchestral composer and arranger. Three of the present pieces are

his own—most notably the bravura *Ouverture* with its pyrotechnically dazzling piccolos. The other eight are transcriptions of favorite airs and dances by Francoeur's predecessors and contemporaries—including not only the still-famous Rameau and Mondonville but such now-forgotten worthies as Grenier, Dauvergne, Rebel, and Royer. For me, first honors are won by the last-named Frenchman's inexhaustibly imaginative Chaconne, but the whole infectious jaunty suite is a delight throughout, and, like the grander baroque masterpieces on the overside, it is well-nigh ideally played and recorded.

R.D.D.

NEW YORK PRO MUSICA: "Music of the Spanish Theater in the Golden Age." ANON.: El villano; Matachin; Marizápalos; Jácara: No hay que decirle el primor. PATINO: Cuatro: Pastorcillo triste; Cuatro: Cantar las gracias de Flora. MARIN: Pasacalle: Què bien canta un ruisenor; Pasacalle: No piense Mingulla; Pasacalle: Desenganémonos ya. HIDALGO: Quedito, pasito. CORREA: Baitete: Con las mozas de Vallecas. GUERRERO: Villanesca; Todo quanto pudo dar; Virgen sancta. VALENCIANO: Tonada: Ay del amor. MUDARRA: Fantasia que contrahaze la harpa. FLECHA: Ensalada: El Fuego. New York Pro Musica, John Reeves White, cond. Decca DL 79436, \$5.98.

The New York Pro Musica's latest release sent me hurrying to the history books to look up Spanish musical history. Writers like Cervantes, Lope de Vega, and Calderon, and artists such as El Greco and Velasquez flourished in the seventeenth century—Spain's Golden Age. But what of the composers? Alas, Jose Marín, Juan Hidalgo, and Miguel Martí Valenciano are only names to all but the most diligent scholars. Most of them earned their livings as church musicians encased in Roman polyphony. What a surprise, then, to encounter their other, secular side—the vital, earthy music they contributed to the new popular theater.

Theatrical performances of the Golden Age were held in open-air theaters, courtyard affairs called *corrales*, and a burst of music like the lively dances which open this recording undoubtedly announced the arrival of the troupe of players. The rousing *Cantar las gracias*, an introductory number of *cuatro da empezar*, evokes the excitement and anticipation which must have stirred the Spanish audience. The forthright rhythms and popular homophony of the *cuatro* were often modified into a more madrigalian ensemble, perhaps depending on the nature of the play.

Between acts, intermezzos, which eventually expanded into complete productions, provided another traditional opportunity for music. A series of masked dances or *baitete* are represented here both by the introductory music and by the ensemble's lively *Con las mozas de Vallecas* where the music echoes the sound of the bells and tambourines which would have accompanied the dance. The second "intermission" features a *jácara* or character

Somebody finally designed a speaker that's compatible with the human ear.

Speakers are shaped like cones, right? The existing cone type speaker was invented by A. S. Sykes in 1919. Then it was refined by C. W. Rice and S. W. Kellogg. The enclosure and bass reflex enclosure happened between 1920 and 1930. The exponential horn was developed about 1919. By 1930, the fundamentals were perfected. And today, these fundamentals are still the same.

Recently, manufacturers have tried to reproduce sound which they believe is comfortable to the human ear—thus, the advent of unreal booming bass and strident highs. And, a great many people like it that way because they think it's high fidelity (in a way it is), but it usually isn't NATURAL sound the way it was originally produced.

With full consideration of the human ear and with the desire to produce a speaker which faithfully reproduces sounds as they were originally created, Yamaha successfully developed the **NATURAL SOUND SPEAKER**. It's not based on the piston motion concept of conventional cone type speakers. It's based on the principles of acoustic musical instruments such as the piano, guitar or violin. The quality of sounds produced are directly correlated to the acoustical design of their sounding boards. The sounds are called **BENDING MOTIONS** of sound, and they are natural sounds.

Following the concept of acoustical bending motions of sound, Yamaha developed the Natural Sound Speaker. Its construction is entirely different from that of a conical type speaker. It has a rigid diaphragm constructed of a spe-

cially formulated polystyrene. The entire edge of the speaker is firmly fixed on a frame.

What about the unusual shape of our speaker? Well, a grand piano isn't exactly round. Like we said, the Natural Sound Speaker operates on the same concept as the sounding board of a grand piano, violin or guitar. They are shaped the way they are for a very good reason, and so is the Yamaha Natural Sound Speaker. Tests show that a symmetrical design (round, rectangular, square, triangular, etc.) gives rise to degeneration in the vibration mode at specific frequencies.

In summary: The tone quality of the Natural Sound Speaker is uniquely natural. The design of the speaker provides for a virtual omnidirectional effect (rather than having the sound blast with a tunnel effect—common with many conventional speaker systems) yet, a full and distinct stereophonic effect is retained.

The Yamaha Natural Sound Speaker brings more live and psychologically pleasing sounds to the human ear.

Listening fatigue is reduced to a minimum, if not

eliminated entirely.

The specifications	
NS-15	NS-10
Impedance — 8 ohms	8 ohms
Power capacity — 30 watts	20 watts
Tone control — Continuously Variable	Continuously Variable
Speakers — Natural Sound: 13 x 17"	Natural Sound: 11 x 15"
Cone: 2"	Cone: 2"
Cabinet — Removable grille	Removable grille
Straight-grain	Straight-grain
American Walnut	American Walnut
Open pore, oil finish	Open pore, oil finish
Dimensions — Height: 23½"	26"
Width: 16½"	14"
Depth: 7½"	7"
Weight: 22 lb	15½ lb

For more information write Audio Products Division

YAMAHA
INTERNATIONAL CORPORATION, SINGLE 1874

7733 Telegraph Road, Montebello, California

Other Yamaha products include pianos, skis, motorcycles, guitars.

CIRCLE 79 ON READER-SERVICE CARD

THE HEART OF YOUR DYNACO RECEIVER SYSTEM



SCA-80 amplifier

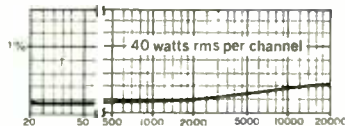

The SCA-80 delivers 40 watts per channel rms continuous power from 20-20,000 Hz at 8 ohms. Plenty of power for driving 4 ohm speakers too.



Front panel low-impedance headphone jack is always live. Rocker switch permits you to choose between main and remote speakers too, or turn speakers off.

Center channel speaker can be driven without an auxiliary amplifier with mode switch in BLEND, which also reduces unrealistic stereo separation when using headphones.

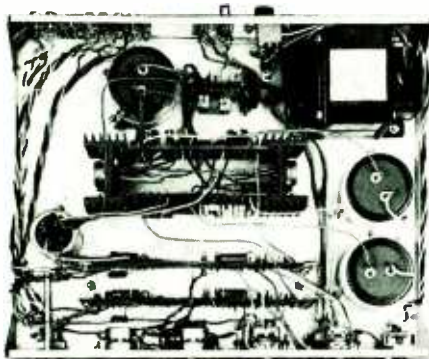

Open, uncluttered layout facilitates kit construction. Four etched circuit boards are factory assembled and tested.



The Dynaco FM-3 tuner (\$99.95) is completely compatible with the SCA-80. The SCA-80/FM-3 system delivers up to three times more continuous power across the audio band than other one-piece receivers in the same price range.

ALL THIS FOR ONLY \$169.95*

*\$249.95 factory-assembled.

See at your dealer or write for information.

DYNACO INC.

3060 JEFFERSON ST., PHILA., PA. 19121
IN EUROPE WRITE: DYNACO A/S, HUMLUM, STRUER, DENMARK

CIRCLE 23 ON READER-SERVICE CARD

Send an Angel to say, "Merry Christmas!"



"... one of the most extraordinary one-woman musical shows of our time." (Louis Snyder, *New York Herald Tribune*)

A treasury of superb performances priced for giving. Merry Christmas! SCB-3745 - 3 stereo records

NEW FINCO® Home entertainment distribution wiring system for do-it- yourselves



MODELS:
HWK-75
75 ohm
HWK-300
300 ohm

● For Color TV—
UHF/VHF ● FM/FM
Stereo

Everything needed
to wire your home
for multiple set
reception—in
easy-to-handle kit
form.

Turn your whole house into a home entertainment center. Operate up to four sets, or be able to move your entertainment equipment from room to room. Kit includes all necessary parts, fittings and instructions.



THE FINNEY COMPANY

34 W. Interstate St., Dept. HF-12 Bedford, OH 44146

CIRCLE 32 ON READER-SERVICE CARD

piece, a forerunner of the zarzuela. The audacious gypsy heroine of *No hay que decirle* is surely an early Carmen.

Often authors indicated songs and musical numbers during the course of their plays. One of the few documented examples is the lovely lullaby *Quedito pasito* which appeared in Calderon's *Ni amor se libra del Amor*. According to the dictionaries, a "Pasacalle" is a procession or march in duple meter, but José Marín's pieces here titled *pasacalles* are clearly incidental songs, strongly influenced by Italian monody but with a grace and spirit all their own. *Ne piense Minguilla*, a charming aria in a lilting triple meter, is a particularly irresistible bauble. *Ay del Amor*, a *tonada* or song by Miguel Valenciano, is close enough to the fluid and expressive arias of Francesco Cavalli to make one wonder what would have happened had opera taken hold in Spain as it did in Italy.

To round off the recording, John White has chosen some earlier Spanish music, popular numbers which were probably still in style during the age of El Greco and Calderon. Despite the sacred texts for Guerrero's *villanescas*, they are cast in a popular lyric style with an authentic Spanish flavor. Matteo Flecha's musical salad, *El Fuego*, is a tiny dramatic cantata, sketching the hustle and bustle of frantic fire fighters battling a mighty blaze. The fire is allegorical, but the music is as realistic as any theatergoer could wish.

The Pro Musica ensemble sounds good here, better than their somewhat raucous recent Petrucci release, but the group's heavy concert schedule is beginning to take its toll on the soloists who sound a shade tired and unsteady in the sustained numbers. The personnel has changed somewhat in the last year or so. Christopher Williams is heard to good advantage in Mudarra's lovely lute solo, and Joan Fuerstman displays a nice mezzo with a clear lower register on Guerrero's *Virgen sancta*. Her high tones cope easily with the regular repertoire of the group, which has always used two sopranos. The recorded sound will not win any prizes but it is adequate, and the package—notes, texts, etc.—is, as usual, very handsome. S.T.S.

BEVERLY SILLS: "Scenes and Arias from French Opera." **MASSENET:** *Manon*: Je marche sur tous les chemins . . . Oui, dans les bois. **CHARPENTIER:** *Louise*: Depuis le jour. **THOMAS:** *Hamlet*: A vos jeux . . . Partagez-vous mes fleurs; *Mignon*: La Philine est vraiment divine . . . Je suis Titania. **MEYERBEER:** *Robert le Diable*: Robert, toi que j'aime; *Les Huguenots*: O beau pays de la Touraine. Beverly Sills, soprano; Ambrosian Opera Chorus; Royal Philharmonic Orchestra, Charles Mackerras, cond. Westminster WST 17163, \$5.98. Tape: ● L 7163, 7½ ips, \$7.95; ● M 87163, \$6.95; ● X 57163, \$5.95.

It has been a wonderful year for Beverly Sills. In 1969, she went to Boston and scaled the high F sharps of Strauss's *Zerbinetta* (original version). In Milan,

she revealed Rossinian coloratura to the patrons of La Scala. At Tanglewood, her Konstanze showed a potentially rich vein of Mozartean ore. Her home base is the New York City Opera, and at the State Theater of Lincoln Center her roles have included Massenet's *Manon* and Gounod's *Marguerite*, and she was preparing (as these words were written) to sing Lucia di Lammermoor for the first time with the company. Everywhere, her appearances have drawn cheers from the crowd and expressions of awe from reviewers.

And now here she is in this fine new recital disc, to suggest that one of the reasons for the present eclipse of nineteenth-century French opera is the want of such spirits as hers, such voices as this. She has a very good time indeed with this material and, being both a fine actress and a superlative singer, brings to pulsing life music one might have thought lost for good.

I should not suggest that she is a perfect interpreter for this material. It is not all equally superlative. There are minor blemishes and felicities sprinkled through singing of the utmost accomplishment and refinement. And she produces her French sounds from somewhere too far back in the throat to make her command of the language complete.

But how she enjoys this music, what free-ranging flashes of temperament she expends on it, what a splendid actress she shows herself to be. How subtly and appropriately she colors that lovely, feminine, always human (and never mechanical) flow of cantilena. You never get the feeling—as you do with some leggiero sopranos—that she is out to stun you with sparks; it is all much gentler and more musical than that.

Those familiar with Massenet's *Manon* may be puzzled by the first item listed above, and wonder where in the opera it comes. The answer is that it doesn't, at least not in the edition customarily performed. It is an alternative to *Manon's* Gavotte in the Cours de la Reine scene, and was written by Massenet six years after the opera was first produced. It is somewhat flashier than the scene we know, and exceedingly difficult to sing well.

The best things here are the Meyerbeer pair, amounting to more than twenty minutes of music. From *Robert le Diable*, Miss Sills sings tenderly and with the utmost appeal the Princess' declaration of love; and the Queen's nostalgic evocation of the countryside in "O beau pays" is another powerful argument in favor of the reevaluation of this moribund composer: the sorcery of a Beverly Sills is clearly what he needs.

Westminster has splurged on this record, obtaining the services of the Royal Philharmonic and a highly polished chorus, and recording the six pieces in a sonic environment of the utmost luxury. A fine setting for such a jewel as Beverly Sills. G.M.





Model 407

only
ASTROCOM/MARLUX
gives you positive
proof of performance

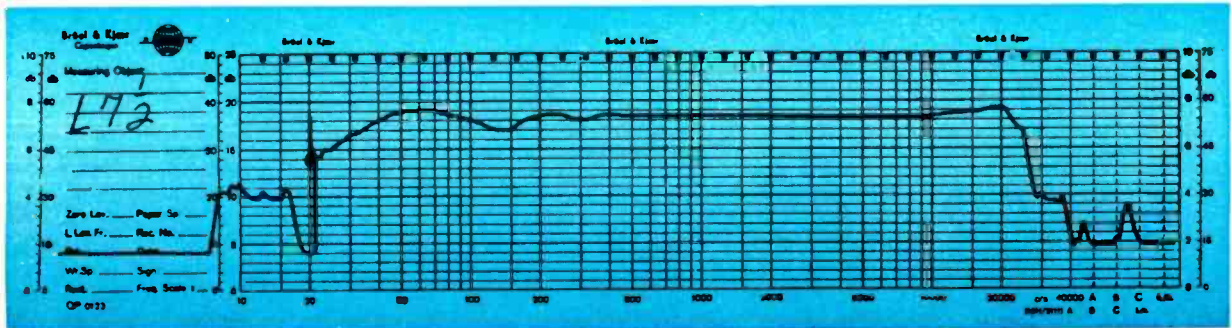

It's easy to print specifications . . . It's something else again to back up performance claims with the hard cold facts of laboratory tests. Every **Astrocom/Marlux Model 407** is furnished with its own graphic read-out of its frequency response tested on level recorders calibrated to National Bureau of Standards Accuracy.

The **Model 407** is built to inspire confidence . . . serious recordists everywhere appreciate the ease of tape handling with the soft touch solenoid operated controls, the unswerving accuracy of the hysteresis synchronous capstan motor and the smooth tape spooling afforded by the supply and take-up reel motors. The addition of a precision impedance roller to this tape drive system ensures consistently low values of wow and flutter. Four heads allow reverse play *plus* "off-tape" monitoring. The premium-quality heads and the all-silicon transistor electronics give signal-to-noise ratios of professional specification.

The **Astrocom/Marlux Model 407** has many other features designed to please the discriminating recordist.

Our dealers can demonstrate to you why the Model 407 is outselling much more expensive recorders and is today's most outstanding tape recorder value.

ASTROCOM | MARLUX

Oneonta, New York 13820
 CIRCLE 5 ON READER-SERVICE CARD

You'll hate
giving it...up!



"There is no tenor in modern times
... whose voice rings out with
greater vibrancy." (Alan Rich,
N.Y. Herald Tribune)

Thirty-three magnificent performances. Superbly packaged. Priced for giving (and keeping).
SCB-3744 —3 stereo records

you're shopping
discounts
because you want
the most system
for your money.



Before you buy, be sure to
check our price list. You'll be
glad you did.

Write us for our price list, DEPT. F,
or check our number on the reader
service card.

Boston / AUDIO
COMPANY

2 Common St., Waltham, Mass. 02154

CIRCLE 11 ON READER-SERVICE CARD

repeat A SELECTIVE GUIDE TO THE MONTH'S REISSUES performance

GLUCK: Orfeo ed Euridice: Orchestral Music. Rome Opera House Orchestra, Pierre Monteux, cond. RCA Victrola VICS 1435, \$2.50 [from RCA Victor LM 6136, 1957].

These performances have been sliced from a long-unavailable complete Monteux *Orfeo* with Risë Stevens—not an especially happy recording, I'm afraid. The music here comprises the orchestral portions of the opera: the Overture, pantomime music from Act I, the dances of the Furies and Blessed Spirits from Act II, and the ballet music that concludes the work. It's all treated with uncharacteristically graceless vehemence by Monteux, who was evidently unable to tame the Rome strings' scrappy assaults and woodwinds' raucous tone. The close miking and poor tape joins also add to the rather brutal flavor of this disc. Renato Fasano's elegant yet vital performances on a full-priced RCA disc (excerpted from the company's current *Orfeo*) are far kinder to Gluck.

HANDEL: Messiah. Elsie Morison (s), Marjorie Thomas (c), Richard Lewis (t), James Milligan (bs); Huddersfield Choral Society; Royal Liverpool Philharmonic Orchestra, Sir Malcolm Sargent, cond. Seraphim SIC 6056, \$7.46 (three discs) [from Angel S 3598, 1959].

There are now *Messiahs* for Handelianists of all faiths, ranging from Beecham's personal arrangement to the "authentic" re-creations of Davis, Shaw, and Mackerras. Sargent's approach was considered traditional and unarguable ten years ago: he uses Mozart's orchestration with generous choral and orchestral forces, and bathes everything in a warm, romantic nineteenth-century wash of sound. Within this framework, the conductor leads an earnest, honestly felt performance, but rather stuffy and bloated when compared to the airy vitality of the more recent Davis and Mackerras readings. The soloists are unexcitingly competent save for the outstanding work of the late James Milligan (still alive and well according to Seraphim's liner biography), and the sound is excellent. There are no other low-priced *Messiahs*, so for the moment it's Hobson's choice for the budget collector.

HAYDN: Symphonies: No. 18, in G; No. 19, in D; No. 20, in C. London Symphony Orchestra, Charles Mackerras, cond. (in No. 18); Vienna State Opera Orchestra, Max Goberman, cond. (in Nos. 19 and 20). Odyssey 32 16 0342, \$2.98 [Nos. 19 and 20 from Library of Recorded Masterpieces originals, 1966].

Volume 7 of Odyssey's chronological traversal of the Haydn symphonies reaches the first work of the complete canon not recorded by Max Goberman at the time of his death. Symphony No. 18 was only discovered in 1960—a delightful creation by the twenty-eight-year-old composer, cast in three brief movements (Andante, Allegro, and Minuet) which charm the ear with a delicate, courtly, slightly archaic baroque flavor. Mackerras' elegant reading is marred only in a few places by patches of imprecise ensemble; otherwise the conductor appears to be an excellent choice to carry on the good work begun by Goberman.

That maestro's familiar zestful drive and buoyant vigor are heard to good advantage on Side 2. Perhaps the festive No. 20 fares better from such a spirited approach than the more reflective No. 19, but in each case Goberman is a persuasive advocate for these early Haydn scores. Bright, forward, crisp sonics.

MOZART: Symphonies: No. 25, in G minor, K. 183; No. 26, in E flat, K. 184; No. 27, in G, K. 199; No. 28, in C, K. 200; No. 29, in A, K. 201; No. 30, in D, K. 202; No. 31, in D, K. 297 ("Paris"); No. 32, in G, K. 318; No. 33, in B flat, K. 319; No. 34, in C, K. 338; No. 35, in D, K. 385 ("Haffner"); No. 36, in C, K. 425 ("Linz"); No. 38, in D, K. 504 ("Prague"); No. 39, in E flat, K. 543; No. 40, in G minor, K. 550; No. 41, in C, K. 551 ("Jupiter"). Berlin Philharmonic, Karl Böhm, cond. Deutsche Grammophon SKL 109173/79, \$31.50 (seven discs) [from various Deutsche Grammophon originals, recorded between 1964–68].

Mozart connoisseurs will not want to be without this appealing, bargain-priced set. These symphonies represent some of Karl Böhm's finest recorded work: gracefully shaped singing lines, mellow orchestral sonorities, and pointed rhythmic buoyancy characterize the immaculately turned performances by the Berlin Philharmonic. For specialists, the discs are absolutely indispensable statements from one of today's leading Mozart interpreters, and more casual collectors, in search of the composer's major symphonies handily gathered under one roof, could not make a safer or more rewarding investment.

Böhm's recordings of symphonies Nos. 25, 27, and 30 are new to the catalogue and not yet available on a single disc. The latter two are perhaps the least ambitious of the sixteen, but Böhm treats them with as much affection and care that he accords the later masterpieces: and No. 25, the "little" G minor, emerges with real fire and passion, a neatly poised *Sturm und Drang* drama. DGG's beautifully recorded orchestral perspectives

and superior pressings complement the aristocratic performances.

OFFENBACH: *La Vie parisienne* (arr. Rosenthal); *La Périchole*: O, mon cher amant; Je t'adore; Ah! quel diner; Mon Dieu, que les hommes sont betes; Les Contes d'Hoffmann: Barcarolle. Jennie Tourel, mezzo; Columbia Symphony Orchestra, Jean Morel, cond. (in *La Vie parisienne*); Maurice Abravanel (in *La Périchole* and *Les Contes d'Hoffmann*). Odyssey 32 16 0351, \$2.98 (mono only) [*La Vie parisienne* from Columbia ML 4608, 1952; the other items from Columbia ML 2024, 1947].

Jennie Tourel often wound up her concert recitals with a couple of Offenbach selections. Her sense of style, insouciance, and caramel-cream mezzo were perfect for this ebullient music, and the two discs that provided the source material for this irresistible reissue have long been treasured items in many vocal collections.

The *Vie parisienne* is a potpourri arranged especially for Miss Tourel by Maurice Rosenthal from *Barbe-bleue*, *La Belle Hélène*, *La Chanson de Fortunio*, *Orphée aux enfers*, and *La Grande Duchesse de Gérolstein*. Rosenthal's orchestrations are rather crass, but the Tourel magnetism conquers all in this kaleidoscopic invocation of the eternal feminine, French style. The four glittering, slyly inflected *Périchole* vignettes are topped off by the Hoffmann Barcarolle with the mezzo deftly supplying both vocal lines. While never one of Columbia's better engineering efforts, the acoustics here have been polished up a bit; oddly enough, the 1947 *Périchole* side has the fuller, warmer sound. But then, the disc would be a treat under any sonic conditions.

STRAUSS, R.: Till Eulenspiegel's *Iustige Streiche*, Op. 28; *Salome*, Op. 54: *Dance of the Seven Veils*; *Die Frau ohne Schatten*, Op. 65: *Suite* (arr. Leinsdorf). Philharmonia Orchestra, Erich Leinsdorf, cond. Seraphim S 60097, \$2.49 [from Capitol SP 8548, 1961].

Leinsdorf conducts one of the better *Tills* on disc—the instrumental lines emerge with beautiful detail and the cool emotional temperature allows the witty orchestral commentary to make its humorous points naturally and effectively. *Salome's* *Dance* is a stodgy affair, though, and the incessantly rattling percussion gets far too much attention.

The conductor's stop-and-go arrangement of music from *Die Frau ohne Schatten* is no better than the composer's own. Taking orchestral scraps from an opera and stitching them together has never added up to a convincing entity: it's surprising to see a musician of Leinsdorf's intelligence indulging himself like this. The Philharmonia plays spectacularly well throughout and the sonics are appropriately big and splashy.

PETER G. DAVIS



We took the tangle out of tape.

Norelco introduced the tape cassette, and cassettes make tape recording simple, because the tape is locked up safe inside.

After we introduced the cassette, we didn't stop there—we introduced complete cassette systems to go with it. We kept introducing and improving until today, Norelco knows more about cassettes and cassette systems than anybody. And we sell more than anybody.

Ask your Norelco dealer to show you one of the Norelco stereo cassette systems. Either the Norelco 450 single play or the 2401 changer that plays up to six hours non-stop. Both record and play back too.

But make sure you buy a Norelco, not an imitation. After all, we introduced the whole idea in the first place.



North American Philips Corporation, High Fidelity Products Department, 100 East 42nd Street, New York, N.Y. 10017

CIRCLE 48 ON READER-SERVICE CARD

the
lees
side

You're Going to Hear From Her

IT'S MY PRIVATE conviction that the best musicians in history are American studio musicians, those who grew out of the bebop era of American jazz and went on to expand their abilities, settle down in New York and Hollywood (and to a lesser extent in other places), and earn steady livings for their families. They are called on to play music for everything from thirty-second television commercials through pop and rock material to symphonic movie scores. Often they play avant-garde classical music, in private or in concert, in their "spare" time.

Nor do I overlook the singers among them. There are some really remarkable singers here, people who work long hours that would give most opera singers laryngitis.

All of these musicians are phenomenal sight readers. And they are expected to play all the doubles. That is to say, a saxophone player, for example, may well be called on to play alto, tenor, and baritone saxophones, clarinet, flute, alto flute, and possibly piccolo, bass flute, and oboes as well.

Recently I had an encounter with five of these people, including a singer, that left me open-mouthed with admiration.

Paramount is developing a television musical special, for which Lalo Schifrin and I have written the songs. The head of specials for Paramount asked for a demo of the songs—a complete musical mock-up of the show, using a rhythm section and a singer.

We managed to get for our rhythm section four men who are normally so busy that you must book them weeks in advance. By sheer luck, we got them on four days' notice. They were Jimmy Rowles, the superbly lyrical pianist you hear on so many of the Henry Mancini albums, a man I have admired so long that I felt honored to meet him; Howard Roberts, a fine guitarist who has a series of albums on Capitol; Ray Brown, who for years was the rhythmic foundation of the Oscar Peterson Trio, and, I think (and a lot of bass players do too), the world's greatest bass player; Stan Levey, a wonderfully tasteful, versatile drummer.

The singer was Betty Jean Baker, whom I knew only slightly. Beejay, as she is known in the Los Angeles music world, has extensive choral experience. She used to be a member of the Anita Kerr singers. Now she's freelancing, and she has a recording deal with Decca. If there's any justice at all in this world, you should hear a lot of her before long.

For music, they were given only "lead sheets," which Lalo and I had written out the previous day. A lead sheet consists of the melodic line, with chord symbols (some of them complex) written over it and the lyrics written under it. They would be required to invent, on the spot, appropriate accompaniments—what are known as "head arrangements." They would have to know thoroughly the contents and character of each chord, know it instantly and at sight and without hesitation, and be able to improvise interesting and appropriate musical figures out of this harmonic material. These abilities are considered elementary in a studio musician.

Beejay would have to sight-sing both the songs. There would not be numerous rehearsals during which she could learn the music. Two or three cracks would be all she'd get on a song. Problem: the date started at 1:00 p.m. and she had been singing at other sessions since 9:00 a.m. This would mean that by the end of our sessions she would have put in nine hours of intensive singing in one day; and she, and people like her, face that sort of thing day after day. The New York Philharmonic considers it works hard putting in twenty hours of playing *a week*.

Everyone was assembled at the Glen Glenn sound studios on the Paramount lot by 1:00 p.m. Helping us, as a general music supervisor, was Leith Stevens, head of music for Paramount television, and himself a fine composer.

The first half hour of the session went into setting balances on the instruments and the voice. When the sound had been adjusted to the satisfaction of Lalo, engineer Leith Stevens, and myself, we went ahead.

The first tune had a soft rock rhythm

—an eighth-note motion of the kind Lalo calls "bossa rock." Beejay and the musicians had had plenty of chances to run over this tune while the engineer was setting balances. When Lalo said they were ready, they did a take. It was a perfectly good one. Beejay didn't like what she'd done, so they did it again.

"Next case," Lalo said, grinning, and they went on to another song. They ran it down for perhaps ten minutes, made little changes here and there, and got it in two takes. Next song. I think they got that one in three takes.

As the hours wore on, they began to get the takes even more quickly. Beejay had trouble with only one tune. The previous one had been loud and belting; now she was called upon to do one so soft as to be almost inaudible! It was 4:30; she'd now been singing something like six hours that day. It took her four takes to get it.

We came to a blues, a mean, sarcastic piece of material completely out of character with what had gone before. Lalo suggested that Ray Brown play a four-bar bass intro, and that he alone accompany Beejay in the first twelve bars, that Stan Levey and Howard Roberts come in on the second chorus, and pianist Jimmy Rowles join in at the first eight-bar release. They did it in one take.

"Wow!" Lalo shouted at the end. Everyone in the booth was grinning.

"Will you marry me?" I said to Beejay. She declined, alas. She's married to the great guitarist Barney Kessel. The take was so good that Beejay would like to release it as a single. Perhaps, when the show is done, she'll be able to.

By 6:45, we had one more song to do. And we had, under union rules, only five minutes to go before Paramount would have to start paying everybody overtime. Leith Stevens said, "Well, we have no choice. We'll have to pay it. We've got to get it done."

Lalo was getting ready to run the group through a rehearsal. And then someone had the preposterous idea that they might be able to do the song without rehearsal, and get it in a single take. Leith Stevens said, "Lalo, let's skip the run-down and try for one. We've got four minutes left."

"Okay," Lalo said, and to the musicians: "Two for nothing," meaning he'd count off two bars to set tempo.

The rhythm was medium-fast rock. They started. No one had even had time to *look* at the song. Yet it was coming incredibly well. Beejay reached the retard at the end. Every man in the studio held his breath. The rhythm section came in perfectly. They'd done the take with thirty seconds to spare.

This is what Beejay and her four colleagues had done: eleven tunes in six hours, some of them intervallically, harmonically, and rhythmically tricky, with perfect intonation, with warmth, intelligence, and great feeling, many of the songs at sight.

I once watched a highly touted rock group spend the first three hours of a recording session trying to get a single take of a song in tune. GENE LEES

The extra features in the new Wollensak 6150 Stereo Deck add to its value but not to its price.



This new Wollensak 6150 stereo tape deck is designed for truly professional recordings.

And all of its unique features are included in the price. There are no hidden extras that are added on later.

For example, the Wollensak 6150 is wrapped in a handsome walnut case to accent any decor.

And inside—it has powerful pre-amplifiers with fixed and controlled outputs.

A four-track stereo with open front threading and two-motor drive.

Patented self-aligning pressure roller for perfect tape alignment.

An exclusive Record Bias Selector to obtain optimum performance from various types of tape.

A controlled tape path that eliminates

the need for a scrape flutter filter.

The 6150 has electro-dynamic braking and patented automatic reel locks.

All of these features add to its value but not to its price. And that's just the beginning. Here's more:

Three tape heads ■ Separate recording/playback pre-amplifier and headphone monitor amplifiers ■ Monitor Switch to hear incoming program directly or from tape ■ Three speeds—7½, 3¾, 1⅞ IPS ■ Solid state ■ Separate Record level control ■ Illuminated professionally calibrated dual-movement VU Meters ■ Professional type patch board for special audio effects ■ Capable of Reverberation, Sound-on-Sound, Sound-With-Sound, Enhanced Mono and Input Mixing ■ Exclusive Plexiglas®

head cover for ease of tape editing ■ Instant pause control ■ Four digit tape counter.

FREQUENCY RANGE: 35-20,000 Hz ± 2 db at 7½ IPS. 35-14,000 Hz ± 2 db at 3¾ IPS. 35-10,000 Hz ± 3 db at 1⅞ IPS. (Special low speed equalization).
WOW AND FLUTTER: 0.12% RMS at 7½ IPS. (Less than 0.05% wow). 0.20% RMS at 3¾ IPS. 0.30% RMS at 1⅞ IPS. **SIGNAL-TO-NOISE RATIO:** 54 db. **WEIGHT:** 25 lbs. **DIMENSIONS:** 20½ x 13½ x 7½ inches with cover.

If you want a complete stereo unit, the new Wollensak 6250 Stereo Audio Center comes with self-contained acoustic suspension speakers. And an exclusive component quality 62 watt amplifier, that's built right in. Everything you need for precise, professional recordings.

Wollensak 3M
COMPANY
SAINT PAUL, MINNESOTA 55101

CIRCLE 78 ON READER-SERVICE CARD

the lighter side

reviewed by

MORGAN AMES

R. D. DARRELL





JOHN GABREE

GENE LEES

JOHN S. WILSON

 symbol denotes
an exceptional recording



THEODORE BIKEL: A New Day. Theodore Bikel, vocals; Richard Perry and Jimmie Haskell, arr. (Lady Jane; The Great Mandala; Piggies; eight more). Reprise 6348, \$4.98. Tape:  RST 6348, 3 $\frac{3}{4}$ ips, \$6.95;  RA 6348, \$5.98;  RM 6348, \$6.95;  X 6348, \$5.95.

Ordinarily, when an actor enters the singing arena, the trained ear trembles. Actor Theodore Bikel is a delightful exception, but then he is an actor who has been singing for years. That means he made the standard blunders long ago, on stages long since converted into supermarkets—and during a period when the young people to whom this fine album is basically directed were sporting iodine on their knees.

Other than Burl Ives, I can think of no seasoned actor who relates so well to contemporary music. Richard Perry's production is equally skilled and sensitive, as are Jimmie Haskell's orchestrations. Obviously, a fluid rapport existed here.

The carefully selected material gives Mr. Bikel room to be himself while bowing to some of our best young writers, including Joni Mitchell (*Urge For Goin'*), Donovan (*Jennifer Juniper*), Lennon/McCartney (*Mother Nature's Son*), and others. Mr. Bikel handles the task with warmth, humor, and the same professionalism which marks his acting. My favorite track is Cat Stevens' *I Love My Dog*, on which everyone (including the best young studio musicians) gets quite a groove going. Jacques Brel's *Amsterdam* is perfect for Mr. Bikel's sense of drama.

Like Burl Ives, Mr. Bikel has a background in folk music which gives him an edge with the music of today. Nevertheless, the album could not have been made so well without great sincerity. Congratulations. M.A.

THOSE WONDERFUL THIRTIES: The Stars of Hollywood's Golden Era. Al Jolson, Mae West, Pinky Tomlin, Dorothy Lamour, Frances Langford, others. Decca DEA 7-1, \$9.98 (two discs, rechanneled stereo only).

THOSE WONDERFUL THIRTIES: The Stars of Broadway, Night Clubs, and Vaudeville: Cab Calloway, Bill Robinson, Ethel Waters, George Jessel, Hildegard, others. Decca DEA 7-2, \$9.98 (two discs, rechanneled stereo only).

THOSE WONDERFUL THIRTIES: The Stars of Radio, the Great Bands, the Great Vocalists. Eddie Cantor, Kate Smith, Fred Waring, Arthur Godfrey, Clyde McCoy, others. Decca DEA 7-3, \$9.98 (two discs, rechanneled stereo only).

It is only in recent years—maybe the past two decades—that records have provided a reasonably accurate reflection of the total entertainment world

around them. During these years, they have become tied in closely with films, with theater (both musical and non-musical), and with television. At the same time, records have taken on an importance in the general promotional scheme of entertainment that they never had before. Back in the Thirties—or, as this Decca series calls it, "Those Wonderful Thirties"—records were still primarily records. If a singer who was in a film or a Broadway musical recorded a song from that show, it was done on recording terms, not taken from a soundtrack or performed in the atmosphere of an original cast recording.

So in these three sets it is, in general, the records that were made simply as records that come off best and reflect the musical feeling and atmosphere of the Thirties most accurately. There is, for example, the Boswell Sisters' inimitable *When I Take My Sugar to Tea* in which Connie Boswell's vocal arrangement and the Dorsey Brothers' studio band blend brilliantly. Other successful performers include the Boswells' successors, the Andrews Sisters, doing their landmark *Bei mir bist du schön*, the Mills Brothers introducing their vocalized-instrumental concept on *Tiger Rag*, or, to pick a less celebrated performer, Frances Faye belting out *No Regrets* and playing a really rocking piano.

Radio was the universal medium then and it left behind evocative theme songs—the Casa Loma Orchestra's *Smoke Rings*, Ben Bernie's *Au Revoir*, *Pleasant Dreams*. Even as gashly a gargle as Arthur Tracy's *Marta* (he was The Street Singer) adds a fitting bit of color to the collection.

And there were some performers in the theater and films who could transfer their magic to records. Two classics of this genre are in the second volume of the series—Libby Holman's original recording of *Moanin' Low* with its ominously rhythmic tuba and Walter Huston's magnificent *September Song*. Bob Hope's *Thanks for the Memory* and Judy Garland's throbbing young voice on *Over the Rainbow* are the high points of Volume 1.

But there is more to compiling a venture into nostalgia than gathering familiar names and songs. Sometimes the aberrations of the past can be gratefully forgotten. Does anyone really want to be reminded of Bobby Breen piping *Rainbow on the River*? After hearing James Melton's stiff, overblown attack on *September in the Rain*, one is surprised that the song managed to survive and become a standard.

And there are times when reality proves to be less than fond memory would have us believe. Wini Shaw singing *Lullaby of Broadway* is an unexpectedly pale, subdued performance. Tiny Tim has taken whatever meat there

LISTEN TO THE HEART LINE FOUR BRAND-NEW
 SPEAKER SYSTEMS THAT HIT YOU WHERE YOU LOVE. THE HEART
 LINE... PERSONAL, LIVING SOUND YOU CAN TURN ON AND GET LOST IN.
 BEAUTIFUL! AND BEAUTIFULLY PRICED TOO.

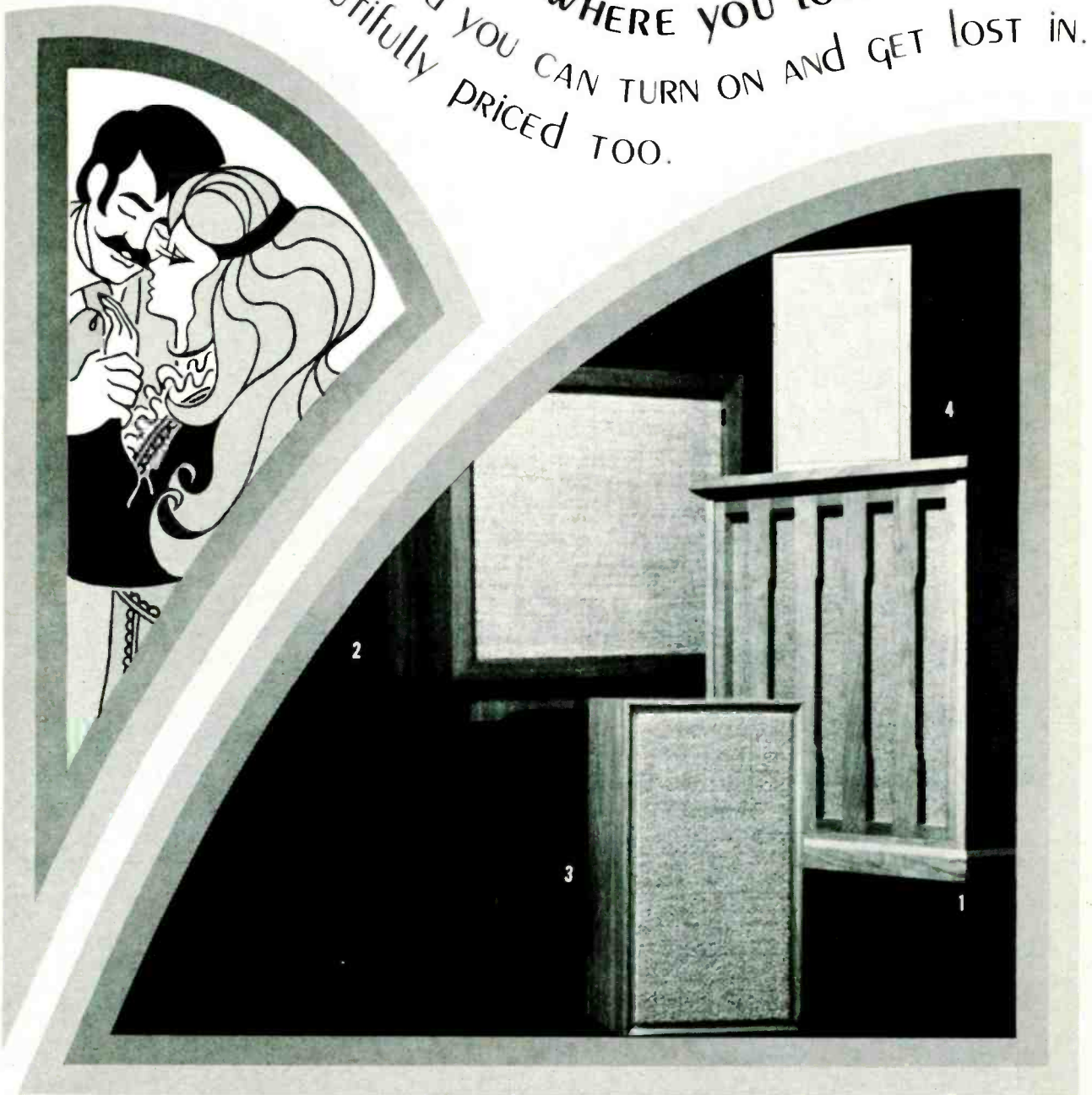

1) The President 2) The Vegas 3) El Paso 4) El Dorado

For some lovely specs, plus more detailed information about this fine new group of speaker systems, see your University dealer or write Heart Line, 9500 West Reno, Oklahoma City, Oklahoma 73126.

CIRCLE 76 ON READER SERVICE CARD

is from Nick Lucas' original high-voiced *Tip-toe Through the Tulips*. Isham Jones, for some reason, recorded his lovely *You're Just a Dream Come True* at a murderously fast and mechanical tempo.

There is also a certain amount of minor fakery involved in these reissues—a form of deviousness that could not be avoided in such a broad program drawn from a single catalogue. No real harm is done when Decca uses a 1941 recording of Guy Lombardo's 1937 hit, *Boo Hoo* (Victor has the 1937 version), since the passing of four years makes little difference in a Lombardo performance. But the whole idea of this series of reissues is undermined when Rudy Vallee's *There Is a Tavern in the Town* is represented by a 1961 record-

ing (Vallee's attitude toward the song and his style as a performer had changed over three decades); or when Eddie Cantor's Depression hit, *Now's the Time to Fall in Love*, is heard in a recording made a decade later when his once buoyant voice was beginning to thicken; or when Wayne King's theme, *The Waltz You Saved for Me* (whose slumberously silken sound made the *Lady Esther Serenade* a memorable part of Sunday afternoon in the Thirties) is offered in a 1955 recording in which the original, direct simplicity of King's performance is buried under an overdressed arrangement.

Despite such lapses, these three sets are crammed with redeeming factors—two appearances by the timeless Jimmy

Durante, one of them with his old partners, Lou Clayton and Eddie Jackson; Marlene Dietrich muttering *Falling in Love Again*; the young, fresh, not yet groaning voice of Bing Crosby singing his theme; an even less affected appearance by Perry Como when he was with Ted Weems's orchestra; and such a long list of major and minor personalities that even the companion experiences of rediscovery and disappointment can be ultimately rewarding. J.S.W.



THE MATCH: A New Light. The Match, vocal group; orchestra, Jules Chaikin, cond. (Don't Take Your Time; Free and Easy; Alfie; eight more.) RCA Victor LSP 4206, \$4.98.

There are different ways to judge popular music. John Gabree, for example, seems to judge it, at least in part, for dramatic values. That's legitimate enough. I look for musical values first, dramatic values second. On musical grounds, this is the best rock-rooted pop album I've heard in months.

The five members of the Match (including second tenor Pat Valentino, who writes their vocal arrangements) are not only the most musical group on the scene; they are, to my mind, the cleanest singing group of any kind since the Hi-Lo's. And they put one in mind of that fondly remembered virtuosic quartet. Their unisons are impeccable. When they sing tight dissonant harmony, they are precisely in tune. When they sing inner lines, they make them clear as crystal—you can hear everything even in the most complex texture. These are musician-singers.

The album will be called saccharine and inconsequential by those for whom pop music is only a platform for polemics. That's because the intent of the Match is music.

The material, with the exception of Burt Bacharach's *Alfie*, is pretty lightweight. It includes that inevitable bit of boredom from *Hair*, the nothing-esque *Where Do I Go*. But the singing itself is remarkable, and in *Alfie*, the group sounds astonishingly like the Hi-Lo's.

The album is so good that I doubt that RCA Victor will put any weight of promotion behind it, and it will probably fade from sight, leaving no wake on the polluted sea of current pops. G.L.

MAVIS STAPLES. Mavis Staples, vocals; instrumental accompaniment. (Until I Met You; Security; Pick Up the Pieces; Chained; Good to Me; You Send Me; six more.) Volt VOS 6007, \$4.98.

THE STAPLE SINGERS: We'll Get Over. Gospel quartet with instrumental accompaniment. (We'll Get Over; Give a Damn; Everyday People; The Challenge; The Gardner; When Do I Get Paid; six more.) Stax STS 2016, \$4.98. Tape: X 42016, \$5.95; X 2016, \$5.95.

CARLA THOMAS: Memphis Queen. Carla Thomas, vocals; instrumental ac-

**A NEW
Tandberg®
STEREO TAPE DECK
FOR LESS THAN \$250 COMPLETE WITH
CROSSFIELD HEAD
3 SPEEDS
SOLID STATE
4 TRACK**

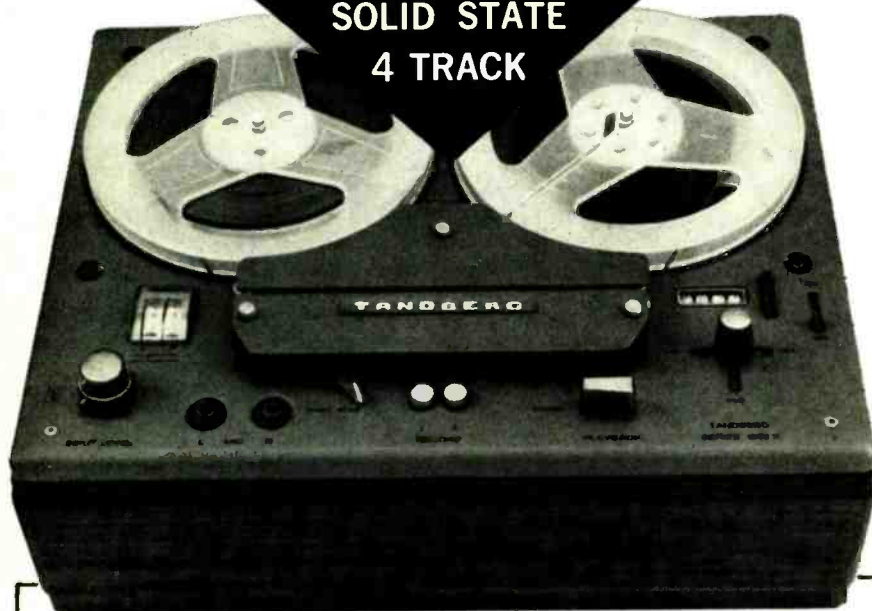

Model 1600X, for the finest quality recording

- Crossfield head assures better frequency response and signal-to-noise ratio.
- Pushbutton record controls.
- Record level indicators corresponding to professional standards.
- Handsome walnut cabinet.

for better, clearer, more natural sound

List Price \$249.00

Tandberg OF AMERICA, INC. P.O. BOX 171, 8 THIRD AVE, PELHAM, N.Y. 10803

CIRCLE 82 ON READER-SERVICE CARD

BOSE on SOUND LOCALIZATION

If you have heard the BOSE 901 Direct/Reflecting™ speaker system, or if you have read the unprecedented series of rave reviews, you already know that the 901 is the longest step forward in speaker design in perhaps two decades. Since the superiority of the 901 (covered by patent rights issued and pending) derives from an interrelated group of advances, each depending on the others for its full potential, we hope you will be interested in a fuller explanation than is possible in a single issue. This discussion is one of a series on the technical basis of the performance of the BOSE 901.

When you stop to think, it is really demanding to expect a few microphones in the concert hall, and two speakers in a living room even to begin to recreate the listening experience provided by a wide stage on which perhaps 100 instruments are playing. Yet we try. It is easy to show that no two speakers (even ours) can recreate the live experience exactly. But there are speaker design factors that can be incorporated to produce significant improvements over conventional speakers.

One of these factors (And you may do simple experiments to verify it, using conventional speakers in your own home.) is the proper LOCALIZATION OF SOUND. In a live performance the wall behind the musicians is one of the most important surfaces in the acoustical design of the hall. It reflects the sound to provide the fullness characteristic of live performances. (Even outdoors, a reflecting shell is a necessary part of good musical performances.) It is for the same reason that speakers should be designed to use one wall of a room to simulate the stage of a live performance. Since home rooms and speakers are smaller than stages and orchestras, good simulation requires that each speaker be capable of presenting a sound image that is broader (physically larger) than the dimensions of the speaker itself. But how can a speaker accomplish this? Try the simple sequence of experiments indicated in Figure 1 and you will discover the answer. In experiment 1 you will localize the source of

the sound to point A, the speaker. Experiment 2 results in your localizing the source of sound primarily to point C on the side wall.

Experiment 3, when both speakers are played together, results in your localizing the sound source as an area between points A and C. The experiment is fascinating; try it. After doing these easy experiments you will understand, in part, how the direct/reflecting principle of the 901 creates a sound image much larger than the speaker and causes your ear to localize the source of sound as if it originated from a stage. Add to the direct/reflecting design factor a multiplicity of full-range speakers, active equalization, and the criterion of flat spectrum of power radiation* and you are in for a most pleasant surprise when you A-B the 901 with any conventional speaker, regardless of size or price. Your franchised Bose dealer can arrange the A-B experiment.

*See 'ON THE DESIGN, MEASUREMENT AND EVALUATION OF LOUDSPEAKERS', Dr. A. G. Bose, a paper presented at the 1968 convention of the Audio Engineering Society. Copies of the complete paper are available from the Bose Corp. for fifty cents.

1. Play Speaker A
2. Play Speaker B
3. Play Both Speakers—adjusting the relative volume levels (B greater than A) to give the best spatial image

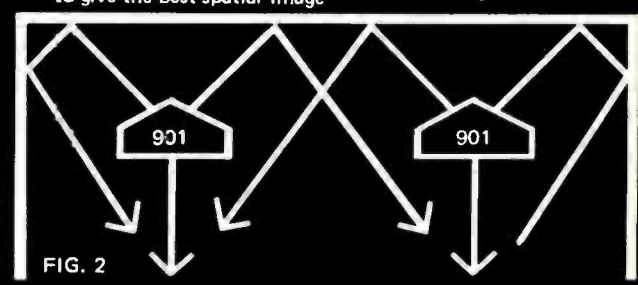
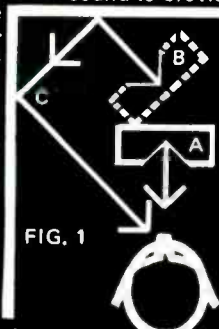
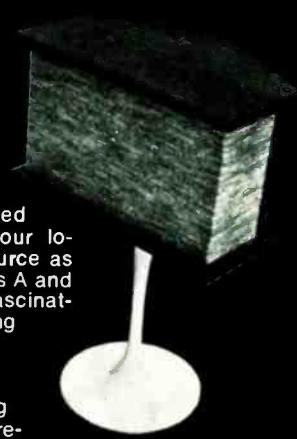

You can hear the difference now.

THE **BOSE** CORP.®

East Natick Industrial Park, Natick, Massachusetts 01760

BOSE 901 DIRECT/REFLECTING™ Speaker System—\$476 the Stereo Pair, including Active Equalizer. Slightly higher in areas south and west. Pedestal base extra.

CIRCLE 10 ON READER-SERVICE CARD

companiment. (I Play for Keeps; Unyielding; Strung Out; Guide Me Well; Precious Memories; Where Do I Go; six more.) Stax STS 2019, \$4.98.

Pop culture thrives on bandwagon-hopping far more than on originality. Beatles-imitating, for instance, is practically an industry in itself. A subsidiary phenomenon is the promotion of artists as if they are mere imitators. For example, because she is a female soul singer, Mavis Staples is being pushed by Stax/Volt as the "new Aretha Franklin." Hypes likes this can really backfire. The record buyer can get pretty annoyed when he finds he is buying one thing and getting another. (Nilsson, for instance, was hurt

when RCA insisted that he was another Paul McCartney rather than a Beatle-derived but very original minstrel.) In the case of Mavis Staples most listeners will come back for more. She is a much more reserved performer than Franklin and greatly influenced by her years with the Staple Singers. The Stax/Volt formula is pretty well worked out by now and getting a bit repetitious; I'm not convinced that most of these songs couldn't have been replaced by better ones. On the other hand, like the rest of her family, she can make almost anything worth listening to.

You can hear Mavis to better advantage with the Staple Singers on *We'll Get Over*. For many years the Staples

have been one of the most popular gospel groups and one of the few with a following outside the black community. They have relied heavily on the lead voices, with little more instrumental support than Pop Staples' rhythm guitar. Stax has repackaged them with extensive rhythmic and instrumental backing and, though they sometimes end up sounding like the Fifth Dimension, for the most part it works well. The material ranges from the Guess Who's *Any Wednesday in Your Garden* and Joe South's *Games People Play* to several first-rate originals and a Japanese folk song called *Solon Bushi*. There aren't more than a couple of other albums in the Memphis style that I like as well as this one.

Carla Thomas is easily one of the really top few soul belters (offhand I would think that Aretha, Carla, and Tina Turner were the three best). On *Memphis Queen*, Carla turns in a beautifully tough performance. She avoids both the coyness and the fake hysterics that mar the singing of so many younger soul performers. In fact, in many ways she is more like the stars of the Thirties and Forties than her contemporaries. When she was still in her teens she scored with *Gee Whiz*, one of the great pre-Beatles hits, and she contributes a couple of good new tunes here, especially *Don't Say No More*. Most of the other songs suit her very well (especially *I Play for Keeps*). No arranging credits are listed but the band is a little less predictable than on most of the other recent releases from Memphis. If you don't already know Miss Thomas' work, you're in for a pleasant surprise. J.G.



RED BEANS AND RICE: Phil Wood, trumpet, flugelhorn, piano, vocals, and arr.; Richard Aplan, tenor sax, bass clarinet, and arr.; David Dahlsten, trombone and congas; Bob Hogans, organ, valve trombone, and vocals; Ron Johnson, bass; Tommy Trujillo, guitar and vocals; Paul Logos, drums; Rodney Gooden III, bass clarinet and vocals; Ray Draper, tuba, valve trombone, vocals, and arr. Epic BN 26461. \$4.98. Tape: N 14 10204, \$5.98; N 18 10204, \$6.98.

Ray Draper was one of the young geniuses of late Fifties jazz, playing tuba with Miles Davis and others while still in his teens. But he was also a young black American and the odds were pretty much in favor of him to end up as he did, a drug addict. The odds weren't in favor of his recovering.

It took Draper six years to break his habit, but somehow he did it and went on to form what I consider the best jazz-rock band yet. Draper assembled his group in the hills of California, and their playing generates an easy, relaxed atmosphere. There have already been personnel changes since the record was cut—in fact, the band will probably always be a relatively unstable one; its members are far too creative to remain together for long. But if Draper can manage to bring them into the studio every



You can even hear it when the water's running.

It's 30 Watts of music power, enough to be heard over any shower.

It's a useable FM sensitivity of 2.5 μ V.
A frequency response of 20 to 30,000 Hz.
An FM harmonic distortion rating of 0.5%.

It's Standard's SR-A205SU stereo receiver: a solid-state thoroughbred, containing 24 silicon transistors, 18 3-reactance diodes and tuned RF stages.

In walnut finish with aluminum trim, astonishingly priced at \$119.95. From your Standard dealer, and we'll be happy to tell you exactly where to find him.

It's The Sound Choice.



STANDARD RADIO CORP
...electronic years ahead!

60-09 39th AVENUE, WOODSIDE, N.Y. 11377,
1934 SOUTH COTNER AVENUE, LOS ANGELES 90025.

CIRCLE 70 ON READER-SERVICE CARD

"Scotch" Brand Cassettes prevent tape hangups

Here's the inside story.

"Scotch" Brand builds in trouble-free performance with exclusive features:

Famous "Dynarange" Magnetic Tape provides highest possible fidelity at slow recording speed. A slick, tough coating affords smooth tape travel, resists oxide ruboff, assures long tape life.

Precision-molded case is high-impact plastic, features permanent ultrasonic sealing, large integral window. Color coded for recording time.

Anti-friction shields combat tape hangups. Exclusive, ultra-smooth material reduces drag. Bowed shape guards against uneven tape wind.

Fixed tape guides help prevent "wow" and "flutter" often caused by imperfect roller guides. Splined design cuts friction and drag.

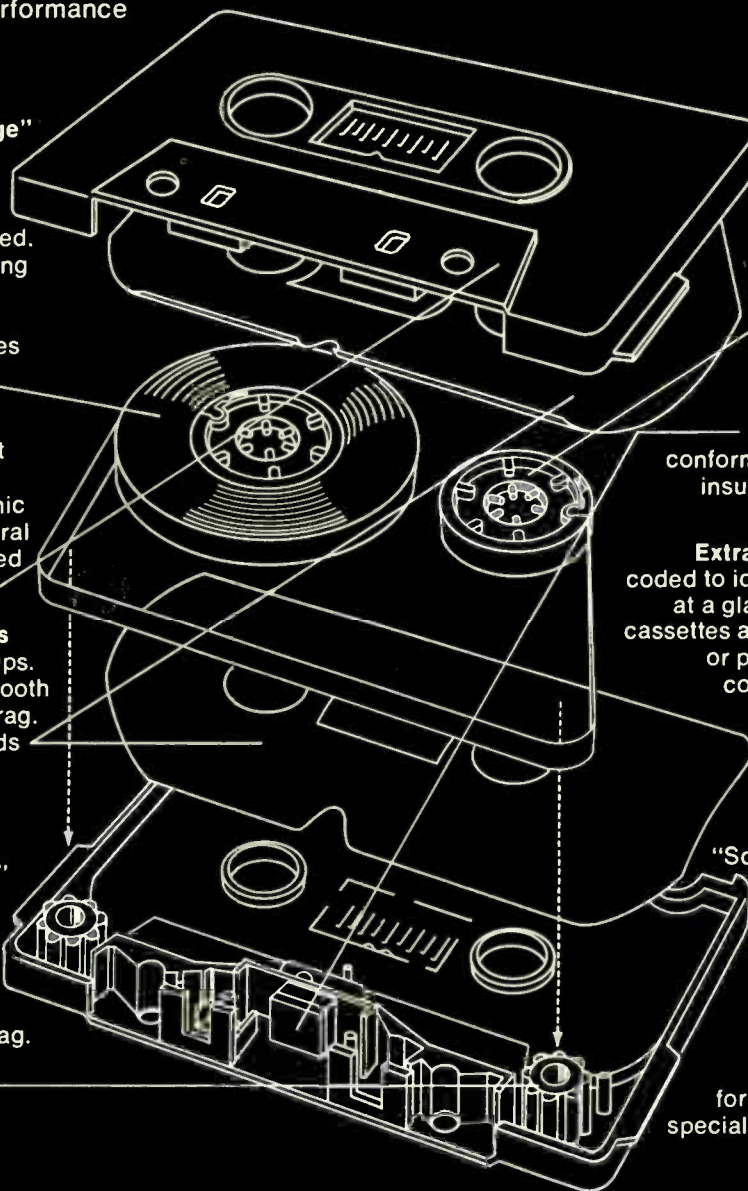

One-piece hub locks leader tape securely, eliminates "bump" that can distort tape in winding.

Unitized pressure pad conforms to recorder head to insure better tape contact.

Extras: Cassettes are color coded to identify recording times at a glance. 30, 60, 90-minute cassettes available in album-style or postal-approved plastic containers. Plus C-120 in album only.

Helpful booklet, "Recording Basics" is yours free with any "Scotch" Brand purchase from your nearest participating dealer. Or send 25¢ coin to cover handling to:
3M Company,
P.O. Box 3146
St. Paul, Minn. 55101.
Also ask your dealer for catalog of special premiums.



"SCOTCH" AND "DYNARANGE" ARE REGISTERED TRADEMARKS OF 3M COMPANY.

Cassettes

Compact Cassettes
Licensed Quality Control by North American Phillips
LIFETIME GUARANTEE!



C-30 1/2 Hr. .55 C-90 1 1/2 Hr. 1.10
C-60 1 Hr. .60 C-120 2 Hr. 1.35
Each cassette in individual mailer box

CASSETTE ACCESSORIES

Cassette Tape Splicer

For easy repair of torn tapes, or splicing in sound effects \$3.95 ea.

Cassette Play/Record Head Demagnetizer

Improve fidelity by removing excessive magnetic build-up. Recommended use: Every 15-20 hours of play/record time. \$7.50 ea.

Norelco Type Hard Plastic Box 25c ea.
Ampex Type Hinged Box 20c ea.
Two Piece Soft Plastic Box 10c ea.

Cassette Head Cleaning Cartridge

(Should be used every 20 hours of playing and/or recording time) 89c ea.
Postage 10c; 5c ea. add'l cassette or accessory
Order for 12 Cassettes ppd.

CASSETTE STORAGE CHEST AND CARRY CASES

Has compartments for 12 Cassettes.



DeLuxe Heavy Leatherette \$3.95 ea. ppd.

Attractive Sturdy Vinyl \$2.95 ea. ppd.

CASSETTE MODULAR STORAGE UNITS

Decorator Walnut Grain covered. Holds 12 Cassettes. Mount on wall or place on book shelf. Stand on end or stack.



\$2.95 ppd. /2 for \$5.40 ppd.

Modular Storage Unit Package Special

Modular Storage Unit complete with 2 C-60s, 2 C-90s, 2 C-120s. 6 Hard Plastic Boxes, Cassette Head Cleaner. reg. \$11.44 Your Price \$10.85 ppd.



New! CASSETTE CADDY

- Attractive walnut finish.
- Holds 12 cassettes in each compartment—Total 48 cassettes.
- Lazy Susan Swivel Base.
- Select cassette with ease.
- 8" x 8" x 10" high.

Reg. \$14.95 Now \$10.95 ppd.



Brand New! CASSETTE ALBUM

- Handsome Library-Styling
- Durable Woodgrain Material
- Holds 12 Cassettes In Molded Plastic Trays
- Index Page For Cataloging
- Stores Vertically 10" x 9 1/2" x 1 1/4" Wide

\$4.50 ppd.

2 for

\$8.25 ppd.

Special! CASSETTE ALBUM PACKAGE

4 C-60s, 4 C-90s, 4 C-120s, a Cassette Head Cleaner plus a CASSETTE ALBUM
regular \$17.59 Your Price \$15.75 ppd.

PACKAGE SPECIALS

Save more than 10% OFF of above prices!
Same Cassettes As Above As Low As
C-60 54c / C-90 99c / C-120 \$1.22

Pkg. Price Cassette Asst

- A. \$12.60 12 C-60s ppd.
B. \$15.30 6 C-60s ppd. & 6 C-90s
C. \$16.65 6 C-60s ppd. & 6 C-120s
D. \$17.20 4 C-60s ppd. 4 C-90s & 4 C-120s
E. \$20.70 12 C-120s ppd.

ACCESSORIES

- Included with A, B, C, D, or E pkg.
Vinyl Storage Chest.
L 12 hard Plastic Boxes & Cassette Head Cleaner (For DeLuxe Storage Chest add 90c to each pkg. price)
S

ECONOMY PACKAGE! 2 C-60s, 2 C-90s, 2 C-120s plus 6 Soft Plastic Boxes and 1 Cassette Head Cleaner. \$7.59 Value **NOW \$6.80 ppd.**
Above Prices Mail Order Only! Catalog Available!

CONSUMERS CO. 103 Park Ave., HF-12
New York, N. Y. 10017

CIRCLE 14 ON READER-SERVICE CARD

now and then, I think we can expect a string of good albums.

The singing on the LP is for the most part quite good: it cuts to ribbons the pretensions of Blood, Sweat, and Tears' David Clayton-Thomas. The best track is *Gentle Old Sea* (as usual there are no liner notes and the credits are vague, but I think the singer here is Rodney Gooden). *Let My People Go* also receives a rousing interpretation by the group.

Red Beans and Rice is loose and unpretentious. I keep finding more things to like with each replay. It should give jazz-rock, in general, a big boost. J.G.



LEE MICHAELS. Lee Michaels, vocals, keyboards, and bass; Bartholomew Smith-Frost, percussion. (Stormy Monday; Who Could Want More; Want My Baby; Heighty Hi; five more.) A & M SP 4199, \$4.98. Tape: 4199, 7 1/2 ips, \$7.98; 4199, \$5.95; 4199, \$6.98; 4199, \$6.98.

LESLIE WEST: Mountain. Leslie West, guitars and vocals; Felix Pappalardi, bass and keyboards; N.D. Smart II, drums; N. Landsberg, organ. (Blood of the Sun; Better Watch Out; Blind Man; Baby I'm Down; This Wheel's on Fire; Look to the Wind; five more.) Windfall 4500, \$4.98.

Here are two extraordinary new releases. Leslie West is a young singer/songwriter who makes his debut at the same time as Felix Pappalardi's new Windfall label. Pappalardi has been for years one of the best hirelings in the business (chiefly at Atlantic), and quite naturally he has decided that he would rather work for himself. He couldn't begin much stronger than with Leslie West.

West's most spectacular asset is a muscular soulful voice, the kind of sound every blues imitator in the country probably dreams about at night, though West does considerably more than imitate; he very effectively socks across any particular message he wishes to relay. Pappalardi lends strong support throughout the enterprise, and drummer Smart never strays when he is needed.

The material, unfortunately, is disappointing, less imaginative and less varied than I would have anticipated. West and Pappalardi share most of the composing duties. Almost all this excellent noise is the product of only three musicians—organist Landsberg is along on only three cuts—and my guess is that the "Mountain" of the title is the one you make out of a molehill.

Lee Michaels and percussionist Frosty have produced one of the three or four finest pop LPs of the year. As vocalist, Michaels redeems himself from his disastrous earlier efforts; as an organist he is nonpareil—Al Kooper, R.I.P. The five songs on Side 1, strung together as a sort of suite, are a testimony to the continued strength of rock as a medium of emotional exchange: Michaels gets down to basics about a lot of young adult problems. His rock is about sex, inadequacy, fear, and loneliness, often

expressed exuberantly but with the hard edge of adolescent insecurity never far below the surface. Michaels has a beautiful natural voice and he uses it skillfully.

As rock instrumentalists, both Michaels and drummer Smith-Frost (Frosty) are among the best. Michaels invests the organ with a rhythmic intensity that is seldom felt even on the funkier jazz LPs, and Frosty is one of the great rock drummers, right up there with Keith Moon of The Who and the Jefferson Airplane's Spencer Dryden. His carefully constructed solo here, *Frosty's*, is one of the most tasteful on record and you receive that recommendation from a critic who is a pronounced drum hater.

I wish everyone would get this album, set their volume controls at the threshold of pain, and let the music smother them. Lee and Frosty are two very beautiful people. J.G.



BUGSY MAUGH. Inside Buggy. Buggy Maugh, vocals and bass; Dale D. Oehler and Buggy Maugh, arr. (Shoeshine; I Can Tell; In Limbo; six more.) Dot DLP 25945, \$4.98. Tape: Y-25945, \$5.98.

More and more flowers are blooming up through the weeds of rock. This is one of five or six truly distinctive rock releases in the past two months. Buggy Maugh is a former member of the Paul Butterfield Blues Band, a white group that made it sounding black. This is Buggy's second on-his-own album for Dot.

Buggy is a powerful, skilled, and earthy blues-based singer. He has that intuitive slyness, plus a genuine love of blues, that enables some white musicians to express themselves in an essentially black style without turning anyone off. But when talent is deep, socioartistic discussions are an even bigger bore than usual. Buggy is a heavy talent, and that's that.

Despite a rather small band (including Buggy on bass and the sensational studio drummer John Guerin), the charts are solid and the feeling spontaneous. Arranging credits list Buggy and Dale D. Oehler (who also plays piano). One of them is deeply into the work of the superb jazz arranger, Gil Evans. The chart for *Give Me Time to Love You*, with its tight voicings and slurring trombone line, is straight out of the Miles Davis/Gil Evans album, *Sketches of Spain*. It's fascinating—and the most compelling blend of jazz and rock since Blood, Sweat and Tears made their appearance.

The album's best songs were written by Buggy (including *Rush Hour* and *Give Me Time to Love You*). The one disaster track is a glaringly inappropriate and corny song by Val Stoecklein called *It's Not That Far Away*.

Warm congratulations to Buggy, producer Ray Ruff, arranger Dale D. Oehler, engineers Stan Ross and Doc Siegel, a wonderful group of studio musicians, and Dot, for coming up with one of the best rock albums of the year.

M.A.

CIRCLE 44 ON READER-SERVICE CARD →

OF ALL THE SPEAKER MANUFACTURERS PRODUCING TODAY, ONLY ONE HAS ELECTRONIC SUSPENSION.

LWE's newly patented* Electronic Suspension speakers actively eliminate reproduction distortion by electrical commands to the amplifier. The result is remarkably improved fidelity.

LWE has put an end to a whole era in speaker design. No longer must a speaker depend on porting, or reflex, or resonance, or baffles, or sand, or lead, or cabinet size, shape or design. Electronic Suspension makes these techniques as outdated as a wind up phonograph. □ LWE research has uniquely adapted the principle of inverse- or negative-feedback to control the speaker cone electronically at all times. This produces unrivaled transient response, virtual elimination of speaker distortion, and extension of low frequency response. In short, LWE out-performs any comparably priced speaker on the market today.

□ LWE prices range from \$60 (Instant Kit) to \$469 (LWE II). Hear LWE at your dealer's, or write for LWE's "Sound of Excellence" Brochure. LWE Electronic Suspension has arrived, and you've never heard it so good!



LWE

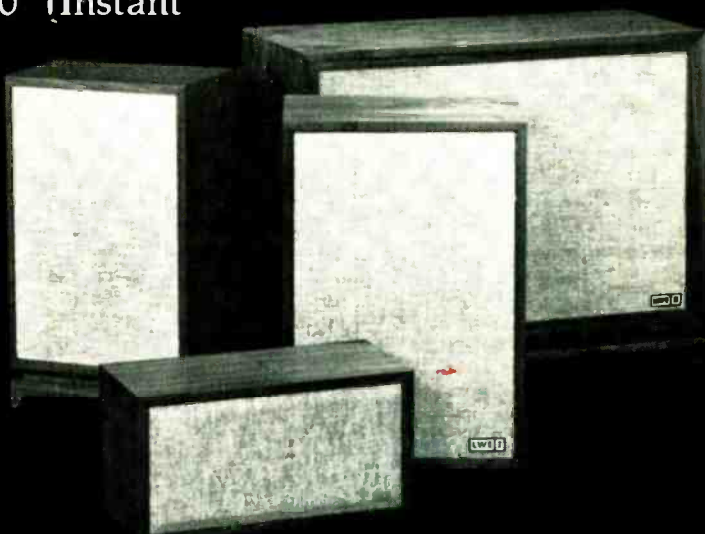

ACOUSTRON CORPORATION

The Sound of Excellence

2418 Bartlett/Houston, Texas 77006/(713) 524-7407

March, 1969

DEFA ELECTRONICS

NEW THE FISHER 500-TX
AM-FM Stereo System



Fisher 500TX 200 watt AM/FM Stereo Receiver with Autoscan touch tuning. Tune-O-Matic push-button Mercury tuning. Auto frequency control. 5 way speaker selector. Complete tape & phone facilities. Plus 2 Fisher XP9B 4 way speaker systems with two 12" bass. Two 6" lower mid-range. Two 5" upper mid-range and two 1 1/2" treble speakers.

ARxa 2 SPEED TURNTABLE
Low flutter, rumble and wow. Exact speed. Incl. arm, oiled walnut base, dust cover and needle force gauge.



3 YR. GUARANTEE

NEW! IMPROVED SHURE V15 TYPE II CARTRIDGE
Analog, computer designed & measured Bi-Radical Elliptical Stylus with diamond tip.

FREE: Stereo Headphone Set With Purchase of Package

WRITE FOR OUR QUOTE ON PACKAGE
HF 204 & ANY OTHER SYSTEM OF YOUR CHOICE

STEREO SYSTEMS—COMPONENTS
Send For Our Quote Today!
We Carry All the Famous Brands.

DEFA ELECTRONICS CORP.
2207 Broadway, N.Y., N.Y. 10024
PHONE 874-0900 & 874-0901

CIRCLE 17 ON READER-SERVICE CARD

DISCOUNTS

SELLING HI-FI
NATION-WIDE
WORLD
WIDE
SINCE
1948



COMPONENTS • RECORDERS
KITS • SPEAKER SYSTEMS • TAPE

- New Lower Prices
- Same Day Reply To Your Inquiry
- Mfrs. Sealed Cartons
- Double Boxed Where Possible
- Fast, Insured Shipments
- Package Deals Save You More
- Franchised Distributors for Over 50 Mfrs.
- Open Monday thru Saturday
- Free Parking at Door
- Phones: N.Y.C. (212) 369-6212
Danbury, Conn. (203) 775-2562

WRITE FOR SPECIALS VISIT
OUR SHOWROOM/WAREHOUSE



CARSTON Studios
R.F.D. #3 — ROUTE 7
BROOKFIELD, CONN. 06804

CIRCLE 12 ON READER-SERVICE CARD

jazz



GARY BURTON: Throb. Gary Burton, vibes; Richard Greene, violin; Jerry Hahn, guitar; Steve Swallow, bass; Bill Goodwin, drums. (Triple Portrait; Throb; Doin' the Pig; six more). Atlantic SD 1531, \$5.98. Tape: M 81531, \$6.95, X 5131, \$5.95.

Gary Burton's first record for Atlantic is a significant turning point in his development as the leader of a group. His last record for Victor (*Country Roads*, RCA Victor LSP 4098) showed his quartet finding the ensemble character and feeling that had been suggested in earlier albums. On this new release, that development has progressed to a distinctive and rewarding fulfillment. The success of this Atlantic disc is not simply in the ultimate coming together of the two new elements in the group—Jerry Hahn's guitar and Bill Goodwin's drums—with the basic elements, Burton's vibes and Steve Swallow's bass. There is an added factor here—the violin of Richard Greene, which is such an invaluable color that I cannot imagine Burton doing without it after hearing these performances.

Greene—whose background includes Bill Monroe's Blue Grass Boys, Jim Kweskin's Jug Band, and a rock group, Sea Train—combines with Swallow's bowed bass to provide an enriching cushion for the soulfully entwined singing of Burton's vibes and Hahn's guitar on *Arise, Her Eyes*. He also contributes an elegantly atmospheric touch to *Turn of the Century* and drives the group through a delightful Swallow piece called *Chickens*. At the same time, the force and value of Hahn's and Swallow's contributions are more evident than ever in this collection—a Hahn piece, *Prime Time*, is a fascinating showcase for Hahn, Swallow, and Greene with Burton adding his bit on electric piano. It is this balancing out of the talent potential of the group, rising above a

primary dependence on Burton, that makes this set so rewarding. However, the album is a onetime shot because Hahn left the group after its performance at Newport this past summer. But now that Burton has come this far, whatever happens next is bound to be provocative. J.S.W.

BENNY GOODMAN: *Collectors' Gems, 1929-1945*. Benny Goodman Orchestra, Charleston Chasers, Ted Lewis' Band, Teddy Wilson Orchestra, New Music of Reginald Forsythe, others. Nostalgia Records CSM 890/891. \$20.00 (two discs, sold only in conjunction with *BG on the Record: A Bio-Discography of Benny Goodman* by D. Russell Connor and Warren W. Hicks, published by Arlington House, 81 Centre Ave., New Rochelle, N. Y. 10801).

In view of the extensive Benny Goodman reissues on LP, it may seem doubtful that there could still be a dozen exciting unreissued performances by his band. Yet this two-disc set, which also features sixteen recordings by studio groups of the early Thirties that included Goodman (only two of them have previously reached LP), adds at least eleven worthy sides to the currently available Goodman orchestra material. (I except one item from the Goodman band's second recording session where it is listed as "Vincent Rose and His Orchestra," apparently included as a curiosity.)

There is a marvelous conjunction of Fred Astaire's voice and feet with the Goodman band and small group, excellent singing by Helen Forrest and Helen Ward, an early sample of Peggy Lee, fresh Eddie Sauter and Fletcher Henderson arrangements. And the early studio recordings offer a long array of groups that include Jack Teagarden, Tommy Dorsey, Adrian Rollini, and Mannie Klein with Benny among such period curiosities as Annette Hanshaw, Lee Morse, and the Yacht Club Boys.

This is something for the Goodman fan who has everything. The only drawback is that the set can be purchased only in conjunction with the book, *BG on the Record*, at a total cost of \$20. On the other hand, it's not such a drawback because any Swing-Era buff

LOW PRICES

Stereo Corporation of America Is One Of the Largest Wholesale Franchised Distributors. All merchandise shipped same day from our warehouse, fully insured in factory sealed cartons. Our one aim is your complete satisfaction, — merchandise-wise, price-wise! From HI-FI components to complete stereo systems, if it's nationally advertised, we have it! Discounts of course! Right now, write now . . . for your special quote. Savings are bigger than ever in honor of our recent expansion.

STEREO CORPORATION OF AMERICA
2122 Utica Ave., Bklyn., N.Y. 11234 (212) 338-8555

CIRCLE 72 ON READER-SERVICE CARD

When Stanton engineers get together, they draw the line.

The frequency response curve of the new Stanton 681 Calibration Standard is virtually a straight line from 10-20,000 Hz.

That's a guarantee.

In addition, channel separation must be 35 dB or greater at 1,000 Hz. Output must be 0.8 mv/cm/sec minimum.

If a 681 doesn't match these specifications when first tested, it's meticulously adjusted until it does.

Each 681 includes hand-entered specifications that verify that your 681 matches the original laboratory standard in every respect.

Nothing less would meet the needs of the professional studio engineers who use Stanton cartridges as their ref-

erence to approve test pressings. They must hear exactly what has been cut into the grooves. No more. No less.

But you don't have to be a professional to hear the difference a Stanton 681 Calibration Standard will make, especially with the "Longhair" brush which provides the clean grooves so essential for clear reproduction. The improvement in performance is immediately audible, even to the unpracticed ear.

The 681 is completely new, from its slim-line configuration to the incredibly low-mass moving system. The 681A with conical stylus is \$55.00, the 681EE with elliptical stylus, \$60.00.

For free literature, write to Stanton Magnetics, Inc., Plainview, L. I., N. Y.

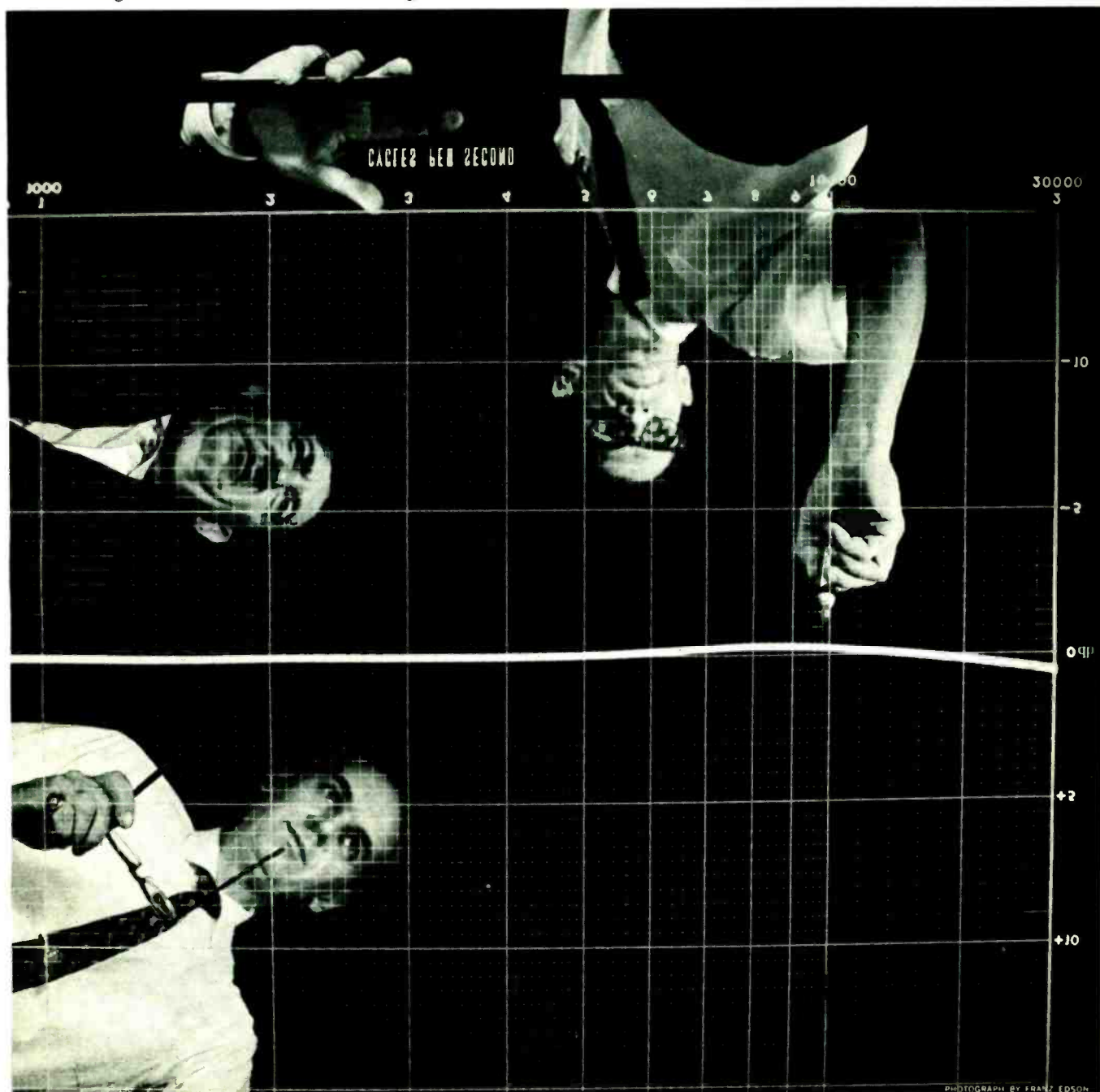

PHOTOGRAPH BY FRANZ EDSON

CIRCLE 71 ON READER-SERVICE CARD

HEAR HERE

FOR THE UTMOST IN

DISCOUNTS

ON NATIONALLY
ADVERTISED

HI-FI STEREO COMPONENTS

WRITE FOR OUR QUOTE

All Merchandise Shipped
Promptly Fully Insured From
Our Warehouse.

DOWNTOWN AUDIO, INC.

17 WARREN ST.
NEW YORK, N.Y. 10007
267-3670-1-2

CIRCLE 20 ON READER-SERVICE CARD

HI-FI COMPONENTS TAPE RECORDERS

TAPES, ACCESSORIES
SLEEP LEARN KITS
MERITAPE

SAVE MONEY

- LOWEST PRICES
- INTEGRITY • SERVICE
- FRANCHISED DISTRIBUTORS

WRITE FOR OUR VERY LOW
PACKAGE QUOTATIONS
Nationally Advertised Brands
Factory Sealed Cartons

Write for **FREE CATALOG**
Visit Our Showrooms

DRESSNER

1523-K JERICHO TPKE.
NEW HYDE PARK, N. Y.
11040

CIRCLE 21 ON READER-SERVICE CARD

ought to have this definitive biographical and discographical story of Benny's career. J.S.W.

VICTORIA SPIVEY: The Victoria Spivey Recorded Legacy of the Blues. (Detroit Moan; Don't Trust Nobody Blues; Telephoning the Blues; eleven more.) Spivey 2001, \$5.00 (Spivey Record Productions, 65 Grand Ave., Brooklyn, N.Y. 11215).

This survey of Victoria Spivey's work between 1927 and 1937 deserves a place beside the great Bessie Smith Columbia sets on any collector's shelf. Miss Spivey did not quite possess the commanding presence that Miss Smith had (even on a record)—although she approaches it on some of these pieces. But she had a very viable quality of her own and her accompaniments are excellent, more consistently interesting than those on the Bessie Smith reissues.

In the late Twenties Miss Spivey was singing the blues in an easy, intimate, warmly involved fashion, highlighted on this disc by *Arkansas Road Blues* and particularly on her magnificent recording of *Organ Grinder Blues*. She was also using a declamatory manner very similar to that of Bessie Smith (as in Bessie's *Backwater Blues*) on *The Alligator Pond Went Dry* and *Murder in the First Degree*. Yet, she also had a pop style which could be brightly effective on a good tune (*Dreaming of You*) or simply emptily glossy (*How Do You Do It That Way* and *Give It to Him*).

But Miss Spivey's singing provides, even at best, only half the interest on this disc. Her accompanists, who are generously featured, both behind her singing and in individual solos, include Lee Collins (in excellent form in 1936); Louis Armstrong; J. C. Higginbotham, emerging from the 1929 Luis Russell band; King Oliver and Eddie Lang (both heard briefly on *Organ Grinder Blues*); Tampa Red and Lonnie Johnson, who has several superb solos and joins Miss Spivey in a vocal duet on *New Black Snake Blues*. The recordings were made for a variety of labels—Vocalion, Okeh, Victor, and Decca. The transfers and sound in general stand up extremely well. J.S.W.

in brief

APPALOOSA: Appaloosa. Columbia CS 9819, \$4.98.

The leader of Appaloosa, nineteen-year-old John Parker Compton, credits Tim Hardin, Donovan, John Hammond, and Bobby Vee as his sources, but to me he sounds like Eric Andersen. The group consists of Compton on guitar with violin, cello, and bass accompaniment. Piano, organ, drums, and horns are added on some cuts. Not bad. J.G.

CUBY & THE BLIZZARDS: Live. Philips PHS 600307, \$4.98.

What can I tell you? This is the first American album by a Dutch (*sic*) blues band. They're no worse than British blues bands. But then, they're not any better, either. J.G.

THE ROCK AND ROLL REVIVAL: The Great Oldies Done (sic) Hear (sic) and Now. Dunhill DS 50059, \$4.98. Tape: Ⓜ A 50059, \$5.98; Ⓜ 823 50059, \$6.98; Ⓜ 523 50059, \$5.98.

This odd record apparently was made to cash in on the Fifties' revival, but it has its moments anyway. The group is better on lighter stuff like the Shirelle's *Dedicated to the One I Love* or Dee Clark's *Raindrops* than on heavies like Buster Brown's *Fannie Mae*. But if you can have the originals, why bother with this? J.G.

BOBBY BRYANT. World Pacific ST 20159, \$4.98.

Trumpet/flugelhorn player Bryant and a sizzling big band take what they call a "Jazz Excursion into *Hair*," with arrangements by Shorty Rogers. But no matter how you cut it, there just isn't enough musicality in the *Hair* music to support such projects. The band's playing is beautiful, but there's nowhere to go with these dumb pseudo-songs. M.A.

ROBERTA FLACK: First Take. Atlantic SD 8230, \$4.98.

Roberta Flack is a mellow jazz-pop vocalist and pianist from the D.C. area who makes her bow here with a well-

We Own The
Sharpest Pencils
In Town!



YOU SAVE MORE
ON HI-FI COMPONENTS
& TAPE RECORDERS

WE INVITE YOUR TEST OF OUR
"WE WILL NOT BE UNDERSOLD POLICY."

- 15-day money-back guarantee.
 - 2-yr. unconditional guarantee parts & labor no charge., at local warranty station or factory.
 - Trade-ins—highest allow. Send your list.
 - Items shipped promptly from our inventory, fully insured.
 - Our specialty—APO & Export.
 - 23rd yr. dependable service—world wide.
- Rated #1 service—satisfaction according to nationwide survey.

Write for Our Price First! You'll Be Glad You did!

HI-FIDELITY

CENTER
"The House of Low Low Prices"

239-H East 149th St., New York, N.Y. 10451

CIRCLE 37 ON READER-SERVICE CARD

ROBERTS beats the high cost of living it up!



...with the
NEW
SOLID STATE
MODEL
771X
only \$329.95

If you thought you could never afford a luxurious solid state stereo tape recorder with big concert-hall sound, 4-speed flexibility, the exclusive ROBERTS Cross Field Head, 40 watts peak power output, and a raft of professional features to make you the envy of every music lover on the block . . . jog (do not walk) to your nearest ROBERTS Dealer for the bargain of a lifetime. We're introducing this new magnificent 771X at an unbelievably low price . . . our own anti-inflationary measure to cool down the high cost of living it up!



The Pro Line

ROBERTS

Div. of Rheem Manufacturing Co.
Los Angeles, California 90016

CIRCLE 60 ON READER-SERVICE CARD

EPI. Tells it like it is.

The Model 100 from EPI,
an omnidirectional bookshelf speaker
with a flat frequency response
from 40-18,000 cps. By flat
we mean flat. This flat.

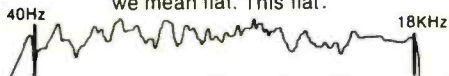

In fact, we pack every EPI speaker with an actual graph of its own individual response curve — so you can literally see what your speaker sounds like. (Which you can do, believe it or not, for under \$120 at a small number of audiosophisticated dealers.)

We think the EPI is the finest, most natural sounding, least fatiguing speaker ever designed, and invite you to compare it with any of the other great names in speakers.



EPICURE PRODUCTS, INC.

185 Somerville Avenue Somerville, Massachusetts 02143 Tel: (617) 666-1454

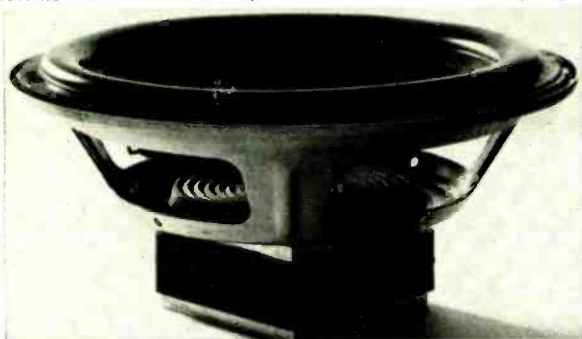

Burhoe designed woofer from standard design.

CIRCLE 31 ON READER-SERVICE CARD

chosen collection of contemporaneity. She gives Ewan MacColl's *The First Time Ever I Saw Your Face* a deserved revival. For lonely winter's eves. J.G.

MAD RIVER: Paradise Bar and Grill. Capitol ST 185, \$4.98. Tape: 8XP 185, \$6.98; 4XP 185, \$5.98.

The first album by Mad River flopped — which has made them extra careful with this one. Included is a poem by Richard Brautigan (read by the author) and a song by former SDS president Carl Oglesby (*Cherokee Girl*). I thought *Revolution in my Pocket* was especially good. J.G.

WAYLON JENNINGS AND THE KIMBERLEYS: Country-Folk. RCA Victor LSP 4180, \$4.98.

MacArthur Park, Cindy Oh Cindy, Games People Play, etc., given smooth country readings by young Waylon and his new friends, the Kimberleys. Very nice. J.G.

EDWIN HAWKINS SINGERS: Let Us Go Into the House of the Lord. Pavilion BPS 1001, \$4.98.

Fans of *Oh Happy Day* (which is the only cut to feature Dorothy Morrison) will be disappointed with the rest of the album. Only *To My Father's House* comes close in intensity and exuberance. J.G.

JIMMY REED: The Very Best of Jimmy Reed. Buddah BDS 4003, \$4.98.

This was a classic r & b album when Vee Jay released it several years ago (VJ 1039 when the title was only *The Best of Jimmy Reed*: the hype marches on), and it seems even better now. *Big Boss Man, Baby What You Want Me to Do*, and on and on like that. J.G.

THE WILD BUNCH. Film soundtrack composed by Jerry Fielding. Warner Bros./7 Arts WS 1814, \$4.98.

Composer Fielding has written a pleasant, tuneful score for what is reported to be the bloodiest film in years. The irony reminds one of *More*—the hit love theme from another grisly movie, *Mondo Cane*. M.A.

MUDDY WATERS: After the Rain. Cadet Concept LPS 320, \$4.98. Tape: 37-320, 3¾ ips, \$5.95; 837-8320, \$6.98; 537-320, \$5.98.

Although this Chess product may win the Gross Album Cover award, the record itself is considerably kinder to Waters than has been the case lately. And the producers have also found a talented new guitarist in Phil Upchurch. Waters is really in the groove on standards like *I Am the Blues, Rambling Mind*, and *Honey Bee*. This is the best Muddy Waters album in a long, long time. J.G.

OLIVER. Crewe CR 1333, \$4.98.

Oliver is William Oliver Swofford, who had a recent single hit with *Good Morning Starshine*, a song from *Hair*. Hate the single, love the album. Oliver is a solid singer with an outlook both young and tasteful. He writes interesting songs too. Fine debut. M.A.

Olson
ELECTRONICS

FREE

Catalog

Fill in coupon for a FREE One Year Subscription to OLSON ELECTRONICS Fantastic Value Packed Catalog — Unheard of LOW, LOW PRICES on Brand Name Speakers, Changers, Tubes, Tools, Stereo Amps, Tuners, CB, Hi-Fi's, and thousands of other Electronic Values. Credit plan available.

NAME _____

ADDRESS _____

CITY _____ STATE _____

GIVE ZIP CODE _____

If you have a friend interested in electronics send his name and address for a FREE subscription also.

OLSON ELECTRONICS
524 S. Forge Street, Akron, Ohio 44308

CIRCLE 50 ON READER-SERVICE CARD

WANT TO REALLY

SAVE?

NEWEST MODELS • LEADING BRANDS!

- hi-fi components
- changers
- tape recorders
- stereo tapes
- c.b. & p.a. equipment
- radio & tv sets

FACTORY-SEALED COMPONENTS
SHIPPED IMMEDIATELY

SAVINGS YOU SEE!

Write for Our Current Discount Price List, or Ask Al Kelly for Quotes on Special Items!

DIXIE HI FIDELITY
WHOLESALE

Our New Warehouse
10530 DETRICK AVENUE
Kensington, Maryland 20795
Phone: 301-933-7600

CIRCLE 19 ON READER-SERVICE CARD

This Christmas Shopping Guide is designed to make your Holiday gift buying easy . . . use it to make your gift selections. You will find something for each and every music listener on your Christmas list. Your favorite high fidelity or record shop is the best place for filling every Christmas stocking.



HIGH FIDELITY

CHRISTMAS SHOPPING GUIDE



Fisher 250-TX 120-Watt AM-FM Stereo Receiver with Tune-O-Matic® Push-Button Memory Tuning. Pre-set 5 FM stations. Flywheel tuning, Stereo Beacon auto switching, d'Arsonval meter. Full tape/phono facilities. \$329.95. Walnut cabinet, 60-UW, \$19.95. Fisher Radio, 11-35 45 Rd., L.I.C., N.Y. 11101



Fisher 125 Home Music Center. High-power AM/FM Stereo Receiver-Phono System has convenience, flexibility of component systems. 2 XP-55B Speakers for quality sound. Walnut finish. \$329.95. 120 FM Stereo/Phono Music Center, less AM, \$299.95. Fisher Radio, 11-35 45 Rd., L.I.C., N.Y. 11101



Fisher XP-66B 3-way bookshelf speaker system. 12" woofer with butyl impregnated surround. 5" midrange covers 500-1000 Hz. 3" widerange dispersion tweeter for 1-20 kHz without coloration or distortion. \$99.95. Fisher Radio, 11-35 45 Rd., L.I.C., N.Y. 11101



New Fisher XP-9C 4-way bookshelf speaker system with 15" free-piston woofer with 12 lb. magnet structure, 10 Hz free air resonance. 2 matched 5" midrange drivers cover 500-1,200 Hz. Dome tweeter for 1,200-5,000 Hz. Dome super-tweeter for 5,000-22,000 Hz. \$199.95. Fisher Radio, 11-35 45 Rd., L.I.C., N.Y. 11101



Fisher 450-T 180-Watt AM/FM Stereo Receiver with AutoScan® Electronic Tuning and RK-40 Remote Control. Includes Stereo Beacon, d'Arsonval meter, full tape/phono facilities. Main and remote speaker switches. \$399.95. Walnut cabinet, 80-UW, \$22.95. Fisher Radio, 11-35 45 Rd., L.I.C., N.Y. 11101



Fisher 500-TX 200-watt AM/FM Stereo Receiver with AutoScan® Electronic and Tune-O-Matic® Pushbutton Memory Tuning. FM section features crystal filter, dual-gate MOSFETs. AM: 4-resonator ceramic ladder filter. \$449.95. Walnut cabinet, 90-UW, \$22.95. Fisher Radio, 11-35 45 Rd., L.I.C., N.Y. 11101



Capitol's "VARSITY" portable cassette player/AM radio. Mono and stereo cassettes. Unparalleled sound from player and radio. Durable, high-impact cabinet of two-tone textured beige and gray. \$29.95. KPR-151. Capitol Records Distributing Corp., Hollywood & Vine, Hollywood, Calif. 90028.



The "FRESHMAN" portable cassette recorder/player. Sturdy polystyrene cabinet of blue and gray. Records mono, plays mono and stereo cassettes. Microphone included. \$29.95. KR-155. Capitol Records Distributing Corp., Hollywood & Vine, Hollywood, Calif. 90028.



The "COLLEGIATE" portable cassette player/AM-FM radio. Really makes it with groovy styling, slide rule radio tuning dial, one-knob function control . . . and great sounds! Mono and stereo cassettes. \$44.95. KPR-153. Capitol Records Distributing Corp., Hollywood & Vine, Hollywood, Calif. 90028.



The "EDITOR". A portable cassette recorder/player, this handsome and rugged professional quality unit comes complete with sensitive bullet microphone, stand and earphone. Records mono, plays mono and stereo cassettes. \$49.95. KR-156. Capitol Records Distributing Corp., Hollywood, Ca. 90028.

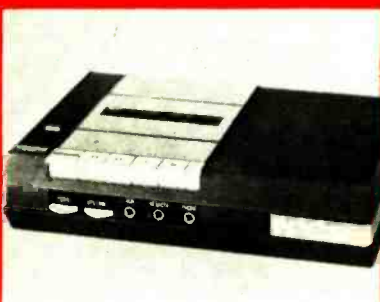

The "Diplomat." A portable cassette recorder/player records mono, plays mono and stereo cassettes. Features a supersensitive built-in microphone, keyboard controls, automatic recording level control. \$69.96. KR-158. Capitol Records Distributing Corp., Hollywood & Vine, Hollywood, Calif., 90028.



The "Regent." Portable cassette player/AM/Stereo FM radio matches beauty with fine fidelity. Detachable speaker affords superb stereo for radio and your favorite cassettes. Built-in A.C. adapter or battery powered. \$109.95. KFM-11. Capitol Records Dist. Corp., Hollywood & Vine, Hollywood, Ca. 90028.



Cassette album prevents accidental hub rotation; holds cassettes securely; protects from dust and damage. All compartments numbered; positive alignment when closed. Red, black or blue scuff-resistant leatherette. \$4.50. Luxury Albums, 80 Fifth Avenue, New York, N.Y. 10011



Transcriptor hydraulic reference turntable; speed stability controlled by viscous fluid flow. Machined perspex top, anti feedback legs, ultra low mass fluid arm, sweep arm record and stylus brush, scale accurate to 1/20 gram. \$303. all. Transcriptors, USA. 32-46 69 St., Woodside, N.Y. 11377



New 7" version of professional light-weight aluminum tape reel angled to fit home recorders. May be loaded up to 3600 ft.; convenient 3-point pick up; fits all makes and models. Only \$3.50 postpaid. Gold or aluminum color. Meister Co., PO Box 633, Downey, California 90241



Sony PS-1800 Playback System. Unique servo-control turntable with a professional-type tone arm on a handsome, oil finished base. Protective dust cover. Flawless tracking, distortion-free reproduction, fool proof automatic shut-off system. \$199.50. Sony Corp. of America, 47-47 Van Dam St., L.I.C., N.Y. 11101.

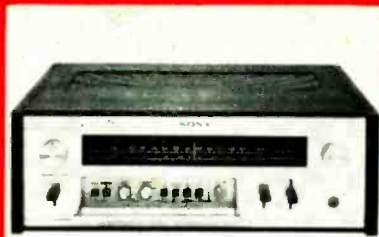

Sony STR 6060 Receiver. Superb performer on FM Stereo, FM and AM broadcasts, records and tapes. Power (110 watts, IHF into 8 ohms both channels) to drive any speaker system. Reproduces entire audio range without a trace of distortion. \$399.50. Sony Corp. of America, 47-47 Van Dam St., L.I.C., N.Y. 11101



Sony STR 6040—The finest FM Stereo/FM-AM Receiver available under \$200. Power to drive even relatively inefficient, bookshelf speaker systems. Excellent sensitivity, stereo separation, capture ratio and noise suppression characteristics. \$199.50. Sony Corp. of America, 47-47 Van Dam St., L.I.C., N.Y. 11101



Garrard SL95B Automatic Transcription Turntable with new Synchro-Lab™ Motor for constant turntable speed; gyroscopically gimballed needle pivots; calibrated stylus force gauge; low mass tonearm; anti-skating control; viscous damped single control cueing; \$129.50. Garrard, Westbury, N.Y. 11590



Garrard SL72B Automatic Turntable with Synchro-Lab™ Motor for constant turntable speed; low mass aluminum tonearm; damped set-down in auto or manual play; anti-skating control; positive 2-point record support; viscous damped single control cueing. \$89.50 Garrard, Westbury, N.Y. 11590



Garrard Module X-10 complete record playing source. Flipover diamond stylus matched to ultra-low mass tubular tonearm. Single lever control cueing/pausing. Plays 7", 10", 12" records at 33 1/3, 45 or 78 rpm. Stereo ceramic cartridge, base and dust cover complete \$52.50. Garrard, Westbury, N.Y. 11590

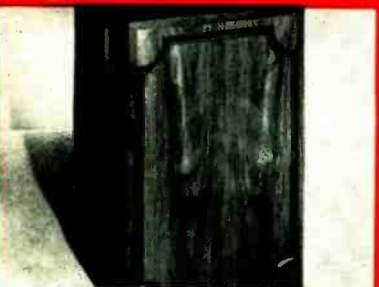

Wharfedale W80 Variflex® Speaker System employs a variable device to bend sound waves in a definite and controllable manner to form the particular sound distribution pattern required by room conditions. Modest in size (only 17" x 17 1/4" x 29"). \$289.95. Wharfedale, Westbury, N.Y. 11590



Wharfedale W20D 2-way Minorette Speaker System. High compliance 8" woofer and advance-design 3" mylar-domed pressure tweeter. LCR 2-section crossover network. Bookshelf dimensions: 9 3/4" x 14" x 8 1/2" deep. \$52.95. Wharfedale, Westbury, N.Y. 11590



Wharfedale W60D Bookshelf and Floor-Standing 3-Speaker System in exclusive sand-filled enclosure. 12 1/2" heavy duty woofer; 5" mid-range speaker; 3" mylar-domed tweeter. Dimensions: 14 1/4" x 24" x 13" deep. Oiled Walnut, \$147. Wharfedale, Westbury, N.Y. 11590



Scott 2550 Compact Casseiver system. AM/FM stereo/Cassette recorder with two matched air-suspension speakers. FET front end/tone control. Integr. Circuit IF/preamp. Full Complementary Output stages. \$299.95. H.H. Scott, Inc., 111 Powdermill Road, Maynard, Mass. 01754



Scott 2506 AM/FM Stereo/Phono compact. Perfectune computer activated tuning signal. Integr. Circuit IF/pre-amp. FET front end/tone control. Plug-in circuit modules. Wire-wrap connections. Choice of speakers. From \$449.95. H.H. Scott, Inc., 111 Powdermill Rd., Maynard, Mass. 01754



Scott Decorator Stereo AM/FM Stereo/Phono system. FET front end/tone control. Integr. Circuit IF/preamp. S-20 2-way air-susp. spkrs. Jacks: mike, guitar, extra speakers, headphones, tape or cartridge. From \$479.95. H.H. Scott, Inc., 111 Powdermill Road, Maynard, Mass. 01754



The Martin Sound Tower is totally hand crafted and designed for outstanding performance. 52" high x 16 1/4" wide x 7 3/4" deep. Uses 8 drivers: 2 2" flare dome tweeters, 2 4" direct radiating midrange, and 4 8" pneumatic load woofers. \$350. Eastman Sound Mfg. Co., 126 Gill Ave., Paulsboro, N.J.



The Prismatic Reflector delivers smooth and effortless reproduction of the entire audible sound spectrum. 25" x 16 1/4" x 16 1/4". Response: below 28HZ to above 18 KHZ. Totally fiberglass damped, hermetically sealed, infinite baffle. \$300. Eastman Sound Mfg. Co., 126 Gill Ave., Paulsboro, N.J.



The Martin Super Spectrum Speaker permits you to change crossover point at will. Bring out highs in a dead room, or eliminate boominess in a live room. Create your own perfect acoustic area. 22" x 12 1/2" x 9 3/4". Handles 5 to 75 watts. \$199. Eastman Sound Mfg. Co., 126 Gill Ave., Paulsboro, N.J. 08066



Elektra Amplidyne Research Inc. SE-III loudspeaker equalizer flattens and extends frequency response of any speaker system. Features 35 equalization curves, no insertion loss and is easily installed. \$129.95 including oiled walnut cabinet. Write Box 698, Levittown, Pa. 19058



BSR McDonald has the Total Turntable to take confusion out of shopping. Factory engineered, pre-assembled, tested. With Shure M-44E cartridge, Decor-matic base with power switch, and dust cover in one carton—ready to plug into your equipment and play. BSR (USA) Ltd., Blauvelt, N.Y. 10913



BSR McDonald 400 proves that a fine auto turntable need not be costly. Counter-balanced tone arm; cuing lever; auto tone arm lock; clip-in cartridge holder; anti-skate control and other features. Suggested retail price \$49.50 less base, cartridge. BRS (USA) Ltd., Blauvelt, N.Y. 10913



Sony HP-155. Compact solid state stereo system. All-silicon transistorized amp for wide freq. range, minimum distortion. Matched speakers. BSR auto turntable. Bass, treble controls, speaker selector, loudness switch, high filter switch. Oiled walnut cases. Jacks for FM/AM tuner. Sony, 47-47 Van Dam St., L.I.C., N.Y. 11101 \$179.95.



Sony HP-188. Handsome All-purpose Compact Stereo Music System. FM Stereo/FM-AM Tuner. All-silicon transistors. FET circuitry in FM tuner, solid state IF filters in FM and AM. BSR auto turntable. Acoustically balanced. Speakers. Oiled walnut, dust cover. Sony, 47-47 Van Dam St., L.I.C., N.Y. 11101. \$239.95.



Sony HP-465. All-silicon Completely Solid State Stereo Music System. Amplifier contains OTL circuitry. Balanced cartridge, amplifier, preamp, and matched speakers complement the system. Full range of inputs/auxiliary outputs. Walnut-finished cabinetry. Sony, 47-47 Van Dam St., L.I.C., N.Y. 11101 \$249.95.



Whisper Fan adds years to life of hifi, tv, other electronic systems. Costs less than average service call. Delivers cool 60 cu ft. of air per minute. Fits easily into popular systems—so quiet you don't know it's running. Delwyn, Rt. 28, RD #2, Box 195B, Kingston, N.Y. 12401



Sherwood SEL 200 Deluxe FM Receiver. Exclusive 9-pole "Legendre" Toroid IF filter for improved selectivity, low distortion. 275 W. \pm 1 dB music power (4 ohms) or 60+60 W. rms (8 ohms). 1.5 μ V sensitivity; FET RF, muting; microcircuits: speaker switching; walnut case. \$599. Sherwood, Chicago, Ill. 60618



Sherwood's new SEL 100 Professional Automatic Belt-drive turntable. Two synchronous motors, 12-inch turntable and arm, Beam-of-light arm trip. Escalator lowering action onto motionless table handles intermixed sizes. Floating arm/turntable suspension. \$149.50. Sherwood, Chicago, Ill. 60618.



Kenwood KS-505 Stereo Compact System wins your heart with its fine sound and good looks. Combines the Dual 1212 with Kenwood's 60-watt FM/AM Stereo Receiver and its own compatible speakers in oiled walnut cabinets. \$330 complete. Kenwood, 15711 S. Broadway, Gardena, Calif. 90247



Kenwood TK-140, 200-Watt FM/AM Stereo Receiver. Four IC FM IF stages; 3 FET 4-gang tuning condenser front-end IHF-rates sensitivity of 1.7 μ V; signal-to-noise better than 65 dB. Inputs for turntable, tape recorder and auxiliary. \$349.95 includes cabinet. Kenwood, 15711 S. Broadway, Gardena, Calif. 90247



Kenwood KA-6000 Stereo Amplifier and KT-7000 Stereo Tuner make beautiful music together. KA-6000 boasts wide power bandwidth with very low IM distortion. KT-700 gives superior sensitivity and spurious response ration. \$249.95 each, including cabinets. Kenwood, 15711 S. Broadway, Gardena, Calif. 90247



Harman-Kardon CAD4 Stereo Tape Cassette Deck. Complete record/playback, pushbutton controls. Pause, Forward, Reverse, Stop/Eject. VU meters, auto shutoff, electronic speed control for minimum wow/flutter. \$159.50. Harman-Kardon, Inc., 55 Ames Court, Plainview, N.Y. 11803

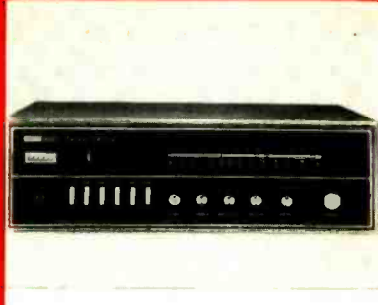

Harman-Kardon Nocturne Three Thirty AM/FM Stereo 90 Watt Solid State Receiver. D'Arsonval tuning meter, defeatable contour for low volume listening. Illuminated call outs indicate operating function. \$199.95. Walnut cabinet, CW30A, \$21.25. Harman-Kardon, Inc., Plainview, N.Y. 11803



Harman-Kardon Nocturne Eight-Twenty 140 Watt FM Stereo Solid State Receiver. Ultra wideband sound, D'Arsonval meter, integrated circuits and crystal filter for unprecedented tuning/reception. \$299.95. Walnut cabinet, CW 80, \$25.50. Harman-Kardon, Inc., 55 Ames Court, Plainview, N.Y. 11803



Harman-Kardon SC1825 FM Stereo Compact Music System with HK25 Omnidirectional Speakers. Plays mono and stereo records, receives mono and stereo FM. Speakers spread sound 360°. \$299.50. Dust cover optional. Harman-Kardon, Inc., 55 Ames Court, Plainview, N.Y. 11803



Harman-Kardon SC2350 AM/FM Stereo Compact Music System with HK50 Omnidirectional Speakers. Component quality sound. Most sophisticated stereo tuner in any compact plus 4 speed Garrard changer. \$399.50. Dust cover optional. Harman-Kardon, Inc., 55 Ames Court, Plainview, N.Y. 11803



Harman-Kardon SC2525B FM Stereo Compact Music System with Tape Cassette Recorder and HK25 Omnidirectional Speakers. Featuring 4 speed Garrard changer, FM stereo radio and cassette recorder. \$469.50. Dust cover optional. Harman-Kardon, Inc., 55 Ames Court, Plainview, N.Y. 11803



PUT A LITTLE LOVE IN YOUR HEART Jackie De Shannon's love filled album features her million selling single (she's one of the few pop female singers to accomplish this feat) plus 10 other great cuts. This is the album to give to someone you love. Imperial LP-12442. Suggested retail price \$4.98.

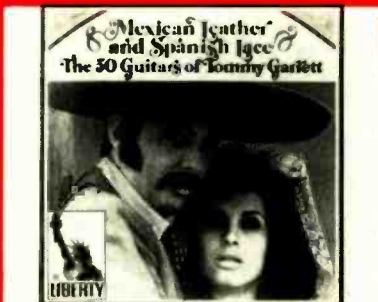

The 50 Guitars of Tommy Garrett pour forth perfectly lush and exotic arrangements on this great album of Latin standards. The beautiful easy listening sounds are certain to please everyone. A stunning LP. Liberty LSS-14046. Suggested retail price \$5.98



BLUE NOTE'S THREE DECADES OF JAZZ Blue Note Records, the world's outstanding jazz label, celebrates 30 years of the greatest in jazz with three 2-record deluxe sets (two records for the price of one). Truly a collector's item. BLUE NOTE BST-89902/89903 & 89904. Suggested retail price \$4.98.



Sony HP-480A. Solid State Stereo Music System/FM Stereo/FM-AM Tuner. Walnut compact cabinet. All-silicon solid state amplifier, OTL circuitry. Twin Field Effect Transistors in tuner. Matched extended response speakers. Dual auto turntable, Pickering cartridge. Sony, 47-47 Van Dam St., L.I.C., N.Y. \$319.95.



Sony HP-580. Stereo music center of component quality. All silicon transistor circuitry. FM Stereo/FM-AM tuner uses FET's and solid state IF filters. Matched high-compliance 3-way speakers. Dual prof. turntable, Pickering cartridge. Oiled walnut cabinet. Sony, 47-47 Van Dam St., L.I.C., N.Y. \$419.95.



Hi-Fi Starter Kit. Contains everything to do a professional job with your new tape recorder. Four 7" reels of BASF tape-assorted lengths; professional-type reel; hobby box with splicer, tape, leaders, etc. recording manual & literature. See your BASF Dealer. BASF Systems Inc., Crosby Drive, Bedford, Ma. 01730



Seven Steps To Better Listening. This record and your own ears are all you need to get the most from your system. Simple instructions show how to balance channels, speaker phasing, etc. Only \$5 postpaid. CBS Laboratories, 227 High Ridge Road, Stamford, Conn. 06905

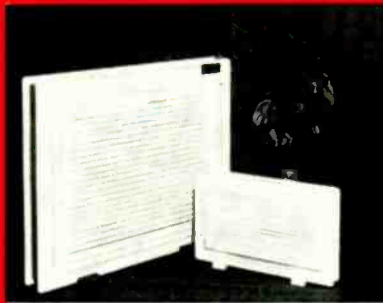

Magitran's Super-thin all-weather Poly-sonic "Anywhere" Hi-Fi bi-directional speaker system. Mount, hang or stand them indoors or out. Ivory white or walnut with trim and stand. E21 20 watts \$19.95. E51 5 watts \$14.95. Magitran, 311 E. Park Street, Dept. 1X, Moonachie, N.J. 07074.



Magitran's Poly-planar super-thin quick mount speaker/grille fits where no others can. Custom flush or surface mount in walls, doors, ceilings, indoors or out. G201P 20 watts 1 1/16" thin \$15.95. G51P 5 watts 7/8" thin \$10.50. Magitran, 311 E. Park Street, Dept. 2X, Moonachie, N.J. 07074.



Artistry CLOSE-UP! Three specially priced double-record stereo sets showcase the exceptional art of four of world music's most celebrated stars. Impeccably performed and recorded. SBB-3749, 3750, 3751. Angel (also available on Reel, 8-track and Cassette tape).



Unique base for Dual 1219 turntable features flip-open panel for storing spindles, extra cartridges. Oiled walnut. WB-19X, \$29.95. Dust cover has lift-up front for access to controls without removing cover. 1/8" smoke-tinted plexiglass. DC-9X, \$24.95. United Audio, 120 So. Columbus Ave., Mt. Vernon, N.Y.



Mikado Stereo 2470 Receiver. 80 Watts Music Power—21 Watts per channel RMS output at 80 ohms. Total harmonic distortion 0.5% at all rated outputs, 20 to 20,000 Hz. FM sensitivity 2.0 μ V for 30 dB S/N. Oiled walnut cabinet. Mikado Electronics Corp., 1072 Bryant St., San Francisco, Calif. 94103.



Irish Tape offers premium quality at popular prices. Color coded leader and trailer plus automatic reversing strip included at no extra cost. Irish makes a complete line of reel-to-reel, cassette, lubricated and video tapes. Irish Recording Tape, 458 Broadway, New York, New York 10013



The performance which affirms the alluring Metropolitan Opera duo to be opera history's definitive characterization of Gounod's ill-fated lovers. A proud gift idea—complete on three stereo discs. Nibretto. SCL-3734. Angel (also available on Reel tape).



HERB ALPERT & THE TIJUANA BRASS—“The Brass Are Coming”. Give and get the latest selections from the best selling “sound” group of all time! A & M Records, SP4228, 1416 N. LaBrea, Hollywood, Calif. 90028.



New Eico “Sound n’ Color” Audio-Color Organs. The new dimension to music pleasure. All Electronic Solid-State. Transform sound into moving synchronized color images. Connects to speaker leads. Available in 3 and 4-color frequency models, various sizes. From \$29.95 kit, \$49.95 wired. EICO, Brooklyn, N.Y.



Introducing Eico Sound/Lite Translators. Creates audio-stimulated light displays. Actuates Display Units, Strobe Lites, Xmas Tree, patio lite, etc. Model 3465 3-Channel Translator \$49.95 kit; \$69.95 wired. Model 3460 Single Channel \$24.95 kit; \$39.95 wired. EICO, 283 Malta St., Brooklyn, N.Y. 11207.



New Eico Solid State Strobe Lites. Hi-intensity bursts of light from Xenon tube flash in cadence to audio beat. Lighting effects for combos, discotheques, etc. Model 3475 Sound Actuated Strobe \$39.95 kit; \$59.95 wired. Model 3470 Adjustable Strobe \$24.95 kit; \$39.95 wired. EICO, 283 Malta St., Brooklyn, N.Y. 11207.



Eico “Cortina” Silicon Solid State 190-Watt Stereo Amplifier for audio perfectionists. Less than 0.1% harmonic distortion, IM distortion less than 0.6%. Controls/inputs for every music source. Eico “Cortina” 3150—\$149.50 kit, \$225.00 wired including cabinet. EICO, 283 Malta St., Brooklyn, N.Y.



Eico “Cortina” Solid State 70-Watt AM/FM Stereo Receiver Kit. Acclaimed by experts and consumers as the most stereo value for your money. Combines engineering excellence with 100% capability and striking esthetics. “Cortina” 3770 easy-to-build kit \$189.95. Wired \$ 279.95. EICO, 283 Malta St., Brooklyn, N.Y.



“The Eico Cortina Series are low-cost audio components that look and sound like high cost components,”—Popular Science Magazine. “Cortina” 3070 90-Watt All Silicon Solid State Stereo Amplifier and “Cortina” 3200 Solid-State FM Stereo Tuner Each \$99.95 kit, \$139.95 wired w/cabinet. EICO, 283 Malta St., Brooklyn, N.Y.



The Infinity 2000 is a new concept 3-way shelf system including dual radiating electrostatic tweeters, high flux density plasticized midrange, 12 inch transmission line bass system. 25" x 15" x 12" deep. \$269, lacquered walnut. Infinity Systems, Inc., 20940 Knapp St., Chatsworth, Ca., 91311.

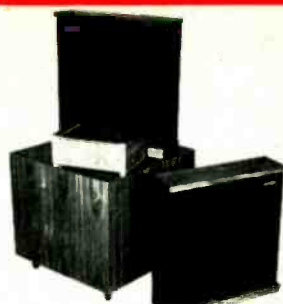

Servo-Statik II system includes two screens with plasticized cone midrange speakers, electrostatic tweeters. Feedback bass system including 110 w RMS Stereo-amplifier electronic crossover (100 Hz). Walnut or Brazilian rosewood \$1195 complete. Infinity Systems, Inc., 20940 Knapp St., Chatsworth, Ca.



Servo-Statik I system includes electrostatic screens radiating from 100 Hz-32 kHz; a feedback bass from 10-100 Hz 18" woofer, 110 w RMS Servo-amplifier-3 way electronic crossover; Walnut or Brazilian rosewood. \$1795 complete. Infinity Systems, Inc., 20940 Knapp St., Chatsworth, Ca. 91311.



Qualiton SLPX 11312. "A sheerly beautiful tenor voice"—Conrad L. Osborne—High Fidelity Magazine. This record and other famous operatic recordings, also music of Bartok, Kodaly, Liszt available from: Qualiton Records, Ltd., 39-38 58th Street, Woodside, N. Y. 11377. Ask for our free catalogue.



Video Tape Recorders. Built for G.E. by Sony. Compatible with all Sony 1/2" VTR's. For home movies, training, ETV, etc. Easy to operate. Brand new, fully guaranteed. Regularly \$795. Now \$397.50. 1/2 hour video tape, \$14.97. 1 hour, \$29.97. GBC Closed Circuit TV Corp., 74 5th Ave., N.Y.C., N. Y. 10011.

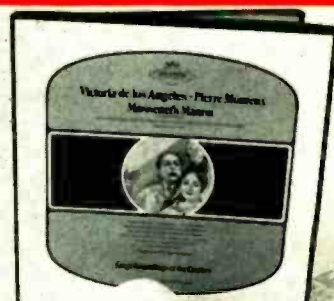

De los Angeles' historic and critically acclaimed performance, newly remastered and issued on Seraphim Great Recording of the Century. "The best 'Manon' yet recorded" Irving Kolodin. The Complete 4 disc recording with libretto. A winning value. Seraphim ID-6057.



JVC Model 5001 AM/FM Stereo Receiver delivers total dynamic power of 60W (30W/30W) IHF Standard. IM Distortion at Rated Power less than 1%. FM Sensitivity 1.8 μ V (IHF Standard); 4 IF Stages. SEA supertone control, exclusive feature. JVC America, Inc., 50-35 56th Road, Maspeth, New York 11378.



JVC 4-speed automatic record changer model 5201 utilizes a quiet 4-pole outer rotor induction motor, combined with die cast 11" p'atter for unwavering speeds, better mechanical balance. Channel separation: better than 28 dB at 1 KHz. JVC America, Inc., 50-35 56th Road, Maspeth, N.Y. 11378.



JVC Model 5003 AM/FM Stereo Receiver includes SEA supertone control preferred by serious stereo fans. Total dynamic power: 140 watts, IHF. Power bandwidth: exceptional range from 7 to 30,000 Hz. All switches and controls arranged for easy access. JVC America, Inc., 50-35 56th Road, Maspeth, N.Y.

General Index, 1969

Articles Listed by Author

- Alberts, Ian. Has Success Spoiled FM? Nov., p. 61.
Angus, Robert and Norman Eisenberg. Are Cassettes Here to Stay? July, p. 46.
Angus, Robert. Hi-Fi in the Sky? Feb., p. 62.
Angus, Robert. The Latest in Stereo Cartridges. Feb., p. 54.
Angus, Robert. The Scrutable Orient. Oct., p. 63.
- Blickstein, Edward. Vladimir de Pachmann—More Than a Clown. July, p. 59.
Boulez, Pierre. Berlioz and the Realm of the Imaginary. Mar., p. 42.
Bowers, Faubion and Diana Cavallo. The Scriabin-Koussevitzky *Scandale*. June, p. 54.
Brown, Royal S. Shostakovich's Symphonies. Apr., p. 43.
Brummell, O.B. Drunkenness, Incest, Murder, and Rape—Fa-la-la La. May, p. 48.
- Cavallo, Diana and Faubion Bowers. The Scriabin-Koussevitzky *Scandale*. June, p. 54.
Coleman, Emily. Eugene Ormandy of the Philadelphia Orchestra. Jan., p. 52.
Culshaw, John. Where Do We Go From Hear? Nov., p. 56.
- Dachs, David. And Then I (Wish I) Wrote. June, p. 34.
Davis, Colin. The Trojans. Mar., p. 61.
- Ehle, Robert. A Plain and Easy Guide to Practical Electronic Music. Aug., p. 50.
Eisenberg, Norman and Robert Angus. Are Cassettes Here to Stay? July, p. 46.
Eisenberg, Norman. Speakers—Fact and Fiction. June, p. 45.
- Fleischmann, Ernest. Who Runs Our Orchestras? Jan., p. 58.
Foster, Edward J. How We Judge FM Tuners. Nov., p. 64.
- Gelatt, Roland.—Music Makers
New Horizons for Maestro Kubelik. Jan., p. 14;
"But Julius, I've Always Sung This Way." Feb., p. 24;
Berlioz Projects to Celebrate a Centenary. Mar., p. 22.
Goldsmith, Harris. Sibelius' Seven Symphonies. May, p. 56.
Gravereaux, Daniel. How We Judge Stereo Cartridges. Feb., p. 48.
Gravereaux, Daniel. How We Test Turntables, Arms, and Changers. Apr., p. 39.
- Haber, Leo. The Perils of Record Collecting. Feb., p. 58.
Hamilton, David. How to Catalogue Your Records. Sept., p. 56.
- Jacobson, Bernard. Berlioz on Records—An Appraisal. Mar., p. 56.
Jacobson, Bernard. The "In" Composers. July, p. 54.
- Lang, Paul Henry. A Critic Answers His Critics. Nov., p. 22.
Lees, Gene.—The Lees Side
Records That Escaped the Trash Bin, Part II. Jan., p. 110; John Hartford, Poet. Feb., p. 124; Frank Sinatra: Confessions and Contradictions. Mar., p. 120; Cycles. Apr., p. 100; Creed Taylor: Music-Business Maverick. May, p. 116; The Underrated Sinatra. June, p. 109; *Hair* in Europe. July, p. 108; Antidise-establishmentarianism. Aug., p. 102; Woody 'n' Me. Sept., p. 118; The Life and Times of Blind Orange Adams. Oct., p. 126; New York City—R.I.P. Nov., p. 136; You're Going to Hear From Her. Dec., p. 132.
- Long, Robert. Are Your Components Compatible? May, p. 44.
Long, Robert. New Products for the New Decade. Oct., p. 54.
Long, Robert. Ping-Ping-Pong-Pong. Sept., p. 62.
Long, Robert. Turntables: Renaissance of the Manual? Apr., p. 34.
Long, Robert. What's New in Stereo Kits? Dec., p. 73.
- Marcus, Leonard. The Best Records of the Year. Dec., p. 67.
McClure, John. The Classical Bag. Aug., p. 58.
McIntyre, Edward F. The Magic Machine. Aug., p. 44.
McIntyre, Edward F. Use Your Room to Enhance Your Stereo. Sept., p. 50.
McMullen, Roy. Berlioz—Sur—Seine. Mar., p. 47.
Movshon, George. The Parallel Careers of Georg Solti. Oct., p. 66.
Movshon, George. Records to Test Your Woofer's "Crunchability." June, p. 28.
- Nilsson, Birgit. My Gypsy Record Collection. July, p. 22.
- Osborne, Conrad L. The Opera Reviewer Strikes Back. Apr., p. 20.
- Price, Leontyne. My Favorite Records. May, p. 28.
- Rorem, Ned. Julius Katchen (1926—1969). Sept., p. 61.
- Shaw, Arnold. Rocks in Their Heads. Apr., p. 48.
Spann, Neil. Fifteen Years of the IHF. Mar., p. 67.
Starker, Janos. Recorded Portraits of the Artist. Nov., p. 32.
- Wilson, John S. Dick Hyman and the Studio Men. May, p. 50.
- Zakariasen, William. Born Losers. Aug., p. 24.
Zide, Larry. Professional Hints for Amateur Tape Recordists. Dec., p. 78.

Articles Listed by Title

- And Then I (Wish I) Wrote. June, p. 34.
Antidise-establishmentarianism. Aug., p. 102.
Are Cassettes Here to Stay? July, p. 46.
Are Your Components Compatible? May, p. 44.
- Berlioz and the Realm of the Imaginary. Mar., p. 42.
Berlioz on Records—An Appraisal. Mar., p. 56.
Berlioz Projects to Celebrate a Centenary. Mar., p. 22.
Berlioz—Sur—Seine. Mar., p. 47.
The Best Records of the Year. Dec., p. 67.
Born Losers. Aug., p. 24.
"But Julius, I've Always Sung This Way." (Beverly Sills) Feb., p. 24.
- The Classical Bag. Aug., p. 58.
The Coming Revolution in Home Recordings (Where Do We Go From Hear?). Nov., p. 56.
Creed Taylor: Music-Business Maverick. May, p. 116.
A Critic Answers His Critics. Nov., p. 22.
Cycles. Apr., p. 100.
- Dick Hyman and the Studio Men. May, p. 50.
Drunkenness, Incest, Murder, and Rape—Fa-la-la La. May, p. 48.
- Eugene Ormandy of the Philadelphia Orchestra. Jan., p. 52.

Continued on page 158

Sounds even better than it looks!



NEW LRK-1600 100 Watt Solid State
AM-FM Stereo Cassette Receiver

4



4-IC's, 4-FET's, 24-Transistors, 25-Diodes
Expertly Crafted For Years Of
Concert Quality Performance

New beauty. Latest solid-state circuitry. Versatility, convenience, and performance add up to a stereo hi-fi component a cut above the ordinary!

Lafayette's new LRK-1600 is a powerful 100-watt AM/FM stereo receiver, plus a professional cassette recorder . . . completely built into one beautiful low profile enclosure.

At the flip of a switch you can listen to AM, FM or FM stereo. You can listen to pre-recorded cassette tapes, or, record onto cassettes, either from voice or instruments (there are two microphone jacks on the front panel), or from records (just connect a turntable or record changer thru the magnetic or ceramic phone inputs), or directly from the stereo receiver. Most important, you can make sound-with-sound recordings . . . superimpose your voice or a musical instrument using mikes while simultaneously recording an external program source such as records or AM/FM broadcast.

You can do a lot more too such as adding extra speakers or a pair of headphones. But, just reading about the LRK-1600 isn't going to let you relax and enjoy it. See and hear it at your Lafayette dealer's showroom . . . you don't have to be an audio expert to appreciate it.

FEATURES And SPECIFICATIONS

Receiver Section—Power Output 100 watts \pm 1 db; FM Tuner IHF Sensitivity 1.7 μ V; front panel stereo headphone jack; illuminated AM and FM tuning meter. Pushbutton switches for Loudness, Stereo/Mono, Tape Monitor, High Filters. Black-face tuning dial.

Cassette Section—4-pole Hysteresis Synchronous motor; dual channel VU recording meter; record indicator light; Cassette Ejector Button; 3-Digit Counter with Reset Button. Records 4-track stereo and 2-track mono, plays-back 4 and 2-track stereo and mono.

Deluxe 100-Watt Component Hi-Fi System
Featuring LRK-1600



319⁸⁵

Magnificent 100-watt component Hi-Fi system featuring the LRK-1600 Cassette/Receiver and 2-Lafayette Criterion 50 Bookshelf Speaker Systems.

Wow!
Only 279⁹⁵

LAFAYETTE®

FREE!

1970 Catalog 700
496 Pages

Featuring Everything in Electronics for



- HOME
- INDUSTRY
- LABORATORY

LAFAYETTE RADIO ELECTRONICS CORP.
Dept. 19129 Box 10, Syosset, N. Y. 11791

Send me the FREE 1970 Catalog 700

19129

Name

Address

City

State Zip

CIRCLE 42 ON READER-SERVICE CARD

General Index, 1969

Continued from page 156

Fifteen Years of the IHF. Mar., p. 67.
Frank Sinatra: Confessions and Contradictions. Mar., p. 120.

Hair in Europe. July, p. 108.
Has Success Spoiled FM? Nov., p. 61.
Hi-Fi in the Sky? Feb., p. 62.
HIGH FIDELITY Compares Stereo Headphones. Jan., p. 63.
How to Catalogue Your Records. Sept., p. 56.
How We Judge FM Tuners. Nov., p. 64.
How We Judge Stereo Cartridges. Feb., p. 48.
How We Test Turntables, Arms, and Changers. Apr., p. 39.

The "In" Composers. July, p. 54.

John Hartford, Poet. Feb., p. 124.
Julius Katchen (1926-1969). Sept., p. 61.

The Latest in Stereo Cartridges. Feb., p. 54.
The Life and Times of Blind Orange Adams. Oct., p. 126.

The Magic Machine. Aug., p. 44.
My Favorite Records (Leontyne Price). May, p. 28.
My Gypsy Record Collection (Birgit Nilsson). July, p. 22.

New Horizons for Maestro Kubelik. Jan., p. 14.
New Products for the New Decade. Oct., p. 54.
New York City—R.I.P. Nov., p. 136.

The Opera Reviewer Strikes Back. Apr., p. 20.

The Parallel Careers of Georg Solti. Oct., p. 66.
The Perils of Record Collecting. Feb., p. 58.
Ping-Ping-Pong-Pong. Sept., p. 62.
A Plain and Easy Guide to Practical Electronic Music. Aug., p. 50.
Professional Hints for Amateur Tape Recordists. Dec., p. 78.

Recorded Portraits of the Artist (Janos Starker). Nov., p. 32.
Records That Escaped the Trash Bin, Part II. Jan., p. 110.
Records to Test Your Woofer's "Crunchability." June, p. 28.
Rocks in Their Heads. Apr., p. 48.

The Scriabin-Koussevitsky Scandale. June, p. 54.
The Scrutable Orient. Oct., p. 63.
Shostakovich's Symphonies. Apr., p. 43.
Sibelius' Seven Symphonies. May, p. 56.
Speakers—Fact and Fiction. June, p. 45.
Speakers—Present and Future. A symposium with C. Victor Campos, Dr. Robert Howard, Jon R. Kelly. June, p. 49.

The Trojans. Mar., p. 61.
Turntables: Renaissance of the Manual? Apr., p. 34.

The Underrated Sinatra. June, p. 109.
Use Your Room to Enhance Your Stereo. Sept., p. 50.

Vladimir de Pachmann—More Than a Clown. July, p. 59.

What's New in Stereo Kits? Dec., p. 73.
Where Do We Go from Hear? (The Coming Revolution in Home Recordings). Nov., p. 56.
Who Runs Our Orchestras? Jan., p. 58.
Woody 'n' Me. Sept., p. 118.

You're Going to Hear From Her. Dec., p. 132.

EQUIPMENT REPORTS

AMPLIFIERS (Basic)
Crown DC-300 Mar., 1969
AMPLIFIERS (Preamp)
C/M Labs CC-2 Apr., 1969
Pioneer SC-100 Jan., 1969
Sony TA-2000 Mar., 1969

CARTRIDGES
ADC 25 Dec., 1969
Elac ST5 444-E Nov., 1969
Goldring C-800 Mark II Feb., 1969
Shure M91E July, 1969
Stanton 681EE June, 1969

COMPACT SYSTEMS
Heathkit AD-27 May, 1969

HEADPHONES
AKG K60 Jan., 1969
Allied H-885 Jan., 1969
Ampex 141 Jan., 1969
Beyer DT-48/5 Jan., 1969
David Clark 100 Jan., 1969
David Clark 300 Jan., 1969
Fisher HP-50 Jan., 1969
Koss ESP-6 Sept., 1969
Koss PRO-4A Jan., 1969
Lafayette SP-55 Jan., 1969
Olson PH-82 Jan., 1969
Permoflux B-DHS-28 Jan., 1969
Permoflux B-HM-16 Jan., 1969
Pioneer SE-30 Jan., 1969
PML (Ercona) D-42 Jan., 1969
RCA 10R200 Jan., 1969
Sansui SS-2 Jan., 1969
Sharpe HA-10A Jan., 1969
Sharpe HA-660/PRO Jan., 1969
Sony/Superscope DR-6A Jan., 1969
Superex ST-PRO-B Jan., 1969
Teac LS-205 Jan., 1969
Telefunken TH-28 Jan., 1969
Telex EN-5 Jan., 1969
Transcriber Alpha SDH-8 Jan., 1969

MICROPHONES
Ercona/PML F-67BS Mar., 1969
Sennheiser MD 421/N Feb., 1969

MISCELLANEOUS
BASF Hobby Box Sept., 1969
BIB Tape Head Maintenance Kit Sept., 1969
Parastat MK IV Record & Stylus Care Kit Nov., 1969

RECEIVERS
Allied 395 Feb., 1969
Fisher 500 TX Sept., 1969
Kenwood TK-140X Oct., 1969
KLH-27 May, 1969
Pioneer SX-1500T June, 1969
Sansui 2000 Jan., 1969
Sansui 4000 Dec., 1969
Scott LR-88 Kit July, 1969
Sherwood S-8800a Apr., 1969
Sony 6120 Aug., 1969
Standard SR-606SU Aug., 1969

SPEAKER SYSTEMS
Acoustic Research AR-5 Jan., 1969
Altec Lansing 893A May, 1969
Bogen LS-10 Feb., 1969
Dynaco A-25 July, 1969
Empire 7000M Aug., 1969
Fairfax C-150 & FX-100 Oct., 1969
Fisher XP-7B Dec., 1969
Harman-Kardon HK50 Apr., 1969
Hartley Holton Jr. Sept., 1969
Heathkit AS-38 & AS-48 June, 1969
Jensen 700-XLW Nov., 1969

TAPE RECORDERS
Ampex 1450 (1455) May, 1969
Bell & Howell 2295 Oct., 1969
Panasonic RS-796US July, 1969
Revox A77 June, 1969
Sony 124 CS Cassette Nov., 1969
Teac A-1200 Mar., 1969
Uher 10,000 Aug., 1969

TURNTABLES & CHANGERS
Dual 1212 Apr., 1969
Elpa PE-2018 Dec., 1969
Seeburg AP-1 Automated System (incl. preamp) Nov., 1969
Thorens TD-125 Sept., 1969

STATEMENT OF OWNERSHIP, MANAGEMENT AND CIRCULATION (Act of October 23, 1962; Section 4369, Title 39, United States Code)

1. Date of Filing: October 1, 1969.
2. Title of Publication: High Fidelity.
3. Frequency of Issue: Monthly.
4. Location of Known Office of Publication: The Publishing House, Great Barrington, Mass. 01230.
5. Location of the Headquarters or General Business Offices of the Publisher: 2160 Patterson Street, Cincinnati, Ohio 45214.
6. Names and address of Publisher, Editor, and Managing Editor: Publisher: Warren B. Syer, The Publishing House, Great Barrington, Mass. 01230; Editor: Leonard Marcus, The Publishing House, Great Barrington, Mass. 01230; Managing Editor: None.
7. Owner: Billboard Publications, Inc., 2160 Patterson St., Cincinnati, Ohio; Marjorie L. Ross, Fort Thomas, Ky.; J. W. Ross Sr., Trustee for John W. Ross Jr., James S. Ross, Robert F. Ross, Fort Thomas, Ky.; John W. Ross Sr., as Custodian for John W. Ross Jr., James S. Ross, Robert F. Ross, Fort Thomas, Ky.; Jane L. Stegeman, Fort Thomas, Ky.; R. S. Littleford Jr., Trustee U/W Marjorie W. Littleford, deceased, Port Washington, N. Y.; William D. Littleford, as Custodian for Marlon Towne, Joseph Towne, Roslyn Harbor, N. Y.; R. S. Littleford Jr., Port Washington, N. Y.; W. D. Littleford, Roslyn Harbor, N. Y.; R. H. Stegeman Jr., Cambridge, Mass.; Anne L. Walsh, Brookville, N. Y.; Michael K. Littleford, Roslyn Harbor, N. Y.; Marjorie S. Tyler, as Custodian for Jane T. Tyler, Scott L. Tyler, Christopher T. Tyler, Niles Mich.; Billboard Publications, Inc., Profit Sharing, Savings & Retirement Plan Trust, Cincinnati, Ohio; L. M. McHenry, Fort Thomas, Ky.

8. Known Bondholders, Mortgagees, and Other Security Holders Owning or Holding 1 Per Cent or More of Total Amount of Bonds, Mortgages or Other Securities: None.

9. Paragraphs 7 and 8 include, in cases where the stockholder or security holder appears upon the books of the company as trustees or in any other fiduciary relation, the name of the person or corporation for whom such trustee is acting; also the statements in the two paragraphs show the affiant's full knowledge and belief as to the circumstances and conditions under which stockholders and security holders who do not appear upon the books of the company as trustees, hold stock and securities in a capacity other than that of a bona fide owner. Names and addresses of individuals who are stockholders of a corporation which itself is a stockholder or holder of bonds, mortgages or other securities of the publishing corporation have been included in paragraphs 7 and 8 when the interests of such individuals are equivalent to 1 per cent or more of the total amount of the stock or securities of the publishing corporation.

10. Extent and Nature of Circulation	Average No. Copies Each Issue During Preceding 12 Months	Single Issue Nearest to Filing Date
A. Total No. Copies Printed (Net Press Run)	209,940	216,599
B. Paid Circulation:		
1. Sales through Dealers and Carriers, Street Vendors and Counter Sales	31,996	33,001
2. Mail Subscriptions	131,119	136,400
C. Total Paid Circulation	163,115	169,401
D. Free Distribution (including samples) by Mail, Carrier or other means	10,075	8,799
E. TOTAL DISTRIBUTION (Sum of C and D)	173,190	178,200
F. Office Use, Left-Over, Unaccounted, Spoiled after printing	36,750	38,399
G. Total (Sum of E & F—should equal net press run shown in A)	209,940	216,599

I certify that the statements made by me above are correct and complete.

(Signature of editor, publisher, business manager or owner)

(Signed) John W. Ross, Secretary
Billboard Publications, Inc.

< 5 >

YEAR GUARANTEE

..... WORTHLESS

.. FRIENDLY GESTURE ..

..... NOT NEEDED

..... NO USE

..... MEANINGLESS

HARMONY HOUSE

Offers a Five Year
Guarantee on All
Quad Components.
Yet We Offer Little
You Won't Need Service

Purchase
Quad Products
and
Buy Quality

Brochure Available
Stock on Hand

Official U.S. Agent

HARMONY HOUSE, INC.

197 EAST 76 ST.
NEW YORK, N.Y. 10021
(212) RE 7-8766

MON.-SAT. 9:00-7:30

CIRCLE 35 ON READER-SERVICE CARD

DECEMBER 1969

Take a loudspeaker. Add resonances at 800 Hz and 1250 Hz. It will reproduce a trumpet that sounds more like a trumpet than the real thing. Move the resonances to 550 Hz and 900 Hz. It will do the same for the oboe.

Many a loudspeaker has been purchased on its impressive performance on certain types of reproduction—built in characteristics which become more and more irritating after the initial glamour has faded.

One good test for a loudspeaker is to reproduce some speech at natural level, while the demonstrator stands next to the loudspeaker, talking or reading from a book. Usually you won't be surprised that it sounds like one real person and a loudspeaker. Occasionally it will sound like two real people—and then you have a speaker really free from colouration.

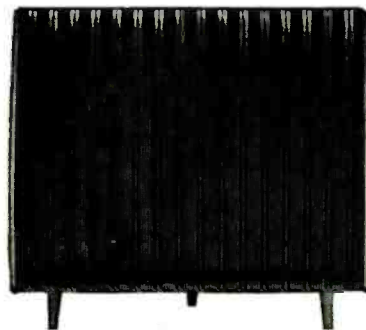

P.S. If you haven't the nerve or the opportunity to do this,
just choose QUAD anyway.

QUAD

for the closest approach to original sound

For further details see your Hi-Fi dealer or write direct to:—
Acoustical Manufacturing Co. Ltd., Huntingdon, England.

the tape BY R.D. DARRELL deck

The Cloudy Dawn of a New Era. Belatedly clambering aboard an already fast-moving bandwagon, Columbia and RCA have finally released their first batch of recorded cassettes. Like the European imports, Columbia cassettes list at the premium price of \$6.98 each and RCA at \$6.95 (plus a dollar more for RCA original-cast shows and soundtracks), whereas most other American manufacturers had settled earlier on a \$5.98 or \$5.95 standard. There are even several series at the bargain price of \$4.95 (soon to be joined by Everest's cassette editions of highlights from its Cetra opera sets). How long this rate fluctuation will last and just which "standard" will eventually prevail remains, of course, to be determined.

Meanwhile, the latest additions to the recorded cassette repertory are frankly aimed at a mass public: pop, background, and Broadway shows dominate the initial releases. Out of forty-four Columbia/Epic cassettes there is only one "classical" program—if that elastic term can be stretched far enough to cover "Switched-On Bach"; and even the show and soundtrack examples are confined to such blockbusters as *My Fair Lady*, *Camelot*, *West Side Story*, and *Funny Girl*. From forty RCA/Colgems releases there are six shows or soundtracks (including *Hair*, as well as such earlier hits as *South Pacific*, *Sound of Music*, *Fiddler on the Roof*, *Hello Dolly*, and *Oliver*), and only ten "classical" programs. These latter items also feature established best sellers: Van Cliburn's Tchaikovsky Piano Concerto, *Victory at Sea* (Vol. 1), and three Fiedler/Boston Pops favorites; such heavily promoted recent Ormandy/Philadelphia releases as the Tchaikovsky *Pathétique* Symphony, the Grieg and Liszt Concertos with Cliburn, Chopin's Second Concerto and *Polish Fantasy* with Rubinstein; and finally such less predictable entries as the Rubinstein/Leinsdorf First Beethoven Piano Concerto and Leinsdorf's Bostonian coupling of the suites from Rimsky-Korsakov's *Coq d'Or* and Stravinsky's *Firebird*.

Well, adventuresome programming scarcely could have been expected. What about technical quality? Here the first report is a bit more cheerful—always with the qualification that the cassette format is as yet inherently handicapped and cannot match the sonic-range and signal-to-noise-ratio standards of cartridge and open-reel tapings. The new Columbia and RCA cassettes I have heard so far are generally quite good technically: perhaps slightly better than most European imports, if not always up to the best earlier American processings—at least where the high-frequency

end of the audio spectrum is concerned. They are notably good in dynamic-range and low-frequency power and solidity characteristics. The most serious technical problem of cassettes—that of surface noise—still dogs these new releases: even by current quality standards for this format the RCA and Columbia cassettes rank from only fair to fairly good.

In all fairness, however, it should be noted that any new editing and processing quality controls take time to perfect. First-run production, some of which often has to be delegated to outside plants, seldom achieves either the excellence or the consistency that comes only with experience. Yet, even at present, skeptical audiophiles must be impressed both by the over-all effectiveness of older recordings in their cassette editions and by the powerfully dramatic potentials cassettes presently show in coping with more recent symphonic engineering.

With my usual reservations that recorded cassettes are presently best heard in *alfresco* mono playback and should not be directly compared with open-reel tapings played on sophisticated equipment, I have no hesitancy in warmly recommending the cassette editions of such popular shows and soundtracks as Columbia's *My Fair Lady* (16 12 0024), *Camelot* (16 12 0006), and *Funny Girl* (16 12 0034); and RCA's *Fiddler on the Roof* (OK 1005) and *Hair* (OK 1038). Vol. 1 of the Rodgers/Bennett *Victory at Sea* is still a tuneful spellbinder (RCA RK 1027), while Ormandy's latest *Pathétique* (RK 1112) boasts some of the most broad and robust cassette sonics to date. It is, however, flawed by an inexcusable midmovement side break, and there are similar annoyances in the Grieg Piano Concerto and Stravinsky *Firebird* Suite. But the last-named, with its coupled *Coq d'Or* (RK 1031) is a delightful surprise—both for its technical and musical content.

Finally, the RCA "classical" programs must be credited with at least brief and generalized annotations. Like most other American cassettes, both the RCA and Columbia pop and show programs are noteless. Our native producers seem to have a low opinion of cassette purchasers' literacy.

Gift Suggestions. The three-hour, something-for-everybody "Astrosterio" open-reel programs make ideal sumptuous holiday gifts for those tape collectors on your list—especially if you're uncertain of their musical tastes. Designed primarily for American Airlines' flight entertainment, they are invaluable to home listeners: each reel gives a comprehensive cross section of repertory from

a leading company and a large proportion of the material is not otherwise available in any tape format. The latest three such cornucopia reels from Ampex (3¾ ips, \$23.95 each) are CW 217, representing the Vanguard, Cardinal, and Everyman catalogues; CW 220, representing Mercury, Philips, Wing, and World Series; and CW 221 representing the Decca catalogue.

Bach specialists will welcome the first tape edition of the complete Sonatas and Partitas for Unaccompanied Violin in superb virtuoso readings by Henryk Szeryng (Deutsche Grammophon/Ampex EX+ T 9270, two 7½-ips reels, \$17.95). And from the same companies are two notable Bach organ recitals: Vol. 1 of Karl Richter's series played on the organ of the Jaegersborg Church, Copenhagen; and the belated first tape representation of the long-acclaimed Archive series by Helmut Walcha, playing here at St. Laurenskerk, Alkmaar, Holland (DGC 9321 and ARC 8304 respectively, 7½-ips reels, \$7.95 each).

Devotees of Frederick Delius' unique tone pictures at last may savor a collection of such old favorites as *In a Summer Garden*, *A Song Before Sunrise*, *Summer Night on the River*, *On Hearing the First Cuckoo in Spring*, *La Calinda* from *Koanga*, and the Intermezzo and Serenade from *Hassan*—plus a discovery, *Late Swallows*, which is Eric Fenby's transcription of a movement from Delius' little-known String Quartet. Sir John Barbirolli, with the Hallé Orchestra (and tenor Robert Tear in the *Hassan Serenade*), succeeds here to the mantle of Sir Thomas Beecham as a Delian interpreter par excellence. The recorded sonics, as well as the musical miniatures themselves, are sheer aural enchantment (Angel YIS 36588, 3¾-ips reel, \$6.98).

Sibelians will definitely appreciate receiving the final two releases in the Lorin Maazel/Vienna Philharmonic series of the complete symphonies. The relatively seldom heard Third and Sixth Symphonies are to my mind the finest of the Finnish master's orchestral works. While I still prefer Watanabe's reading of the Third on Epic, Maazel's is a good one, even more warmly and vividly played and recorded (London/Ampex EX+ L 80211, 7½-ips reel, \$7.95). Maazel's Fourth Symphony, coupled with the great *Tapiola* tone poem, surely is the best tape version to date of this enigmatic work, and while I have heard only the cassette edition (London/Ampex X 10215, \$5.95), the performance is sure to sound even more brilliant in the 8-track cartridge (M 67215, \$6.95) and best of all in the 7½-ips open reel (L 80215, \$7.95).

The snap-in, pop-out home stereo tape system.

Snap-in Cassette Convenience. Spectacular stereo sound. The Sony TC-130 is a cassette 4-track stereophonic tape recorder, mounted in an attractive walnut wood cabinet, with two matching full-range Stereo speakers. Amplifier delivers 15 watts of dynamic power for big-console sound.

Pop-out Cassette Ejector. Push the button, the lid flips up, the cassette pops out. Snap a new cassette into place in seconds.

Sonymatic Recording Control. Automatically adjusts recording level and stereo balance so you never have to touch a knob. Ensures perfect stereophonic or monophonic recording from any source.

Tape Sentinel Lamp. Visually indicates when tape is in motion and when the end of the tape has been reached. Additional features: Pause control. Three-digit tape counter. Public-address capability. Stereo headphone jack. And many more.

Push-Button Tape-Transport Controls. Just push a button for forward, rewind, fast-forward or stop. Safety interlock prevents accidental erasure of recorded tape. Separate controls permit continuously-variable stereo balance, tone, and volume.

Noise-Suppressor Switch. Special filter eliminates undesirable hiss that may exist on older pre-recorded tapes.

Sony Model TC-130 Easymatic Stereo Cassette-Corder[®] Console System. Less than \$229.50 complete with two matching walnut speakers. For your free copy of our latest catalog, please write Mr. Phillips, Sony/Superscope, 8144 Vineland Avenue, Sun Valley, California 91352.

SONY SUPERSCOPE The Spirit in Stereo

You never heard it so good.

Stereo
Tape

Tote-Case®

FOR CAR • BOAT • HOME



Sturdy Royal
Blue Stitched
Vinyl Leather
Case; Slotted
Red Suede —
Finish Interior;
Bright Silver
Finish Metal
Fittings

Holds 6/8 Tracks
or 12 Cassettes

\$5.95
each

Stereo
Tape

Porta-Case®

Holds 12/8-Tracks or 24 Cassettes



\$8.95
each

Same Durable Make as
TOTE-CASE® Above



**TAPE PHONICS
INTERNATIONAL, INC.**
1101 State Road
Princeton, N.J. 08540
Tel.: 609-924-9723

No C.O.D.—Clip & Mail with
your Check or Money Order

Tape Phonics International, Inc. (TPI, Inc.)
1101 State Rd., Princeton, N.J. 08540

SEND:

Quantity _____

Stereo **TOTE-CASES®**
Tape @ \$5.95 each plus
50¢ per case for
postage & handling

SEND:

Quantity _____

Stereo **PORTA-CASES®**
Tape @ \$8.95 each plus
50¢ per case for
postage & handling

TO:

Name _____

Address _____

City _____

State _____

Zip _____

Send FREE **Tape** (11,000 Tape)
Titles

HF1269

• DEALERS' INQUIRIES INVITED •
CIRCLE 77 ON READER-SERVICE CARD

ADVERTISING INDEX

Key No.	Page No.	Key No.	Page No.
2	ABC Records	107	
1	Acoustic Research, Inc.	7, 21-45	
	Acoustical Mfg. Co. Ltd.	159	
3	Altec Lansing	51	
	Ampex Corp.	Cover III	
	Angel Records	110, 112, 120, 122, 124, 128, 130	
5	Astrocom/Marlux	129	
6	Audio Sales	120	
	Audio Unlimited, Inc.	120	
8	Benjamin Electronic Sound Corp.	83	
10	Bose Corp.	137	
11	Boston Audio Co.	130	
	Bozak	57	
101	British Industries Co.	5	
12	Carston Studios	142	
	Christmas Shopping Guide	147-155	
13	Columbia Records	92, 113	
14	Consumers Co.	140	
15	Coronet Recordings	110	
17	Defa Electronics Corp.	142	
18	Deutsche Grammophon Gesellschaft	105	
19	Dixie Hi Fidelity Wholesalers	146	
20	Downtown Audio, Inc.	144	
21	Dressner	144	
22	Dual	119	
23	Dynaco, Inc.	49, 127	
24	Electro-Voice, Inc.	104	
33	Electro-Voice, Inc.	104	
25	Elektra Corp.	99	
26	Elpa Marketing Industries	10	
27	Elpa Marketing Industries	16	
29	Elpa Marketing Industries	12	
28	Empire Scientific Corp.	64, 65	
31	Epicure Products, Inc.	146	
32	Finney Co., The	128	
30	Fisher Radio Corp.	Cover II, 1, 46, 111	
34	Harman-Kardon, Inc.	18, 19	
35	Harmony House	159	
36	Heath Co.	52-55	
37	Hi-Fidelity Center	144	
38	International Hi-Fi & Camera Exchange	124	
39	JBL International	17	
40	JVC America, Inc.	11	
41	Kenwood	121	
42	Lafayette Radio Electronics	157	
43	London Records	101	
44	LWE, Acoustron Corp.	141	
53	Marantz Co., Inc.	8, 9	
45	McIntosh	108	
46	Mercury/Philips Records	114	
	Minnesota Mining & Mfg. Co.	139	
25	Nonesuch Records	99	
48	North American Philips	131	
50	Olson Electronics	146	
26	Ortofon	10	
80	Panasonic	59	
27	Perpetuum Ebner	16	
49	Pickering & Co.	2	
52	Pioneer Electronics U.S.A. Corp.	63	
81	Pioneer Electronics U.S.A. Corp.	123	
54	Polish Record Center	118	
18	Polydor, Inc.	105	
55	Rabco	100	
56	Rabsons-57 St., Inc.	120	
57	RCA Stereo 8	109	
58	RCA Victor Records	103	
59	Rectilinear Research Corp.	117	
60	Rheem Roberts	145	
61	Sansui Electronics Corp.	90, 91	
62	SCA Services	122	
100	Scott, H. H., Inc.	13-15	
65	Sherwood Electronic Laboratories, Inc.	Cover IV	
64	Shield International Corp.	116	
66	Shure Brothers, Inc.	84	
51	Shure/SME Ltd.	102	
67	Sony Corp. of America	125	
68	Sony/Superscope, Inc.	6	
63	Sony/Superscope, Inc.	47, 161	
69	Sound Reproduction, Inc.	112	
70	Standard Radio Corp.	138	
71	Stanton Magnetics, Inc.	143	
72	Stereo Corp. of America	142	
82	Tandberg	136	
77	Tape Phonics International	162	
75	TDK Electronics Co., Ltd.	66	
73	Teac Corp. of America	115	
29	Thorens	12	
74	Uniclub, Inc.	48	
22	United Audio Products, Inc.	119	
76	University Sound	135	
2	Westminster Records	107	
101	Wharfedale	5	
78	Wollensak	133	
79	Yamaha International Corp.	126	

Some people think cassette decks have no place in a sophisticated stereo system.

Until now, perhaps it was true. Because there just haven't been any sophisticated cassette decks around. Until the new Ampex Micro 52 stereo cassette deck.

Is it good enough to match your system? Judge the features for yourself. Features like precision sliding mixing controls found only in the expensive open reel decks. Defeatable automatic level control that delivers virtually distortion-free recordings, switches out for full dynamic range. Two VU meters. Digital counter. Quick response pushbutton cassette controls.

Famous Ampex hysteresis synchronous motor for perfect speed regulation and negligible wow and flutter regardless of voltage variation. Recording in stereo with mike and live mixing.

And look at the specs. 40-12,000 Hz frequency response; 45 db signal/noise ratio; 0.25% w.r.m.s. wow and flutter; 2 mike inputs and 2 line inputs; 2 line outputs.

Will the sound be as good as your open-reel deck? Probably not. But, most people won't be able to tell the difference.

So think of it as the part of your system you let your wife use (women who never would touch open reel go crazy over cassettes because they're so easy to use). Or take advantage of the interchangeability it will give you with your car or portable

cassette unit (if you don't already have one, you will soon).

But however you think of it, it's a nice thing to have in your system. Because of ease of operation, good sound, convenience and versatility.

All very sophisticated reasons to find a place in your system for the sophisticated cassette deck, the Ampex Micro 52.



TOP

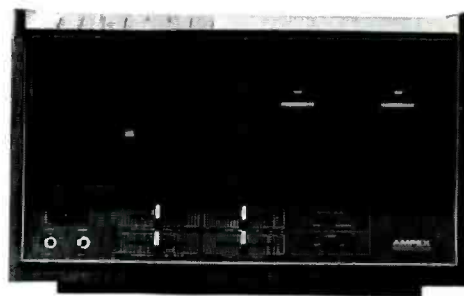

FRONT

AMPEX

CONSUMER EQUIPMENT DIVISION
2201 Landmeier Road, Dept. HF12
Elk Grove Village, Ill. 60007



"Our finest receiver"...

SHERWOOD ELECTRONIC LABORATORIES



Model SEL-200

dedicated to sound, not gimmicks. Conservatively stated specifications, not misleading bravado. There's much more. See your Sherwood dealer today or write us.

- **Exclusive "LEGENDRE" Torrid FM IF Filter** — an advanced "Butterworth" type 9-pole filter, permanently aligned; the industry's most perfect FM filtering device, measurably superior to crystal filters.
- **Hermetically-Sealed Microcircuits**—eliminates field failures now being experienced by many manufacturers with conventional plastic-encapsulated integrated circuits.
- **60 + 60 Watts RMS at 8 OHMS**
- **1.5 uv Sensitivity (IHF)** — 0.9 μv for 20 dB quieting, 3.0 μv for 50 dB quieting.
- **0.15% FM Distortion** — Sherwood FM circuits continue to boast the industry's lowest distortion.
- **3-Year Factory Warranty**—Parts and Labor (transportation not included).

SHERWOOD
ELECTRONIC LABORATORIES, INC.



INNOVATORS IN FINEST QUALITY TUNERS / AMPLIFIERS / RECEIVERS / SPEAKERS
4300 North California Avenue, Chicago, Illinois 60618

CIRCLE 65 ON READER-SERVICE CARD