

**SPECIAL**  
**39<sup>c</sup>**  
THIS ISSUE ONLY

REVIEWS OF MORE THAN 150 NEW RECORDS AND TAPES

~~60 cents~~

# high fidelity<sup>®</sup>

DECEMBER  
1965

THE MAGAZINE FOR MUSIC LISTENERS

**Stereo  
Accessories  
Under \$50**

**This Season's  
Unusual New  
Christmas Records**

**Questions and  
Answers on  
Stereo  
Equipment**



# her rece



receiver is the kind of gift everyone everyone would like to receive. Solid-amplifier and solid-state stereo control and all of the very latest Fisher components in transistor technology. If it naturally." But what would you say if it tional cabinet? "Gift wrap it, please"?

#### Features and Specifications

**Tuner Section:** 4-gang transistor front end; 4 IF stages; 3 limiters; STEREO BEACON<sup>®</sup>; automatic stereo switching; sensitivity, 2.0  $\mu$ v (IHF); stereo separation, 35 db; S/N (100% mod.), 68 db; selectivity, 50 db; capture ratio, 2.2 db.

**Amplifier Section:** Silicon output transistors; short circuit protection; speaker selector switch (main or remote.); front-panel headphone jack; music power (IHF), 4-ohms, 70 watts; harmonic and IM distortion, 0.8%; frequency response (overall), 20-22,000 cps  $\pm$  1.5 db; hum and noise, 80 db; input sensitivity, phono magnetic (low), 4.5 mv; stereo separation, phono magnetic, 50 db.

**Mechanical:** Size: 16 $\frac{3}{4}$ " wide x 5 $\frac{1}{8}$ " high x 11" deep (12 $\frac{3}{8}$ " including knobs and heat sink). Weight: 21 pounds. <sup>®</sup>PATENT PENDING

CIRCLE 35 ON READER-SERVICE CARD

# of a Fisher

**FREE! \$2.00 VALUE!** Send for your free copy of *The New Fisher Handbook*. This entirely new, revised and enlarged edition of the famous Fisher high fidelity reference guide is a magnificent 80-page book. Detailed information on all Fisher components is included.



0112

Name \_\_\_\_\_  
 Address \_\_\_\_\_  
 City \_\_\_\_\_ State \_\_\_\_\_

FISHER RADIO CORPORATION  
 11-35 45th Road  
 Long Island City, N. Y. 11101

PLACE  
 4¢  
 STAMP  
 HERE

OVERSEAS AND CANADIAN RESIDENTS PLEASE WRITE TO FISHER RADIO INTERNATIONAL, INC., LONG ISLAND CITY, N. Y. 11101.

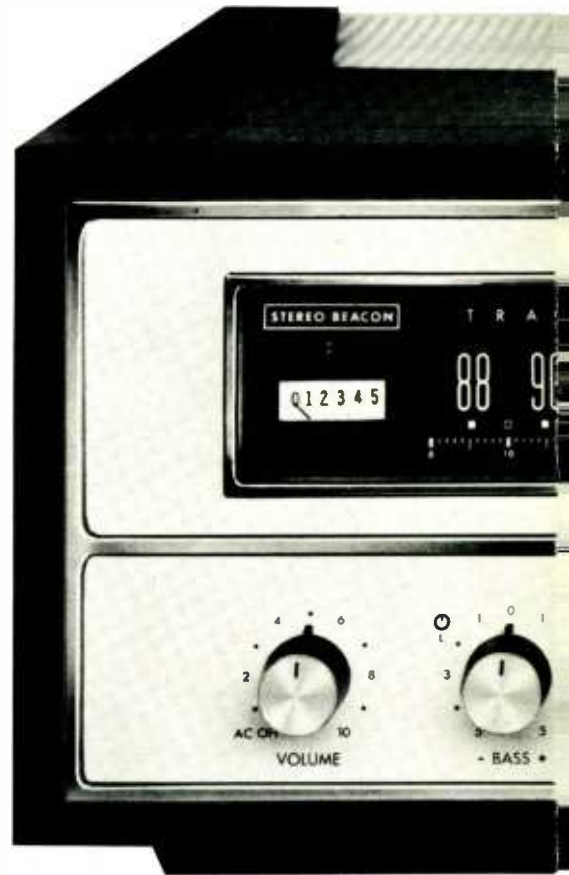

**The new Fisher 440-T** all-transistor stereo would like to give—because it is the kind state FM-multiplex tuner, solid-state stereo center—all on a single 16¾" x 11" chassis circuitry, incorporating the most recent developments. If you had bought the Fisher 440-T were expensive, you would say, "No!" cost only \$329.50, plus \$24.95 for the op

**D**e a g

**iver.**

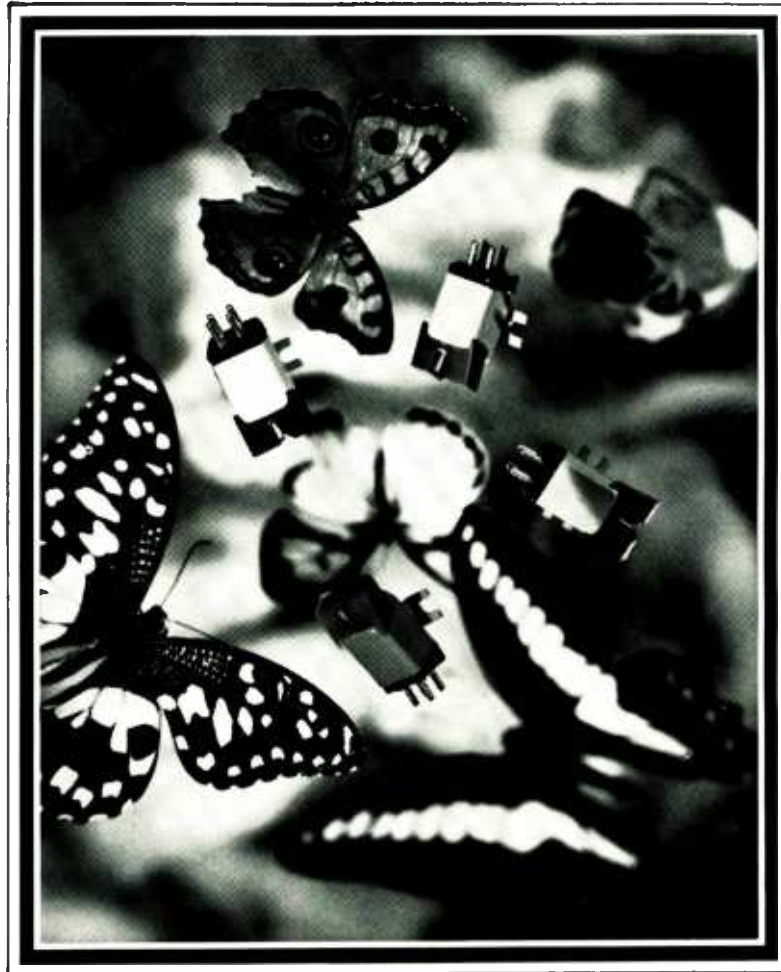

## *Capture natural sound with Pickering.*

From the softest flutter of the woodwinds to the floor-shaking boom of the bass drum, natural sound begins with Pickering. Right where the stylus meets the groove.

Any of the new Pickering V-15 stereo cartridges will reproduce the groove, the whole groove and nothing but the groove. That's why a Pickering can't *help* sounding natural if the record and the rest of the equipment are of equally high quality.

To assure compatibility with *your* stereo equipment, there are four different Pickering V-15 pickups, each designed for a specific application. The new V-15AC-2 is for conventional record changers where high output and heavier tracking forces are required. The new V-15AT-2 is for lighter tracking in high-quality automatic turntables. The even more compliant V-15AM-1 is ideal for professional-type manual turntables. And the V-15AME-1 with elliptical stylus is the choice of the technical sophisticate who demands the last word in tracking ability.

No other pickup design is quite like the Pickering V-15. The cartridge weighs next to nothing (5 grams) in order to take full advantage of low-mass tone arm systems. Pickering's exclusive Floating Stylus and patented replaceable V-Guard stylus assembly protect both the record and the diamond. But the final payoff is in the sound. You will *hear* the difference.

PICKERING—for those who can hear the difference.

Pickering & Co., Plainview, L.I., N.Y.  
CIRCLE 60 ON READER-SERVICE CARD



Page 56



Page 48

# high fidelity

## Music and Musicians

- 47 Why Save the Old Met?—an editorial
- 48 Sibelius and the Tide of Taste *William R. Trotter*
- 56 When Records Reached the Supermarket *Roland Gelatt*
- 14 Notes from Our Correspondents: New York, London, Paris

## Sound Reproduction

- 36 High Fidelity Newsfronts: New York High Fidelity Show
- 54 Stereo Accessories Under \$50
- 61 Stereo Question Box *Norman Eisenberg*
- 67 Equipment Reports
  - Fisher TX 200 Amplifier
  - McIntosh MI-3 Maximum Performance Indicator
  - Euphonics Cartridge System
  - Bozak B-4000 Speaker System
  - Concord R-2000 Tape Recorder

## Reviews of Recordings

- 28 A Harvest of Hosannas: Christmas records *Peter G. Davis*
- 32 The Sonic Showcase
- 75 Feature Record Reviews
  - Berg: *Wozzeck* (Soloists; Chorus and Orchestra of the Deutsche Oper Berlin, Karl Böhm, cond.)
  - Bach: *Brandenburg Concertos* (Berlin Philharmonic Orchestra, Herbert von Karajan, cond.; Marlboro Festival Orchestra, Pablo Casals, cond.)
- 77 Other Classical Reviews
- 120 Reissues
- 125 The Lighter Side
- 133 Jazz
- 139 The Tape Deck
- 142 General Index, 1965

**DECEMBER 1965 • VOLUME 15 NUMBER 12**

Published monthly at Great Barrington, Mass., by The Billboard Publishing Co. Copyright © 1965 by The Billboard Publishing Co. The design and contents of High Fidelity Magazine are fully protected by copyright and must not be reproduced in any manner. Second-class postage paid at Great Barrington and at additional mailing offices. Authorized as second-class mail by the Post Office Department, Ottawa, and for payment of postage in cash. High Fidelity/Musical America Edition published monthly except December when it is published semi-monthly. Subscription Anywhere on Earth \$9. National and other Editions published monthly. Subscription Anywhere on Earth \$7. Indexed in the "Reader's Guide to Periodical Literature." Change of address notices and undelivered copies (Form 3579) should be addressed to High Fidelity, Subscription Department, 2160 Patterson Street, Cincinnati, Ohio 45214.

**KEEP  
YOUR RECORDER  
IN  
TIP-TOP  
SHAPE...**



**BY  
ALWAYS USING  
TIP-TOP  
TAPE!  
-TARZIAN**

A good tape recorder deserves good care. Handle yours respectfully, maintain it regularly, and protect it by using brand-name tape exclusively.

Off-brands and "white box" tapes are manufacturer rejects! They give you no assurance of quality in performance, and they may seriously damage the magnetic recording head in your instrument. Brand-name tape protects you and your recorder.

Of course, we hope you'll choose Tarzian Tape. (Triple your tape recording fun; buy it three reels at a time.) The finest materials, most advanced manufacturing techniques, and strictest quality control are your assurance that you can't do better.

*FREE: Our brand-new 24-page booklet, "Everybody's Tape Recording Handbook," tells you how to get more out of your recordings. Write for your copy.*



**SARKES TARZIAN, Inc.**

World's Leading Manufacturers of TV and FM Tuners • Closed Circuit TV Systems  
Broadcast Equipment • Air Trimmers • FM Radios • Semiconductor Devices  
**MAGNETIC TAPE DIVISION • BLOOMINGTON, INDIANA**  
Export: Ad Auriema, Inc., N.Y. • Canada: E. J. Piggott Enterprises Ltd., Toronto, Ont.  
**CIRCLE 69 ON READER-SERVICE CARD**

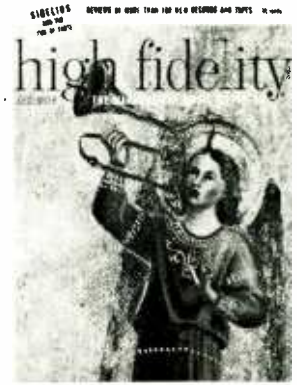

Cover: Detail from a triptych by Fra Angelico, c. 1435, now in San Marco Museum, Florence.

**Roland Gelatt**

Editor in Chief

**Joan Griffiths**

Executive Editor

**Norman Eisenberg**

Audio Editor

**Sue Severn**

Managing Editor

**Peter G. Davis**

Assistant Editor

**Shirley Fleming**

Managing Editor  
Musical America Section

**Leonard Marcus**

Special Projects Editor

**Roy Lindstrom**

Art Director

**Nathan Broder**

R. D. Darrell

**Alfred Frankenstein**

Conrad L. Osborne

Robert C. Marsh

Contributing Editors

**Claire N. Eddings**

Director of Advertising Sales

**Walter F. Grueninger**

Circulation Director

**Warren B. Syer**

Publisher

**ADVERTISING**

**Main Office**

Claire N. Eddings, The Publishing House  
Great Barrington, Mass. 01230  
Telephone: 1300

**New York**

165 West 46th St., New York 10036  
Telephone: Plaza 7-2800  
Seymour Resnick, Andrew Spanberger  
Norman Redmon (Musical America Section)

**Chicago**

Taylor/Friedman  
333 N. Michigan Ave., Suite 314, Chicago 60601  
Telephone: 332-7683  
Jerry Taylor, Jerry France

**Los Angeles**

434 So. San Vicente Blvd.  
Los Angeles 90048  
Telephone: Olympia 2-2100  
Robert J. Friedman, Joseph P. Diamond



NEW FROM COMMAND



**ALL FOUR  
MIGHTY  
BRAHMS  
SYMPHONIES**  
IN ONE SUPERB  
COLLECTION



**William Steinberg and The Pittsburgh Symphony Orchestra**

With each Command release of a Brahms symphony, a new pinnacle of recording history was reached.

Now, all four Brahms Symphonies have been combined by Command in one superb 4-record package. And you may now possess the complete Brahms symphonic library recorded by the orchestra which Eugene Ormandy has called one of the six greatest orchestras in the world . . . The Pittsburgh Symphony conducted by William Steinberg.

Presently, Musical Director of the Pittsburgh Symphony, Dr. Steinberg has also directed the London Philharmonic and most world famous orchestras. Steinberg has appeared at Tanglewood, the Hollywood Bowl, and major European festivals. During the 1964-65 season he conducted the New York Philharmonic for 12 weeks and was also guest conductor at the Metropolitan Opera.

In addition to his work with the Pittsburgh Orchestra, he will again conduct the New York Philharmonic during the 1966-67 season. The Brahms recordings were recorded with Command's almost fanatical dedication to technical perfection and excellence. Unquestionably, this volume of all four Brahms Symphonies will be among the finest and most enjoyable recordings in your entire record collection.

SYMPHONY No. 1 IN C MINOR, OPUS 68	SYMPHONY No. 3 IN F MAJOR, OPUS 90
SYMPHONY No. 2 IN D MAJOR, OPUS 73	Plus the TRAGIC OVERTURE IN D MINOR, OPUS 81
	SYMPHONY No. 4 IN E MINOR, OPUS 98



2 DRAMATIC NEW CLASSICAL ALBUMS

**BRAHMS**  
Symp. No. 4, E Min., Op. 98 #11030

**BEETHOVEN**  
Symp. No. 5, C Min., Op. 67 #11031  
William Steinberg And The Pittsburgh Symphony Orchestra

AVAILABLE IN STEREO & MONAURAL RECORDS AND 4-TRACK TAPE AT ALL LEADING RECORD OUTLETS

PLUS A SPECIAL OFFER OF TWO COMMAND CLASSICAL SAMPLERS



PAY ONLY  
**\$2.98**  
each

COMMAND CLASSIC SAMPLER #4

COMMAND CLASSIC SAMPLER #5

OR BOTH ALBUMS FOR \$5.00

**COMMAND CLASSICS SAMPLER 4**

- BEETHOVEN - Symphony No. 7 in A. Opus 92, 3rd Movement, Steinberg . . . Pittsburgh Symp. Orch. (11014 SD)
- BRAHMS - Symphony No. 1 in C minor, Opus 68, 3rd Movement, Steinberg . . . Pittsburgh Symp. Orch. (11011 SD)
- RACHMANINOFF - Prelude in G minor, Opus 23, No. 5 from the Album "Piano 'Pops' Promenade" Hambro and Zayde (11023 SD)
- DEBUSSY - Fetes (From Trois Nocturnes) Dervaux . . . L'Orchestre des Concerts Colonne (11008 SD)
- SCHUBERT - Symphony No. 3 in D Major, 2nd Movement. Steinberg . . . Pittsburgh Symp. Orch. (11017 SD)
- BACH - All Men Are Mortal, S. 643, (Alle Menschen Mussen Sterben) Virgil Fox at the Organ (11022 SD)
- BEETHOVEN - Symphony No. 4 in B Flat, Opus 60, 3rd Movement Steinberg . . . Pittsburgh Symp. Orch. (11016 SD)

**COMMAND CLASSICS SAMPLER 5**

- BRAHMS - Symphony No. 4 in E Minor. Op. 98, 3rd Movement. Steinberg . . . Pittsburgh Symp. Orch. (11030 SD)
- BEETHOVEN - Sonata 29 (Hammer-Klavier) Op. 106 Daniel Barenboim (11026 SD)
- FAURE - Nocturne. Virgil Fox Plays The John Wanamaker Organ (11025 SD)
- BEETHOVEN - Symphony No. 1 in C, 3rd Movement Op. 21. Steinberg . . . Pittsburgh Symp. Orch. (11024 SD)
- BEETHOVEN - Symphony No. 5, C Minor. Op. 67. 1st Movement. Steinberg . . . Pittsburgh Symp. Orch. (11031 SD)

berg . . . Pittsburgh Symp. Orch. (11031 SD).  
SAINT-SAENS - Minuet & Gavotte. Op. 65. Hambro & Zayde (11013 SD)  
VERDI - String Quartet in E Minor. 4th Movement. Steinberg . . . Pittsburgh Symp. Orch. (11027 SD)

**THESE ALBUMS  
NOT AVAILABLE IN STORES**

To obtain your Command Sampler albums, order direct by mailing this convenient coupon. You may select either album for only \$2.98 each, or both albums for just \$5.00 (Command Stereo albums sell nationally up to \$5.79 each). Your albums will be shipped postpaid - Command pays all postage and handling. Order as many albums as you wish, but don't delay . . . mail your order today.

COMMAND RECORDS DEPT. HF-12  
Post Office Box 2567  
Church Street Station, New York, N.Y. 10036

Gentlemen: Please send me the Command Sampler Albums I have checked below. I understand Command pays all postage and handling costs.

QUANTITY	ALBUM	PRICE	TOTAL
_____	CLASSICAL SAMPLER 4	_____	_____
	STEREO Only @ \$2.98		
_____	CLASSICAL SAMPLER 5	_____	_____
	STEREO Only @ \$2.98		
_____	SPECIAL OFFER	_____	_____
	(Both Albums) @ \$5.00		

Enclosed is \$..... (Check or Money Order)

NAME \_\_\_\_\_  
ADDRESS \_\_\_\_\_  
CITY \_\_\_\_\_ ZONE \_\_\_\_\_ STATE \_\_\_\_\_

CIRCLE 19 ON READER-SERVICE CARD

## HOW TO BUILD YOUR OWN STEREO TAPE RECORDER...

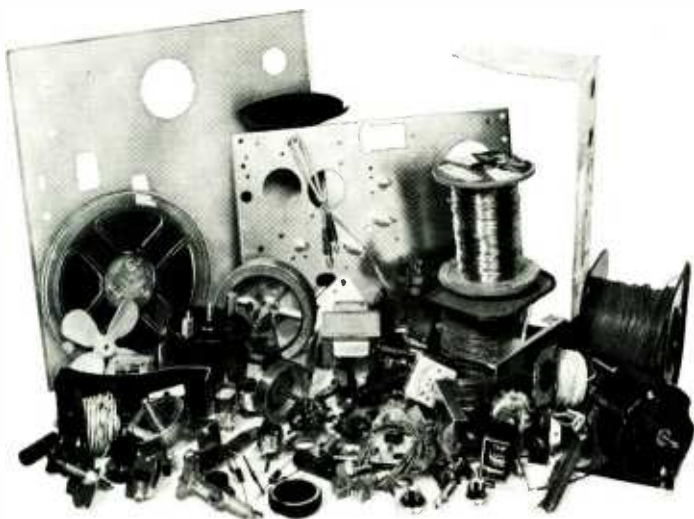

Start out by engineering a mechanical transport to move tape from one reel to another, tracking accurately within 1/5000 inch over three hyperbolic heads at 3-3/4 and 7-1/2 ips. Tape must run very smooth to hold flutter and wow below 0.2%. Provide high speed-take-up and rewind with a dependable brake system to stop the tape instantly without snapping or stretching. Add tape lifters, counter, automatic stop, pause control, cueing. Connect a fool-proof record interlock to the amplifier section. Design separate amplifiers for recording and playback with a 30-18,000 cps frequency range and facilities to monitor the tape while recording. Provide a bias/erase frequency of 95KC, signal-to-noise ratio of 55DB with total harmonic distortion not to exceed 1%. Include calibrated VU meters, stereo-mono switch, AB monitor switch, high level inputs, mike inputs, amp outputs, monitor outputs and independent record/playback controls for each channel. Package the entire assembly into a compact enclosure no larger than 13 x 13 x 7", provide forced air cooling and cover with a decorator styled stainless steel panel.

IF YOU DON'T FEEL QUITE UP TO MAKING YOUR OWN TAPE RECORDER, ASK YOUR NEAREST VIKING DEALER ABOUT THE...

### 88 STEREO COMPACT



Hear the magnificent sound, see the smooth action, all set and ready to take home for less than \$340.00. Walnut base \$29.95 extra.



MADE BY SKILLED AMERICAN CRAFTSMEN AT  
**Viking** OF MINNEAPOLIS®

9600 Aldrich Ave. S. Minneapolis, Minnesota, 55420

CANADA: Alex L. Clark, Ltd., 3751 Bloor St. W., Islington, Ontario  
Electro Tec Marketers, Ltd., 1624 W. Third Av., Vancouver, British Columbia  
CENTRAL & SOUTH AMERICA: ManRep Corp., P.O. Box 429 N. Miami Beach, Florida, U.S.A.  
OVERSEAS EXPORT: International Division Viking of Minneapolis, Inc., 9600 Aldrich Av. S., Minneapolis, Minn., U.S.A.

CIRCLE 91 ON READER-SERVICE CARD



#### The Ives Homestead

Sir:

During a trip through Connecticut last summer, my wife and I decided to stop in Danbury for the express purpose of visiting Charles Ives's birthplace there and to see his later home in nearby West Redding. After making several inquiries it soon became evident that hardly anyone with whom we talked had even heard of the composer and seemed to regard our search for Ives's homestead as a decidedly eccentric project. We eventually found Ives's niece, who was most gracious and directed us to the composer's home.

During our visit we learned that the house must be moved or torn down to make room for a bank parking lot. The Danbury Scott-Fanton Museum and Historical Society had been given the house and the responsibility of moving it. Obviously such an undertaking required more funds than the Historical Society had at its disposal, so contributions were sought through the local newspapers and radio stations. The meager response was painful evidence that the people of Danbury were not in the least bit interested. Most of the contributions to date have come from out-of-state music lovers, but over \$10,000 is still needed.

Many of your readers, I am sure, share my opinion that Charles Ives was the greatest composer this country has yet produced; they, too, may want to visit Ives's home and the town in which he lived. I feel strongly that it would be a tragedy for our American musical heritage if the Ives birthplace were demolished and future generations were denied this privilege. Interested readers may send contributions to "The Ives Homestead Fund," c/o The Fairfield County Trust Company, 210 Main Street, Danbury, Connecticut.

Thomas J. Newlin  
Chesapeake City, Md.

#### Unfathomable Complaint

Sir:

Harris Goldsmith, whose superb reviews I have always admired, must have been dozing when he wrote in the October issue regarding Montoux's coupling on RCA Victrola VIC/VICS 1102 of Beethoven's Fourth Symphony and Wagner's *Siegfried Idyll*. "... we cannot help noting with a certain ruefulness that RCA has chosen to issue this magnificent

Continued on page 8

HIGH FIDELITY MAGAZINE

# Before you send money to any record club, join the best one for 3 months, free!

Now, without paying a cent or obligating yourself in any way, you can join for three months the one record club that has every single advantage and none of the disadvantages of all the others—including those advertised in this and similar publications. (Your trial membership applies equally to phonograph records and 4-track recorded tapes.)

Here is what the Citadel Record Club offers to all its members:

**Discounts!** As a member, you are entitled to unusually large discounts on the records you want—sometimes as high as 55%! You can save as much as \$300 a year if you buy many records and get them all at Citadel discounts.

**No obligations!** You can buy as few or as many records as you want, when you want them. You are not obligated to buy any specific number of records—or tapes. The choice is always yours at top savings. Citadel has no "agree to purchase" requirement of any kind.

**All labels!** Your choice is unlimited. Virtually any record, album or tape by any artist on any label is available at a discount to Citadel members. This includes opera, classical, jazz, pop, folk, spoken word—anything. You receive Citadel's periodic bulletins and catalogs that keep you abreast of the newest recordings. You never get a "preselected" list—Citadel does not limit your choice.

**Promptest service!** Orders are usually shipped the same day

as received, rarely later than the next few days. In the event of a delay, partial shipments are made and your order completed as soon as the record or tape is available. There is no additional cost to you for this service.

**Specials!** In addition to your regular Citadel Club discounts, you will periodically receive lists of hit albums and tapes in all categories of music, offered at super discounts. These are special purchases your Club can make through its unusual buying power, and the savings are passed along to all members. Again, you are under no obligation to purchase any of these selections.

**Free Schwann catalog!** With your membership, Citadel immediately sends you the standard reference guide to more than 25,000 long-playing records. This comprehensive catalog has separate sections for classical, popular, ballet, opera, musical shows, folk music, jazz, etc., and another section for all new releases.

**100% guarantee!** Your records and tapes from Citadel are guaranteed factory-fresh and free of defects of any kind. If a damaged or defective record or tape does get through our close inspection, we immediately replace it with a perfect copy.

Try membership in the Citadel Record Club for three months. Find out why it is the club for the fastidious record buyer. You have nothing to lose except your possible illusions about other record clubs.

**Citadel Record Club**  
545 Fifth Avenue, New York, N. Y. 10017

Please enroll me for three months, without charge, as a member of the Citadel Record Club. I understand that I am entitled to all membership privileges without any obligation to buy anything, ever.

Name \_\_\_\_\_

Address \_\_\_\_\_

City \_\_\_\_\_ State \_\_\_\_\_ Zip \_\_\_\_\_

HF125

**CITADEL RECORD CLUB**

CIRCLE 17 ON READER-SERVICE CARD

 **KENWOOD**

**60 WATT  
SOLID STATE  
SILICON POWER  
AM/FM STEREO  
\$239.95**



If you're looking for the finest value in an AM/FM multiplex stereo receiver, look no further! Because here it is: KENWOOD's fabulous new all solid state, silicon power transistorized AM/FM Automatic Stereo Receiver, Model TK-60.

This latest addition to the KENWOOD line of hi-fi stereo components provides wide frequency response, 20 cps - 70 Kc, with total music power of 60 watts at 4 ohms, 50 watts at 8 ohms. No wonder the TK-60 offers the kind of quality and performance that is unsurpassed by other, more expensive units!

Check some of these outstanding features: 4-gang tuning condenser, 5 I.F. Stages with 3 noise limiters, automatic silent switching to proper mode, indicating instantly the reception of FM or AM broadcast.

Visit any KENWOOD franchised dealer, and we feel sure you will agree that Model TK-60 is an exciting value for only \$239.95. Also, price includes the handsome cabinet.

For complete specifications, write to KENWOOD.

the sound approach  to quality

**KENWOOD**

Los Angeles Office: 3700 South Broadway Pl., Los Angeles, Calif. 90007, ADams 2-7217

New York Office: 212 Fifth Avenue, New York, New York 10010. Murray Hill 3-1115

CIRCLE 45 ON READER-SERVICE CARD

## LETTERS

*Continued from page 6*

coupling in its low-priced series. Surely an artist of Monteux's stature deserves first-rate billing. . . ."

This is the first time that I have heard of a critic carping because a recording cost too little and therefore will be available to a larger number of people than a \$5.79 disc. Since RCA's "low-priced" line includes Strauss's *Ein Heldenleben* and Bartók's *Concerto for Orchestra* both conducted by Reiner, as well as recordings by Gilels, Munch, and other luminaries, I really cannot fathom Mr. Goldsmith's complaint.

*Henry Fogel*

Program Director, WONO-FM  
Syracuse, N. Y.

### Toscanini Today

Sir:

I second the comments of James J. Badal, Jr. ["Letters," October 1965] regarding Harris Goldsmith and his devotion to Toscanini. Toscanini has been dead a number of years and it would be a welcome change to see Mr. Goldsmith become more objective in his reviews of present conductors instead of constantly pulling the late Maestro's ghost out of the coffin.

*Bruce Brown*  
Newport, Ore.

Sir:

I believe that Mr. Badal, like myself, must belong to the younger generation which never heard Toscanini conduct in the concert hall. What we hear when we listen to the Toscanini recordings that the older generation holds up as *the* standard of excellence are nervous, erratic, and overly fast performances in which thin-sounding, imbalanced violins are supposed to represent "the grand line." I am always at a loss whenever I hear my elders lavish encomium on, say, Toscanini's recording of Beethoven's Ninth Symphony, which sounds to me—

*Continued on page 10*

**High Fidelity**, December 1965, Vol. 15, No. 12. Published monthly by The Billboard Publishing Co., publisher of *Billboard*, *Vend*, *Amusement Business*, *American Artist*, and *Modern Photography*. **High Fidelity/Musical America** Edition published monthly except December, when it is published semi-monthly. Member Audit Bureau of Circulations.

**Editorial correspondence** should be addressed to The Editor, *High Fidelity*, Great Barrington, Mass. 01230. Editorial contributions will be welcomed. Payment for articles accepted will be arranged prior to publication. Unsolicited manuscripts should be accompanied by return postage.

**Subscriptions** should be addressed to *High Fidelity*, Great Barrington, Mass. 01230. Subscription rates: *High Fidelity/Musical America*: Anywhere on Earth, 1 year \$9. National and other editions published monthly: Anywhere on Earth, 1 year \$7.

**Change of address** notices and undelivered copies (Form 3579) should be addressed to *High Fidelity*, Subscription Fulfillment Dept., 2160 Patterson St., Cincinnati, O. 45214.

# ALL THE BEST FROM SONY



## The Most Complete Line of Tape Recording Equipment in the World!

1. Sterecorder 500-A — A complete 4-track stereo/mono tape system with unsurpassed studio quality. The full range, infinite baffle detachable speaker systems integrate into the recorder lid, and separate 15 feet for optimum stereo effect. Less than \$399.50. 2. Sony Sterecorder 777 — Professional, solid state 2- or 4-track stereo/mono tape recording system featuring remote control and the exclusive Sony Electro Bi-Lateral head system. World's finest tape recorder. \$695. 3. Sony Sterecorder 260 — Complete solid state 4-track stereo/mono system with built-in XL-2 Radial Sound speakers for total stereo-dimensional sound, with 10 watts of pure music power per channel. Less than \$249.50. 4. Sony ESP Reverse 660 — The world's first truly automatic tape reversing system. 3 motors, 4 heads, and featuring Sony XL-4 Quadradial Sound speaker system with 50 watts of music power per channel — surrounds you with a stereophonic curtain of music. Less than \$575. 5. Sony Voice Command Battery Portable 905-A — Starts at the sound of your voice. Less than \$159.50. 6. Sony Stereo Mixer MX 777 — For advanced recording techniques, this all-transistorized, battery-powered 6 channel stereo/mono mixer is the perfect accessory to complete the 777 professional system. Less than \$175. 7. Sony Sterecorder 200 — The most compact and lightweight quality 4-track tape recording system on the market today. Carrying case lid separates into 2 full range speaker systems. Unequaled for performance and price. Less than \$199.50. 8. Sony Portable Tape recorder 102 — Rugged 2 speed, dual track hi fidelity recorder with deluxe features and 7" reel capacity satisfies the most exacting recording requirements. Less than \$129.50. 9. Sony-

matic solid state 900 — The 5½ pound wonder with the big voice. Conveniently operates everywhere — on 4 flashlight batteries or AC with no adapter needed. 2 speed with stop-&-go mike, automatic volume control. Only \$67.50. 10. Sonymatic TapeMate 123 — Bantam-weight with over 2 hours recording time on small reel, 2 speeds, and automatic volume control. Body-storing mike, simplified Sonymatic operation. Ideal for sending "Talking Letters." \$39.95 for a single unit. \$79.50 for a pair. 11. Sony Stereo Tape Deck 350 — A 4-track, solid state, stereo playback tape system with 3 heads to give a component set-up the versatility and capabilities of stereo tape facilities. Vertical or horizontal installation. Complete with walnut finish cabinet: \$199.50. Portable model 350C: \$219.50. 12. Sony Professional Condenser Microphone C-37A — A high performance studio and theater microphone for both uni- and omni-directional use. \$295.00. 13. Sony Uni-Directional Professional Dynamic Microphone F-113 — Lightweight cardioid hand or stand held, for top quality performance in broadcast and recording use. Less than \$249.50. 14. Sony Omni-Directional Professional Microphone F-91 — A slim-tapered probe or stand held mike for public address and on-the-spot pick-up of wide-field sound coverage. Less than \$149.50. 15. Sony Solid State 250-A — The country's best selling stereo tape deck, adds the scope of stereo tape recording/playback to any sound system. 4-track, 2 speed, vertical or horizontal operation, walnut base. All for less than \$149.50. 16. Sonymatic 135 — Ideal family recorder with simplified Sonymatic one-two-three operation, automatic volume control, and full 5" reels. Has body-storing mike, vinyl carrying case. Less than \$69.50.

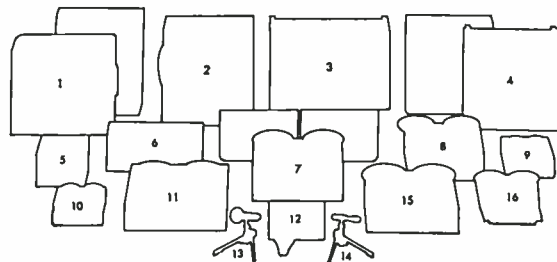

For literature or name of nearest franchised dealer, write to  
Superscope, Inc., Sun Valley, California. Dept. 11



CIRCLE 78 ON READER-SERVICE CARD

# Now, stylus-angle and position control from Elac, pioneer in magnetic stereo cartridge design

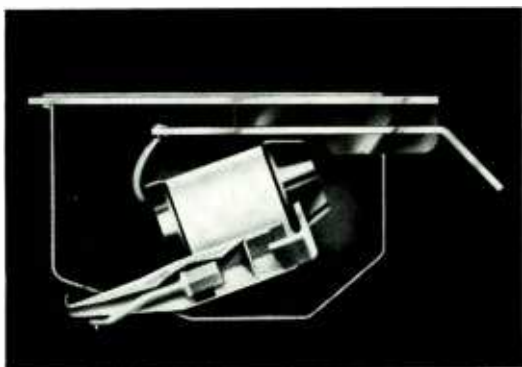

**F**irst to demonstrate the quality capabilities of the moving magnet principle in stereo cartridge design, Elac has continued in its development of engineering techniques for achieving these theoretical capabilities in practice.

Most recently, Elac devised a simple, ingenious cartridge-retaining bracket. Not only does this bracket adapt any Elac cartridge to any standard tone-arm, it also provides the means for independently adjusting fore-and-aft stylus position and stylus angle.

Both of these conditions have strong bearing on tracking error and distortion. And the facility for their adjustment enables the Elac user to obtain optimum performance with virtually any tone arm. The adjustable bracket is supplied with each of these cartridges:

**ELAC 322** Designed for stereo only. Virtually flat from 20 to 20,000 cycles with practically complete channel separation over the entire range. Harmonic distortion is less than 1%; IM, less than 2%. Tracks at less than 1 gram. Supplied with interchangeable 0.5 mil diamond stylus. **\$24.95.**

**ELAC 322 DE** Same as 322, but with elliptical stylus. Reduces distortion due to pinch effect. **\$29.95.**

**ELAC 240** New compatible cartridge for mono and stereo records. Comparable in performance to many top-reputed, stereo-only cartridges available today. Supplied with interchangeable 0.7 mil diamond stylus. **\$19.95.**

See your hi-fi dealer for details, or write: Benjamin Electronic Sound Corp., Farmingdale, N. Y. 11736.

**BENJAMIN  
ELAC**



CIRCLE 12 ON READER-SERVICE CARD

## LETTERS

Continued from page 8

as I think it does to the majority of the new, post-Toscanini generation—preposterously fast and clipped, hollow, and generally unsatisfying.

But the important thing to remember is that this is a *recording*, and as such I wonder if it does not represent a memory of a magnificent live performance which Mr. Goldsmith heard. I agree with Mr. Badal that critics like Mr. Goldsmith are doing us a disservice. But they are also doing a disservice to Toscanini by insisting that this patently great conductor can be represented by his patently unsatisfying recordings.

Brian Murphy  
Ferndale, Mich.

### Buried Treasure

Sir:

Without in any way decrying the need for publication of the Furtwängler *Ring* ["Who's Afraid of the Furtwängler *Ring*?" October 1965], may I put in a word for Furtwängler's Mozart? On the evidence of his recordings of the Symphony No. 40 (Odeon 91075 or 70361) and the Serenade No. 10 (Odeon 91175) he must stand as one of the greatest Mozarteans of this century. Yet apart from these, we have only the Symphony No. 39 (Deutsche Grammophon LPM 18725), two versions of *Eine kleine Nachtmusik* (Odeon 80801 and Deutsche Grammophon LPM 18960) and overtures to *Le Nozze di Figaro* and *Die Entführung aus dem Serail* (Deutsche Grammophon LPM 18960).

I have always regretted that the sound track from the memorable 1954 Salzburg Festival film of *Don Giovanni* has never been made commercially available. Surely there must be other such historic Mozart performances by Furtwängler gathering dust in the vaults of European radio stations and record companies that could, with the good will of the parties involved, eventually be released.

A. A. Cane  
Australian Broadcasting  
Commission  
302 Orchard Road  
Singapore

Sir:

Judging from past history in this area, I was not unduly surprised by Martin Mayer's résumé of the tragic circumstances preventing the commercial release of the Furtwängler *Ring* from Radio Italiana. Mr. Mayer's article did a great service by revealing this sequence of frustrating events to an ever growing audience exasperated with the endless re-recordings of *Il Trovatore*, *La Bohème*, and *The Barber of Seville*.

Another unreleased treasure, currently reposing in the vaults of RAI, is Rossini's *Armida* from the Florence May Festival of 1952. Maria Callas scored one of her greatest triumphs in this opera and I feel certain that not only Callas fans but opera enthusiasts the world over would

Continued on page 12

## This Sony has ESP\*



*Model 660 Solid State*

### The world's first fully automatic tape reversing system

\*Electronic Sensory Perception—an amazing Sony development. The ESP electronic brain constantly scans and automatically senses the voice or music modulations on your recorded tapes. Within 10 seconds after the sound has ended, the Electronic Sensory Perceptor *automatically reverses the tape direction!* Then, magically, the music resumes—every note flawlessly reproduced. You never touch the tape, you never touch the recorder—Sony ESP reverses the tape automatically. You never again bother about recording electronic reversing signals. Sony ESP tape reverse is activated solely by silence. Sony ESP automatic tape reverse works on

your old tapes and on your new tapes. The Sony 660 also records in both directions for making your own 4-track tapes.

And the Sony 660 adds a whole lot more. XL-4 Quadrantal Speaker System surrounds you with a virtual curtain of stereophonic sound. 50 watts of pure music power per channel. Two professional V U meters. 3 motors. 2 speeds. Sound on sound. Separate bass and treble controls. FM stereo inputs. Push-button solenoid activation of all mechanical modes. For literature and address of dealer nearest you, write Superscope, Inc., Department 11, Sun Valley, California.

**SONY**

**SUPERSCOPE**

*The Tapeway to Stereo*

CIRCLE 79 ON READER-SERVICE CARD

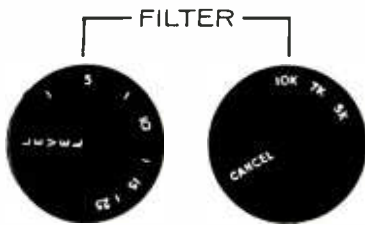

## More of the music and less of the distortion!

The processing and production of discs produces a waveform in which distortion rises extremely rapidly as the upper frequency limit is approached. To obtain the best quality under such conditions the very high harmonics must be attenuated at a rate which is a function of the rate of rise of distortion.

The QUAD filters provide both switched adjustment for frequency and continuously variable adjustment for rate of attenuation. The degree of attenuation need therefore never be greater than necessary to clean up the programme but is always adequate even for very bad cases.



### *For the closest approach to the original sound*

Our slogan for fifteen years and our design objective for twice that long. Ask your dealer for details of the QUAD range of high fidelity units or write direct to:-

**Ref. F.D. Acoustical Manufacturing Co. Ltd.,  
Huntingdon, England.**

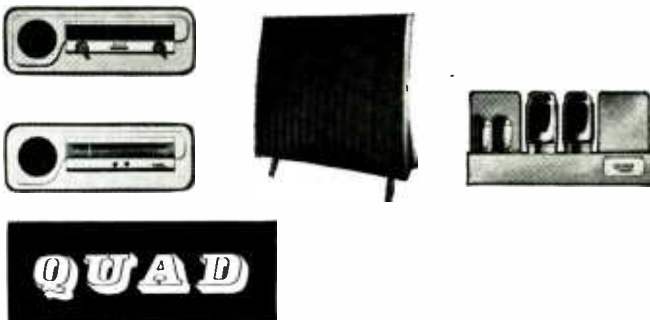

## LETTERS

*Continued from page 10*

welcome the opportunity to hear such a legendary performance.

*Donald J. Evers  
Chicago, Ill.*

### Turntable Snobbery

SIR:

I would like to counter a statement made by Harris Goldsmith in his review of the Beethoven Trios for Piano and Strings [July 1965]. He there lamented the fact that Vox presses its multiple-record sets in automatic changer sequence rather than for manual play. I thought this type of turntable snobbishness went out a long time ago.

It should be obvious to anyone that a multiple-record album pressed so that the music continues from Side 1 of the first disc to Side 1 of the second and so on can be played on a turntable with only very slight inconvenience to the operator. However, the alternate method—the music continuing from Side 1 of the first record to the overside, then to Side 1 of the second disc followed by its overside, and so on—is infuriating for anyone trying to use a changer. I realize that a company issuing a set of, say, the Beethoven symphonies might prefer to press the records in the latter fashion with a view to their later release as single discs. In the case of a small company I reluctantly accede to the economics involved, but I appreciate RCA Victor's release of the Toscanini set in changer sequence.

Now that we have entered a stage of equipment design where changer performance is rivaling turntable performance, the position of your critic makes even less sense.

*Robert Heñich  
Los Angeles, Calif.*

### Instrument Survey

SIR:

The Music Library Association is undertaking a survey of musical instrument collections in the United States and Canada. We are interested in all public and private collections, however small, and would be grateful for information about any which might otherwise remain unknown to us. Letters should be addressed to the Committee To Survey U.S. & Canadian Musical Instrument Collections, Music Library Association, in my care.

*Dr. Dale Higbee  
412 S. Ellis St.  
Salisbury, N.C. 28144*





## The lyric majesty of Sony sound

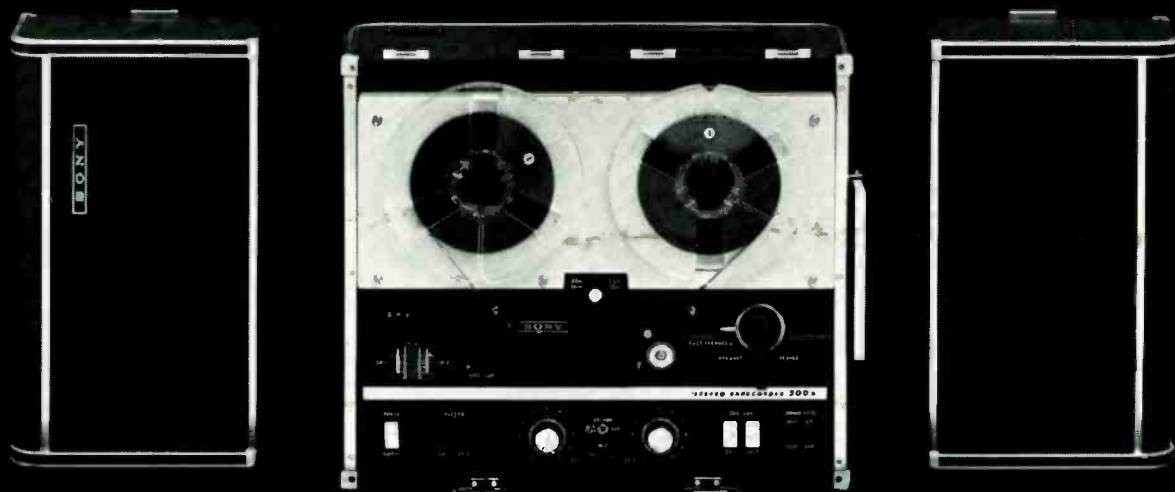

The new **Sony 500-A**: A magnificent stereophonic tape system with the amazing new **2.5 micron-gap head** that produces a flat frequency response from 40 to 18,000 cps  $\pm$  2 db.\* A remarkable engineering achievement; a complete four track stereo tape system with detachable speakers\*\* and two new award winning F-96 dynamic microphones. **All the best from Sony for less than \$399.50.**

Outstanding operational features distinguish the amazing new Sony Stereocorder 500-A: ■ Two bookshelf type acoustical suspension speaker systems combine to form carrying case lid ■ 4-track stereo/mono recording and playback ■ Vertical or horizontal operation ■ Special effects with mike and line mixing and sound on sound ■ Two V.U. meters ■ Hysteresis-Synchronous drive motor ■ Dynamically balanced capstan fly-wheel ■ Pause control ■ Automatic sentinel switch ■ Multiplex Ready with FM Stereo inputs. ®

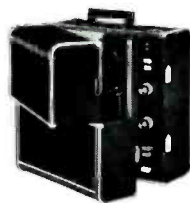

®Rave Review: "The NAB playback characteristic of the 500, as measured at USTC, was among the smoothest and closest to the NAB standard ever measured."—High Fidelity Magazine, April 1964. ■ °Rave Review: "One of the striking features of the TC 500 is the detachable speakers, ...they produce a sound of astonishing quality."—Hi Fi/Stereo Review, April 1964. Available now: A sensational new development in high quality magnetic recording tape, **SONY PR-150**. Write today for literature and your special introductory bonus coupon book allowing a substantial discount on 12 reels of PR-150. Superscope Inc., Sun Valley, Calif. Dept. 11.

**SONY SUPERSCOPE** *The Tapeway to Stereo*

# NOTES FROM OUR CORRESPONDENTS

## NEW YORK

During a brief visit here last September, Dr. Jeffrey B. Hanson, head of Editions Oiseau-Lyre, filled us in on some of the past, present, and future activities of the firm which he operates from his home in the tiny principality of Monaco. This hardy little independent was founded in 1932 by Dr. Hanson's late wife, Louise Hanson-Dyer, shortly after she had left her native Australia to settle in France. At first the enterprise was concerned exclusively with issuing beautifully printed and bound volumes of old music, scrupulously edited by eminent musicologists, but in 1936 Mrs. Hanson-Dyer began to complement her printed scores with recordings—quite a pioneer effort in those days when Couperin, Purcell, and other such composers were infrequently played and almost never recorded.

**The Cachet of Oiseau-Lyre.** The scholarly care which went into all Oiseau-Lyre recordings right from the beginning has given the label a touch of "professorialism," and Dr. Hanson is proud of it. "Quite a lot of the music we record has no performance tradition behind it," he explains. "So we need the best musicians and musicologists to prepare the scores: Thurston Dart, Neville Marriner, and Anthony Lewis in England, A. Tillman Merritt up at Harvard . . . with men of this caliber you may be sure the texts are authentic. Why, Dart and Marriner spent a full two years editing the score of Couperin's *Les Nations* for our recording!" As our conversation progressed, it soon became apparent that Dr. Hanson, a sprightly little man in his sixties who might possibly resemble your Latin professor, bases his philosophy of recordings on a broad cultural and academic foundation undoubtedly born from his own impressive scholastic background: an M.A. from the University of Melbourne, Doctor of Letters from the Uni-



*The late Louise Hanson-Dyer.*

versity of Paris, Doctor of Philosophy from Oxford (where he has also taught modern French literature), and a complete musical training at the Conservatory of Melbourne.

After the War, the Oiseau-Lyre catalogue advanced rapidly; by 1950 the company had introduced Europe to LP with its discs of Couperin's *Concerts royaux* and *Apothéose de Lully*. Music of the baroque era has always formed the backbone of the label's releases, although there have been forays into the romantic and contemporary periods. Policies as to artists and repertoire rarely have a commercial basis—if a certain piece of music seems to demand a recording and the right musicians are on hand, the decision to go ahead is automatic. The results, particularly in the neglected field of baroque opera, speak for themselves: Handel's *Acis and Galatea*, *Sosarme*, and *Semele*; Blow's *Venus and Adonis*; Purcell's *Dido and Aeneas*, *Fairy Queen*, and *King Arthur*.

*Continued on page 16*

## New ADC 404s are now at these dealers:

<b>ARIZONA</b> Phoenix	Audio Specialists
<b>CALIFORNIA</b> Anahelm	Ball Electronics Henry Radio
Buena Park	Park Electronics
Culver City	Hi-Fi Matic Company
Downey	N.E.T. Electronics
Garden Grove	Sav-On Electronics
Glendora	Stereo Hi-Fi Center
Hollywood	Hollywood Electronics
Los Angeles	Figart's Sound Unltd. Gmora Stereo Center Inglewood Electronics S & N Camera Supply Fidelity Sound
Oakland	Fisher Electronics Wayne's Sound Accent Electronic Components
Pasadena	Henry Radio
Reseda	Colorvision Electronics
San Francisco	Eber Electronics House of Sound San Francisco Radio Skinner, Hirsch & Kaye
San Jose	Alco Paramount Unifed Radio & TV West Coast Audio Sales
San Pedro	Bowers Music
Santa Ana	High Fidelity Associates
Santa Monica	Midway Electronics Sane & Insane Golden Ear
Santa Rosa	Boyd-Wonn Hi-Fi
Vallejo	Edison Electronics
Van Nuys	Bel Air Camera
Westwood	Hi-Fi Haven
Whittier	Woodland Stereo Center
Woodland Hills	
<b>COLORADO</b> Boulder	Sound System Specialists
Colorado Springs	Dick Jurgens High Fidelity
Denver	Gramophone Shop Howard Sound Lloyd's Hi-Fi
<b>CONNECTICUT</b> Bridgeport	Bridgeport Hi-Fi Center
Hartford	The Stereo Shop
New Haven	Audio Den
Stamford	Atlantic Electronics Audio Exchange
<b>DISTRICT OF COLUMBIA</b>	Custom Hi-Fi & TV
<b>GEORGIA</b> Maconville	Discount Records
<b>MASSACHUSETTS</b> Boston	Cramer Electronics
Cambridge	Lechmere Sales Minute Man Radio Soundco Electronics
Springfield	The Music Box
Wellesley	Consumer Audionics
Worcester	
<b>MICHIGAN</b> Ann Arbor	The Music Center
Birmingham	McCallum & Dean
Dearborn	Lewis Radio & TV
Detroit	Uptown Radio
East Lansing	Hi-Fi Buys
Pontiac	New Center Electronics
<b>MISSOURI</b> St. Louis	GEM—Dunn Rd. GEM—Lemay Ferry Rd. GEM—Page Ave.
<b>NEW JERSEY</b> Trenton	George's Stereo Center
<b>NEW MEXICO</b> Albuquerque	Hi-Fi House
<b>NEW YORK</b> Albany	Fort Orange Radio
Buffalo	Spark's Radio
Kingston	Arace Electronics
Lockport	Lockport Audio
New York	Airex Radio Packard Electronics Eastman Appliance Robert M. Hyatt Adirondack Electronics
Rochester	Reales Sam Goody
Schenectady	
Valley Stream	
<b>NORTH CAROLINA</b> Winston-Salem	Trayer-Yelverton
<b>OHIO</b> Toledo	Jamiesons'
<b>OKLAHOMA</b> Tulsa	Sound Unlimited
<b>PENNSYLVANIA</b> Ardmore	Soundex Electronics
<b>RHODE ISLAND</b> Cranston	Sound-O-Rama
<b>SOUTH CAROLINA</b> Columbia	Hi-Fi Sound & Records
<b>TEXAS</b> El Paso	Audio Consultants
Fort Worth	Audio Associates
<b>UTAH</b> Salt Lake City	House of Music
<b>VIRGINIA</b> Hampton	GEX
Virginia Beach	GEX
<b>WASHINGTON</b> Spokane	H. C. J. Electronics Huppins Hi-Fi

**Trial offer expires Dec. 31, 1965.**

**CIRCLE 9 ON READER-SERVICE CARD**

**HIGH FIDELITY MAGAZINE**

From the makers of the 303A Brentwood, top-rated speaker of the year...

# ADC announces the new 404, the compact speaker for people more impressed with sound than size

Listen to these remarkable speakers at your dealer today... *Then test them in your home for an 8-day trial at our risk!*

Will 404s perform as well in your home as they do in your dealer's listening room? Perhaps. But don't take a chance. Do this: Listen to a pair of these compact 404s at your dealer's. Even after he's given you his word that he hasn't mistakenly hooked up those big, expensive speakers in the corner, be skeptical... Buy a pair of 404s... Listen to them

critically for 8 days... If they don't perform as well as they did in your dealer's, bring them back... He'll refund your money — no questions asked. ADC guarantees it.

Should you decide to keep them (and we secretly believe you will), you'll be pleased to know your speakers are guaranteed for 5 years against failures in

workmanship or parts—which gives you a hint of their quality.

Come on, be skeptical. But take home a pair of 404s while this offer lasts. (Expires December 31, 1965.)

404s come twin-packed in a special box with a handle ready to tote.

Isn't this a refreshing way to buy components?

AUDIO DYNAMICS CORP., Pickett District Rd., New Milford, Conn.



The new ADC 404 measures only 11 $\frac{7}{8}$ " high, 7 $\frac{3}{4}$ " wide, 8 $\frac{1}{4}$ " deep. Its cabinet is handsomely finished in oiled walnut. Handles 6 min. to 50 max. watts per channel. Price, \$56.00 each.

CIRCLE 9 ON READER-SERVICE CARD

## NOTES FROM OUR CORRESPONDENTS

Continued from page 14

**Performances and Promises.** One of the company's most ambitious projects to date is a complete recording of Rameau's opera *Hippolyte et Aricie*, intended to replace the single disc of excerpts made several years ago. (The new album will be released this April.) The musicians involved are familiar Oiseau-Lyreans: the English Chamber Orchestra conducted by Anthony Lewis with Thurston Dart playing the continuo. Dr. Hanson is especially enthusiastic about the young English singers who also take part: "Janet Baker and John Shirley-Quirk—keep your eye on them . . . they're headed right to the top." When one recalls that Joan Sutherland's recorded debut was on Oiseau-Lyre (in a group of Handel arias and *Acis and Galatea*) and that the label also brought conductor Colin Davis to wide public attention, this recommendation is well worth pondering.

In addition to the Rameau opera, upcoming releases include a group of baroque flute concertos played by Claude Monteux, the Melos Ensemble in Schoenberg's Suite, Op. 29, Janet Baker in a collection of Ravel songs, and Purcell's *Indian Queen*, recorded last month with the cast of its recent London performances conducted by Charles Mackerras. Farther off in the future, indeed only at the wishful-thinking stage at the moment, is Berlioz's *Benvenuto Cellini*—certainly the perfect complement to Oiseau-Lyre's much admired *L'Enfance du Christ* and *Béatrice et Bénédict*.

P.G.D.

### LONDON

"How unfortunate the recording light is red!" This comment from the young American pianist Stephen Bishop was good-humored as he started on the taping of Beethoven's Opus 101 and Opus 109. Musician drivers, he pointed out, must always find it hard to take the stop sign as a starting signal. Nonetheless, his sessions for these two taxing last-period works went off extremely well. Opus 101 being recorded complete at a single sitting one evening between 7 and 10 in EMI's Abbey Road studios.

**Bishop and Friends.** At twenty-four, Bishop has established himself as one of London's most important pianists. His performance of the *Emperor* Concerto at this year's Promenade Concerts held the whole Royal Albert Hall in thrall, and called forth from the critics comparisons with Schnabel on the one hand and Kempff on the other. His years of study with Dame Myra Hess (he came to live in London in 1959) have borne fruit in an unusual thoughtfulness and maturity—qualities which do not, however, mitigate against an infectious sense of

Continued on page 22

HIGH FIDELITY MAGAZINE



STEREO UAS 6444 MONO UAL 3444

Here's the excitement and great music from Ferrante and Teicher's concert tours that have broken box office records all over the country. It's a great one...

on



of course

Available wherever albums are sold

CIRCLE 86 ON READER-SERVICE CARD

## Enjoy BIG wall to wall sound ear to ear



The only stereophones with separate tweeters and woofers and crossover networks, models from \$30 to \$50.

It's one thing to fill a whole room with music. But getting to enjoy it at the volume you want, anytime you want, can be a problem.

That's where Superex stereophones come in.

They make listening a strictly personal pleasure. Whether it's Stereo, HiFi, Tape, F.M. Etc.

You don't bother anyone. No one bothers you. Which is a good thing.

Because Superex are professional quality all the way. They're for people who have an ear for music.

Try-out Superex stereophones at your nearest Hi-Fi Dealer and send for our 16 page catalog.

**SUPEREX**  
stereo/phones

SUPEREX ELECTRONICS, 1 RADFORD PLACE YONKERS, N.Y.

CIRCLE 77 ON READER-SERVICE CARD

**Empire invites you  
to listen to the most  
significant advance in  
stereophonic reproduction,  
the New Empire Grenadier,  
world's most perfect  
speaker system.**



CIRCLE NUMBER 108 ON READER SERVICE CARD

[www.americanradiohistory.com](http://www.americanradiohistory.com)

# Feature by feature the Grenadiers take you into a new world of sound. Listen for a moment.

Take a good look at the statuesque originality of this wide angle speaker system. Note its hand rubbed walnut finish, its imported marble top. Now, hear it perform. The new Empire 8000P is truly the most significant advance in stereophonic reproduction.

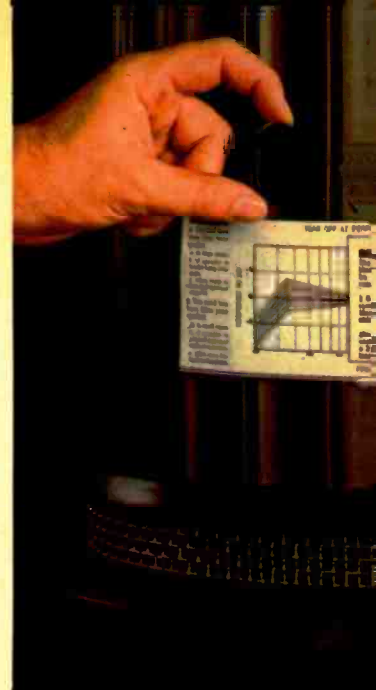

Empire's exclusive "Dynamic Reflex Stop System" allows you to adjust the bass and treble response to suit your individual room acoustics

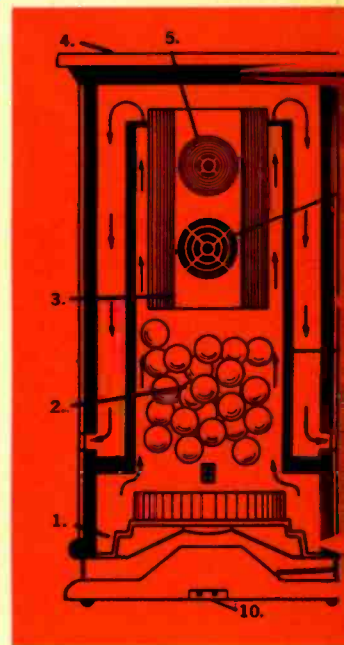

Irresistible beauty from any angle.  
Captivating sound from any position!

Empire's revolutionary die-cast divergent acoustic lens assures fuller frequency and separation, plus broader sound propagation. Lets you sit anywhere—hear everything.

Grenadier placement is non-critical. Phenomenal Stereo Separation and the highest fidelity of music is assured from any area in the listening room. Try this simple test! Walk around the Grenadier. You will experience no change in sound level of the bass, mid-range or highs. Full frequency and separation is assured by Empire's exclusive divergent acoustic lens system.

### MODEL 8000P

Frequency Response: 25-20,000 cps.  
Nominal Impedance: 8 ohms.  
Power Handling Capacity: Music Power—Maximum undistorted 100 watts.  
Sine Wave Power—25-450 cps 60 watts  
—450-5000 cps 40 watts  
—5000-20,000 cps 20 watts  
Components: Woofer—12" High Compliance with 4 inch voice-coll.  
Mid Range—Direct Radiator  
Tweeter—Ultra Sonic Dome Tweeter  
Both Coupled to Die-Cast Acoustic Lenses  
Finish: Satin Walnut finish, hand rubbed.  
Overall Dimensions: Dia. 16". Ht. 29".  
Weight: 85 lbs., \*List Price: \$235.00 with imported marble top. \$225.00 with hand rubbed walnut top.



**EMPIRE**

EMPIRE SCIENTIFIC CORP.,  
245 STEWART AVE., GARDEN CITY, N.Y.  
CANADA: EMPIRE SCIENTIFIC CORP. LTD.,  
1476 EGLINGTON W., TORONTO

The new Empire Royal Grenadier—classically designed, elegantly styled. Let the magic of this wide angle speaker system invade your presence with its majestic sound and richness of tone. Truly, one of the world's greatest speaker systems.



You're on the threshold of a new realm of excitement in music and sound. Empire has created for you, the world's most perfect high fidelity components. Combining unparalleled stereophonic sound with refreshing furniture styling ... the Empire Grenadier—projects a sense of presence never before achieved in a speaker system. Hear it! Compare it! Stare at it! You too, will be captivated by its greatness! The Empire Grenadier, first speaker system designed and engineered for stereophonic reproduction.

No less perfect than the Grenadiers are the Incomparable Troubadors—complete record playback systems.



The famous Empire 398—outstanding! too perfectly engineered for even a whisper of distortion...to handsomely finished to hide behind cabinet doors.

The Empire 498—no larger than a record changer—tailor made for console or equipment cabinets.

The Troubadors consist of the Empire 3 speed professional "Silent" turntable... Empire 980 dynamically balanced arm with sensational dynamic lift... and the new Empire "Living" cartridge, featuring the exclusive magnetic cone stylus. No other cartridge can reproduce the entire musical range as precisely and with such clarity.



Hi Fidelity reports: "The Troubador represents a precision engineered product of the highest quality... the finest, handsomest, record player available."

Hearing it all—a little better than it was intended to be heard. You, too, can enter Empire's new world of sound.

Just go 'round to your Hi Fi dealer for a sound demonstration of the world's most perfect High Fidelity components... Empire Grenadiers, Troubadors and "Living" Cartridges.

CIRCLE NUMBER 108 ON READER SERVICE CARD

High Fidelity reports—"... and what a speaker!" ... voices sounded quite natural with no coloration evident; orchestral music was balanced and full; transients came through cleanly; the organ sounded authentic. Overall, the sonic presentation was excellent; the speaker did not favor one type of instrument or any one portion of the spectrum and it never sounded honky or boxy."

- OUTSTANDING FEATURES**
- 1. 12 inch mass loaded woofer with floating suspension, four inch voice coil and world's largest (18 lbs.) speaker ceramic magnet structure.
  - 2. Sound absorbent rear loading.
  - 3. Die-cast acoustic lens.
  - 4. Imported marble top.
  - 5. Ultra-Sonic domed tweeter
  - 6. Full presence mid range radiator.
  - 7. Damped enclosure.
  - 8. Dynamic Reflex Stop System.
  - 9. Front loaded horn.
  - 10. Complete symmetry of design with terminals concealed underneath.

**Technical Specifications: (Model 9000)**  
 Frequency Response: 20-20,000 cps.  
 Nominal Impedance: 8 ohms.  
 Power Handling Capacity: Music Power—Maximum undistorted 100 watts  
 Sine Wave Power—20-450 cps 60 watts  
 —450-5000 cps 40 watts  
 —5000-20,000 cps 20 watts  
 Components:  
 Woofer—15". High Compliance with 4 inch voice coil.  
 Mid Range—Direct Radiator  
 Tweeter —Ultra Sonic Domed Tweeter  
 Both Coupled to Die-Cast Acoustic Lenses  
 Infinite baffle system.  
 Finish: Satin Walnut finish, hand rubbed.  
 Overall Dimensions: Dia. 22". Ht. 29".  
 Weight: 120 lbs. \*List Price: \$285.00 with imported marble top. \$275.00 with hand rubbed, walnut top.

Decorator designed to complement any decor. Engineered to outperform any other speaker system. Truly the ultimate in sound and styling.

The woofer faces downward, close to the reflecting floor, surface, feeds through a front loaded horn with full circle aperture throat. This provides 360° sound dispersion and prevents standing waves from developing in the room.

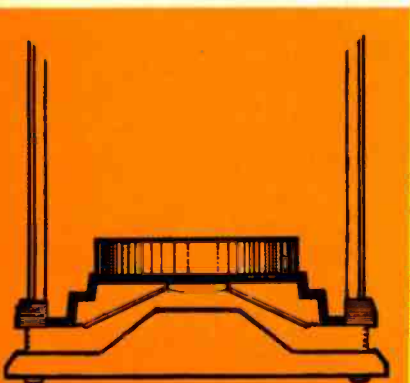

SPECIAL OFFER TO HIGH FIDELITY READERS

**16% DISCOUNT**

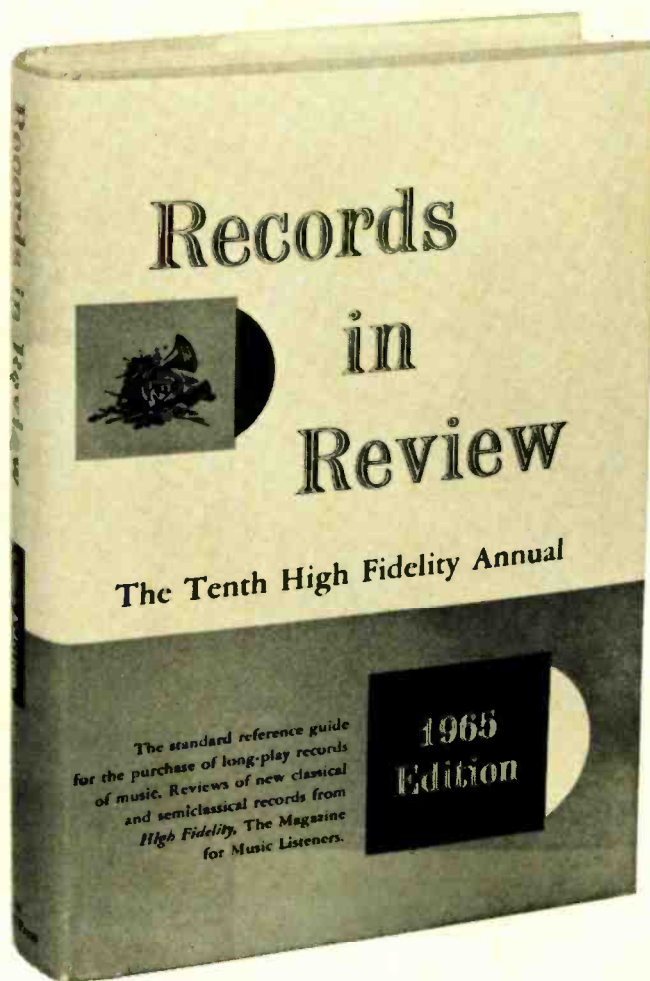

Like its nine predecessors, RECORDS IN REVIEW 1965 Edition brings you in one convenient book hundreds of reviews of records (stereo and mono) which appeared in *High Fidelity Magazine*. This edition reprints reviews that appeared in 1964 – classical and semi-classical music exclusively.

It will save you many hours in your dealer's listening booth or earphone corner. And it will help you build a library of music YOU enjoy, for it is the most complete and authoritative book of its kind – the standard reference work that gains in value as the years roll by.

Each reviewer stands high in his field – Nathan Broder, for example, reviews Bach and Mozart, Alfred Frankenstein the moderns . . . Paul Affelder covers the romantics, Robert C. Marsh specializes in Haydn and Beethoven . . . Conrad L. Osborne writes on opera recordings. Forthrightly, they discuss the composition, performance and fidelity. And they compare new recordings with earlier releases.

You'll find the reviews organized alphabetically by composer for quick, easy reference – and in the case

of composers frequently recorded, further subdivided by such categories as Chamber Music, Vocal Music, etc. You'll find, too, a special section on Recitals and Miscellany. And an Artists' Index.

Saturday Review comments: "Comprehensive coverage of each year's recordings gives a surprisingly well-rounded picture of what's available on records, and most reviews describe the work as well as the performance, providing each annual with a permanent use."

Chicago Tribune states: "The record collector who is bewildered by the sheer number of discs which are issued each year will find this book valuable as a means of bringing order out of chaos."

This hardcover book of 482 pages bears a cover price of \$8.95.

But as a High Fidelity reader, for the next 60 days you may have a copy for only \$7.49. Payment with order but satisfaction guaranteed or your money back. Write to Wyeth Press, A Division of High Fidelity, Publishing House, Great Barrington, Mass. 01230. Dept. E.



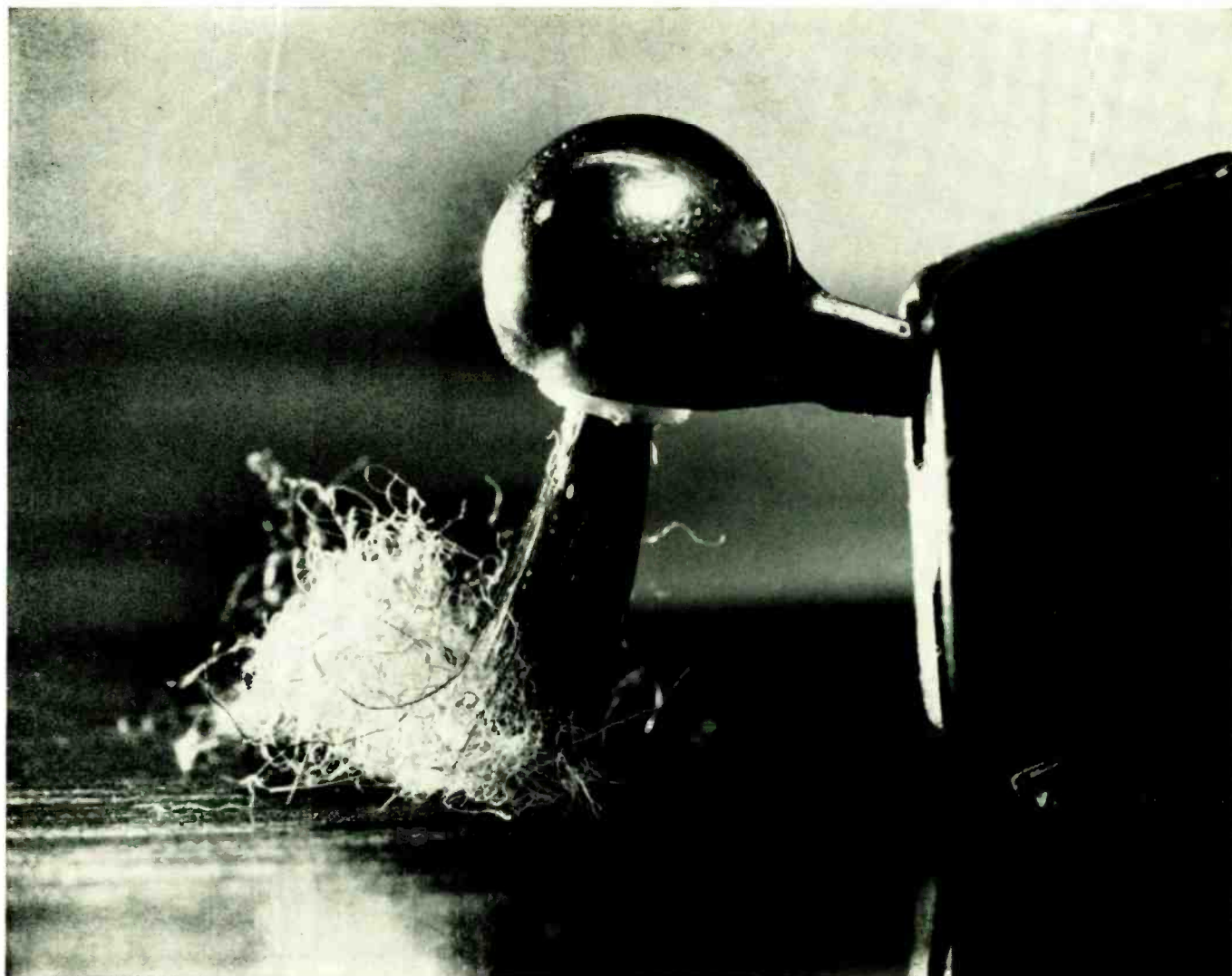

You are looking at the world's only true **longhair** cartridge.

In this unretouched photograph, the long, black hair of the brush built into the new Stanton 581 is shown in action on a rather dusty record. Note that all the loose lint, fuzz and dust are kept out of the groove and away from the stylus. That's why the Longhair is the ideal stereo cartridge for your Gesualdo madrigals and Frescobaldi toccatas. Its protective action is completely automatic, every time you play the record, without extra gadgets or accessories.

The stem of the brush is ingeniously hinged on an off-center pivot, so that, regardless of the stylus force, the bristles never exert a pressure greater than 1 gram and always stay the right number of grooves ahead of the stylus point. The bristles provide just the right amount

of resistance to skating, too.

But even without the brush, the Stanton 581 Longhair is today's most desirable stereo cartridge. Like its predecessors in the Stanton Calibration Standard series, it is built to the uniquely stringent tolerances of Stanton professional audio products. Its amazingly small size and light weight (only 5 grams!) make it possible to take full advantage of the new low-mass tone arms. And its frequency response is factory calibrated within 1 db from 20 to 10,000 cps and within 2 db from 10,000 to 20,000 cps. Available with 0.5-mil diamond (581AA) or elliptical diamond (581EL); price \$49.50.

For free literature, write to Stanton Magnetics, Inc., Plainview, L.I., N.Y.

**Stanton**

CIRCLE 76 ON READER-SERVICE CARD

## NOTES FROM OUR CORRESPONDENTS

*Continued from page 16*



*give your music  
the silent treatment*



**MODEL TR-707A**

There's nothing quite so annoying as having somebody talk during a performance. Even if that performance is preserved on tape or record. By the same token, humming and other noises are just as irritating — particularly when they come from your tuner/amplifier.

Transistors eliminate these disturbances to some extent. But not all receivers so equipped have what it takes to give your music the silent treatment it deserves.

That's why Sansui has come out with the TR-707A, a solid-state AM-FM multiplex stereo tuner-amplifier that may be just what you need if you're looking (and listening) for that little bit extra.

Like the muting switch that suppresses noise during channel selection. Or the center-channel output terminal that makes three-dimensional performance possible. Add to these two features a built-in ferrite antenna and four ultra-accurate class free transistors and you have a set that produces music and music only.

The Sansui TR-707A is worth your undivided attention, so keep your ears and eyes open for when your local dealer has one in stock.

**SANSUI**

SANSUI ELECTRIC COMPANY LIMITED 460 IZUMI-CHO, SUGINAMI-KU, TOKYO, JAPAN  
DISTRIBUTORS: ●CANADA: INTER-MARK (CANADA) LTD. 298 Bridge-land, Toronto 19, Ontario, Canada. ●SOUTH AFRICA: GLEN'S (PTY) LTD. P.O. Box 6406 Johannesburg, Republic of South Africa. ●HONG KONG: WO KEE HONG LTD. Rm. 807, Hang Seng Bank Bldg., 77 Des Voeux Road, Central, Hong Kong. ●EUROPE: AD. AURIEMA—EUROPE S.A. ELECTRONICS HOUSE. 172a, Rue Brogniez, Bruxelles 7, Belgium.

humor. Interestingly, this combination of dedicated earnestness and youthful zest is shared by the even younger artist cellist Jacqueline Du Pré [see "Notes from London," in these pages last month], and it is particularly fitting that the two regularly perform duos together. Following Bishop's solo sessions, EMI will be recording them in complete Beethoven cello sonatas. (Another partner of Bishop is the young pianist Vladimir Ashkenazy, an expatriate from the U.S.S.R. now also resident here. The combination is exciting and unexpected, but when you think about it they have much in common, each gravitating to London, one from the East, one from the West.)

When Bishop talked about his recording experiences, his first words were in tribute to EMI's Kinloch Anderson, who supervised the Beethoven sessions. The pianist has his own very clear ideas of interpretation, and he felt that Anderson had helped to draw them out. To Bishop's surprise, the fast movements were taped to his satisfaction more readily than the technically less demanding passages. Even the long and exacting final fugue of Opus 101 was completed in under an hour, whereas some of the slow movements required many takes before the performer was content with the results. Bishop is acutely analytical of his own reactions during playing: he discovered that in recording sessions he became sensitive to minute variations in the timbre of the piano to an extent inconceivable in the concert hall.

**New Labels, New Prices.** In Britain, at least, the record will come out on a new label being inaugurated by EMI to bridge the gap between full premium-price discs and bargain labels (resale price maintenance still lingering on in Britain). As well as featuring such outstanding young performers as Bishop and Du Pré, the new series will also include re-pressings of such classic opera sets as the Furtwängler/Flagstad *Tristan und Isolde* and the earlier De los Angeles *Butterfly*.

EMI is also linked with another venture in the bargain field, this to be called "Music for Pleasure." The title was invented by the brilliantly successful young book publisher Paul Hamlyn, who has in recent years revolutionized the marketing of books and gone a long way towards revolutionizing record marketing too. As I wrote in this column last winter [February 1965], Hamlyn imports Czech Supraphon albums, which he markets, at a very modest price, not only through conventional trade outlets but in bookshops and drugstores. "Music for Pleasure" discs will be handled in the same way, but the price will be even lower—12s 6d, or roughly \$1.50. The repertory will be entirely from EMI sources—mainly Capitol, to judge by the

*Continued on page 24*

CIRCLE 68 ON READER-SERVICE CARD

HIGH FIDELITY MAGAZINE

# SOMEDAY, THERE MAY BE OTHER FULLY AUTOMATIC TAPE RECORDERS LIKE THE NEW CONCORD 994



The 994 gives you automatic reversing  Plays or records automatically three different ways  Stops by itself where you want it to  Threads itself automatically  And, the 994 is available now!

With the transistorized 994, Concord introduces a new dimension to tape recording. Some might call it modernization, some might call it automation. We think of it as *convenience*—in playing, in recording, in starting and stopping, in threading, in hours of uninterrupted listening. You can't compare it to anything because the 994 is as different from the conventional stereo recorder as the old crank-type Gramophone is from the modern record changer.



**AUTOMATIC PROGRAMMING.** You can program the 994 to play or record one side of a tape from beginning to end and stop automatically. Or, to play/record first one side of the tape, reverse, play the other side, then stop automatically. Or, to play/record forward and back, forward and

back, continuously, as long as you like—an hour, six hours, or all day. You may change direction of tape any time you like by merely pressing the direction change buttons. These same lighted buttons automatically show you direction of tape travel.

**PUSH-BUTTON KEYBOARD.** The operating controls are literally at your fingertips. This is the one recorder you can operate without arm waving, and with one hand! As far as threading, that's even simpler—the 994 threads itself automatically.



After all this, we didn't just stop in designing the 994. We kept going. As a result, the 994 offers superb performance and every conceivable feature required for your listening and recording pleasure. Here's a brief sample: three speeds with automatic equalization, four professional heads, two VU meters, digital tape counter, cue control, sound-on-sound, exclusive Concord Trans-A-Track recording, 15-watt stereo amplifier, professional record/monitoring system. The 994 may also be used as a portable PA system, with or without simultaneous taping.



**TWO-WAY STEREO SPEAKERS.** The split lid of the 994 houses a pair of true two-way speaker systems, each containing a tweeter, woofer, and crossover network. A pair of highly sensitive *dynamic* microphones is included.



The 994 is priced under \$450.\* An identical recorder, Model 990 comes without speakers or microphones and is priced under \$400.\* Both are at your dealer's now. So why wait? Drop in for a demonstration and find out for yourself what *fully automatic tape recording by Concord* is all about! Or, for complete information, write Dept. HF-12

For Connoisseurs of Sound

Other Concord models from \$50 to \$800.

# CONCORD 994

CONCORD ELECTRONICS CORPORATION, 1935 Armacost Avenue, Los Angeles, California 90025  
IN CANADA: Magnasonic Industries, Ltd., Toronto/Montreal

\*Prices slightly higher in Canada.

THE SIGNATURE OF QUALITY ■ Tape Recorders/Industrial Sound Equipment/Dictation Systems/Communications Devices/Closed Circuit Television

CIRCLE 21 ON READER-SERVICE CARD

DECEMBER 1965

23

**HARRY DAVIDSON  
♥ LOVES KOSS  
STEREOPHONES**



Harry's a cliff dweller on Chicago's North Side. He loves his music at volume levels the neighbors wouldn't be happy about. With Koss Stereophones, he can hear the New York Philharmonic as loud as he pleases. Not only do the neighbors not hear, but he doesn't even disturb his family in the same room! That's because Koss Stereophones are for personal listening.

And sound? Well, just ask your dealer for a demonstration and you'll understand what we mean when we describe it as breathtaking.



**NEARLY  
EVERYBODY  
LOVES KOSS  
STEREOPHONES**

**KOSS REK-O-KUT**

2227 N. 31st Street • Milwaukee, Wisconsin 53208

CIRCLE 48 ON READER-SERVICE CARD

**NOTES FROM  
OUR CORRESPONDENTS**

*Continued from page 22*

first release list. The records will be pressed by EMI to the same technical standards as the more expensive product and, in the case of the older recordings, will be reengineered for stereo. Hamlyn gets a big new catalogue: EMI gets an enormously expanded outlet for dozens of records previously deleted. What could be better on both sides? Some people shake their heads about the possibility of such rock-bottom prices breaking the market for the premium article, but the trade still seems very buoyant. EDWARD GREENFIELD

**PARIS**

Among the several good local chamber orchestras which have sprung up in France since World War II, that of the City of Rouen is unusual in being very young, very local, and very good. It was created in 1963 on the initiative of its conductor, Albert Beaucamp, an energetic Rouen organist, composer, professor, choirmaster, and chief musical citizen who is also head of the local conservatory (he created that too, in 1945, when he was only twenty-four years old).

The dozen members of the ensemble include a Belgian, a Chinese, a Yugoslav, and some Parisians with first prizes from the National Conservatoire, all chosen on the basis of competitive examinations. All are required by their contracts to live in Rouen, and it is understood that they will give their full time to the orchestra (rehearsals are theoretically unlimited; salaries, paid by the city, are high enough to make outside work unnecessary). Those musicians who need them are provided with old violins of exceptional quality. The city has also invested in some collections of music not generally available, and expects each concert to include at least one work never performed before in Rouen. As the capital of an important province, it also expects the orchestra to give at least ten concerts elsewhere in Normandy.

The results of such an intelligent policy can be heard on two discs just released here by Philips. One is devoted to Purcell, Lully, W. F. Bach, and Corelli. The other is devoted to Telemann suites, and includes the *Don Quixote*. In listening to a tape of the latter in one of Philips' Paris studios, I was especially taken by Beaucamp's version of the gallop of Sancho Panza's ass. And I left with a serious hunch that Rouen has found a remedy for some of France's national musical ailments.

Rameau and Sonatas. The same tape-sampling session offered excerpts from two other forthcoming Philips records. On one of them Marcel Couraud con-

*Continued on page 26*

HIGH FIDELITY MAGAZINE

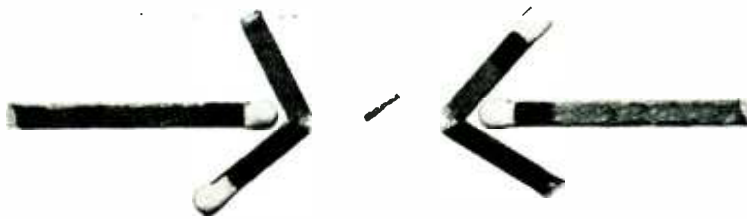

# This is all that moves in the new ADC 10/E cartridge

We figure it costs you roughly \$49,000 a lb.

You'll probably never buy anything man-made as costly by weight as this tiny, incredibly rugged moving stylus of the new ADC 10/E cartridge.

It reduces "moving mass" to about *one-third* that of the best magnetic cartridges.

Moving mass (the weight or inertia of the total moving system as felt at the stylus tip) is what your record has to push around. The groove must move it in one direction, stop it, then push it another direction—thousands of times a second.

Even a few milligrams of moving mass set up such tremendous forces that the record groove *yields* as the stylus passes. . . . So even on the very first play, you hear a distorted groove, not the groove that was pressed in. Now, by a major jump forward in de-

sign, the ADC 10/E reduces moving mass well *below* the critical point of groove yield. Result: for the first time ever, you can hear the actual record you bought . . . on the first play, or the 500th. (Wear is negligible.) Listen to a complex passage, piano, operatic or choral selection, and you hear the difference. You get clarity, brilliance, reality and definition never obtained before. At long last, true "clean-ness"!



How good is the new ADC 10/E? By any test, lab or listening, it is so perfect that any improvement would be pointless. For the first time it can be said: no one will ever make a cartridge that performs perceptibly better.



This actual photo of the moving parts of these popular cartridges contrasts dramatically the much lower "moving mass" of the new ADC 10/E.

## SPECIFICATIONS — ADC 10/E

Type	Induced magnet
Sensitivity	4 mv at 5.5 cms/sec re-recorded velocity
Channel separation	30 db, 50 to 10,000 cps
Frequency response	10 to 20,000 cps. $\pm 2$ db
Stylus tip	Elliptical Stylus Contact radius—.0003" Lateral radius—.0007"
Vertical tracking angle	15°
Tracking force range	1/2 to 1 1/4 grams
I.M. distortion	Less than 1% — 400 & 4,000 cps at 14.3 cms/sec velocity
Compliance	$35 \times 10^{-4}$ cms/dyne
Price	\$59.50

## AUDIO DYNAMICS CORPORATION

Pickett District Rd., New Milford, Conn.



CIRCLE 10 ON READER-SERVICE CARD

## NOTES FROM OUR CORRESPONDENTS

Continued from page 24

ducts the Lamoureux Chamber Orchestra in suites from Rameau's *Indes galantes* and *Les Surprises de l'amour*. On the other, flutist Roger Bourdin, of the Versailles Conservatoire faculty, and harpist Annie Challan (who also unearthed some of the music in the manuscript section of the Bibliothèque Nationale) play sonatas and charming bagatelles by Telemann and such rarely heard composers as Nicholas Bochsa, Leonardo Vinci, and Karl Friedrich Abel. Bochsa, although he was Napoleon's and Louis XVIII's court harpist, a world-touring virtuoso, and the inventor of the modern technique for his instrument, is perhaps more interesting as a scoundrel than as a musician. He fled his native France after some monumental financial forgeries in the names of Méhul, Boieldieu, and the Duke of Wellington. In London he became a famous conductor, and bigamist, and stole the wife of Henry Bishop, composer of *Home, Sweet Home*.

**Vivaldi in St. Mark's.** While the French branch of Philips has been recording French musicians at home, the Dutch office has embarked on some far-flung operations. One was the recording, in the Basilica of St. Mark in Venice, of Vivaldi's Gloria in D major, *Salve Regina* in C minor, Magnificat in G minor, and Te Deum in D major. The chorus and orchestra of La Fenice are conducted by Vittorio Negri, who also revised the unpublished manuscripts of the Te Deum and *Salve Regina*. The soloists are soprano Agnes Giebel and contralto Marga Höffgen. The disc coupling the Magnificat and Te Deum should be available in the United States shortly; you may have to wait a while for the companion set.

I was told that this project involved much besides the problems of Vivaldi's music per se. Tons of equipment had to be transported by canal. The sessions had to be held at night, after the tourists had left the building. Quiet didn't settle in then, either: performers and recording crew had to be patient until the café orchestras in the piazza outside had stopped playing Strauss waltzes.

**More Roussel.** The revival of interest in Roussel, mentioned in this space a few months ago, continues to hold its own, both in French concert halls and in recording studios. Charles Munch and the Lamoureux Orchestra, whose recording of the Third and Fourth Symphonies for Erato has just been released in Paris, has now taped the composer's Suite in F, Op. 33. On the overside will be Henri Dutilleux's Second Symphony. Another Munch-Lamoureux disc for Erato will be cello concertos of Lalo and Saint-Saëns (No. 2), with André Navarra as the soloist. At the moment, arrangements for American distribution of these interesting items have not been made.

ROY McMULLEN



A ceramic cartridge  
in a system like this?

 Absolutely!

The new Sonotone Velocitone Mark IV has everything the finest magnetic cartridges have, including compliance of  $15 \times 10^{-6}$  cm/dynes in all directions. Tracks at the low forces required by professional turntables. The Velocitone Mark IV is also ideal for changers.

It offers advantages not possible with magnetic cartridges—a virtually indestructible stylus, the SONO-FLEX®; freedom from magnetically-induced hum. Factory-matched equalizers plug into any magnetic input. With dual diamond styli, \$27.75 Sugg. list; diamond/sapphire, \$23.15 Sugg. list.

**Sonotone** Corporation, Electronic Applications Division, Elmsford, New York  
CIRCLE 74 ON READER-SERVICE CARD

## FOR CHRISTMAS

# GIVE THE "NEW" HIGH FIDELITY

HIGH FIDELITY/MUSICAL AMERICA Edition, our "new" publication, includes everything you find in HIGH FIDELITY plus two big features—

—32 more pages per month most of which focuses on news and reviews of operas and concerts throughout the world and some of which offers revealing chit chat about concert artists.

—a 13th issue of about 400 pages, the Concert Artist Booking Issue, which includes fascinating information about artists, managers, concert auditoriums, orchestras, etc. sure to delight and inform anyone interested in the world of serious music. Cover price for this issue alone—\$5.

You may send a one-year subscription of HIGH FIDELITY/MUSICAL AMERICA Edition anywhere in the world for only \$9. Order two subscriptions for only \$16. After that—only \$6. each. We will announce your gift with an attractive card.

Why not include for yourself a present of the "new" HIGH FIDELITY/MUSICAL AMERICA Edition? If you are now getting the regular edition of HIGH FIDELITY, we'll transfer the remaining issues due you at no extra charge providing you let us know when you send us your order with your payment. Send to HIGH FIDELITY/MUSICAL AMERICA, 512 Publishing House, Great Barrington, Mass. 01230.

# At last! A solid-state amplifier as great to listen to as it is to talk about.



The relatively young technology of transistor circuits has resulted in quite a number of solid-state amplifier designs that sound better on paper or in conversation than in listening tests. It seems that producing a no-compromise transistor amplifier which equals or surpasses the performance of comparable vacuum-tube models demands a special kind of engineering ability and experience. The Fisher kind.

Fisher solid-state amplifier design begins with the elimination of the output transformers. Thus, the bass performance and transient response of the new Fisher TX-200 stereo control-amplifier are not limited by transformer characteristics. And instead of the conventional two output transistors per channel, Fisher engineers put in *four*, to give you conservative operation at high power.

Not only can the rated power of 90 watts (IHF Stan-

dard) be obtained at 8 ohms, but almost as much power is available at 4 or 16 ohms, via the special impedance-selector switch. The IHF power bandwidth (half power at low distortion) extends from 12 to 50,000 cps!

As for preamplifier and control features, the TX-200 provides 16 inputs and 12 outputs to accommodate every type of program source, recording instrument, loudspeaker or headphone — plus 16 controls and switches for total control of the sound by the listener.

And, unlike certain hastily engineered transistor amplifiers, the TX-200 works equally well after three hours, three months, or three years. That's Fisher reliability. And that's *really* something to talk about.

Size: 15-1/8" x 4-13/16" x 11-7/8" deep. Weight: 24 lbs. Price: \$279.50. Cabinet: \$24.95. (The Fisher TFM-200, a transistorized tuner designed to match the TX-200, costs \$229.50.)

**THE NEW  
FISHER  
HANDBOOK**



For your free copy of this 80-page book, use coupon on magazine's cover flap.

FISHER RADIO CORPORATION, INC., 33-34 49TH ROAD, LONG ISLAND CITY, N. Y. 11101 OVERSEAS AND CANADIAN RESIDENTS PLEASE WRITE TO FISHER RADIO INTERNATIONAL, INC., LONG ISLAND CITY, N. Y. 11101.

## The Fisher TX-200

CIRCLE 35 ON READER-SERVICE CARD



## A HARVEST OF HOSANNAS

The current crop of Christmas records ranges from the twelfth century to our own and yields some unusual and delectable fare.

**F**ROM St. Godric to Benjamin Britten, this year's flood of new Christmas records will surely offer a carol or two for all tastes and Yuletide music to complement all holiday activities. Space limitations preclude detailed consideration of all the new releases, but here are some of the highlights.

Just issued by Vanguard, whose repertoire of fine Christmas recordings is already embarrassingly rich, is "Christmas Carols and Motets of Medieval Europe," sung by the Deller Consort, Alfred Deller, director, and played by the Musica Antiqua led by Dr. René Clemenčič (Bach Guild BG 680; BGS 70680). The album title is somewhat of a misnomer since a good deal of the music stems from the Renaissance and very little of it can be classified as either carols or motets; even the connection with Christmas is sometimes tenuous. Never mind that, though; the beauty of the music and the authentic and sensitive performances offer their own excuses—this is a superb release. The program strikes a good balance between the familiar (Palestrina's *Hodie Christus natus est*, Isaac's *Puer natus est*, John Dunstable's *Sancta Maria*) and works by less frequently heard composers (including some anonymous Mass fragments and works by Fogliano, Escobar, Byttering, Ciconia, Stolzer, Senfl, and Power). One particularly intriguing selection is the monodic hymn *Crist and Sainte Marie*, written in the mid-twelfth century. Legend tells us that this hymn was sung to the Saxon hermit St. Godric by the soul of

his dead sister in response to his prayerful inquiries of her fate in the other world.

Also from Vanguard is an attractive collection of Czechoslovakian and Polish Christmas songs, sung by the Children's Chorus of Radio Prague with the Ensemble Pro Arte Antiqua, Dr. Bohumil Kulinski conducting (VRS 1114; VSD 71144). The approach here is happily devoid of the cloying cuteness often characteristic of such programs. All the charm and spontaneity of these folk tunes are delightfully preserved by the young singers, and the arrangements display considerable ingenuity. The rather monotonous timbre of the chorus (a built-in limitation with any children's choir) is here offset by a variety of piquant accompaniments utilizing the organ, recorders, bagpipe, glockenspiel, gambas, harpsichord, and triangle.

From England comes a live recording of last year's Christmas Eve service in King's College Chapel, Cambridge, directed by David Willcocks (Argo RG 450; ZRG 5450). The Festival of Lessons and Carols is a forty-five-year-old tradition at the College. Nine Lessons are read by members of the College—beginning with the First Lesson read by a choirboy, the second by a choral scholar (a college undergraduate or junior-graduate), and so on up to the Vice-Provost—and interspersed among them are carols sung by the choir and hymns in which the entire congregation takes part. The service is a beautiful one,

*Continued on page 30*





**1.** The new Fisher XP-5A makes 'compact' a description of size rather than of performance. Its full, solid bass is very close to that of the largest speaker systems. Naturally. No 'boosting' networks which eat up amplifier power and destroy transients. Instead, Fisher engineers designed an unprecedented woofer for the XP-5A: an 8" driver with a totally new suspension system, plus a 1 1/4"-diameter voice coil wound on an aluminum former. Free-air resonance is an incredible 25 cps.



**2.** At the heart of the woofer is this massive magnet structure weighing 3 pounds.



**3.** Complementing the unique new woofer is an equally advanced tweeter. It has a new low-mass cone made of a combination of fibrous material plus a special polyurethane foam, resulting in smooth, peak-free response out to 20,000 cps, without coloration.



**5.** When baffled, enclosed and damped with AcustiGlas packing, the XP-5A provides fundamental bass response down to 34 cps without doubling. And handles transients as if they were sine waves.



**4.** Low-loss air-core inductors are used in the LC-type crossover network.

# At last! A small speaker that can handle the big amplifiers!

Of course, the new Fisher XP-5A also works perfectly with low-power amplifiers. But it is the *first* ultracompact loudspeaker of Fisher quality which will handle up to 30 watts of program material and take the big powerhouse amplifiers in its stride. And the power is delivered to the listener, not devoured in the speaker. The Fisher XP-5A will satisfy even the most demanding audio perfectionist who has limited space. It is an outstanding value at \$59.50 in oiled walnut, \$54.50 in unfinished birch. Size: 20" by 10" by 9" deep.

For a free copy of the 80-page Fisher reference guide to high fidelity, use card on front cover flap.



## The Fisher XP-5A

FISHER RADIO CORPORATION, 15 ... 31 31 4TH ROAD, LONG ISLAND CITY, N.Y. 11101. OVERSEAS AND CANADIAN RESIDENTS PLEASE WRITE TO FISHER RADIO INTERNATIONAL, INC., L. N. 111 4TH AVE. CITY, N.Y. 111 11.

CIRCLE 35 ON READER-SERVICE CARD

[www.americanradiohistory.com](http://www.americanradiohistory.com)



MODEL 606-D  
stunning all-in-one stereo component center

Our new collection is now available . . .

equipment cabinets • speaker enclosures • consoles • cabinets galore. Danish and Provincial styles in new decorator finishes.

see your dealer or write for free brochure



MODEL 303D  
for the "bookshelf speaker" and components

## A HARVEST OF HOSANNAS

Continued from page 28

the readings are uncommonly well done, and the carols, nicely performed by the choir, are all fresh and un-hackneyed, including several by contemporary British composers. Three Lessons have been omitted in order to contain the service on two LP sides; all of the music is there, however. Those who have heard the Argo recordings of this service from 1954 and 1958 know that there can be no finer way to spend Christmas Eve than in the King's College Chapel. The recording is excellent and stereo effectively captures the Chapel's unique acoustics; the text of the entire service—Lessons, carols and hymns—is included.

The perfect supplement to Argo's Christmas Eve service is a new Angel record again featuring the King's College Choir, in this case with a collection of Renaissance choral works entitled "The Nativity to Candlemas" (36275; S 36275). One interesting feature of this well-sung program is the inclusion of several different settings of the same text: *Hodie Christus natus est* by Palestrina and by Sweelinck, *Hosanna to the Son of David* by Gibbons and Weelkes, and *Senex Puerum portabat* by Victoria and Byrd. The sound on the mono copy was first-rate; the stereo (unfortunately not available at press time) should go even further in re-creating Wordsworth's description of the Chapel's acoustics: ". . . branching roof,/Self-poised and scooped into ten thousand cells./Where light and shade repose, where music dwells/Lingering—and wandering on, as loath to die. . . ."

Another disc of choral music, entitled "In dulci júbilo" and sung by the Monteverdi Choir of Hamburg, under Jürgen Jürgens (Telefunken AWT 9409-C; SAWT 9419-B), presents a varied assortment of medieval, Renaissance, and baroque Christmas music from Ockeghem to Buxtehude. The choir is a fine group, capable of turning out lovely molded lines, and, when the occasion demands, of infusing the music with an infectious gaiety (especially in the anonymous eighteenth-century *Noël*). Appropriately enough, the *In dulci júbilo* text is heard in three different settings: by Scheidt, Buxtehude, and Paminger, and the choir neatly projects the stylistic variations of each.

For a purely instrumental approach to Christmas, organist Carl Weinrich, playing on the organ at the General Theological Seminary in New York City, offers a recital of "Christmas Music of the Baroque" (RCA Victor LM 2820; LSC 2820). Side 1 includes Christmas choral preludes, fantasies, and postludes by Buxtehude, Pachelbel, Sicher, and Schlick and the tenth *Noël* from Daquin's *Nouveau Livre de Noël's*, Op. 2 (a collection of variations on French carols). Side 2 contains the first fourteen chorale preludes of Bach's *Orgelbüchlein*, all based on chorales relating to Advent and the Nativity. Weinrich's registrations and

performances are modest and straightforward, and he is content to let these polished little gems shine in their own light.

Nor has St. Nicholas forgotten the opera fan—Joan Sutherland stars in a group of familiar carols and hymns, all done up in superslick arrangements for choir and orchestra by Douglas Gamley (London OL 5943; OS 25943). Richard Bonyngé conducts the New Philharmonia Orchestra, and the Ambrosian Singers join in on the refrains. Most of the carols are thrice-familiar, but I still imagine that most people would enjoy hearing more of the words than are possible as one strains to catch Miss Sutherland's muffled diction. Be that as it may, the performances are impeccable (save for an annoyingly droopy *It Came Upon the Midnight Clear*); the decorations, superbly executed as usual, are kept to a tasteful minimum; and the burnished beauty of the singer's voice has perhaps never before been displayed so gorgeously as on that horrid old chestnut *O Holy Night*. The arrangements are on the whole apt and complement the tone of each carol: trumpet and drums for *Joy to the World*, an intimate chamber atmosphere with harpsichord continuo for *Good King Wenceslas*, throbbing strings for Gounod's *O My Redeemer*, and a roaring, cymbal-crashing, old-fashioned Meyerbeer finale for *Adeste Fideles*.

Among contemporary composers few have done more for Christmas than Benjamin Britten. From Argo (RG 440; ZRG 5440) come three of his choral pieces, the pride of place being given to the evergreen *Ceremony of Carols*. The chorus here is the Children's Choir of St. John's College, Cambridge. George Guest director with Marisa Robles on the harp. Although the boys are not always the most exact in this music (the wickedly difficult close canon on "This Little Babe" is rather ragged), their fresh-scrubbed spontaneity is preferable to the brilliantly precise but oversophisticated work by the ladies of the Robert Shaw Chorale (RCA Victor LM 2759 or LSC 2759, a disc which somehow escaped HIGH FIDELITY's attention when it was released last year). Britten's sure sense for selecting exactly the right text is once more demonstrated in these lovely old carols, which he has adapted with all his familiar skill and unflinching musical response. The same is true for the two items on Side 2. *Rejoice in the Lamb* (also on the Shaw disc) and the *Missa brevis*. *Rejoice in the Lamb* is set to an extraordinary text by the eighteenth-century poet Christopher Smart, written while he was an inmate of an asylum. Britten somehow conveys the strangely moving imagery in the simplest and most beautiful terms. The performances again are exemplary, suggesting that England's supply of first-rate choral organizations is virtually limitless.

CIRCLE 11 ON READER-SERVICE CARD

# When these EMI loudspeakers speak... people listen!

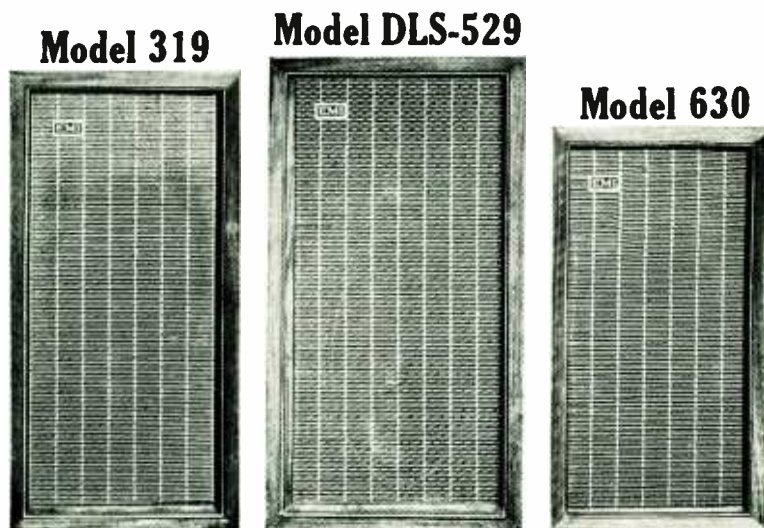

There are two ways to buy a loudspeaker. Take the one you're being sold. Or listen, and let your ears do the choosing. We recommend the latter because we have no fear of the inevitable judgment of your ears.

If anything, we fear the perfection of our loudspeakers. Their transient-perfect sound reproduction can be "dangerous" because it exposes the flaws in other components used with them.

But it is this same perfection that makes EMI loudspeakers reproduce music like you've never heard it before. Vital and alive. Smooth and balanced. Whether the volume is played at a shout. Or a whisper. You'll think you're at the actual performance.

That's the kind of realism you get from an EMI loudspeaker.

If one listen is worth a thousand words, these three EMI speakers are sure to leave you speechless.

CIRCLE 31 ON READER-SERVICE CARD

They speak for themselves. In performance, popularity and prices. The DLS-529 is \$159.00. The 319 is \$99.75. And the 630 is \$69.75. Other models range from \$49.95 to \$395.00\*. And they're all *dangerous*.

*\*All prices slightly higher in South and West.*

**EMI / SCOPE**  
Scope Electronics Corporation, 235 East 42 Street,  
New York, N.Y. Also available in Canada.

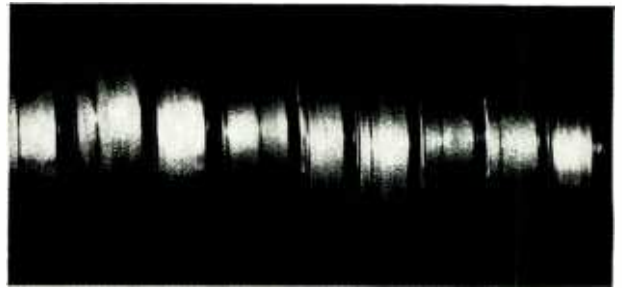

**"Holiday for Orchestra!"** Percussion, Brass, Woodwind, and String Choirs of the Philadelphia Orchestra, Eugene Ormandy, cond. Columbia MS 6757, \$5.79 (SD).

"Holiday for an Arranger" might have been an apter title for this program, since it is devoted to Arthur Harris' special showpiece scorings for various orchestral choirs—and it's obvious that Mr. Harris revels in his work. The showy arrangements of *Camptown Races* and *When Johnny Comes Marching Home* feature the Philadelphia's brass players, not excluding the fine tuba-ist. A *Sailors' Hornpipe*, Paderewski Minuet in G, and Rameau *The Hen* star, rather more imaginatively, the woodwind section. Benjamin's *Jamaican Rumba*, Debussy's *Prelude General Lavine—Eccentric*, and Harris' own *March of the Mandarins* feature the percussionists (who are by no means silent elsewhere either). The incomparable Philadelphia strings are heard at their lushest in the *London-derry Air* and at their zippiest in Rimsky's *Flight of the Bumblebee*. And the program concludes, perhaps anticlimactically, with a full-orchestral *March of the Dwarfs* by Grieg.

Needless to say, the playing is bravura throughout, and the recording (apparently varied in miking setups to make the most of each choir featured) is both ultrabrilliant and ultrastereoistic. It seems to me, though, that Harris—like many other ingenious orchestrators—tries too hard to provide novel effects, often in such profusion that they tend to cancel out each other's effectiveness. But for some audiophiles, as for Oscar Wilde, perhaps nothing succeeds like excess—and the disc certainly offers a fabulous variety of instrumental timbres displayed in adroitly enhanced power, piquancy, and persuasiveness.

**"Encores for Orchestra."** Pro Arte Orchestra, Charles Mackerras, cond. Vanguard Everyman SRV 178, \$1.98 (LP); SRV 178SD, \$1.98 (SD).

For this bargain-priced collection of symphonic showpieces, Mackerras has selected well-varied materials, each decidedly effective in its individual way: Falla's *Three-Cornered Hat* dances, Weinberger's Polka and Fugue from *Schwanda*, Smetana's *Bartered Bride* Overture, and the Overtures to Donizetti's *Daughter of the Regiment* and *Don Pasquale*. But while the conductor's readings are consistently vital and precise, I feel that his Pro Arte Orchestra isn't quite large or refined enough (the flatulent brass qualities are particularly disturbing) to do the music full justice.

Furthermore, the stereo recording, for all its clarity and vividness, is handicapped both by some rather unnatural spotlighting of solo (especially percussion) instruments and by an unduly dry acoustical ambience. (I should add that these performances first appeared in a series of British Pye EPs in 1959.) Yet despite the disc's failure to meet the highest executant and engineering standards, it provides a maximum of high musical spirits at a minimum cost.

**"Ship of Fools' Music (Composer's Symphonic Score)." Boston Pops Orchestra, Arthur Fiedler, cond. RCA Victor LSC 2817, \$5.79 (SD).**

For the sake of realism, the original *Ship of Fools* sound track was scored almost exclusively for a salon trio of the type so often heard on shipboard, playing purported transcriptions of song and dance tunes popular on the eve of World War II. Here its creator, Ernest Gold (he of *Exodus* fame), supplies on special commission from the Boston Pops what might have been the full-orchestral originals of supposed paraphrases. These do indeed evoke the characteristic idioms and moods of their period, but they are often far more distinctively individual than the notion of paraphrases might suggest. They are also admirably varied—from such lush mood music as the Love Theme and swirling *Candlelight and Silver* and *Party Favors* Waltzes to a cheerful *Heute Abend*, rowdy *Charleston for an Old Fool*, and, in *Bremerhaven Welcomes You*, an almost frighteningly accurate parody of a Teutonic band piece. Fiedler and the Bostonians of course make the most of the opportunities for both bravura and schmaltz, as do the Dynagroove engineers in providing outstandingly big and vivid yet warmly authentic sonics. The technically excellent 4-track tape transfer (FTC 2203, 38 min., \$7.95), by the way, is

processed at a considerably lower modulation level than the stereo disc, which complicates the problem of deciding whether the tape's highs are quite as ultrabrilliant as those heard here; I doubt that they are.

**"Magnificent Movie Themes." Enoch Light and His Light Brigade. Command RS 887, \$5.79 (SD).**

The present Light program of film score hits probably isn't the last we'll have in the conductor/promoter's Command legacy—he has recently departed from that company—but it certainly is representative of his finest display performances and recordings. Except for a very few lapses, arranger Lew Davies has avoided overfanciness and yet has come up with some of his most imaginative scorings. These feature the harpsichord of Dick Hyman (particularly effective in the Theme from *The Amorous Adventures of Moll Flanders*), the harp of Robert Maxwell, guitar of Tony Mottola, and (in a too intense but formidably bravura *Goldfinger*) the trumpet of Doc Severinsen. All the other virtuosos of the some forty-man Light Brigade are in fine fettle too—especially in the exciting *Von Ryan's March*, haunting *Forget Domani*, hard-driving *Zorba the Greek* Theme, and jaunty *Chim Chim Cheree*. As always, the Command recording itself (originally made on 35-mm magnetic film and exploiting the "Dimension-3" center-fill technique) is spectacularly stereoistic, crystalline, and glittering. But (again, as nearly always) I, for one, would welcome just a bit more acoustical warmth.

**"Tanzende Finger." Akkordeon Orchester "Quintenz," Ingeborg Mückenberger, cond.: Rudolf Würthner Ensemble. Polydor 237429, \$5.95 (SD).**

**Chaikin: Accordion Concerto; Shishakov: Balalaika Concerto; etc.** Various soloists and orchestras. Monitor MCS 2074, \$1.98 (SD).

Discounting some more or less routine accordion solo pops programs, the present releases are the first noteworthy recordings of their kind since the memorable April 1962 Vanguard "Accordiorama" collection of light classical transcriptions played by the Hohner Accordion Symphony Orchestra under Rudolf Würthner. In this Polydor program of light music it is a Würthner sextet that contributes the seven most distinctive and professionally skillful performances. The nine others are by a Munich amateur ensemble of some fifteen young accor-



Continued on page 34

# Perfection is worth waiting for...

A year ago Saul B. Marantz made this statement: "Only when the development of solid state electronics has reached the stage wherein it can match the dependability and performance of Marantz-designed vacuum tube circuitry will our equipment be transistorized."

Now the Marantz Company is bringing out its first solid state component. With the development of the Marantz solid state 7T stereo preamplifier completed and ready for the market, Mr. Marantz is proudly able to state: "After 2 years of research, we know that at last a transistorized component can perform with the established quality we demand."

Until now, when a transistorized preamplifier was operated for the best signal-to-noise ratio, it was most readily subjected to overloading. Thus, you had the unhappy choice of undue noise or clipping and distortion.

As of today, that is no longer the case. The Marantz 7T matches the previously unequalled signal-to-noise ratio of the Marantz 7, yet the widest dynamic range from any sound source will not overload even its sensitive low-level phono stages.

And now, discriminating audiophiles, who waited for the best, can reap the rewards of their patience . . . the new Marantz 7T.

**GAIN:** Phono to main output; 64.5 db.

Phono to recording output; 42.5 db.

High level to main output; 22.5 db.

**FREQUENCY RESPONSE:** 20 to 20,000 cps  $\pm$  0.1 db.

**TOTAL NOISE:** 20 to 20,000 cps, 80 db below 10 mv input. (1 uv equivalent broadband noise input).

**I.M. DISTORTION:** 0.15% at 10 volts RMS output.

**DYNAMIC RANGE, PHONO INPUT:** Approx. 100 db above 1 uv equivalent noise input. (1 uv to 100 millivolts at less than 0.15% I.M. Distortion).

#### NEW FEATURES:

**2 Front Panel Jacks:** For recording, copying or playback with an external tape recorder.

**Panel Headphone Jack:** Built-in circuit drives 500 ohm or higher impedance phones.

**Center Channel Output:** Separate A + B mixing circuit with level control.

**Tape Play/Tape Copy Switch:** Permits tape recording playback or monitoring, plus duplication of tapes.

**OTHER FEATURES:** Selector Switch with automatic equalization insertion. Mode Switch. Precision Volume Control. Wide Range Balance Control. Selectable-curve Feedback Tone Control. High Filter. Rumble Filter. Power Switch. Output Level Adjustment for high or low efficiency speakers. Tape-head Equalizer adjustment. 6 AC Convenience Outlets. Panel Headphone Jack, Panel Tape Recorder Jack, Panel Tape Playback Jack, Center Channel Output. All outputs match 500 ohm inputs at very low distortion.

## THE NEW **marantz** *Solid State* **7T**



CIRCLE 52 ON READER-SERVICE CARD

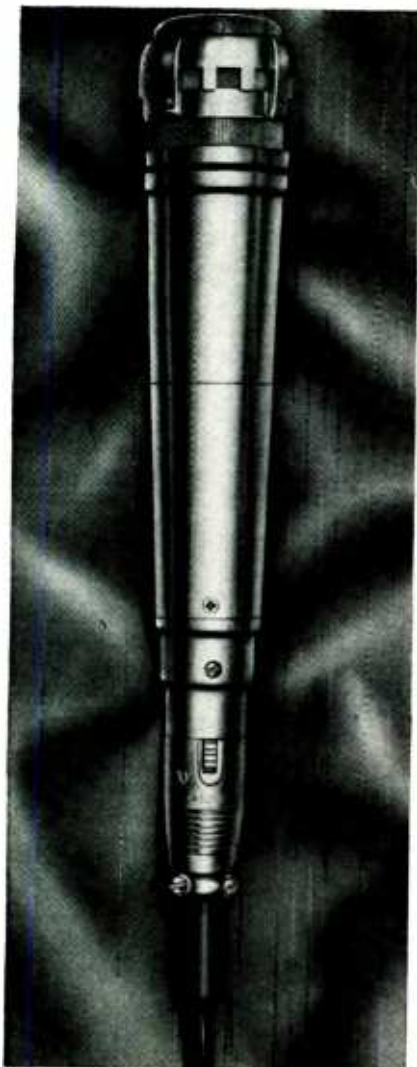

# art collector

The finest home recording equipment in the world can only record what comes through the business end — that's why it doesn't pay to cut corners when selecting your microphone. If quality counts with you, enjoy the magnificent reproduction possible with the Turner Model 500 Cardioid. With fine equipment, and the Turner 500 every tape is a work of art. Ask your dealer about it next time you're in.

**THE TURNER MICROPHONE COMPANY**  
942 17th Street N.E.  
Cedar Rapids, Iowa

In Canada: Tri-Tel Associates, Ltd., 81 Sheppard Ave. West, Willowdale, Ontario  
Export: Ad Auriema, Inc., 85 Broad Street, New York 4, N.Y.

CIRCLE 85 ON READER-SERVICE CARD

## THE SONIC SHOWCASE

Continued from page 32

dionists plus a percussionist, playing with fine gusto but with somewhat less precision and definitely less tonal refinement. The mostly folkish or traditional dance pieces are topped by Lumbye's *Champagne Galop* and an amusing horn-pipe, *Englischer Schiffsjungentanz*. The recording is extremely clean, bright, and unexaggeratedly stereoistic, but either it—or, more likely, the ensemble itself—lacks any very substantial tonal body.

The Russian program is much more of an oddity. It is in part, at least, an electronic reprocessing of items that originally appeared in a Westminster LP back in 1957. Its accordion concerto, one of the few on records, stars the great Yuri Kazakov on the Bayan—a Russian type of button (rather than keyed) accordion. Unfortunately, Chaikin's music is of negligible worth; Kazakov's playing is here overly vehement and slapdash (he was heard to much better advantage in an Angel solo recital, 65020); and the synthetic stereoism adds little to the attractions of the strong, decidedly coarse recording. There is somewhat more musical interest in what must be the only recorded concerto for the balalaika, written by Shishakov and starring Mikhail Rozhkov with a "folk-instruments" orchestra under Victor Smirnov. This is a short two-movement work and the disc-side is filled out by a Vassilenko Suite on folk themes and a Reznikov Toccata, featuring solo balalaikists Eugene Blinov and Eugene Avksentiev respectively. These last two performances were not included in the Westminster mono release, but they certainly don't sound like very recent recording.

"'Der Bettelstudent,' 'Schwartzwaldmadel,' 'Gasparone,' 'Der Vogelhändler' Excerpts." Various soloists: operetta chorus and orchestra, Franz Marszalek, cond. Polydor 237169, \$5.95 (SD).

Americans who have never heard more than a few of the engaging tunes from the popular operettas by Millöcker, Jessel, and Zeller can hardly be given a more profitable musical tip than to make their better acquaintance. But for sound fanciers in particular, perhaps the most pertinent feature of this imported disc (apparently one of an extensive operetta series) is its technical quality—seemingly more American than German in its emphasis on an ultravivid presence of the soloists yet without any loss in the tonal ring and clarity of the well-back orchestra. And at that the engineering skills manifest here by no means overshadow those of the unaccredited arranger (who has deftly crammed a large number of selections into a relatively short space). of conductor Marszalek (who gives his forces considerable freedom without ever risking a loss of assured control), or of the many soloists (including Sándor Kónya, Ingeborg Hallstein, Herta Talmar, Willy Schneider, and Franz Fehringer, among others).

"Reiterfreuden," Vol. 2. Das Deutsche Trompeter-Korps. Hans Freese, cond. Polydor 237434, \$5.95 (SD).

I wonder whether what may be "Riders' Joy" isn't sometimes their horses' sorrow. . . . But perhaps many horses actually enjoy ring training in *dressage* techniques performed to the strains of band marches in tempos suitable for walking, trotting, and galloping maneuvers. At any rate, anyone who wants to train his own horse (whatever the latter's feelings on the subject may be!) and who hasn't any experienced musicians handy should find this undoubtedly unique Polydor series invaluable. I haven't heard Vol. 1 (237064), but the present sequel employs the same apparently fairly small brass and timpani ensemble and the technical advice of Lt. Ulrich Janssen. There are some fourteen obviously highly appropriate selections, introduced by a Fanfare and "*Paradepost der berittenen Truppen*." The recording is unexaggeratedly stereoistic, strong and clean if a bit thin, and sometimes rather sharp sonically. Except for a few of the more tuneful items (Schubert's *Ich höre ein Bächlein rauschen*, and the marches on motives from *Die lustigen Weiber von Windsor*, *Die schöne Galathée*, *Der Prophet*, etc.) the music isn't very well suited for listening-only, at least by human rather than equine ears—for the very reason that it is probably so extremely well suited for its specific purpose: i.e., its stiffly precise articulation. Even the most rhythmically obtuse horse is given no excuse for missing the beat!

"Selections from 'The Roar of the Greasepaint—The Smell of the Crowd.'" Dick Schory and His Orchestra. RCA Victor LSP 3394, \$4.98 (SD).

I won't go quite so far as to assert that moving Dick Schory's recording locale from Chicago's Orchestra Hall to New York's Webster Hall has been as disastrous for him as Delilah's shears were for Samson. . . . Probably it isn't as much the move itself as it is the loss of almost all natural reverberation that strikes me as the crowning indignity in the recent steady deterioration of what was once a sonically superb series. Granted that Schory had to expand his repertory from one devoted to percussion spectaculars only; granted too that the shift from strictly novelty selections to more widely appealing pops programs isn't an easy one to make; and granted finally that even now some of the Schory performances (like the present *Beautiful Land* and possibly also the more conventional *Sweet Beginning*, *This Dream*, and *Feeling Good*) still can be a musical as well as a sonic delight. . . . The fact remains that a truly extraordinary talent has been increasingly denatured, and that even the velvety plush Dynagroove recording of recent Schory releases seldom matches the exhilarating sonic vitality of his earlier programs. To anyone who wants to hear what Schory does best, I strongly advise going back not only to his first recordings for RCA Victor but to the still earlier Concertape "Re-Per-cussion" program, recently reissued as an Everest stereo disc. R. D. DARRELL

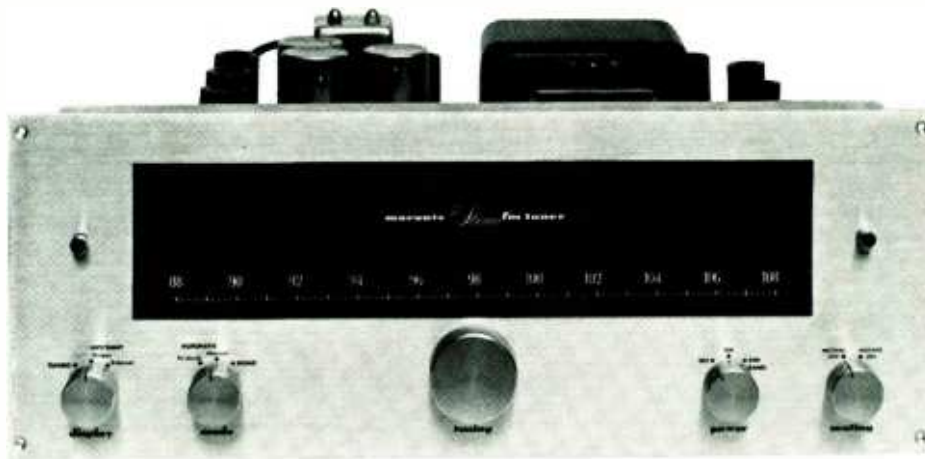

## MARANTZ 10-B TUNER: "... rather spectacular results."

**Q.** Mr. Marantz, your new 10B stereo FM tuner has caused quite a stir in the hi-fi industry. Now that a large number are in the field, what reactions have you received?

**Mr. Marantz:** The overwhelming reaction has been one of surprise from owners who found our claims were not exaggerated. One user wrote he had "... taken with a grain of salt your statement that reception was as good as playback of the original tape or disc. However, after using the tuner for several days I felt I owed an apology for doubting the statement." This is typical.

**Q.** What success have users had with fringe area reception?

**Mr. Marantz:** Letters from owners disclose some rather spectacular results. From the California coast, which is normally a very difficult area, we have had many letters reporting clean reception from stations *never reached before*. An owner in Urbana, Illinois told us he receives Chicago stations 150 air miles away with a simple "rabbit ears" TV antenna. Another in Arlington, Virginia consistently receives fine signals from Lancaster, Pennsylvania, 125 miles away; Philadelphia, 200 miles away, and three stations in Richmond 100 miles over mountains, which he said "come in as good as local stations."

**Q.** For the benefit of these readers interested in the technical aspects, what

are the reasons for this improved fringe area performance?

**Mr. Marantz:** Technical people will find it self-evident that the rare four-way combination of high sensitivity—better than  $2 \mu\text{v}$ , IHF—both phase linearity and ultra-sharp selectivity in our new advanced IF circuit, and a unique ability to reach full quieting with very weak signals—50 db @  $3 \mu\text{v}$ , 70 db @  $24 \mu\text{v}$ —virtually spells out the 10B's superior reception capabilities. Engineers will also appreciate the additional fact that our circuitry exhibits very high rejection of "ENSI," or equivalent-noise-sideband-interference.

**Q.** Considering the 10B's excellent fringe area performance, shouldn't one pick up more stations across the dial?

**Mr. Marantz:** Yes. The report published in the April edition of Audio Magazine claimed to have logged 53 stations with an ordinary folded dipole used in the *reviewer's apartment*, which was "more than ever before on any tuner!"

**Q.** I appreciate, Mr. Marantz, that the 10B's built-in oscilloscope tuning and multipath indicator is very valuable in achieving perfect reception. How big a factor is this device in the total cost of the 10B?

**Mr. Marantz:** Well, first we should note the fact that no manufacturer would offer a quality tuner without tuning and signal strength meters. Therefore, what we should really consider is the difference in price between ordinary tuning meters, and our infinitely more useful and versatile Tuning/Multipath Indicator, which is only about \$30! While our scope tube and a pair of moderately priced d'Arsonval meters costs about the same—slightly under \$25—the \$30 price differential covers the slight additional power supply complexity, plus two more dual triode tubes with scope

adjustments and a switch. The rest of the necessary associated circuitry would be basically similar for both types of indicator. The price of the 10B tuner is easily justified by its sophisticated precision circuitry and extremely high-quality parts.

**Q.** With the 10B's exceptionally high performance, does it have any commercial or professional application?

**Mr. Marantz:** Yes, very much so. In fact, a growing number of FM stations are already using 10B's for monitoring their own broadcast quality. One station wrote that they discovered their 10B outperformed their expensive broadcast monitoring equipment, and were now using it for their multiplexing setup adjustments and tests.

**Q.** Just how good is the general quality of FM stereo broadcast signals?

**Mr. Marantz:** As I have remarked on previous occasions, the quality of FM broadcasting is far better than most people realize. The Model 10B tuner has proven this. What appeared to be poor broadcast quality was, in most instances, the inability of ordinary FM receiving circuits to do the job properly. The Model 10B, of course, is based on a number of entirely new circuit concepts designed to overcome these faults.

**Q.** In other words, the man who uses a MARANTZ 10B FM tuner can now have *true* high fidelity reception?

**Mr. Marantz:** Yes, very definitely—even under many conditions where reception may not have been possible before. This, of course, opens up a tremendous source of material for the man who wants to tape off the air, and who needs really good fidelity. He can, as many of the 10B owners are now doing, build a superb library of master-quality tapes, especially from live broadcasts.

**Price: \$600**



**marantz**

MARANTZ, INC. SUBSIDIARY OF **SUPERSCOPE** • INC.  
25-14 BROADWAY, LONG ISLAND CITY, NEW YORK

CIRCLE 52 ON READER-SERVICE CARD

Also see the exciting Marantz Stereo Pre-Amplifier, Stereo Amplifier, and Straight Line Tracking SLT-12 Turntable.

# HIGH FIDELITY NEWSFRONTS

BY NORMAN EISENBERG

**A Show with Some Asides.** Neither the paucity of press coverage due to the newspaper strike nor the vagaries of early fall weather in New York kept the recent High Fidelity Music Show from turning out to be one of the best-attended to date. By official count, some 25,600 persons came to see and hear new equipment, leading figures in the industry, and some distinguished recording artists. In lieu of newspaper announcements, show publicizers took to the air, using one of the industry's main areas of interest, FM, to help promote itself. The results would seem to justify this move.

The audience which crowded into the New York Trade Show Building from September 29 through October 3 not only surpassed those of previous years in number, but to this observer it had a well-defined character. We saw very little of the sort of aggressive hi-fi-manship often practiced at earlier shows—where an enthusiast might buttonhole an audio manufacturer to tell him “how to build his own amplifiers.” Instead, we saw an audience that seemed fairly serious and affluent, that had come to learn, to be shown, to be guided in their planned purchases and use of equipment. In keeping with this tone, there were clearly more ladies present than ever before; indeed, the number of couples in evidence, particularly on Friday and Saturday evenings, suggested forcibly that high fidelity has become a family affair, serving a broad audience of diverse interests as well as the embodiment of a pursuit, after perfection by a relatively smaller group of enthusiasts.

This dual note was echoed by the prod-

ucts shown which, in sum, represent the industry's strongest effort yet to offer high performance in attractive formats, or, as one company head put it, “engineering combined with cosmetics.” Most of what was on display was noted in this journal's account of “New Products” (October 1965); some other items had been kept under wraps until the very opening day of the show. Benjamin, for instance, displayed its Miracord 40H, a four-speed automatic turntable with hysteresis-synchronous motor and an arm similar to that used on the costlier Model 18. A double-arch front is a new style note found on some Bozak speaker systems; the insides remain the same. Concertone's 800 series, we learned, includes basic tape decks as well as elaborate furniture-housed systems. An enormous pair of speaker systems—designed by Michael Kay of Lyric Hi-Fi, a New York dealer, and costing \$2,200 for the pair—were being driven in the Crown room by the Crown SA 20-20 “pancake” amplifier. Dynaco surprised everyone by showing a prototype of its Model 60/60 basic amplifier—solid-state (the company's first in this area) and not to be available until mid-1966.

Electro-Voice's entry into solid-state electronics was signaled by tuners and a control amplifier, available separately or combined and dressed up with a common front panel as a receiver. The entire receiver, as E-V's Larry LeKashman demonstrated, fits neatly into an ordinary size attaché case. A new solid-state pre-amp and basic amplifier were featured by Hadley. A medium-size floor-standing speaker system, the Concertmaster Junior, was on hand at Hartley Products. A

novel item at the Kenwood exhibit was a self-tuning FM tuner that “hunts” automatically for a station; this unit is a one-of-a-kind model which may be released some time in the future. The only product shown by KLH was its Model 12 speaker system, medium-size and using four drivers. New headphones were shown by Telex, Superex, and Sharpe. Koss demonstrated a new headset and headset-amplifier, the latter's design contributed by Koss's newly acquired division, Acoustech. A new Rek-O-Kut turntable and arm ensemble also was on hand. At the Norelco exhibit we saw an adapter kit that permits the Carry-Corder tape machine to be used in an auto. New styling graced some of the Magnecord tape machines on view.

Marantz showed its first solid-state product: the Model 7T preamplifier-control. Cartridges for the 8-track auto-stereo system were featured at RCA Victor's room; its catalogue lists more than two hundred releases priced from \$4.95 to \$10.95. The newest modular disc playback system is the EMI/Scope, consisting of a Garrard automatic, Pickering V-15 cartridge, built-in solid-state amplifier, and a pair of EMI “dangerous” speakers. At the Sherwood exhibit we learned of this company's latest solid-state equipment: a tuner, an amplifier, and a 100-watt receiver. Among the new items from Shure was a “Gard-A-Matic” phono cartridge, using a retractile suspension system. Automatic reverse of tape, actuated by silence, was featured on new Sony/Superscope equipment (this company was handing out a

*Continued on next page*



*Gould and Stanton: a touch of nostalgia . . . the Streisand room: stereo and décor.*



# Surprise Christmas present from Scott

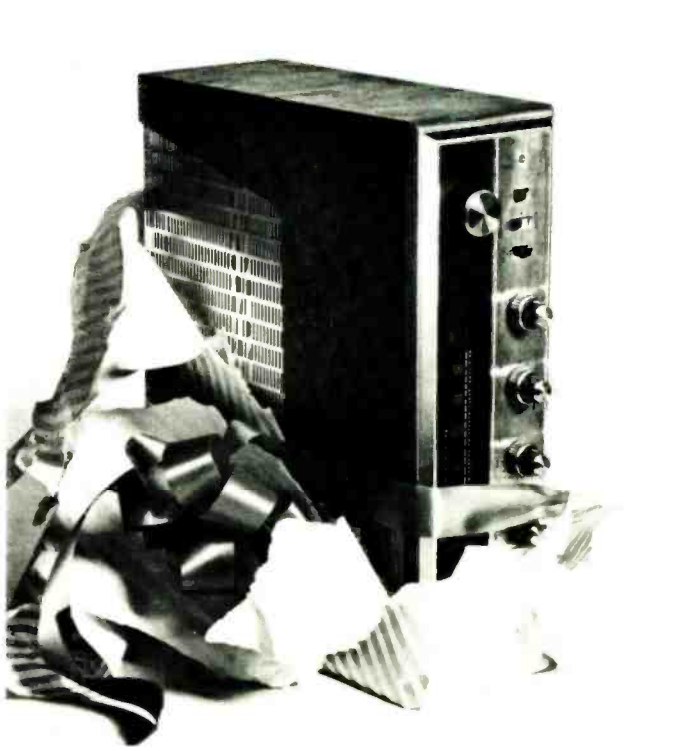
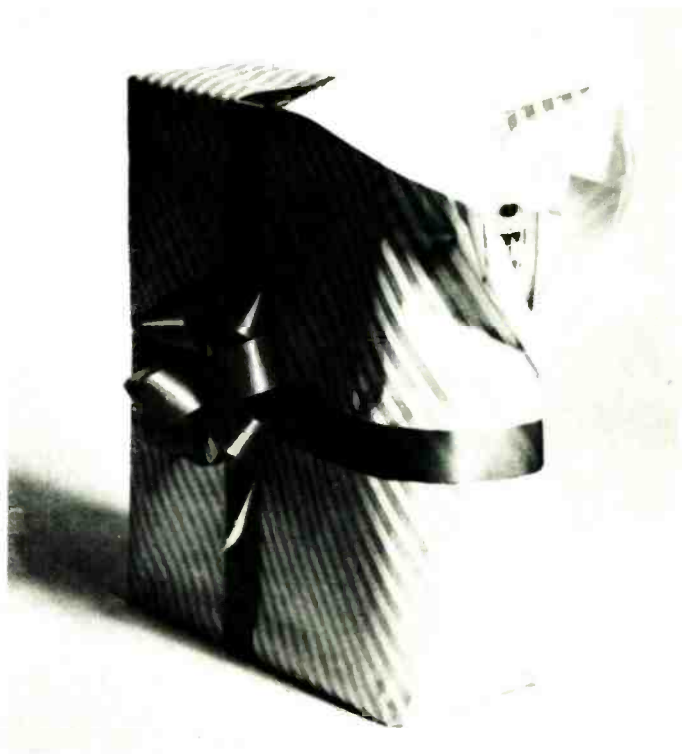
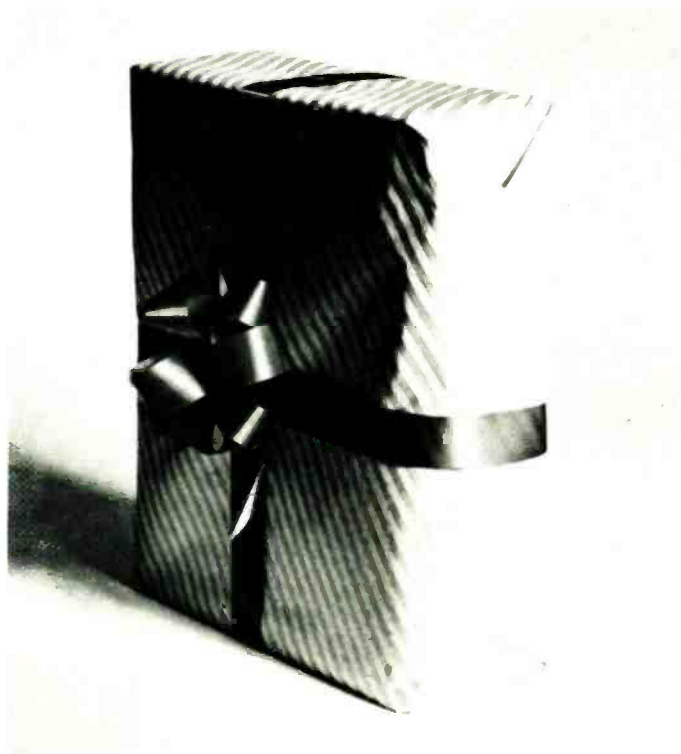

# New 65-Watt Solid-State Receiver..



Scott's new low-priced 65-watt receiver has the quality and features you expect only in the most expensive components:

**1** The 342 utilizes silicon transistors . . . more costly, but far more effective than germanium in terms of ruggedness, reliability and sound quality. Silicons resist overload, resist heat, and do not change with age. Silicons are used in the 342 IF circuit for superior stability, selectivity and wide bandwidth. In the 342 output circuitry, silicon transistors allow instantaneous power for extreme music dynamics, while affording your sensitive speaker systems complete protection against overload.

**2** All 342 audio circuits are direct-coupled. Both output and driver transformers, major sources of distortion and diminished power, are eliminated from Scott's radically new solid-state amplifier design. As a direct result of transformerless, direct-coupled output design, the Scott 342 has high frequency response superior to units costing far more.

**3** The 342 silver-plated front end is completely solid state with field-effect circuitry, achieving maximum tuner sensitivity with virtually no cross-modulation, no drift, no more problems caused by changing tube characteristics.

**4** The 342's clean chassis layout is an immediate tip-off to expert engineering and careful design planning. In addition, well-planned parts placement

minimizes service problems, eliminates the danger of shorting, and keeps your equipment running cool for optimum performance and long-lived reliability. Scott uses high conductivity electrolytic aluminum for chassis, never mere cadmium-plated steel. The 342 looks as good as it sounds . . . both inside and out.

**5** The 342 incorporates a fool-proof protective system, designed to withstand these common problems: accidental shorting of speaker terminals, operating the amplifier section without a load, or subjecting the input to a high level transient signal. Capacitive loads, such as electrostatic loudspeakers, will not harm the output transistors. Your expensive loudspeakers are protected from direct current by special circuitry combined with heavy-duty output coupling capacitors. Special quick-acting fuses protect both associated equipment and the transistors themselves.

**6** The 342 includes these popular features found in the most expensive Scott components: Tape Monitor switching, Speaker switching with provision for remote speaker selection, switched front panel stereo headphone output, front panel balance switch, separate channel clutched bass, treble, and volume controls, fully automatic stereo switching with indicator, precision tuning meter, and many more.

**342 SPECIFICATIONS** . . . Usable sensitivity, 2.7  $\mu$ v; Harmonic distortion, 0.8%; Drift, 0.02%; Frequency response, 18-25,000 cps  $\pm$ 1 db; Music power rating per channel at 4 ohms load, 32½ watts; cross modulation rejection, 75 db; Stereo separation, 35 db; Capture ratio, 6.0 db; Selectivity, 40 db. 14 front panel controls, precision slide-rule tuning.

## Here's what the experts say about Scott's solid state engineering

*"If any doubt remains in the minds and hearts of audiophans as to the acceptability of transistors for use in high-quality FM-stereo tuners, the Scott 312 should still these fears forevermore . . . it is one of the finest tuners Scott makes. And that means it is one of the finest tuners anywhere."* Audio July 64

*"In a sense, there is little to say about the sound of the Scott 260 since . . . it has no "sound" of its own — the listener hears the music, not the amplifier. The 260 will reproduce any signal that is fed into it with well-nigh perfect exactness, and without adding any sonic coloration of its own."*

HiFi/Stereo Review April 65

*"The IHF rated sensitivity of the Scott 344 . . . was a lot better than specified by the manufacturer — and at 2 microvolts for 98 megacycles it is one of the most sensitive sets available. Capture ratio and selectivity also were better than specified. All told, the performance characteristics of the Scott 344 are among the finest for an "all-in-one" . . . The set is a delight to use and listen to."*

High Fidelity

*"To sum up, the Scott 312 has remarkable sensitivity, good stereo separation and excellent overall audio quality. It can be recommended particularly to fringe-area dwellers who don't want to spend a year's income or thereabouts on other tuners of comparable capabilities."* Radio Electronics March 65

# less than \$300...and it's a SCOTT!

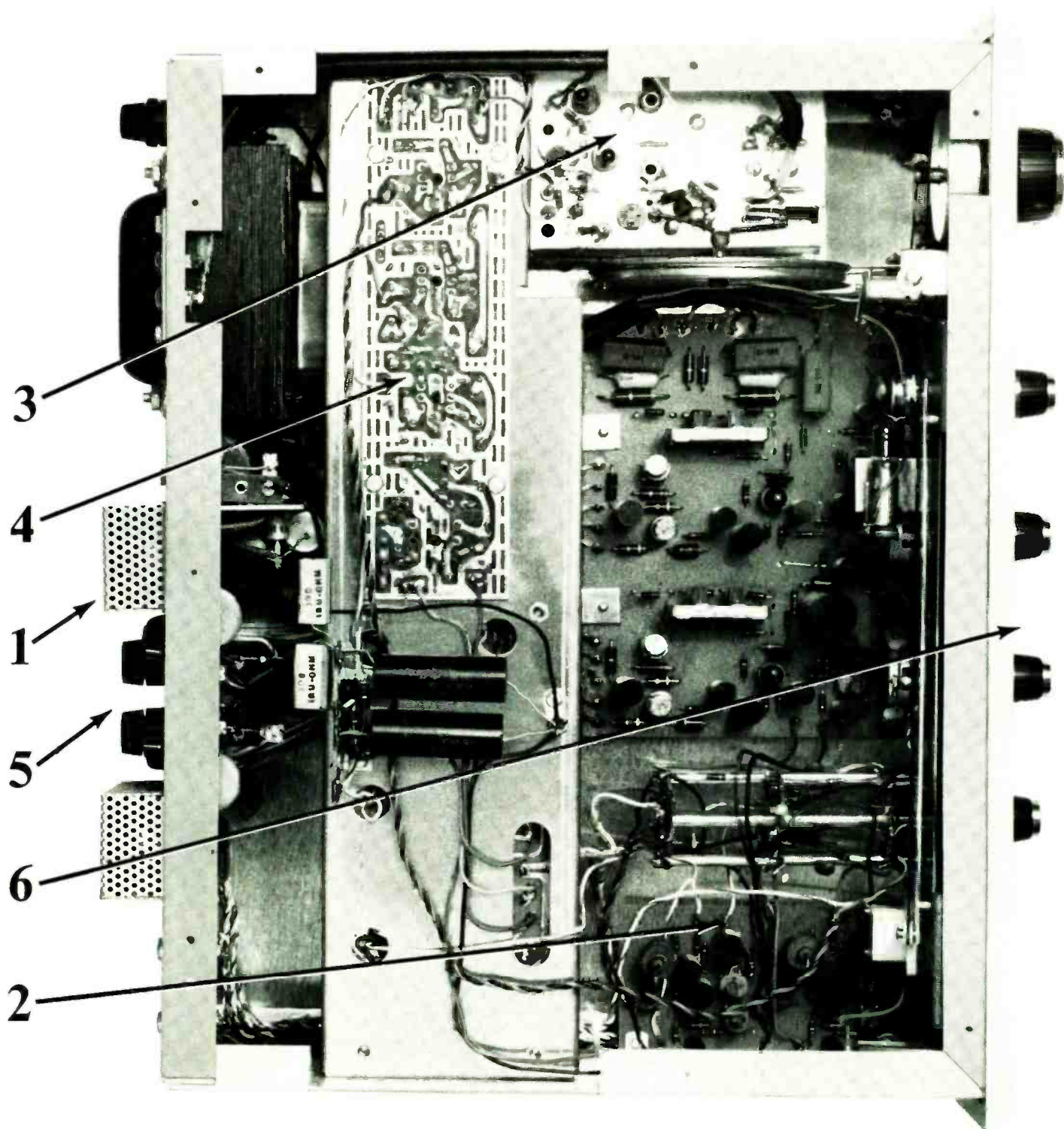

For complete information on the new Scott 342,  
send for Scott's colorfully-illustrated 1966 Custom Stereo Guide.

**CIRCLE READER SERVICE NUMBER 100**



H. H. SCOTT, INC., 111 POWDERMILL RD., MAYNARD, MASS.

EXPORT: SCOTT INTERNATIONAL, MAYNARD, MASS. CABLE HI-FI. PRICES SLIGHTLY HIGHER WEST OF ROCKIES. PRICES AND SPECIFICATIONS SUBJECT TO CHANGE WITHOUT NOTICE.

CIRCLE 100 ON READER-SERVICE CARD

# Looking for fine Stereo Furniture?

the **MULTICUBE**  
A NEW DIMENSION  
IN AUDIO-STORAGE FURNITURE



## Toujay designs

"The Showroom of Fine Audio Furniture"

DESIGNERS  
MANUFACTURERS  
& DISTRIBUTORS

CUSTOM CABINETS  
AUDIO WALLS  
TRADITIONAL • MODERN  
CONTEMPORARY • ORIENTAL

SHOWROOM VISITS THROUGH YOUR AUDIO DEALER or DECORATOR ONLY  
HOURS: TUESDAY-FRIDAY: 10 A.M. to 5 P.M.: SATURDAY by APPOINTMENT—CLOSED MONDAY

SEE YOUR DEALER OR WRITE FOR FREE MULTICUBE COLOR BROCHURE, DEPT. 12A  
146 EAST 53RD ST., N.Y.C. TEL 752-2354 (NO BROCHURE ON CUSTOM DESIGNS)

CIRCLE 88 ON READER-SERVICE CARD

## Condescend to observe honorable tape recorder.

Is unnecessary to give what our honored American friends call "snow job" in pointing out superiority of new Cipher 98 four-track stereo recorder. Specifications are own best advertisement. Honorable audiophiles will recognize Cipher 98 as number one sun of world's fastest-rising tape recorder industry. New solid-state Cipher 98 incorporates nearly every feature of very expensive professional machine, at price significantly lower than comparable recorders made across Pacific or in Europe. Observe: 3 heads (erase, record, playback); no

pressure pads; tape speeds 7½ and 3¾ ips with knob change, 1½ ips with capstan sleeve change; wow and flutter less than 0.2%; signal-to-noise ratio better than 52 db; two VU-type panel meters; automatic shutoff; digital tape index; pause control; plays horizontally or vertically; comes with own detachable stereo speakers and two dynamic microphones. Honorable dealer most happy to demonstrate. (Ah so! Our honored American friends wonder where we learned to speak well English. We studied electronic engineering at University of California!)

**CIPHER 98 \$350.00**



WITH HANDSOME CARRYING CASE AND WALNUT-COLOR CONTROL PANEL.  
FOR MORE INFORMATION, WRITE TO INTER-MARK CORPORATION,  
29 WEST 36TH STREET, N. Y. 10018.  
IN CANADA: INTER-MARK ELECTRONICS LTD., 298 BRIDGELAND AVE., TORONTO 19, ONT.

CIRCLE 43 ON READER-SERVICE CARD

## HIGH FIDELITY NEWSFRONTS

Continued from preceding page

product catalogue done in "op art" form). At Tandberg's exhibit we encountered a new line of compact speakers. The feature-laden Dual 1019 was the star performer at United Audio's display.

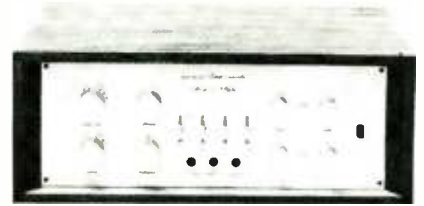

Solid-state firsts: above, Marantz 7T preamp-control; below, Dynaco's model 60, 60 basic amp, kit or wired.

Viking showed its Studio 96, a heavy-duty, NAB-reel-size deck, available with separately housed electronics.

As at last year's showing, this one featured a series of panel discussions on audio. This time, however, a much larger room was devoted to these events and it was filled to capacity at each session. Varying touches of novelty could be found in some of the product exhibits themselves: Sherwood's room featured an attractive walnut wall installation; visitors to the Viking display were invited to make their own tape recordings; the Pickering exhibit boasted an unusual collection of old music boxes—which worked, and which lent a certain nostalgia and change-of-pace charm to the show. UTC demonstrated its new Maximum speakers in a large room against a decorative background; Empire conducted a "cartridge clinic" at which Leon Kuby, with the aid of specially built instruments, tested scores of pickups brought in by visitors; Tandberg had set up a language laboratory at its exhibit, with booths for private tape-learning sessions.

The Panasonic room featured what this company termed "the world's largest speaker"—a 39-inch driver in an enclosure almost as wide as the room itself (strictly for demonstration—this is not a commercial product, at least so far). At both the AR and KLH exhibits, rows of chairs were set up and visitors were invited simply to sit and listen. A replica of Barbra Streisand's own study—complete with furnishings and items lent by the performer and including a stereo system that duplicated her own—formed a major part of British Industries' Wharfedale exhibit, while in the room next door, sales v.p. Frank Hoffman demonstrated this company's new speak-

Continued on page 42

HIGH FIDELITY MAGAZINE



AR-2<sup>x</sup> (new model of the AR-2)—\$89 to \$102



AR-2a<sup>x</sup> (AR-2<sup>x</sup> plus super-tweeter)—\$109 to \$128



AR-3—\$203 to \$225

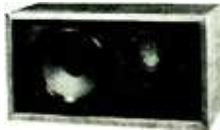

AR-4—\$51 to \$57 depending on finish

[Speakers are shown with grille cloths removed.]

## why **AR**<sup>INC.</sup> guarantees its speakers for 5 years

(covering all repair costs, including freight):

- 1. It's fair.**
- 2. It's good business.**
- 3. It keeps our quality control department on its toes.**
- 4. Because of #3, it doesn't cost us very much.\***

AR turntables are guaranteed for one year, with freight and repair costs covered.

The superior performance of AR speakers and turntables, attested to almost universally in equipment reviews,\*\* is not likely to change after years of use. If the unlikely does occur, we take care of it.

Literature on AR products will be sent on request.

\*The return rate of some models over the entire 5-year life of the guarantee is less than 1%.

\*\*Lists of the top equipment choices of four magazines are available on request. All four chose the AR turntable, and three of the four chose AR-3 speakers.

**ACOUSTIC RESEARCH, INC.,**

**24 Thorndike Street,**

**Cambridge, Massachusetts 02141**

CIRCLE 2 ON READER-SERVICE CARD

# COLOR



## MOSLEY ANNOUNCES AN EXCITING COLOR BREAKTHROUGH!

Now Mosley offers you a colorful NEW line of TV outlets designed for coax installations! Available to you are coax outlets in decor-harmonizing colors of Antique Ivory, Fawn Beige, and Grey Mist; packaged complete with matching C-59 receptacle plug for use with RG-59/U Coax.

Mosley 300 ohm TV outlets (packaged with model 303 plug) are also available in NEW eye-appealing colors plus Standard Brown and Ivory.

For More Information Write:

**Mosley Electronics, Inc.** 4610 N. Lindbergh Blvd.,  
Bridgeton, Missouri 63044

CIRCLE 55 ON READER-SERVICE CARD



## HOW FAR WRONG CAN YOU GO?

Eager to sell, buy or swap used high fidelity speakers, amplifiers, cartridges, turntables, tuners, records, etc.? Turn to our monthly bulletin: *The BUY-SELL-or-SWAP NEWSLETTER*.

If you want to *SELL*—classified listings of used equipment and records cost only \$1 per ad—limit 30 words including name and address. No dealer ads accepted.

If you want to *BUY*—lots of bargains offered in the 50 or more ads that appear here every month. Subscription price; only \$2 a year!

If you're audio-minded, how far wrong can you go for these small sums? Fill in and mail the form below today!

HIGH FIDELITY, Dept. CE  
Great Barrington, Mass.

Start my subscription to your BSS Newsletter with the next issue. (Only \$2)

Name \_\_\_\_\_  
Address \_\_\_\_\_  
City \_\_\_\_\_  
State \_\_\_\_\_ Zip \_\_\_\_\_

Enclosed is my payment for \$\_\_\_\_\_.

Insert the following 30-word advertisement (including name and address) in the next issue of the BSS Newsletter. (Type or print plainly.) (\$1)

## HIGH FIDELITY NEWSFRONTS

*Continued from page 10*

er-expansion program: you start with one basic system and add units to it later. Across the hall, the Garrard exhibit was abetted by talks delivered by a bevy of young ladies with the aid of large-scale working models of the parts of a Lab 80 turntable, the whole thing taking on a sort of Museum of Science and Industry approach.

At the Magnecord exhibit, a Model 1022 tape recorder amazed everyone by responding to commands delivered in a loud voice; the trick, we learned, was done by an assistant hiding a remote-control box hooked to the machine by a 25-foot cable.

Ampex and Sony showed their about-\$1,000 video-tape systems and then, by means of playback on a TV monitor, let the visitors view themselves looking at the equipment. Interest in this new product form, as far as we could gauge, was mixed. Most sophisticated New Yorkers seemed not overenthused about a device that suggested television-viewing—a reaction perhaps prompted by the concurrent opening of the TV season, which, it seemed universally agreed, offered the most banal collection of programs yet scheduled by the networks. When it was pointed out that the video-tape system could be used for other purposes—making one's own films, or showing pre-recorded (and presumably high quality) audio-visual tapes—the climate became much more favorable.

An unusual aspect of this year's show was the number of "side shows" held for the press and trade. For instance, a

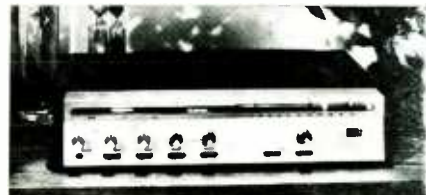

*From Electro-Voice, a receiver small enough to fit inside an attaché case.*

week before the show, we attended a special demonstration of the Dual 1019 automatic turntable, at which United Audio head Julian Gorski explained the 1019's features, especially its antikating facility. A novel accessory for the 1019 is a skating meter that plugs into the tone arm in place of the regular pickup shell to indicate the need for adjustment of the arm. A preshow exhibit was also held by Electro-Voice, while almost simultaneously, Koss/Rek-O-Kut threw a mid-morning party to award a mustang (a horse, not a car) to Robert Bach as the company's "best salesman of the year." University Sound celebrated its thirtieth birthday at a party at which

*Continued on page 44*

# For only \$3.78 per watt you can own the world's first all-silicon stereo receiver!

## New **PLAYBACK** series



It's completely new and way ahead of its time! The Altec 711 **PLAYBACK** receiver gives you an honest 100 watts in a rugged, trouble-free all-silicon design that's the best power-per-dollar value on the market!

### SOME AMPLIFIER!

It provides 100 hefty watts of clean, undistorted power. The kind you can *use*, not just talk about! Turned up to a roof-lifting 70 watts, this fantastic amplifier has a total harmonic distortion of a mere 0.25%. Even at the full 100 watts, distortion is still only 0.5%!

**Three Good Reasons Why You Need Such Power in an Amplifier.** If you're lucky enough to own high-efficiency Altec **PLAYBACK** speakers, you can use your power to achieve concert-hall listening levels. Because Altec's **FULL-SIZE** speakers dissipate so little of your power, you can bring the full sound of the orchestra into your home!

On the other hand, if you have ordinary, low-efficiency speakers, you need the 711's

power to coax a good listening level from them. And you'll still have enough reserve power to handle the sudden dynamic changes which are inherent to most music. In fact, the Altec 711 has enough power to help reduce clipping—even with very inefficient speakers!

Third, no matter what kind of speakers you have, an amplifier that's designed to perform so well at 100 watts provides a brilliant fidelity at lower listening levels that low-power amplifiers just can't match. It's like a fine motor car designed to operate at 120 mph. When you cruise at 65, you know you're just loafing along without strain. If your car had a top speed of only 80, however, then 65 mph would be close to the car's endurance.

**Other Amplifier Features** include frequency response of 20-20,000 cps  $\pm 1$  db at 100 watts—and at lower power settings a fantastic 10-100,000 cps response / rocker panel switches / automatically resetting circuit breakers instead of fuses / and no transformers anywhere to cause distortion.

### SOME TUNER!

The 711's masterful combination of sensitivity and selectivity picks up even the weakest stations—then hangs onto them like a bulldog. Drift is a problem of the past!

The 711 tuner is extremely sensitive, with a volume sensitivity of 0.9  $\mu$ v and usable sensitivity of 2.2  $\mu$ v IHF. Other specs that back up the superior performance of this years-ahead tuner include capture ratio of 2.5 db, stereo separation at 1000 cps of 40 db, and a power bandwidth of 20-20,000 cps  $\pm 1$  db.

A unique 4-gang tuning condenser makes the 711's special sensitivity-selectivity combination possible. The fully neutralized 1F uses the newest high-gain silicon transistors for optimum integration with the tuning gang.

### WHAT THE 711's ALL-SILICON DESIGN MEANS TO YOU

Only silicon transistors have the inherent ruggedness, the ability to "take it," that ensures you years of trouble-free listening enjoyment. And by "take it" we mean that silicon can handle at least 200% more heat than germaniums!

The rugged reliability of silicon transistors is why military specifications for critical electronic equipment demand silicon instead of germanium transistors. This is the kind of reliability you get in the new Altec 711!

### REALLY CONVINCCE YOURSELF—COME SEE THE FANTASTIC ALTEC 711!

It's all silicon—it's all excitement! The 711 comes completely enclosed in a beautiful metal case (walnut case optional), thanks to its no-heat operation! Your Altec dealer is waiting to show you the new 711. Or, for complete information, write Dept. HF12A

### COMPARE FOR YOURSELF THE 711's POWER-PER-DOLLAR VALUE!

Make	Model	Price	Watts	Dollar-per-watt	All-Silicon Transistors
Altec	711	\$378.00	100	\$3.78	Yes
Bogen	RT 6000	359.95	60	6.00	No
Fisher	500 C	349.50	75	4.66	Tube
Fisher	600 T	459.50	110	4.17	No
Fisher	440 T	329.50	80	4.12	No
Harman-Kardon	SR 300	264.00	36	7.33	No
Harman-Kardon	SR 600	354.00	50	7.08	No
Harman-Kardon	SR 900	434.00	75	5.79	No
Scott	344	429.95	50	8.60	No
Scott	340 B	399.95	70	5.70	Tube
Scott	348	499.95	100	5.00	No
Sherwood	S-8000 IV	312.50	80	3.92	Tube
Kenwood	TK 80	339.95	80	4.22	No
Kenwood	KT 10	269.95	40	6.74	No
Kenwood	KW 55	219.95	40	5.49	Tube

Chart is a cross-section of comparably priced receivers available at the time this advertisement was prepared. Prices and wattage figures are based on information contained in advertisements of the respective manufacturers.

CIRCLE 5 ON READER-SERVICE CARD



**ALTEC LANSING**  
A Division of  
LTV  
Ling Altec, Inc.  
ANAHEIM, CALIF.

# ONLY OKI

**Gives You Such Great Sound Per Pound!**

The Oki 555 lightweight solid-state portable stereo tape system weighs less than 25 pounds, yet gives you better than concert hall sound reproduction. And the price? Only \$349.95\* complete with two unique "OKidizine" Speaker Systems, each containing two speakers with a crossover network. Oki has a fine choice of other solid state tape recorders, starting at \$129.95\*. See and hear them now at your Oki dealer.



## ONLY OKI 555



\*manufacturer's suggested list price.



**Chancellor Electronics, Inc.**

457 Chancellor Avenue, Newark, New Jersey 07112

CIRCLE 57 ON READER-SERVICE CARD

## HIGH FIDELITY NEWSFRONTS

*Continued from page 42*

visitors met company heads and heard the latest University equipment.

Audio Dynamics had set up its exhibit at the Statler-Hilton, a few blocks away from the Trade Show Building. Among its latest products were the Model 10E cartridge, a very compact speaker system, and—what do you know—a new line of electronics: tuner, amplifier, and receiver. The solid-state components are relatively low in cost and will be manufactured at a new plant ADC is setting up on Long Island. Whitecrest, a recently formed company, booked a suite at the New Yorker to show three speaker systems: a very compact model, a 2-cubic-foot, and a medium-size floor-standing model. Also at the New Yorker was Concord, introducing its Model 350, so far as we know the first battery-operated recorder with automatic reverse for recording and playback. Not actually part of the high fidelity show but certainly germane to its interests was an all-day meeting of the IHF Standards Committee at which the final version of the new Standard on Amplifiers was discussed and accepted. Among its notable features: 120 volts, rather than 117 volts, becomes the new line voltage for rating and testing equipment; amplifiers may be rated for continuous (rms) power and for music power, the latter now "fitted with a new set of teeth" as one member put it.

The closeness of the high fidelity and

musical worlds was underscored not only by the program material most prominently used for demonstrating new equipment (Vivaldi's strings, rather than train whistles, to show off the highs this year) but by the appearance of such performers as Robert Merrill, Morton Gould, and Paula Wayne. In fact, a musical ambience surrounded the show building—from the handbills announcing that University Sound was awarding six thousand records to lucky number holders to the traffic officer on the corner of Eighth Avenue and 35th Street who drew his own audiences by directing traffic with highly original themes whistled at astonishing volume.

One final comment on the show must deal with the building in which it is held. Although renamed "the high fidelity palace" for this occasion, it remained the same crowded and noisy locale as in the past. Even with most exhibitors refraining from conducting a "battle of decibels" with their neighbors, it still was difficult really to hear equipment critically, to converse, and even to move down the corridor from one room to another. Out of consideration for the visitors, to say nothing of the exhibitors themselves, we herewith make a motion for a move next year.

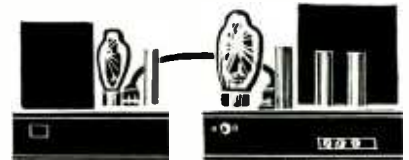

### STATEMENT OF OWNERSHIP, MANAGEMENT AND CIRCULATION (Act of October 23, 1962; Section 4369, Title 39, United States Code).

- Date of Filing: October 1, 1965.
- Title of Publication: High Fidelity.
- Frequency of Issue: Monthly.
- Location of Known Office of Publication: The Publishing House, Great Barrington, Mass. 01230.
- Location of the Headquarters or General Business Offices of the Publisher: 2160 Patterson Street, Cincinnati, Ohio 45214.
- Names and addresses of Publisher, Editor, and Managing Editor: Publisher, Warren B. Sver, Great Barrington, Mass.; Editor, Roland Gelatt, Bridgewater, Conn.; Managing Editor: Sue Severn, Great Barrington, Mass.
- Owner: The Billboard Publishing Company, 2160 Patterson Street, Cincinnati, Ohio; Marjorie L. Ross, Fort Thomas, Ky.; J. W. Ross Sr., Trustee, Fort Thomas, Ky.; Jane L. Stegeman, Fort Thomas, Ky.; R. S. Littleford Jr., Trustee U/W Mariana W. Littleford, deceased, Port Washington, N. Y.; William D. Littleford, Custodian for Michael Littleford, Roslyn Estates, N. Y.; William D. Littleford, Custodian for Anne Littleford, Roslyn Estates, N. Y.; R. S. Littleford Jr., Port Washington, N. Y.; Marian H. Littleford, Roslyn Estates, N. Y.; W. D. Littleford, Roslyn Estates, N. Y.; L. M. McHenry, Fort Thomas, Ky.
- Known Bondholders, Mortgagees and Other Security Holders Owning or Holding 1 Per Cent or More of Total Amount of Bonds, Mortgages or Other Securities: None.
- Paragraphs 7 and 8 include, in cases where the stockholder or security holder appears upon the books of the company as trustee or in any other fiduciary relation, the name of the person or corporation for whom such trustee is acting; also the statements in the two paragraphs show the affiant's full knowledge and belief as to the circumstances and conditions under which stockholders and security holders who do not appear upon the books of the company as trustees, hold stock and securities in a capacity other than that of a bona fide owner. Names and addresses of individuals who are stockholders of a corporation which itself is a stockholder or holder of bonds, mortgages or other securities of the publishing corporation have been included in paragraphs 7 and 8 when the interests of such individuals are equivalent to 1 per cent or more of the total amount of the stock or securities of the publishing corporation.
- This item must be completed for all Publications except those which do not carry advertising other than the Publisher's own and which are named in sections 132.231, 132.232, and 132.233, Postal Manual (Sections 4355a, 4355b and 4356 of Title 39, United States Code).

	Average No. Copies Each Issue During Preceding 12 Months	Single Issue Nearest to Filing Date
A. Total No. Copies Printed (Net Press Run)	153,330	155,941
B. Paid Circulation:		
1. Sales through Dealers and Carriers, Street Vendors and Counter Sales	19,094	19,000
2. Mail Subscriptions	105,153	108,550
C. Total Paid Circulation	124,247	127,550
D. Free Distribution (including samples) by Mail, Carrier or other means	4,963	5,261
E. TOTAL DISTRIBUTION (Sum of C and D)	129,210	132,811
F. Office Use, Left-Over, Unaccounted, Spoiled after printing	24,120	23,130
G. TOTAL (Sum of E & F—should equal net press run shown in A)	153,330	155,941

I certify that the statements made by me above are correct and complete.

(Signature of editor, publisher, business manager or owner)

(Signed) John W. Ross, Secretary  
The Billboard Publishing Company



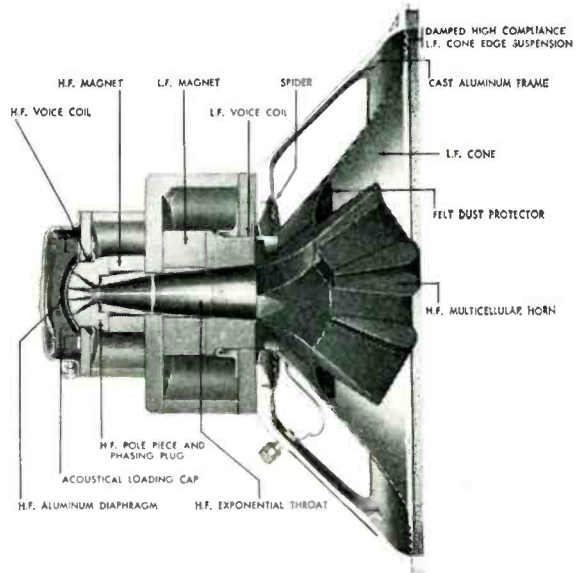

THIS IS THE NEW  
*Super* **DUPLEX** 604E  
 FROM ALTEC. ITS PEDIGREE IS AS  
 LONG AS YOUR ARM. THE HISTORY  
 BEHIND IT IS MUCH LONGER.

Twenty years ago, the first 604 DUPLEX made speaker history  Next came the 604A  Then the 604B  The 604C came next, followed by the 604D  Each was better than its predecessor  All were better than any other single-frame speaker ever made  The new SUPER DUPLEX 604E is better than any other DUPLEX ever made  If you know a recording or broadcast engineer, ask him about DUPLEX speakers. If you don't know one, here are some vital statistics:

The SUPER DUPLEX has a smooth frequency range from 20 to 22,000 cycles. This means not only superb sound quality at the extremes of the frequency spectrum, it also means exceptional smoothness in the mid-range. When you consider that about 90% of all music is contained in the mid-range, you will know why the SUPER DUPLEX sounds so good.

Its dual magnetic structure weighs 26 pounds, 13 ounces. Among other things, this means that the SUPER DUPLEX is the most efficient speaker made. Its coaxially mounted multicellular horn provides a perfectly controlled high frequency distribution angle of 40° by 90°.

This 15", two-way speaker system in a single frame comes complete with a dual full-section dividing network which incorporates a high frequency shelving control with a 0 to -10 db range.

A slightly lighter, lower efficiency version of the 604E is the Altec 605B Duplex.



**PROPER PLAYBACK**

**ENCLOSURES FOR THE 604E:**

Vertical design of the Altec 855A "Malibu" walnut cabinet, above, saves floor space while providing the necessary air volume for maximum bass. The new 859A "Valencia" cabinet, below, features classic fretwork grille, rich hand-rubbed walnut finish, and dimensions to fit most living rooms.

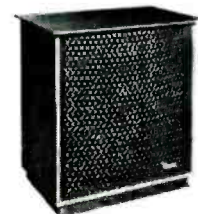

**ALTEC LANSING**

A Division of *LSL* Ling Altec, Inc.  
 ANAHEIM, CALIFORNIA  
 ©1965 ALTEC LANSING

CIRCLE 5 ON READER-SERVICE CARD

Here's how your dealer can show you what skating force is; how the Lab 80 eliminates it; protects your records; tracks both stereo channels more evenly — more perfectly than any other integrated record playing unit.

**1.** "This is a blank record with no grooves. I place it on the Lab 80."



**2.** (left) "I set the tracking force at 2 grams, (as an example). Since each click of the stylus pressure gauge on the tone arm equals 1/4 gram, I turn it for 8 clicks."

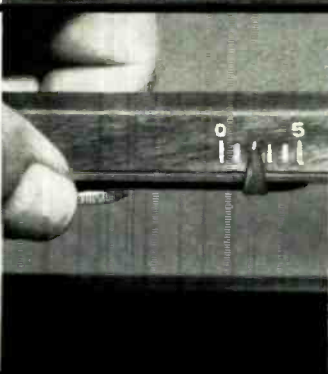

**3.** (right) "I slide the counterweight on the anti-skating device to the second notch... for a compensation of 2 grams... equivalent to the tracking force I have just set on the tone arm."



**4.** "Now you can actually watch the strength of the skating force. I start the Lab 80, but flip the anti-skating device over and out of operation. Note that as soon as I put the stylus on the grooveless record, the arm moves rapidly... with force, toward the center."



**5.** "Now watch me neutralize the skating force. I swing the anti-skating device back into position... and the arm tracks as perfectly as if there were a groove in the record! If I were playing a regular record—with the side pressure gone and resulting distortion eliminated—the sound would be cleaner."



**AUDIO** says: "Special features set this arm apart from the other automatics (and quite a few manuals). The first is an adjustable skating-bias control. This can be set for the proper stylus force used. It works effectively, without binding on the arm."

**HI-FI/STEREO REVIEW** says: "I found that the bias compensator was quite effective... When adjusted, the distortion was very low even at the highest velocities, and was observably lower than when no compensation was used."

**HIGH FIDELITY** says: "Tracking is well nigh perfect; the machine can handle cartridges of all weights, including the lightest, and of all compliances, including the highest; the assembly has a high immunity to external shock."

# Exclusive! Anti-Skating Demonstration with the *Garrard*<sup>®</sup> LAB 80

Due to the offset angle of any cartridge, and the rotation of the record, all tone arms have an inherent tendency to move inward toward the center of the record. This skating force, a definite side pressure against the inner wall of the groove, is a major cause of poor tracking, right channel distortion, and uneven record wear. Now, Garrard dealers have been supplied with grooveless records which make it possible to visualize the skating force and how it is overcome in the Lab 80. The demonstration takes only a few minutes, but it is well worth seeing before you decide on any record playing unit.

Oscilloscope readings (using 1000 cycle, 30 cm 1 sec. test record as signal source) verify effects of skating force on record reproduction.



Tracking without the anti-skating compensator, sine wave form shows considerable distortion.

Tracking with anti-skating compensator, sine wave form becomes a clean picture of the output of the cartridge.



The patented Garrard method of neutralizing skating force is but one of a number of Lab 80 developments exclusive today but sure to be imitated tomorrow by other manufacturers. Compare! You'll find this Lab 80 feature is simple and fool-proof... works perfectly without springs, balancing devices or other delicate mechanisms.

Visit your dealer to see the anti-skating device in operation, or send \$1.00 to Garrard for your own grooveless demonstration record. For your complimentary copy of our new 32-page Comparator Guide, write Garrard, Dept. GM-25, Westbury, New York 11591.

CIRCLE NO. 103 ON READER SERVICE CARD

AS high fidelity SEES IT



## Why Save the Old Met?

**I**N OUR September issue, we devoted considerable space to a preview inspection of the new Metropolitan Opera House. Like everyone else interested in matters operatic, we are excited by the prospects afforded by the first new major opera house to be erected in this country in many years. But at the same time we are saddened by the almost certain loss of the building at Broadway and 39th Street. For over eighty years, it has been more than one of the world's half-dozen great lyric theatres, and certainly more than the elegant tool of social oneupmanship forged by its original owners; it has, indeed, been an artistic symbol, a monument to our European inheritance and to our own cultural beginnings.

We say that its loss is "almost" certain because there are signs of a gradually awakening public interest in the preservation of the old house. The small but determined organization known as the Save the Met Committee (Box 714, Mt. Vernon, New York) has recently picked up some momentum, and presented its case at the first meeting of the newly formed New York Landmark Preservation Commission. Regrettably, however, this campaign (like those of many nobly intentioned but badly organized movements) is engaged in firing off ammunition in all directions at once; much energy is expended on charges of governmental conflicts of interest, on the demonstration of the Metropolitan administration's alleged wish to eliminate possible sources of competition, on completely unsubstantiated arguments for the old Met's superiority to the new, and on attempts to show that the building can yet be made to pay its way as a functioning theatre. Any or all of these hypotheses might, in responsible hands, be fruitful fields of inquiry. But they are essentially irrelevant to the matter of saving the old house.

In our opinion, the fundamental issue is something else. We believe that it is a mark of maturity in a society (as in a person) to recognize the primary importance of what we must call spiritual values. America's new performing arts centers are said to

symbolize our nation's coming of age. But a society that will trade in opera houses as if they were cars; that will destroy buildings rich in historical and architectural interest merely to turn over another profligate spade of earth; that will almost unquestioningly yield a unique symbol of heritage in return for yet another anonymous example of sterile acquisitiveness—that society has not come of age. This is self-mutilation, and it is unhealthy.

In the nineteenth century, it was to Europe that we looked for cultural instruction. It seems that in the twentieth we are still in need of some tutoring. We need hardly point out that in almost any European city a landmark like the Met would be preserved as a matter of course—not because it might have a "practical" use or a good profit yield but simply because it graced the city's past and meant something precious to its people. The Theater an der Wien in Vienna is an excellent case in point. The house that saw the first *Fidelio* has stood while nearly all Vienna changed, through bombardment and vicissitudes of every conceivable kind. At times, it has stood empty—but it has stood, for who would dream of removing it?

We believe that the old Met can find its place as a museum of the performing arts—a repository for everything related to our cultural beginnings and history. Such an institution is badly needed, for the scattered small collections that form parts of more comprehensive museums are not sufficient, or sometimes even accessible. The old Met is a splendid location for such a purpose, and the auditorium itself is a prime exhibit. In our view, the city administration, the officials of the Metropolitan (theoretical guardians of this heritage), and the opera public at large (to whom it largely belongs, for they have supported and sustained it, and at least once quite literally saved it from destruction) should make it their business to take an active and determined interest in the preservation of what has, since 1883, been *the* Metropolitan Opera House.

by WILLIAM R. TROTTER

# Sibelius

*and the tide of taste*

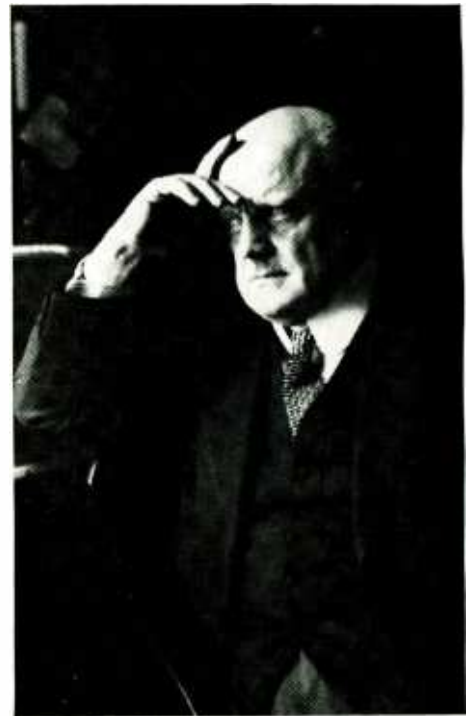

**In the composer's centennial year, the music that was once extravagantly applauded, once wholly dismissed, at last finds its own place.**

**F**EW IMPORTANT COMPOSERS have, during their own lifetime, experienced such heights of popularity or fallen into so dreary a pit of indifference as Jean Sibelius. At one time among his champions were great conductors—Koussevitzky, Stokowski, Beecham—who acted as persuasive spokesmen for his music and brought it to wide audiences through their recordings as well as their concert programs. His self-constituted apostles were legion, including the influential English critic Cecil Gray, who in an adulatory book heralded Sibelius as the savior of modern music, the greatest symphonist since Beethoven. Gray's extravagant claims were echoed in public opinion: a survey of New York concert audiences of the period revealed that Sibelius stood higher in their favor than any of his great nineteenth-century predecessors. And then, beginning in the late Thirties, came the reaction.

It could perhaps have been anticipated. People simply became sated with Sibelius, and a younger generation of listeners took their cue from authorities more fashionable than Cecil Gray. Nadia Boulanger was quoted as saying, "Sibelius, ah, poor, poor Sibelius! A tragic case!" Virgil Thomson, High Priest of Nadiatism, took every opportunity to impress his readers with how worthless, bleak, and

murky everything in the music was. The antagonism of a René Leibowitz expressed itself in articles like "Sibelius, the World's Worst Composer," in which the author summed up the Finn's contribution as "a heavy dead weight" in twentieth-century music. Bright young men used his fall from grace as an exercise for jejune witticisms: "Sibelius? My dear fellow, what possible merit can he have? He never caused a single riot!" And as the music declined in popularity, the caliber of performances tended to become perfunctory and haphazard, thus further alienating the composer from his audience.

Between the two extremes of adulation and hostility stands a considerable and fascinating body of work. Much purple prose has been gushed about its Nordic lustiness and mystery—so much, that one tends to forget that such descriptions have a basic truth. It can be safely said that few composers of our time (Vaughan Williams excepted) or any other have put so much pure nature (in the Wordsworthian sense) into their music. But there is something more than the evocation of atmosphere. There is a basic sincerity, a universality, a genuine emotional communication. Influences there were: Bruckner influenced Sibelius' first big composition, a massive cantata-cum-symphony based on the

*Kalevala* epic; Tchaikovsky appears in the First Symphony; hints of Debussy are found in *Oceanides*, and the short piece *Pan and Echo* is almost a rewrite of *Afternoon of a Faun*. But beyond these matters, it is the inherent integrity of Sibelius' output that has drawn myself and many other young music lovers towards his works. It is the sense that, from first to last, Sibelius expresses himself in a way that is the natural evolution of one man's creative processes—that, indeed, he never did cause any riots.

At a time when musical traditions and the ears of audiences were being blasted into by many isms, Sibelius worked apart, fought through his problems in the recesses of his own mind and heart, and, as he was fond of saying, went his own way. At this point in our century, when so much music seems to be written by professionals for the consumption of other professionals, music so much of which is as prickly as a cactus and as cerebral as a UNIVAC, many modern listeners find something enduring, refreshing, and invigorating in the music of Sibelius. It contains the kind of poetry and truth so often lacking in vacuous scores of the type presently flowing from (whisper the black heresy) Stravinsky, who has been playing a practical joke on art for the past thirty years.

Today the tide against Sibelius may be turning a bit. Ormandy and Stokowski have continued to program his works regularly. Of the younger generation, Lorin Maazel seems to be taking his place as a Sibelian. This season Leonard Bernstein will play all the symphonies with the New York Philharmonic, and an integral recording will be forthcoming from that conductor. And as an indication of the changing temper of the times comes word of the recent conversion of Ernest Ansermet, long in the camp of the Stravinskyans. In a printed interview, Ansermet repudiated the inbredness and sterility of that school, and recently he has recorded the Second and Fourth Symphonies and the tone poem *Tapiola*. In this there is much to ponder.

**I**F I were to single out one work as the most profound of Sibelius' compositions, it would be the Fourth Symphony. Critics have frequently labeled it sterile; when rehearsing it for performance with the Boston Symphony in 1912, Karl Muck shook his head over the score and muttered, "I'm blest if I know what he wants." It is a difficult work, and repeated patient listenings are necessary for its full impact to be felt by most listeners. It creates itself out of small bodies of ruminative and melancholy sound, and in it the orchestra is used in a daringly effective way: each group of instruments speaks among itself with the intimate give-and-take of a chamber composition. To me, Sibelius' Fourth Symphony is as sincere and poignant a statement of anguish as has been wrung from the heart of any composer of our century. This is the *Pathétique* of modern man. It has a cold and awesome loneli-

ness; its instrumental tones wander and float over a vast plane. To the listener who has become familiar with its style, it is a journey through a region of remote and profound sadness, and its ideas reveal a granitic strength of will. And Sibelius has created these impressions with the sparest orchestral forces. Surely, the Fourth is a great symphony.

Even less appreciated than the Fourth is the diametrically different Sixth. No one could possibly speak of this piece in terms of Nordic gloom and dark, drab colors. Why the Sixth has never found a wide audience is to me a puzzle. It is a glowing nature poem. It has a youthful quality that belies the fifty-eight years of the man who wrote it, a faint and delicious sadness for lost springtimes, with the cool passing of occasional dark and troublous shadows. The translucent beauty and warmth of the Sixth streams like sunlight through a fresh leaf, straight into the heart.

A good word should be put in too for the neglected Third Symphony. In this work Sibelius shows us the inner struggles he was going through to accomplish that amazing concise-vastness of statement which was to culminate in the noble Seventh. Gone are the tubas, cymbals, etc. of the heavier and more romantic first two symphonies. Tentatively—and sometimes very strongly and rightly—the new and more pastoral elements of the Sibelius style appear: horn pedals, delicate woodwind fragments in thirds, broad and flowing writing for the strings. The third and last movement is an attempt to combine forms, to compress, to pare the music down to an essence which the composer found still elusive. But hybrid though this symphony is in construction, and lacking though it may be in both the rough sweep and power of the first two symphonies and the maturity of the last ones, it is nevertheless filled with rich musical ideas. I would place it on par with the infinitely more popular Fifth, which, fine though it is, has never seemed to me to justify the favoritism the public has shown to it in comparison with the Sixth or Seventh.

No one familiar with Sibelius' work would quibble with the statement that he wrote streams of pot-boilers and insignificancies. But it is a shame that more people do not know some of his most characteristic and attractive works. Not long ago, I was privileged to audition, through the courtesy of the Finnish Radio in Helsinki, several tape recordings from Sibelius Festivals. Among these performances was a real rarity—the tone poem *Luonotar*, for soprano and orchestra, sung by Elisabeth Schwarzkopf and conducted by Tauno Hannikainen. The Finnish text is taken from the creation myth in the *Kalevala*, and the words are wedded to the musical imagery in a most striking and effective way. As a powerful, sometimes chilling evocation of the spirit behind a myth, it is music of real interest. Yet, not only has it never been recorded, but Breitkopf & Härtel have not even published the score. Certainly this piece should be played, both in concert and on records.

The complete music for *The Tempest*, one of



Photos courtesy Finnish National Travel Office

the glories of theatre music, is another recording we need, preferably in the dramatic context of the play to which it belongs. The manuscript is one of the largest of its kind in all music, some two hundred pages, jealously guarded by the Danish music publisher Hansen. According to the report of one who has examined the entire score, there is a complete and brilliantly effective way of interweaving of music for the entire play: dances, choral interludes, songs, and instrumental music. Indications are that the concert versions—Sibelius made two suites from the music, totaling seventeen numbers in all—hardly convey the inspired thoroughness and rightness of the music in its dramatic context. Even out of context, however, the storm music which opens the action is surprisingly effective—all the clichés of storm music are there but fitted together so skillfully that one is quite swept up in it: it is entirely the proper kind of Shakespearean storm. Certain of the musical character sketches—Caliban's Song, Prospero, Miranda—are delights for the ear and certainly conjure images fully in keeping with the play's characters. As for the Berceuse, the lullaby (apparently used in the play in connection with the spirit Ariel), there is nothing lovelier in all music. Within the compass of a few soft bars, an entire world of fairy enchantment and fragile beauty

is created. *The Tempest* is perhaps Shakespeare's most musical play, and its predominant mood is autumnal, gently mellow. That mood is matched by the mood of the composer, then sixty-one. After the music to *The Tempest* would come *Tapiola*. And after that, a yawning, tragic silence.

In two of Sibelius' better-known theatre scores, *King Christian II* and *Pelléas et Mélisande*, we hear the same kind of magic. Both were composed much earlier than *The Tempest*, and neither of the plays for which the scores were composed has survived. Yet the music for the lesser dramas stands alone as concert music much more strongly than *The Tempest* suites. In these scores, Sibelius reveals anew his gripping and altogether beautiful mastery of mood—he is able to conjure a somber, dreamlike quality that suggests age and mellowness, dim castles and half-real twilights, the romantic ideal of the medieval. In *King Christian* and *Pelléas*, there is a brooding bardic quality about the various pieces—heartfelt and never overdone; one senses that one is hearing the unfolding of a hoary and wonderful legend, even with no programmatic ideas in mind. The music for *Pelléas et Mélisande* contains just the right touch of youthful passion to fit the story, together with a quality of faded tapestry and moonlit-gold.

A title like *Night Ride and Sunrise* scares off a

lot of people. One imagines, all too confidently, the stringing-together of clichés and musical horsemanship that would illustrate such a title (shades of *Mazeppa*). But the actual score is a surprise. The piece is programmatic, but freshly and invigoratingly so. I once attended a live performance under Dr. Jusi Jalas, Sibelius' son-in-law, which revealed the score more thrillingly than any other I have ever heard. If not top-drawer Sibelius, *Night Ride and Sunrise* is at least an interestingly wrought and absorbing piece of music.

Everyone knows *The Swan of Tuonela*, the dolorous English horn bit. . . . But it is not generally realized that the *Swan* is only one-fourth of a cycle of vigorous and red-blooded poems called the *Lemminkäinen* Suite, dealing with the adventures of an amorous and mischievous young buck in the *Kalevala*. The whole cycle of four legends is a balanced and total concert work, and ought to be revived as such. It would be good to give the *Swan* a bit more to float in. The first part of the Suite, *Lemminkäinen and the Maidens of Saari*, is a jaunty and raffish bit of music, and the second section, *Lemminkäinen in Tuonela*, is the equal of the *Swan* in atmospheric effect.

The music to *Belshazzar's Feast* is good Hollywoodish orientalism and would make a delectable pops item. *The Lover* (*Rakastava* in Finnish) is a passionate and tender work somewhat in the Borodin manner, but with touches that could only be Sibelius. String ensembles would find it a rich addition to their repertoire.

It was fitting that Sibelius' last great composition should in so many ways be the symbolic crown of his career. *Tapiola* is, purely and simply, homage to the Northern forests and their mythological god, Tapio, of Finno-Ugric mythology. Some critics have found the composition far too long for its "meager" ideas. I would ask them if they have ever wandered for long and timeless hours through the world of the deep forest. The life of the forest grows to the eyes, ears, and heart from the softest and smallest things—rain trembling on the edge of a fern; moats of living sunshine floating in the air; the slight rustle of an animal; a sudden vista of wind-bent firs—until the vast totality of the Northland is sensed all around. And just so does Sibelius create his dark and pagan tapestry from the smallest kind of theme, dappling the music with sunlight and elfin scurryings, slowly massing the darkness of storm clouds. And once, briefly and hackle-raisingly, in the sudden cries of the horns after the second storm episode, one knows the presence of the Forest God himself, omnipresent and hidden and old as earth, a shape felt dimly through a storm. In his own hand, at the top of the score, Sibelius penned this short poem: "Widespread they stand, the Northland's dusky forests,/Ancient, mysterious, brooding savage dreams;/ And within them dwells the Forest's mighty God./ And woodsprites in the gloom weave magic secrets."

Old friends remembered that he saw those woodsprites as a child; in his sixties, he saw them still.

**I**N Finland itself, Sibelius is a fading shadow, though still a visible one. This is as it should be; for too long his influence dominated Finnish music completely and foredoomed the efforts of almost all other Finnish composers. Today, the major Finnish orchestras and the Finnish Radio are giving a large portion of their attention to contemporary music and the results are gratifying. There is some fine and original music being composed in Finland today, including much that is impressive enough to warrant a hearing outside its native country.

The debate over Sibelius as a human being still goes on. There were certainly defects in his character, moments of vanity and pride, but nothing that should set him off from the rest of us. It is unfortunate both for Finland and for Sibelius that

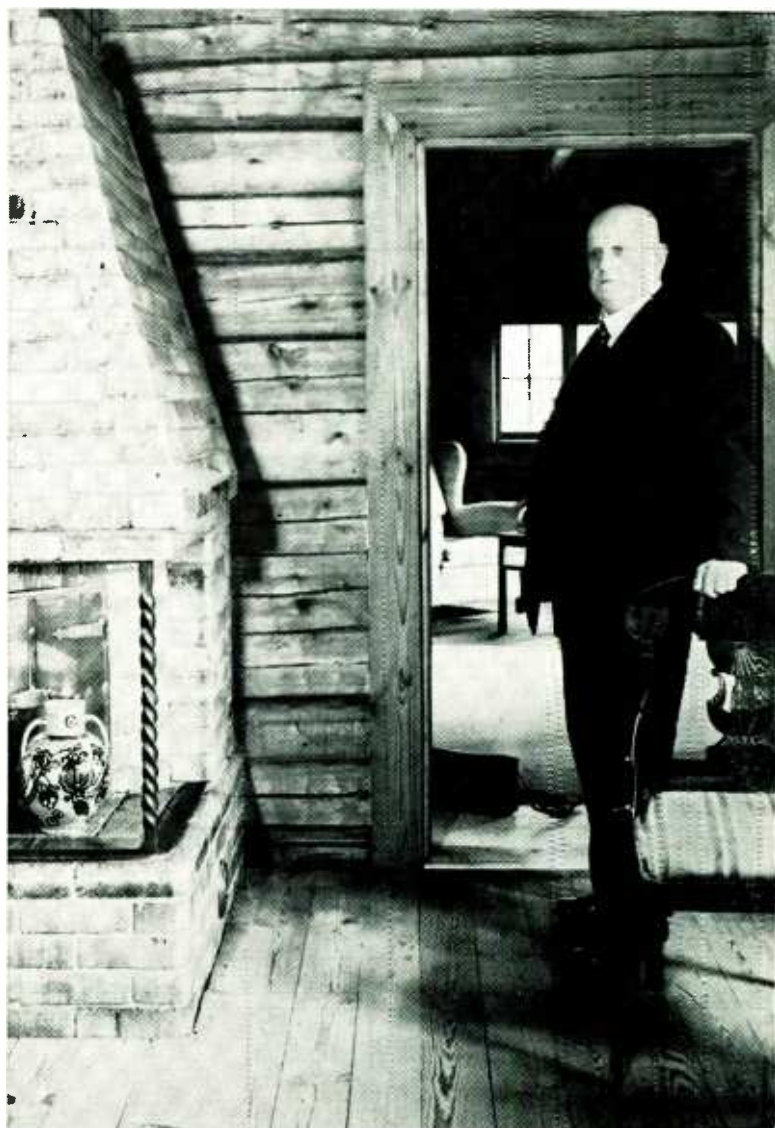

At seventy-five, in his country home at Järvenpää.

his people deified him. When I was in Helsinki, a student at the Sibelius Academy asked me: "How can you, an American, believe that you fully understand this music, which is so Finnish?" It was hard to answer him without insulting him, because the Finns believe in Sibelius' Finnishness with a deep and passionate pride. For a time, this national feeling was so strong that the Finnish masses seemed almost to be identifying themselves with the composer. Understandable and perhaps inevitable though this was, there is obviously no more similarity between the crude, red-faced Finnish farmer-peasant and Sibelius than there was between Beethoven and the average German cheese merchant. In fact, the great Finnish composer never mastered the fiendishly hard Finnish language well enough to write it. Like that of most members of the upper classes of the time, his correspondence was mainly in Swedish.

The powers of dreams are great. Sibelius finally led me to Finland, drawn by the visions of his world that the music had imparted to me. Thus, tacitly, I was accepting him first and foremost as a Finnish composer. These feelings were slowly altered during the year I lived in that country. The silver beauty of the lakes and birches, the sometimes very sad gentleness one finds in the Finnish character, that brooding sense of the infinitude of the forests, these are in the music, captured and limned with deep love and truth. But it was not Finland that supplied the crags and overflowing spirit of the music: Finland has no mountains. It is time that Sibelius be considered what he truly is: a composer belonging to people everywhere, who employed, as any real artist must, the ambience of his environment and the wellsprings of his heritage to express the visions of his own heart and spirit. His art is too vital, too human, too communicable to be contained in the word "nationalistic."

The place of Sibelius today? There is a story, which may or may not be apocryphal, that Richard Strauss, some years before his death, remarked: "I know more about music than Sibelius, but he is the greater composer." Strauss, it must be remembered, had conducted the world premiere of the Violin Concerto. This would give the lie to the oft-heard statements that the spirit of Sibelius' works is too foreign for the Germanic or Gallic ear to appreciate. Just as no one listening to a Dvořák symphony could fail to hear its origins in Bohemia, no one could mistake the essentially Northern sound of Sibelius—but not only the Czechs find a delight and satisfaction in Dvořák. And if Sibelius offers us the poetry of the forests, well, there are forests other than Finnish ones; and if that poetry contains all the delicate and somber lights and shadows, all the sudden sense of mystery and wonder of a sensitive wayfarer through these forests, then we may be glad such hearts are found among men; and, finally, if at times the music is the cold poetry of a warmthless and dark despair, is there not a time in everyman's life when he must face journeys along his own Tuonela?

## A Selective Discography

ALTHOUGH THE PRESENT Schwann listing affords an adequate representation of Sibelius' work, it could hardly be called ideal. Recently, however, there has been a quickening tempo of new releases, concomitant with the centennial, and Sibelius' discography may be significantly expanded a year or two hence. In the meantime, here is one listener's view of the current offerings. Judgments expressed do not always coincide with those of other Sibelians (including HIGH FIDELITY'S reviewers), but perhaps that in itself may suggest something of Sibelius' richness and complexity. In any case, the possibility of diverse—and even contrary—opinions is what makes music criticism interesting. . . .

As far as the Symphonies are concerned, one finds a predictable state of affairs. The first two, along with the Fifth, are the ones audiences still hear with some frequency, and they are well represented by recorded performances. There are, it seems to me, two basic approaches to the First Symphony: one stresses the odd-numbered movements' Nordic virility; the other the purplish romanticism inherent in the Tchaikovsky pages of the even-numbered movements. Ideally, a performance should blend these together. Only then, I think, does this symphony really "work." Two recent recordings take this approach: Lorin Maazel's with the Vienna Philharmonic (London CM 9375 or CS 6375); and Sir John Barbirolli's, with the Hallé Orchestra (Vanguard Everyman SRV 132 or 132SD). Maazel's is one of his finest recorded performances. He gets rich playing from the Viennese performers, and the snarling, biting brass and timpani of the first movement should delight the most fervent Sibelian. Maazel lets those long melodies sing out, but does not forget the sinews and guts in the music. His scherzo is the best on records. Still, his performance is not the last word—there are times when Maazel blasts away furiously when a lighter touch is called for. Sir John's is a performance of an older, and perhaps wiser, man. His is a rather gentle performance, built on long eloquent phrasing, and with climaxes that seem to roll out grandly and have their own kind of power. Sir John treats the second and last movements with manly tenderness and grace. On a par with these two fine performances is the mono-only Paul Kletzki/Philharmonia reading (Angel 35313), which seems to me to be one of the most satisfying ever released—Kletzki obviously loves Sibelius' music too, and he injects a slight dash of Polish passion



# SIBELIUS ON MICROGROOVE

which gives the Symphony real fire. Of other editions, Anthony Collins' (Richmond 19069) is for the most part routine, excepting a splendidly muscular and intense first movement; Ormandy's (Columbia ML 5795 or MS 6395) is overripe and flabby; and Beecham's (Columbia ML 4653), despite some superb playing by the Royal Philharmonic, is cranky and brittle.

The Second Symphony is the most played and most recorded of all Sibelius' big-scale orchestral works. Ruling the field among recorded editions is a well-nigh unsurpassed live concert recording by Sir Thomas Beecham and the BBC Symphony, dating from 1954 and available in this country as an Odeon import, ALP 1947. This is the classic, 1930's, gospel way of Sibelius playing, and it's also Beecham at his inspired best. It's a no-nonsense, masculine reading, moving with great energy and heroic momentum, beautifully rough and impolite. The tension raised in those famous last movements of the work is quite hair-raising, and when the studio audience breaks into "Bravos" at the conclusion, one is tempted to join them in full voice. Rather to my surprise, I find myself fascinated with the recording by Ernest Ansermet (London CM 9391 or CS 6391), who turns in a serious, absorbing, and richly detailed reading of the first two movements, giving them a sense of dignity and form few conductors could match; it's refreshing to hear it done this way. Unfortunately, Ansermet treats the climax, where a bit of the showy romantic is necessary, with similar sobriety. Pierre Monteux delivers a beautiful account of the first half of the Symphony (RCA Victor LM 2342 or LSC 2342), but his pointless acceleration of the last two movements robs the music of its nobility. Collins (Richmond 19103) gives a fine, straightforward performance at a bargain price. The readings by Herbert von Karajan (Angel 35891 or S 35891) and Thomas Schippers (Columbia ML 5935 or MS 6535) have their individual points of interest but each is highly idiosyncratic. Maazel's performance of the Second (London CM 9408 or CS 6408) is capricious and nit-picking despite some resoundingly successful moments, such as the sonorously impressive finale, and Paul Paray's (Mercury MG 14057 or SR 18057) falls short of providing a full Sibelian experience. Ormandy's reading (Columbia ML 5027 or MS 6024), preferred by some critics of note, I regard as bloated and spineless. I would like to add a strong plea that RCA be prevailed upon to re-

issue the Koussevitzky/BSO performance of this work—it was the touchstone for a whole generation of Sibelius listeners.

The interesting and delightful Third Symphony is well played by Kletzki and the old Philharmonia on Angel 35315. The Philharmonia had the best "sound" for Sibelius of any orchestra anywhere at the time its integrated Sibelius series was released.

For a long time, the only available performance of the masterful Fourth Symphony was a superslick one by Ormandy (Columbia ML 5045). Now, however, we've been given an amazing performance by Ansermet (London CM 9387 or CS 6387). The venerable Swiss maestro plunges deeply into the score, draws out the inner logic of its movements, probes for its meanings, and firmly holds the entire conception together. The orchestra plays richly and glowingly, and the recording is startlingly pellucid and intimate. This profound interpretation of a difficult work is one of the most important Sibelius releases in years.

The Fifth Symphony is well documented. Ignore Ormandy's (Columbia ML 5045), Erick Tuxen's (Richmond 19036), and the altogether lamentable attempt by Theodore Bloomfield (Everest 6068 or 3068). There are three really excellent performances currently available. Barbirolli (Vanguard Everyman SRV 137 or 137SD) gives a loving, expansive performance which builds to a truly noble climax. His is a "personal interpretation" in the very best sense of the word—a reading of rare insight and loveliness, though somewhat hampered by a diffuse recording. Von Karajan seems to have made this symphony "his" in an unusual way—he's recorded it three times in the past decade, and each time his conception of it has altered significantly. His first recording, with the Philharmonia (Angel 35002), suggested that he did not really understand this music. His second (Angel 35922 or S 35922) is far better—a firmer, yet more expansive reading, almost Brucknerian in its breadth and deliberation. Some may object to this treatment, but the dark glowing sound of the Philharmonia is perfection itself for this sort of thing. Now comes yet another Von Karajan Fifth, this time with the Berlin Philharmonic, on Deutsche Grammophon LPM 18973 or SLPM 138973. It's a tauter performance than the two Philharmonia versions, yet it still retains plenty of that wide-openness so essential to this Symphony. I do not think the last

movement is as heroic as Barbirolli's, or as somberly impressive as Von Karajan's own second version, but it fits his new over-all conception of the work. One cannot resist mentioning here, again, that Koussevitzky's rendition is both a historic and an artistic standard and ought to be made available somehow.

At this writing, there is only one performance of the Sixth, led by Von Karajan on Angel 35316. It is a radiant performance, glowing with the sunny translucence that the Philharmonia's strings could produce so beautifully. The reading is not alert to every aspect of the work, but no matter—if we must have only one performance of this minor masterpiece, it is well that it is as beautiful as this one.

Of the few generally accessible readings of the Seventh, I find Ormandy's (Columbia ML 5675 or MS 6275) the best by default. Beecham's is a horse race of hectic tempos (Angel 35458 or S 35458); Von Karajan's, while broodingly effective, is a bit stodgy (Angel 35316). (The talented young Russian conductor Gennady Rozhdestvensky has recorded a robust yet sensitive performance, coupled with the only contemporary recording of the lovely string suite *Rakastava*, on the Soviet MK label. The disc may be obtainable in an occasional import store.)

In the Violin Concerto, Op. 47 you pay your money and takes your choice. Jascha Heifetz (RCA Victor LM 2435 or LSC 2435) and David Oistrakh (Columbia ML 5492 or MS 6157) both own the work as soloists, but neither gets more than perfunctory orchestral backing from Walter Hendl and Ormandy, respectively. Leonard Bernstein and Zino Francescatti (Columbia ML 6131 or MS 6731) are in good rapport, but fine as their collaboration is, it doesn't really compare with the tremendous reading given by Christian Ferras and Von Karajan (Deutsche Grammophon LPM 18961 or SLPM 138961). Ferras created a sensation at the 1964 Sibelius Festival with a performance of wild, gypsylike flame-and-fury which toppled all technical problems with bold ease. This recorded performance is a bit cooler and darker, but it is also more precise and finely shaded in tone; the soloist is undoubtedly influenced by the massive but clean-lined support given by Von Karajan. Ferras need stand behind no one, even Heifetz, as far as his violin playing is concerned—it is dazzling.

Turning to the tone poems, I should like first to dispose of Sir Adrian Boult's  
*Continued on page 145*

# STEREO ACCESSORIES UNDER \$50

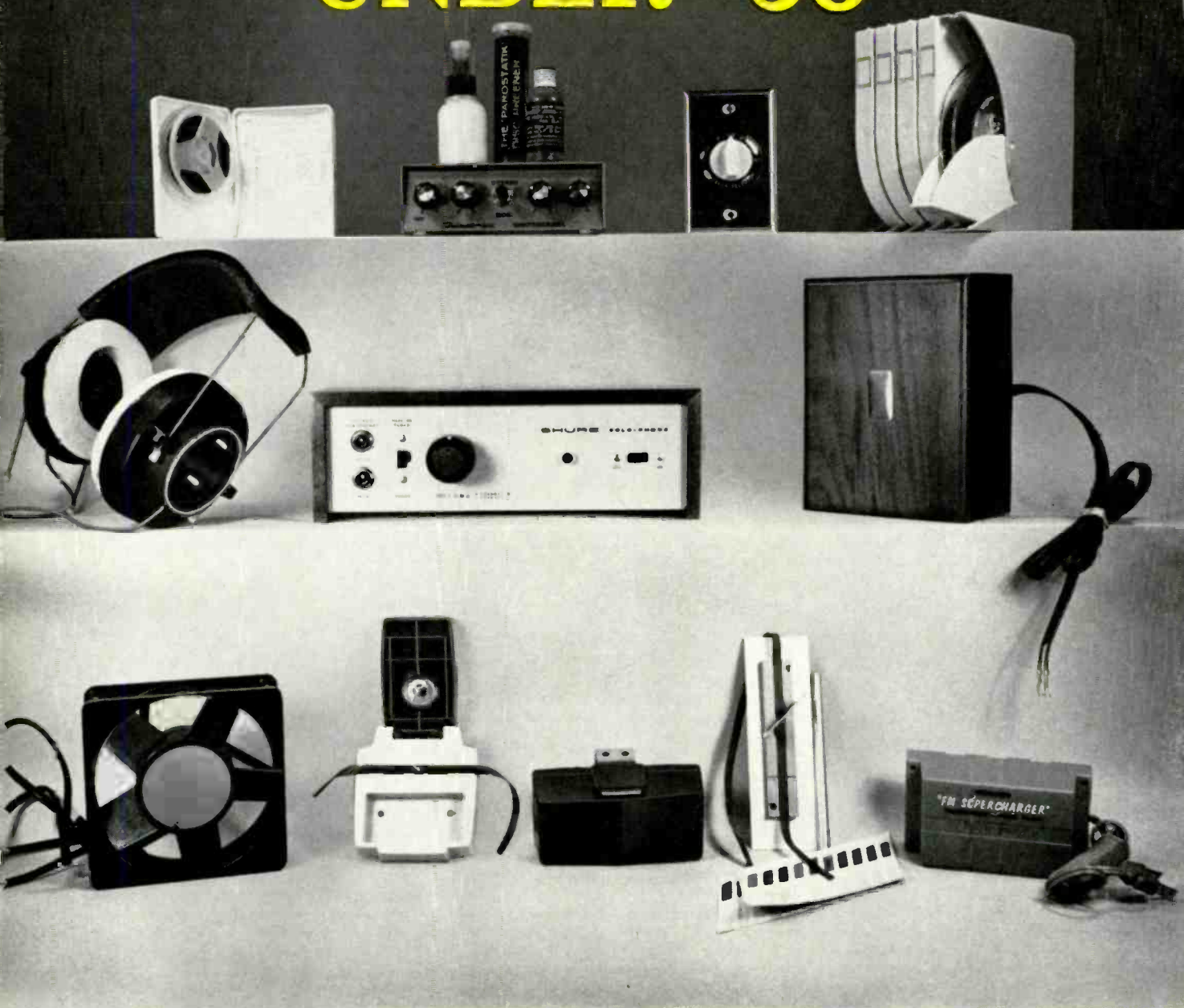

**I**N AUDIO, it's often the little things—not unlike the proverbial wanted nail—that can markedly improve performance or facilitate a hobbyist's activity. That this notion is shared by high fidelity owners and the audio industry alike is evident from the array of accessories and gadgets on display at most dealers', which—to judge from reports—enjoy a very brisk trade indeed. Herewith is illustrated an assortment of the very latest, chosen for their representative interest to the owner of an audio system. Moreover, in the spirit of the season, any of these devices—all priced under \$50—might make a thoughtful gift to a deserving sound enthusiast.

A tribute to a growing hobby among tape fans is the item pictured at left in the top row. A 3-inch reel of 0.5-mil tensilized polyester (Mylar) tape comes housed in a self-sealing plastic packet, which includes a label for mailing purposes. The 3M Company describes it as a "living letter"; by whatever name you call it, correspondence by recorded tape offers possibilities for communication far beyond those of the written page.

Next in line is another delight for tape enthusiasts: a battery-powered, transistorized stereo mixer offered by Switchcraft. This compact gadget permits you to blend two separate signals on each stereo channel while recording, and feeds the resultant "mix" to the twin inputs of your recorder. In its mono mode, the Model 306TR handles four signal channels.

Sitting atop the mixer are the latest record-cleaning agents devised by the British inventor Cecil Watts, and distributed here by Elpa. These include a "Humid Mop" for conditioning the bristles of the Parastat, itself a cylinder of nylon brush tips treated with a special formula contained in the small vial next to it.

Shown next to this group is a switch for the man with three sets of stereo speakers. Switchcraft's Model 657 permits selecting any one stereo pair, any combination of two, or all three. Similar switches are made by others, including Audiotex and Vidair.

From Rye Sound comes the unique tape storage bin (at the right, top row). Available in different sizes, the plastic bin has swing-out sections for reels; each section has a label.

The popularity of stereo headphones, for listening in privacy, continues unabated, thanks largely to the wide-range and smooth-sounding models brought out by a number of companies. New models have been announced by Koss, Sharpe, Telex, and Superex. The Telex Adjustatone shown here is unique in that it is designed to provide either a normal headphone effect or a more "forward" effect by reversing the set. Next to it is a logical companion, the Shure Solo-Phone headphone amplifier. This solid-state device accepts signals directly from magnetic phono cartridge, tuner, or tape recorder and drives two separate sets of stereo headphones. It also may be used as a modest system preamplifier, and even as a tape recorder mixer.

The latest indoor FM antenna, to the right of the

Shure amplifier, is the Model 201 by Eagle International. Resembling a walnut cigarette box, it connects readily to an FM set and may be positioned easily for best reception.

In addition to the well-known Rotron fan, we now have a new model, the IMC Boxer shown at the left in the bottom row. Designed for ventilating high fidelity equipment, the Boxer comes with a mounting kit and installation instructions.

Next in the row is a new tape splicer from Robins, a company which offers more than two dozen different kinds of tape and disc accessories, including groups of devices packaged as kits. The TS-6 shown here features a control knob that adjusts the angle of a cutter under a lift-up lid. Tape guides hold the tape in place. The TS-6 is supplied with twenty-five precut splicing tabs.

From the antenna manufacturer Finney comes a useful "little black box"—the Finco Model 3007 FM band-pass filter, designed to permit only FM signals to reach your set. The Model 3007 stops interference by blocking out unwanted signals from TV, citizens band, and ham rigs. It also is effective against noise from motors and fluorescent lamps. Supplied with an adjustable bracket, the unit may be installed wherever convenient.

Draped, appropriately enough, with tape is the EDITall splicing kit, developed by tape recorder expert Joel Tall and now marketed by Elpa. The kit features Tall's patented splicing block—a groove holds the tape in place, and mitered cuts permit splicing at either of two angles. The block itself may be fastened directly to a tape deck by screws or by its self-adhering back. Also included in the KP-2 Kit is a supply of thirty precut splicing tabs, a demagnetized razor blade, a grease pencil for marking tapes, and a detailed instruction booklet.

The last item pictured here may well be one most welcomed by FM listeners. Compact, lightweight, and transistorized, the Winegard Model 340 booster is connected between the FM antenna and the FM set. The name of Supercharger suggests the unit's function: that of perking up FM reception—in difficult locales, or of weak signals.

The items displayed in this roundup are a small fraction of the total available. Most tape manufacturers offer various accessories. Reeves, for one, has announced a chemical solution which, applied to recorded tape, enables one to see the magnetic pattern of the recording to study track uniformity, head alignment, and so on. Greentree Electronics has released a tape care and cleaning kit, and similar products are offered by many firms. In FM antennas, in addition to the names mentioned, there are comprehensive lines of boosters, filters, and couplers from Jerrold, JFD, and Channel Master. Record care kits are offered by Duotone, Audiotex, Lektrostat, and others. In fact, if the interest in little things continues, there soon may be as many manufacturers of accessories as of equipment.

**BARGAIN**



by Roland Gelatt

# When Records Reached the Supermarket



The following article forms the postscript chapter to a revised and updated edition of *The Fabulous Phonograph*, which has just been published by Appleton-Century. When the book first appeared in 1954, it was described by *Newsweek* as "the first truly objective study of the trials and triumphs of the talking machine." The revised edition adds another decade to this chronicle of trials and triumphs.

**A**T THE END of 1954, it appeared as if the business of making and selling records was prospering as never before. The microgroove LP disc was securely established, new and adventurous companies were rapidly expanding the recorded repertoire, and converts to high fidelity were multiplying at a satisfactory rate. But appearances were somewhat deceiving. Total record sales in the United States for 1954 came to \$199,000,000. This was a startling sum in comparison with the annual sales figures of the mid-1930s, but rather less startling in comparison with the boom year of 1921, when domestic record sales amounted to \$106,000,000. Considering the decrease in buying power of the dollar and the increase in population, one could well question whether the record industry had really made much headway

in thirty-three years. Certainly, for a few farsighted executives at Columbia and RCA there were no grounds for complacency. "It's still a tiny business," I remember one of them telling me, with the worried frown of someone who understands a problem but hasn't yet come up with a solution. "It's like the book trade—small volume and inefficient distribution." His indictment still had considerable force as 1954 drew to a close, but it was not to remain valid for long. Records, like books, were about to be catapulted into a mass market.

The initial step occurred on January 3, 1955, when—the Christmas buying spree over—RCA Victor cut the price of every LP record in its catalogue to \$3.98. Overnight the cost of a Red Seal record went down by two dollars, that of a popular record by one dollar. This was the most dramatic realignment of record prices since Columbia's bold half-pricing of 78s in August 1940, and, as then, a good many customers were found for the suddenly devalued merchandise. Columbia, Capitol, and Decca had no choice but to follow RCA's lead without delay. The small companies, however, held firm. Their economic existence was predicated on a generous per-unit profit on small total sales. Demand for Bach cantatas was limited; at a retail price of \$5.95 you could afford to put out an edition of, say, two thousand copies and end up with a small profit; at \$3.98 you couldn't. And so there developed

a strange imbalance: a Beethoven symphony conducted by Toscanini carried a list price of \$3.98, whereas a Mozart trio played by uncelebrated Central European instrumentalists was quoted at \$5.95. The disparity didn't make any sense, and it was not destined to endure.

The price cuts of January 1955 represented a last major effort to expand the record business through the traditional channels of regional distributors and local dealers, a retailing network which for half a century had been the mainstay of the industry. It was now a network riddled with faltering outlets. By the early 1950s the neighborhood record store had tumbled into rapid decline, a victim of unaggressive merchandising and inadequate stocks (a small dealer with limited capital could not begin to keep pace with the expansion of the LP catalogue). Much of the business was being siphoned off by a few cut-price retailers (most notably Sam Goody in New York City) who offered huge inventories and whopping discounts in barnlike emporiums lacking frills or service. For the committed record collector who knew what he wanted, Sam Goody was just the place to get the most for a dollar. But the discount houses in New York, Chicago, and Los Angeles did not reach the grass roots, did not appeal to the millions of potential new record listeners on whom the industry was pinning its future expansion. Behind RCA's price cut lay the hope that discounters would be neutralized and neighborhood record stores restored to their erstwhile solvency. The low prices were widely advertised, and as an additional lure RCA devised a series of sampler records which sold for 98 cents and contained excerpts from current pop and classical albums. Never had there been a more massive effort to entice old and new customers into the record dealer's door.

**B**UT BY THEN there were other—and, for many, more convenient—ways of obtaining records than by recourse to the nearest record store. Mail-order record clubs had already secured a firm beachhead in the business. Back in 1950, Concert Hall Records, one of the early independents, had started the Musical Masterpiece Society to purvey its wares on a regular mail-order basis. It was followed by a club known as Music Treasures of the World, and before long by the powerful Book-of-the-Month Club, which had joined the act with a subsidiary operation called Music-Appreciation Records. BOMC's ploy was to combine diversion with education, its advertisements being directed to those "who enjoy good music but are aware, too often, that they do not listen to it with complete understanding and appreciation." A Music-Appreciation Record (they cost \$3.60, "to subscribers only") devoted one side to a performance of a standard piece and the other side to its musical analysis. Among them, the three enterprises were striking pay dirt. By 1955 their total membership was somewhere between 600,000 and 1,000,000, and they were accounting for about 35 per cent of the

total dollar volume of all classical LP records sold in the United States.

Not a penny of this money was going either to the regular dealers or to the major companies. The clubs made their own recordings (usually in Europe), developed their own customers, and pocketed the proceeds. This was bad enough, but the prospects for the future seemed even more alarming. Music-Appreciation Records no longer wanted to content itself with second-string orchestras, conductors, and soloists. The club was spending an enormous sum to advertise a recording of the Brahms Violin Concerto by Endre Wolf and the London Symphony under Walter Goehr. The returns were good, but they would be that much better, the club surmised, if the recording were by Isaac Stern and the Philadelphia Orchestra under Eugene Ormandy. In due course, Book-of-the-Month started negotiating with a few of Columbia's and RCA's most celebrated artists, and because of the club's prestige and resources it was able to make some tempting proposals. The New York Philharmonic, for example, was reportedly considering an offer that would guarantee minimum royalties of \$500,000 a year. Taking a hard look at this situation, the major record companies could foresee a future in which they would have to share not only the distribution but also the production of records with interlopers from outside the industry. Indeed, it was not too difficult to conceive of a time when the whole record business in America might be controlled by the book clubs. There was only one way to forestall such an eventuality: the major record companies would have to get into the club field themselves.

Columbia got in first. In August 1955 the company announced the formation of the Columbia Record Club. As was to be expected, the dealers cried foul. They complained of being cast off, swept into the dustbin, deserted in an hour of need, and many of them vowed to boycott Columbia forevermore. But the company stuck to its guns and began recruiting a brand-new market for recorded entertainment, a market which embraced communities where records had never before been sold. Free merchandise constituted the bait with which club members were snared. Columbia splashed a covey of album jackets across the top of its ads and offered to mail any four of them to a new member without charge. One's only obligation was to purchase four additional records from the club during the next twelve months. Unlike its predecessor clubs, Columbia's offered popular music as well as classical. It also offered recordings by performers of widespread celebrity: André Kostelanetz and Louis Armstrong, Mary Martin and Alexander Brailowsky, the New York Philharmonic and the Philadelphia Orchestras. It was a question of the right idea and the right ingredients at the right time. The club caught on beyond Columbia's most optimistic expectations. Within twelve months 409,000 members were on the books.

RCA Victor held off for two years, reasserting its



## Supermarket

belief in the independent retailer as the backbone of the business, and directing all its efforts to a strengthening of his position. But despite lower prices, sampler records, cooperative advertising, and a variety of other props, the local record store continued to lose ground. Too many other people were selling the same product more advantageously. Discount houses continued to flourish (the effect of the price cuts having been merely to make their low prices even lower) and record clubs were booming. To these potent competitors was now added another: the so-called "rack-jobber," who served as middleman between record manufacturers and supermarkets, drug stores, and five-and-tens. For the LP record was suddenly up for sale wherever you turned, cunningly displayed on self-service racks and priced (generally at \$1.98) to meet minimal resistance. Initially, the rack merchandise was of a fairly sleazy order, for the major companies refused to make their wares available. But as rack sales grew in importance, there loomed again the specter of appreciable profits accruing to outsiders, and before long the majors began producing their own special lines expressly tailored for the casual, self-service customer in the supermarket. In 1957 the nation's record racks accounted for 15,000,000 out of a total sale of 52,000,000 LPs. The clubs that year disposed of 12,000,000 records. That left 25,000,000 which were sold through normal retail outlets. It just wasn't enough, and in January 1958 RCA Victor yelled uncle, joined forces with Book-of-the-Month, and launched the RCA Victor Record Club.

As a come-on for joining the new club, RCA put forward its most irresistible attraction: the nine Beethoven symphonies performed by Arturo Toscanini and the NBC Symphony, a seven-record set originally published in 1953 and priced variously from \$50 to \$34.98 in the intervening years. It was now to be had for \$3.98, provided you agreed to purchase six additional records from the RCA Victor Record Club during the course of a year. Within three months 340,000 sets of the Toscanini recordings were distributed in this fashion. The Maestro's name had once again exerted its old magic. But it

was for the last time. For twenty years his records had consistently outsold all others. Suddenly, demand for them began to ebb. Doubtless the conductor's disappearance from the musical scene contributed to this disenchantment; with rare exceptions (Caruso, Furtwängler), a performing artist's popularity does not long survive his death. But there was a more important reason for the quick and drastic decline in sales: sonically, the Toscanini recordings had fallen behind the times.

In the three years since his retirement (April 1954), tremendous strides had been made in the technique of sound recording. No longer were engineers content merely to string up microphones above the orchestra and eavesdrop on a performance. Each session now posed its own particular challenges, wherein microphone placement, dynamic levels, reverberation patterns, and contouring of frequencies were adjusted and readjusted for optimum effect. More and more, records were being "produced"—were being planned, that is, in terms of electronic potentialities and conceived as entities in themselves rather than as mere duplications of concert-hall performance. Nothing exemplified the new approach more strikingly than the recording of Tchaikovsky's *1812 Overture* put out by Mercury Records in March 1956.

The recording endeavored to re-create the performance conditions which Tchaikovsky had originally envisaged for this patriotic war horse—a performance out-of-doors, with a military band abetting the orchestra, and with Kremlin bells and a salvo of cannon resounding in the finale. Mercury's producers began by recording the strictly musical parts of the score in Minneapolis' Northrup Auditorium, using the Minneapolis Symphony Orchestra and the University of Minnesota Brass Band under the direction of Antal Dorati. Then they moved their recording truck to New Haven to put the bells of Harkness Memorial Tower on tape. Finally, they moved on to West Point and prevailed on the authorities to fire off a 1761 brass cannon for the benefit of their microphones. Back in the New York studio, the engineers superimposed these various tapings onto a final master tape, employing whatever electronic trickery seemed in order (for example, overlaying the bell clamor with a double-speed recording of itself, to create the cascade of tintinnabulation that a Muscovite would have heard when his city's thousand bell towers rang out simultaneously). No dynamic compression was employed in transferring the tape to disc, and not every needle could track the final measures without sometimes popping out of the groove. No matter. The record made a tremendous, soul-satisfying noise. It quickly dislodged Toscanini from the top of the classical best-seller list, and it stayed there for years.

**J**UST AS sales of the *1812 Overture* were gaining momentum, a new method of recording began to make its presence felt. It went under the name of

stereophonic sound, and it really wasn't all that new. The notion of "two-eared listening" had been around for many years. Bell Laboratories had put on some very effective binaural sound demonstrations at the Chicago World's Fair of 1933, and in 1940 the Disney-Stokowski film *Fantasia* had shown what could be accomplished with multisource music reproduction in a movie theatre. Only with the advent of high-quality magnetic tape, however, was stereophonic sound able to enter the home. Essentially, stereo aimed at reproducing the spaciousness, clarity, and realism of two-eared listening. Of course, everyone with normal hearing had been listening to standard monophonic recordings with both ears, but the loudspeaker itself conveyed only a one-eared image. Even if it reproduced the sound of a symphony orchestra picked up from a dozen scattered microphones, one heard in the end only a single-source reproduction of that orchestra. All the sound was eventually funneled into a solitary channel. And hearing with one ear was like seeing with one eye: clear and detailed in effect, but flat; sharply contoured, but without depth.

Stereo could help to liberate sound from these one-eared limitations. In its simplest form, a stereo recording derived from two microphones placed several feet apart in the studio. The sounds from each microphone, instead of being amalgamated as in a monophonic recording, went separately and simultaneously onto two independent channels—that is, onto adjacent tracks of a magnetic tape. During playback these two channels would be routed through two independent amplifiers and loudspeakers, the latter also placed several feet apart. And because the sonic image emitted by each speaker differed in slight but vital degree, an effect was re-created akin to the minutely divergent "points of view" of our own two ears.

"The most exciting development yet in music listening" proclaimed an advertisement by Ampex, the country's leading manufacturer of tape equipment, in the fall of 1955. But the excitements of stereo promised by Ampex were still of a very special and restricted nature. Only a handful of stereo tape recordings had yet been released, and these were the products of small companies whose engineering expertise and musical resources left much to be desired. A year later the stereo scene had brightened. For some time RCA Victor had been making experimental stereo tapings of all its important orchestra sessions, and by mid-1956 the company was ready to test the market with a few of its more successful efforts. For the Christmas trade that year RCA could offer a small but imposing catalogue of stereo tapes featuring the Boston Symphony under Munch and Monteux, the Chicago Symphony under Reiner, and such prestigious soloists as Gilels, Heifetz, Oistrakh, and Rubinstein. RCA was offering, too, the Victrola Stereo Tape Player, which packaged tape deck, stereo amplifier, and speakers in a pair of table-top units selling for \$350.

No one hearing the early stereo tape recordings

could fail to be impressed by their sense of spaciousness, by the buoyant airiness and "lift" of the sound as it swirled freely around the listening room. Stereo seemed to dissolve the walls; and unlike even the best monophonic recordings, it could clarify a complex musical construction, enabling the listener to sort out simultaneous strands (particularly in a large-scale work for chorus and orchestra) that had previously been forced into a muddy sonic impasto. One began listening to sound in a new way, savoring its breadth and depth as well as its melodic outlines and harmonic textures.

Delights of this order did not go unappreciated. A small but growing market for stereo tapes began to develop, and soon other major record companies joined RCA Victor in making a portion of their current releases available in stereo tape as well as mono disc form. But at the prevailing price structure no dramatic expansion of the stereo business could be expected. RCA Victor's stereo tape of the *Symphonie fantastique*, a particularly effective display piece for the two-channel medium, sold for \$18.95 (as opposed to \$3.98 for the same Boston Symphony recording on a monophonic LP disc), and to play it one had to make an investment in costly stereo tape equipment. At these prices, stereo tape was solely for the connoisseur and the avant-garde; it related to the standard LP record as the Jaguar to the Chevrolet. Stereo would find a mass market only when its cost had been brought down, and that awaited the perfection of a stereo disc. Meanwhile, the record industry was not disposed to rock the boat. In 1957 record sales in the United States amounted to \$405,000,000, more than double the 1954 figure. Obviously there were plenty of avid customers for the monophonic product. The stereo disc could wait.

But it didn't. By force of circumstances and the workings of a free economy, the stereo disc was forced on an unwilling record industry long before its anticipated debut.

The challenge of impressing two well-separated channels in a single record groove—at the same time maintaining the playing time and high-fidelity characteristics of a monophonic LP disc—posed engineering problems of gigantic proportions. Researchers on both sides of the Atlantic were grappling with them. But though one heard occasional rumors about work going on behind closed doors, nothing seemed to materialize, and, when questioned, record executives indicated that a stereo disc could not be expected for years. In the summer of 1957, however, an RCA engineer unwittingly let it be known that the Westrex Company (part of the A.T. & T. complex) had devised a successful method of putting two stereo channels into a single groove. His revelation was immediately denied, but a cat had been let out of the bag, and rumors began to fly thick and fast. To set the record straight, Westrex decided to demonstrate its new stereo disc at the Audio Engineering Society's annual New York convention in October. At the same time, engineers from the

Decca Record Company in London flew over to demonstrate another stereo disc. And a few weeks later, Columbia chimed in with a third. But nobody wanted a repetition of the War of the Speeds, and in due course technical representatives from the major American and European companies met in solemn conclave and agreed on the Westrex system as the preferred choice. There was agreement too that the raw Westrex prototype needed considerable refining before anyone could think of putting stereo records on the market. And so, as 1957 drew to a close, the stereo disc remained quietly ensconced in the laboratory. The general public, ignorant of rumors and demonstrations, would wait for its debut until such time as the big companies elected to launch the new product.

Now enters Audio Fidelity, Inc., a smallish record company specializing in sonic blockbusters. Shortly after the initial Westrex demonstration, Audio Fidelity dispatched some of its stereo tapes to Westrex and requested the company to cut a stereo master disc from them, purely for experimental purposes. At the time there was no phonograph cartridge on the market capable of playing a stereo disc. But this did not deter Audio Fidelity from duplicating the Westrex stereo master and putting copies of the "unplayable" record on sale. Within weeks of its appearance, Fairchild Recording Equipment Company had started making a stereo cartridge with which to play it. And suddenly the fat was in the fire. Other small companies got into the stereo act, other cartridge manufacturers went into production, and the leaders of the industry, rubbing their eyes at the unexpected *fait accompli*, abandoned their well-laid plans for a controlled change-over to stereo and quickly slipped into high gear themselves. By September 1958 every record company of any importance in the United States was offering stereo discs for sale.

Most were of rather indifferent quality. The industry had been pushed into stereo production too quickly. Neither disc-cutting techniques nor cartridge design were up to former monophonic standards, and the hapless customer in 1958 had to accustom himself to instruments that would wander from one speaker to the other across a yawning chasm in the middle, as well as to accept a degree of fuzzy distortion that would have seemed intolerable in a mono LP. It is no wonder that the customers were few. In December 1958 stereo discs accounted for a mere 6 per cent of total dollar sales. The ordinary record buyer had adopted a wait-and-see attitude. Something irresistibly attractive would have to come along before he converted to stereo.

**F**OR THE CLASSICAL CUSTOMER, the persuasive "something" turned out to be a recording of *Das Rheingold*, the first opera in Wagner's *Ring* tetralogy, and a work never before committed to discs. It came from the Decca Record Company Ltd. (London Records in the U.S.A.) and boasted an all-star cast

from bottom to top, including the legendary Kirsten Flagstad in the last important recording of her career. But it was the sound that made people sit up and take notice. *Rheingold's* producer, a young Englishman called John Culshaw, had fully grasped the potentialities of stereo. His aim, as he put it, "was that of re-creating in the studio an environment as close as possible to the theatre, with singers acting their parts in a production almost as elaborate as the real thing." Within Vienna's Sofiensaal, Culshaw set up a huge stage, marked off into numbered squares that served as guidelines for the deployment of his forces. Long before the sessions began, his whole production had been plotted out, in minute accordance with the composer's stage directions. When Wagner wanted a character to move, he moved; and at home the listener could hear his progress across the imaginary sonic stage created by stereo.

On occasion the stereo medium could even attempt to improve on the original. "Thus," wrote Culshaw, "in Scene Three, Alberich puts on the Tarnhelm, disappears, and then thrashes the unfortunate Mime. Most stage productions make Alberich sing through a megaphone at this point, the effect of which is often less dominating than that of Alberich in reality. Instead of this, we have tried to convey, for thirty-two bars, the terrifying, inescapable presence of Alberich: left, right, or center there is no escape for Mime." For the Nibelheim scene, eighteen anvils of the type and size specified by Wagner were obtained, played by percussionists affiliated with the Vienna Philharmonic, and for the Rainbow Bridge section the composer's full complement of seven harps was on hand. Conductor Georg Solti led all these forces with taut incisiveness; Culshaw employed his "effects" with knowledge and taste; and the engineers succeeded in getting everything into easily tracked stereo grooves. The result was overpowering. Soon after *Das Rheingold* appeared in August 1959, everyone was talking about its magical moments: the passage of Wotan and Loge through the anvil-hammering Nibelungens' caverns, the piling of the hoard, the heaven-splitting thunder and lightning that dissolve the mists around Valhalla, and at the very end the Rhinemaidens' seductive song off in the distant depths while the gods cross triumphantly over the Rainbow Bridge downstage. Hearing all this, even an imperfect Wagnerite could not help but succumb to stereo.

While *Rheingold* was doing its work in the classical market, a record aptly titled *Persuasive Percussion* was engaged in the same kind of proselytizing on a much larger scale in the popular field. The advertisements ("greatest advance in sound since hi-fi was invented") had a familiar ring, but everything else about the disc was new: the label (Command), the jacket (an abstract design of dots), and the stereo engineering. Its producer, a veteran band-leader named Enoch Light, believed that the ordinary listener would take to stereo only if it were made to sound entirely

*Continued on page 146*



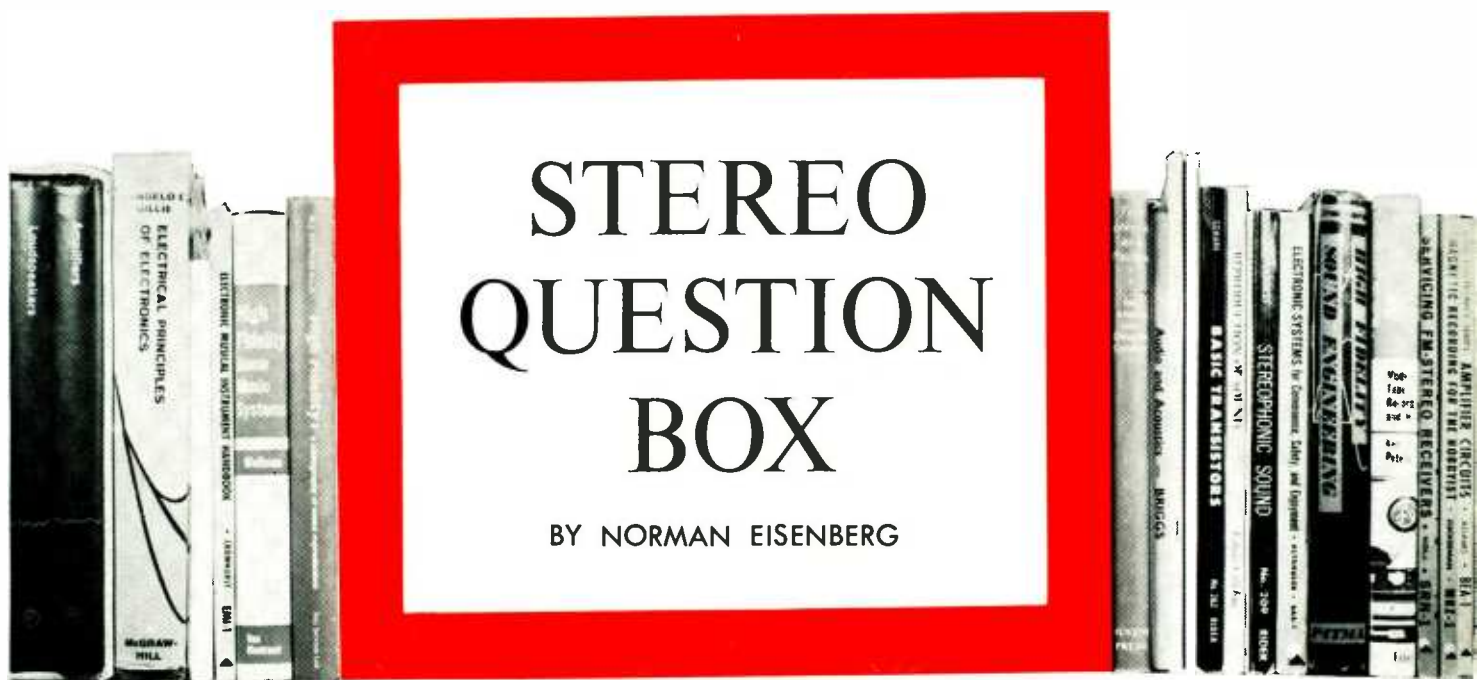

## Some expert answers to some recurrent queries.

**A** WRITER of antiquity said: "It is not every question that deserves an answer." No doubt—and some questions cannot be answered, or can be answered only in part or with qualification. Particularly is this true of the audio art, resting as it does on both science and aesthetics, and involving such variables as personal taste, room acoustics, different (but equally valid) approaches to similar problems. Moreover, it seems to be a characteristic of this field that as new answers are found, new questions come up, in a kind of self-perpetuating dynamism that fascinates, even as it confounds, many observers. Thus, while some questions can be answered in clear-cut fashion, others must rather be played with. For all this, and not forgetting the hazard of "a little knowledge," it seems self-evident that some information is better than none at all. The questions that follow are based on a compendium of queries received here over the past year or so; they are answered—we hope—in a manner that may provide some guidance in the fertile field of stereo playback equipment.

### 1. Can a warped record be "unwarped"?

Regrettably, a record is not as susceptible to being straightened out as a dented fender. If the warp is not too severe, a record sometimes can be pressured back to shape by being placed under a heavy weight for several days: a pile of telephone directories, perhaps abetted by an unabridged dictionary, may do the trick. If you try this, however, be sure to place some cushioning—a felt pad or a thin layer of flexible foam rubber—between the disc and the objects bearing down on it. Even then, there is no assurance

that the groove may be not damaged even while the record's surface is forced back to shape. A severely warped record—as from exposure to sunlight or other intense heat—probably cannot be restored.

### 2. Most of the published advice on FM antennas assumes that the reader lives in a private house rather than an apartment. Just how can we cliff dwellers satisfy the needs of an all-out installation, in terms of multielement antennas, rotators, and the like?

In a word, you probably can't—unless you are free to use the roof of your apartment building for such an installation. There are some "next best" solutions, however, and the one to be adopted depends largely on reception quality in your locale, or even in your own apartment (that is, what works for the neighbor on another floor, or even down the corridor, may not work for you). For instance, you may find that tapping into the building's master TV antenna system may do the trick—especially if you use an "FM splitter," a small electronic device costing a few dollars. Or, you may get by with a rabbit-ears aided by a booster. Just make certain that there is enough free space around the rabbit-ears to permit rotating it by hand to orient it for different stations. In any case, you should expect to get best reception from local stations only.

### 3. Is it true that British watts are different from American watts?

Actually, no. A watt is the same anywhere in the world. The confusion arose some years ago out of



a different system used by the British to rate amplifiers for power (wattage) output. This difference exists in the U.S.A. too, between various segments of the industry and even among different manufacturers of similar equipment. It involves one's technical frame of reference—or such variable factors as the line voltage used, the distortion level at which an amplifier is rated, the specific value of output power chosen to describe the amplifier. For instance, an amplifier (British or American) that provides continuous (or root-mean-square, sine-wave) power of 15 watts at 0.05% distortion when plugged into a 117-volt line may provide as much as 25 watts at a higher distortion when energized from a 125-volt line. The “peak” power of such an amplifier would be, under those conditions, as much as 50 watts. If you double this figure, to emphasize stereo operation, it is possible (though obviously somewhat misleading) to refer to this amplifier as a “100-watt” amplifier. In general, the British prefer to think in terms of the less spectacular rating methods. So do many Americans, although there has been a tendency in this country to promote the higher values (bigger numbers for expressing the same thing).

The recent work by the IHF Standards Committee and the procedures used by this magazine in its published test reports represent an effort to “hold the line” to some reasonable level. Actually, no expression or rating of amplifier power has meaning unless it is qualified by additional information as to the distortion level, the load into which the amplifier was working, the line voltage used, the specific value of power being presented (continuous, music, or peak), and—in the case of stereo amplifiers—whether the figure is the sum of the outputs of both channels or the individual output of one channel and, if the latter, whether the other channel was being driven at the same time (the most rigorous form of testing). For all this, it is quite conceivable that the same amplifier could be presented as a “15-watts-per-channel” unit or as a “75-watt” or even a “100-watt” model.

**4. I finally have decided to convert to stereo, but I would hate to waste the excellent monophonic equipment I now own and which still seems very listenable. My system consists of a manual turntable and professional arm (which is wired for stereo although I've never used it that way); a mono preamp; and a huge coaxial speaker in a bass-reflex enclosure. What should I do?**

If budgeting is a problem, you might consider selling or trading in everything but the turntable, to help you start from scratch. If you are not concerned about cost, you would do well to keep what you now own for a “center channel”—either to provide monophonic versions of stereo programs in another room or to enhance the “wall of sound” stereo effect in one fairly large room (or against the longer wall of an average-size room). To do so, make certain that your new stereo amplifier has a derived or “A plus B” output jack intended for connection to an external monophonic amplifier. Connect a signal cable from this jack to a high-level input (such as “auxiliary”) on your mono preamp, which will continue to drive the old mono power amp and speaker system. Use the stereo outputs on the new amplifier, of course, to drive a new pair of stereo speaker systems. Place these as far apart as possible, and center your old speaker between them. Use the volume control on the old mono preamp to adjust the output of the center speaker so that it fills in between the stereo pair but does not overwhelm them.

You may be able to achieve this setup without even using the old mono preamp—simply connect the “A plus B” signal directly into the input on the old basic amplifier. If the basic has a level control, use it to adjust the center channel. If it has no control, you will have to wire in an L-pad between it and the center speaker.

Your present turntable may suffice, depending on what condition it is in. Playing stereo records will, of course, accentuate any inherent vertical rumble (which would have been inaudible as long as it was used in a mono system). If rumble is a problem in the new stereo setup, you would do well eventually to replace the turntable with a newer model.

**5. The controls on my amplifier make scratchy noises when I turn them. Is this serious, and how can I eliminate it?**

Often, noisy controls can be silenced by injecting a suitable fluid (available for \$1.00 or less at radio supply outlets) into the resistive element of the control, accessible behind the control shaft. Essentially, it is a matter of cleaning the metal contacts that may have become dirty or corroded. If this dodge does not help, the control needs replacement, or the noise may be caused by current leakage. In either case, seek professional help.

**6. A tape recorder I am contemplating is listed with response to 15,000 Hz (cps). Another model, costing less, claims response to 20,000 Hz (cps). Who's kidding whom?**

Chances are that the wider frequency response claim of the cheaper model either does not include such pertinent data as the degree of variation in the response (plus and minus so many decibels), or else allows for a wider variation than the costlier model. For example, the cheaper unit may extend its response to 20K Hz (kc)—but with such variation and

distortion in this frequency region as to render the extreme high-end response virtually worthless; the more expensive machine will provide relatively smooth response over whatever range its specifications include. Another factor to consider is whether the response claimed is for playback (of commercially recorded tapes—presumably tested by standard test tape) or for record/playback (of tapes made on the machine itself). As a rule, the former response will be somewhat smoother than the latter. A fairly rigorous statement of tape recorder response, for record/playback, would include: tape speed, degree of amplitude variation, distortion level over the frequency range claimed, and recording level used, such as the data supplied on tape recorders in this magazine's own test reports. At the very least, any response claim that is stipulated without variations in decibels should be questioned.

#### **7. What causes groove-skipping when I play records, and how can it be cured?**

Any of several factors, or a combination of them, can cause the stylus to leave the groove of a record momentarily or even to go skating across the surface. To begin with, the turntable itself may not be level. A check with a split level—and a shimming up of the base or mounting board—may readily solve the problem. Another cause of groove-jumping is an arm that is unbalanced towards its rear or pivot end. Make certain that the instructions furnished with the unit are followed carefully in checking out this critical area. With the arm balanced, the tracking force used for a particular cartridge may be too light—if so, readjust it. Often it may be necessary to use the highest tracking force recommended on the cartridge data sheet.

Groove-skipping also will occur when a cartridge is seated too high up in the arm shell so that the edge of the shell, rather than the stylus, makes contact intermittently with the record surface. To remedy this, reinstall the cartridge, using the small stand-off mounts supplied with it or with the arm. If you have no such stand-offs, they can be purchased very cheaply at most dealers'.

Under certain conditions, a very light tracking force combined with a "natural" tendency for the arm to be pulled towards the center of a record may cause groove-skipping during heavily modulated passages. The "bias adjustment" or "antiskating" adjustment found on some arms can overcome this tendency and, in general, improve tracking of the inner portion of the groove.

Dust, accumulated on the stylus tip, can cause groove-skipping, particularly with an elliptical stylus, which rides somewhat higher in the groove. Finally, if a cuing device—either built in or added to the ensemble—is used, make certain that it does in fact permit the arm to be lowered fully to the record surface.

#### **8. A friend of mine insists that only a horn-type tweeter can reproduce the true sound of brass and horn instruments because it is, after all, shaped like**

**a horn. Cone tweeters, he says, are all right for people who listen only to string music. Should this argument determine what kind of speaker I buy? I play in a dance band and I am mainly interested in popular music.**

You might legitimately prefer a horn tweeter to a cone type, but not for the reason your friend gives. The fallacy in his argument is that no speaker—of whatever type—is intended to replace a trumpet, or any other instrument. A speaker's function is to translate electrical signals from an amplifier into sound energy and then to "couple" this energy to the room. The design, material, and shape of any speaker all are calculated to do these two related jobs, not to "sound like" specific instruments or even groups of instruments. It is absurd and misleading to think in terms of designing a speaker to imitate physically all the possible sources of live sound. The various designs encountered in speakers represent individual approaches to solving the same basic problem: generating sound and transferring it to the listening area. If a speaker has a characteristic timbre of its own, it is not because it was designed to favor one class of instruments or one type of music; rather it indicates, to that extent, a degree of imperfection in a man-made artifice.

#### **9. What is the meaning of "high" and "low" magnetic phono inputs, and how do I know into which my cartridge should be connected?**

If your preamplifier or combination amplifier has two sets of magnetic phono inputs (or one set that can be switched from "high" to "low"), the one marked "low" probably will accept signal levels of, say, 2 to 6 millivolts—which covers most of today's cartridges. Higher output magnetic cartridges may overload the preamp circuits and therefore should be fed to the "high" magnetic input, which has less gain. The correct equalization will be provided in either case. Where to draw the line between high-output and low-output magnetic cartridges is difficult inasmuch as there is no industry standard in this particular area—and in fact much depends on the sensitivity and gain characteristics of a given preamp. If you are still in doubt, after consulting both the cartridge data sheet and the amplifier instruction manual, simply try each of the two magnetic inputs. A cartridge that is overloading its input will cause unusual loudness combined with distortion. A cartridge that is not getting enough gain will sound weak even with the amplifier's volume control turned to maximum.

#### **10. Can you suggest a simple way of checking the speed of my tape recorder? How serious is any given amount of variation from true speed?**

There are two kinds of speed variation in tape recorders (as well as in turntables). The cyclic or steadily recurrent kind, known as wow and flutter, cannot be measured except by professional laboratory instruments—although the effects of such variation, if pronounced, can be readily heard as slow and



rapid changes in musical pitch. As for measured values, the figures of 0.3% and 0.1% for wow and flutter respectively are generally regarded as desirable performance goals for high fidelity use.

A steady departure from true speed (the machine runs faster or slower than its nominal speed setting) is measured most accurately, again, with professional instruments. However, a fairly good idea of speed accuracy can be obtained by several alternate methods. One is to use a strobe tape, available at audio dealers', and a neon lamp. The tape is run on the deck and the markings observed. If they move in the direction of the take-up reel, the machine is running too fast; if the markings seem to move towards the supply reel, the transport is running too slow. A similar kind of indication can be obtained by using a strobe wheel placed against regular tape during its passage across the deck. It is important to remember that the speed of each reel itself varies, depending on how much tape is on it at any given instant. The actual tape speed is the rate at which tape passes over the heads, and this is most accurately gauged by checking it as close as possible to the drive capstan, located just to the right of the head assembly.

While either of these methods can indicate whether the tape is moving too fast or too slowly, neither can tell you by how much. A simple method for calculating the percentage of speed variation (which may be useful, although not as accurate as the professional instrument method used in the lab) is to use a length of timing tape, sold as an accessory at most dealers'. Markings on this tape indicate specific lengths for exact timing—for instance, a 7½-inch length represents 1 second at the 7½-ips speed, or 2 seconds at 3¾-ips speed. By counting the number of marked sections, then timing the run with a stop watch or a clock with a sweep-second hand, you can calculate the percentage of speed accuracy. Of course, the more timed sections and the longer your test-run, the more accurate will be your calculation. For high fidelity use, a recorder that has an average speed variation of not more than 1 per cent would be quite acceptable; such a variation would represent no more than a tone-shift of about ⅛, insignificant from a listening standpoint.

**11. I have been given a pair of speakers described as "low efficiency" and requiring "a high-powered amplifier to drive them." I have been considering an amplifier advertised as "120 watts peak power"**

**but a friend advises that this may not be strong enough for these speakers. How can this be? Isn't 120 watts an awful lot of power?**

Your friend probably is right. To begin with, the "120 watts" probably refers to the sum of both channels. However, each speaker will have to be driven by its own amplifying channel—so with reference to what each speaker will get from the amplifier, we are talking about "60 watts peak power." (See Question 3, above.)

It is well to remember that to produce only a small increase in volume from a speaker, an amplifier has to furnish double the power it supplied an instant before. The lower the speaker's efficiency, the greater becomes the numerical value of that power. For best performance with very low efficiency speakers, an amplifier capable of supplying an rms power of about 35 watts (per channel) is recommended. Such an amplifier could perhaps be described as a "200 watts peak power" amplifier, but the manufacturers of such equipment eschew, as a rule, astronomical numbers in favor of a more conservative statement of legitimate performance data.

**12. I own a fairly costly component stereo system that I'd like to take with me when I move to Europe next spring. Will my equipment operate abroad? If not, what will I need to get it to do so?**

Power line standards differ abroad from the 117-120 volt, 60-cycle current used in the U.S.A. All foreign current is supplied at a frequency of 50 Hz (cps), and the exact voltages vary. Throughout most of Britain the mains supply is 240 volts; on the Continent it is 220 volts, although parts of France and Italy use 110 volts. So, for most locales, you will need a step-down transformer. The most common type sold is for cutting 230 volts to 115 volts, which should suffice in most places abroad. Cost ranges from just below \$5.00 to about \$30, depending on the transformer's wattage rating, or power-handling ability. Be sure to estimate this figure correctly by adding the power requirements of every one of your components that has an AC line cord. This, by the way, is *not* the audio output power of your amplifier, nor is it the power-handling ability of your speakers. It is the power drain on an AC line required for operating the equipment. The figures often are printed on the rear of equipment, or are listed in the owner's manual, or can be obtained from the manufacturer or your dealer. To the total wattage you have calculated, better add another 25 to 50 per cent for safety and to allow for the possible acquisition of additional equipment. The resultant figure is the wattage rating required for your step-down transformer. If the transformer itself is not specified in terms of wattage, it will be listed with a "volt-amp" rating. For practical purposes, voltage multiplied by amperage gives you wattage.

In addition to the transformer, you will need for most turntables on 50-cycle current a new motor pulley. Your tape recorder may require a new capstan or a sleeve fitted over the present capstan.

Better consult the manufacturer of your particular model(s) for exact instructions.

**13. Just how important is the signal-to-noise ratio characteristic of an amplifier or tuner? I own an old set which, when tested, had an S/N ratio of 74 db. My friend has a new transistor amplifier which, according to a test report, has an S/N ratio of 61 db. Yet both amplifiers, playing the same record through the same speakers, sound alike in this respect. Shouldn't we be able to hear a 13-db difference in noise level?**

At S/N ratios as high as 60 db, it is doubtful that an additional drop in relative noise level would be audible except possibly in an anechoic chamber and with deliberately selected program material or test signals. In other words, an S/N ratio better than 60 db may indicate a certain rigorousness of design rather than any significant listening improvement. When comparing tube and transistor amplifiers, another factor must be considered: the characteristic noise frequencies of tubes are generally higher-pitched than those of transistors and consequently more apparent to the ear. A really valid comparison between the noise level of a tube amplifier and that of a transistor amplifier ought to take into account the frequencies at which the noise occurs. Such "weighting" would be very difficult to assign, however. The lower-pitched noise characteristic of transistors does not increase as rapidly, with respect to lowering frequencies, as does the high-pitched noise of tubes with respect to rising frequencies. And the exact increase varies from one transistor to another. What's more, the ear itself becomes less sensitive to increases of amplitude (of noise as well as signal) as frequency is lowered. For all this, it is entirely understandable—in fact, quite logical—that a solid-state amplifier of about 60 db S/N ratio will be as quiet as a tube amplifier of about 75 db S/N ratio. In comparing two tube amplifiers with a 15-db difference in S/N ratio the difference probably will be more apparent than when A-B'ing two solid-state amplifiers with a similar difference.

**14. How many speakers can be connected to one amplifier channel?**

By "connected," we assume you mean "driven from" or "played at once." As a rule, you can run as many as you like—up to the point at which the power reserves of the amplifier become so "drained" that not enough energy is delivered to any of the speaker systems to produce an appreciable volume of sound. But this rather loose rule has some important exceptions. If the total impedance presented to the amplifier becomes too low (several speakers in parallel), you run the risk of excessive current in the output stages or of a near or actual short circuit across the output terminals. In some transistor amplifiers this condition could either blow a fuse or damage the output transistors. Usually, the instruction manual supplied with a solid-state amplifier or receiver contains some advice on this point.

At the opposite extreme, if you connect your speakers in series, to increase the load to the amplifier, you may decrease your amplifier's damping factor (see Question 19, below) and thereby degrade bass response. This is very relative to the original damping factor of the amplifier and the requirements of your particular speaker, and therefore cannot be predicted in advance. Usually, the instruction manual supplied with the equipment will indicate what precautions, if any, should be observed for multiple speaker hookups.

For hints on impedance matching and switching arrangements, using more than one speaker, see "Extension Speakers," *HIGH FIDELITY*, March 1965.

For a "center-channel" speaker hookup, made by interconnecting the opposite-side outputs of a stereo amplifier, again check the owner's manual for your amplifier or receiver. In some transistor models, such a hookup may defeat the built-in protective circuitry around the output transistors. Nothing bad may happen, of course, but you have left the door open for possible trouble. If in doubt on this point, query the manufacturer of your set.

**15. Is it necessary to have several different kinds of styli for playing various types of records—such as stereo discs, recent and older mono LPs, and records of different speeds?**

An elliptical stylus of about 0.8 mil in its frontal dimension (or measuring across the width of the groove) will do for all microgroove records, whether stereo or mono and whatever the speed. A conical stylus of about 3-mil radius will handle all 78-rpm discs made since the mid-1940s. The larger stylus is offered by many manufacturers of stereo cartridges as an accessory item. Inasmuch as discs made much earlier than, say, 1940 may vary considerably in groove shape and width, the 3-mil stylus may not be able to play them all. Styli for such old rarities are no longer made commercially although an affluent collector might be able to order one custom-made.

If one doesn't own an elliptical stylus cartridge, the next best "perfectionist" approach would be to use a 1-mil stylus for mono discs and a very narrow-radius conical stylus (average, 0.5-mil) for stereo discs. Industry sources advise that the narrower the stylus tip the more difficult it becomes to hold dimensional tolerances, and a "0.5-mil" stylus actually may have a tip that measures from 0.4 to 0.6 mil. Finally, the popular 0.7-mil stylus can serve as a suitable "compromise" for most microgrooves, stereo and mono.

**16. What is the difference between "gain," "level," "volume," and "loudness"? I have seen all these terms used on audio components, and to my untrained eye and ear all these controls do the same thing. Or do they?**

The first three controls listed above do one and the same thing: they regulate the amplitude level of electrical signals. By custom or usage, rather than for any technical reasons, "gain" *Continued on page 155*

# THE COMPLEAT AUDIOPHILE

The intrepid angler without a tackle box? The mighty hunter with no gun case? The philatelist without a stock book or stamp album? The artist without his taboret? The chef without a pantry? Never. Never. Never!

The fact is you enjoy an avocation more fully with the right accoutrements for the task at hand—and, inevitably,

this leads to the need for a place to store the many small and delicate items comprising your collection.

Cartridges, for example. The true audiophile invariably owns more than one. He chooses the correct cartridge for the record—and for the occasion. Keeping them safe and handy is a problem that Shure has undertaken to solve. Voilà!



Exclusive, custom-designed, handsome 12" x 5 1/4" x 2 1/2" black simulated leather box with gold leaf tooling. Compartmentalized and fully lined. Holds up to 4 cartridges and 6 extra styli—or 3 cartridges and 6 extra styli, with room to spare for your pressure gauge, brush, etc. Simply send \$4.95 and proof of purchase of any Shure Stereo Dynetic cartridge to the address below.

(Value? Name your own price—the Shure Cartridge Caddy is unavailable anywhere else at any price!)

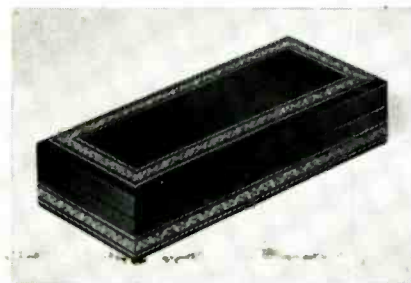
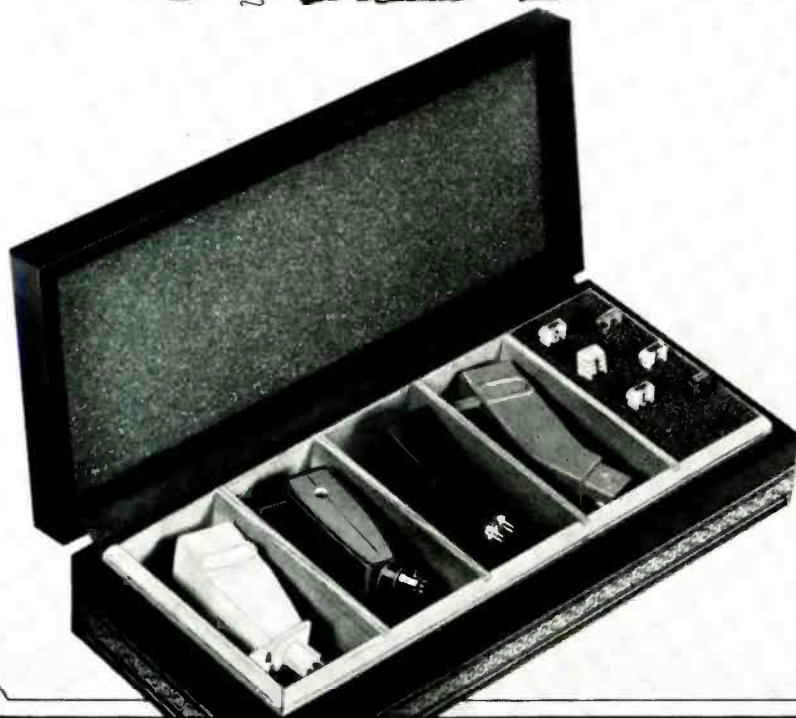

... the Shure Cartridge Caddy only \$4.95

IT'S YOURS FOR ONLY \$4.95 WITH THE PURCHASE OF ANY SHURE STEREO DYNETIC® CARTRIDGE

(Offer available in U.S.A. only)

V-15



THE ULTIMATE! Literally handmade and inspected in accordance with the stringent standards of the Shure Master Quality Control Program. Features bi-radial elliptical 15° stylus. Reduces IM, harmonic and tracing distortion. A purist's cartridge throughout. \$62.50.

M55E



MODERATE PRICE. Compares favorably to the V-15, but produced under standard quality control conditions. Features elliptical 15° stylus. Will improve the sound of any system (except those using the Shure V-15). \$35.50.

M80E



THE "FLOATING" CARTRIDGE. M55E type, spring-mounted in head-shell for Garrard Lab 80 and Model A70 Series automatic turntables. Bounce-proof and scratch-proof. Cartridge retracts when pressure exceeds 1 1/2 grams. \$38.00.

or the Shure M3D at \$15.75; M7/N21D at \$17.95; or any of the Shure M44 series cartridges at \$17.95 to \$21.95.

Shure Brothers, Inc., 222 Hartrey Ave., Evanston, Illinois

CIRCLE 72 ON READER-SERVICE CARD

high fidelity

# EQUIPMENT REPORTS

*The consumer's guide to new and important high fidelity equipment*

---

## FISHER MODEL TX 200 CONTROL AMPLIFIER

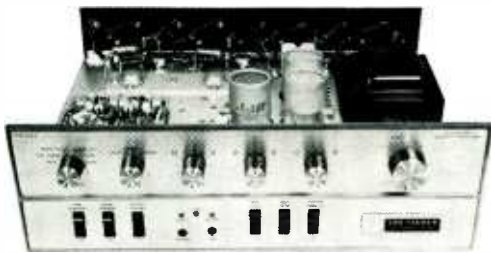

**THE EQUIPMENT:** Fisher TX 200, a solid-state pre-amplifier and power amplifier on one chassis. Dimensions: front panel, 15 $\frac{1}{4}$  by 4 $\frac{3}{4}$  inches; depth behind panel, 12 inches. Price: \$279.50. Manufacturer: Fisher Radio Corp., 11-40 45th Rd., Long Island City, N.Y. 11101.

**COMMENT:** Solid-state and using no output transformer, the new Fisher TX 200 amplifier is a high-performing unit that offers a full panoply of control features as well as high, clean power across the audio band. The gold-anodized front panel, divided into two horizontal areas by a decorative ridge, presents a neat and well-ordered appearance. The upper row of controls includes: a six-position program selector; a mode switch (mono, stereo, reverse); a channel balance control; and a pair of dual-concentric, friction-coupled tone controls (so that bass and treble

can be adjusted simultaneously or independently on each channel, as desired). The larger knob at the upper right is for power off/on and volume.

The lower half of the escutcheon contains six rocker switches for: tape monitor; main speakers off/on; remote speakers off/on; low filter; high filter; and loudness contour. Centered between the rocker switches are three pilot lamps which indicate what mode of operation is being used, a stereo headphone jack, and a tape jack that permits hookup to a stereo tape deck directly from the amplifier's front panel.

At the rear of the chassis are two sets of barrier terminal strips for speaker connections; two switched AC convenience outlets; seven stereo pairs of input jacks; another pair for feeding to a recorder; and four fuses for the set's eight output power transistors (one fuse for two transistors). A slide switch selects the speaker output impedance (4, 8, or 16 ohms). In addition, there are special input and output jacks for connecting an external reverberation unit; normally, these jacks are kept shorted.

The back panel of the TX 200 serves as the heat-sink for its eight output transistors. Individual bias controls are provided on the chassis for each set of two output transistors, making four adjustments in all; these are factory preset and not normally used by the owner.

In tests conducted at Nationwide Consumer Testing Institute, Inc. (a subsidiary of United States Testing Company, Inc.) the TX 200 shaped up as a very clean performer, with characteristics that would suit it for driving any known speaker system of any efficiency. The measured performance data, shown in the accompanying chart and graphs, all follow the manufacturer's specifications very closely and indicate an honestly rated, well-engineered product. The IM characteristic is representative of many solid-state inte-

---

## REPORT POLICY

Equipment reports are based on laboratory measurements and listening tests. Data for the reports, on equipment other than loudspeakers, is obtained by Nationwide Consumer Testing Institute, Inc., a subsidiary of the United States Testing Company, Inc., of Hoboken, New Jersey, a completely independent organization not affiliated with the United States Government which, since 1880, has been a leader in product evaluation. Speaker reports are based on controlled listening tests. Occasionally, a supplementary agency may be invited to contribute to the testing program. The choice of equipment to be tested rests with the editors of HIGH FIDELITY. No report, or portion thereof, may be reproduced for any purpose or in any form without written permission of the publisher. No reference to the Nationwide Consumer Testing Institute, Inc., to its seals or insignia, or to the results of its tests, including material published in HIGH FIDELITY based on such tests, may be made without written permission of the publisher.

grated chassis, in which distortion measures higher at lower power output levels. However, at the levels most often used the IM doesn't rise much above 0.5 per cent. The amplifier's damping factor is a very favorable 10, and its harmonic distortion is very low across the audio band. Both the RIAA (disc) and the NAB (tape head) equalization characteristics are excellent, and this is one of the few integrated amplifiers encountered that can supply accurate playback direct from tape heads, if desired.

Tone controls, filters, and loudness contour all functioned smoothly and exhibited very favorable characteristics from a music-listening standpoint. Sensitivity and signal-to-noise ratios of all inputs were very good. The high-frequency square-wave response showed no ringing and good transient characteristics; the low-frequency square-wave showed some tilt, reflecting the rolloff in the extreme bass (below 20 Hz) that is typical of integrated amplifiers. The stability of the TX 200 was found to be excellent.

A versatile unit, the TX 200 is also a clean-sounding one, and another example of how solid-state design can achieve superior performance in an attractive and relatively compact format. It should be of interest to anyone seeking a substantial control amplifier at a fairly reasonable cost.

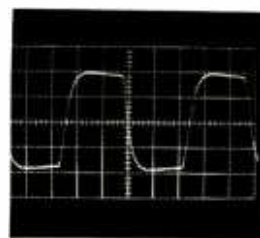
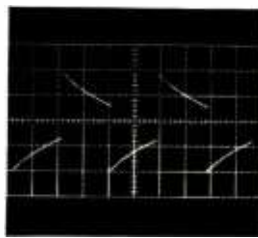

Square-wave response to 50 Hz, left, and to 10 KHz.

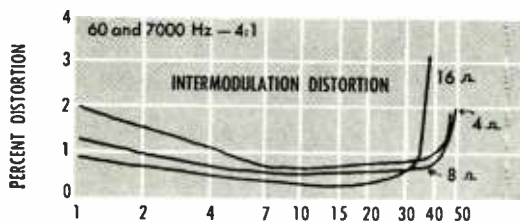
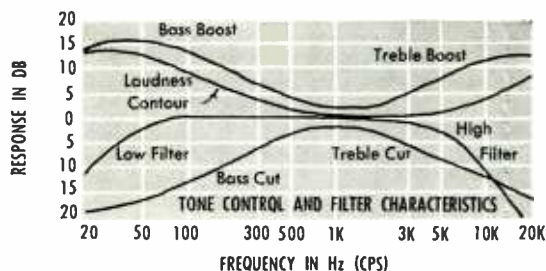
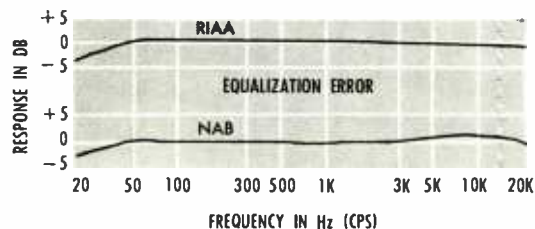
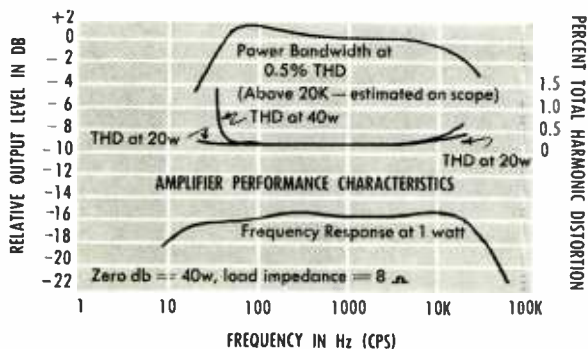

## Fisher TX 200 Amplifier

### Lab Test Data

#### Performance characteristic

#### Measurement

Power output (1K Hz into 8-ohm load)

l ch at clipping	40 watts at 0.13% THD
l ch for 0.5% THD	50 watts
r ch at clipping	38.2 watts at 0.19% THD
r ch at 0.5% THD	45 watts
both chs at once	
l ch at clipping	35.7 watts at 0.14% THD
r ch at clipping	34 watts at 0.2% THD

Power bandwidth for constant 0.5% THD

25 cps to 30K Hz

Harmonic distortion

40 watts output	under 0.5%, 37 Hz to 15K Hz
20 watts output	under 0.4%, 20 Hz to 20K Hz

IM distortion

8-ohm load	under 1.3%, 1 to 44 watts output
4-ohm load	under 1.5%, 2 to 46 watts output
16-ohm load	under 0.85%, 1 to 32 watts output

Frequency response, 1-watt level

+0.3, -2 db, 10 Hz to 30K Hz

RIAA equalization

+0, -2 db, 29 Hz to 20K Hz

NAB equalization

+0.5, -2 db, 25 Hz to 20K Hz

Damping factor

10

Characteristics, various inputs

	Sensitivity	S/N Ratio
phono low	3.9 mv	51 db
phono high	7.2 mv	51 db
tape head	2.5 mv	51 db
microphone	2.9 mv	54 db
tape monitor	270 mv	65 db
tuner	270 mv	67 db
auxiliary	270 mv	67 db



## McINTOSH MI-3

### MAXIMUM PERFORMANCE INDICATOR

**THE EQUIPMENT:** McIntosh MI-3, a self-contained visual-display (oscilloscope) device. Dimensions: front panel, 16 $\frac{1}{8}$  by 5 $\frac{3}{8}$  inches. Chassis depth, 11 $\frac{1}{2}$  inches behind panel. Price: \$249. Manufacturer: McIntosh Laboratory, Inc., 2 Chambers St., Binghamton, N.Y. 13903.

**COMMENT:** Originally designed as a tuning aid for dealers for its own line of stereo FM equipment, McIntosh's scope indicator has been revamped and restyled, and now is offered as a general purpose instrument for use with other makes of tuners as well as for observing stereo characteristics of other program sources, such as discs and tapes. The unit's new nomenclature reflects the change too: from "Model MI-2 Multipath/Tuning Indicator" it has become "Model MI-3 Maximum Performance Indicator."

Essentially the MI-3 is an oscilloscope using a 3-inch cathode-ray tube as its "screen." Front panel controls include a power off-on knob; an audio display knob which adjusts the relative size of the pattern; a selector switch with positions for test, multipath, and left and right audio; and four additional adjustments for horizontal and vertical position, focus, and intensity of the trace.

The rear of the MI-3 contains additional operating adjustments, four input jacks and two output jacks. Also at the rear is the AC line cord, a fuse-holder, and an unswitched AC convenience outlet. Circuitry of the MI-3 is part solid-state, part tubes. Heavy-duty professional-grade parts are used on a well laid-out chassis, and wiring and construction are very obviously in the McIntosh tradition: sturdy and solid. For a near-professional instrument, the MI-3 is unusually attractive in appearance. Its front panel is styled in the gold and black of other recent McIntosh products—this, together with its sensible dimensions, would suggest its suitability for "show-off" installation along with one's other audio gear.

Quality and appearance aside, what exactly is the point of a stereo display unit? Why should one think in terms of "watching" as well as hearing stereo? In great measure, the answer depends on the extent of one's involvement with stereo. While a device such as the MI-3 may not prove to be everyone's cup of tea, it certainly could have value for the professional, and for the advanced hobbyist concerned about getting the best possible quality for listening and for tape recording. Analogies can be misleading but we would say that the MI-3 relates to one's use of a high quality stereo system roughly somewhat more pertinently than, say, an engine RPM indicator relates to the driving of a high-performing motor car.

HIGH FIDELITY is now employing the letters Hz—representing the name of the nineteenth-century physicist Heinrich Hertz—in place of the former abbreviation cps (cycles per second) used to designate frequencies. This practice has been adopted internationally throughout the electronics and allied fields, and is now used by the U.S. Government's National Bureau of Standards, HIGH FIDELITY's testing agency, and by the Standards Committee of the Institute of High Fidelity. As Hz stands for cps, K Hz stands for kc (kilocycles per second) and M Hz for mc (megacycles per second).

To use the MI-3 requires study of its accompanying instruction manual which, happily, is clearly written and well illustrated, and presumes no particular technical background on the part of the reader. The display patterns, of course, are derived from the variable trace that appears on the face of the scope, and which is deflected—according to the signal being monitored—in various planes along the surface of the screen. Quite attractive, by the way: a green trace against an opaque blue background. The position, and shape, of the trace represent various operational conditions which, when interpreted correctly, indicate performance characteristics as well as the possible need for adjustment or even repair of some part of the stereo rig. For instance, when tuning in an FM signal, the hori-



zontal level of the trace indicates incoming signal strength; the left and right extensions of the trace indicate station modulation and relative volume of the audio. A wiggly trace signifies the presence of multipath distortion and indicates the need for re-orienting the antenna to get a cleaner signal.

When used for monitoring the output of a tuner, tape deck, or disc playback system, the MI-3 can show varying degrees of stereo separation, channel balance, and whether the system, or the program source, is in or out of phase. A more or less rounded, and constantly varying, set of random lines (the "scrambled eggs" pattern) shows excellent stereo separation and full response on both channels. A single vertical line means that only channel A (left) is playing; a single horizontal line shows that only channel B (right) is on. With monophonic singles (A plus B), the single line shows diagonally; if running from top left to bottom right of the screen, the signal is in phase; if running in the opposite direction, the signal is out of phase. A single line that cants to either side of the true diagonal of the screen indicates channel imbalance: thus, if the diagonal line leans to the vertical axis, then channel A (left) is being favored; if to the horizontal axis, then the other channel is being favored. With some practice, it should be fairly easy for the user to readily identify these various signs, especially since they are clearly shown in the instruction manual and quite easy to duplicate accurately on the MI-3. With additional experience, the user can even pinpoint possible sources of trouble and the need for maintenance in a complex stereo system.

In our tests, the MI-3 went through its paces perfectly, displaying patterns that matched those shown in the manual for various conditions we introduced into the stereo system—deliberately unplugging one of the stereo cables from a tape deck; mistuning an FM receiver; and so on. The MI-3 also indicated, happily, that no FM station within our reach was overmodulating its signal and that every one was in phase. It did remind us that our own roof-top antenna needs repositioning, thanks to the recent winds. (We probably will get a rotator and have done with it!)

The MI-3 may be hooked into a stereo system in either of two ways. If a stereo receiver is used, the connecting cables supplied permit the MI-3 to tap off a negligible amount of signal voltage for display purposes. If a separate preamp and power amp are used, the MI-3 may be connected "in series" between them; that is, the preamp feeds the MI-3, and the MI-3 feeds the power amp.

## EUPHONICS CARTRIDGE SYSTEM

**THE EQUIPMENT:** Euphonics CK-15-LS, a semiconductor phono cartridge system (pickup and power supply). Price: \$55. Manufacturer: Euphonics Corp., Box 233, Guaynabi, Puerto Rico. Distributed by Euphonics Marketing, 173 W. Madison St., Chicago, Ill. 60602.

**COMMENT:** From the way it is installed in a tone arm to the manner in which it generates signals, the Euphonics cartridge is about as different as a pickup system can get. A brochure explaining its theory and operation is available from the distributor on request. Briefly, the cartridge element itself consists of tiny silicon semiconductor elements which, when deflected by stylus motion in the record groove, modulate an external current to produce the electrical signal. The current is derived from a small "power source" (the box shown in the photo) which contains a solid-state circuit, input and output connections, an AC line cord, and a "high-low" switch. A five-prong connector hooks up the power source to the leads from the tone arm; another pair of prewired cables feeds to the amplifier. The AC line cord may be plugged in wherever convenient; an AC outlet on the rear of the amplifier chassis would be the most logical place.

In the "high" position of the switch, the power source furnishes an output signal strong enough to permit connecting the cables directly into a high-level input, such as "auxiliary." In the "low" position of the switch, the system puts out a signal suited for magnetic phono inputs.

The cartridge itself is a small, lightweight unit boasting very low mass, fitted with a biradial (elliptical) stylus, and designed to track at the 15-degree vertical angle. Its four connecting pins are fairly tiny and very closely spaced, and connecting it into a tone arm by means of the sleeves usually found is virtually impossible. Instead, a sleeve is provided which fits over the pins; the leads from this sleeve then must be soldered to the leads in the tone

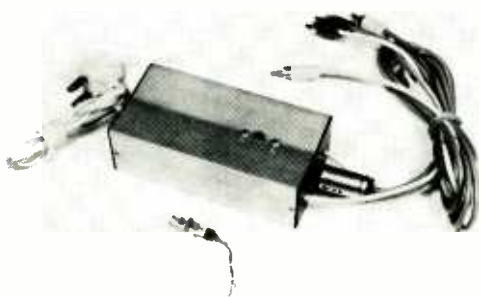

arm. The assembly is fairly delicate and requires care and some patience. Moreover, the cartridge—being so light and relatively small—will require the use of the spacers and small weight(s) supplied when installed in many standard arms. Another complication arises when running the cables from the turntable to the Euphonics' power pack. Most high fidelity tone arms—whether supplied separately or as part of a turntable ensemble—come with prewired signal cables fitted with standard male pin plugs for connecting into amplifier input jacks. The Euphonics cables also are fitted with male plugs. This means

that either the original arm cables must be snipped off and female jacks installed under the turntable, or the Euphonics' plugs must be removed and the cables soldered directly to a terminal strip under the turntable, or a pair of double-ended feed-through phono jacks must be used for connecting the arm cables to the Euphonics' cables.

Once installed, however, the Euphonics has much to recommend it. Compliance is quite high (rated at  $20 \times 10^{-6}$  cm/dyne), and the required tracking force rather low. In tests at Nationwide Consumer Testing Institute, Inc. (a subsidiary of United States Testing Company, Inc.), a tracking force of 1.5 grams was found to yield optimum performance. The manufacturer's recommended tracking force is within 0.75 to 2 grams.

Measurements indicate that the smoothest and widest response from the Euphonics was obtained with the switch in the "low" position—that is to say, when using the pickup system for standard magnetic phono inputs. In this mode, the Euphonics performed like a typically good magnetic cartridge.

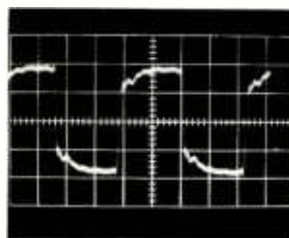

*Response to 1 KHz square-wave.*

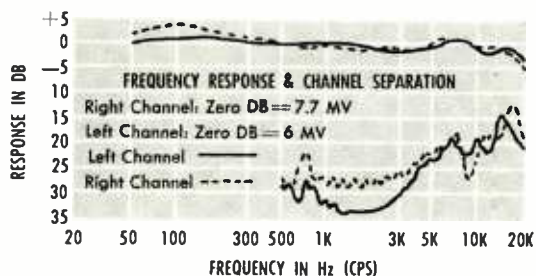

For instance, output signal levels were 6 millivolts and 7.7 millivolts for left and right channels respectively—values amply suited for magnetic inputs and reasonably well balanced (within 2 db). Harmonic distortion did not become apparent until about 5K Hz (5 kc) and remained low on both channels. Lateral and vertical tracking both were excellent, and lateral and vertical IM distortion both were low. Channel separation was very good: better than 25 db at 1K Hz, and remaining at least 17.5 db up to 10K Hz. Frequency response was fairly smooth across the audio range: the left channel was measured as within plus 1, minus 3 db out to 20K Hz; the right channel showed plus and minus 3.75 db out to 19K Hz. Square-wave response had a fast rise-time, and some ringing which was quickly damped.

The "sound" of the Euphonics, as is true of all transducers, was in our listening tests—as it has become in the industry generally—a source of disagreement. Some listeners preferred it to all others they have heard; others allowed that it was good, but

not better than today's top-performing magnetics. Our guess is that while many audio enthusiasts may choose this unit, it probably will make its greatest mark as a means of upgrading older, or relatively lower-priced, or package-set-type rigs. Its method of installation and hookup (which seems to be based on the type of wiring usually found in the changers supplied as part of a package set) plus the indication by the manufacturer that the power pack cuts down by nineteen the number of parts in a medium-priced phonograph (simultaneously improving its sound) would seem to bear out this conclusion.

## BOZAK B-4000

### SPEAKER SYSTEM

**THE EQUIPMENT:** Bozak B-4000, a full-range speaker system in an enclosure. Dimensions: 44 inches high, 27 13/16 inches wide, 16 inches deep. Price, in oiled walnut, \$495. Manufacturer: R. T. Bozak Manufacturing Company, 587 Connecticut Ave., South Norwalk, Conn. 06854.

**COMMENT:** The Bozak B-4000, known as the Symphony No. 1, is an infinite-baffle speaker system. That is to say, the drivers are installed in a completely sealed, nonresonant cabinet so that only the front radiation is permitted to emanate into the listening area. This design approach depends, for its bass response, on well-constructed, low-resonance speakers and a very solid, internally braced, and acoustically dead enclosure.

The Bozak system qualifies admirably on all counts. It actually employs a total of eleven speakers: a 12-inch woofer is mounted fairly near the bottom of the front baffle-board; another 12-inch woofer is mounted nearer its center; an 8-inch midrange driver is installed near the top of the baffle; and an array of eight 2-inch tweeters is found in a vertical column nearer to one edge of the baffle, starting near its top and running down for about two-thirds its length. A dividing network, also housed inside the enclosure, provides frequency crossovers at 400 Hz (cps) and at 1,500 Hz (cps). The rate of crossover is 6 db per octave, intended to function as a "slow" or "gradual" crossover to lend tonal continuity from one range to the next.

An interesting, and useful, design departure in the B-4000 is the vertical column of tweeters. Known as a "line radiator," this array of drivers feeds into a narrowing opening, or slot, which—because of its inverted taper—helps spread the highs and load them to the room with a broad and smooth dispersion pattern.

The enclosure itself is of oiled walnut, faced with shaped walnut strips over a neutral-tint grille cloth to present a neat and attractive appearance. The same system, in an alternate style enclosure featuring a double-arch design, is available for \$510. Connections are made by screw terminals at the rear, marked for polarity. Input impedance is 8 ohms. Efficiency is on the low side, and the B-4000 is recommended for use with a high-quality amplifier capable of delivering at least 30 watts per channel over the entire audio range, and with a damping factor of 8 to 20. When bought in twos as a matched stereo pair, each B-4000 is—as far as the arrangement of speakers on each baffle is concerned—a mirror image of the other. That is to say, the high-frequency columnar array of the left-channel system is toward the right-hand side of the baffle-board as you face the system; the column for

the right-hand system is on the left-hand side. This arrangement assures a satisfactory balance between stereo separation and stereo blending for a broad "wall of sound" effect with no "hole in the middle." A control, on the rear of the enclosure, adjusts the relative level of the highs to suit the system to different room acoustics.

In our tests, the B-4000 has proven to be one of the cleanest, most transparent speaker systems yet auditioned, irrespective of size, type, or price. Full and clean bass is audible down to 30 Hz (cps); response continues somewhat below this frequency with some doubling when driven very hard. Upward from the bass, response is outstandingly smooth and uniform through the midrange and extreme highs to beyond audibility. It also is quite nondirectional, and produces a very wide and broad dispersion pattern that does not seem to diminish until well above 10K Hz (kc). Actually, a 10K-Hz test tone is completely audible from any spot around the system, and even 14 K-Hz test tones could be heard well off-axis of the system. White noise response was very smooth, subdued, and, again, perceptible as a fairly broad spread throughout the listening area.

On program material, the B-4000 is quickly discerned as one of the top-performing speaker systems currently available. Its over-all quality can be described as full, clean, well-articulated, musically balanced, transparent, and eminently honest. It comes as close as any we have auditioned to providing a sense of "listening through" to the program material, and is in fact a system that helps reveal, rather than blur over, subtle differences in program sources including record-

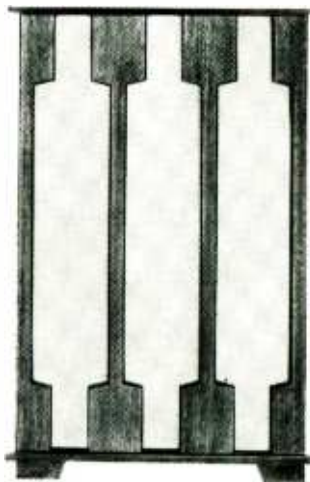

ings and broadcasts. On stereo, the pair provide a satisfying combination of breadth and depth so that the "wall of sound" seems to have some dimension forward and back as well as from side to side. On solo material, the sound is nicely "focused" between the pair; on complex ensemble material, the presentation of the blend, combined with a revealing of inner musical detail, is superb.

The B-4000 does not emphasize one portion of the audible range over any others; nor does it favor one type of instrument over others. Its "sound" is essentially the sound of the program source, the music, itself. To a great degree of course the performance of the B-4000 depends on the quality of the associated equipment used for driving it. The B-4000 almost demands, and certainly merits, being teamed up with a low-noise turntable, sensitive pickup, and high-powered wide-range amplifier. In this sense, the B-4000 suggests use as a professional monitor as well as for installation in the finest of home music systems.

## CONCORD MODEL R-2000 TAPE RECORDER

**THE EQUIPMENT:** Concord R-2000, a two-speed tape recorder deck supplied with remote control box and featuring automatic-reverse playback. Dimensions in integral case: 17 inches wide, 15¾ inches high, 7 inches deep. Deck plate, removed from case: 16½ by 14½ inches. Price: \$795. Manufacturer: Concord Electronics Corp., 1935 Armacost Ave., Los Angeles, Calif. 90025.

**COMMENT:** The R-2000 is Concord's "top of the line" model and a worthy addition to the class of high-quality tape decks near-professional in design and performance, but styled and loaded with features to appeal to the home recordist. As supplied, it is a quarter-track, two-speed (7½ and 3¾ ips) machine; other configurations, such as half-track and 15-ips speed, are available too. The deck contains built-in recording and playback preamps; signal outputs are provided for driving headphones and, of course, an external amplifier and speaker system.

The R-2000 offers automatic-reverse playback without the need to stop the machine and flip the tape reels. In addition, the tape can be reversed manually at any time by moving a lever near the left-hand reel. A separate head is used for playing a recorded tape in the opposite (right-to-left) direction of tape travel. For the normal left-to-right direction, the R-2000 employs a three-head complement, with separate heads for erase, record, and playback. The machine thus is supplied with four heads. The transport is powered by three hysteresis-synchronous motors for capstan drive, and left and right reels.

The deck is strikingly styled and logically arranged. The tape runs from the supply reel past the reverse-play lever, around a swinging guide (a tension arm that serves as a "flutter filter"), around a large fly-wheel-loaded idler capstan, across the head assembly, between the drive capstan and its associated pinch roller, around another tension arm, and to the take-up reel. The entire mechanism is machined and built with extreme precision, and proved, in our tests, to run very smoothly.

The lower portion of the deck plate contains controls. At the lower left is a dual-concentric, friction-coupled stereo gain control for the microphone inputs.



Both channels may be regulated simultaneously or independently, as desired. Next is a similar type control for line input signals (from a tuner or from the tape-feed jacks of an amplifier). Next in line is a dual output control, with a section for each channel. The off position of this control is at dead-center; rotating it clockwise increases playback volume from the tape on the deck; rotating it counterclockwise increases the volume from the source feeding the deck (for monitoring purposes). Separate, calibrated VU meters are provided for each channel; these work on both record and playback.

Mechanical functions are selected by a series of push buttons for fast-rewind, fast-forward, stop, play, and record. This group is followed by the power off/on switch, and another dual-concentric (but not friction-coupled) switch. The outer section of this switch selects playback, stereo record, channel A or B mono record, and sound-on-sound recording. The inner portion of the switch selects tape speed.

The left-hand side of the deck contains a pair of phono jacks for line input, and a pair of phone jacks for high-impedance (10K ohms or more) microphones. For low-impedance mikes, plug-in matching transformers—available as an accessory—must be used. Mike and line inputs may be mixed on each channel during recording by the front-panel level controls. The right-hand side of the machine contains a stereo pair of output phono jacks for connecting to an external amplifier, and a stereo headphone jack for driving a

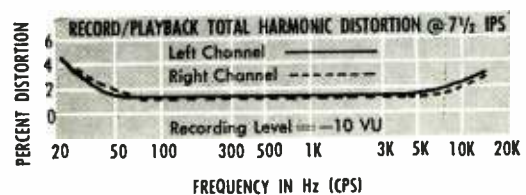
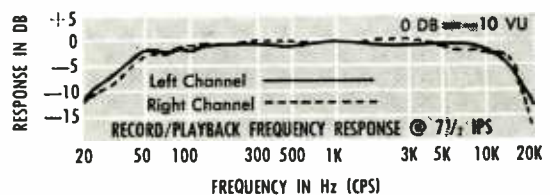
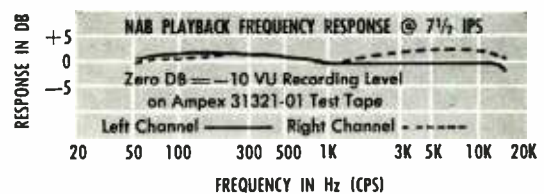
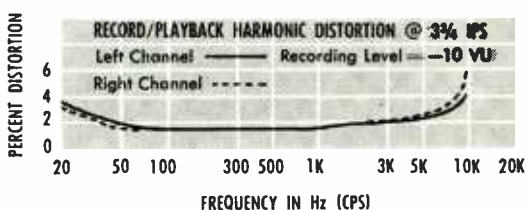
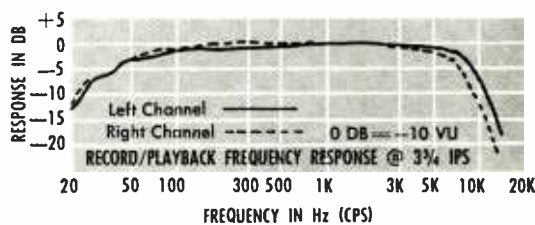

high-impedance headset. This side also contains the connector for the remote-control cable and a 2-amp fuse for the power line, itself connected through a safety interlock-plug which becomes disconnected when the chassis is removed from its outer case. During use, the VU meters light up; in addition, a red light comes on when the record button is pressed. Tape alignment and bias adjustments are found under the head assembly name-plate. The circuitry of the R-2000 uses nine vacuum tubes and seven diodes.

In addition to recording and playback of mono-phonics and stereo quarter-track tapes, the R-2000 can be used for sound-on-sound recording in which a recording from one track is impressed, along with new material, onto another track. This composite signal then can be re-recorded, with still more new material, onto another track—and so on. Echo effects also can be introduced during recording. The automatic reverse-play feature is activated by attaching a length of leader tape to the end of a reel of recorded tape, and then looping the end of the leader to the left-hand (supply) reel. The machine shuts itself off at the end of a tape. It will not go into the record function unless both the record push button is depressed and the selector switch is moved off the play position. Details on all operations are carefully spelled out in the unit's instruction manual.

In tests conducted at Nationwide Consumer Testing Institute, Inc. (a subsidiary of United States Testing Company, Inc.), the Concord R-2000 met its specifications with ease, providing mechanical and electrical performance of very high caliber. Speed accuracy was excellent and no variation of speed with respect to changes in line voltage was observed. Wow and flutter were insignificant. The transport responded quickly and smoothly to all its control orders, including fast buttoning in which fast-forward and rewind are activated, one after the other, without first pressing the stop button. Throughout the tape was handled positively and gently.

The response and distortion characteristics of the R-2000 were, in sum, above average for typical home equipment. Playback response, for recorded tapes, was about as smooth as we have yet seen, indicating that the R-2000 will render commercially recorded tapes accurately—at both speeds. Record/playback response at the faster speed was uniform within a few db across the audio range; at the slower speed, response rolled off a bit before 10K Hz but was still—for 3¾ ips, and especially in view of the low distortion at that speed—very good over-all. Detailed measurements are given in the accompanying chart and graphs; they bespeak an exceptionally well-made tape deck, offering superior performance. Clearly, the R-2000 is aimed at pleasing the advanced hobbyist, and the deck even may have appeal for some professional recordists.

#### MARANTZ RE-TEST

Due to an error in USTC's multiplex generator, which became apparent just after tests were concluded on the Marantz 10B tuner reported here last month, some of the test figures given were incorrect. On re-test, separation on stereo was found to exceed the limits of the generator, being better than 40 db at mid-frequencies and conforming to Marantz's specification of better than 30 db across the band to 15 KHz. Frequency response, also re-checked, was found to be +0, -0.4 db from 20 Hz to 15 KHz in mono, and on either channel in stereo. THD was less than 0.2% in stereo, and the suppression of both the 19 KHz pilot and 38 KHz subcarrier signals was greater than 60 db. These new figures indicate an even finer tuner than originally reported.

## Concord R-2000 Tape Recorder

### Lab Test Data

Performance characteristic	Measurement
Speed accuracy, 7½ ips	0.18% slow, all line voltages
3¾ ips	0.24% slow, all line voltages
Wow and flutter, either speed	0.06% and 0.08% respectively
Rewind time, 7-in., 1,200-ft. reel, either speed	35 seconds
Fast-forward time	35 seconds
NAB playback response (ref. Ampex test tape No. 31321-01), 7½ ips	
l ch	+1.25, -1.5 db, 50 Hz to 15K Hz
r ch	+2, -0 db, 50 Hz to 15K Hz
Record/playback response (with -10 VU recorded signal), 7½ ips, l ch	+0, -5 db, 40 Hz to 14K Hz
r ch	+0.5, -4.5 db, 45 Hz to 15K Hz
3¾ ips, l ch	+0, -5 db, 40 Hz to 9.6K Hz
r ch	+0.25, -5 db, 40 Hz to 7.8K Hz
S/N ratio (ref. 0 VU, test tape), playback	either ch: 50 db
record/playback	l ch: 48 db; r ch: 49 db
Sensitivity (for 0 VU level), line input	l ch: 85 mv; r ch: 97 mv
mic input	l ch: 0.75 mv; r ch: 0.95 mv
THD, record/playback (-10 VU recorded signal)	
7½ ips, l ch	under 1.6%, 50 Hz to 5K Hz; under 3%, 30 Hz to 14K Hz
r ch	under 1.6%, 62 Hz to 5.8K Hz; under 3%, 36 Hz to 15K Hz
3¾ ips, l ch	under 3%, 27 Hz to 8K Hz
r ch	under 3%, 25 Hz to 7.2K Hz
IM distortion, record/playback	
-10 VU recorded signal	l ch: 2.8%; r ch: 3%
0 VU recorded signal	l ch: 4.7%; r ch: 4.9%
Recording level for max 3% THD	l ch: +5 VU; r ch: +4.5 VU
Accuracy, built-in meters for 0 VU recording level	meters read 3 VU low
for -10 VU recording level	meters are exact

## REPORTS IN PROGRESS

### Dynaco Beocord 2000 Tape Recorder

### Kenwood KT-80 Receiver

**ELEGANT...INIMITABLE!**

**BACH**  
The Six  
Brandenburg  
Concertos  
and Orchestral  
Suites 2 & 3



**KARAJAN**  
Conducting the  
Berlin Philharmonic  
Edith Picht-Axenfeld,  
harpichord

(Boxed 3-disc set  
with brochure) 18 976/8;  
Stereo 138 976/8

**New Recording  
of A  
Masterpiece  
of  
Opera Buffa**



**DONIZETTI: Don Pasquale (Complete)** with Alfredo Mariotti, Mario Basiola, Ugo Benelli, Anna Maccianti, Augusto Frati, Chorus & Orchestra of Florence May Festival, Ettore Gracis, cond. (Boxed 2-disc set with libretto)

18 971/2; Stereo 138 971/2

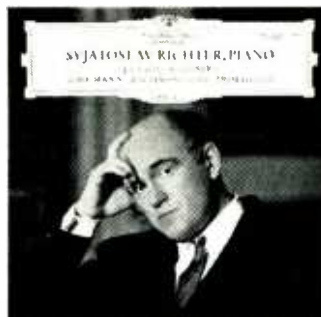

**More  
Definitive  
Performances  
by  
Richter**

**SVIATOSLAV RICHTER: Piano Recital**, Bach—5 Preludes & Fugues from "The Well-Tempered Clavier", Book 1; Schubert—Allegretto in c/Laendler in A; Schumann—"Abegg" Theme and Variations; Rachmaninoff—Prelude in G# minor; Prokofiev—Visions fugitives, Op. 22, Nos. 3, 6, 9

18 950; Stereo 138 950

**And continuing the DGG tradition of great artists!**

**DAVID OISTRAKH**—BACH'S Violin & Harpsichord Sonatas No. 2 in A, BWV 1015/No. 3 in E, BWV 1016; Hans Pischner, harpsichord.

18 989; Stereo 138 989

**EVELYN LEAR**—HUGO WOLF LIEDER: "Elfenlied", "Zitronenfalter im April" and 15 other songs; Erik Werba, piano.

18 979; Stereo 138 979 (leaflet of texts)

**LUCERNE FESTIVAL STRINGS**—MOZART SERENADES: Serenata Notturna in D, Divertimentos in D, B flat, F; Rudolf Baumgartner, cond.

19 480; Stereo 136 480



**Free! On request:**

The new DGG/ARCHIVE  
illustrated catalogs.

**Write:** MGM Records,  
Classical Division,  
1540 Broadway, N. Y. 10036

CIRCLE 23 ON READER-SERVICE CARD

reviewed by  
NATHAN BRODER  
O. B. BRUMMELL  
R. D. DARRELL  
SHIRLEY FLEMING  
ALFRED FRANKENSTEIN  
HARRIS GOLDSMITH



BERNARD JACOBSON  
ROBERT LAWRENCE  
CONRAD L. OSBORNE  
ALAN RICH  
ERIC SALZMAN  
DENIS STEVENS  
JOHN S. WILSON



Protagonists Lear and Fischer-Dieskau.

by Conrad L. Osborne

## Berg's *Wozzeck*—

## All Made Lucid and Urgent

**E**VEN IF this recording were not the brilliant achievement it undoubtedly is, it would have immense importance as the first adequate disc presentation of an essential work. (I do not mean that the Mitropoulos performance on Columbia, which for so many of us constituted the first experience of *Wozzeck*, is incompetent, but only that it is badly out of date in a technical sense, and that this is an extremely important matter with this opera.)

One is tempted to term *Wozzeck* a cornerstone work, except that it is a cornerstone of nothing. The only parallel is to *Pelléas*, another cornerstone with no structure rising above it. It was Shaw's view that the great "revolutionary" operas were not that at all—not the beginnings of new traditions, but the culminations of old. I am not sure we need agree: I do not think it is true of *Wozzeck* or *Pelléas*. And yet the new roads that each work seemed to take turned to a confusion of meandering footpaths and boggy ruts through which operatic composers are still slogging; they pass the bleaching bones of verismo and the romantic grand opera

with a seemingly firm sense of direction, but still end up in nowheresville.

This view will no doubt mark me as an antimodernist. *E sia*. I really am not trying to express an opinion, but to describe a situation. *Wozzeck*, like *Pelléas*, works because it is a nearly perfect fitting together of elements in an absolutely unique set of circumstances. The loudly bruted-about formal structure of the score is feasible, almost necessary, only because of the unarranged, unsequenced condition of the scenes which made up Büchner's *Wozzeck* manuscript, and because Berg was genius enough to make it the organic means of dramatic progression, rather than simply some music coexisting with a play. The subject matter and atmosphere of the drama are admirably suited to expression by atonal means, as those of *Pelléas* are to expression by impressionistic means.

But largely it is a case of a composer being seized and compelled by his subject. of recognizing that in this particular subject lay precisely the vehicle he needed for expression of everything that had been growing within him. This is the *sine qua non* for the creation of

any work that is "original," in the sense of being outside a tradition. In the nineteenth century, there were accepted notions of what an opera was—notions that worked very well. One can imagine that if someone had given Donizetti an early or even middle-period Verdi scenario (not even, I mean, a finished libretto), he would have produced a score of course different in all its details from the one his successor would in fact write, but almost identical in its outline and even, probably, in its general rhythmic pattern. Half the writing, in both libretto and music, was accomplished not by the composer, but by the accumulation of accepted notions called tradition, as with any current Broadway musical comedy. But where we have no secure idea of what an opera is—and we still have not decided on that—or even what music is, this fevered-love-at-first-sight is necessary, which is why there can be only one of a kind, and not many of those.

*Wozzeck* is one such, a finely hewn cornerstone amidst a rubble of busted bricks. What a job Berg made of it! It is one of the great pieces of operatic

construction, tight, unified with a terrifying logic. All the rules are successfully defied—the emphatically unlyrical blatherings of the Captain and the Doctor turned into brilliant character studies, for instance. One of the emphases achieved by the DGG production is on the structural function of the scene interludes, both as ingeniously colored framework and as dramatic motive forces, so that we see clearly a series of progressively moving scenes embedded in an orchestral fabric that draws around the drama like a net.

Of all the wonderful contributions that Dr. Böhm has made of late to the catalogue of recorded opera, this is possibly the finest, though he must share the credit with the DGG engineers, who have assisted him in laying out the elements of this score as if it were on a dissecting table. So many pages of the score are like a series of overlapping transparencies—and so many are lit from behind here for the first time, at least in my experience. Orchestra and conductor really know their music; they may concentrate on it, and it alone, and so may we, as we cannot in the theatre. All the magnificent contrasts and joinings of sonorities, all the passages of such fragile balance between leading and subsidiary voices, all the detail brought up for sharp focus, like the keening of the muted solo double bass under the humming of the soldiers in the barracks scene—everything is made lucid and immediate, so that the coming-together of everything musically in the final interlude is all the more crushing. It would be hard to select a better cast from among all the singers of the contemporary world; this one is especially strong in the vital character roles which populate the world of *Wozzeck's* tragedy. Gerhard Stolze achieves his finest recorded interpretation yet with his captain—he has a reinforced falsetto that sounds like a factory whistle, and makes of every line a specific part of his characterization. Fritz Wunderlich is probably the finest Andres one will ever hear, with wonderful reserves of clear, brilliant tone for the high Bs and Cs, but a good sense of his function as a dramatic foil too.

The doctor of Karl Christian Kohn has an almost bourgeois air—one is reminded of Hannah Arendt's phrase "banality of evil." I wish Kohn's voice had a bit more of a sharp, bright color, particularly on top (he avoids a couple of the top F sharps altogether); but the picture is a complete one, nevertheless. Helmut Melchert has the right sort of brassy, crowing sound for the role of the Drum Major, and all the comprimario parts are in good hands.

It is impossible to complain of anything Dietrich Fischer-Dieskau does here, but I often have the feeling that this *Wozzeck* is too aware of what is going on, too alive to the ironies of his situation, too much an activist. Part of it, perhaps, is the voice itself—it is too beautiful and colorful, and though the singer does a great deal towards making his delivery as straightforward as it

needs to be, we are conscious that he is doing just that. This is a *Wozzeck* who seems to realize the meanings of events as they happen, and that cannot be right. Musically and vocally, everything is magnificently accomplished, and for that matter, the interpretative ideas are right too. But we should have the feeling that if we were to ask *Wozzeck*, "Tell me, are you unhappy?" the answer would be puzzled and inconclusive. Fischer-Dieskau sounds capable of writing at least a coherent composition on the subject. Still, who else could have come this close to a complete execution of the role?

Evelyn Lear is wonderful in the straight singing passages and in the straight speaking passages. The voice sounds beautiful, the pitches are secure, and there is a knowing projection of a woman who has feelings she does not know what to do with yet who is not quite ready simply to surrender to the subhuman status clearly intended for her and her peers. Her version of *Sprechgesang* seems to me less successful; she really sings nearly everything, somewhat colorlessly, it is true, and with peculiar little quasi-rests between notes, to distinguish the *Sprechgesang* from the outright cantabile bars. But she is by no means simply speaking the words with a suggestion of pitch and singing overtone, which is what is wanted. I might add that there is more than one point at which cast members (usually Fischer-Dieskau, strangely) fail to observe the relationship between the indicated pitches of the *Sprechgesang*—inflections go up where the score goes down, and a shout intended for the vicinity of middle C will attain the same level as one pitched around high F. Berg's instructions in the score are most specific on this matter.

It must not be thought that these reservations in any way overbalance the positive nature of the achievement, for the impact of the whole is tremendous, and at many points one feels that parts of the scoring are coming to life in quite a new way. A great and unique opera has been given a splendid cast, the right sort of engineering, a most authoritative leader, and an orchestra which is, at least in this score, a great one. The result is a near essential recording.

#### BERG: *Wozzeck*

Evelyn Lear (s), Marie; Alice Oelke (ms), Margret; Gerhard Stolze (t), The Captain; Helmut Melchert (t), The Drum Major; Fritz Wunderlich (t), Andres; Martin Vantin (t), The Fool; Dietrich Fischer-Dieskau (b), *Wozzeck*; Robert Koffman (b), Second Apprentice; Walter Muggelberg (b), A Soldier; Karl Christian Kohn (bs), The Doctor; Kurt Böhme (bs), First Apprentice; Chorus and Orchestra of the Deutsche Oper (Berlin), Karl Böhm, cond.

• DEUTSCHE GRAMMOPHON LPM 18991/92. Two LP. \$11.58.

• • DEUTSCHE GRAMMOPHON SLPM 138991/92. Two SD. \$11.58.

**T**HERE ARE NOW some twenty complete *Brandenburgs* in the domestic catalogues. If number of recordings is an acceptable gauge of popularity, this puts the six compositions, formerly regarded as complicated, abstract, and devoid of feeling, on the same level as the Beethoven Violin Concerto or the Tchaikovsky Fourth, and above the Franck Symphony, Beethoven's Seventh, and any symphony by Brahms! If anyone had predicted this a generation ago, he would have been rushed to a hospital for mental disorders.

This month we get two new recordings of the *Brandenburgs*. One of them takes a place among the best of the available versions. The other presents problems. Let us consider the former first.

Karajan with the excellent players of the Berlin Philharmonic turns in a reading that is warm, vivid, and except in one movement, free of eccentricity. There is never any tendency to place the conductor, rather than the composer, in the forefront of the listener's attention. At the same time the men do not merely read notes. This is not a drawing of sound-patterns but a musical discourse. There are many fine details in this performance; to mention a few: the horns in No. 1 are pointed and on pitch, instead of blurry and approximate, as they often are; in No. 2 the trumpet blends very well with the other solo instruments instead of lording it over them; the slow movement of No. 6 has just the right mood and tempo, it seems to me—grave, but with motion. There is only one miscalculation, I think: the Minuet of No. 1 is dragged out unconscionably. Even though the second Trio is speeded up considerably, this movement takes twelve minutes, which is far too long. There are a couple of impressive moments in the first movement of No. 4 and, as frequently happens, the harpsichord in No. 5 is not forward enough, but otherwise there seems to be nothing wrong with either the performance or the recording.

In the Suites too, Karajan offers many splendid things. The orchestra sounds large here, but it is very flexible and spry. In No. 2 the flute is always audible, even when its only function is to add a bright edge to the violins. The orchestra is handled in masterly fashion: Karajan doesn't miss a trick when it comes to pointing up—without stressing—thematic work in the inner voices; the opening attack in No. 3, usually a blurt, often ill-balanced and sometimes ragged, is as smooth as silk. It is only in a few matters of interpretation that what enters the ears may lift the eyebrows. The first period of the Polonaise in No. 2 begins *forte*, suddenly sinks to *piano*, and just as suddenly reverts to *forte*. Why? The familiar Air of No. 3 seems endless, it is played so slowly. Aside from these aberrations, this is a superior performance, and first-rate recording, of both works.

Pablo Casals must be the best-known and most admired musician in the world today. Nothing can detract from his heroic stature as a fighter for freedom,



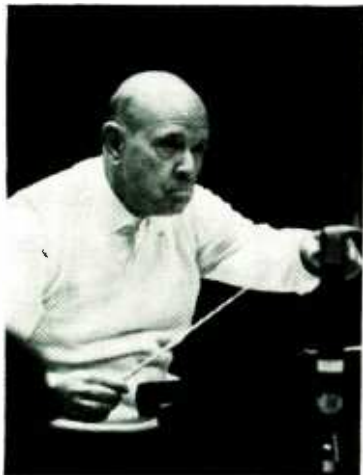

Casals: *passionato octogenarian.*



Karajan: *smooth as silk.*

## The *Brandenburgs*— “So Musical a Discourse”

by Nathan Broder

and for half a century he has been the emperor of all cellists. But no one can be supreme in everything, and I am afraid that the conducting of Bach is not one of Casals' great gifts. Some of his recordings from the Prades Festivals revealed certain idiosyncrasies; in the present set they seem more marked than ever. The most obvious one is his tendency to play a rising figure crescendo and a descending one diminuendo. His phrasing is curious in other respects, too. The beginning of the finale of No. 5, for example, is written as a sixteenth, a dotted eighth, and a sixteenth but is usually played as a triplet eighth, and then a full triplet. This conforms with what is believed to be general practice in Bach's time and certainly makes a smooth beginning for the *gigue* like theme in triplets. Casals not only doesn't lengthen the sixteenths; he shortens them to thirty-seconds, accents the dotted eighth, and makes a little rest after it. The result is a jerkiness that breaks the flow of music whenever the figure appears. There are other questionable aspects of this performance. There is, for example, the hurried, breathless tempo of the first movement of No. 4 (the players here are not always precisely together); the similarly breakneck speed of the first movement of No. 2, which is a coarse-sounding scramble; the Rossinian crescendos to fortissimo in No. 3, perhaps the richest, most poetic of all the *Brandenburgs* and the least in need of any such artificial stimulation. There are also some very beautiful things, including such entire movements as the slow sections of Nos. 2, 5 (especially), and 6. The solo playing throughout is magnificent, especially that of Rudolf Serkin, who plays the *clavier* part of

No. 5 on a piano, and Alexander Schneider, as solo violin in No. 4. Modern instruments are used. The continuo is played on a piano by Serkin in Nos. 1 and 4 and on a harpsichord (which is often inaudible) by his son Peter in Nos. 2, 3, and 6. Except for the faintness of the harpsichord and the roughness in the first movement of No. 2, the sound is very good.

As a bonus, Columbia includes with the set a third disc containing excerpts from the rehearsals for this recording. This is remarkable testimony to the vitality and patience of a man just short of ninety. It shows the great pains he takes to get precisely the articulation he wants. Regardless of how distorted the result may be, one cannot help admiring the spirit of this octogenarian artist who admonishes his men to play Bach “*passionato* . . . not one note cold.”

BACH: *Brandenburg Concertos, S. 1046-1051; Suites for Orchestra, No. 2, in B minor, S. 1067; No. 3, in D, S. 1068*

Berlin Philharmonic Orchestra, Herbert von Karajan, cond.

• DEUTSCHE GRAMMOPHON LPM 18976/78. Three LP. \$17.37.

• • DEUTSCHE GRAMMOPHON SLPM 138976/78. Three SD. \$17.37.

BACH: *Brandenburg Concertos, S. 1046-1051*

Marlboro Festival Orchestra, Pablo Casals, cond.

• COLUMBIA M2I. 331. Three LP. \$9.58.

• • COLUMBIA M2S 731. Three SD. \$11.58.



BACH: *Air With 30 Variations, in G, S. 988 (“Goldberg Variations”)*

Peter Serkin, piano.

• RCA VICTOR LM 2851. LP. \$4.79.  
• • RCA VICTOR LSC 2851. SD. \$5.79.

Martin Galling, harpsichord.

• TURNABOUT TV 4015. LP. \$2.50.  
• • TURNABOUT TV 34015S. SD. \$2.50.

To make your solo recording debut at the age of eighteen with the *Goldberg Variations* is a courageous act that prompts respect and that should preclude any patronizing critical indulgence. There is a story that when Rudolf Serkin made one of his first appearances with orchestra and was prevailed on to give an encore, he played the variations complete; and now here is his son re-recording them.

The first thing to be said is that Peter Serkin is clearly a musician of stature. The second is that this performance does not really succeed. It is full of felicitous touches, it is beautifully executed in terms of piano tone, and it has moments, such as the wonderful 25th variation in G minor, when a bold choice of tempo and an imaginative conception prove entirely convincing. But the felicities are obtrusive. Mr. Serkin has thought deeply about the music, but his thinking is too apparent, and spontaneity flies out of the window. There are far too many “expressive” bulges in the line, far too many mannerisms, like the contrived holding-back on the first note of the penultimate measure of the Aria and the fussy accentuation in the fugal 10th variation. But in total, with all these irritations, this is responsible music making, and I am sure that this artist will go on to do great things.

In comparison with Peter Serkin, Martin Galling is venerable: he was born in 1935. My previous acquaintance with his work has been limited to several excellent pieces of continuo-playing in Bach recordings conducted by Marcel Couraud. I find his performance on the present disc technically competent, stylistically unobjectionable—and so dull that I can't imagine myself ever wanting to listen to it again. Paradoxically, the variations are far less sharply characterized here, with all the resources of the harpsichord, than they are by tonal variety and purposeful phrasing in Mr. Serkin's piano performance.

In my opinion the *Goldberg Variations* really need the resources of a two-manual instrument, and I would put at the head of the recorded versions either the Landowska set (RCA Victor) or that

by George Malcolm (Oiseau-Lyre). (Kirkpatrick is stylish and often beautiful, but over-all his reading lacks strength.) Landowska is irritating in her inconsistency with repeats—she throws in an odd one here and there—and once or twice her rubato obscures the structure of the music, but for the most part her performance combines rare artistry with irresistible human warmth. Malcolm is on a less exalted plain, but he uses his lovely Goff instrument with imagination and enormous technical skill, and his recording has the great advantage of being the only one complete with repeats. This makes his edition twice as long and twice as expensive (it is, of course, a two-disc album), but to my mind the gain in musical sense is decisive. (And anyway, if you like the music, why shouldn't you want to listen to it for an hour and a half?)

If you want a piano version, principal competition comes from Glenn Gould, and I think Serkin wins. Gould is brilliant and often profound, but most of his tempos are far too fast. B.J.

**BACH: Brandenburg Concertos, S. 1046-1051; Suites for Orchestra: No. 2, in B minor, S. 1067; No. 3, in D, S. 1068**

Berlin Philharmonic Orchestra, Herbert von Karajan, cond.

**BACH: Brandenburg Concertos, S. 1046-1051**

Marlboro Festival Orchestra, Pablo Casals, cond.

For a feature review of these recordings, see page 76.

**BACH: Cantatas: No. 6, Bleib' bei uns; No. 65, Sie werden aus Saba alle kommen**

Ingeborg Reichelt, soprano; Hertha Töpfer, contralto; Helmut Krebs, tenor; Franz Kelch, bass; Heinrich Schütz Chorale of Heilbronn; Pforzheim Chamber Orchestra, Fritz Werner, cond.

• MUSICAL HERITAGE SOCIETY MHS 653. LP. \$2.50.

• • MUSICAL HERITAGE SOCIETY MHS 653. SD. \$2.50.

In the opening movement of No. 6, Bach builds out of a single sentence one of his great choruses, a moving and beautiful supplication. The Cantata also contains two fine arias, one for alto with obbligato oboe da caccia and one for tenor with extremely expressive counter-melody in the violins. Miss Töpfer's pitches, unfortunately, are often only approximate, but Krebs is his usual capable self. Miss Reichelt has only an unadorned chorale to sing. The old Renaissance recording, now cut out, had better alto singing, but in every other respect this is a superior performance and recording.

In No. 65 it is again the opening chorus that reveals the great Bach. This magnificent procession, majestically in-

troducted by the horns, is given its full grandeur by Werner and his able forces. Krebs again does well with his aria, though in passages where he is supported only by the continuo, the harpsichord cannot be heard. Kelch is in excellent form, singing his recitative and aria with attractive, well-focused tone and musicianly phrasing. From the standpoints of both performance and recording this supersedes the Lyrichord set, the only other one domestically available. N.B.

**BACH: Keyboard Music, Vols. 1 and 2**

Martin Galling, harpsichord.

• Vox VBX 434/35. Six LP. \$9.95 each three-disc set.

• • Vox SVBX 5434/35. Six SD. \$9.95 each three-disc set.

The first volume of a series of seven that will contain all of Bach's clavier music offers the *French Suites* and a number of miscellaneous preludes and fugues. In Vol. 2 are the six Partitas and several shorter pieces. Galling shows an easy command over his instrument. There is nothing here that appears to present any technical problems to him. Moreover, he has a knack of hitting upon a tempo for each piece that seems entirely right. The pace chosen not only suits the character of the piece but also often keeps the music moving along in a connected, shapely discourse.

This is, of course, one of the main problems in Bach, but it is not the only

one. There is also the matter of what is behind the notes, and in this respect Galling is less satisfactory. The rhythm of a piece is seldom departed from by more than a hairsbreadth. Everything—dances, preludes, fugues—is played in an utterly straightforward fashion, with little give or nuance. This is an approach that suits some of the fugues, but leaves the more improvisatory preludes sounding dull. In the *French Suites* each section is repeated exactly, and in some of the dances, while the tempos remain convincing, the rhythm is metronomic.

This regularity of rhythm is even more pervasive in the Partitas. Sometimes it does no harm, as in the Sixth Partita, which comes off best. In the Toccata of this suite, for example, the drama is built in, and all the performer has to do is play the right notes and keep the piece going. But when nuance is called for, it is not forthcoming here, and the mechanical accuracy of the playing renders such movements as the Menuetto of No. 1 and the Sarabande of No. 2 deadly. Most of the dance sections are repeated, as is proper, but with no change whatever. Mr. Galling accomplishes the remarkable feat of making even the romantic C minor Fantasy, S. 906, sound monotonous. What is lacking, in short, is imagination, fantasy—which we now know, thanks to such artists as Landowska and Kirkpatrick, is just as vital in playing Bach as in any other type of music. N.B.

**BACH: Motets (5)**

Chorus of St. Hedwig's Cathedral (Berlin), Karl Forster, cond.

• MACE M 9016. LP. \$2.49.

• • MACE SM 9016. SD. \$2.49.

**BACH: Motets (3)**

Norddeutscher Singkreis, Gottfried Wolters, cond.

• NONESUCH H 1060. LP. \$2.50.

• • NONESUCH H 71060. SD. \$2.50.

The chorus heard on the Mace disc is very efficient: everyone, man and boy, sings in tune and follows the conductor with precision. Forster leans towards fast tempos. This works out well in some sections, not so well in others. Thus the beginning of *Jesu, meine Freude* seems a little too businesslike, but later on in the same work "*Gute Nacht*" is not dragged or sentimentalized, as it sometimes is. The difficult first section of *Singet dem Herrn* is sung accurately, but this marvelous ululation needs more dash, more bravura. I have not heard a more exciting performance of this motet than Hindemith's, still available on an Overtone disc. The chorus seems large for the eight-part pieces. Forster uses solo voices in a few passages, but the tutti in this complicated part-writing are rather thick. Matters are not helped by the stereo setup: there is not much directionality, and the works for double chorus are not divided that way on the sound tracks. No texts are supplied.

The Nonesuch disc offers only three motets—*Komm, Jesu, komm* (which is

**NEXT MONTH IN**  
*high fidelity*

**Michelangelo and the Machine**  
Introducing a celebrated  
European pianist  
who regards his instrument  
as a racing driver regards his car.  
by Roy McMullen

**A Survey Of  
Solid-State Stereo Receivers**  
by Robert Angus

**The Posthumous Career  
Of J. S. Bach**  
To Johann Sebastian we owe  
not only a legacy of masterpieces  
but our common musical language.  
by Leonard Marcus

**The Unfashionable Generation**  
The case for  
some between-wars composers  
who turned away from  
the prevailing vogues of their time.  
by Peter J. Pirie

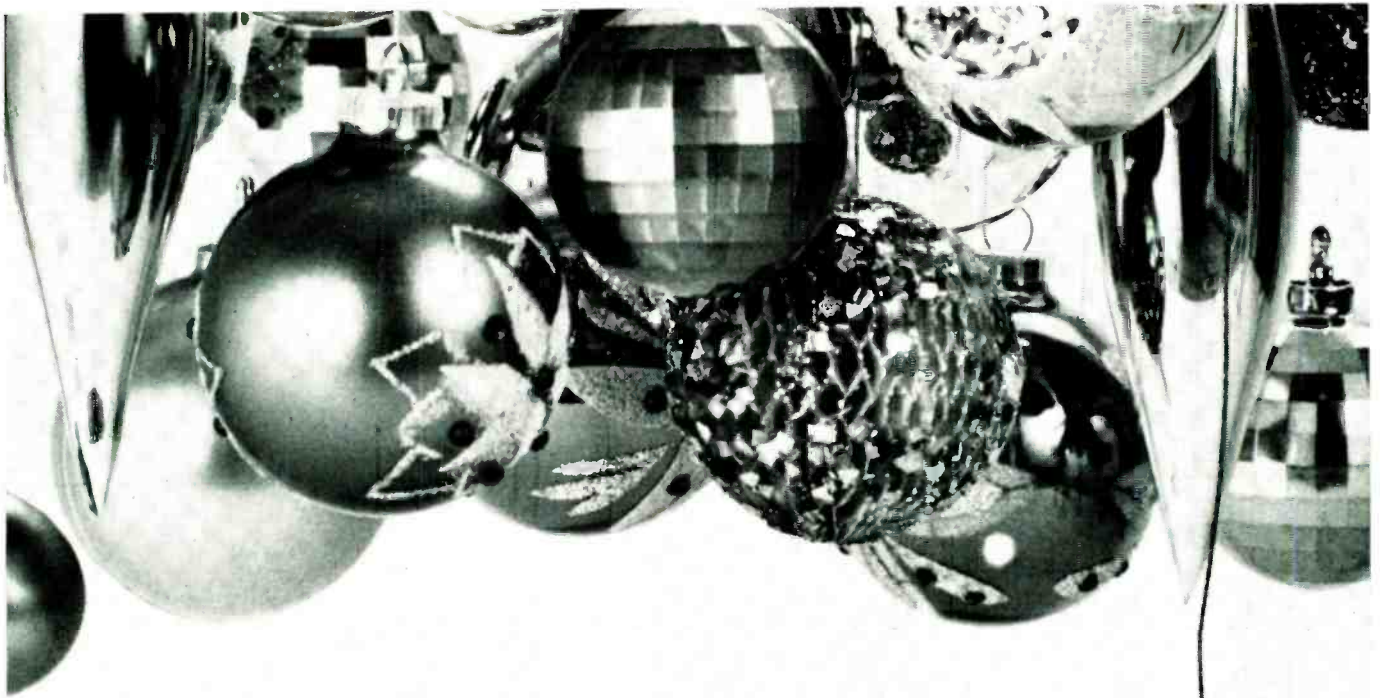

## Great Christmas Gift Values from RCA "Victrola"®

The always-welcome gift of fine music, beautifully recorded by renowned artists, and priced within the reach of every music lover.

**VICTROLA**  
**BEETHOVEN**  
 SYMPHONY NO. 5  
**SCHUBERT**  
 SYMPHONY NO. 8  
 "UNFINISHED"  
**BOSTON**  
 SYMPHONY  
 MUNCH

**PUCCHINI**  
**TOSCA**  
**MILANOV · BJOEFLING · WARREN**  
**LEINSDORF, Cond.**  
 Rome Opera House Orch./Chorus

**RIMSKY-KORSAKOV**  
**SCHEHERAZADE**  
**MONTEUX**  
 conducting the  
 LONDON SYMPHONY OF CHESTRA

**Beethoven:** Symphony No. 3, Monteux, Vienna Philharmonic. **Brahms:** Violin Concerto in D, Szeryng, Monteux, London Symphony. **Berlioz:** Symphonie Fantastique, Monteux, Vienna Philharmonic. **Mendelssohn:** Violin Concerto, Laredo, Munch, Boston Symp. **Bruch:** Violin Concerto No. 1. Laredo, Mitchell, National Symphony. **Franck:** Symphony in D Minor, Munch, Boston Symphony. **Tchaikovsky:** Violin Concerto in D, Szeryng, Munch, Boston Symphony.

**PUCCHINI**  
**MADAMA BUTTERFLY**  
**MOFFO · ELIAS · VALLETTI**  
**LEINSDORF, Conductor**

**STRAVINSKY · FIREBIRD**  
**DEBUSSY · NOCTURNES**  
**MONTEUX**  
 conducting  
 Paris Conservatoire Orchestra · Boston Symphony

**TCHAIKOVSKY**  
**PIANO CONCERTO No. 1**  
 GILELS/CHICAGO SYMPHONY/REINER

**RCA**  
**VICTROLA**  
 EMMS 11

**TCHAIKOVSKY — 1812 OVERTURE**  
**LISZT — MEPHISTO WALTZ**  
**DEBUSSY — IBERIA**  
 REINER / CHICAGO SYMPHONY

**Rachmaninoff**  
**Piano Concerto No. 2**  
**Brailowsky**  
 San Francisco Symphony/Jorda  
 and 4 solo selections —  
 Weber, Mendelssohn

**Debussy**  
**LA MER**  
 Rave  
**RAPSODIE ESPAGNOLE**  
 BOSTON SYMPHONY ORCHESTRA, CHARLES MUNCH



CIRCLE 93 ON READER-SERVICE CARD

not included in the Mace set), *Der Geist hilft unsrer Schwachheit auf*, and *Jesu, meine Freude*—but they are beautifully done. Wolters has women for the treble parts, and while boys may be more authentic from the historical point of view, I'll take the color of women's voices any time. *Komm, Jesu, komm*, with its garlands of intertwined melody, is sung with tenderness. All three motets are accompanied by a couple of low strings and an organ: this definitely adds to the security of the singers' intonation. The continuo is maintained a little too doggedly—there are moments when the effectiveness of the music would be enhanced if the instruments were silent—but this is a small blemish. In general, Wolters keeps everything moving with a kind of watchful relaxedness: there is no tenseness, but nothing drags either. Very good sound, with clear separation in the works for double chorus. German texts and English translations are provided. N.B.

**BACH: *The Passion According to St. Mark, S. 247***

Helen Erwin, soprano; Emmy Liskén, contralto; Georg Jelden, tenor; Members of Stuttgart Madrigal Choir; Pforzheim Chamber Orchestra, Wolfgang Gönnewein, cond.  
 • EPIC LC 3906. LP. \$4.79.  
 • • EPIC BC 1306. SD. \$5.79.

Last year Lyricord offered us a setting of the Passion According to St. Luke attributed to Bach but very likely by someone else. The present disc represents a different type of problem: that of locating missing compositions by Bach. The text of this *St. Mark Passion* has survived, but no music. Since it is well known that Bach often adapted to new texts music written for a different occasion, scholars have hunted among his works for music that would fit the text of this Passion, known to have been performed at Leipzig in 1731. The present disc contains twelve numbers that have been arrived at in this manner (it does not include a chorus later used in the *Christmas Oratorio*). Five of them—two big choruses and an aria each for soprano, alto, and tenor—come from the *Trauerode* (Cantata 198). Another alto aria comes from Cantata 54. Then there are five chorales, including the music of *O Haupt voll Blut und Wunden*, familiar from the *St. Matthew Passion*.

Much of this music—especially the two choruses—is of very high quality and all of it seems to suit the new text well enough in singability as well as in mood. The result, while not presenting any hitherto unknown music, may very well be regarded as a small portion (twelve out of 132) of a Bach Passion heretofore unrepresented on records. Of the soloists Miss Erwin sings with skill and attractive tone, and Miss Liskén and Georg Jelden deal with their arias ably. Gönnewein's reading is not always as effective as it could be: the great choruses from the *Trauerode* are considerably more impressive in Scherchen's recording. Good sound. N.B.

**BARTOK: *The Wooden Prince***

London Symphony Orchestra, Antal Dorati, cond.  
 • MERCURY MG 50426. LP. \$4.79.  
 • • MERCURY SR 90426. SD. \$5.79.

This ballet, dating from 1917, was Bartók's first large-scale success. Based on a scenario by Béla Balász (who also did the libretto for *Bluebeard*) it tells a fairy tale for grownups of a Prince whose wooing of a Princess is beset with difficulties conjured up by a spirit first malignant and later benign.

The score represents Bartók in a period of transition. The orchestration has much of the shimmer and the myriad colors of his later scores, although the French influence is quite pronounced and not completely assimilated. As a listening experience, however, the principal lack is of strong melodic profile. Much of the music seems sketchy and lacking in direction, even in comparison with the composer's other scores of the period.

Dorati and his orchestra give an excellent account of the score's strong point, its fantastic range of sound. Minor Bartók though it may be, *The Wooden Prince* is still worth investigating as a way station in the development of a magnificent composer. A.R.

**BEETHOVEN: *Bagatelles, Op. 126; 15 Variations with Fugue on Eroica Theme, Op. 35***

Joerg Demus, piano.  
 • WESTMINSTER XWN 19066. LP. \$4.79  
 • • WESTMINSTER WST 17066. SD. \$4.79.

This is easily the best playing that I have yet heard from Demus. He gives the taxing *Eroica* variations a superbly judged reading, full of eloquence and impetuous detail, and clarifies the more introspective later writing of the six great Op. 126 Bagatelles with consummate poise and faultless dexterity. All considered, the pianist's interpretations here can be placed alongside those of the old masters Schnabel and Kempff. Moreover, the piano sound is magnificent, both in mono and in stereo. H.G.



Demus: alongside the old masters.



M2L 330/M2S 730\* (A 2-Record Set)/M2Q 759†

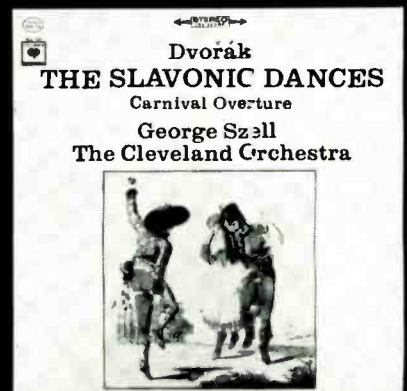

M2L 326/M2S 726\* (A 2-Record Set)

# TO GIVE, TO HAVE, TO SHARE



M2L 331/M2S 731\* (A 2-Record Set) /  
M2Q 760†



D3L 333/D3S 733\* (A 3-Record Set)  
A specially reduced price.



M2L 334/M2S 734\* (A 2-Record Set)

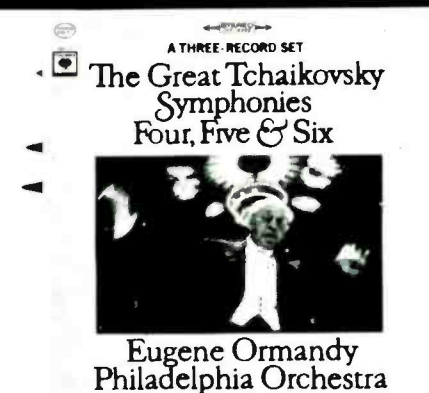

D3L 327/D3S 727\* (A 3-Record Set)  
specially reduced price.



D3L 325/D3S 725\* (A 3-Record Set)  
A specially reduced price.



D3L 321/D3S 721\* (A 3-Record Set)  
A specially reduced price.

**THE VERY  
SPECIAL GIFT  
OF MUSIC  
ON COLUMBIA  
RECORDS** 

## BEETHOVEN: *Quartets for Strings*

No. 1, in F, Op. 18, No. 1; No. 9, in C, Op. 59, No. 3 ("Rasumovsky").

Barchet Quartet.

- RCA VICTOR LM 2832. LP. \$4.79.
- • RCA VICTOR LSC 2832. SD. \$5.79.

No. 7, in F, Op. 59, No. 1 ("Rasumovsky"); No. 8, in E minor, Op. 59, No. 2 ("Rasumovsky"); No. 9, in C, Op. 59, No. 3 ("Rasumovsky"); No. 10, in E flat, Op. 74 ("Harfen").

Juilliard Quartet.

- EPIC SC 6052. Three LP. \$14.37.
- • EPIC BSC 152. Three SD. \$17.37.

No. 10, in E flat, Op. 74 ("Harfen"); No. 11, in F minor, Op. 95 ("Serioso").

Weller Quartet.

- LONDON CM 9431. LP. \$4.79.
- • LONDON CS 6431. SD. \$5.79.

One would be hard put to find three groups more divergent in style than those represented on the discs here under review. The Weller performances could aptly be classified as "Neuwienersich." Along with some recent performances of chamber music by members of the Vienna Octet and the newly reconstituted Vienna Philharmonic Quartet, the Weller's readings attempt to combine the *Gemütlichkeit* of old Viennese tradition with the more objective hard-hitting approach heard in most other parts of the world. The results are always interesting if not completely convincing; while much of the emotional spontaneity of the instinctive Viennese manner has been quelled, the hallowed Viennese failings—sentimentality and lack of incisiveness—are still very much in evidence. The performance of the Op. 74 is the more successful of the two included on the London disc; it is, in fact, arguably the best stereo edition now available. Its tempos are well chosen (although the pyrotechnics of the scherzo tax the players), and there is much in the way of coloristic lyricism to be heard. In one or two places the first violinist's heart-on-sleeve manner of inflection comes dangerously close to instrumental crooning; but as the *Harp* Quartet is not, by Beethovenian standards, of great emotional substance, I find this sentimentalizing only mildly inimical. The brusque, angry, and desperately anguished music of the *Serioso* demands far more emotional subtlety and restraint than the Weller group is able to provide. The onslaught of the opening movement sounds elephantine, with all sorts of tenutos and rubato mannerisms which would be far more appropriate to the Brahms-Schumann literature. As for the scherzo movement, the Weller's heavily "interpretative" reading would be excessive even in Tchaikovsky. This ripely sentimental, grandiosely romantic exposition of Op. 95 is, in my opinion, dead wrong. I should make it clear that my objections are to this approach per se and not to the over-all caliber of the ensemble's playing. London's engineering is

thoroughly admirable, with fine spaciousness, great clarity, and excellent balance.

In striking contrast to the Weller's readings are those of the Juilliard. With their militaristic precision and thoroughly direct tonal quality, these performers are as un-Viennese as could be imagined. Their best work is done in Op. 74 and, particularly, in Op. 59, No. 2, where they are content, for the most part, to permit the music to speak for itself. The Juilliard *Harp* lacks the tenderness (and also the first-movement repeat) heard in the Weller exposition, but compensates with its expertise and sheer self-assuredness. It is a worthy competitor of the Weller edition—and certainly much to be preferred to the stolid Amadeus reading (DGG) or to the current, relatively lackluster Budapest (shorn of repeats yet inexplicably spread over an entire twelve-inch Columbia disc). The Juilliard's E minor *Rasumovsky* is handsomely played too, opening with a slashing nervous tension and sustaining tautness throughout (as the latest Budapest reading, with a similar approach, quite fails to do). This version also makes the work sound "big," simply by observing the all-important repeats of the first-movement exposition and third-movement *da capo*. A long line is maintained throughout the poignant Adagio molto, while the third movement is delightfully crisp and supple in execution. I also like the sea-shanty effect which the Juilliard's sprightly timing and clipped efficiency produce in the Finale. In sum, this Op. 59, No. 2 is an exceedingly fine presentation, exceeded in my affection only by the Janáček reading for Westminster (monumental and searching) and by the memorable pre-war Budapest set.

The two remaining Juilliard performances exhibit some of the ensemble's less admirable aspects. Most of the trouble, I suspect, derives from this foursome's desire to be a little different in their approach to Beethoven. Frequently, they substitute theatricality for drama, brashness for fervor. Nor can they always convincingly negotiate those tricky tempo modifications so necessary if the true significance of contrasting sections and episodes is to be realized. In Op. 59, No. 1, for example, the very opening sounds curiously noncommittal, while the Budapest—at practically the same fast tempo—seems thoroughly eloquent and at ease with the music. After settling down to a more comfortable expansiveness for the lyrical secondary material, the Juilliard then summarily resumes a dryly inexpressive approach. This arbitrary fluctuation between what one presumes is instinctive feeling and analytical cerebration makes for a disjointed, unsettled reading of the entire quartet (although in the heavenly slow movement the feeling almost wins out). The gracious, elaborately decorative writing of the second and third movements of Op. 59, No. 3 also proves a problem for the Juilliard foursome. Here they sound thoroughly out of their element, with awkward ritenutos at the ends of phrases, arbitrary dynamic gradations, and contrived *Luftpausen* before many *forte-pianos*. The lovely, flowing minuet-

to, in particular, emerges in a decidedly languid fashion. On the other hand, Moto perpetuo sections such as the final fugue apparently give the players less time to ruminate, and are thus tossed off with breath-taking control and knife-edged brilliance. A similarly driven account of this third *Rasumovsky* (minus the lily-gilding showiness) may be had in the superb performance by the lamented New Music Quartet on an old Bartok Society record, while adherents of the more expansive conventional view need look no further than to the fine stereo Columbia disc by the Budapest. Epic's reproduction is, on the whole, very suave and spacious—presumably there was little the engineers could do to remedy the thin, acerbic, bloodless sound which passes for the first violin line.

The Barchet set offers the identical coupling as that of the excellent Lenox Quartet disc issued on the cut-rate Dover label, and its release at RCA's standard prices is rather curious (it originally appeared in Europe in the Oriole-Eurodisc bargain series). Purely as instrumentalists, the Barchets, I'm afraid, are not much above middle-routine student level: sour intonation, inept bowing, limited articulation, and coarse texture in general characterize their work here. Where the going is relatively easy, the Stuttgart ensemble can manage some good things—for example, in the wonderful slow movement of Op. 18, No. 1, which for once has a true adagio quality—but on the whole they are simply not up to the competition. They have been accorded close-up, well-balanced sound (with more cello in the monophonic pressing). H.G.

## BEETHOVEN: *Serenades: for String Trio, in D, Op. 8; for Flute, Violin, and Viola, in D, Op. 25*

Jean-Pierre Rampal, flute (in Op. 25); Michel Tournus, cello (in Op. 8); Gerard Jarry, violin; Serge Collet, viola.

- DECCA DL 10116. LP. \$4.79.
- • DECCA DL 710116. SD. \$5.79.

If you are seeking an accessible introduction to Beethoven's chamber music, the present disc ought to prove ideal. The unusual divertimento structure of the Op. 8 captures attention with its lively opening march (a sort of predecessor to the great one in the monumental Op. 132 String Quartet) and holds it fast throughout the subsequent sections. As for the Flute Serenade, an unusual instrumentation transforms austerity into perpetual delight, and that delight is immeasurably heightened by the pliant, witty, masterly writing.

The present readings, happily, uphold a long tradition of first-rate recorded performances for these scores. Rampal's artistry goes without saying at this late date, but the exquisite work of his less well-known colleagues deserves explicit praise. Their playing of the Op. 8 String Trio is more closely akin to the Pougnet/Riddle/Pini ideal than to those of Heifetz/Primrose/Piatigorsky or Goldberg/

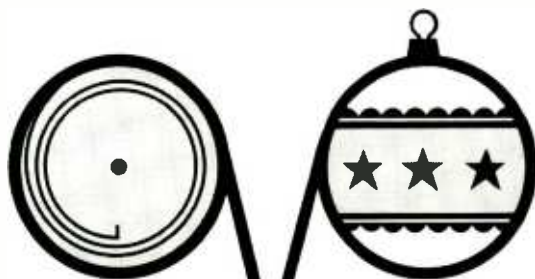

Give a Gift of Great Entertainment on  
4-Track Recorded Tapes  
from RCA Victor



FTO-5033



FTP-1298



FTP-1308



FTC-2205



FTO-5034



FTP-1305



FTC-2203



FTO-5032



FTP-1307



RCA's superlative "Red Seal" Magnetic Tape is used in recording RCA Victor pre-recorded tapes.

CIRCLE 64 ON READER-SERVICE CARD

Hindemith/Feuermann. Composure, elegant ensemble tone, and classical finesse of line take precedence over vehemence, steely showmanship, or romantic extroversion. By this statement I mean not to imply any lack of robust humor or emotional warmth in the present rendition but to associate it with the finest Franco-British tradition of ensemble work rather than with the Russo-American or Teutonic approach.

The engineering (originally by Pathé-Marconi) has faultless balance and definition. Stereo and monophonic pressings sound equally realistic and agreeable, but treble should be reduced a bit for even greater warmth. H.G.

**BERG: *Wozzeck***

Evelyn Lear, Gerhard Stolze, Fritz Wunderlich, Dietrich Fischer-Dieskau, et al.; Chorus and Orchestra of the Deutsche Oper (Berlin), Karl Böhm, cond.

For a feature review of this recording, see page 75.

**BIBER: *Sonata for Strings, No. 1, in B minor, from "Fidicinium sacro-profanum"***—See Haydn, Michael: *Turkish March*.

**BOCCHERINI: *Concerto for Cello and Orchestra, in B flat***—See Haydn: *Concerto for Cello and Orchestra, in D*.

**BRAHMS: *Quartets for Strings, Op. 51: No. 1, in C minor; No. 2, in A minor***

Weller Quartet.

- LONDON CM 9431. LP. \$4.79.
- • LONDON CS 6431. SD. \$5.79.

These quartets are already splendidly represented in stereo by the Amadeus Quartet (DGG) and by the Fine Arts (ConcertDisc). There is nothing wrong with the present coupling, however. The Wellers are earnest, musicianly, and very Viennese in their outlook. Some of the tempos (the finale of the A minor, for instance) are a bit slower than usual, with rugged rhythm supplying the fire lost in sheer bravura. Ludwig Beinl, the cellist of the ensemble, has a curiously pallid sound, but the other players are more forthright. (If they too are rather oversweet and underintense in their phrasing, at least they are using sugar rather than saccharine!)

The Amadeus gives very similar performances to those of the Wellers, albeit with a bit more tonal finish and sweeping assurance. But it is the sinewy, muscular, and rather analytical Fine Arts version which best emphasizes Brahms's classical containment and intellectual strength. Theirs is the rendition that most corresponds to my own preferences. London's sound, like that on the two rival discs, is excellent. H.G.

**CAMPRA: *Psalms: 129 (130), De profundis; 46 (47), Omnes gentes***

Soloists; Philippe Caillard and Stéphane Caillat Choirs; Jean-Francois Paillard Orchestra, Louis Frémaux, cond.

- MUSICAL HERITAGE SOCIETY MHS 613. LP. \$2.50.
- • MUSICAL HERITAGE SOCIETY MHS 613. SD. \$2.50.

The same conductor and choral and instrumental forces that gave us André Campra's Requiem and Te Deum (both issued here by Westminster) now put us further in their debt with these two Psalms. For Campra, though he does not belong on the exalted level of his younger contemporaries Bach and Handel, wrote music of a grandeur and expressiveness that still create a deep impression. Each Psalm is composed as a kind of cantata. The solo writing has an Italian cantability, the choral writing is rich and effective.

Psalm 129 begins with a poignant bass solo. From the second movement on, the mood grows optimistic, in keeping with the text, and the final chorus, when it reaches "*Et lux perpetua*," is full of joy. Psalm 46 is set to brilliant, jubilant music; it includes a noble trio for basses and a soprano solo with a beautiful middle section. Helmut Krebs turns countertenor for this occasion. He ought to go right back to being a tenor again: here his voice has an unattractive, metallic sound. Denise Monteil, who sings a movement in each work, does them very nicely; she is aided by resonant recording. Xavier Depraz sings the bass solo in No. 129 with feeling. Frémaux paces everything in lively fashion, and there is effective separation in the stereo. Latin texts and English translations are provided. N.B.

**CHABRIER: *España; Suite pastorale; Joyeuse marche; Le Roi malgré lui; Danse Slave; Fête Polonoise***

Orchestre de la Suisse Romande, Ernest Ansermet, cond.

- LONDON CM 9438. LP. \$4.79.
- • LONDON CS 6438. SD. \$5.79.

I used to meditate on the most effective way of torturing war criminals and decided it might best be done by drilling their teeth to the roots. For lesser foes of society I should propose compulsory attendance at an all-Chabrier program. *España*, of course, has its points; and it is here led by Ansermet with cool brilliance instead of warm glow, a linear rather than coloristic flair . . . all goes well, with the bassoon sonorities (always difficult of projection in a concert hall) picked up deftly by the microphones and the trombone glissandos played impeccably. The rest of the program, however, is an irretrievable loss. Whatever Fauré-like charm might be inherent in portions of the *Suite pastorale* is dissipated by the work's enormous length and commonplace material; while the *Joyeuse marche* and both excerpts from the comic opera *Le Roi malgré lui* thrive on brassy boule-



Composer-conductor Morton Gould.

vard impact. This is the France not of Debussy's scudding clouds nor of Berlioz's Gothic frenzy but of café concerts, street-corner urinals, and 1910 architectural opulence gone to seed. Some of the music has infectious humor, à la Satie, but in most of it the intent to amuse is submerged by gaudy instrumentation, obvious effects. Ansermet and his men do their best, performing with clarity. The trombonists, in particular, have a field day. R.L.

**COPLAND: *Dance Symphony***  
†Gould: *Spirituals for Orchestra*

Chicago Symphony Orchestra, Morton Gould, cond.

- RCA VICTOR LM 2850. LP. \$4.79.
- • RCA VICTOR LSC 2850. SD. \$5.79.

Copland's *Dance Symphony* dates from 1929, and is a reworking of material from an even earlier score, the ballet *Grohg* of 1922-24. Its present form was created for a recording prize offered by Victor; the prize materialized, but the recording has taken another thirty-six years to bring about. And high time, for this is a brilliant work, the neglect of which in the concert hall is puzzling, to say the least. It is recognizably Copland all the way, even to a distinct foreshadowing near the beginning of a passage from *Appalachian Spring*. Brightly scored, vital, and resourceful (including some adventures with polytonality), it is clearly worth reviving. This is its second recording, the first (on CRI, by Watanabe and the Japan Philharmonic) being intelligent but poor in sound.

Gould's performance is extremely fine, and the orchestral execution is equally superb. The other side of the disc, given over to one of the composer-conductor's most attractive large-scale scores (which has made better headway in concerts than the Copland), is also played with verve. A.R.



**BACH ON 5 GLORIOUS DISCS**  
A SPECIAL DGG/ARCHIVE PRODUCTION

# Buy Three... Get Two Free!

**The Magnificat and Eight Great Cantatas**  
**Now Available on Archive at Special**  
**Low Price...The gift for any music lover on**  
**your Christmas list!**

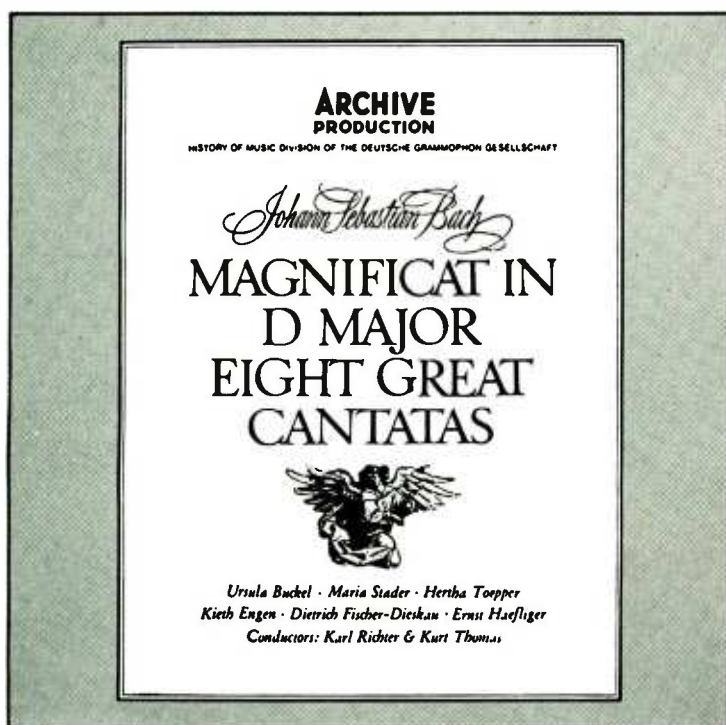

**J. S. BACH:** Magnificat & Eight Cantatas (No. 8, *Liebster Gott, Wann Werd' Ich Sterben*; No. 45, *Es Ist Dir Gesagt*; No. 51, *Jauchzet Gott in Allen Landen*; No. 78, *Jesu, Der Du Meine Seele*; No. 201, *Phoebus and Pan*; No. 202, *Weichet Nur, or Wedding Cantata*; No. 211, *Coffee Cantata*; No. 212, *Peasant Cantata*.)

Soloists include Maria Stader, Dietrich Fischer-Dieskau, Hertha Toepfer, and Ernest Haefliger, among others.

Munich Bach Orchestra & Chorus, Karl Richter, Cond. and

Leipzig Gewandhaus Orchestra, Kurt Thomas, Cond.

**KL-301/5; Stereo: SKL-1301/5**

5-disc set, handsomely boxed, with booklet

**SPECIALLY PRICED AT \$17.98. SEE YOUR DEALER.**

## ARCHIVE PRODUCTION

**FREE! ON REQUEST:** The new DGG/ARCHIVE illustrated catalogs. Write: MGM Records, Classical Division, 1540 Broadway, New York, N.Y. 10036

CIRCLE 7 ON READER-SERVICE CARD

DEBUSSY: *La Mer; Prélude à l'après-midi d'un faune*

†Ravel: *Daphnis et Chloë: Suite No. 2*

Chorus of the Schola Cantorum (in the Ravel); New York Philharmonic, Leonard Bernstein, cond.

• COLUMBIA ML 6154. LP. \$4.79.  
• • COLUMBIA MS 6754. SD. \$5.79.

Although the present Bernstein program is selection for selection identical with the same company's release just over six years ago of an Ormandy/Philadelphia disc, competition between the two sets is minimal, since the conductors' readings are distinctively different.

Bernstein's characteristically impassioned performances of the Ravel Suite and Debussy Prelude are already well known to record collectors, the former in his complete *Daphnis et Chloë* of 1961, the latter as part of a 1961 all-Debussy program and, more recently, as part of the miscellany "Leonard Bernstein Conducts for Young People." His *La Mer* appears here for the first time, but its technical qualities are much the same: extremely robust, seemingly quite closely miked stereo sonics, particularly notable for the glitteringly vivid presence of the—surely somewhat spotlighted—percussion instruments. (I haven't yet heard the mono edition.) Inasmuch as *La Mer* is a work that lends itself to an extraordinarily wide variety of interpretative approaches, Bernstein's somewhat grimly earnest, fiercely dramatic one is by no means unjustified. It is not at all "impressionistic" in either this vigorous reading or the penetratingly detailed recording, and there are surely architectural grandeurs and profundities of eloquence which Bernstein has yet to encompass. Nevertheless, his version is an immensely vital one. R.D.D.

DEBUSSY: *Quartet for Strings, in G minor, Op. 10*

†Ravel: *Quartet for Strings, in F*

Fine Arts Quartet.

• CONCERTDISC M 1253. LP. \$4.98.  
• • CONCERTDISC CS 253. SD. \$4.98.

Performances of these works are extremely difficult to evaluate. As with much so-called impressionistic literature, some of the seemingly most convincing interpretations summarily shed their magic when one consults the score. Conversely, because so much of the music depends for its communication upon the evocation of atmosphere and on tonal beauty per se, a performance well-nigh "perfect" from the textual standpoint can fail utterly in capturing a listener's fancy.

The new Fine Arts edition stands up very well, both from the point of view of sheer music making and of an accurate rendition of the scores. The group gives strong, forthright, polished readings midway between the warmly subjective (too warmly in the case of the Ravel) Budapest statements and the tautly purist Juilliard-Paganini versions. I would take occasional exception to a slight matter-of-factness (as opposed to the Juilliard's

slickness) in some of the Fine Art's phrasing, and also to an overdone ritard or two (e.g., in the last movement of the Ravel, six bars after letter M to letter N in the International score which the composer indicated should be "à tempo" until just before letter N). In the main, though, the cleanliness and unanimity shown by the Fine Arts team more than offset the momentary calculated sectionalizations. Furthermore, the recorded sound is both spacious enough to avoid the uncomfortable closeness of Vox's Loewenguth coupling and compact enough to prevent the overblown effect marring the otherwise satisfactory Stuyvesant pairing (originally Philharmonia, now Nonesuch).

It should be added that the excellent violist in the present performances is Irving Ilmer, not Gerald Stanick as specified on the record sleeve. Though the disc is being released only now, it was taped several years ago, before the quartet's personnel changed. H.G.

### DONIZETTI: *Don Pasquale*

Anna Maccianti (s). Norina: Ugo Benelli (t). Ernesto: Mario Basiola (b), Dr. Malatesta: Alfredo Mariotti (bs). Don Pasquale: Chorus and Orchestra of the Maggio Musicale Fiorentino, Ettore Gracis, cond.

• DEUTSCHE GRAMMOPHON LPM 18971/72. Two LP. \$11.58.

• • DEUTSCHE GRAMMOPHON SLPM 138971/72. Two LP. \$11.58.

It is rather unusual nowadays to find a major company releasing an opera set with no big-sell international names in the cast list; both Anna Maccianti and Alfredo Mariotti, in fact, are completely unknown quantities to most American listeners, and none of the others is going to bring the riot force to your friendly neighborhood record outlet. Nonetheless, this is a perfectly presentable *Pasquale*. While the singing is only occasionally much above competence, it is never less than that, and Ettore Gracis proves to be an admirable conductor of this music—the performance has plenty of idiomatic life and spirit without becoming knockabout or provincial.

Among the singers, the most positive impression is made by Miss Maccianti, an artist new to me. Her voice, basically of a fresh, bright quality and some

body (she is not a thin, gargly sort of coloratura) has the trace of acidulousness that comes to some Italian singers with very forward, high placements; some listeners may find it unbeautiful, but I think it is exactly the quality a Norina should have. Beyond this, she handles it with dash and freedom—the coloratura is always acceptable and sometimes brilliant, the tone in sustained passages pliant and secure. She is especially fine in the Act III scene with Pasquale ("*Signorina, in tanta fretta*," etc.), where all those top-to-bottom runs are really beautifully done, and the recitative has a pointed, vixenish quality of the sort that even good non-Italian sopranos always seem to overshoot.

The Pasquale, Mariotti, is less impressive—a solid, secure bass but a somewhat throaty one, with a weak bottom. The characterization is correct without being at all inimitable or lovable, or ever really funny. Competent and well-routined are the appropriate terms. Ugo Benelli is not in the form he showed on the London *Barbiere* or, more particularly, in the *Cenerentola*. His slim lyric tenor is attractive only so long as he does not push with it, and too much of his singing here is rammed at us in an unpleasantly strained way; he is obviously giving his all, for example, in the climaxes of "*Sogno soave e casto*" (pp. 30-31 of the Ricordi vocal score). We must grant that the role's tessitura is not easy, and that there are surely some fine moments when Benelli is not pressing—"Tornami a dir che m'ami" is lovely, with an excellent top C sharp.

Mario Basiola, son of one of the most prominent baritones of the 1920s and '30s, makes a better impression here than on the Angel *Bohème*, revealing himself as a gifted character baritone who can be counted on to bring life and understanding to his scenes. A really first-rate Malatesta, though, will add some sunny, smooth vocalizing to the characterization, and Basiola's baritone, at least as presently produced, simply is not beautiful, except at very low dynamics—it has a woolly, hot-potato sort of focus. He "does" it well, as they say, and fits into the ensembles nicely.

The orchestra, not a brilliant virtuoso ensemble, nevertheless plays more than acceptably, and I am quite favorably impressed by Gracis' *cantante* feeling for the music, his sensible selection of tempos, and his sense of ensemble balance. Once in a while he allows a recitative to go a bit dead, but I have no other serious strictures to make. The chorus sings extremely well, and the sound is fine.

This version embraces all the "standard" cuts. I think this is too bad, especially with respect to the Act II finale and Ernesto's serenade—as I noted in reviewing London's genuinely complete version, most of the omitted music is usable ore, not slag. London certainly has the superior Pasquale (Corena), but DGG has the better Norina, and the other roles are mostly a matter of taste. C.L.O.



Continued on page 92



Under this copy of HOUSE BEAUTIFUL  
is our new combination of  
a sensitive AM/FM stereo tuner  
plus a powerful 50 watt stereo amplifier.

Beautiful.

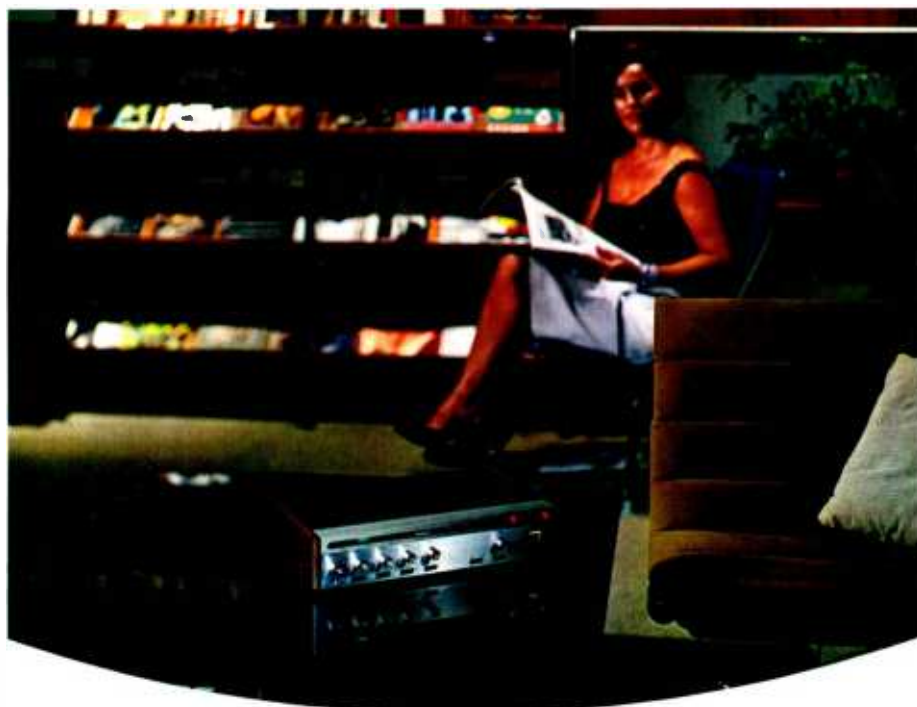

It might strike you as just a fine decorator accessory. True, it is an asset anywhere in any room. But if you can tear yourself away from just looking at it, flick it on and you'll HEAR the true beauty it was invented for. Fifty watts of extraordinary stereo sound can't be seen, but you'll feel it completely filling your room. The receiver is all solid state. E-V has removed all the bulk, the heat, and the cost that mean nothing to your listening (and looking) enjoyment. Series 1100 units give you all the control you need to satisfy the most discerning musical taste. Peek at the features of the

amplifier and tuner. Everything said about those units has been combined in this receiver, and that's a lot in a package this size. All connections are recessed and hidden. Every model is complete with case including solid walnut end panels. There are the sound source lights, "spot of light" tuning dial, and FTS stereo broadcast indicator that works even when you're listening to records. It's almost as much fun to watch as to hear. At home in a bookshelf, on a table or cabinet. Just add a pair of Electro-Voice speakers for a completely satisfying high fidelity system.

**E-V 1177 FIFTY WATT FM STEREO RECEIVER**    **E-V 1178 FIFTY WATT AM/FM STEREO RECEIVER**



*Electro-Voice*<sup>®</sup>

Careful! Here's an amplifier so small you may misplace it under a few decorator magazines. You'll never misplace the sound, of course — it's superb! But the size means you can really put the E-V 1144 anywhere. Whatever your sound source — tuner, turntable, tape — it has a place with this amplifier. And the unit shows you what's operating, because there's a color light bar, different for each source, glowing on the front panel. The amplifier is completely enclosed, of course, with a solid walnut panel at each end. Connections are hidden under the back. Solid!

**E-V 1144 FIFTY WATT STEREO CONTROL AMPLIFIER**

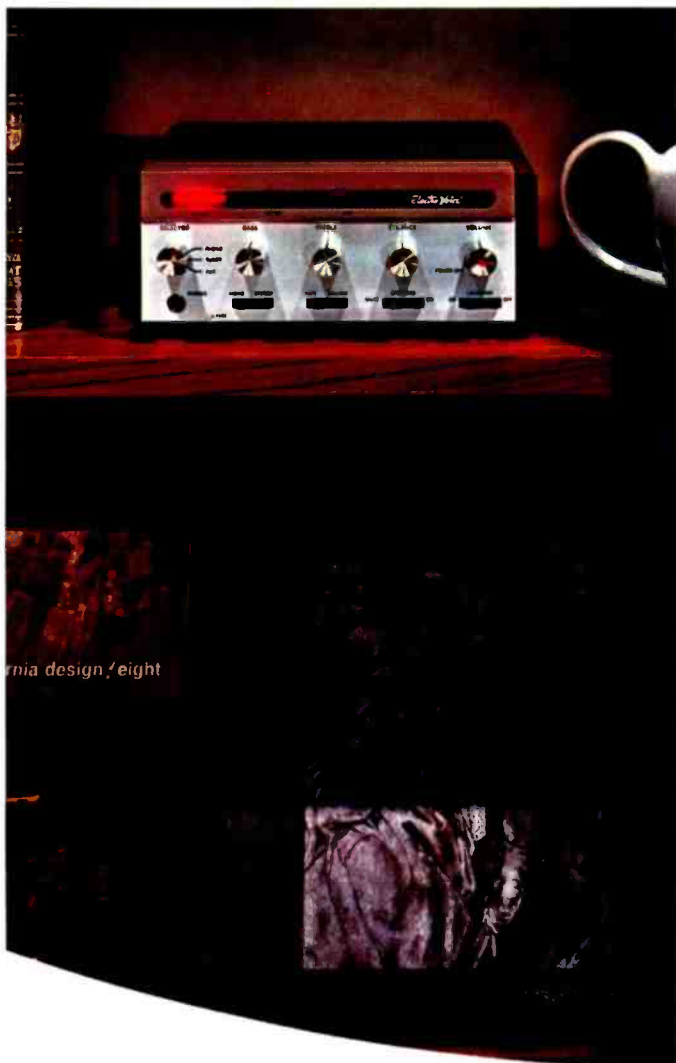

And for a perfect companion, the E-V tuner, matching the amplifier exactly. This all-solid-state unit just won't let you stray from optimum satisfaction. You tune, and the "spot of light" leads you along the dial. Your favorite stations can be marked by exclusive E-V movable locaters. If you wish, AFC locks in fm stations, and the illuminated meter shows when tuning is perfect. The FTS (full time stereo) light tells when stereo is there! Listen, it's simply great. After all, this is one tuner that's as sensitive as you are.

**E-V 1155 FM STEREO TUNER**

**E-V 1156 AM/FM STEREO TUNER**

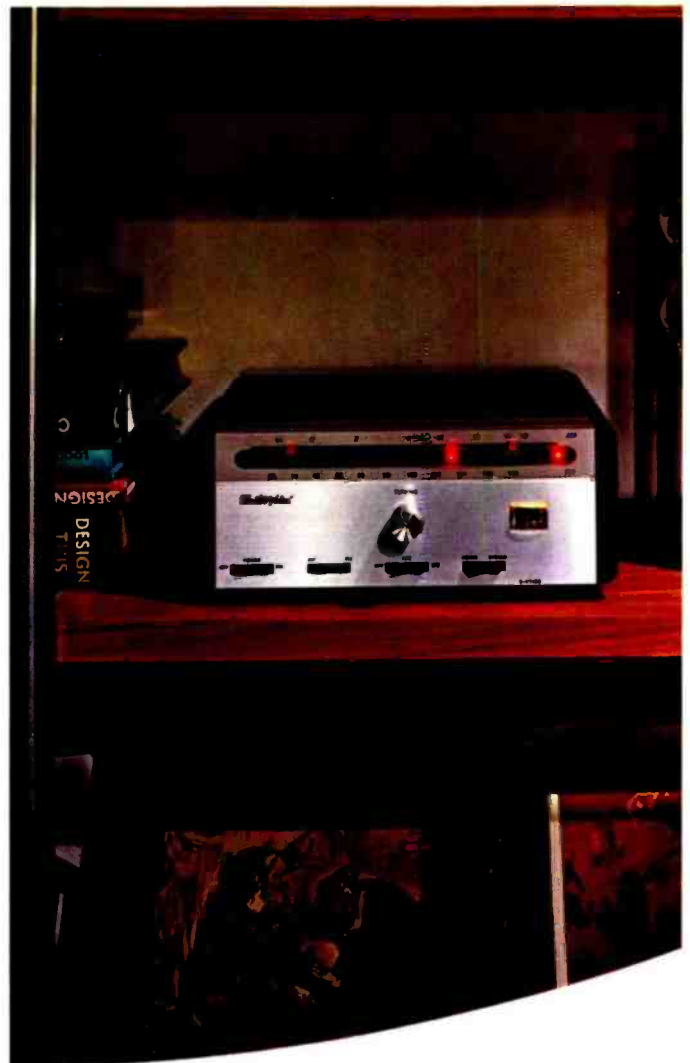

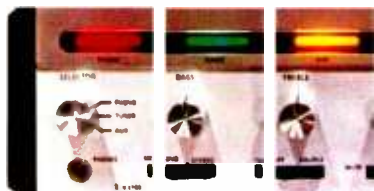

**COMPUTER-TYPE INDICATOR LIGHTS** call out which audio source you are hearing — tuner, phono, or auxiliary. The lights are attractively color keyed for quick and easy identification.

**EXCLUSIVE STATION LOCATORS** mark your favorite stations for quick, accurate tuning. Easily reset at any time.

**"SPOT OF LIGHT" DIAL INDICATOR**, instead of hard to see pointer, pinpoints tuning day or night.

**"FTS" (full time stereo) INDICATOR LIGHT** glows whenever you are tuned to a stereo broadcast even when listening to records or tape, or system is switched to mono. Automatic fm stereo switching.

**ZERO-CENTER TUNING METER** permits ultra-precise tuning of weakest signals. Illuminated for easy use.

Electro-Voice electronic components are warranted for two years from date of purchase against defects in materials and workmanship. Any unit showing evidence of such defect will be repaired or replaced without charge.

- E-V 1144 FIFTY WATT STEREO AMPLIFIER .....\$124.50
- E-V 1155 FM STEREO TUNER ..... 160.00
- E-V 1156 AM/FM STEREO TUNER ..... 195.00
- E-V 1177 FIFTY WATT FM STEREO RECEIVER .. 280.00
- E-V 1178 FIFTY WATT AM/FM STEREO RECEIVER 315.00



**FIT ANY SPACE** with E-V 1100 series solid state electronics. Tuner and amplifier units stack less than 6 1/2" high. Case with solid walnut end panels is standard — nothing extra to buy.

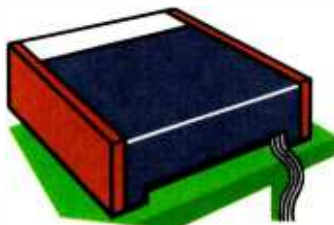

**NEAT INSTALLATION ANYWHERE** is assured by recessed terminal panel at rear. All connections are out of sight. Wires can be wrapped together and run behind a table leg. Units can be placed flush against a wall if space is at a premium.

**amplifier specifications / IHF music power output**, 50 watts (into 8 ohms, output increases into lower impedances), 25 watts per channel / **Continuous sine wave output**, 18 watts per channel / **Frequency response**, ±1.5 db 20-20,000 cps at rated output, ±1.5 db 20-30,000 cps at 1 watt / **Harmonic Distortion**, less than 1.0% at rated output / **Hum and noise**, better than 70 db below rated output (magnetic phono input better than 60 db below rated output) / **Inputs**—phono (mag), tuner, aux, tape (high level). **tuner specifications: Sensitivity**, 2 uv IHF. **amplifier and tuner dimensions: 3 3/8" high, 8 3/8" wide, 10 1/4" deep. / receiver dimensions: 3 3/8" high, 15 7/8" wide, 10 1/4" deep.**

ELECTRO-VOICE, INCORPORATED BUCHANAN, MICHIGAN 49107

Setting courtesy of Herman Miller, Inc.

You can see and hear 1100 series components at your E-V high fidelity specialist's showroom.



LITHO IN U.S.A.

Form 1072



# Coming in December HIGH FIDELITY'S Annual Guide to Stereo-

## Only \$1

Aside from HIGH FIDELITY Magazine, our most popular publication created in Great Barrington is the annual roundup of developments in stereo.

Like its six predecessors, the upcoming STEREO 1966 Edition generates ideas that help you achieve the best stereo reproducing system at the price you decide to pay. And it helps you get the most out of your present system, if you are that far along. In sum, it's a blend of news and expert comment which covers such exciting subjects as these:

**Record Players and Pickups.** New turntables, arms, cartridges, integrated ensembles. Hints on selecting from the variety of gear available; speeds; types of units; installation; record wear.

**Tape Recorders for All Tastes:** The evolving world of magnetic tape; a survey of new equipment including decks and complete recorders; a glimpse of the imminent future in video tape; pending developments such as slower speeds. Microphones. Accessories.

**Amplifiers.** Current and choice amplifiers; a survey of new models including a discussion of solid state amplifiers. Some advice on power ratings, distortion, controls and their use.

**FM and Tuners.** What's happening in FM stereo broadcasting. Equipment available for listening and for taping off the air. Guides to purchasing an FM tuner. Antenna and related accessories.

**Speakers.** Large, small and in-between. What's available; hints on how to select a pair for stereo; advice on placement.

**Installation and Decor.** Every stereo installation can be attractive. Ideas. Many photos with running text.

**Year's Best Recordings.** Capsule comments on choice stereo discs and tapes.

There's much more, of course, including scores of illustrations, but this gives you the gist of the contents offered in STEREO 1966 Edition which approximates the size of HIGH FIDELITY Magazine. Is there a better way to invest \$1?

-----  
High Fidelity Publishing House  
Great Barrington, Mass. 01230 1265

For the dollar enclosed send me as soon as published  
a copy of STEREO 1966 EDITION.

Name .....

Address .....

City .....

State & Zip .....

Continued from page 86

**DVORAK: Chamber Works**

*Quintet for Strings, in G, Op. 18; Quintet for Piano and Strings, in A, Op. 81; Quartet for Strings, in B flat, Op. posth.; Twelve Cypresses for String Quartet, Op. posth.*

György Sandor, piano (in Op. 81); Murray Grodner, double bass (in Op. 18); Berkshire Quartet.

- Vox VBX 51. Three LP. \$9.95.
- • Vox SVBX 551. Three SD. \$9.95.

Here is Volume 3 in a projected complete survey of the Dvořák chamber music literature. The album is the first recording made by the Berkshire Quartet, a foursome which spends its winters teaching at the University of Indiana and its summers playing at Music Mountain in Falls Village, Connecticut. Volumes 1 and 2 of the series featured the Kohon Quartet of New York University, and the change of artists is, to judge from the present album, much for the better. In place of the nasal, edgy sounds produced by the New York group, the Berkshire ensemble plays with warm, expansive sonorities and a good deal of old-fashioned romantic spirit. To be sure, they are hardly more subtle than the Kohons, but the over-all musical feeling is far more sympathetic to the music.

Two new versions of the popular Piano Quintet are slated for release in the not too far distant future: a Vanguard disc with Peter Serkin, Alexander Schneider, Felix Galimir, Michel Tree, and David Soyer; and one from RCA Victor with Jacob Lateiner, Jascha Heifetz, Israel Baker, Joseph de Pasquale, and Gregor Piatigorsky. In the meantime, I am prepared to call the Sandor/Berkshire performance the best available in stereo. The Vox team delivers here a big, warmly extrovert reading, stronger and more exciting in spirit than the rather precious Curzon/Vienna Philharmonic Quartet edition (London) and more effectively paced than the otherwise forthright Frank Glazer/Fine Arts reading (ConcertDisc). If you can still derive satisfaction from monophonic reproduction, the beautifully recorded 1953 Curzon/Budapest Columbia disc offers an elegant, subtle account of this irresistible work.

The Double Bass Quintet receives a reading from the Berkshire ensemble that is somewhat brisker and more businesslike than the performance by the Dvořák Quartet and František Posta (Supraphon, mono only). While the latter version scores by virtue of a more spacious type of acoustics, the economical Vox exposition gives one little to cavil at. I would also be interested in hearing a Repeat edition, which reputedly uses special electronically treated instruments designed to minimize the factor of room acoustics in the recording of this odd work.

Dvořák's very early (1869) String

Quartet in B flat shows the composer still under the influence of Wagner—an influence manifested here mainly in the work's prolixity: despite the heavy cuts in the present performance, it takes 33 minutes and 29 seconds to play. Notwithstanding its derivative nature and structural gaucheries, however, the B flat Quartet is obviously the product of an incipient master. As for the lovely *Cypresses*, which Dvořák reworked from some songs, they can be enjoyed without any reservations whatsoever.

The sound is occasionally a bit tubby in the Double Bass Quintet's opening two movements (it somehow improves later on) and the piano is just a shade too dominant in the A major Quintet. In the main, though, Vox has provided excellent sonics and quiet surfaces. H.G.

**FARBERMAN: Evolution; Impressions; Progressions**

Phyllis Curtin, soprano; Ralph Gomberg, oboe; John Perras, flute; Ralph Pottle, horn; Boston Chamber Ensemble, Harold Farberman, cond.

- CAMBRIDGE CRM 805. LP. \$4.98.
- • CAMBRIDGE CRS 1805. SD. \$5.98.

We are given here three compositions by Harold Farberman using the percussion ensemble with other instrumentalities. *Evolution* is a three-movement work employing voice and horn in its second chapter. *Impressions* and *Progressions* are both in four movements: the first uses oboe and strings in addition to the percussion. In all, the music may be most charitably described as utterly sterile and hopeless, but the performances are superb and so is the recording. A.F.

**GOULD: Spirituals for Orchestra—**  
See Copland: *Dance Symphony*.

**GRIEG: Songs—**See Sibelius: *Songs*.

**HAYDN: Concerto for Cello and Orchestra, in D**  
†Boccherini: *Concerto for Cello and Orchestra, in B flat*

André Navarra, cello; Camerata Academica of the Salzburg Mozarteum, Bernhard Paumgartner, cond.

- NONESUCH H 1071. LP. \$2.50.
- • NONESUCH H 71071. SD. \$2.50.

Haydn and Boccherini, perpetually wedded as far as recording of their cello concertos are concerned, are both quite handsomely dealt with here. Navarra is a warm-hearted instrumentalist who can put a large measure of love into the

shortest of Haydn's three-note phrases, and who, at the same time, holds himself a bit more in reserve than Pierre Fournier, for instance. One thing Navarra lacks is Fournier's wonderfully palatable tone on the high registers; the thin-air acrobatics of the Haydn first movement seem to catch Navarra under a certain stress here. And I can't forget the inimitable Gallic something which Fournier puts into the opening figure of the Boccherini third movement (on DGG SI.PM 138816). But Navarra should by no means be short-changed on these performances, and he has excellent cooperation in the Salzburg players. (The lively, articulate precision of the rising, crescendo scale figure of the Boccherini Adagio, to cite one instance, is a measure of the quality of their support.) Nonesuch's sound is adequate. S.F.

**HAYDN: Katherinentänze (H. IX:11)**  
—See Mozart: *12 Deutsche Tänze, K. 586*.

**HAYDN, MICHAEL: Turkish March; Concerto for Trumpet and Orchestra, in D; Divertimento in G ("The Pastoral Wedding")**

†Mozart, Leopold: *Sleigh Ride*  
†Biber: *Sonata for Strings, No. 1, in B minor, from "Fidicinium sacro-profanum"*

Adolf Scherbaum, trumpet (in the Haydn); Camerata Academica (Salzburg), Bernhard Paumgartner, cond.

- MUSICAL HERITAGE SOCIETY MHS 622. LP. \$2.50.
- • MUSICAL HERITAGE SOCIETY MHS 622. SD. \$2.50.

This is an agreeable assortment of musical small beer from Salzburg, most of it by people's relatives. The odd man out, both temporally and because he doesn't seem to have been the father or brother of anyone special, is Heinrich Biber (1644–1704). He is best known for his sonatas for violin and figured bass, which have attracted some attention lately. Here he is represented by the first of a collection of sonatas for strings: the music has some stimulating turns of harmony and rhythm, but I doubt if its interest would survive many hearings.

The three pieces by Joseph Haydn's younger brother that make up one side of this disc are good *Kapellmeister* music, no less but no more. Mozart's father, whose important violin manual was recently reissued in Holland in a fine facsimile edition, comes off better: his *Sleigh Ride*, an early piece of descriptive music resembling some of Dittersdorf's symphonies, is simple-minded but tuneful, and it has more character than the present example of Michael Haydn.

Performances and recording are fair, though the strings sound a bit thin. But Adolf Scherbaum can hardly have gained his enormous reputation on playing like this: his phrasing is slack, his breathing careless, and his tone often painfully shrill. The record has its pleasures, but they are less positive than its historical interest. B.J.





# The splendor of Sound Unbound



## ...now in a superb compact music system

Harman-Kardon, creator of Stratophonic Sound—a totally new experience in stereo realism—now brings you this incredibly lifelike quality in a complete stereo music system . . . the great new Stratophonic SC-440.

Here for the first time are perfectly matched components: a powerful all-transistor AM/FM stereo receiver, built-in Garrard automatic turntable with magnetic cartridge and diamond stylus, and a pair of radically new Harman-Kardon speakers, designed especially for this remarkable system . . . speakers which disperse the sound widely to produce the full stereo effect even in a small room.

LEADER IN SOLID-STATE STEREO COMPONENTS

**harman kardon**

Subsidiary of The Ferrol Corporation

At \$399\*, the SC-440 brings the magic of Stratophonic Sound quite down to earth. This system is a worthy addition to the widely acclaimed Harman-Kardon Stratophonic Series of solid-state stereo receivers, tuners, and amplifiers. You'll like it on sight . . . buy it on sound.

Send the coupon for beautiful illustrated Harman-Kardon catalog.

*\*Slightly higher in the West. Dust cover optional.*

Harman-Kardon, Inc., Dept. HF-12  
P.O. Box 12866, Phila., Pa. 19108

I'd like a demonstration of the new Stratophonic Compact Music System. . . . send name of my nearest Harman-Kardon Dealer.

Send complete information on Harman-Kardon all-transistor stereo equipment.

Name \_\_\_\_\_

Address \_\_\_\_\_

City \_\_\_\_\_ State \_\_\_\_\_ Zip No. \_\_\_\_\_

CIRCLE 40 ON READER-SERVICE CARD

**IVES: Sonatas for Violin and Piano**  
(4)

Paul Zukofsky, violin; Gilbert Kalish, piano.

• FOLKWAYS FM 3346/47. Two LP. \$5.79 each.

Ives's four Violin Sonatas provide a particularly persuasive introduction to his idiom. The music is full of the complex, tormented, transcendental Ives; the folksy, barn-dancy, country-fiddler Ives; the profoundly polyphonic Ives who used the American Protestant hymn as Bach had used the Lutheran chorale; and the Ives for whom past and present ran together in a complex, many-stranded

skain. But Ives was always conservative in his use of the violin, always respected its lyric nature, and never experimented with its potentialities as, say, Stravinsky did in his *Story of a Soldier*. Consequently the Violin Sonatas, while great and essential Ives, are a little less far out in style than the Piano Sonatas or the Symphonies.

It would be difficult to imagine a finer performance of these pieces than the one provided here and equally difficult to imagine a finer recording. Zukofsky and Kalish, both young New Yorkers, are superb virtuosos, and together they make a really great chamber music team; and the subtlest nuances of their playing are perfectly caught by the engineers.

Extensive and excellent notes by Samuel Charters make the thing complete. More, please. A.F.

**KODALY: Missa Brevis; Jesus and the Traders**

Whitehart Chorale, Lewis F. Whitehart, cond.

• LYRICHORD LL 144. LP. \$4.98.  
• • LYRICHORD LLST 7144. SD. \$5.95.

The *Missa Brevis* might just turn out to be Kodály's masterpiece. For sheer beauty of choral sound; for the rich, lovely, subtle orchestration of voices and organ; for exalted mysticism and enchanting melodicy there has been nothing like it since the Fauré Requiem. No small part of this effect, of course, is to be credited to the Whitehart Chorale's magnificent performance and the excellent recording.

The *Missa Brevis* occupies all of one side and most of the next. *Jesus and the Traders* is a short motet, very complex in its polyphony, a little on the angular side, and scarcely the kind of thing one expects of this composer. It is probably more fun to sing than it is to hear, but it is not bad hearing, either. A.F.

**LISZT: Missa Choralis**

Margit Lászlo, soprano; Zsuzsa Barlay, mezzo; Alfonz Bartha, tenor; Sándor Palcsó, tenor; Zolt Bende, baritone; Tibor Nádas, bass; Sándor Margittay, organ; Budapest Choir. Miklós Forrai, cond.

• QUALITON LPX 1141. LP. \$5.98.

This Mass, basically for a *cappella* choir sometimes reinforced with organ, and with short incidental solo passages, was composed by Liszt in 1869, the same year in which he took holy orders. The work can reasonably be taken, therefore, as some measure of his attitude towards religious faith.

As such, it is a rather damning document. I find this a work of almost painful pretentiousness, all the more so because its austere format is supposed to invoke a host of memories of the great liturgical settings of the past. The pseudo-counterpoint is labored, and it seems quite clear that Liszt is far more interested in a procession of sweet (and often cloying) harmonies. By comparison, the far more spectacular liturgical works by Berlioz and Verdi are also far more devotional in their total effect. Only once, in the Benedictus with its stabbing dissonances, do I feel in the presence of an important and dedicated composer.

Forrai leads an admirable performance, captured (mono only) with reasonable clarity. His soloists are better than those on the Vox recording under Hans Gillesberger. That, however, is a dollar cheaper, and I don't consider this music worth a penny more. A.R.

**LULLY: Arioso; Minuet—See Mozart: Divertimento No. 17, in D, K. 334.**

**VANGUARD**  
Recordings for the Connoisseur



**STILLE NACHT, HEILIGE NACHT**

18 beloved German and Middle European Christmas songs and folk songs of the Nativity.

ERICH KUNZ, baritone with the Mozart Boys Choir of Vienna  
Vienna State Opera Orch.  
VRS-1143 & \*VSD-71143

**CHRISTMAS CAROLS AND MOTETS OF MEDIEVAL EUROPE**

THE DELLER CONSORT with Musica Antiqua of Vienna  
(Renaissance Instruments)  
BG-680 & \*BGS-70680

**CZECH AND POLISH SONGS OF CHRISTMAS**

CHILDREN'S CHORUS OF RADIO PRAGUE, acc. by gambas, recorder, bagpipes, organ, harpsichord, glockenspiel and triangle.  
Dr. Bohumil Kulinski, conductor.  
VRS-1144 & \*VSD-71144

The pinnacle of today's flamenco art.



**MANITAS DE PLATA**

Guitarra  
Flamenco

VRS-9203 & \*VSD-79203

"A great and savage artist"

JOHN STEINBECK

"In that kind of music, I have never heard the equal of the man with the hands of silver (Manitas de Plata)."

VINCENT SHEEAN

"With Manitas de Plata the begging and the crying are actually a cry of angels."

MACKINLAY KANTOR

\*Stereo

Other New Releases



**JEANNE-MARIE DARRÉ, piano**

"France's first lady of the keyboard—and very possibly the world's." Louis Biancolli, *New York World Telegram*  
A LISZT RECITAL  
B minor Sonata—Feux follets  
— Harmonies du Soir—Sonnetto 123 del Petrarca—La Campanella  
VRS-1150 & \*VSD-71150

A CHOPIN RECITAL  
24 Preludes, Op. 28—Fantasy in F minor, Op. 49—Berceuse, Op. 57  
VRS-1151 & \*VSD-71151

ANTON HEILLER, organ  
ORGAN WORKS OF J. S. BACH, Vol. 2  
Prelude & Fugue in E minor, "Wedge", BWV 548—Prelude & Fugue in A major, BWV 536—Passacaglia and Fugue in C minor, BWV 582—Fantasia in G Major, BWV 752  
BG-674 & \*BGS-70674

ANTONIO JANIGRO, cello & JOERG DEMUS, piano  
THE 'CELLO-PIANO SONATAS OF BEETHOVEN—Complete  
Vol. 1 Sonata in G minor, Op. 5 No. 2—Sonata in A major, Op. 69  
VRS-1136 & \*VSD-71136  
Vol. 2, Sonata in F major, Op. 5 No. 1—Sonata in C major, Op. 102 No. 1—Sonata in D major, Op. 102 No. 2  
VRS-1137 & \*VSD-71137

CIRCLE 89 ON READER-SERVICE CARD

CIRCLE 12 ON READER-SERVICE CARD—>

# Of the 3 automatic turntables priced at 99<sup>50</sup> only one offers all these features.

## Look into it.

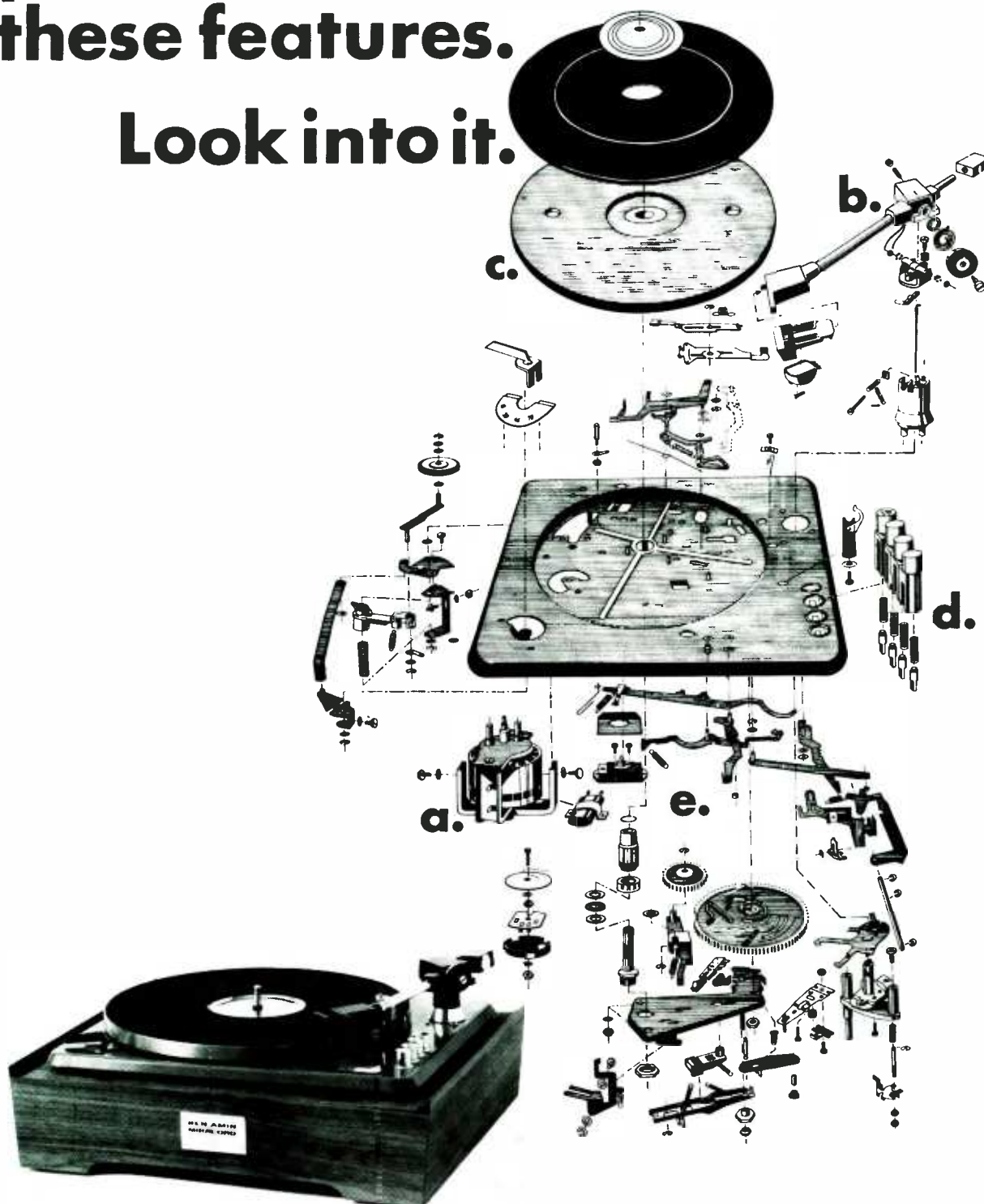

**a.** Hysteresis Motor. The 40H is the only automatic so equipped. Maintains accurate speed even with extreme voltage variations. Uses famous Papst motor, found in professional turntables and tape transports.

**b.** Dynamically Balanced Tone Arm. Tracks any cartridge at its recommended stylus force setting, as low as ½ gram. Calibrated rotating dial provides direct adjustment of stylus force. Cartridge head has interchangeable insert; permits interchanging cartridges without rewiring.

**c.** Dynamically Balanced Turntable.

One-piece, 12", non-magnetic casting is machined to precise concentricity, then individually tested for dynamic balance. Weights are affixed to one or more points for equal mass distribution. Rides in Teflon-enclosed, dust-free, ballbearing races.

**d.** Feathertouch Push Buttons. A Miracord exclusive—only the slightest touch is needed for automatic play or reject. Arm responds gently without jumping, slapping or skating.

**e.** Time-Tested Mechanism. The same basic internal mechanism which gave the Miracord 10 and 10H their repu-

tation for trouble-free reliability. Assures smooth, quiet operation even with extended bass response.

The Miracord 40H operates at 4 speeds: 78, 45, 33 and 16 rpm, and handles 7, 10 or 12" records. It plays single records manually or automatically, and stacks of up to 10 in automatic sequence. It is a modern instrument for modern stereo systems.

See it at your hi-fi dealer, or write. Benjamin Electronic Sound Corp., 40 Smith St., Farmingdale, N.Y. 11736

## The Miracord 40H

MARAIS: *Three Folk Dances*—See Mozart: *Divertimento No. 17, in D, K. 334*.

MOZART: *Concerto for Flute, Harp, and Orchestra, in C, K. 299*; *Fantasia for a Mechanism in a Clock, in F minor, K. 608*; *Adagio for Glass Harmonica, in C, K. 326*

Helmuth Rilling, organ (in K. 608); Bruno Hoffmann, glass harmonica (in K. 326); Jean Patero, flute, Helga Storck, harp, Württemberg Chamber Orchestra (Heilbronn), Jörg Faerber, cond. (in K. 299).

- Vox PL 12880. LP. \$4.79.
- • Vox STPL 512880. SD. \$4.79.

The works offered here may be far out of the way for concertgoers but they have long been available on records. The double concerto is nicely done. Both of the soloists are excellent. Patero's lovely, liquid tone is favored a little too much by the engineers, especially in the first movement, and in the finale the conductor's rhythm could be firmer, but by and large this is another of the several satisfactory recordings now in the catalogue.

According to both sleeve and label, the big *Fantasia* is played here on a "mechanical organ." I had a vision of Mr. Rilling turning a wheel, or perhaps pedaling away at a gadget like a player-piano roll, but a phone call to Vox elicited the admission of an error and the information that the instrument in question is a normal pipe organ. It is the playing that is, unfortunately, a little mechanical. By no means the least interesting of the pieces performed here is the one for glass harmonica, with its shivery, ethereal sounds, clearly conveyed in this excellent recording. Hoffmann, who seems to have a monopoly on the instrument, plays it well. N.B.

MOZART: *Concertos for Horn and Orchestra: in D, K. 412; in E flat, K. 417; in E flat, K. 447; in E flat, K. 495*

Mason Jones, horn; Philadelphia Orchestra, Eugene Ormandy, cond.

- COLUMBIA ML 6185. LP. \$4.79.
- • COLUMBIA MS 6785. SD. \$5.79.

Mr. Ormandy, having displayed the virtuosity and musicality of his first flutist, oboist, clarinetist, and bassoonist in Mozart concertos for those instruments, now features his first hornist in the same way. Mason Jones, like his colleagues, is a musician of whom Philadelphia—and America—can be proud. His playing of these tricky works is impeccable. Rapid passages are tossed off effortlessly, slow ones are sung beautifully, the trills are clean and accurate. The finale of K. 447 seems a little too fast—the players have to slow down for the first episode—but otherwise I could hear no defect of any sort here. Ormandy, of course, provides his usual considerate but far from perfunctory support. There is no finer performance of these works on discs. N.B.



Milstein: *purity's the word.*

MOZART: *Concertos for Violin and Orchestra: No. 4, in D, K. 217; No. 5, in A, K. 219*

Nathan Milstein, violin; Philharmonia Orchestra.

- ANGEL 36007. LP. \$4.79.
- • ANGEL S 36007. SD. \$5.79.

The word that came into my mind more often than any other as I listened to this disc was purity. Here is fiddle playing in which every note, no matter how long or short, no matter where on the fingerboard it is obtained, no matter how much or how little of the bow is applied, nor with how much pressure, is clean and live. Milstein's tone is the triumph of sheen over schmaltz. All the joints in his right arm are clearly well lubricated and under complete control. Add to the mastery of the mechanics of violin playing a discerning taste and sound musical instincts, mix further with first-class work by the orchestra (conducted by the soloist?), and you have performances that rank with the best on records. As always with Milstein the approach is a bit impersonal, but it wears better in the long run than many a more individual or flamboyant interpretation. Excellent sound in both versions. N.B.

MOZART: *Dances and Marches, Vols. 2 and 3*

Vienna Mozart Ensemble, Willi Boskovsky, cond.

- LONDON CM 9413/14. Two LP. \$4.79 each.
- • LONDON CS 6413/14. Two SD. \$5.79 each.

MOZART: *12 Deutsche Tänze, K. 586*

†Haydn: *Katherinentänze (H. IX: 11)*

Innsbruck Symphony Orchestra, Robert Wagner, cond.

- TURNABOUT TV 4015. LP. \$2.50.
- • TURNABOUT TV 34015. SD. \$2.50.

The second and third discs in London's

recording of Mozart's complete dances and marches offer additional evidence of that master's inability to produce shoddy work. The marches are elaborate and inventive pieces. Of the two in Vol. 3, K. 249 was intended to introduce the *Haffner Serenade* (K. 250) and K. 335, No. 1, to perform the same function for the *Posthorn Serenade* (K. 320). Neither of the large works is really complete without its introductory march. Vol. 2 includes an unusual pair of dances, K. 463: each one consists of a fast contredanse flanked fore and aft by a graceful minuet section. Most striking of all are the *German Dances*, of which there are twelve (K. 586) in Vol. 2 and six (K. 600) in Vol. 3. Here are eighteen pieces, each in 3/4 time and thirty-two measures long (not counting repeats), yet no two of them are alike. The same is true of the twelve Minuets, K. 568, in Vol. 3. Even though all of these pieces are intended for dancing, Mozart seldom takes the easy, mechanical way. He takes special pains to make the trios not only contrasting to the main body of the dance but especially attractive. He even uses, once or twice, a bit of contrapuntal imitation.

As in Vol. 1, the Vienna Mozart Ensemble plays with zest as well as with polish and finesse, and the sound is first-rate. The same unfortunately cannot be said of the performance or recording of the Turnabout disc. There the playing is consistently stodgy and three-square, so to speak. Moreover there is little definition and not much clarity in the sound. This is a pity, because the Haydn pieces, a set of twelve minuets he wrote, without fee, for a charity ball in 1792, are almost symphonic in scope, and in quality on the same level as the mature Mozart pieces. N.B.

MOZART: *Divertimento No. 7, in D, K. 205 (with March in D, K. 290); Cassation in B flat, K. 99*

Members of Vienna Octet.

- LONDON CM 9433. LP. \$4.79.
- • LONDON CS 6433. SD. \$5.79.

This disc presents two very attractive products of the teen-age Mozart. To me, the earlier one is even more interesting than the other. In this *Cassation* the thirteen-year-old composer strews ideas around in profusion. Each one of the seven short movements has its own charm, but the first *Andante*, a poetic little nocturne for muted strings, and the finale, a swift piece with a highly contrasted interpolation, are especially noteworthy. The *Divertimento* is unusual in that it calls for only one violin instead of the usual pair, though it has two horns and the bass is doubled by a bassoon. In the fast movements this work has an open-air breeziness and vigor, while the slow movement, for violin, viola, and bass, has a chamber music intimacy. The players of the Vienna Octet as usual turn in an excellent performance. This is a welcome addition to the Octet's series of Mozart recordings for London. N.B.

# Bozak Can't Bring Back A Summer Evening, But . . .



## Bozak Loudspeakers Can Re-Create The Concert

Each summer more great musical organizations are taking to the outdoors where at a single concert their music may reach more people than in an entire indoor season.

A case in point is the series of Central Park concerts by the New York Philharmonic where individual audiences ranged upwards from 70,000.

Naturally, if persons in the last row, a quarter of a mile from the orchestra, are to hear the concert, there must be a sound reinforcement system. If the entire audience is to **enjoy** the music, that system must deliver the music as naturally as possible — nothing added, nothing taken away.

That has been our goal in speaker design through the years — to deliver music exactly as played. We're proud to have attained that goal to the extent that our speakers are used for outdoor performances of the New York Philharmonic, the Metropolitan Opera, the St. Louis Little Symphony, and the Miami Symphony, among others.

You don't have to wait until next summer, though, to hear music reproduced naturally. You can bring outstanding musical performances into your home through loudspeakers built to the same standards as those used by great orchestras — loudspeakers by . . .



The R. T. Bozak Manufacturing Co.  
Box 1166 Darien, Connecticut

Write for our 1966 catalog.

MOZART: *Divertimentos: No. 7, in D, K. 205; No. 10, in F, K. 247; Six Country Dances, in B flat, K. 606*

Salzburg Mozart Players.

• MUSICAL HERITAGE SOCIETY MHS 609. LP. \$2.50.

• • MUSICAL HERITAGE SOCIETY MHS 609. SD. \$2.50.

MOZART: *Divertimento No. 15, in B flat, K. 287*

Orchestre des Solistes de Paris, Louis Martin, cond.

• NONESUCH H 1046. LP. \$2.50.

• • NONESUCH H 71046. SD. \$2.50.

MOZART: *Divertimento No. 17, in D, K. 334*

†Lully: *Arioso; Minuet*

†Marais: *Three Folk Dances*

Leningrad Philharmonic Orchestra, Kurt Sanderling, cond. (in the Mozart); Moscow Chamber Orchestra, Rudolf Barshai, cond. (in the Lully and Marais).

• MONITOR MC 2067. LP. \$1.98.

• • MONITOR MCS 2067. SD. \$1.98.

The divertimento (or cassation, nocturne, or serenade) seems to be mainly an Austrian product. Its origins, and whatever differences may be indicated by the different terms, are still vague, but one thing seems clear: once Mozart took it up, it turned to gold. Each of the four examples offered on this batch of discs is a delight. Especially noteworthy in K. 205 are the two fine minuets and the high-spirited finale. The "Salzburg Mozart Players"—here violin, viola, bass, and two horns—perform it in clean and lively fashion. K. 247 is even more charming. Here, however, the strings (with only one player on a part) sound a bit thin; a few more fiddlers and another viola are needed, it seems to me.

The first movement of K. 287 has a development section that is surprisingly dramatic for a genre supposed to be for entertainment only; the Adagio is a beauty; and a mock-serious instrumental recitative leads into a gay, dancelike finale. The French orchestra plays the work with grace and some elegance. If you don't mind streaked violin tone, this disc is a bargain. If you do, try the London.

The sound on the Monitor record is quite good, and K. 334, with another serious development section, a fine set of variations, a familiar minuet, and a delicious rondo, is perhaps the best of the four. But the conductor doesn't know what to do with his excellent orchestra in this music. In the first movement the articulation of the sixteenth-note figures is swallowed up, and the tempo is slowed down for the development section, as it is for the trio of the Minuet, and for an episode in the finale. Even worse, the second minuet and the Adagio are omitted and instead we are given the Lully and Marais lollipops. And in the Lully Arioso the players pour butter cream over the candy. A good complete, up-to-date recording of K. 334 is badly needed. N.B.

MOZART, LEOPOLD: *Sleigh Ride*—  
See Haydn, Michael: *Turkish March*.

OFFENBACH: *Les Contes d'Hoffmann*

Gianna d'Angelo (s), Olympia; Victoria de los Angeles (s), Antonia; Elisabeth Schwarzkopf (s), Giulietta; Christiane Gayraud (ms), Voice of the Mother; Nicolai Gedda (t), Hoffmann; Jacques Loreau (t), André, Cochenille, Frantz, Pitichinaccio; Michel Sénéchal (t), Spalanzani; André Mallabrera (t), Nathan-aël; Ernest Blanc (b), Dapertutto; Jean-Christophe Benoit (b), Nicklausse; Jean-Pierre Laffage (b), Luther, Schlem-il; Jacques Pruvost (b), Hermann; George London (bs), Coppélius, Dr. Miracle; Nikola Guiselev (bs), Lindorf; Robert Geay (bs), Crespel; Renée Fauré (actress), La Stella, La Muse; Choeurs René Duclos; Orchestre de la Société des Concerts du Conservatoire de Paris, André Cluytens, cond.

• ANGEL CL 3667. Three LP. \$14.37.

• • ANGEL SCL 3667. Three SD. \$17.37.

This is the first full-length edition of the opera we have been given since Epic's was released seven years ago. *Hoffmann* is a work that has fared badly on discs. There was an Opéra-Comique version on Columbia in the late Forties, which at least had integrity and the right flavor, but it has long been unobtainable; then there was the Beecham sound track, on London, with Beecham, an English translation and some wretched singing; then the Epic, quite heavily cut and lacking in dramatic punch, with much too much doubling and tripling and even worse by the singers, and only some good work by Heinz Rehfuss and Mattiwilda Dobbs and pleasant, if pale, singing by Léopold Simoneau to compensate.

The new Angel has some serious failings, but since it is the one acceptable *Hoffmann* on the market, let us first investigate its virtues. To start with, it is the most complete of all the recorded performances. The usually cut final scene of the Muse is restored, and so are most of the shorter passages sometimes dropped en route. The stature of the score gains thereby, particularly in the strengthening of the Prologue and Epilogue episodes, which often form an inappropriately delicate frame for so splashy a canvas. In terms of construction and pacing, this opera is a beautiful piece of work, and since it is not especially long and certainly not lacking in variety, there seems no good reason for any significant cutting. I am also favorably impressed by André Cluytens, not generally the most brilliant or galvanic of conductors but one who seems to hold this music in affection and is willing to let it play and sing—it is a nice change from the pressing and pushing of some of our "exciting" young maestros.

When we come to the casting, we are

on less happy ground. There are some good contributions in comprimario roles—Christiane Gayraud, Michael Sénéchal, Jean-Pierre Laffage, and Robert Geay are all first-rate, and Jacques Loreau is certainly acceptable in the four small tenor roles. Nicolai Gedda sings with his usual clarity, sense of phrasing, reliable musicianship, and expert French, and projects everything knowledgeably—the Kleinzach ballad, for instance, is very well defined and animated. The voice itself, though, is not as relaxed and beautiful as it has been on some past recordings—the quality often has a sour edge, and there seems less reserve behind his singing than there has formerly been. He is still probably the best Hoffmann available; it is just that he does not seem here at his best.

Of the three ladies, the most satisfactory is Gianna d'Angelo, who lacks only a touch extra dash and brilliance to make a really stunning effect. She sings everything very prettily and very musically, and almost everything in tune, which is unusual in this music. Elisabeth Schwarzkopf does not have the sort of voice, whether soprano or mezzo, that I like for Giulietta, for it has little warmth or sensuality. She sings well, though, except for heavy weather in some of the climaxes, and does a good deal with little inflections and accents, which one will find advantageous or not, according to one's taste. Victoria de los Angeles, in her first operatic recording in some time, shows that the cherishable timbre of her voice is still intact (even the off-stage D natural is there, and substantially so); and that her musicianship and taste are of their accustomed high order. It cannot be said, though, that her singing here is as secure or spontaneous as it once was—there are some precarious moments, mostly early on, and a feeling of overcarefulness in most of her work. Her best singing, curiously, comes in the arduous trio near the end of her scene.

The four villains just do not fare well. George London, who has sung all four of these roles with high competence on many occasions, is in far from his best form; the voice sounds ponderous and labored, with little real flow, and the top Es and Fs are effortful and unattractive. At least, though, he is at pains to project his two roles dramatically. Nikola Guiselev, the Lindorf, shows a fine bass voice, presently a little hooty and unfocused at the top. He does almost nothing to draw a character for us. And Ernest Blanc is also off-form for his Dapertutto. Except at the top, where it opens out beautifully, his voice sounds dry, with a husky edge on it, as if he were recovering from a cold, and his singing has a literal, bland quality that, again, fails to establish his place in the dramatic scheme.

The idea of casting a light baritone as Nicklausse seems to me a dreadful one, whatever the precedent. Jean-Christophe Benoit is a pleasant, easy singer, but even a high lyric baritone does not wrap itself easily around these lines, and, more importantly, does not weave through the chorus in the Prologue in any distinguishable manner—



# The Quality Is Bozak's



## The Decor Is Yours

When you buy a Bozak loudspeaker, you can expect to get the best – both in sound reproduction and in furniture craftsmanship.

For sound we have only one standard – provide the most realistic reproduction of music possible; add nothing, take nothing away. To maintain that standard, we manufacture our own component speakers – even to compounding the felt used in speaker cones.

We have only one standard for furniture, too – it must reflect the quality of the Bozak speakers which it contains. So we maintain our own furniture factory where every step – from applying selected true hardwood veneers to hand-rubbing authentic finishes – is accomplished with painstaking care.

With the quality thus assured, you can concentrate on selecting the furniture style that will most perfectly blend with your interior decor. To be sure you find one exactly suited to your decorative scheme we offer a broad selection including both contemporary and classical designs. For example, shown above are five styles available as enclosures for Bozak B-300 and B-302A speaker systems. Italian Provincial, Urban, French Provincial, Moorish or Century – the choice is yours.

Every Bozak speaker is all Bozak. That means, when you use it with the highest quality associated equipment, you are assured . . .

**The Very Best In Music**



Box 1166 Darien, Connecticut

Our new catalog shows all the Bozak models. It's yours for the asking.

an octave down, these figurations are meaningless. And it is still necessary to import a mezzo (Jeannine Collard) for what becomes a concert rendition of the Barcarolle.

What it comes down to is a complete Hoffmann with good leadership; good, up-to-date sound; a recognizable French ambience from the native artists in small roles; and a strong-looking group of principals, almost none of whom are in top form. It is the best available version, even if it is not what one had hoped for. C.L.O.

**RANGSTROEM:** *Songs*—See Sibelius: *Songs*.

**RAVEL:** *Daphnis et Chloë: Suite No. 2*—See Debussy: *La Mer*.

**RAVEL:** *Quartet for Strings, in F*—See Debussy: *Quartet for Strings, in G minor, Op. 10*.

**ROREM:** *Eleven Studies for Eleven Players*  
†Sydeman: *Orchestral Abstractions*

Louisville Orchestra, Robert Whitney, cond.

- LOUISVILLE. LOU 644. LP. \$7.95.
- • LOUISVILLE. LOU S644. SD. \$8.95.

Ned Rorem is clever. William Sydeman

is rather more than that. Such is an apt summation of this record.

Mr. Rorem's *Eleven Studies for Eleven Players* make adroit use of the instruments' resources, exploring their coloristic possibilities entertainingly and generally affording an excellent show; the work must be amusing to watch, and its fast movements are amusing to hear. Its slow movements are unfailingly trashy and obvious, however, and the indebtedness of the whole to film and television scores need scarcely have been pointed out in the titles to the various movements.

Mr. Sydeman's *Orchestral Abstractions* is actually a symphony in three movements, and a most attractive one. Dating from 1958, it is a relatively early work of its composer and its idiom is rather more conservative than that of Sydeman's recent music, but it weaves a complex orchestral skein with considerable mastery both in the manipulation of thematic materials and in orchestration. The Presto with which it ends is an altogether breath-taking affair. Both works are performed with great zest and vitality, and to my ears the recording marks a special high for fidelity of sound so far as the Louisville series is concerned. A.F.

**SCARLATTI, DOMENICO:** *Sonatas for Harpsichord (34)*

- Fernando Valenti, harpsichord.
- WESTMINSTER WM 1010. Three LP. \$9.57.
- • WESTMINSTER WMS 1010. Three SD. \$9.57.

The 313th to 346th Scarlatti Sonatas released by Westminster in Valenti's mammoth project. Previous recordings have been issued in a long run of separate discs numbered up to Volume 26. The new releases are not similarly referenced in the sequence but packaged as a three-record album in the company's current, compact "Multiples" series. The result is a large economy-size package with a good sampling of the seemingly endless riches that issued from the Italian master's fertile brain (with Scarlatti any reasonably large sampling is likely to yield considerable treasure). Valenti's playing is characteristically open, large-scaled, and expressive. There are, as I can gather, a few textual and ornamentation problems here and there; in one or two places Valenti seems to have omitted things inadvertently (see, for example, the missing measure in L. 331, mysteriously restored on the repeat). In any case, the harpsichordist's flexible approach is (if the bad pun can be pardoned) sound and he is the technician, the colorist, and the musician to carry it through. The recording is dry but acceptable. One footnote: for some reason the works are listed on the album jacket in order of Longo number but this is not the actual sequence in which they are performed; if you care about which sonata is which, you'll have to copy the listings off the label before putting the record on the turntable—unless you can read a spinning record label, that is. E.S.



Ampex captures the spirit of Christmas...

on Stereotape! [ WHY DON'T YOU? ]

Here are just a few of the many Christmas favorites you'll find in the special Ampex display at your tape dealers.

- Joan Sutherland—"The Joy of Christmas" (London)
  - Joan Sutherland—"Handel: The Messiah" (2 reel set) (London) (Also available: the Westminster "Messiah" with the Vienna Academy)
  - Leontyne Price—"A Christmas Offering" (London)
  - Lisa Otto/Berlin Handel Choir/Berlin Radio Symphony—"Hallelujah... Hallelujah" (Great vocal choruses from Deutsche Grammophon)
  - Bing Crosby—"I Wish You a Merry Christmas" (mono or stereo)
  - Mantovani—"Merry Christmas" (double-play)
  - "Christmas With the King Family"
  - Jack Jones—"Christmas Album"
  - Harry Simeone Chorale—"Little Drummer Boy"
  - Johnny Mathis—"Sounds of Christmas"
  - "'Twas the Night Before Christmas" and other Children's Stories
- List prices start as low as \$4.95.

tape recorders / speakers / microphones / headsets / blank tape / accessories / stereotapes

ask anyone who knows

**AMPEX**

AMPEX CORPORATION, 2201 LANDMEIER ROAD, ELK GROVE VILLAGE, ILLINOIS 60007

CIRCLE 6 ON READER-SERVICE CARD



# Only complete line of FM ANTENNAS finest in every price range!

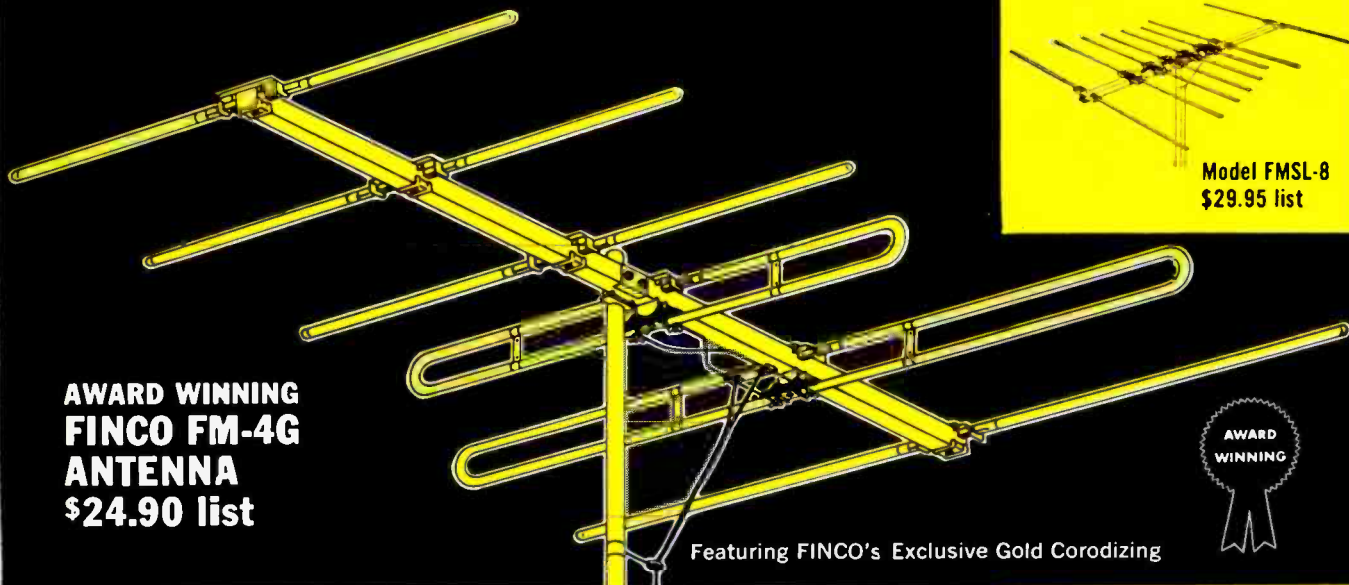

**AWARD WINNING  
FINCO FM-4G  
ANTENNA  
\$24.90 list**

Featuring FINCO's Exclusive Gold Corodizing



**Award Winning  
FINCO FM-5  
\$36.35 list**



**Model FMSL-5  
\$17.95 list**



**Model FMSL-8  
\$29.95 list**

# FINCO

Discover the difference that a FINCO Antenna makes in FM sound. FINCO's maximum gain means a substantially greater signal over the full 88 to 108 MC band. Regardless of your location, you bring in more stations — with exacting station separation — free from multi-path reflections. Choose a superb FINCO FM Antenna, and get perfect FM sound.

Include a FINCO FM Band Pass Filter and stop FM interference by blocking out unwanted signals from TV stations, citizens band, amateur transmitters, electric motors, fluorescent lamps, automobile ignitions, etc. You'll never hear a signal that's cleaner, clearer, purer.

FINCO is the name to look for, when you want the very best in FM reception.

**THE FINNEY COMPANY**  
**34 West Interstate Street • Bedford, Ohio**

Write for Bulletin #20-213, Dept. HF



**Model FMSL-10  
\$39.95 list**



**Model FMSL-12  
\$49.95 list**



**Model 3007  
Band Pass Filter \$6.95 list**  
Eliminate FM Interference with  
FINCO's Band Pass Filter

CIRCLE 34 ON READER-SERVICE CARD

A joyous combination...

# Sutherland and Christmas

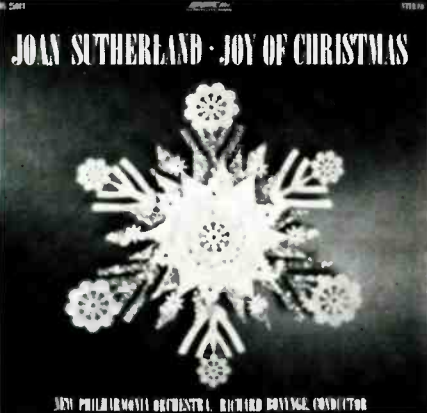

Ave Maria: O Holy Night;  
Adeste Fideles: O Divine  
Redeemer: Good King  
Wenceslas: Virgin's  
Slumber Song; Hark The  
Herald Angels Sing; It  
Came Upon The Midnight  
Clear: The Twelve Days  
Of Christmas: Angels We  
Have Heard on High: The  
Holly And The Ivy;  
What Child Is This:  
Joy To The World:  
Deck The Hall  
Stereo OS 25943 Mono 5943



**SCHUBERT:** *Music for Violin and Piano*

*Sonatas for Violin and Piano, Op. 137: No. 1, in D; No. 2, in A minor; No. 3, in G minor; Sonata for Violin and Piano, in A, Op. 162 ("Duo"); Fantasy in C, Op. 159; Rondo brillante, Op. 70.*

Michel Auclair, violin; Genevieve Joy, piano.

• MUSICAL HERITAGE SOCIETY MHS 606/07. Two LP. \$2.50 each.

• • MUSICAL HERITAGE SOCIETY MHS 606/07. Two SD. \$2.50 each.

*Sonatas for Violin and Piano, Op. 137: No. 1, in D; No. 2, in A minor; No. 3, in G minor; Sonata for Violin and Piano, in A, Op. 162 ("Duo"); Rondo brillante, Op. 70.*

Johanna Martzy, violin; Jean Antonietti, piano [from Angel 35364/66, 1958].

• MACE M 9012/13. Two LP. \$2.49 each.

It will be noted that the Auclair/Joy cycle (originally a French Erato product), like that of Max Rostal and Colin Horsely for British HMV, manages to squeeze onto two discs everything that Schubert wrote for the violin-piano combination. The Martzy/Antonietti traversal was similarly complete in its issue on the Angel label, but took three discs. Even with the new regrooving techniques available today, the slower tempos of these artists evidently precluded Mace's encompassing all the material in a two-record set: alas, the superb Fantasy—easily the best music and also the least known of these compositions—was the piece discarded. As a result, the Musical Heritage album has an initial advantage, and, fortunately, the Fantasy is here very well played. Its impassioned substance (but a step removed from the *Kreutzer*) can absorb the kind of hectic verve which both Auclair and Joy furnish in such plentiful degree. In the Rondo, a decision between these performers and Martzy/Antonietti boils down to personal preference. In this piece, I myself feel more comfortable with the deliberate pacing, emphatic shaping, and essentially Germanic handling of Martzy/Antonietti than I do with the undeniably more impetuous, Italianate precipitateness of Auclair/Joy. Both versions, however, are decidedly well played and excellently recorded. When it comes to the Duo Sonata, Op. 162, Martzy/Antonietti are essentially the genial lyricists, while Auclair/Joy present a greater volatility. While either edition would be worth owning, neither would make me want to part with my Kreisler-Rachmaninoff RCA Victor disc.

Similarly, both versions of the Op. 137 Sonata under scrutiny fall slightly wide of the mark. Martzy/Antonietti are sound, musical, but a trifle prosaic. Auclair/Joy are fast, efficient, and equally prosaic. Although the recorded balance on both of these sets is superior to the Vanguard (which gave short shrift to Peter Serkin's piano), Schneider and young Serkin got far closer to the heart of Schubert's writing here. H.G.



SR 2-9015/OL 2-115



SR 2-9013/OL 2-113



SR 90431/MG 50431



SR 90391/MG 50391



SR 90054/MG 50054

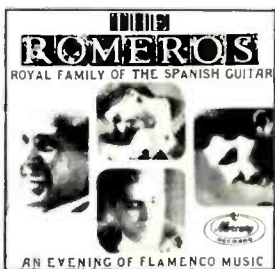

SR 90434/MG 50434

CIRCLE 54 ON READER-SERVICE CARD

Why are these

# DYNAKITS

the most popular  
of all high fidelity components?



PAS-3  
\$69.95 kit  
\$109.95 assembled



Stereo 70  
\$99.95 kit  
\$129.95 assembled



FM-3  
\$109.95 kit  
\$169.95 assembled

The superior quality of separate components (tuner, pre-amplifier, power amplifier) is universally accepted. Only with separate components can you achieve the "state of the art" in music reproduction.\* Integrated components, receivers, or packages are compromises which deny the perfectionist his goal of the highest possible fidelity.

Why are components so much better?

#### UNCOMPROMISING ENGINEERING

lower hum ■ lower noise ■ lower distortion

#### GREATER CONVENIENCE

more flexibility ■ logical control groups  
easier installation ■ freedom of choice

#### SUPERIOR RELIABILITY

higher quality parts ■ better ventilation  
conservative operation

isolation of sensitive parts from heat sources

Quality is never cheap. Most components are very expensive. But not Dynakits. The universal recognition that Dynakits offer "the very best for the money" does not satisfy us. Never has a Dynakit been introduced which could not meet or exceed the listening quality of the most expensive alternatives. We urge you to evaluate every Dynakit on performance standards without regard to cost.

The overwhelming acceptance and subsequent word-of-mouth advertising by Dynakit owners has made the 3 Dynakits shown above the most popular of all such components.

In Europe write to Audio Dyne a/s Christian X's vej 42, Aarhus, Denmark.

No other stereo tuner has ever matched the phenomenal popularity of the FM-3. More Dynakit stereo preamps and Stereo 70's are being sold than all other such components combined.

Modest initial cost (even lower if you build-it-yourself!) is a powerful incentive, but this acceptance would not have been maintained year after year in ever increasing numbers were it not for Dynakit's proven reliability and the recognition that every new Dynakit design is so far ahead of its time that it stays on top for years. This partly explains why critical audiophiles have been known to "trade up to Dynakit" from far more expensive models.

In the face of the extraordinary publicity given transistorized equipment in recent months, it is significant that these pace-setting Dynakits are well established tube designs. When transistors have matured so that they can provide comparable quality and value with tubes, Dynakit too will offer solid state circuitry. Dynakit does not believe in riding the promotional bandwagon at the consumer's expense through inauspicious introduction of premature products. We will continue our established practice of introducing new products only when they represent improved quality or value.

Rarely is quality as inexpensive as Dynakits.

\*Live vs recorded concerts, performed on several occasions using Dynakits and AR speakers, best demonstrate the "state of the art" in music reproduction.

**DYNACO INC.** 3912 POWELTON AVENUE, PHILADELPHIA 4, PA.

CIRCLE 27 ON READER-SERVICE CARD

SCHUBERT: *Octet for Strings and Winds, in F, Op. 166, D. 803*

Berlin Philharmonic Octet.

• DEUTSCHE GRAMMOPHON LPM 19102. LP. \$5.79.

• • DEUTSCHE GRAMMOPHON SLPM 139102. SD. \$5.79.

The second Berlin Philharmonic Octet version of Schubert's wondrous score, this recording duplicates the performance qualities of the first (once on Decca 9669) and provides some of the most lustrous and balanced sound ever accorded a chamber ensemble. In the playing there is a sense of momentum that sweeps the listener past any awareness of length and repetitiveness. Nothing is slighted, no phrase robbed of its tenderness, but there is shape and substance as well. This is, to my ears, an exceptional way to deal with this music, and creates a wholly sympathetic picture of Schubert's state of mind when he fashioned this treasurable score. A.R.

SCHUBERT: *Die schöne Müllerin, Op. 25*

Gérard Souzay, baritone; Dalton Baldwin, piano.

• PHILIPS PHM 500074. LP. \$4.79.

• • PHILIPS PHS 900074. SD. \$5.79.

This is a somewhat muted realization of the cycle, but within its frame, a sensitive and often satisfying performance. I find it much more interesting than the same team's *Die Winterreise*, partly because this cycle does not demand quite the same sustained intensity of mood and partly because Souzay is especially good at bright, quickly moving songs, of which *Schöne Müllerin* affords several.

By and large, the dynamic level is kept quite low. Given the very lyrical nature of Souzay's voice, this is a shrewd decision, since it means that the few songs which do get the full measure (such as *Eifersucht und Stolz*, *Die böse Farbe*, the climax of *Trockne Blumen*) make a strong impact by contrast. Also on the positive side are the prevailingly relaxed, even legato (Souzay sings on the vowels more than most of his German competitors, and it is soothing to find the flow unbroken by clusters and splatters of expectorated consonants) and the unfussy musicality of the straight strophic songs—*Das Wandern*, for example. Most of the big challenges (I am thinking particularly of *Mein!*) are intelligently and thoroughly met.

A few songs do not come off—the failure really to encompass the top climaxes more or less compromises an otherwise well-done *Am Feierabend*, and *Ungeduld* suffers from this same problem (the Fs on "ewig" in all four verses are overopen and lacking in ring) and from a deliberate pace which sounds schoolish rather than impetuous—anything but *ungeduld*—especially in the repeated piano introduction. Some songs seem a little slow and careful, at least for my taste (*Wohin?* is one), and Baldwin sometimes indulges in rubatos that

just about creep to a halt—the introduction to *Träne Regen*, for instance, sounds very mannered.

Several of the songs are taken a semitone or full tone down from the nominal "middle" keys of the Peters edition. This seems to me to make no difference at all (there are no sudden wrenches) except in *Der Jäger*, which loses considerable brilliance and bite in this transposition, well as Souzay articulates it.

It is, in sum, an extremely musical *Müllerin*. My own choice is the second Fischer-Dieskau/Moore version, a tremendous emotional experience as well as a virtuoso performance. But for those who want something a bit less overpowering, simpler, and more chamberlike, this would be an excellent choice. Philips' sound is good; there was, however, a higher than acceptable level of surface noise on my copy. C.L.O.

SCHUETZ: *Cantiones sacrae: Motets*

Niedersächsischer Singkreis (Hanover), Willi Träder, cond.

• NONESUCH H 1062. LP. \$2.50.

• • NONESUCH H 71062. SD. \$2.50.

Of the forty sacred motets published by Schütz in 1625, this disc presents seventeen. Not one of them is a dud, and most of them are exquisitely beautiful. In these four-part choruses, some with instrumental support and some without, Renaissance flexibility and freedom from rhythmic regularity are combined with a new warmth and expressivity. In addition there is Schütz's special sensitivity to quantity and accent in the words: these pieces are models of the correct and smooth setting of Latin to music. Willi Träder, a conductor new to me, leads his group with a sure hand, eliciting a fine tone and shaping the lovely lines so that they flow naturally. In view of the quality of the music, of the performance, and of the recording, this disc is a great bargain. N.B.

SIBELIUS: *Songs: Var det en Dröm?; Flickan kam ifrån sin älsklings Mote; Svarta Rosor; Säv, sav, Susa; Demanten på Marssjön; Höstkväll; Vären flyktar hastigt*

†Grieg: *Songs: En Svane; Fra Monte Pincio; Vären*

†Rangström: *Songs: Melodi; Bön till Natten; Sköldmön; En gammal Dansrytm*

Birgit Nilsson, soprano; Vienna Opera Orchestra, Bertil Bokstedt, cond.

• LONDON OL 5942. LP. \$4.79.

• • LONDON OS 25942. SD. \$5.79.

Heinous indeed, the crime of performing art songs with orchestrated accompaniment, but there are two mitigating factors here: one, that Sibelius and Grieg (and, presumably, Rangström) orchestrated some songs themselves; two, that pitting Miss Nilsson against a mere pianist sets up a rather unfair battle.

Those who prize this marvelous singer only for her ability to cut through the

heaviest orchestral fabric should listen, here, to the gradually accumulating quotient of warmth in her soft, inward singing. For Miss Nilsson is no longer out merely to bury her material, as on her previous song recital on RCA; she has become, instead, a moving stylist in the small forms as well as on the operatic stage. The lovely, humorous way she treats subsidiary episodes in the Grieg *Fra Monte Pincio* is a case in point.

The material is largely familiar, but sung with this formidable artistry it becomes all fresh. For those unfamiliar with the Swedish composer Ture Rangström (1884-1947), I might add that he wrote songs much in the Grieg manner, somewhat touched by the harmonic richness and declamatory gestures of Richard Strauss. A.R.

STRAUSS, RICHARD: *Die ägyptische Helena: Zweite Brautnacht! Salome: Dance of the Seven Veils; Interlude: Final Scene*

Leontyne Price, soprano; Boston Symphony Orchestra, Erich Leinsdorf, cond.  
• RCA VICTOR LM 2849. LP. \$4.79.  
• • RCA VICTOR LSC, 2849. SD. \$5.79.

When Leontyne Price first hit the international opera circuit and we got our first recordings of her voice, one of the speculations I allowed myself (a speculation entered in these pages about six years ago) concerned her suitability for some of the Strauss roles. The *Capriccio* Countess? Chrysothemis? Ariadne? Even, in time, the Marschallin? So far as vocal timbre and quality goes, these still seem to me distinct possibilities. For the theatre, at least, *Salome* does not—the voice is not large enough or cutting enough, has a weakness in the low register, and narrows a bit at the top. The actual sound, though, is an appropriate one; Salome's voice should be young and soaring and ecstatic, not *hochdramatisch*, and Price's round, floating soprano has these qualities. For recording purposes, the relative lack of power is of minimal importance.

So she starts with some advantages, and as it happens, she is also in excellent voice. Thus, there is a basic plus—she sounds good, and refreshingly girlish alongside some of the Salomes we hear more regularly. The recording is emphatically more successful than the broadcast Boston Symphony concert of the same program last season.

As yet, however, Miss Price does not do a great deal to shape the big scene or to propel it towards its dramatic conclusion. The handling of the text is correct but a little flavorless, and the tone color tends to remain pretty much the same throughout. Since it seems unlikely that she would commit herself to this part onstage, this is probably her finished statement on the matter, and we must be content with lovely, occasionally exciting vocalism and generally sound, sensible phrasing.

The irresistible little scene from *Ägyptische Helena* goes extremely well, except for one high climax that is just not

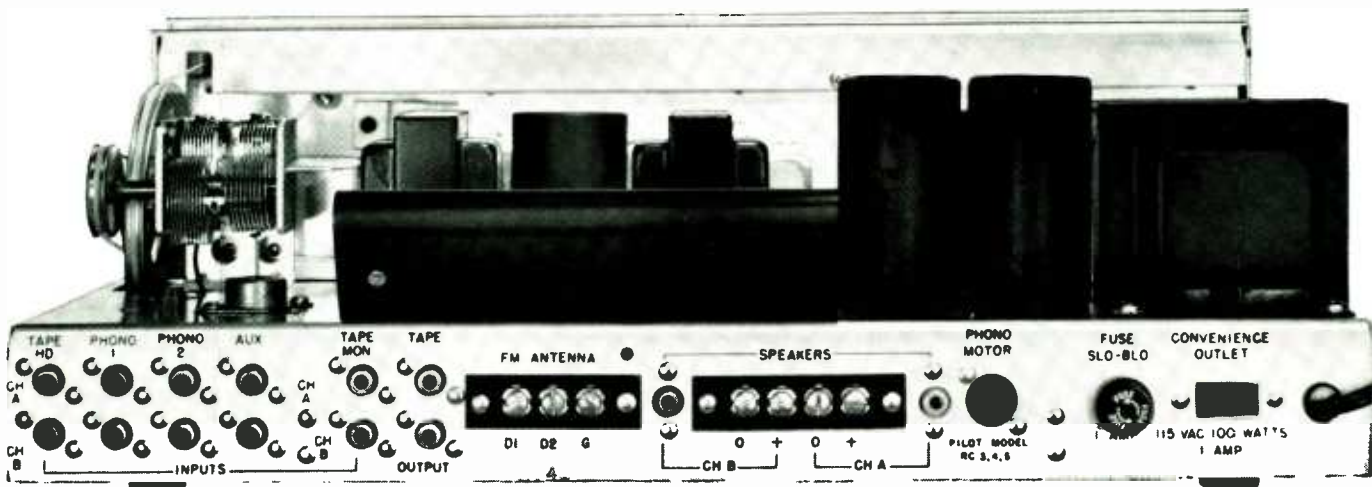

In 1958 Pilot introduced the first stereo receiver...In 1962 Pilot added solid state amplification...now for 1966 Pilot receivers are all new...all great...all solid state!



The Pilot 602 was hailed as the beginning of a new component age. Now, Pilot begins another era with a family of fully transistorized stereophonic receivers featuring the dependability and value that has typified Pilot since 1919. Each of the four new Pilot receivers combines a fully transistorized tuner, all-solid-state control pre-amplifiers and highly dependable, fully transistorized power amplifiers all on one compact, strikingly styled chassis. When you buy Pilot such luxury features as... a "sensi-matic" FM tuner with automatic stereo-mono switching, an automatic FM stereo signal indicator, professional D'Arsonval tuning meter, complete tape facilities including tape monitor, drive-limited amplifier circuitry and drift-field output transistors that assure long, dependable, broad frequency range performance... all are standard equipment.

Even the "baby" of the family, the Pilot RA300 shown above, offers all these features plus specifications that defy comparison at this price... *Power-Output*—40 watts IHF music power at less than 0.5% harmonic distortion. *Frequency Response*—15 to 40,000 cps. *FM Stereo Separation*—better than 30db. The RA300 with AM and FM stereo tuners lists for a modest \$339.95. Also available as the model R300 with FM stereo tuner only, at \$299.95.

Write today for specifications and features on the Pilot R300 and RA300, the 70 watt Pilot R700 and the 120 watt Pilot R1100.

Dept. H, PILOT RADIO, Inc., 100 Electra Lane, Yonkers, New York 10704

CIRCLE 61 ON READER-SERVICE CARD

PICK  
  
 PILOT



... right into your tape recorder — then play it back and listen to the lively sound of your own voice — so natural, no one can tell the difference. University's new revolutionary Attache' is the smallest cardioid dynamic microphone ever made. Priced right too! Free! "Microphones '66" — a book every owner of a tape recorder should have.

**U UNIVERSITY SOUND**  
A DIVISION OF THE HICKS AUDIO CO.  
 Dept. M51M Box 1056  
 Oklahoma City, Okla. 73101

Name .....

Address .....

City .....

State ..... Zip .....



The lively sound of the Mustang! The more-than-you-pay-for performance of University's newest and liveliest line of Mustang speakers. New slim line profile permits easy installation. Read the full story of the Mustang in University's newest catalog. You'll also receive our *Guide To Component Stereo High Fidelity*. They're Free! Write today.

**U UNIVERSITY SOUND**  
(1211) UNIVERSITY SOUND OFFICE  
 Desk M51S Box 1056  
 Oklahoma City, Okla

Name .....

Address .....

City .....

State ..... Zip .....

CIRCLE 87 ON READER-SERVICE CARD

quite within Miss Price's real singing territory. Her voice moves well in this sort of music.

Leinsdorf's work is well controlled and nicely detailed, though I do not happen to like the brilliant, pinpoint kind of sound he secures (intensified by Victor's customarily bright engineering), nor the taut, considered way he knives through the points where some dramatic quickening is needed. Reiner/Welitch, of course, remains the reference point. C.L.O.

**SYDEMAN: *Orchestral Abstractions***  
 —See Rorem: *Eleven Studies for Eleven Players*.

**TCHAIKOVSKY: *Swan Lake: Orchestral Suite; Sleeping Beauty: Orchestral Suite***

Vienna Philharmonic Orchestra, Herbert von Karajan, cond.

- LONDON CM 9452. LP. \$4.79.
- • LONDON CS 6452. SD. \$5.79.

There are many symphonic suites from *Swan Lake* on records but none quite so moving, for my taste, as the latest version directed by Herbert von Karajan. This conductor's gift, revealed in a new light, seems truly theatrical, gleaming with footlight magic, yet always chaste. Everything is free, marvelously rubato—a case in point being the haunting oboe solo that begins the second act: the rhythm is easy and unforced, the counter-rhythms miraculously articulated. Some outstanding memories are the sinister decrescendo that ends the introduction, the amusing lilt of the Baby Cygnets, the exquisitely played solos in the *pas de deux* by Josef Sivo, violinist, and Emanuel Brabec, cellist. In addition to extracts from Act II, the suite brings us the Czardas of Act III, and the apotheosis with which the ballet ends.

If the selections from *The Sleeping Beauty (Introduction and the Lilac Fairy, Pas d'action, Puss in Boots, Panorama, Waltz)* are a bit less dazzling in performance, they are still wonderfully well done, with great melodic afflatus in the Rose Adagio. R.L.

**TCHAIKOVSKY: *Symphony No. 5, in E minor, Op. 64***

New Philharmonia Orchestra, Georges Prêtre, cond.

- ANGEL 36259. LP. \$4.79.
- • ANGEL S 36259. SD. \$5.79.

While Prêtre's New York performance of this symphony with the Philadelphia Orchestra last spring must have been, to judge from the reviews, a really startling one, the present recording is reasonably straightforward and unexceptionable. The French conductor obtains a pleasing clarity from the orchestra, and I especially like the way the syncopes come forward at the end of the waltz movement (a notable feature also of the Klemperer and Cantelli recordings). Where Prêtre lets one down

is in the rhythmic pulse. With seemingly no inner metronome to guide him, the conductor succumbs to the plasticity of his phrasing, with resultant bogging of impetus. The music goes as limp as wet Monday wash.

Of available Tchaikovsky Fiftths, the far more mature and thoughtful Klemperer (also Angel) is the one to have, while Sawallisch's youthful, controlled account (Philips) is also worth looking into. H.G.

**TELEMANN: *Fantasias for Harpsichord, Nos. 13-36***

Helma Elsner, harpsichord.

- DOVER HCR 5236/37. Two LP. \$2.00 each.

Some years ago Miss Elsner recorded all thirty-six of Telemann's fantasias. Vox brought out the first dozen soon thereafter, but the rest have had to wait until now. It is good to have them all, not only because they are the only examples of Telemann's music for solo clavier in the lengthening list of his recorded works but because they show that he had worthwhile things to say in any medium he tackled. Nos. 13-24 are French in style: they have French markings and their pattern is A (slow or moderate)—B (fast)—A (exact repetition)—C (very fast and short). The final dozen are Italian, with the pattern A—B—A (usually fast-slow-fast). The texture is two-part practically throughout. These pieces may not have the contrapuntal interest of Bach's Inventions or the originality of Scarlatti's Sonatas, but they are remarkably varied in melody and rhythm and make highly pleasurable listening when heard a few at a time. Miss Elsner plays with skill and verve, maintaining interest by tasteful changes in registration. Good sound. N.B.

**TELEMANN: *Musique de table, Production II***

Schola Cantorum Basiliensis, August Wenzinger, cond.

- ARCHIVE ARC 3236/37. Two LP. \$11.58.
- • ARCHIVE ARC 73236/37. Two SD. \$11.58.

The two entries, Archive and Telefunken, in the complete *Musique de table* derby are running neck and neck. Both have now issued the first two of Telemann's three "productions," and both have done such good work that a choice between them boils down to such peripheral matters as the number of bands on the disc (Archive has them between movements, Telefunken only between works).

In the present performance of Part II, Wenzinger and his expert players once more turn in stylish readings, a player here and there embellishing his part with taste and with an easygoing air of improvisation. This is particularly true in the Solo, a violin sonata.

Continued on page 110



# DECCA · CORAL · VOCALION

## CHILDREN'S RECORDS



A CHILD'S FIRST RECORD  
FRANK LUTHER  
VL 3625

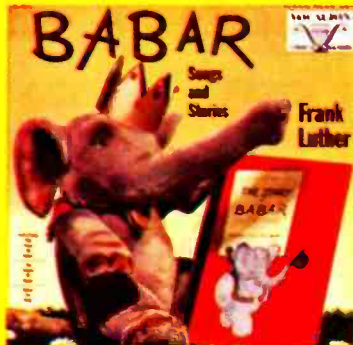

BABAR SONGS AND STORIES  
FRANK LUTHER  
VL 3666

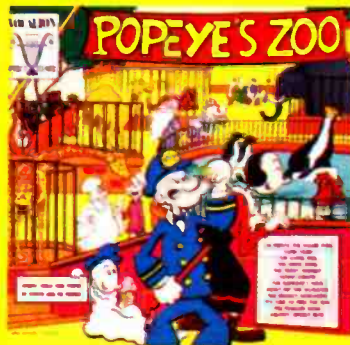

POPEYE'S ZOO  
JACK MERCER  
VL 3703 • VL 73703 (S)



GRIMM'S FAIRY TALES  
MARLA RAY  
VL 3704 • VL 73704 (S)

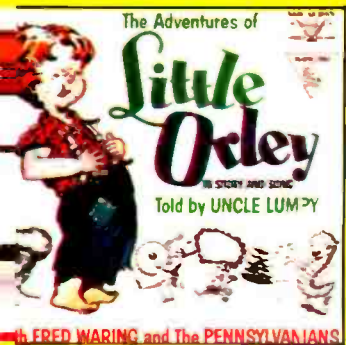

THE ADVENTURES OF LITTLE ORLEY  
UNCLE LUMPTY  
VL 3737

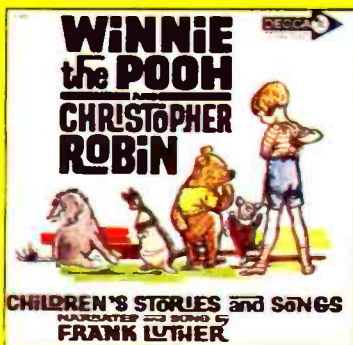

WINNIE THE POOH AND  
CHRISTOPHER ROBIN  
FRANK LUTHER DL 4203



THE BEST OF BURL'S  
FOR BOYS AND GIRLS  
DL 4390 • DL 74390 (S)



ROLITO  
FRANK LUTHER  
DL 8021



MOTHER GOOSE SONGS  
FRANK LUTHER  
DL 8357



THE WIZARD OF OZ AND PINOCCHIO  
JUDY GARLAND, VICTOR YOUNG  
DL 8387



Songs From Walt Disney's  
LADY AND THE TRAMP  
PEGGY LEE DL 8462



HANS CHRISTIAN ANDERSEN AND  
TUBBY THE TUBA DANNY KAYE  
DL 8479 • DL 78479 (SE)



WOODY WOODPECKER'S  
FAMILY ALBUM  
DL 8659



CIRCUS IN TOWN  
MERLE EVANS  
DL 9058



ICHABOD AND RIP VAN WINKLE  
BING CROSBY, WALTER HUSTON  
DL 9106



NONSENSE SONGBOOK  
THE THREE STOOGES  
CRL 57289 • CRL 757289 (S)

(SE) DENOTES ENHANCED FOR STEREO

(S) DENOTES STEREO

# GOLDEN RECORDS

## "THE FASTEST SELLING, MOST COMPLETE LINE OF CHILDREN'S RECORDS IN THE WORLD."

Entertainment and Education at the lowest prices.

With more than 100 best-selling LP's and hundreds of singles, books and records, and packages available at all times.

All Single LP's \$1.89



LP 1 A Child's Introduction to the Orchestra



LP 139 The Munsters Original TV Cast

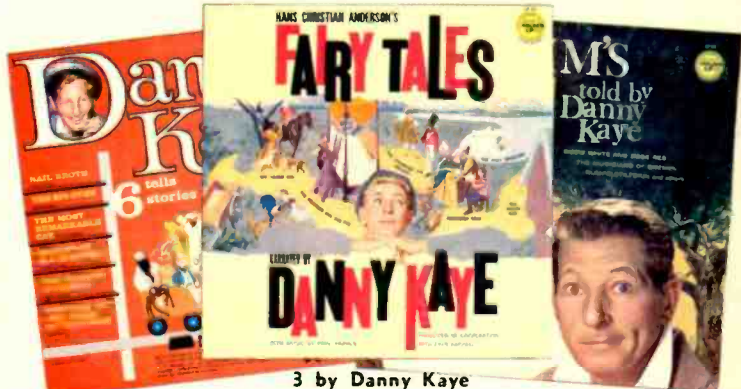

LP 62 Folk Tales

3 by Danny Kaye  
LP 74 Anderson's Fairy Tales

LP 92 Tales by Brothers Grimm



LP 116 Cap't Kangaroo's "Horse in Striped Pajamas" and other favorites



LP 119 Romper Room Official Songs and Games



LP 152 Aesop's Fables Told by Burgess Meredith

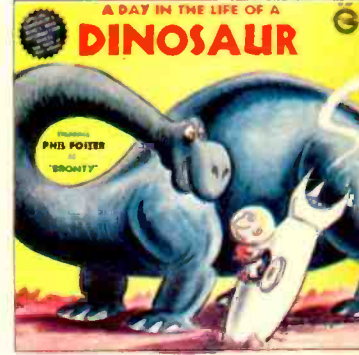

LP 150 A Day in the Life of a Dinosaur Told by Phil Foster

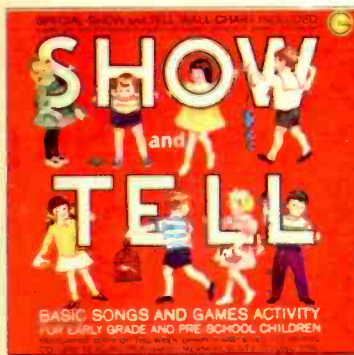

LP 118 Show and Tell Games and Songs with 4-foot wall chart



Help your child learn to read with these four Golden Story Tellers—GST 1, 2, 3, 4

GIANT LP BOOK & RECORD ALBUMS

\$3.79

Each boxed set holds SIX little golden books and a 12" LP.

### GOLDEN FIRST ADVENTURES IN LANGUAGE 99c EACH



A new, easy way for English-speaking children to learn French or Spanish, and for French & Spanish-speaking children to learn English. Six books (24 pgs. ea.) and six records for each language.

French LF 1-6

Spanish LS 1-6

### AND! THE NO. 1 HIT PACKAGE OF THE YEAR—2 MILLION SOLD TO DATE!

69c Single Little Golden Book & Record Sets



More than 50 titles



4 Christmas

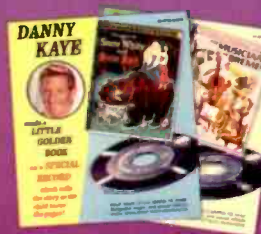

2 by Danny Kaye EXCLUSIVE on Golden Records



100 copy Self-display contains complete assortment

Write for information and convenient order forms and catalogues to  
GOLDEN RECORDS, 250 West 57th Street, New York, N.Y. 10019



LAST CHANCE PRE-PUBLICATION OFFER TO HIGH FIDELITY READERS—

# CONCERT ARTIST

*booking issue*



only  
**\$3.95**  
(regularly \$5)

**P**LEASE DON'T MISS this upcoming reference guide if you're passionately absorbed in classical music. Concert managers, musicians, libraries, music schools and those who have a voice in the selection of concert performers have kept its predecessors handy for decades.

The Concert Artist Booking Issue will be published as the December 15, 1965 issue of HIGH FIDELITY/MUSICAL AMERICA Edition. While single copies sell for \$5, as a HIGH FIDELITY reader you may have one for only \$3.95 provided you send the coupon herewith with your payment before December 15, 1965.

In HIGH FIDELITY/MUSICAL AMERICA Edition, which is our "new magazine," you find all of HIGH FIDELITY plus a 32 page section each month devoted to news and reviews of concerts and opera throughout the world. Also, fascinating chit-chat about concert artists, many of whom record.

Subscription copies of this special issue go only to HIGH FIDELITY/MUSICAL AMERICA Edition subscribers (\$9 a year) as the thirteenth issue in an annual subscription. It is not included in subscriptions to the regular edition of HIGH FIDELITY (\$7 a year).

Subscribers to the regular edition of HIGH FIDELITY who send us \$9 now will receive this special Booking Issue plus 12 issues of the HIGH FIDELITY/MUSICAL AMERICA Edition—and the unexpired term of their subscription to HIGH FIDELITY will be transferred to the MUSICAL AMERICA Edition. *The subscriptions will not overlap.*

The offer of \$3.95 a copy instead of \$5 expires December 15, 1965. As this offer applies to HIGH FIDELITY readers only, the coupon herewith and your payment must be sent to us for this special rate. Don't miss this indispensable reference volume. Order now!

## FEATURES INCLUDED

Musician of the year featured on the cover and in a major article.

Review of the year in music.

Activity reports and photos of leading concert managers.

List of American orchestras with address and phone plus number of musicians, concerts, budgets, hall seating capacity and other pertinent information.

List of American opera companies, festivals, music schools, music publishers, critics, record manufacturers, other organizations with head personnel, address, phone and other pertinent information.

The foreign section will include a comprehensive list of foreign managers with addresses and head personnel—orchestras—opera producing organizations—festivals—music publications—radio and TV music departments—musical organizations.

Also, an index by category of many concert artists. And much informative artist advertising.

A reference guide worth its weight in gold . . . 400 pages!

HIGH FIDELITY/MUSICAL AMERICA,  
Publishing House, Great Barrington, Mass. 01230

I wish to take advantage of your special pre-publication rate to HIGH FIDELITY readers of the upcoming HIGH FIDELITY/MUSICAL AMERICA Concert Artist Booking Issue scheduled for publication December 15, 1965. Instead of paying the regular price of \$5, please accept the enclosed payment in full of \$3.95. You pay the postage.

Enter my subscription for one year of the new HIGH FIDELITY/MUSICAL AMERICA Edition for which I enclose \$9. Include the Booking Issue of December 15, 1965.

Inasmuch as I already subscribe to HIGH FIDELITY regular edition, transfer the remaining term of my subscription to your MUSICAL AMERICA Edition at no extra charge. (Good only if the \$9 payment referred to above accompanies this order.) 1265

NAME \_\_\_\_\_

ADDRESS \_\_\_\_\_

CITY \_\_\_\_\_

STATE & ZIP \_\_\_\_\_

This offer expires December 15, 1965

## RECORDS IN REVIEW

Continued from page 106

Eduard Melkus, the soloist, plays cleanly and with vitality. Also especially well exemplified in this section is Constantin Floros' interesting and musical realization of the continuo. In the Quartet, Wenzinger, like his opposite number on Telefunken, opts for a recorder for the top part, although Telemann doesn't insist on a *flauto dolce* and says the part may be played by a bassoon or cello instead! The sound of the recorder, two flutes, and continuo is charming. In the Suite that opens Part II the trumpet does not cast everybody else into the shade. It blends very nicely with the oboe and in fact seems a little too bland and not brassy enough.

This is pleasurable listening throughout, and in some sections, as in the Trio and the slow movement of the Concerto (for three violins and strings), it attains a rather high level of expressivity. As in Part I (and in both Parts on Telefunken) the sound is first-rate. N.B.

### VICTORIA: *Motet and Mass "O Quam gloriosum"; Motet and Mass "O magnum mysterium"*

Choir of the Carmelite Priory, London, John McCarthy, cond.

- OISEAU-LYRE OL 270. LP. \$5.79.
- • OISEAU-LYRE SOL 270. SD. \$5.79.

Completely different in style from the singing of the better-known King's College Choir, recently heard in a recording of Palestrina, this London group presents a perfectly valid approach that is at the same time more vigorous and less mannered than that of the Cambridge team. It sounds like an idealized Continental interpretation, the kind of sound that Italian choirs aim for but never really achieve. The tone is full-bodied with ample reserve, and the soprano and alto lines are sung by women's voices.

It was an excellent plan to preface each Mass by the motet on which it is based, even though the relationship seems fairly free, as in *O Quam gloriosum*. Also welcome, for reason of contrast, are the sections sung by a highly competent quartet (Mary Thomas, Jean Allister, Edgar Fleet, Christopher Keyte). Good sound throughout. D.S.

### VIVALDI: *Il Cimento dell' armonia e dell' inventione, Op. 8, Nos. 1-4 ("The Four Seasons")*

John Corigliano, violin; Leonard Bernstein, harpsichord; Members of the New York Philharmonic, Leonard Bernstein, cond.

- COLUMBIA ML 6144. LP. \$4.79.
- • COLUMBIA MS 6744. SD. \$5.79.

Otto Büchner, violin; Liesl Heidersdorf, harpsichord; Pro Arte Chamber Orchestra of Munich, Kurt Redel, cond.

- MUSICAL HERITAGE SOCIETY MHS 579. LP. \$2.50.

- • MUSICAL HERITAGE SOCIETY MHS 579. SD. \$2.50.

Reinhold Barchet, violin; Southwest German Chamber Orchestra, Friedrich Tilegant, cond.

- NONESUCH H 1070. LP. \$2.50.
- • NONESUCH H 71070. SD. \$2.50.

Well, maybe Bernstein is just what the *Four Seasons* needs, after forty seasons of having been worked over by ensembles good and bad, rough and smooth, quick and dead. One thing is certain: nobody is going to make background music out of this version. It is incredibly virile, incredibly fast in the finale, jubilantly militant in the strength and emphasis of its rhythmic articulation—in short, an adventure from beginning to end. The virtuosity of the ensemble is at times almost disconcerting. The tremendous speed and sizzling, jazzed-up nervousness of the *Allegro non molto of Summer*, for example (where the *non molto* is thrown overboard in favor of hurricane velocity) makes of Vivaldi a pure virtuoso showcase; and the finale of the same Concerto is simply frenetic. This mode of jet travel forces Corigliano at times to dash somewhat peremptorily past notes of lesser importance on his way to the next point of emphasis; but his stop-watch performance is on the whole admirable, and his tight, precise hold on the music in the opening movement of *Winter* creates a tension that pushes almost to the breaking point. As for Bernstein in the role of continuo player, he seems born to the part: his melodic embellishments and occasional flourishes are anything but self-effacing, but neither are they intrusive. The slow movement in *Autumn*, in which the harpsichord moves freely above the sustained orchestral harmonies, adds up to the most interesting performance I've heard. The recorded balances are beautifully handled: the harpsichord is given due attention, but no more than it deserves. Whether this *Seasons* will be easy to live with remains a question. But it is hardly one you can afford to ignore.

On the daily living level, the Pro Arte performance on Musical Heritage would be hard to beat. The tempos are happily chosen, the rhythms resilient, and the soloist superb—perhaps a bit more impersonal than Corigliano (especially in the slow movements, where less heart shows on sleeve), but effortless-sounding and note-perfect in the rough places, and dedicated throughout. The interesting thing about this performance is Büchner's free elaboration on the solo part as written. It takes some getting used to (the *Autumn* slow movement, in which Bernstein has his way at the keyboard, sounds like a different piece of music here, with Büchner having *his* way on the fiddle). But the improvisation is well handled, and sets this recording quite apart from the run-of-the-mill.

The Nonesuch entry is third in the running, with rather stodgy rhythms and nothing new to offer in exploration of the score. From here on in, anyone getting set to record the *Seasons* will have to look sharp. S.F.

travel in style  
with stereo . . .



## Auto-tape 500

Magnificent music of your choice surrounds you wherever you go in full dimensional stereo. No static noises, no fading, no commercials — just pure undistorted sound you never thought possible in a car.

Occupies minimum space under dash in most cars. Two speakers mount in doors or under dash for full stereo effect. Operates off 12 volt car battery.

Wide variety of music tapes in car-tridges — never fuss with threading tape or turning reels — superb recordings by outstanding artists.

Charcoal black or stainless steel satin finish compliments car decor. 2 speakers, sample stereo cartridge, hardware included.

From \$149.95

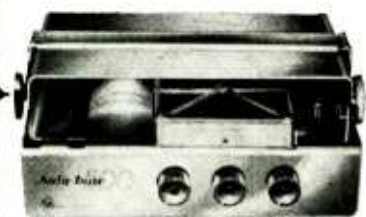

Ask your dealer for the Auto-Tape 500 or write to factory



MADE BY SKILLED  
AMERICAN CRAFTSMEN  
OF MINNEAPOLIS

9600 Aldrich Avenue So, Minneapolis, Minn. 55420

CIRCLE 91 ON READER-SERVICE CARD

# Total Sound Spectrum



An exciting journey  
into the World of Sound . . .

Model XIII Shown

FOR INFORMATION WRITE:

**FRAZIER** INCORPORATED

INSTRUMENTS COURTESY McCORD MUSIC CO.

1930 VALLEY VIEW LANE • DALLAS, TEXAS • 75234

CIRCLE 36 ON READER-SERVICE CARD

## The Christmas Gift Most Appreciated

**MACE**  
Division of Scepter Records

Music For The Connoisseur



### GERMAN LITURGICAL MUSIC

J. S. Bach • Moritz Van Hessen • Johann Staden • Heinrich Isaac • Tilman Susato.  
M9022 \$2.49 Mono or Stereo



### 4 CONCERTI FOR PIANO & STRING ORCH.

J. C. Bach: Concerti in E-flat Major, B Major, D Major. C. P. E. Bach: Siciliana.  
M9024 \$2.49 Mono or Stereo



### CLASSICS OF THE EARLY 18TH CENTURY

Rosetti: Symphony in C Major — Hertel: Symphony in D Major — Sachsen-Weimar: Concerto No. 4 in D Minor / Concerto in B Major / Concerto in C Major.  
M9021 \$2.49 Mono or Stereo



### J. S. BACH: FLUTE SONATAS — Vol. 1

B. Minor / A Major / G Minor / E-Flat Major.  
M9017 \$2.49 Mono or Stereo

Send for complete FREE catalog. Write Dept. H,  
MACE Records, 254 W. 54th St., N.Y., N.Y.

CIRCLE 50 ON READER-SERVICE CARD

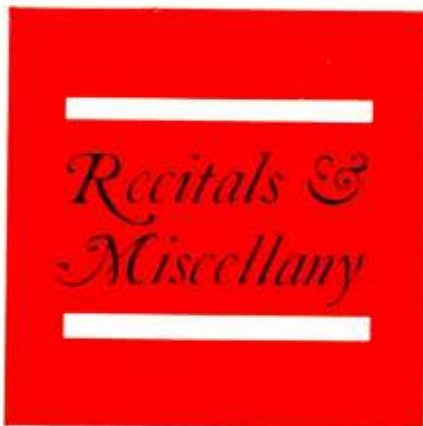

### ACADEMY OF ST. MARTIN IN THE FIELDS: *Recital for Strings*

Telemann: *Concerto for Viola and Strings*, in G. G. Gabrieli: *Canzona Noni Toni*. Vivaldi: *Concerto for Four Violins and Strings, Op. 3, No. 10, in B minor*. Handel: *Concerto grosso, Op. 6, No. 4, in A minor*.

Soloists; Academy of St. Martin in the Fields, Neville Marriner, cond.

• OISEAU-LYRE OL 276. LP. \$5.79.  
• • OISEAU-LYRE SOL 276. SD. \$5.79.

The St. Martin players are decidedly accomplished in the baroque line, and approach this music in a bold and knowing fashion. The Telemann finale is probably the most vitamin-packed on records, and in addition the solo violinist displays a fine, full tone and a happy sense of freedom in the dark, low regions of the instrument. The four solo violins in the Vivaldi are extremely competent, though at the beginning of the first movement the lead-off player falls just short of the crisp style set by the tutti. The Gabrieli seems to me to cry for brass sonorities and echoing archways, but the Handel leaves absolutely nothing to be desired. S.F.

### EARLY GERMAN OPERA FROM THE GOOSEMARKET

Keiser: *Croesus* (excerpts). Mattheson: *Boris Goudenow* (excerpts). Telemann: *Pimpinone: Recitative & Duet*. Handel: *Almira: Ballet Music*.

Lisa Otto, Shige Yano, Marlies Siemeling, Ursula Schirrmacher, sopranos; Manfred Schmidt, Karl-Ernst Mercker, tenors; Hermann Prey, Herbert Brauer, Theo Adam, baritones; Günther Arndt Chorus; Berlin Philharmonic Orchestra, Wilhelm Brückner-Rüggeberg, cond.  
• ANGEL 36273. LP. \$4.79.  
• • ANGEL S 36273. SD. \$5.79.

This delightful disc draws its contents from operas performed in Hamburg at the opera house on the *Gänsemarkt* (Goosemarket). From 1677 to 1738 (I owe all this information to the interesting liner notes accompanying the record), an energetic and successful company held forth there—probably the first native German opera house. The com-

pany eventually succumbed to the popularity of Italian opera, and the theatre itself was razed in 1765.

One entire side of the record is occupied by the selections from *Croesus*, by Richard Keiser, perhaps the most important of the Hamburg composers (assuming we regard Handel as a London composer). The most captivating moments of this music, at least for me, are the five selections from a peasant scene, including a charming dance song ("Kleine Vöglein") which has an almost romantic warmth, an engaging soprano air with children's chorus, and a lovely ritornello and ballet movement to begin and end the sequence. The serious portions are certainly solid, but less distinctive, except for the slow movement of the overture, a gorgeous little section with a lute continuo.

The excerpts from Johann Mattheson's *Boris* are not so individual, though very listenable: the best of them, I think, is a chorus whose text parallels almost exactly the people's chorus in the prologue of Mussorgsky's *Boris*. The Telemann *Pimpinone* is the *Serva padrona* business, nowhere near as good as the Pergolesi intermezzo but enjoyable in this short scene.

It was out of all this that Handel emerged. His *Almira* was produced in Hamburg in 1705. The ballet interlude is a lovely one, especially the concluding Sarabande (later transferred into *Rinaldo*), with some really magical employment of the harp.

The performances here are practically faultless. Brückner-Rüggeberg is a regular conductor of the current Hamburg forces, and certainly knows his way through this music, which he reads in a clean, steady, but never metronomic manner. Of the soloists, only Otto and Prey have "international" reputations (unless we count Adam, the latest Bayreuth Wotan), but the others are fully up to their assignments, and I was particularly struck by the fresh, free lyric soprano of Ursula Schirrmacher, who sings the Peasant Girl's music in the Keiser. The sound is splendid, and there are texts as well as annotations. C.L.O.

### BRACHA EDEN AND ALEXANDER TAMIR: *Two-Piano Recital*

Lutoslawski: *Variations on a Theme of Paganini*. Milhaud: *Scaramouche*. Poulenc: *Sonata for Piano, Four Hands*. Rachmaninoff: *Suite No. 2, Op. 17*.

Bracha Eden and Alexander Tamir, pianos.

• LONDON CM 9434. LP. \$4.79.  
• • LONDON CS 6434. SD. \$5.79.

Bracha Eden and Alexander Tamir are an Israeli duo who have been playing together in Europe for fourteen years. This is their first record to reach this country, and may there be many more! From whatever standpoint you care to judge these players' work, it is obviously first-class. For one thing, it is entirely fresh and spontaneous. Individually, the pianism sounds brilliant and limpid at the same time: in terms of ensemble

# The Remarkable REVOX



has finally arrived in the U.S.

**You've heard of the remarkable REVOX, of course. You've heard them rave about this recorder in London. Paris. Rome. Johannesburg. Everywhere. But you couldn't buy it in the U. S. until now. Now, finally, REVOX is ready for its American and Canadian debut. Is there another tape recorder anywhere that matches it, feature for feature? Decide for yourself:**

Is the REVOX different? Consider these features, found only in the most expensive, professional tape recorders. Each of the two reels has its own Pabst motor. There is also a separate, heavy duty Pabst 6/12 pole hysteresis synchronous capstan motor that electrically changes the number of poles for the speeds. This is a direct drive unit assuring linear tape speed, whether at 3¾ ips or 7½ ips. Direct coupling eliminates wow and flutter; no belts to break or slip. Tension adjustment contrast assures use of any reel up to 10½ inches with assurance that tape will not snap or break. There are three ring-core heads, specially designed and manufactured by REVOX . . . each head performing its own function of record, playback and erase. Other features? All operating modes are switched electrically by push-buttons; you can use remote control on the REVOX; also a highly accurate tape counter; no pressure pads (for long head life); no need for hum-bucking gimmicks. Vertical or Horizontal Mounting.

#### EXCLUSIVE BENEFITS

The REVOX is the only recorder in its price category that takes a 10½-inch reel. You

can record up to 4,800 feet of LP tape with unsurpassed sound quality. It's a complete 4-track stereo recorder. Exceptionally fast rewind. Oversized, solenoid-operated brakes assure quick and positive braking, even with extremely fast winding speeds. A microswitch senses the end of the tape and automatically stops the motor after a reel has been rewound or where a splice has opened. Tape breakage and tape spill are virtually impossible.

#### CREATING SPECIAL EFFECTS

With the built in mixing facilities of the REVOX, you can mix and record any two signals. You can also set one channel for playback, while the other is recording, and thus achieve all kinds of multiplay and duoplay effects — sound with sound — even sound on sound with echo.

#### PROFESSIONAL QUALITY FEATURES

The REVOX G-36 includes two VU meters, one for each channel, for accurate control of recording levels. All operating controls are electrically operated by pushbuttons. There are no gears, belts, levers or friction drives. In its smart gray, portable carrying

CIRCLE 29 ON READER-SERVICE CARD

case, with pockets for reels (reels not included), the REVOX is built for a lifetime of proud performance. Only \$500.

#### AN EXPERT'S VIEW

Recently, British critic Geoffrey Horn wrote this about the REVOX: "One can record a piano at 3¾ ips, and if on listening critically to a held chord one detects the slightest waver, then it is likely to be the piano tuner you should send for, not the tape mechanic. This is a superlative machine, quite the best domestic tape recorder I have experienced, and so well worth saving and waiting for."

The REVOX is available only through carefully selected Franchised Dealers. Complete literature and Dealer listings are available upon request. Write Dept. HF-12.

ELPA MARKETING INDUSTRIES, Inc.,  
NEW HYDE PARK, N. Y.



REVOX — another Elpa quality product distributed in the U. S., Canada and Puerto Rico.

Why  
everybody visits

# OSAKA INTERNATIONAL FESTIVAL

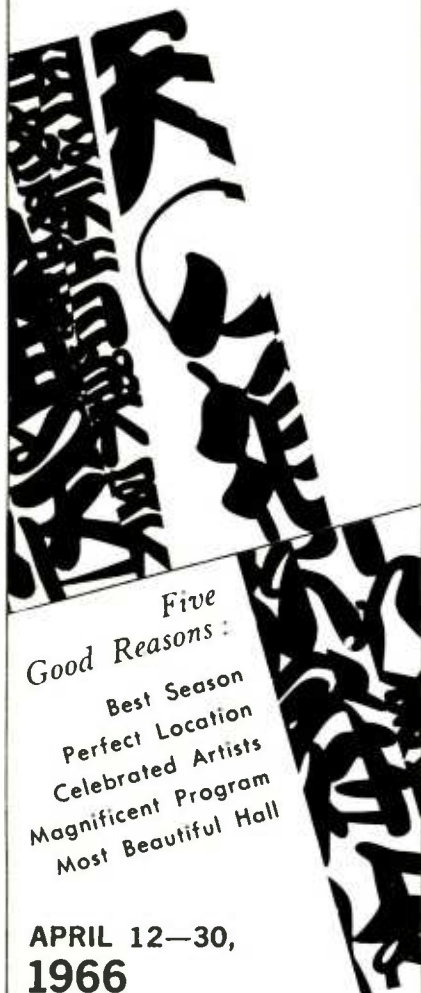

Five  
Good Reasons:  
Best Season  
Perfect Location  
Celebrated Artists  
Magnificent Program  
Most Beautiful Hall

APRIL 12—30,  
1966

Symphony Concert  
Chamber Music  
Opera  
Soloists  
Noh-Plays  
Kabuki  
Bunraku

For details please write to  
**OSAKA INTERNATIONAL  
FESTIVAL SOCIETY**  
22, 2-chome, Nakonoshima, Kita-ku,  
Osaka, Japan

CIRCLE 59 ON READER-SERVICE CARD

playing, it has extraordinary give-and-take.

The lyrical portions of the Rachmaninoff Suite have a supple expressivity which virtually sings and breathes, while the more bravura moments of that piece are conveyed with stunning presence (and none of the hardness that blemished the recent Vronsky/Babin RCA Victor version). I also admire the saucy, light-handed manner with which the Milhaud *Scaramouche* and the Poulenc Sonata are projected. (The latter, incidentally, is the work written in 1918, and not the later Sonata dedicated to Gold and Fizdale.)

In sum, these pianists have a feeling for romantic music that for sheer flair equals the legendary Bauer/Gabrilowitsch performance of the Arensky Waltz. Perhaps in the near future Eden and Tamir will turn their attention to the complete Arensky Suite. They would appear to be an ideal choice for the assignment. H.G.

### THEODOR GUSCHLBAUER: "Composers to the Court of the Holy Roman Empire"

Georg Muffat: *Sonata No. 1, for String Orchestra, in D. Wagenseil: Trio Sonata for Two Oboes (English horns), Cello, and Harpsichord, in F. Fux: Sinfonia for Flute, Oboe, Cello, and Harpsichord. Froberger: Suite for Harpsichord, in A minor.*

Hilde Langfort, harpsichord (in the Froberger); instrumental soloists; Austrian Tonkünstler Orchestra (Vienna), Theodor Guschlbauer, cond.

• MUSICAL HERITAGE SOCIETY MHS 601. LP. \$2.50.  
• • MUSICAL HERITAGE SOCIETY MHS 601. SD. \$2.50.

A quite enticing collection of works that were born in Austria (except for Muffat's, probably all in Vienna) over a period, roughly, from mid-seventeenth century to mid-eighteenth. The great organist Johann Jacob Froberger is, of course, the earliest of these composers; his harpsichord suite, displaying a certain amount of his famous German "severity," is an imposing and at times complexly linear essay—strongly rhythmic (and this comes through beautifully in Hilde Langfoit's superb performance) and always boldly drawn. Muffat strikes me as the least interesting here, with a suite of dances cast in a conventional Corelli-ish mold. The Fux Sinfonia—essentially a trio sonata in which the two winds pursue quite separate paths at times—is given an extra dimension by the vitality of the continuo-cello line, and is agreeably lighthearted most of the way. Probably the most immediately appealing work of the four is Wagenseil's (he was a pupil of Fux's, and much admired by the six-year-old Mozart). The bright oboe pairing in the first movement gives way to English horns in the second, moving in sonorous parallel motion; the oboes return and become engaged in some rather coy conversation in the final

Allegro assai. The spare texture, in this case particularly, is well framed in sharp left-right stereo separation, and the sound throughout is close and clear. S.F.

### JOSE MARIA MANCHA: *Recital of Spanish Organ Music*

José Maria Mancha, organ.

• MUSICAL HERITAGE SOCIETY MHS 603/04. Two LP. \$5.00.

Just as German organ music conjures up preludes, fantasias, and fugues, so for the connoisseur does the organ music of Spain bring to mind *tientos*, *glosas*, and *diferencias*. Each country brought forth its own forms and styles, in organ music, organ playing, and organ building; and if Spain's contribution to the sum total is less well known than that of other nations, it is partly due to the very small proportion of recorded material.

An anthology such as this one is therefore welcome, though in a brief two-disc survey some important composers have been omitted entirely (the Peraza brothers, José Lidon, and Felix Lopez, for instance) and the music is often presented in an incomplete form. Nevertheless, Padre Mancha's contribution is a useful one, and he gives the impression of being technically and musically competent, besides demonstrating an almost easy familiarity with the fine but cumbersome organ in Seville Cathedral.

He plays music by acknowledged masters of the sixteenth century—Cabezón, Santa Maria, and Heredia—as well as a *tiento* by the little-known Bernardo Clavijo del Castillo. But he has obviously not read Santa Maria's famous book on how to interpret organ music of that age, for his quarter notes plod evenly one after the other instead of bending to the rhythms of the three subtle and different *maneras*, and in consequence what could have been interesting sounds merely boring. As for Cabezón's *Magnificat*, we hear only the organ verse, and not the intervening (and very necessary) plainsong verses from the choir.

Later generations are well represented, and room has been found for excellent pieces by Correa de Arauxo, Alvarado, Cabanilles, Elias, Oxinagas, and Soler. Two pages of notes, atrociously translated from Spanish via French, could have been cut to make way for a specification of the Seville organ. D.S.

### NEW YORK PRO MUSICA: "The Renaissance Band"

Praetorius: *Terpsichore: Suite of Dances*. Isaac: *A la bataglia*. Lassus: *Hor che la nuova; Chi chilichi?; Echo—Valle profonda; Passan vostri triumphi*. Demonstration of instruments.

New York Pro Musica, Noah Greenberg, cond.

• DECCA DL 9424. LP. \$4.79.  
• • DECCA DL 79424. SD. \$5.79.

Aside from any considerations of his-

AR two-speed turntable .....	\$ 78.00
<i>(includes oiled walnut base and transparent dust cover)</i>	
Shure M7/N21D cartridge .....	17.95
Dynakit SCA-35 integrated amplifier .....	139.95
<i>(in kit form \$99.95)</i>	
Two AR-4 speakers in oiled walnut .....	114.00
<i>(in unfinished pine \$102.00)</i>	
Total .....	\$297.90 to \$349.90

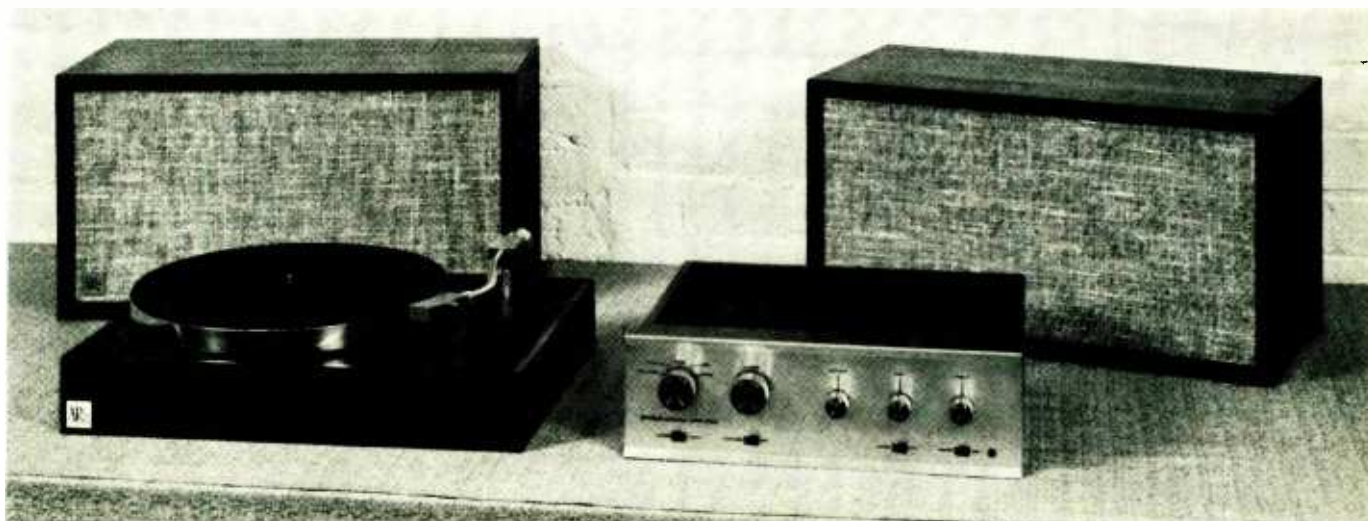

***This is an AR-Dyna-Shure system.  
1½ years ago it would not have been possible  
to assemble a stereo system of this high qual-  
ity at this low cost.***

Each of these components has already earned a unique reputation for absolute quality independent of price.

The AR turntable, one of the most honored products in hi-fi history, has been selected by five magazines as number one in the field. (*Gentlemen's Quarterly* chose it editorially for a price-no-object system costing \$3,824.)

The Shure M7/N21D cartridge has been top-rated for some years, and it has a new low price. It remains one of the truly musical pickups.

The Dynakit SCA-35 integrated amplifier was described simply and accurately in the 1964 *Hi-Fi Tape Systems* as "the finest low-powered amplifier on the market." We have nothing to add except to note that the all-in-one SCA-35 has more than adequate power

to drive AR-4 speakers.

*Modern Hi-Fi* wrote of the new AR-4 speaker: "The results were startling...the AR-4 produces extended low-distortion bass. The power response and dispersion of the AR-4's tweeter are as good as those of units that cost many times as much. All in all, it is difficult to see how AR has achieved this performance at the price."

These components comprise a complete record-playing system that will play both monaural and stereo records at 33½ or 45 rpm. A Dynakit FM-3 stereo tuner may be added simply by plugging in to the SCA-35.

***You can hear this stereo system at the AR Music Room, New York City's permanent hi-fi show on the west balcony of Grand Central Terminal.***

*Further information on this system is available from:*

**ACOUSTIC RESEARCH, INC.,**

**24 Thorndike Street,**

**Cambridge, Massachusetts 02141**

**CIRCLE 3 ON READER-SERVICE CARD**

# "No one can make a guitar 'speak' as does SEGOVIA."

The master brings to the music a scintillant control, elastic rhythm, and wealth of poetic color, and he is gorgeously recorded."

—High Fidelity



ANDRÉS SEGOVIA, GUITAR • Alexandre Tansman: Suite in Modo Polonico • Federico Mompou: Suite Compostelana • María Esteban de Valera: Two Miniatures. DL 10112 (M) • DL 710112 (S)



always points to the best in music

(M) MONAURAL • (S) STEREO

CIRCLE 22 ON READER-SERVICE CARD

torical interest, musicological accuracy, and the like, which virtuous readers will be anxious to have evaluated, the best thing about this record is the lovely noise it makes. A varied assortment of recorders, krummhorns, cornetts, sackbuts, rauschpfeifes, flutes, shawms, rackets, and dulcians, together with viola da gamba, harpsichord, regal, and portative, is used in a skillfully contrasted succession of instrumentations, and the last eight minutes of the second side are taken up with a useful demonstration of many of these instruments, alone and in combination.

The works included here range from 1487—the Heinrich Isaac battle piece—by way of the second half of the sixteenth century—the four madrigals by Lassus—to 1612, when Michael Praetorius completed his collection of over three hundred dance tunes from French court sources harmonized and arranged in four to six parts. Documentation of instrumental practice during those times is sketchy, and it is rarely possible to declare categorically that one realization is right and another wrong: but insofar as there is evidence, the versions put together by Noah Greenberg and his assistant director, LaNoue Davenport, are faithful to it. The music, which is played as it would have been on big festive occasions, neatly pinpoints the difference between talent and genius. The four Lassus madrigals—it was common Renaissance practice to perform vocal music in instrumental versions, and Charles Canfield Brown's helpful liner note here properly stresses the vocal origins of much instrumental music—are enough to show what a great composer this Italianized Netherlander was. Praetorius is thought of primarily as a musicologist (above all for the *Syntagma Musicum*, an exhaustive treatise dating from 1615–19): but though he was not a creative musician of Lassus' caliber, the arrangements in *Terpsichore* display both technical skill and a lively imagination. Isaac occupies a level between the other two, and he is represented by the earliest surviving large-scale example of a popular Renaissance genre, the musical battle scene.

The performers handle their often awkward instruments with authority and convey an infectious sense of enjoyment. The record is beautifully engineered: the mono version may be slightly less spacious and brilliant than the stereo, but it is excellent in its own right. Great care has been taken with the presentation, and the album is so good that I hope Decca will not mind my suggesting two ways in which similar projects could be made even better in future: fuller documentation of the instrumentation of individual movements would be helpful, and pictures of instruments are much more enlightening when they are reproduced to a uniform scale. B.J.



PETER PEARS and JULIAN BREAM: *English Lute Songs*

Dowland: *Fine Knacks for Ladies; Sorrow Stay; If My Complaints; What If I Never Speed*. Rosseter: *Sweet Come Again; What Is a Day; Whether Men Do Laugh or Weep*. Morley: *Thyrsis and Milla; I Saw My Lady Weeping; With My Love My Life Was Nestled; What If My Mistress Now*. Ford: *Come Phyllis Come*. Pilkington: *Rest, Sweet Nymphs*. Campian: *Come Let Us Sound with Melody; Fair If You Expect Admiring; Shall I Come Sweet Love*. Anon.: *Have You Seen but a White Lily Grow; Miserere, My Maker*.

Peter Pears, tenor; Julian Bream, lute.  
• LONDON OL 5896. LP. \$4.79.  
• • LONDON OS 25896. SD. \$5.79.

One of the most astounding things about the quarter-century around 1600 when the English lute song flourished is the sheer number of fine composers who were active. Of the selected six who, together with Anon, make up this record, only Thomas Ford can be regarded as unequivocally minor and even his work has ample charm. Francis Pilkington, who was Canon of Chester Cathedral, likewise wrote only a small quantity of music, but he had a ravishing melodic gift, and *Rest, Sweet Nymphs* is one of his two best songs. Philip Rosseter's talent was perhaps not on the same high level as that of the remaining three masters, but he too could turn a delicious tune—*Sweet Come Again* is meltingly lovely—and in *Whether Men Do Laugh or Weep* he captures the devil-may-care quality of the words perfectly.

Another legitimate cause for astonishment in these songs is the way in which, more than the products of any other period, they combine the finest music of the age with the finest poetry. In the case of Thomas Campian, who for good measure was a doctor too, the two arts were combined in one person, for his airs are settings of his own words. *Shall I Come Sweet Love* is a melody of wonderful subtlety, and in this particular collection Campian emerges not a whit inferior to Dowland and Morley, who are both represented by some of their best work.

The two anonymous songs are beautiful ones—and this brings me to the performance, for in the refrain of *Have You Seen but a White Lily Grow* there is a piece of singing as exquisite as any I know on record. Pears is one of the great musicians of our time. For me, he is also one of the great singers of our time, but that is a much more personal judgment. I know there are many people who do not like his voice. However, for anyone not irreconcilably of that party, this record cannot be too highly recommended: Pears is in superb form. His phrasing is sensitive, his breath control impeccable, his extemporized ornamentation ravishing, and his vibrato well under control. Bream is no mere accompanist but a true partner, executing miracles of subtle tonal variation and giving full rein to the romanticism of



PROFESSIONAL QUALITY

SPLICE FREE

ON THE CONVENIENT C-SLOT REEL

# audiotape

TRADEMARK

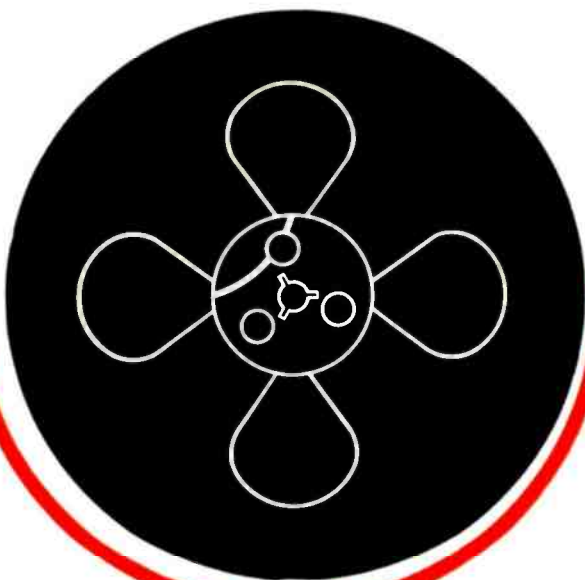

MAGNETIC RECORDING TAPE MANUFACTURED BY AUDIO DEVICES, INC., NEW YORK, N.Y.

## Listen. Compare. Your money back if you can't hear the difference.

We've made nine (9) improvements in Audiotape.

Can you hear them? We don't know. But we can.

If you can't hear the difference in a reel of new Audiotape, if you don't think it sounds better, mail it back to us with your sales slip within 10 days.

Back will come your money.

Laboratory instruments *show* the difference. You can see the better tone. We're betting that your ears are just as sensitive as the instruments.

But—Holy Smoke!—listen *carefully*.

Hear our new Low-Noise tape, too.

**AUDIO  
DEVICES** INC.

235 E. 42nd St., New York 10017  
Sound Tape • Computer Tape • Instrumentation Tape

CIRCLE 8 ON READER-SERVICE CARD

**VANGUARD**  
Recordings for the Connoisseur



The most explosive discovery of the Baroque Revival!

**PETER SCHICKELE** presents the life and works of **P. D. Q. BACH (1807-1742)? CONCERTO FOR HORN AND HARDART, S. 27** CANTATA, "IPHIGENIA IN BROOKLYN", S. 53162 SINFONIA CONCERTANTE, S. 98.6 (for Bagpipes, Lute, Left-handed Sewer Flute and Double-reed Slide Music Stand) and **QUODLIBET** by **PROF. SCHICKELE** Chamber Orchestra under the direction of Jorge Mester John Ferrante, countertenor Leonid Hambro, harpsichord Ralph Froelich, French horn VRS-9195 & \*VSD-79195

"The works were given splendid performances by Mr. Schickele and some of New York's best musicians... The risibility of the audience, however, threatened to become a problem... perhaps a foundation can be urged to subsidize a tour." *Howard Klein, New York Times, on the Town Hall Concert now immortalized on this disc.* \*Stereo

CIRCLE 89 ON READER-SERVICE CARD

## JOSEF FIDELMAN

PLAYS RECITAL NO. 3  
ON A NEW PARLIAMENT RELEASE  
**BACH MOZART SCARLATTI**



"... a performer of sensitivity and with a good deal of musical perceptiveness."

**Herbert Kupferberg, N. Y. Herald Tribune**

"'Appassionata'... Emotionalism... never gets the better of his essentially sound sense of musical values... Fidelman's musical intelligence is no less apparent in Chopin... He shows... that rubato... need never interfere with basic rhythm. Chopin... stressed this point, and if Fidelman passes it along to his pupils, he is doing music a great service."

**Dean Wallace, San Francisco Chronicle**

"... Mr. Fidelman has... a fine, lyric touch that brings the music to life and sends it straight to the heart... great rhythmic subtlety..."

**McLellan, The Pilot, Boston**

"... a remarkable... pianist, Josef Fidelman... a truly remarkable performance which should win him long delayed recognition as one of our best pianists..." **Gerald Ashford, San Antonio Express**

"... a sensitive and lyrical pianist..."

**Rafael Kammerer, American Record Guide**

CIRCLE 32 ON READER-SERVICE CARD

what was, after all, an exciting and highly colored epoch.

I have possessed a mono pressing of this record since it was first issued in England about five years ago. That was good; but the stereo, which I have now heard for the first time, is still better. A word-sheet is enclosed. All told, this is one of my favorite recordings. B.J.

### SVIATOSLAV RICHTER: *Piano Recital*

Bach: *Well-Tempered Clavier, Book 1: Preludes and Fugues: No. 1, in C; No. 4, in C sharp minor; No. 5, in D; No. 6, in D minor; No. 8, in E flat minor.* Prokofiev: *Visions fugitives, Op. 22: Nos. 3, 6, and 9.* Rachmaninoff: *Prelude in G sharp minor, Op. 32, No. 12.* Schubert: *Allegretto in C minor; Ländler in A.* Schumann: *Theme and Variations on the Name "Abegg," Op. 1.*

Sviatoslav Richter, piano.

• DEUTSCHE GRAMMOPHON LPM 18950. LP. \$5.79.

• • DEUTSCHE GRAMMOPHON SLPM 138950. SD. \$5.79.

Containing still more material from Richter's 1962 Italian concert tour, the present collection immortalizes some well-recorded piano playing along with sometimes distracting audience noise. On the whole, it is not the most interesting of the Soviet pianist's many discs. His Bach is rather conventional, with improper ornamentation and no embellishing to speak of, although the fingerwork is wonderfully fleet and Richter's sonority is beautiful as sheer sound. The witty Prokofiev *Visions fugitives* fare somewhat better, and it is to be hoped that this artist will one day give his attention to the entire set. The Schubert and Rachmaninoff *morceaux* have been previously available in Richter performances, but those here have a beguiling simplicity. Schumann's youthful set of Variations suits the mercurial style of the pianist perfectly: this performance is the high point of the entire anthology. Now, when will Richter get around to *Carnaval*? H.G.

### HELMUT TRAMNITZ: *"Organ Music at the Time of Schütz"*

Helmut Tramnitz, organ.

• ARCHIVE ARC 3250. LP. \$5.79.

• • ARCHIVE ARC 73250. SD. \$5.79.

Those who relish the pungently raw colors and taut busy patterns so distinctive of baroque-era organ music will be gratified by the present Archive miscellany on at least two counts. The first is its fascinating variety of both true and imitative baroque timbres commanded by the two instruments on which Herr Tramnitz plays. The Side 1 selections are played on the organ of the St. Marien Kirche in Wolfenbüttel, one which includes some of the original 1618-23 Gottfried Fritzsche stops but

which was almost completely rebuilt in 1960 by Karl Schuke. It's a magnificent instrument of apparent baroque sonic authenticity and it is recorded with quite astonishing clarity considering the long reverberation period of the church itself. But the entire Side 2 is devoted to that old idol of so many baroque connoisseurs, the c. 1610 Compenius chamber organ, of all-wooden pipes, which still stands intact in the Frederiksborg Castel at Hillerød, Denmark. Ever since I first heard it on records (as far back as 1938 in imported 78s), its ineffably piquant tonal qualities have reverberated in my memory more hauntingly than those of any other individual instrument, of any kind, I've ever heard. What a delight it is to have it brought back to vivid life in this spacious, pure, unexaggeratedly stereoisitic recording!

The second major attraction here is the program's presentation of an extraordinarily comprehensive and illuminating cross section of mid- and late (but still pre-Bach) baroque keyboard masters. Oddly, though, the charismatic figure of Heinrich Schütz himself is missing. Either he wrote no independent organ works or none has survived, but his influence is evident to a greater or lesser extent in the works of the various contemporary and next-generation-or-two German composers who are represented here. In chronological order they are: Michael Praetorius (1571-1621) with two variations on "Nun lob' mein Seel den Herren"; Samuel Scheidt (1587-1654) with a chorale-tune setting and variations on the Netherland folk song "Ach, du feiner Reiter"; Heinrich Scheidemann (1595-1663) with two chorale-tune settings: Johann Lorentz (c. 1610-89) with a short Dorian Prelude; Matthias Weckmann (1619-74) with a Fantasia in D minor; Dietrich Buxtehude (1637-1707) with a *Ciaccona* in E minor and *Toccata* in G; and Christian Ritter (c. 1645-1725) with a *Sonatina* in D minor. Not all of these works are recorded for the first time, or for the first time in organ rather than harpsichord versions, but many of them are. To the best of my knowledge, Lorentz has never been represented on records before, Ritter and Scheidemann only rarely; and the four little anonymous dances (played on the Compenius organ to illustrate its onetime common use for home music making and dancing) are probably all record firsts.

I never hear music of this particular period without remembering what Lawrence Gilman had to say about it long before the baroque-era repertory became as widely known or as much in vogue as it is now. "There are more noteworthy things in this seventeenth-century music than prophecies of Bach: one finds here a freedom and liberality of tonal speech, a poignant beauty and expressiveness, that seem to connote an order of musical thinking which we are disposed to appropriate for our own mature period—far too light-handedly, alas! For, as a caustic philosopher briefly and devastatingly observed, 'Our new thoughts have thrilled dead bosoms.'" R.D.D.



The Exponent 4/40: 40-watt E.I.A. solid-state amplifier, Garrard Custom Professional Turntable, Air-Suspension speaker systems.

## BRAVO!



The Exponent 4/30: 20-watt E.I.A. solid-state amplifier, Garrard Custom Professional Turntable, Air-Suspension speaker systems.

## ENCORE!

The Exponent 4/40 went right to the top of its class. In style, in performance. It was recognized as a standout by everyone who heard it. And now there's a new member of Sylvania's component portable family—the Exponent 4/30. Designed to be the best in *its* class. The 4/40 rated bravos. We think the 4/30 stacks up as a great economy-priced encore.

For specifications and a look at other Sylvania stereo, send 25¢ to: Sylvania Entertainment Products Division, Dept.HF-2, Box 7, Station C, Buffalo, N. Y. 14209.

**SYLVANIA**  
SUBSIDIARY OF  
**GENERAL TELEPHONE & ELECTRONICS GTE**  
CIRCLE 81 ON READER-SERVICE CARD

**A VERY SPECIAL OFFER**

**TO READERS OF**

**HIGH FIDELITY MAGAZINE!**

**Save \$1.20 On The  
Purchase Of This Classic...**

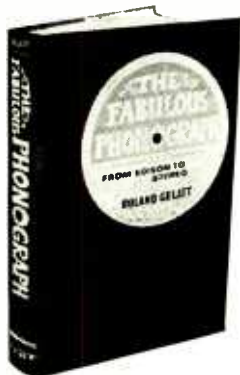

## THE FABULOUS PHONOGRAPH

**From Edison to Stereo**

**by Roland Gelatt, Editor-in-Chief,  
High Fidelity Magazine**

Roland Gelatt's fabulous history of the fabulous phonograph is again available in a brand new and revised edition which now includes recent developments in stereo, recordings and tapes.

THE FABULOUS PHONOGRAPH traces progress from the early cylinder recordings to the astounding high fidelity and stereophonic systems of today. The turbulent story of the entrepreneurs, the great musicians and singers who transformed the phonograph into an instrument of tremendous cultural importance is told "... with a vast knowledge and an engaging style, bringing warmly to life a history which in other hands could have been a perfunctory compilation of dates and facts." (Chicago Tribune)

"Gelatt has written lucidly and entertainingly ... told the story superbly. His book should become a standard reference work." (Variety)

**NOW YOU CAN OWN THIS  
VALUABLE WORK AND SAVE.**

By a special arrangement with the publisher, Appleton-Century, THE FABULOUS PHONOGRAPH is offered to readers of *High Fidelity* at \$5.75. A saving of \$1.20 over the regular bookstore price of \$6.95.

**MAIL THIS COUPON TODAY**

**WYETH PRESS PUBLISHING HOUSE  
Great Barrington, Mass. 01230**

Gentlemen: Please send me \_\_\_\_\_ copies of THE FABULOUS PHONOGRAPH by Roland Gelatt. I enclose payment—\$5.75.

Name \_\_\_\_\_

Address \_\_\_\_\_

City \_\_\_\_\_

State & Zip \_\_\_\_\_



**BIZET: *Carmen: Suite***  
†Gounod: *Faust: Ballet Music; Funeral March of a Marionette*

Royal Opera House Orchestra, Covent Garden, Alexander Gibson, cond. [from RCA Victor LM/LSC 2449, 1960].  
• RCA VICTROLA VIC 1108. LP. \$2.39.  
• • RCA VICTROLA VICS 1108. SD. \$2.89.

Instead of either of the two familiar *Carmen* suites, based upon the several interludes and dances that adorn Bizet's opera (one thinks back to the Beecham performances of both suites as models in elegant and idiomatic approach), we have here a mélange of instrumental pieces plus transcriptions of such vocal and choral stand-bys as the *Habanera* and the smugglers' ensemble of Act III. Andre Kostelanetz has performed this type of operation more successfully, with a compensating glow of orchestral tone. The present record brings only the original lapse in taste compounded by dull, straightforward playing and a plethora of bass drum. The ballet music from Gounod's *Faust*, delivered sturdily, comes off somewhat better; but the same composer's *Funeral March of a Marionette*, an inconsequential pops piece tacked on as dividend, adds little to the second side. R.L.

**BRAHMS: *Concerto for Piano and Orchestra, No. 1, in D minor, Op. 15***

Gary Graffman, piano; Boston Symphony Orchestra, Charles Munch, cond. [from RCA Victor LM/LSC 2274, 1958].  
• RCA VICTROLA VIC 1109. LP. \$2.39.  
• • RCA VICTROLA VICS 1109. SD. \$2.89.

My views of this performance remain just about what they were at the time of the original release: an extrovert reading such as this is all surface value and is unlikely to shed any belated surprises. One hears virtually all it has to offer the first time through. That observation is not necessarily a disparagement either of Graffman's technically brilliant, musically tasteful treatment of the solo part or of Munch's forthright, driving leadership of the orchestral part. Indeed, the Serkin-Ormandy edition presents an almost identical point of view and costs

nearly twice as much. Nevertheless, it should be noted that English Decca's Ace of Clubs series has restored the subtle Curzon/Van Beinum reading to circulation in Britain at bargain rates, and it is probable that its American counterpart, Richmond, will soon do likewise for the domestic buyer. H.G.

**HANDEL: *Suites for Harpsichord: No. 2, in F; No. 5, in E; No. 7, in G minor; No. 10, in D minor; No. 14, in G***

Wanda Landowska, harpsichord [from HMV DB 4977-82, 1935].  
• ANGEL COLH 310. LP. \$5.79.

Handel's harpsichord suites are landmarks in the history of the instrument and of the form. Written with brilliant technical resource and intended as teaching pieces, they contain many movements of structural interest and several in which the old dance forms can be seen as developing towards sonata form. To my taste—and I say this with trepidation—they are also a bit of a bore. Handel is fine when he is making stately choral effects or, sometimes, when he is writing with unaffected simplicity for the solo voice. But in these instrumental works the level of his inspiration is simply not high enough to maintain interest.

However, this finely engineered reissue of five of the best suites makes as convincing a case for them as I can imagine. I don't know why Landowska felt it necessary to transpose the order of movements in the G minor Suite, but otherwise her performances can scarcely be faulted. Her rhythms are as vigorous and sensitive, her phrasing as grand as always. So, since the sound is clean and brilliant, those who like the music should be delighted with this record. I shall go on trying. B.J.

**MOZART: *Concertos for Horn and Orchestra: No. 1, in D, K. 412; No. 2, in E flat, K. 417; No. 3, in E flat, K. 447; No. 4, in E flat, K. 495***

Albert Linden, horn; Vienna State Opera Orchestra, Hans Swarowsky, cond. [from Vanguard VRS 1068/VSD 2092, 1961].  
• VANGUARD EVERYMAN SRV 173. LP. \$1.98.  
• • VANGUARD EVERYMAN SRV 173SD. SD. \$1.98.

We are here given very skillful horn-playing by a young (born 1937) Danish artist. With Swarowsky providing an alert and polished accompaniment, and with first-class sound, this disc remains among the best of the recordings of these concertos. It has, to be sure, a lot of company there: the new Mason Jones on Columbia, Civil on Angel, Penzel on Mercury, Tuckwell on London, and of course the classic Dennis Brain on Angel. Old Leutgeb would have felt at home with any of these experts, and one imagines Mozart would have too. N.B.

# Wollensak for '66 new beauty with a soul of stereo

You're looking at over six feet of slim-lined beauty. Seductively clothed in walnut wraps. But underneath lies a soul of powerful stereo sound. A magnificent piece of modern design combined with the traditional excellence of Wollensak . . . this is the beginning of a new era in tape recorders, a new idea in fine sound systems. So let your wife call it beautiful furniture. You call it beautiful sound. And here are some of the reasons why!

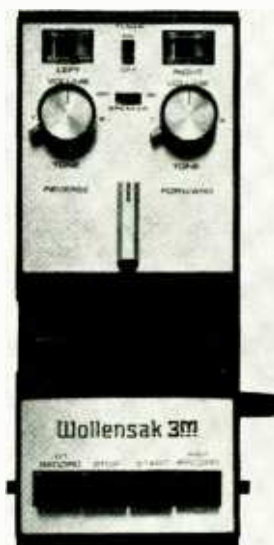

**WOLLENSAK CONTROL CENTRAL** An exclusive new concept in tape recorder control . . . a complete Sound Studio in a hand-span! All controls are centrally grouped for maximum simplicity, more compact construction, more satisfying sound-on-tape performance.

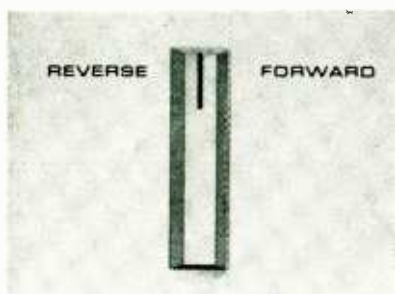

**HIGH SPEED SEARCH CONTROL** This new tape handling mechanism provides positive control in fast forward or fast rewind operation for extremely accurate program location. Simplifies both program editing and playing.

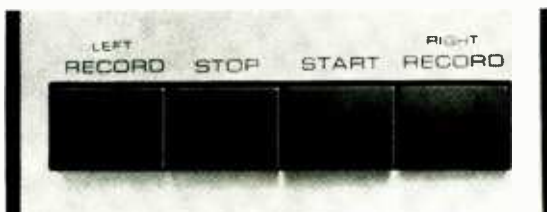

**POWER ACTIVATED PUSH BUTTONS** For each playing and recording operation, power activated push buttons provide fingertip touch control of tape. Positive locking control mechanism prevents the accidental erasure or tape recordings.

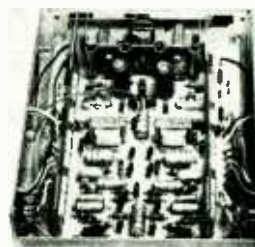

**SOLID-STATE CIRCUITRY** Space age transistors allow replacement of vacuum tubes, reduce heat, provide for compact design and more rugged reliability for trouble-free operation. They also assure instant warm-up.

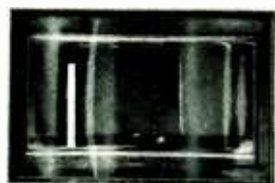

**PRECISION VU METERS** Even the most critical recording gain control settings are made precise through these easy-to-read Wollensak VU meters. All Wollensak stereo models feature individual left and right channel meters.



**FOUR-DIGIT COUNTER** New, push-to-reset four digit tape counter accurately indicates program location on tapes. Essential for recording/playing long uninterrupted material.



**4-SPEED OPERATION** 7 1/2 - 3 3/4 - 1 7/8 - 15/16 ips. A tape speed for every application and need. From long-play voice at an economical 15/16 ips to highest fidelity at 7 1/2 ips. Allows for the utmost in tape recording and playing versatility; with more musical satisfaction than you've ever had.



**EXTRA LARGE BALANCED FLY-WHEEL** Provides positive, constant speed. Minimizes wow and flutter which provides most exact sound reproduction in both record and playback. An assurance of finest true hi-fidelity.

THE SLEEK LOOK IN SUPERB SOUND—WHAT YOU WANT IS A WOLLENSAK!



CIRCLE 94 ON READER-SERVICE CARD

for the critical ear

SHURE

Stereo Dynamic®

HIGH FIDELITY PHONO CARTRIDGES

BEST SELLER



MODEL M3D

Where cost is the dominant factor, the M3D provides extremely musical and transparent sound at a rock-bottom price. The original, famous Shure Stereo Dynamic Cartridge . . . with almost universal application. Tracks at pressures as low as 3 grams, as high as 6 grams. For any changer. Only \$15.75

Write for literature:

SHURE BROTHERS, INC.

222 HARTREY AVE., EVANSTON, ILLINOIS  
CIRCLE 73 ON READER-SERVICE CARD



How to  
gift-wrap  
an  
LP record

For music-loving friends, pack by Methods 4 or 5 such fine, unusual Cambridge-Record renditions as: Bartók, Biber, Ives, Monteverdi, Rorem, Schütz, Thompson or Zelenka — Cuenod, Curtin, Farberman, Fuller, Ghittalla, Leonhardt, Monosoff or Votapek/Vosgerchian.

Artists and composers, as delectably paired as strawberries and kirsch, described in new Cambridge catalog. For timely, speedy delivery, write direct.

CAMBRIDGE RECORDS

477 Washington St., Wellesley, Mass. 02181  
CIRCLE 14 ON READER-SERVICE CARD

PROKOFIEV: *Concerto for Violin and Orchestra, No. 1, in D, Op. 19 (A)*

†Chausson: *Poème (B)*

†Ravel: *Tzigane (C)*

David Oistrakh, violin; U.S.S.R. State Radio Orchestra, Kiril Kondrashin, cond. [(A) from Westminster 18178, 1956; (B) and (C) from Westminster XWN 18177, 1956].

• MONITOR MC 2073. LP. \$1.98.

• • MONITOR MCS 2073. SD. \$1.98.

Oistrakh has recorded the Prokofiev D major Concerto so many times (one version even lists the composer as conductor) that it is a bit hard to keep track of them all. Presumably, this performance is, as noted above, the same as that once carried in the Westminster catalogue. It is well played indeed, with a slightly softer lyric focus and slightly crisper inflection than the Angel disc which the soloist recorded with Lovro von Maticic. There are other fine readings in the catalogue, some of them with better sound, but this one stands up well enough.

It is illuminating to have the present account of the Ravel *Tzigane* reissued almost simultaneously with another celebrated reading—that by Jascha Heifetz. Where the latter made the pyrotechnics crackle with electricity, Oistrakh is far more soft-spoken and urbane about the whole thing. Both approaches work when given executant skills such as each of these artists possesses, but I rather prefer the Heifetz.

As for Oistrakh's Chausson *Poème*, one must bear in mind that his 1955 American recording with the Boston Symphony is currently listed in the low-priced RCA Victrola catalogue. That version boasts the advantages of Munch's sensuous, idiomatic accompaniment and the fullness of true (as opposed to reprocessed) stereo sound. The disc under scrutiny, though, may be recommended if one likes the coupling: sound and accompaniments are more than passable.

H.G.

PROKOFIEV: *Lieutenant Kije: Suite, Op. 60; Peter and the Wolf, Op. 67*

Boris Karloff, narrator (in *Peter and the Wolf*); Vienna State Opera Orchestra, Mario Rossi, cond. [from Vanguard VRS 1028/VSD 2010, 1958].

• VANGUARD EVERYMAN SRV 174. LP. \$1.98.

• • VANGUARD EVERYMAN SRV 174SD. SD. \$1.98.

Even on its third time around (the original 1958 discs were followed by an early 1960 4-track taping), this program's early stereo recording is still spectacularly vivid in spite of a somewhat dry acoustical ambience, which is less noticeable in the more sharply focused, rather more natural-sounding mono version. The familiar voice of William Henry Pratt, alias Boris Karloff, also seems more authentically captured in monophony,

but in any case he makes a fine—if sometimes just a bit overdramatic—narrator for *Peter*. Unfortunately, though, the current editions perpetrate the early ones' error of presenting the narration at such a relatively high level and with so much presence, vis-à-vis the orchestral playing, that the over-all effect is more one of a musically accompanied story than of a verbally annotated musical work. This side still can be recommended, with appropriate reservations, especially to Karloff fans, but even at the disc's current bargain price its *Lieutenant Kije* Suite is not likely to be acceptable to Prokofievians. The performance is slapdash where it is not methodical and the usually perceptive Rossi seems lacking in any feeling whatever for the film score's humor and fancifulness. R.D.D.

SCHUBERT: *Music for Violin and Piano*

Johanna Martzy, violin; Jean Antonietti, piano.

For a review including this reissue, see Schubert Music for Violin and Piano, page 102.

TCHAIKOVSKY: *The Nutcracker, Op. 71*

Utah Symphony Orchestra, Maurice Abravanel, cond. [from Vanguard SRV 123/24, SRV 123/24SD, 1962].

• VANGUARD EVERYMAN SRV 168/69. Two LP. \$3.96.

• • VANGUARD EVERYMAN SRV 168/69SD. Two SD. \$3.96.

The major appeal of the Vanguard *Nutcracker*, when it first appeared, was its provision of such aurally attractive sonics (delightfully bright and airy even in monophony, although of course more atmospheric in stereo) at a modest price. And since this current Everyman-series reprint shaves off a couple of dollars from the original cost, it at least is now a better buy than ever. That is, though, provided one isn't familiar enough with performances of the complete ballet to realize that there are poetic and dramatic enchantments in the score quite beyond the ken, to say nothing of the abilities, of the Utah Symphony and its conductor. Their performance is by no means a bad one, but it just isn't in the same class with the superb *Nutcrackers* by Dorati for Mercury, Ansermet for London, and Rodzinsky for Westminster. In this case, certainly, a good sonic investment can be a poor musical bargain. R.D.D.

**Correction:** Alan Rich's statement in the September issue that the American Recording Society recording of Piston's Second Symphony (reissued on Desto D410; DST 6410) was taped in New York City by the Juilliard Orchestra is incorrect. Mr. Piston assures us that the recording was made in Vienna by the Vienna Symphony as were the majority of the American Recording Society releases. Our apologies to Desto Records for this misunderstanding.

**FREE FREE FREE FREE FREE**

McIntosh Laboratory, Inc., 4 Chambers St., Binghamton, N.Y.  
**FM STATION DIRECTORY**  
**EXCITING TEST REPORTS**  
**36 PAGE CATALOG**

Name \_\_\_\_\_  
Street \_\_\_\_\_  
City \_\_\_\_\_  
State \_\_\_\_\_ Zip \_\_\_\_\_



**DON'T ENVY A McIntosh OWNER...**

*be one!*

**McINTOSH ONLY COSTS  
\$3 MORE A MONTH  
THAN A COMMON STEREO**

The new McIntosh 36 page catalog is great.  
Write for your free copy today.

**BUY A McIntosh**

McIntosh Laboratory, Inc., 4 Chambers St., Binghamton, N. Y.

CIRCLE 53 ON READER-SERVICE CARD



Looks can be deceiving! Just because the new Magnecord Model 1020 has a pretty face and optional walnut base, don't get the idea it's not a professional quality instrument. ■ When your wife starts raving about the way it complements her decor, don't be afraid you're going to miss any of that famous Magnecord quality. If the elegant new appearance fools you, just put

## INTRODUCING THE NEW MAGNECORD 1020

the 1020 through its paces. The Model 1020 has Magnecord's unsurpassed ability to record from any program source, gentle and sure tape handling and professional endurance. ■ The new Magnecord may not look like a big, business-like professional tape recorder/reproducer . . . but it sounds like one. ■ See the new Magnecord Model 1020 at your dealer's or write for new brochure.

DECORATOR STYLED WITH A PROFESSIONAL HEART . . .

 **magnecord** Sales Div. | Subsidiary of the TELEX Corporation  
MIDWESTERN INSTRUMENTS | P. O. Box 7509 / Tulsa, Oklahoma 74105

CIRCLE 51 ON READER-SERVICE CARD



# The Lighter Side



**Edith Piaf.** *Pathé FSX 154-163. \$33.00 (ten LP).*

AT FIRST glance, it would appear that an album containing ten LPs devoted to one popular singer, even one as distinctively superior as Edith Piaf, could turn into too much of a good thing. The only comparable release that comes to mind is the series of fifteen Bing Crosby LPs issued by Decca—a series whose nostalgic qualities could not make up for many of the barren stretches. It would be foolish for anyone who has ever been entranced by Piaf to deny the nostalgia that one feels while listening to the present ten-disc set. But in this case nostalgia is never a crutch or a cover-up for a fondly remembered performance which, in cold analysis and in retrospect, may not prove to be quite so remarkable as one had remembered.

No, there is none of that in the course of the 105 songs that Piaf sings. The memorable Piaf songs remain as electrifying as ever, from *L'Accordéoniste*, recorded in 1941, down through the magnificent years of the Fifties that brought *Le Chevalier de Paris*, *Hymne à l'amour*, *Padam Padam*, *Je hais les dimanches*, *La Goualante du pauvre Jean*, *Sous le ciel de Paris*, and *Milord*. Not that everything in this set is a masterpiece—some of her songs are excellent, some are only adequate. But she herself is almost always, in these recordings, a uniquely brilliant interpreter with an immediate authority that sets mood



*The great Piaf: 105 songs—and none too many.*

and atmosphere in an instant, as that remarkable voice wells up with incredibly broad, vibrant tones.

The scope and variety of this huge set is impressive. In your mind's eye you may remember Piaf as the eternal little sparrow in the inevitable black dress, thin, drawn, pale. Visually, this was the constant image. But there were two Piafs—the visual and the vocal. The vocal Piaf had all the strength and power and variety that one did not see in the visual Piaf. In these songs, recorded between 1941 and 1963 (two selections from her last public appearance, not previously issued, are included), there is passion, charm, drama, joy, gentleness, sorrow, grueling intensity, vibrant resilience, airy gaiety. And they cover nearly every facet of her career: she sings English songs (with a touch of accent but with a surprising comprehension of the rhythm of the English language); she is heard with Les Compagnons de la Chanson (her 1946 recording of *Les trois cloches* is done with them), with Eddie Constantine, Jacques Pills, and her last husband, Théo Serapo; there are songs recorded both in the studio and in the music hall; she sings songs from an operetta, *La Petite Lily*, to which Marguerite Monnot, Charles Aznavour, and Piaf herself contributed; and we hear Piaf, the actress (the actress without music, that is, because in her songs she is always the actress) in a monologue-cum-sound-effects by Cocteau entitled *Le bel indifférent*.

There is, in short, all of Piaf that we have known and possibly considerably more. One of the merits of such a collection is that it brings into focus many details—for instance the extent to which Piaf as performer and Marguerite Monnot as composer complemented each other; twenty-five of these songs are the work of Miss Monnot, including many identified as most typically Piaf.

On the other hand, the set has one enormous demerit: it does not contain one word of annotation—no appreciation of Piaf, no remembrances, not even the most basic biographical facts. There is no explanation of the songs or of the Cocteau playlet or the circumstances under which some of the recordings were made. What could have been a monumental set is sent into the world limping, simply because one of the essential aspects of such a package has been completely neglected. J.S.W.

This is the Cecil E. Watts  
Record Cleaning!

IMPROVED

\*PREEMER

KEEPS NEW RECORDS CLEAN... DUST FREE!

The Cecil E. Watts PREEMER provides the perfect solution for keeping new records new. This handy record cleaning component protects the mirror-like finish of a fresh pressing, leaving no trace of film or residue to clog the stylus of sensitive cartridges. As the record rotates on the turntable, the specially designed plush pile of the PREEMER penetrates each groove, removing dust and grit... cleans entire record so quickly it can be used between record changer cycles.

Acclaimed by Experts as the finest method for the maintenance of new records.

For full information on how to protect your big investment in records, get a copy of "How to Clean, Maintain and Protect Records" by Cecil E. Watts, world's leading authority on record care... only 25c. Write to Dept. HF12.

ELPA MARKETING INDUSTRIES, INC., New Hyde Park, N. Y.

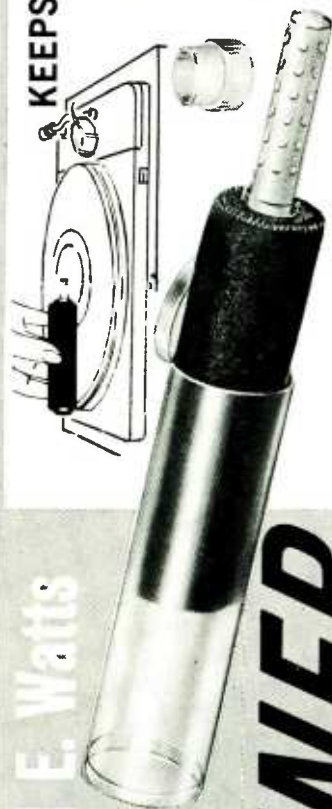

\*PREEMER - A Mark of Elpa Marketing Industries, Inc.

**P. F. Sloan:** "Songs of Our Times." Dunhill 50004, \$3.98 (LP).

**Barry McGuire:** "Eve of Destruction." Dunhill 50003, \$3.98 (LP).

Both these discs are products of the marriage between rock 'n' roll and folk-protest, a trend that began with Bob Dylan. P. F. Sloan is, like Dylan, both composer and singer (he wrote all the songs on his disc and most of those on McGuire's) and his *Eve of Destruction*, included in both collections, has become a popular hit. This song is not only the bellwether of what appears to be a new turn in the development of rock 'n' roll, but a song that may possess considerable sociological significance. During one stage of its development, rock 'n' roll appealed to subteen-agers because the lyrics offered protest value against adult oppression and misunderstanding and the restrictions of school. Now the steady, propulsive rock beat backs up comment on a far less juvenile world. "If the button's pushed, there's no runnin' away," the new breed of rock 'n' roll singer chants, "... and you tell me... you don't believe we're on the eve of destruction." Or, in *What's Exactly the Matter with Me?*, he asks, "Why can't I march when the cause is just?" and finds that he is inhibited from expressing his real feelings by a sense of inferiority and insecurity. Sloan is so prolific that it is not surprising to find him involved with some trite ideas (a daughter suffering for the sins of her family) and with echoes of rock 'n' roll's earlier juvenile protest. But the success of *The Eve of Destruction* indicates that something new, musically and politically, may be blowing in the wind. Sloan is a relatively unimpressive, thin-voiced performer of his own works, but McGuire is a stronger, more emotional singer, whose hoarse and husky voice brings a sense of urgency to the songs.

**Danny Meehan:** "Meehan's In!" Mercury 21043, \$3.79 (LP); 61043, \$4.79 (SD). Danny Meehan is a showman—a wiry little man with a leprechaun's grin, a bit of a lilt in his voice and a lot of bounce in his feet. There is a touch of the old music hall about him but mixed with this is a suave, contemporary approach. He can charm you with such period pieces as *On the Street of Regret*, or with his blithe singing of the 1920s' *The One I Love Belongs to Somebody Else*, or with the tenderness he finds in *It Was My Father's Fashion*. At the same time he explores the less exploited works of Cole Porter (*So Near and Yet So Far*), Rodgers and Hart (*This Funny World, Ev'rybody Loves You*), and Bart Howard (*Beautiful Women*) with easy, intimate warmth. And given a strong ballad (*Where I Belong*) he is very close to the Tony Bennett technique. There is more to a Meehan performance than comes through on this generally satisfying disc because he is one who must be seen as well as heard. And there are some things here—an overextended *She Loves Me* and a saccharine *The House I Live In*—that might not have seemed out of place if they were accompanied by the charm of the visual Meehan.

**Nina Simone:** "Pastel Blues." Philips 200-187, \$3.79 (LP); 600-187, \$4.79 (SD).

One of the essentials in Nina Simone's performances is time—not in the sense of beat or rhythm (although this is also at the heart of her work) but of duration. She has a unique skill for setting a mood and then building layers of mounting intensity upon this foundation, a technique she uses to excellent effect on *Sinner-man*, one of the high points of this disc. The song lasts for more than ten minutes as Miss Simone develops a moving and emotional performance involving not only her own compelling singing, but guitar and cymbal passages, handclapping and shouts that evoke the same fervor one associates with flamenco dancing. Yet she can also catch and establish a mood quickly, as she does on a short, gentle, lyrical piece called *End of the Line*. She can alter the traditional work song form—the rhythmic whacks, even the use of falsetto—for strictly female purposes on *Be My Husband*. And she dares to stir the ashes of memory by undertaking *Strange Fruit*, a searing song that is inextricably associated with Billie Holiday. Miss Simone's version is more deliberately dramatic than Miss Holiday's and, though it may not cut as sharply, it is a valid and effective approach. Yet with all her versatility, Miss Simone is surprisingly bland on two classic blues—*Nobody Knows You When You're Down and Out* and *Trouble in Mind*—both of which she tosses off with seemingly little feeling. Ah, well—you can't have everything.

**Juliette Greco:** "This Is Juliette Greco." Philips 215, \$4.79 (LP); 615, \$5.79 (SD).

This practically definitive collection of latter-day Greco not only presents the Parisian favorite in well-recorded interpretations of such French popular song classics as *Clopin-clopant*, *L'Amé des poètes*, *La Mer*, *Moulin rouge*, and *Mon homme*, but it is intelligently packaged for the English-speaking listener (this is the latest entry in the Philips Connoisseur Collection, a series notable for its excellent presentation). The album includes highly atmospheric notes on Miss Greco and her songs by Vernon Duke, as well as complete French lyrics and English translations. Miss Greco's dark, husky voice is recorded in close and intimate fashion. She can essay a lyrical, lilting approach to a song, although she often trims a melody to an almost spoken outline with great effect—notably in her unusual presentation of the all too familiar *Mon homme*. The songs are excellent, Miss Greco is in fine fettle, and she receives interesting and highly effective accompaniments from a small group of musicians under François Rauber.

**George Brassens:** "Sings of the Birds and the Bees." Philips 218, \$4.79 (LP); 618, \$5.79 (SD).

This is another in Philips' Connoisseur Collection—a well-annotated, illustrated set of Brassens' ironic songs complete with the original lyrics and their English translations. Brassens, a poet with a guitar, views society with a penetrating

# The more you know about solid state receivers...

## ... the more you'll appreciate the value of Bogen's new RT8000

Outside, there's the bold thrust of its bevelled front panel, the sweep of its recessed, walnut-grained dial. The full complement of controls and switches provides for simultaneous or selective listening to local and remote speakers plus phones.

Also on/off switching for tape monitoring, loudness/volume and AFC. Geared flywheel action makes tuning smooth and fast; the instrument-type meter makes it precise. ■ But it's *inside* the RT8000's all-transistorized circuitry that you get

the full benefit of Bogen's ten years-plus in solid state design. Circuitry that includes 34 transistors, 12 diodes, 3 multi-cell silicon rectifiers, 1 AFC diode and 1 zener diode. The power supply alone uses 6 silicon diodes and 3

transistors for superior filtering, lower residual hum, consistent performance regardless of line voltage variations. ■ Multi-stage AM and FM circuitry

offers high gain, superior adjacent channel separation, incredibly low distortion and low drift. Completely automatic time-division type multiplex, with special composite-signal amplifier improves stereo separation, especially at high frequencies. And there's advanced Stereo-Minder circuitry to prevent triggering on false stereo signals.

■ Oversize military-type heat sinks provide lower operating temperatures and increase transistor life.

■ If you are in the market for total performance at a totally realistic price, visit your Bogen dealer today and listen to the expensive sound of this modestly priced receiver.

**Bogen's new  
RT8000  
Solid State  
70 watt AM/FM  
Stereo Receiver  
Only \$319<sup>95</sup>**



# BOGEN

COMMUNICATIONS DIV.  LEAR SIEGLER, INC.  
Paramus, New Jersey

CIRCLE 16 ON READER-SERVICE CARD

# Sit in your own Super Concert Hall!



## SHARPE HEADPHONES give dynamic new range to stereo listening

Only Sharpe Headphones have the patented combination noise-attenuation cup and cavity divider with three harmonic dampers to produce the unequaled flat frequency response. Sharpe Headphones "shut out" random noise that masks the very highs, the very lows. Sharpe Headphones reproduce the audio frequency ranges smoothly and distortion-free, outperforming the finest loud-speakers. Professional in every detail, from comfortable, dual-slide headband to liquid-filled, noise-attenuating ear seals.

- Complete with strain relief cord
- Dynamic driver
- Inner and outer frequency dampers
- Acoustic sealing ring
- Full spectrum frequency dampers and resonance attenuator.

Life time guarantee on performance, workmanship, material.

Frequency response: flat from 20-20,000 cps  $\pm$  3 db. Impedance: 8 ohms per phone, used with 4, 8, 16 ohm outputs. Power output: 2 watts per phone. Noise attenuation: 40 db at 1000 cps.

MODEL HA-660/PRO: \$60.00  
MODEL HA-10: \$43.50  
MODEL HA-8: \$24.50

Look for colorful  
Sharpe Headphone  
demonstration  
display at leading Hi-Fi  
stores. For specifica-  
tions and the name of  
your nearest Sharpe  
dealer write:





# SHARPE

Instruments, Inc.  
DEPT. A  
955 MARYVALE DRIVE  
BUFFALO, NEW YORK 14225  
Sharpe of Canada, 79 Martin Ross Ave., Toronto, Ont.

CIRCLE 71 ON READER-SERVICE CARD

and sarcastic wit, although he couches his songs in relatively gentle terms. But he makes his points in a rough, warm voice as he sings of a gorilla in a zoo who finds himself free to lose his innocence, of a cuckold whose rivals share more than his wife, and of the barren future facing the young couples who express their affection so openly on park benches.

**John Barry:** "The Knack." United Artists 4129, \$4.79 (LP); 5128, \$5.79 (SD).

John Barry's score for *The Knack* consists of a single theme—a delightfully perky little tune—which is the basis of a series of variations bearing such titles as *Here Comes Nancy Now* (muted trumpets over fiddles), *Photo Strip* (organ with deep trombone fills), *Doors and Bikes and Things* (very bright, clipped, rhythmic xylophone, brushes, organ). It is a tour de force and, thanks to Barry's imaginative wit, a completely entrancing light musical experience. The music is full of bounce, sly accents, and swinging merriment and, despite the apparent limitations, it is far more interesting than most of the more expansive scores.

**Laurindo Almeida:** "Sueños." Capitol 2345, \$3.79 (LP).

Almeida's renown as a guitarist seems to move in rising and falling waves. The first peak was in the late Forties when he was a member of Stan Kenton's band. In the early Fifties, he received renewed attention for his experiments in jazz samba with Bud Shank on flute—a precursor of bossa nova. His star rose again with the success of bossa nova early in the Sixties, and more recently Almeida has been collaborating very successfully with the Modern Jazz Quartet. So Capitol has chosen to re-release this collection of guitar solos which may have escaped general notice the first time around. It is a happy reappearance for Almeida, an unusually skillful guitarist whose background ranges from classical guitar to jazz, although his recent participation in the bossa nova wave has tended to obscure the breadth of his talents. He plays a varied program that includes a rich, dark interpretation of *Laura* (involving, as an interlude, a run he once played on Stan Kenton's *Lament*) and *Tea for Two* from the popular world; *Malagueña* and *Barrios' Vals de Concerto* from the longer-haired fields; and several of his own compositions, among them a charming tune called *Mystified, Staniana* (a reflection of his association with Kenton), and a premature bossa nova, *Braziliance*. One of Almeida's most interesting performances in this program is *Eili, Eili*, to which he brings a fresh and provocative interpretation.

**Copacabana Municipal Orchestra:** "Carnival in Rio, 1965." Kapp 1446, \$3.79 (LP); S 1446, \$4.79 (SD).

This disc of prize-winning songs from the 1965 Carnival in Rio does not, fortunately, resemble a similar routine presentation of unfamiliar songs from the San Remo Festival. Instead, a carnival spirit,

a feeling of gaiety and abandon, has been conjured up in remarkable fashion, and projected with appropriate rowdiness by the Copacabana Municipal Orchestra and an ensemble of singers and soloists. Everyone involved seems to be completely a part of the carnival atmosphere—there is no suggestion of self-conscious professionalism. Amid a realistic semblance of outdoor merriment, a series of extremely rhythmic songs are played, sung, or simply shouted. The high spirits and the naturalness of the whole presentation result in a completely delightful and unusual disc.

**The Swingle Singers:** "Getting Romantic." Philips 200-191, \$3.79 (LP); 600-191, \$4.79 (SD).

By now the pattern of swingling—vocalizing the works of classical composers over the swinging beat of bass and drums—has been sufficiently well established to permit most listeners to decide whether or not this is their cup of tea. The composers given the swingle treatment here are Beethoven, Chopin, Schumann, Mendelssohn, Mussorgsky, Albéniz, and Schubert. Ward Swingle, the group's leader, describes the nineteenth century as "not a particularly swinging period," but he has managed to find material that swings along very nicely in the clean, precise execution of his singers. The group manages to make their repeated "dabba-dabba-dabbas" even more clipped, crisp, and expressive with each new recording.

**The Smothers Brothers:** "Mom Always Liked You Best!" Mercury 21051, \$3.79 (LP); 61051, \$4.79 (SD).

The Smothers Brothers serve up a gaudy mixture of slapstick and sentiment, stand-up comedy, and romantic song. It is an oddly assorted stew, some of it well seasoned and smoothly turned out, parts of it lumpy and rather ordinary. The routine, based on the premise that Mom always liked Tommy Smothers better than Dickie, allows Dickie to indulge in his impressive projection of a small boy's shrill irritation. This in-and-out bit of humor might have come off better if the audience laughter had not been so oppressive. In between Dickie's comedy turns Tommy sings pleasantly enough, but on the whole these promising ingredients would probably have been even more effective with a bit more editorial discretion.

**Ray Baretto:** "Viva Watusi!" United Artists 3445, \$3.79 (LP); 6445, \$4.79 (SD).

**Mongo Santamaria:** "La Bamba." Columbia CL 2375, \$3.79 (LP); CS 9175, \$4.79 (SD).

**Machito:** "Mucho Mucho Machito." United Artists 3447, \$3.79 (LP); 6447, \$4.79 (SD).

**Xavier Cugat and His Orchestra:** "Feeling Good!" Decca 4672, \$3.79 (LP); 74672, \$4.79 (SD).

The four Latin bands heard on these discs cover more than three decades of shifting popularity in Latin dance styles in this country. Cugat was one of the early popularizers of the rumba

in the Thirties and the conga in the Forties; Machito, a product of the late Forties and early Fifties (the mambo and cha-cha), was one of the channels through which jazz and Latin band styles intermingled during that era; Baretto and Santamaria are part of the new Latin band renaissance presently active in the United States.

On these discs the one live, vital, exciting band belongs to Baretto. A delightful flow of fun, rhythm, and frolic comes from his ensemble of fiddles, flute, trumpets, piano, percussion, and voices. As the instruments and voices swirl in and out of the basic ensembles, they create a gay sense of abandon, a feeling of enthusiastic involvement that inevitably draws the listener along. Santamaria, on the other hand, working in much the same idiom, misses the joy and spirit Baretto projects. His heavy-handed approach seems geared toward wearing the listener down rather than lifting him up. He also has a fondness for such incredibly corny effects as a rickety trumpet and a yackety sax.

Machito's powerhouse band is, in contrast to Baretto and Santamaria, almost stately in its approach. Using typical American swing-band instrumentation instead of the fiddles and flutes that color the Baretto and Santamaria groups, Machito still plays the essentially formal Cuban music laced with jazz touches that brought him recognition in the late Forties. In this collection, the high points are provided by his vocalist, Graciela, whose sinuous and expressive voice is

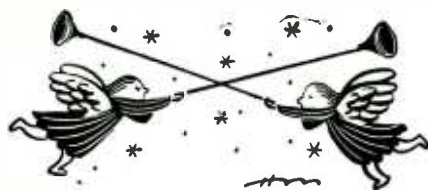

beautifully suited to the haunting boleros that makes up the bulk of her contributions. As for Cugat, you'd scarcely recognize him on this new Decca disc. Evidently attempting to combine the best of everything, he plays current pop hits (*Downtown*) and show tunes (*Fiddler on the Roof*) with instrumentations and styles that mix a contemporary twist-based attack with Latin rhythms. This Cugat orchestra (since he no longer heads his own band, this is presumably a studio group) features organ and guitar from the twist world along with the traditionally Latin flute, marimba, Mariachi trumpets, and percussion. The attractive Dick Jacobs arrangements, played in discothèque-style continuity, make up a pleasant dance program, but, unlike Baretto, Machito, or even the extravagant Santamaria, Cugat seems to have abandoned most of his legitimate Latin associations.

**Aretha Franklin:** "Yeah!!!" Columbia CL 2351, \$3.79 (LP); CS 9151, \$4.79 (SD). On the whole, Miss Franklin's gospel background serves her well in this collection (recorded during a club performance with backing from an excellent

quartet). She rocks and shouts her way through *Trouble in Mind* and *Muddy Water*, demonstrating how well the preaching, declamatory side of gospel can underline and expand the lyrics. And the lusty, open attack that gospel engenders, along with the insistently rolling, all-pervasive sense of rhythm, makes fast pop tunes such as *This Could Be the Start of Something Big*, *If I Had a Hammer*, *More*, and even *Love for Sale* move with incredible vitality (although, in the process, *Love for Sale* loses much of its musical and lyrical sense). But for a slow ballad—no. In these songs, her gospel shout becomes affectation and the emotionalism turns to pure ham. In other circumstances, however, Miss Franklin has lots of voice, lots of rhythm, and lots of life. Getting her out of the studio and onto a night club floor has fully released these qualities.

**Jerry Herman and His Orchestra:** "Hello, Jerry!" United Artists 3432, \$3.79 (LP); 6432, \$4.79 (SD).

Herman's reputation is based on his scores (music and lyrics) for *Hello, Dolly* and *Milk and Honey*, not on his abilities as a pianist. So here he is at the piano, accompanied by an orchestra, playing songs from several recent Broadway shows, including his own *Dolly*. He plays a modest, capable, composer-type of piano—conservative, sensible, with an occasional flourish thrown in just to be daring, but so placid that he rarely does real justice even to his own tunes. JOHN S. WILSON

# SPECIAL FREE OFFER

## from Tandberg

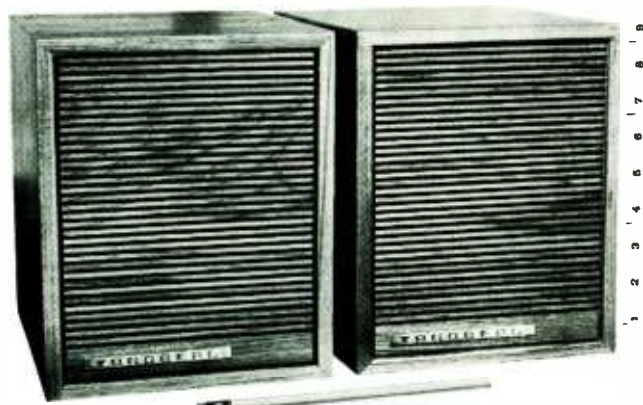

**Two Stereo Speakers  
Worth \$99<sup>00</sup>**

This special free offer begins Oct. 15 and expires Dec. 31, 1965.

To introduce the superb Tandberg MINI-SPEAKER Model 113 Stereo Loudspeakers, you will receive a pair *free of charge* when you buy a Tandberg Model 74B Tape Recorder.

A numbered certificate given to you at the time of your purchase, together with your guarantee card, should be forwarded to us. Upon receipt, we'll ship two MINI-SPEAKERS direct free of any additional cost.

The new Tandberg MINI-SPEAKER has been specifically designed to provide a high fidelity response. The MINI-SPEAKER is housed in an attractive teakwood cabinet.

**OUTPUT:** 8 watts

**IMPEDANCE:** 4 ohms

**WOOFER:** 6.5"

**TWEETER:** 2"

**FREQUENCY RESPONSE:** 60-16,000 cps

**MINI-SPEAKER DIMENSIONS:** 7" long x 9" high x 9" deep

The Tandberg Model 74B Tape Recorder offers you better, clearer, more natural sound. If you don't know where to get your Tandberg Model 74B, write us for dealer list.

**TANDBERG OF AMERICA, INC.**

P.O. BOX 171 / 8 THIRD AVENUE / PELHAM, NEW YORK 10803

CIRCLE 82 ON READER-SERVICE CARD

# New Ideas For Christmas Giving...

Now Choose From 2 Heathkit® Transistor Stereo Receivers



**New 30-Watt Transistor FM Stereo Receiver . . .  
Less Than \$100!**

Features 31 transistors, 11 diodes for cool, natural transistor sound; 20 watts RMS, 30 watts IHF music power @ ±1 db, 15 to 60,000 cps; wideband FM/FM stereo tuner plus two preamplifiers & two power amplifiers; front panel stereo headphone jack; compact 3 7/8" H x 15 1/4" W x 12" D size. Assembles in 20 hours or less. Custom mount it in a wall, or optional Heath cabinets (walnut \$9.95, beige metal \$3.95) 16 lbs.

Kit AR-14  
**\$99<sup>95</sup>**  
(less cabinet)



**66-Watt Transistor AM/FM Stereo Receiver**

Just add 2 speakers for a complete stereo system. Boasts AM/FM/FM Stereo tuning; 46-transistor, 17-diode circuit for cool, instant operation and natural transistor sound; 66 watts IHF music power (40 watts RMS) at ±1 db from 15 to 30,000 cps; automatic switching to stereo; preassembled & aligned "front-end" and AM-FM IF strip; walnut cabinet. 35 lbs.

Kit AR-13A  
Now Only  
**\$184<sup>00</sup>**

## Best Hi-Fi News Of '65...New Low Cost Transistor Stereo Twins!



**New Transistor FM/FM Stereo Tuner**

Heath's easiest to build stereo/hi-fi kit . . . takes only 4 to 6 hours! 14 transistor, 5 diode circuit for cool instant operation, transparent transistor sound. Phase control assures best stereo performance. 3 transistor "front-end" plus 4-stage IF section. Filtered outputs for direct stereo recording. Automatic stereo indicator light. Preassembled & aligned "front-end." Install in a wall or either Heath cabinet (walnut \$7.95, beige metal \$3.50). 6 lbs.

Kit AJ-14  
**\$49<sup>95</sup>**  
(less cabinet)



**Matching 30-Watt Transistor Stereo Amplifier**

Assembles in 10 hours or less! 17 transistors, 6 diodes. 20 watts RMS, 30 watts IHF music power @ ±1 db, 15 to 60,000 cps. No audio transformers . . . assures minimum phase shift, extended response, lower distortion. Solid-state power supply plus electronic filter for regulation within 10%. Accommodates phono, tuner, auxiliary . . . 4, 8, 16 ohm speaker impedances. Lighted control panel. Installs in wall, or Heath cabinets (walnut \$7.95, metal \$3.50). 10 lbs.

Kit AA-14  
**\$59<sup>95</sup>**  
(less cabinet)

## Acclaimed By Hi-Fi Experts & Owners Alike...Heathkit® Solid-State Stereo!



**Transistor AM/FM/FM Stereo Tuner**

Features 23-transistor, 8-diode circuit; built-in stereo demodulator; automatic switching to stereo; stereo indicator light; stereo phase control; filtered outputs for beat-free stereo recording; preassembled & aligned FM "front-end" & AM-FM I.F. circuit; walnut cabinet. 17 lbs.

Kit AJ-33A  
Now Only  
**\$94<sup>50</sup>**



**Matching 66-Watt Transistor Stereo Amplifier**

20-transistor, 10-diode circuit delivers full 66 watts IHF music, 40 watts RMS power at ±1 db from 15 to 30,000 cps. Less than 1% distortion; 5 stereo inputs for any program source; 4, 8, and 16 ohm speaker impedances; simple circuit board assembly; walnut cabinet. 23 lbs.

Kit AA-22  
**\$99<sup>95</sup>**

CIRCLE 41 ON READER-SERVICE CARD

# ... "Do-It-Yourself" Heathgifts!

Now Install 3 Ways... Wall, Custom Or Heath Cabinets!

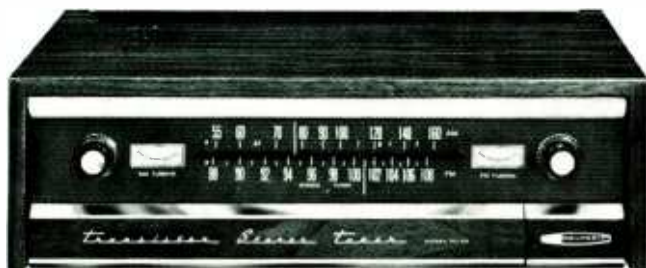

**Deluxe Transistor AM/FM/FM Stereo Tuner**

25-transistor, 9-diode circuit assures cool operation, natural transistor sound; automatic switching to stereo; stereo indicator light; stereo phase control; filtered outputs for direct stereo recording. Optional cabinets, walnut \$12.95, metal \$6.95. 15 lbs.

Kit AJ-43D  
Now Only  
**\$109<sup>00</sup>**  
(less cabinet)



**Matching 100-Watt Transistor Stereo Amplifier**

70 watts RMS power at  $\pm 1$  db from 13 to 25,000 cps; 26-transistor, 10-diode circuit; inputs and outputs for any source; 4, 8, & 16 ohm speaker impedances; assembled encapsulated modules for fast, simple assembly. Optional cabinets, walnut \$12.95, metal \$6.95. 23 lbs.

Kit AA-21D  
**\$137<sup>00</sup>**  
(less cabinet)



## New Heathkit Deluxe 3-Way System With 4 Special Design Speakers!

Kit AS-15  
**\$144<sup>95</sup>**

New design for the new trend to larger speaker systems! Boasts 12" high compliance, low resonance woofer; two special design 2" direct radiator dome-type mid-range speakers; special design 1" direct radiator dome-type ultra-high frequency tweeter; response 40 to 20,000 cps; 50 watt power capability; high and middle frequency attenuators; 3-way LC & RC crossover networks @ 1 kc & 10 kc; preassembled walnut finish cabinet—18½" W x 19" D x 32¾" H; tube vented, bass reflex design. 74 lbs.

## Make Your Own Music This Christmas With A Heathkit®/Thomas Organ!



**Low-Cost "Artiste" Transistor Organ**

As easy to build as it is to play. Features 10 organ voices, repeat percussion for additional banjo, mandolin, etc., effects; two 37-note keyboards; 13-note heel & toe bass pedal; 50-watt EIA peak music power amplifier and speaker; luxurious hand-crafted, preassembled walnut cabinet. All genuine Thomas factory-fabricated parts. 154 lbs. Matching bench, GDA-232-1, 19 lbs. . . . \$24.95

Kit GD-232B  
Now Only  
**\$332<sup>00</sup>**  
(less bench)

**Deluxe "Coronado" Transistor Organ**



Kit GD-983  
Now Only  
**\$799<sup>00</sup>**

All genuine Thomas factory-fabricated components. 17 true organ voices; two 44-note keyboards; Leslie plus 2-unit main speaker systems; 28 notes of chimes, 13-note heel & toe pedalboard; color-tone attack, repeat and sustain percussion; reverb; vibrato; manual balance; stereo chorus control; expression pedal; full-bodied, walnut-finished cabinet, factory assembled with matching bench; 5-year warranty on transistor tone generators . . . the heart of the organ. 242 lbs.

Buy Now—Use This Order Blank

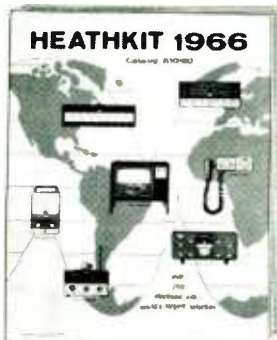

## New! 1966 Catalog

Free! 108 pages . . . many in full color . . . describe these and over 250 easy-to-build Heathkits. Save up to 50%. Mail coupon for your free copy.

Heath Company, Dept. 8-12  
Benton Harbor, Michigan 49023



- Please send FREE 1966 Heathkit Catalog  
 Enclosed is \$\_\_\_\_\_ plus shipping.

Please send model(s) \_\_\_\_\_

Name \_\_\_\_\_

Address \_\_\_\_\_

City \_\_\_\_\_ State \_\_\_\_\_ Zip \_\_\_\_\_

**SHIP VIA:**

- Parcel Post  Express Collect  Freight  20% Included, C.O.D.  Best Way  
All prices & specifications subject to change without notice. HF-187

CIRCLE 41 ON READER-SERVICE CARD



Jensen Model HS-2 Stereo Headphones bring an exciting new dimension to your favorite recordings. Unusually smooth full range undistorted output set these headphones apart. Soft foam cushions provide feather weight comfort and preserve the undistorted bass response without pressure. Response is true, com-

# HAVE YOU HEARD ?

plete, distortion-free from below 20 to 17,000 cycles!

HS-2 Stereo Headphones may be connected to any stereo or mono system. A full 8-foot input cable is conveniently located to the rear of the left phone. Of course, it carries the Jensen 5 year hi-fi guarantee. Suggested resale price \$24.95. See your Jensen hi-fi dealer.



JENSEN MANUFACTURING DIVISION/THE MUTER COMPANY 6601 SOUTH LARAMIE AVENUE, CHICAGO, ILLINOIS 60638  
 Canada: Radio Speakers of Canada, Ltd., Toronto • Argentina: Ucoa Radio, S.A., Buenos Aires • Mexico: Fapartel, S.A., Naucalpan, Mex.

CIRCLE 44 ON READER-SERVICE CARD





**George Barnes and Carl Kress:** "Guitars. Anyone?" Carney 202. \$3.98 (LP). The death of Carl Kress last spring ended one of the most perfect collaborations jazz has ever known. The two-guitar work of Kress and George Barnes was a marvel of light, delicately balanced, and completely relaxed interplay. Kress was basically the accompanist to Barnes's single string solos, but every once in a while he moved out front to play a chorded solo—the result, some of the happiest sounds imaginable (he does it on this disc on *Clap Yo' Hands* and *Undecided*). This collection, presumably Kress's last recording, is a fitting memorial to him: his performances are impeccable. They are unique miniatures, subtle, beautifully shaded, swinging ever so airily, and blessed with a quiet charm that has all but disappeared from jazz. The talents of Barnes and Kress are mirrored in their ever tasteful selection of fine tunes which range, on this occasion, from *Memories of You* to *Satin Doll*, with strong emphasis on the great show tunes of the Twenties.

**"The Be-Bop Era."** RCA Victor LPV 519, \$4.79 (LP). Victor, along with the other major labels, showed relatively little interest in be-bop when that revolutionary jazz form was riding high in the mid-Forties. The company took a few stabs at it, however, and has now put together this reissue disc, which includes most of the major names of the period (Charlie Parker, Dizzy Gillespie, Bud Powell, J. J. Johnson, Fats Navarro, Kenny Clarke, and Miles Davis) plus one important group. Gillespie's big band, Parker's appearances are quite brief (short solos on two 1949 *Metro-nome All-Star* pieces) and Davis is heard even more fleetingly on the same selections. There are entries by Coleman Hawkins' 52nd Street All-Stars, Illinois Jacquet's combo, Lucky Thompson's Lucky Seven, Charlie Ventura's group, and Count Basie's sextet—all of them actually reflecting transitional styles rather than full-blooded bop. That leaves four pieces by a Kenny Clarke group that includes Navarro, Kenny Dorham, Powell, and Sonny Stitt, and five by the Gillespie band. Gillespie's band, recorded between 1947 and 1949, is a

lumbering, heavy-footed group that slogs its way through relatively turgid arrangements brightened by Gillespie's flashing trumpet solos and one of John Lewis' earliest piano solos. Gillespie's comedy singing helps a bit, too, but the effect is limited. Clarke's group was as close as Victor ever came to recording a really first-rate bop small group. All in all, however, the disc is not apt to convince anyone who was not sold on bop at the time, although the collection does offer some fine performances by Thompson, Buddy De Franco, and Lennie Tristano.

**Phil Bodner:** "Living Jazz: Quiet Nights." RCA Camden 914, \$1.98 (LP); S 914, \$2.49 (SD). On this disc Bodner gives us light, airy, springy performances played by a small group over what is, for the most part, a sort of bossa nova shuffle rhythm. The beat is irresistible; the ensembles are tightly woven and threaded with attractive colors, shadings, timbres; and arrangements are structured with an ear for strong contrasts (bass trombone against flute or vibes, broad organ against light guitar), and phrasings are clipped and precise but singing. The selection of tunes is interesting—one bossa nova (*Quiet Nights*), Neal Hefti's delightful *Cute* (a splendid vehicle for Bodner's group), *Honeysuckle Rose* (it takes real imagination to find a different way to play this—but Bodner does), *A Taste of Honey*, and *In the Still of the Night*. Even the pop hit of a few years ago, *Mister Sandman*, emerges with inviting charm. Bodner plays flute, piccolo, and alto saxophone while Dick Hyman (organ, piano), Mel Davis (trumpet, flugelhorn), Bucky Pizzarelli (guitar), and Buddy Morrow and Paul Faulise

(trombones) are prominent among his associates.

**Duke Ellington and His Orchestra:** "Will Big Bands Ever Come Back?" Reprise 6168, \$3.79 (LP); 9-6168, \$4.79 (SD). This is the sort of record that can drive an Ellington enthusiast to the depths of despair. Here is the most original and creative jazz orchestra in the world reduced to the banal assignment of playing the signature themes of other bands—the kind of program usually used as an attention-attracting device for bands with nothing of their own to offer. And they call the result "Will Big Bands Ever Come Back?" Not if record companies attempt to kill off the most unique big band still functioning with such demeaning projects as this. And yet, Ellington being Ellington, all is not completely lost. The Ellingtonians may lumber dismally through *Tuxedo Junction*, *One O'Clock Jump*, and *Woodchopper's Ball* (they do not swing comfortably on such blues-based pieces) but simply by turning Glen Gray's *Smoke Rings* or Benny Goodman's *Goodbye* over to the infallible Johnny Hodges, the day can be saved. And Ellington's talent for getting to the heart of a piece does wonders for *Artistry in Rhythm*, a piece with which Stan Kenton has been struggling for twenty years. With Ray Nance's violin, both plucked and bowed, as a focal point and Harry Carney's dark-toned bass clarinet and Cootie Williams' superb plunger trumpet wandering in and out, the Kenton theme is turned into a little gem—so good that one can forgive the waste represented by much of the disc. Williams, incidentally, shines through constantly, no matter how drab the situation may be. The disc is accompanied by unctuous, uninformative (even misinformed) liner notes which provide neither a band personnel nor an identification of soloists.

**Hall Brothers Jazz Band.** GHB 11, \$4.98 (LP); S 11, \$5.98 (SD). The Hall Brothers band is a semipro group in Minneapolis. It plays the traditional repertory with a bit more enterprise in digging out material than most other groups of this type, and it also boasts an attack notable for its ease, relaxation, and lack of forcing. This col-



lection includes a rousing *Bogalusa Strut* (from the Sam Morgan repertory): *The Entertainer*, played in the easy, deliberate fashion favored by Bunk Johnson; and a treatment of *Skid-Dat-De-Dat* which flows along so naturally that one is never conscious of the Louis Armstrong overtones usually dominating this piece. The ensemble playing is rugged and forthright. Charles DeVore on cornet and Russ Hall on trombone contribute strongly to the sturdy tones of the front line, but the real spark both in ensembles and solos is provided by clarinetist Richard Thompson. His rich tone and free, soaring style add color to all the pieces, but he makes *Bogalusa Strut* a particularly brilliant showcase for his work. And when

he joins his clarinet with Mike Polad's soprano saxophone on *Kansas City Man*, their duet pays its respects to Sidney Bechet without being buried by Bechet's devices. The sound on most of the disc is clean and full, but the first three selections on Side 1 of my copy are strangely muffled.

**Jon Hendricks:** "Recorded in Person at the Trident." Smash 27069, \$3.79 (LP); 67069, \$4.79 (SD).

When he appeared with the Lambert, Hendricks, and Ross/Bavan trios, Jon Hendricks' drawbacks as a singer were of relatively little consequence. Backed by a trio and with either Annie Ross or Yolande Bavan to carry the more

rigorous vocalizing. Hendricks made up in spirit and zest what he lacked in voice. Working on his own as a singer, however, his lack of voice creates difficulties, particularly on ballads. And when one of these ballads is the maudlin *Old Folks*, the results are deplorable. The program also includes his tongue-twisting lyrics to jazz solos on *Cloudburst* and *Shiny Silk Stockings*, his more formal lyrics to Quincy Jones's easy and rhythmic *Stockholm Sweetnin'*, and his tiresome and tasteless but apparently very popular novelty, *Gimme That Wine*. In these songs Hendricks' amiability and good spirits shine through his hoarse, voiceless singing but do not offer quite enough compensation for his lack of vocal equipment.

## Features never before offered on a stereo headset

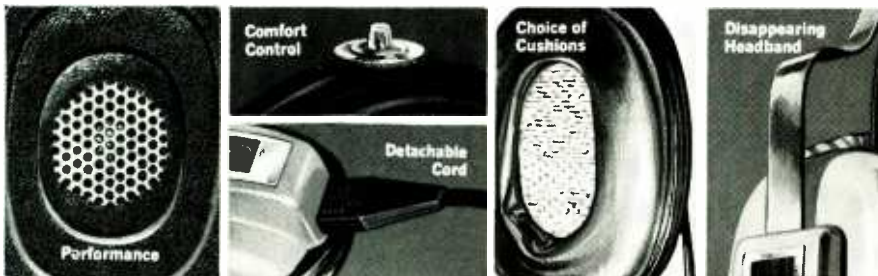

are standard on the new Telex professional quality . . .

*Serenata*



A **TELEX FIRST**—Comfort Control . . . knob adjusts earcup pressure for best sound and comfort.

A **TELEX FIRST**—Electronic Tone Control . . . controls tone according to preference and program.

A **TELEX FIRST**—Disappearing Headband . . . no bulky exposed adjustment parts. Smooth, clean design, completely adjustable.

A **TELEX FIRST**—Detachable Cord . . . New convenience. Stores neatly. Add adapter cords for a variety of connections.

A **TELEX FIRST**—Choice of Cushions . . . Liquid-filled are standard, foam cushions optional.

A **TELEX FIRST**—Choice of Impedance . . . Either 8 or 600 ohms. Use for tape editing or monitoring.

A **TELEX FIRST**—Performance . . . New all dynamic sound reproducers set a new standard for stereo response. One minute's listening will convince you.

Products of Sound Research

# TELEX

DEPARTMENT 19-L, 3054 EXCELSIOR BLVD., MINNEAPOLIS, MINNESOTA  
CIRCLE 84 ON READER-SERVICE CARD

Listen-test Telex Stereo phones and You'll Accept Nothing Less.

Ask your dealer to demonstrate the *Serenata* (\$59.95) or write for full information. See also the three other great Telex stereo headsets. One will match your exact preference — **Adjustatone** (\$15.95), ST-10 (\$24.95), ST-20 \$29.95.



**Woody Herman and His Swinging Herd:** "My Kind of Broadway." Columbia CL 2357, \$3.79 (LP); CS 9157, \$4.79 (SD).

Although there are only three big jazz bands of consequence still functioning—Basie, Ellington, and Herman—the record companies seem determined to grind even these into the ground. Basie has been devoting an inordinate amount of time to current pop hits on Verve and Reprise, while Ellington, since joining Reprise, has turned out current pop and film songs but almost nothing of his own. And now Woody Herman (who has lately made a fine set of discs for Philips) makes his new debut on Columbia with a banal set of show tunes. Like Basie and Ellington, Herman takes the assignment and gives it more than it deserves. Nat Pierce brings a little straightforward simplicity to some of the arrangements, the Herman band still has its vigor and discipline, and Woody himself is an alert and engaging clarinetist and alto saxophonist. But the band, in general, is wasted playing *I Feel Pretty*, *Never Will I Marry*, *Hello Young Lovers*, and such things. The fire the sparkle, the humor, the zest that make the Herman band what it is are all missing in this routine assignment.

**Earl Hines:** "Up to Date." RCA Victor LPM 3380, \$3.79 (LP); LSP 3380, \$4.79 (SD).

This is the fourth Hines LP to be released in recent months (the fifth if you count RCA Victor's reissue of Hines's Grand Terrace band). It differs from the earlier discs, which were primarily devoted to Hines's piano, in that several instruments are present (although, aside from Aaron Bell on bass and Jimmie Crawford on drums, only two other musicians are heard). However, Budd Johnson plays three instruments—tenor, baritone, and soprano saxophones—and Ray Nance doubles on violin and cornet. As a result, the programming is more varied than on the first three discs. Sometimes this is an advantage, sometimes not. Playing with Johnson or Nance, Hines is inclined to defer to them, to let them build the piece instead of building it in his own fashion. However, Hines's skill as an accompanist is tremendously impressive, notably behind Johnson on *Linger Awhile* and in back of Nance's violin

on *The Hour of Parting*. The ideal setup in this collection, and one that might have been used more than once, is an extended performance (seven minutes) of *It Had To Be You*, in which Hines has time to develop his solo portion before Johnson comes in on tenor saxophone. Bell and Crawford form an admirable rhythm section all through the disc.

**Paul Horn Quintet:** "Cycle." RCA Victor LPM 3386, \$3.79 (LP); LSP 3386, \$4.79 (SD).

The quintet that Paul Horn leads on this disc shows itself capable of tremendously broad and powerful playing, both in ensemble and in solos. The group's use of dynamics is at times overwhelming, not only in the roaring percussion work of Bill Goodwin, the striking chordal piano playing of Mike Lang, and the spreading, stretching effects achieved by Bill Plummer on bass, but even in Horn's work on flute. He is one of the very few jazz flutists who can project a sense of depth and body with this normally shrill instrument, and he gives us a striking display of his ability on this disc. On two pieces Horn has added a pair of bagpipes, both as atmosphere (for the opening of *Greensleeves*) and as a background to support some very strong fluting on his part. This is an unusual disc and one that shows the rapidly developing Horn playing with great authority.

**Stan Kenton:** "Wagner." Capitol 2217, \$3.79 (LP); S 2217, \$4.79 (SD).

A meeting between Stan Kenton's blustering brass and the music of Wagner was probably bound to happen. Well, they have met but nothing happens—absolutely nothing. Instead of pulling out all the stops Kenton sidles up to Wagner rather shyly and tries to play him straight. Oh, there's a little bongo rapping here and there and some tentative riffing in the brass. But the approach is straight-faced, humorless, and respectfully timorous. Dull, too.

**Herbie Mann:** "Standing Ovation at Newport." Atlantic 1445, \$4.79 (LP); S 1445, \$5.79 (SD). "Latin Mann." Columbia CL 2388, \$3.79 (LP); CS 9188, \$4.79 (SD).

Herbie Mann's efforts to find a suitable jazz outlet for his flute led him, quite a few years ago, to Latin rhythms, and he has been working fairly consistently in this field ever since. His present octet includes two trombones, vibraphone, a regular drummer, and a conga drummer. The trombones are presumably present to give the group solidity and body, but they still do not offer quite enough relief from the busy, piping quality of Mann's flute in the longer pieces (eight to ten minutes) on the Newport album. Mann's best moments on this disc occur during a fascinating flute improvisation—unaccompanied except for a repeated bass figure on *Comin' Home Baby*. Oliver Nelson's big-band arrangements on *Latin Mann* offer the flutist a more varied accompaniment. With the big band, Mann touches the highlights in the de-

velopment of Latin jazz. Beginning with Esy Morales' classic *Jungle Fantasy* (which Morales played with a much more earthy and vital attack than Mann), he progresses through *Bijou*, *Manteca*, *Señor Blues*, and *Watermelon Man* to a presentation of the current state of Latin jazz which he describes as "boom chitty boom." It is a varied panorama with strong performances by Chick Corea on piano and Carmel Jones (trumpet), and it includes a particularly lively vocal and instrumental version of a Cuban song, *Ave Maria Morena*.

**Tony Parenti and His Downtown Boys.** Jazzology 11, \$4.98 (LP).

Tony Parenti's Downtown Boys is a trio

which, by virtue of Dick Wellstood's romping, stomping piano and Parenti's ripe, woody tone and sometimes jaggedly forceful attack on clarinet (slightly reminiscent of Johnny Dodds), falls into the Jelly Roll Morton school of clarinet-piano trios rather than in the Benny Goodman vein. The repertory also favors the Morton view: blues, rags, and stomps, including Morton's own *Shreveport Stomp*. With Sam Ulano supporting them ably on drums, Parenti and Wellstood are full of lively, bubbling gaiety on *Railroad Man*, *Wildcat Blues*, and *Eccentric*, while the broad, warm timbre of Parenti's low register is particularly effective on *Atlanta Blues* and *Chantelles bas*. Although seven of the ten selec-

## REVERSE PLAY automatically SELECT PLAY automatically REPEAT PLAY automatically



### NEW! SOLID STATE 400X STEREO TAPE RECORDER

- 22,000 CPS Cross Field Response
- 4 heads, 3 motors
- timed or signal reverse
- sound-on-sound, sound-with-sound using channel transfer, sound-over-sound
- push button controls, 2 speakers
- echo chamber effect
- remote control plug
- 10½" reel adaptable
- 3 speeds (15 ips optional)
- 4 digit index counter, 2 VU meters

The new 400X from Roberts performs every tape recording technique within the unit itself. No need to set up 2 or 3 tape recorders in tandem to do complicated sound mixing and re-recording effects. Added to these recording techniques are the new automatic play features built into the 400X. Includes an automatic reverse triggered either by timer or sensing tape.

In addition to versatility, the amazing 22,000 cycle Cross Field Head brings to stereo recording a clarity, brilliance, and response not possible with conventional tape heads.

**\$799<sup>95</sup>**



**ROBERTS**

LOS ANGELES, CALIFORNIA 90016

DIVISION OF RHEEM MANUFACTURING CO. WITH 75 PLANTS AROUND THE WORLD

HF12

RT20

CIRCLE 66 ON READER-SERVICE CARD

**ONLY THE NAME  
HAS CHANGED  
A NAME IS  
EASY TO CHANGE;  
A REPUTATION ISN'T.  
WE'VE BEEN KNOWN  
AS ARGO RECORDS  
FOR TEN YEARS AND  
DURING THAT TIME  
WE'VE BUILT AND  
ENJOYED A  
REPUTATION FOR  
PRODUCING  
PHONOGRAPH  
RECORDS OF  
UNSURPASSED  
EXCELLENCE.  
BUT NAMES ARE NOT  
UNIQUE, AND IF  
AN ORGANIZATION  
FINDS THAT THEY  
ALONE NO LONGER  
ANSWER TO AND FOR  
THE RECORD OF  
THEIR NAME, AND  
THAT THEIR  
INDIVIDUALITY IS  
AT STAKE, A NEW  
IDENTITY MUST BE  
ESTABLISHED.  
OUR NAME WAS ARGO  
—OUR NEW NAME IS  
CADET. THE NAME  
AND ONLY THE NAME  
HAS CHANGED.**

**SOME ARTISTS  
WHO RECORD  
EXCLUSIVELY  
FOR CADET;  
RAMSEY LEWIS,  
AHMAD JAMAL,  
ETTA JAMES,  
GEORGE KIRBY,  
JEAN DUSHON,  
LOU DONALDSON,  
ETC., ETC.**

**There's A World  
of Excitement on  
Cadet  
2120 So. Michigan Ave.  
Chicago, Ill. 60616  
Send for  
free catalog**

**CIRCLE 13 ON READER-SERVICE CARD**

tions were recorded in 1961 and the remaining three in 1965, the trio is remarkably consistent all through the disc. Its release most appropriately marks the fifteenth anniversary of Jazzology Records, for it was Parenti who made the label's first LP in 1950.

**Django Reinhardt: "Django, Volume 10."** Pathé 247, \$5.98 (LP).

Although this is listed as Volume 10 in the valuable series of Reinhardt's work that Pathé has compiled, it is actually the twelfth disc in the set. All the recordings on this disc are from Reinhardt's postwar period, mostly with the reconstituted Quintet of the Hot Club of France featuring Stephane Grappelly on violin once again. There is also one piece with Hubert Rostaing (playing alto saxophone) in place of Grappelly, one Reinhardt solo accompanied by Grappelly on piano, and an unaccompanied Reinhardt solo. This last solo—an extended series of improvisations on *Nuages*, one of Reinhardt's most familiar compositions, which he performed for a film in 1951 three years before his death—is a superb performance which highlights Reinhardt's brilliance in a way that none of his shorter works has ever done. The quintet selections are of varying quality, both in performance and recording (several have a ringing, echoing sound). Here Reinhardt is often rather perfunctory (for Reinhardt), so that one's interest tends to be carried by Grappelly's gracefully swinging violin. But there are other moments when the group recaptures the suave ease of the prewar performances, particularly on the languorous *Diminishing* and the sprightly *Eveline*. The Reinhardt solo with Grappelly on piano is an oddity: listed as *To Each Is Own Symphony* (sic), it is a medley of *To Each His Own* and *Symphony*, through which Reinhardt builds from an ad-lib opening to a driving finale.

**Sonny Rollins: "The Standard."** RCA Victor LPM 3355, \$3.79 (LP); LSP 3355, \$4.79 (SD). "On Impulse!" Impulse 91, \$4.79 (LP); S 91, \$5.79 (SD).

The positive, highly affirmative attack of Sonny Rollins on tenor saxophone (Nat Hentoff aptly refers to it as "instant authority" in his notes for the Impulse disc) is applied to familiar popular tunes on both of these collections. Despite the fact that Rollins uses more or less identical devices in developing his treatments on both records, the two sets are quite dissimilar. Rollins' performances on the Victor disc are short, mostly around three minutes, while the Impulse pieces average about six or seven minutes (one piece is even eleven minutes). *Three Little Words*, which is on both discs, serves as both a connecting link and a point of departure between the two sets. The Victor, lasting two minutes and fourteen seconds, is taken at a medium tempo and, after some darts and stabs and a bit of strained wriggling by Rollins, just peters out. The Impulse (six minutes, fifty-five seconds) is a fast, rhythmic, running performance, full of dazzling virtuosity and headlong flights.

Rollins works on technical development in the Impulse performances, and he takes the time to explore his ideas, whereas the Victor efforts are apt to seem stunted. The addition of Jim Hall's guitar on four Victor pieces helps open them up, providing contrast to the dark, ropelike texture of Rollins' playing. David Izenzon's bass is heard on one Victor selection and his bowed playing adds a sweetly singing quality to the generally rough, abrupt sound that Rollins produces. On the Impulse, Ray Bryant's smooth, flowing piano solos are the primary contrasting element. Rollins' authority is made immediately evident on both discs, but, despite the power of his playing, the performances almost always tend to fall into a disjointed series of stabs and flares.

**Artie Shaw and His Orchestra: "September Song."** RCA Camden 908, \$1.98 (LP); S-908 (e), \$2.49 (SD).

None of the ten selections in this seven-year cross section of Shaw's groups (1938-1945) is among his more celebrated efforts, yet the mere fact that run-of-the-mill Shaw remains bright and attractive after a quarter of a century is a remarkable tribute to the fine, jazz-tinged dance bands that Shaw led. Shaw's three big bands are here—the original group of the late Thirties, the post-Mexican-hiatus studio band with strings, and the postwar band. The original band, heard on five selections, remains the best of the lot—a band that played beautifully tight, swinging ensembles, a band that had a group sound of its own and phrased impeccably. The sound remained with the second band (heard once on this disc), although the strings diluted its effect; the third band, with three selections here, was a harder, heavier group than the earlier ones, with only Shaw's mellow, bubbling clarinet lines to remind us of his earlier ensembles. The 1940 Gramercy Five is also here (*My Blue Heaven*), swinging brightly through Johnny Guarnieri's hot harpsichord and a muted trumpet solo punched out by Billy Butterfield in the best Muggsy Spanier plunger style.

**Archie Shepp: "Fire Music."** Impulse 86, \$4.79 (LP); S 86, \$5.79 (SD).

There is quite a bit of Charlie Mingus in Archie Shepp's music—the shifting, sliding tempos, the sense of tension and violence that lurks in much of Mingus' work. Shepp, who plays tenor saxophone, goes a bit farther than Mingus, however, in establishing and maintaining a grating sense of frustration in the almost unremitting harshness of his tone as a soloist and in the discordant ensemble sound that he favors. On this disc Shepp leads a sextet on all but one selection, abandoning his abrasive approach only for an odd and affecting treatment of *The Girl from Ipanema*, which he plays with a soft, lost sound, a sort of moaning that builds to a frantic climax. A single trio selection (with David Izenzon on bass and J. C. Moses on drums) is a fascinating conjunction of keening bowed bass lines, strong splashes of saxophone, and provocative drumming.

JOHN S. WILSON

HIGH FIDELITY MAGAZINE

Merry Christmas! Say it with music...

a complete  
Ampex stereo  
tape recorder  
system...plus \$50  
worth of stereo  
tapes...all for  
just \$299<sup>95</sup>!

Now he can record and listen the way professionals do... with Ampex quality equipment! This special Christmas gift offer includes everything he'll need: the new #860 Ampex Stereo Tape Recorder complete with matching, slide-on stereo speakers and two high-fidelity dynamic microphones, plus a \$50 library of pre-recorded stereo tapes of his choice, from the Ampex catalog of over 1300 selections! Never before, a gift so lavish at a price like this, so go ahead... record your Christmas cheer this year on an Ampex!

Free tape offer expires midnight, 12/31/65

ask anyone who knows

**AMPEX**



AMPEX CORPORATION, 2203 LANDEMEIER ROAD, ELK GROVE VILLAGE, ILLINOIS 60007

CIRCLE 6 ON READER-SERVICE CARD



**Now, there's a tape that lets you**



**record twice the music per foot.**

**How? It's so sensitive you can cut  
recording speed in half with no loss in  
fidelity. Your budget will applaud.**

**Savings start with this box.**



**SCOTCH® Brand "Dynarange" Series Recording Tape** is the name on the box. The tape that just prepared your recorder for the best performance of its life. This new tape makes all music come clearer, particularly in the critical soprano or high-frequency range. So much clearer, you can now record at  $3\frac{3}{4}$  ips and enjoy all the fidelity until now possible only at  $7\frac{1}{2}$  on your recorder. Your dealer has a demonstration reel that proves the case.

And by cutting your recording speed in half, you won't need as much tape—can save 25% or more in costs. Or, you can use new "Dynarange" Tape at  $7\frac{1}{2}$ —and discover sound quality you didn't know your recorder had.

The technical achievement behind all this . . .

we've cut background tape noise (what little there is in "SCOTCH" Recording Tape) in half so the listening's better. And we made the wear-life better, too! 15 times greater than ordinary tape. Exceedingly low rub-off keeps equipment clean. Lifetime Silicone lubrication assures smooth tape travel, protects against head wear and extends tape life. Comes in new sealed pack so the tape is untouched from factory to you. Hear new "Dynarange" Tape demonstrated at your dealer. Then try a roll on your own recorder.

"SCOTCH" AND THE PLAID DESIGN ARE REG. TMS OF 3M CO., ST. PAUL, MINN. 55119. ©1965, 3M CO.

**Magnetic Products Division** 

by R. D. DARRELL

# the tape deck

Unless specifically noted otherwise, the following reviews are of standard open-reel 4-track 7.5-ips stereo tapes.

**BACH:** *Concertos for Harpsichord and Strings: No. 1, in D minor, S. 1052; No. 5, in F minor, S. 1056; No. 7, in G minor, S. 1058*

Sylvia Marlowe, harpsichord; Baroque Chamber Orchestra, Sylvia Marlowe, cond.

• • DECCA ST74 10104. 47 min. \$7.95.

Miss Marlowe here makes her far too long delayed tape debut with a flourish, conducting from the keyboard in the old tradition, and bringing us the first tape editions of the sturdy S. 1056 and S. 1058 concertos. (The latter is much better known in its original scoring as the Violin Concerto No. 1, in A minor, S. 1041—available in a 1961 Epic taping by Michelucci and I Musici). Bachians will want the present reel for these new works alone, even at the cost of duplicating the grander-scaled and more dramatic Malcolm/Münchinger Vanguard tape of the D minor Concerto, S. 1052. That performance remains preferable for its grace and verve. While Miss Marlowe's playing is consistently notable for its energy and steadiness, it is also oppressively heavy-handed; and this feeling of excessive weight is enhanced by recording that endows the lower strings of the Baroque Chamber Ensemble with seemingly far more sheer tonal mass than ever could be accounted for by the actual number and playing strength of instruments involved. On the other hand, the recording handles these powerful lows with ease and without darkening the gleaming-bright timbres of the solo harpsichord. Sound specialists well may find this reel a fascinating one for its technology alone, and at their best the hard-driven performances are exciting renditions.

**BEETHOVEN:** *Concerto for Piano and Orchestra, No. 4, in G, Op. 58*

Rudolf Serkin, piano; Philadelphia Orchestra, Eugene Ormandy, cond.

• • COLUMBIA MQ 737. 35 min. \$7.95.

In view of the excessively mannered readings provided in the most recent tapings of this most poetic of Beethoven piano concertos (Katchen's of March 1965 for London and Gould's of July 1963 for Columbia), the present reel of the latest Serkin/Ormandy performance is unrivaled among sonically up-to-date editions. Beautifully broadspread yet unexaggerated stereoism and flawless tape processing capture in well-nigh ideal balance and transparency the authentic tonal qualities of both Serkin's piano and Ormandy's orchestra. The reading itself is a fine one too, especially attractive for its lyricism and (in the finale) for its vivacity. This is not to say, however, that it will satisfy Beethovenians who seek a greater eloquence and profundity in the work. Admirers of the Fleisher/Szell taping for Epic or that by Backhaus and Schmidt-Isserstedt for London (both dating from 1960) are not likely to feel that their favorites have been superseded; and those versions also have the considerable advantage of having been processed complete on a single reel side instead of being split, like Serkin's, between the first and second movements. For others, however, the new edition has the powerful attraction of technological superiority—plus, of course, many endearing, characteristically Serkinian, interpretative details.

**BEETHOVEN:** *Sonatas for Piano*

*No. 8, in C minor, Op. 13 ("Pathétique"); No. 14, in C sharp minor, Op. 27, No. 2 ("Moonlight"); No. 23, in F minor,*

*Op. 57 ("Appassionata"); No. 26, in E flat, Op. 81a ("Les Adieux").*

Artur Rubinstein, piano.

• • RCA VICTOR FTC 2206. 75 min. \$7.95.

In connection with this RCA Victor tape transfer of Rubinstein's 1963 disc collection of the Sonatas Nos. 8, 14, and 26 plus the No. 23 from a more recent Rubinstein disc, some people will promptly recall Columbia's much acclaimed 1964 taping of Serkin's performance of Nos. 8, 14, and 23 (MQ 582). But for true music lovers there is never any either/or choice between Serkin and Rubinstein, whose performances of even the same works are as different as the two pianists' distinctive personalities. Insofar as comparisons are illuminating rather than odious, I'd venture to say that in general Serkin's readings are somewhat more romantic, slightly more dramatized, and at times a bit tenser; whereas Rubinstein's are for the most part more straightforward, more relaxed, and a bit more grand-mannered. It would be hard to decide also which recording is technically preferable: both are excellent, with Rubinstein's perhaps just a shade more robustly solid-toned.

**BEETHOVEN:** *Symphonies: No. 1, in C, Op. 21; No. 7, in A, Op. 92*

Berlin Philharmonic Orchestra, Herbert von Karajan, cond.

• • DEUTSCHE GRAMMOPHON DGA 8806. 59 min. \$8.95.

The fourth and penultimate installment of the Von Karajan Beethoven Nine brings us the same kind of unexpected delicacy that distinguished the conductor's *Pastoral* (reviewed here in No-

*Continued on next page*

## THE TAPE DECK

Continued from preceding page

vember). Of course, it is scarcely surprising that his Seventh should be taken quite fast and with exuberant vitality. (It is the fastest of any taped Seventh I know, although that results partly from the omission of most of the repeats outside the last movement.) But one hardly could have expected either this reading's freedom from any sense of hurry (except, naturally, in the hard-driving finale) or its exceptional lyrical expressiveness. While the First Symphony runs truer to Karajan form in its use of a rather large-sized orchestra and an often overvehement interpretative approach, it also has some delectably light and fleet moments as well, and in this shorter work the repeats indicated in the first and last movements are observed. In both symphonies the stereo recording is again admirably clear and open, if perhaps less spectacularly luminous than in some of the earlier reels; and the tape processing is immaculate, although the modulation level in my review copy seems to be a bit lower than elsewhere in the series.

### BOYCE: *Symphonies* (8)

I Solisti di Zagreb, Antonio Janigro, cond.

• • VANGUARD VTC 1704, 50 min. \$7.95.

What a pity that Max Goberman, who first brought these "symphonies" to records back in 1937, did not live to record his corrected edition of these delectable scores! Happily, however, Janigro's readings—together with the Zagreb players' and harpsichordist Herbert Tachezi's invigorating performances and Vanguard's most gleamingly vivid, yet never too close stereoism—do full justice to the music. If Boyce's pieces are as new to you as they are to tape, I can only hint that his music is so concisely concentrated, so inexhaustibly inventive, and so bubbling over with vitality that it might well rank as a kind of apotheosis of baroque-era creativity. There have been bigger and grander masterpieces brought to tape, but not one that—minute for minute of playing time—can provide more rapturous listening satisfaction!

### STRAUSS, RICHARD: *Don Juan*, Op. 20; *Tod und Verklärung*, Op. 24

Vienna Philharmonic Orchestra, Lorin Maazel, cond.

• • LONDON LCL 80158. 39 min. \$7.95.

Either the present tape processing is far superior to that of the disc edition (reviewed last June by Robert Charles Marsh) or my colleague must have had a poorly processed review copy, for the recorded sonics I hear are by no means lacking in low frequency solidity nor are

they hard in quality. (I hasten to add, however, that this taping never matches sonically the luminous transparency of the Karajan/London *Tod und Verklärung* of June 1962.) Perhaps it's just because Maazel's performances "sound" better to me that I can't be as harsh on his interpretations—which strike me as evoking a more youthful Don, a less grim "Death," and less pretentious "Transfiguration" than most. But subjective factors figure strongly in everyone's evaluations of these tone poems. I've spent many hours comparing various examples on tape alone and yet still can't find any that I consider ideal, although the Szell/Epic taping of March 1961 (which I wasn't very enthusiastic about at the time) now seems to offer the most satisfactory performances of the present two works (plus *Till*). That reel is much less impressive technically, however, than either the present one or those of Von Karajan's *Tod* (one a "single" which also includes *Till* and *Salomes Tanz*; the other a double-play release which adds to these *Also sprach Zarathustra*).

### NOAH GREENBERG: "Renaissance Festival Music"

New York Pro Musica Instrumental Players, Noah Greenberg, cond.

• • DECCA ST74 9419. 35 min. \$7.95.

A special reason for rejoicing in Decca's resumption of serious musical tape activities is the prospect of again having reel editions of the unique Greenberg/Pro Musica programs. These are not only extraordinary in themselves, but they are just the sort of historically significant, off-the-beaten-path music often neglected in the tape repertoire. The present program offers a wealth of such attractions featuring works by Andrea and Giovanni Gabrieli as well as those of less familiar late-Renaissance composers of the Venetian school: Florentio Maschera (d. c. 1584), Giovanni Battista Grillo (d. c. 1622), and Lodovico Viadana (c. 1564-1645). Even better still, it presents these works in performances that make use of authentic contemporary instruments, usually known only from history books: here we can actually hear those strange wooden-and-leather "brasses," the cornetts (*zinken*), Krummhorns (cromornes), shawms and schryari (ancestors of the oboe), sackbuts (trombones), recorders, viols, portative organ, and percussion. And what a resplendently Renaissance-magnificent variety of timbres they produce! Perhaps the Pro Musica performances vary the instrumentation more often within the course of a single piece than might have been the custom originally—the number and pungency of contrast changes is particularly marked in the delectable opening Suite of Dances (*basse danses, branles, pavans*, etc.)—but so much the better for present-day sound fanciers. Every tonal detail is beautifully preserved in strong, pure recording and flawless tape processing, though it's a bit disconcerting

that so little exploitation was made of the stereo-antiphonal potentials in works like the 8-part *Canzon Septimi Toni* by Giovanni Gabrieli and 8-part *Canzon "La Padovana"* by Viadana, which emphatically call for spaced-out double-choir performance.

**Marginalia: New Format.** A special warning may be needed by Leontyne Price fans before they rush out to buy her recital program of arias by Puccini (*Madama Butterfly*, *Rondine*, *Tosca*, and *Turandot*) and Verdi (*Aida* and *Il Trovatore*) sung to accompaniments by the Rome Opera House Orchestra, Oliviero de Fabritiis and Arturo Basile, conductors (RCA Victor FTC 2205, 46 min., \$7.95). It's a first-rate release in every respect, but these same recorded performances (except for the *Butterfly* "Un bel di" and "Tu, tu, piccolo iddio") were taped earlier as the Side-4 filler for the complete *Madama Butterfly* reels of August 1963 (FTC 8006).

**"Anyone for Mozart?"** The Swingle Singers. Philips PTC 600149, 29 min., \$7.95.

Granted that a little scat-singing-the-classics goes a long way . . . granted that *Eine kleine Nachtmusik* may not lend itself to such treatment quite as well as do the K. 545 Piano Sonata (also known in another incarnation as *In an Eighteenth-Century Drawing-Room*) and the Variations on "Ah! vous dirai-je Maman" . . . Nevertheless, only the sourest of sour-puss listeners could fail to respond gleefully to these zestful divertissements. And under all the jauntiness there is exceptional executant skill, while every detail of the expertly controlled and nuanced performances is captured in the purest of stereo recording.

**"Black Satin"/"Latin Lace."** George Shearing Quintet with Strings and Latin Percussion. Capitol Y2T 2263, 3¾-ups double-play, 64 min., \$9.98.

**"Latin Rendezvous"/"Out of the Woods."** George Shearing Quintet with (respectively) Latin Percussion and Woodwind Quartet. Capitol Y2T 2336, 3¾-ups double-play, 63 min., \$9.98.

A mixed bag of Shearingiana. It hits bottom in the almost unvaried juicy schmaltz of the "Black Satin" program, and although it takes on more animation in the coupled "Latin Lace" (which also dates from 1958), it often sounds mighty clattery there. But the 1965 "Latin Rendezvous" program of romantic, mildly Latin-flavored mood-music selections is generally very attractively played and recorded (particularly so in *Yours Is My Heart Alone*, *Quiet Night*, and *The Donkey*). And the other current recording, devoted entirely to pieces by vibraphonist-composer Gary Burton, is often notably fascinating, although it is perhaps less distinctively original for its Bachian contrapuntalisms (in the *J. S. Bop*, *Chorale*, *Great Fugue*, etc.) than for the



imaginative scorings which feature not only spicy woodwinds but also the versatile Burton's executant talents on vibes (throughout), piano (in the Dialogue for Two Pianos), and a nobly expressive Nordic lyre (in *Lyric Ballad*).

**"Broadway Bouquet."** Percy Faith Strings. Columbia CQ 754, 38 min., \$7.95.

The players are hailed as "The Magnificent Strings of Percy Faith"—and not without some justification, for the large ensemble not only plays with exceptionally rich sonic warmth and coloring but is recorded so opulently, with plenty of reverberation, that it often sounds even bigger and better than life. The performances are unfailingly expansive and well controlled and the scorings seldom too elaborate, with the result that almost everything comes off well and the best of these mostly recent show-hit tunes (*Once Upon a Time, Sunrise Sunset, Long Ago, and Make Someone Happy*) are quite enchanting. The impressively big, broadspread, and vivid stereoism is particularly magical in the many passages starring an eloquently expressive cello section.

**"One Night of Love."** Anna Moffo, soprano; RCA Victor Orchestra, Skitch Henderson, cond. RCA Victor FTC 2199, 38 min. \$7.95.

Although my recollection of Grace Moore's old recordings is now pretty dim, my impression in listening to the present program of mostly favorite Moore songs is that Miss Moffo has a much prettier and truer voice but practically nothing of the late star's distinctive powers of personality projection. The almost painful self-consciousness of the young soprano seems likely to work against her otherwise richly performed and recorded program's achieving wide popular success.

**"Songs America Loves."** Eileen Farrell, soprano; London Festival Orchestra and Chorus, Robert Sharples, cond. London LOL 90096, 37 min., \$7.95.

Though the sound here is impressively spacious, the performances on this tearjerker reel—of *You'll Never Walk Alone, Bless This House, Trees, the late Malotte's Lord's Prayer, etc.*—are for the most part so earnestly expressive that they stop just short of travestying the genre. It seems to me the ideally apt comment was provided by Samuel Pepys: writing in May 1668 of a Nonconformist minister's talk to which he had been subjected, he described it as "a great deal of noise and a kind of religious tone, but very dull."

**"American Airlines Astrovision Pop Program No. 8."** Various artists. Atlantic/Atco W 8, 3¾-ips, 179 min., \$23.95.

Hear now; fly later. And it's the same price for the whole family. Here are sixty-two selections representing twenty-two artists—presenting nearly as many vocalists as instrumental ensembles or soloists, offering a wide range of pops

*Continued on page 143*



## EVERYTHING! FOR THE TAPEWORM

**SANTA'S CHOICE . . .** The perfect gift! The exciting new American Tape Kit contains everything the tape recorder owner needs to fully enjoy his hobby in one beautiful package. No more odds and ends. Only the TAK-100 includes:

- (1) A 1500 ft. reel of American's Professional Length Recording Tape.
- (2) A Stereotape Showcase featuring Frank Sinatra, Dean Martin, Trini Lopez, and many others.
- (3) A handy Mail-A-Tape.
- (4) A complete head cleaner kit.
- (5) A professional tape splicer with splicing strips.
- (6) A 250 ft. reel of leader tape.
- (7) A heavy duty take-up reel.
- (8) A 16 page booklet of Tape Tips.

See your dealer or write to:

# AMERICAN RECORDING TAPE

GREENTREE ELECTRONICS  
2135 Canyon Drive, Costa Mesa, Calif.



CIRCLE 38 ON READER-SERVICE CARD

# General Index, 1965

## Feature Articles Listed by Author

- Berger, Ivan B. New Trends in Stereo Kits. Feb., p. 57.  
Botsford, Ward. Sir Thomas and the Gramophone—1910-1960. June, p. 45.  
Buckwalter, Len. Extension Speakers. Mar., p. 70.  
Buckwalter, Len. Tape for Turnpikes. June, p. 42.
- Cantor, Lon. The Indispensable Antenna. Oct., p. 64.  
Chasins, Abram. Conversations with Horowitz. Oct., p. 50.
- Davis, Peter G. Signor Bettini's Cylinders. Aug., p. 24.
- Eisenberg, Norman. The British Audio Establishment. Apr., p. 56.  
Eisenberg, Norman. The Magnificent Monsters: a report on large speakers. Sept., p. 55.  
Eisenberg, Norman. New Products: 1965. Oct., p. 55.  
Eisenberg, Norman. Stereo Question Box. Dec., p. 61.  
Eisenberg, Norman. Tape in Transition. Aug., p. 36.  
Eisenberg, Norman. Turntables and Changers. June, p. 34.
- Feldman, Leonard. An Inquiry Into Spatial Stereo. May, p. 38.  
Fleming, Shirley. Masters, Matrices, and Mass Production. Jan., p. 46.
- Gelatt, Esther. An Interview with Maria Callas. Feb., p. 42.  
Gelatt, Roland. When Records Reached the Supermarket. Dec., p. 56.  
Greenberg, Noah. A Soft Sound in the U.S.S.R.: the New York Pro Musica in the Soviet. May, p. 41.  
Greenfield, Edward. The City of Five Orchestras: London. Apr., p. 51.  
Grozny, I. L. Tapes To Choose From. Aug., p. 40.
- Helm, Everett. The Miraculous Inventions of Heinrich Schütz. Aug., p. 51.  
Heyworth, Peter. A Thorn Grows in Warsaw: Poland's musical avant-garde. Sept., p. 60.
- Kotlowitz, Robert. Boadicea in Walthamstow: Joan Sutherland. Feb., p. 52.
- Landon, H. C. Robbins. The Honorable Tradition of Englishmen. Apr., p. 44.  
Landon, H. C. Robbins. Mozart on the Eighteenth-Century Stage. Nov., p. 62.  
Lang, Paul Henry. "A Mixture of Instinct and Intellect": conversations with George Szell. Jan., p. 42.  
Lindstrom, Roy. A Kit Can Be a Harpsichord. July, p. 34.
- Mayer, Martin. Who's Afraid of the Furtwängler *Ring*? Oct., p. 32.  
McClure, John T. The Cheerful Ghost of Eisenstadt: recording Haydn in Austria. Jan., p. 56.  
McIntyre, Edward F. Antidotes for Noise. July, p. 39.  
McMullen, Roy. The Ubiquitous Flutist: Jean-Pierre Rampal. May, p. 34.  
Miller, Philip L. Archives of Recorded Sound. June, p. 38.
- Osborne, Conrad L. The New Met. Sept., p. 50.  
Osborne, Conrad L. The Operas of Mozart on Microgroove: a discography-in-depth. Nov., p. 65.
- Radant, Else. The Strange Demise of W. A. Mozart. Mar., p. 62.  
Reid, Charles. Patti at Craig-y-Nos. July, p. 43.  
Rich, Leslie. Music for Non-Listening. Nov., p. 34.  
Rogoff, Gordon. "That True Phoenix"—Lorenzo da Ponte. Nov., p. 58.
- Smith, Patrick J. A Question of Function: music critics and musicologists. Mar., p. 67.  
Sterling, Albert. Basics for the Tape Recordist. Aug., p. 43.  
Sterling, Albert. Stereo Cartridges—a Status Report. Jan., p. 52.
- Trotter, William R. Sibelius and the Tide of Taste. Dec., p. 48.
- Vaughan, Denis. The Schubert Symphonies—A Revisionist View. Oct., p. 60.
- Weaver, William. Die Nilsson and La Nilsson: Birgit Nilsson. Feb., p. 48.  
Weaver, William. The Unknown Smetana. May, p. 44.

## Feature Articles Listed by Title

- Antidotes for Noise. July, p. 39.  
Archives of Recorded Sound. June, p. 38.
- Basics for the Tape Recordist. Aug., p. 43.  
Boadicea in Walthamstow: Joan Sutherland. Feb., p. 52.  
The British Audio Establishment. Apr., p. 56.
- The Cheerful Ghost of Eisenstadt: recording Haydn in Austria. Jan., p. 56.  
The City of Five Orchestras: London. Apr., p. 51.  
Conversations with Horowitz. Oct., p. 50.
- Extension Speakers. Mar., p. 70.
- The Honorable Tradition of Englishmen. Apr., p. 44.
- The Indispensable Antenna. Oct., p. 64.  
An Inquiry Into Spatial Stereo. May, p. 38.  
An Interview with Maria Callas. Feb., p. 42.
- A Kit Can Be a Harpsichord. July, p. 34.
- The Magnificent Monsters: a report on large speakers. Sept., p. 55.  
Masters, Matrices, and Mass Production. Jan., p. 46.  
The Miraculous Inventions of Heinrich Schütz. Aug., p. 51.  
"A Mixture of Instinct and Intellect": conversations between George Szell and Paul Henry Lang. Jan., p. 42.  
Mozart on the Eighteenth-Century Stage. Nov., p. 62.  
Music for Non-Listening. Nov., p. 34.  
The Music of Schütz on Records. Aug., p. 55.
- The New Met. Sept., p. 50.  
New Products: 1965. Oct., p. 55.  
New Trends in Stereo Kits. Feb., p. 57.  
Die Nilsson and La Nilsson: Birgit Nilsson. Feb., p. 48.
- The Operas of Mozart on Microgroove: a discography-in-depth. Nov., p. 65.
- Patti at Craig-y-Nos. July, p. 43.  
A Portfolio of Stereo Décor—1965 (picture spread with text). Mar., p. 54.

A Question of Function: music critics and musicologists. Mar., p. 67.

The Schubert Symphonies—A Revisionist View. Oct., p. 60.

Sibelius and the Tide of Taste. Dec., p. 48.

Signor Bettini's Cylinders. Aug., p. 24.

Sir Thomas and the Gramophone—1910-1960. June, p. 45.

A Soft Sound in the U.S.S.R.: the New York Pro Musica in the Soviet. May, p. 41.

Stereo Accessories for Under \$50 (picture spread with text). Dec., p. 54.

Stereo Cartridges—a Status Report. Jan., p. 52.

Stereo Question Box. Dec., p. 61

The Strange Demise of W. A. Mozart. Mar., p. 62.

Tape for Turnpikes. June, p. 42.

Tape in Transition. Aug., p. 36.

Tapes To Choose From. Aug., p. 40.

"That True Phoenix"—Lorenzo da Ponte. Nov., p. 58.

A Thorn Grows in Warsaw: Poland's musical avant-garde. Sept., p. 60.

Turntables and Changers. June, p. 34

The Ubiquitous Flutist: Jean-Pierre Rampal. May, p. 34.

The Unknown Smetana. May, p. 44.

When Records Reached the Supermarket. Dec., p. 56.

Who's Afraid of the Furtwängler Ring? Oct., p. 32.

Equipment Report Index will appear in January

## THE TAPE DECK

Continued from page 141

music. The recordings themselves are generally clean, bright, and light, and the tape processing is first-rate. But, over-all, the effect is numbing—a consequence possibly desirable in jet air travel but scarcely so in home listening. (Apparently there are other Astrovision pop programs coming along: the slow-speed reels W 9 and W 10 representing Mercury/Philips/Smash and Twentieth Century-Fox respectively.

**"Heritage."** Robert De Cormier Folk Singers. Command C 884, 34 min., \$7.95.

Although this program of "American Ballads and Songs, 1750-1840" is considerably more ambitious than that of the De Cormier group's first tape release (June 1964), it confirms my favorable earlier impressions of the ensemble's rhythmic precision and clarity of enunciation—even if, in the present case, the latter doesn't entirely justify the lack of a text leaflet, especially for the three William Billings classics: the relatively familiar *Chester*, poignant *David's Lamentation Assurance*, and amusing *Modern Music*. The date limitations haven't prevented the inclusion of Oscar Brand's fine *When I First Came to This Land* and perhaps some other ringers (I'm inclined to doubt the historical authenticity of *Betty Saro*). But besides the Billings items and the inevitable *Yankee Doodle*, there are such appropriate others as *Mad Anthony Wayne*, *The White Horses*, *Johnny Has Gone for a Soldier*, *In the Good Old Colony Days*, etc.—all of which are simply yet imaginatively arranged as well as excellently per-

formed, often in markedly antiphonal style, by a double chorus with light (and sometimes no) instrumental accompaniment.

**"Jug Band Music."** Jim Kveskin and the Jug Band. Vanguard VTC 1702, 43 min., \$7.95.

It's been a good many years since I've heard any authentic documentations of old-time jug bands from the back country, and in any case I don't pretend to any expertise on the subject. Moreover, I hesitate to quarrel with the Newport Festival and other audiences which have acclaimed the Kveskin Band in live performances. Just the same, my ears tell me that what I hear here is a pale and thin imitation of the distinctive sonics of which a true jug band is capable.

**"Flora, the Red Menace."** Original Broadway Cast Recording. Hal Hastings, cond. RCA Victor FTO 5036, 47 min., \$8.95.

**"Half a Sixpence."** Original Broadway Cast Recording. Stanley Lebowsky, cond. RCA Victor FTO 5035, 38 min., \$8.95.

The prime attractions of these reels are their brand-new stars, Liza Minnelli, daughter of Judy Garland but with a personality all her own, and Tommy Steele, British onetime rock 'n' roller reformed into a highly versatile and engaging song-and-dance man. *Flora* is rather lightweight, but if you're in the mood for a disarming combination of mild nostalgia and mild comedy you'll probably relish, in addition to Miss Minnelli's contributions, the amusing evocations of the Thirties by Mary Louise Wilson (in *The Flame* and *Knock*,

Continued on page 144

## New from Acoustech The Add-A-Kit Amplifier



An excitingly different way  
to build a solid state  
amplifying system

First — Build the Acoustech XI



In less than four hours, a stereo power amplifier kit with 35 watts, equivalent RMS power per channel at less than 1/4% IM — PC boards, pre-wired and tested — all parts in bags mounted on KitKloth in order of use — works well with any good preamplifier, tube or transistor, only \$129.50.

Second — Add the preamp module



anytime you want, the preamplifier fits right into the same chassis — inaudible hum and noise — amazing transient response — all the features you need — only \$89.50, complete with gold anodized panel.

World-famous, "State of the Art" Acoustech amplifying system can now be yours at moderate cost. See your dealer, or mail coupon below for full details.

# ACOUSTECH

ACOUSTECH, INC.  
Div. of Koss/Rek-O-Kut  
Dept. H12, 139 Main Street  
Cambridge, Mass. 02142  
FREE Newly revised, edition



Please send free booklet "Why Solid State Amplifiers Can Sound Better" and full information on Acoustech solid state kits to

Name \_\_\_\_\_

Address \_\_\_\_\_

City \_\_\_\_\_ Zone \_\_\_\_\_ State \_\_\_\_\_

CIRCLE 1 ON READER-SERVICE CARD

THE

# Turntable of the Tape-Age

## 807



Enjoy playing the superior quality of tapes with the convenience of phonograph records.

Connect a Viking 807 to your music system and play stereo or monaural tapes, half or quarter track at 3-3/4 or 7-1/2 ips. Automatic shut-off, Cueing, Counter and Pause features included for your pleasure.

## 807

complete with walnut base

# \$154<sup>95</sup>

MADE BY SKILLED  
AMERICAN CRAFTSMEN AT



OF MINNEAPOLIS®

9600 Aldrich Ave. So. Minneapolis, Minn. 55420

CIRCLE 91 ON READER-SERVICE CARD

## THE TAPE DECK

Continued from page 141

Knock), Bob Dishy (in *Sign Here* and *Express Yourself*), and James Cresson (in *Palomino Pal*). The brashness of the vividly bright recording is accentuated by oppressively close miking of the soloists. This fault is happily absent in the more moderately modulated and more natural recording of *Half a Sixpence*. David Heneker's musical-comedy version of H. G. Wells's delectable novel *Kipps*. The music here is also light-weight perhaps, but it is less synthetically contrived and at its best boasts a quite irresistible British music-hall verve. Steele is given effective support by a skilled supporting cast, topped by the charming Polly James, who does as well with the more sentimental airs as Steele does with such lively ones as *Flash Bang Wallop!*, *The Party's on the House*, *Money To Burn*, etc.

**"Guys and Dolls."** Original Cast Recording. Irving Actman, cond. Decca ST 74 9023, 42 min., \$7.95.

All right, so I'm a sucker for nostalgia! But hearing the Frank Loesser *Meisterwerk* freed of the distortions and ticks of my well-worn disc copy, I'm convinced all over again that this is one of, if not *the*, most rewarding musical shows of all time. From the delectable *Fugue for Greenhorns* to the last reprise of *Guys and Dolls*, a listener is equally delighted and awed as he is presented with one incomparable hit after another. And just when one is convinced that nothing can top Stubby Kaye's *Sit Down, You're Rocking the Boat*, or Vivian Blaine's *A Bushel and a Peck*, *Adelaide's Lament*, *Take Back Your Mink*, and (with Sam Levene) *Sue Me*, along comes Pat Rooney, Sr., to break one's heart with *More I Cannot Wish You*. If the "enhancing for stereotape" hasn't achieved any feeling of true stereoism, it has spaced out the sonics a bit without doing any real harm to the fine, strong, if maybe a bit hollow, original recording. There have been a good many original-cast performances made available on tape by this time, but not one of them, new or old, has given me more consistently lively pleasure than this one!

**"Music of a People."** London Festival Chorus and Orchestra, Stanley Black, cond. London LPL 74060, 39 min., \$7.95.

**"The Beloved Melodies of Stephen Foster."** Eric Rogers Chorale and Orchestra. London LPL 74050, 41 min., \$7.95.

Of this latest pair of Phase-4 recordings in tape transfers, Stanley Black's "Music of a People" is a surprisingly serious and sensitive attempt to make the most of typical old and new Jewish melodies. At their best both his scorings and performances are a delight—the dramatic introductory *Shema* and exciting *Hava Nagala*, the tender *Almonds and Raisins* lullaby, and the amusing *Yes, My Darling Daughter*. But also highly effective are his whirling *Tzena, Tzena*, catchy *Joseph!*

*Joseph!*, and robust Israeli national anthem *Hatikvah*; and even the much more sentimental *Eili Eili*, *Letter to My Mother*, and Achron *Hebrew Melody* are by no means lacking in haunting appeal. The stereo recording itself is quite monumental in its strength, breadth, and almost palpable solidity.

In the Stephen Foster program the same engineers revert to the exaggerated left- and right-channel differentiations, antiphonies, and "persuasive-percussion" switching jumps of a more juvenile stereo age. Worse than the sonic trickery, however, which at least is handled with professional skill, are Rogers' cynically contrived arrangements and performances. The distinction between sentiment and sentimentality is one entirely lost here: there is no "feel" at all for the authentic idioms and spirit of these materials. There are some occasionally striking effects, of course, as in the theatrical treatment of *Ring de Banjo*, but long before most listeners get through the seemingly endless *Stephen Foster Rhapsody* which winds up this thoroughly tasteless program they are likely to be quite nauseated.

**"Spectaculars!"** Philadelphia Orchestra, Eugene Ormandy, cond. Columbia MQ 730, 37 min., \$7.95.

For once a come-on title is no misnomer: the thirteen selections are all long successful show-off music, the performances are the Philadelphians' most high-powered, and the stereo sonics are stupendous—just about as brilliantly sharp in the extreme highs as in the disc edition and even more substantial in the midrange and low frequencies. Included are excerpts from Ormandy programs devoted to such ballets as *Gaité Parisienne*, *The Nutcracker*, *Swan Lake*, *Coppélia*, and *Sylvia*, plus Prokofiev's *Lt. Kije*, the Strauss family *Tritsch-tratsch* and *Feuerfest* Polkas, and a Galop from the *Gioconda* "Dance of the Hours"—all but the last of which have been available in earlier (1962-64) tape releases. Here, however, they seem to be processed with somewhat heavier modulation levels: at any rate, the sonics are mighty loud at their loudest, and even in the relatively few quieter moments they are impressively big.

**"Tenderly."** Boston Pops Orchestra, Arthur Fiedler, cond. RCA Victor FTC 2201, 40 min., \$7.95.

There's very little to surprise one any more in hearing favorite torch songs elaborately arranged by Jack Mason and Dick Hayman for richly multicolored symphonic presentation. Just the same, few previous programs of this kind have been more effectively devoted to unabashed melodic schmaltz than this one, which ranges from current hits (*San Francisco*, etc.) through pop standards (*September Song*, *Through the Years*, etc.) to the European *Yours Is My Heart Alone*, *Vienna City of My Dreams*, and even the Brahms *Cradle Song*. Tough-eared sophisticates will poke fun at these lush inflations, but a mass audience yearning to be tranquilized will no doubt be enraptured.

## SIBELIUS DISCOGRAPHY

Continued from page 53

more or less complete set (Vanguard 489/90), which includes the only recorded example of *The Bard and Night Ride and Sunrise*. To my mind, this collection is out of the running. Dated sound, Boult's pedantic, four-square conducting, and the rather characterless playing of the Proms orchestra all combine to make boringly routine performances.

*En Saga*, Op. 9 was considered a historic piece of music. Once. At the time it was written, no one had ever written anything like it: no one has since. Ormandy did well with it on a now hard-to-find Sibelius collection (Columbia ML 5249). Sir Malcolm Sargent in his Odeon collection (ALP 1990 or ASD 541) does even better. The Vienna Philharmonic plays the piece with lots of swagger and gorgeous tone.

The youthful *Karelia Suite*, Op. 11 is one of those unpretentious pieces of music that are simply good fun to listen to occasionally. Sargent on the Odeon disc and Maazel, as a bonus on his First Symphony recording, offer the best available readings. Maazel excels with the zippy outer movements, but Sargent has a way of making the orchestra sing more beautifully in the soulful "ballade" section. Each version, in its own way, is excellent.

The *Four Legends*, Op. 22, also known as the *Lemminkäinen Suite*, are done with authority by the Finnish conductor Tauno Hannikainen and the U.S.S.R. Radio Orchestra on a Soviet impopt (MK 1558), although this *Swan of Tuonela* is oddly dim and reticent. The *Swan of Tuonela*, though technically part of the *Four Legends*, is nearly always recorded as a separate item. There are several good performances—Ormandy's (with the Violin Concerto), Morton Gould's (with *Finlandia*, etc., on RCA Victor LM 2666 or LSC 2666), Sargent's (on the Odeon set)—but there is, to my mind, only one great one: Leopold Stokowski's (Capitol P 8399 or SP 8399). Here the Maestro conjures up a sense of the mysterious and otherworldly which is almost terrifyingly evocative. *Lemminkäinen's Return* gets a lusty, virile rendering from Gould.

The much maligned *Finlandia*, Op. 26 suffers from a plethora of stodgy, bloated readings, epitomized by the abortion committed by Ormandy and the Mormon Tabernacle Choir (Columbia ML 5596 or MS 6196). There are two really superb *Finlandias* at the head of the list. Gould (on the RCA Victor disc cited above) gives a reading of fiery militancy and fervor; Von Karajan on the reverse side of his second recording of the Fifth Symphony (Angel 35922 or S 35922) gives a tonally stunning, darkly massive, almost Teutonic account. Some may think this reading takes the music too seriously, but I personally find it very thrilling. Sir Malcolm Sargent and the Vienna Philharmonic on the Odeon set give a richly musical performance, but without the stylistic excellences of either Gould or Von Karajan.

*Pohjola's Daughter*. Op. 49 gets an overdeliberate treatment from Gould, a lilting, just-right one from Barbirolli (coupled with the Fifth Symphony).

The *Oceanides*, Op. 73 is one of Sibelius' most beautiful works, and both Beecham (on the Angel set including Symphony No. 7) and Ormandy (on the deleted Columbia disc, ML 5249) make the most out of its impressionistic qualities. Predictably, Beecham is more careful in his attention to details, but the tonal splendor of the Philadelphia is a joy to the ear.

The last and greatest tone poem, *Tapiola*, Op. 112 is acceptably done by Hannikainen (Everest 6045), and a bit less acceptably by Ansermet (coupled with the Fourth); both conductors mince details and both use that dratted overfast, BAM-BAM-BAM-BAM-BAM! treatment for the storm passages, which I insist unto death is wrong. This music is too mystical, too boundless, to allow for anything but an expansive, atmospheric reading. A "straight" performance just misses the mark entirely. Oddly, no one has ever caught that gloom-and-sunlight vastness of the Northern forests on records the way Von Karajan has. His Deutsche Grammophon performance with the Berlin Philharmonic, coupled with the Fifth Symphony, is fine in its way, but I cannot place it ahead of the old Philharmonia performance (Angel 35002), which was pervaded by a chilling sense of majestic awe quite unlike anything I have ever heard. Beecham's (Odeon ALP 1968 or ASD 518) has some exquisite moments and superb playing, but once again Sir Thomas fusses with the phrasing too often for my taste.

Brief mention should be made of the only real representations of Sibelius' theatre music. The now deleted Westminster 18529 featured the music to *The Tempest* and *King Christian II* Suites warmly played by the Stockholm Radio Orchestra under Stig Westerberg. The disc is a splendid one, well worth the trouble of locating in collectors' stores. Beecham gives a moving, tender performance of the Suite from *Pelléas et Mélisande* on the Angel record including the Seventh Symphony.

But so much is missing! *Luonotar*, *Night Ride and Sunrise*, *Rakastava*, *The Origin of Fire*, up-to-date versions of the Third and Sixth Symphonies. Leonard Bernstein—a man temperamentally suited to the heroic vein of Sibelius if not to the mystic—has expressed interest in some of the lesser-known pieces, and there are plans for him to record a number of Sibelius works this season. These could be exciting recordings. But there are still a number of fascinating Sibelius scores which no one outside of Finland seems interested in performing. What one would not give to hear the huge, early *Kullervo* Symphony in its entirety or the full music to *The Tempest*? Perhaps some day these gaps will be filled. Until then, we must be grateful for the fine recordings which can introduce this music to the uninitiated listener, and give continued delight to the listener who already responds to Sibelius' special kind of magic.

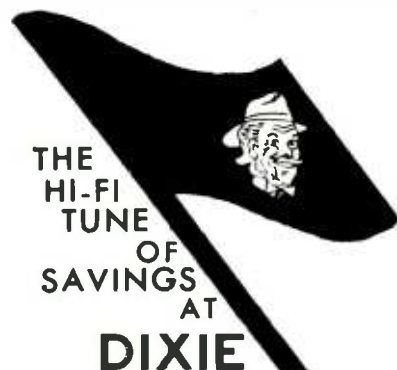

Largest discount High Fidelity component distributors in the South. Wholesale prices on package or individual components. Latest models in factory sealed cartons shipped immediately from our warehouse. Special attention given to Audio Clubs, Churches and Schools.  
For Special Price Quote—Write



CIRCLE 24 ON READER-SERVICE CARD



- LOWEST PRICES
- SAME DAY REPLY TO YOUR INQUIRY
- MFRS. SEALED CARTONS
- DOUBLE BOXED WHEN POSSIBLE
- FAST, INSURED SHIPMENTS
- PACKAGE DEALS SAVE YOU MORE
- FRANCHISED DISTRIBUTORS FOR OVER 50 MFRS.
- PARKING METERS AT PREMISES

• SPECIAL STEREO DYNE II DIAMOND STEREO CARTRIDGE — \$7.25 ppd.

Send for FREE "MONTHLY SPECIALS" on other Cartridges, Tapes, and Components.

WRITE FOR MONTHLY SPECIALS VISIT OUR STORE  
**CARSTON** Studios

1686-F Secane Ave. (Nr. 87), N.Y. 10028

CIRCLE 15 ON READER-SERVICE CARD

SAVE MONEY on

NATIONALLY  
ADVERTISED BRANDS

# HI-FI COMPONENTS TAPE RECORDERS



TAPES,  
ACCESSORIES  
SLEEP LEARN KITS

MERITAPE

Top Quality Recording Tape

- Franchised Distributors
- Factory Sealed Cartons
- Lowest Prices
- Integrity—Service

Write for our  
VERY LOW QUOTATIONS

FREE CATALOG

## DRESSNER

1523 Jericho Tpke. New Hyde Park 32, N.Y.  
Visit Our Showroom

CIRCLE 25 ON READER-SERVICE CARD

## WRITE FOR QUOTATION

FACTORY SEALED CARTONS  
FRANCHISED DISTRIBUTOR  
QUICK SHIPMENT

## WE GIVE DISCOUNTS ON HI-FI COMPONENTS

### SOUND REPRODUCTION INC.

34 New Street, Newark, N. J. (07102)  
(201) Mitchell 2-6816

CIRCLE 75 ON READER-SERVICE CARD

## WHEN RECORDS REACHED THE SUPERMARKET

Continued from page 60

different from anything he had encountered before. Thus, instead of the broad "curtain of sound" which had been the early stereo ideal, Light favored two distinctly separate sound sources, and for them devised some delightful arrangements in which the musical line shuttled back and forth from one speaker to the other, like the ball in a ping-pong game. The record was wildly successful. For more than two years, *Persuasive Percussion* and its sequel *Provocative Percussion* dominated the popular record business; between them they sold a total of 800,000 copies. Naturally, other companies followed Command's lead, and in due course the market became glutted with every conceivable kind of stereo gimmickry. By the time the public had had its fill, however, stereo was established as the preferred choice for home listening.

In changing over to twin-channel sound, the record buyer was also changing over to new and greatly improved listening gear. Few people bothered to make the requisite conversions of their old mono sets; it was easier and sightlier to start from scratch. For stereo's acceptance in the home had been facilitated by a progressive miniaturization of high-fidelity apparatus. Small "book-shelf" speakers were now capable of reproducing the full gamut of sound, from the lowest organ-pedal throb to upper frequencies beyond audibility; compact automatic turntables were combining the convenience of the old changer mechanisms with the performance capabilities of studio transcription equipment; miniature tubes and, later, transistors were enabling manufacturers to offer superior electronics in minimal space. High-fidelity componentry was also reaching out for a mass market; and as it proliferated, more and more listeners were growing impatient with the tubby "console" sound of yore.

The advent of stereo allowed record companies to raise the list price of classical discs to \$5.98—back, that is, to the level prevailing before the price slash of January 1955. But in the interim the industry's complexion had altered almost beyond recognition. Most of the independents spawned by LP had either

disappeared altogether (like Concert Hall and the Haydn Society) or gone into receivership (like Urania and Westminster), victims of circumstances (price cuts, clubs, the whole realignment of buying habits) and of their own too ambitious expansion. The majors themselves had also undergone considerable metamorphosis. In January 1955 the British-controlled Electric and Musical Industries combine had purchased Capitol Records for something over four million dollars, a transaction which tolled the death knell for the fifty-five-year-old reciprocal exchange agreement between RCA's Victor label and EMI's His Master's Voice label. Soon Capitol became sole distributor in the Western Hemisphere for EMI recordings, while RCA concomitantly set up its own subsidiaries in Europe to record and sell Victor productions. EMI's entry into the American market was symptomatic of a general reawakening and expansion of European record firms. Deutsche Grammophon again became a formidable power, bidding high for celebrated artists in both classics and pops, and achieving world renown for its scholarly Archive Series of pre-nineteenth-century repertoire; while in Holland the huge Philips electrical empire launched its own record company, ultimately establishing a strong foothold in Europe and later, with the acquisition of Mercury Records, entering the American market as well.

**B**UT PERHAPS the greatest metamorphosis of all lay in the record entrepreneurs themselves. A new kind of executive had emerged from the ranks—men of culture and taste and responsibility, typified by Columbia's Goddard Lieberson, a composer-critic-novelist, and by RCA Victor's George R. Marek, a biographer and authority on opera. These new leaders of the industry had as sharp an eye for profits as their predecessors, but they were nevertheless men of an entirely different stamp from the musically obfuscated Thomas Edisons and Edward Eastons of the early days, and the creativity which they and their associates brought to the industry augured well for its future well-being.

In a business as fertile and burgeoning as this one, creativity was in high demand. Record companies no longer existed in splendid isolation but had become increasingly intertwined with the whole entertainment industry, and with the gestation of Broadway musicals in particular. Columbia had led the way with *My Fair Lady*, the Frederick Loewe-Alan Jay Lerner adaptation of Shaw's *Pygmalion*. Long before the show's opening night in March 1956, Goddard Lieberson had examined the score and persuaded Columbia's parent corporation, CBS, to finance the entire production. It turned out to be a bonanza without

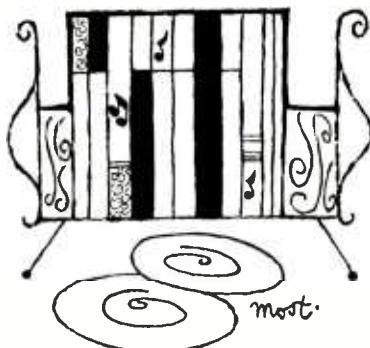

precedent. Columbia Records automatically enjoyed rights to the original-cast recording, which sold in excess of 5,000,000 copies, more than any other album in the history of the industry. Later, Columbia brought out the movie soundtrack recording as well, and all the while the parent corporation was profiting handsomely from its initial investment in the show. After 1956, very few Broadway musicals went before the public without large-scale participation, both financial and creative, from one of the major record companies. And though nothing ever duplicated *My Fair Lady* and much money was lost on outright failures, the potential for great profits remained high, and it seemed as if record companies and Broadway producers would remain partners for a good while to come.

There were advantageous partnerships, too, with the movies, television, and the legitimate theatre. For in the decade following RCA's price reductions and Columbia's formation of a mail-order club, the record industry had indeed found a mass audience. You could follow the story in its annual sales figures, jumping from \$199,000,000 in 1954 to \$693,000,000 ten years later, but in truth the evidence was apparent wherever you looked. Records had become a standard American commodity, almost like soap flakes or candy bars, and everyone seemed to be buying. Even the kids in elementary school were now cash customers, for the phenomenon of rock-and-roll music had made fervent record listeners out of the subteen and teenage population, an affluent society that paid out \$175,000,000 in 1964 for its beloved 45s. As the teenagers married and settled down, their purchases of singles would taper off in favor of stereo albums. But they had been bitten by the record bug early and were likely to remain addicted. The "stereo hi-fi" occupied a favored position in the newly-weds' list of essential furniture.

And though they might begin with The Beatles, a few of them were going to end up with Bach and Varèse. The base of the pyramid was huge, but there remained plenty of room at the top, for complete recordings of Schoenberg's collected works and Wagner's *Ring*, for the Britten *War Requiem* and the Mahler *Resurrection* Symphony, for Horowitz's Scarlatti and Fischer-Dieskau's Schubert. Higher profits had not been purchased with lowered standards, and as the phonograph approached its ninetyeth birthday the instrument appeared to be in fabulously radiant health.



# Why?

DO THOUSANDS OF HI-FI ENTHUSIASTS BUY FROM AUDIO UNLIMITED

## It's Obvious!

- LOWEST PRICES
- FAST SERVICE
- FACTORY SEALED UNITS
- FULLY INSURED SHIPMENTS
- MANUFACTURERS' WARRANTIES
- PACKAGE DEALS—SAVE MORE
- FRANCHISED DISTRIBUTORS

Write for **FREE** Listing today

**SEND US YOUR LIST FOR OUR AIR MAIL QUOTE TODAY**

Visit Our Showroom and Warehouse

**AUDIO** unlimited, inc.  
715-F Second Ave. (Nr. 38) N. Y. 16, N. Y.  
3 blocks from the U.N.

laboratory standard

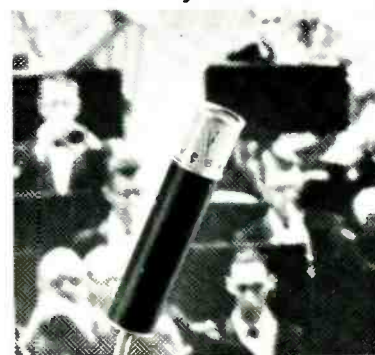

## VEGA

### Capacitor Microphone

You capture the *complete sound* every time. Whether it's a big symphony orchestra, a mighty pipe organ or a combo. Ultra low distortion. Exciting fidelity, transparency and clarity. 10-20,000 hz linear response guaranteed. Switchable low or high impedance output. Switchable low frequency filter. Superior stability. *Why accept less?*

Single microphone, power supply **\$185**

Two microphones and dual power supply for economical stereo arrangement . . . . . **\$315**

Write for free brochure. Vega Electronics Corp. (creator of the world-famous Vega-Mike® wireless microphone), 1161 Richard Ave., Santa Clara, Calif. 95050. (Ask any franchised Vega dealer for a demonstration.)

CIRCLE 90 ON READER-SERVICE CARD

## SAVE over 40% on hi-fi

### COMPONENTS & TAPE RECORDERS

- Easy-Pay-Plan—Up to 24 mos. to pay
- 15 day money-back guarantee.
- Franchised all lines, assuring you up to 5 yr. Mfr. Warranty.
- Most items shipped promptly from our \$250,000 inventory.
- Trade-Ins—Highest allow.—Send your list.
- Shipments double packed & fully insured.
- Our Specialty—Export & APO inquiries.
- 21st yr. dependable service—World Wide. Write for price, and receive **FREE**—\$1.00 List—Clip-on-Record Brush or Record Cloth (please specify)

*We own the sharpest pencils in the U.S.A.*

### PREMIUM RECORDING TAPE GUARANTEED TOP QUALITY

Type	Brand	3-11	12+
166	3M	7" 1200'	Acetate Ea. 1.19 1.09
167	3M	7" 1800'	Acetate Ea. 1.39 1.29
941-15	Ampex	7" 1800'	Mylar Ea. 2.69 2.59
A724M	Allegra	7" 2400'	Mylar Ea. 2.49 2.29
A724T	Allegra	7" 2400'	Ten.Mylar Ea. 3.49 3.29

Minimum Order \$10.00. All prices include shipping USA, APO. Any assortment permitted for best price. 100+ reels deduct additional 10%. Please write for types not listed.

## HI-FIDELITY

CENTER  
"The House of Low Low Prices"

1797-H 1st Ave.  
New York, N. Y. • 10028

CIRCLE 42 ON READER-SERVICE CARD

# Olson

## FREE

Fill in coupon for a **FREE** One Year Subscription to **OLSON ELECTRONICS' Fantastic Value Packed Catalog**—Unheard of **LOW, LOW PRICES** on Brand Name Speakers, Changers, Tubes, Tools, Stereo Amps, Tuners, CB, Hi-Fi's, and thousands of other Electronic Values. Credit plan available.

NAME \_\_\_\_\_  
ADDRESS \_\_\_\_\_  
CITY \_\_\_\_\_ ZONE \_\_\_\_\_ STATE \_\_\_\_\_

If you have a friend interested in electronics send his name and address for a **FREE** subscription also.

**OLSON ELECTRONICS, INC.**

434 S. Forge Street Akron, Ohio 44308

CIRCLE 58 ON READER-SERVICE CARD

*This Christmas Shopping Guide is designed to make your Holiday gift buying easy . . . use it to make your gift selections. You will find something for each and every music listener on your Christmas list. Your favorite high fidelity or record shop is the best place for filling every Christmas stocking.*



# high fidelity CHRISTMAS SHOPPING GUIDE



Component-quality stereo goes portable with E-V Entertainer 1. Response from 70 to 15,000 cps from 8" dual-cone speakers. Diamond needle, Garrard changer, 30-watt solid-state amplifier. Handsome, scuff-proof, luggage style cases. \$199. Electro-Voice Inc., Buchanan, Mich. (1)



E-V 1178 sensitive solid-state AM/Stereo FM tuner & 50-watt stereo amplifier, all in one compact unit. Tuning meter, full time stereo indicator, handsome walnut-paneled case. Fits any shelf. Ideal mate to E-V 7 speakers. \$315. Electro-Voice Inc., Buchanan, Mich. (2)



Compact E-V SEVEN fits any bookshelf. 8" acoustic-suspension woofer, 3 1/2" tweeter. Smooth response from 50 to 15,000 cps. Handles 50 watt peaks. Hand-rubbed walnut cabinet finished all 4 sides. \$65. Electro-Voice Inc., Buchanan, Mich. (3)



Fisher 440-T Transistorized 70-Watt\* FM-Stereo-Multiplex Receiver. All solid state 4-gang front end, Stereo Beacon, d'Arsonval tuning meter. 4 IF stages, 3 limiters. 2.0 microvolt sensitivity (IHF). Fisher Radio Corp., 11-35 45th Road, L.I.C., N.Y.  
\*At 4 ohms; 50 watts at 8 ohms. (4)



Fisher 50 Portable. 30-Watt Transistorized Stereo Master Control Amplifier. Front-panel headphone jack, speaker-silencing switch. Detachable speaker systems. Garrard 4-speed automatic turntable. 3 piece unit snaps into Royalite® case. Fisher Radio Corp., 11-35 45th Rd., L.I.C., N.Y. (5)



Fisher 500-C 75-Watt Stereo Multiplex Receiver with Stereo Beacon, Nuvistor-Golden Synchrode front-end. 4 IF stages, 3 limiters. 1.8 microvolt sensitivity (IHF). d'Arsonval tuning meter. Heavy-duty transformers with grain-oriented laminated steel cores. Fisher Radio, 11-35 45th Rd., L.I.C., N.Y. (6)





Fisher TX-200 90-Watt Transistorized Stereo Control Amplifier. Direct-Tape-Monitor, front-panel headphone jack, speaker-silencing switch, 6-position selector, 3-position Mode Selector. RMS power per channel: 35 Watts. Fisher Radio Corporation, 11-35 45th Road, Long Island City, N. Y. (7)



Fisher KX-90 StrataKit 40-Watt Stereo Control Amplifier. Reliable Fisher engineering at 'do-it-yourself' prices. 4-position Selector, front-panel headphone jack, speaker silencing switch. Full input-output facilities. Fisher Radio Corporation, 11-35 45th Road, Long Island City, New York. (8)



Fisher XP-7 Four Speaker 3-Way Speaker System. 12-inch free-piston bass, two 5-inch mid-range, 2½-inch soft-dome treble speaker. Crossover at 300 and 2500 cps. In attractive oiled Walnut cabinet measuring 23"W x 13"H x 10½"D. Fisher Radio Corporation, 11-35 45th Road, L.I.C., N.Y. (9)



Rockford Acoustical Cabinetry. Model 560-561 Contemporary Ensemble takes tape deck, changer, tuner/amp. in center cabinet; 15" speakers; tweeters in twin enclosures. Oil walnut finish. More styles, sizes available. Rockford Special Furniture Co., 2024 23rd Ave., Rockford, Ill. (10)



A Sound Christmas Gift! 30 watt system with Unbound Sound electric guitar amplifier. Tremolo, 3 instrument inputs, 5 controls, 5 tubes, 2 dual purpose, 3 transistor REVERB circuit with Hammond Reverb units. 24 lbs., 19x19x9". \$149.95 Gregory Amplifier Corp., 3650 Dyre Ave., Bronx, N.Y. (11)

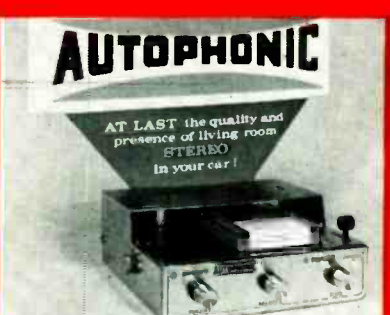

**AUTOPHONIC**  
 AT LAST the quality and presence of living room STEREO in your car!  
 "NOW STEREO YOUR CAR!"  
 AUTOPHONIC professional 4 track continuous Stereo tape cartridge player now available for your car . . . dual heads . . . full gain amplifiers . . . fully transistorized . . . no static interference . . . no fading. Quality Audionics, Inc., 39 W 55th St., NYC 10019 (12)



Harman-Kardon Stratophonic Compact Music System SC-440, 36-watt all-transistor AM/FM stereo receiver; Garrard changer; H-K twin speaker systems featuring wide sound dispersal for full stereo effect at any point in room. \$399. Harman-Kardon, Inc., Philadelphia, Pa. 19132. (13)



Harman-Kardon Stratophonic 75-watt Solid-State FM Stereo Receiver SR-900. New performance standard for all-in-one receivers. Power bandwidth 3 to 75,000 cps; distortion less than 0.2%; hum & noise 95 db down; usable FM sensitivity 1.85 μv IHF. \$429. Harman-Kardon, Inc., Phila., Pa. 19132. (14)

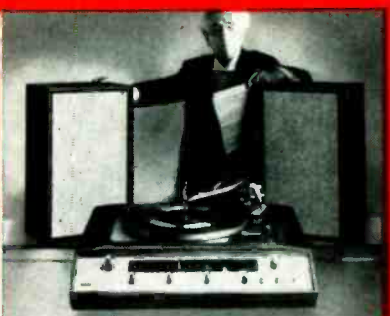

Harman-Kardon Stratophonic Solid-State AM/FM Stereo Receiver SR-400. 36 watts IHF music power; power bandwidth 9 to 24,000 cps; distortion less than 1%; usable FM sensitivity 2.9 μv IHF; multiplex separation 30 db. \$289. Harman-Kardon, Inc., Philadelphia, Pa. 19132. (15)

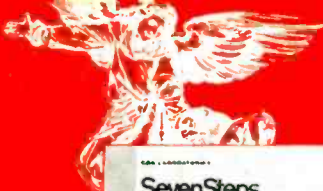

Seven Steps  
to Better Listening

# 13467

1 2 3 4 5 6 7

Seven Steps To Better Listening. This record and your own ears are all you need to get the most from your system. Simple instructions show how to balance channels, speaker phasing, etc. Only \$5 pp—Delivery by Christmas guaranteed. CBS Laboratories, Stamford, Conn. (16)



ME-99 Magnetic Bulk Tape Eraser. Clears entire reel in seconds without rewinding; removes unwanted signals; reduces background noise from 3-6 db below normal erase head level. Takes up to 10 1/2" reel, 1/2" tape. \$43.50. Robins Industries Corp., 15-58 127th St., Flushing, New York. (17)

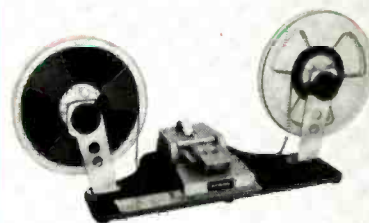

TK-9 Complete Tape Editing Workshop. Hand operated tape winders teamed with famous "Gibson Girl" Stereo 4 Deluxe Tape Splicer for fast Tape editing, repairs. Calibrated Tape Timing and Editing Scale. 7x14x5 1/2". \$24. Robins Industries Corp., 15-58 127th St., Flushing, New York. (18)



PK-10 Deluxe Phono-Record Care Kit. Contains: 10" Foam Cushion; Strobe & Light to check speed; 15 record covers; Record Brush; Stylus Pressure gauge; Stylus Microscope; "Disk-Whisk" Kit; 144 Friction-Spots; 12 "Platter-Pusses". \$16. Robins Industries Corp., 15-58 127th St., Flushing, N.Y. (19)



Benjamin DC-2 Dust Cover fits Miracord and other turntables and record changers. Made of heavy-gauge, high-impact, vacuum-formed clear plastic. 13 1/2 x 15 3/8 x 3 3/8". \$5.95 at most hi-fi dealers. Benjamin Electric Sound Corp., Farmingdale, N.Y. 11736. (20)



Benjamin-Elac Stereo diamond-stylus, magnetic cartridges—wide frequency response, low distortion, relatively high output. Elac 322: \$24.95; Elac 322DE (elliptical stylus): \$29.95; Elac 240 (mono/stereo): \$19.95. Benjamin Electronic Sound Corp., Farmingdale, N.Y. 11736 (21)



Heritage III . . . Utah's proudest achievement. Each component in this 8-speaker system has been carefully developed. 4 5" tweeters, 2 8" mid-range, 2 matched 12" heavy duty woofers. 30 1/2 x 33 x 18 3/4". \$229.95. Write for complete specs. Utah Electronics, Huntington, Ind. (22)



Cartridge-Loading "Lodestar" changes tapes in 2 seconds. Lets you do everything from the hip . . . record, play, and reload without removing Lodestar from its case. Only 32 oz., 6 1/2 x 3 1/2 x 1 3/8". One knob control, clip-on dynamic mike. Hi-Fidelity Center, 1797-A 1st Ave., NYC 10028. (23)



Whisper Fan adds years to hi-fi systems, costs less than average service call. Moves 60 cu. ft. of air a minute; draws only 7 watts. Prelubed bearings need no attention. Fits anywhere; mounts quickly; runs silently. Rotron Manufacturing Co. Woodstock, New York (24)



Garrard's Lab 80 Automatic Transcription Turntable is unequalled by any unit on the market. Dynamically balanced; counterweight adjusted tone arm; calibrated Click-set stylus pressure; anti-skating; built-in cuing; many other features. \$99.50. Garrard, Div. of British Industries, Westbury, NY (25)



New Garrard AT60 Automatic Turntable. Dynamically balanced counterweight—adjusted tubular tone arm; stylus pressure gauge; automatic anti-skating compensator; automatic intermix operation when desired; plus many other features. \$59.50. Garrard, Div. of British Industries, Westbury, N.Y. (26)



Garrard Model 50 Automatic Turntable. Counterweighted cast aluminum tone arm; lightweight cut away shell; tone arm safety catch; automatic intermix operation; simple stylus pressure adjustment; optional decorator styled base; many other features. \$44.50. Garrard, Westbury, N.Y. (27)



Wharfedale W30 speaker with entirely new technique for complete acoustical correction: the Acoustic Compensation Circuit. Bookshelf dimensions: 19 x 10 x 9 1/4". Oiled/Polished Walnut \$69.95; Sanded Birch \$63.95. Wharfedale, Div. British Industries, Westbury, N.Y. (28)



Wharfedale W60 Full Range 2-Speaker System in exclusive Sand-Filled Enclosure. 12 1/2" low freq. driver; 5" high freq. driver. Power: 5 watts or more; Dimensions: 14 1/4 x 13 x 24". Oiled/Polished Walnut \$122.50; Sanded Birch \$106.50. Wharfedale, Div. British Industries, Westbury, N.Y. (29)

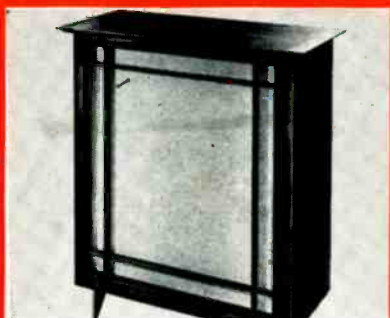

Wharfedale W90 6-Speaker System—the ultimate Achromatic system. 2 12 1/2" low freq. drivers; 2 5 1/4" mid-range; 2 3" high freq. speakers. Power: 12 watts or more; Dimensions: 32 1/4 x 30 3/4 x 14 1/4". Oiled/Polished Walnut \$272.50. Wharfedale, Div. British Industries, Westbury, N.Y. (30)

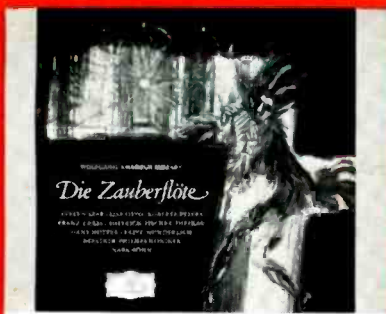

Mozart's "The Magic Flute"—18 981/3; 138 981/3 (Stereo). New DGG version with Evelyn Lear, Lisa Otto, Robert Peters, Franz Crass, Dietrich Fischer-Dieskau, Hans Hotter, James King, Fritz Wunderlich & others; Berlin Philharmonic conducted by Karl Boehm. Boxed 3-Disc Set, with libretto. (31)

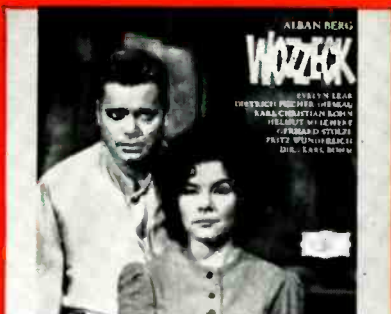

Alban Berg's "Wozzeck"—18 991/2; 138 991/2 (Stereo). Only new recording in many years. The definitive performance by a spectacular cast: Evelyn Lear, Dietrich Fischer-Dieskau, Fritz Wunderlich, and others, with Orchestra and Chorus of the German Opera, Berlin; Karl Boehm, conductor. (32)



DGG presents the first Stereo Recording of Arnold Schoenberg's "Gurre Lieder"—18 984/5; 138 984/5 (Stereo). Brilliantly conducted by Rafael Kubelik and recorded live in Munich this year. With the Bavarian Radio Symphony are three separate male choirs, a huge mixed chorus. (33)



McIntosh C24 Solid State Preamp. Freq. Response  $\pm 0.5$  db 20/20,000 cps. Distortion less than .1% at 2.5 volts; less than .3% at 10 volts. Features 3 high and 3 low level inputs. Many other features. \$249. McIntosh Laboratory, Binghamton, New York. (34)



McIntosh MC275 Stereo Power House. Two 75 watt amplifiers on one compact chassis. 75 watts per channel. Freq. Range output. Typical performance distortion less than .3% 20/20,000 cps at full power. \$440. McIntosh Laboratory, Binghamton, New York. (35)



McIntosh MA230 Compact Pre-Amp/Amplifier with 30 watts Power Output per channel. Distortion less than 0.5% at 30 watts. Frequency Range  $\pm 0.5$  db 20 through 20,000 cps. \$349. McIntosh Laboratory, Binghamton, New York. (36)

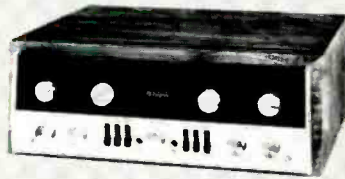

McIntosh C22 Preamp. Frequency Response:  $\pm 0.5$  db from 20 to 20,000 cps; Distortion: less than 0.2% at 10 volts output 20/20,000 cps, less than .1% at 3 volt output. 4 high level, 4 low level inputs. \$279. McIntosh Laboratory, Binghamton, New York. (37)



McIntosh MR67 Stereophonic FM Tuner. Built-in multipath indicator, Nuvistor front end, self peaking multiplex decoder and many other features. Sensitivity: 2.5 microvolts IHF; Freq. Response: within  $\frac{1}{2}$  db 20/20,000 cps. \$299. McIntosh Laboratory, Binghamton, New York. (38)



McIntosh MX110 Stereo Tuner/Pre-amplifier. Tuner: Sensitivity 2.5 microvolts IHF; Capture Ratio 1.7db Pre-amp: Distortion less than 0.2% at rated output; Freq. Response within  $\frac{1}{2}$  db 20/20,000 cps. \$399. McIntosh Laboratory, Binghamton, New York. (39)



McIntosh MC240 Power Amplifier. The most popular McIntosh amplifier. 40 watts per channel; Harmonic distortion less than 0.5% at rated output or less, 20/20,000 cps. Freq. Range  $\pm 0.5$  db 18/60,000 cycles. \$288. McIntosh Laboratory, Binghamton, New York. (40)



McIntosh MR71 Stereo FM Tuner with Nuvistor front end, built-in multipath indicator, self-peaking multiplex decoder and many other features. Usable sensitivity 2.5 microvolts IHF; Freq. response within  $\frac{1}{2}$  db 20/20,000 cps. \$399. McIntosh Laboratory, Binghamton, New York. (41)



McIntosh M13 Maximum Performance Indicator. A professional oscilloscope, signal strength indicator, FM deviation meter, calibrated balance meter and phase indicator. The M13 lets you attain quality professional FM listening. \$249. McIntosh Laboratory, Binghamton, N.Y. (42)



Scarlatti Model \$2,150.00

Six additional harpsichords, two clavichords and tracker action organs also available.

Harpsichords and Baroque Instruments, 4556 Hazeltine Avenue, Sherman Oaks, California. (43)



Clark/100 Headset. Superb bass response obtained with small transducers and acoustical coupling. Freq. Range: 10/20,000 cps; Distortion less than 0.2% @ 100 phon level over useful range. High compliant earseal of polyvinyl chloride. \$39.50. David Clark Co., Worcester, Mass. (44)



Clark/200 Headset. Clark quality within reach of more modest budget. Frequency Range: 20/17,000 cps; Sensitivity: 1 milliwatt input @ 1000 cps produces 105 db reference 0.0002 microbar per earpiece. Nominal Impedance: 8 ohms. \$26.95. David Clark Co., Worcester, Mass. (45)



New Eico Solid State Tuner/Amplifier. No tubes, not even nuvistors. Delivers 112 watts IHF total to 4 ohms, 74 watts to 8 ohms. Kit \$219.95. \$325.00 wired including walnut cabinet. Eico Electronic Instrument Co., 131-01 39th Ave., Fushing, N.Y. (46)



Norelco FM-AM World Receiver Deluxe. The ultimate in quality radios . . . extended frequency coverage on short wave, marine and aircraft; electrical band spread fine tuning on short wave; Azimuth rotating pedestal. North American Philips Co., 100 E. 42nd Street, New York, N.Y. (47)

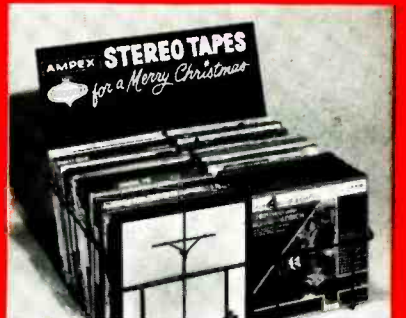

Twenty-Six great new albums specially selected by Ampex Stereo Tapes for your Christmas music enjoyment including: The brand new "Joy of Christmas" album by Joan Sutherland. Write for complete Christmas list to Ampex, 2201 Landmier Rd., Elk Grove Village, Ill. (48)

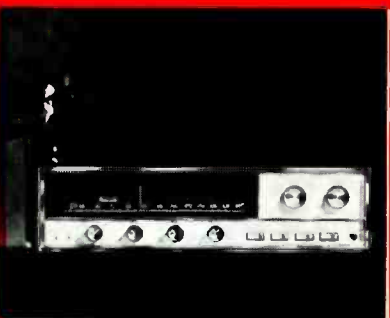

Sherwood S-8800 All-Silicon Solid-State FM Receiver—100 watts music power/1.6  $\mu$ v FM sensitivity. Harmonic distortion: 0.3% @ rated output; 0.1% @ 10 watts or less. \$368.50 leatherette metal case; \$387.50 walnut cabinet. Sherwood—12SG, 4300 N. California Ave., Chicago, Ill. (49)



Unique Lifetime Guarantee! The "Plainsman" AM-FM Receiver incorporates Two 25 watt amplifiers. Automatic switching from FM mono to stereo, high and low cut filters, plus many more exciting features. Artronics Co., Inc., 630 Cleveland Ave., River Vale, N.J. (50)

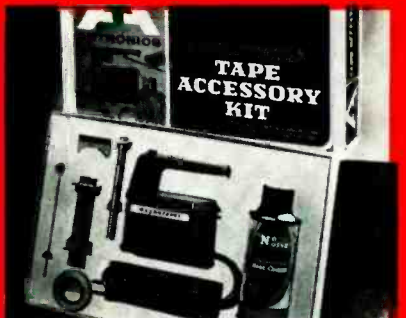

A Perfect Gift for anyone with a tape recorder . . . the Artronics professional tape accessory kit. Complete with bulk tape eraser, tape splicing/editing kit, and spray-on non-flammable, non-toxic head cleaner. Artronics Co., Inc., 630 Cleveland Ave., River Vale, N.J. (51)

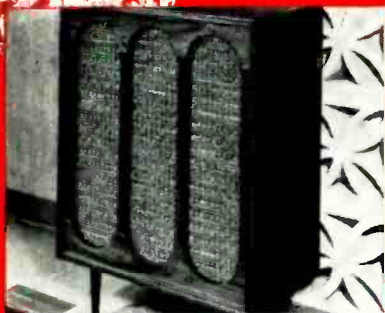

Hartley Concertmaster Junior full-range speaker system. Contains new Hartley-Luth 210 woofer and new 207 mid-range/high-freq. speakers which have patented all-polymer cones and magnetic suspension. Cabinet 32 x 24 x 14". \$345. Hartley Products Corp., Barnert Place, Ho-Ho-Kus, N.J. (52)



Just the thing for your Christmas Stocking . . . His and Hers Klipschorns. Output 3 acoustic watts with max. 0.1% FM distortion at 10 electric watts input. Response range 30/20,000 cps. Full spec available on request. The pair: \$1588. Klipsch & Assoc., Hope, Ark. (53)



Viking Auto-tape 500 solid-state stereo tape cartridge player with "Sound Center" controls to adjust volume/tone. Operates on 12 volts anywhere. Charcoal: \$149.95; Stainless steel satin: \$159.95. Speakers and cartridge incl. Viking, 9600 Aldrich Ave. S., Minneapolis, Minn. 55420. (54)

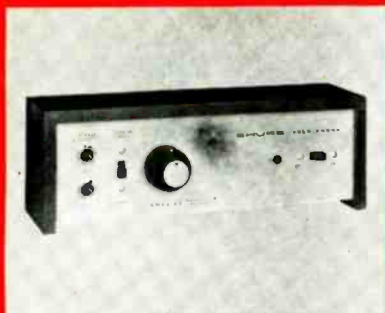

Shure Solo-Phone Stereo Headphone Amplifier enables two to listen to records, tape, or tuner. Output jacks accept standard stereo headphones. Solid-state circuit optimizes response characteristics at low level for distortion-free listening. \$45. Shure, 222 Hartrey Ave., Evanston, Ill. (55)



Rye Tape Storage Cabinets. Plastic containers hold 5 tape reels in individual compartments. Available in three sizes for 3½", 5" or 7" reels for \$3.00, \$4.50 and \$5.10 respectively. Available with reels at additional cost. Rye Sound Corp., 122 Spencer Place, Mamaroneck, N.Y. (56)



PML EK-61A Condenser Microphone with matching Model 4317 battery-operated power supply (for Hi-Z only). Gift packed, \$99.50. Freq. Response below 30 c/s to above 18 kc/s ± 3 db. Complete with 10' each of signal and power supply cable. Ercona Corp., 432 Park Ave. S., NYC 10016, N.Y. (57)

Mail this coupon now for additional information on any items featured in HIGH FIDELITY's Christmas Shopping Guide. Just circle the numbers corresponding to each item and mail to:

**HIGH FIDELITY Magazine**  
Dept. CSG  
Publishing House  
Great Barrington,  
Mass. 01230

1	11	21	31	41	51
2	12	22	32	42	52
3	13	23	33	43	53
4	14	24	34	44	54
5	15	25	35	45	55
6	16	26	36	46	56
7	17	27	37	47	57
8	18	28	38	48	58
9	19	29	39	49	59
10	20	30	40	50	60

Name .....

Address .....

City ..... State ..... Zip .....

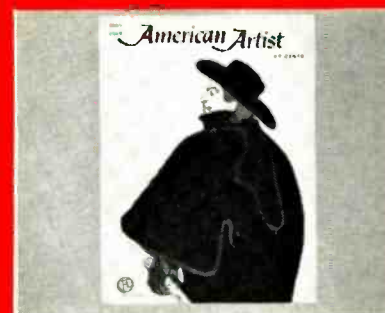

American Artist. Most widely circulated art magazine in the world. Enriches understanding of the visual arts. Focuses on ideas, techniques and methods in drawing, painting, design, sculpture, the drafts. Free announcement card, 1 yr. \$7. American Artist, 2160 Patterson St., Cincinnati, Ohio

## STEREO QUESTION BOX

Continued from page 65



JZ-800 Economy Dynamic System with special 3½" cone-type tweeter matched to dynamic woofer in sealed enclosure for reproduction to 30 cps without doubling. \$129.95 in shelf-type oiled walnut cabinet 13½ x 23½ x 11⅞". Made in USA by Neshaminy Electronic Corp., Furlong, Pa. (58)



Z-600 compact, wide-range console system featuring 2 JansZen Electrostatic treble radiators and a special, high-compliance woofer for clean, natural reproduction. \$195. Lacquered or oiled walnut. 26⅞ x 20 x 13". Made in USA by Neshaminy Electronic Corp., Furlong, Pa. (59)

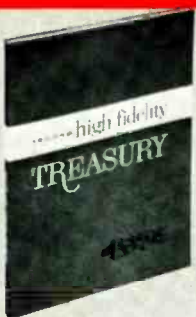

Second HIGH FIDELITY Treasury. Tells what you need to know for achieving good sound reproduction at home. ABC's of stereo, servicing, antennas, speakers, FM, etc. . . . 28 top audio articles. Illustrated soft cover book. 132 pages. Only \$2.50. Wyeth Press, Great Barrington, Mass.

and "level" have come to describe settings or adjustments that are preset and not normally used very much during playback. "Volume" has come to designate the familiar control knob that is used relatively often and which—when other similar controls are present in the system or in any device—is the final adjustment and so may be thought of as the "master level" or "master gain" control. "Loudness" describes a gain, level, or volume control tied into a compensating circuit or network, often termed a "contour" network, that adds some bass boost at low listening levels and perhaps some treble boost too. On most amplifiers, the user has the option of using the same control as a "loudness" control or as an uncompensated "volume" control.

**17. My FM set, which is one highly praised in your test reports, continues to pick up ignition noise from passing cars. I have been told that this can be traced to the lead-in wire from my antenna. What do you say?**

Chances are, the lead-in from the antenna is the culprit. Make sure of this, however, by checking for a defective tuner. The simplest way to do so would be to substitute another tuner, using it with the same antenna. If it sounds very much cleaner, your own tuner is at fault. If the second tuner also picks up noise and interference, you would do well to change to either shielded twin-lead (which may eliminate interference) or to 75-ohm coaxial cable (which will). The "mismatch" between your 300-ohm antenna and the lead-in can be overcome by using a small, inexpensive balun transformer at the antenna. If your set has 75-ohm antenna terminals, simply connect the cable to them. If not, use another balun transformer at this end. In some cases, despite the mismatch between 75-ohm cable and a 300-ohm input, good reception may result even without the balun transformer.

**18. I own a large collection of early LPs and 78-rpm discs. Recently, I decided to convert to stereo, but none of the amplifiers I've seen provides equalization for these records. Will I have to sacrifice accurate playback of my older discs in order to be able to play the new stereo records?**

To begin with, some of the costlier separate-preamp-control units do provide variable equalization for records made prior to the industry-wide adaptation of the RIAA characteristic in mid-1954. If, however, you buy a new stereo model that provides only the RIAA equalization (as most of them do), you can use the set's tone controls to approach the required settings for at least two of the more widely used pre-1954 recording curves. A small degree of bass boost and an equally small degree of treble cut can approximate the LP curve. Leaving the bass "flat" and boosting the treble a little can come fairly close to simulating the old AES curve. These recommenda-

tions, of course, are very approximate.

For accurate playback of 78 rpms, you will have to experiment a little more, inasmuch as tone control adjustments are least satisfactory in simulating the 78 curve. A final thought: you could keep your mono preamp—patched into the auxiliary input of your new stereo amplifier—for playing pre-1954 mono records. All mono records made since then, and of course all stereo records, require only the RIAA equalization.

**19. What is meant by "damping factor," so frequently used in equipment test reports and advertising?**

Damping factor (or DF) is a ratio of the nominal output impedance of an amplifier (or, of the load it is driving) to the actual circuit or internal impedance of the amplifier. For instance, if the amplifier output taps are rated for an 8-ohm load, and if the actual impedance of the amplifier measured at that tap is 2 ohms, then the amplifier is said to have a damping factor of 4:1, or simply, 4. The higher the amplifier's damping factor, the more precisely its signals can control loudspeaker diaphragm movement and thus, the more accurate the reproduction. Many transistor amplifiers, because of their lack of an output transformer, and their very low internal impedance, have very high damping factors. Experts, however, disagree as to the effect of damping factors much above 10—and, in fact, a change in DF from, say, 30 to 60 is far less important in terms of speaker performance than a change of 2 to 4. A DF of 10 to 20 is generally considered excellent for driving most conventional dynamic speakers. Electrostatics, it is agreed, do benefit from higher damping factors; low-efficiency air-suspension cone speakers also seem to respond gratefully to high damping in an amplifier.

**20. Are there any major changes or developments in stereo equipment coming up in the next six months that ought to keep me from buying what is now on the market? I am interested in a high-quality, long-lasting system mainly for playing records, but I will want FM (and maybe AM) later and probably tape a year from now. What do you advise?**

The major change in audio gear, which is still in process, is the swing to solid-state circuitry. A major trend in equipment format is the integrated chassis that combines tuner and control amplifier into a "receiver." During the next year there will be, of course, refinements and the kind of cumulative improvement that always have been the hallmark of audio, but nothing that ought to keep you from buying what is now offered as new and current equipment. Depending on your budget and personal inclination, you could buy an amplifier-only now, and add an FM stereo tuner to it later. Or, you could buy a receiver and have your FM right now. Both kinds of units will be available indefinitely. As for tape, the coming year may see the introduction of video recorders at lower prices and on a wider scale than hitherto, but this development will be in addition to, and not in place of, audio tape equipment.

# ADVERTISING INDEX

**PURCHASING  
A HI-FI  
SYSTEM?**

**TRADE-INS OK—TIME PAYMENTS  
Up to 2 years to pay!**

**Send Us  
Your List of  
Components  
For A  
Package  
Quotation**

**FREE TIME  
STEREO RECORDS  
WITH ORDER**

All merchandise  
is brand new,  
factory fresh.

Visit our N. Y. Showroom.  
FREE Hi Fi Catalog.

**AIREX  
RADIO  
CORPORATION**

85-HF Cortlandt St., N.Y. 7, WO 4-1820

Altec Lansing  
Electrovoice  
Jensen • Harlicrafter  
USL Citizen Band  
Texas Crystals  
Internat'l Crystals  
University  
Acoustic Research  
Janszen • Viking  
Wharfedale  
Marantz\*  
Bell • G. E.  
Weathers  
Harman-Kardon  
Eico • Ampex\*  
Sherwood\*  
Crown Recorders\*  
Superscope  
Dual Changer\*  
Bogen • RCA  
Dynakit • Fisher  
H. H. Scott • Leak\*  
ECI • Roberts  
De Wald • National  
Sony • Challenger  
Browning  
Garrard  
Miracord  
General Radio  
Rek-O-Kut  
Polytronics  
Norelco • Finco  
Fairchild  
Pickering • Sonar  
ADC Cartridges  
Audio Tape  
Magnecord\*  
Rockford Cabinets  
ADC Speakers  
KSC Speaker  
Systems\*  
• Fair Traded

CIRCLE 4 ON READER-SERVICE CARD

**NOTICE  
TO STEREO  
& HI-FI BUYERS**

**BEFORE YOU BUY GET A RABSONS  
QUOTE... YOU'LL BE GLAD YOU DID!**

At Rabsons Competitive Prices, Reliability and Personal Service have been bywords for over 60 years

It's so **EASY** and **SAFE** to deal with Rabsons

- Up to 36 months to pay on Easy Pay Plan
- Centrally located—as close as your telephone—as near as your mail box • Free Mail Order-Hi Fi Clinic Service • Fast Air Mail Response on Quotation Requests • Franchised Distributor for Hi Fi Lines • 60 Years of business "Know How" to serve you better • Shipments **DOUBLE PACKED** and **FULLY INSURED**
- "Attractive" Prices • Warehouse on premises • Fast Delivery—Large inventory permits processing and shipment promptly • All merchandise brand new in factory sealed cartons • Save even more on complete system quotes • Export Packing—220 Volts 50 Cycle merchandise a speciality • Free list of monthly specials.

**Free** BALL POINT PEN with every quote

**OVER 60 YEARS  
OF RELIABILITY**

**RABSONS** 57 ST. INC.  
119 West 57th Street, New York, N. Y. 10019  
Tel. Area Code 212-247-0070

CIRCLE 63 ON READER-SERVICE CARD

Key No.	Page No.	Key No.	Page No.
1...	Acoustech, Inc. .... 143	45...	Kenwood Electronics, Inc. 8
2...	Acoustic Research, Inc. 41	48...	Koss/Rek-O-Kut ..... 24
3...	Acoustic Research, Inc. 115		London Records ..... 102
	Acoustical Mfg. Co., Ltd., The ..... 12	50...	Mace Records ..... 112
4...	Airex Radio Corp. .... 156	51...	Magnecord Sales Dept. 124
5...	Altec Lansing Corp. .... 43, 45	52...	Marantz ..... 33, 35
6...	Ampex Corp. .... 100, 137	53...	McIntosh Laboratory, Inc. .... 123
7...	Archive Production .... 85	54...	Mercury Records ..... 102
8...	Audio Devices, Inc. .... 117		Minnesota Mining & Mfg. Co. .... 138
9...	Audio Dynamics Corp. .... 14, 15	55...	Mosley Electronics, Inc. 42
10...	Audio Dynamics Corp. 25	57...	OKI-Chancellor Electronics, Inc. .... 44
11...	Audio Originals ..... 30	58...	Olson Electronics, Inc. 147
	Audio Unlimited, Inc. 147	59...	Osaka International Festival Society ..... 114
12...	Benjamin Electronic Sound Corp. .... 10, 95	60...	Pickering & Co., Inc. ... 2
16...	Bogen Communications Division ..... 127	61...	Pilot Radio ..... 105
	Bozak, R. T., Mfg. Co. .... 97, 99	63...	Rabsons-57 St., Inc. ... 156
103...	British Industries Corp. 46	64...	RCA Tape ..... 83
13...	Cadet Records ..... 136	93...	RCA Victrola ..... 79
14...	Cambridge Records ..... 122	29...	Revox ..... 113
15...	Carston Studios ..... 145	66...	Rheem-Roberts ..... 135
	Christmas Shopping Guide ..... 148-155	68...	Sansui Electric Co., Ltd. 22
17...	Citadel Record Club... 7	69...	Sarkes Tarzian, Inc. .... 4
18...	Columbia Records ... 80, 81	31...	Scope Electronics Corp. 31
19...	Command Records ..... 5	100...	Scott, H. H., Inc. .... 37-39
21...	Concord Electronics Corp. 23	71...	Sharpe, E. J., Instruments ..... 128
22...	Decca Records ..... 107, 116	70...	Sherwood Electronic Laboratories, Inc. Cover IV
23...	Deutsche Grammophon Gesellschaft ..... 74	72...	Shure Brothers, Inc. .... 66
24...	Dixie Hi-Fi ..... 145	73...	Shure Brothers, Inc. .... 122
25...	Dressner ..... 146	74...	Sonotone Corp. .... 26
27...	Dynaco Inc. .... 103	75...	Sound Reproduction, Inc. .... 146
28...	Electro-Voice, Inc. Cover III	76...	Stanton Magnetics, Inc. 21
26...	Electro-Voice, Inc. .... 87-90		Stereo 1966 Edition .... 91
29...	Elpa Marketing Industries, Inc. .... 113	77...	Superex Electronics .... 16
30...	Elpa Marketing Industries, Inc. .... 126	78...	Superscope, Inc. .... 9
31...	EMI, see Scope Electronics	79...	Superscope, Inc. .... 11
108...	Empire Scientific Corp. .... 17-19	80...	Superscope, Inc. .... 13
32...	Fidelman, Josef ..... 118	81...	Sylvania Electric Products ..... 119
34...	Finney Company, The ... 101	82...	Tandberg of America, Inc. .... 129
35...	Fisher Radio Corp. .... Cover II, 1, 27, 29	84...	Telex Acoustic Products 134
36...	Frazier Incorporated ... 111	88...	Toujay Designs ..... 40
103...	Garrard ..... 46	85...	Turner Company ..... 34
33...	Golden Records ..... 108	86...	United Artists Records ... 16
38...	Greentree Electronics ... 141	87...	University Sound ..... 106
40...	Harman-Kardon, Inc. ... 93	89...	Vanguard Records ... 94, 118
41...	Heath Company ... 130, 131	90...	Vega Electronics ..... 147
42...	Hi-Fidelity Center ..... 147	91...	Viking of Minneapolis, Inc. .... 6, 110, 144
43...	Inter-Mark Corp. .... 40	30...	Watts Division ..... 126
44...	Jensen Mfg. Co. .... 132	94...	Wollensak ..... 121
			Wyeth Press ..... 20, 120



At last amplifier manufacturers  
are breaking the 20 to 20,000 cps  
response barrier.

**IT'S ABOUT TIME.**  
After all, we've been making  
speakers that go well beyond  
those limits for years!

**(E-V)** Let's start at the bottom (as much as  
an octave below most other woofers).  
Our thirty-inch diameter woofer repro-  
duces 15 cps fundamental bass at full vol-  
ume without doubling. Nothing less than a  
live performance can compete with the  
sound you hear—and feel—from this giant  
speaker. **Model 30W \$250.00**

Over a decade of  
engineering refinement  
has made this E-V  
twelve-inch cone speaker  
unexcelled in mid-bass  
performance (and it's  
also an uncommon value  
as a full-range speaker  
from 30 to 15,000 cps).

**Model SP12 \$65.00**



It takes this sophisticated  
team of compression driver  
and patented diffraction  
horn to fully satisfy the  
rigorous demands of the  
treble range. There's no  
smoother combination  
than E-V T250 and 8HD.

**Model T250 \$88.00**  
**Model 8HD \$21.00**

Ruler flat from 3,500 to  
23,000 cps! But extended  
range is just one of the bene-  
fits of the T350 VHF driver.  
Its exclusive throat and horn  
design spreads undistorted  
highs to every corner of your  
listening area. Delightful!

**Model T350 \$66.00**



These unusual component speakers have  
been combined in the Patrician 800—often  
acclaimed the world's finest loudspeaker  
system. \$995.00 in Traditional or Contem-  
porary cabinetry. It's waiting to be chal-  
lenged by the most powerful, widest-range  
amplifier you can buy. Listen. The difference  
you hear is what high fidelity is all about!

Other E-V component speakers for every re-  
quirement—indoors or out—range in price from  
\$14.00 to \$250.00. Hear them at your nearby  
Electro-Voice high fidelity showroom. Write for  
free catalog.

**ELECTRO-VOICE, INC.**, Dept. 1254H  
619 Cecil Street, Buchanan, Michigan 49107

**CIRCLE 28 ON READER-SERVICE CARD**

**Electro-Voice®**  
SETTING NEW STANDARDS IN SOUND

Compare these Sherwood features and specs! *ALL-SILICON* reliability. Noise-threshold-gated automatic FM Stereo/mono switching. FM stereo light, zero-center tuning meter, FM interchannel hush adjustment, front-panel stereo headphone jack, rocker-action switches for tape monitor, mono/stereo, noise filter, speaker disconnect and loudness contour. 100 watts music power (8 ohms) @ 0.3% harm distortion. IM distortion 0.1% @ 10 watts or less. Power bandwidth 12-35,000 cps. Phono sens. 1.8 mv. Hum and noise (phono) -70 db. FM sens. (IHF) 1.6  $\mu$ v for 30 db quieting. FM signal-to-noise: 70 db. Capture ratio: 2.4 db. Drift  $\pm$ .01%. 40 silicon transistors plus 14 silicon diodes and rectifiers. Size: 16 $\frac{1}{2}$  x 4 $\frac{1}{2}$  x 14 in. dp.

Model	V-Vacuum Tube S-Silicon Transistors	Power (IHF) 8 ohms Watts	% THD Below 10 watts	FM Sensitivity Microvolts	Price	Dollars/Watt
Sherwood S-8800	S	100	0.10%	1.6	\$ 359.50	3.60
Altec 711	S	100	0.15%	2.2	378.00	3.78
Bogen RT 8000	T	70 (40)	0.3%	2.5	319.95	4.57
Dyna FM-3, PAS-3, & S-70	V	90	0.1%	4.0	394.85	4.38
Fisher 600 T	V & T	120	1.6%*	1.8	459.50	4.82
Harman-Kardon SR-900	T	75 (40)	0.9%*	3.3	429.00	5.61
McIntosh MR71 & MA230	V & T	88	0.25%	1.8*	700.00	6.30
Marantz 8B, 7, & 10B	V	75*	0.2%	2.0	1170.00	15.60
Scott 348	V & T	100	0.5%	1.9	479.95	4.79

Reference "T" (above) may include some silicon transistors.  
Figures above are manufacturers' published specifications except (\*) which are published test findings.

## SHERWOOD SPECS SPEAK FOR THEMSELVES



S-8800 100-watt FM *ALL-SILICON* Receiver  
\$359.50 for custom mounting  
\$368.50 in walnut leatherette case  
\$387.50 in hand-rubbed walnut cabinet



*Sherwood*

Sherwood Electronic Laboratories, Inc., 4300 North California Avenue, Chicago, Illinois 60618 Write Dept. 1211

CIRCLE 70 ON READER-SERVICE CARD