

# high fidelity

60 CENTS

THE MAGAZINE FOR MUSIC LISTENERS

APRIL

**Two Hundred Years Alive** by *E. Power Biggs*

**A Presentment of Englishry** by *A. Hyatt King*

**Four Thousand Choristers Can't Be Right** by *Winton Dean*

**Handel on and off Records** by *Nathan Broder*

**The Imperishable Wag** by *Charles Cudworth*

*A salute to*

*The Great Mr. Handel*

*1685-1759*

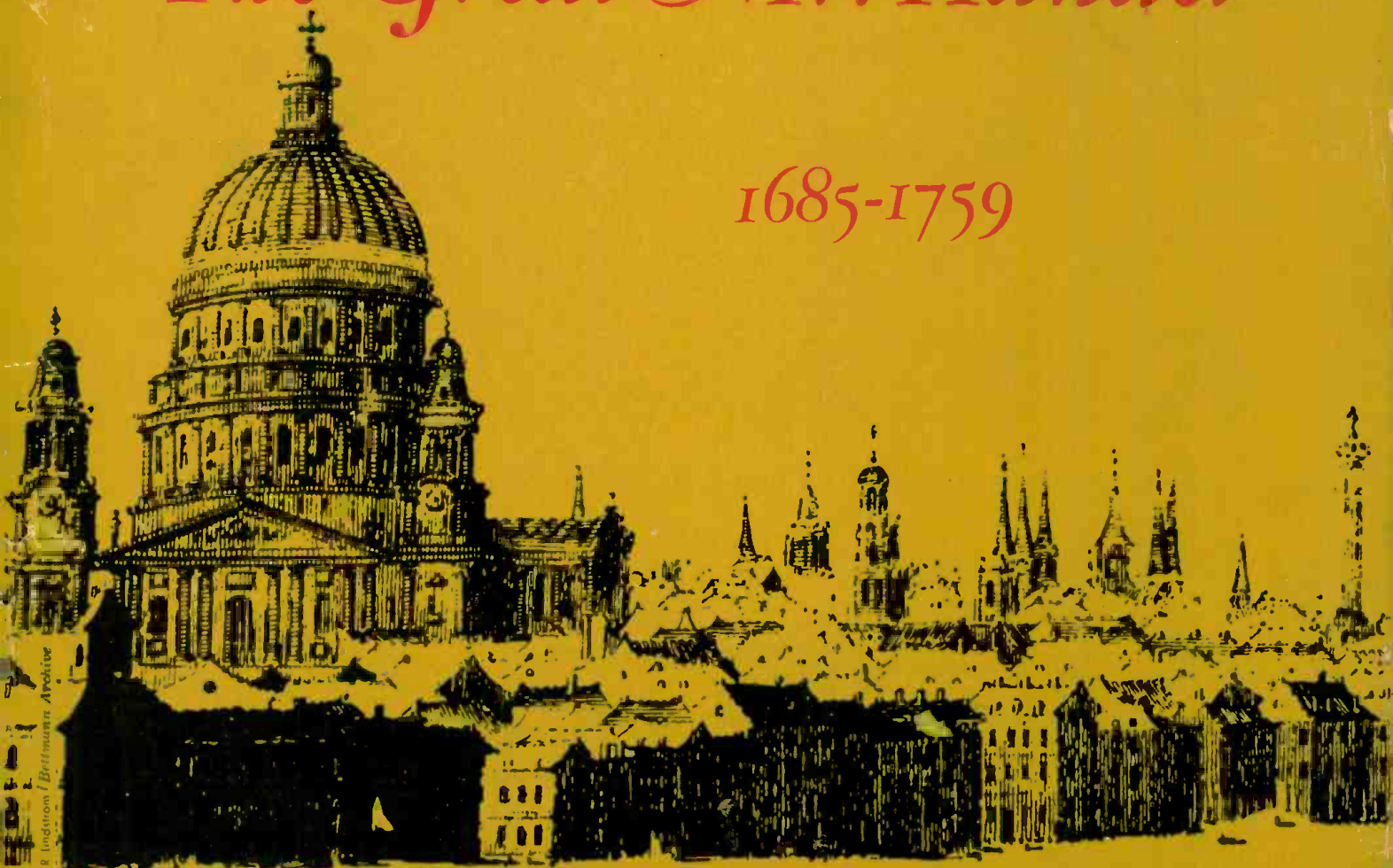
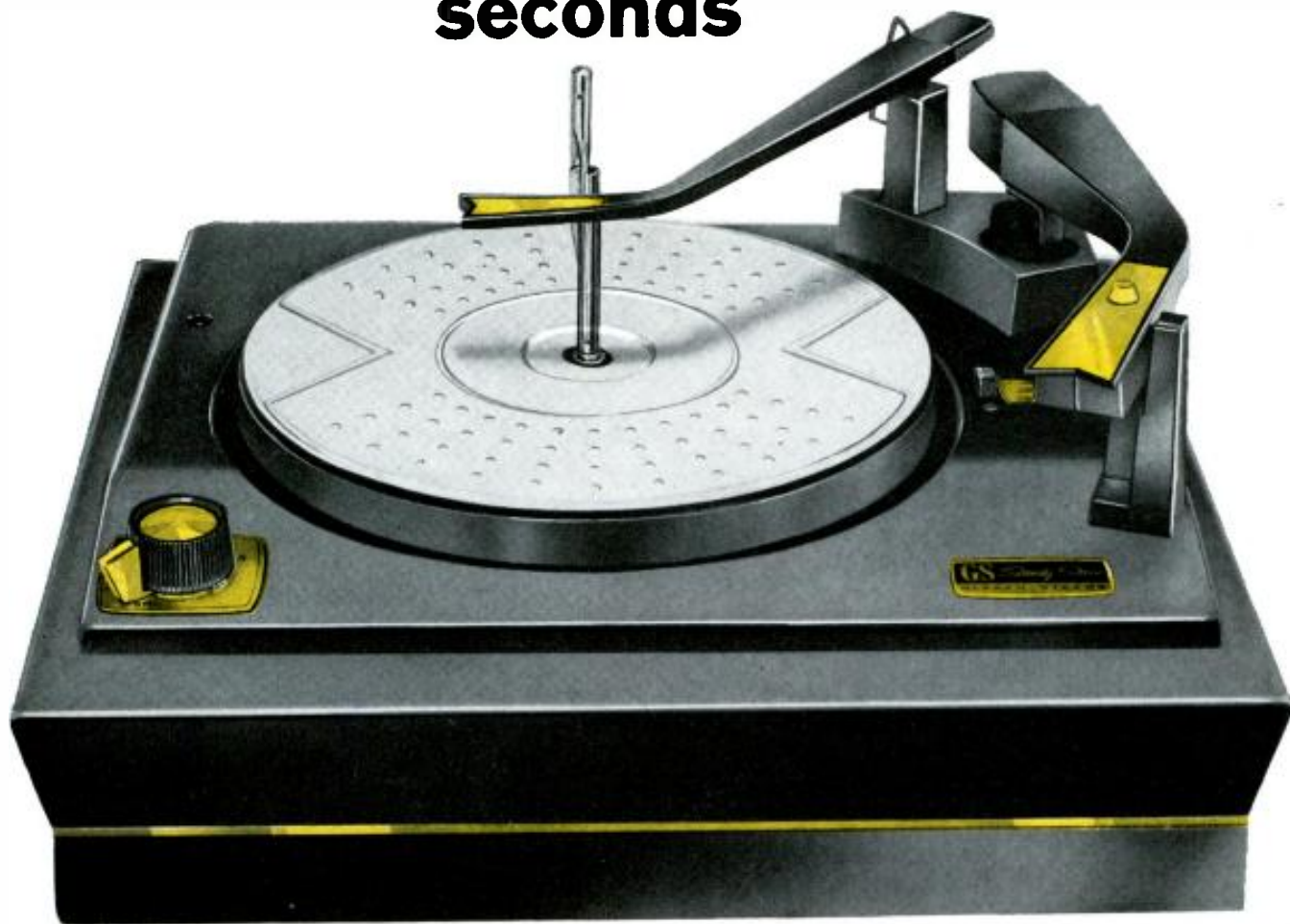

Illustration by Bellman Apolite

6  
7  
8  
the 9  
seconds



## THE 9 SECONDS THAT ADD HOURS TO YOUR LISTENING PLEASURE

9 seconds — that's all it takes to put the Glaser-Steers GS-77 through one complete change-cycle. 9 seconds — and see what happens in that brief space of time.

A record completes its play . . . *the turntable pauses* . . . the next record drops, gently — more gently than if you were handling it yourself . . . the tone arm lowers into the lead-in groove. *Only then does the turntable resume its motion.* Thus, the original brilliance of your records is preserved through hundreds of additional playings by eliminating the grinding action that occurs when records are dropped on a moving disc — a common drawback in conventional changers.

Every GS-77 feature contributes towards your listening pleasure — inaudible wow, rumble and flutter; uniform stylus pressure from first to top record on a stack; resonance-free arm with high compliance and minimum tracking-error; four leads to cartridge for hum-free performance.

The GS-77 combines traditional turntable quality with modern record changer convenience. See it at your dealer, today. In just 9 seconds, you'll gain a fresh, new point-of-view on record changers. \$59.50 less base and cartridge. Write to:

GLASER-STEERS CORPORATION, 155 Oraton St., Newark 4, N. J.  
In Canada: Alex L. Clark Ltd., Toronto, Ont. Export: M. Simons & Son, Inc., N. Y. C.

GLASER-STEERS GS-77/SUPERB FOR STEREO . . . BETTER THAN EVER FOR MONOPHONIC RECORDS

all **15** of these **Jensen** hi-fi speakers contain a *new* idea...

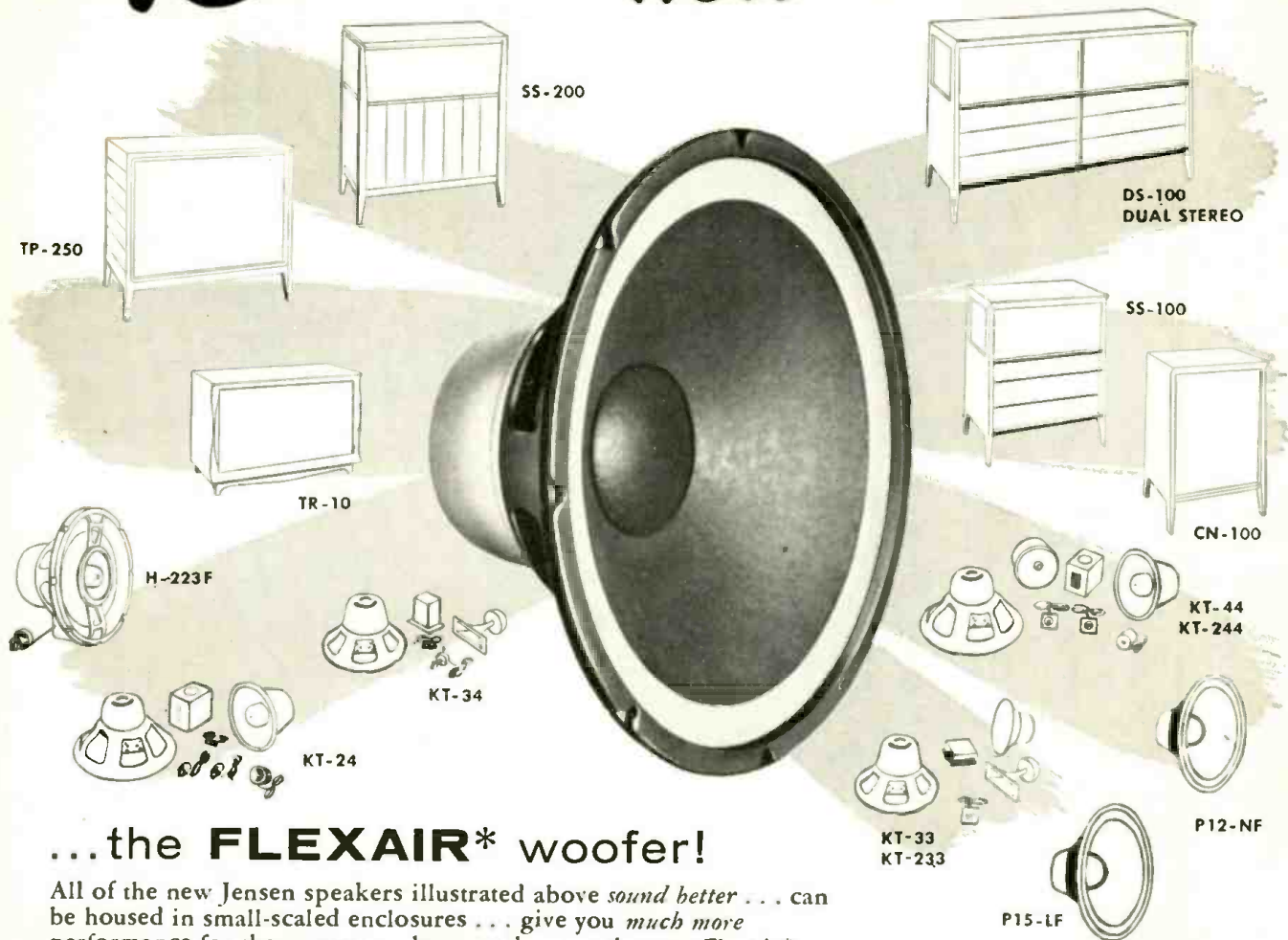

...the **FLEXAIR\*** woofer!

All of the new Jensen speakers illustrated above *sound better* . . . can be housed in small-scaled enclosures . . . give you *much more* performance for the money . . . because they use the new Flexair\* woofer developed and perfected by Jensen.

Relative freedom of cone movement is not new but this is only part of the story. When used in a Bass-Superflex\* tube vented enclosure, the Flexair woofer for the first time gives you *ALL* these important performance features for vastly superior, utterly authentic bass response: (1) Extremely long cone travel; (2) very high compliance throughout total travel; (3) very low resonance; (4) extremely low distortion; (5) high efficiency (will drive with a 10-watt amplifier). If you'd like to know more about this exclusive Jensen development, write for free Brochure KF.

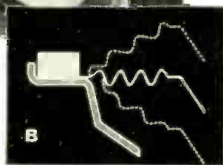

**A** White dot shows forward, central and inward positions of Flexair woofer cone during 1" movement. (Perspective shortens apparent distance between dots for inward travel). **B** Diagram shows extreme accordion action of annulus permitting linear extra-long cone travel.

**C** shows the scientifically proportioned tube vent used in the Bass-Superflex enclosure for extended bass and very low distortion with the Flexair woofer. Except for vent, enclosure is air-tight. Vent action during large motions of woofer cone is dramatically illustrated in the two unretouched photos at the right. Jensen TR-10 TRI-ette\* (with grille cloth removed) was used in the experiments. In **D**, air filled balloon is kept in suspension by air flow from vent. Successive high speed exposures show rise of balloon when signal is turned on. In **E** a candle flame is deflected by air motion from tube vent with same low frequency signal.

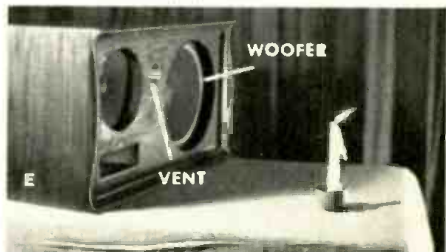
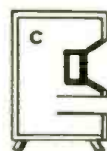
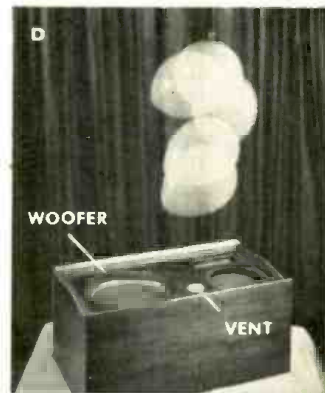

**Jensen** MANUFACTURING COMPANY

\*T. M. J. M. Co.

Division of The Muter Co.

6601 S. Laramie Avenue, Chicago 38, Illinois

In Canada: J. R. Longstaffe Co., Ltd., Toronto • In Mexico: Radios Y Television, S.A.. Mexico D.F.

*The responsibility of being the finest...*



## A LIFETIME WARRANTY

FLUXVALVE AND T-GUARD ARE TRADEMARKS USED TO DENOTE THE QUALITY OF PICKERING & COMPANY INVENTIONS.

2371 A

**T**ruly the finest stereo pickup ever made... the STANTON Stereo FLUXVALVE is hermetically sealed in lifetime polystyrene with all of the precision that has made Pickering a quality leader in the field of high fidelity for more than a dozen years.

**F**or instance... only the STANTON Stereo FLUXVALVE has the "T-GUARD" stylus assembly—so safe and easy to handle... so obedient and responsive to every musical nuance in the stereo groove.

**O**nly the STANTON Stereo FLUXVALVE has the parallel reproducing element contained in the "T-GUARD"... assuring the proper angle of correspondence between recording and playback styli for maximum Vertical Tracking Accuracy.

\*Excluding wear and tear of the diamond stylus tip and parts of the related moving system in the "T-GUARD" assembly.

**A**nd... because of this the STANTON Stereo FLUXVALVE reproduces music with magnificent sound quality... from both stereophonic and monophonic records... with negligible wear on record and stylus.

**I**n plain truth... the STANTON Stereo FLUXVALVE is by far the finest stereo pickup made... backed by a Lifetime Warranty\*, assuring you a lifetime of uninterrupted, trouble-free performance—with a quality of reproduction no other pickup can equal.

We suggest you visit your Pickering Dealer soon  
—drop in and ask for a personal demonstration.  
NEWLY REVISED—"IT TAKES TWO TO STEREO"—ADDRESS DEPT. A49 FOR YOUR FREE COPY.



For those who can *hear* the difference FINE QUALITY HIGH FIDELITY PRODUCTS BY  
**PICKERING & COMPANY, INC., Plainview, N. Y.**

HIGH FIDELITY MAGAZINE



APRIL 1959  
volume 9 number 4

**John M. Conly**  
Editor

**Roland Gelatt**  
Executive Editor

**Miriam D. Manning**  
Managing Editor

**Joan Griffiths**  
Associate Editor

**J. Gordon Holt**  
Technical Editor

**Roy Lindstrom**  
Art Director

**Philip C. Geraci**  
Photographic Editor

**Frances A. Newbury**  
Manager, Book Division

---

**Nathan Broder**  
**R. D. Darrell**  
**Alfred Frankenstein**  
**Robert Charles Marsh**  
Contributing Editors

---

**Charles Fowler**  
Publisher

**Warren B. Syer**  
Associate Publisher

**Claire N. Eddings**  
Advertising Sales Manager

**Andrew J. Caida**  
Marketing and  
Merchandising Manager

**Joseph W. Pace**  
Circulation Fulfillment  
Manager

### ADVERTISING

**Main Office**  
Claire N. Eddings, The Publishing House  
Great Barrington, Mass. Telephone 1300

**New York**  
1564 Broadway, New York 36  
Telephone: Plaza 7-2800  
Bert Cavit, Sy Resnick

**Chicago**  
188 W. Randolph St., Chicago 1  
Telephone: Central 6-9818  
Andy Sponberger

**Los Angeles**  
1520 North Gower, Hollywood 28  
Telephone: Hollywood 9-6239  
George Kelley

### ARTICLES

- Two Hundred Years Alive** 41 E. Power Biggs  
*A Guest Editorial.*
- A Presentment of Englishry** 42 A. Hyatt King  
*How a German became music's greatest Briton.*
- Four Thousand Choristers Can't Be Right** 46 Winton Dean  
*"Improving" Handel started with Mozart — and hasn't stopped yet.*
- Handel on and off Records** 49 Nathan Broder  
*The Great Man, alas, has not been greatly served.*
- The Imperishable Wag** 53 Charles Cudworth  
*Not all composers were noted for a sense of humor, but Handel was.*

### REPORTS

- Books in Review** 32 R. D. Darrell
- Music Makers** 57 Roland Gelatt
- Records in Review** 59
- Tape Deck** 101

### AUDIOCRAFT

- Adding the Third Channel** 109  
*Simple methods for filling in the center.*
- The HF Shopper** 110  
*This issue: Stereo Cartridges.*
- R<sub>x</sub>: Stereo Cartridges** 112  
*How to install your pickup properly.*
- HF Equipment Reports** 114  
Heath PT-1 AM-FM Stereo Tuner—Isotone  
Toccata Speaker System—Pilot SA-232 Stereo  
Power Amplifier—General Electric MS-4000  
Stereo Control Amplifier
- Audio Forum** 119
- Tips from Audio Salesmen** 120 Herman Burstein  
*Your dealer can help you—if you let him.*
- Audionews** 122

AUTHORitatively Speaking 4    Noted with Interest 9    Letters 16    As the Editors See It 41

Professional Directory 137    Trader's Marketplace 138    Advertising Index 140

Published monthly by Audiocom, Inc., Great Barrington, Mass. Copyright © 1959 by Audiocom, Inc. The design and contents of High Fidelity Magazine are fully protected by copyrights and must not be reproduced in any manner. Second class postage paid at Great Barrington and at additional mailing offices. Subscription rate in the U. S. \$6.00 per year.

*New! Years Ahead!*



Use it as a Binaural-Stereophonic FM-AM tuner  
Use it as a Dual-Monaural FM-AM tuner  
Use it as a straight Monaural FM or AM tuner

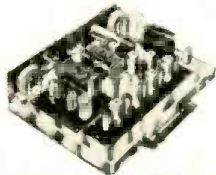

**KT-500 IN KIT FORM**  
**74.50**  
ONLY 7.45 DOWN  
7.00 MONTHLY

## LAFAYETTE STEREO TUNER KIT

THE MOST FLEXIBLE TUNER EVER DESIGNED

- Multiplex Output for New Stereo FM
- 11 Tubes (including 4 dual-purpose) + Tuning Eye + Selenium rectifier Provide 17 Tube Performance
- 10KC Whistle Filter • Pre-aligned IF's
- Tuned Cascade FM • 12 Tuned Circuits
- Dual Cathode Follower Output
- Separately Tuned FM and AM Sections
- Armstrong Circuit with FM/AMC and AFC Defeat
- Dual Double-Tuned Transformer Coupled Limiters.

More than a year of research, planning and engineering went into the making of the Lafayette Stereo Tuner. Its unique flexibility permits the reception of binaural broadcasting (simultaneous transmission on both FM and AM), the independent operation of both the FM and AM sections at the same time, and the ordinary reception of either FM or AM. The AM and FM sections are separately tuned, each with a separate 3-gang tuning condenser, separate flywheel tuning and separate volume control for proper balancing when used for binaural programs. Simplified accurate knife-edge tuning is provided by magic eye which operates independently on FM and AM. Automatic frequency control "locks in" FM signal permanently. Aside from its unique flexibility, this is, above all else, a quality high-fidelity tuner incorporating features found exclusively in the highest priced tuners.

FM specifications include grounded-grid triode low noise front end with triode mixer, double-tuned dual limiters with Foster-Seely discriminator, less than 1% harmonic distortion, frequency response 20-20,000 cps  $\pm$  1/2 db, full 200 kc bandwidth and sensitivity of 2 microvolts for 30 db quieting with full limiting at one microvolt. AM specifications include 3 stages of AVC, 10 kc whistle filter, built-in ferrite loop antenna, less than 1% harmonic distortion, sensitivity of 5 microvolts, 8 kc bandwidth and frequency response 20-5000 cps  $\pm$  3 db.

The 5 controls of the KT-500 are FM Volume, AM Volume, FM Tuning, AM Tuning and 5-position Function Selector Switch. Tastefully styled with gold-brass escutcheon having dark maroon background plus matching maroon knobs with gold inserts. The Lafayette Stereo Tuner was designed with the builder in mind. Two separate printed circuit boards make construction and wiring simple, even for such a complex unit. Complete kit includes all parts and metal cover, a step-by-step instruction manual, schematic and pictorial diagrams. Size is 13 3/4" W x 10 3/4" D x 4 1/2" H. Shpg. wt., 27 lbs.

**KT-500** ..... Net **74.50**  
**LT-50** Same as above, completely factory wired and tested... Net **124.50**

## NEW! LAFAYETTE PROFESSIONAL STEREO MASTER AUDIO CONTROL CENTER

Solves Every Stereo/Monaural Control Problem!

- UNIQUE STEREO & MONAURAL CONTROL FEATURES
- AMAZING NEW BRIDGE CIRCUITRY FOR VARIABLE 3d CHANNEL OUTPUT & CROSS-CHANNEL FEED
- PRECISE "NULL" BALANCING SYSTEM



**KT-600**  
**79.50**

ONLY 7.95 DOWN  
8.00 MONTHLY

- RESPONSE 10-25,000 CPS  $\pm$  0.5 DB
- 6 CONCENTRIC FRONT PANEL CONTROLS
- 4 CONCENTRIC REAR PANEL INPUT LEVEL CONTROLS
- 180° ELECTRONIC PHASE REVERSAL

A REVOLUTIONARY DEVELOPMENT IN STEREO HIGH FIDELITY. Provides such unusual features as a Bridge Control, for variable cross-channel signal feed for elimination of "ping-pong" (exaggerated separation) effects and for 3d channel output volume control for 3-speaker stereo systems; 3d channel output also serves for mixing stereo to produce excellent monaural recordings. Also has full input mixing of monaural program sources, special "null" stereo balancing and calibrating system (better than meters), 24 equalization positions, all-concentric controls, rumble and scratch filters, loudness switch. Clutch type volume controls for balancing or as 1 Master Volume Control. Has channel reverse, electronic phasing, input level controls. Sensitivity 1.78 millivolts for 1 volt out. Dual low-impedance outputs (plate followers), 1300 ohms. Response 10-25,000 cps  $\pm$  0.5 db. Less than .03% IM distortion. Uses 7 new 7025 low-noise dual triodes. Size 14" x 4 1/2" x 10 1/2". Shpg. wt., 16 lbs. Complete with printed circuit board, case, profusely illustrated instructions, all necessary parts.

**LAFAYETTE KT-600** — Stereo Pre-amplifier kit ..... Net **79.50**  
**LAFAYETTE LA-600**—Stereo Pre-amplifier, Wired ..... Net **134.50**

## NEW! LAFAYETTE STEREO/MONAURAL BASIC POWER AMPLIFIER KIT



**KT-310**  
**47.50**

ONLY 4.75 DOWN—  
5.00 MONTHLY

- 36-WATT STEREO AMPLIFIER—18 WATTS EACH CHANNEL
- FOR OPTIONAL USE AS 36-WATT MONAURAL AMPLIFIER
- EMPLOYS 4 NEW PREMIUM-TYPE 7189 OUTPUT TUBES
- 2 PRINTED CIRCUIT BOARDS FOR HEAT, SIMPLIFIED WIRING
- RESPONSE BETTER THAN 35-30,000 CPS  $\pm$  1/2 DB AT 18 WATTS
- LESS THAN 1% HARMONIC OR INTERMODULATION DISTORTION

A superbly-performing basic stereo amplifier, in easy-to-build kit form to save you lots of money and let you get into stereo now at minimum expense! Dual inputs are provided, each with individual volume control, and the unit may be used with a stereo preamplifier, for 2-18 watt stereo channels or, at the flick of a switch, as a fine 36-watt monaural amplifier — or, if desired, it may be used as 2 separate monaural 18-watt amplifiers! CONTROLS include 2 input volume controls, channel Reverse switch (AB-BA), Monaural-Stereo switch. DUAL OUTPUT IMPEDANCES are: 4, 8, 16 and 32 ohms. INPUT SENSITIVITY is 0.45 volts per channel for full output. TUBES are 2-6AN8, 4-7189; GZ-34 rectifier. SIZE 9-3/16" d (10-9/16" with controls) x 5 1/4" h x 13 1/4" w. Supplied complete with perforated metal case, all necessary parts and detailed instructions. Shpg. wt., 22 lbs.

**KT-310** Stereo Power Amplifier Kit ..... Net **47.50**  
**LA-310**—Stereo Power Amplifier, Wired ..... Net **69.50**

*Lafayette Radio*

P. O. BOX 511  
JAMAICA 31, N. Y.

Dept. WD-9

Send FREE LAFAYETTE Catalog 590

Name .....

Address .....

City..... Zone..... State.....

CUT OUT  
AND  
PASTE ON  
POSTCARD



## AUTHORitatively Speaking

E. Power Biggs, our guest editorialist this month, is not only one of the world's most famous organists, but also considerable of a Handel authority. He is in process of putting out, for Columbia, a complete set of the organ concertos, made last year at Great Packington, near the Forest of Arden, using an organ that Handel probably played himself.

Handel as Englishman is presented to us — on page 42—by A. Hyatt King, who is obviously also an Englishman, being Superintendent of the Music Room at the British Museum. A native of Dulwich, he took first-class honors in Classical Tripos at King's College, Cambridge, and went to work for the Museum at twenty-three. He is Chairman of the British Institute of Recorded Sound, among other things, and is fond of sea fishing, watching cricket, opera, and mountain hiking.

Winton Dean is patently well qualified to discuss methods of performing Handel (see page 46), since he has just finished what he calls "a very substantial book," *Handel's Dramatic Oratorios and Masques*, due just about now from Oxford University Press. He also has written biographies of Bizet, Franck, and Puccini, and the entry on Criticism in the 1954 *Grove's Dictionary of Music and Musicians*.

Nathan Broder, whose selective Handel discography starts on page 49, is of course no stranger to regular readers of *HIGH FIDELITY*, having been a reviewer for us, mostly in the pre-classical field, for some years. Born in New York, he attended C.C.N.Y., and went thence almost at once to G. Schirmer, the music publisher, where he stayed fifteen years. He is now associate editor of the *Musical Quarterly*.

Charles Cudworth is a scholar with a sense of humor—you may remember his "The Frite of Spring, or *Le Scare du Printemps*"—and thus the ideal man to write on Handel as wag (see page 53). He was born in Cambridge and is still there, being now Curator of the Pendlebury Library in the University School of Music.

*High Fidelity*, April 1959; Vol. 9, No. 4. Published monthly by Audiocon, Inc., Great Barrington, Mass., a subsidiary of The Billboard Publishing Co., publishers of The Billboard, *Vend*, *Funspot* and The Billboard International. Telephone: Great Barrington 1300. Member Audit Bureau of Circulation.

Editorial Correspondence should be addressed to The Editor, Great Barrington, Mass. Editorial contributions will be welcomed. Payment for articles accepted will be arranged prior to publication. Unsolicited manuscripts should be accompanied by return postage.

Subscriptions, change of address notices, undeliverable copies, orders for subscriptions should be addressed to *High Fidelity Magazine*, 2160 Patterson Street, Cincinnati 22, Ohio.

Subscription rates: United States and Canada, 1 year, \$6; 2 years, \$11; 3 years, \$15. Single copies 60 cents.

# The RCA VICTOR Society of Great Music

UNDER THE DIRECTION OF THE Book-of-the-Month Club

... can help you build a fine record library at an immense saving

AS A BEGINNING, IN THIS TRIAL MEMBERSHIP, YOU CAN CHOOSE  
**EITHER** OF THESE MULTI-RECORD ALBUMS FOR ONLY **\$398**

## 69 BELOVED WORKS OF CHOPIN

All the Nocturnes, Waltzes, Impromptus, Preludes (Opus 28),  
and Eight Polonaises . . . played by

*Artur Rubinstein*



IN AN ALBUM OF SIX 12"  
33 1/3 R.P.M. LONG-PLAYING  
RECORDS NATIONALLY ADVERTISED  
PRICE \$29.98

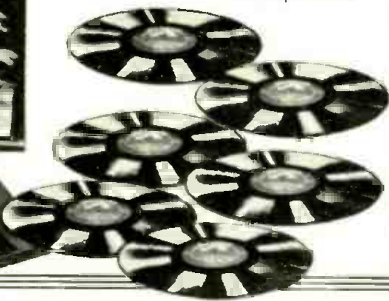

## ARTURO TOSCANINI

CONDUCTING THE  
NBC SYMPHONY ORCHESTRA

IN

AN ALBUM OF SEVEN  
12" 33 1/3 R.P.M. LONG-  
PLAYING RECORDS OF



## BEETHOVEN'S NINE SYMPHONIES

NATIONALLY ADVERTISED PRICE \$34.98

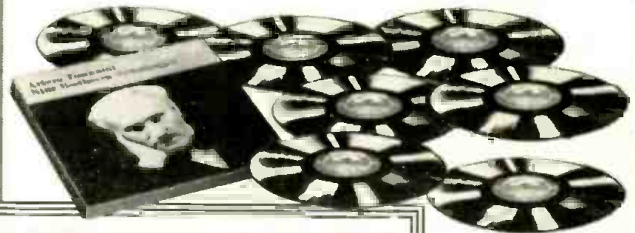

THE SOLE CONDITION OF MEMBERSHIP IS TO BUY SIX ADDITIONAL RECORDS FROM  
THE SOCIETY DURING THE NEXT YEAR FROM AT LEAST 100 TO BE MADE AVAILABLE

### THE SENSIBLE PLAN: SYSTEMATIC COLLECTION

Most music lovers, in the back of their minds, certainly intend to build up for themselves a representative record library of the World's Great Music. Unfortunately, almost always they are haphazard in carrying out this aspiration. Because of more systematic collection by members of the Society, operating costs can be greatly reduced and great savings can be passed on to record collectors. The remarkable Introductory Offer above is a dramatic demonstration.

\* After their sixth purchase, continuing members can build their record libraries at almost a **ONE-THIRD SAVING** over the manufacturer's nationally advertised price. For every two records purchased (from a group of at least 100 made available annually by the Society) members will receive a third RCA Victor Red Seal Record free.

\* A cardinal feature of the plan is **GUIDANCE**. The Society has a Selection Panel whose sole function is to recommend "must-have" works for members. Members of the panel are: **DEEMS TAYLOR**, composer and commentator, Chairman; **SAMUEL CHOTZINOFF**, General Music Director,

**NBC: JACQUES BARZUN**, author and music critic; **JOHN M. CONLY**, editor of *High Fidelity & Audio-craft*; **AARON COPLAND**, composer; **ALFRED FRANKENSTEIN**, music editor of the *San Francisco Chronicle*; **DOUGLAS MOORE**, composer and Professor of Music, Columbia University; **WILLIAM SCHUMAN**, composer and president of Juilliard School of Music; **CARLETON SPRAGUE SMITH**, chief of Music Division, N. Y. Public Library; **G. WALLACE WOODWORTH**, Professor of Music, Harvard University.

### HOW THE SOCIETY OPERATES

Each month, three or more 12-inch 33 1/3 R.P.M. RCA Victor Red Seal Records are announced and described to members. One is singled out as the *record-of-the-month* and, unless the Society is otherwise instructed (on a simple form always provided), this record is sent to the member. If the member does not want the work he may specify an alternate, or instruct the Society to send him nothing. For every record purchased, members pay only \$4.98, the nationally advertised price. (For every shipment a small charge for postage and handling is added.)



RCA VICTOR Society of Great Music  
c/o Book-of-the-Month Club, Inc.  
345 Hudson Street, New York 14, N. Y.

V12-4

Please register me as a member of The RCA Victor Society of Great Music and send me immediately the RCA VICTOR album checked below, billing me \$3.98 plus a small charge for postage and handling. I agree to buy six additional records within twelve months from those made available by the Society, for each of which I will be billed \$4.98, the manufacturer's nationally advertised price (plus a small charge for postage and handling). Thereafter, I need buy only four such records in any twelve-month period to maintain membership. I may cancel my membership any time after buying six records from the Society (in addition to those included in this introductory offer). After my sixth purchase, for every two records I buy from the Society I will receive a third RCA VICTOR Red Seal Record, free.

- RUBINSTEIN PLAYS CHOPIN  
 THE NINE BEETHOVEN SYMPHONIES

MR. }  
MRS. }  
MISS } (Please print plainly)

ADDRESS .....

CITY ..... ZONE .....

STATE .....

NOTE: If you wish to enroll through an authorized RCA VICTOR dealer, please fill in here:

DEALER'S NAME .....

ADDRESS .....

PLEASE NOTE: Records can be shipped only to residents of the U. S. and its territories, and Canada. Records for Canadian members are made in Canada and shipped duty free from Ontario.

**new**  
**THORENS KIT**  
**"TD"**



*easily assembled  
 in half an hour with  
 no special tools...*

Now for the first time you can get a Thorens TD transcription turntable in kit form—at big savings to you.

It's the new TDK-101 featuring the same precision Swiss craftsmanship that made the now-famous TD-124 an immediate success on the American market. Just examine the mirror-finished machining on this kit turntable (or for that matter on any of the Thorens "TD" units) and compare with that of any other make of turntable. You'll see the reason for the TDK's extremely low rumble, wow and flutter. See the TDK-101, newest member of the TD family of fine turntables, at your Thorens hi-fi dealer's.

**Features:**

Same compliant belt-plus-idler drive as on more expensive TD units; provides complete motor isolation. Single, retained, ball-thrust bearing, plus mirror-finished main bearing, for absolute minimum of rumble, both vertical and horizontal—so necessary for stereo. Single-speed 33 1/3. Adjustable speed ( $\pm 3\%$ , a total of about one musical semitone). Built-in strobe allows setting to exact speed. Automatic disengagement of idler when unit is switched off. Drive mechanism completely enclosed—no "string" belts or external belt shields. Accessory wooden base is available in walnut, blond, or mahogany; \$9.00 net.

9.5



**TDK-101**

**\$47.50 NET, BASE \$9.00**

*And these precision "TD" units  
 ... completely assembled*

**TD-124.** Absolute tops for stereo or mono records... quietest, smoothest, most exact. 11 1/2 lb. table; clutch for fast, noise-free starts with needle in groove. 4 speeds, all adjustable ( $\pm 3\%$ ) for perfect pitch; built-in illuminated strobe; built-in level. All assembled TD turntables are 100% tested electronically and aurally for wow, rumble and flutter before shipment. **\$99.75 net. Base \$9.00.**



**TD-184.** This 4-speed high-quality turntable with integral arm has same precision-machined adjustable speed drive as Thorens TD-124. Semi-automatic operation—one dialing motion selects 7", 10", 12" record size. Arm literally floats down to record on air. Absolutely no connection between arm and table. **\$75.00 net. Base \$6.00.**



**TD-134.** 4-speed turntable with integral arm for manual operation. Same high-performance tone arm as used on TD-184 equals tracking performance of arms costing as much as half the price of this entire unit. Same adjustable speed drive mechanism as on more expensive units. **\$60.00 net. Base \$6.00.**



**THORENS**

**SWISS MADE PRODUCTS**  
 MUSIC BOXES • HI-FI COMPONENTS  
 SPRING-POWERED SHAVERS • LIGHTERS  
 NEW HYDE PARK, NEW YORK

Write Dept. H-4 for catalog on complete Thorens hi-fi line.



# TODAY'S BEST HIGH FIDELITY STEREO TUNER

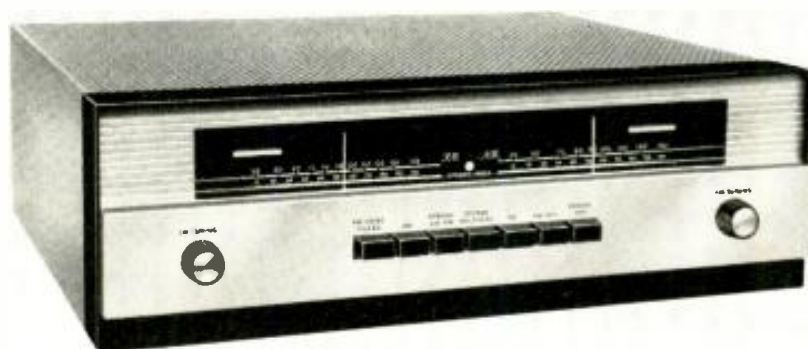

ALSO  
HAS ITS FUTURE  
BUILT-IN!

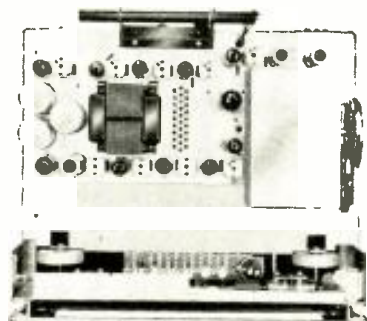

Top view of ST350. (Note new swivel antenna in flush position for cabinet and wall installations.)



New MA350 Multiplex Adapter

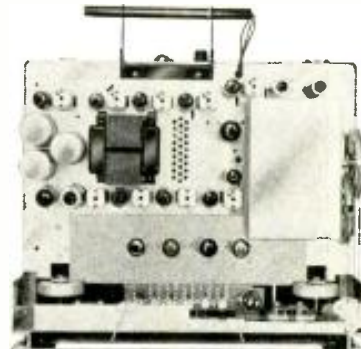

Top view of ST350 with MA350 installed (Note swivel antenna extended for use with CX50 enclosure.)

*The new Harman-Kardon Madrigal, Model ST350, actually has the very best of everything.*

**BEST FM:** Distortion and drift are virtually unmeasurable. Sensitivity limited only by galactic noise. Superior signal to noise ratio results in clean, transparent sound unmarred by background noise.

**BEST AM:** IF stages designed with "broad nose" for excellent high frequency response and with "sharp skirts" for improved spurious response rejection. AM noise filter provides noise-free long distance reception.

**STEREO - NOW:** Completely separate AM and FM front ends for simulcast (stereo) reception. Each with electronic bar tuning indicator. Ingenious Stereo Indexer for identification of six pairs of stations.

**STEREO - FUTURE:** New MA350 Multiplex Adapter plugs into chassis of ST350 (see illustration) to provide the only completely integrated tuner for receiving Crosby compatible multiplex (FM stereo) broadcasts.

**PUSH-BUTTON CONVENIENCE:** All functions—including AM Noise Filter, AM, AM/FM Stereo, Multiplex, FM, FM-AFC and Power Off—are operated by push-button control center.

The price of the ST350 is \$199.95; optional enclosure, Model CX50—\$12.50. Multiplex Adapter, MA350—\$49.95.

We also invite your attention to the superb new single channel versions of the ST350; The Ode, Model T250, is an AM/FM tuner; The Lyric, Model F250, is an FM only tuner. Both accommodate a plug-in multiplex adapter on their chassis. Model T250—\$149.95. Model F250—\$129.95. Prices slightly higher in the West. For free colorful catalog on complete H-K line, write Harman-Kardon, Inc., Dept. HF-4 Westbury, N. Y.



harman kardon

from the audio research center of the world

THE NEW  
LINE OF

# Norelco®

## T-7 LOUDSPEAKERS

featuring new TICONAL VII® magnets  
(30% more powerful than alnico)

This new line of 5" to 12" loudspeakers is designed to match the quality requirements of the discriminating music lover . . . at a surprisingly moderate price. The world's greatest buys on the basis of listening quality, the T-7 series incorporates voice coil magnets of Ticonal-7 steel, the most powerful of modern magnet alloys, for maximum efficiency and damping . . . dual cones for wide frequency response . . . constant impedance resulting in an extremely straight response curve . . . longer effective air-gaps and extra high flux density to provide exceptional transient response and to eliminate ringing and overshoot.

Model	Size	Power (watts) Continuous Peak	Impedance (ohms)	Efficiency at 400 cps	Total Flux (Maxwells)	Flux Density (gauss)	Frequency Response (cps)	Audiophile Net
AD-5277M	12"	20 30	8	14%	134,000	11,000	35-18,000	\$72.50
AD-4277M	12"	20 30	8	7%	98,000	8,000	35-18,000	39.00
AD-4877M	8"	6 10	4-6	10%	58,300	13,000	50-20,000	26.00
AD-3800M	8"	6 10	4-6	6%	26,200	11,000	75-19,000	9.90
AD-3500M	5"	3 5	4-6	4%	26,200	11,000	130-19,000	8.34
AD-3690M	6x9"	6 9	4-6	5.5%	26,200	11,000	70-18,000	7.95
AD-2690M	6x9"	6 9	4-6	2.5%	15,200	8,500	70-16,000	6.75

Developed  
and  
Guild-crafted  
by  
Philips  
of the  
Netherlands

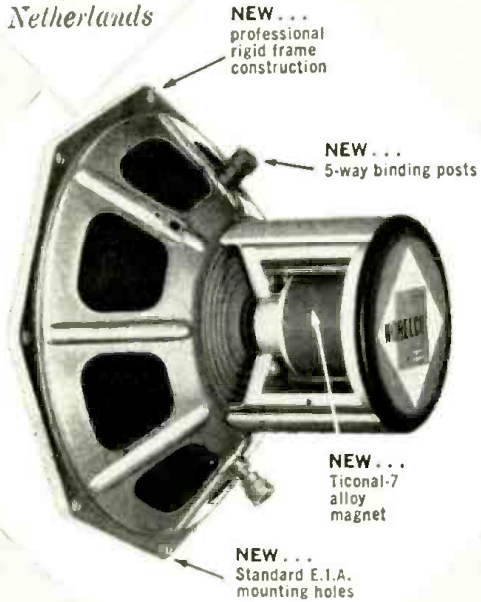

## Norelco 'EXHIBITION' SPEAKER ENCLOSURES



Acoustically designed to achieve moderate size without loss of bass response or wideness of dispersion. Perfectly matched for the bass response of the NORELCO T-7 speakers . . . ideal for most quality 8" to 12" speakers. Available in three sizes in hand-rubbed Mahogany, Walnut, Blond or Cherry finishes. Specifications: The "Rembrandt," (26" x 21½" x 17¼" deep) Walnut or Cherry \$99.50; Blond \$94.95; Mahogany \$91.00. The "Van Gogh," (23¾" x 13¾" x 11¾" deep) Walnut or Cherry \$59.95; Blond \$55.50; Mahogany \$51.00. The "Vermeer," (18½" x 12" x 8-15/16" deep) Walnut or Cherry \$35.00; Blond \$33.25; Mahogany \$31.00. \*May be placed horizontally or vertically.

. . . also new from **Norelco**

The "HAGUE"; Completely integrated quality speaker system. Two high-efficiency T-7 loudspeakers in an acoustically matched enclosure. Designed for optimum dispersion . . . maximum efficiency . . . extremely wide-range, flat response. 26" x 21½" x 17¼" deep. Walnut or Cherry \$159.95; Blond \$154.95; Mahogany \$149.95.



**NORTH AMERICAN PHILIPS CO., INC.**  
High Fidelity Products Division  
230 DUFFY AVENUE, HICKSVILLE, L. I., N. Y.

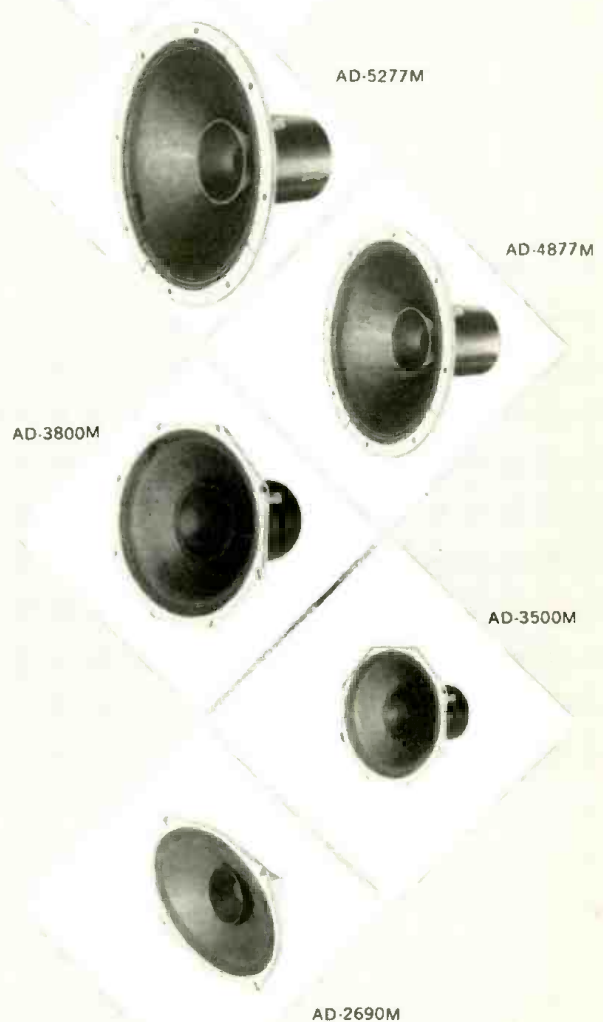



### Industry Growth

The Institute of High Fidelity Manufacturers reports that high-fidelity component sales in 1950 amounted to \$12,000,000. In 1958 they jumped to \$260,000,000 and are expected to reach \$300,000,000 this year.

FM radio, after several rough years, is growing in size and strength. The National Association of Broadcasters' FM Radio Committee reported that as of December 1958 there were 565 commercial FM stations on the air, compared with 533 in 1957. FM set sales for last year exceeded 500,000, bringing the total in use to something over 14,000,000.

William Speed, president of Audio Devices, predicts a 35% growth for the magnetic tape industry in 1959. Industry sales, he said, may reach \$100,000,000 in three years.

### Stereo Standards

The Board of Directors of the Electronic Industries Association has established a National Stereophonic Radio Committee. The committee has been charged with responsibility to "develop a set of standards for stereophonic radio which, in the opinion of the industry as represented by the Electronic Industries Association, represents the most economical method of serving the American public. This set of standards must permit full compatibility to the extent economically feasible; that is, all reasonable systems of multiplexing plus regular FM transmissions."

### Equipment Specifications

The need for standard methods of testing audio equipment is so apparent, and has been stated in print so many times already, that it makes us feel a bit like cranks to bring it up again.

Yet we are duty-bound to talk about it from time to time, in order to warn readers against giving the published specifications too much weight in comparing units of different manufacturers. There are honest differences

*Continued on next page*

# the Royalty of Value in STEREO HI-FI

## knight®

created by ALLIED RADIO

advanced design, features, performance and styling  
outstanding for superb musical quality  
each unit guaranteed for one full year

### THE KNIGHT STEREO ENSEMBLE



#### knight KN734 deluxe 34-watt stereo amplifier

compare these "royalty of value" features:

only  
**\$12950**  
easy terms:  
\$12.95 down

Full stereophonic and monophonic controls • 17 watts per stereo channel...34 watts monophonic • Separate bass and treble controls for each channel • 5 pairs of stereo inputs...input jack for accessory remote control • DC on all preamp heaters • Wide range balance control • 3-step loudness contour • Variable input loading control for any magnetic cartridge • May be used as 34 watt add-on with special preamp output • Mar-proof vinyl-clad metal case...solid aluminum anodized front panel.

#### knight KN120 deluxe stereo FM-AM tuner

compare these "royalty of value" features:

only  
**\$12950**  
easy terms:  
\$12.95 down

Separate FM and AM sections for simultaneous or separate operation • Dynamic Sideband Regulation for minimum distortion of FM • Dual limiters on FM • Tuned RF stage on FM and AM • 3-position AM bandwidth switch • Cathode follower multiplex output jack • Four cathode follower main outputs • Dual "Microbeam" tuning indicators • Illuminated 9½" tuning scale; inertia tuning with advanced flywheel design • High-sensitivity AM ferrite antenna • Handsome solid aluminum front panel, gold anodized, with beige leathertone case.



#### FREE 1959 ALLIED CATALOG

Send for your complete, money-saving guide to the world's largest selection of hi-fi systems and components. See everything in thrilling stereo; all the new KNIGHT systems and components; every famous make line. For everything in hi-fi, for everything in Electronics, get the 452-page 1959 ALLIED Catalog. FREE—write for it today.

order from  
*America's*  
*Hi-Fi Center*



#### ALLIED RADIO

100 N. Western Ave., Dept. 49-D9  
Chicago 80, Illinois

# FAIRCHILD

## unique exchange plan

### KEEPS CUSTOMER'S EQUIPMENT UP-TO-DATE

Seemingly endless refinements in high fidelity concepts and equipment have brought the average customer face-to-face with the problem of how to keep his equipment from growing obsolete.

We say *average* customer because Fairchild customers are less concerned with this problem. Their equipment is generally several years ahead of that offered by other manufacturers. In addition, Fairchild's exclusive Exchange Plan provides them with the *latest* components at practically no penalty for obsolescence. Owners of Fairchild cartridges have been taking advantage of this plan for years.

you can  
convert to  
stereo  
and save  
up to \$36!

Owners of a Fairchild cartridge can turn it in to their dealer and obtain a new Fairchild 232 Stereo cartridge **at a saving of . . . \$8.00**

Owners of a Fairchild 280 or 281 arm can ask their dealer to send it to the factory and have it converted to Stereo for a cost of only **\$14.50**  
**a saving of . . . \$28.00\***

Total cost for converting to Fairchild Stereo  
**. . . \$56.00**

Total Saving to Fairchild owners . . . **\$36.00**

*\*If you cannot wait your dealer will give you a brand new 282 in exchange for your 280 or 281 plus \$29.50 a saving of . . . \$13.00*

*To the audiophile who is not now a Fairchild owner we say these superb Fairchild products are more than worth their cost. The 232 cartridge with its Dual-Rotating-Coil design and linear damping provides the cleanest listening you have ever heard in Stereo records.*

**Cost \$49.50**

The 282 Stereo arm is newly redesigned, handsomely finished and comes complete with integral high quality shielded cables, ready to plug into your preamplifier! No soldering — no hum. It is the world's finest arm, and the easiest to mount.

**Cost \$42.50**



## FAIRCHILD "The Sound of Quality"

Hear these Fairchild components at your dealer, or write to Dept. HF49

FAIRCHILD RECORDING EQUIPMENT CORP. • 10-40 45th Ave., Long Island City 1, N. Y.

## NOTED WITH INTEREST

*Continued from preceding page*

of opinion among manufacturers as to how tests should be made and which test methods give the most significant results; as long as there are no official standard methods of measurement, these differences will produce differing specification figures.

Confusion is caused sometimes even in the interpretation of test results from independent sources. In our March issue, for example, we published an "Audiolab Test Report" on the Bell 3030 stereo amplifier. Power output was tested on the 8-ohm output taps, which seemed reasonable to Hirsch-Houck Laboratories (our ATR test organization). The amplifier didn't quite meet the manufacturer's specs when tested that way. According to Bell, the specs are met easily if the 16-ohm taps are used. Such misunderstandings would be avoided if we had standards of measurement to be followed by everybody.

Fortunately, the Institute of High Fidelity Manufacturers is working diligently at this problem. It has worked out complete (and excellent) standards for testing tuners, and these have been accepted by the membership. At the time this is written the IHFM is said to have test standards for amplifiers nearly completed. Hirsch-Houck Labs now follow the IHFM's tuner standards in preparing reports; as other standards are accepted they will use them also. We may at last be getting out of the specifications mess.

### Telediffusion

The heading is misleading; it's not what you think it is. Generally speaking, in the United States the word might mean some method of carrying television programs throughout a community on cable. Service is rented; you simply connect your television set to the cable outlet and you can then receive a number of television stations—usually many more than if you put up your own antenna.

Thanks to reader Noel Arnold in Lausanne, Switzerland, it has been brought to our attention that telediffusion in Switzerland applies to radio programs. Transmission is direct from studio to listener by telephone cables and, in the service being offered in Lausanne, offers a selection from some twenty different studios throughout Switzerland and as far away as London. Although telephone lines are used, Mr. Arnold says the fidelity is excellent. Cost is about 50 cents per month, charged on the telephone bill.

CHARLES FOWLER

**STEREO  
STEREO  
AND  
MONAURAL**

the  
experts  
say...  
in HI-FI  
the best buys are

**EICO**

World-famous  
EICO advantages  
guarantee your complete satisfaction:

- Advanced engineering • Finest quality components
- "Beginner-Tested," easy step-by-step instructions
- LIFETIME service & calibration guarantee
- IN STOCK — Compare, then take home any EICO equipment—right "off the shelf"—from 1900 neighborhood EICO dealers.



Stereo Preamp HF85



Stereo  
Amplifier-Preamp  
HF81



Monaural Integrated Amplifiers:  
50, 30, 20, and 12-Watt  
(use 2 for Stereo)



Monaural Power Amplifiers:  
60, 50, 35, 30, 22 and 14-Watt  
(use 2 for Stereo)  
Stereo Power Amplifier HF86



FM Tuner HFT90  
AM Tuner HFT94



Bookshelf  
Speaker System  
MFS1



Omn-directional  
Speaker System MFS2  
36" H x 15 1/4" W x 11 1/2" D



Monaural Preamp HF65, HF65A  
(stack 2 for Stereo)



Over 1 MILLION EICO instruments in use throughout the world.

**NEW STEREOPHONIC EQUIPMENT**

**HF85:** Stereo Dual Preamp is a complete stereo control system in "low silhouette" design adaptable to any type of installation. Selects, preampifies, controls any stereo source—tape, discs, broadcasts. Superb variable crossover, feedback tone controls driven by feedback amplifier pairs in each channel. Distortion borders on unmeasurable even at high output levels. Separate lo-level input in each channel for mag. phono, tape head, mike. Separate hi-level inputs for AM & FM tuners & FM Multiplex. One each auxiliary A & B input in each channel. Independent level, bass & treble controls in each channel may be operated together with built-in clutch. Switched-in loudness compensator. Function Selector permits hearing each stereo channel individually, and reversing them; also use of unit for stereo or monophonic play. Full-wave rectifier tube power supply. 5-12AX7/ECC83, 1-6X4. Works with any high-quality stereo power amplifier such as EICO HF86, or any 2 high-quality mono power amplifiers such as EICO HF14, HF22, HF30, HF35, HF50, HF60. "Extreme flexibility... a bargain" — HI-FI REVIEW. Kit \$39.95. Wired \$64.95. Includes cover.

**HF86:** Stereo Dual Power Amplifier for use with HF85 above or any good self-powered stereo preamp. Identical Williamson-type push-pull EL84 power amplifiers, conservatively rated at 14W, may be operated in parallel to deliver 28W for non-stereo use. Either input can be made common for both amplifiers by Service Selector switch. Voltage amplifier & split-load phase inverter circuitry feature EICO-developed 12DW7 audio tube for significantly better performance. Kit \$43.95. Wired \$74.95.

**HF81:** Stereo Dual Amplifier-Preamp selects, amplifies & controls any stereo source — tape, discs, broadcasts — & feeds it thru self-contained dual 14W amplifiers to a pair of speakers. Monophonically, 28 watts for your speakers; complete stereo preamp. Ganged level controls, separate focus (balance) control, independent full-range bass & treble controls for each channel. Identical Williamson-type, push-pull EL84 power amplifiers, excellent output transformers. "Service Selector" switch permits one preamp-control section to drive the internal power amplifiers while other preamp-control section is left free to drive your existing external amplifier. "Excellent" — SATURDAY REVIEW: HI-FI MUSIC AT HOME. "Outstanding quality... extremely versatile" — RADIO & TV NEWS LAB-TESTED. Kit \$69.95. Wired \$109.95. Includes cover. **MONO PREAMPLIFIERS (stack 2 for Stereo)** HF-65: superb new design, inputs for tape head, microphone, mag-phono cartridge & hi-level sources. 1M distortion 0.04% @ 2V out. Attractive "low silhouette" design. HF65A Kit \$29.95. Wired \$44.95. HF65 (with power supply) Kit \$33.95. Wired \$49.95.

**MONO POWER AMPLIFIERS (use 2 for STEREO)**

HF60 (60W), HF50 (50W), HF35 (35W), HF30 (30W), HF22 (22W), HF14 (14W): from Kit \$23.50. Wired \$41.50.

**MONO INTEGRATED AMPLIFIERS (use 2 for STEREO)**

HF52 (50W), HF32 (30W), HF20 (20W), HF12 (12W): from Kit \$34.95. Wired \$57.95.

**SPEAKER SYSTEMS (use 2 for STEREO)**

**HF82:** Natural bass 30-200 cps via slot-loaded 12-ft. split conical bass horn. Middles & lower highs: front radiation from 8 1/2" edge-damped cone. Distortionless spike-shaped super-tweeter radiates omni-directionally. Flat 45-20,000 cps, useful 30-40,000 cps. 16 ohms. HWD 36", 15 1/4", 11 1/2". "Eminently musical" — Holt, HIGH FIDELITY. "Fine for stereo" — MODERN HI-FI. Completely factory-built: Mahogany or Walnut, \$139.95; Blonde, \$144.95.

**HF81:** Bookshelf Speaker System, complete with factory-built cabinet. Jensen 8" woofer, matching Jensen compression-driver exponential horn tweeter. Smooth clean bass; crisp extended highs. 70-12,000 cps range. Capacity 25 w. 8 ohms. HWD: 11" x 23" x 9". Wiring time 15 min. Price \$39.95.

**FM TUNER HFT90:** Surpasses wired tuners up to 3X its cost. For the first time, makes practical even for the novice the building of an FM tuner kit equal to really good factory-wired units. No alignment instruments needed. Pre-wired, pre-aligned temperature-compensated "front end" is drift-free — eliminates need for AFC. Precision "eye-tronic" DM-70 traveling tuning indicator, supplied pre-wired, contracts at exact center of each FM channel. Pre-aligned IF coils. Sensitivity 6X that of other kit tuners: 1.5 uv for 20 db quieting, 2.5 uv for 30 db quieting, full limiting from 25 uv. IF bandwidth 260 kc at 6 db points. Frequency response uniform 20-20,000 cps ± 1 db. Cathode-follower & Multiplex outputs. Flywheel tuning, automatic gain control, stabilized low limiting threshold for excellent performance from weaker signals, broad-band ratio detector for improved capture ratio & easier tuning, full-wave rectifier & heavy filtering, very low distortion. "One of the best buys you can get in high fidelity kits" — AUDIOCRAFT Kit Report. Kit \$39.95\*. Wired \$65.95\*. Cover \$3.95. \*Less Cover, F.E.T. incl.

**NEW AM TUNER HFT94:** Matches HFT90. Selects "hi-fi" wide (20c — 9kc @ -3 db) or weak-station narrow (20c — 5kc @ -3 db) bandpass. Tuned RF stage for high selectivity & sensitivity; precision "eye-tronic" tuning. Built-in ferrite loop, prealigned RF & IF coils. Sensitivity 3 uv @ 30% mod. for 1.0 V out, 20 db S/N. Very low noise & distortion. High-Q 10 kc whistle filter. Kit \$39.95. Wired \$69.95, incl. Cover & F.E.T.

EICO, 33-00 Northern Blvd., L.I.C. 1, N.Y. MF-4

SHOW ME HOW TO SAVE 50% on 65 models of top-quality:

Hi-Fi  Test Instruments  "Ham" Gear  
Send FREE catalog & name of neighborhood EICO dealer.

NAME.....  
ADDRESS.....  
CITY..... ZONE..... STATE.....

Copyright 1958 by Electronic Instr. Co., Inc. 33-00 N. Blvd., L.I.C. 1, N.Y.

Add 5% in the West.

# new

## for the Stereophile

from

**SARGENT-RAYMENT**  
LEADERS IN AUDIO AND RADIO ENGINEERING SINCE 1927

### 3 Brilliant Stereo Reproducers

featuring \*STEREO SEPARATION CONTROL  
and other exclusive SR engineering features

SR-1000 DE LUXE  
Stereo AM-FM Tuner  
\$184.50



Clean, precision design—loaded with advanced features for the discriminating stereophile:

- Gold-plated "frame grid" cascode tube, guarantees maximum obtainable sensitivity— $0.85 \mu\text{v}$  for 20 db quieting!
- Exclusive SR 2-tube AM detector, acclaimed by all leading test laboratories as the only detector capable of reproducing AM at less distortion than FM—0.1% harmonic at 50% modulation; 0.45% at 100% modulation.
- 2-position AM bandwidth selector—sharp and extremely broad—4.5 kc flat audio response on Sharp; 8.2 kc flat audio response on Broad.

SR-2000 DE LUXE  
Stereo Pre-Amp  
\$163.50

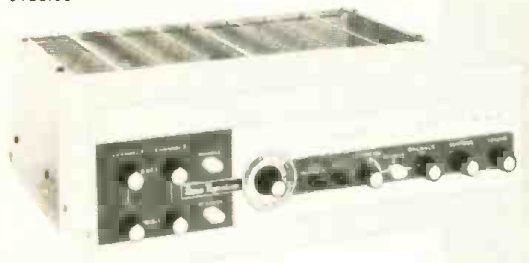

**STEREO SEPARATION CONTROL**—an exclusive new SR feature that's a full year ahead—gives you finger-tip control of the degree of separation between the two stereo channels, lets you blend them at will to suit your own ear. With the Stereo Separation Control, you can fill the "hole in the middle," eliminate objectionable separation or "ping-pong" effect, and compensate for variations in stereo programming recorded with extreme channel separation.

Other advanced features:

- Phase alternating button—enables you to separate, or to exaggerate stereo programming that is heavily mixed.
- Totally inaudible distortion—only 0.08% IM at 1 volt output, 0.2% at 3 volts, 0.5% at 10 volts.
- Professional control functions include separate bass and treble, variable loudness, rumble and scratch filters.
- Twelve variable input level controls to accommodate any stereo or monaural signal inputs.

SR-5100 DUAL  
50-watt Amplifier  
\$175.50 (\$183.60 with  
perforated cage)

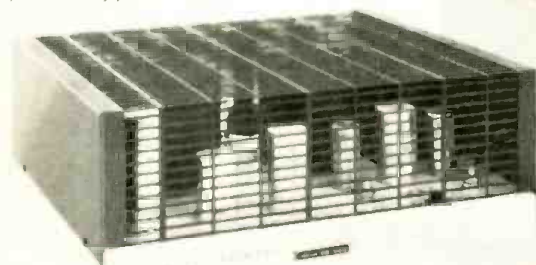

**Combines two professional-quality 50-watt amplifiers, electrically isolated, yet on one chassis; engineered for stereo.**

- Each channel delivers full rated power (50 watts) with less than 1% IM distortion; less than 0.2% at 45 watts.
- Switching provided for instantly paralleling channels to permit use as 100-watt monaural amplifier (200 watts peak).
- Dual GZ34 cathode type rectifiers for optimum regulation and long life.

Full 1-Year Guarantee on  
all SR Stereo Reproducers

Write for your copy of the exciting new 12-page SR brochure, discover why SR components out-perform and out-last all others in their price range, and "check the specs" on other SR stereo products such as the SR-380 AM-FM Tuner/Stereo Pre-Amp tone control, the SR-534 Dual 17-watt basic power amplifier, and the SR-1717 Stereo Pre-Amp/Dual 17-watt amplifier.

# SR

**SARGENT - RAYMENT CO.**

4926 East 12th Street • Oakland 1 • California

NOW the Columbia  Record Club offers BOTH  
**STEREOPHONIC**  
 and **MONAURAL RECORDS**  
 at Tremendous Savings!



1. Johnny sings What'll I Do, Warm, While We're Young, 9 more



2. This vivid musical Painting has become an American classic

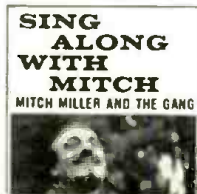

3. 16 favorites—Sweet Violets, Down by the Old Mill Stream, etc.



4. Pianistic fireworks abound in these two romantic scores



5. Where or When, The Way You Look Tonight, Be My Love, 9 more



6. 43 hits for listening and dancing—in the smooth Lanin style

# FREE ANY 3

OF THESE SUPERB  
**COLUMBIA and EPIC RECORDS**  
 (AVAILABLE IN STEREOPHONIC SOUND OR MONAURAL HIGH FIDELITY)

If you join the Columbia  Record Club now—and agree to purchase 4 selections during the coming 12 months

Yes, now you can acquire the world's finest stereophonic AND high-fidelity monaural recordings — at truly substantial savings! And as a dramatic demonstration of the Columbia  Record Club's money-saving Bonus Plan — you may have, at once, ANY 3 of the sixteen records shown here, FREE . . . available in your choice of stereophonic sound OR monaural high fidelity!

### HOW THE CLUB SAVES YOU MONEY

Your only membership obligation is to purchase four selections from the almost 200 Columbia and Epic records to be offered in the coming 12 months. Thus you receive seven records for the price of four — a saving of more than one-third on your record purchases.

Furthermore, after buying four selections you receive your choice of a Columbia or Epic Bonus record (stereo or monaural) free for every two additional selections you buy.

### HOW THE CLUB OPERATES

You enroll in any one of the six Club Divisions: If you have stereo equipment you enroll in either the Stereo Classical or Stereo Popular Division.

If you have monaural equipment you enroll in any one of four Divisions: Classical; Listening and Dancing; Broadway, Movies, Television and Musical Comedies; Jazz.

Each month the Club's staff of musical experts selects outstanding recordings from every field of music. These selections are described in the Club Magazine, which you receive free each month.

You may accept or reject the selection for your Division, take any of the other records offered (stereo or monaural), or take NO record in any particular month. You may discontinue membership at any time after purchasing four records.

The records you want are mailed and billed to you at the regular list price: Popular Monaural Selections, \$3.98; Classical Monaural, \$4.98; all Stereo Records, \$5.98 — plus a small mailing charge.

To receive your three stereo or monaural records FREE, fill in and return the coupon today!

**COLUMBIA  RECORD CLUB**  
 Terre Haute, Indiana



7. The ingratiating Miss Holliday in her biggest Broadway hit

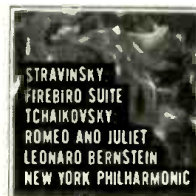

8. Bernstein's exciting performances of two colorful scores

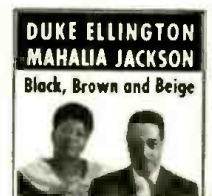

9. The finest performance ever of the Duke's masterpiece



10. A truly magnificent performance of this majestic symphony



11. The great tunes from Rodgers and Hammerstein's fabulous hit

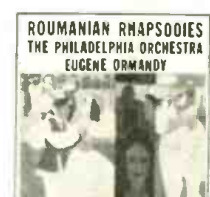

12. The two fiery Rumanian Rhapsodies—plus 2 more works

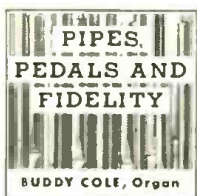

13. Organist Buddy Cole plays 11 tunes—Mine, Caravan, Carloc, etc.



14. Cugat's greatest hits—Besame Mucho, Tico-Tico, Brazil, 9 more



15. The most popular of Tchaikovsky's lovely, melodic symphonies



16. Available in stereo only. 16 popular and classical selections

## FREE — ANY 3 — MAIL COUPON NOW

**COLUMBIA  RECORD CLUB, Dept. 224-3**  
 Terre Haute, Indiana

Please send me as my FREE gift the 3 records whose numbers I have circled at the right — and enroll me in the following Division of the Club: (check one box only)

MONAURAL DIVISIONS		STEREO DIVISIONS
<input type="checkbox"/> Classical	<input type="checkbox"/> Broadway, Movies, Television and Musical Comedies	<input type="checkbox"/> Stereo Classical
<input type="checkbox"/> Listening & Dancing		<input type="checkbox"/> Stereo Popular
<input type="checkbox"/> Jazz		

I agree to purchase four selections from the almost 200 stereophonic and monaural records to be offered during the coming 12 months, at regular list price plus small mailing charge. For every two additional selections I accept, I am to receive a Columbia or Epic Bonus record (stereo or monaural) of my choice FREE.

Name..... (please print)  
 Address.....

City..... Zone..... State.....

CANADA: prices slightly higher, address 11-13 Soho St., Toronto 2B  
 If you want this membership credited to an established Columbia or Epic record dealer, authorized to accept subscriptions, fill in below:

Dealer's Name.....  
 Dealer's Address..... 215  
 \*Columbia,  Epic,  Mercury Reg. © Columbia Records Sales Corp., 1959

### CIRCLE 3 NUMBERS BELOW:

(Indicate here whether you want your 3 records in Stereo or Monaural):  
 STEREO L-50  MONAURAL L-49

1. Johnny Mathis — Warm
2. Grofé: Grand Canyon Suite
3. Sing Along With Mitch Miller
4. Grieg Piano Concerto; Rachmaninoff Rhapsody
5. 'S Marvelous — Ray Conniff
6. Lester Lanin at the Tiffany Ball
7. Bells Are Ringing — Original Broadway Cast
8. Firebird; Romeo and Juliet
9. Black, Brown and Beige
10. Beethoven: Eroica Symphony
11. Percy Faith Plays "South Pacific"
12. Rumanian Rhapsodies 1, 2; plus two more works
13. Pipes, Pedals and Fidelity
14. Cugat Cavalcade
15. Tchaikovsky: Pathetique Symphony
16. Listening in Depth (Available in stereo only)

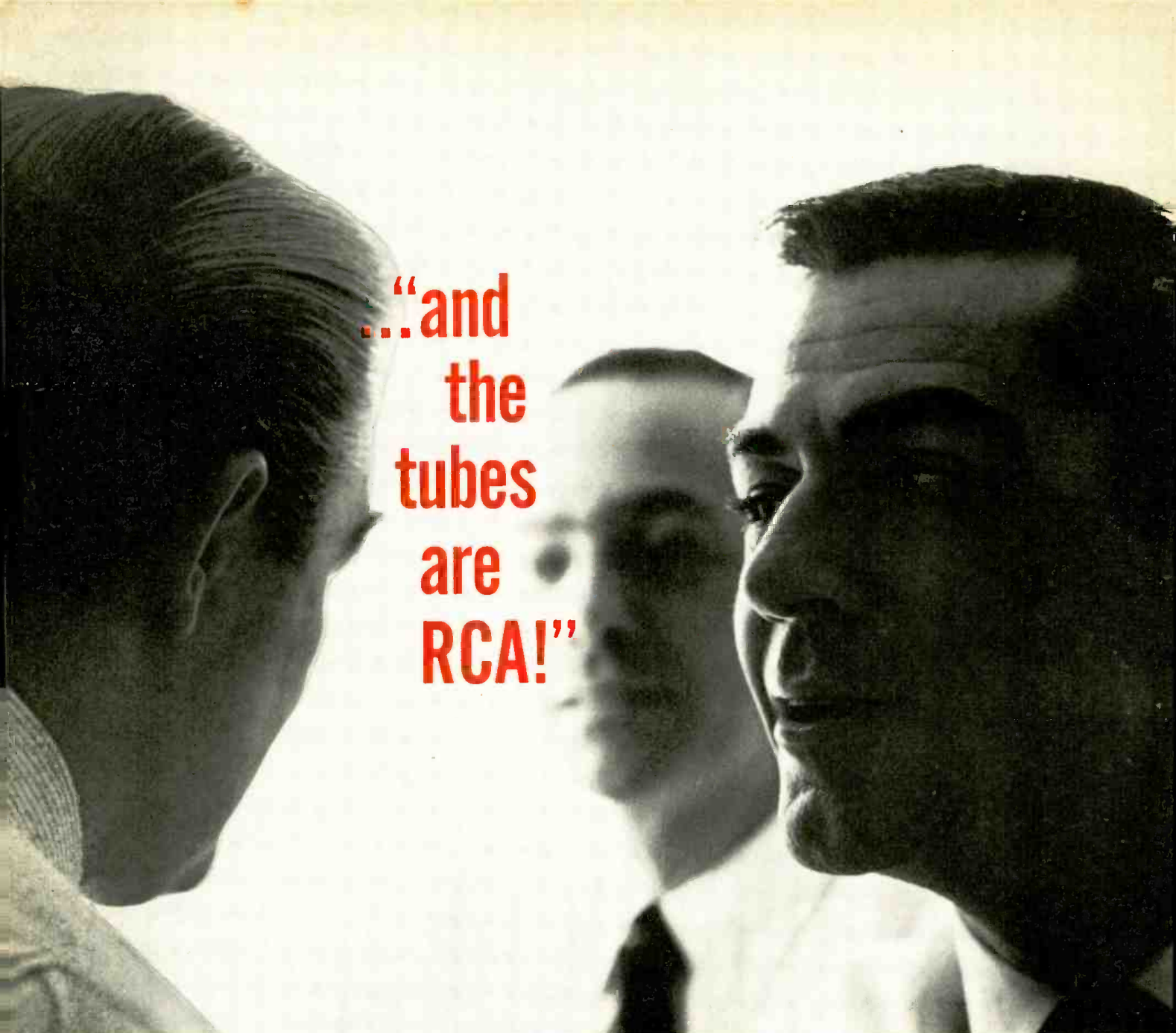

...and  
the  
tubes  
are  
RCA!"

One design engineer tells another exactly how he puts the "high" in "fidelity"

New design! Just demonstrated the model! FM's superb...such quieting...rock-stable tuning! Can't hear any hum in the wide-open audio preamplifier...or noise in the treble! And the power amplifier...*just feel that bass!* He has good reason to be proud. From front end to output stage, the design's a honey. And, as he says: "...*the tubes are RCA!*"

RCA tubes for monophonic and stereophonic high fidelity have been especially de-

signed to bring out the best in your equipment. Among these are four special types—RCA-6973 and 7027 beam power tubes. RCA-7025, a high-mu twin triode controlled for hum and noise and the 7199, a remarkable triode-pentode combination.

Your RCA Field Representative will be glad to help you select the right tube for your circuit. Call him now. Or you can get technical data from RCA Commercial Engineering, Section D-74-DE, Harrison, N. J.

**RCA Field Offices**

**EAST:**

744 Broad Street  
Newark 2, N. J.  
HUMboldt 5-3900

**MIDWEST:**

Suite 1154  
Merchandise Mart Plaza  
Chicago 54, Ill.  
WHitehall 4-2900

**WEST:**

6355 E. Washington Blvd.  
Los Angeles 22, Calif.  
RAYmond 3-8361

RCA tubes for High Fidelity also available from  
your local Authorized RCA Tube Distributor



**RADIO CORPORATION OF AMERICA**  
Electron Tube Division  
Harrison, N. J.





To introduce you to the

# RCA VICTOR POPULAR ALBUM CLUB

**ANY FIVE OF THE  
24 ALBUMS BELOW  
FOR ONLY \$3.98**

[NATIONALLY ADVERTISED \$24.90  
PRICES TOTAL UP TO]

ALL ALBUMS ARE  
12-INCH 33 1/3 R.P.M.  
LONG-PLAYING

... if you agree to buy five albums from the Club during the next twelve months from at least 100 to be made available

THIS exciting new plan enables you to have on tap a variety of popular music... and, once and for all, takes bewilderment out of building such a well-balanced collection. YOU PAY FAR LESS FOR ALBUMS THIS WAY than if you buy them haphazardly. For example, the extraordinary introductory offer described above can represent as much as a 40% saving in your first year of membership. Thereafter, through the Club's Record-Dividend Plan, YOU SAVE ALMOST 33 1/3% of the manufacturer's nationally advertised price. After buying the five albums called for in this offer, you will receive a free 12-inch 33 1/3 R.P.M. album, with a nationally advertised price of at least \$3.98, for every two albums purchased from the Club. A WIDE CHOICE OF RCA VICTOR ALBUMS will be described each month. One will be singled out as the *album-of-the-month*. If you want it, you do nothing; it will come to you automatically. If you prefer an alternate—or *nothing at all*—you can make your wishes known on a form always provided. You pay the nationally advertised price—usually \$3.98, at times \$1.98 (plus a small charge for postage and handling).

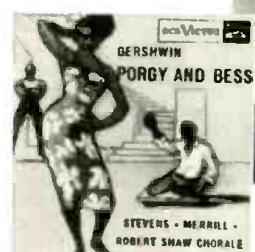
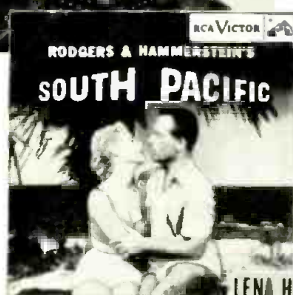
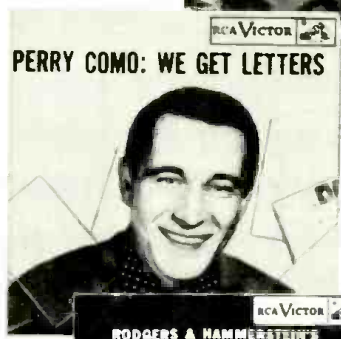

SINGING STARS • BROADWAY MUSICALS • JAZZ  
DANCE MUSIC • MOOD MUSIC • COLLECTOR'S ITEMS

**CHECK THE FIVE ALBUMS YOU WANT. DO NOT DETACH FROM THE COUPON**

- WE GET LETTERS** Perry Como sings 12 standards.
- BELAFONTE** Folk songs, ballads, calypsos.
- FRANKIE CARLE'S SWEETHEARTS** Dancy piano, twelve "girl" songs.
- NEW GLENN MILLER ORCHESTRA IN HI FI** Ray McKinley, 12 dance items.
- BRASS & PERCUSSION** Morton Gould Symphonic Band, 17 hi-fi marches.
- LENA HORNE AT THE WALDORF ASTORIA.**
- MARIO LANZA — STUDENT PRINCE.**
- BOUQUET OF BLUES** Dinah Shore, torch songs.
- BING WITH A BEAT A** Crosby Jazz lark with Bob Scooby, 12 evergreen hits.
- TOWN HALL CONCERT PLUS** Louis Armstrong all-star collector's item.
- LET'S DANCE WITH THE THREE SUNS** Forty show tunes, standards.
- SOUTH PACIFIC** Original movie soundtrack.
- BOSTON POPS PICNIC** All time favorites: *Jalousie, Malagueña, etc.*
- MUSIC FOR DINING** Melachrino strings in hi-fi mood music.
- TOMMY DORSEY: YES INDEED!** *Marie, Star Dust.*
- SWEET SEVENTEEN** Ames Brothers. *Little White Lies, I Don't Know Why, etc.*
- LET'S CHA CHA WITH PUENTE** Latin dance fare; modern, big-band style.
- BLUE STARR** Kay Starr sings and swings torch songs.
- THE EYES OF LOVE** Hugo Winterhalter's lush orchestra in 12 standards.
- THINKING OF YOU** Eddie Fisher's top 12 all-time hits.
- MOONGLOW** Artie Shaw. *Begin the Beguine, Frenesi, Star Dust, etc.*
- DUKE ELLINGTON: IN A MELLOW TONE** 16 gems from the Duke's golden era.
- VICTORY AT SEA** Richard Rodgers' stirring score for the NBC-TV program.
- PORGY AND BESS** Gershwin highlights. *Rise Stevens, Robert Merrill.*

THE RCA VICTOR POPULAR ALBUM CLUB P. O. Box 80, Village Station, New York 14, N. Y. P12-4

Please register me as a member of The RCA Victor Popular Album Club and send me the five albums I have checked at left, for which I will pay \$3.98, plus a small charge for postage and handling. I agree to buy five other albums offered by the Club within the next year, for each of which I will be billed at the manufacturer's nationally advertised price: usually \$3.98, at times \$4.98 (plus a small charge for postage and handling). Thereafter, I need buy only four such albums in any twelve-month period to maintain membership. I may cancel my membership any time after buying five albums from the Club (in addition to those included in this introductory offer). After my fifth purchase, if I continue, for every two albums I buy I may choose a third album free.

Name \_\_\_\_\_  
 Address \_\_\_\_\_  
 City \_\_\_\_\_ Zone \_\_\_\_\_ State \_\_\_\_\_  
 NOTE: If you wish to enroll through an authorized RCA VICTOR dealer, please fill in here:  
 Dealer \_\_\_\_\_ Address \_\_\_\_\_  
 Send no money. A bill will be sent. Albums can be shipped only to U.S., its territories and Canada. Albums for Canadian members are made in Canada and shipped duty free from Ontario.

# LARRY ELGART *at the* CONTROL CONSOLE *of his* RECORDING STUDIO

(Note the AR-1 monitor loudspeakers, in stereo)



LARRY ELGART, RCA VICTOR RECORDING ARTIST

One of the most exacting jobs for a speaker system is that of studio monitor in recording and broadcast work. Technical decisions must be made on the basis of the sound coming from these speakers, which will affect, for good or for ill, the quality of a record master or FM broadcast.

AR acoustic suspension speaker systems, although designed primarily for the home, are widely employed in professional laboratories and studios. Below is a partial list of companies using AR speakers (all models) as studio monitors:

Dawn Records	Concertapes—Concertdisc
Elektra Records	WGBH
Mastercraft Record Plating	WPFM
Canterbury Records	WXHR
Raleigh Records	Counterpoint Recordings
Concert Network stations	(formerly Esoteric Records)
WBCN, WNCN,	Magnetic Recorder and Reproducer
WHCN, WXCN	Dubbings

AR speaker systems, complete with enclosures—the AR-1, AR-2, and AR-3—are priced from \$89 to \$225. Literature is available for the asking.

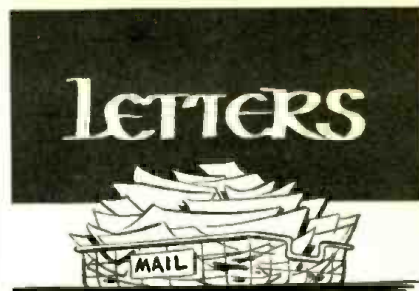

## Bravo for Bernstein

SIR:

I have been reading your magazine month after month since 1953 and wish to congratulate you for publishing the article "Who Lives at Carnegie Hall?" by Joseph Roddy.

Mr. Bernstein's accomplishments with the New York Philharmonic have indeed been colossal. . . . As a fellow New Yorker and frequent visitor to Carnegie Hall I can fully attest to Mr. Roddy's statement that the New York Philharmonic under the direction of Mr. Bernstein sounds like Toscanini's orchestra.

*Gunther H. Jansen*  
New York, N. Y.

## Foreboding

SIR:

I have just finished reading the article by Paul Wrablica entitled "Audio Styling: A Look Ahead" [January]. I honestly hope that the designs that he outlined are not a forecast of the fate of high fidelity. True, his ideas are original and stimulating; they stimulated me to write this letter. However, it would be sad to see electronic equipment go the way of the metal monsters issued from Detroit. Once automobiles belonged to the realm of the male. Now it seems that amplifiers and associated equipment are about to become finned and chromed things of beauty (beauty??) with wrap-around cabinets.

It may be true that I "satisfy my ego" with the knowledge that I alone can operate my amplifier, but what of it? I like my audio equipment to look and sound professional.

Another point. Mr. Wrablica hints in his article that manufacturing would be made easier, which implies assembly line procedure. I do not believe that a precision device can be built on an assembly line or that human care can be replaced by an electronic brain.

A final question: Do you know a real high-fidelity addict who would object strongly enough to adjusting his

*Continued on page 20*

**ACOUSTIC RESEARCH, INC.** 24 Thorndike Street, Cambridge 41, Mass.

HIGH FIDELITY MAGAZINE

Engineered for STEREO by

# McIntosh®



\$225 less cabinet

The **C 20**  
**COMPENSATOR**  
FOR  
**STEREO**

Intensive and thorough engineering for over a year has resulted in a preamplifier *designed for stereo*. McIntosh engineering has made McIntosh products the acknowledged leader in quality, flexibility, and features and now the McIntosh C 20 Stereo Compensator is destined to continue McIntosh in this coveted leadership. See the features of the preamplifier *designed for stereo* at your high fidelity dealer. He has the McIntosh C 20 Stereo Compensator in stock.

**McIntosh** ... *the Mark of Excellence*

# McIntosh® - Designed for STEREO

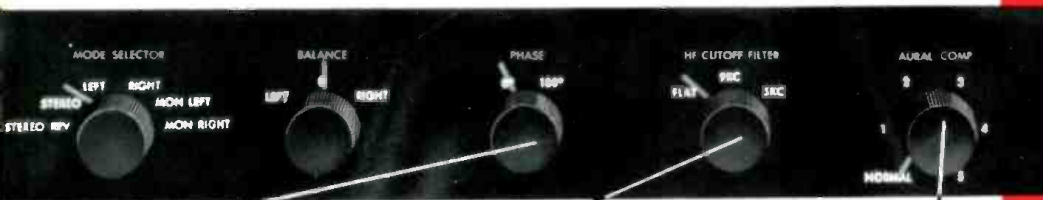

- MODE SELECTOR
- BALANCE CONTROL
- PHASE CONTROL
- HI FREQUENCY CUTOFF
- AURAL COMPENSATION

Correct phase relationship of the loudspeakers is absolutely essential in the reproduction of stereo. The front panel phase switch on the C 20 controls loudspeaker phase without any change in loudness or frequency response. An essential addition in a control unit *designed for stereo.*

As records become worn or dirty, high frequency noises become annoying. The high frequency cutoff switch permits the attenuation of the objectionable noise at a rate of attenuation of 20 DB per octave above 9 KC or 5 KC.

A continuously variable loudness control has been incorporated to permit playback at low levels. As the control is advanced the signal is reduced in intensity maintaining the aural response of the Fletcher-Munson curve.



- INPUT SELECTOR
- BASS COMPENSATION
- TREBLE COMPENSATION
- BASS TONE CONTROL
- TREBLE TONE CONTROL

Eight inputs are supplied including special input switching to parallel the sides of a stereo cartridge to cancel the vertical signal for highest quality monophonic reproduction from a stereo cartridge. Sufficient gain has been provided to give full output from even the lowest output cartridges.

Separate equalization controls for bass and treble to give the highest flexibility in record compensation. NAB equalization has been incorporated for direct tape head playback. Adequate equalization has been provided to protect your investment in monophonic records and tape.

In addition to the ganged tone controls on the front panel McIntosh has added separate and independent tone balancing controls on the back panel. The back panel controls are set once for balancing the response of the entire system. The front panel tone controls then can be used for flavoring the music without the need to re-balance the system after each use.

Jacks have been provided on the front panel to permit the use of a portable tape recorder in addition to a tape recorder built in the system. The jacks, in stereo of course, are for playback or record as controlled by the push button. By the use of these jacks two tape recorders can be used with the C 20.

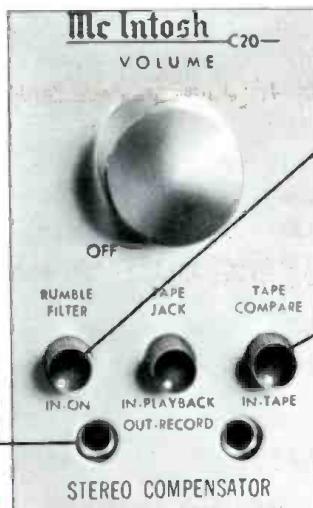

The push button Rumble Filter control sharply attenuates the extreme low frequencies to eliminate any objectionable noises generated in the source equipment.

Instantaneous tape comparison is controlled by the Tape Compare push button without affecting the signal being recorded. All functions are for either stereo or monophonic applications.

**McIntosh®**  
LABORATORY, INC.

*The C 20 is in stock  
at your McIntosh  
Franchised Dealer*

4 Chambers St., Binghamton, N. Y.

IN CANADA: MANUFACTURED BY McCURDY RADIO INDUSTRIES, LTD.; 22 FRONT STREET WEST, TORONTO, CANADA

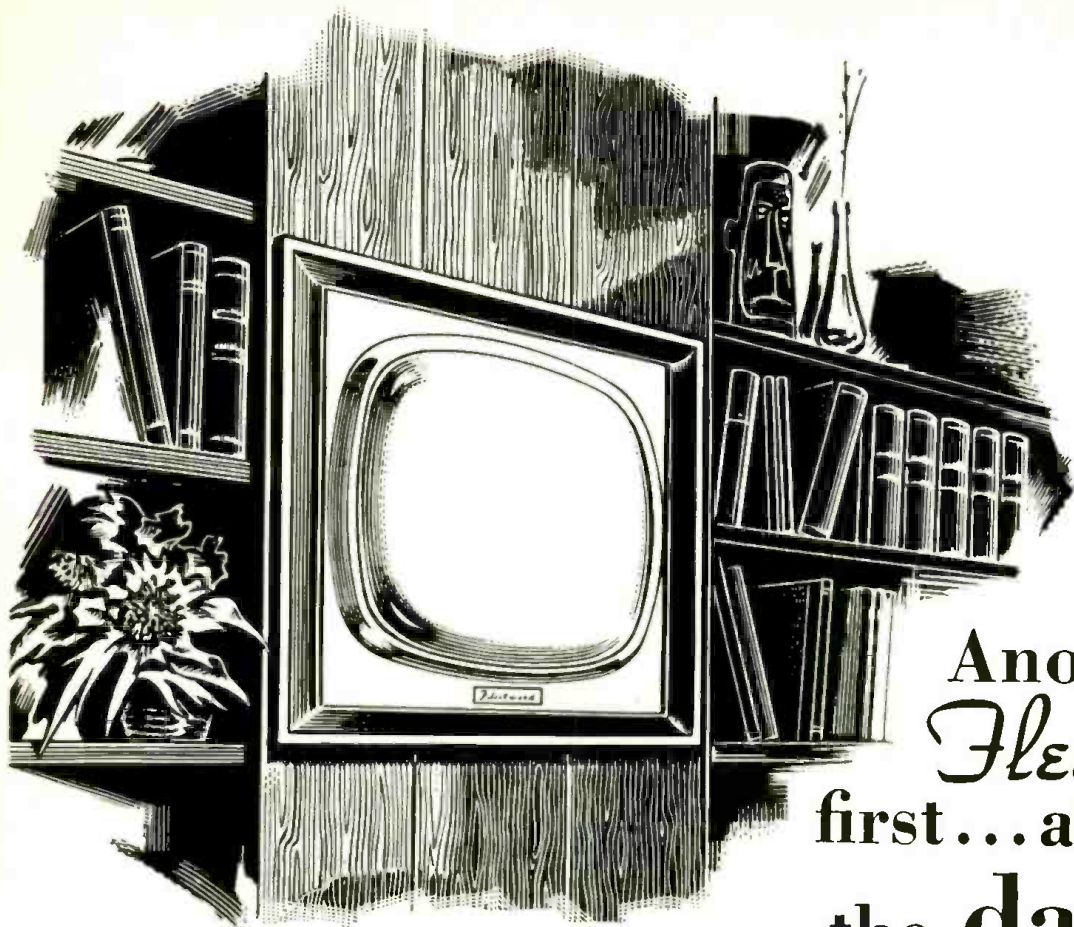

Model 900 with full electronic remote control.

## Another Fleetwood® first...and finest the daVinci

### Picture-Framed Custom Television

Startling, striking innovations of the new 21" da Vinci make this set a vanguard of the industry!

Named for the great Renaissance master who combined science and art, the da Vinci puts television in the fore of decor! Front of the receiver accepts picture framing when installed. Frame is chosen to harmonize with room motif, possibly matching other picture frames. Television literally becomes a favored piece of art as well as entertainment!

Technically superior, the da Vinci has a revolutionary new tube. Safety glass is curved and laminated to face of tube which is a 110° tri-potential focus type. Safety glass is etched for glare reduction, and, with flat glass eliminated, there is almost no reflection or washout even with every light in the room ablaze.

\*21" Diagonal measure

#### Other outstanding daVinci features:

- Wide Bandpass reproduces all useful information broadcast.
- Definition Control tailors picture texture to your taste.
- Excellent Circuitry . . . no inexpensive printed circuits; costly Silicon rectifiers for years of trouble-free service.
- Easy Installation with new short chassis only 11 1/2" deep. Bookshelves make perfect settings where wall apertures are impractical.

Model 910 designed for manual tuning with self-contained controls.

The daVinci is built-in beauty that belongs. See it at your hifi dealers' today . . . and you'll want it in your home.

# Fleetwood®

Write for dealer nearest you.

CUSTOM TELEVISION crafted by CONRAC, INC.

DEPT. A, GLENDORA, CALIFORNIA

For Ultimate Fidelity

# STEREO by SHERWOOD\*



If your choice is stereo, Sherwood offers The Ultimate in performance—and two models to choose from:

Model S-5000, a 20+20 watt dual amplifier-preamplifier for stereo "in a single package"...

Model S-4400, a stereo preamplifier with controls coupled with a single 36 watt amplifier for converting monaural systems to stereo (can also be used with Model S-360—a 36 watt basic amplifier (\$59.50) to make a dual 36 watt combination).

Basic coordinated controls for either stereo or monaural operation include 10 two-channel controls, stereo normal/reverse switch, phase inversion switch, tape-monitor switch and dual amplifier monaural operation with either set of input sources. Bass & Treble controls adjust each channel individually or together.

The five modes of operation (stereo, stereo-reversed, monaural 1, monaural 2, monaural 1+2) are selected by the function switch which also operates a corresponding group of indicator lights to identify the selected operating mode... and all Sherwood amplifiers feature the exclusive presence rise control.

Model S-4400: Stereo pre-amp, controls & single 36-watt amplifier, **Fair Trade \$159.50**  
 Model S-5000: 20+20 watt dual stereo amplifier, **Fair Trade \$189.50**

For complete specifications write Dept. H-4

## SHERWOOD

ELECTRONIC LABORATORIES, INC.  
 4300 N. California Ave., Chicago 18, Illinois

BURTON BROWNE ADVERTISING

The "complete high fidelity home music center"—monophonic or stereophonic.

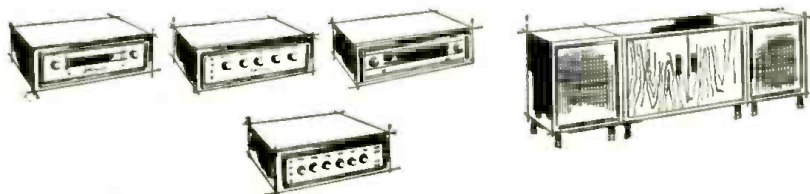

\*outstanding honors bestowed, unsolicited, by most recognized testing organizations.

## LETTERS

Continued from page 16

own "complicated" gear manually to buy an effeminate, push-button condensation to "public opinion?" I don't.  
*William A. Harting*  
 Boston, Mass.

### Record Reviews and the Arts

**SIR:**  
 I feel compelled to thank you for your impartial and splendid record reviews. Of particular interest was David Johnson's Puccini discography [December]. Mr. Johnson's careful and illuminating analysis is reassuring to us who have an extensive library of Madame Callas' recordings, for it gives authority to our belief in her vocal ability and unequalled dramatic interpretation. I might here add that her artistry is not the product of electronic amplification, but that on stage she is even more vibrant and her musicianship—if possible—even more apparent. Mr. Johnson's article fully supports my belief that artists are to be judged on performance, and that reportorial bias, prejudice, and sensationalism have no place in the arts.  
*Doris L. Rothgesser*  
 Hillside, N. J.

### Rebuttal to Reader

**SIR:**  
 I am writing because of the letter of Mr. Carlton C. Porter in your February issue attacking opera as, in great part, "tinsel and bombast . . . a poor and mongrel simulation of an art form."

Let me first admit that he could find examples of the nursery rhyme arias and lurid librettos he decries with little trouble. But only a person without taste could fail to find the same uneven quality in any form of music, or any other art for that matter.

Just as in the theatre, it is not poor works which justify the devotion of opera's admirers, but the occasional great masterwork which stamps opera with the badge of true art. Should the numerous bad plays of today convince us to shut our theatres because we have outgrown them?

If one should answer that great plays are still written, while great operas are not, he would have made a valid point, but not one which would discredit opera as an art form. The answer to this is to be found, not in any flaw in opera, but in the failure of modern composers to face the problems of opera and work hard

Continued on page 22

THE WORLD'S GREATEST MUSICAL ARTISTS  
TAPE THEIR OWN RECORDINGS ON

**irish**  
BRAND

FERRO-SHEEN® RECORDING TAPE:



Renata Tebaldi



Claudio Arrau



Roberta Peters



Isaac Stern

THAT ALONE IS NOT THE REASON WHY YOU SHOULD USE

**irish**  
BRAND

FERRO-SHEEN RECORDING TAPE:



Richard Tucker



Joseph Szilgeti



Regina Resnik



Leonard Rose



George London

HERE'S WHY YOU SHOULD USE

**irish**  
BRAND

FERRO-SHEEN RECORDING TAPE:



It's the best-engineered tape in the world . . . gives you better highs . . . better lows . . . better sound all around! Saves your tape recorder, too – because the **irish** FERRO-SHEEN process results in smoother tape . . . tape that can't sand down your magnetic heads or shed oxide powder into your machine. Price? Same as ordinary tape!

ORRadio Industries, Inc.  
Opelika, Alabama

World's Largest Exclusive Magnetic Tape Manufacturer

Export: Morhan Exporting Corp., New York, N.Y.

Canada: Atlas Radio Corp., Ltd., Toronto, Ontario

# BOGEN

*the sound way  
to better living*



**SHOPPING FOR STEREO?** The manufacture of stereo high-fidelity components is an extremely technical, highly specialized phase of electronics. So before you buy any stereo equipment, ask yourself this question: "Is the component I'm buying

made by a manufacturer who has a long history of brilliant successes in sound."

Bogen is a name known, and respected for over a quarter century as *the* authority on all types of sound equipment. Your child may listen to a Bogen central sound system in his classroom. Perhaps you use a Bogen intercom. Wherever professional sound equipment is used, you'll find Bogen—the sound equipment *made* by professionals.



**THE SAME FLAWLESS SOUND QUALITY** that engineers and musicians demand is yours to enjoy at home in Bogen stereo high-fidelity components. Take the Bogen DB 230, for example. Here in one chassis is all the versatility...all the sensitivity...

all the power you need for perfect stereo pleasure.

You can't hear Bogen's engineering excellence... only its brilliant achievements! And this technical artistry, confirmed by leading testing organizations, is complemented by outstanding styling. See —and hear—the DB 230 *today*.



DB 230. STEREO CONTROL CENTER AND DUAL 30-WATT AMPLIFIER.

The DB 230 controls all stereo sources (tape, FM-AM stereo broadcasts and stereo discs) and feeds them through self-contained dual 30-watt amplifier to your two speaker systems. For monophonic program material, 60 watts of power is available. *Price: \$189.50. Enclosure and legs: \$8.00.*



**ILLUSTRATED BOOKLET:** 64-page explanation of hi-fi and stereo, "Understanding High Fidelity-Stereo Edition." Enclose 25c please. **BOGEN-PRESTO COMPANY**, Paramus, N. J. A Division of the Siegler Corporation

**BOGEN**  
HIGH FIDELITY COMPONENTS



## LETTERS

*Continued from page 20*

enough to solve them. Puccini has had the last word in opera by default. The limits of that most beautiful instrument, the human voice, make it a poor tool for the use of moderns who scorn lyrical beauty in music.

Perhaps the real cause of opera's decline is its inherent need for beautiful melody. It cannot thrive where composers thrive on ugly discords, so much in vogue in modern music.

*John Fick*  
Chicago, Ill.

### Arm-held Speakers

SIR:

Dr. John Stern of Utica, who complains about women holding speakers in their arms [December], overlooks the fact that women have always managed to get about any response they desired from arm-held speakers and, generally, fidelity far beyond the original intention of the speaker.

What more could any speaker desire than to be enclosed in the arms of luscious listeners!

*Alvin Duis*  
Sidney, Neb.

### Monophonic Future Dire?

SIR:

Not long ago we read advertisements of high-fidelity equipment promising "Listen to live sound." "Turn your living room into a concert hall." "Realistic lifelike reproduction of sound," and many other fine things.

Suddenly we are told that monophonic music reproduction is antiquated, inferior, and unreal, that stereophonic music alone is realistic music reproduction. Soon there will be no more monophonic amplifiers in catalogues, and we may have to buy monophonic records in shops for antiques.

Allow me to protest emphatically against this development. Stereophonic sound may be superior in years to come but until now I have not heard stereo (except at a price of \$2,000 and more) which I prefer to the monophonic music I enjoy with my own setup at home. . . .

To say that only stereophonic music is lifelike and that monophonic music appears "to come out of a box" is definitely untrue unless a poorly designed enclosure is used. Good speakers in technically good enclosures disperse the sound which is also multidirectionally reflected by walls, ceiling, and floor. . . .

*Eric Bock, M.D.*  
Waukegan, Ill.



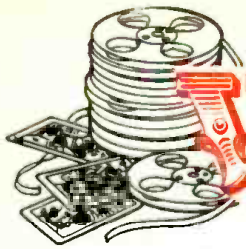

**When**

the chips are down...

**tape is still king**

**SONY**  
**Stereocorder**

*the finest complete* **STEREOPHONIC RECORDING**  
*and* **PLAYBACK SYSTEM\*** *in one low cost unit.*

\* All STERECORDER models are also available with an extra stereo play-back head with a frequency response of 30-12,000 CPS to reproduce the new pre-recorded 4-track stereo-  
phonic tapes (Model 555-A4).



Model CSS-555-A



DK 555-A

Ideal for "built-in" installations

**Tape Speeds**

Instantaneous selection —  
7½ IPS or 3¾ IPS

**Frequency Response (per Channel)**

30-18000 CPS at 7½ IPS  
± 2 DB 50-15000 CPS at 7½ IPS  
30-12000 CPS at 3¾ IPS

**Signal to Noise Ratio (per Channel)**

50 DB or more across line output  
(measured by proposed NARTB  
standards)

**Flutter and Wow**

Less than 0.2% at 7½ IPS  
Less than 0.3% at 3¾ IPS

**Harmonic Distortion**

Less than 2% at 3 DB below  
rated output

**Tube Complement**

2-EF86, 4-12AZ7, 3-6AQ5  
1-5V4-G

...and the **SONY**  
**STERECORDER**  
*is your best bet!*

- Built-in stereo pre-amplifiers and power amplifiers (can be used for other components)
- Separate head for 4-track tapes
- Two V. U. meters for professional level indication
- Stereo outputs for loud speakers and external amplifiers
- Two Sony professional dynamic microphones
- Individual stereo tone and volume controls plus master volume
- Inputs for live stereo and "off the air" stereo recording
- Automatic tape lifters (eliminates head wear in fast forward and rewind)

**SONY**  
**SUPERSCOPE**  
**Stereocorder**

*Finest components and construction  
assures years of guaranteed operation*

• For Free Descriptive Literature and Name of Nearest Franchised Dealer write  
**SUPERSCOPE, INC., Audio Electronics Division / Sun Valley, California**

new from Altec— leader in professional stereophonic sound

superb  
stereo  
systems  
for  
your home!

**ALTEC LANSING**, who pioneered and developed stereophonic sound for theatres and has more professional stereo installations than all other makes combined, now offers complete component stereophonic sound systems designed especially for your home.

These ALTEC home stereo systems are made with the same precision built into ALTEC professional stereo systems.

The result—You've got to hear it to believe it!

And while you're listening—compare ALTEC with any other sound system for truth of performance...for rich, brilliant, undistorted sound.

Can you afford it? ALTEC sells high fidelity speakers for as low as \$31.00. Complete component stereo systems sell for as low as \$450.00.

Described here is an ALTEC stereo system costing slightly under \$2000.00—it provides the ultimate in stereo listening for hundreds of dollars less than some monaural systems!

**445A Stereo Preamplifier**

**Features:** Orientation Control—moves the listening area to give you stereophonic sound *anywhere* in the room • Contour Control—for low level stereo listening without loss of extreme high and low frequencies • Master Volume Control—adjusts volume for both channels simultaneously • Channel Switch—for listening to each speaker singly or

together, or reversing speakers • Bass and Treble Control for each channel • 6 paired, push-button controlled inputs for tape deck, phono, mike, tape machine, radio and spare.

**345A Stereo Amplifier**

**Features:** 60 Watt stereo • Control for paralleling both stereo amplifiers into one speaker • Individual Gain Controls • Automatic impedance matching for speakers.

**830A Laguna Speaker Systems**

A pair of superlative ALTEC 830A Laguna speaker systems in beautiful walnut, blond, or mahogany hardwood cabinets with 30–22,000 cps range—30 watt power rating—16 ohm impedance.

To complete this stereo system combine with two new ALTEC 307 FM tuners or your own tape machine or record changer.

For more about stereo, write:  
**ALTEC LANSING CORPORATION**  
Department 411-A  
1515 S. Manchester Avenue, Anaheim, Calif.  
161 Sixth Avenue, New York 13, N. Y.

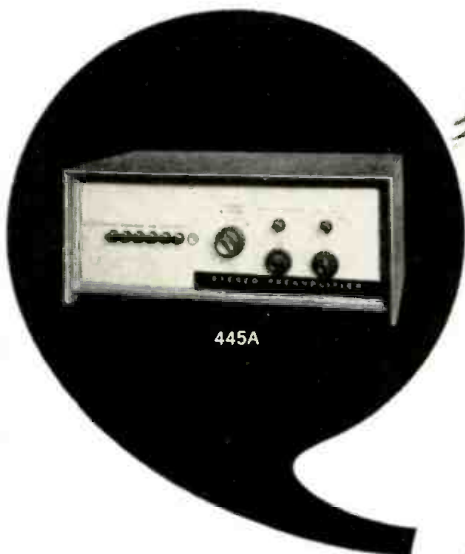

445A



830A

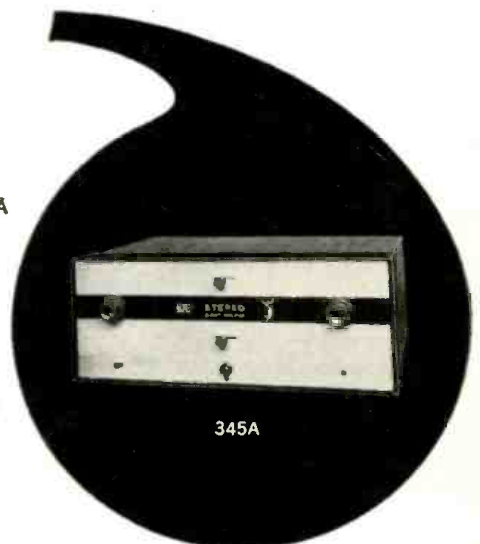

345A

# IT WAS ALL THEY HAD THEN...

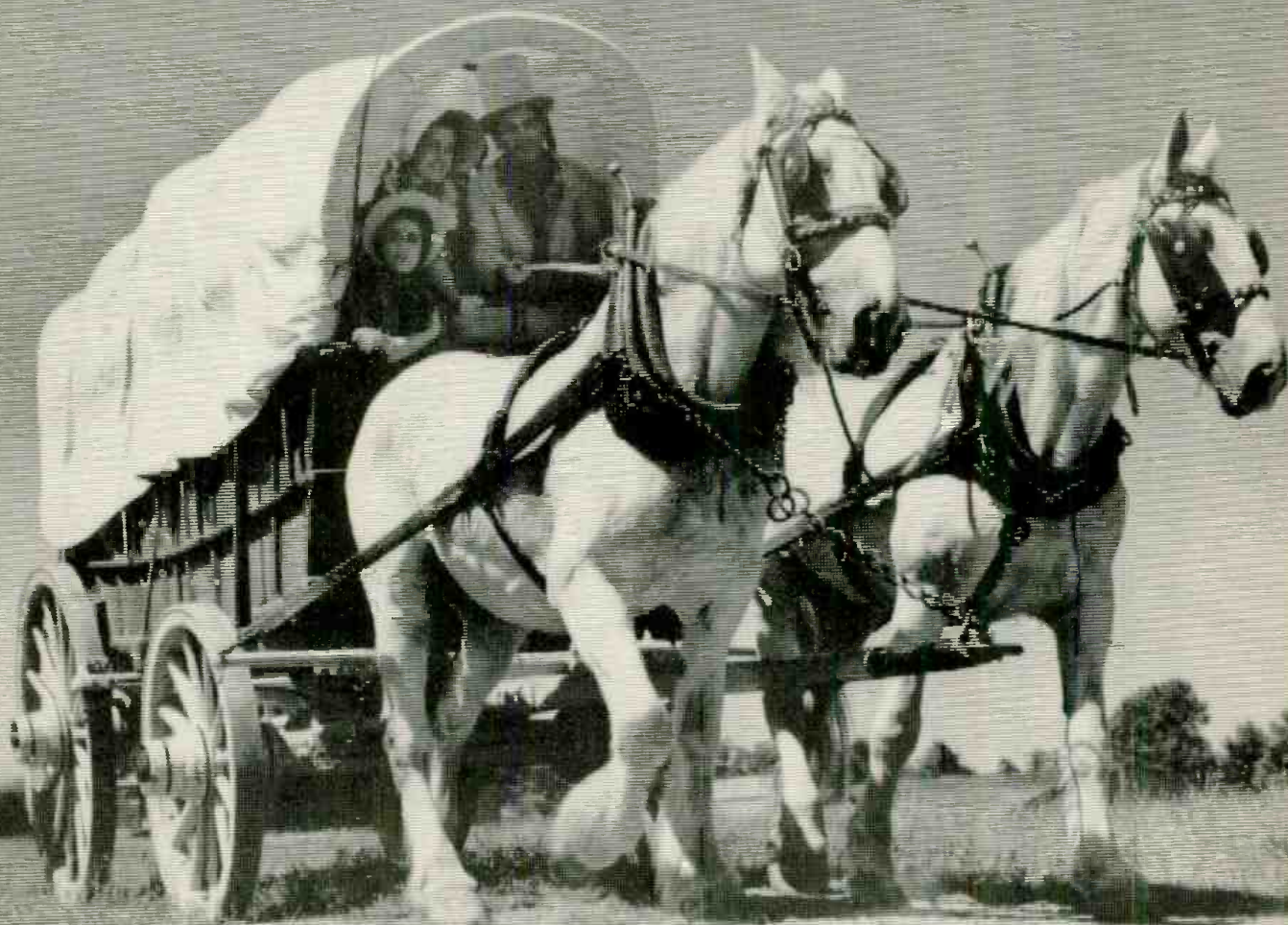

In the days of "78", the changer was the only convenient way to enjoy fast-playing discs. We've come a long way since. The first break-through was the LP, offering up to one hour of continuous music. Many serious music listeners began playing these LP's on turntables to achieve the ultimate in reproduction. However, for most people the choice of "Turntable vs. Changer" was still a matter of personal preference. Not so with STEREO! *The turntable is an absolute must, if you want true "high fidelity" in your stereo reproduction.* For, unlike the monaural cartridge, the stereo cartridge picks up vertical rumble and transmits it through the speakers. So for stereo, your only real choice now is "which turntable?" And that choice is easy: Rek-O-Kut stereoTables°. StereoTables are available in a wide range of models, each the unchallenged leader in its class. And, you can enjoy a stereoTable° at the cost of a changer! Whether you're a "pro" or first venturing into high fidelity, the best way to enjoy stereo music is with a stereoTable—and only Rek-O-Kut makes the stereoTable! For more about Rek-O-Kut stereoTables and Tonearms write Rek-O-Kut Co., Inc., Dept. HF, 38-19 108th St., Corona 68, N. Y.



Model N-33H  
with hysteresis  
motor  
single-speed  
(33 1/3 rpm)  
belt-drive.  
\$69.95  
turntable only.  
Kek-O-Kut  
S-120 Tonearm  
\$27.95

## REK-O-KUT stereoTables° AND STEREO TONEARMS



Model B-12GH  
with hysteresis  
motor  
3-speeds.  
\$99.95  
turntable only.

stereoTables from \$39.95—bases also available.

Export: Morhan Exporting Corp., 458 Broadway, N. Y. C. 13, N. Y. Canada: Atlas Radio Corp., 50 Wingold Ave., Toronto 19, Ont.

\*Reg. T.M.

www.americanradiohistory.com

RK 39

now you can easily  
assemble your own  
professional tone arm



with  
the  
new

**GRAY**

12" stereo-monophonic

**TONE ARM**

**KIT**

only  
**23<sup>95</sup>**



Exclusive slide assembly for quick cartridge change without rewiring.

Dual viscous damping in lateral and vertical pivots eliminates resonance distortion.

Adjustable static balance control provides maximum tracking stability.

Accommodates all cartridges: monophonic, 3 or 4 wire stereo.

Model SAK-12  
12" tone arm kit.

**GRAY**

For new literature on  
GRAY RECORD PLAYING EQUIPMENT write to:

**High Fidelity Division**

DEPT. H4 • 16 ARBOR STREET, HARTFORD 1, CONN.

# Notes

F  
R  
O  
M



## Abroad

LONDON—This city is to commemorate Handel and Purcell jointly, in a Purcell-Handel Festival lasting June 8-27. The BBC, the Arts and British Councils, the British Museum, and the London County Council are collaborating in this venture, of which the Queen is patron. The most interesting events are productions, by the Handel Opera Society at Sadler's Wells, of *Rodelinda* and *Semele*, one of which should star Joan Sutherland. Miss Sutherland is one of the very few sopranos today capable of dealing with Handel's music convincingly: witness her Alcina for the Handel Opera Society (some of it on a Oiseau-Lyre record) and her "Let the bright Seraphim," which brings the house down each time Covent Garden stages *Samson*. Other events: Dryden's version of *The Tempest*, with Purcell's incidental music, at the Old Vic; concert performances of *King Arthur*, *The Faery Queen*, *Solomon*.

The most important scholarly contribution bids to be Winton Dean's long-awaited study of the Handel dramatic oratorios (which he believes to be much more dramatic than the operas). It is exhaustive, learned, with long analyses of each of the works, but always with an eye and an ear directed outside the study to the concert hall and opera house. A recent HMV disc of "O ruddier than the cherry," sung by Owen Brannigan, shows how scholar and performer can happily collaborate. Dean told Charles Farncombe, conductor of the Handel Opera Society, that although the score shows a treble recorder for the obbligato, Handel used to employ a sopranino recorder (an octave higher). And on this disc, for the first time, we are able to hear the deliciously merry piping, high above the amorous bass giant's protestation, which lends to the piece an irresistibly comic and attractive effect.

Klemperer Recovered. Otto Klemperer's illness (smoking a pipe in bed, he

Continued on page 28

HIGH FIDELITY MAGAZINE



*basic contributions to our culture*

We are indebted to William Henry Fox Talbot for the invention of the photographic negative and discovery of the latent image. His work greatly advanced the art-science of photography. More than a hundred years later the laboratories of James B. Lansing Sound, Inc., developed the principle of radial refraction, a break-through which may prove to be equally significant in the field of stereophonic music reproduction. First applied to the magnificent JBL Ranger-Paragon, an instrument originally designed for use as a monitor in perfecting stereo recording techniques, radial refraction has now been used in a more compact, home-sized stereophonic loudspeaker system called the JBL Ranger-Metregon. The curved refracting panel on the front of the dual acoustical enclosure integrates two precision loudspeaker systems. A wide-angle stereo field is radiated throughout the listening area. Radial refraction obviates the hole in the middle, ping-pong effects, and split soloists which plague expedient stereo arrangements. No less than seven different speaker systems, including one with new high frequency drivers, exponential horns, and dividing networks may be installed in the Metregon. You may very well be able to use some of your present JBL loudspeakers. Write for a complete description of the JBL Ranger-Metregon and the name and address of the Authorized JBL Signature Audio Specialist in your community.

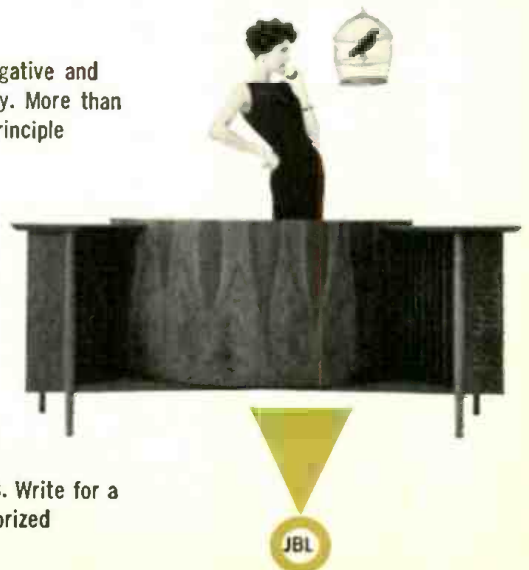

JAMES B. LANSING SOUND, INC., 3249 Casitas Ave., Los Angeles 39, Calif.



This  
is  
the  
Fidelitone  
Diamond  
Stereo  
Needle

the ultimate  
in stereophonic sound reproduction

Now hear *all* the living range of stereophonic sound with a Fidelitone diamond. Why Fidelitone? Because Fidelitone Diamond Needles are designed and manufactured for high quality stereo reproduction. Each one is precision ground on Fidelitone-designed machinery to fit the stereo microgroove exactly. Then it's carefully polished to a perfectly smooth ball point. A Fidelitone Diamond correctly follows the intricate vertical and lateral sound impressions. Result! Unsurpassed stereo reproduction with all the balance and clarity of living realism.

Fidelitone Diamonds last longer, too.

They're engineered for extra hours of play. You see a diamond has many planes. Some are ten times harder than others. Fidelitone orients each point in the stylus to place the hardest planes in contact with the record groove. Fidelitone quality demands this exactness and you get up to ten times longer wear.

And because Fidelitone Diamonds meet the rigid standards of stereo, your monaural records are produced with more exciting brilliance.

To achieve the highest fidelity reproduction — stereo or monaural — your equipment needs a Fidelitone Diamond. See your record dealer today.

Fidelitone, Record Care Booklet. Chicago 26, Illinois. Gentlemen: Please send me my free copy of your Record Care Booklet.

**Fidelitone**

"Best buy on records"

Name \_\_\_\_\_  
Address \_\_\_\_\_  
City \_\_\_\_\_ State \_\_\_\_\_

## NOTES FROM ABROAD

Continued from page 26

fell asleep; the bed caught fire and he was severely burned) jarred both London's concert season and Angel's recording plans. But Dr. Kleinperer is now out of hospital; and on May 7-19 he is scheduled to record Bach's *St. Matthew Passion* in the Hampstead Parish Church, with the Philharmonia Orchestra and the professional Philharmonia Choir of sixty singers. The soloists are Elisabeth Schwarzkopf, Christa Ludwig, Peter Pears, Nicolai Gedda, Dietrich Fischer-Dieskau, and Donald Bell, the young Canadian baritone who was Nightwatchman in Bayreuth's *Meistersinger* last year. Benjamin Britten has been invited to supply the continuo.

**Sopranos and Stereo.** Claire Watson, an American soprano who sings at Frankfurt, made a lightweight Marschallin in the Covent Garden revival of *Der Rosenkavalier*—a performance conducted by Rudolf Kempe with so little emotion or affection as to jeopardize his Strauss reputation as seriously as the last Ring here did his Wagner one. But everyone who heard Miss Watson's Ellen Orford in *Peter Grimes* seemed to like it. She learned the role specially for the Decca (London Records in the States) recording of the opera, which has now been made, out at Walthamstow—the first opera-in-stereo recording to be done in England, and the first recording of the Covent Garden Opera Company. The company used the technique it pioneered in Vienna, throwing out a stage into the hall, and on to this it put, more or less, the Covent Garden production. The stage noises—oohs and ahs in the Trial Scene, dancing about outside the Boar—are said to have authenticity and naturalness. Britten conducted his own opera (for the first time ever) and everything went so smoothly that long stretches—the whole of the first scene, for example—were done as a single take.

Flagstad has been in London again, following up the success of her Sibelius recital with another collection of Scandinavian song, Grieg and others, again with orchestral accompaniment. The Vienna-recorded *Rheingold* (in which Flagstad sings Fricka) represents a distinct stereo advance on the *Walküre*; anvils, thunderclaps, ambulatory (if not water-borne) Rhine-maidens, make a picturesque and visually evocative effect.

ANDREW PORTER



HIGH FIDELITY MAGAZINE

Judged-**"BEST STEREO"** sound

at HIFI shows everywhere!

Sounds best on ALL equipment—  
sounds better on expensive  
equipment, of course.



SOUNDS A COMPLIMENT TO YOUR EQUIPMENT !

STEREOPHONIC  
**HIFIRECORD • HIFITAPE**

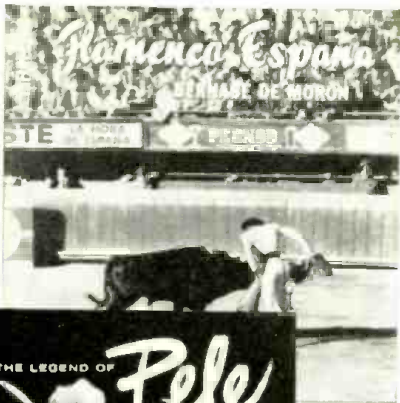

R811



R813



R805



R609

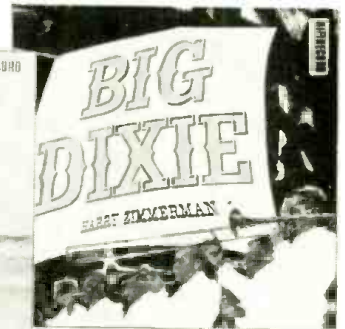

R608

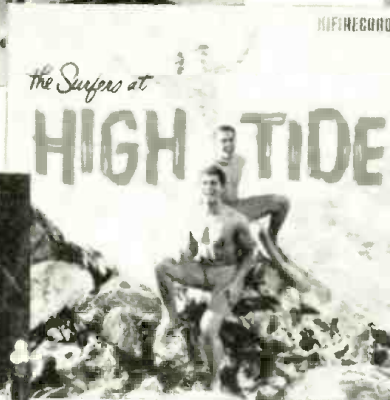

R411



R718



R816

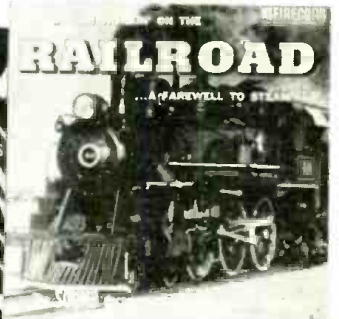

R901

**R411 THE SURFERS AT HIGH TIDE** — Latest "HIT" album of famous "SURFERS" now appearing at the Star Dust Hotel in fabulous Las Vegas.

**R813 THE LEGEND OF PELE** — The legend of fire goddess PELE as interpreted by Arthur Lyman. Recorded in Henry J. Kaiser's Aluminum Dome, Honolulu. Same big sound with intriguing new effects. It's a gas!

**R718 ROARING 20's**

**R609 WEST COAST JAZZ IN HI FI**

**R608 BIG DIXIE**

**R811 FLAMENCO ESPANA** — Sixteen exciting flamenco tracks with Bernabe DeMoron, guitarist; three other guitars and six castanet dancers.

**R805 RAZMAJAZZ** — more red-hot rhythms from the Roaring Twenties with GEORGE WRIGHT'S VARSITY FIVE.

**R901 A FAREWELL TO STEAM**

**R816 VIVA**

Available at record shops and HIFI equipment dealers everywhere

"The sound that named a company"

**HIGH FIDELITY RECORDINGS, INC.**

7803 Sunset Boulevard, Hollywood 46, California

In Canada — Sparton Records • P. O. Box 5035, London, Ontario



# NEW!

• THE WORLD'S ONLY  
**STEREO RECEIVER FOR**  
**THE DISCRIMINATING**  
**AUDIO ENTHUSIAST**

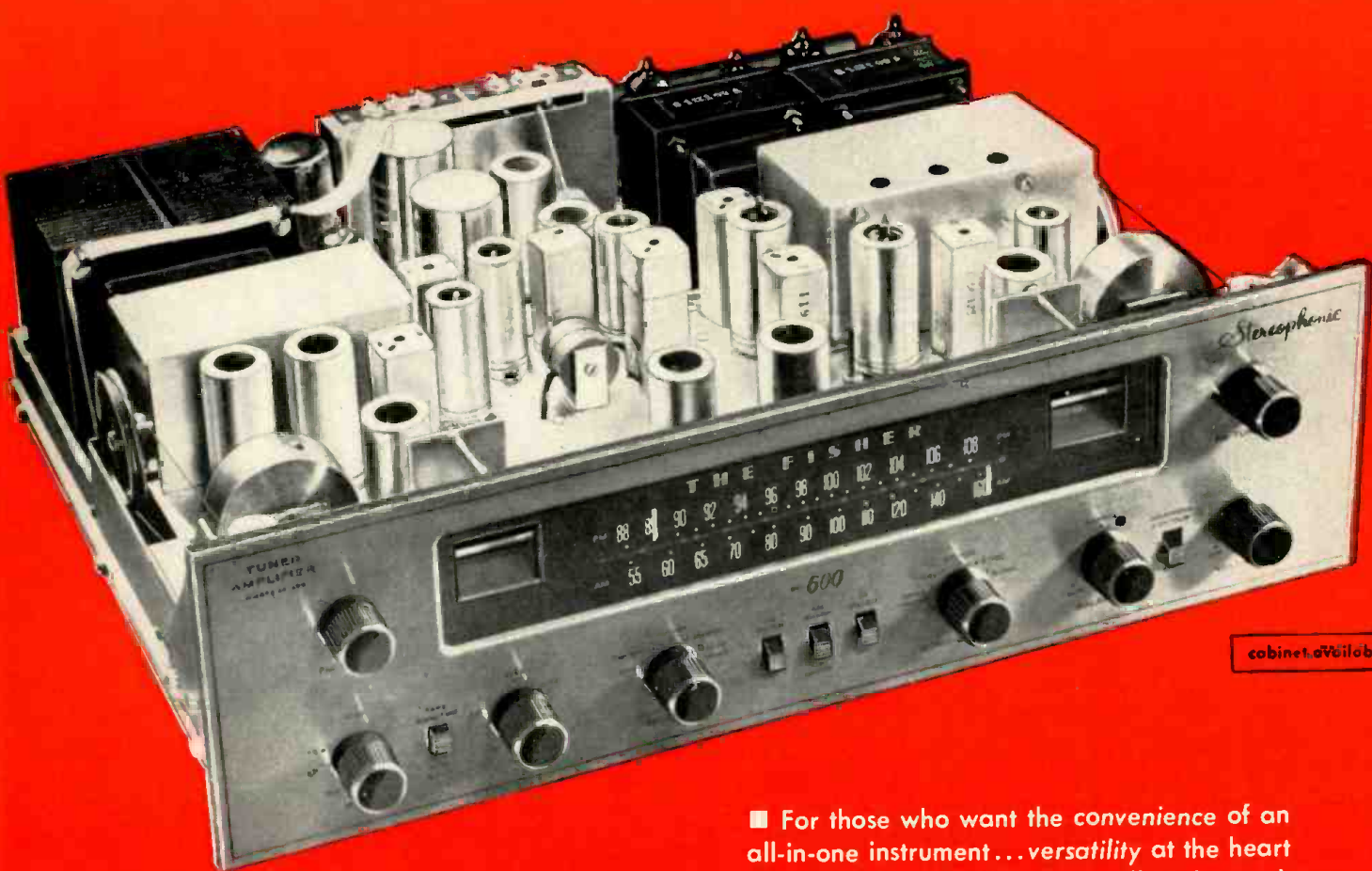

cabinet available

- 17" wide, 14½" deep, 4¾" high.
- 35½ lbs. net.

■ For those who want the convenience of an all-in-one instrument... *versatility* at the heart of their hi-fi installation... as well as the *quality* of performance and *dependability* that have typified all FISHER high fidelity products for over twenty-one years — THE FISHER TA-600 is the only possible choice.



Everything you need - on **ONE** compact chassis!

- STEREO FM-AM TUNER
- STEREO MASTER AUDIO CONTROL
- STEREO 40-WATT AMPLIFIER

**\$349<sup>50</sup>**

*Slightly Higher  
in the Far West*

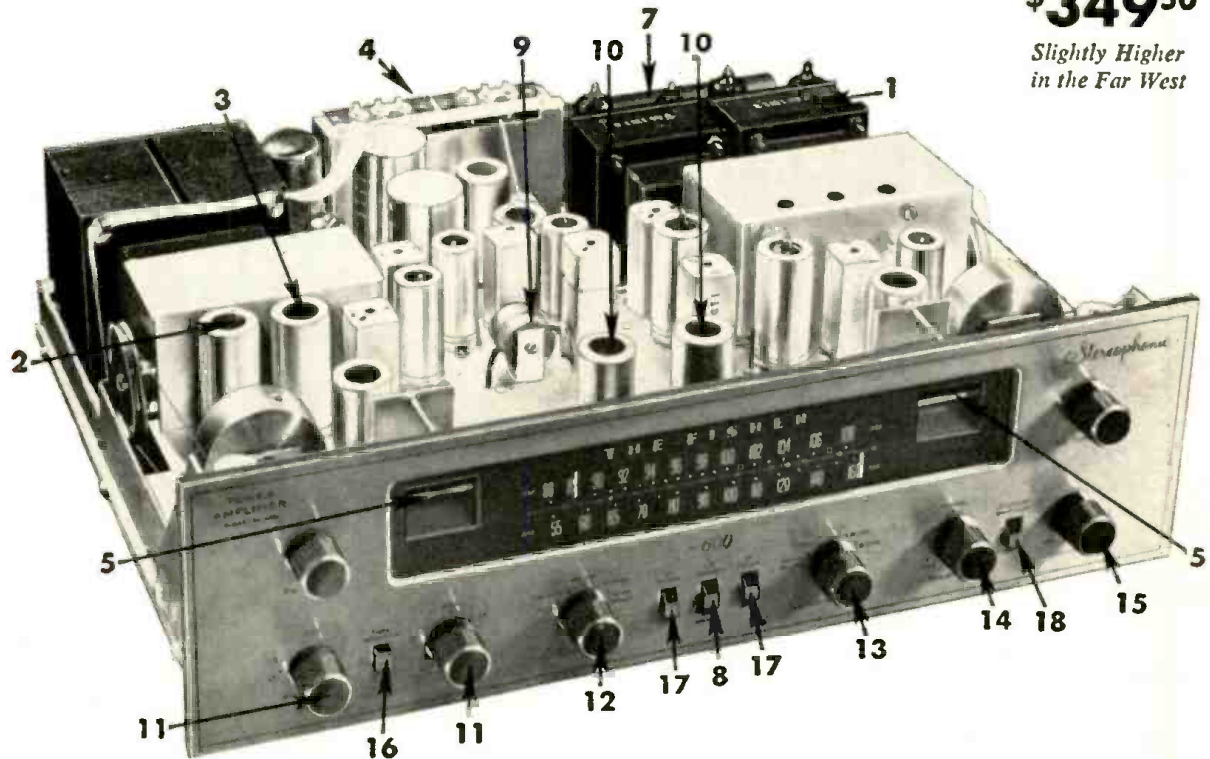

# THE FISHER 600

**BEST STEREO RECEIVER MADE!**

**1** Forty watts of power from dual twenty-watt amplifiers (seventy watts peak power.) **2** Cascode RF stage on FM for extreme sensitivity. **3** Bridge-type, low-noise triode mixer on FM. **4** Input and output jacks for MULTIPLEX reception. **5** Two MicroRAY tuning indicators to help you tune in the weakest signal as easily as the strongest. **6** Connections for four, eight, and sixteen-ohm speakers (rear.) **7** Rotatable, ferrite loop antenna, for maximum signal power and minimum interference (rear.) **8** Two-position bandwidth on AM (a *must* for stereo.) **9** Ten kilocycle whistle filter to eliminate interference from adjacent stations. **10** DC filament supply to reduce hum to complete

*inaudibility.* **11** Dual bass and treble tone controls. **12** Five-position input selector. **13** Five-position stereo-monophonic switch. **14** Dual balance control. **15** Master volume control. **16** Tape monitor switch. **17** High and low frequency filters. **18** Loudness contour switch. **19** Five input level adjustments (rear.) **20** Phase-reversing switch to compensate for any improperly phased tape recordings or speakers (rear.) **21** Tape recorder output jacks (rear.) **22** Special input jack arrangement to permit using an external FM tuner with the TA-600 for the reception of FM-FM stereo broadcasts (rear.) **23** Auxiliary AC outlets for plugging in associated equipment (rear.) *Frequency response, 25 to 20,000 cps, ± 1 db*

WRITE TODAY FOR COMPLETE SPECIFICATIONS

**FISHER RADIO CORPORATION • 21-25 44th DRIVE • LONG ISLAND CITY I, N. Y.**

Export: Morhan Exporting Corp., 458 Broadway, New York 13, N. Y.



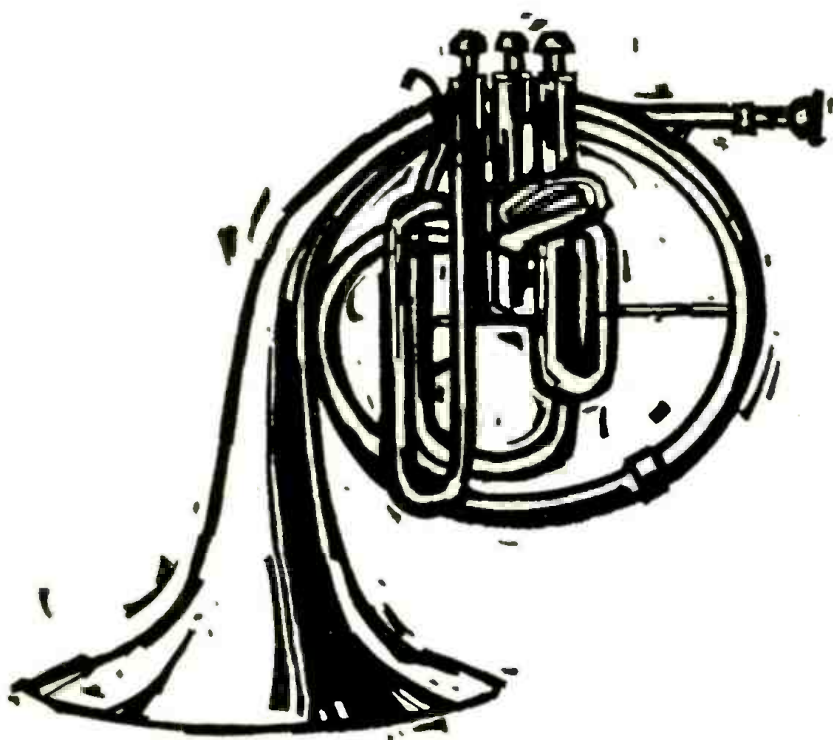

**H**OW often have you found the reproduction of a favorite french horn passage dulled by recording technique, room acoustics or perhaps the characteristics of your own equipment? In such instances, what a blessing a Blonder-Tongue Audio Baton—for, just by a turn of a few selected knobs controlling the fundamentals and overtones of the french horn, the crisp, truthful rendering of the instrument suddenly emerges in all its original beauty.

The Audio Baton does this by dividing the audible spectrum into nine separately controllable octaves. Each octave can be independently boosted or attenuated as much as 14 db. By boosting the overtone frequencies of a specific instrument you can enhance its character and timbre. By boosting its fundamentals, as well, you can bring the instrument forward in relation to the rest of the orchestra or ensemble. To make even the finest high fidelity system sound better, simply connect the Audio Baton. In modern enclosure 119.95 at high fidelity dealers or write: Blonder-Tongue Laboratories, Inc., 9 Alling Street, Newark 2, New Jersey.

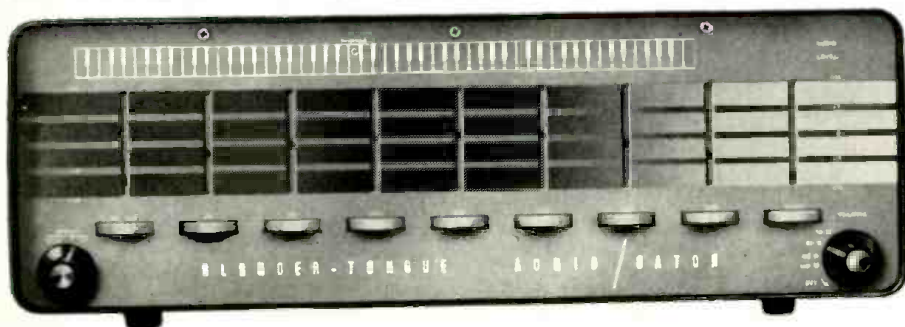

fingertip control of the full orchestral range... octave by octave... new blonder-tongue audio baton



## Books in Review

**In Memoriam: Curt Sachs.** Probably only a few veteran devotees of baroque and earlier music remember that the iron bonds of "standard" repertory were first broken almost single-handedly by the imaginative daring of Dr. Curt Sachs. Even fewer may recall his pioneering *Two Thousand Years of Music* of 1934 or the far more ambitious *Anthologie sonore* series launched in 1937; yet it was these bold challenges which first aroused the record industry to the importance of historical authenticity in re-creations of old music and which persuaded listeners that the world of vital music making was far wider and more inviting than they had imagined. Dr. Sachs's long and fruitful career came to an end on February 5, 1959, with his death at the age of seventy-seven, but his wisdom has left an ineffaceable imprint on recorded music for all time.

More directly, every serious music lover is incalculably indebted to him for a legacy of writings which represent not only the finest musical scholarship of our era, but the still more precious gift of stimulating enthusiasm and curiosity. The best known of his books in English probably is *Our Musical Heritage* (Prentice-Hall, 2nd ed. 1955, \$7.35); yet admirable as this concise history is, the most characteristically exhilarating and illuminating words of Dr. Sachs are to be found in his larger and more deeply probing studies, all of which (in English, at least) are fortunately still, and promise long to remain, in print—in the catalogue of his principal publisher, W. W. Norton & Co. My personal favorites are the standard *History of Musical Instruments* (1940, \$7.95) and that remarkable exploration of the relationships among the various arts, *The Commonwealth of Art* (1946, \$7.50). Yet I scarcely dare give precedence to these over such no less valuable works as *The Rise of Music in the Ancient World, East and West* (1943, \$5.95), *World History of the Dance* (1937, \$5.95), and *Rhythm and Tempo* (1953, \$7.95). And, if rumor is to be trusted, still another work, *An Introduction to Ethnomusicology*, was completed in manuscript just this last winter. To know these works is to enrich immeasurably one's own capacities for catholic, perceptive, and profoundly rewarding musical experience.

*Music in the Medieval and Renaissance Universities* is only too obviously one of those pachyderms which

Continued on page 34

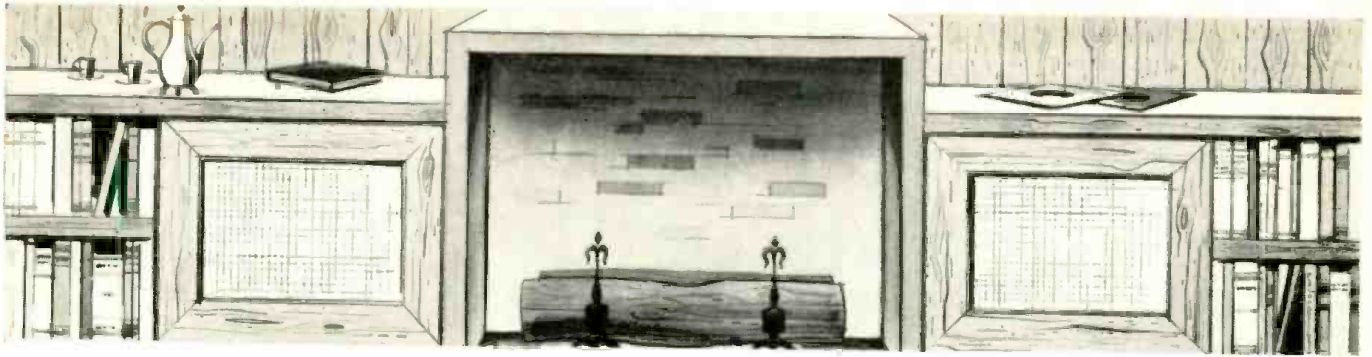

First Choice for BUILT-INS: the BOZAKS — because, unlike “pre-packaged” units, the modestly-priced Bozaks are available separately or panel-mounted for FLEXIBLE combination into any size of speaker system — because the infinite-baffle enclosure, easy to build, is ADAPTABLE to almost any available location — because the possibility of SYSTEMATIC GROWTH allows you to start modestly with a single B-207A and enlarge later without difficulty — and finally, because Bozak’s uncompromising policy of *one line, one quality*, assures you always THE VERY BEST IN SOUND.



Bass/Treble

B-207A



Midrange  
B-209

the infinite-baffle enclosure, easy to



Crossover

N-10102

The BOZAK B-305 speaker system (below) in pairs for stereo provides a thrilling realism that must be heard to be believed. See a Bozak franchised dealer, write for catalog.

BOZAK • DARIEN • CONNECTICUT



Worth waiting for . . .

You've waited because . . . this all-new series of Grommes amplifiers, preamplifiers and tuners with the newest look and cleanest sound in hi-fi has been received with tremendous enthusiasm. Now, production facilities have been expanded to meet this demand.

STEREO

BY *Grommes*

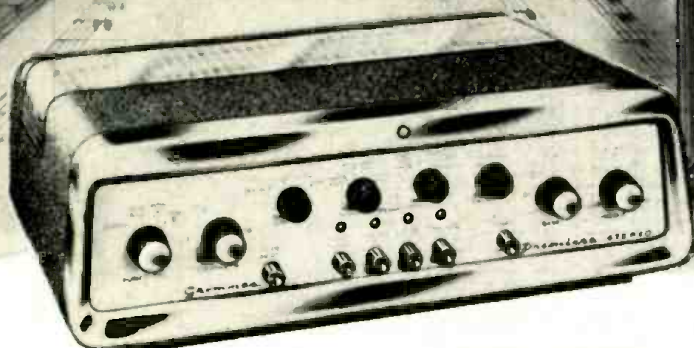

You turn a dial . . . and something wonderful happens!  
 You're there . . . reliving the original performance,  
 hearing the songs you love with a new  
 brilliant clarity . . . hearing the depth of life  
 in each musical passage. Grommes  
 Stereo is stereophonic reproduction at  
 it's finest . . . superb fidelity  
 with a new realistic depth . . .  
 bringing you truly, music  
 that lives.

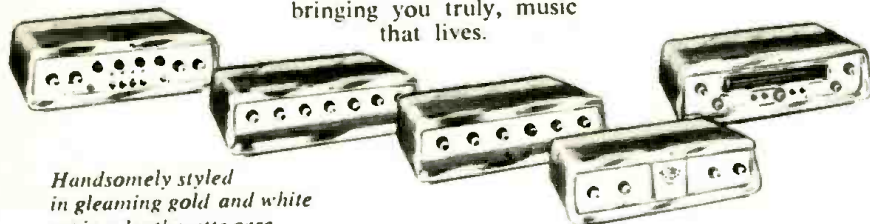

Handsomely styled  
 in gleaming gold and white  
 set in a leatherette case

Grommes Stereo High Fidelity Amplifiers,  
 Preamplifiers and Tuners are craftsman-  
 designed and assembled with jewel-like pre-  
 cision . . . built to last for years of musical  
 enjoyment.

Visit your Grommes Hi-Fi Dealer . . . you owe it to yourself to see and  
 hear the most exciting new series in high fidelity . . . Stereo by Grommes.

Please send me Free Color  
 Brochure featuring the new  
 Grommes Hi-Fi Series.



*Grommes* Div. of Precision Electronics, Inc.  
 Dept. H-4, 9101 King St., Franklin Park, Ill.

Name \_\_\_\_\_

Street \_\_\_\_\_

City \_\_\_\_\_ State \_\_\_\_\_

EXPORT: E. D. Magnus and Assoc. • Chicago 1, Illinois

BOOKS IN REVIEW

Continued from page 32

lumber formidably through the musi-  
 cological preserves of contemporary  
 literature: in short, a doctoral disser-  
 tation rigorously confined to the sober  
 compilation of obscure historical facts.  
 And even its subject (unlike author  
 Nan Cooke Carpenter's earlier study of  
*Rabelais and Music*, University of  
 North Carolina Press, 1954) is scarcely  
 enlivening in itself. Like the writings  
 of one of the early scholars exhumed  
 here (the thirteenth-century encyclope-  
 dist Bartholomaeus Anglicus), "These  
 wordes ben in themselfe deepe and  
 full mystyk, derk to understandyng."

Properly, I can commend this work  
 only to devout scholars well versed in  
 medieval Latin and French as well as  
 music history. Nevertheless, it would  
 be unfair not to add that this esoteric  
 work has its own curious fascinations  
 and rewards. Miss Carpenter does  
 eventually succeed in convincing us  
 that her thesis has genuine validity  
 and significance, that the apparently  
 quaint "Dark-Age" and Renaissance  
 theories of music were better articu-  
 lated and disseminated than the self-  
 proclaimed enlightened ages have ever  
 realized, and that the composers of  
 those days were by no means the un-  
 tutored natural songsters of popular  
 imagination, but respectful inheritors  
 and diligent refiners of already great  
 traditions, the influences of which re-  
 main ineradicable, however obscure,  
 in the pages of subsequent musical his-  
 tory (University of Oklahoma Press,  
 \$6.00).

Gustave Mahler: The Early Years, by  
 Donald Mitchell, is, as its subtitle indi-  
 cates, only the first installment of a  
 badly needed standard English biog-  
 raphy of one of the most enigmatic  
 personalities in modern music. Since it  
 is limited to the first twenty years  
 (1860-80) of Mahler's life, only *Das  
 klagende Lied* and a few very early  
 songs of this composer's steadily grow-  
 ing discography are discussed here,  
 but discussed in a minute detail (some  
 fifty-seven pages of text with many  
 musical illustrations for the *Song of  
 Lament* alone). This is musical schol-  
 arship without compromise and, need-  
 less to say, neither the analyses nor  
 the painstakingly documented (in no  
 less than 37 pages of source references)  
 biographical chapters are calculated  
 for easy reading. Yet, for anyone will-  
 ing to struggle through these dense  
 thickets of facts, conjectures, and ex-  
 egesis, Mahler's tortured figure does be-  
 gin to emerge at last—and with it at

Continued on page 37

HIGH FIDELITY MAGAZINE

# STOP WISHING!

*The only combination professional turntable and deluxe changer created for uncompromised stereo and mono reproduction*

# IT'S HERE!

JUST SOME OF  
THE IMPORTANT  
FEATURES  
FOUND ONLY IN  
THE UNITED AUDIO  
DUAL-1006



the UNITED AUDIO

Is both a professional turntable and a deluxe record changer.

Actually tracks, and operates automatically, with only 2 grams pressure.

Built-in direct reading stylus pressure/tracking force gauge, to insure optimum cartridge operation and long record life.

Obsolescence-proof intermix works with any size records, present or future, and in any sequence.

Exclusive elevator action changer spindle design positively safeguards record grooves and centers.

Uses new rigid equipoise motor suspension principle to eliminate vertical rumble on stereo.

# DUAL-1006

The United Audio DUAL-1006 is so new, so advanced, so unlike anything else, that it represents the finest in enlightened design and maximum flexibility . . . hence greatest value.

Dual pioneered the record changer concept with actual production models as far back as fifty years ago, and is today the leading authority and largest supplier of changers on the continent of Europe. No "warmed-over" mono version, the 1006 is a dream engineered into a reality. Embodying the many exclusive and time-proven accomplishments resulting from the skill and experience of the past, this new Dual also introduces numerous new features essential to the true fulfillment of stereo.

Nonetheless, you'll find no superfluity . . . no needless "gimmicks" in the United Audio DUAL-1006. It is a professional instrument — for the serious high fidelity enthusiast and discerning music lover. It is a practical machine, simple to operate, intended to yield greatest usefulness, convenience and accurate, lifelong dependability. It is, indeed, a wish come true!

Stereo-Mono Switch has phase-cancelling feedback circuit. **Removes vertical noise signal from mono records**, when played with stereo cartridge.

Multiple transmission motor drive uses set of individual gears for each speed; **complete automatic disengagement** makes "flat spot thumping" impossible.

Totally new design one-piece tonearm . . . provides **perfect lateral and vertical tracking**, always—vital for stereo. Also eliminates multiple arm resonance and overcomes cartridge vertical amplitude distortion.

## united

PRODUCTS OF  
202-4 East

# To know the difference...is to select the Dual-1006

**MOTOR** — Quality and reliability unheard of in the changer field and seldom found even in professional turntables. Unusually high horsepower insures *constant* RPM under any load condition; enables turntable to reach full speed within ½ second, from dead start! Motor rotor is oscilloscope balanced, and set in extra-large, costly *self-aligning* ball bearings. New, *exclusive* "rigid equipoise" motor suspension eliminates vertical rumble. Field coils are vacuum impregnated and tropicalized; motor core laminations are staked, to avoid "chatter" and magnetic "thump." Thorough shielding and full-jacket, high permeability motor core prevent hum. These and other important features combine to provide exceptional life-long, trouble-free operation.

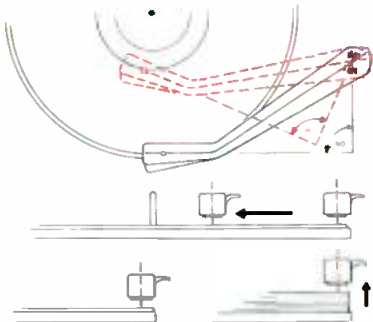

Always perfect vertical and lateral stereo tracking because arm pivot axis remains 90° to cartridge axis.

**ONEARM** — Rigid, locking key snap-in accommodation for all mono or stereo cartridges. Super lightweight *one-piece* construction eliminates multiple tonearm resonance, minimizes cartridge horizontal and vertical amplitude distortion developed in cartridges when mounted in two-piece or plug-in head type arms. This maintains original cartridge compliance specifications. *Double* set of direct-acting ball bearings (in *both* axes) insures complete freedom of vertical and lateral motion . . . and prevents tracking force variations possible with "damped" or otherwise poorly suspended arms due to changes in weather or environment. Fingertip stylus pressure adjustment is directly on tonearm assembly. Tonearm is *automatically secured* in place, when at rest.

**MANUAL OR AUTOMATIC SINGLE PLAY**  
Three choices with the 1006! Start manually, with *either* a rotating or motionless turntable, setting the tonearm anywhere on the record to play all or just a desired portion. Or push a button and the 1006 starts, and finds the record lead-in groove. In all cases, the tonearm returns to rest after play, motor shuts off, and drive disengages . . . all *automatically!* Stop, repeat, or reject (manually or automatically) any time you please.

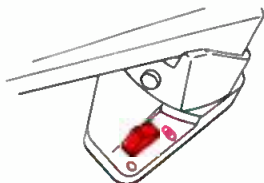

**STEREO/MONO SWITCH** — Does more than instantaneously adapt cartridge for either mono or stereo output! Also introduces special phase-cancelling feedback circuit for stereo cartridges when used on conventional single-track mono records. This *removes* random noises resulting from cartridge high vertical sensitivity to the rough, unused groove trough of mono records.

Even mono records sound better. Two color coded 48" output cables are *individually* shielded to avoid ground loop hum.

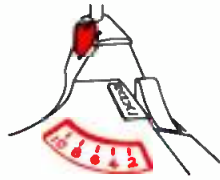

**BUILT-IN PRESSURE GAUGE** — A *precision* stylus pressure gauge is a vital necessity for the preservation of valuable records and for optimum cartridge operation. A professional, *direct reading* gauge is conveniently located for instant check and adjustment of the entire tonearm, as different cartridges are used. No need for guesswork or to rely on arbitrary, printed calibrations on a tonearm. Tamperproof and factory-sealed for lifelong accuracy.

**TURNTABLE**—Large diameter, heavyweight turntable uses unique, laminated and concentrically girded construction for *positive* retention of dynamic balance and plano surface . . . vital to stereo cartridges. This, and the use of reliable Oilite type, permanently self-lubricating ball bearing assembly provide

**AUTOMATIC CHANGER** — *Whether for stereo or mono reproduction, the outstanding qualities of the 1006 as a professional turntable are remarkably preserved as a record changer too! Look . . .*



**MINIMUM CONTROLS**— Simple to operate in spite of its many special features — only three buttons start, stop, reject, or repeat action. Repeat button is *self-cancelling* after replay, or can repeat same record any number of times without disturbing the stack. Spindle need *not* be removed from turntable to remove records or rearrange record sequence...even while record is playing.

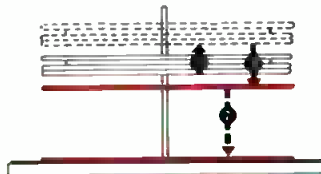

1. Record stack separates from bottom record. 2. Bottom record descends. 3. Stack gently lowers for next play.

**ELEVATOR ACTION** — The bottom-most record of the stack is separated by the action of the changer spindle into an *interim position*, ready for travel to the turntable, and divorced from the weight and pressure of the stack. The stack is gently lowered—*never dropped*—into position for the next record. This unique principle preserves and protects the record center-hole from wear and tear; and since no pusher arm or stabilizing guides are needed, warped records and chipped edges do not affect changer action. Furthermore, the "no load" condition of the stack eliminates damaging friction to grooves of adjacent records. Here is *truly gentle* handling of your precious recordings.

virtually frictionless, *non-resonant* rotation, avoiding need to rely on "fly-wheel action" of conventional castings, machine turnings, or "weighted" turntables to maintain constant speed. Properly designed table mat prevents record slip without surface strain to the delicate record grooves.



**FOUR SPEEDS**—Self-locking and trouble-free, a multiple transmission system is used. With a set of individual drive gears for *each* speed, possible future changes in recording speeds are thus accommodated. *All* drive and idler wheels automatically disengage after *each* playback and also when machine is turned off . . . nothing to adjust or remember, never any "flat spot thump." Speeds provided: 16 $\frac{2}{3}$ , 33 $\frac{1}{3}$ , 45, 78 rpm.

**QUIETING CIRCUITS** — Self-muting and squelch filter circuits keep the electrical operation of the 1006 as wonderfully quiet as the mechanical action of the skillfully crafted assembly. No "pops" or buzzes.

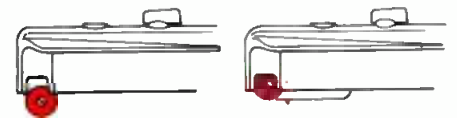

**OBSOLESCENCE-PROOF INTERMIX** — Patented roller-feeler guide in the *tonearm head* enables the 1006 to operate automatically, *regardless* of record size. Future record size innovations are of no concern to owners of the 1006! And, no sequence to observe in stacking up to ten varying size records. Fast change-cycle time is *constant* regardless of RPM or record load.

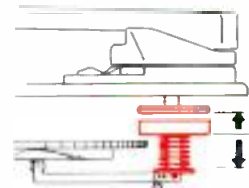

**FREEFLOATING TONEARM** — Not just a statement, but a *fact*. New, advanced-design clutch *completely* frees the *tonearm during* play. Since the record lead-in groove-finding device is a part of the tonearm assembly, the arm is engaged by the cycling cam *only* during the start and stop actions.

**LOW PRESSURE TRACKING** — Incredibly low tracking force operates changer action . . . only 2 grams! With the skill that comes with *fifty years* of specialized experience, the 1006 is a classic achievement in the production of custom fitted parts that operate so effortlessly as to make this feat possible. No warmed-over mono version, the 1006 was made to meet the *exacting* requirements of stereo records. Naturally, monophonic records benefit too.

DISTRIBUTED ONLY BY AUTHORIZED DEALERS OF UNITED AUDIO PRODUCTS

united  audio  
PRODUCTS OF DISTINCTION

202 J. East 19th Street, N. Y. 3, N. Y.  
www.americanradiohistory.com

## BOOKS IN REVIEW

*Continued from page 34*

least some sympathetic comprehension of the ambiguities which were to lift him so close to, and yet so tragically short of, the supreme genius to which he so desperately aspired (Macmillan, \$8.50).

**Loudspeakers, 5th Ed.** At this late date, there can be few if any literate audiophiles who remain unfamiliar with the earliest of G. A. Briggs's books. Indeed a good index to the birth date of their interest in sonic technology might well be the particular edition (from the veteran's First of 1948 to the relative newcomer's Fourth of 1955) of the some 90-page paperback proudly cherished in their libraries. Now, however, this copy must be superseded by what is less a new edition than a vastly more substantial clothbound expansion, enlarged to 336 pages, and with over 200 illustrations, all but a handful of which are brand-new. The evangelical gospel of low-resonance cones, sand-filled or brick-reinforced enclosures, and the significance of discriminating musical-ear tests over response curves of steady-state laboratory measurements is preached more persuasively than ever, but the technical analyses are much more extensive and rigorous, thanks to the collaboration of R. E. Cooke and the inclusion of many of his invaluable wave-form photographs. Yet it still is Briggs himself—with his engaging combination of humor, poetic epigraphs, and stubborn Yorkshireman's insistence on the need for even technical complexities to make common sense in plain English—who gives the work its unique and piquant flavor. And, for good measure, he not only brings his studies of speakers and enclosures up to date to include electrostatic types, stereo applications, etc., but adds as sheer lagniappe for non-technicians several delightful chapters of reminiscences of his own career as a manufacturer and writer, his impressions of audio fairs in England and the United States, and a report on the lessons he, as well as his audiences, have learned from his famous series of demonstration concerts (Wharfedale Wireless Works, Ltd., via British Industries Corp., \$4.50).

R. D. DARRELL



# AT LAST:

## a mike that gives you professional quality at a real budget price!

# Sonotone CERAMIKE

Model CM-10

Replace your old tape recorder mike with this new baby from Sonotone! Ceramike is impervious to a wide range of temperature and humidity changes without essential variation in performance. Sturdy, one-piece case is die cast, has satin chrome finish. Matching table stand available with standard  $\frac{5}{8}$ " No. 27 thread, for floor stand mounting.

SPECIFICATIONS	
Transducer . . . . .	Ceramic element mounted in shock-proof rubber.
Frequency response . . . . .	50 to 13,000 cycles flat within plus or minus 2 db.
Sensitivity . . . . .	62 db below 1.0 volt per microbar.
Damping . . . . .	Perforated metal grid.
Connections . . . . .	7 feet of shielded cable with phone plug.
List price . . . . .	\$19.50



# Sonotone

Electronic Applications Division, Dept. PH-49

ELMSFORD, NEW YORK

In Canada, contact Atlas Radio Corp., Ltd., Toronto

C  
P  
R  
O  
P.

Leading makers of fine ceramic cartridges, speakers, microphones, tape heads, electron tubes.

# The Dream Amplifier

IS NOW A REALITY!



**Hum and Noise:** Only 1/1000th of 1% of full rated output!  
**IM Distortion:** Less than 0.08% (European CCIR standards.)

## THE FISHER SA-300

Laboratory Standard Stereophonic

### 60-Watt Amplifier

#### FIRST STEREO AMPLIFIER TO GUARANTEE

• Hum and noise content less than 0.00001 part of full rated output (1/1000th of 1%!)

• Distortion-free audio power at ALL listening levels. Less than 0.1% harmonic distortion at full rated output.

• Optimum fidelity with ALL existing speakers, BOTH low-efficiency and high! Uniform response from 20 to 20,000 cps, within +0 and -0.5 db.

Only FISHER could have produced so unique an instrument, and at such moderate cost. The SA-300 will match *any* existing speaker, and supply the distortion-free power all speakers require for optimum results. When using low-efficiency, high-compliance systems, the SA-300 is an absolute *prerequisite* for professional sound reproduction! With this amazing instrument, even your choice of enclosures is less critical. The SA-300 actually permits you to obtain the damping factor your system requires! Complementing this FISHER exclusive is still another – TWO inputs for each channel (one for standard response, and one with controlled frequency response to improve high frequency reproduction!) The dream amplifier has, indeed, become a reality. This is it! **\$169.50**

*Slightly Higher in the Far West*

WRITE TODAY FOR COMPLETE SPECIFICATIONS



FISHER RADIO CORPORATION • 21-25 44th DRIVE • LONG ISLAND CITY 1, N. Y.

Export: Morhan Exporting Corp., 458 Broadway, New York 13, N. Y.



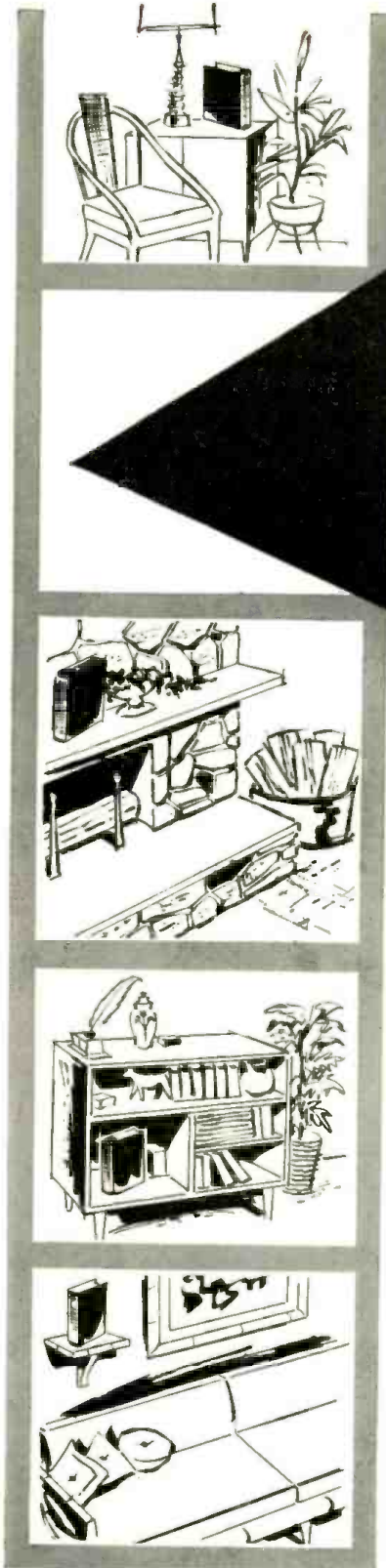

Made in U.S.A.  
Patent Applied For

## A Conquest of Space The Harmony Trio Speakers

Here is a complete three channel stereo speaker system — better than you have ever heard at any price — which gives the full stereo effect in every part of any room. And yet it consists of only two booksize speakers and a hideaway bass that is completely concealed from view. Sound impossible? Well it was, until Weathers developed the Harmony Speakers utilizing the principle of Variable Mass—the first major breakthrough in speaker design in twenty years. Now space need no longer be a barrier to speaker performance.

Stop in at your dealer  
and see why.



### System Features:

Three channels. A full range speaker for each of the stereo channels and a non-directional bass. The smallest and most efficient stereo speaker system available. Fits any size room. Blends with any decor.

- Component Features:
- Harmony Speaker.  
Size: 11" x 9 1/4" x 3 3/8".  
Response: 70 to 15,000 cycles.  
Finish: Black leatherette. Golden grille.
  - Hideaway Bass.  
Size: 16 1/2" x 16 1/2" x 5 1/2".  
Response: 30 to 100 cycles.  
Finish: Ebony.

- Harmony Trio \$119.50
- Harmony Speaker \$29.75
- Hideaway Bass \$69.50

*Weathers Industries*  
DIVISION OF ADVANCE INDUSTRIES, INC.

66 E. Gloucester Pike, Barrington, N. J.  
Export: Joseph Plasencia, Inc., 401 Broadway, New York 13, N. Y.

# THE GARRARD PAGE

Serving the owners of Garrard—world's finest record playing equipment... and other discriminating listeners interested in high fidelity.



Here are the reasons why people who will not compromise with quality insist upon a GARRARD CHANGER for playing stereo records:

#### It's QUIET

The Garrard is actually a super turntable. No matter how precisely you check wow, flutter, and rumble content—you will find Garrard Changers comparable to the best professional turntables.

#### It's "CLEAN"

The exclusive aluminum tone arm on every Garrard Changer is non-resonant, non-distorting... thus superior to most separate transcription arms.

#### It's CORRECT

Precision-engineered to track all cartridges at lightest proper weight, the Garrard Changer tone arm insures minimum friction and record wear.

#### It's GENTLE

Garrard's exclusive, foolproof pusher platform actually handles records more carefully than by your own hand—far more carefully than by any other changer or turntable.

#### It's CONVENIENT

Garrard affords all the features of a manual turntable, with the tremendous added advantage of automatic play when wanted! Pre-wired for stereo—and installed in minutes.

#### It's ECONOMICAL

Despite its many advantages, a Garrard Changer costs less than a turntable with separate arm. Backed by Garrard's 36-year record of perfect, trouble-free performance.

Garrard is a quality-endorsed component of the British Industries Corporation (BIC) Group.

Your name below will bring you the new Garrard Comparator Guide

Name \_\_\_\_\_  
 Address \_\_\_\_\_  
 City \_\_\_\_\_ State \_\_\_\_\_

Mail to: Dept. GD-29

Garrard Sales Corporation  
 Division of British Industries Corp.  
 Port Washington, N. Y.

Canadian inquiries to  
 Chas. W. Pointon, Ltd., 6 Alcina Ave., Toronto.  
 Territories other than U.S.A. and Canada to  
 Garrard Engineering & Mfg. Co., Ltd.,  
 Swindon, Wilts., England

**Stereo and monaural**... most people ready to buy high fidelity components seek advice from friends who own them. Generally you will find that these knowledgeable owners have a Garrard changer. And if you ask experienced dealers, they will invariably tell you that for any high fidelity system, stereo or monaural, the world's finest record changer is the...

# Garrard



<p>There's a Garrard for every high fidelity system... all engineered and wired for stereophonic and monaural records.</p>	<p>RC 98 Super Changer                    \$67.50</p>	<p>RC 84 Stereo Changer                    \$54.90</p>	<p>RC 121/II Intermix Changer                    \$42.50</p>
<p>301 Transcription Turntable                    \$89.00</p>	<p>TPA/12 Stereo Transcription Tone Arm                    \$19.50</p>	<p>4HF DeLuxe Manual Player                    \$59.50</p>	<p>Model T/II Manual Player                    \$32.50</p>





## *Two Hundred Years Alive—George Frederick Handel*

**I**N PRAISE of George Frederick Handel, what is there to add to the tributes that have echoed down the past two centuries? In these years, some four hundred books and extended articles, by about as many authors, have discussed England's great musical immigrant. His music, his personality, details of his daily life, even the minutiae of his bank accounts have been documented and analyzed.

First among the composer's biographers was John Mainwaring. His slim book, *Memoirs of the Life of the Late George Frederic Handel*, published in 1760, is said to have been the first biography of a musician to be set in print. Just over a century later, in 1883, W. S. Rockstro produced his enormously engaging *Life of Handel*. Among twentieth-century biographies, undoubtedly the book that offers us the most is the monumental *Documentary Biography*, by Otto Erich Deutsch. Here are organized chronologically all available documents, newspaper accounts, advertisements, and letters bearing on Handel's life. A clear picture emerges. One sees the man as his contemporaries saw him, and one is able to evaluate anew the vast range of Handel's musical thought. This book is a unique tribute of modern scholarship to the anniversary of the Halle master.

In outline, Handel's career is familiar: his eminent genius for music, so strong that it overrode his father's wish to train the young George Frederick for the law; his two or three years study in counterpoint, organ, oboe, and violin with Zachau, organist at the Liebfrauenkirche at Halle, which in fact constituted about the only formal musical instruction that Handel ever received; his short appointment as organist at the Cathedral Church of Halle, and his brief visit as a prodigy to Berlin; his journey at the age of eighteen to Hamburg, "on his own bottom" as Mainwaring puts it; the several years that he spent in the chief musical centers of Italy and his fortunate contact with the two Scarlattis, Alessandro and Domenico, and with Arcangelo Corelli—musical experiences that were to add melody and frankness to his Germanic creative genius; his brief sojourn at Hanover; and finally, his irresistible gravitation, in the summer of 1710, towards England, the country that afforded him the spacious stage for his overwhelming talents and became, in fact, his adopted fatherland.

Stirring events were taking place in England at the beginning of the eighteenth century. Much of London had been rebuilt, following the Great Fire of 1666. Many Parliamentary steps towards achieving constitutional and

individual liberty had been taken. There was a broadening base of support for the arts, and music reached an ever widening public. Yet no native composer of equal gifts had appeared to fill the shoes of Henry Purcell, and the times awaited the talents of a dominating musician.

It was Handel's particular genius to write music that was, in the best sense of the word, popular. He addressed himself directly to his public. Never did he need an interpreter, or a champion. The effect of his music was immediate and universal, and never has his music fallen from fashion or—at any rate—never have certain works lacked frequent performance.

Handel understood the art of living. He was quite the cultivated gentleman, an excellent Latin scholar, and master of the German, Italian, French, and English languages—several pointless anecdotes about his accent notwithstanding. He mixed with kings, yet kept the common touch; and he had a poise, a good sense, and a humor that served him under every circumstance. He could be bearish and rough-tempered, and his wit was pungent and barbed, yet it was often directed against himself. He could swear as profusely and in more languages than the best of his eighteenth-century compatriots. Yet a sincere spiritual conviction governed his whole life, and his concern for people less fortunate than himself led him to a practical and openhanded generosity unique among composers.

In Handel, then, one has this vast personality behind the creative musician. But, vital as all this is, it is self-evident that with Handel, as with any great composer, music is the essence. Emerson remarks in his *Essay on Art*: "Raphael paints wisdom, Shakespeare writes it . . . Handel sings it. . . ." Handel's music possesses enormous strength, natural beauty, a miraculous simplicity. It is in study and performance of this music, familiar and unfamiliar, that Handel will be understood at this anniversary. As Rockstro, writing of Handel and his music a century ago, put it: "If we would understand what he was, what he thought, hoped, loved and faithfully believed, it is here [in the music] . . . that we must look for it. . . ."

*Mr. Biggs, a considerable Handel authority as well as a famous organist, served as special consultant to the editors in the preparation of this issue.*

by A. Hyatt King



# A Presentment Of Englishry

*Actually "Presentment of Englishry" comes from an early Norman murder law but, later, Englishry began to mean a special inclination towards English ways, and seemed appropriate to music's greatest Briton. Mr. King is Superintendent of the Music Room at the British Museum.*

ON April 17, 1759 James Smyth wrote to Bernard Granville: "On Saturday last at eight o'clock in the morn died the great and good Mr. Handel." Two hundred years later, this simple sentence, with its direct and moving adjectives, poses something of a paradox. How was it that the German-born composer—whose style became, and remained, basically Italian, and who was for long hardly regarded as really English—nevertheless stamped his personality on England's musical consciousness, at least from 1740 onwards, as no other musician has done before or since? What were the qualities which made him into a national figure? If we consider some aspects of Handel's career in the light of what we know of his personality and relate it to the events and character of his age, perhaps we may shed some light on the paradoxical Englishness of his musical achievement.

We should never forget that Handel originally came to England in 1710 to compose Italian opera. *Rinaldo* was not merely the first of the long series which bulked so large in his output for the next twenty-five years. It typified the music through which Handel made an immediate and lasting impact on the English court and nobility. In this world, where music was the focus of passionate enthusiasm and controversy, Handel soon gained a secure place as royal music master with a

pension. Although he became the subject of active interest in the talk and letters of the town and country, he remained at first aloof from society and cultivated only a small circle of friends.

When he first returned to Germany, in July 1711, perhaps dimly conscious of his destiny, he had begun to learn English—his statement on its virtues thirty-four years later is most illuminating—but his progress was slow. Although his name soon became Anglicized, through the Italianate "Hendel" of 1711 to "Mr. George Friederick Hendell" and to "Mr. Handel" (in 1714), and although he was naturalized in the coronation year of 1727, he seems never to have mastered thoroughly his adopted tongue in speaking. (His understanding of it is a different matter.) All his life, indeed, according to Burney and Hawkins, his spoken English retained a German accent and idiom, suggesting a certain mental inflexibility which is at variance with his adaptability in other directions and with his amazing opportunism—in the best sense of the word. This quality he linked with a tenacity and rugged independence which must have endeared him even to his enemies. For the English have always respected and admired a fighter.

From these beginnings, and with this character, what were the stages by which Handel became the center of

musical life in England? It might be thought that in this process the Italian opera, with which he was so long identified, played but little part, as its center of interest and contention lay in London. Some of the music, however, gradually became known in homes far from the capital, partly through concert performance, but far more from the inclusion of popular melodies in the delightful illustrated songbooks, such as *Universal Harmony*, *Clio and Euterpe*, *The Musical Entertainer*, and in anthologies of harpsichord music. These, with such charming titles as *The Lady's Banquet*, contained arrangements of the airs which, often all too briefly, had charmed the London stage. No country gentleman's music library was complete without these publications. The overtures of the operas, too, became very popular in arrangements for the harpsichord. Walsh issued no fewer than five sets, containing usually six overtures in each. So few copies now survive that we are justified in assuming that many became worn out by several generations of harpsichordists.

Even more powerful in building up Handel's status in England was his musical and personal association with great public events and famous institutions. In January 1713, he completed a *Te Deum* in celebration of the Peace of Utrecht. But he was uncertain whether music by a foreigner would be acceptable for such an occasion, and also composed a birthday ode for Queen Anne. (This was his first important setting of English words.) She was so delighted with it that she commanded Handel to have his *Te Deum* and a *Jubilate* as well ready for the celebration in St. Paul's. Thereafter these two pieces were sung alternately at the Festival of the Sons of the Clergy (which was held in St. Paul's) every year from 1713 to 1743, after which the *Dettingen Te Deum* replaced that of Utrecht. In 1724 there began the long connection of Handel's music with the Three Choirs' Festival. Three years later came the Coronation of George II, with Handel's immortal anthems, and in 1730 began the yearly performance of Handel by the Academy of Ancient Music. The year 1733 saw one of the strangest events of Handel's career, when the University of Oxford offered him an honorary degree, which for various reasons he ultimately refused, although he visited the city subsequently and gave many concerts there, winning much renown in academic circles. When Princess Anne married William of Orange in 1734, and again when Frederick Prince of Wales married Princess Augusta in 1736, Handel provided the music, as he did in 1737 for the melancholy occasion of Queen Caroline's funeral. Another notable commission came in 1739 when he composed his *Ode for St. Cecilia's Day*, which continued to be performed every year until 1756. Likewise in 1739 Handel took an active part, with the highest in the land, in founding the great charity now known as the Royal Society of Musicians; he left it £1,000 in his will. The year 1743 brought the noble *Te Deum* and Anthem in celebration of the victory of Dettingen.

Thus were strengthened the links which bound Handel to the official England of his day. Other composers, of course, had similar associations, but none so many, so lengthy, or so distinguished as his. Equally significant, in a rather different way, was his election in 1749 as a governor of the Foundling Hospital. This leads us on to the manifold Englishness of the oratorio.

On May 2, 1732, a few months after *Esther* was first given in public, Viscount Percival wrote in his diary: "I went to the Opera House to hear Hendel's 'oratory,' composed in the church style." Before the end of the month the Royal Family attended several performances, and gradually a new form of music became firmly established, born of Handel's courageous opportunism after the attractions of Italian opera faded and died. In 1750, Madame Anne-Marie Fiquet du Bocage wrote from London to her sister in Paris: "The oratorio, or pious concert, pleases us highly. English words are sung by Italian performers, and accompanied by a great variety of instruments. Handel is the soul of it: when he makes his appearance, two wax lights are carried before him, which are laid upon his organ. Amidst a loud clapping of hands, he seats himself, and the whole band of music strikes up at exactly the same moment."

Some years earlier, Walpole had written to Horace Mann: "The oratorios thrive abundantly—for my part, they give me an idea of heaven where everybody is to sing whether they have voices or not." As a cap to these observations, we should note the remark which Handel is said to have made to Lord Kinnoull after a performance of *Messiah* and which the latter repeated to James Beattie: "My Lord, I should be sorry if I only entertained



Bettmann Archive

Thomas Hudson's famous portrait of Handel in middle age.

them, I wish to make them better." Whether Handel actually said this or not, it may be taken as fairly representing the pleasurable state of exaltation felt by most of those who heard the oratorios.

Mere fashionable popularity alone would not have accounted for their hold on the public and for the quickening of Handel's rise to nationwide esteem. There were subtle overtones which were probably only half realized at the time and which we can now see more clearly. Although some of the most popular oratorios had scriptural plots, they were not *ipso facto* religious music: they could, however, evoke religious feeling somewhat in the way that Walpole ironically suggests. Their appeal was to all levels of society. After Lady Luxborough's steward had heard *Judas Maccabaeus*, in 1748, she wrote: "He speaks with such ecstasy of the music, as I confess I cannot conceive anyone can feel who understands no more of music than myself: which I take to be his case. But I suppose he sets his judgment true to that of the multitude; for if his ear is not nice enough to distinguish the harmony, it serves to hear what the multitude say of it."

In the first half of the eighteenth century, men were much more concerned than perhaps they are now with the moral problems of life and its relation to a divine purpose. These problems Handel posed in abundance, and in music of majestic grandeur and moving quality, worthy of the conflicts of right and wrong and of the ethical dilemmas that form the core of the scriptural oratorios. Above all, in the mighty choruses which crystallize or resolve the moral issue, Handel went straight to the hearts of the English people. When adapting the scriptures, even the worst of his librettists could hardly help producing words of a directness and simplicity that were worthily matched by Handel's own character and the nobility of his music.

Besides the appeal of Biblical associations of oratorio to an age in which men read and cherished the Old Testament, there was its unprecedented power for charitable purposes. In Handel's day Englishmen of all classes were moved to good works of many kinds; it was hardly surprising that, quite early in the history of oratorio, performances should have been given to raise money for deserving causes. Handel's music thus became identified in the public mind with a salient virtue of the time—with what more noble climax than the performances of *Messiah* which he gave or organized on behalf of the Foundling Hospital from 1750 to 1759? Thereby he raised the sum, amazing for those days, of over £7,000: his example was followed and his oratorio music performed all over the country, thus adding another cornerstone to the imperishable edifice of his Englishness.

To his contemporaries, Handel's use of textual sources other than the Bible was mostly of less significance and interest than it is to us. But we must take it into account if we would understand his "English" characteristics, and here we must go rather beyond the range of the oratorios. There is little doubt that on the few occasions when Handel was setting great English poetry, it inspired him in a special way. In several sections of *Alexander's Feast*, his music perfectly matches the sonorous grandeur of Dryden's verse, even as rearranged by Hamilton. Again, in *Samson*, where Milton was heavily recast, Handel's inspiration was thus judged by contemporary opinion:

By Milton fir'd, brave Handel strikes our ear,  
And every power of harmony we hear.  
When two such mighty artists blend their fire,  
Pour forth each charm that genius can inspire,  
The man whose bosom does not raptures feel  
Must have no soul, or all his heart be steel.

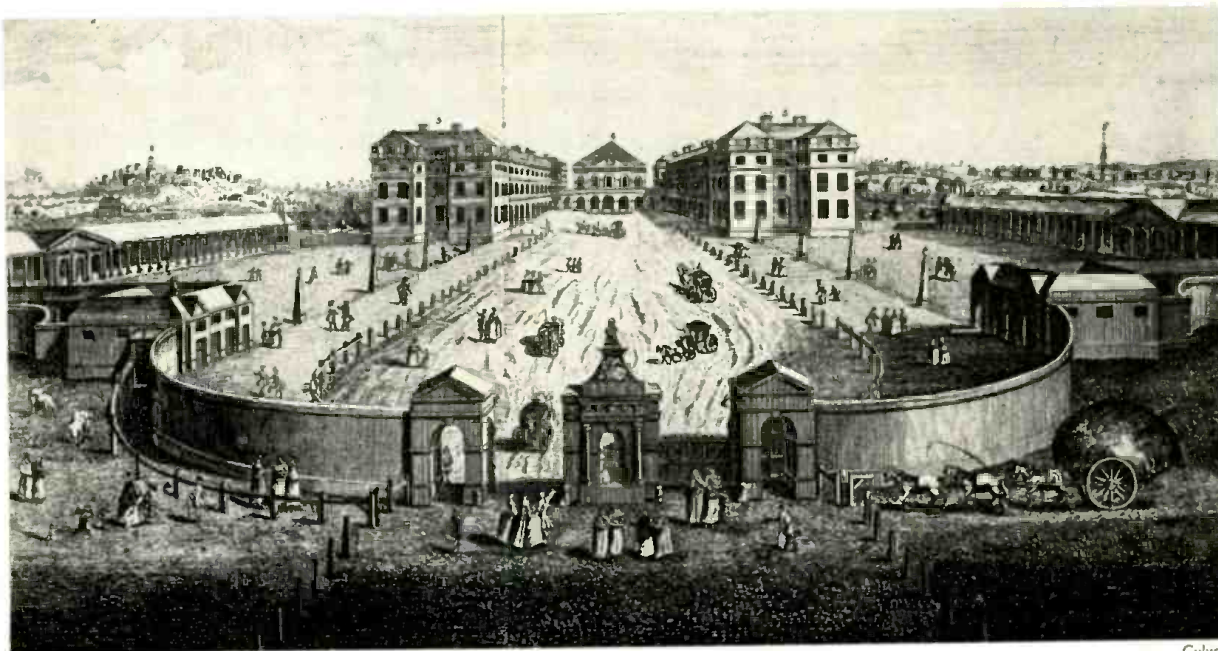

Culver

The Foundling Hospital, for which performances of *Messiah*, organized by the composer raised £7,000 between 1750 and 1759.

But it is in *L'Allegro ed Il Penseroso*, the wonderful music to Milton's verses, that Handel comes closest to the Englishness of the poetry, and expresses with lyrical simplicity his obviously deep affection for the sights and sounds of the countryside. He was equally sensitive to some of the musical noises of the town. Lady Luxborough wrote in 1748: "The great Handel has told me that the hints of his very best songs have several of them been owing to the sounds in his ears of cries in the street." One such cry—that of "bouy any matches"—survives written out in his autograph, and another has been detected in Elviro's flower-selling song in *Serse*.

In the past, scholars have held conflicting opinions about Handel's feeling for the English language in relation to his musical setting of it. Although it now seems fairly certain that this understanding was much finer than used to be admitted, it contrasts with his imperfect command of the spoken tongue. But close examination bears out Handel's own claim, put forward in a letter to the *Daily Advertiser* of January 17, 1745: "As I perceived, that joining good sense and significant words to musick, was the best method of recommending this to an English audience, I have directed my studies that way, and endeavor'd to shew that the English language, which is so expressive of the sublimest sentiments, is the best adapted of any to the full and solemn kind of musick." The autographs, which contain many changes of text in Handel's own hand, show that he developed a feeling for verbal niceties. In his mature vocal works there occur examples of misaccentuation, but many instances also of his finding a musical rhythm perfectly matched to the lilt of the words. The famous story, told by Morell, of Handel's difficulty in setting words with an iambic rhythm in *Alexander Balus* (provoking the immortal exclamation "Damn your iambs!") and of his speedy solution, serves to illustrate the quick grasp of metrical subtleties he could display.

We may well ask how far this genius, who had such a lively appreciation of the musical possibilities of the speech of his adopted country, also evolved affinities with its musical idiom. The fact that these are small is much less of a paradox than it might seem if we remember that Handel's musical style was strongly Italian before he ever came to England. What affinity there is derives from Purcell. Structurally, Handel's debt to the English tradition is small. The *Utrecht Te Deum*, which seems clearly modeled on Purcell, is exceptional. More generally, the reflective type of chorus which plays so important a part in Handel's oratorios certainly owes more to Purcell's usage, as does also his habit of using the same bass through several movements. The occasional use of two different rhythms simultaneously is another specifically English trait, though not akin to Purcell alone.

While these niceties were hardly observed by Handel's contemporaries, the study of them shows that he tempered his Italian style with a certain English asstringency. But it is clear that his music contained a fusion of

elements which appealed strongly to "all sorts and conditions of men." He early found the secret of the common touch. This is evident not so much in the noble music which he wrote for the great ceremonies of state as in the pieces composed to match the mood of the man in the street. Handel was deeply stirred by the rebellion of 1745. His *Occasional Oratorio*, though not containing his best music, served well the need of the day, and the very popular song *O Liberty* was used again in *Judas Maccabaeus*. The Battle of Culloden evoked another fervent ditty, *From scourging rebellion*, a little after he had written the song *Stand round my brave boys* for the Gentlemen Volunteers. As an example of a popular work in the grand manner, we have the *Fireworks Music*, written to mark the general rejoicing at the Peace of Aix-la-Chapelle.

One reason for the continual growth of Handel's popularity lay in the fact that his publisher Walsh was a business man of genius, who issued an endless spate of editions, selections and arrangements, from the 1720s right up to 1759. Innumerable reprints, the bane of the modern bibliographer, kept Handel before the public as a national figure. In Walsh's extensive catalogue of about 1740, Handel's music occupies three pages out of a total of twenty-seven: no other composer exceeds half a page. Besides the medium of printing from the engraved plate, vast quantities of manuscript copies were written and circulated widely. In the so-called circle of J. C. Smith the elder, no fewer than *Continued on page 133*



*Still gleaming white: the statue by Roubiliac in the Abbey.*

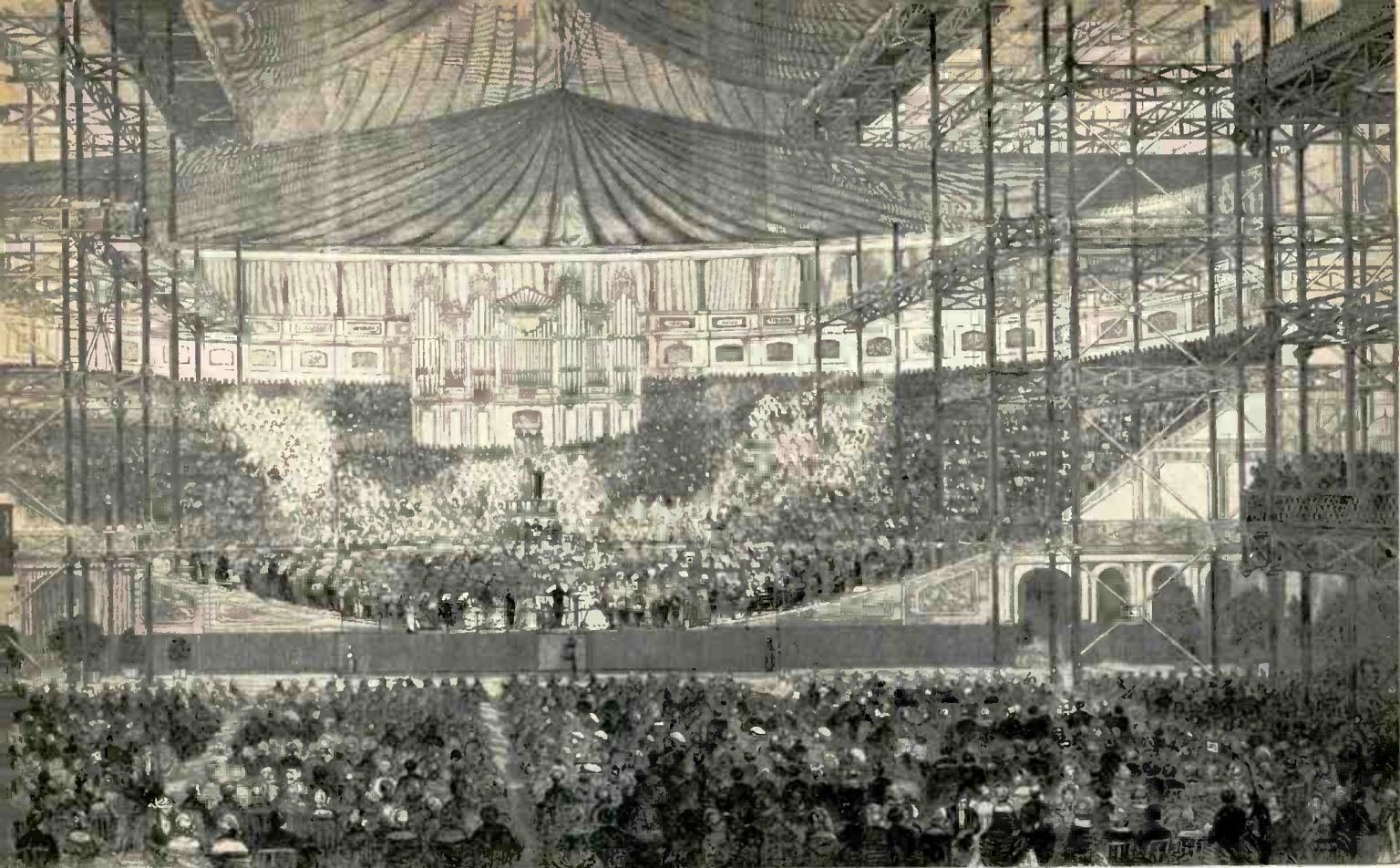

*Handel Festival at the Crystal Palace, 1859.*

Culver

# Four Thousand Choristers Can't Be Right

by Winton Dean

*More than any other composer, for some reason, Handel has exercised on conductors and arrangers an irresistible temptation to "modernize" his works. The result has been an almost totally false public impression of this light, vital, and clean-lined music. Winton Dean is author of the new book, Handel's Dramatic Oratorios and Masques, published by Oxford University Press.*

**T**HE HISTORY of Handel's music in performance is strange, sinister, and instructive. No composer has been subjected to more wholesale misinterpretation and disfigurement; none has lost so much credit as a result; none stood in less need of "improvement"; and none has been so consistently admired and attacked for what he never was and never did.

All music written in the baroque period was bound to present problems in performance as soon as the executive traditions that governed it were lost. This happened very quickly. Early in the nineteenth century not only

the keyboard continuo (played from a figured bass) and the baroque conventions of vocal and instrumental ornament, but many of the instruments themselves (including the most important of all, the harpsichord) had been discarded as obsolete. Such old music as survived the rosy dawn of romanticism was either played as it stood, unornamented and incomplete, or refashioned by editors who, if they did not fail (as many of them did) to grasp its underlying principles, were concerned to accommodate it to contemporary ears. Much of it is still played in that way today.



Some composers can stand this treatment better than others. J. S. Bach, who was valued during his life primarily as an organist, was never typical of his age; the intricate contrapuntal texture of his music is much fuller than that of his contemporaries and leaves (or appears to leave) less to be improvised by the performer. The practices of the romantic arranger, though damaging enough, seldom distorted the music beyond recognition. The image was out of focus, but it was still Bach. With Handel the position is very different. Not only was he a much more flexible composer than Bach, requiring a correspondingly more supple response from performers; the very nature of his genius had been progressively misunderstood ever since his own lifetime. He was revered less as an artist than as a great moral teacher, a sort of musical Jehovah, whose oracular utterances required enormous choirs and no building less exalted than an abbey or cathedral.

This image of a somber, humorless Handel is a travesty. Handel was a theatre composer with a marvelous understanding of human nature in its utmost variety—grave and gay, frivolous and serene, spontaneous and inhibited, in sickness and in health—and with a no less remarkable command of vocal and instrumental sonorities ranging from the thunderbolt to the most fastidious delicacy. In both capacities, characterization and orchestration, he has since had very few rivals, let alone superiors. The practice of filling his scores with rubble and performing his oratorios as if they were sacred music obliterates the true Handel both musically and spiritually, much as discolored varnish and wholesale repainting can render an Old Master unrecognizable even to an expert.

Many people think of *Messiah* as a massive score. It is nothing of the sort. We know the forces with which Handel performed it at the Foundling Hospital. In 1754 he had an orchestra of thirty-eight (and probably two continuo players), five solo singers, and a choir of eighteen or nineteen; in 1758 an orchestra of thirty-three, six solo singers, and a chorus of seventeen. (In Handel's day the soloists regularly led the choruses.) His resources in the theatre were probably little larger, except for works with double chorus, when the orchestra would be proportionately strengthened. The first performance of *Deborah* in 1733 was "very magnificent, near a hundred performers, among whom about twenty-five singers." For a work containing seven solo parts and many eight-part choruses (and much more heavily scored than *Messiah*) this does not seem to us a large ratio, though by contemporary standards it was certainly formidable enough.

Handel's orchestra was usually, if not always, larger than his chorus. Its size varied at different periods. At Cannons it was no more than a chamber group: *Acis and Galatea* was probably composed for an orchestra of seven, and can be performed by a total of twelve persons, voices included. *Athalia*, another oratorio with

double choruses, was performed in Oxford by "about seventy Voices and Instruments of Musick"; and the score of *Saul* has an almost Wagnerian splendor, involving three trombones, harp, theorbo, carillon or glockenspiel, and two organs, not to mention the vast kettle-drums of the artillery train, sounding an octave lower than ordinary timpani, which Handel borrowed from the Tower of London. In his operas and elsewhere he used clarinets, bass flute, sopranino and bass as well as treble recorders, double bassoon, mandolin, side drum, *violetta marina*, and many other instruments. He was the first composer to write for pairs of horns in different keys playing together (in *Giulio Cesare*), and he often employed double orchestras, especially for scenes of enchantment. His scoring is conditioned not by the contrapuntal texture (as is often the case with Bach), and still less by the line of least resistance, but by dramatic context. In 1748 he composed the oratorios *Solomon* and *Susanna* within a few weeks for the same London season. The former, as befits its theme, is splendidly rich, with eight-part choruses and the whole orchestra divided into ripieno and concertino groups; the violas as well as the violins are in four parts. *Susanna*, which is really a comic opera of village life, has the exquisite delicacy of chamber music. This same propriety governs the scoring of individual numbers throughout his work; the total effect depends on balance and contrast, light and shade, music and drama for ever going hand in hand.

It should be obvious that Handel was the last composer to need "additional accompaniments"; when he wanted them, he wrote them himself—and was, indeed, often criticized for drowning his singers. The process of distortion was social rather than musical in origin. The English middle class, strongly Puritan in sentiment, had never taken kindly to the dramatic basis of the oratorios (it is a strange fact that with the exception of *Samson* all the greatest of them met a frigid or at best lukewarm reception at their first London performance), and had no use whatever for the operas. Taught to regard the theatre as a palace of sin, they could swallow its offerings only when disguised by a nutritious coating of edification. And if the oratorios were really church music, the louder and more solemn the noise that went up to God, the more comfortable everybody's conscience could be. Naturally *Messiah* came out on top, and for generations Englishmen flocked to it, in the words of an American critic, R. M. Myers, "to experience the pious emotions of divine service without the inconvenience of a sermon or a collection." *Messiah* was no longer a fine entertainment, as Charles Jennens, the compiler of the text, called it, but had become almost a sacrament; the congregation even stood up in the "Hallelujah Chorus," which George III is said to have mistaken for the national anthem.

It was no far cry from this state of affairs to the mass performance, which had been foreshadowed during

Handel's life by the larger provincial festivals at Oxford and the cities of the Three Choirs (Worcester, Gloucester, and Hereford). Why confine the choirs to three? Why not assemble all the best singers in the country and dispel the last lingering taint of the theatre by reverently escorting the oratorios into church? So we have the famous Commemoration of 1784 (the first of many), when *Messiah* made a resounding entry into Westminster Abbey with a choir of 275 and an orchestra of 250. It was not Handel's most elaborate scores that were selected for inflation, but those like *Messiah*, *Samson*, and *Judas Maccabaeus* which had strong religious or patriotic appeal. There were not enough such: so while many uncomfortable masterpieces were shuffled into obscurity, bogus oratorios were constructed out of anthems and opera airs, the love songs of the *castrati* being overlaid by an insipid sanctimony. But perhaps the most significant comment on this movement of taste is the repeated declaration of Charles Burney, who had known and played under the composer, that "from this period [1740] Handel may be said to have devoted his labours solely to the service of the church," and again that "after this period . . . he never set any other works than English, and those wholly confined to sacred subjects." In fact Handel wrote almost no church music after 1740, and it is doubtful if even an ancient Greek would have classified *Semele* and *Hercules* as sacred subjects.

The systematic rescoring of Handel began in Germany. In 1786 J. A. Hiller conducted his notorious *Messiah* in Berlin with an orchestra of 184 and a chorus of 118. He justified his malversations on the ground that "many improvements may be made in Handel's compositions by the employment of the wind instruments according to the fashion of the present day." It is not clear whether he offered a similar excuse for having the text sung in Italian. These junketings were a great success, and were repeated two years later at Breslau, with the orchestra reduced to 142 but the chorus expanded to 259. And in Vienna, in 1788-90, Mozart rescored four works for Baron van Swieten. They reveal a total misunderstanding of Handel: Jens Peter Larsen has well said of Mozart's version of "The people that walked in darkness" that "the Valley of the Shadow of Death has become a well-kept cemetery-garden." Incidentally, like many other arrangers, Mozart did not shrink from rewriting the substance of the music when it suited his own purposes.

Monster performances of other works followed, with the cumulative rivalry now displayed in the testing of atomic bombs. In 1812 Vienna twice heard *Alexander's Feast* (under a false title) rendered by 287 singers and an orchestra of 300 (including two double bassoons and nine trombones), reinforced by the thunder machine from the Hoftheater. A similarly dropsical *Samson* with a chorus of 400 interrupted the Congress of Vienna in October 1814. The performance took place before the

Emperor and the Czar at the Imperial Riding School, though apparently not on horseback. The composer Tomaschek thought *Samson* an unsuitable choice "for such a mixed audience," and very properly complained that "in the case of such powerfully organic writing as that of Handel, a musically inept age should not meddle with the work at all, but should merely listen, the better to correct the error of its ways."

Some of the earliest English critics took the same line about the Mozart *Messiah*. At its first London performance in 1805 the *Sun* protested against Mozart's violation of the "integrity in the productions of this great Master, the result of the most powerful talents in his art"; and *The Quarterly Musical Magazine and Review* wrote in 1822: "If [Handel's] music does not contain within itself the seeds of immortality, let it sink into obscurity and be forgotten. It will acquire no additional fame by being tricked out in modern dress." This pronouncement proved a poor prophecy. Although the great bass James Bartleman refused to sing in performances in which the Mozart accompaniments were used, the English public and musical world soon came to regard them as considerably more sacred than the rest of the score: the latter could be tampered with, but not the former. Further expansions were of course permissible, and were frequently undertaken both in England and in Germany: Costa imported the ophicleide, Macfarren a complete military band, while Robert Franz in 1885 enlarged the Mozart version to iron out "imperfections and deficiencies." In the 1860s Peters published a full score with a footnote (in German and English) to the chorus "Glory to God": "Handel's original Trumpet parts. To be omitted in performance." The trumpets and drums are then given a grotesquely inappropriate entry at "And peace on earth."

Other works suffered just as severely. *Acis and Galatea* was rescored by Mozart, Mendelssohn, Tom Cooke, Cipriani Porter, George Perry, and Michael Costa. Although often announced as an oratorio, it could not be regarded strictly as church music and was permitted frequent appearances on the London stage. It had been staged in Marylebone Gardens as early as 1773, when the press announced that "before the Sere-nata (by a particular Desire) the Three Italian Musicians, Blind from their Birth, will perform a Comic Act." In 1829 a harpist put it on at the King's Theatre, yoked with a danced version of Beethoven's *Pastoral Symphony*. At the Tottenham Court Road Theatre in 1841 it was provided not only with additional accompaniments but with additional dialogue: Acis acquired a father (Faunus), Galatea a mother (Doris) and a sister (Eudora), and Ulysses looked in on the family on his way back from Troy. Macready's Drury Lane production in 1842, which was a great success, began with a substantial excerpt from Shelley's *Prometheus Unbound*, and endowed Polyphemus with a bodyguard of Cyclopes who constructed the hundred-

*Continued on page 130*

by NATHAN BRODER

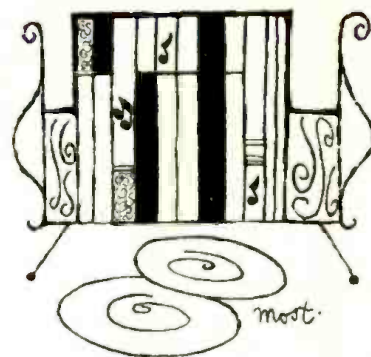

## HANDEL *on and off* Records

THERE IS, of course, much more off than on. It is customary, when dealing with this master, to speak of his vast output as though most of it were hidden treasure, which the opera, concert, and record world neglects to its loss. But let us face facts in this bicentennial year: Handel is a very uneven composer. There is glory enough for him. When he is at his peak, he is one of the greatest of the giants. For much of the time, however, he jogs along a middle way—always a tremendous craftsman and worthy of careful study by any composer, and often of absorbing interest to the music historian, but not invariably appealing to the plain music lover.

Nevertheless, there is much topnotch Handel not now available on records. It is generally agreed that his operas are not viable today. In the German Handel renaissance of the 1920s a number of them were performed and even published, but the scores had to be manipulated in various ways, new German recitative replaced Handel's Italian monologues and dialogues, and so on. Even so, the movement did not last. In a recent concert performance of *Giulio Cesare* in New York the resemblance of what was sung and played to what Handel wrote was at times rather distant. But to ignore the operas altogether is to deprive ourselves of some wonderful music. Perhaps the solution would be to adapt a procedure familiar to Handel's audiences. In those days an opera was seldom published complete. If it was successful on the stage, a London publisher would bring out a volume of "The Favourite Songs from . . .," containing not only the best airs but also duets and trios and often the overture and other instrumental numbers. How fine it would be if we could have, well performed and recorded and intelligently annotated with descriptions of what went on between selections, "the favourite songs from" *Radamisto*, *Orlando*, *Giulio Cesare*, *Tamerlano*, *Deidamia*!

The situation is worse with respect to the oratorios. These are not, like many of the operas, strings of recitatives and arias. Some of those not on records—*Samson*, *Esther*, *Jephtha*—contain much rich or powerful and

varied music. *Acis and Galatea* is one of the loveliest of Handel's works in a lyric vein. So is *Semele*, which was available in an excellent performance (Oiseau-Lyre OL 50098/100) until only a few months ago. These are gaping holes in the record catalogue.

As for what *is* available on records, some of it, unfortunately, would be better off. But there are a few acceptable performances of some of Handel's great works. Let us take a look at the most interesting of those that I am familiar with.

### The Oratorios and *Dettingen Te Deum*

In *Israel in Egypt* (first performed in 1739) the chorus, usually divided into two four-part choirs, is the protagonist, describing graphically the plagues that struck the Egyptians and glorifying the Lord in music of great beauty ("And Israel saw that great work") or sublime profundity ("Thy people shall hear"). Fine arias are, however, not lacking (for example, "Thou shalt bring them in"). Both of the two available recordings (Angel 3550B, two LP; Westminster XWL 2224, two LP) are cut, and neither follows Handel's orchestration exactly; but the Angel, particularly (Sir Malcolm Sargent conducting the Huddersfield Choral Society and Liverpool Philharmonic), has a number of attractive qualities—including good solo singing by Elsie Morison, soprano, and Monica Sinclair, contralto, a highly trained chorus, and clear and lovely sound—along with a flatness of projection that makes the words of the chorus often hard to understand.

Concerning *Saul* (1739), which many consider one of the great oratorios, I myself must turn in a minority report. Much of it seems to me routine Handel. There are one or two fine arias, like the noble "As great Jehovah lives"; one or two first-rate choruses, like the touching "Mourn, Israel" and "O fatal consequence of rage," with its curious drunken gait at "he blindly goes from crime to crime"; and the scene at Endor has some powerful moments. But these high spots are surrounded by a

good deal of characterless music. The Urania recording (URLP 240, two LP), sung in German, is rather unfortunate in its soprano soloists, somewhat luckier in its contralto (who sings David, tenor (Jonathan), and baritone (Saul). There are, as usual, a considerable number of cuts, including, unaccountably, the *Dead March*, once one of the most famous of Handel's compositions.

One of the most dramatic of the great oratorios is *Belshazzar* (1745). The scene of the handwriting on the wall is vividly painted in bold strokes by a masterly use of the chorus, reflecting now the terror of the superstitious courtiers, now the puzzlement of the sages summoned to interpret the strange inscription. Elsewhere there are monumental choruses, of a power rare even for Handel, like "Recall, oh king!" and "By slow degrees," the latter debouching into a tremendously impressive fugue. And the chorus of Persians, "Oh glorious prince!" has something of the sublimity of Beethoven's *Ode to Joy*. In the Vanguard recording (BG 534/5, two LP) an attempt is made to stick to Handel's orchestration, and the overture is rich with the reedy sounds of oboes and bassoons. Unfortunately, there are serious weaknesses: the work is sung in German, the soloists are all second-rate or (in the case of the soprano and tenor) worse, the direction in general is heavy-handed, and the sound is distorted in many of the choruses. There is a great need for a good performance well recorded.

The same is true of *Solomon*, which inevitably brings us to Sir Thomas Beecham. They tell of Beecham that he was once to conduct in Canada a concert that would be attended by the Lieutenant Governor. Sir Thomas was informed that although it was customary to play the national anthem complete for the Governor General, for the Lieutenant Governor only a portion of it was played. The conductor indignantly refused to curtail the anthem, and in tones that decidedly settled the matter announced, "For this occasion we shall promote the Lieutenant Governor."

One treasures such Beecham stories, and lays them away in one's memory alongside recollections of some of his great performances, like his old *Magic Flute* on RCA Victor. They help to offset the other side of Beecham, which does not hesitate to commit mayhem on the works of masters he professes to revere. Handel's *Solomon* (1749) is a particularly painful example (Angel 3546B, two LP). The original libretto, though no master-



Sir Adrian Boult

piece of conciseness or logic, made some sense in its division into three acts, the first dealing with Solomon's completion of the Temple, his piety, and his love for the queen (Pharaoh's daughter); the second with his judgment between the two women who claimed the one child; and the third with the visit of the Queen of Sheba. Beecham cuts out almost all of the second act, thereby sweeping away some fine music, but keeps the chorus from the end of the judgment scene, "From the East unto the West, Who is so wise as Solomon?" which now dangles in mid-air. He deletes other numbers, and shifts this way and that

those that are left. Although Handel calls for almost as rich an orchestra as the baroque period knew, Beecham remarks: "The entire score has been reorchestrated by me"—with the addition of English horn, clarinets, bass clarinet, contrabassoon, trombones, tuba, and percussion, including cymbals. The harm that can be done by such a royal mishmash is obvious: innocent listeners get a completely distorted notion of the work, and other record companies may hesitate to undertake the expense of recording an acceptable version while the Beecham edition stays in the catalogue. It's a pity, because we stand to remain deprived of a true masterwork, full of lovely arias, expressive recitatives, and choruses ranging from tender little poems to massive splendor.

As for *Messiah*, if you sang or played in a performance of that work with orchestra in school or church, the chances are ninety-nine out of a hundred that the orchestration used was Mozart's or Ebenezer Prout's or some modification thereof. The chances are about the same that certain numbers were omitted and that certain others were shortened. To most of us the sound of *Messiah* is the sound of a large chorus, of an orchestra with flutes, clarinets, and horns; and few of us ever had an opportunity to hear the complete work.

There are several recordings that present the work uncut and purportedly in its "original Dublin version," "according to the manuscript." The best of these, it seems to me, are the performances conducted by Scherchen (Westminster XWN 3306, three LP) and Boult (London A 4403, four LP). Even these are not, strictly speaking, musicologically accurate. Handel's score calls for strings and continuo throughout, with trumpets and drums in some of the big choruses. But it is known that in performances conducted by the composer oboes and bassoons constituted a



Hermann Scherchen

sizable proportion of the orchestra. In Scherchen's recording oboes may be faintly heard in one or two numbers, and in Boult's, bassoons are similarly audible in a few spots. And Scherchen (though not Boult) ignores all unwritten embellishments, even the most obvious appoggiaturas—a case of a conductor being more Handelian than Handel probably was. Each performance has its excellences and weaknesses. Scherchen's bass (Richard Standen) is first-rate, contralto and tenor (Constance Shacklock and William Herbert) fair, and soprano (Margaret Ritchie) uneven, expressive in "I know that my Redeemer liveth," for instance, but colorless and routine in "He shall feed His flock." Scherchen's chorus (the London Philharmonic Choir) is well balanced and transparent, but so, as it happens, are all the others considered here. He is given to faster tempos than are customary. Sometimes, as in "Every valley" and "Why do the nations," his rapid tempos are convincing, and enable the soloist to take long phrases in one breath. At other times, as in "O thou that tellest good tidings," they seem too fast. Boult uses the same chorus. His soprano and tenor (Jennifer Vyvyan and George Maran) are very fine, contralto and bass (Norma Procter and Owen Brannigan) fair. In some movements his performance lacks the intensity of Scherchen's, but as a whole it seems to me that it might stand up better in the long run.

Of the conventional performances, Sargent's (Angel 3510C, three LP) seems to me by far the best. He uses Mozart's orchestration plus some ideas of his own, and omits the movements and sections usually omitted. None of his soloists—Elsie Morison, soprano; Marjorie Thomas, contralto; Richard Lewis, tenor; Norman Walker, bass—is especially outstanding here. But the chorus (the Huddersfield Choral Society) is splendid, the sound in general is beautiful, and above all the spirit of the music is so clearly and lovingly conveyed by Sargent that I am not sure I do not prefer this to any other recording of *Messiah*. Beecham's version (RCA Victor LCT 6401, four LP) is for dyed-in-the-wool Beechamites. Although it is an old recording, the sound is still passable. One of its features is a recorded talk by Sir Thomas, in which he discusses the proper proportions of instruments to voices in this work, and gives sensible reasons for using four choruses ranging in size from about fifty voices to about 250. He then proceeds to perpetrate, or condone, the performance of "He was despised" and "The trumpets shall sound" with their middle sections but without the *da capo*! Now it is common enough to perform the first section only of these airs. But to do them as they are done in this recording is as if a theatrical company were

to go home after the second-act curtain of a three-act play, or a surgeon were to make a neat incision and a deft excision, and then neglect to sew the patient up.

One of Handel's famous choral works is the *Dettingen Te Deum*. Although some of it is run-of-the-mill baroque pomposity, there are sections that belong among Handel's best, such as the extraordinarily beautiful "We therefore pray Thee" and the magnificent and majestic final number, "O Lord, in Thee." The composition has been recorded in English by soloists, the Choir of the Netherlands Bach Society, and the Holland Festival Orchestra conducted by Anthon van der Horst on Epic LC 3540. The performance as a whole is an attractive one, though slowish tempos sometimes rob it of brilliance ("Thou art the King of Glory") and animation ("Day by day"), and the choral sopranos sound a bit thin. Almost everyone here pronounces English surprisingly well, and the soloists sing agreeably, the contralto (Aafje Heynis) having a particularly lovely voice.

#### The Orchestral Music, Including the Organ Concertos

Handel left many orchestral works, of which by far the best, as well as the most popular, are the twelve *Concerti Grossi*, Op. 6, the *Water Music*, the *Royal Fireworks Music*, and the twelve Organ Concertos, Opp. 4 and 7.

The concertos of Op. 6 are scored for a concertino of two violins and a cello and a four-part string orchestra with continuo. Handel achieves a good deal of variety by pitting the solo instruments against the full band, but in many movements, including some of the finest, he ignores the soloists and writes for the string orchestra. No two of the concertos are exactly alike in pattern, and the style ranges from delicately wrought chamber music to the broad, robust, beef-eating type of writing that many consider especially characteristic of this composer. And here and there, alongside a delightful fugue or one on a curiously shaped subject, or alongside a capricious *Allegro* or an attractive dance, there is a nobly songful movement in Handel's most moving and elevated style (No. 1, *Adagio*; No. 2, *Andante Larghetto*; No. 3, *Larghetto* and *Andante*; No. 12, *Larghetto*).

Three recordings of the complete Op. 6 are available, of varying degrees of excellence. Scherchen's (with the English Baroque Orchestra, Westminster XWN 4403, four LP) is in some respects the best and in others the worst. This puzzlingly uneven conductor at times seems to penetrate to the heart of a movement and to convey it to us with all the vitality that Handel put into it. He does this for example in the finale of No. 6, the



Sir Malcolm Sargent

third movement of No. 3, the first movement of No. 2, all of No. 4. But at other times he imposes a curiously erratic interpretation upon the music, a reading that seems to distort and for which there appears to be no sound justification. Such, to name only some instances, is the case with the brusque shift from forte to piano in the theme of the finale of No. 2, the uncalled-for sforzandi in the first movement of No. 8 and the Largo of No. 11; the Minuet of No. 9 drags and the Air of No. 10 sags towards the end; Scherchen permits his first violinist occasionally to indulge in a vibrato that is much too juicy for Handel; and he is the only conductor of the three who does not play the complete finale of No. 11. Fritz Lehmann (with the Bamberg Symphony Orchestra, Archive ARC 3084/87, four LP) may not achieve all the high spots that Scherchen reaches, but neither does he hit the low ones. With his more sensible, if at times less inspired, approach, his avoidance of tricks, the excellent solo playing, and the generally even better sound of his recording, he promises to wear better than Scherchen. The third set (Pro Arte Orchestra, Munich, conducted by Kurt Redel, Vox PL 10043, three LP) has its attractions, including some rather bold ornamentation, but is in most respects inferior to the other two, especially in the oversweet tone of the solo violinists, and the overreverberant sound of the recording.

The tangled tale of the origin of the delightful set of pieces called the *Water Music* need not be rehearsed here. What it boils down to is that we have about twenty pieces, at least some of which were performed on a barge in the Thames for the delectation of George I. No one knows precisely which pieces or in what order; a plausible surmise seems to be that the group includes two sets of pieces, played on two different boat rides. Every one of the five available recordings of the complete work (Boult and the Philharmonic Promenade Orchestra on Westminster NWN 18115; Lehmann and the Berlin Philharmonic on Archive ARC 3010; Bamberger and the Netherlands Philharmonic on Crowell-Collier Record Guild G 144; Boyd Neel and his orchestra on London LL 1128; and Maurice Hewitt and his orchestra on Haydn HSL 107) has its very good qualities; and if you own any one of those discs, there would be no great advantage, it seems to me, in replacing it with one of the others. The following comments may, however, be of interest. Boult's performance is, I think, the most imaginative. In a movement like the D minor Adagio with the oboe solo he permits the soloist to embellish his rather bare part generously (as Handel's oboist most likely would have done) and in the trio of the F major Minuet he reinforces the viola-cello line with

one or more bassoons to excellent effect. Lehmann's recording has the warmest, loveliest sound. Neel is uneven, playing some sections rather stolidly and others with a good deal of vitality. His horns are not impeccable, but his disc has one important advantage that all the others lack—the convenience of visible bands between movements.

Most of the present generation of concertgoers have come to learn and love this music through the suite made by Sir Hamilton Harty, who chose six or seven of the pieces and reorchestrated them. To anyone familiar with the original, whose orchestration is quite varied and colorful, Harty's version may sound overdone and not without an occasional Brahmsian or Wagnerian touch. For those who want this version, good recordings are available. The most satisfactory performance I am acquainted with is Van Beinum's on London LL 214 (with Mozart's *Haffner* Symphony), but the sound is not the finest possible. Better reproduction and an acceptable performance, if not quite as successful a one as Van Beinum's, may be found in Karajan's recording on Angel 35004 (with the *Nutcracker* Suite).

The *Royal Fireworks Music* must have made a splendid sound when it was originally performed in Green Park by a large wind band. It is a noble set of pieces in Handel's later version for strings and winds, excellently performed and recorded by Lehmann and the Berlin Philharmonic on Archive ARC 3059 together with two of the miscellaneous oboe concertos and the Concerto Grosso in G, Op. 3, No. 3. The Harty version of this suite is available combined with his arrangement of the *Water Music* in an effective performance by Dorati and the London Symphony Orchestra, fairly well recorded on Mercury MG 50158.

Four sets of organ concertos by Handel were published in the eighteenth century. Of these the first (Op. 4) and third (Op. 7) contain some magnificent music. They were played, mostly by Handel himself, in the intervals of oratorios, and proved so popular that the first set was brought out in an unauthorized edition before Handel had a chance to publish his own version.

These are not massive compositions. They were written for English organs, which in Handel's time were seldom large and usually lacked a pedal (the pedal is called for only in Op. 7, No. 1). The style is that of the chamber concerto; some of the movements in Op. 4 are in fact transcriptions of movements from sonatas. The organ is treated as the equal of the small orchestra. Along with some routine writing there are many fine passages in both sets. Such, in Op. 4, are the tender dialogue between organ and strings

*Continued on page 134*



*E. Power Biggs*



# The Imperishable Wag

by CHARLES CUDWORTH

*Anglo-Saxons always have been most sympathetic to genius when it did not take itself too seriously — which may explain why George Frederick Handel was one of the most popular men in all Georgian Britain. The author is Curator of the Pendlebury Music Library at the University School of Music, Cambridge.*

IF YOU ARE SO BENIGHTED as to think of George Frederick Handel solely as a solemn embodiment of musical uplift, it's time to mend the error of your ways. For the greater part of Handel's life, entertainment was his lot; he was indeed a public entertainer, albeit of an exalted kind. And although the great bulk of his musical output may seem to be somber in character, yet there is a vein of humor just beneath the surface of even his gravest works — think of that last little flutter of angels' wings in *Messiah* itself, for example, or of the chorus "All we like sheep," in the same oratorio.

He was indeed a droll fellow, in life as well as art. The friend of his youth, Johann Mattheson, tells us that even as a young man Handel was "naturally inclined to dry humour" and "behaved as if he could not count five. . . . He had a dry way of making the gravest people laugh, without laughing himself!" He seems to have made a very vivid impression on nearly everyone who met him and, as a result, his lively image is preserved in numerous portraits by his contemporaries. Charles Burney and Sir John Hawkins, the two famous English music historians of the later eighteenth century, both knew him personally and have left us accounts of him.

Handel's gait, says Hawkins, was sauntering and rather ungainly; "It had in it somewhat of that rocking motion which distinguishes those whose legs are bowed." Dr. Burney adds that Handel's figure "was large, and he was somewhat corpulent and unwieldy in his motions; but his countenance . . . was full of fire and dignity; and such as impressed ideas of superiority and genius. His general look was somewhat heavy and sour; but when he *did* smile, it was his sire the sun bursting out of a black cloud. There was a sudden flash of intelligence, wit and good humour, beaming in his countenance, which I hardly ever saw in any other. He was impetuous, rough, and peremptory in his manners and conversation, but totally devoid of ill-nature or malevolence; indeed there was an original humour and pleasantry in his most lively sallies of anger or impatience, which with his broken English, were extremely risible. His natural propensity to wit and humour, and happy manner of relating common occurrences, in an uncommon way, enabled him to throw persons and things into very ridiculous attitudes. Had he been as great a master of the English language as Swift, his *bons mots* would have been as frequent, and somewhat of the same kind." Another contemporary wrote: "Mr. Handel . . . was possessed of a great stock of wit and humour. No man ever told a story with more effect. But it was requisite for the hearer to have a competent knowledge of at least four languages — English, French, Italian, and German — for in his narratives he made use of them all."

Alas, we know all too little of the stories Handel himself may have told, but many a story has been told of him. Some of these are well known, others almost unknown. Many come from the pages of Burney, or Coxe's *Anecdotes*. We have a glimpse of him "sauntering" through the park, "talking to himself, so loud, that it was easy for persons not very near him to hear the subject of his soliloquies. . . ." On one occasion he was thus soliloquizing about a boy whom he had helped, but who had "turned out ill" and run away: "Der teiffel! De fater was desheevd; de mutter was desheevd; but I was not desheevd — he is ein tanned sheauntrel — and coot for nutting." This seems to have been a time when the composer was not amused, but on other occasions he was quite capable of enjoying a joke at his own expense. One day he took an old clergyman friend of his, Rev. J. Fountayne, to Marylebone Gardens; as they drew near the orchestra, a new piece was struck up. "Come, Mr. Fountayne," said Handel, "let us sit down and listen to this piece; I want to know your opinion of it." Down they sat, and after some time, the old parson turned to his companion and said: "It's not worth listening to — it's very poor stuff!" Mr. Handel's reply: "You are right, Mr. Fountayne. It *is* very poor stuff — I

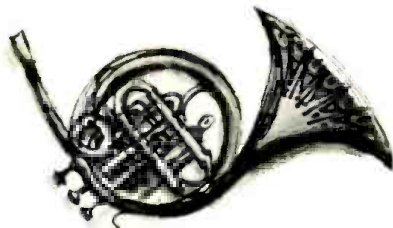

thought so, myself, when I had finished it!" But he was not always quite so patient with musical pretensions on the part of the gentlemen of the cloth. One morning he was in the midst of being shaved when a fellow musician called to request Handel's permission to add his great name to the subscription list of a set of organ concertos composed by a clergyman friend. Handel jumped up in a passion and a flurry of lather, thrust the barber's hand aside, and cried out with great vehemence: "Tamm your seluf and go to der teiffel! — a barson make concerto? vy he no make sarmon?"\*

Many of the best stories about him are naturally enough concerned with his public life. We are told that "he understood the art of asserting his own dignity, whilst rendering all possible deference to the noble personages with whom he came in contact." But, if Burney is to be believed, "all possible deference" is scarcely the phrase one would use to describe some of Handel's almost Beethovenian dealings with people in high places. "At the rehearsals of his oratorios, at Carleton-House, if the prince and princess of Wales were not exact in coming into the Music-Room, he used to be very violent . . . if the maids of honour, or any other female attendants, talked, during the performance, I fear that our modern Timotheus not only swore, but called names; yet at such times, the princess of Wales, with her accustomed mildness and benignity, used to say 'Hush! hush! Handel's in a passion.'" At such rehearsals, wrote Burney, "He was a blunt and peremptory disciplinarian . . . but he had a wit and humour in delivering his instructions, and even in chiding and finding fault, that were peculiar to himself, and extremely diverting to all but those on whom his lash was laid. . . . He wore an enormous white wig, and when things went well . . . it had a certain nod or vibration, which manifested his pleasure and satisfaction. Without it, nice observers were certain that he was out of humour."

But if things did go wrong, and Handel let his "great bear" of a temper loose, only to discover that he himself was in the wrong, then no one was quicker to apologize and make amends: "I pec your barton — I am a very odd tog!" he said to Burney, on one such occasion. The same authority relates how Handel, on his way to Dublin to produce *Messiah*, was detained at Chester, awaiting a favorable wind and tide. Thinking he would like to try out some of the numbers, he got together a number of local performers, among whom was one Janson, by profession a printer. Handel, having first ascertained that they could all sing at sight, handed out the music, but was soon in a fury at poor Janson's mistakes: "You sheauntrel! tit you not dell me dat you could sing at

\* Different chroniclers' attempts to reproduce Handel's accent yield wonderful orthographical variety, but altogether they do give some idea of what it must have been like.



soire?" "Yes, sir," protested Janson manfully, "and so I can; but not at *first sight!*" Poor Janson! he is among the immortals, not for being a good printer, but for being a bad sight reader — or perhaps a smart hand at repartee. Perhaps it was on the same occasion that Handel fell foul of the old cellist who assured the great man that he was a good player, because "he played in church." Unfortunately he could play neither in time nor in tune, and soon Handel's "great bear" was loose and he was shouting "You blay in de church; very well, you *may* blay in de church, for we read de Lord is long suffering, and of great kindness. You shall blay in de church, but you shall not blay for *me!*" And with that he snatched up his part books, and rushed out, swearing, no doubt, with fearsome and polyglot fluency.

It was not merely the back desks and the chorus singers who came in for Mr. Handel's sharp reproofs, however. Matthew Dubourg, his orchestral leader in Dublin, once lost his way in an unnecessarily long cadenza; when he finally did reach his final trill, he was greeted with a loud "You are welcome home, Mr. Dubourg!" — much to the delight of the audience, adds Burney. Handel even let his "great bear" loose among the prima donnas — we have all heard of how he seized the great Signora Cuzzoni by the waist and threatened to throw her out of the window, shouting, "Dey say you are a very teiffel; you must know dat I am Beelzebub, de Brince of Teiffels!" On another occasion, when a petulant tenor objected to the way Handel was accompanying him at the harpsichord, and even threatened to jump on the instrument and smash it to pieces: "Oh!" said Handel, "Let me know ven you vill do dat, and I vill advertise it; I am sure more beoble vill come to see you jump, dan to hear you sing!" To one recalcitrant singer who objected to singing the famous air "*Verdi prati.*" in *Alcina*: "You toe! don't I know petter as your seluf, vaat is pest for you to sing?" But he was not always in a passion, even with singers; sometimes the great bear merely gave a good-humored growl, as when the charming but rather featherheaded soprano Frasi told him she was going to learn thorough-bass, so that she could accompany herself. "Oh — vaat may ve not expect?" quizzed Handel, speaking in his driest vein, and knowing the lady's indolent nature only too well.

When his own favorite oratorio, *Theodora*, failed, playing to almost empty houses, he consoled himself and the artists with a "Never moind; de moosic vill sound de petter." But when a little later, two professionals

applied for what we should now call complimentary tickets for *Messiah*, he flashed out, bitterly: "Oh, your sarvant, mein Herren! You are tamnoble tainty! You would not go to *Teodora* — dere vas room enough to tance dere, ven dat vas perform'." The old dry humor continued with him to the very end. In his later years, when blindness came upon him, he was in some doubt as to how he could continue with his oratorios, and Sharp, his surgeon, rather tactlessly recommended the celebrated blind organist John Stanley. Handel gave a great shout of laughter and rejoined, "Mr. Sharp, have you never read the Scriptures? Do you not remember, if the blind lead the blind, they both fall into the ditch?"

Handel's drolleries are legion, some real, some apocryphal. And this same humor lurks beneath the apparently formal baroque lines of his melodies. Even in his music, he can "make the gravest people laugh, without laughing himself," or at least without obviously seeming to laugh. Just think for a moment of some of his avowedly comic creations: "the monster Polypheme" in *Acis and Galatea*; the boastful giant Harapha, in *Samson*; the two naughty old men in *Susanna*. These are comic characters worthy to be placed beside Mozart's immortal Barber. Polyphemus, in particular, is one of the greatest characterizations of all eighteenth-century music, and like all the best (or should it be worst?) fairy tale ogres, he is frightening as well as funny; after we have been laughing over his grotesque love making, we suddenly realize that he is a giant, after all, liable to become dangerous, and lo, he has hurled his piece of "massy ruin" and poor Acis is no more. But on the whole it is the comic Polypheme we remember, and not the savage brute.

Yet Handel's characterizations did not stop at the merely comical; he could depict madness (in *Saul* and *Orlando*); villainy (the false Ptolemy, in *Alexander Balus*); jealousy (Dejanira, in *Hercules*, and again, *Saul*); bitter regret for past misdeeds, and lost glory (in *Samson*); seductive feminine charm (Galatea, Dalila, and Cleopatra in *Giulio Cesare*), and so on and so on. Indeed, his catalogue of portraits is unending, for every character he encountered in his librettos he put into memorable music. His way with the words themselves was rather peremptory, of course, like his way with people: as he said to the tamest of his collaborators, Doctor Morell, "What! You teach me Music? The Music, sir, is good Music. It is your words is bad. Hear the passage again. There! go you, make words to that Music." There is another tale, perhaps spu- *Continued on page 135*

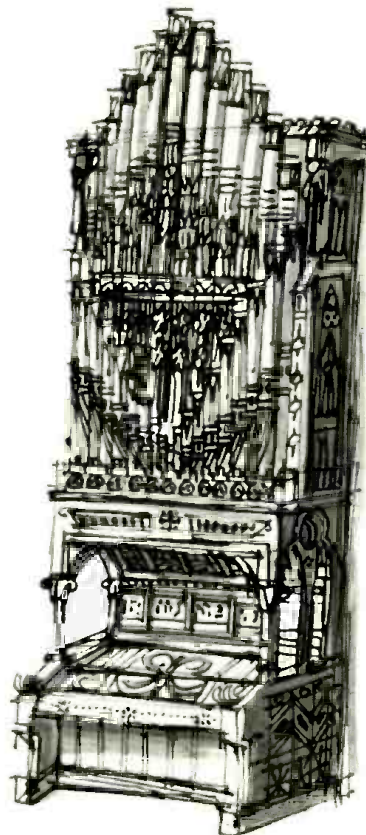



"... approaches the authenticity of concert hall performance," says famed violinist Mischa Elman about his TMS-2, shown with deflector doors opened for full stereo.

The TMS-2 marks the most significant loudspeaker achievement since the advent of popular stereo. Combining two complete multi-speaker systems in one compact en-

closure only 30" wide, it solves for the first time all the problems of placement, space limitations, decor and cost inherent in conventional stereo systems. Most important of all, the TMS-2 literally adds a third dimension to stereophonic sound... the perception of depth.

This is accomplished by its unique acoustic design that recreates multiple sound sources by utilizing the walls of the room similar to the way sound is transmitted in the concert hall. The bass emanates from the rear of the enclosure, the mid and treble ranges from the sides. Adjustable deflector doors increase or decrease the amount of stereo spread, as desired, according to the program material, room acoustics, etc.

The TMS-2 can be placed in a corner or anywhere along a wall, and since with this system there are no critical listening positions, any number of listeners can enjoy stereo from most anywhere in the room. Even with monophonic equipment and program material, the TMS-2 provides a

very pleasing stereo-like effect. It looks more like a piece of fine furniture than a speaker cabinet, and will harmonize with any decor—modern or traditional. (Full details in catalog—see below.) In Mahogany \$258, Blond or Walnut \$263, user net.



With deflector doors closed for monophonic use, the incredibly compact TMS-2 is only 30" wide, 25" high, 12 1/2" deep.



# TMS-2\*

~~IN SHORT SUPPLY~~

*NOW BEING DELIVERED!*

We regret any delay you may have experienced in receiving your TMS-2 'Trimensional' system. The unprecedented consumer demand for this remarkable new stereo speaker system has sold out the initial production runs. But with our production facilities now trebled, these delays are rapidly being overcome. If your dealer cannot give you immediate delivery, please be patient.

*HAVE BEEN*

*YOUR*

*THANK YOU FOR YOUR PATIENCE.*

*Other University approaches to stereo... for every space, budget and decor requirement*



Leading Metropolitan Opera Star Leonard Warren converted to stereo easily and inexpensively... using a compact Stereoflex-2\* "add-on" speaker with his full-range "Troubadour" speaker system.

For those with a full-range monophonic system or planning to buy one now with an eye to stereo later, University offers three different "add-on" speakers. Choose the one that suits you best—for bookshelf, wall, or "litepole" installation—or as an end table.

\* Trade-mark. Patent Pending.



Discriminating music lovers may enjoy magnificent stereo by simply connecting two University "add-on" speakers to one dual-voice-coil woofer in a suitable enclosure.

This approach offers great versatility. The woofer may be installed wherever most convenient... either in a small, suitable enclosure, or concealed in a wall, closet, etc. The two "add-on" speakers can then be placed to provide optimum stereo reproduction without upsetting room decor.



Noted choral and orchestra conductor Fred Waring chose a pair of University RRL\* Ultra Linear Response speakers for his system.

Two such identical speakers are an excellent stereo solution in rooms where they can be placed in reasonably symmetrical positions, far enough apart to provide sufficient stereo separation. All University systems are ideally suited for this purpose, because they are stereo-matched in production to within one decibel.

† Bass frequencies below 150 cycles do not contribute to the stereo effect.



**WHICH WAY TO STEREO IS IDEAL FOR YOU?**

Send for FREE Informative Guide to High Fidelity Stereo and Monophonic Speaker Systems and Components. Complete information on the TMS-2 and other stereo speaker systems... how to adapt your present system to stereo... how to choose a monophonic system now for most efficient conversion to stereo later... how to "do-it-yourself" economically, etc. See your dealer or write Desk P-11, University Loudspeakers, Inc., White Plains, N. Y.



by Roland Gelatt

## Music Makers

"I DECLINE to be a part of this wholesale cashing in on Handel, so characteristic of the industrialization of music in our time. Be sure you write that down. Music has become an industry; it is no longer an art." Thus, Sir Thomas Beecham when we encountered him, on Washington's Birthday, en route to the French Riviera following two months of guest-conducting engagements with the Philadelphia, Chicago, and Houston orchestras. Beecham would not be Beecham were he not evincing some sort of extreme exasperation, so we nodded our agreement on the subject of commercialized anniversaries and acknowledged our appreciation of Sir Thomas' long, persistent, and persuasive efforts on behalf of Handel. When he had fired off a few more salvos (on America's "appalling rise of violent crime," on our "ghastly paper matches," etc.), Sir Thomas settled back in his chair and delivered some voluble and illuminating discourse on the great George Frederick.

We observed that though Handel is universally acknowledged as a composer of the highest rank, he is nonetheless represented in performance by extremely few works. "In fact," interjected Sir Thomas, "you might say that Handel is widely known by only one work, his *Messiah*. It was first performed in Dublin, of all unlikely places, in 1742 and immediately became wildly popular. It still is popular, in a way. At Christmas time everybody goes out shopping, the women bake plum puddings and roast turkeys, there's a general air of festivity, and then comes *Messiah* on top of it all. Of course, this has nothing whatsoever to do with music.

"Incidentally, Handel wrote only one really religious oratorio, and that is because it happens to deal with Jesus Christ. All the others are about people who had nothing to do with religion. As a matter of fact, they are about a lot

of Old Testament gangsters. When Handel hit upon the idea of writing oratorios, he read the Bible—undoubtedly for the first time in his life—and chose lively stories of heroic deeds to set to music.

"He had the good sense to realize that the English were a singing nation and he made the chorus the chief protagonist of his oratorios. As long as choral music maintained its popularity in England, Handel's oratorios were often performed. But a serious rival of the chorus arose in the nineteenth century: the orchestra. It was mainly a poor affair until the middle of the century. Then the orchestra began to glow, and the public gradually grew to prefer the sound of instruments to the sound of voices. By the end of the nineteenth century the victory was complete. The large chorus suffered a catastrophic decline; today the public doesn't go to choral concerts at all. There's beginning to be a revival now, but it will never be as it was. Handel is no longer popular because the real protagonist of his oratorios, the chorus, is no longer popular. In the oratorios there's not enough orchestral interest to offset this disability. From this standpoint the operas stand a somewhat better chance of being revived, because of the marvelous orchestral dance music that Handel wrote for them. I am thinking particularly of *Il Pastor Fido*, *Ariodante*, and *Alcina*."

This mention of Handel's orchestra led us to question the various modernizations of his instrumentation. "We must ask ourselves first," Sir Thomas began, "in what sort of building were these works first played. Handel's compositions were usually performed in buildings which seated about 500 people. Today the average concert room holds 3,000 people. Yet it is still maintained by a choice company of half-wits, called musicologists, that Handel's music should

be treated on the same basis in this vast space as it was in a building seating 500 listeners. Is it really conceivable that Handel would have wanted his oratorios performed by thirty singers and thirty instrumentalists in Carnegie Hall?

"We must ask another question. Suppose Handel came on the scene now and discovered that flutes could play in tune, that the *cor anglais* was a really musical instrument, that the range of oboes and trumpets had been considerably extended, that horns could play chromatics, that a new instrument called the clarinet had been invented. Would he use the orchestra today that he had used in 1730?"

We raised the matter of recordings. Does not the microphone allow one to perform Handel under similar acoustic circumstances and with the same performing forces that the composer had originally intended? Beecham preferred not to discuss this possibility. "I record Handel in the same manner as I perform him in public, and I thumb my nose at musicologists. They are dreamers, not practical musicians. It's a matter of sound, you know, not theory."

In June, Sir Thomas Beecham will make a recording of *Messiah* in England for RCA Victor. It will be issued later this year as one of the first gala albums in RCA's new "Soria Series." The orchestra will be the Royal Philharmonic and the soloists will include tenor Jon Vickers and basso Giorgio Tozzi (soprano and contralto had not been picked at press time). RCA's forthcoming *Messiah* will, needless to say, be recorded stereophonically, a technique that Sir Thomas views with no little asperity. "It allows engineers to ruin a performance. They look in the score and think to themselves, 'What a pity that I can't hear the trombone part.' So then they go bringing something out that I have, at great pains, left successfully in the background."



**Dyer-Bennet: Beethoven with much style.**

laxed, not overdemanding temper may very likely find its contents intriguing, perhaps modestly delightful. For these little chamber songs, if of no great consequence as Beethoven and practically none as folklore, have still a curious hybrid attractiveness; and they are played and sung with much style and unforced charm in a recording (monophonic; I have not heard the stereo) that is notably natural in sound and free from technical bothers.

Mr. Dyer-Bennet recorded all these songs, plus six more of the Scottish, some time ago for a Concert Hall limited edition; but these fairish 78s have long been out of print, and are in all regards inferior to the new disc. An LP of Helen Traubel in rather majestic readings of a mostly different lot of songs could once be had from Columbia; but no longer. In fact, this repertoire has always been neglected more than it deserves. If nothing else, it has a fascinating history.

George Thomson, born in 1757, was an Edinburgh officeholder whose energetic character had in it something of the visionary and something of the bookkeeper, promoter and antiquary, patron of the arts and thin-lipped thrifty dominie—a mixture that might seem peculiar in anyone other than a lowland Scot. As a young man, he set out to collect (literally) every traditional Scottish tune, and determined to publish "all the fine airs both of the plaintive and lively kind, un-mixed with the trifling or inferior ones." Soon he widened his program to include Ireland and, later, Wales.

But many of his select "fine airs" had no words at all, or none in English; the others had words that seemed to him foolish or indecent or not sufficiently poetical. Many of the airs themselves seemed not quite "correct" as jotted down, and all lacked accompaniments. So he set about enlisting the finest poets in view (among them Robert Burns and Walter Scott, who wrote some of their best-known lyrics for him) to provide new texts, and the best composers (among them Pleyel and Haydn) to arrange the tunes for drawing-room performance. The first volume was issued in 1793. By 1806, three more had been added. But Haydn, having arranged over two hundred airs, was slowing down; Beethoven was asked to carry on, and, bogged in unproductivity and money troubles, he agreed. Between 1809 and 1823, he completed about (computations vary) a hundred and fifty arrangements for Thomson.

According to specification, the tunes were scored for voice and piano (the vo-

cal line doubled by the right hand), violin or flute, and cello, with little preludes and *ritornelli*. Copies of the lyrics were not usually sent with the tunes; and in answer to Beethoven's repeated protests that he absolutely had to have them ("I will have them translated here") in order to "give the true expression," Thomson wrote with bland truthfulness that this was impossible, "since most of these words are still in the poet's brain." Nor were the writers much better informed. No one knew for sure what a song would be like until Thomson had assembled it in Edinburgh.

For all this scattered method of manufacture, the results are not all so monstrous as might be imagined. Though the poems do sometimes sit uneasily on the musical accents, and though the harmonizations do drain the melodies of their national individualities, the ensemble writing is often quite pretty and sometimes, especially in purely instrumental passages, distinctively vigorous and unmistakably Beethoven. Taken in a congenial spirit, the songs can be a good deal of fun.

As noted, the performances are excellent. Mr. Dyer-Bennet is in fresh, rested-sounding voice, and within his limited resources of color sings with really lovely tone and true intonation, save in the occasional cadenzalike figurations, where discretion might have been the better part of technical valor; and the Berkshire Quartet players are never less than very good. Texts on a slipped-in leaflet. For myself, I'd buy it. J.H., JR.

**BEETHOVEN: *Symphony No. 1, in C, Op. 21; Leonore Overture No. 3, Op. 72a***

Mannheim National Symphony, Joseph Rosestock, cond.

• • JANUS FST 2002. SD. \$4.95.

The first stereo First in the catalogue proves, like the Livingston tape that was its source, to be an enjoyable, craftsman-like performance, well recorded and lacking only the element of greatness. However, in the current shortage of good recordings of this score, 'twill suffice. The *Leonore*, however, is not up to its competition. R.C.M.

**BERG: *Sonata for Piano, Op. 1—See Schoenberg: Piano Pieces, Op. 11.***

**BERLIOZ: *Symphonie fantastique, Op. 14***

New York Philharmonic, Dimitri Mitropoulos, cond.

• • COLUMBIA MS 6030. SD. \$5.98.

The first *Fantastique* on stereo to come near being satisfactory, this is wonderfully transparent right down to the smallest detail, yet vibrantly dramatic and taut where the music requires it and, in the *Scene in the Fields*, exceptionally imaginative. (For the first time on stereo, too, this movement isn't split between two disc sides.) The impressively handled introduction to the final movement produces a particularly eerie effect. In order

to get the last three movements on the second side, however, the volume level is noticeably lower, spoiling the climactic moments in the *March to the Scaffold* and the *Dream of a Witches' Sabbath*. P.A.

**BIZET: *Carmen: Orchestral Suite* †Ravel: *Boléro***

Virtuoso Symphony of London, Alfred Wallenstein, cond.

• • AUDIO FIDELITY FCS 50005. SD. \$6.95.

This record deserves all praise for the quality of its sound, which it seems to me cannot be bettered, and for the quality of the performances, which are as good as any recorded versions I know. As to the imagination of its programing, that speaks only too eloquently for itself. Still, the *Boléro* responds very cleverly to the stereo process, with its gradual accretion of instrumental color and volume. So does the Pandora-like *Carmen Suite* (the adjective refers to the fact that one never knows what's to be had inside). I have been afflicted with an epidemic of *Carmen Suites* of late, all on stereo labels. This one is a mélange of the Preludes to Acts I, IV, III (in that order), the Smugglers' March, the March of the Street Urchins, and the Gypsy Dance. D.J.

**BRAHMS: *Concerto for Violin and Orchestra, in D, Op. 77***

Henryk Szeryng, violin; London Symphony Orchestra, Pierre Monteux, cond.

• RCA VICTOR LM 2281. LP. \$4.98.

• • RCA VICTOR LSC 2281. SD. \$5.98.

Here, if such be needed, is proof that music is a truly international language. A Polish-born violinist, trained in Germany and France, and now a citizen of Mexico, plays a concerto by a German-born composer who lived in Austria. The conductor, who is French, resides mostly in America, and the orchestra is English. No doubt, the violin is Italian.

Szeryng is a thorough musician, exceptionally sensitive in matters of phrasing. To judge by the recording, his tone is not massive, yet it is very clear and sweet, and every note is articulated with the utmost care and refinement. His is as fine and probing an interpretation of the concerto as anyone could want, and Monteux, an expert Brahms interpreter in his own right, seconds him with like care and sympathy. The stereo edition has the advantage over the monophonic in instrumental separation and in the increased purity of the soloist's tone. P.A.

**BRUCH: *Concerto for Violin and Orchestra, No. 1, in G minor, Op. 26—See Mendelssohn: Concerto for Violin and Orchestra, in E minor, Op. 64.***

**BRUCH: *Scottish Fantasia, Op. 46—See Mendelssohn: Concerto for Violin and Orchestra, in E minor, Op. 64.***

**CHOPIN: *Piano Works***

*Fantaisie, in F minor, Op. 49; Trois nou-*

*velles études*; Barcarolle, in F sharp, Op. 60; *Berceuse*, in D flat, Op. 57; *Impromptus*: No. 1, in A flat, Op. 29; No. 2, in F sharp, Op. 36; No. 3, in G flat, Op. 51; *Fantaisie-Impromptu*, in C sharp minor, Op. 66.

Artur Rubinstein, piano.

• RCA Victor LM 2277. LP. \$4.98.

On this disc Rubinstein plays some material he never before has recorded: the F minor *Fantaisie*, the first two *Impromptus*, and the *Trois nouvelles études*. There is little left for him to go before he has recorded the cycle: the *Ballades*, *Études*, and B minor *Sonata* are the only major works that come to mind. Rubinstein is in top form here. His performance of the *Fantaisie*, which many believe to be the greatest work Chopin ever composed, is noble and in the grand line. For once, a pianist has the imagination to come smashing down on the keys on the chord that follows the pianissimo ending of the chorale, and what an effect it is! This is easily the greatest recorded performance that has been given this work, and one has to go back to the Cortot version of the early 1930s to find one that begins to approach it.

Rubinstein is just as colorful in the other pieces on the disc. This is Chopin playing that combines poetry, masculinity, a plastic rhythm, and an encompassing technique. Nobody today can match it. The recorded sound is admirably clear. There is one mistake in the label and note copy: the key of the Barcarolle is F sharp major, not minor (a prevalent error that even music researchers have fallen into). H.C.S.

**COPLAND: A Lincoln Portrait**  
†Schuman: *New England Triptych*  
†Barber: *Vanessa: Intermezzo*

Carl Sandburg, narrator (in the Copland); New York Philharmonic, Andre Kostelanetz, cond.

• COLUMBIA ML 5347. LP. \$4.98.  
• • COLUMBIA MS 6040. SD. \$5.98.

Copland composed *A Lincoln Portrait* for Kostelanetz, and Kostelanetz is its finest interpreter. It is very brilliantly done here, and gorgeously recorded; Sandburg reads the text with the intonation of a poet and the philosophic understanding of Lincoln's foremost biographer.

William Schuman's *New England Triptych* is a new piece which here makes its debut on records. It is a short symphony in three movements based on themes by the eighteenth-century Boston composer, William Billings. Billings' craggy individualism, his moral fervor and daring inventiveness, obviously have great appeal for Schuman, and the work is a convincing salute from a highly creative American of our period to another creative American of times past. Now Schuman must get his Juilliard boys and girls together to make a handsome record of Billings' own anthems and fuguing tunes. The great New Englander is not represented under his own name in the LP lists.

The Barber intermezzo is a pleasant whiff from Vanessa's boudoir. A.F.

**DEBUSSY: Images: No. 2, Ibéria**

†Ravel: *Miroirs: No. 4, Alborada del gracioso*

†Ibert: *Escalaes*

Orchestre National de la Radiodiffusion Française, Leopold Stokowski, cond.

• CAPITOL P 8463. LP. \$4.98.

All of Stokowski's familiar mannerisms serve here to make Debussy the servant of the conductor, not his master. This is doubly unfortunate since the Stokowski palette is liberally spread with all the opal colors that any proper impressionist might demand. But throughout *Ibéria* the tempos are so odd—some extra-fast, some ultra-slow—that the work's continuity dissolves in a flurry of eccentricity. Moreover, the mystery of the score, its evocation of Spain as heard in a dream, is dissipated by virtue of the phrasal exaggerations that cling to every measure. Ravel's *Alborada*, however, is read with a genuine virtuoso flair, and *Escalaes* is a warm bath of pseudo-exotic sound. The latter, of course, is a piece that borders often on the banal; Stokowski's way with it does nothing to adulterate the banality.

JAY S. HARRISON

**DEBUSSY: Prélude à l'après-midi d'un faune; Nocturnes: No. 1, Nuages; No. 2, Fêtes; Jeux**

Orchestre du Théâtre National de l'Opéra de Paris, Manuel Rosenthal, cond.

• WESTMINSTER XWN 18771. LP. \$4.98.

For the most part, Rosenthal's views on Debussy are worth any man's attention. His *Faun* is soaked in color, perfumed, too, and voluptuous but never vulgar. And his instrumentalists—though the French sound of the wood winds may appear a mite grainy—are everywhere accomplished and expert. In fact, you are not likely to hear on records a performance of *Fêtes* more distinguished in its bravura, nor does any other conductor manage the famous march-from-afar section with quite this stateliness and bursting majesty. Rosenthal's *Jeux*, on the other hand, is so clear and explicit that the work tends to lose those vaporous qualities that make it unique in the Debussy catalogue. The piece is an essay in orchestral pulverization and formal disintegration; but by spelling this out for us step by step, Rosenthal quite robs the work of its secrets, acting rather as a magician who, having amazed us by his tricks, then proceeds to explain how they were done. JAY S. HARRISON



Rubinstein: still matchless in Chopin.

**DELANDE: Sur le bonheur des justes et le malheur des réprouvés—See Marchand: Cantiques spirituels.**

**DELIBES: Sylvia**

London Symphony Orchestra, Anatole Fistoulari, cond.

• MERCURY OL 2106. Two LP. \$7.96.

*Sylvia's* view of classical Greece is decidedly filtered through the lorgnette of Third Republic France, but those who have seen the brilliant Sadler's Wells revival can testify that it passes muster in the never-never land of the ballet stage. This first complete recording proves that much more of it than the brief suite deserves to be known. The *Pas des éthiopiens* for piccolo and percussion is especially fetching, and *Sylvia's* Dance of the Bacchante is a lesson in the use of orchestral primary colors. The score—uncut here, save for two brief pieces in the concluding celebrations—is unified by a series of recurring motifs which justify this kind of integral recording, if any justification be needed.

Fistoulari is an experienced conductor of music for the dance, but it seems to me that neither he nor his orchestra displays the rhythmic dash and imaginative teamwork of Dorati and the Minneapolis Orchestra in *Coppélia*. D.J.

**DVORAK: Symphony No. 4, in G, Op. 88**

Cleveland Orchestra, George Szell, cond.

• EPIC LC 3532. LP. \$4.98.  
• • EPIC BC 1015. SD. \$5.98.

The music of Dvořák is close to Szell's heart and temperament. As usual, he demands and gets a performance from his highly trained orchestra that is flawless. Occasionally one might wish for a little more abandon, as in parts of the first and last movements here, but this is a most commendable interpretation.

And what is of equal importance is the sound. This is one of the first recordings made in the recently revamped Severance Hall with its new acoustical shell that permits more reverberation. For one who has heard a number of concerts in this auditorium and, in years past, has supervised some recording sessions there, the new sound comes as a pleasant shock. It certainly is a vast improvement over some of the old Cleveland discs (in recent years, the orchestra has been recording elsewhere). There is considerable directionalism in the stereo version, but that directionalism also involves an illusion of depth, the horns in particular emerging from deep center. The only flaw is a strange hiss that appeared toward the end of the second movement in the left channel of my stereo review copy. It was not in the monophonic edition. P.A.

**DVORAK: Symphony No. 5, in E minor, Op. 95 ("From the New World")**

Bamberg Symphony Orchestra, Heinrich Hollreiser, cond.

• • Vox STPL 10810. SD. \$5.95.

Hollreiser leads a transparent perform-

ance of the *New World* Symphony, one that is marked also by clean attacks and dramatic tension. But there isn't much subtlety or imagination here, although the music is satisfactorily conveyed. As for the orchestral playing, there is considerable lack of polish in the winds. Vox's sound matches the conductor's transparency; it is also admirably directional, pinpointing each section of the orchestra. However, it definitely favors the highs at the expense of the lows, which results in a thin bass line. P.A.

**FALLA: *El Amor brujo***—See Surinach: *Sinfonietta flamenca*.

**GLAZUNOV: *Birthday Greeting: Ballet Suite*** (arr. Irving)—See Lecocq: *La Fille de Mme. Angot: Ballet Suite*.

**GRIEG: *Peer Gynt: Incidental Music***

Ilse Hollweg, soprano; Beecham Choral Society; Royal Philharmonic Orchestra, Sir Thomas Beecham, cond.

• • ANGEL S 35445. SD. \$5.98.

All the clarity and depth of feeling in the monophonic pressing of this performance is enhanced by the aural spread of stereo, especially in the choral movements and in the passages where there is interplay between two string sections or between winds and strings. The conducting, playing, and singing are of such a high order that they impart much greater stature to Grieg's score than it usually achieves in the average performance. Like David Johnson, who reviewed the monophonic disc, I too regret that Beecham didn't elect to record the incidental music complete, but am grateful for what has been included, such as the original choral versions of *In the Hall of the Mountain King* and the *First Arabian Dance*, as well as Ilse Hollweg's tender delineation of *Solveig's Lullaby*. P.A.

**GRIEG: *Sonata for Violin and Piano, No. 1, in F, Op. 8***

†Szymanowski: *Sonata for Violin and Piano, No. 1, in D minor, Op. 9*

David Oistrakh, violin; Lev Oborin (in the Grieg) and Vladimir Yampolsky (in the Szymanowski), piano.

• M-G-M GC 30004. LP. \$3.98.

The three Grieg violin sonatas are very seldom encountered on recital programs these days, which is a shame. Although they may seem old-fashioned to some listeners, they contain a great deal of charming music. The Sonata No. 1 does not even appear very often on discs, so it is particularly good to have this facile performance by Oistrakh and Oborin. This is early Grieg, to be sure, but the germs of what was to follow are very evident here. The Szymanowski, which Oistrakh and Yampolsky have recorded before for Angel, is also an early effort. Here, however, little of the composer's individuality shows through a pleasing, if somewhat derivative work. Processing of the Soviet tapes has been skillfully accomplished. P.A.

**HAYDN: *Concerto for Cello and Orchestra, in D ("Op. 121")***

†Wagenseil: *Concerto for Cello, Strings, and Continuo, in A*

Enrico Mainardi, cello; Münchener Kammerorchester, Enrico Mainardi, cond.

• ARCHIVE ARC 3110. LP. \$5.98.

The Haydn performance is, unfortunately, nothing to cheer about. Both of the fast movements seem to be too slow. Mainardi, whose intonation is generally accurate (there is one sour note in the first movement), just barely resists the temptation to sentimentalize that occasionally besets performers in this lyric work. The Concerto by Georg Christoph Wagenseil (1715-1777), a compatriot and older contemporary of Haydn, was written in 1752 and rediscovered in 1953. It is an attractive piece in the rococo style of the time and it is well performed. The recording throughout, as usual with Deutsche Grammophon Gesellschaft products, is superb. N.B.

**HAYDN: *Symphonies: No. 100, in C ("Military"); No. 101, in D ("Clock")***

Vienna State Opera Orchestra, Mogens Woldike, cond.

• VANGUARD SRV 109. LP. \$1.98.

• • VANGUARD SRV 109SD. SD. \$2.98.

A big-league disc from every point of view. R. D. Darrell has reported in these pages on the magnificent quality of the stereo tape version. I have not heard that version and can only say that the stereo disc presents as real orchestral sound as I have ever heard in reproduction. The two channels are not obviously separated. Instead, the instruments seem to be spaced out evenly from the far edge of one speaker across to the far edge of the other. But in this dispersal of the sound nothing is lost in the definition and tim-



Woldike: a big-league Haydn Military.

bre of the individual instruments. Add good balance, first-class playing, and a conducting job that conveys all of the joy and beauty of this music, and you have a practically unbeatable record. N.B.

**HINDEMITH: *Symphony, Mathis der Maler***

†Bartók: *Divertimento for Strings*

Philharmonia Orchestra, Constantin Silvestri, cond.

• ANGEL 35643. LP. \$4.98 (or \$3.98).

The Hindemith is somewhat mannered in performance, but so beautifully recorded that one tends to forgive the peculiarities of the interpretation because of the beauty of the sound. The Bartók, a piece for small chamber orchestra, is here recorded with the full string complement of a symphonic ensemble, and, inevitably, it sounds heavy, overrich, and overromanticized. A.F.

**IBERT: *Escales***—See Debussy: *Images: No. 2, Ibéria*.

**D'INDY: *Symphonie sur un chant montagnard français, Op. 25***—See Ravel: *Concerto for Piano and Orchestra, in G*.

**KHACHATURIAN: *Spartacus* (excerpts)**

State Radio Orchestra of the U.S.S.R., Alexander Gauk, cond.

• MONITOR MC 2025. LP. \$4.98.

This ballet about the slave uprising in ancient Rome has everything—gladiatorial contests, dances of nymphs, a seduction scene, and, of course, an orgy. Its score is hereby nominated as the century's stales. The performance seems to be better than the music deserves. The recording is mediocre. A.F.

**KRENEK: *Sonata for Piano, No. 3, Op. 93***—See Schoenberg: *Piano Pieces, Op. 11*.

**LALO: *Namouna: Orchestral Suite No. 1***—See Schmitt: *La Tragédie de Salomé*.

**LECOQC: *La Fille de Mme. Angot: Ballet Suite*** (arr. Jacob)  
†Glazunov: *Birthday Greeting: Ballet Suite* (arr. Irving)

Royal Philharmonic Orchestra, Robert Irving, cond.

• • ANGEL S 35588. SD. \$5.98.

The quintessence of balletic preciousness, this is a release likely to be as ecstatically prized by certain balletomanes as it is to discomfit listeners of more robust tastes. Such exquisitely delicate playing and recording are aptly tailored to Irving's potpourri of blandly elegant Glazunov dances originally assembled as a glossy display case for the six leading ballerinas of the Sadler's Wells (now Royal Ballet) Company on the occasion of its Silver Jubilee in 1956; but they ill become the far less sophisticated and epicene music of Lecocq, which is here singularly miniaturized and denatured. For those who remember the lustiness of the now-withdrawn Kurtz reading of a *Mam'zelle Angot* suite in Mohaupt's arrangement, all the luminosity and grace of the present Irving-Jacob version can never compensate for its deficiencies in humor, vigor, and even frank vulgarity. A great pity, for the stereo technology here is flawless except for its apparently deliberate es-

chewal of sonic depths and impacts, and a properly full-blooded recorded performance of Lecoq's invigorating rhythms and lilting tunes easily might be as widely popular as those of the now overly familiar Offenbach-Rosenthal *Gaîté Parisienne*.  
R.D.D.

**LEHAR: Die Lustige Witwe**

Hilde Gueden (s), Hanna Glawari; Emmy Loose (s), Valencienne; Per Grunden (t), Danilo Danilowitsch; Waldemar Kmentt (t), Camille de Rosillon; Peter Klein (t), Cascada; Karl Dönch (b), Baron Mirko Zeta; Kurtz Equiluz (b), St. Brioche. Soloists, Chorus, and Orchestra of the Vienna State Opera, Robert Stolz, cond.

• • LONDON OSA 1205. Two SD. \$11.96.

London's new *Merry Widow* is a considerable but not victorious rival of the classic Angel recording issued five years ago. Stereophonic sound, when it is done as well as it is here, is a decided point in favor of any opera recording. London's engineering in the *Merry Widow* is mellow, less raucous (also perhaps a bit less exciting) than in some of its other recent releases. Voices are a little too forward and the orchestra is at times too retiring, but there can be no question that the sound as a whole is superior to Angel's—although the latter is still quite acceptable. Angel's Philharmonia under Ackermann plays brilliantly and is lacking neither in warmth nor idiomatic style. But the Vienna State Opera Orchestra plays with still more warmth and is even more idiomatic—as well it should be since it is led by an elderly gentleman who helped Lehár prepare the operetta's premiere in 1905 and has since conducted it hundreds of times. Robert Stolz provides especially for this recording an overture concocted of tunes from the work; some may consider this an asset, others a bore.

Hilde Gueden sings charmingly as Hanna Glawari, but she doesn't do the role to the teeth as Angel's Schwarzkopf does. Gueden is more peasantlike in her approach. This ought to be right for the character, but somehow it does not quite come off; one misses Schwarzkopf's ton. Gueden's speaking voice, too, does not have the nuances of Schwarzkopf's, and tends to a rather guttural monotony. Angel's Danilo is Erich Kunz, a baritone. The score calls for a tenor in this role and London provides one in Per Grunden. This might be considered an advantage if it were not that Kunz is the more polished singer and the wittier actor. Waldemar Kmentt and Nicolai Gedda are more evenly matched; Kmentt is developing into a first-rate lyric tenor; his voice is handsomer and better controlled in this release than it was several years ago. Still, he does not quite measure up to Gedda's gracefully sentimental Rosillon. The lesser roles are more or less fit for tat; in fact, London and Angel share the same Valencienne.

What may be a deciding factor for prospective buyers is that London, instead of a libretto, provides an awkward-

ly written and incomplete summary of the action. Most of said action is carried on in fairly leisurely German dialogue, which is not difficult to follow if one has a smattering of German. Those who have no German at all will, and ought to, resent the omission of text and translation.  
D.J.

**MARCHAND: Cantiques spirituels: Sur le bonheur des justes et le malheur des réprouvés: A la louange de la charité**  
†Delalande: *Sur le bonheur des justes et le malheur des réprouvés*

Nadine Santereau, soprano; Jeannine Colard, mezzo; Michel Hamel, tenor; Camille Maurane, baritone; Jean-Marie Leclair Instrumental Ensemble, Louis Frémaux, cond.

• WESTMINSTER XWN 18792. LP. \$4.98.

These three works are settings of two religious canticles by Racine. In Louis Marchand's *In Praise of Charity* each of the soloists has a verse or two, and they sing together only in one verse at the middle and another at the end. Similarly, in his *On the Happiness of the Just and the Misery of the Damned*, the three soloists (the mezzo does not sing here) join only at the end. Some of this music reaches a considerable degree of eloquence, and at no point is it unworthy of the elevated spirit of the text.

The Delalande is less elaborate. It is sung mostly by the mezzo, the soprano joining her only occasionally. The instrumental accompaniment to this work, a reconstruction by an unnamed editor, is less interesting than the orchestral portions of the Marchand settings. All of the singers turn in good, solid performances, and the sound is spacious and resonant.  
N.B.

**MENDELSSOHN: Concerto for Violin and Orchestra, in E minor, Op. 64**  
†Bruch: *Concerto for Violin and Orchestra, No. 1, in G minor, Op. 26*

Yehudi Menuhin, violin; Philharmonia Orchestra, Efrem Kurtz (in the Mendelssohn) and Walter Süsskind (in the Bruch), conds.  
• EMI-CAPITOL G 7148. LP. \$4.98.

**MENDELSSOHN: Concerto for Violin and Orchestra, in E minor, Op. 64**  
†Bruch: *Scottish Fantasia, Op. 46*

Alfredo Campoli, violin; London Philharmonic Orchestra, Sir Adrian Boult, cond.  
• • LONDON CS 6047. SD. \$4.98.

The difference between these two performances is more than a difference between monophonic and stereo recording, though that has an important place in the reckoning. Menuhin works very hard in the Mendelssohn—almost too hard. He is rather too strict in his treatment of the cadenza in the first movement, while elsewhere his playing is more intense than lighthearted. One must admire, nevertheless, the firmness of his tone and the absence of his customary slides. He sounds much happier in the Bruch Concerto, which he treats



Winograd's Mendelssohn makes news.

most tenderly, especially in the exquisitely phrased slow movement. The recording has a slightly cramped sound, with the soloist practically on top of the microphone and with a fairly limited tonal range.

Campoli is a bit freer with the Mendelssohn, and his basically sweeter—if occasionally less even—tone is better suited to this essentially sweet-tempered composition. He puts ample forcefulness into his performance of the Bruch Fantasia, however. Though the latter work is not the greatest piece of music, it is an entertaining setting of four Scottish folk tunes. From the standpoint of sound, it is the most successful of the four recordings. Whereas London's stereo makes the violin stand out in bold relief in the Mendelssohn, the orchestral accompaniment lacks sufficient presence. In the Fantasia, however, there is a more equitable balance, and the orchestra has a full, resounding ring to it.  
P.A.

**MENDELSSOHN: Octet in E flat, Op. 20** (arr. Winograd); *Sinfonia for String Orchestra, No. 9, in C minor*

Arthur Winograd String Orchestra, Arthur Winograd, cond.  
• M-G-M E 3668. LP. \$3.98.

The big news here is the *Sinfonia* No. 9 which, as far as I can ascertain, has never been recorded before. Composed in 1823, when Mendelssohn was only fourteen, it is a remarkably fresh work, perhaps more Schubertian than Mendelssohnian, but admirably put together. Any composer of forty would have been glad to call it his own. Particularly unusual is the beginning of the second movement, which is scored for violins only, in four parts. The *Sinfonia*, along with a number of other Mendelssohn juvenilia, was found a few years ago in the Berlin State Library. It would be wonderful to have more of these treasures. Meanwhile, we can be grateful to Winograd for bringing it to discs in a sprightly fashion. His expansion of the Octet for strings into a work for full string orchestra enhances its sonority, yet the performance retains its original lightness. M-G-M has provided good sound for this welcome release.  
P.A.

**MENOTTI: Maria Golovin**

Franca Duval (s), Maria Golovin; Genia Las (ms), Agata; Patricia Neway (c), the Mother; Herbert Handt (t), Dr.

Zuckertanz; William Chapman (b), Prisoner of War; Richard Cross (bs-b), Donato. Chorus and Orchestra, Peter Herman Adler, cond.

• RCA Victor LM 6142. Three LP. \$14.94.

Menotti's latest opera had its premiere at the Brussels World's Fair, followed by a brief and unsuccessful run on Broadway. I am grateful that RCA Victor chose to issue this recording despite *Maria Golovin's* initial failure in this country, although I cannot pretend to a wild enthusiasm for it based on the first two-and-a-fraction hearings (the fraction consisting of the trio for the women and the whole of the second scene of Act III, which I listened to a third time for the sheer pleasure of it). As a dramatic and musical whole, the opera disappoints me—but I recall being even more keenly disappointed at first by *The Saint of Bleeker Street*, which I now consider this composer-librettist's most considerable achievement to date.

The libretto, like so many by Menotti, is deliberately vague as to locale, but the characters mostly have Italian names and the time of action is soon after World War II. The story, like *Vanessa*, handles the subject of love with its (for Menotti) concomitant complex of isolation, captivity, and deceit. Donato, a young architect, blinded in the war and now living in bitter loneliness with his mother and the spinster family servant (both of them bitter and lonely too), falls in love with the beautiful lady who has rented the second floor of his mother's house. Maria Golovin returns his love but their happiness is prevented by a variety of factors: she is married and has a son to whom she is devoted, the spinster servant is envious and troublesome, and Donato is fiercely jealous. A series of painful scenes ensue; finally, when a telegram arrives announcing her husband's release from a prisoner-of-war camp, Maria takes the easy way out by telling Donato that she must leave him. He brandishes a pistol and calls his mother to direct his aim at Maria. The mother pretends to do so, but beckons Maria out of the way; he shoots into empty space. "She is yours forever now," sings the mother, and leads him from the room. Maria brokenheartedly goes upstairs to the party she is giving in celebration of her husband's home-coming.

The substance is somewhat thin for three acts, but Menotti pads it out with a tutor named Dr. Zuckertanz ("Sugar-dance") and an escaped prisoner, both of whom have substantial solos. In Zuckertanz the composer strikes out, more in amused contempt than in anger, at the snobism of our age, which turns up its exquisite nose at neoromantics like himself, and will hear of nothing but "Monteverdi, Vivaldi, Stravinsky, Bartók. To painting, Piero—Piero, of course, della Francesca. And the great, great Mondrian—so divinely geometrical." Zuckertanz's aria (accompanied by rhythmic horn figures straight out of Stravinsky's neoclassical period) is wonderfully funny, if perhaps not quite so integral a part of the opera as Samuel Chotzinoff's pref-

atory essay (a very good one) would have it.

The opera is performed by the original cast, an all-American one despite the fact that Franca Duval and Herbert Handt (the memorable Orpheus of the long-vanished Haydn *Orfeo ed Euridice*) have been more honored abroad than at home. Perhaps only Handt merits unqualified praise. Miss Duval has a voice appealingly tender in its middle reaches but not all of a piece; and she does not have the volume needed for climactic moments. Patricia Neway is a dramatic soprano of real merit, but since Menotti wrote the part of the mother for a contralto it is puzzling indeed that he assigned it to Miss Neway. She often cannot negotiate it. The youthful Richard Cross, who virtually makes his first appearance in opera as Donato, has good basic vocal equipment which needs ripening—it is as yet inflexible and rather constricted. And so deep a voice somehow does not accord well with the role. The long monologue of the escaped prisoner of war is sung by a baritone whose voice assaults the eardrum most unpleasantly.

I had hoped that the orchestra would be a bigger one. Menotti has not been well served by orchestras in the recordings of his operas. The strings, as they are here, generally are far too few to carry the long warm cantilenas he sometimes assigns them (e.g., the lovely tune played first by the cellos and then by the upper strings in the prelude to Act III). And too frequently the strings are ill-balanced with the brass and percussion. Adler conducts carefully but with no great imagination. The packaging is handsome, but the libretto contains many discrepancies with what gets sung, and part of the last-act duet is not printed at all. The engineers do their job well; the far-off singing in the prisoner-of-war camp is especially well realized. D.J.

#### MILHAUD: *Le Carnaval d'Aix*

†Saint-Saëns: *Concerto for Piano and Orchestra, No. 4, in C minor, Op. 44*

Grant Johannesen, piano; Philharmonia Orchestra, Georges Tzipine, cond.

• EMI-CAPITOL G 7151. LP. \$4.98.

Milhaud's *Carnaval d'Aix* is one of the most delightful things he has ever written. It is a series of twelve short character and comedy sketches for piano and orchestra based on the score of *Salade*, his *commedia dell'arte* ballet of 1924. The parallel with Schumann's *Carnaval* is readily apparent, and the work is quite as successful, as full of humor, color, and original fantasy as its romantic predecessor. The performance is good, the recording fair. The performance of the Saint-Saëns on the other side is very superficial. Perhaps this is as it should be, for Saint-Saëns is supposedly a superficial composer; but the recording of the same work by Robert Casadesu gives one a totally different feeling about it. A.F.

#### MOZART: *Così fan tutte* (excerpts)

Lisa della Casa (s), Fiordiligi; Emmy

Loose (s), Despina; Christa Ludwig (ms), Dorabella; Anton Dermota (t), Ferrando; Erich Kunz (b), Guglielmo; Paul Schoeffler (bs), Don Alfonso. Vienna State Opera Chorus and Vienna Philharmonic Orchestra, Karl Böhm, cond.  
• • LONDON OS 25047. SD. \$5.98.

Happily, stereo does not alter the small-scaled, intimate atmosphere that Karl Böhm was at such pains to create in this performance. If anything, it helps—by accenting that balance between solo voices and solo instruments which gives *Così fan tutte* its unique aural appeal among Mozart's operas. For instance, Fiordiligi's aria "Per pietà, ben mio" has here the sense first of a duet between soprano and solo horn which later—with the addition of clarinet and bassoon—blossoms into a quartet. It's all very lovely and all very delicately achieved.

No fewer than thirteen numbers are included in this stereophonic sampling of the complete set. Side 1, band two alone contains the recitative before the "Addio Quintet," the Quintet itself, the ensuing military chorus, and the concluding trio, "Soave sia il vento." This certainly suggests that stereo discs need not give one less playing time for one's money than LPs do. Incidentally, the list of credits *supra* may prove helpful to prospective purchasers since the record itself fails to indicate who sings what. D.J.

#### MOZART: *Serenade for Strings, No. 13, in G, K. 525* ("Eine kleine Nachtmusik")

†Tchaikovsky: *Serenade for String Orchestra, in C, Op. 48*

Israel Philharmonic Orchestra, Georg Solti, cond.

• • LONDON CS 6066. SD. \$4.98.

The playing is impressively pithy in the outer movements of the Tchaikovsky and agreeably warm in the inner ones. The Mozart is performed with skill and sensitivity. Splendid stereo is combined with a very wide range of dynamics. But the string tone is harsh and unreal. N.B.

#### MOZART: *Die Zauberflöte* (excerpts)

Hilde Gueden (s), Pamina; Wilma Lipp (s), Queen of the Night; Emmy Loose (s), Papagena; Leopold Simoneau (t), Tamino; August Jaresch (t), Monostatos; Walter Berry (b), Papageno; Kurt Boehme (bs), Sarastro. Soloists, Vienna State Opera Chorus and Vienna Philharmonic Orchestra, Karl Böhm, cond.  
• • LONDON OS 25046. SD. \$5.98.

The sound here seems to me as disappointing as that on the simultaneously released excerpts from *Così fan tutte* is admirable. *The Magic Flute* ought to lend itself brilliantly to double-channel reproduction—it has big choruses, it is ambitiously scored, it indulges in all kinds of antiphonal effects. But in this early effort (1956) London's stereo engineers let most of their opportunities slip past them. The twelve selections are well

Continued on page 66



# Hark! Behold!

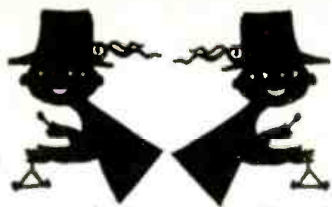

New...Recorded especially for STEREO!  
**MERCURY LIVING PRESENCE**  
 Stereo records of these  
*best-selling landmarks of the record industry.*

**TCHAIKOVSKY** Festival Overture 1812 (with brass band, cannon and bells); Capriccio Italien. Minneapolis Symphony, Dorati. Stereo SR 90054, Monaural MG 50054. Mercury's monaural version of this work has remained at the top of the best-seller charts since its release in 1956. *"There isn't, and won't be another record like this one... it has to be heard to be believed... is it possible to exceed this in the art of reproduced sound?"*—THE NEW RECORDS

**RIMSKY-KORSAKOV** Scheherazade. Minneapolis Symphony, Dorati. Stereo SR 90195, Monaural MG 50009. Dorati's widely hailed monaural recording of Scheherazade for Mercury has been a fixture on the best selling charts for six years. This is the most gorgeous stereo you've ever heard.

**RAVEL** Boléro; Ma Mère l'Oye. **CHABRIER** Bourrée Fantasque. Detroit Symphony, Paray. Stereo SR 90005, Monaural MG 50020. Paray's has become THE definitive recording of this work; another chart best-seller for six years. *"Fantastic dynamic range—the impact of the Boléro is positively awesome."*—THE AMERICAN RECORD GUIDE

**SAINT-SAËNS** Symphony No. 3 in C Minor. Detroit Symphony, Paray; Marcel Dupré, organist. Stereo SR 90012, Monaural MG 50167. This joined the best-seller lists two weeks after its release and has remained there since. John Conly says in THE ATLANTIC: *"...one of those performances we call (for lack of a more exact term) inspired... Saint-Saëns would have thought his point well made in this Mercury version."*

**CHERUBINI** Medea (complete recording, deluxe factory-sealed album). Maria Meneghini Callas, Chorus and Orchestra of La Scala, Serafin conducting. Stereo SR 3-9000, Monaural OL 3-104. *"The most beautiful vocal recording today is that of the opera Medea on Mercury..."*—THE GRAMOPHONE

**PROKOFIEV** Suite from "The Love of Three Oranges"; Scythian Suite. London Symphony, Dorati. Stereo SR 90006, Monaural 50157. A breathtaking demonstration of the depth and spread of sound of TRUE stereo, or as John Conly said in THE ATLANTIC *"...a real spectacular: rich, close-up, thunderous, brilliant..."*



Drawings by *John W. Wood, '58.*



Wollmann: half a fine Prokofiev team.

chosen, but I would recommend the single disc of monophonic excerpts that Decca has provided from their complete set. The sonics as well as the performance are significantly better. D.J.

**PROKOFIEV:** *Sonata for Cello and Piano, No. 2, in C, Op. 119*  
 †Shostakovich: *Sonata for Cello and Piano, in D minor, Op. 40*

Antonio Janigro, cello; Eva Wollmann, piano.

• WESTMINSTER XWN 18791. LP. \$4.98.

It would be difficult to imagine a finer performance of cello sonatas—anybody's cello sonatas—than that provided here, or a finer recording of the instruments involved. The works are not especially profound—they stand just on the good side of the line that divides salon music from chamber music—but the interpretation, by Janigro and Wollmann alike, lends them depth, dignity, and interest of the highest musical importance. A superb release. A.F.

**PROKOFIEV:** *Symphony No. 4, in C, Op. 47/112*

State Radio Orchestra of the U.S.S.R., Gennadi Rozhdestvenski, cond.

• M-G-M GC 30001. LP. \$4.98.

Prokofiev composed his fourth symphony in 1929 for the Boston Symphony Orchestra's fiftieth anniversary celebration, but late in his life he completely rewrote it and nearly doubled its length; hence its double opus number. Written in the bardic-heroic tradition of the Russian symphony, it stands in a direct line of descent from the symphonies of Borodin, but there is a good deal of Glazunovian dullness about it, too (for which I suspect the revision was responsible). The performance seems good enough, though the recording is not especially remarkable. A.F.

**RACHMANINOFF:** *Concerto for Piano and Orchestra, No. 2, in C minor, Op. 18*

Kjell Baekkelund, piano; Oslo Philhar-

monic Orchestra, Oivin Fjeldstad, cond.  
 • • RCA CAMDEN CAS 475. SD. \$2.98.

This is a rather mild-mannered presentation of a glowing concerto. The Scandinavian collaborators do not treat the work with Northern coldness, but the soloist could have been a little less analytical and could have sustained a longer singing line. At the same time, he and the conductor could have been more forceful in many of their statements in the first and last movements. Even though this disc isn't spectacular, however, it's a sincere performance, recorded in satisfactory stereo, and not a bad buy at the bargain price. P.A.

**RACHMANINOFF:** *Symphony No. 2, in E minor, Op. 27*

Detroit Symphony Orchestra, Paul Paray, cond.

• • MERCURY SR 90019. SD. \$5.95.

Those who are looking for a stereo edition of Paray's thoughtful reading of this symphony would do better by selecting the tape version. The sound is well distributed on this disc, but there is an unaccountable distortion of the upper frequencies that is not in keeping with the general high quality of Mercury's stereo product. P.A.

**RAVEL:** *Boléro*—See Bizet: *Carmen: Orchestral Suite.*

**RAVEL:** *Concerto for Piano and Orchestra, in G*

†D'Indy: *Symphonie sur un chant montagnard français, Op. 25*

Nicole Henriot-Schweitzer, piano; Boston Symphony Orchestra, Charles Munch, cond.

• RCA VICTOR LM 2271. LP. \$4.98.

• • RCA VICTOR LSC 2271. SD. \$5.98.

Nicole Henriot, who has married a relative of Albert Schweitzer since her last visit to this country, is a pupil of Marguerite Long, for whom Ravel's two-handed concerto was written. This means that she has the true tradition of the piece, and her recording of it is the first to equal Mme. Long's in musical understanding. It is incomparably finer than hers, however, so far as sound is concerned, especially in the stereo version.

Mme. Schweitzer does a very skillful and competent piece of work with the D'Indy, but the Casadesus version still remains the best on records. The coupling of these two beautiful works on a single disc is extremely attractive. A.F.

**RAVEL:** *Miroirs: No. 4, Alborada del gracioso*—See Debussy: *Images: No. 2, Ibéria.*

**SAINT-SAENS:** *Concerto for Piano and Orchestra, No. 4, in C minor, Op. 44*—See Milhaud: *Le Carnaval d'Aix.*

**SCHMITT:** *La Tragédie de Salomé*

†Strauss, Richard: *Salome: Salomes Tanz*

†Lalo: *Namouna: Orchestral Suite No. 1*

Detroit Symphony Orchestra, Paul Paray, cond.

• MERCURY MG 50177. LP. \$3.98.

The late Florent Schmitt completed *La Tragédie de Salomé* in 1907, just two years after Richard Strauss's fiery operatic score on the same theme. Originally conceived as a ballet, the work was ultimately recast as a symphonic suite. In some respects, it is far less savage in concept than the Strauss opera. For the most part, it is a combination of late romantic and early impressionistic writing, fully and colorfully orchestrated. As Harold Lawrence points out in his excellent jacket notes, the final *Dance of Fright* definitely foreshadows *Le Sacre du Printemps*. There may be more than coincidence here, for the score is dedicated to Stravinsky, who expressed his great admiration of it to the composer. Unlike Strauss, who based his opera on Oscar Wilde's play, Schmitt used as the foundation for his *Salomé* a poem by Robert d'Humières which varies considerably from the familiar story. The score, which employs a large orchestra, is brilliantly and opulently set forth by Paray, who plays up the sharp contrasts between its lyrical and orgiastically rhythmic movements.

Strauss's *Dance of the Seven Veils* makes a fitting disc companion to the French *Salomé*. Paray is equally enthusiastic in his treatment here, though he emphasizes the orchestral coloring rather than the sensual aspects of the music.

Next to these two incandescent works, Edouard Lalo's *Namouna* sounds just a trifle pale. Like *La Tragédie de Salomé*, it was originally a ballet, from which the composer later extracted three concert suites. With his affinity for French music of all periods, Paray enhances the Suite No. 1 with an exhilarating reading.

All three compositions are orchestral showpieces, and Mercury has set them off in beautifully balanced, wide-range sound, completely free from distortion. This disc ought to be tremendous in stereo. P.A.

**SCHOENBERG:** *Piano Pieces, Op. 11*

†Berg: *Sonata for Piano, Op. 1*

†Křenek: *Sonata for Piano, No. 3, Op. 93*

Glenn Gould, piano.

• COLUMBIA ML 5336. LP. \$4.98.

Schoenberg's three piano pieces, Opus 11, are beginning to sound like Bralums today, but their solidity and meaningfulness increase with each rehearing. The tendency to treat them merely as forerunners of Schoenberg's later style is an aberration which, let us hope, Gould's magnificent performance has finally put to rest.

In his notes, Gould says "Berg's Opus 1 is as fine as anything he ever did. (I am aware that this remark is open to contradiction.)" For me, it is contradicted by all the later music of Berg, but the diffuse, *schwärmerisch* sonata is of value in juxtaposition to the Schoenberg as a revelation of the master-pupil relationship.

Continued on page 68

# LIVING STEREO

...with the world's greatest artists on RCA Victor

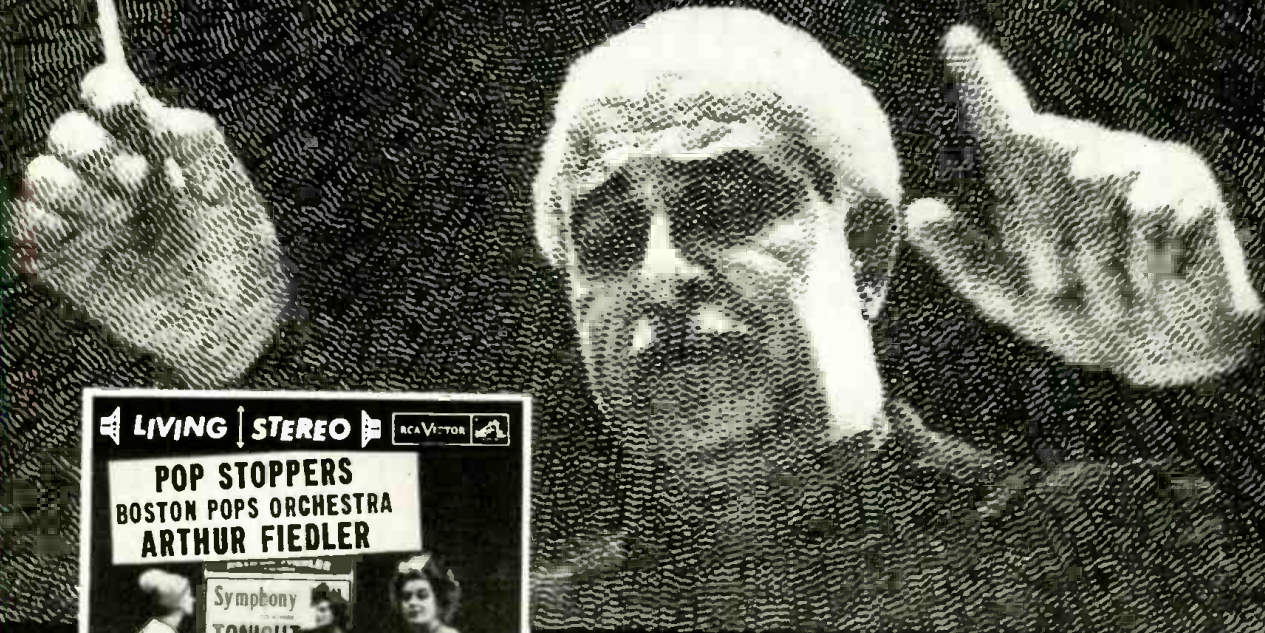

**THE BOSTON POPS STOPS THE SHOW WITH "POP STOPPERS"!**

*Jalousie, Ritual Fire Dance, Liebestraum* and 5 others that bring audiences to their feet whenever Fiedler conducts. Also available on regular L. P. LSC/LM-2270

**NEW! AVAILABLE IN "LIVING STEREO" OR ON REGULAR LONG PLAY**



Strikingly beautiful passages from everyone's favorite orchestral works. LSC/LM-2238



Munch interprets D'Indy and Ravel; Nicole Schweitzer, pianist. LSC/LM-2271



Light, lively music by French composers Dukas, Saint-Saëns, Ravel. LSC/LM-2292

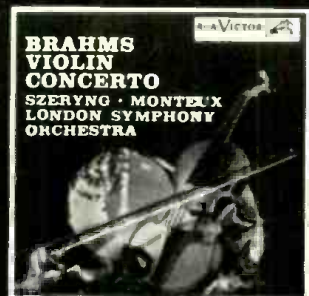

Superb performance by a great Polish violinist, now on RCA Victor. LSC/LM-2231

**WHEN ORDERING STEREO, SAY... RCA!**

\*Manufacturer's nationally advertised price shown—optional.



**RCA VICTOR**  
RADIO CORPORATION OF AMERICA





Not just Hi-Fi

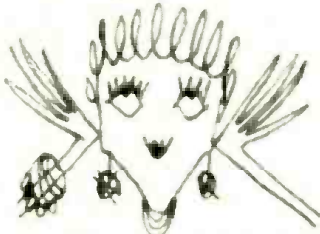

Not just Stereo



But STEREO in HI-FI!

with  
Stereovox®  
records

Stereovox records give you Stereo reproduction with both the range and the clarity engineered to bring out the fullest capacities of the most advanced sound systems.

They are a fast growing library of important works. To hear them is to want them!

**TCHAIKOVSKY:** SYMPHONY #5, E MINOR, OP. 64. Bamberg Symphony—Heinrich Hollreiser, conductor. **STPL 510.380**

**TCHAIKOVSKY:** SYMPHONY #4, F MINOR, OP. 36. Bamberg Symphony—Heinrich Hollreiser, conductor. **STPL 511.190**

**DVORAK:** SYMPHONY #4, G MAJOR, OP. 88. Bamberg Symphony—Jonel Perle, conductor. **STPL 511.050**

**HANDEL:** 8 OVERTURES. Bamberg Symphony—Rolf Reinhardt, conductor. **STPL 511.300**

\*Also available on VOX monophonic records. Write to Dept. H for complete Stereo or Monophonic catalogs.



VOX PRODUCTIONS, INC.  
236 W. 55th Street, New York 19, N. Y.

The brilliantly written sonata by Křenek finally takes Schoenbergian atonality, so far as this collection is concerned, out of the romantic emotional orbit of the Viennese school and develops it in the direction of a cooler, in some ways more adventuresome, lyricism.

I become more and more fully convinced that Glenn Gould is the foremost pianist whom this continent has produced in recent decades. The beauty of his tone and the depth of his musicianship are revealed here through a recording of marvelous fidelity. A.F.

**SCHUBERT: Quartets and Quintets**

Vol. III: Quartet for Strings, No. 5, in B flat, D. 68; Quartet for Strings, No. 14, in D minor, D. 810 (*Tod und das Mulchen*); Quintet for Piano and Strings, in A, D. 667 (*Trout*); Quintet for Strings, in C, D. 956.

Rolf Reinhardt, piano; Fritz Kiskalt, cello; Georg Hoernagel, double-bass; Endres Quartet.

• Vox VBX 6. Three LP. \$8.95.

The final volume of this complete set of Schubert's quartets and quintets has the same merit of good taste and the same failing of excessive understatement I noted in the earlier two volumes. More disturbing is a certain insensitivity to shading and a tendency to confound mezzo and piano and to ignore pianissimo marking altogether.

But these readings are rarely unenjoyable; and when one considers that the whole set can, like the others, be purchased for \$8.95, one may be willing to accept something less than perfect performances for the sake of owning the whole series of marvelous works. Certainly the C major Quintet and the D minor Quartet have been given more inspired interpretations on LP (the latter notably in the new version by the Smetana Quartet), but I am not aware that the *Trout* is available in a clearly superior edition. Vox has already issued this *Trout* as a single, stereophonic release—and curiously enough the sound in the monophonic version proves to be better than its stereo counterpart. The fragmentary Fifth Quartet has been recorded only once before, by the Vienna Konzerthaus Quartet, and the Endres group has the edge in this instance. D.J.

**SCHUBERT: Sonata for Piano, No. 16, in A minor, Op. 42, D. 845; Impromptus: Op. 142, D. 935; No. 2, in A flat; Op. 90, D. 899; No. 2, in E flat**

Sviatoslav Richter, piano.

• MONITOR MC 2027. LP. \$4.98.

This is piano playing of great strength and authority. The 1825 piano sonata receives here easily its best interpretation to date. The grim, death-and-the-maiden atmosphere of the first movement is conveyed with a unity of design and a cumulative impact only too rare among interpreters of Schubert's keyboard music. The variations of the slow movement may be somewhat lacking in tenderness and Richter's tempos are certainly brisk, but it is a thrilling thing to hear thirty-seconds

and sixty-fourths played with such absolute clarity and control. The trio of the ensuing scherzo proves that this artist is capable of a subdued, manly tenderness as well as delicacy and variety of touch. The A flat impromptu has been recorded by pianists more attune to it (Schnabel and Gieseking), but I doubt if the whirlwind E flat impromptu has ever fared better on or off records. A very exciting release.

Richter scrupulously observes every repeat in the sonata (including the whole of the first movement's exposition) which accounts for the fact that the work takes up all of Side 1 and half of Side 2. The Soviet engineers have reproduced the piano tone convincingly, although a trace or two of preecho (of no great consequence) can be detected. D.J.

**SCHUMAN: New England Triptych—See Copland: A Lincoln Portrait.**

**SCHUMANN: Concerto for Piano and Orchestra, in A minor, Op. 54**

Artur Schnabel, piano; RCA Victor Symphony Orchestra, Josef Krips, cond.

• RCA VICTOR LM 2256. LP. \$4.98.

• • RCA VICTOR LSC 2256. SD. \$5.98.

Rubinstein's last recorded performance of the Schumann Concerto was released in 1948. Obviously, a remake has long been overdue. Victor now supplies one both in monophonic and in stereophonic versions, in each case using an entire disc for this work. This is something to make the economy-minded purchaser pause. About a half hour's (32'09", to be exact) worth of music on an LP disc is fairly short change these days, especially as there is available a fine performance of the work, played by Serkin, and backed with a stupendous performance of the Strauss *Burleske*. Rubinstein's performance, however, is, as always, beautiful. Although he drags the A flat section in the first movement a little too much for my taste, the authority and color of his playing establish themselves on their own terms. Through the years, by the way, his conception of the concerto has changed. The 1948 version is a little less personal, much more direct and red-blooded. I think it is superior to the new version, though there is room for argument on both sides. In any case, the playing in the new discs is unmistakably Rubinstein, which should be enough for anybody.

The stereophonic version has a more mellow sound than the monophonic, which comes out somewhat harshly in the climaxes. In the stereo disc, the piano is firmly centered between the speakers, and there is no wandering. The piano, however, tends to dominate the orchestra and sounds too big in this most ensemble of concertos. And can't Victor do something about the poor surfaces that mar so many of its discs? H.C.S.

**SHOSTAKOVICH: Sonata for Cello and Piano, in D minor, Op. 40—See Prokofiev: Sonata for Cello and Piano, No. 2, in C, Op. 119.**

Continued on page 72

HIGH FIDELITY MAGAZINE

# SIX for \$4.98

By Subscribing NOW to Take Six Additional Louisville Orchestra FIRST EDITION RECORDS in Next Twelve Months, at \$4.98 Each

Can you imagine the thrill of owning a library of hi-fi records made at the original concerts of such composers as Bach, Beethoven, Brahms?

First Edition Records give you such an opportunity today — for these are the works of today's leading Contemporary composers, some of whom are famous today — may well be *fabulous* names tomorrow (see list at right).

Until now, these matchless recordings have been available either singly at \$7.95 each, or by subscription at \$4.98 each. Now our subscribers have increased so magnificently that we can now offer 12 records for the price of 7 — *saving you nearly 50% on your purchases.*

Make no mistake about it — there are no other records in the world that are like Louisville Orchestra First Edition Records. The music (commissioned by the Louisville Orchestra and written by outstanding contemporary composers from almost every country in the free world) has been recorded by Columbia in 12" hi-fi discs, played and interpreted as the composer intended.

Critics have praised First Edition Recordings to the skies:

"Splendid sound".

*Cleveland Plain Dealer*

"... a service to music unequalled".

*Christian Science Monitor*

"... the reproduction is model of clarity".

*St. Louis Globe-Democrat*

"... recording and performances, excellent".

*Pittsburgh Post-Gazette*

"... quality higher than critics dared hope".

*Time Magazine*

"... It would seem clear that the Louisville commissions enrich European as well as American repertoires. And the value of recordings for the formulation of second thoughts and longer perspectives on contemporary works would be hard to exaggerate".

*New York Times*

● The first 6 records (all 6 for \$4.98) will be mailed you upon receipt of the coupon at the right.

● You may discontinue your subscription at any time after purchasing 6 records at \$4.98 each, within one year.

● The 6 additional records, for which you pay \$4.98 each, will be mailed you at intervals of approximately two months during the next 52 weeks, with bill enclosed (we pay the postage). After purchasing these 6 records at \$4.98 each, you receive a First Edition Record of your choice, free, for every 2 additional selections you buy.

THE LOUISVILLE PHILHARMONIC SOCIETY  
(A Non-Profit Organization)  
Robert Whitney, Conductor



Fine Columbia Hi-Fi Recordings of Award-winning Compositions,  
Brilliantly Played by One of the Nation's Outstanding Orchestras

Paul Creston Heitor Villa-Lobos	Invocation and Dance Overture. "Dawn in a Tropical Forest"	Henk Badings Ben Weber Leo Sowerby	LOU-545-1	LOU-56-0	The Louisville Symphony Prelude and Passacaglia All on a Summer's Day
Halsey Stevens	Triskelion	Paul Nordoff Paul Muller-Zurich	LOU-545-2	LOU-57-1	Winter Symphony Concerto for Cello and Orchestra, Op. 55 (Grace Whitney, Cellist)
Henry Cowell Alexander Tcherepnin Bernard Wagenaar	Symphony No. 11 Suite, Opus 87 A Concert Overture	Andre Jalivet John Vincent	LOU-545-3	LOU-57-2	Suite Transacane Symphony in D
Peter Mennin Wallingford Riegger	Symphony No. 6 Variations for Piano and Orchestra (Benjamin Owen, Pianist)	Rolf Liebermann	LOU-545-4	LOU-57-3	Opera: "School for Wives" Moritz Bamhard, Director
Ernst Toch	Naturino	Roger Sessions	LOU-545-5	LOU-57-4	"Idyll of Theocritus" for Soprano and Orchestra (Audrey Nassaman, Soprano)
Alan Hovhaness Marlo Castelnuovo- Tedesco Carlos Surinach	Concerto No. 7 for Orchestra Overture to "Much Ado About Nothing" Sinfonietta Flamenca	Ned Rorem Bernard Reichel	LOU-545-6	LOU-57-5	Design for Orchestra Suite Symphonique
Jacques Ibert Gardner Read Otto Luening-Vladimir Ussachevsky	Louisville Concerto Toccata Giocosa Rhapsodic Variations for Tape Recorder and Orchestra	Edmund Rubbra	LOU-545-7	LOU-57-6	Improvisation for Violin and Orchestra (Sidney Horth, Violinist)
Peggy Glanville-Hicks	Opera: "The Transposed Heads" Moritz Bamhard, Director	Irving Fine	LOU-545-8	LOU-57-7	Serious Song: A Lament for String Orchestra Passacaglia, Adagio and Finale
Vincent Persichetti Robert Sanders Boris Blacher	Symphony for Strings Little Symphony No. 2 in Bb Studie im Pianissimo, Opus 45	Harold Morris	LOU-545-9	LOU-58-1	Ballet in E Symboli Christiani for Baritone and Orchestra (William Pickett, Baritone)
Luigi Dallapiccola Jose Pablo Moncayo Ulysses Kay Darius Milhaud	Variationi per Orchestra Cumbres Serenade for Orchestra Ouverture Mediterraneenne	Alexei Haieff Nicolas Nabokov	LOU-545-10	LOU-58-2	"Four Strict Songs" for Eight Baritones and Orchestra Variations on a Tune from "The Beggar's Opera"
Gottfried Von Einem Karol Rathaus George Perle	Mediations Prelude for Orchestra, Opus 71 Rhapsody for Orchestra	Lou Harrison	LOU-545-11	LOU-58-3	Variations for Orchestra Second Piano Concerto (Benjamin Owen, Pianist)
Alberto Ginastera	Pampeana No. 3, A Pastoral Symphony	Peter Jona Korn	LOU-545-12	LOU-58-4	Polyphony for Orchestra Feria Magica Overture Fourth Symphony
William Bergsma Henri Sauguet Robert Ward	A Carol on Twelfth Night Les Trois Lys Euphony for Orchestra	Arthur Berger Carlos Surinach Meyer Kupferman	LOU-545-13	LOU-58-5	Concertino for Orchestra II Symphony No. 2 in F
Gian-Francesco Malipiero Vittorio Rieti Ernst Bacon	Fantasia di Ogni Giorno Introduzione e Gioco Delle Ore The Enchanted Island	Roger Goeb Gail Kubik	LOU-56-1	LOU-58-6	Serenata Fantasia, Chaconne and Allegro Pezzi Sinfonici, Opus 109
Richard Mohaupt	Opera: "Double Trouble" Moritz Bamhard, Director	Walter Piston David Van Vactor Niels Viggo Bentzon	LOU-56-2	LOU-56-3	Louisville Concerto And the Fallen Petals Suite IV Centenario
Hilding, Rosenberg Chou Wen-Chung Camargo Guarnieri	Capriccio The Mirror The Tower of St. Barbara	Richard Wangerin	LOU-56-4	LOU-56-5	Eleven Transparencies Magnificat, Op. 20 Choir of Southern Baptist Theological Seminary
Alexandre Tansman Felix Borowski Ingolf Dahl	Eleven Transparencies Magnificat, Op. 20 Choir of Southern Baptist Theological Seminary	Richard Wangerin	LOU-56-5	LOU-56-6	Serenata Concertante, Op. 42 Credo for Orchestra Concerto No. 1 for Piano and Orchestra (Robert Muczynski, Pianist)
Ernst Krenek Roberto Caamano	Opera: "The Wish" Moritz Bamhard, Director	Richard Wangerin	LOU-56-6	LOU-56-7	Serenata Concertante, Op. 42 Credo for Orchestra Concerto No. 1 for Piano and Orchestra (Robert Muczynski, Pianist)
George Antheil	Opera: "The Wish" Moritz Bamhard, Director	Richard Wangerin	LOU-56-7	LOU-56-8	Serenata Concertante, Op. 42 Credo for Orchestra Concerto No. 1 for Piano and Orchestra (Robert Muczynski, Pianist)
Juan Orrego-Salas Harold Shaper Robert Muczynski	Serenata Concertante, Op. 42 Credo for Orchestra Concerto No. 1 for Piano and Orchestra (Robert Muczynski, Pianist)	Richard Wangerin	LOU-56-8	LOU-56-9	Serenata Concertante, Op. 42 Credo for Orchestra Concerto No. 1 for Piano and Orchestra (Robert Muczynski, Pianist)

SEND NO MONEY — 6 RECORDS FOR \$4.98 WILL BE  
MAILED YOU UPON RECEIPT OF THIS COUPON

Richard Wangerin, Manager  
LOUISVILLE PHILHARMONIC SOCIETY  
Suite 4, 830 S. Fourth Street  
Louisville 3, Kentucky

Please enroll me as a subscriber for First Edition Records, and send me the 6 records whose numbers have been circled above. You may bill me a total of \$4.98 for these 6.

I agree to purchase the next 6 releases during the next twelve months, at \$4.98 each.

Name \_\_\_\_\_

Address \_\_\_\_\_

City \_\_\_\_\_ Zone \_\_\_\_\_ State \_\_\_\_\_

*looking high and low  
for your kind of music?*

# KAPP HAS IT IN STEREO

*Now you will be able to find entertainment that  
entertains . . . the most wanted kinds of music . . .  
your kind of music . . . beautifully recorded in  
KAPP STEREO and so simple to select, you'll know  
in an instant which album is for you.*

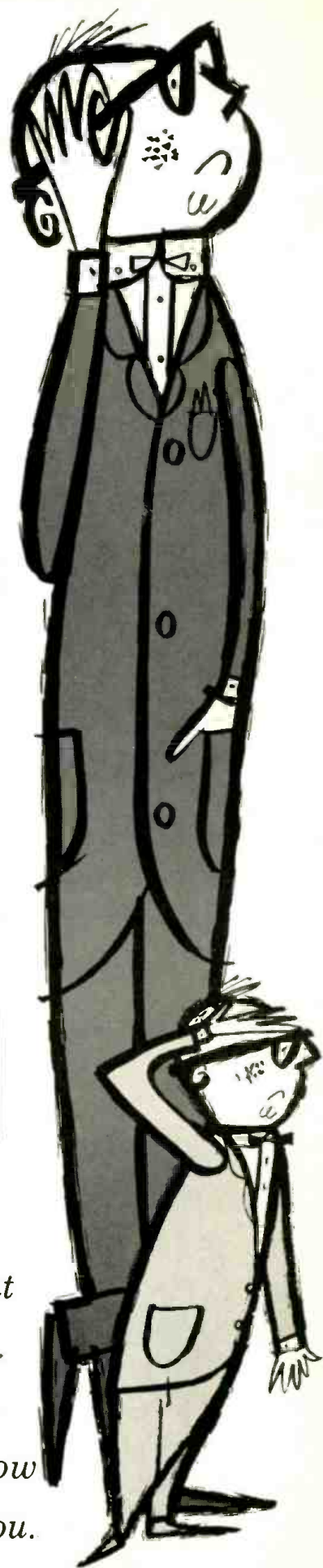

# WHAT'S YOUR PLEASURE IN STEREO?

*They're all wonderful...they're all stereo...they're all KAPP!*

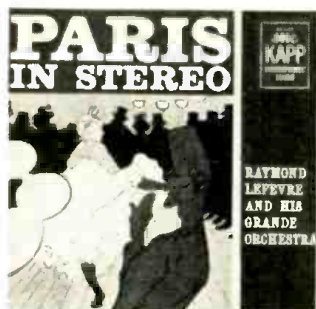

**PARIS IN STEREO**, Raymond Lefevre and His Grande Orchestra • Valentine • The Song From Moulin Rouge • La Gaiete Parisienne • Mon Homme • A Paris • La Belle Helene • La Ronde de L'Amour La Vie Parisienne • Apache Dance Sous Les Toits de Paris • Paris Canaille **KS-3003**



**HOLLYWOOD THEMES IN STEREO**, Frank Hunter and His Orchestra • Terry's Theme • A Very Precious Love • Tara's Theme • Ruby • Wild Is The Wind Variations on Colonel Bogey • Gigi Love Theme From La Strada • Spellbound • The Long Hot Summer • The Old Man and The Sea • Katsumi Love Theme **KS-3005**

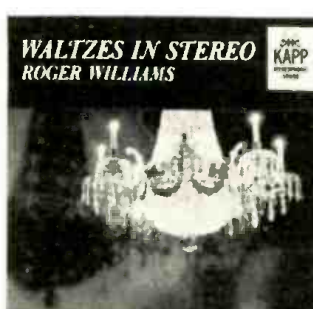

**ROGER WILLIAMS, Waltzes in Stereo** The Merry Widow Waltz • The Whiffenpoof Song • Three O'Clock In The Morning • Oh, What A Beautiful Morning The Girl That I Marry • Speak To Me Of Love • Sleepy Lagoon • Far Away Places I Dreamt I Dwelt In Marble Halls Marcheta • Home On The Range • Always **KS-3000**

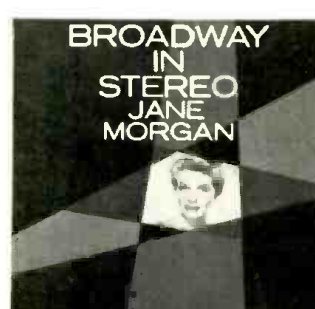

**JANE MORGAN, Broadway In Stereo** • I Could Have Danced All Night • I Love Paris • C'est Magnifique • How Are Things In Glocca Morra • Just In Time You'll Never Walk Alone • A Wonderful Guy • Oancing In The Dark • You're Just In Love • Hey There • A Bushel and A Peck • If I Were A Bell • Give My Regards To Broadway and others **KS-3001**

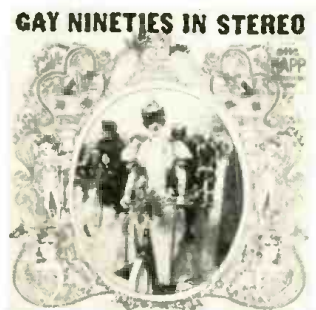

**GAY NINETIES IN STEREO** Overture The Acrobats Are On • The Song and Dance Team • The Barber Shop Quartet Here Come The Minstrels • Animal Tricks • The Bicycle Act • Finale (Over 50 songs) **KS-3008**

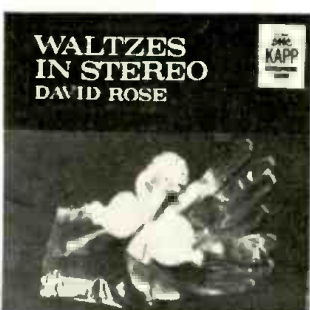

**WALTZES IN STEREO**, David Rose • Fascination • Die Fledermaus Waltz • Beautiful Ohio • Missouri Waltz • Intermezzo Remember • Cruising Down The River Tales From The Vienna Woods • Around The World • Diane • Deep In My Heart, Dear • Estudiantina • It's A Big Wide Wonderful World **KS-3010**

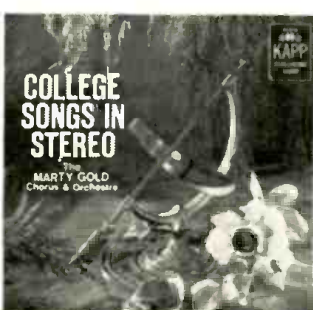

**COLLEGE SONGS IN STEREO**, The Marty Gold Chorus and Orchestra • Down The Old Ox Road • The Halls Of Ivy Clementine • Autumn Leaves • The Whiffenpoof Song • Round Her Neck—Vive La Compagnie • Moments To Remember • Scarlet Ribbons • Streets of Laredo • Sweetheart of Sigma Chi Girl of My Dreams and others **KS-3006**

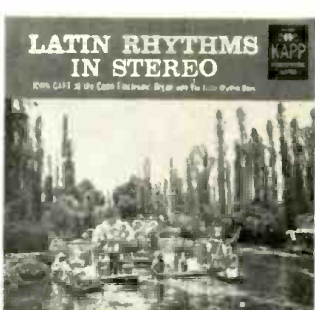

**LATIN RHYTHMS IN STEREO**, John Gart at the Conn Electronic Organ with the Latin Rhythm Boys • The Peanut Vendor Quiereme Mucho • A Gay Ranchero Cielito Lindo • Chiapanecas • Always In My Heart • The Breeze and I • South of the Border • Jungle Drums • Green Eyes • Mexican Hat Dance **KS-3007**



**BANJOS AND MINSTRELS IN STEREO** The Happy Harts "Singing Banjo" Band Heart of My Heart • My Wild Irish Rose Take Me Out To The Ball Game • Oh! You Beautiful Doll • When Johnny Comes Marching Home • Yellow Rose of Texas • Mrs. Murphy's Chowder Macnamara's Band • Sweet Genevieve Red Wing • Polly Wolly Doodle • My Old Kentucky Home • Oh! Susanna and others **KS-3012**

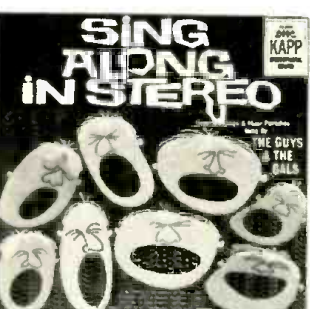

**SING ALONG IN STEREO**, Marty Gold's Guys and Gals • Sentimental Journey Show Me The Way To Go Home • Oh, You Can't Get To Heaven • Ain't She Sweet • Five Foot Two • Marie • Down By The Old Mill Stream • I'm My Own Grandpaw • Side By Side • I Want A Girl Bicycle Bullt For Two • Red River Valley • On Top Of Old Smokey and others **KS-3004**

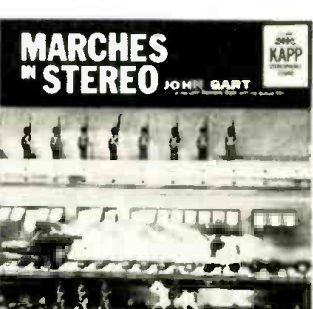

**MARCHES IN STEREO**, John Gart at the Conn Electronic Organ with the Minute Men • The Toreador Song • The Parade of the Wooden Soldiers • Colonel Bogey Pomp and Circumstance • The March of the Toys • American March Medley (Yankee Doodle, Caissons Go Rolling Along, Anchors Aweligh, The Marine's Hymn, U.S. Air Force Song and others) **KS-3011**

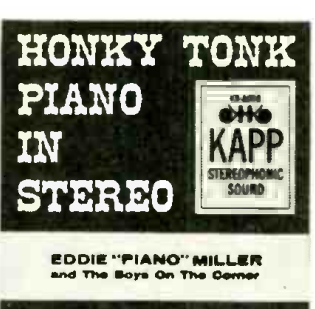

**HONKY TONK PIANO IN STEREO**, Eddie "Piano" Miller and The Boys On The Corner • Mademoiselle From Armentieres • My Buddy • School Days • Show Me The Way To Go Home • On The Road To Mandalay • Wedding Bells Are Breaking Up, etc. • Dardanella • Memories The Ace In The Hole • Strike Up The Band, Here Comes A Sailor • When The Red, Red Robin Comes Bob, Bob Bobbin' Along and others **KS-3002**

FREE: Send for latest catalog: Kapp Records, Inc., 136 East 57 Street, New York 22, New York

# KAPP RECORDS

# JAZZ IS A FOUR LETTER WORD

It's a much abused and a much beloved word too. And like the wife who's been a peach after ten years of marriage, jazz is too often taken for granted.

It wasn't always so. Sure there's a hard core of aficionados who can't hardly look at anything unless the liner notes tell you that "Pinetop spat blood." And there are collectors who forage through murky antique record shops looking for a genuine Buddy Bolden recording. But jazz wasn't meant to lie down in a dark corner and play dead, and it hasn't. Even though you may take your wife for granted, she still exercises her wiles via the well known feminine devices; the trapeze dress, pointed shoes, pale-pink lipstick, padded hips, cleavage (more or less), ad infinitum. Just as styles change, so has jazz. More appropriately, jazz has grown.

When Warner Bros. Records set out to produce a series of albums devoted to jazz, artists and repertoire director George Avakian set one simple ground rule: "let's not make it a potpourri—an alphabet soup series of jazz albums." You may think we've violated the boss' instructions by offering different types of jazz, but honestly we haven't. We've put together ten albums in different styles of jazz simply because we realize that some people may think Dixieland is out, while others will swear it's in. And the release is capped

by an album we've called "Jazz Festival—Near In and Far Out."

Listed below are the varied ways we have spelled that four-letter word called jazz.



Available in Vitaphonic Stereo and monaural long play. Write for free complete catalog to Dept. N, Warner Bros. Records.

GONGS EAST TROMBONES, INC.	Chico Hamilton The Trombones, Inc.	W/WS 1271
GIRL CRAZY FIRST JAZZ PIANO QUARTET	Ruby Braff The First Jazz Piano Quartet	W/WS 1272 W/WS 1273
BIX-MCMLIX CHARLESTON 1970	Dick Cathcart Robert Prince Tentette	W/WS 1274 W/WS 1275
FOLK SONGS FOR FAR OUT FOLK GILBERT AND SULLIVAN REVISITED	Fred Katz Orch. Jim Timmens All Stars	W/WS 1277 W/WS 1278
ROBERTA FOUR BUTTON DIXIE	Morris Nanton Trio Matty Matlock and the Paducah Patrol	W/WS 1279 W/WS 1280
JAZZ FESTIVAL— NEAR IN AND FAR OUT		W/WS 1281

**WARNER BROS.  
RECORDS**

BURBANK, CALIF.



Continued from page 68

**SHOSTAKOVICH: Symphony No. 5, in D, Op. 47**

Stadium Symphony Orchestra of New York, Leopold Stokowski, cond.

• • EVEREST SDBR 3010. SD. \$5.98.

Stokowski's old 78-rpm records of Shostakovich's First, Fifth, and Sixth Symphonies were primarily responsible for establishing the reputation of that composer in this country. They had a tension, a breadth, drama, richness, and drive that no other interpretation has ever quite equaled, and to hear Stokowski's performance of the Fifth again is like a home-coming. His way with the music hasn't changed in the slightest. The only thing that has changed is the art of recording, and that has been immeasurably improved. Ladies and gentlemen, the old master is back, and better than ever. A.F.

**SHOSTAKOVICH: Symphony No. 11**

Orchestre National de la Radiodiffusion Française, André Cluytens, cond.

• ANGEL 3586 3S/L. Two LP, one single-sided. \$8.98 (or \$6.96).

In his Eleventh Symphony, Shostakovich returns to the colossal proportions of his Seventh and Eighth. The work was composed in 1957 and commemorates, at least ostensibly, the abortive Russian revolution of 1905. Revolutionary folk tunes of that period are woven through its texture, and the titles of the four movements, referring to incidents of the 1905 revolution, provide it with a "program" that will impress the naïve and infuriate the sophisticated. As I suggested in reviewing Stokowski's recent Houston Symphony recording of this work, I suspect that its real program is not the revolution of 1905 but the spiritual autobiography of Dmitri Shostakovich, and if so, he is a bitter man indeed. At all events, there is little of the "parade ground" Shostakovich here and none of the "official" Shostakovich at all. The enormous scale of the work is altogether convincing, and the symphony as a whole is one of the most eloquent, moving, and genuinely tragic to be produced in modern times.

Cluytens' performance is very powerful, not as sensitive as Stokowski's in some respects, but still altogether authoritative. The recording is superb, and the Orchestre National de la Radiodiffusion Française is a much finer organization than the Houston Symphony. A.F.

**SOLER: Quintet for Organ and String Quartet, No. 6, in G minor ("Op. 1")**  
—See C.P.E. Bach: *Concerto for Organ and Orchestra, in E flat.*

**STRAUSS, JOHANN II: Waltzes**

*Emperor, Op. 437; Vienna Life, Op. 354; By the Beautiful Blue Danube, Op. 314; Tales from the Vienna Woods, Op. 325.*

Virtuoso Symphony of London, Emanuel Vardi, cond.

• • AUDIO FIDELITY FCS 50013. SD. \$6.95.

This is the brightest-sounding, best balanced of the three Audio Fidelity "First Component Series" discs I have heard.

Vardi has restudied these oft-played waltzes, and offers an approach completely stripped of hidebound interpretative traditions. There can be no denying the freshness of effect that results. He gives a most musicianly, abundantly exuberant account of the music, and fortunately takes the trouble to observe all repeats and, in *Tales from the Vienna Woods*, to include the original zither solos. Still, there will be those who prefer to hear these waltzes with more characteristic Viennese inflections, including a few more rhythmic liberties, such as the anticipated second beat and an occasional retard or hesitation. For those who want their Strauss straight, however, these are top-quality presentations in every respect.

P.A.

**STRAUSS, RICHARD: Also sprach Zarathustra, Op. 30**

Berlin Philharmonic Orchestra, Karl Böhm, cond.

• DECCA DL 9999. LP. \$4.98.  
• DECCA DL 79999. SD. \$5.98.

Deutsche Grammophon, who made this tape, record their stereo from the perspective of the balcony. They do it well in those terms, but produce a far less intense experience than the companies that work at closer range. The monophonic version consequently has a somewhat more concentrated quality than the stereo, and the best stereo version of the work continues to be Reiner's historic tape of some years ago.

Böhm's performance of the score is as uneven as Strauss's inspiration. He seems to want to eliminate the bombast and subdue the trite material, but in doing so he robs the piece of many of its most commonly appealing features. Both Reiner and Krauss struck a happier balance in interpreting this outpouring of Nietzschean visions. R.C.M.

**STRAUSS, RICHARD: Rosenkavalier: Suite; Die Frau ohne Schatten: Suite**

Philadelphia Orchestra, Eugene Ormandy, cond.

• COLUMBIA ML 5333. LP. \$4.98.

Strauss himself, in the last years of his life, made a symphonic fantasia on themes from *Die Frau ohne Schatten*. The so-called "suite" of this recording may well be that fantasia: the annotator, in his hasty and incorrect notes (the Emperor is not turned to stone at the close of the opera), fails to inform us. Certainly the symphonic score Ormandy conducts here, the fact that there is no break in the musical architecture, the seemingly non-chronological use of material from various parts of the opera would suggest that this is a fantasy or meditation rather than a conventional collection of favorite tunes. At any rate, if Strauss did not fashion this piece, whoever did has succeeded admirably in translating the music

Continued on page 74

HIGH FIDELITY MAGAZINE



# Music of 5 centuries and 7 European lands in 9 new albums from



Inspired Renaissance church music by Palestrina, Victoria and others. This renowned ensemble sings *a capella* with both tenderness and fervor. (S)P8460



Three Strausses and four other Viennese composers contribute some of their brightest gems to this lilting invitation to pleasure. *Prosit Wien!* (S)G7167

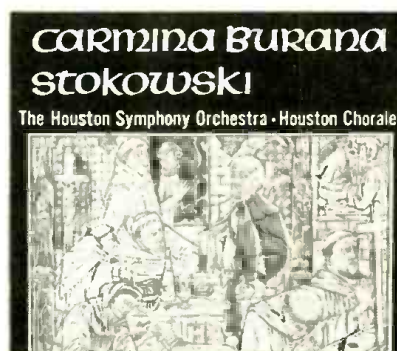

This "piece of musical electricity" (*N.Y. Post*) crackles when Leopold Stokowski conducts. German modernist Carl Orff's most spectacular work. (S)PAR8470

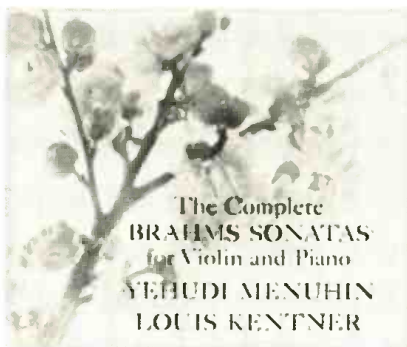

The three Brahms sonatas plus Schubert's brilliant *Fantasia in C Major, Op. 159*, are all here in this one memorable album. Two records. GBR7142

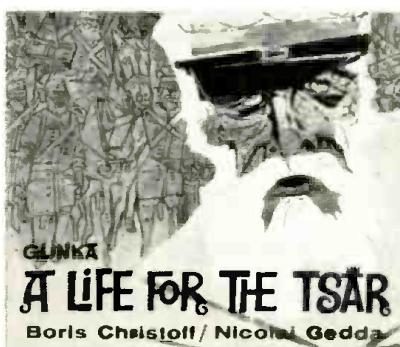

Christoff as the tragic hero; American-born soprano Teresa Stich-Randall as his daughter. Lamoureux Orchestra, Igor Markevitch. Three records. GCR7163

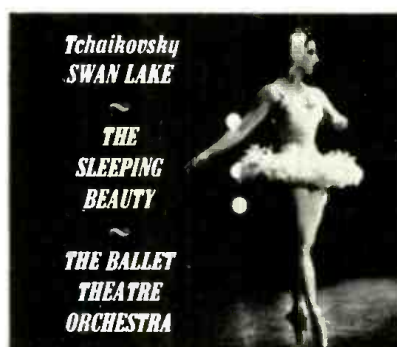

Superb sound recording; the leading American ballet company's orchestra; favorite selections from the world's best-loved ballet scores: a delight! (S)P8471

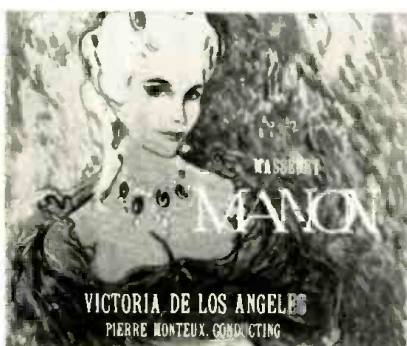

"Her voice is miraculously beautiful" (*The New Yorker*). With Henri Legay and Opéra-Comique soloists. Four records, French-English libretto. GDR7171



Foremost harpist of our day plays 16th and 18th Century Spanish music and contrasting contemporary works by de Falla, Albéniz, Turina and others. P8473



Italian operas of Puccini, Rossini, Boïto, Mascagni, Catalani and Verdi provide soprano highlights in this stunning recital. Rome Opera House Orchestra. G7172

*All in incomparable high fidelity; several also available in Capitol Stereo. Prefix (S) indicates stereo version.*

# 27

ways to protect your records and tapes ... improve hi-fi and stereo performance

## ROBINS audio accessories

### RECORD CARE ACCESSORIES

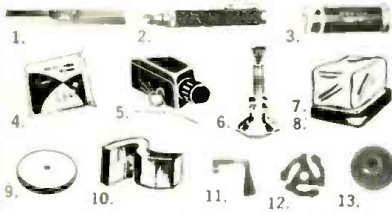

### TAPE CARE ACCESSORIES

Gibson Girl Tape Splicers



### RECORD CARE ACCESSORIES

- |  |         |
|--|---------|
| 1. Turntable Level TL-1                  | \$ 1.15 |
| 2. Professional Stylus Microscope MX-1   | 2.60    |
| 3. Hobbyist Stylus Microscope MX-40      | 1.35    |
| 4. Record Cleaning Cloth JC-1            | .80     |
| 5. Atomic Jewel SE-900                   | 4.00    |
| 6. KleeNeedle NB-1                       | 1.35    |
| 7. Changer Covers (2 sizes) CC-1, 2      | 1.75    |
| 8. Turntable Covers (2 sizes) CC-3, 4    | 2.25    |
| 9. Phono-Cushion, 10" x 12" PC-10, PC-12 | 1.00    |
| 10. Acoustic Insulation AM-9             | 2.25    |
| 11. Record Brush RB-75                   | .75     |
| 12. 45 rpm. Adapters - RA-45             | .25     |
| 13. 45 rpm. Spindle Adapter SA-45        | .25     |
| 14. Tone Arm Lift TA-1                   | .35     |

### TAPE CARE ACCESSORIES

- |                                  |           |
|----------------------------------|-----------|
| 1. Hobbyist H-4                  | \$ 1.75   |
| 2. Semi-Pro SP-4                 | 3.50      |
| 3. Junior TS4A-JR                | 6.50      |
| 4. Standard TS4A-STO             | 8.50      |
| 5. Deluxe TS4A-DLX               | 11.50     |
| 6. Industrial (5 sizes to 1")    | 55.00 net |
| 7. Splicing Tape ST-500          | .40       |
| 8. Recording Head Cleaner HC-2   | 1.00      |
| 9. Tape Cleaning Cloth JCI-2     | 1.00      |
| 10. Tape Storage Can (7" and 5") |           |
| TC-7                             | .75       |
| TC-5                             | .55       |
| 11. Tape Threader TT-1           | 1.00      |
| 12. Tape Head Demagnetizer HD-6  | 10.00     |
| 13. Tape Clips TC-12             | .35       |

WRITE FOR FREE CATALOG

At dealers everywhere

**ROBINS INDUSTRIES CORP.**  
FLUSHING 54, N. Y.

drama into purely orchestral terms: most of the important musical ideas of *Die Frau* are woven into this score, and, by a stroke of genius, Barak's ravishing third-act solo beginning "Mir anvertraut, das ich sie hege" is made to serve as the keystone to the whole structure. Those who already know and admire this opera will find the symphonic synthesis of it quite as much a treat as some of us who know and admire *Rosenkavalier* find the suite excised from it an annoyance.

The Philadelphia Orchestra is at its lushest here. And the sound is at Columbia's. D.J.

**STRAUSS, RICHARD:** *Salome: Salomes Tanz*—See Schmitt: *La Tragédie de Salomé*.

**STRAVINSKY:** *Ebony Concerto; Symphony in Three Movements*

Woody Herman and His Orchestra (in the Concerto); London Symphony Orchestra, Sir Eugene Goossens, cond. (in the Symphony).

• • EVEREST SDBR 3009. SD. \$5.98.

If someone were to issue Beethoven's *Wellingtons Sieg* on the same disc with his Seventh Symphony, we should have a fair parallel to what is offered here. In other words, the *Ebony Concerto* is a pot-boiler that happens to be exactly contemporary with a masterpiece from the same hand. The pot-boilers of a great composer are always interesting, however, even if, as here, the interest is essentially pathetic; it arises from the conflict between what Stravinsky could have done with a jazz band and the limitations imposed upon him by his (or, more likely, Woody Herman's) idea of what the Herman audience could take. The recording takes full advantage of stereo to do all manner of dimensional tricks with the music, but this jugglery does not help it much.

The *Symphony in Three Movements*, of course, one of the major works of modern times, but Goossens' performance of it altogether lacks the tension and grace of Stravinsky's own recorded version, and the sound is on the thick and heavy side. A.F.

**STRAVINSKY:** *The Rite of Spring*

Orchestre de la Suisse Romande, Ernest Ansermet, cond.

• • LONDON CS 6031. SD. \$4.98.

Stereo was made to order for the *Sacre*, and it is not surprising that there are four stereophonic versions of it in the catalogues. Even in the best monophonic recording, the enormous orchestral sonorities of this work are muffled and strain the speaker, and many of its subtleties are too elusive to be caught. It really flowers out in stereo, and one feels that one is really hearing it for the first time so far as recorded performances are concerned. But so far as interpretation is at issue, I can only repeat what I have often said before—that Ansermet, despite his devotion to Stravinsky, takes cautious tempos which tend to reduce the excitements of a score like the *Sacre*. A.F.

**SUPPE:** *Overtures: Leichte Kavallerie; Pique Dame; Ein Morgen, ein Mittag, ein Abend in Wien; Dichter und Bauer; Tantalusqualen; Die Irrfahrt ins Glück*

Philharmonic Promenade Orchestra, Henry Krips, cond.

• • ANGEL S 35427. SD. \$5.98.

If ever a single disc could radically transform the stereotyped image of a composer, this Krips program would dramatically redeem Franz von Suppé from the back status with which he is now generally credited. Even the four familiar overtures here reveal powers of invention of which there is scarcely a hint in the usual bandstand and pops-concert renderings; the seldom-heard *Tantalusqualen* displays a still fresher treatment of similar materials, and the almost-never-heard *Irrfahrt ins Glück* goes even further in disclosing an authentic mastery of near-Gluckian musical drama.

The stereo recording is so effective by current disc standards that only those who have heard the recent Angel taping of the first three overtures here (the others, including the two best ones, are as yet available on tape only in England) will realize that, satisfactory as it may be when heard by itself, it still encompasses less than its "master's" exceptionally full dynamic range and sonic spaciousness. R.D.D.

**SURINACH:** *Sinfonietta flamenca*

†Albéniz: *Iberia: Bk. III, No. 8, El Polo*  
†Falla: *El Amor brujo*

Orchestre Radio-Symphonique de Paris, Carlos Surinach, cond.

• • MONTILLA FM 142. LP. \$4.98.

Although composers often lack the skill in handling orchestras of those who give most of their time to conducting, when they play their own music they often reveal things which the hardened professionals fail to uncover. The case at hand is a good example of this, and in spite of the fine qualities of the Argenta edition, Surinach's own treatment of his *Sinfonietta flamenca* is of greater interest.

The Falla is played in what is described as a "symphonic version"—that is, without vocal parts. Surinach gives it a well-conceived and evocative statement, but versions such as Ansermet's which include a singer will retain a wider appeal. R.C.M.

**SZYMANOWSKI:** *Sonata for Violin and Piano, No. 1, in D minor, Op. 9*—See Grieg: *Sonata for Violin and Piano, No. 1, in F, Op. 8.*

**TCHAIKOVSKY:** *Francesca da Rimini, Op. 32; Hamlet, Overture-Fantasia, Op. 67*

Stadium Symphony Orchestra of New York, Leopold Stokowski, cond.

• • EVEREST SDBR 3011. SD. \$5.98.

Stokowski's *Francesca da Rimini* is expressive and dynamic; furthermore, it is incisive, a rare quality in too many performances of this work. Particularly effective is his beautiful phrasing of the

Continued on page 76

**BETTER SOUND**

**BRILLIANTLY BETTER!**

**WHEN**

**MGM**

**STEREO RECORDS  
ARE PLAYED  
ON THESE MATCHED  
STEREO  
HIGH-FIDELITY  
COMPONENTS!**

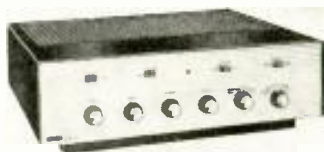

**HARMON-KARDON  
STEREO AMPLIFIER**

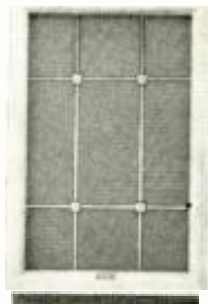

**ELECTRO-VOICE  
HIGH-FIDELITY SPEAKER**



**REK-O-KUT  
STEREO TURNTABLE  
AND TONE ARM**

The gay and sparkling, colorful and inimitable melodies of David Rose are obviously best-played by David Rose. The melodic, romantic music of America's favorite purveyor of mood magic as played by the maestro and his orchestra may be heard in M-G-M Records new album "David Rose plays David Rose". But evocative as the talent of the composer-conductor might be, sensitive as his strings undoubtedly are, there remains a third dimension to be considered for complete listening pleasure. Proud to present David Rose and his Orchestra in new albums for hi-fi aficionados, M-G-M Records respectfully suggests that the excitement is enhanced on the proper reproducing equipment. Until you have heard David Rose in rounded stereo sound, you just haven't heard David Rose. So we suggest the Rek-O-Kut Stereo Turntable and Arm, with Electro-Voice Speakers and Harmon-Kardon Stereo Amplifier. Sound engineers (those perfectionists!) who have surveyed the new-sound systems believe there is nothing better than the best. And that means component High Fidelity... for the best performance from any M-G-M Stereo Record. And particularly when you play David Rose... you'll see and hear that "a Rose is a Rose is a Rose!"

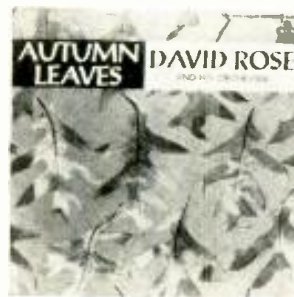
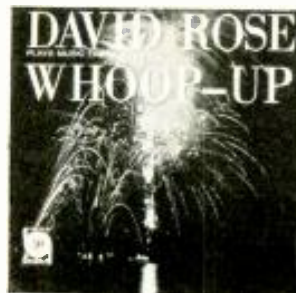



# HAS SOLD MORE STEREO RECORDS THAN ANY COMPANY IN THE WORLD— THERE ARE REASONS BEYOND THE PRICE!

The stereo scored magnificence of "101 Strings" brings you a speaker to speaker interplay of counter lines and thrilling orchestral colors unequalled in their dynamic placements and tonal purities. In all the world of sound—nothing quite equals the emotional depth of "101 Strings". For example, we suggest you hear these new "101 Strings" releases at your dealers. They will become a thrilling part of your stereo collection.



SF-8500  
"101 Strings"—Russian Fireworks



SF-6600  
"101 Strings"—The Soul of Spain

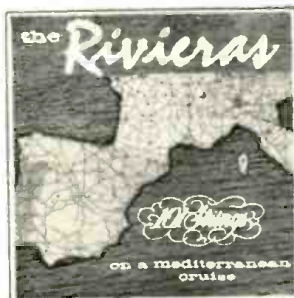

SF-9000  
"101 Strings" on the Riviervas



SF-8700  
"101 Strings"—Opera Without Words



SF-8100  
"101 Strings" at Gypsy Campfires



SF-6900  
"101 Strings" play Rudolph Frim!

# 2<sup>98</sup>

Each stereo 12" long play at  
available at better record dealers everywhere—no clubs or coupons

Buy where you can hear what you buy... at your local music counter

Write for complete catalog to  
Dept. 101 F, Box 45, Swarthmore, Pa.



Stereo Fidelity manufactured by Miller International Co., Swarthmore, Pa., U. S. A.

wind-wind solos and ensembles in the lyrical middle section. *Hamlet* is a less even composition, but Stokowski makes the most of the drama and orchestral coloring in a brilliant performance, with the New York Philharmonic under its summer pseudonym playing in top form. The wonderful interplay between the various string sections at the opening is given sweeping treatment by the conductor and realistic stereo handling by the engineers. The recording has excellent perceptive depth, enabling the listener to pinpoint each of the brass and percussion instruments as they enter from the rear of the orchestra. In short, both performance and sound are impressive. P.A.

**TCHAIKOVSKY: *Nutcracker, Op. 71***  
(excerpts)

Philharmonia Orchestra, Efreim Kurtz, cond.  
• EMI-CAPITOL G 7149. LP. \$4.98.

For those who want a one-disc survey of the dances in Tchaikovsky's ballet *The Nutcracker*, this well-recorded album answers the need very nicely. It includes the Overture, four excerpts from Act I and, as far as I can ascertain, all of the dances in the Act II *divertissement*. Kurtz, a veteran conductor of ballet, makes a fine compromise between dance and concert styles in presenting this music with good effect. P.A.

**TCHAIKOVSKY: *Serenade for String Orchestra, in C, Op. 48***—See Mozart: *Serenade for Strings, No. 13, in G* ("Eine kleine Nachtmusik").

**TCHAIKOVSKY: *Symphony No. 6, in B minor, Op. 74*** ("Pathétique")

Virtuoso Symphony of London, Alfred Wallenstein, cond.  
• AUDIO FIDELITY FCS 50002. SD. \$6.95.

With considerable fanfare Audio Fidelity, which until now has concentrated on finely engineered recordings of popular and novelty music, has released its first classical disc. There is more than an expansion of repertoire here. Aiming for the highest quality stereo reproduction, the company has tried to retain tape fidelity in its new discs. This means greater dynamic range and quieter surfaces. The latter were not hard to come by, but the former were—and, for many, still are. For unlimited dynamic range can mean serious tracking problems for many arms and cartridges. Therefore, these new records bear the label "First Component Series," and the jackets include the warning that they can be played only with certain tested components, which are listed. Since these include many of the better stereo arms and cartridges currently in use, owners of top-grade equipment have little to worry about.

At the press demonstration for the new series, part of the third movement of the *Pathétique* was played with recommended components, then the same passage was repeated on an inexpensive stereo portable phonograph. Everything went smoothly on the first playing, but on the

second, the stylus hopped around like a Mexican jumping bean.

Since I am one of those doubting Thomases who doesn't believe everything he sees and hears at prepared demonstrations, I took the records home and tried them with arms and cartridges that were both recommended and not recommended. Except for two minor spots in the aforementioned *Pathétique* movement, everything tracked perfectly. There is no question about this being a superior product, carefully engineered, though the present disc is not the best one I have heard. The bass here seems a trifle overweighted, while the strings could be brighter, with a bit more presence.

Last, but not least, we come to one of the most felicitous features of this disc—the performance. Wallenstein gives a most commendable reading of the symphony, firm and forward-moving, yet amply intense and virile in its over-all conception. P.A.

**VIVALDI: Six Concertos for Flute, Strings, and Continuo, Op. 10**

Gastone Tassinari, flute; I Musici.  
• Eric LC 3541. LP. \$3.98.

These are pleasing performances, on the whole, of the finest of Vivaldi's flute concertos. Difficult passages no longer seem troubling to Tassinari, as they occasionally did in his recording of these works for Vox's de luxe album of the complete eighteen flute concertos of Vivaldi. And the sound on this disc is somewhat better than in the Vox. On the other hand the harpsichord here can be heard only by straining one's ears, and sometimes not even then; the first movement of No. 6 seems too slow (it is livelier in the Vox); and there are moments in the fast movements of No. 1 when flute and orchestra are not precisely together. N.B.

**WAGENSEIL: Concerto for Cello, Strings, and Continuo, in A—See Haydn: Concerto for Cello and Orchestra, in D ("Op. 121").**

**RECITALS AND MISCELLANY**

**BOYS CHOIR OF VIENNA: "Voices from the Vienna Woods"**

Boys Choir of Vienna, Carl Etti, cond.  
• • OMEGA OSL 28. SD. \$5.95.

The Boys Choir of Vienna may or may not be from the same organization that produces the internationally touring groups known as the Vienna Choir Boys, but they sing with the same piping charm, childish gusto, and sentimental style. Relatively simple arrangements of works by Mozart, Haydn, Beethoven, Schubert, and Johann Strauss II and of some folk tunes form the appropriately German-Austrian repertoire here. Only a tricky arrangement of Schubert's *Die Forelle* is clumsily performed. Orchestra, organ, or



"Aristocrats of High Fidelity"  
**ANGEL**



"Her exquisite voice and personality give a special radiance to any song she touches." (High Fidelity)

**SCHWARZKOPF**



**OPERA**

*Newest Schwarzkopf album:*  
**Mozart: Marriage of Figaro (Highlights)**  
(with London, Jurinač, Seefried, Kunz, Vienna Philharmonic, Karajan, Cond.) 35326

**R. Strauss: Capriccio (First complete recording)**  
"A superb Countess" (*N.Y. Times*)  
(With Gedda, Ludwig, Fischer-Dieskau, Hotter, Philharmonia, Sawallisch, Cond.) 3580 C/L

**R. Strauss: Der Rosenkavalier**  
"Never encountered a performance closer to absolute perfection" (*New Yorker*)  
(With Ludwig, Stieh-Randall, Edelmann, Philharmonia, Karajan, Cond.) 3563 D/L

**OPERA**

"What can one do when Mme. Schwarzkopf sings (Viennese operetta) except get up and dance?" (*High Fidelity*)

**Lehar: The Merry Widow** 3501 B/L  
**J. Strauss: Die Fledermaus** 3539 B/L

**COLLECTIONS**

"For Lotte Lehmann fans, Schwarzkopf is the successor." (*Harper's*)

**Song Recital**  
Bach, Gluck, Mozart, Schubert, Wolf, Brahms, etc. (with Gerald Moore, Piano) 35023

**Songs You Love**  
Dvořák, Sibelius, Tchaikovsky, Grieg, Mendelssohn, etc. (with Gerald Moore, Piano) 35383



ANGEL RECORDS NEW YORK CITY

piano variously accompanies the boys when they do not sing alone. Except for a few places where the orchestra overpowers the voices, the sound is clear and well balanced if not noteworthy stereophonic. R.E.

**JOHN BROWNING: "Debut"**

Chopin: Etude in G Flat, Op. 10, No. 5; Nocturne in D Flat, Op. 27, No. 2; Grande Valse Brillante in E Flat, Op. 18. Liszt: Mephisto Waltz. Bach-Busoni: Nun komm, der Heiden Heiland; In dir ist Freude. Schubert: Impromptu in B Flat, Op. 142, No. 3. Debussy: Reflets dans l'eau. Rimsky-Korsakov-Rachmaninoff: Flight of the Bumblebee.

John Browning, piano.  
 • CAPITOL P 8464. LP. \$4.98.

This is an exceptional record from an exceptionally gifted young American pianist. John Browning's merits already have been clearly recognized, for he has won two major awards in this country—the Steinway Centennial in 1955 and the Leventritt in 1956—and he was runner-up to Ashkenazy in the Queen Elisabeth International Contest in Brussels in 1956. Service in the armed forces interrupted the momentum these honors gave to his career, but his New York recital debut this season was a major event.

The twenty-five-year-old pianist's playing on this recording is practically flawless in its glistening tone, technical perfection, musical discipline, and stylistic intuition (including the romanticized

Bach à la Busoni). Indeed, the performances are so polished it is sometimes hard to see the substance beneath the shining surface. For example, the Schubert impromptu, full of air and grace, almost seems glib (though glibness is better here than sententiousness). The Mephisto Waltz is swift, mercurial, dazzling, without quite the demonic quality it can have. In their negative aspects these two performances point up Mr. Browning's bent towards the poetic and lyrical. The Chopin nocturne is ravishing in its dreamlike flow of tone and subtly shifting nuance; the Debussy could not be more iridescently lovely. At his best, Mr. Browning is a remarkably sensitive artist. Even now he deserves to be heard further; with increasing maturity, depth, and power he should become indispensable. R.E.

**GUSTAV CERNY: "Strauss in Stereo"**

Johann Strauss II: Elfen a Magyars; Schnellpolka, Op. 332; Die Fledermaus; Overture; Frisch ins Feld; March, Op. 398; Ein Nacht in Venedig; Overture; Artist's Life, Op. 316. Richard Strauss: Der Rosenkavalier; Waltzes.

Graz Philharmonic Orchestra, Gustav Cerny, cond.

• • JANUS FST 2003. SD. \$4.98.

Janus, a new label, is offering disc editions of Livingston stereo tapes. To judge by the present release, the disc rivals the tapes in quality, which is saying a great deal. The sound is full, deep, and rich;

instrumental presence is very good; stereo distribution is excellent; and surfaces are silent. As a matter of fact, in the heavier passages the disc is more clearly defined than its tape counterpart.

Unfortunately, the same high praise cannot be given to the performances. Cerny's approach to this lighthearted music is heavy-handed and is marked by few Viennese stylistic subtleties. The orchestral playing, too, is not all it might be, with a number of unpolished wood-wind solos. Whoever wrote the jacket notes doesn't know his Strauss: though he states that there are six waltzes on this record, there are only two, together with a polka, a march, and a couple of overtures. P.A.

**CHARLES K. L. DAVIS: Operatic Arias**

Flotow: Martha; M'appari. Puccini: La Bohème; Che gelida manina; Turandot; Nessun dorma; La fanciulla del West; Ch'ella mi creda; Manon Lescaut: Donna non vidi mai; Tosca: Recondita armonia. Verdi: Rigoletto: La Donna è mobile; La Traviata: De' miei bollenti spiriti. Donizetti: L'Elisir d'amore: Una furtiva lagrime. Meyerbeer: L'Africana: O paradiso. Massenet: Manon: Le rêve. Mozart: Don Giovanni: Il mio tesoro.

Charles K. L. Davis, tenor; Stadium Symphony Orchestra of New York, Wilfred Pelletier, cond.

• • EVEREST SDRB 3012. SD. \$5.98.

Mr. Davis won the 1958 Metropolitan Opera Auditions of the Air. Everest has

# INTEGRITY IN MUSIC...

**ASR-444 dual-channel stereo amplifier**

POWER OUTPUT: SC Rating<sup>®</sup>—60 watts (Two 30-watt channels).  
 FREQUENCY RESPONSE: 20-20,000 cycles ± 9 db.  
 HARMONIC DISTORTION: Less than .7% at 30 watts each channel.  
 IM DISTORTION: Less than 1% program level (60 and 7,000 cps at 4:1 ratio).  
 NOISE LEVEL: 70 db down (Aux.).

him under contract and, it may be felt, has rather precipitously hurried him into an ambitious recorded recital. The quality of Mr. Davis' voice is a familiar one. He has evidently listened long and devoutly to phonograph records of tenors like Gigli and Schipa and McCormack, tenors of marked individuality who are not, except in the most general sense, ideal models to try to reproduce. The voice is light *spinto* in quality, pleasant to listen to save when it is being forced to make sounds bigger than it ought and despite a decidedly nasal production (grotesquely so at the opening of the French piece). It has good flexibility: the "*Il mio tesoro*" indicates that Mr. Davis may develop into a valuable Mozart tenor if he takes Puccini in smaller doses. He runs the notorious hurdles of this aria well, though he approaches the long-held "*cercar*" apprehensively the first time, reducing his voice to a virtual falsetto in order to conserve breath. "*De' miei bollenti spiriti*" is done at a break-neck clip: both Mr. Davis and Maestro Pelletier would do well to remember that Alfredo is in love as well as in a ferment. The *Manon* has some lovely half-voice moments, but again I was uncomfortably conscious of the singer's eclecticism.

In short, Mr. Davis would do well to grow more familiar with himself as artist before venturing again into this most cruelly irrevocable of media. D.J.

**RICHARD DYER-BENNET: "Requests"**  
*Greensleeves; The Golden Vanity; The*

*White Lily; Lord Rendal; Westryn Wynde; Barbara Allen; Venezuela; The Quaker Lover; John Henry; Spanish Is the Loving Tongue; I Ride an Old Paint; Edward.*

Richard Dyer-Bennet, tenor and guitarist.  
• DYER-BENNET DYB 5000, LP. \$4.98.

**RICHARD DYER-BENNET: "With Young People in Mind"**

*Come All Ye; Old Bangum; Aunt Rhody; Frog Went a-Courting; John Peel; The Leprechaun; The Piper of Dundee; Bow Down; The Tailor and the Mouse; I Went Out One Morning in May; Green Corn; Buckeye Jim; Little Pigs; Three Crows; The Hole in the Bottom of the Sea.*

Richard Dyer-Bennet, tenor and guitarist.  
• DYER-BENNET DYB 6000, LP. \$4.98.

It will be no new thing to remark that by no means all fanciers of the sorts of music Richard Dyer-Bennet sings hold with his custom of taking what he refers to as "the minstrel's liberty" in facturing his own versions of traditional and semitraditional material. It is quite possible to doubt the felicity of particular emendations he makes (and, for one, I often do). But it is rather silly to damn them, and him, on puristic grounds—and, which is the main point, it is almost impossible to keep from being beguiled whilst hearing his extremely individual, truly re-creative singing. No ballad-chanting child of nature, surely, he is just as surely a very con-

scious and self-exacting artist in his métier, and, furthermore, one whose abilities are even yet still maturing in emotional persuasiveness.

These two discs hold some of the most satisfying, completely accomplished performances I have heard Mr. Dyer-Bennet give. Their characteristics are typical and familiar: the high, clear voice, so pure and lacking in vibrato that it might almost be termed neuter were it not for the strongly masculine projective thrust; the far forward open vowels and precise enunciation that might seem merely affected were this not so integral a part of his whole honest, personal manner; and so on. There are, to be sure, folksier singers, for those who prefer them, but none so sure of what they want to accomplish and how to go about accomplishing it.

Both of these releases are most attractive in detail—the by-request disc, to me, less so in sum, since it contains songs I myself care for less than others (e.g., *Venezuela*); others that are, exceptionally, not so well sung as they ideally might be (e.g., that haunting *Westryn Wynde*); and some that seem basically less than ideal for a voice of this timbre (e.g., *John Henry*). Still, listener requests doubtless have to be gratified. The so-called young-people disc, though, is a sheer (though not, by all standards, unarguably "pure") delight from beginning to end—the last a grand accumulative song, new to me, that is worth the whole price as a specific to put one in a senselessly good humor.

## NEW "STEREO 60" AMPLIFIER BY STROMBERG-CARLSON

On stage and screen the name Yul Brynner means integrity in performance. In high fidelity Stromberg-Carlson means integrity in music reproduction. For example, here is a new dual-channel stereo amplifier with performance and control features that add up to the best value in the field.

Each channel gives you 30 watts of clean, balanced power. Exclusive Stromberg-Carlson "Stereo Tone Balance" lets you balance the two channels by a signal tone. You set up to

what you actually hear.

Each channel has its own complete set of controls: loudness/volume, bass and treble—plus a master gain control.

For complete details and specifications see your dealer or write to us for literature.

\*Our deliberately conservative ratings will exceed published specifications, based on ASRE measurement procedures.

Find your dealer in the Yellow Pages, under "High Fidelity"

INPUTS: Magnetic Phono, Ceramic Phono, Tape Head, Tuner and Aux. Tape.  
AMPLIFIER OUTPUTS: 4, 8, 16 ohms.  
PRE-AMPLIFIER OUTPUTS: Dual Tape Out; Output for external second-channel amplifier.  
LOUDNESS CONTROL: In-out, continuously variable.  
TONE CONTROLS: Bass 15 db droop, 15 db boost; Treble 14 db droop, 12 db boost.

EQUALIZATION: RIAA Mag. Phono, NARTB Tape Head.  
TUBES: 2-12AX7/7025, 2-6AV6, 2-6U8, 4-7027.  
CHANNEL SELECTOR: Channel "A," Channel "B," Stereo, Monaural, Crossover (at 3000 cycles).  
CHANNEL REVERSE  
TWO AC CONVENIENCE OUTLETS  
DIMENSIONS: 13½" W, 13⅝" D, 4⅝" H.  
PRICE: \$169.95 (Audiophile Net, Zone 1).

**STROMBERG-CARLSON**  
A DIVISION OF GENERAL DYNAMICS CORPORATION  
1419C N. GOODMAN STREET • ROCHESTER 3, N. Y.



Your best single source of matched components for complete systems—Stromberg-Carlson



PR-499 "Perfectempo" manual turntable



RA-498 Tone Arm



SR-440 AM-FM Tuner

# HANDEL IN WARWICKSHIRE



In the village church of Great Packington, Warwickshire, England, E. Power Biggs recently found an organ designed and often played by Handel—the ideal one for recording the composer's 16 splendid Organ Concertos. Volume 1 of this 3-part bicentenary edition is already making high-fidelity history. Here now is the second in the series.

**HANDEL: Organ Concertos Nos. 7-12—E. Power Biggs, organist, with Sir Adrian Boult conducting the London Philharmonic Orchestra.**  
M2L 261 K2S 604 (stereo)

GUARANTEED HIGH-FIDELITY AND STEREO-FIDELITY RECORDS BY



© "Columbia" "Masterworks" © Marmex Rev. A division of Columbia Broadcasting System, Inc.

Every High Priced Feature  
*except* high price!

"Get more in Stereo—  
Pay less for Stereo"



Also available monaurally

FREE Hi-Fi cleaning cloth with each record

WRITE FOR COMPLETE CATALOGUE

DESIGN \$5.98 VALUE  
LISTS AT ONLY. **\$2.98**

**STEREO SPECTRUM**

If not available at your dealers write: PICKWICK SALES CORP., DEPT. HF2 BROOKLYN 32, N. Y.

The engineering is excellent. There are no printed texts, regrettably for those who might want to learn to sing the songs themselves, but good notes by the singer—brief, informative notes, save for a wonderfully punctuated, rambling discourse that tells not much about *The Leprechaun* but rather a lot about the strange effects of dew on the mountains. Highly desirable. J.H., Jr.

## DANIEL ERICOURT: *Waltzes*

Ravel: *Valses nobles et sentimentales*. Debussy: *Danse de la poupée; La Plus que lente*. Schubert-Liszt: *Soirées de Vienne*, No. 6. Chopin: *Waltz in A Flat*, Op. 42. Liszt: *Mephisto Waltz*.

Daniel Ericourt, piano.

- KAPP KCL 9021. LP. \$3.98.
- • KAPP KC 9021S. SD. \$4.98.

Now an American citizen currently teaching at Peabody Conservatory in Baltimore, the French-born and-trained Daniel Ericourt is best known in this country for his devotion to the music of Debussy and Ravel. On this disc his playing resembles that of many other Latin pianists—slightly penetrating (but not unpleasant) in tone, having much sharp accentuation and considerable individuality in treatment of rhythm and phrasing. Within this style the pianism is admirable; in particular, the Ravel and Debussy pieces are given a combination of Chopinesque rubato and etchinglike tonal clarity that makes them uncommonly absorbing if a little mannered. There is virtually no difference in sound between the monophonic and stereophonic versions played on stereophonic equipment, and the monophonic version on a monophonic machine is perfectly satisfactory. R.E.

## MAUREEN FORRESTER: *Recital*

Schumann: *Frauenliebe und Leben*, Op. 40. Brahms: *Gestillte Sehnsucht* and *Geistliches Wiegenlied*, Op. 90; *Zigeunerlieder*, Op. 103.

Maureen Forrester, contralto; John Newmark, piano; Otto Joachim, viola.

- RCA Victor LM 2275. LP. \$4.98.
- • RCA Victor LSC 2275. SD. \$5.98.

Maureen Forrester, the Canadian contralto who sang so beautifully in the *Urlicht* section of the Bruno Walter recording of Mahler's Second Symphony, makes an auspicious bow with this first solo recital. Her voice is true contralto throughout its tessitura; there is no mistaking it for a mezzo in the middle register or a dramatic soprano on top. Indeed, it is misleading to talk of "registers" with a voice like this, so perfectly homogeneous it sounds from top to bottom. As an interpreter of the art song she is not yet of the stature of a Marian Anderson or Kathleen Ferrier, but she proves to be the most likely candidate to succeed those distinguished artists. She is a far more flamboyant singer than Ferrier and shows little of the British contralto's habitual understatement and reserve; the fire that burned within for Ferrier is external with Forrester (so far) but a good, hot glow

it is, nonetheless. I have never heard the Gypsy Songs done by so big a voice with quite such fine abandon—not even barring the famous 78s of Elena Gerhardt—and the two lovely songs of Brahms's Opus 91 find just the right timbre in her voice to complement their obbligato viola.

The Schumann cycle leaves me less enthusiastic, however. It is really intended for a soprano; Miss Forrester at times overwhelms its delicate structure. Her most serious shortcoming, noisy and often poorly planned breathing, is especially evident in this song cycle. But even here are ample evidences of a superior musical intelligence and a voice of real loveliness.

The stereo and monophonic versions are both well engineered. They seem fairly indistinguishable to me, except for a bit of *précho* in the more expensive edition. Texts for all the songs, but translations only for Schumann's. D.J.

## VLADIMIR GOLDSCHMANN: *Ballet Music*

Delibes: *Sylvia*; Suite; *Coppélia*; Suite. Easdale: *The Red Shoes Ballet*. Weber: *Invitation to the Dance*, Op. 65.

St. Louis Symphony Orchestra, Vladimir Goldschmann, cond.

- • COLUMBIA MS 6028. SD. \$5.98.

Some very pleasurable listening here. The Brian Easdale *Red Shoes Ballet* not only stands up well when divorced from the film sequence it was designed to accompany but makes its own claim to consideration as a solidly built and continuously interesting score. The Weber piano piece is done, as usual, in the Berlioz edition, and brilliantly done too, but I rather wish that Goldschmann had chosen the pyrotechnic Stokowski orchestration, which needs a good new recorded version and would respond to stereo as the proverbial duck to water. The two Delibes offerings do not contain quite all the music generally associated with the suites from *Coppélia* and *Sylvia*, but in view of the fact that both are got onto one side of the disc, Columbia can hardly be charged with parsimony.

The sound indicates a vast improvement over the first Columbia stereo releases. Here orchestral timbres are isolated occasionally for special effects (e.g., the solo cello in the coda of the Weber), but the general impression is of an arc of richly radiating sound. D.J.

## ALEXANDER IVANOV-KRAMSKOY: *Recital*

Alexander Ivanov-Kramskoy, guitar; string quartet; Orchestra of Folk Instruments, Nikolai Annsov, cond.

- MONITOR MC 2024. LP. \$4.98.

Not all the strummers in Russia play the balalaika. Alexander Mikhailovich Ivanov-Kramskoy, who started to do so when he was seven, apparently tired of that instrument when he was nineteen and turned to the classical guitar. Now forty-six, he has had, according to the



liner notes, a long and renowned career in Russia as teacher, performer, and composer of guitar music.

On this record he demonstrates an admirable technical command of his instrument and a rather earthbound style that is far from the aristocracy and sensuousness of Segovia's artistry. (One has only to compare their recordings of the Malats *Spanish Serenade* to see this.)

Yet, this disc has a couple of ingratiating features. The first is Mr. Ivanov-Kramskoy's *Variations on Russian Themes*, an innocently delightful piece based on pretty folk tunes and played by the soloist against a background of balalaikas, accordions, tambourines, and other simple popular instruments. The other is the Concerto for Guitar and String Quartet by Mauro Giuliani, a guitar virtuoso born in Bologna in 1780, who spent several years in Russia. This is more interesting as a curiosity than as a piece of music. The guitar and quartet of stringed instruments blend well; the long work is well knit formally, but its charm is about that of Hummel's music and no more worthy of perpetuation. Adequate sound. R.E.

**SYLVIA MARLOWE: *Music for Harpsichord***

Sylvia Marlowe, harpsichord.

- DECCA DL 10001. LP. \$3.98.
- • DECCA DL 710001. SD. \$5.98.

The twelve pieces presented here include such very familiar ones as Rameau's *Tambourin*, Daquin's *Le Coucou*, Handel's *Harmonious Blacksmith Variations*, and the little Mozart Sonata in C, K. 545, as well as some that are less well known, by Haydn (the Sonata No. 37, in D), Couperin, Rameau, Purcell, and Byrd. Adding a good deal of spice to the collection are two works by living American composers, *Lagu Délem* by Colin McPhee and *Three Bagatelles* by Alexei Haieff. The McPhee is a charmingly insouciant transcription of a Balinese tune. The first and third of Haieff's clever little pieces exude a faint scent of high-class honky-tonk, while the second is a piquant two-part invention. Miss Marlowe plays all the pieces with her customary skill and insight. The stereo version is a little more resonant than the other, but I am not sure this is an important advantage in harpsichord music. N.B.

**JOHN McCORMACK: *Recital***

Songs by Marshall, Liddle, Capel, Squire, Stephen Adams, Clay, Ronald, Roeckel, Claribel, Crouch, Hatten, Robinson, Moore, and Metcalf. Ballet: *The Bohemian Girl: When Other Lips*.

John McCormack, tenor.

- SCALA 843. LP. \$5.95.

On this disc Scala issues sixteen selections, all made for the Odéon company during 1907 and 1908, when McCormack received \$750 for twelve double-sided records a year; he was not yet twenty-five at the time. Some of these songs—*Absent*, *O Lovely Night!*, *Roses*, *Love's Golden Treasury*, and the aria

***NOW...choose from Capitol's full range of music in 120 STEREO ALBUMS!***

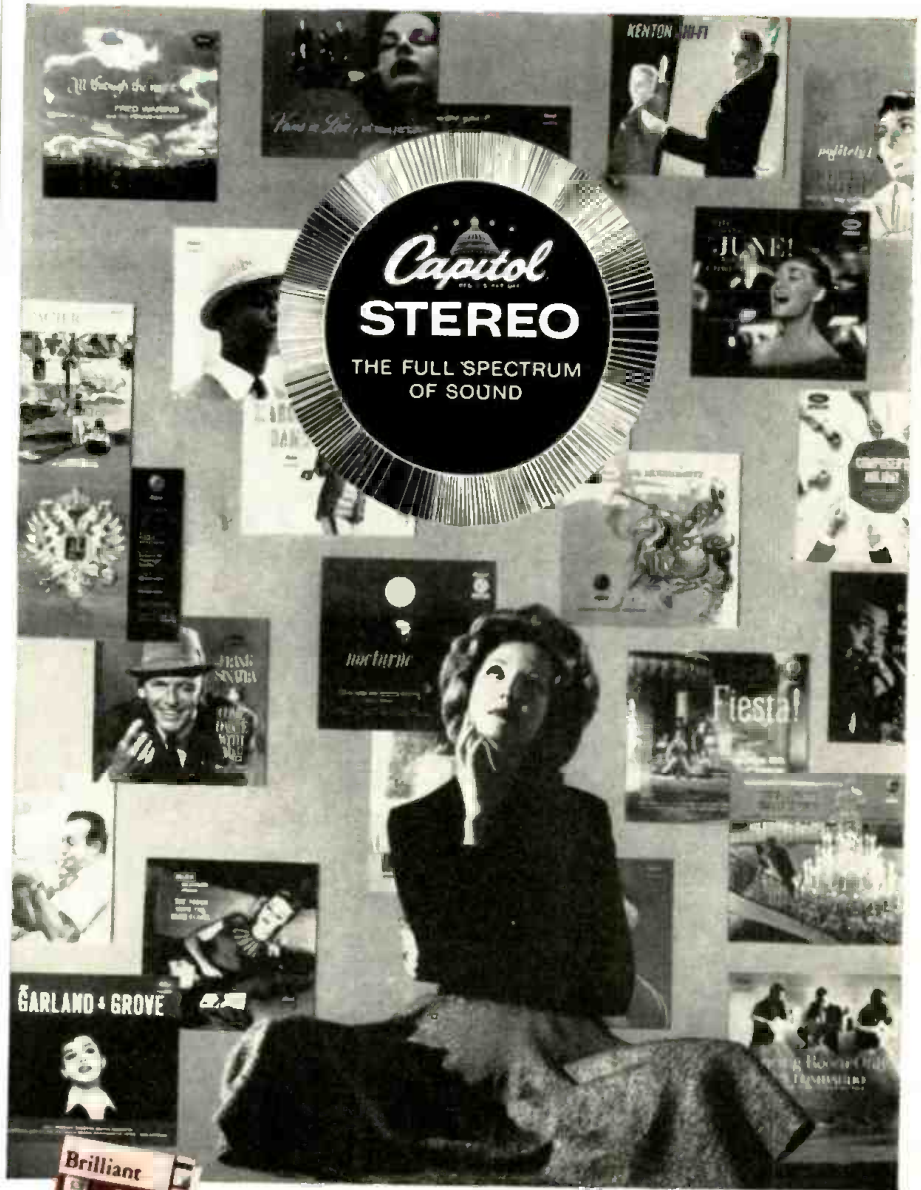

**FREE:** *These popular and classical catalogues that list the entire Capitol Stereo library*

You'll find the superb performances of some of the world's greatest popular and classical artists listed in these booklets. Capitol's sound engineers, pioneers in the development of stereophonic sound, have reproduced these performances with flawless precision.

Hear Capitol Stereo—the Full Spectrum of Sound—the next time you visit your music dealer. Then ask for either, or both, of these catalogues for a better idea of the universal scope of Capitol Stereo. Or write for them now to:

Dept. F, Capitol Tower, Hollywood, California



from *The Bohemian Girl*—were never duplicated in later recordings. The repertoire stems from the Irish-type song and the Victorian drawing-room ballad, as exemplified by Moore, Marshall, Lid-dle, Squire, and others. Among these we find the first of the four recordings Mc-Cormack made of *I Hear You Calling Me*; the composer is at the piano.

The records emphasize the foundations for an important career—a haunting quality of voice and the caressing legato acquired from study with Sabatini in Italy. At this time there was perhaps even more velvet on the tone than there was later, but consequently less projection. Here, McCormack's very personal style had not yet jelled. Later, his diction became more stenciled and his intentions more vivid. But the warm, lovely tone and the sincerity with which it was employed, even at so early a date, should

hold more than passing appeal for all lovers of beautiful singing.

MAX DE SCHAUENSEE

**DIMITRI MITROPOULOS:** "*Marche Slav*"

New York Philharmonic, Dimitri Mitropoulos, cond.

- COLUMBIA ML 5335. LP. \$4.98.
- • COLUMBIA MS 6044. SD. \$5.98.

Mitropoulos offers here virile readings of Tchaikovsky's *Marche slav* and Mussorg-sky's *A Night on Bald Mountain*; his *Capriccio italien* is decidedly uneven. The monophonic disc also includes the *Four Greek Dances* by the late Nikos Skalkoitis, which Mitropoulos introduced to his concert audiences with signal success a few seasons ago. It would have been better to have had these colorful

and attractive dances on the stereo, too, instead of the umpteenth version of one of the other works.

Stereo adds immeasurably to the spaciousness and quality of sound, but there is not enough presence in the percussion instruments, the cymbals and tambourine sounding as if they came from the next room. P.A.

**ANN SCHEIN:** *Etudes*

Ann Schein, piano.

- KAPP KCL 9023. LP. \$4.98.

The concentration here is on Chopin, with ten études drawn from both books. Schein also plays études by Debussy, Szymanowski, Moszkowski, Scriabin, Rachmaninoff, and Liszt. She seems to be a powerful technician, and she easily whizzes through all the music; but in the process she omits some of the expressive qualities. Splendid, realistic recorded sound. H.C.S.

**FRIEDERICH SCHORR:** *Recital*

Scenes from *Die Walküre* and *Die Meistersinger*. Arias from *Tannhäuser*, *Der Freischütz*, *Les Huguenots*, *Zar und Zimmermann*, *Euryanthe*. Schubert: *Aus Heliopolis*; *Im Abendroth*.

Friederich Schorr, baritone.

- SCALA 842. LP. \$5.95.

When one considers the high esteem in which American audiences held Friederich Schorr (for many there could be but one Hans Sachs, one Wotan), it is indeed hard to explain his almost total neglect on LP records. Scala has somewhat rectified this situation with a disc that presents the beloved Wagnerian not only in sizable slices from his two most famous roles, but also in his less-known repertoire—Meyerbeer, Weber, Lortzing, and two examples of Schubert Lieder. While grateful for the present offering, we will have to await a fitting memorial until EMI delves into its stock of former HMV records to present Schorr's noble art in its "Great Recordings of the Century" series. The excerpts here were made during the acoustical era, which was unable to cope with the Wagnerian orchestra. Added drawbacks are the impossibility of playing this record at high volume without blasting, and extensive cuts in the music.

Nevertheless, we can hear Schorr's voice and style in a curtailed *Wotan's Farewell*, and in four passages from his still remembered Hans Sachs. Under acoustical reproduction the voice sounds dry, a fact emphasized by the two early electric examples—*Tannhäuser* and *Frei-schütz*—which mirror the vibrant quality of Schorr's tone. We are also given the opportunity of admiring the baritone's fine legato in Czar Peter's third-act cavatina from *Zar und Zimmermann*, and in an extended scene from *Euryanthe*. Two Schubert songs display another facet of Schorr's art, weakly supported by a muffled, sketchy orchestra. It is good to have this singer finally represented in LP catalogues, but this example can hardly prove a satisfactory record for the true Schorr enthusiast. MAX DE SCHAUENSEE

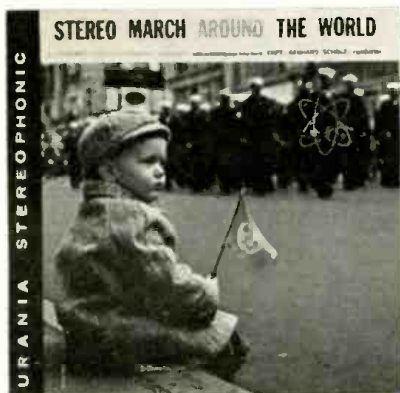

STEREO MARCH AROUND THE WORLD MusikKorps Der Bundeswehr, Hamburg. Captain Gerhard Scholz, conductor. Stereo—US01033—\$5.95. Mono (Hi-Fi March Around The World) UR9015—\$3.98.

A stirring selection of the world's most rousing marches in superlative stereo that has to be heard to be believed! Capt. Gerhard Scholz conducts the official West German Army Band in marches by Sousa, Elgar, Arnold, Fucik and Strauss.

Urania's latest releases of interest to all categories of music listeners include "Jazz at Stereoville" with Coleman Hawkins, Rex Stewart, Cootie Williams, Bud Freeman and other jazz greats; "Opera Sampler" spotlighting such international artists as Kurt Boehme, Dolores Wilson, Tiana Lemnitz and Erna Berger in arias from favorite operas in the Urania catalog; "Stereo Sampler" of selections from Urania stereo discs.

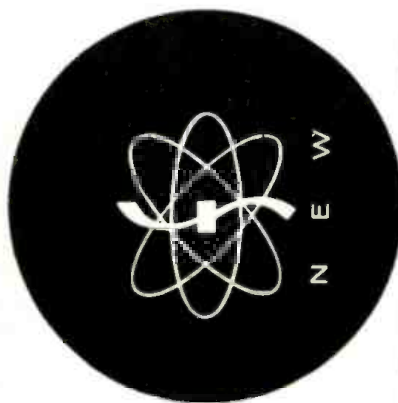

**URANIA**  
RECORDS

WRITE FOR FREE URANIA STEREO AND MONOPHONIC CATALOG HF-4  
509 Fifth Avenue, New York 17, N. Y.

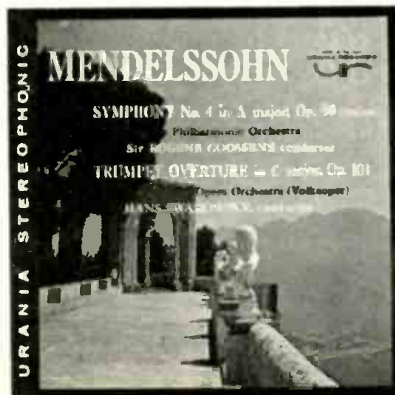

MENDELSSOHN Symphony No. 4 in A Op. 90 London Philharmonic, Sir Eugene Goossens; Trumpet Overture in C, Op. 101, Vienna State Opera Orch., Hans Swarowsky. Stereo—US01013—\$5.95. Mono—UX112—\$4.98.

This vibrant and exciting recording of Mendelssohn's popular "Italian" Symphony is coupled with a new Urania FIRST, the Trumpet Overture. In thrilling stereo or high fidelity monophonic, a truly exciting addition to any collection.

Other distinctive Urania stereo and monophonic classics to keep in mind: "La Grande Duchesse De Gerolstein", Offenbach's delightful operetta featuring Eugenia Zareska and the Padeloup Orchestra under Rene Leibowitz; Highlights from Wagner's "Die Meistersinger"; Beethoven's "Missa Solemnis"; Tchaikovsky's Symphony No. 1 ("Winter Dreams").

**DAVIS SHUMAN: Recital**

Hindemith: *Morgenmusik*; *Trauermusik* (arr. for trombone and strings). Starer: *Five Miniatures*. Rimsky-Korsakov: Concerto for Trombone and Military Band; Three Russian Folksongs (arr. for wood-wind quartet). Beethoven: Three *Equali*, for Four Trombones.

Davis Shuman, trombone; various instrumentalists.

• CLASSIC EDITIONS CE 1041. LP. \$4.98.

Hindemith's *Morgenmusik*, for two trumpets, horn, trombone, and tuba, is in the tradition of Johann Pezel and the other seventeenth-century composers of "tower music" for the brass bands of German towns. It is music of almost unparalleled solemnity, majesty, and power; clearly the musicians in the tower are celebrating on that auspicious morning the arrival of a pope or emperor. The *Trauermusik* was written in a few hours' time for performance on the BBC two days after the death of King George V. It was composed originally for viola and strings and as such has had much success; it is one of Hindemith's most frequently performed and recorded works. Shuman has arranged the viola part for trombone, and the big, noble-Roman voice of the brass instrument adds color and its own kind of dignity to the beautiful score. The modern side of the record ends with the *Five Miniatures* of Robert Starer, a zestful and extremely well-written suite for brass quintet in modern neoclassical style, with a lively, jazz-colored finale.

Rimsky-Korsakov's trombone concerto is an engaging curiosity. It was written for the band concerts at Kronstadt, the imperial Russian navy base, in 1876, when Rimsky-Korsakov was inspector of the navy bands and was only just beginning his career as a composer. Except for the obviously Russian character of its finale, it sounds like one of those Paris Conservatory test pieces, by obscure composers, that are to be found in the back of every instruction book for wind instruments; but Shuman has sparked it up with some virtuoso tricks of his own, has added a fancy cadenza, and obviously takes great delight in playing it. The three Russian folk songs from Rimsky-Korsakov's collection, arranged for wood-wind quartet and played by an unnamed ensemble, merely fill a few grooves between the concerto and the magnificent *Equali* of Beethoven, which stand in a direct line of descent from the brass canzonas of Giovanni Gabrieli and are Beethoven's finest work for wind ensemble.

Davis Shuman, the David Oistrakh of the trombone, is a very remarkable musician, and he has attracted equally good musicians to assist him. The recording is something sensational. A.F.

**RUTH SLENCZYNSKA: "A Twenty-Fifth Anniversary Program"**

Ruth Slenczynska, piano.

• DECCA DL 10000. LP. \$4.98

• • DECCA DL 710000. SD. \$5.98.

**RUTH SLENCZYNSKA: "Encore! Slenczynska"**

Ruth Slenczynska, piano.

- DECCA DL 9991. LP. \$4.98.
- • DECCA DL 79991. SD. \$5.98.

The first of these two collections might be described as a musical autobiography. One or two of the numbers were included by Miss Slenczynska in her Town Hall recital in New York in 1933 when, as an eight-year-old prodigy, she astounded the musical world. The other works here have, in one way or another, been bound up closely with the events of her life since that time. For example, she plays the Rachmaninoff C sharp minor Prelude to commemorate her studies with the late composer-conductor-pianist; but why she chose the one work he grew to hate is a mystery. Her interpretation of the Chromatic Fantasy and Fugue is thoughtful and clearly articulated, as is her

handling of the Scarlatti sonata. Her Mendelssohn is fluent, but her Bartók is a little too refined. The difficult Liszt Rhapsody No. 15 is performed in glittering fashion and is technically pure throughout, though the whole work could have been played on a grander scale.

The encore album—including such works as Mendelssohn's *Spinning Song*, Liszt's *Hungarian Rhapsody* No. 12, a Chopin Polonaise, and a Schubert *Moment Musical*—comes off with equal success. Except for a draggy *Clair de lune*, the pianist interprets each of these pieces here with care and stylistic individuality.

The monophonic edition of the anniversary record is marked by a rather wooden tone quality and limited range. Aside from an added richness to the sound in the stereo version (which even

## MUST ALL RECORDS BE BEST SELLERS?

Not necessarily. Naturally we welcome the best-sellers (and we have our fair share of them.)

But more gratifying to us is the success of our connoisseur items, distinctively

VANGUARD, which make up a major part of our catalogue. Intended for

highly selective listeners, rather than the best-seller lists, they none-the-less sell comfortably year in and year

out. This smaller, more discriminating segment of the public knows that our records

are planned in choice of repertory, excellence of

performance and perfection of sound to be permanent

treasures of any record library. They are always

fresh and exciting. This is why no record has ever been

withdrawn from the VANGUARD catalogue.



Send for Catalogue to

VANGUARD RECORDING SOCIETY INC.  
154 West 14th Street, New York City, 11



GIOVANNI GABRIELI—PROCESSIONAL AND CEREMONIAL MUSIC Choir and Orchestra of the Gabrieli Festival, Edmond Appia, conductor Monaural—BG-581 Stereolab BGS-5008 A BACH GUILD RELEASE "Vanguard's Gabrieli—a stereo triumph... the phonographic repertory is immeasurably richer for this disc."—AMERICAN RECORD GUIDE "... a magnificent representation of the splendor of Gabrieli's art."—HIGH FIDELITY

NOTABLE NEW RELEASES MOZART—PIANO CONCERTO IN C MINOR K 4391—PIANO SONATA IN B FLAT, K333 Denis Matthews, piano; Vienna State Opera Orch., Hans Swarowsky, cond. Monaural VRS-1037 Stereolab VSD-2025

BEETHOVEN — SONATAS IN A MINOR, F MAJOR, G MAJOR Monaural VRS-1038

BEETHOVEN — SONATAS IN A MAJOR, C MINOR Paul Makanowitzky, violin; Noel Lee, piano Monaural VRS-1039

BACH — CONCERTOS FOR HARPSICHOORD & STRINGS NO. 1 IN D MINOR, NO. 4 IN A MAJOR, NO. 5 IN F MINOR. Anton Heiller, harpsichord; Chamber Orchestra of the Vienna State Opera, Miltiades Caridis, conductor. Monaural BG-589 Stereolab BGS-5014

MONTEVERDI - MADRIGALI AMOROSI The Deller Consort; Baroque String Ensemble Monaural BG 579 Stereolab BGS 5007

List Price: MONAURAL 12" \$4.98 STEREO LAB 12" \$5.95

# The art of the VIENNA PHILHARMONIC ORCHESTRA in **ffss**



## Beethoven

Piano Concerto No. 5 in E Flat Major "Emperor" (Opus 73) Clifford Curzon (piano) — conductor: Hans Knappertsbusch CS-6019 4.98  
Famous Overtures (Egmont; Fidelio; Coriolan; Leonore No. 3) conductor: Hans Knappertsbusch CS-6053 4.98  
Piano Concerto No. 4 in G Major (Opus 58) Wilhelm Backhaus (piano) — conductor: Hans Schmidt-Isserstedt CS-6054 4.98

## Brahms

Symphony No. 2 in D Major (Opus 73) conductor: Rafael Kubelik CS-6004 4.98  
Symphony No. 1 in C Minor (Opus 68) conductor: Rafael Kubelik CS-6016 4.98  
Symphony No. 3 in F Major (Opus 90) conductor: Rafael Kubelik CS-6022 4.98  
Variations On A Theme of Haydn (Opus 56a)  
Academic Festival Overture (Opus 80)  
Tragic Overture (Opus 81) conductor: Hans Knappertsbusch CS-6030 4.98

## Dvořák

Symphony No. 5 in E Minor "New World" (Opus 95) conductor: Rafael Kubelik CS-6020 4.98

## Haydn

Symphony No. 94 in G Major "Surprise"  
Symphony No. 99 in E Flat Major conductor: Josef Krips CS-6027 4.98

## Mahler

Kindertotenlieder-Song Cycle  
Lieder eines fahrenden Gesellen-Song Cycle Kirsten Flagstad (soprano) — conductor: Sir Adrian Boult OS-25039 5.98

## Mozart

Don Giovanni (Complete Opera) Cesare Siepi; Fernando Corena; Anton Dermota; Walter Berry; Kurt Boehme; Lisa della Casa; Hilde Gueden; Suzanne Danco — conductor Josef Krips OSA-1401 23.92  
The Marriage of Figaro (Complete Opera) Cesare Siepi; Fernando Corena; Alfred Poell; Murray Dickie; Lisa della Casa; Hilde Gueden; Suzanne Danco; Anny Felbermayer — conductor: Erich Kleiber OSA-1402 23.92

The Marriage of Figaro — Highlights. Same soloists and conductor as above OS-25045 5.98  
The Magic Flute — Highlights. Hilde Gueden; Leopold Simoneau; Wilma Lipp; Walter Berry — conductor: Karl Bohm OS-25046 5.98  
Cosi Fan Tutte — Highlights. Lisa della Casa; Christa Ludwig; Emmy Loose; Anton Dermota; Erich Kunz; Paul Schoeffler — conductor: Karl Bohm OS-25047 5.98

## Smetana

Ma Vlast — Cycle — conductor: Rafael Kubelik CSA-2202 9.96

## Johann Strauss

The Blue Danube; Acceleration; Emperor; Roses of the South — conductor: Josef Krips CS-6007 4.98  
Wiener Blut; Liebeslieder; Wiener Bonbons; Champagne Polka etc. — conductor: Willi Boskovsky CS-6008 4.98  
Tales of the Vienna Woods; Acceleration; Tritsch Tratsch Polka etc. — conductor: Hans Knappertsbusch CS-6014 4.98

## Richard Strauss

Arabella (Complete Opera) Lisa della Casa; George London; Hilde Gueden; Otto Edelmann Anton Dermota; Waldemar Kmentl; Eberhard Wächter — conductor: Georg Solti OSA-1404 23.92

## Tchaikovsky

Symphony No. 6 in B Minor "Pathétique" (Opus 74) — conductor: Jean Martinon CS-6052 4.98

## Wagner

Die Walküre — Act 3; Die Walküre — Act 2 Todesverkündigung — Kirsten Flagstad; Set Svanholm; Otto Edelmann — conductor: Georg Solti OSA-1203 11.96  
Die Walküre — Act 1 (Complete); Götterdämmerung Siegfried's Rhine Journey and Funeral March — Kirsten Flagstad; Set Svanholm; Arnold van Mill — conductor: Hans Knappertsbusch OSA-1204 11.96  
Great Scenes for Bass-Baritone (Die Walküre; Meistersinger and Fliegende Holländer) — George London (bass-baritone) — conductor: Hans Knappertsbusch OS-25044 5.98

then could have been brighter), it is impossible to tell the difference between the two versions when played on stereo equipment. This same relationship exists in the second disc, but in this case both versions are somewhat brighter in texture. P.A.

## LEOPOLD STOKOWSKI: Music for Strings

Bach: *Mein Jesu, was für Seelenweh befüllt Dich in Gethsemane*; Partita for Unaccompanied Violin, in E: Prelude (both trans. Stokowski). Gluck: *Iphigenia in Aulis: Lento*; *Armide: Musette and Sicilienne*. Borodin: Quartet for Strings, No. 2, in D: Nocturne. Paganini: *Moto Perpetuo*. Rachmaninoff: *Vocalise*, Op. 34, No. 14.

String orchestra, Leopold Stokowski, cond.

- CAPITOL PAO 8415. LP. \$4.98.
- • CAPITOL SP 8415. SD. \$5.98.

Stokowski has always been a master at drawing a sensuous tone from a string section. In addition, he has always insisted upon achieving the highest possible standards of sound reproduction. The combination on this record makes for a most rewarding string concert, interestingly varied in musical content, warmly and cleanly played. If there is anything to criticize, it is the conductor's rather too romantic, freely rhythmical handling of the Bach Prelude. Elsewhere his readings of this music are extremely tasteful.

Since neither the notes nor the labels make it absolutely clear whose transcriptions have been used, only the versions of the two Bach works can be positively identified as Stokowski's. The recorded sound is highly polished. Stereo provides a pleasing separation of voices, though the monophonic version is almost as good. P.A.

## VIRTUOSI DI ROMA: Recital

Vivaldi: Concerto in D (*Accademico formato*). Respighi: *Antiche arie e danze*, Suite No. 3. Albinoni: Concerto for Two Oboes and Strings, in C, Op. 9, No. 9. Bassani: *Canzoni amoroze*.

Virtuosi di Roma, Renato Fasano, dir.  
• ANGEL 45028. LP. \$3.98.

Four pleasant pieces, of which the Albinoni and the Bassani are especially attractive. The former has the lighthearted elegance characteristic of this composer, and its slow movement is weightier than is usual with him. The piece for strings by Giovanni Battista Bassani (c. 1657-1716) is quite charming and somewhat advanced in harmony and instrumentation for its time; it would be interesting to know how much was contributed to it by its distinguished editor, Malipiero. I could not find the Vivaldi, which features an oboe, a violin, and a cello, in the Pincherle catalogue. The performances are up to the high standard of this group and the recording, except for a bit of distortion near the end of the Bassani, is excellent. N.B.



# ffss

full frequency  
stereophonic sound

Over 200 London ffss Stereo Records are now available. WRITE FOR CATALOG.

Dept. KM 539 W. 25th St., New York 1, N.Y.

**ARTHUR WINOGRAD: "Marches from Operas"**

Berlioz: *Damnation de Faust*. Bizet: *Carmen*. Borodin: *Prince Igor*. Glinka: *Ruslan and Ludmilla*. Meyerbeer: *Le Prophète*. Mozart: *Le Nozze di Figaro*. Rimsky-Korsakov: *The Golden Cockerel*. Verdi: *Aida*. Wagner: *Die Meistersinger; Tannhäuser*.

Virtuoso Symphony of London, Arthur Winograd, cond.

• • AUDIO FIDELITY FCS 50008. SD. \$6.95.

Some brilliant stereophony here. Listening to these refurbished bits of old finery is pleasurable first time through, but whether one is likely to play them often

afterwards will probably depend upon the nature and number of one's visitors. I would call attention particularly to the effect the sets of antiphonal trumpets, playing at opposite ends of the orchestra, make in the *Aida* march. D.J.

**ARTHUR WINOGRAD: "Russian Composer Masterpieces"**

Rimsky-Korsakov: *Easter Overture*, Op. 36; *The Snow Maiden: Dance of the Buffoons*. Mussorgsky: *Boris Godunov: Polonaise*. Borodin: *Prince Igor: Polovtsian Dances*. Glière: *The Red Poppy: Russian Sailors' Dance*.

Virtuoso Symphony of London, Arthur Winograd, cond.

• • AUDIO FIDELITY FCS 50009. SD. \$6.95.

Unusually clean-cut and transparent, yet high-spirited, rhythmically incisive performances lend freshness to these Russian orchestral showpieces. The reproduction is a trifle brighter than that on Wallenstein's Tchaikovsky *Pathétique*, in this same series. The dynamic range doesn't seem to be quite as wide either, but there is no suppression of volume. Instrumental balance is better, too, though all of the percussion except the timpani could have been more prominent throughout. Once again, surfaces are absolutely noiseless. P.A.

*Reviews continued on page 87*

## Via Discs: Culture in Capsules, and Tennis Balls, Too

AS THE PREFATORY SENTENCE to each little book nested into each of these language-learning packets phrases it, "The world is growing smaller every day." Somewhat nearer the pith of the argument (and no worse rhetoric) would be "Time is growing shorter all the time." Such, in effect, is the appeal to learn a language "In Record Time."

And why not? The defining contradiction of here and now is that while more people have more cultivatable leisure than ever before, few seem to find hours they are willing to invest in stretching their minds to learn anything really whole. The preferred investment seems rather to be in waiting for the *Reader's Digest* condensation, or writing off for *1,001 Things You Can Get Free*. So why not learn French, say, on a no-effort basis?

Actually, the culture-capsule courses offered here (if decidedly not for free) are well enough planned to have a certain helpfulness, so long as the prospective user does not let himself be dazzled into the notion that any real idiomatic command of a new tongue is to be got through mere passive washing in the sounds of pleasant voices saying simple things. For someone who is willing to work and who simply has no other means of trying to gain a very basic idea of how a second language strikes the ear, one of these sets is surely better than nothing at all. For anyone else—well, \$9.98 is almost ten dollars. Better to spend more for fuller instruction with live people, or save money by praying for the gift of tongues to descend.

"The busy person's shortcut to everyday (name your language of preference)" is their common surtitle. "A Complete Language Course that enables you to learn . . . So Easy / just listen and learn / 40 Lessons complete on two 12-inch high-fidelity LP records Plus Authoritative Textbook / concise grammar ("concise" is scarcely an adequate word) / 5000-word dictionary"; so runs the album-selling copy. And the textbook amplifies the pitch: ". . . will unlock for you the treasure house of learning a language the easy way—without monotonous exercise." Which covers the

facts, and a deal more besides. It all seems most disingenuous in view of the plain truth that exercise, repeated again and again, is precisely what is required and, in a measure, provided for.

Each thick album contains two LPs, striped into forty-odd separated bands, each containing a brief lesson, along with some smarmy words of exhortation from Teacher—and a book. The book is indispensable, for the recorded sentence material is drawn from its cutely decorated pages. The sentences to be rehearsed are printed there, with English above and alphabetical-phonetic equivalents below.

The sentence ideas chosen for inclusion are pretty nearly identical for each of the four languages; they are simple, and suited to the expectations of tourists-to-be. The Englishings and attempted phonetic equivalents are neither more nor less problematic than those in most other similar do-it-yourself texts. Which is to say that the English-other juxtapositions suffer the inevitable tension between giving sense in terms of block ideas, to be learned by rote (e.g., *Veuillez répéter* = "Please repeat"), as in the tourist-oriented sections devoted to Useful Phrases; and giving translations in more carefully ordered units of syntax (e.g., *Wer sind sie?* = "Who are they?"). The latter appear in the much briefer but very sensible sections on basic sentence structures, which are the most long-term useful parts of the lessons.

As for the attempted phonemes, they seem to me very variable in usefulness at best, and at worst positive impediments, especially in French, where the sounds can be but vaguely approximated by English letter combinations. At least this proved true (notwithstanding the authority of wartime Government research, or the Institute for Language Study which prepared these courses) for one American guinea pig, who had great trouble with such concatenations as "eef foh kuh zuh pahrt" for "*Il faut que je part*" and "Zang" for "Jean"—mainly because of sturdy republican independence in taking a "z" for a "j" and refusing to drop his "g's." Things went much better when he simply looked at the French,

listened to the record, and avoided the phonetics entirely. The same held true in less measure with other languages. Why the phonemes anyhow—especially since none are provided in the crowded dictionary sections, where of all places they might serve some purpose?

In using these sets, it is the business of the learner to hold the book, look at the proper sentence, listen to it spoken from the record, and then, during a silent interval, make a try at saying it back in imitation. How good the try is, of course, depends on individual sharpness of ear and oral facility—and, above all, on the exercise that the advertisement claims is not needed.

The results, though, can only be validated by reference to some other flesh-and-blood person; the record can, or will, do nothing to correct faulty articulation. You can misparrot "*Signorina, ho male d'aria*" until the groove is worn out. There will be no protest. But if, when the wretched day comes, the airline stewardess fails to understand and provide an upchuck bag, the mess will be none the less. After all, any speech is a matter of communication between people, and no phonograph yet made can provide quite that, even though by investing some forty dollars you may at least learn to ask for a can of tennis balls in four different nations—and, obviously, no one can afford to be without tennis balls abroad. Probably the wisest and most significant of all the sentences included translates, from any of the languages, as "I need a doctor who speaks English." That—in German, French, Spanish, or Italian—might make the whole price worthwhile.

The speaking voices are unexceptionable, to an American ear; the recording is excellently clear; the books, well printed in a fussy sort of way.

JAMES HINTON, JR.

**LANGUAGE RECORDS:** *Learn French in Record Time; Learn Italian in Record Time; Learn Spanish in Record Time; Learn German in Record Time*

• COLUMBIA D2L 246/249. Two LP each album. \$9.98 each album.

UNITED ARTISTS IS STACKING UP a great permanent catalogue of outstanding jazz albums. The discriminating listener can rely on the finest in jazz and high fidelity, recorded with the most sensitive monaural and stereophonic equipment available. All United Artists jazz recordings have met with wide acclaim, and our forthcoming releases certainly speak for themselves. Here are just a few of them: **The Milt Jackson Touch** featuring the great Milt Jackson, **Motor City Scene** starring Thad Jones, **Stretching Out** starring Zoot Sims with Bob Brookmeyer, **Benny Golson & The Philadelphians** with Lee Morgan, **Blues In The Mississippi Night**, **The Defiant Ones** with Booker Little and Max Roach. All monaural and stereo albums are \$4.98 each.

**UA**  
UNITED ARTISTS RECORDS



IRENE KRAL, HERB POMEROY  
THE BAND AND I  
STEREO UAS 4015



HERB POMEROY  
BAND IN BOSTON  
STEREO UAS 4015



EDMOND HALL  
PETITE FLEUR  
STEREO UAS 4028



ANDRE PREVIN  
DIAHANN CARROLL  
PORY AND BESS  
STEREO UAS 5022



BENNY CARTER  
ASPECTS  
STEREO UAS 4017



JOHNNY MANDEL'S  
GREAT JAZZ SCORE  
STEREO UAS 5005



CECIL TAYLOR QUINTET  
HARD DRIVING JAZZ  
STEREO UAS 5014



BOB BROOKMEYER  
KANSAS CITY REVISITED  
STEREO UAS 5008



GERRY MULLIGAN  
SHELLY MANNE  
STEREO UAS 5005



ART FARMER  
MODERN ART  
STEREO UAS 5007



REX STEWART  
HENDERSON HOMECOMING  
STEREO UAS 5009



PEE WEE ERWIN  
OH PLAY THAT THING  
STEREO UAS 5010



BANDY WESTON  
LITTLE NILES  
STEREO UAS 5011

# STACKING UP

FOR COMPLETE CATALOGUE UNITED ARTISTS RECORDS, BOX 6, 729 SEVENTH AVENUE, NEW YORK 19, NEW YORK

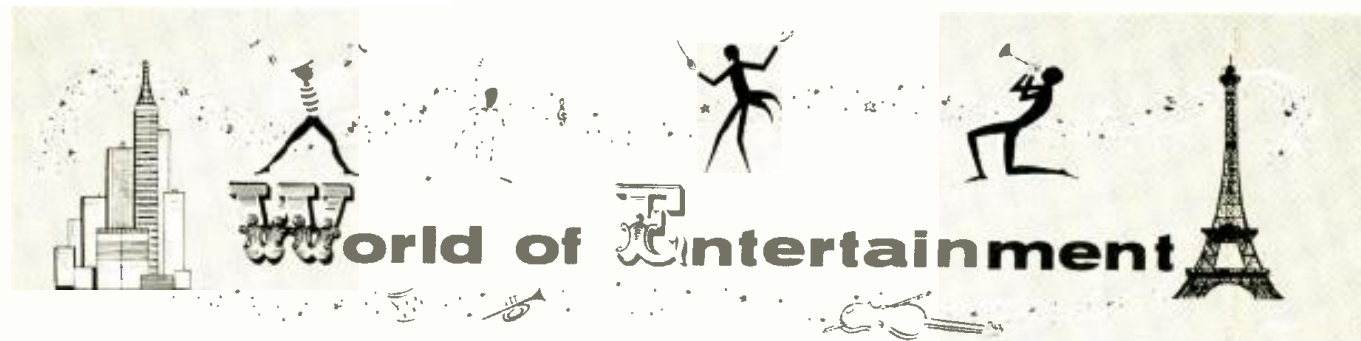

## Here at Home

"Easy To Love." (Songs of Cole Porter.)  
 Cesare Siepi, Roland Shaw Orchestra.  
 London OS 25054, \$5.98 (SD).

An interesting record, mainly because few opera singers go in for this sort of program at the peak of their careers, as the Met basso is right now. Siepi's expert phrasing and clean enunciation help to offset the fact that his big, luscious tones are a bit heavy for these songs and that his interpretations are rather ponderous and lacking in variety; but I am afraid the singer has not been greatly helped by a rather erratic stereo recording. Side 1 is particularly variable in quality, with the orchestral sound almost overpowering the singer, who periodically seems to be moving away from the mike. The arrangements are intriguing and the Shaw orchestra plays them well.

"Flower Drum Song." Andre Kostelanetz  
 and His Orchestra. Columbia CL 1280,  
 \$3.98 (LP); Columbia CS 8095, \$5.98  
 (SD).

A profusion of recordings of music from *Flower Drum Song* have suddenly appeared on the scene. None that I have listened to even equal this sumptuous performance by the Kostelanetz forces. This exotically colored music is of a kind that in the past frequently led the conductor into bizarre orchestral effects. Here his arrangements are striking and ingenious, yet still in good taste. The introduction of the sound of foghorns and a cable car (does this really establish the locale as San Francisco?) are the only obvious novelty effects; and since neither is objectionably intrusive, they are not annoying. There is splendidly rich orchestral sound in both issues, but I find I have a slight preference for the deeper, creamier quality of the monophonic version.

"From the Hungry i." Kingston Trio.  
 Capitol T 1107, \$3.98 (LP).

Recorded live in San Francisco's famous "Hungry i," this disc suffers from a number of things. The sound, as might be expected, is not particularly good. The exhortations of a seemingly frantic audience are disturbing enough, but to me the most detrimental aspect is the consistent play to the gallery. This is an extremely

talented trio of singers, whose earlier LP showed that they need not descend to such tricks to hold an audience. The sooner they get back to studio recording, the better for everyone concerned. Even such delicate songs as *Gué, Gué* or *South Coast* do not escape the free-for-all. *They Call the Wind Maria* from *Paint Your Wagon* is probably the only completely satisfactory band on the entire record.

"The Garbage Collector in Beverly Hills."  
 Orchestra, Billy Liebert and Carl Brandt, conds. Warner Bros. B 1254,  
 \$4.98 (LP); BS 1254, \$5.98 (SD).

Some decidedly odd occupations, all apparently conceived by Irving Taylor, are the basis for the wacky songs in this album. Such improbable titles as *Cop in a Nudist Colony*, *Cab Driver in Venice*, *Marriage Counselor in a Turkish Harem* and, of course, the garbage man of the title song will give you some idea of what to expect. This is the zany sort of material that Spike Jones favored, but I can't say that the author-composer ever reaches the dizzy heights that Spike did. The humor is too often labored and soggy, though there are one or two numbers that will raise a chuckle. Warner Brothers maintain the excellent sound that was noticeable on their original issues, and their stereo sound is exceptionally good on this record.

"A Handful of Stars." Bill Snyder, piano;  
 instrumental accompaniment. Decca  
 DL 8734, \$3.98 (LP).

This is one of those all too rare piano recordings where it is not necessary to consult the record sleeve to discover what the pianist is playing. Bill Snyder, no believer in overembellishing a melody or noodling around it, plays this fine collection of "Star" songs with deceptive simplicity, but tremendous style. Particularly happy is his treatment of Kreisler's *Stars in My Eyes* and that real old-time favorite, *Underneath the Stars*. The instrumental accompaniments add greatly to the over-all pleasure of these sparkling performances, and unusually realistic piano sound and good balance make the record excellent for dancing or just easy listening.

"Have Band, Will Travel." Lester Lanin  
 and His Orchestra. Epic BN 517, \$5.98  
 (SD).

Here is the kind of superb stereo record-

ing that could easily sound the knell for those five-piece bands you've been struggling to dance to at the local country club. Put this record on your turntable, and the finest society dance band in the business today is brought to you in larger-than-life, room-enveloping sound. And if the toe-titillating arrangements don't impel you to try a cha-cha-cha, why worry; you can sit it out until one of the evenly paced Lanin fox trots comes along. This is the sort of program, designed to please everyone, that actually will.

"Improvisations to Music." Mike Nichols  
 and Elaine May; Marty Rubenstein,  
 piano. Mercury SR 60040, \$5.98 (SD).

This remarkable exhibition of extemporaneous dialogue is a tour de force of pure improvisation. From the merest germs of ideas, the talented Nichols-May team have conjured up a series of eight short vignettes that wittily satirize a number of diverse matters. Among the more successful are those poking fun at a Noel Coward play, psychiatric treatment, a Hitchcock spy drama, and the bumbling efforts of a boss to entice his secretary up to see his hi-fi. But in every one it is fascinating to observe how each partner develops the idea, to marvel at the expert timing, and to be amazed at the credibility of the off-the-cuff chatter. Ideal background music is provided by Marty Rubenstein at the piano, the third member of an act that seems to operate by mental telepathy. Stereo sound is not al-



Lester Lanin: tops in toe titillation.

ways ideal for the intimacy of some of these scenes.

**"Inn of the Sixth Happiness."** Recording from the sound track of the film. Royal Philharmonic Orchestra, Malcolm Arnold, cond. Fox 3011, \$3.98 (LP).

Although record companies continue to issue original sound track recordings of music from their major screen epics, I can't help wondering how many people recall anything of the music they heard while watching these masterpieces. Take *Inn of the Sixth Happiness*, for which Malcolm Arnold composed a score that strikes me as being a little above the usual run of such things. Some people may remember *The Old Man* song (now on the Hit Parade), but this is not an original Arnold work; it's a children's game song almost as ancient as the hills. The remainder of the music has vanished, I'm sure—and understandably so, since without the dramatic action of the film it has little point. Fox has provided excellent sound for the music on this disc, but the spoken dialogue, used as a bridge, is often very blurred.

**"The Mills Brothers' Great Hits."** Mills Brothers; Orchestra, Milton DeLugg, cond. Dot DLP 3157, \$3.98 (LP).

In an age when singing groups come and go with almost the speed of a Sputnik, the durability and success of the Mills Brothers is something of a phenomenon. The group cut their first record in 1931, for Brunswick; moved over to Decca in 1934; and here they are in 1959, affiliated with Dot, for whom they have recorded a dozen of their most successful hits of the past twenty-five years. Although now a trio, instead of the quartet they started as, they still retain the flowing style that was their original trademark—a strong accent on the melodic line, excellent harmony, no vocal tricks (they gave up instrumental imitations some time ago), and a warm well-blended sound. Thanks to Dot's fine sound and the singers' good taste, *Paper Doll*, *You Always Hurt the One You Love*, *Till Then*, and nine others sound even better than they did in their original editions.

**"Garry Moore Presents That Wonderful Year—1940."** Orchestra, Irwin Kostal, cond.; Chorus, Keith Textor, dir. Warner Bros. W 1282, \$3.98 (LP); WS 1282, \$4.98 (SD).

There are hints that this is merely the first in a series of recordings intended to recall the great songs of the last two decades. If so, I'm all for it, especially if they are as well managed as those on this first issue. Garry Moore calls anyone over twenty "an old foof," obviously a term of endearment for those who can look back with pleasure to these old favorites. The fact is that these songs are still as popular as when they first caught the public fancy. Anyone over fifteen will love them, except possibly those who find the chorus, with its inevitable cooing of *Remember* as an introduction to every song, an intrusion. Excellent stereo sound, though I don't think it adds much to this particular type of presentation.

**"Music from the Blue Room."** Jan Garber and His Orchestra. Decca DL 8793, \$3.98 (LP); DL 78793, \$5.98 (SD).

It must be all of thirty years since Jan Garber abandoned his original dance band style in favor of one patterned closely on that of Guy Lombardo. I don't recall that Garber has ever claimed that his music is "the sweetest music this side of heaven," but there are times when I feel he justifiably could. This admirable dance program is a case in point. It is as smooth as silk, particularly in the waltz medley, brisk and perky in the cha-cha-chas, and nicely paced in the fox trots—in a word, a well-rounded program of fine dance music. I definitely prefer the stereo version, but Decca's monophonic sound is extremely satisfying.

**"Play Mr. Banjo."** The Happy Harts' "Singing Banjo" Band. Kapp KL 1115, \$3.98 (LP).

There is such a jolly and informal air about this record that even the most capricious critic would be silenced. Old, old songs—some from the days of the Civil War and others belonging to what is rather disrespectfully termed the Gaslight Era—are sung with a great deal of gusto by a mixed chorus ably abetted by the excellent and jovial sound of The Happy Harts' "Singing Banjos." If their support is more notable for exuberance than polish, it matters not one whit. Everybody appears to be having a wonderful time; and should you feel in the mood for a little community singing, chances are you'll find it hard to resist joining in.

**"Redhead."** Original cast recording with Gwen Verdon, Richard Kiley, and others. RCA Victor LOC 1048, \$4.98 (LP).

This is Albert Hague's second complete score for a Broadway musical, and though I find it an improvement over his initial effort (*Plain and Fancy*, of 1954), it is by no means top drawer. Gwen Verdon, a comedienne and dancer of extraordinary talent, is not a strong vocalist, and I imagine the composer has attempted to tailor her numbers very carefully to her limited vocal range. I think he's managed this with some success, but

in doing so hasn't managed to come up with anything very interesting musically. An old-fashioned tongue-twisting number on the style of *Sister Susie's Sewing Shirts for Soldiers* seems to suit the Verdon personality to a tee, and she appears to be reveling in it—particularly in the last chorus, which is dashed off in the Danny Kaye manner. Her other numbers are decidedly routine. Her male partner, Richard Kiley, is really no more fortunate, being condemned to present a reasonable imitation of Rex Harrison, but with tonsils. With Leonard Stone in the offing to provide the sort of support Robert Coote gave Harrison, the *My Fair Lady* situation is quite nicely, if unconsciously, realized. To Stone falls the most inventive and exhilarating number in the entire score, *The Uncle Sam Rag*, a hilarious spoof on how the English handled ragtime music. Mr. Stone does it to a turn.

The rest of the cast have little to do, except raise their voices in a typical free-for-all, the-pubs-are-closed, limey song, *We Loves Ya, Jimey*, a feat they accomplish with considerable enthusiasm. Incidentally there is an odd assortment of English accents throughout, with Miss Verdon adopting a reasonably good stage-cockney accent at the start, but forgetting it by the end of the record. Jay Blackton and his orchestra are well in the picture with excellent orchestral support, and the Victor sound is good indeed. I wonder if this all might not sound more beguiling in stereo.

**"Salute to the Smooth Bands."** Freddy Martin and His Orchestra. Capitol T 1116, \$3.98 (LP).

Freddy Martin's attempt to re-create the individual styles of a dozen sweet bands of the past twenty years is only intermittently successful. On the credit side place his imitations of the Wayne King, Glenn Miller, Dick Jurgens, Clyde McCoy, and Lawrence Welk bands. Only partially successful is his Ray Noble, for which, oddly enough, he has chosen *Blue Danube Waltz*, which he considers Noble's most exciting arrangement. (Ever listen to Noble's old *Who Walks in When I Walk Out*, Freddy?) I don't think he has captured the Ambrose style very well; and unless my memory is at fault, Hal Kemp played *Got a Date with an Angel* at a much slower tempo. This does add up to a really good dance record, however, especially for those who recall the original bands in their palmyest days.

**"Sea Chanties."** Roger Wagner Chorale. Capitol P 8462, \$4.98 (LP).

A really good recording of sea chanties, those nautical work songs from the day of sailing ships, has long been needed. The few records that do exist are disqualified as to authenticity by being sung by a lone male singer. Now comes Capitol to fill this vacancy with these stirring performances by the Roger Wagner Chorale. Their program is a splendid assortment of capstan, forecandle, and hal-yard chanties, with some of the ever-popular sea ballads of the past injected to create a good variety. Recorded in lusty



The Mills Brothers as trio.



sound, the group catches the strong rhythmic impetus of the working chanties with fine spirit and is equally happy in the more subdued flow of the ballads. Spirited solo work by Earl Wrightson adds a great deal to the general heartiness of this most excellent record.

"Serenades for Sex Kittens." Dante and His Orchestra. Carlton 12101, \$3.98 (LP).

For this provocatively titled record, Jay Arcy has written some embarrassingly coy notes, explaining exactly what Sex Kittens are. It appears, according to him, that they are "flat-tummed, twin-turret-ed gamins, amoral pixies with moist pouted underlips." Oh well, even if you don't qualify (and who does?), this won't disqualify you from thoroughly enjoying a fine program of off-the-beaten-track numbers. The arrangements are lush, but not cloying; the Dante orchestra plays with considerable suavity; and some super Carlton sound enhances all.

"Billy Vaughn Plays." Billy Vaughn and His Orchestra. Dot DLP 3156, \$3.98 (LP).

To judge from the heavy, insistent, slow rock-and-roll beat that pervades every item in this instrumental program, Vaughn has devised it to appeal primarily to the teen-age set. They'll probably love it; but older listeners, who recall such numbers from the mid-Thirties as *Red Sails in the Sunset*, *Indian Love Call*, or *Isle of Capri* as romantic, dreamy ballads, are not likely to be greatly entranced by these stodgy-sounding performances, despite the meritorious sound that Dot has lavished on them.

"When Your Lover Has Gone." Teresa Brewer: Orchestra, Dick Jacobs, cond. Coral 757257, \$5.98 (SD).

This program of torchy ballads is a decided about-face for a singer usually associated with bouney razz-ma-tazz numbers. Miss Brewer's performance is honest and pleasing, but it strikes me that her voice is altogether too light in color and too suggestively impish to make these songs as effective as they can be. I half expected her to burst into *Music, Music, Music* at some point in the program and, as a matter of fact, I'm sorry she didn't. Good arrangements and support from the Jacobs orchestra, with pleasantly arranged stereo sound, but I suspect the monophonic version is almost as effective.

JOHN F. INDOX

### Foreign Flavor

"Around the Samovar." Leonid Bolotine and Orchestra. Warner Bros. W 1255, \$3.98 (LP); WS 1255, \$4.98 (SD). Genuine musical interest plus handsomely recorded stereo sound (including surfaces far silkier than the two-channel mean) spell a winner for WB. In Leonid Bolotine they have found a conductor who strikes Slavic fire from his musi-

# ALL-TIME BARGAIN!



## RCA CAMDEN'S ALL STAR SPECTACULAR

A listener's sampler of 12 great artists. Enjoy complete selections by Tony Martin, Count Basie, Eddie Fisher, Mario Lanza, 8 others! **ONLY 98¢**

More great bargains on RCA Camden... only \$1.98 each L. P.

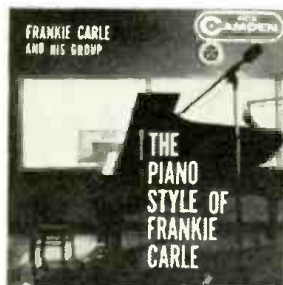

Played with the verve that keeps the melody humming in your heart long after the record is over! CAL-478

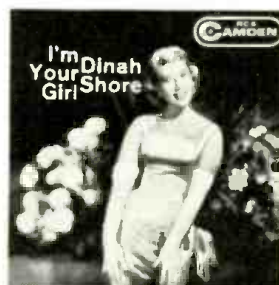

The easy warmth of a famous voice, glowing as brightly as ever. Tunes include "I'm Your Girl, Eternally." CAL-477



A cross-section of the famous songs of "hame" and heather, chuckling monologues and genial humor. CAL-479



One of the most beloved of all musicals, with a score that has been sung for almost half a century! CAL-483

**BIG-NAME RECORDINGS AT HALF THE BIG-NAME PRICE**



O! Man River, Why Do I Love You, Bill and other Jerome Kern melodies. Available in Stereo only. \$2.98. CAS-488

Manufacturer's nationally advertised prices shown—optional with dealer.





## requests

A group of the most frequently requested songs in the Dyer-Bennet repertoire, songs not previously recorded or available only on inferior pressings.

**Richard Dyer-Bennet 5 (Requests)**

**DYB 5000 • \$4.98.** Greensleeves, Venezuela, Spanish is the lovin' tongue, Westryn wynde, Barbara Allen, Lord Rendal, The white lily, The Golden Vanity, The Quaker lover, John Henry, I ride an old point, The brothers.

This is one of the seven new records by Richard Dyer-Bennet, released under his own label, acclaimed by critics throughout the country.

Write for free catalog.

**Dyer-Bennet records**

Postal Box 235, Woodside 77, N. Y.

## BERNSTEIN DOUBLE BILL



Traveling composers in a holiday mood have given us a happy collection of "place-name" symphonies. Two of the finest in this category (and surely among the finest efforts of their respective authors) are the joyous "Italian" of Mendelssohn and the warm, glowing "London" of Haydn. Here are fresh, new "New York" versions of both, led by Leonard Bernstein.

**MENDELSSOHN: Symphony No. 4 in A Major ("Italian"); HAYDN: Symphony No. 104 in D Major ("London")—the New York Philharmonic, Leonard Bernstein, Conductor.**  
ML 5349 MS 6050 (stereo)

GUARANTEED HIGH-FIDELITY AND STEREO-FIDELITY RECORDS BY

**COLUMBIA**

© "Columbia" "Masterworks" © Marcan Reg.  
A division of Columbia Broadcasting System, Inc.

icians, and someone has devoted time and insight to choosing an unhackneyed group of traditional Russian songs. Particularly appealing are *Troika Waltz*, *Styanka Rasin*, and *Curly-Haired Catherine*. Certainly no one will regret purchasing the splendid monophonic edition, but the crisply separated stereo disc is a run-away choice for those equipped to play it.

"Around the World." Steve Allen and His Orchestra. Dot DLP 3150, \$3.98 (LP). To the many guises Steve Allen's talent takes—comedian, writer, poet—add another: musician. As an instrumentalist, pianist Allen plays simply, avoiding all complexities; but the results are satisfying. Allen has also composed—not brilliantly, but not without skill—five of the national portraits on this disc. Elsewhere, he has chosen the likes of *Danny Boy* to represent Ireland, *The Peanut Vendor* for Cuba. On the whole, a slow-paced, tasteful *tour du monde* that will appeal not only to Allen's many admirers but to those who enjoy background music on the undemanding side. Excellent engineering.

"Beat Tropicale." Harry Coon and Richard Campbell, drums; Jose Bethancourt and His Orchestra. Concert-Disc CS 33, \$6.95 (SD).

Dazzling sound with striking stereo separation is the hallmark of this release; you can, in fact, do no better at this stage of the art. While Señor Bethancourt presents a diverting rhythmic pastiche built

around his own formidable marimba virtuosity, the flip side—*Savage Drum Fantasy*—is the *pièce de résistance*. Drummers Campbell and Coon shape an arresting sequence of African drum patterns: the *Masai Rumble* is hair raising. There is no plethora of musical value here, but there's a lot of fun.

"Champagne Cocktail." François Charpin Trio. Kapp KL 1111, \$3.98 (LP).

Backstopped by guitar, piano, and drums, François Charpin warbles his way through sixteen French favorites, including four of his own composition. Charpin has a soft, pleasing vocal style; his cohorts shape the *ambiance* of a *boîte intime*; and Kapp's engineers have captured the whole in bright, full-range sound.

"Danzónes Bailables." Orquesta Folklórica de Cuba, Odilio Urfe, cond. Toreador T 533, \$3.98. (LP).

A sumptuously recorded program of Cuban *danzónes*. Derived from the Spanish word for dance, the *danzón* has African roots and, in its pure form, erotic overtones. In modern format, however, the highly rhythmic—yet stately—music makes for more pleasant, and far less hectic, listening than most Latin imports. At the same time it remains dance music *par excellence*. Here is a "different" Latin beat worth exploring.

"The Fantastic Guitars of Sabicas and Escudero." Decca DL 8795, \$3.98 (LP); DL 78795, \$5.98 (SD).

Here are two superb flamenco guitarists at the top of their form. It is awe-inspiring to contemplate the rapport that underlies these duets in an idiom that relies for its principal impact upon improvisation. To me, the peak of the record is the somber, moving interplay of the guitars in the variations and elaborations on the Andalusian folk song *El Vito*. Rather to my own surprise, I found the stereo version to be distinctly superior to the LP, even when the latter is played through two speakers. The two channels give an unaccustomed depth and solidity to the sound, as well as differentiate neatly between the two guitars.

"Isle of Enchantment." Charles Dant and His Orchestra. Coral CRL 757249, \$5.98 (SD).

With the rhythm section at the helm, Charles Dant and his orchestra cruise the South Seas in skillfully recorded stereo. Maestro Dant keeps an eye on the beat throughout, but tends to anoint it with too many brushes on the drums for my taste. His repertory is on the tired side, featuring as it does *Harbor Lights*, *Blue Hawaii*, etc. Actually, unless you are a blood descendant of Queen Liliuokalani, there is nothing much to get excited about here, pro or con.

"Love Dances of Brazil." Bernardo Segall, piano; Emanuel Vardi and His Orchestra. Decca DL 8764, \$3.98 (LP); DL 78764, \$5.98 (SD).

As rippling and distinctive as the mosaic sidewalks of Rio, these arrangements of Brazilian staples unfold in multihued

## "C" OVER HIGH "C"

The voice of  
**ERNA SACK**  
a vocal phenomenon  
of our age

Now available in

### ERNA SACK RECITAL

Auf der Kirmes; Ouvre Ton Coeur; You Will Return to Vienna; Estrellita; Serenata; Throw Open Wide Your Window; Berceuse de Jocelyn; Coppélia Waltz; The Last Rose of Summer; Il Bacio. B19049

WRITE FOR CATALOG.



\$1.98  
LONG PLAY

Dept. KL • 539 W. 25th St., New York 1, N. Y.

orchestral color beneath the gifted baton of Emanuel Vardi. Brazilian pianist Segall, front and center for all the works, blends his instrument neatly with Vardi's lush strings. The stereo recording imparts glints of light and darkness as well as an over-all spaciousness that just are not present in the monophonic version.

"Music of the African Arab." Music of the Middle East, Vol. 3. Mohammed El-Bakkar and His Oriental Ensemble. Audio Fidelity AFSD 5858, \$6.95 (SD).

El-Bakkar is back, bracketed by mikes, in a gaudy, exotic, percussive, and brilliantly recorded tour de force. As in his previous efforts in this genre, El-Bakkar has assembled compositions of his own that reflect and illustrate characteristics of, in this case, African Islamic music. The performance is enthusiastic; and the sound, to belabor a point, is gorgeous.

"A Night at the Tropicoro." Lito Peña and His Orchestra Panamericana. Cook 2187 SD, \$5.98 (SD).

Technically, this recording adds no luster to the Cook reputation: separation, depth, and range are adequate—little more. But, lending an ear to the melodic mediocrities of Lito Peña and his benchmark—luminaries of the Tropicoro Room at Puerto Rico's Hotel El San Juan Intercontinental—one wonders why anyone would tote a single mike, let alone two, into their presence. If, as the annotation states, "the music in the Tropicoro is the best in Puerto Rico," then may God help that unhappy island.

"A Night in Vienna." 101 Strings. Stereo-Fidelity SF 6800, \$2.98 (SD).

This low-priced label scores again with its regiment of strings in a concert of old Viennese stand-bys such as *Blue Danube*, *Vienna Life*, and *Merry Widow Waltz*. Stereo-Fidelity's unnamed conductor prefers languorous tempos, but otherwise no interpretative idiosyncracies mar his readings. Nicely delineated, full-range sound that would be acceptable at any price; at \$2.98 it's a rare stereo bargain.

"St. Patrick's Night in Dublin." Brendan Hogan and the Ballinakil Ceili Band. Capitol T 10201, \$3.98 (LP).

It is almost inconceivable that a live recording from Dublin's Irish Club on St. Patrick's Day could miss the boat. Yet this one, sadly, does just that. Neither the musicians nor the singers are particularly gifted and a wearisome sameness informs the band's unchanging instrumental assault. Although it is impossible to demolish these grand old Irish songs entirely, Hogan and his group make a heroic attempt.

Thick-textured sound replete with coughs, laughter, and assorted background decibels adds to the carnage. In no case are the vocalists adequately miked.

"Songs of Old Napoli." Roberto Murolo, guitar. Epic LC 3544, \$3.98 (LP). Star of Italy's popular Durium label, Murolo strays from the trodden-to-death track in his recital of Neapolitan songs.

# dynamic!

the sound of

# stereo on

# Roulette

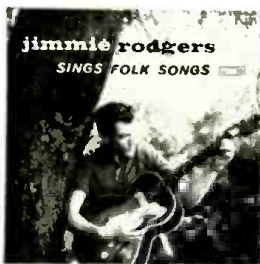

JIMMIE RODGERS SINGS FOLK SONGS. R-25042



COUNT BASIE & JOE WILLIAMS: *Memories Ad Lib.* R-52021



JULIUS LA ROSA: *Love Songs a La Rosa.* R-25053



PEARL BAILEY SINGS PORGY & BESS & other Gershwin Melodies. R-25063



MAYNARD FERGUSON & HIS ORCH: *Swingin' my way through College.* R-25058



THE DIMARA SISTERS: *Cha Cha Italiana.* R-25062



SING ALONG WITH BASIE: vocalese versions of great Basie arrangements. R-52018



SWINGIN' MARCHIN' & WHISTLIN': BUDDY WILLIAMS & his ORCH. R-25064



AT HOME WITH THE BARRY SISTERS: a variety of wonderful Yiddish melodies. R-25060

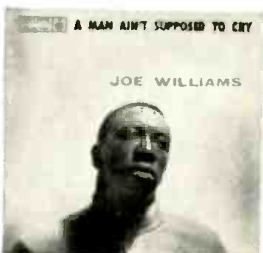

JOE WILLIAMS: *A Man Ain't Supposed to Cry.* R-52005



BASIE: *Count Basie & his Orch.* R-52003



TYREE GLENN AT THE ROUNDTABLE. R-25050

for more of the best in Stereo & Standard LP's

SEND FOR FREE CATALOG



**ROULETTE**

Dept. D, 659 10th Ave., New York, N. Y.

# SALT LAKE IN PHILADELPHIA

THE BELOVED CHORUSES  
*The Mormon Tabernacle Choir,*  
 DR. RICHARD P. CONDIE, DIRECTOR  
*The Philadelphia Orchestra,*  
 EUGENE ORMANDY, CONDUCTOR



In the fall of 1958 the mountain came to Mohammed, musically speaking, in the concert appearances of the Salt Lake City Mormon Tabernacle Choir with the Philadelphia Orchestra. Here are the first fruits of their resounding meeting: 4 splendid choruses of Bach plus works of Haydn, Schubert, Rimsky-Korsakov, Sibelius, and Handel.

THE BELOVED CHORUSES—The Mormon Tabernacle Choir, Dr. Richard P. Condie, Director; The Philadelphia Orchestra, Eugene Ormandy, Conductor ML 5364 MS 6058 (stereo)

GUARANTEED HIGH-FIDELITY AND STEREO-FIDELITY RECORDS BY

**COLUMBIA**

© "Columbia" "Masterworks" ® Marcas Reg. A division of Columbia Broadcasting System, Inc.

*Champagne Music in Stereo!*



Sparkling champagne music, uncorked by Lloyd Mumm and His Starlight Roof Orchestra on Omega disk! Three new stereo albums each a varied dance program of bubbling waltzes, polkas, fox trots and novelties.

**CHAMPAGNE MUSIC OSL-1**

—Lloyd Mumm pours as you sip BUBBLES IN THE WINE, IN A LITTLE SPANISH TOWN, POOR PEOPLE OF PARIS, LA RONDE. Intoxicating!

**PINK CHAMPAGNE OSL-37**

—PINK COCKTAILS FOR A BLUE LADY, CHAMPAGNE WALTZ, BEER BARREL POLKA, THE HAPPY WHISTLER, MISSOURI WALTZ and others. For the connoisseur!

**BLUE CHAMPAGNE OSL-46**

—Lloyd unbottles the SHADOW WALTZ, PUT YOUR LITTLE FOOT, HOT LIPS, BLUE CHAMPAGNE, LITTLE SIR ECHO. Limit: one per customer!

**omega disk STEREO PHONIC**

PRODUCED BY OMEGATAPE • INTERNATIONAL PACIFIC RECORDING CORP. • 6906 SANTA MONICA BOULEVARD HOLLYWOOD, CALIFORNIA

The clear-voiced baritone has chosen a number of lovely little-known ballads which he sings in a pure, uncluttered style. Particularly enjoyable are the droll *La Cammesella (The Camisole)* and the hauntingly medieval *Ritornello delle Lavandaie del Vomero (Refrain of the Vomero Laundresses)*.

"Soviet Army Chorus and Band in a New Program of Favorites." Boris Alexandrov, cond. Monitor MP 540, \$4.98 (LP).

This is the most lucidly recorded Soviet offering I have yet heard. It is also among the most stirring. The massed chorus has always been a Russian speciality, and the Red Army group is in the great tradition. The bulk of the songs are by Soviet popular composers, with a sprinkling of folk ballads and a brace of operatic choruses thrown in. Recommended.

"T Town!" Los Tres Caballeros. HiFi Record R 810, \$4.95 (LP).

Saddest of settlements, Tijuana crouches just below the Mexican border, a long stone's throw from San Diego and the moored Pacific Fleet. Week end after week end squadrons of sailors descend on the pari-mutuel booths and drifting women of this dusty town. And week end after week end cheap wants are cheaply satisfied.

Somewhere in the frenzied miasma, HiFi Records found an instrumental quartet—unaccountably called Los Tres (*sic*) Caballeros—that specializes in rhythm, melody, and Latin atmosphere aplenty. Old favorites—*Mexican Hat Dance, El Relicario, España Cañi*—provide the underpinning of their repertory. Nothing here to awaken nostalgia in old sinners, but this Mexican night club combo is an uncommonly good one. Excellent recorded sound.

O. B. BRUMMELL

## FI MAN'S FANCY

"A Farewell to Steam." HiFiRecord R 901, \$4.95 (LP); \$5.95 (SD).

Anyone who's doubted that anything new and different could ever be done with recordings of steam locomotives, is in for a surprise. High Fidelity Recordings has done it—by the simple expedient of attaching a pair of microphones to a steam engine, turning on a recorder, and letting 'er go. Four hours of tape, edited into a forty-minute record, provide the novel approach—a recording from the train itself. The disc is wisely engineered: microphones capable of high intensity sounds were employed, as well as electrical gimmicks which permitted the use of high-fidelity tape recorders instead of low-quality portable units. The result: fascinating—impressively realistic monophonically, overwhelming in stereo.

"Favorite Marches." Norwegian Military Band, Leif Nagel, cond. RCA Camden CAS 474, \$2.98 (SD).

Here's a low-priced edition of the best-

known works of that king of march time, John Philip Sousa, vigorously performed by Leif Nagel and the Norwegian Military Band. Spirit is a trade-mark of Nagel's martial corps, and—via this crisp and well-defined recording—it's quickly infectious.

"Flight to Tokyo." George Wright, organ. HiFiRecord R 717, \$4.95 (LP); \$5.95 (SD).

Any resemblance between this disc and authentic Japanese music (or, for that matter, any Oriental music) is purely imaginary. What we have here are such purely Occidental specimens as *China Nights, Ricketty Rickshaw Man, and Poor Butterfly*. Wright's style is well beloved of theatre-organ fanciers, and *Flight to Tokyo* represents no deviation. The monophonic disc is transparent and cleanly recorded, but it takes the stereo disc to swell the Wurlitzer into the monster-sized demon that many fi-fans demand.

"Grand Canyon Suite." Symphonic Orchestra Graunke, Frederick Stark, cond. Disneyland Records WDL 4019, \$4.98 (LP); STER 4019, \$4.98 (SD).

First reaction to this latest version of Ferde Grofé's aural spectacular is distinctly visual. The records come bound in handsome double folders decorated with fourteen (I counted) gorgeous, full-color reproductions of the Grand Canyon's mystic moods and faces. Aurally, the monophonic disc is a thrilling evocation of fire and splendor and tenderness—but something went wrong in the recording of the stereo edition. You can search far and wide to find a more spirited performance than this, but beware the stereo.

"International Marches." Marine Band of the Royal Netherlands Navy, 1st Lt. H. C. van Lijschooten, cond. Epic BN 510, \$5.98 (SD).

Only one of the marches here, *Strike Up the Band*, is of American lineage, and its composer (George Gershwin) was not widely known for band music. The rest are relatively unfamiliar European pieces. The Netherlands marines zip through everything with enormous enthusiasm, energy enough for an entire regiment. The recording is outstandingly natural with respect to tonal and instrumental balance, its sound exceptionally pure. On this score alone, this is one of the finest discs of military music you can get.

"Leibert Takes a Holiday." Dick Leibert, organ. Westminster WST 15034, \$5.98 (SD).

Most listeners will be glad to know that Leibert's holiday is not from his favorite musical vehicle, the mighty Wurlitzer. Here he travels to Richmond, Virginia, where he manipulates the giant Byrd Theatre instrument. Leibert is not an avid sensationalist at the keyboard, but he does risk a few entertaining shenanigans now and then. Westminster employs a distant approach in recording, but careful microphone selection and placement keep excess hall reverberation to a minimum. This is not billed as a show-off disc, but

it is a fine example of what taste and restraint can accomplish in stereo.

"Mello-Dee." Lenny Dee, organ. Decca DL 8796, \$3.98 (LP); DL 78796, \$5.98 (SD).

Lenny Dee is a young virtuoso with a peculiarly adaptable name (his other albums have been called "Dee-Most," "Dee-Lightful," "Dee-Licious," etc.). His playing is "Dee" almost anything you'd care to append, except "Dee-Void" of satisfaction, which it certainly is not. Dee's organ is not identified, but it sounds very much like a Hammond. His style is mostly serene, sometimes brisk, and the occasional frills fall gracefully in place. The same is true of the drums which patter quietly somewhere off mike. Since both discs are technically first-rate, stereo does not enhance the sound significantly. It simply widens the aural curtain to fit your own speakers.

"Music in Orbit." Ron Goodwin and His Orchestra. Capitol T 10188, \$3.98 (LP).

Ron Goodwin is a thirty-three-year-old British composer and arranger who has worked for a number of name bands in Britain. Five years ago he set out on his own orbit. *Music in Orbit* bears scant relevance to space travel, but Goodwin's twelve compositions are lighthearted and fanciful. Recorded in London's EMI studios, Goodwin's music has been given a sparkling transparency characteristic of only the very tops in engineering.

"Nautilus." Sounds and voices recorded during the voyage of the Nautilus under the North Pole. Herb Shriner, narrator. Colpix CP 701, \$7.50 (LP). Fi-fanciers will not find this record as aurally satisfying as the space rocket documentary reviewed last month. Its sound effects are more subdued; they were collected, as a matter of fact, on recorders which make no pretense to high fidelity. Historically speaking, however, this is one of the most monumental scientific achievements of our time. Produced and narrated by Herb Shriner, it comes complete with illustrated folder, jam-packed with facts about the Nautilus and the North Pole in particular, and submarines and submariners in general.

"Organ on the March." John Gart, organ; The Minute Men. Kapp 1119, \$3.98 (LP).

Organist John Gart has bolstered his Conn instrument with a collection of twenty-five percussion devices and a group called The Minute Men to operate them. He plays segments of seventeen marches, improvising at will with percussion effects or oddly shaped organ tones. In fact, often slim trace of the original remains after Gart completes his tonal therapy. Despite this drastic treatment, however, Gart's pieces *do* remain tuneful, the percussion being so skillfully handled that it is never too loud or too prominent, but blends smoothly with the tinkling tones of the organ. This is an unusual instrumental pairing, which demands ex-



The many faces of BEETHOVEN as interpreted by

**Giesecking** at the piano

**KLEMPERER** with the Philharmonia

the **DAVID OISTRAKH TRIO**

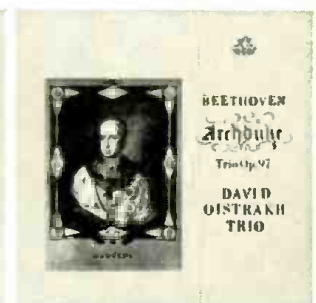

Before his death in London (1956) Walter Giesecking had recorded two-thirds of the Beethoven Piano Sonatas for Angel. These two albums make 18 sonatas now available.

Nos. 13 and 14 ("Moonlight"), Op. 27, Nos. 1 & 2; Nos. 9 and 10. Op. 14, Nos. 1 & 2 Angel 35652  
No. 7, Op. 10, No. 3; No. 11, Op. 22 Angel 35653

Klemperer "has emerged the supreme interpreter of the classics" (*London Observer*). This is the newest in the complete series of Beethoven symphonies which Otto Klemperer is recording with the Philharmonia for Angel. Have you heard the others? Angel 35711

First Angel recording by the David Oistrakh Trio! Russia's greatest living violinist is joined by Sviatoslav Knushevitsky, Cello, and Lev Oborin, Piano, in a performance of Beethoven's supreme achievement in the chamber music medium. Angel 35704

AND MORE... RECORDED IN EUROPE FOR ANGEL



**For Orchestra**

**LISVESTRI CONDUCTS LISZT PROGRAM**

Les Préludes · Tasso  
Philharmonia Orchestra  
Rumanian Constantin Lisvestri conducts two symphonic poems by Liszt—one heard frequently, the other, *Tasso*, almost never (on record) until this Angel recording. Angel 35636

**KARAJAN AND BERLIN PHILHARMONIC**

Dvořák: Symphony No. 5 ("From the New World")  
Smetana: The Moldau  
Favorites of almost everyone, especially as conducted by Herbert von Karajan, "most powerful man in the world of music" (*Holiday*), and certainly one of the busiest. Angel 35615

**Especially for Children**

(Hint: a wonderful Easter gift idea!)

**MUSIC FOR CHILDREN**

Carl Orff, Gunild Keetman. English version by Margaret Murray.  
Not the standard "music appreciation" album! Instead, this is a participation in the delightful adventure of making music—especially for very young children. Carl Orff wrote these simple songs, rhythms, nursery rhymes with his assistant, Gunild Keetman, in Munich's *Gunterschule*. Here they are recorded in English, with three children's choruses and an instrument ensemble. *Very contagious, on purpose!* (See what happens when you play it at home.) With explanatory notes. Angel Album 3582 B (2 records)

**For Voice**

**MARRIAGE OF FIGARO: HIGHLIGHTS**

A lovely money's worth of Mozart! Almost a solid hour of overture, arias, duets, and ensembles from *Figaro*. And the remarkable cast stars ELISABETH SCHWARZKOPF (Countess), GEORGE LONDON (Cointi), SENA JURINAC (Cherubino), IRMGARD SEEFRIED (Susanna), ERICH KUNZ (Figaro). With the Vienna Philharmonic, Vienna State Opera Chorus, HERBERT VON KARAJAN, Conductor. (Libretto notes) Angel 35326

**FISCHER-DIESKAU SINGS BACH**

Arias from six Bach cantatas, including the complete Cantata No. 158 (*Der Friede sei mit dir*), sung by the German baritone whose "consistently high level of recordings is nothing short of miraculous" (*Hi-Fi Review*). With the Choir of St. Hedwig's, and the Berlin Philharmonic Orchestra, conducted by Karl Forster. Angel 35698

**New in Angel Stereo**

HANDEL: SOLOMON Beecham conducts Royal Philharmonic Orch., Beecham Choral Society, Soloists. Angel S 3546 B (2 records)

REGIMENTAL MARCHES OF THE BRITISH ARMY. Kneller Hall Band. Angel S 35609

# GRADO

“Truly  
the  
world’s  
finest...”

STEREO CARTRIDGE \$49.50

COMPATIBLE WITH:  
Monaural • Lateral • Vertical  
Stereo • Westrex • Minter

STEREO TONE ARM \$29.95

Finest Walnut Wood  
4 Wires and Shield

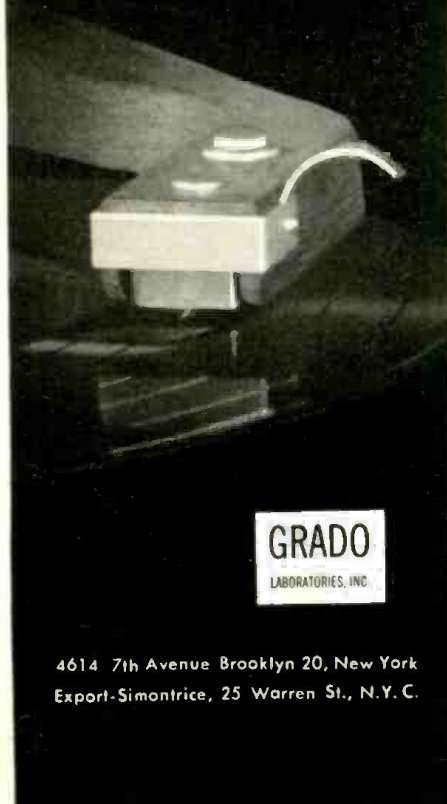

GRADO  
LABORATORIES, INC.

4614 7th Avenue Brooklyn 20, New York  
Export-Simantrice, 25 Warren St., N.Y.C.

treme delicacy in handling. Kapp's engineers qualify as experts.

“Overture.” Hollywood Bowl Symphony Orchestra, Felix Slatkin, cond. Capitol SP 8380, \$5.98 (SD).

Many reviewers often regard new recordings of such often-performed works as these overtures with pretty jaded ears. They'll perk up at this, though. Slatkin unleashes one of the most powerful, driving, and generally impressive *William Tell's* ever to rattle a stereo system, not to speak of Tchaikovsky's *1812*, and Von Suppé's *Light Cavalry* and *Poet and Peasant* Overtures. Here is a fi festival *par excellence*, overflowing with stereo warmth, full to the brim with sensuous stereo spaciousness, and chock full of fortissimo punch that will shake your floors and astound your guests. This is a full-blown stereo extravaganza that no dyed-in-the-wool fi fanatic should be without.

“Pop Concert, U. S. A.” Cleveland Pops Orchestra, Louis Land, cond. Epic LC 3539, \$3.98 (LP).

This recording was made in Cleveland's Severance Hall in August 1958, immediately after the completion there of acoustical renovations aimed at lengthening the reverberation period—in a word, making the hall more alive. *Pop Concert U.S.A.* (including short compositions by Anderson, Copland, Piston, and Bernstein, and leading off with Gould's *American Salute*) is a tribute to the success of the undertaking. The clarity of the recording is outstanding; virtually perfect positioning of carefully selected microphones reveals every facet of the music. Distortion and surface noise are practically nonexistent. In short, this is a splendid record for fi-fans who want to demonstrate the merits of their systems, as well as one which fully displays the sonic beauties of a fine recording hall.

“The Red Army In Hi-Fi.” Alexandrov Song and Dance Ensemble. Artia 101, \$4.98 (LP).

The Alexandrov Song and Dance Ensemble is another name for a musical aggregation better known as the Red Army Chorus, Orchestra, and Dancers. More than 300 members are heard here in a collection of thirteen folk songs from Russia, Hungary, and Czechoslovakia. The massive chorus, backed by an apparently gargantuan orchestra, is an auditory spectacular—one whose joys are further enhanced by superlative recording.

“Reverie.” Norman Luboff Choir. Columbia CL 1256, \$3.98 (LP); CS 8074, \$5.98 (SD).

I have often thought that it is sometimes more important to have extremely low distortion in low-level, quiet recordings than in those with crushing crescendos, simply because the *total* effect of tranquil music depends so much on sustaining the mood. *Reverie* is such a disc. Twelve peaceful melodies (*Strange Music, If You Are But a Dream, My Reverie*, etc.) by the Luboff choir establish a nice drowsiness that even a tiny measure of distortion would destroy. Happy for listeners,

there is *no* distortion, just sweet, sleepy melodies superbly designed for anyone's reverie.

“Strings by Starlight.” Hollywood Bowl Symphony Orchestra, Felix Slatkin, cond. Capitol P 8444, \$4.98 (LP); SP 8444, \$5.98 (SD).

Felix Slatkin conducts the string section of the Hollywood Bowl Symphony Orchestra in six pieces written expressly for strings: Borodin's *Nocturne*; Bach's *Air* for the G String; Tchaikovsky's *Andante cantabile* and *Waltz* from the *Serenade* for Strings; Barber's *Adagio* for Strings; and Percy Grainger's arrangement of *Londonderry Air*. Capitol's recording technique, on both monophonic and stereo versions is distant, spacious, and syrupy smooth. The stereo disc is somewhat more open than the monophonic, and both are soothing fare for lazy summer evenings.

“Terror Tales.” Liberty LST 7025, \$4.98 (SD).

Forty minutes of whistling winds, screams, shots, splashing waves, thunder, insane laughter, foghorns, roaring trains, and otherworldly sound effects are the unnerving background for the crackling voice of *The Old Sea Hag*, a role portrayed by veteran actress Martha Wentworth. Miss Wentworth's characters are convincingly created. But terror? Well, hardly, at least for those beyond the age of implicit belief in ghosts and goblins. But the stereo sound effects are another story. Under the guiding hand of some master, they form a fine horrific foundation for the narrator's scary tales.

“Virtuoso.” Roger Wagner Chorale. Capitol SP 8431, \$5.98 (SD).

The monophonic version of this release was particularly impressive for its treatment of Carl Orff's *Praeludio* from *Catulli Carmina*, in which Capitol engineers triumphantly captured the massed voices and percussion ensemble with breath-taking results. Such a topnotch monophonic recording usually presages more spectacular aural thrills in stereo, and that expectation is fully realized here. To attempt to describe accurately the dynamic impact of this stereo extravaganza with its widespread chorus, thunderous percussion, and mammoth acoustics would be futile. It must be heard to be fully appreciated, an experience which I heartily recommend to all lovers of the finest of fi.

“Western Sunset.” Robert Prince and His Orchestra. Warner Bros. W 1259, \$3.98 (LP); WS 1259, \$4.98 (SD).

The titles on the jacket (*Wagon Wheels, Cool Water, Red River Valley*) suggest strummed guitars, wailing male voices, and twangy accents. Not so. These are orchestral versions, and each of the twelve western war horses has been newly caparisoned and presented ensemble fashion. Although the approach is sentimental, the sound of both monophonic and stereo editions is so outstandingly transparent that these records positively shine with aural brilliance.

PHILIP C. GERACI

## JAZZ

**Basie Reunion.** Prestige 7147, \$4.98 (LP).

A warm evocation of the Basie band of the late Thirties with Buck Clayton, Jack Washington, Freddie Green, and Jo Jones present from that classic group along with Paul Quinichette and Shad Collins from later versions and the inevitable Basie piano sit-in, Nat Pierce. The tunes are established Basie standards (*John's Idea*, *Roseland Shuffle*, *Blues I Like to Hear*, etc.), the ensembles swing with proper Basie airiness and, except for Quinichette, the soloists play with requisite verve. Quinichette, however, goes through a flirtation with gawkish, distorted sounds completely out of keeping with the spirit of the performances.

**Les Baxter: "African Jazz."** Capitol T 1117, \$3.98 (LP).

Baxter's approach to what he calls African jazz will undoubtedly affront purists (jazz purists and African purists), but he has produced an unusual and frequently fascinating amalgam of musical devices. It is, in essence, a mixture of exotic rhythms, jazz, and mood music which manages to be explosive, suave, and foot-tapping almost all of the time. Baxter has made good and valid use of three jazz musicians—Milt Bernhart, trombone, Larry Bunker, vibraphone, and Plas Johnson, tenor saxophone—to underline and intensify his ideas. And he has been particularly ingenious in his use of a jazz device that was very close to the heart of Jelly Roll Morton—the break. On a craftily constructed train piece, there is a train whistle break and on another occasion he pulls in a thunderclap as a break. This African jazz is a bit different and it's a lot of fun.

**Benny Carter: "Jazz Giant."** Contemporary 3555, \$4.98 (LP).

Benny Carter, one of the most winning performers that jazz has known, has been unaccountably neglected on discs throughout almost his entire career. Even during the Swing Era, when a musician of Carter's generally mainstream tendencies might have had a great deal of success, he managed to avoid it by spending much of the Thirties in Europe. By the time he came back and organized a big band he had missed the boat. Since the middle Forties he has been very active in the Hollywood studios but represented on records only sporadically.

This disc places him in good company (Ben Webster, Jimmie Rowles, Shelly Manne, among others), provides him with opportunities to be heard on both alto saxophone and trumpet, and gives him a sound program of standards especially suited to him (*Blue Lou*, *I'm Coming Virginia*, *Old Fashioned Love*) as well as two worthwhile originals. His pure, sweeping alto is a joy to hear as it swings lightly and purposefully through all but two selections. On these two he shifts to trumpet, playing with much the same lean purity. Webster, Rowles, An-

# 2 new releases new moods...

**UNIQUE!**

\*CELP 421

**STUBBY KAYE**  
Sings Music for  
Chubby Lovers

A collection of well known standards done with Chubby's humorous touch, sure to bring a smile to your face.



**BEGUILING!**

CELP 430

**SHOSHANA DAMARI**  
Sings Songs of  
Israel



The sounds of Biblical times are brought up to date. Israel's top folk singer brings you this unusual album filled with romance and mysticism.

Suggested retail price \$3.98 each

\*Available in STEREO of \$4.98

If not available at your dealer, write to:

SEECO RECORDS, DEPT. HF  
39 W. 60 ST. N.Y.C.



WRITE FOR COMPLETE CATALOG OF FINE SEECO RECORDINGS.

**RECORD AUTHORITIES  
AGREE... STYLUS AND  
RECORD LIFE DOUBLED**



BY USE OF THE  
**DIS-  
CHARGER**

No More Brushing,  
Spraying or Wiping  
Records

**LEAVES NO RESIDUE**

**IMITATED, BUT NOT  
DUPLICATED**

The Discharger controls static electricity generated by your records, a static-free record stays clean, quiet, and lasts far longer. Discharger element never needs replacing.

- Clips on any arm
- Lasts indefinitely
- Weight 1/2 gram

SEE YOUR LOCAL DISTRIBUTOR OR  
SHIPPED POSTPAID IN U.S.A. .... \$4.50

**MERCURY SCIENTIFIC PRODS. CORP.**  
1725 West 7th Street, Los Angeles 17, California

## GUITAR ADVENTURE

ADVENTURES IN SOUND\*

COLUMBIA

**ONE HUNDRED GUITARS**

Orquesta Popular de Madrid de La O.N.C.E. Directed by Rafael Rodriguez Albert  
(Recorded in Spain)



This dazzling addition to Columbia's "Adventures in Sound" series presents Spanish music played by no less than one hundred guitars of varying types and sizes. Even more remarkable is the fact that the orchestra consists entirely of blind musicians (each was provided with earphones and the conductor with a microphone to make this recording!). **ONE HUNDRED GUITARS—Orquesta Popular de Madrid de La O.N.C.E. directed by Rafael Rodriguez Albert.** WL 143

GUARANTEED HIGH-FIDELITY AND  
STEREO-FIDELITY RECORDS BY

**COLUMBIA**

© "Columbia" & Marcas Reg. A division of Columbia Broadcasting System, Inc.

*The  
Melody,  
as  
Mr. Weston  
sees it,  
is the  
thing*

Two magical new albums  
by Paul Weston glowingly  
affirm his contention that  
"the melody is the thing."

*Floatin' Like a Feather:*  
The orchestra "floats"  
atop a very happy  
rhythm section. T1153

*Music for Dreaming:*  
Weston's great  
original "mood"  
album, newly  
recorded! T1154

*on stereo  
too!*



# SOME CAME RUNNING



The Original Film Score Of The  
SOL C. SIEGEL Production

## INSIDE THIS ALBUM:

One of the finest motion picture scores ever recorded

Celebrated film composer Elmer Bernstein conducts a brilliant, lyric score that ranges from the driving jazz of a rowdy cafe to the deeply tender theme of an awakening love. Superb high fidelity. W1109

IN STEREO  
TOO!  
SW1109



# 3 PANCHOS

ADVENTURES IN SOUND\*  
RECORDED IN MEXICO COLUMBIA

## VIVA LOS PANCHOS



Very recently our "Adventures in Sound" series introduced the guitar strumming "Los Panchos"—Mexico's famed vocal trio. Their album, *A Moment of Love*, sold so fast we put in a call to Mexico City and gave them the go-ahead on another. Here it is. More Los Panchos. More love songs. Viva them!

VIVA LOS PANCHOS—Trio Los Panchos WL 141

GUARANTEED HIGH-FIDELITY AND STEREO-FIDELITY RECORDS BY

COLUMBIA

© "Columbia" ™ Maracas Reg. A division of Columbia Broadcasting System, Inc.

## A CATALOG OF EXCLUSIVES

The intent of Washington Records is to catalog the uncataloged, to fill the interesting gaps left by major labels between their safe war-horses. Rather than bring you the twentieth version of a Tchaikovsky symphony, we have started complete Haydn Sonata and Quartet cycles, insured the continuation of the unique Aeolian-Skinner volumes, recorded such varied talents as Vivaldi, Telemann, Rampal, Beaux-Arts Quartet, classical and jazz guitarist Charlie Byrd, Ronnie Graham in the *Take Five* revue, and *Demi-Dozen*. Write for a new catalog.

## WASHINGTON RECORDS

1340 Connecticut Ave. N.W.  
Washington 6, D. C.

Announcing  
*music...fit for the Gods!*

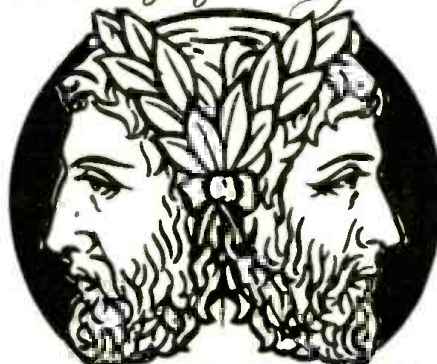

# JANUS

The new stereo discs that introduce to mere mortal ears, the musical incandescence of the second threshold of sound.

ONLY JANUS STEREO

FEATURES

LENNY HERMAN

LENNY HERMAN "MUSIC IN MOTION"  
ALBUMS FST2004—FST2005—FST2008

JANUS RECORDS

1159 Broad St.  
Newark 2, N. J.

dré Previn, and Frank Rosolino make themselves felt from time to time, but this is essentially Benny Carter's record—a welcome portrait of one of the great jazzmen who is still in his prime.

**Eddie Davis Trio.** *Roulette* 52019, \$3.98 (LP). *Roost* 2227, \$3.98 (LP). Both discs are very similar. Davis' strident, sharply assertive tenor saxophone dominates almost all of the pieces, although it is organist Shirley Scott, kept in the background much of the time, who provides the group with its swinging strength. On each disc she is given a pair of solo pieces which are far more attractive than Davis' braying. Both programs are made up largely of ballads.

**Wild Bill Davis:** "Swings My Fair Lady." Everest SDBR 1014, \$5.98 (SD). Davis' customary raucous, jabbing organ attack gives way on this disc to more subtle playing. The result is a mildly interesting jazz set which does no damage to the Lerner-Loewe score and provides a few close-ups of Jo Jones's deft and witty use of wire brush and cymbal. Stereo places Davis' organ to the right of center, Jones on the right, and Maurice Simon's unobtrusive tenor saxophone on the left, but the expansive sound of the organ holds the group together.

**Delta Kings:** "Down the River." Down South 201, \$4.98 (LP). *Down the River* is an act of enthusiasm and love committed by a pipeline engineer and banjoist, Russ Wait, and a lawyer-trombonist, Bill Crais, assisted by five practicing musicians. They form a rough, happy septet which occasionally manages to strike some bright sparks in its attacks on popular and Dixieland standards. Even in its more plodding moments the group conveys what is usually identified as a "good time" feeling. Crais is an uncommonly good trombonist, but there are times when Wait strums so enthusiastically that his time becomes vague.

**Tommy Dorsey and His Orchestra:** "Sentimental and Swinging." Columbia CL 1240, \$3.98 (LP). These are further recordings made by the Tommy Dorsey band in 1955 when brother Jimmy was with it, drawn from the same sessions that produced the earlier *The Fabulous Dorseys in Hi-Fi* on Columbia. It is a varied program—from rather agitated Dixieland to pretty ballads and brawny, swinging instrumentals, many in the heavy, lumpy vein of the present Basie band. The playing is clean, professional, and impersonal. It is hard to believe that anyone was particularly wrapped up in these pieces.

**Coleman Hawkins:** "The High and Mighty Hawk." Felsted 7005, \$4.98 (LP). The high and mighty Hawk has his wings clipped repeatedly on this disc by trumpeter Buck Clayton who plays with some semblance of spirit and imagination while Hawkins concentrates on diddle-diddle exercises. By sheer rhythmic force, Hawkins jabs some life into the



confined set of mechanical figures with which he elects to work, but too much of his playing is earth-bound.

**Billie Holiday:** "Songs for Distinguished Lovers." Verve 8257, \$4.98 (LP).

The apparent shriveling of the once vibrant voice of Billie Holiday can be traced through most of her recordings during the Fifties. One almost came to dread the next bit of recorded evidence of the difficult Miss Holiday was having in projecting her songs. Consequently, this new disc is especially welcome; it is the most refreshing and hopeful work that Miss Holiday has done in years. Not that the old flexibility has returned; but she seems to have learned how to make the most effective use of her voice as it is now, and she has reacquired the confidence to phrase with assurance. Furthermore she skirts one of her most obvious pitfalls on

recent discs—very slow tempos. This time her songs are all moderately paced, she has a buoyant rhythm section in back of her to give her an encouraging lift, and a small crisp jazz group (no strings, another millstone she has had around her neck) which apparently includes Ben Webster and Harry Edison. Her old artistry comes through once more on this disc, sometimes in harsher tones than it once had but quite often all the more compelling because of this.

**Jonah Jones Quartet:** "Jonah Jumps Again." Capitol T 1115, \$3.98 (LP).

Now that he has lured a wide audience with the relatively simple, rhythmic, and stylized trumpet work on his last two or three discs, Jonah Jones has astutely broadened his scope a bit on this set. There is less dependence on formula here (but enough of it so that newly arrived

Jones enthusiasts won't be scared away) and more display of the rugged, Armstrong-derived trumpet that Jones plays so well. With greater variety of material, better pacing in programming, and a wider view of Jones's real jazz talents, this is one of his best discs.

**Barney Kessel:** "The Poll Winners Ride Again." Contemporary 3556, \$4.98 (LP).

The three men who make up the Poll Winners (Kessel, guitar; Ray Brown, bass; Shelly Manne, drums) are an unusually sensitive and inventive trio. In view of the seeming limitations of their instruments, they find a constantly surprising variety of ways of developing their selections as a group. A great deal of this comes from Manne's use of the drums as a melodic instrument and from Kessel's ability to make interesting use of

## The Search for Jazz Origins — and New Inspiration

FOR WHATEVER REASONS, the very early stages of jazz are presently commanding an unusual amount of attention. In part this attention is expressed in a searching back through the folk roots of jazz for new inspiration, in part in a flurry of interest in on-the-spot recordings of the still active exponents of early jazz forms.

The most thoroughgoing and adventurous of the on-the-spot recorders is Samuel B. Charters, who has preserved some of the more inimitable musical sounds of New Orleans in a series of Folkways discs, *The Music of New Orleans*. The three discs issued so far suggest that, when completed, this will be an invaluable documentation of a fast-fading musical way of life.

In the first volume of the series, *The Music of the Streets; The Music of Mardi Gras*, jazz and folk music meet on a common ground. The itinerant street singers—peddlers, beggars, evangelists—whom Charters has caught enliven ideas and attitudes common to folk song in many different regions with a swinging, jazz-tinged beat that may be unique to New Orleans. Certainly it makes for unusually catchy street music. The Mardi Gras music is even more jazz-oriented, since it is largely the music of the marching bands which contributed greatly to early jazz. The Mardi Gras recordings are rather haphazard (understandably, considering the happy turmoil on the streets), but they convey some suggestion of the musical flavor of the occasion.

Charters explores the marching bands more thoroughly in *Music of the Eureka Brass Band*. The Eureka is one of the last of the colorful bands that have been a part of New Orleans life for almost a hundred years. Its members are getting along in years, but they still attack their marches with jaunty vigor and draw from their dirges a somber sweetness both strange and moving. Trumpeter Percy Humphrey, the Eureka's leader, is a firebrand on the brighter pieces as he flares out of the ensemble to soar into some tremendously exciting solos. Charters'

astute inclusion of Humphrey's brilliant work both as a soloist and as ensemble leader makes a muffled recording of a rather ragged rehearsal performance of *Panama* one of the high points of the set.

The Eureka band was recorded in a hall, but a rival group, the Young Tuxedo Brass Band, has been caught in its natural habitat—outdoors—on *Jazz Begins*. This gives the band a more open, a more airy (what else?) sound than a recording in which the sound is being turned inward by four walls. The Tuxedo's program is divided between the two traditional segments of New Orleans funeral music: the solemn, restrained march to the cemetery, and the abandonment and release of the journey back. The Tuxedo is particularly effective on dirges, for its leader, John Casimir, plays a plaintive clarinet which builds these pieces to a throbbing intensity.

Charters' third volume, *Music of the Dance Halls*, is a report of the music in the dime-a-dance joints of the Negro districts. It is played for the most part by musicians who have been carrying on New Orleans jazz traditions in almost complete obscurity since the jazz migration from New Orleans to Chicago forty years ago—Billie and Dee Dee Pierce, Emile Barnes, Charlie Love, Albert Burbank, and others. Although their music is far from polished, it always swings; and it is frequently extremely moving, especially in the deeply traditional blues singing of Billie Pierce and Burbank's sometimes electrifying clarinet work.

The other approach to early jazz—the reexamination of its folk roots—has appeared in the work of Jimmy Giuffrè during the past two years and is also the basis of John Benson Brooks's *Alabama Concerto*. Brooks's *Concerto* is an outgrowth of an assignment he had several years ago to transcribe for a book some folk recordings made in Alabama by Harold Courlander. He was struck then, he says, by the light this material cast on jazz origins—"a different taste from New Orleans' urban finery." Working from several rural folk themes, he develops his

concerto through ensembles, written solos, and improvised solos played by a quartet made up of Julian Adderley, alto saxophone, Art Farmer, trumpet, Barry Galbraith, guitar, and Milt Hinton, bass.

As an exploration of jazz origins, this composition is a rather peculiar work for there is very little in it that can be identified as jazz. The only really effective jazz moments are in some warm, firmly expressed solos by Adderley. Farmer's playing in general is sure and clean, but his solos are inclined to a static coolness that is much more drily urbane than the "urban finery" of New Orleans. Aside from the question of whether the concerto has any relationship to jazz, it lacks movement and explicit development. One gets the feeling that a single little jiggling riff is being bandied about over and over again and the work becomes lost in monotony long before the two full LP sides have been completed. JOHN S. WILSON

**The Music of New Orleans:** "The Music of the Streets; The Music of Mardi Gras." Folkways FA 2461 (LP); "Music of the Eureka Brass Band." Folkways FA 2462 (LP); "Music of the Dance Halls." Folkways FA 2463 (LP). \$5.95 each.

**The Young Tuxedo Brass Band:** "Jazz Begins." Atlantic 1297, \$4.98 (LP).

**John Benson Brooks:** "Alabama Concerto." Riverside 12276, \$4.98 (LP).



*A musical way of life fast-fading.*

The  
**ORIGINAL**  
**EXOTIC**  
**SOUNDS**  
OF  
**MARTIN DENNY**



**AFRO-DESIA**

STEREO LST 7111  
monaural LRP 3111



**PRIMITIVA**

STEREO LST 7023  
monaural LRP 3087



**HYPNOTIQUE**

monaural LRP 3102

WRITE FOR FREE CATALOGUE

DEPT.  
H-4

**LIBERTY**  
**RECORDS, Inc.**  
HOLLYWOOD 28, CALIF.

both chorded and single string guitar styles. In a quiet and very persuasive way, they make stimulating jazz sense.

**Shelly Manne and His Men:** "Peter Gunn." Contemporary 3560, \$4.98 (LP).

The themes written by Henry Mancini for the television series, *Peter Gunn*, show up in an even better light on this set than they did on Mancini's RCA Victor disc of the same material. The difference lies in the fact that Mancini's own recordings were as written and played for the television series, a situation usually so far removed from jazz that it raised interest and surprise simply because some good jazz resulted. Manne's group, on the other hand, is not hemmed in by such considerations. They play the pieces strictly as jazz. There is more freedom to build in jazz terms and Manne's group takes advantage of the circumstances. Aside from Conte Candoli, whose range of trumpet ideas is rather limited, this is a good group, particularly in the bristling alto saxophone work of Herb Geller and, needless to say, the crisp, lifting drumming of the leader.

**Joe Marsala:** "Chicago Jazz." Stereo-Craft 102, \$5.98 (SD).

Marsala, one of the more original and definitely hot clarinetists of the Swing Era, has not been on records for years, but his playing on this disc shows him to be as warmly swinging as he ever was. He is especially winning on a pair of richly developed ballads—good ones, too: *I Cried for You* and *Singin' the Blues*. His stimulating companions include Rex Stewart, playing some biting, muted cornet, and Marsala's old helpmate, Adele Girard, whose harp still has an effortless lilt. The stereo balance is generally satisfactory but Johnny Blowers' drumming is too dominant, at times covering Marsala's clarinet.

**The Frank Moore Four.** Capitol T 1127, \$3.98 (LP).

In these days when everybody in jazz is a soloist, the Frank Moore Four reverses the trend. This is a gently swinging group (accordion, reeds, bass, drums) centered on close ensemble voicing. The solos are poor, particularly those by the saxophonist, but the quartet's attractive ensemble playing makes good background jazz.

**Turk Murphy:** "At Easy Street." Verve 1015, \$4.98 (LP).

Murphy's band is as spirited and thumping as ever on this disc. The program is well balanced between the overdone (*Fidgety Feet*, *Dippermouth*), the less frequently heard (*Take Me to the Land of Jazz*, *Melancholy*), and a neglected masterpiece (Gene Gifford's *Square Face*). Bob Helm has returned as the group's clarinetist, and his Dodds-like phrasing and urgent vinegary attack are an enlivening influence. Murphy foregoes any singing (he does a recitation on *Square Face*), but if cornetist Larry Conger is to be the vocal alternative, it might be just as well if Murphy returned to the singing chores.

**George Shearing:** "Blue Chiffon." Capitol T 1124, \$3.98 (LP).

The steady watering down and waste of George Shearing's talent is getting to have a macabre fascination. How far can they go? This is the most banal Shearing release yet. Music from behind the potted palms.

**Stuff Smith:** "Have Violin, Will Swing." Verve 8282, \$4.98 (LP).

The astringent, biting, jabbing attack of Stuff Smith is as close as anyone has yet come to a real jazz use of the violin. This disc gives ample display to his jazz qualities—possibly too ample. His tone is almost consistently harsh; and since his only accompaniment is piano, bass, and drums, Smith is the soloist throughout practically the entire record, creating a monotonous similarity of texture. The late Carl Perkins, who has a few brief and engaging piano solo spots, might well have been given more space.

**Sonny Side Up.** Verve 8262, \$4.98 (LP).

The main participants in this blowing session are Dizzy Gillespie, Sonny Rollins, and Sonny Stitt, all of whom are known to have more than considerable ability. It is somewhat of a shock to find that they can find very little to say in the course of the four selections they play. An arrogant, joyous stop-time chorus by Rollins on *I Know That You Know* is the only point of real interest throughout a long and boring disc.

**Rex Stewart:** "Rendezvous with Rex." Felsted 7001, \$4.98 (LP).

Strong echoes of the Ellington small groups that Stewart once led sound through the pieces played by Stewart and some very able sidemen. Three originals by Stewart and Dick Cary are particularly suggestive of Ellington in their minor themes, the tang of Stewart's muted cornet, Hilton Jefferson's singing alto saxophone, and the unusual coloration brought to the group by Garvin Bushell's discreet use of the bassoon. For change of pace, there is an outgoing, rocking blues with a delightfully blowsy baritone saxophone introduction by Heywood Henry, a pleasantly casual recitative by Stewart in an adaptation of the Bert Williams manner, and some rowdy muted trombone by George Stevenson. Stewart has not been recorded in such agreeable circumstances since he left the Duke.

**Stewart-Williams & Co.:** "Porgy and Bess Revisited." Warner Bros. W 1260, \$3.98 (LP); Warner Bros. WS 1260, \$4.98 (SD).

Instead of a "blowing" jazz version of tunes from *Porgy and Bess*, this disc is built around the idea of assigning to jazz instrumentalists the various singing roles in the Gershwin work with the intent of projecting the melodies with a jazz inflection rather than working out jazz variations on them. It is a provocative and largely successful experiment largely because the musicians involved—Cootie Williams, Rex Stewart, Lawrence Brown, and Hilton Jefferson in the principal roles—are all jazz musicians who

are naturally inclined toward a singing, melodic style. The jazz subtleties that are possible in such an approach are beautifully expressed in the duet between Porgy (Williams' trumpet) and Bess (Jefferson's unusually pure-toned alto saxophone) on *Bess, You Is My Woman*. Some of the other ballads, particularly those featuring Brown's trombone, are done almost straight, but Stewart's half-valve technique on cornet brings an appropriately wicked jauntiness to Sportin' Life's songs. This is an imaginative and rewarding joining of jazz and a show score. The stereo disc puts the brass definitely on the left and the saxophones well on the right, detracting from the unity of the performances. The monophonic version has as much presence as the stereo disc and it brings all the elements into closer and more natural relationship (the *Bess* duet, for example, is greatly improved).

**Buddy Tate and His Orchestra:** "Swinging Like . . . Tate!" Felsted 7004, \$4.98 (LP).

There are two different groups on this disc under the leadership of Tate, who took Herschel Evans' place in Count Basie's band in 1939. Tate has rarely been heard on records since he left Basie in 1948, although for several years he has been leading his own group in New York. This band plays on one side of the disc. On the other side Tate is joined by several other Basie alumni—Buck Clayton, Dicky Wells, Earl Warren, Jo Jones—but aside from the contributions of Tate and Warren, their performances are far less interesting than those by Tate's regular combo. The almost forgotten benefits that can accrue to a jazz group simply by working together steadily make a long, languorous blues that rarity in jazz recording—an extended bit of "blowing" that sustains interest. In his group Tate is harboring a warm, singing clarinetist, Ben Richardson, and a well-grounded pianist, Skip Hall. This enticing introduction to Tate's band deserves an encore, next time with confidence on both sides of the disc.

**Dicky Wells:** "Bones for the King." Felsted 7006, \$4.98 (LP).

Wells's coy talking trombone is an extremely limited device which might be amusing if it were used sparingly. But Wells is inclined to look on it as a key element in his musical personality, and it takes the edge off the pleasantly Basie-ish performances (on which he is joined by Buck Clayton, Buddy Tate, and Rudy Rutherford) which make up half the disc. The other half, built around a trombone quartet (Wells plus Vic Dickenson, Benny Morton, George Matthews) places Wells in a different and more refreshing context where he is either involved in helping to explore the majestic sounds of which four trombones are capable or giving more rational vent to his comic leanings in a loose-jointed rhythmic riff number that might have been created by Slim Gaillard. There are a few welcome glimpses of Benny Morton's neatly turned, full-voiced trombone.

JOHN S. WILSON

## SONGS, WELL-LATHERED



Modern barbershop quartet singing? Yes indeed! We found out about it recently, when we signed the Buffalo Bills (of "Music Man" fame) to a recording contract. If you're curious, gather 'round, for here is one of America's great quartets, come to serenade you with the most spirited and inspiring tonorial parlor singing that ever sweetened the air.

**BARBER SHOP!—The Buffalo Bills With Banjo**  
CL 1288

GUARANTEED HIGH-FIDELITY AND  
STEREO-FIDELITY RECORDS BY

**COLUMBIA**

© "Columbia" & Marks Reg. A division of Columbia Broadcasting System, Inc.

Save Half  
**ASSEMBLING**  
ONE OF THESE TWO

*Schober*

**ELECTRONIC  
ORGANS** in KIT form

"CONCERT" "CONSOLETTÉ"



**NO SPECIAL SKILLS  
PAY KIT-BY-KIT**

CONCERT MODEL  
Conforms to AGO standards  
32 Bass Pedals

- HANDSOME ASSEMBLED CONSOLES
- DOUBLE KEYBOARDS — 122 KEYS
- ABOVE-KEYBOARD TABS
- CONSOLETTÉ MODEL OCCUPIES ONLY 2' x 3'2" FLOOR SPACE
- BUILT-IN SPEAKERS OPTIONAL (For Consolette Model only)
- COMPLETE DETAILED INSTRUCTIONS
- FREE—NEW 1959 EDITION of 16-page BOOKLET DESCRIBING BOTH MODELS
- 10" LP RECORD DEMONSTRATING BOTH MODELS

available for \$2, refundable on receipt of order

Write today—see what fine instruments you can have at such great savings.

**The SCHOBER ORGAN CORP.**  
2248-L Broadway, New York 24, New York



So many  
exciting new  
**AUDIO FIDELITY**  
records  
we just can't  
show all of them  
... please write for  
free catalog.

**AUDIO FIDELITY, INC.**  
770 ELEVENTH AVENUE  
BOX 421, NEW YORK 19, N. Y.

Record Market

**NEW "STARDUST"  
RECORD CLEANER**

Enables you to wash ALL your records CLEAN of dust and dirt. Protects the label—fits all records. Handy sponge leaves thin film of water to reduce static and enhance reproduction. Keeps wet sponge in airtight holder for easy, repeated use. Pat. Pend. Money back guarantee. Only \$3.95 postpaid. Dealer inquiries invited.



**C & D PRODUCTS CO.**

Old Marlboro Road, East Hampton, Conn.

**RECORD BROWSER**

Holds 100 LP's



Chairlike Browser, puts record collection in order, the moment you receive it! Adjustable plastic stops, allow collection to expand. Open front invites browsing from your favorite easy chair! Self-leveling vinyl pads protect floors and carpets. Sturdy black wrought iron. 19" H. 14" W. 21" D. Please remit \$8.95, or cng. Diners' Acct. Small Express charge collected on delivery. Air-Mail, Money Back! **\$8.95** Guarantee!  
© LESLIE CREATIONS  
Dept. 209R, Lafayette Hill, Pa.

Rush my Record Browser! I enclose \$8.95 Ck. or M.O.  
Name .....  
Address .....  
City .....  
Zone .....

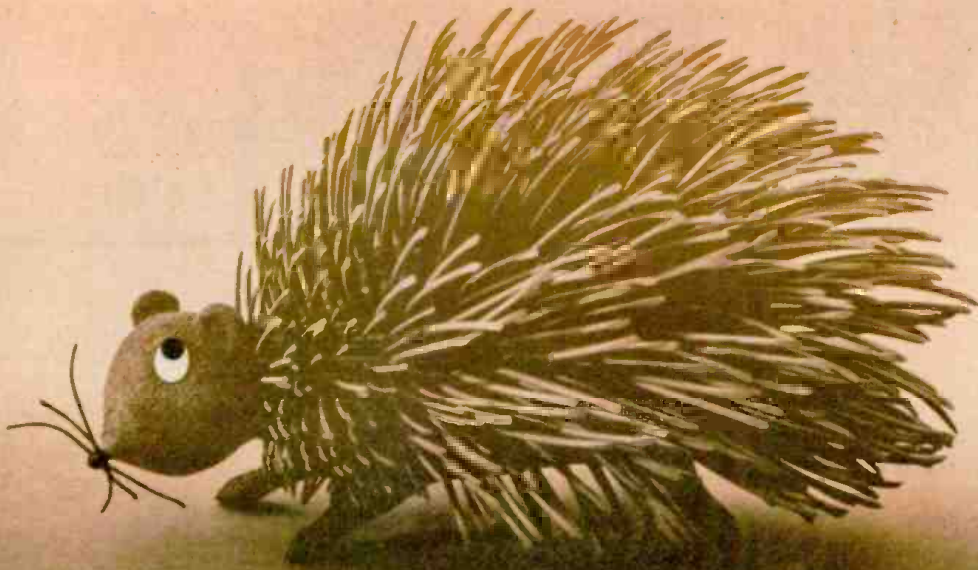

there's this much difference  
in tape surface too!



## ONLY SOUNDCRAFT TAPES ARE MICROPOLISHED SMOOTH!

There's more to tape surface than meets the eye. Any coating process can make the surface of unpolished tape *look* smooth. However, unpolished tape surfaces contain microscopic irregularities that prevent the tape from making intimate contact with the recorder heads. With ordinary tapes, it takes about 10 plays, a "breaking in" period, before these irregularities are smoothed out and proper contact is made.

*During this critical period* you lose important high frequencies and force your recorder heads to do the job of physically polishing the tape surface. This can result in excessive wearing of your recorder heads and in gradual head deterioration.

With SOUNDCRAFT TAPES there is no "breaking in" period—no excessive head wear—no loss of high frequency response...

because SOUNDCRAFT TAPES ARE MICROPOLISHED! MICROPOLISHING is SOUNDCRAFT'S exclusive way of physically polishing the tape to insure a mirror-smooth and irregularity-free tape surface. Your recorder heads make immediate and intimate contact with the tape surface, guaranteeing uniform high frequency response right from the very first play. Remember, *only* SOUNDCRAFT TAPES are MICROPOLISHED for your protection. Buy them—use them, your recorder doesn't deserve less than the best. Write for SOUNDCRAFT'S free catalog RS58-10R.

**EXCLUSIVE BONUS RECORDING** — "Sweet Moods of Jazz in Stereo" recorded on one of two 7" reels of tape in SOUNDCRAFT'S NEW PREMIUM PACK. You pay for the tape plus only \$1.00. Ask your dealer today!



REEVES **SOUNDCRAFT** CORP.

Great Pasture Road, Danbury, Conn. • West Coast: 342 N. La Brea, Los Angeles 36, Calif. • Canada: 700 Weston Road, Toronto 9, Ont., Canada R-59

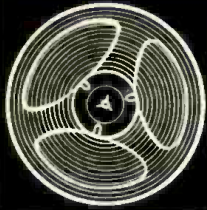

# the **Tape Deck**

Reviewed by R. D. DARRELL

The following brief reviews are of stereo tapes of the conventional 2-track 7½-ips type.

**Larry Fotine's Beale Street Buskers:** "Take Five." Bel Canto STB 45, 23 min., \$9.95.

I suspect that Fotine's Dixieland style is too lighthearted and by no means rough enough for the Real McCoy, but I've heard few present-day Dixie performances which take themselves less seriously, bubble over with so much exuberance, or that are as consistently good fun to listen to—even at their (obviously intentional) corniest. The raggy *Rink Tink Piano Man*, jaunty *Goodbye Blues*, saucy revival of *Yes We Have No Bananas*, and the catchy title piece are perhaps the best of the nine here, but all have a persuasive lilt; and the strongly marked stereoism adds a sonic sheen no less bright than the performances themselves.

**Evelyn Freeman Conducts the Exciting Voices:** "Didn't It Rain." Bel Canto STB 46, 23 min., \$9.95.

The "voices" here are too few for a true chorus and their style is generally closer to jazz than to conventional spiritual singing; but with the assistance of a similarly small and jazzy instrumental ensemble they bring immense fervor to slapdash but robust "gospel-singing" performances of the title song, *All God's Chillun*, and seven other mostly familiar spirituals. But I wish the arranger had made more use of cross-channel-response stereo potentialities: the occasional examples here are tantalizingly few.

**Arthur Lyman Group:** "Leis of Jazz." HiFiTape R 607, 43 min., \$12.95.

Although Lyman's big-band exotic best-sellers, *Taboo* and *Bwana A*, failed to impress me (except for their glittering sonics), his present quartet performances (the leader on vibes, Alan Soares on piano and celesta, John Kramer on bass and percussion, and Harold Chang on percussion) not only enjoy the same thrilling recording expertise and the superb acoustics of the Kaiser Aluminum Dome auditorium, but are consistently zestful and imaginative. I particularly like the cool yet lilting title piece, odd *Trigger Fantasy*, bright *Way You Look Tonight*, and ingenious *Lullaby of Birdland*, but the other eight pieces in this long program are almost equally outstanding.

Lyman and his arranger deserve special kudos for their tasteful use of *sotto-*

*voce* and channel-antiphonal effects, as do the HiFiTape engineers for capturing the kaleidoscopic range of tonal colors here (from the most ethereal tinkle to the solidest timpani thud) in incomparably translucent and aurally bewitching stereo sound. Few pops programs in any medium can match this one in either musical or technical distinction.

**Ralph Marterie:** "Jumpin' Trumpet."

Mercury MVS 2-30, 17 min., \$7.95.

If you want to wean your teen-agers from rock 'n' roll, you can make a good start with Marterie's *Somebody Loves Me, Rain*, and three other lusty pieces here. While these have all the heavy drive and squally brass that the kids demand, there is also enough variety and jaunty songfulness to whet their appetites for more elastically rhythmized and ingeniously colored jazz styles—including those in Latin-American idiom. The last is represented here by a seventh piece, a new arrangement of Marterie's earlier hit, *Guaglione*—a rather incongruous addition to the present program, but one so cleverly scored and festive that it is to be welcomed for its own sake as well as for its exceptionally brilliant and stereoistic recording.

**Diek Schory's New Percussion Ensemble:**

"Music for Bang, BaaROOM, and Harp." RCA Victor CPS 203, 26 min., \$8.95.

The titular stress on "bang" and the annotator's pride in the fact that no less than two large vans full of assorted "kitchenware" were crowded on the stage of Chicago's Orchestra Hall for this recording session misleadingly suggest that the present tape is merely another excruciatingly noisy virtuoso percussion display. It is indeed a fi-man's dream of the glitter, solidity, and enormous dynamic range with which the most steep-fronted transients now can be recorded; but in the present combination of broad-spread stereoism and exceptionally warm and rich auditorium acoustics, the sonics here are as delightful for their crystalline delicacies as they are exciting in their incandescent—yet always musical—climaxes. The arrangements, too, of well-varied pops, exotic, and novelty materials are uncommonly subtle. A "must" tape for every percussion fancier, this should not be missed either by any connoisseur of impressionistic tonal coloring.

**Hugo Winterhalter:** "Goes Latin." RCA Victor CPS 156, 26 min., \$8.95.

Despite its somewhat Hollywoodian arrangements and occasional interpretative

mannerisms, this is one of the best programs I've heard of semisymphonic Latin-American dance music (topped by the leader's own highly atmospheric *Isabel's Tango* based on the fifth Spanish Dance of Granados, his catchy original *La Muñeca Española*, and a dramatic evocation of Mexican bull ring music in *La Marcarena*). And it is technically notable, too, for the marked stereoism and reverberance with which the big band has been ultrabrightly recorded.

**Si Zentner:** "High Noon Cha Cha Cha."

Bel Canto STB 47, 23 min., \$9.95.

The notion of treating the famous film theme song and other pops favorites in cha-cha style might have had lamentable results (as indeed it does in the present version, complete with vocals, of *Sonny Boy*); but the title tune itself and, even more surprisingly, *Softly as in a Morning Sunrise* and *Mr. Sandman*, turn out to be attractively piquant, as are several of the more suitable Latin pieces also included. And the brightly clean recording does full justice to the zestful playing of Zentner's fine flute, marimba, and percussion soloists.

The following brief reviews are of 4-track 3¾-ips stereo "tapettes": supplied on normal reels in the case of the HiFiTape releases; supplied in "cartridge" form (but removed to normal reels for present review purposes) in the case of the RCA Victor "K" releases.

**"Jamaica" Highlights.** Original Broadway Cast. RCA Victor KPS 4002, 47 min., \$8.95.

Since I have heard neither the 7½-ips taping (CPS 100, issued at \$18.95, currently priced at \$15.95) nor the stereo disc version of *Jamaica*, I had assumed that it was largely a one-woman—Lena Horne—show. Miss Horne is indeed starred, and does some of her best singing here, but I was scarcely less impressed by Josephine Premice, Ricardo Montalban, and Adelaide Hall. And although the Broadway critics may have a point in claiming that the calypso-vein music doesn't approach Arlen's best earlier scores, I must confess that I found it invigorating throughout, perhaps thanks as much to the recording engineers, who have so successfully captured its theatrical festivity in wonderfully open stereoism, as to the verve of the performances.

**The Surfers:** "On the Rocks." HiFiTape R 408, 32 min., \$7.95.

Since my private black list of tempera-

# Are you a recording engineer?

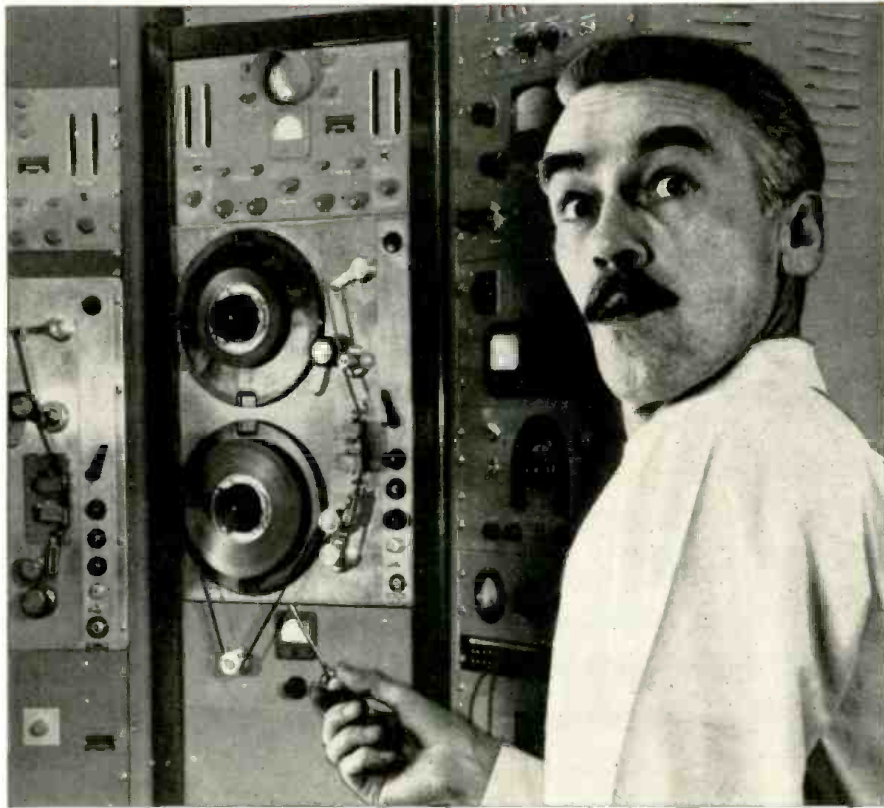

## "No, I'm a plumber

*...but I know good recording tape"*

AUDIOTAPE, the thinking recordist's tape, gives you the full, rich reproduction so satisfying to the happy audiophile — be he doctor, lawyer or Indian chief. Because behind every reel of Audiotape are two decades of research and development in sound recording.

When you buy a reel of Audiotape you're getting the tape that's the professionals' choice. Why? For example, the machines that coat the oxides onto the base material are unique in this field — designed and built by Audio engineers who couldn't find commercial machines that met their rigid specifications. Then there's the C-slot reel — the fastest-threading reel ever developed. For that matter, there's the oxide itself — blended and combined with a special binder that eliminates oxide rub-off.

There are many more reasons why the professionals insist on Audiotape. They know that there is only one quality of Audiotape. And this single top quality standard is maintained throughout each reel, and from reel to reel — for all eight types of Audiotape. That's what makes Audiotape the world's finest magnetic recording tape. For recording engineers, doctors, garbage men, investment brokers, sculptors . . . and plumbers!



Manufactured by AUDIOTAPES, INC.  
444 Madison Ave., New York 22, New York  
Offices in Hollywood & Chicago

# audiotape

TRADE MARK

mental aversions is headed by male quartets and "Hawaiian" music, no one could have been more astonished than I was to find this tape not merely tolerable, but actually enjoyable. These native Hawaiians not only sing well, with practically no suggestion of conventional male-quartet clichés, but their instrumental accompaniments completely avoid the expected queasy ukulele side-slipping glissandos. Moreover, the musical materials themselves (some fourteen pieces in all, topped by the jaunty *Papio* and an amusing *Pidgin English Hula* with spoken translations) are largely confined to authentic island songs. Add excellent recording and unexaggerated yet well-spread stereoism and you have what is by far the best introduction to genuine Hawaiian music that I've ever come across.

George Wright: "Goes South Pacific" and "Flight to Tokyo." HiFiTapes R 716/17, 42 and 40 min., \$7.95 each.

Here George Wright cavorts with characteristic verve and schmaltz through a twelve-item anthology of familiar *South Pacific* tunes and another twelve-item program of pseudo-exotic *divertissements* (*China Nights*, *Japanese Sandman*, etc., not excluding a heart-throbbing slice of Puccinian *Japonaiserie*) which, as the liner notes concede, are about as Japanese as chop suey is Chinese, yet which are admirably suited to display the gong, xylophone, and bell auxiliaries as well as the more normal registration resources of his five-manual ex-Paradise-Theater instrument. Even listeners anesthetic to the charms of theatre organs must agree that Wright is one of their least offensive exponents. He can dish out sentiment with the best, or worst, of them, but he also can be as engagingly amusing as he is here, especially in a *Japanese Can Can* translated very freely from Offenbach and the livelier *South Pacific* pieces. These are surely two of the best of his many releases—and likely to be a revelation to admirers who have known him hitherto only in monophony.

Harry Zimmerman: "Big Dixie." HiFi-Tape R 608, 38 min., \$7.95.

At first I thought the recording here somewhat weaker at the high end than the best of either HiFiTape's or RCA Victor's slow-speed 4-track releases, but I soon realized that this impression was the result of the more-military-than-jazz band scoring, which mainly exploits the middle and lower registers, and which in these regions is captured with impressive strength and depth in exceptionally reverberant acoustics. Zimmerman makes no particular claim to stylistic authenticity in his powerful big-band readings of *Wabash Blues*, *When the Roll Is Called Up Yonder*, *Tiger Rag*, *Darktown Strutters' Ball*, and eight other Dixieland favorites, but his arrangements are both original and effective, and his rollicking performances inferior to none in devil-may-care exuberance.



HIGH FIDELITY MAGAZINE

# Easy-to-build



- style
- performance
- quality

## costs you less!



### PROFESSIONAL STEREO-MONAUROAL AM-FM TUNER KIT

MODEL PT-1 \$89<sup>95</sup>

The 10-tube FM circuit features AFC as well as AGC. An accurate tuning meter operates on both AM and FM while a 3-position switch selects meter functions without disturbing stereo or monaural listening. The 3-tube front end is prewired and prealigned, and the entire AM circuit is on one printed circuit board for ease of construction. Shpg. Wt. 20 lbs.

MODEL SP-2 (stereo)  
\$56<sup>95</sup> Shpg. Wt. 15 lbs.

MODEL SP-1 (monaural)  
\$37<sup>95</sup> Shpg. Wt. 13 lbs.

MODEL C-SP-1  
(converts SP-1 to SP-2)  
\$21<sup>95</sup> Shpg. Wt. 5 lbs.

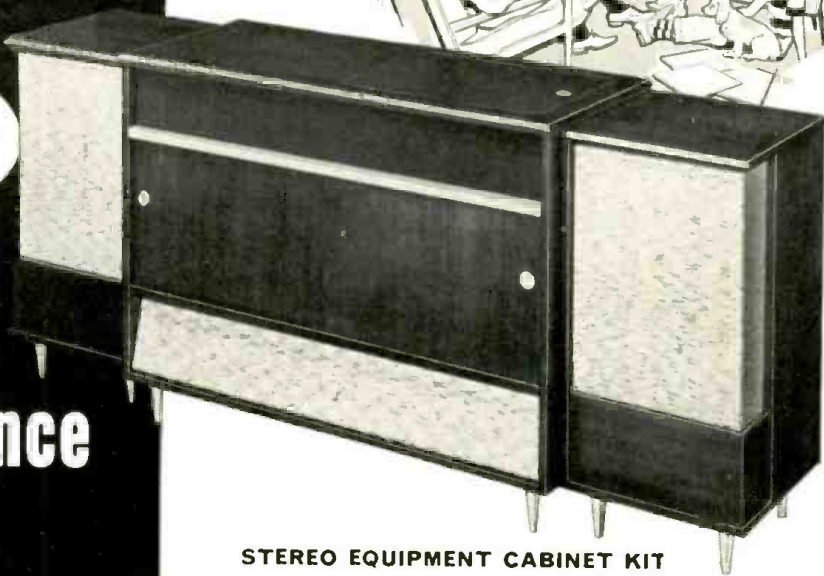

### STEREO EQUIPMENT CABINET KIT

MODEL SE-1 (center unit) \$149<sup>95</sup>  
Shpg. Wt. 162 lbs. (specify wood desired)

MODEL SC-1 (speaker enclosure) \$39<sup>95</sup> each  
Shpg. Wt. 42 lbs. (specify R. or L. also wood desired)

Superbly designed cabinetry to house your complete stereo system. Delivered with pre-cut panels to fit Heathkit AM-FM tuner (PT-1), stereo preamplifier (SP-1 & 2) and record changer (RP-3). Blank panels also supplied to cut out for any other equipment you may now own. Adequate space is also provided for tape deck, speakers, record storage and amplifiers. Speaker wings will hold Heathkit SS-2 or other speaker units of similar size. Available in 3/4" solid core Philippine mahogany or select birch plywood suitable for finish of your choice. Entire top features a shaped edge. Hardware and trim are of brushed brass and gold finish. Rich tone grille cloth is flecked in gold and black. Maximum overall dimensions (all three pieces); 82 3/4" W. x 36 1/2" H. x 20" D.

World's largest manufacturer of  
electronic Instruments in kit form

**HEATH COMPANY**  
Benton Harbor, 8, Michigan



### MONAUROAL-STEREO PREAMPLIFIER KIT (TWO CHANNEL MIXER)

Complete control of your entire stereo system in one compact package. Special "building block" design allows you to purchase instrument in monaural version and add stereo or second channel later if desired. The SP-1 monaural preamplifier features six separate inputs with four input level controls. A function selector switch on the SP-2 provides two channel mixing as well as single or dual channel monaural and dual channel stereo. A 20' remote balance control is provided.

## HIGH FIDELITY RECORD CHANGER KIT

MODEL RP-3 \$64<sup>95</sup>

Every outstanding feature you could ask for in a record changer is provided in the Heathkit RP-3, the most advanced changer on the market today. A unique turntable pause during the change cycle saves wear and tear on your records by eliminating grinding action caused by records dropping on a moving turntable or disc. Record groove and stylus wear are also practically eliminated through proper weight distribution and low pivot point friction of the tone arm, which minimizes arm resonance and tracking error. Clean mechanical simplicity and precision parts give you turntable performance with the automatic convenience of a record changer. Flutter and wow, a major problem with automatic changers, is held to less than 0.18% RMS. An automatic speed selector position allows intermixing 33 $\frac{1}{3}$  and 45 RPM records regardless of their sequence. Four speeds provided: 16, 33 $\frac{1}{3}$ , 45 and 78 RPM. Other features include RC filter across the power switch preventing pop when turned off and muting switch to prevent noise on automatic or manual change cycle. Changer is supplied complete with GE-VR-11 cartridge with diamond LP and sapphire 78 stylus, changer base, stylus pressure gauge and 45 RPM spindle. Extremely easy to assemble. You simply mount a few mechanical components and connect the motor, switches and pickup leads. Shpg. Wt. 19 lbs.

Model RP-3-LP with MF-1 Pickup Cartridge \$74.95

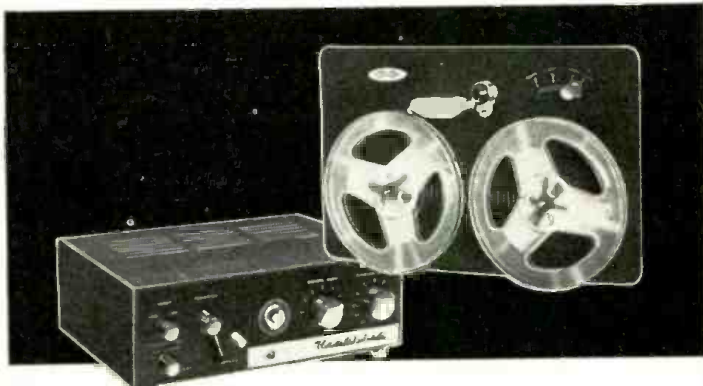

## HIGH FIDELITY TAPE RECORDER KIT

MODEL TR-1A \$99<sup>95</sup> Includes tape deck assembly, preamplifier (TE-1) and roll of tape.

The model TR-1A Tape Deck and Preamplifier, combination provides all the facilities you need for top quality monaural record/playback with fast forward and rewind functions. 7 $\frac{1}{2}$  and 3 $\frac{3}{4}$  IPS tape speeds are selected by changing belt drive. Flutter and wow are held to less than 0.35%. Frequency response at 7 $\frac{1}{2}$  IPS  $\pm 2.0$  db 50-10,000 CPS. at 3 $\frac{3}{4}$  IPS  $\pm 2.0$  db 50-6,500 CPS. Features include NARTB playback equalization—separate record and playback gain controls—cathode follower output and provision for mike or line input. Signal-to-noise ratio is better than 45 db below normal recording level with less than 1% total harmonic distortion. Complete instructions provided for easy assembly. (Tape mechanism not sold separately). Shpg. Wt. 24 lb. Model TE-1 Tape Preamplifier sold separately if desired. Shpg. Wt. 10 lbs. \$39.95.

**IT'S EASY . . . IT'S FUN**  
**And You Save Up To  $\frac{1}{2}$**   
**With Do-It-Yourself Heathkits**

*Putting together your own Heathkit can be one of the most exciting hobbies you ever enjoyed. Simple step-by-step instructions and large pictorial diagrams show you where every part goes. You can't possibly go wrong. No previous electronic or kit building experience is required. You'll learn a lot about your equipment as you build it, and, of course, you will experience the pride and satisfaction of having done it yourself.*



## HIGH FIDELITY AM TUNER KIT

MODEL BC-1A \$26<sup>95</sup>

Designed especially for high fidelity applications this AM tuner will give you reception close to FM. A special detector is incorporated and the IF circuits are "broadbanded" for low signal distortion. Sensitivity and selectivity are excellent and quiet performance is assured by high signal-to-noise ratio. All tunable components are prealigned. Your "best buy" in an AM tuner. Shpg. Wt. 9 lbs.



## HIGH FIDELITY FM TUNER KIT

MODEL FM-3A \$26<sup>95</sup>

For noise and static-free sound reception, this FM tuner is your least expensive source of high fidelity material. Efficient circuit design features stabilized oscillator circuit to eliminate drift after warm-up and broadband IF circuits for full fidelity with high sensitivity. All tunable components are prealigned and front end is preassembled. Edge-illuminated slide rule dial is clearly marked and covers complete FM band from 88 to 108 mc. Shpg. Wt. 8 lbs.



- No Woodworking Experience Required For Construction
- All Parts Precut and Pre drilled For Ease of Assembly

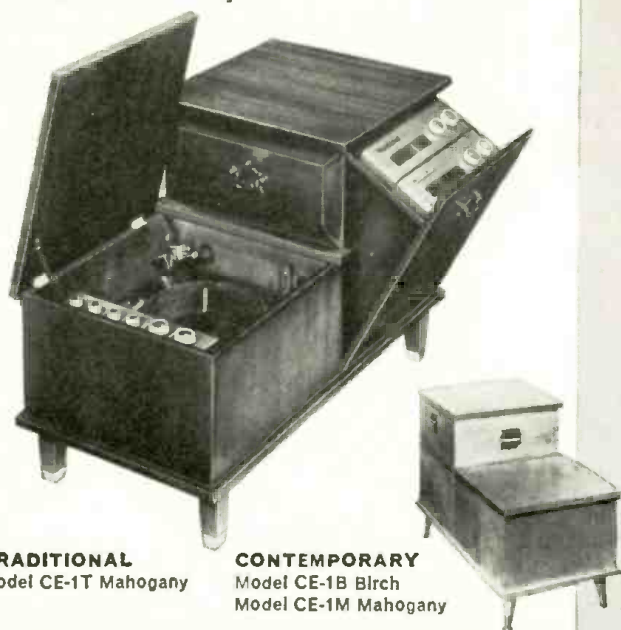

**TRADITIONAL**  
Model CE-1T Mahogany

**CONTEMPORARY**  
Model CE-1B Birch  
Model CE-1M Mahogany

### CHAIRSIDE ENCLOSURE KIT

MODEL CE-1 **\$43<sup>95</sup>** each (Specify model and wood desired when ordering.)

Your complete hi-fi system is right at your fingertips with this handsomely styled chairside enclosure. In addition to its convenience and utility it will complement your living room furnishings with its striking design in either traditional or contemporary models. Designed for maximum flexibility and compactness consistent with attractive appearance, this enclosure is intended to house the Heathkit AM and FM tuners (BC-1A and FM-3A) and the WA-P2 preamplifier, along with the RP-3 or majority of record changers which will fit in the space provided. Well ventilated space is provided in the rear of the enclosure for any of the Heathkit amplifiers designed to operate with the WA-P2. The tilt-out shelf can be installed on either right or left side as desired during construction, and a lift-top lid in front can also be reversed. Both tuners may be installed in tilt-out shelf, with preamp mounted in front of changer . . . or tuner and preamp combined with other tuner in changer area. Overall dimensions are 18" W. x 24" H. x 35½" D. Changer compartment measures 17¾" L. x 16" W. x 9¾" D. All parts are precut and pre-drilled for easy assembly. The Contemporary cabinet is available in either mahogany or birch, and the Traditional cabinet is available in mahogany suitable for the finish of your choice. All hardware supplied. Shpg. Wt. 46 lbs.



### "BOOKSHELF" HI-FI 12 WATT AMPLIFIER KIT

MODEL EA-2 **\$28<sup>95</sup>**

An amplifier and preamplifier in one compact unit, the EA-2 has more than enough power for the average home hi-fi system and provides full range frequency response from 20 to 20,000 CPS within ±1 db, with less than 2% harmonic distortion at full power over the entire range. RIAA equalization, separate bass and treble controls and hum balance control are featured. An outstanding performer for the size and price. Shpg. Wt. 15 lbs.



### "EXTRA PERFORMANCE" 55 WATT HI-FI AMPLIFIER KIT

MODEL W7-M **\$54<sup>95</sup>**

This hi-fi amplifier represents a remarkable value at less than a dollar a watt. Full audio output and maximum damping is a true 55 watts from 20 to 20,000 CPS with less than 2% total harmonic distortion throughout the entire audio range. Features include level control and "on-off" switch right on the chassis, plus provision for remote control. Pilot light on chassis. Modern, functional design. Shpg. Wt. 28 lbs.

World's largest manufacturer of electronic instruments in kit form

## HEATH COMPANY

Benton Harbor, 8, Michigan

 subsidiary of Daystrom, Inc.



### "UNIVERSAL" HI-FI 12 WATT AMPLIFIER KIT

MODEL UA-1 **\$21<sup>95</sup>**

Ideal for stereo or monaural applications. Teamed with the Heathkit WA-P2 preamplifier, the UA-1 provides an economical starting point for a hi-fi system. In stereo applications two UA-1's may be used along with the Heathkit SP-2, or your present system may be converted to stereo by adding the UA-1. Harmonic distortion is less than 2% from 20 to 20,000 CPS at full 12 watt output. "On-off" switch located on chassis and an octal plug is also provided to connect pre-amplifier for remote control operation. Shpg. Wt. 13 lbs.

### "MASTER CONTROL" PREAMPLIFIER KIT

MODEL WA-P2 **\$19<sup>75</sup>**

All the controls you need to master a complete high fidelity home music system are incorporated in this versatile instrument. Featuring five switch-selected inputs, each with level control. Provides tape recorder and cathode-follower outputs. Full frequency response is obtained within ±1½ db from 15 to 35,000 CPS and will do full justice to the finest available program sources. Equalization is provided for LP, RIAA, AES and early 78 records. Dimensions are 12¼" L. x 3¾" H. x 5¾" D. Shpg. Wt. 7 lbs.

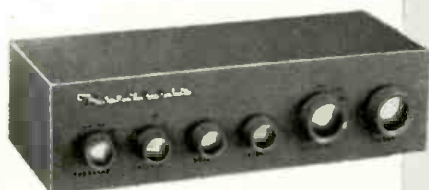



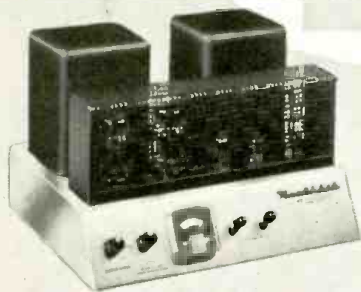

**"HEAVY DUTY" 70 WATT HI-FI AMPLIFIER KIT**  
**MODEL W6-M \$109<sup>95</sup>**

For real rugged duty called for by advance hi-fi systems or P.A. networks, this high powered amplifier more than fills the bill. Silicon-diode rectifiers are used to assure long life and a heavy duty transformer gives you extremely good power supply regulation. Variable damping control provides optimum performance with any speaker system. Quick change plug selects 4, 8 and 16 ohm or 70 volt output and the correct feedback resistance. Frequency response at 1 watt is  $\pm 1$  db from 5 CPS to 80 kc with controlled HF rolloff above 100 kc. At 70 watts output harmonic distortion is below 2%, 20 to 20,000 CPS and IM distortion below 1% 60 and 6,000 CPS. Hum and noise 88 db below full output. Shpg. Wt. 52 lbs.

**YOU'RE NEVER OUT OF DATE WITH HEATHKITS**

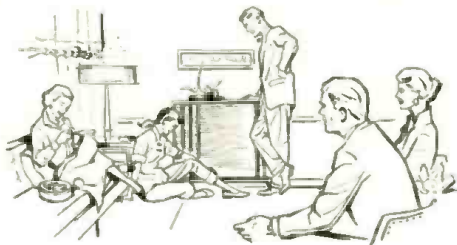

*Heathkit hi-fi systems are designed for maximum flexibility. Simple conversion from basic to complex systems or from monaural to stereo is easily accomplished by adding to already existing units. Heathkit engineering skill is your guarantee against obsolescence. Expand your hi-fi as your budget permits . . . and, if you like, spread the payments over easy monthly installments with the Heath Time Payment Plan.*

**GENERAL-PURPOSE 20 WATT AMPLIFIER KIT**  
**MODEL A9-C \$35<sup>50</sup>**

The model A9-C combines a preamplifier, main amplifier and power supply all on one chassis, providing a compact unit to fill the need for a good amplifier with a moderate cash investment. Features four separate switch-selected inputs. Separate bass and treble tone controls offer 15 db boost and cut. Covers 20 to 20,000 CPS within  $\pm 1$  db. A fine unit with which to start your own hi-fi system. Shpg. Wt. 23 lbs.

**ELECTRONIC CROSSOVER KIT**  
**MODEL XO-1 \$18<sup>95</sup>**

This unique instrument separates high and low frequencies and feeds them through two amplifiers to separate speakers. It is located ahead of the main amplifiers, thus, virtually eliminating IM distortion and matching problems. Crossover frequencies for each channel are at 100, 200, 400, 700, 1200, 2,000 and 3,500 CPS. This unit eliminates the need for conventional crossover circuits and provides amazing versatility at low cost. A unique answer to frequency division problems. Shpg. Wt. 6 lbs.

**"ADVANCE DESIGN" 25 WATT HI-FI AMPLIFIER KIT**

**MODEL W5-M \$59<sup>75</sup>**

Enjoy the distortion-free high fidelity sound reproduction from this outstanding hi-fi amplifier. The W5-M incorporates advanced design features for the super critical listener. Features include specially designed Peerless output transformer and KT66 tubes. The circuit is rated at 25 watts and will follow instantaneous power peaks of a full orchestra up to 42 watts. A "tweeter saver" suppresses high frequency oscillation and a unique balancing circuit facilitates adjustment of output tubes. Frequency response is  $\pm 1$  db from 5 to 160,000 CPS at 1 watt and within  $\pm 2$  db 20 to 20,000 CPS at full 25 watts output. Harmonic distortion is less than 1% at 25 watts and 1M distortion is 1% at 20 watts (60 and 3,000 CPS, 4:1). Hum and noise are 99 db below 25 watts for truly quiet performance. Shpg. Wt. 31 lbs.



**20 WATT HI-FI AMPLIFIER KIT**  
**MODEL W4-AM \$39<sup>75</sup>**

This top quality amplifier offers you full fidelity at minimum cost. Features extended frequency response, low distortion and low hum level. Harmonic distortion is less than 1.5% and IM distortion is below 2.7% at full 20 watt output. Frequency response extends from 10 CPS to 100,000 CPS within  $\pm 1$  db at 1 watt. Output transformer tapped at 4, 8 and 16 ohms. Easy to build and a pleasure to use. Shpg. Wt. 28 lbs.

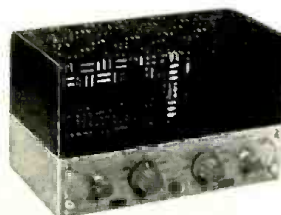
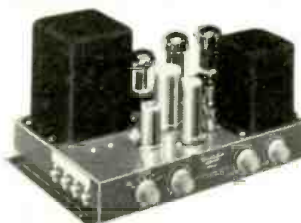

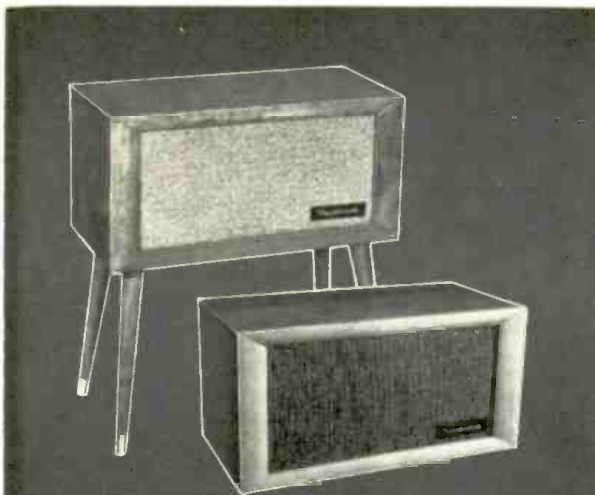

**"BASIC RANGE" HI-FI SPEAKER SYSTEM KIT**

MODEL SS-2 **\$39<sup>95</sup>**

Legs optional extra. \$4.95

Outstanding performance at modest cost make this speaker system a spectacular buy for any hi-fi enthusiast. The specially designed enclosure and high quality 8" mid-range woofer and compression-type tweeter cover the frequency range of 50 to 12,000 CPS. Crossover circuit is built in with balance control. Impedance is 16 ohms, power rating 25 watts. Cabinet is constructed of veneer-surfaced furniture-grade 1/2" plywood suitable for light or dark finish. Shpg. Wt. 26 lbs.



**"LEGATO" HI-FI SPEAKER SYSTEM KIT**

MODEL HH-1 **\$299<sup>95</sup>**

Words cannot describe the true magnificence of the "Legato" speaker system . . . it's simply the nearest thing to perfection in reproduced sound yet developed. Perfect balance, precise phasing, and adequate driver design all combine to produce startling realism long sought after by the hi-fi perfectionist. Two 15" Altec Lansing low frequency drivers and a specially designed exponential horn with high frequency driver cover 25 to 20,000 CPS. A unique crossover network is built in. Impedance is 16 ohms, power rating 50 watts. Cabinet is constructed of 3/4" veneer-surfaced plywood in either African mahogany or imported white birch suitable for the finish of your choice. All parts are precut and predrilled for easy assembly. Shpg. Wt. 195 lbs.

**"RANGE EXTENDING" HI-FI SPEAKER SYSTEM KIT**

MODEL SS-1B **\$99<sup>95</sup>**

Not a complete speaker system in itself, the SS-1B is designed to extend the range of the basic SS-2 (or SS-1) speaker system. Employs a 15" woofer and a super tweeter to extend overall response from 35 to 16,000 CPS ± 5 db. Crossover circuit is built-in with balance control. Impedance is 16 ohms, power rating 35 watts. Constructed of 3/4" veneer-surfaced plywood suitable for light or dark finish. All parts precut and predrilled for easy assembly. Shpg. Wt. 80 lbs.

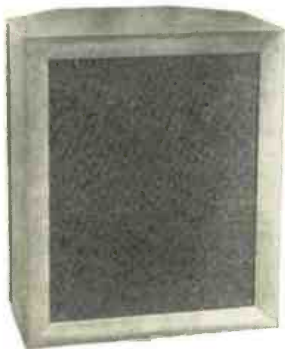

**DIAMOND STYLUS HI-FI PICKUP CARTRIDGE**

MODEL MF-1 **\$26<sup>95</sup>**

Replace your present pickup with the MF-1 and enjoy the fullest fidelity your library of LP's has to offer. Designed to Heath specifications to offer you one of the finest cartridges available today. Nominally flat response from 20 to 20,000 CPS. Shpg. Wt. 1 lb.

**SPEEDWINDER KIT**

MODEL SW-1 **\$24<sup>95</sup>**

Rewind tape and film at the rate of 1200' in 40 seconds. Saves wear on tape and recorder. Handles up to 10 1/2" tape reels and 800' reels of 8 or 16 millimeter film. Incorporates automatic shutoff and braking device. Shpg. Wt. 12 lbs.



**NEW! "DOWN-TO-EARTH" High-Fidelity Book**

The "HOW AND WHY OF HIGH FIDELITY", by Milton Sleeper explains what high fidelity is, and how you can select and plan your own system. This liberally-illustrated 48-page book tells you the hi-fi story without fancy technical jargon or high-sounding terminology. 25c.

**SEND FOR FREE CATALOG**

Write today for free catalog describing over 100 easy-to-build kits in hi-fi—test—marine and amateur radio fields. Complete specifications, schematics, and detailed information to help you in your selection.



**HEATH**

*pioneer in "do-it-yourself" electronics*

Enclosed find \$..... Please enclose postage for parcel post—express orders are shipped delivery charges collect. All prices F.O.B. Benton Harbor, Mich. A 20% deposit is required on all C.O.D. orders. Prices subject to change without notice.

**COMPANY • BENTON HARBOR 8, MICH.**

**H** a subsidiary of Daystrom, Inc.

- Please send the Free Heathkit catalog.
- Enclosed is 25c for the Hi-Fi book.

name \_\_\_\_\_

address \_\_\_\_\_

city & state \_\_\_\_\_

QUANTITY	ITEM	MODEL NO.	PRICE

## This Man is Using an Electronic Crystal Ball

The H. H. Scott advance development team must foresee the future. They must design new products so that they stay current for many years. Hermon Hosmer Scott insists on this as a protection to your investment.

The new 130 Stereo preamp is an example of the way Scott engineers work ahead. Engineering of this brand new product was started when stereo was nothing more than a hobbyist's delight. This allowed time for thorough testing of its many advanced features.

Careful, long-range planning has always made H. H. Scott a top buy. The 330 Stereo AM-FM tuner is an example. When the 330 was first marketed in 1955, it was designed for stereo . . . it used wide-band circuitry . . . it was equipped for multiplex . . . it included many new engineering advances to keep it current for years to come.

Every H. H. Scott component is designed to defy obsolescence. Careful planning, fine engineering, exceptional quality mean your investment in the new H. H. Scott stereo-preamp . . . or any H. H. Scott product . . . is an investment in a component that will still be up-to-date many years from now.

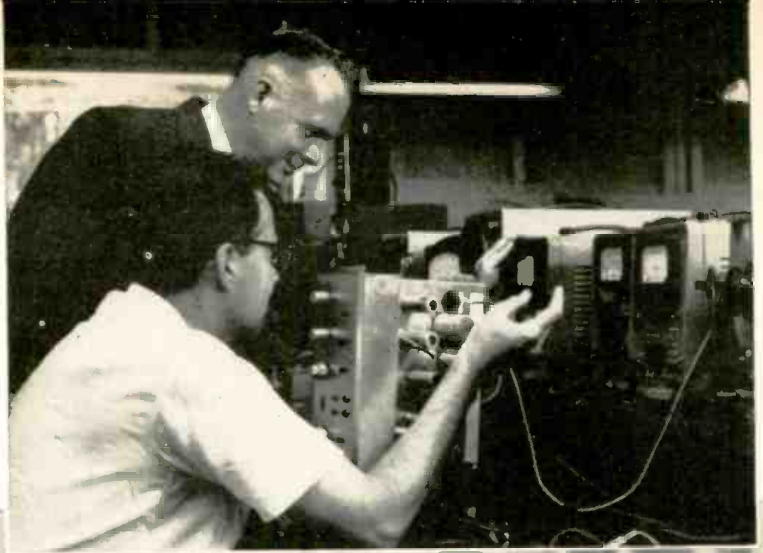

17 reasons why you should buy the

# New H. H. Scott Stereo- Preamp



H. H. SCOTT, INC., 111 POWDERMILL RD., MAYNARD, MASS.  
EXPORT: TELESKO INTERNATIONAL CORP., 35 W. 40TH ST., N. Y. C.

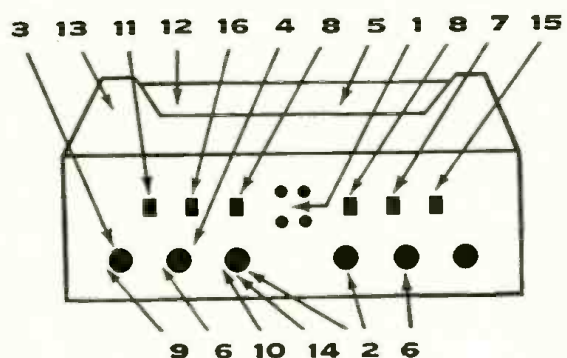

1 Visual signal light display panel shows mode of operation at a glance. 2 Completely separate bass and treble controls on each channel so that different speakers may be matched. 3 Play stereo from any source — Records, FM-AM Tuner, Tape. 4 Reverse channels instantly, or play monaural from any source through both channels doubling your power. 5 Play Trereo — a center channel output lets you use your present speaker as a middle channel. 6 Special circuitry lets you balance channels quickly and accurately. 7 Reverse the phase of one of your channels 180 degrees instantly. Lets you correct for improperly recorded tapes. 8 Separate 12 db/octave rumble and scratch filters. 9 Complete record equalizer facilities. 10 Use as an electronic crossover at any time. 11 Two stereo low-level inputs. You can connect both a stereo phono pickup and stereo tape head. 12 Stereo tape recorder inputs and outputs. 13 Provision for operating stereo tape heads without external preamps. 14 Quick-set dot controls allow any member of your family to use equipment. 15 Loudness-volume switch. 16 Stereo tape monitor switch. 17 The exceptional quality of all H. H. Scott components . . . PLUS all the features and specifications long associated with H. H. Scott monaural preamplifiers.



Sensitivity  $1\frac{1}{2}$  millivolts on tape head input, 3 millivolts on phono for full output. Hum level 80 db below full output on high level outputs. Size in accessory case  $15\frac{1}{2}$  w x 5 h x  $12\frac{1}{4}$  d. Model 130 price \$109.95 (\$172.95, West of Rockies).

Write for complete technical specifications and new catalog HF-4

## Some tips on

# Adding the Third Channel

Some stereo systems suffer from lack of center fill. Here's how to plug that hole in the middle.

THE PRACTICABILITY of two-channel stereo reproduction is based on the assumption that any sound picked up with equal intensity by two microphones and reproduced with equal intensity by two loudspeakers will appear to emanate from a point midway between the loudspeakers. This is true in theory, but it doesn't always work in practice, as witness the number of stereo listeners who point a critical finger at a vaguely-defined area between stage left and stage right—the area commonly known as the “hole in the middle.”

An ideal stereophonic reproduction of a large performing group will, when heard from a point equidistant from the loudspeakers (and at least as far away from them as the distance between them), provide an even spread of sound across the entire area between the speakers. Front row performers at the middle of the group will sound as close to the listener as those at the sides of the stage, and the location of all performers should be equally distinguishable. When the listener moves to one side, he should hear the instruments on that side of the stage more loudly, but he should still be able to hear the ones on the other side of the stage coming from the other speaker.

Unfortunately, the ideal is not always achieved, partly because recording engineers aren't yet thoroughly familiar with this new medium, partly because the reproducing loud-

speakers may not be suited for or placed for optimum stereo reproduction, and partly because of the psychological effect of being able to see two distinct sources. Thus, instead of the continuous “curtain of sound,” we may get something resembling a bow tie: broad and full at the ends, and pinched in the middle.

The “hole in the middle” is rarely a totally vacant area; more often, it causes a “ping-pong” effect whereby performers who should be located between the speakers seem to jump from one side to the other instead of staying put. In its milder forms, it simply shows up as a vagueness in the location of middle instruments—a perfectly natural phenomenon in the concert hall, but one that is hard to accept when, in the living room, the performers at the sides of the group are often so pinpointed you almost feel you could aim a rifle at them.

Given optimum placement of microphones at the recording session, the most usual causes of the hole in the middle are excessive spacing between or disadvantageous orientation of loudspeaker systems which tend to be directional at high frequencies. Wide speaker spacing increases the breadth and massiveness of stereo reproduction; close spacing solidifies the middle, but reduces the spaciousness of the sound. Optimal spacing and orientation of speakers depend upon their directional characteristics, the acoustics of the listening room, and the distance the listener sits from the speakers. But there are instances when it is impossible to place stereo speakers optimally, so several schemes have been worked out to plug up the resulting hole between them.

These remedial systems fall into two broad categories which we will call, for want of better designations, A+B and A-B arrangements.

An A+B system utilizes a mixture (or addition) of the left- and right-hand channel signals, whereas an A-B system utilizes the signal that is left over when the main channel signals are subtracted from one another. This remnant is the so-called difference signal, which causes the stereo effect.

The simplest form of A+B'ing works on the principle that monophonic sound, reproduced through a stereo system, appears to emanate from a narrow area between the speakers.\* The trick here is to use a “blend control,” whose range varies from total channel isolation (normal stereo) to total channel blending (mono sound through both speakers). Rotation of this control has precisely the same subjective effect as varying the distance between the speakers; increased blending tends to move the sound sources towards the middle, improving center fill-in and decreasing spaciousness.

In order to strengthen the center *without* unduly sacrificing breadth, it is necessary to add a third speaker between the main ones, and feed this with a separate signal that is related to the main stereo signals.

One inexpensive approach to this is Paul Klipsch's A-B arrangement, utilizing his Model H speaker (H for heresy, meaning noncorner). The center speaker is connected between the “hot” output terminals of both amplifiers (Figure 1), where equal voltages are produced when both amplifiers pass identical signals. Thus, voltage is

Continued on page 125

\* It is assumed throughout this discussion that both main speakers are in phase with and identical to one another. Identical speakers provide the least spaciousness from monophonic material, but give the least shifting of sources when reproducing stereo.

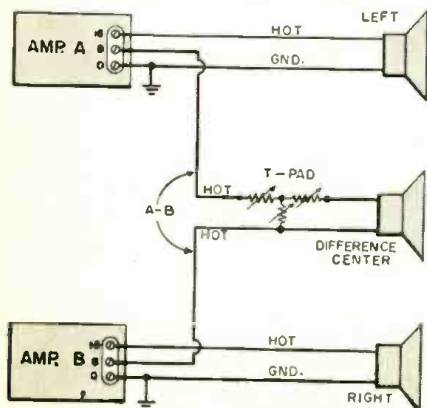

Figure 1. A speaker tied to both “hot” outputs reproduces difference signals.

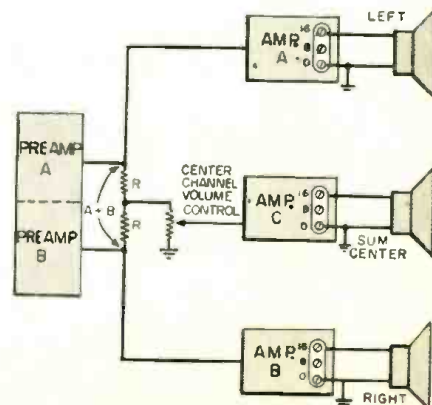

Figure 2. Resistors (R) mix the stereo signals to give a third-channel output.

# The HF Shopper, No. 3C: Stereo Cartridges. See comments on facing page.

Manufacturer or Importer	Model		Tip Rad., Mils	Tip Rep. by User?	Vert. Comp. %	Lat. Comp. %	Eff. Tip Mass, Mg	Rec. Min. Force		Rec. Load, Per Chan.	Output, Per Chan.	Response <sup>5</sup>	Chan. Sep., db	Basic Price		Stylus Rep. Cost	
	Dia. <sup>1</sup>	Sapp. <sup>1</sup>						Pro. Arm	Chgr.					Dia. <sup>1</sup>	Sapp. <sup>1</sup>	Dia. <sup>1</sup>	Sapp. <sup>1</sup>
Astatic	13-TB <sup>10</sup>	13-TB	0.7 & 3 <sup>11</sup>	No <sup>7</sup>	1	1	13	7 gm	7 gm	2 Meg	0.5 v	20-15,000	20	\$16.50 <sup>8</sup>	\$7.95	\$15.50 <sup>8</sup>	\$6.95
Audiogersht	200	none	0.7	Yes	4.1	4.1	—	4 gm	4-6 gm	47 K	10 mv	30-18,500 <sup>11</sup>	20	44.50	none	24.50	none
CBS-Columbia	SC-1D <sup>10</sup>	SC-1S <sup>10</sup>	0.8	Yes	2	2	—	5-7 gm	5-7 gm	1 Meg	0.4 v	30-20,000	—	24.25	—	—	—
Duotone (Acos)	GP73D <sup>11</sup>	GP73S	0.7 & 3	Yes	4	4	—	2 gm	4 gm	0.5 Meg	1 v	40-15,000	25	20.70 <sup>11</sup>	8.70	6.95	3.50
Dynaco (B & O)	Stereodyne	none	0.7	Yes	5	5	3	2 gm	4 gm	47 K	7 mv	30-15,000 <sup>9</sup>	22	29.95	none	14.95	none
Electro-Sonic	C100	none	0.7	No	5	5	2	1 gm	4 gm	— <sup>12</sup>	0.5 mv	35-15,000	20	69.95 <sup>13</sup>	none	—	none
Electro-Voice	21D, 26DST	21S, 26ST	0.7 & 3 <sup>11</sup>	Yes	4	4	—	4-6 gm	4-6 gm	3-9 Meg	0.5 v	20-16,000	25	19.50 <sup>14</sup>	9.90 <sup>15</sup>	9.90	2.10
	21MD, 26MDST	21S, 26MST	0.7 & 3 <sup>11</sup>	Yes	4	4	—	4-6 gm	4-6 gm	20-100 K	20 mv	20-16,000	25	19.50 <sup>15</sup>	9.90 <sup>15</sup>	9.90	2.10
	61DS, 66DS	61, 66	0.7 & 3 <sup>17</sup>	No <sup>7</sup>	2.5	2.5	—	4-6 gm	4-6 gm	3-9 Meg	0.5 v	20-15,000	—	15.50 <sup>18</sup>	5.95 <sup>18</sup>	— <sup>7</sup>	— <sup>7</sup>
Erie Resistor	1304 <sup>8</sup>	1303	0.7 & 3	—	3	3	—	5-6 gm	5-6 gm	2 Meg	0.5 v	20-16,000	20	24.50 <sup>14</sup>	14.50 <sup>14</sup>	—	—
Fairchild	232	none	0.6	No <sup>19</sup>	6	6	3	3 gm	3 gm	5 K +	4 mv	10-20,000	25	49.50	none	22.50 <sup>19</sup>	none
General Electric	GC-7	CL-7	0.7	Yes	2	3	2	3.5 gm	5 gm	50-100 K	8 mv	20-17,000	20+	23.95	16.95	9.95	2.50
	GC-5	none	0.7	Yes	2.5	4	2	2 gm	— <sup>20</sup>	50-100 K	8 mv	20-20,000	20+	26.95	none	11.95	none
	DST	none	0.6	No	3.4	3.4	—	4 gm	— <sup>20</sup>	50 ohms	0.75 mv	30-15,000 <sup>9</sup>	38	69.00	none	20.00	none
	Stereo Sid.	none	0.7	No	— <sup>21</sup>	— <sup>21</sup>	1	4 gm	4 gm	5 K +	2.5 mv	10-35,000 <sup>23</sup>	—	49.50	none	21.50	none
	Special <sup>22</sup>	none	0.7	Yes	4	4	—	— <sup>22</sup>	3-6 gm	50 K	5 mv	30-14,000 <sup>23</sup>	—	— <sup>22</sup>	none	—	none
Heath	SF-1	none	0.6	Yes	4.3	5	—	1 1/2 gm	3-4 gm	47 K	3 mv	20-15,000 <sup>23</sup>	25	39.95	none	13.95	none
Pickering	371	none	0.7 <sup>21</sup>	Yes	4-6	4-6	—	2-4 gm <sup>25</sup>	4-6 gm <sup>26</sup>	27 K	10 mv	20-15,000 <sup>8</sup>	24	29.85	none	18.00	none
Recofon	RG74S <sup>27</sup>	none	0.7 & 1 or 3	Yes	4	4	3	3-5 gm	3-5 gm	68 K	4 mv	20-15,000 <sup>9</sup>	20+	29.95	none	11.95	—
	BF-40-4/D	BF-40-4	0.75	Yes	3.5	3.5	—	2-5 gm	—	1 Meg	0.35 v	30-15,000	24	18.30	12.00	6.70	1.10
Ronette	Stereo OV/D <sup>8</sup>	Stereo OV	0.75 & 2.5	Yes	3	3	—	2-5 gm	—	1 Meg	0.3 v	30-12,000	15	19.00 <sup>8</sup>	12.75	6.70	1.10
	Stereo T/D <sup>8</sup>	Stereo T	0.75 & 2.5	Yes	2.5	2.5	—	3-6 gm	—	1 Meg	0.7 v	30-12,000	12	19.00 <sup>8</sup>	12.75	6.70	1.10
	M3D	none	0.7	Yes	4	4	2	3 gm	3-6 gm	50 K	5 mv	50-15,000 <sup>24</sup>	20	45.00	none	22.50	none
Shure	M7D	none	0.7	Yes	3.5	3.5	2	4 gm	4-7 gm	47 K	5 mv	50-15,000	20	24.00	none	12.00	none
	8T4 <sup>28</sup>	8T4 <sup>29</sup>	0.7 & 3 <sup>29</sup>	Yes	2	2	11	5-7 gm	5-7 gm	2.2 Meg	0.3 v	20-12,000	20	— <sup>30</sup>	— <sup>30</sup>	— <sup>30</sup>	— <sup>30</sup>
Sonotone	10T <sup>21</sup>	10T <sup>21</sup>	0.7 & 3 <sup>31</sup>	Yes	1.3	1.3	8	5-7 gm	5-7 gm	2.4 Meg	0.5 v	20-15,000	18	— <sup>32</sup>	— <sup>32</sup>	— <sup>32</sup>	— <sup>32</sup>
	C501D	C501S	0.7	Yes	6	6	1	2 gm	4 gm	47 K <sup>33</sup>	25 mv	20-20,000 <sup>9</sup>	25	17.50	9.75	12.75	4.50
Weathers	SM-100 <sup>34</sup>	SM-105 <sup>34</sup>	0.7	Yes	20	20	0.5	1 gm	—	—	—	10-35,000 <sup>35</sup>	30	— <sup>31</sup>	— <sup>31</sup>	— <sup>31</sup>	— <sup>31</sup>
Webster Electric	SC-2D, SC-3D	none	0.7 & 3 <sup>36</sup>	—	—	—	—	5-7 gm	5-7 gm	—	0.5 v	30-15,000	—	— <sup>36</sup>	none	—	—
Westrex	10-A	none	0.7	No	2.6	2.6	3	5-7 gm	—	—	0.65 mv	40-15,000	23	275.00	none	—	none

Notes: Dash indicates information not supplied. **1**—For dual-stylus cartridges, this refers to the stereo stylus; **2**—"crys" indicates crystal; "cer" indicates ceramic; "vr" indicates variable reluctance; "mm" indicates moving coil; "mm" indicates moving magnet; "FM" indicates frequency modulation type. **3**—Expressed in microcentimeters per dyne. **4**—Expressed as mv at 1 kc at 5 cm/second stylus velocity. **5**—Range specification, if decibel limits are specified, this is indicated by a note in each case. **6**—Model 1117B is identical in price and specifications with Model 13 TB except that two 0.7-mil sapphire styli are supplied. **7**—Replacement plug-in cartridge includes stylus. **8**—Diamond 0.7-mil stylus; sapphire 3-mil stylus. **9**—2 db. **10**—Also available are Models SC-2D and SC-2S, with reversed phasing for matrix-type stereo amplifiers; unusable with conventional stereo amplifiers. **11**—Both styli are diamond. Model GP73SD, at \$14.70, has diamond 0.7-mil and sapphire 3-mil styli. **12**—Load value not critical. **13**—If transformers are required, Model TM-100 transformers are available at \$15.00 pair. **14**—Models 21D and 21S have single 0.7-mil styli, diamond and sapphire, respectively; Model 26ST has diamond, 0.7-mil and sapphire, 3-mil styli; Model 26ST has 0.7-mil and 3-mil sapphire styli. **15**—Price for single-stylus models. For dual-stylus types, add \$3.00. **16**—Identical to corresponding models above, except intended for use in magnetic-type input circuits. **17**—Model 61DS has two 0.7-mil styli, one diamond and one sapphire; Model 61 has two 0.7-mil sapphire styli; Model 66DS has diamond 0.7-mil and sapphire 3-mil styli; Model 66 has sapphire 0.7-mil and 3-mil styli. **18**—Stylus price. **19**—Old cartridge will be exchanged for new cartridge by any dealer for stylus replacement price. **20**—Not recommended for changers. **21**—Dependent on stylus force. **22**—50 only as part of Heath RP-3 record changer; total price, \$74.95. **23**—4 db. **24**—Other sizes on request. **25**—With D3707-A stylus. **26**—With D3707-C stylus. **27**—Model RG74S-1SD has 0.7-mil diamond and 1-mil sapphire Model RG74S-3SD has 0.7-mil diamond and 3-mil sapphire. **28**—3 db. **29**—Model 8T4-D has 0.7-mil and 3-mil diamond and 1-mil sapphire Model 8T4-SD has 0.7-mil diamond and 3-mil sapphire. Model 8T4-S has 0.7-mil diamond and 3-mil sapphire styli; Model 8T4-SW has two 0.7-mil sapphire styli. **30**—Stylus prices. **31**—Model 10T-SD has 0.7-mil diamond and 3-mil sapphire styli; Model 10T-SW has two 0.7-mil sapphire styli. **32**—Stylus prices. **33**—Stylus prices. **34**—Model 10T-SD has 0.7-mil diamond and 3-mil sapphire styli; Model 10T-SW has two 0.7-mil sapphire styli. **35**—Stylus prices. **36**—Intended for use in magnetic-type input circuits. **37**—Stylus prices. **38**—Stylus prices. **39**—Stylus prices. **40**—Stylus prices. **41**—Stylus prices. **42**—Stylus prices. **43**—Stylus prices. **44**—Stylus prices. **45**—Stylus prices. **46**—Stylus prices. **47**—Stylus prices. **48**—Stylus prices. **49**—Stylus prices. **50**—Stylus prices. **51**—Stylus prices. **52**—Stylus prices. **53**—Stylus prices. **54**—Stylus prices. **55**—Stylus prices. **56**—Stylus prices. **57**—Stylus prices. **58**—Stylus prices. **59**—Stylus prices. **60**—Stylus prices. **61**—Stylus prices. **62**—Stylus prices. **63**—Stylus prices. **64**—Stylus prices. **65**—Stylus prices. **66**—Stylus prices. **67**—Stylus prices. **68**—Stylus prices. **69**—Stylus prices. **70**—Stylus prices. **71**—Stylus prices. **72**—Stylus prices. **73**—Stylus prices. **74**—Stylus prices. **75**—Stylus prices. **76**—Stylus prices. **77**—Stylus prices. **78**—Stylus prices. **79**—Stylus prices. **80**—Stylus prices. **81**—Stylus prices. **82**—Stylus prices. **83**—Stylus prices. **84**—Stylus prices. **85**—Stylus prices. **86**—Stylus prices. **87**—Stylus prices. **88**—Stylus prices. **89**—Stylus prices. **90**—Stylus prices. **91**—Stylus prices. **92**—Stylus prices. **93**—Stylus prices. **94**—Stylus prices. **95**—Stylus prices. **96**—Stylus prices. **97**—Stylus prices. **98**—Stylus prices. **99**—Stylus prices. **100**—Stylus prices. **101**—Stylus prices. **102**—Stylus prices. **103**—Stylus prices. **104**—Stylus prices. **105**—Stylus prices. **106**—Stylus prices. **107**—Stylus prices. **108**—Stylus prices. **109**—Stylus prices. **110**—Stylus prices. **111**—Stylus prices. **112**—Stylus prices. **113**—Stylus prices. **114**—Stylus prices. **115**—Stylus prices. **116**—Stylus prices. **117**—Stylus prices. **118**—Stylus prices. **119**—Stylus prices. **120**—Stylus prices. **121**—Stylus prices. **122**—Stylus prices. **123**—Stylus prices. **124**—Stylus prices. **125**—Stylus prices. **126**—Stylus prices. **127**—Stylus prices. **128**—Stylus prices. **129**—Stylus prices. **130**—Stylus prices. **131**—Stylus prices. **132**—Stylus prices. **133**—Stylus prices. **134**—Stylus prices. **135**—Stylus prices. **136**—Stylus prices. **137**—Stylus prices. **138**—Stylus prices. **139**—Stylus prices. **140**—Stylus prices. **141**—Stylus prices. **142**—Stylus prices. **143**—Stylus prices. **144**—Stylus prices. **145**—Stylus prices. **146**—Stylus prices. **147**—Stylus prices. **148**—Stylus prices. **149**—Stylus prices. **150**—Stylus prices. **151**—Stylus prices. **152**—Stylus prices. **153**—Stylus prices. **154**—Stylus prices. **155**—Stylus prices. **156**—Stylus prices. **157**—Stylus prices. **158**—Stylus prices. **159**—Stylus prices. **160**—Stylus prices. **161**—Stylus prices. **162**—Stylus prices. **163**—Stylus prices. **164**—Stylus prices. **165**—Stylus prices. **166**—Stylus prices. **167**—Stylus prices. **168**—Stylus prices. **169**—Stylus prices. **170**—Stylus prices. **171**—Stylus prices. **172**—Stylus prices. **173**—Stylus prices. **174**—Stylus prices. **175**—Stylus prices. **176**—Stylus prices. **177**—Stylus prices. **178**—Stylus prices. **179**—Stylus prices. **180**—Stylus prices. **181**—Stylus prices. **182**—Stylus prices. **183**—Stylus prices. **184**—Stylus prices. **185**—Stylus prices. **186**—Stylus prices. **187**—Stylus prices. **188**—Stylus prices. **189**—Stylus prices. **190**—Stylus prices. **191**—Stylus prices. **192**—Stylus prices. **193**—Stylus prices. **194**—Stylus prices. **195**—Stylus prices. **196**—Stylus prices. **197**—Stylus prices. **198**—Stylus prices. **199**—Stylus prices. **200**—Stylus prices. **201**—Stylus prices. **202**—Stylus prices. **203**—Stylus prices. **204**—Stylus prices. **205**—Stylus prices. **206**—Stylus prices. **207**—Stylus prices. **208**—Stylus prices. **209**—Stylus prices. **210**—Stylus prices. **211**—Stylus prices. **212**—Stylus prices. **213**—Stylus prices. **214**—Stylus prices. **215**—Stylus prices. **216**—Stylus prices. **217**—Stylus prices. **218**—Stylus prices. **219**—Stylus prices. **220**—Stylus prices. **221**—Stylus prices. **222**—Stylus prices. **223**—Stylus prices. **224**—Stylus prices. **225**—Stylus prices. **226**—Stylus prices. **227**—Stylus prices. **228**—Stylus prices. **229**—Stylus prices. **230**—Stylus prices. **231**—Stylus prices. **232**—Stylus prices. **233**—Stylus prices. **234**—Stylus prices. **235**—Stylus prices. **236**—Stylus prices. **237**—Stylus prices. **238**—Stylus prices. **239**—Stylus prices. **240**—Stylus prices. **241**—Stylus prices. **242**—Stylus prices. **243**—Stylus prices. **244**—Stylus prices. **245**—Stylus prices. **246**—Stylus prices. **247**—Stylus prices. **248**—Stylus prices. **249**—Stylus prices. **250**—Stylus prices. **251**—Stylus prices. **252**—Stylus prices. **253**—Stylus prices. **254**—Stylus prices. **255**—Stylus prices. **256**—Stylus prices. **257**—Stylus prices. **258**—Stylus prices. **259**—Stylus prices. **260**—Stylus prices. **261**—Stylus prices. **262**—Stylus prices. **263**—Stylus prices. **264**—Stylus prices. **265**—Stylus prices. **266**—Stylus prices. **267**—Stylus prices. **268**—Stylus prices. **269**—Stylus prices. **270**—Stylus prices. **271**—Stylus prices. **272**—Stylus prices. **273**—Stylus prices. **274**—Stylus prices. **275**—Stylus prices. **276**—Stylus prices. **277**—Stylus prices. **278**—Stylus prices. **279**—Stylus prices. **280**—Stylus prices. **281**—Stylus prices. **282**—Stylus prices. **283**—Stylus prices. **284**—Stylus prices. **285**—Stylus prices. **286**—Stylus prices. **287**—Stylus prices. **288**—Stylus prices. **289**—Stylus prices. **290**—Stylus prices. **291**—Stylus prices. **292**—Stylus prices. **293**—Stylus prices. **294**—Stylus prices. **295**—Stylus prices. **296**—Stylus prices. **297**—Stylus prices. **298**—Stylus prices. **299**—Stylus prices. **300**—Stylus prices. **301**—Stylus prices. **302**—Stylus prices. **303**—Stylus prices. **304**—Stylus prices. **305**—Stylus prices. **306**—Stylus prices. **307**—Stylus prices. **308**—Stylus prices. **309**—Stylus prices. **310**—Stylus prices. **311**—Stylus prices. **312**—Stylus prices. **313**—Stylus prices. **314**—Stylus prices. **315**—Stylus prices. **316**—Stylus prices. **317**—Stylus prices. **318**—Stylus prices. **319**—Stylus prices. **320**—Stylus prices. **321**—Stylus prices. **322**—Stylus prices. **323**—Stylus prices. **324**—Stylus prices. **325**—Stylus prices. **326**—Stylus prices. **327**—Stylus prices. **328**—Stylus prices. **329**—Stylus prices. **330**—Stylus prices. **331**—Stylus prices. **332**—Stylus prices. **333**—Stylus prices. **334**—Stylus prices. **335**—Stylus prices. **336**—Stylus prices. **337**—Stylus prices. **338**—Stylus prices. **339**—Stylus prices. **340**—Stylus prices. **341**—Stylus prices. **342**—Stylus prices. **343**—Stylus prices. **344**—Stylus prices. **345**—Stylus prices. **346**—Stylus prices. **347**—Stylus prices. **348**—Stylus prices. **349**—Stylus prices. **350**—Stylus prices. **351**—Stylus prices. **352**—Stylus prices. **353**—Stylus prices. **354**—Stylus prices. **355**—Stylus prices. **356**—Stylus prices. **357**—Stylus prices. **358**—Stylus prices. **359**—Stylus prices. **360**—Stylus prices. **361**—Stylus prices. **362**—Stylus prices. **363**—Stylus prices. **364**—Stylus prices. **365**—Stylus prices. **366**—Stylus prices. **367**—Stylus prices. **368**—Stylus prices. **369**—Stylus prices. **370**—Stylus prices. **371**—Stylus prices. **372**—Stylus prices. **373**—Stylus prices. **374**—Stylus prices. **375**—Stylus prices. **376**—Stylus prices. **377**—Stylus prices. **378**—Stylus prices. **379**—Stylus prices. **380**—Stylus prices. **381**—Stylus prices. **382**—Stylus prices. **383**—Stylus prices. **384**—Stylus prices. **385**—Stylus prices. **386**—Stylus prices. **387**—Stylus prices. **388**—St

# The HF Shopper

## THIS ISSUE: Stereo Cartridges

*A tabulation of specifications, special features, and prices of high-fidelity components, prepared by the HIGH FIDELITY staff from information supplied by manufacturers.*

**YOU CAN BUY** most stereo cartridges and arms separately. In a few cases, however, they are available only as complete pickup combinations. Because there are so many stereo cartridges, arms, and combinations on the market, we were forced to publish this "Shopper" article in two installments: Tables 3A and 3B (in the preceding issue) covered all arms including those of fixed combinations, and the cartridge sections of combination pickups, respectively. Table 3C, in this issue, contains information on all other stereo cartridges.

It should be kept in mind, however, that the "HF Shopper" is intended only to help you narrow your field of investigation to a few items which appear to meet your needs better than others. Beyond that, personal shopping is recommended; or, if that is impossible, you should rely on more detailed evaluations such as appear in our "High Fidelity Reports" section. You'll find that advertisements often are quite helpful, too.

Virtually all cartridges can be classified as one of two **TYPES**: magnetic or piezoelectric. Only one well-known cartridge, the Weathers FM-capacitance pickup, doesn't fall into either category.

Magnetic cartridges include variable-reluctance, moving-coil, and moving-magnet systems; they are all characterized by low voltage output, and accordingly require preamplifier stages. Their output voltage is proportional to the velocity of groove modulation, so that they must be deëqualized to compensate for the preëqualization with which records are made.

Piezoelectric cartridges include those known as ceramic and crystal pickups. These usually have enough output voltage to drive amplifiers directly. Because their output is proportional to the amplitude of groove swing, and record preëqualization is

such that groove swing is nearly constant for all frequencies, piezo cartridges can be made very nearly self-equalizing by controlled high-frequency resonance and proper loading. Thus, piezo cartridges require simpler amplifier circuits and, moreover, are generally less expensive than magnetics.

Not too many years ago it could be said flatly that piezo cartridges were also lower in quality than magnetics. But the gap in quality has been closing recently and, with stereo, the manufacturers of piezo cartridges have made giant strides. It is fair to say now that some piezo cartridges are better than some magnetics, although of the two types the best magnetics are still conceded first place.

In making your choice there are three other facts to consider. First, nearly all current control units and control amplifiers have provisions for both types of cartridges, so that the piezo unit's amplifier cost advantage is more theoretical than practical in most cases. (In fact, some piezo cartridges are designed for operation with magnetic cartridge input circuits.) Second, the lower amplification required for piezo units often simplifies hum problems. Third, aside from quality considerations, the average magnetic cartridge will play a record properly with a lower tracking force than the average piezo unit, and this implies a lower rate of record and stylus wear. There are a few exceptions.

Most cartridges are designed to allow **TIP REPLACEMENT** by the user, which is a real convenience factor. Obviously, though, some manufacturers are convinced that an easily-replaceable stylus assembly would limit the quality of their cartridge designs. A few piezo cartridges are low enough in price so that the entire unit is replaceable at virtually the price of a diamond stylus alone, and at least one manufacturer of magnetic car-

tridges offers a trade-in arrangement at stylus replacement cost.

In a stereo cartridge, **COMPLIANCE** is important for both lateral and vertical stylus motion. Compliance is a measure of how easily the stylus can be moved from its at-rest position, and is, therefore, a factor in determining tracking ability. Together with the arm's dynamic mass it determines the low-frequency resonance point. Compliance should be as high as is consistent with mechanical sturdiness in any given design; if it is very high, the pickup may tend to be fragile and the manufacturer must take special precautions to keep the stylus centered and protected.

The effective **TIP MASS**, or the dynamic mass of the stylus assembly, is especially important at higher frequencies. It resonates with the compliance of the record material to produce the familiar high-frequency response peak. Above the peak, response invariably falls off sharply. For a given stylus radius the peak can be pushed to a higher frequency by reducing the effective tip mass; the lower this mass is, the better. Obtaining sufficiently low tip mass has been and remains one of the most difficult design problems in stereo cartridges.

Tip mass also has a direct bearing on the **MINIMUM STYLUS FORCE** required for proper tracking, and on the wear rate of the record and stylus. Record groove acceleration rates of 1,000 g are not extremely uncommon; it would require a downward force of 3 grams simply to keep a 3-milligram stylus assembly in contact with the groove walls under such an acceleration. Cartridges with much higher stylus mass simply will not track such high accelerations at moderate tracking force.

**RECOMMENDED LOAD** values are shown for purposes of information  
*Continued on page 128*

**Next month: The HF Shopper, No. 4: Preamp Control Units**

# Rx

## *How to install and care for* **Stereo Cartridges**

*The pickup is where disc stereo in the home begins. Here's how to start it off right, and make sure it stays that way.*

A MONOPHONIC pickup requires a fair amount of care in installation, but stereo disc equipment intensifies every requirement of the monophonic medium, as well as adding a couple that are unique to stereo. Practically any pickup malfunction that increases monophonic distortion and groove wear will be even more serious in stereo.

The smaller stylus tip used in stereo, and the increased complexity of the stereo groove, combine to place unprecedented importance on the accuracy of stylus force adjustment and cartridge orientation. And as if that weren't enough, the addition of the second channel quite often breeds hum problems knottier than any ever encountered in the average monophonic system.

Mechanically, the installation of a stereo cartridge involves exactly the same procedures as are called for in mono pickup installation; stereo just makes these operations more critical. For instance, a monophonic cartridge installed with a slight list to one side might give increased distortion and chew up record grooves more rapidly than normal. But a stereo cartridge with the same amount of list will produce considerably more distortion and will lose some of its ability to separate the individual stereo signals.

In making electrical connections for a stereo cartridge you should keep these points in mind: (1) The left-channel output from the cartridge must end up at the left-hand loudspeaker, and the right-channel sound must come from the right-hand speaker; (2) If each output channel (from the cartridge) has its own ground connection, each should be grounded at that side of the system which is fed by that channel; (3) If the stereo cartridge is to be used for playing mono discs also, there should be some means of combining the stereo channels (to give A+B mixing); (4) If the cartridge has four

output terminals, the channel outputs must be wired so as to be in-phase with one another; \* and (5) The pickup arm and turntable should be grounded at some point in the system to reduce audible hum to a minimum.

If the arm has yet to be mounted, consult its instructions to determine where it is to go, and drill any holes that are needed for it. Before mounting the arm, make sure the cartridge can be installed in it once it's mounted. If it can, go ahead and fasten the arm in place. If it can't, postpone the arm installation until after the next step, which may require some cogitation.

A stereo cartridge must have a minimum of three output connections: two "hot" terminals for the right- and left-hand-signal outputs, and one for their common ground. Four-terminal cartridges have a separate ground connection for each channel output, while five-terminal ones have these plus a separate terminal for a hum-shield around the cartridge. Similarly, a stereo arm must have at least three leads, two of which must be ungrounded for carrying the "hot" signal circuits.

In general, the more of a cartridge's output connections that can be utilized, the less chance there is of encountering hum problems. Thus, if a four-terminal cartridge is going into a four-wire arm, it's wise to use all of the separate connections that are on hand. An arrangement in which the grounds of both stereo channels are brought together at the cartridge can cause hum because of the formation of what is known as a ground loop. More about this later.

The limiting factor in any pickup/arm combination will obviously be the item with the fewer output leads. If the cartridge sports four terminals and

the arm has three, then you've no choice but to adopt a three-terminal system, tying together both ground terminals right at the cartridge, and running these through the arm's single ground lead. Some four-terminal pickups come equipped with an interconnecting strap between the ground terminals, enabling the cartridge to be used as a three-terminal or (by removing the strap) four-terminal type.

It is an easy matter to convert most monophonic pickup arms for stereo use: all you do is rewire the arm with the necessary one or two additional pickup leads. This can be done in any arm that does not have two-contact plug-in heads or one of those ingenious plug or plunger arrangements; the important thing is that the new leads be at least as flexible as the ones that are already in the arm. If they aren't, they'll impede the arm's lateral movement. And remember that a pair of uninsulated shielded cables whose braids touch the arm metal, or contact each other, is the same as a three-wire arm system.

There is no established standard color code for stereo pickup leads. The only thing to do in a particular instance is to follow carefully the wiring instructions supplied with the stereo arm and the cartridge, and then to double-check the final job by tracing each lead from its cartridge pin to its ultimate connection at the amplifier(s).

In case there are no instructions at hand, though, here are some safe rules of thumb. If the arm uses two shielded cables, the shields are ground connections and the inner conductors are "hot" (as usual); if you end up with the channels reversed, simply switch the input plugs at the amplifiers. If one of the shielded cables is color-coded red, this should carry the right-hand signal circuits. If the leads aren't shielded, light-colored wires carry the "hot" signal circuits and dark-colored

\*One system which requires out-of-phase connection of the pickup is CBS's special two-way stereo amplifier, which passes two separate program channels through a single push-pull amplifier.



ones the grounds. If any leads are paired (*i.e.*, twisted together), a pair should be used for one output channel. The most important thing at this stage of the game is to be sure that "hot" leads carry "hot" circuits, and that if there's a choice of grounds, the right-hand ground goes to the right-hand side of the amplifier system, and so forth.

Once you've puzzled out the pickup connections, attach the cartridge connecting clips to the leads inside the head of the pickup arm. When soldering these, turn each clip upside down (so that solder won't run down inside it) and hold it with a small pair of pliers. *Never* solder directly to the cartridge pins, and don't attach the clip to the cartridge before soldering it. Either of these expedients can ruin a pickup cartridge.

The next step depends upon the type of counterbalancing system used in the arm. If weighted inserts must be used in the cartridge shell, the proper insert should be determined by trial and error before fastening the arm in place. To do this, screw the cartridge into its shell temporarily (leaving its leads disconnected) and put different weights on top of the end of the arm until the measured stylus force complies with the manufacturer's recommendation. When this has been done, or if the arm's tracking force can be adjusted *after* installation, fasten the arm onto the motor board. If the height of the arm base is adjustable, set this so that the axis of the arm is parallel to the top of a record when playing it.

Stylus force should be measured at normal record-playing height, and should be set initially for the *minimum* value recommended by the cartridge manufacturer for the type of arm you're using. Additional force may be needed if appreciable distortion is later observed during recorded fortissimi, but it should never be necessary to use a value above the manufacturer's recommended force range. Should this extra force seem to be re-

quired, the pickup or some other component in the system (possibly the arm) is more than likely to be defective or substandard.

Now drape the pickup leads at the rear of the arm so that they produce as little resistance as possible to lateral motion of the pickup, and use a small cable clamp screwed to the motor board to hold the cables in place.

The cartridge's orientation with respect to the record can be checked by placing a single, unwarped record on the turntable and laying a small, thin mirror on top of this. With the pickup stylus resting on the mirror, it is easy to see from directly in front of the cartridge whether or not its stylus is vertical to the surface of the mirror. If it isn't, note whether the whole arm is canted or whether the trouble is limited to the cartridge, and straighten the offending component by shimming it up or manipulating any leveling screws that it may have. The angle of the stylus when viewed from the side will vary from one pickup design to another, and may be assumed correct so long as the axis of the arm is parallel to the disc surface.

Now, the amplifier connections. Herein lie the answer to stereo's number one bugaboo — hum. A well-designed monophonic amplifier is so constructed as to provide no more than one grounding point for all critical low-level stages. If two widely-separated grounding points are utilized for different parts of a low-level amplifier stage, the electrical resistance between these points can inject a hum voltage into the signal. In a stereo system, it is easy to overlook the possibility of these so-called ground loops. For example, two amplifiers may have a common ground connection at one point through an integrated stereo adapter or control section, and at a second point through the common-ground connection of a three-terminal pickup cartridge. Possible result: hum.

Here's an easy way to avoid this trouble, from the outset. If you use a three-terminal pickup system, and a

completely integrated stereo amplifier or two separate systems with a central stereo control adapter, connect the pickup's ground to *either* (not both) the left- or right-hand amplifier input receptacle, choosing that which gives the least hum. If the amplifier channels are totally separate, connect their grounds together at the common-ground wire coming out of the pickup arm. With a four-terminal cartridge, connect both of the pickup's ground leads to their respective input receptacles, no matter what the amplifier system; if separate amplifiers are used, rely on the stereo adapter to make the common ground connection. The object in each case is to provide but a single ground connection between the two stereo amplifier systems. As long as this precaution is observed, there should be no more trouble from hum in a stereo system than in a monophonic one.

If hum is still encountered, it can be remedied sometimes by moving the common ground point between the systems to another part of the circuit — say from between the phono inputs to between the control unit outputs. Persistent hum in a stereo system is probably being caused by something that causes hum in mono systems.

Finally, a note about monophonic discs and stereo pickups. A well-designed monophonic cartridge will produce an electrical output only for lateral motion of its stylus. A stereo cartridge, however, must be responsive also to vertical stylus motion if it is to reproduce the intrachannel difference which accounts for the stereo effect. Unfortunately, the only vertical modulation to be found in a monophonic groove is that caused by the so-called pinch effect, which is audible as a particularly offensive form of distortion. Thus, if a stereo pickup is to be used for monophonic discs, its vertical output should be suppressed; this can be done by combining its two output channels. A versatile stereo control unit will provide for "blended" or

*Continued on page 126*

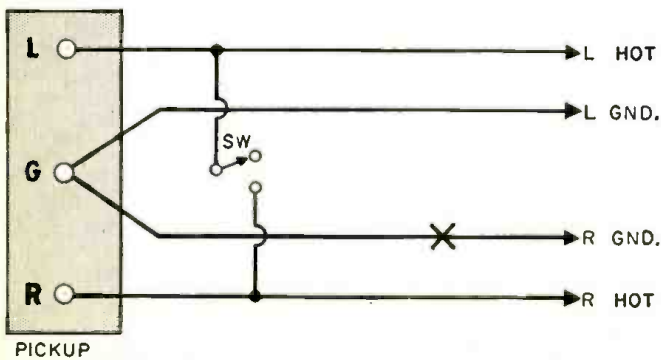

Figure 1. This simple switching system enables a stereo cartridge to be used for playing monophonic discs. The switch parallels the pickup's outputs, eliminating its sensitivity to the vertical vibrations of "pinch effect" on monophonic recordings.

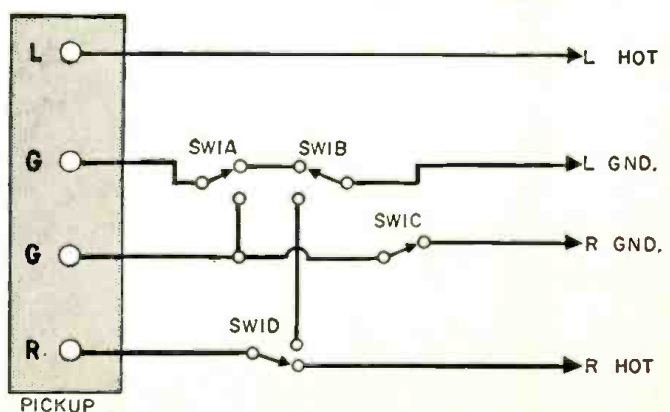

Figure 2. A four-pole two-position switch is required for series connection of a four-terminal stereo pickup cartridge.

# HF reports

combining:  
**Audiolab Test Reports**  
**Tested in the Home**

prepared by **Hirsch-Houck Laboratories**  
and the technical staff of  
**High Fidelity**

## HF REPORT POLICY

Equipment reports appearing in this section are of two types: Audiolab Test Reports and Tested in the Home Reports. **AUDIOLAB TEST REPORTS** are prepared for us by Hirsch-Houck Laboratories, a completely independent organization whose staff was responsible for the original Audio League Reports. Audiolab Reports are published exactly as they are received. Neither we nor manufacturers of the equipment tested are permitted to delete information from or add to the reports, to amend them in any way, or to withhold them from publication; manufacturers may add a short comment, however, if they wish to do so. Audiolab Reports are made on all-electronic equipment (tuners, preamplifiers, amplifiers, etc.). **TESTED IN THE HOME REPORTS** are prepared by members of our own staff on equipment that demands more subjective appraisals (speakers, pickups, etc.). The policy concerning report publication and amendment by the manufacturer is the same as that for Audiolab Reports.

(Note: some reports in this issue were prepared before the new policy went into effect.)

**ATR**

### Heath PT-1 AM-FM Stereo Tuner

**Price:** \$89.95. **MANUFACTURER:** Heath Company, Benton Harbor 8, Michigan.

The Model PT-1 Stereo AM-FM tuner represents one of the Heath Company's most ambitious efforts. A high-performance AM-FM tuner is a difficult item for a manufacturer to produce under any conditions, even with experienced personnel and complete test facilities. The design of such a tuner for home construction by relatively inexperienced individuals, which must operate without being aligned with costly laboratory equipment, is a formidable task.

This is a true stereo tuner; AM and FM sections are completely separate except for the power supply and tuning meter. The FM tuner has a cascade RF amplifier, mixer, oscillator and reactance tubes, no less than five IF amplifier and/or limiter stages, a discriminator, and a cathode follower audio output. Automatic gain control (AGC) is applied to three IF stages, and also operates the tuning meter.

The "front end" is supplied wired and prealigned, with factory-sealed adjustments. This obviates the need for the kit builder to do any alignment

in the tuning portion of the receiver. The IF coils are prealigned also; it is intended that the receiver be in final operating condition after completion, without any IF alignment other than a touch-up adjustment of the discriminator transformer. A complete alignment procedure is detailed in the manual accompanying the kit, for the benefit of anyone having the requisite knowledge and equipment to perform such an alignment.

Designed as a high-quality adjunct to the FM tuner, the AM tuner is much more sophisticated in its design than most we have seen offered to the audio hobbyist. It has an RF amplifier



Heath stereo AM-FM tuner.

and two IF stages with controllable bandwidth. A push-pull germanium diode detector is used for low distortion, and there is a separate cathode follower stage for the audio output.

A separate AGC amplifier and detector maintain constant audio level over a wide range of input signal strengths.

The power supply uses silicon diode rectifiers, which generate much less heat than tubes and occupy less space.

Very complete performance specifications are supplied in the operating manual. For the FM tuner, the quieting sensitivity is stated to be  $3 \mu\text{V}$  for 30 db of quieting. The minimum signal strength required to pass through the tuner without exceeding 1% distortion at 100% modulation is  $5 \mu\text{V}$ . Hum and noise are rated at 40 db below 30% modulation, or 50 db below 100% modulation, for a 20- $\mu\text{V}$  input signal. Capture ratio (the minimum difference between the strengths of two signals on the same channel for which only the stronger one is heard) is specified as 12 db, and the AFC correction factor (the amount by which a tuning error or drift is reduced by the AFC), 12 db. Suppression of amplitude modulation is claimed to be 25 db.

The AM tuner is rated at approximately  $5 \mu\text{V}$  sensitivity with the IF selectivity on the narrow setting, and 5 db less, or about  $9 \mu\text{V}$ , on the broad setting. Audio response on AM is shown as being down 3 db at 20 and 1,500 cps on the narrow IF setting,

and at 20 and 6,500 cps on the broad setting. In the latter condition, which would be used for any sort of high-fidelity application, there is a sharp null at 10 kc caused by the whistle filter, and this also reduces response by 10 db at 9 kc. Hum and noise are rated at 35 db below 30% modulation with a 100- $\mu$ v input signal.

The tuner we tested was received from Heath already wired. We have had considerable experience assembling Heathkits, and are familiar with the unusual thoroughness of their manuals. Even so, we found the PT-1 manual most impressive. This is a highly complex instrument, both mechanically and electrically. The electrical assembly has been made nearly foolproof by the use of three printed boards for the IF circuits. The mechanical assembly of the tuning dial in particular seems quite involved; although it is fully described both verbally and pictorially, it should be a time-consuming operation. The entire manual contains seventy-one pages, and the construction of this tuner is obviously not a job for a rank beginner.

#### Test Results

Sensitivity of the tuner was measured in accordance with IHFM standards proposed at the time of testing. The total hum, noise, and distortion in the output was measured relative to the level of a 100%-modulated carrier (400-cps modulation), as a function of signal strength. As received, the tuner showed considerable second harmonic distortion in its output at all signal strengths above 10  $\mu$ v. An attempt to correct this by a simple touch-up alignment of the discriminator proved fruitless. Therefore, we performed a complete realignment of the FM tuner, including the front end. This required a sweep generator and oscilloscope (a Kay Electric "Ligna-Sweep" was used). Alignment indicated that the discriminator transformer was defective, since its primary winding could not be tuned to the correct point. The tuning slug was set as far out of the coil as it could be, and all indications were that the correct setting had not yet been reached. Nevertheless, performance after alignment was close to the published Heath specifications and, in fact, met them in most respects, so that we feel this report represents a valid appraisal of the unit.

The usable sensitivity, as defined by the IHFM standard, is the minimum signal which results in total noise and distortion being 30 db below 100% modulation at 400 cps (this corresponds to 3% distortion). We found the usable sensitivity of the PT-1 to be 6.2  $\mu$ v. This was the major difference

we noticed between our measurements and the Heath specifications: the distortion wasn't reduced to 1% until a 16- $\mu$ v input signal was used. It is entirely possible that a good discriminator transformer would reduce the distortion substantially at low signal levels.

For signal strengths in the 50- to 5,000- $\mu$ v range, which is typical of the amplitude of practical FM signals, the distortion was less than 0.5% at 100% modulation. That is quite negligible in view of the distortion levels existing in other links of the recording and reproducing chain, from microphone to speaker. Distortion rises slightly for very strong signals (over 5,000  $\mu$ v), but does not exceed 0.8%.

The AGC action is very effective. Maximum audio output is reached with a 10- $\mu$ v signal, and no change in level occurs as signal strength increases from that point.

The IF transformers are over-coupled to produce a "double-humped" response. This results in wide IF bandwidth (over more than 200 kc) combined with steep skirts

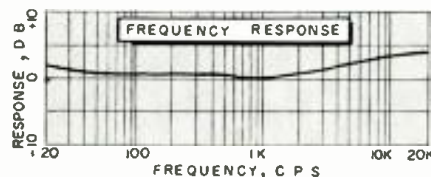

for good adjacent-channel selectivity. The discriminator peaks are about 400 kc apart. This means that even the weakest signals can be received without serious distortion from clipping of the sidebands. Even at 5  $\mu$ v, 93 kc deviation was required to produce visible clipping of the modulating waveform; at slightly higher signal strengths the permissible deviation approached 200 kc or more. The practical advantage of this design is that an FM station which overmodulates (and a number of them do) can be received without the roughness and distortion that overmodulation causes on tuners without the IF and discriminator bandwidth characteristics of the Heath PT-1.

Over-coupling of the IF transformer, however, makes it necessary to use a sweep generator and oscilloscope to align this tuner. Many tuners can be aligned to a considerable extent using their own tuning meter, or at most an external voltmeter, but this is quite impossible in the case of the PT-1.

We measured the drift of the oscillator in the PT-1 from a cold start as about 145 kc (without AFC). Most of this occurred in the first seven minutes of operation. The AFC correction was 14.7 db, which reduced the drift to an effective 30 kc. A sta-

tion can be tuned in immediately after turning the set on, without AFC, and the AFC then turned on. No further retuning is required. The drift with line fluctuations from 105 to 125 volts was 31 kc, which is reduced to negligible proportions when AFC is used.

The capture ratio turned out to be 17 db, not quite as good as the rated 12 db, but the AM rejection exceeded the specified 25 db by a considerable margin. The cathode follower output stage makes the frequency response of the tuner quite independent of cable capacitance. A 1,000- $\mu$ mf capacitance across the tuner output reduced the 10-kc response by only 0.5 db. Overall frequency response was within  $\pm 1.8$  db from 20 to 20,000 cps. Most of this variation is, apparently, the result of component tolerances in the de-emphasis network. It is interesting to see that the response at 20 cps was totally unaffected by the AFC circuit. A common fault of FM tuners, especially inexpensive ones, is a lack of filtering in the AFC circuit which may sharply reduce the low-frequency response.

The hum level of the FM tuner was -56.5 db relative to the 100% modulation level, which is well below the -50 db specification in the manual. Power line leakage was negligible.

We didn't test the AM tuner in the laboratory, but gave it careful listening tests and A-B comparisons against the FM tuner when listening to local stations broadcasting good-quality FM and AM programs simultaneously. On much of the recorded material being broadcast there was little difference between the quality of the AM and FM tuners. When good recordings or live broadcasts were used as a basis for comparison, the loss of highs in the AM tuner could be heard. At all times, the difference in background noise level was very evident.

#### Summary

The Heath PT-1 is, potentially at least, a very fine AM-FM tuner at a most reasonable price. When properly aligned the FM tuner is the equal of many more expensive manufactured units. The AM tuner is distinctly better than any we have heard in combi-

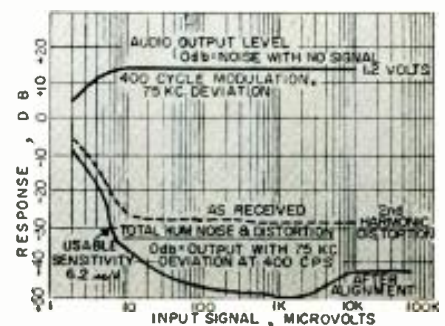

nation with an FM tuner at prices up to 50% more than the PT-1. The complexity of this set is such that we suspect the builder will appreciate the reasons behind the pricing of some of the more expensive AM-FM tuners after he has completed the PT-1. It

should be a very educational process. As a matter of fact, the mere study of the manual accompanying the PT-1 constitutes an excellent home study course on FM tuner design.

Of course, we have no way of knowing how typical was our experience

with the misaligned or defective discriminator transformer, but we recommend strongly that anyone building this tuner have it aligned by a competent serviceman. This should greatly increase the chances of realizing the full performance designed into it.



## Isotone "Toccatà" Speaker System

**SPECIFICATIONS** (furnished by manufacturer): an integrated two-way speaker system incorporating cone drivers and a tuned, damped air column for woofer loading. **Frequency range:** 30 to 18,000 cps. **Impedance:** 8 ohms. **Power rating:** 30 watts. **Dimensions:** 26 in. wide by 32 high by 18 deep, over-all. **Price:** \$248.75. **MANUFACTURER:** Isotone Acoustic Spiralways, Inc., 3402 Third Ave., New York 56, N. Y.

Isotone speaker systems utilize a long column of air, like an organ pipe, to load the woofer cone. This isn't a new idea; other designs have used variations on the same theme, but the principle itself is fraught with potential problems, not the least of which is the inclination of such pipes to resonate at several frequencies unless carefully damped. Acoustic Spiralways have attacked this problem by venting the remote end of their tuned column and loading it with a considerable amount of acoustic resistance. The result is a system which effectively combines most of the advantages of both a tuned system and a nonresonant system, but has few of the disadvantages of either.

The sound of the "Toccatà" system was at once massive-sounding and sweet, yet without the boominess that is characteristic of uncontrolled resonant systems. Its bass range was sub-

jectively flat to an estimated 40 cps, and useful response was maintained to around 30 cps. There was little evidence of doubling, and no significant peaks were observed throughout the system's entire range. Bass definition was good enough to permit fairly easy

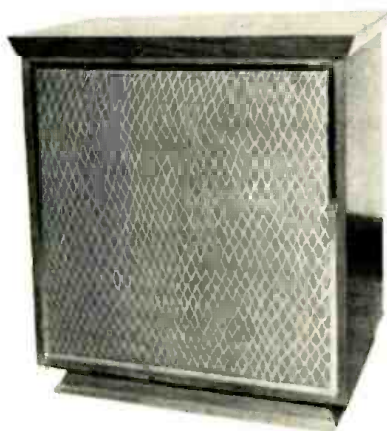

Isotone "Toccatà" speaker system.

identification of instruments and bass lines, although best results were obtained from our sample "Toccatà" when it was fed by an amplifier having a high damping factor (which happens to be the nature of most of the available high-quality power amplifiers).

The middle range appeared to be free from sharp peaks, although subtly colored by an "oh" quality. Highs were

smoothly sweet: there was no tendency toward spitting, and nary a trace of shrillness. String tone was reproduced musically, although without some of the gutty quality that bespeaks full response to well beyond 10,000 cps. Over-all definition was good but not outstanding; the system seemed to cause a very slight blending of sonic details rather than a reproducing of them with analytical precision.

This is by no means an inexpensive system. It has certain positive qualities of sound that are not to be found in any other systems I've encountered, however; ones which will appeal strongly to musically-oriented listeners who prefer a wide-range system without conspicuous idiosyncrasies but having unusual warmth and massiveness. The cabinet work on our sample unit was exemplary.—J.G.H.

**MANUFACTURER'S COMMENT:** Because of the very high acoustic resistance of the Isotone, we suggest that particular attention be paid to equalization and compensation of the device. Record manufacturers' recommendations should not necessarily be followed to the letter. In high fidelity everything varies. With compensation done to a nicety, given a clean amplifier with musically adequate reserve power, we believe that the Isotone is, subjectively, the least disturbing of any conventional sound system to be obtained.

Best definition with the Isotone is obtained, usually, by lifting the rolloff and then by carefully adjusting the treble control. Also, on control-unit quality, or lack of it, depends the nature of the end result in the speaker system.



## Pilot SA-232 Stereo Amplifier

**SPECIFICATIONS** (furnished by manufacturer): **Model SA-232**—dual-channel power amplifier. **Rated power:** music waveforms, 40 watts total, 20 watts per channel; 17 watts rms per channel. **Frequency range:** 20 to 20,000 cps. **Harmonic distortion:** 1% at full output. **IM distortion:** 1.5% at full output. **Hum:** 90 db below full output. **Inputs:** channel A, channel B. **Outputs:** 8 and 16 ohms to channel A and channel B speakers. Two switched AC outlets, power supply for preamplifier, switched AC outlet for turntable. **Dimensions:** 13½ in. long by 5½ high by 5 wide, over-all. **Price:** \$89.50. **MANUFACTURER:** Pilot Radio Corp., 37-06 36th St., Long Island City 1, N. Y.

This stereophonic amplifier is for all intents and purposes two completely independent power amplifiers on a single chassis. Only the

power supply is common to both channels; all other parts are duplicated from end to end.

It is equipped with two standard AC power outlets which turn on or off with the amplifier, and it has a special four-pin AC outlet for a record changer or turntable. It is adequately fused, and appears to be designed sufficiently within the ratings of its

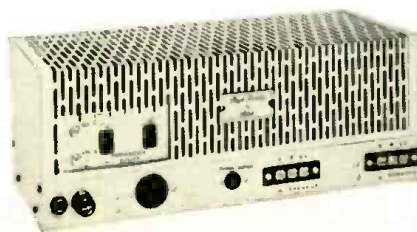

Pilot SA-232 stereo amplifier.

components so as to assure long, trouble-free life. In addition to its AC outlets, it is equipped with a power supply outlet socket which provides heater and B+ power for Pilot's SP-210 stereo preamplifier.

Our sample SA-232 met its power specifications with ease, and its hum level was so far below the limit of audibility that it could justifiably be called nonexistent. Over-all sound was clean and well balanced, with no tendency to emphasize or deemphasize any part of the audible spectrum, and with tight, moderately well-defined bass. Middles and highs were subtly soft and velvety rather than startlingly lucid. All in all, this ranks with the finest amplifiers in its price and power class. An excellent buy for the tightly-budgeted stereophile.

J.G.H.

ATR

## General Electric MS-4000 Stereo Amplifier

Price: \$169.95. MANUFACTURER: General Electric Co., West Genesee St., Auburn, N. Y.

The General Electric MS-4000 is an integrated stereo amplifier, containing two 20-watt power amplifiers, two preamplifiers, a common power supply, and complete switching for various modes of stereo and monophonic operation.

Three sets of stereo inputs are provided: magnetic phono with RIAA equalization, tape head with NARTB equalization, and tuner inputs, unequalized. In addition, there are two monophonic inputs: a nonequalized AUX input and an RIAA-equalized phono input. A single input selector switch is used.

A MODE switch selects either normal stereo operation or reversed-channel operation. A third position parallels both stereo inputs and feeds the common signal to both channels. If separate mono signal inputs are used instead of a stereo input, the MODE selector provides reproduction on either speaker from its corresponding input signal, or mixes both signals and feeds them to both speakers.

After the mode selection, all controls are common to both channels. Fletcher-Munson compensation is by means of a separate contour control which works in conjunction with the volume control. In the counterclockwise position of the contour control, the volume control is uncompensated. Clockwise rotation of the contour control introduces increasing amounts of bass boost which occurs as the volume is reduced. This arrangement provides a high degree of flexibility in adjusting loudness compensation to suit personal taste.

Bass and treble tone controls for both channels are ganged. A balance control provides a very gradual change in the relative outputs of the two channels over most of its rotation, after which the rate of change increases sharply. In its extreme positions, the balance control cuts off one or the other channel completely.

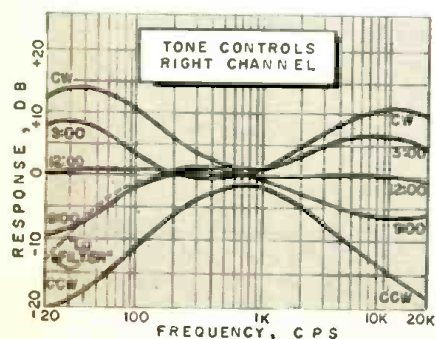

The power switch is a slide switch, independent of all other controls. A rumble filter switch on the front panel is effective on all inputs. This can be very useful when a broadcast program contains rumble, which sometimes happens. A small hole in the front panel provides access to a screw-driver-adjusted tuner input level control, affecting both channels simultaneously. This is normally set to reduce the tuner volume level to the typical level obtained when playing records.

In the rear of the amplifier are the input connectors, on a vertical terminal board which clearly identifies



GE MS-4000 stereo amplifier.

left and right channels. The two sets of speaker outputs each have 4-, 8-, and 16-ohm taps. When 8-ohm speakers are used, a special set of terminals is connected to the left-channel amplifier, and a phase reversal switch on the rear of the amplifier permits the speakers to be phased without disconnecting any speaker leads.

Two AC convenience outputs also are located at the back of the MS-4000 amplifier. One is energized at all times; the other is turned on by the amplifier power switch. Two tape output jacks supply low-impedance (10-k) outputs to a stereo tape recorder. They are located after the volume and tone controls, but ahead of the balance control.

Each power output stage has a push-pull pair of 6973 tetrodes. The power supply is unusually extensive for such a compact and moderate-power amplifier. There are actually three separate power supplies: a selenium bridge rectifier provides DC to the heaters of the preamplifier and tone control stages, as well as fixed bias to the output tubes; a 6X4 slow-heating rectifier supplies the plate power to all stages; and a separate supply with a 6X4 slow-heating rectifier is used only for screen voltage on the output tubes.

### Test Results

In practically all respects the two channels were identical. Except where otherwise specified, our curves apply equally well to either channel.

The power output of each channel met the manufacturer's rating of 20 watts at middle frequencies. Full

power could be developed between 30 cps and 10 kc, and 10 watts could be obtained at 15 cps and 20 kc. The tone controls were entirely conventional in their operation. The loudness control worked well, although there was little effect until it was rotated beyond its 12-o'clock position.

Phono and tape equalization were both quite accurate and well matched on both channels. The over-all equalization error did not exceed 2 db from 20 to 20,000 cps. The rated distortion specification of 1% at 20 watts was exceeded handily, with typical 1,000-cps distortion figures of 0.4% at 20 watts, and about 0.2% at ordinary listening levels. Intermodulation distortion also was low at low outputs, and only reached 1.6% at 20 watts.

The only place there was any significant difference between channels was in the 20-cps harmonic distortion measurement. Both channels were quite satisfactory for an amplifier in the price range of the MS-4000 (\$170), but one was markedly better than the other. This was probably because the output tubes of one channel were slightly unbalanced. No balance controls are provided.

Hum level ratings, -62 db on phono and -73 db on tuner input (referred to 20 watts), proved to be very conservative. We measured hum levels of -77 db and -82 db on the two channels for tuner inputs, and -65 db and -66 db on the phono inputs. Hum on the tape-head inputs was appreciably higher, being in the vicinity of -50 db.

The gain of the preamplifier is high enough for practically any of the low-output stereo cartridges. A full 20 watts output can be obtained with a 2.5-mv input signal. The tuner inputs are also quite sensitive.

Output tubes and filter capacitors are operated conservatively, and the use of slow-heating rectifiers eliminates the warm-up surges which frequently overload filter capacitors. The power line leakage is 0.8 ma. That isn't dangerous but it can be felt if one touches the amplifier chassis and a good ground at the same time.

Damping factors of the two power amplifiers were measured as 6.0 and

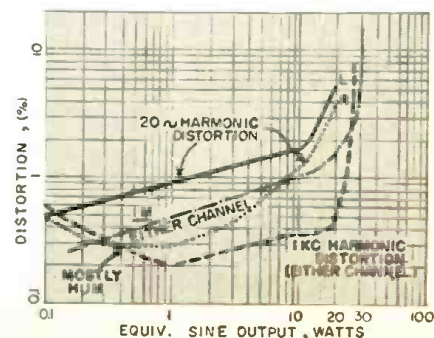

6.4. The power which could be developed with a 3.0- $\mu$ fd capacitor shunting an 8-ohm resistive load (to simulate an electrostatic speaker) was about 5.5 watts at 10 kc. Under this condition of loading, the amplifier was stable and the 10-kc square-wave response was good. (See photo.) With the shunting capacitor reduced to 0.25  $\mu$ fd, however, there was high-frequency ringing which amounted to a sustained oscillation.

### Listening Test

Our measurements suggest that the MS-4000 is a first-rate amplifier of more than usual flexibility. Listening to it under usual home conditions confirmed that impression completely. It is very clean sounding and easy to operate. We especially appreciated the speaker phase reversal switch, which makes possible a true A-B comparison of in-phase and out-of-phase operation.

Even at very high listening levels, there was no sign of strain or breakup. On the phono inputs, when the volume is advanced the tube hiss exceeds the hum in audibility, but neither can be heard at gain settings which would be used in ordinary operation.

The use of gauged tone controls may draw some criticism from purists, though we did not find it to be a disadvantage even with two dissimilar speaker systems. Conceivably, if the speakers were quite different in their characteristics, separate tone controls

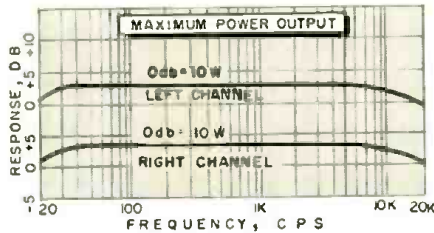
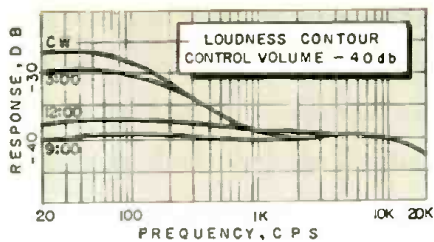

would be important. We suspect that GE intended this amplifier to be used with a pair of identical speakers, in which case we can see no objection to the gauged tone controls.

The loudness compensation worked well, without the tubbiness which sometimes plagues less flexible designs. The rumble filter also was useful, since it reduced the 70-cps response by only 3 db and the 30-cps response by 9 db. No audible change in the balance of the sound could be discerned when the rumble filter was switched in.

### Summary

The General Electric MS-4000 is of excellent design and construction, and should prove adequate for most home stereo installations. The front panel has a disarmingly simple appearance in this day of multi-controlled stereo amplifiers, yet the only feature of conceivable importance lacking in the MS-4000 which is present in competitive units is that of separate tone controls for the two channels.

The instruction booklet accompanying the amplifier is unusually complete, in a way which we would like to see imitated by other high-fidelity equipment manufacturers. Performance specifications are very completely presented—and, what is more important, the amplifier lives up to them or exceeds them in every respect. Typical curves are included showing frequency response, distortion, and other properties of the amplifier. Complete and easily understood installation and operation instructions, a replacement parts list, a functional block diagram, and a schematic diagram are a few more reasons why we appreciate the thoroughness of the MS-4000 manual.

The only possible limitation on the performance of this amplifier which was disclosed by our tests was the tendency toward instability at certain values of capacitive loading. Under

the circumstances, we would not recommend the use of the MS-4000 with an electrostatic speaker. On the other hand, we know of no electrostatic speaker of good quality which would be used with an amplifier of this power rating, so that may be a trivial consideration.

In our report on the General Electric GC-5 stereo cartridge, we commented on the requirement of a pre-amplifier with low input capacitance in order to maintain the full high-frequency response of the cartridge. At the time, General Electric engineers assured us that their amplifiers were designed so as not to degrade the cartridge performance. We checked the MS-4000 with a GC-5 cartridge, measuring the change in response resulting from inserting the cartridge coil in series with the test signal into the preamplifiers. We found that the change in response was less than  $\pm 2$  db from 20 to 20,000 cps when the GC-5 cartridge was used. The two components obviously are quite compatible.

**MANUFACTURER'S COMMENT:** The particular unit tested was one of the first production models of the MS-4000. Two important modifications have been made in later production units: (1) in order to obtain maximum quality from the recording source, the tape outputs are now taken off just ahead of the tone circuit, and (2) the output transformer has been modified to handle a full 20 kc at 20 watts with negligible distortion, and is able to handle any electrostatic tweeter and any capacitance with complete stability. These modifications have in no way affected the unit's excellent low-end performance.

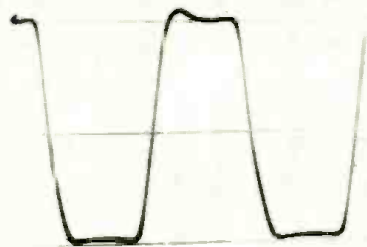

10-kc square wave with resistive load.

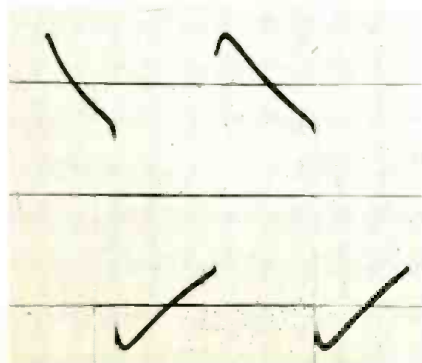

50-cps square wave, tone controls flat.

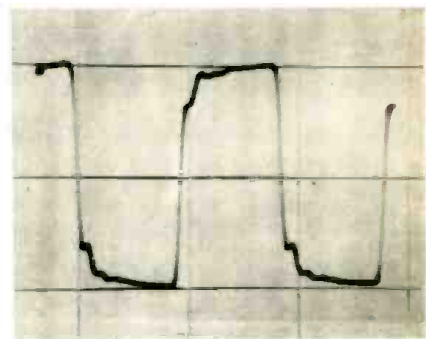

10-kc square wave with 3-mfd load.

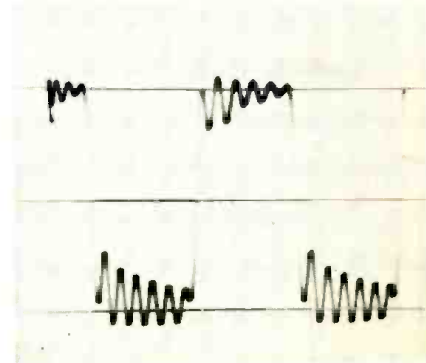

Same as above, but with 0.25-mfd load.

# AUDIO FORUM



## Asymmetrical Baffling

SIR:

I have read that a loudspeaker should be placed off-center when mounted on a baffle. Could you please tell me why?

Is it necessary to have the speaker's center a different distance from all four edges, or may it be placed up and over by the same distance? Is there any rule (approximate or otherwise) as to how far off-center it should be placed? If two speakers are to be mounted on the same baffle, may they be symmetrical with respect to each other—that is, one up and right from center and the other down and left from center?

Charles Ryberg  
Palatine, Ill.

*Off-center mounting of a loudspeaker minimizes the effects of any resonant conditions between the speaker and the edges or interior surfaces of the baffle.*

*If a flat baffle board is used, asymmetrical speaker mounting reduces the tendency toward peaking of bass response and produces a less sharp attenuation of bass below the critical cutoff frequency of the baffle. If the speaker is in an enclosure, asymmetrical mounting on the front panel will minimize the middle-frequency peaks which arise from diffraction effects due to the radiated sound attempting to "fold" around the front edges of the cabinet.*

*The speaker should, ideally, be off-center vertically and laterally, but there is no hard-and-fast rule about this. On a rectangular baffle, the unit should be off-center by about 10% of the total dimension in each direction. On a square baffle, asymmetry of about 10% in one direction and 20% in the other direction will give the desired result. When two speakers are used, these should be asymmetrical with respect to one another as well as with respect to the edges of the baffle.*

## Stereo Disc Equalization

SIR:

I recall when you used to publish each month a table listing the playback

equalization required by different brands of monophonic LP discs, and am wondering if you intend to do the same thing for stereo discs? This would be a great help to those of us who are buying stereo discs and are not certain how to equalize them.

D. R. Porter  
Pottstown, Pa.

*All available 45/45 stereo discs are recorded to conform to the RIAA playback standard.*

## Stylus Force

SIR:

The instructions supplied with my new monophonic cartridge state that it should be tracked at a stylus force of between 4 and 6 grams, yet I find that it will stay in the groove when tracked at forces as low as 2 grains. There is some distortion audible during loudly-recorded passages, but is it not better to tolerate this distortion in favor of the reduced record wear that I'll get from tracking at this very low force?

Lawrence M. Mader  
Pittsburgh, Pa.

*A pickup tracked at inadequate force can do almost as much damage to grooves and styli as will one that is somewhat too heavy.*

*Excessive tracking force causes rapid wear of both the groove and the stylus, by increasing contact friction and deforming the vinyl record material beyond its limit of elasticity. Insufficient force has much the same effect, because it permits the stylus to skitter back and forth in the groove, riding up first one and then the other groove wall and battering from side to side every time the groove swings back and forth.*

*Optimum tracking force is a compromise between both extremes, and usually works out to be the minimum force value that can be obtained without introducing audible distortion. The manufacturer's recommended force range should be observed, using the minimum recommended value that provides distortionless, fuzz-free tracing of loudly-recorded passages.*

## Matched Loudspeakers

SIR:

I have read several times in HIGH FIDELITY that "Best results are obtained from stereo material when both loudspeaker systems are identical." I'm willing to take your word for this, but I would like to ask why this should be the case.

William Mulloy  
Brooklyn, N. Y.

*Proper aural localization of sounds in their original positions across the area between stereo speakers depends to a major extent upon the relative loudness with which the sounds issue from the speakers. A sound which emanates equally from both speakers will appear to be located dead-center between them; one which comes more strongly from one or the other of the speakers will appear to be located some distance to left or right of center. This is why it is important that the volume levels of both stereo channels be as close to identical as possible; an imbalance will seem to shift all instruments to one side, bunching them together near one or the other of the speakers.*

*If the two stereo speakers have widely different frequency response characteristics, it will be impossible to balance their outputs properly, because balance at one frequency will create imbalance at another frequency. The result of this is an apparent shifting back and forth of sounds which are supposed to originate from a fixed spot between the speakers.*

*If the speakers are only moderately different in response, there will simply be poor localization of centered sounds, rather than a constant shifting of them. This will cause lack of definiteness of the locations of instruments which were originally located between the microphones.*

*Amplifiers and room placement will tend to make identical speakers sound slightly different, but the chances of achieving consistent balance and good aural localization are greater when both stereo speakers (particularly the units reproducing the middle and upper ranges) are of the same make and model, and are identically baffled.*

# Tips

*from audio salesmen*



by HERMAN BURSTEIN

*Two well-known audio salesmen from New York City proffer advice to the high fidelity customer on many facets of equipment purchasing.*

WITH EACH high-fidelity component available in many brands and models, and at various prices, a bewildering complex of choices confronts the newcomer to high fidelity, or anyone replacing his original system or adding a second channel for stereo. I know a man who bought a fine power amplifier and control unit several months ago. He has never put them to use; during this time he has been wandering from dealer to dealer, not knowing what tuner, what speaker, what turntable, what arm, and what pickup to buy.

Ultimately, the choice of components must be made by the purchaser. He does well to seek expert guidance first, however, and a source of good counsel is the salesman in an audio salon of good reputation. Frequently he is a technician as well, often with formal training in electronics. He has to offer not only his personal opinion based on experience, but also the consensus of other important people—technicians, engineers, and customers.

Following is a view of high-fidelity buying problems as seen by two well-known audio salesmen in New York City: Jim Carroll of Harvey Radio and Harold Weinberg of Hudson Radio. This is a distillation of their answers to some of the most frequent questions posed by the customers they have served.

(1) Most audio equipment on the market meets generally accepted high-fidelity specifications concerning frequency response, distortion, signal-to-noise ratio, and so on.

What, then, distinguishes the truly superior unit from its competitors? Considering components in general, Carroll and Weinberg answer that the superior item is distinguished by clarity of reproduction, definition of details, "natural sound"—that is, similarity to the original. "Listening to music through good equipment is like looking through a clear window," says Weinberg. Carroll compares the sound provided by good equipment with the sharply-focused picture of a fine TV set.

Taking components one by one, here are some of Weinberg's pointers on each. A top-quality cartridge, while having extended high-frequency response, should produce comparatively little surface noise and needle talk. A good tone arm should handle well and not tend to fly out of the operator's hand. A turntable should be quiet in operation, and free of detectable vibration anywhere on its motor board or base. An FM tuner should have high sensitivity, sharp selectivity, and low distortion; in a low-price tuner the customer should be wary of sensitivity comparable with that of expensive units, for this may imply a sacrifice in other characteristics. A tape recorder should handle easily and have no audible wow and flutter; good places to check are at the beginning and end of a reel. An audio control unit should have high gain and low noise, no audible hum at customary levels, and should be free of any tendency to oscillate or motorboat (a frequent problem in high-gain affairs). A power amplifier ought to be of simple, straightforward design, with solid bass and transparent highs. A speaker system should be free of harshness, although it may sound brilliant (depending upon the listener's taste); it is more important for it to have smoothness and balance than the ability to reproduce extreme lows and extreme highs.

(2) Lately there has been a pronounced trend toward amplifiers of 40, 50, 60, and yet higher wattage ratings, although 20- and even 10-watters were considered until recently quite adequate for rooms of average size and speakers of average efficiency. Often the audio salesman is asked if the high-power unit provides superior performance at moderate levels, when probably a watt or two at the most is used. Carroll and Weinberg differ somewhat in their answers. Carroll's observation, based in part upon his customers' reactions, is that the high-power unit generally has greater clarity and more fullness at all levels. Most of his customers who have traded in a low-wattage amplifier



*The audio salesman is quite often the high fidelity equipment buyer's most sympathetic friend. It will pay you well to respect his advice on matters electronic.*



for one of greater capacity have been pleased with the change. Weinberg, however, points out that if the low-power unit produces equally low IM distortion at ordinary levels, there can be no audible difference at such levels. Apparently, in designing an amplifier to perform well at 50 watts or so, the manufacturer *ipso facto* assures excellent performance at moderate levels. On the other hand, it is also possible to design directly for excellent performance at moderate levels without having to aim at maximum power output above 10 or 20 watts.

(3) Exceptional is the man who cannot look back upon errors in the selection, installation, or operation of his audio equipment. What are the major and most common mistakes?

In choosing equipment, a fundamental error is to mistake spectacular for natural sound. Carroll likens this to a photograph with colors that are extremely vivid rather than true to nature. Mismatch of components, in the sense of acquiring units not consistent in quality, is a prominent fault; this is particularly true of the speaker, which is very often inferior to the rest of the system. The problem goes even further, Carroll holds, for it is necessary to match the speaker to its environment. He will ask a customer for a complete description of his listening room and furnishings in order to advise him on a speaker and enclosure in a given price class. Weinberg points out that another common error in selecting equipment is overgreat reliance on the recommendations of friends, who seldom have the required experience and breadth of view, or fail to consider the purchaser's special circumstances and needs—which may differ greatly from their own.

As for installing the equipment, Weinberg says that all too often the customer seems to follow the precept "when all else fails, read the instructions." The problem of hum besets many an installation. Frequently, it is caused by not inserting a phono plug tightly enough to make a secure ground connection. Hum may result from locating a phono arm too near a power transformer when mounting the equipment in furniture. It often can be subdued by simple measures, such as reversing the power plug in the house outlet, tightening a phono plug, or connecting a ground wire from a chassis to a radiator, water pipe, or similar fixture (never to a gas line). Unfortunately, many a customer starts exploring the insides of his equipment for the cause of the trouble. "Never!" says Weinberg. "Call the salesman. His job isn't finished until you are satisfied."

Acoustic feedback is a common problem, points out Carroll, because many customers place the speaker too near the rest of the system, where the sound may vibrate the phono stylus and the tubes. Weinberg says that many bass-reflex cabinets have improperly adjusted ports, causing audible low-end resonance. Many light speaker enclosures can use additional bracing, he says, and suggests that the installer experiment with speaker location (an advantage of a small speaker system) because a speaker that sounds woefully bad in one part of the room may change character elsewhere.

(4) To maintain a distinct advantage over ordinary reproducing systems, high-fidelity equipment must be not merely functioning, but in virtually perfect condition. What should be done in the way of preventative maintenance? Carroll suggests that, if daily use is made of the system, the stylus be checked every three months and the tubes every six months. The owner of an FM tuner should be careful to identify the exact socket where each tube was located, because an interchange involving the same type of tube can upset alignment. About once a year all the equipment should be taken into a qualified service shop for a performance check and necessary alignment. A typical charge for this service, according to Carroll, is about \$30;

Continued on page 124

## Why salesmen grow ulcers...



"I want a radial tweeter with acoustic feedback, a 16-ounce damping factor and blue vellum upholstery—and no backtalk!"



"My system sounded scratchy on 78s so I looked inside to find the trouble, and now it won't play at all. Fix it, will you?"

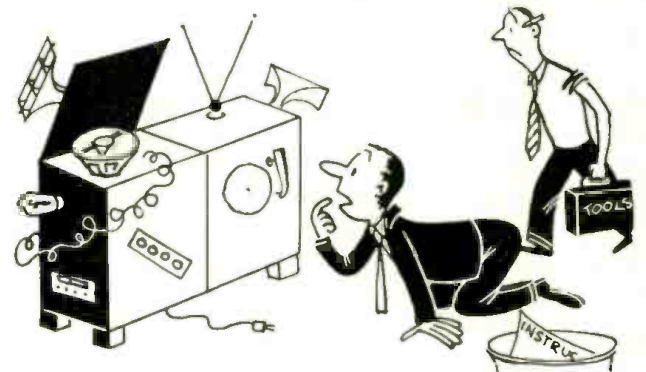

"Boy, am I glad to see you. I got this set together but it looks different, somehow. How about fixing it for me?"



"I'll hook these preamps in series, turn the bass and treble knobs up all the way, and I'll have me some REAL COOL hi fi."



# Audio**news**

## Heath Stereo Cartridge

The Heath Company is now delivering its *Model SF-1* stereo pickup cartridge, which will fit any stereo tone arm. Of the moving-magnet type, the SF-1 has a 0.6-mil diamond stylus. Specified frequency response is 20 to 15,000 cps,  $\pm 4$  db; output impedance, 6,000 ohms per channel; output voltage, 3 mv; and tracking force, 2 to 4 grams. The price is \$39.95.

## Scott 40-Watt Amplifier

The *Model 250* is a 40-watt power amplifier from H. H. Scott, Inc. which incorporates Scott Power-Balance Circuitry. Its distortion at a full 40 w output (80 w peak) is claimed to be less than 0.1% first-order difference tone, and less than 0.5% harmonic. Hum level is rated at 85 db below full output. Other specifications: frequency response, flat from 12 to 40,000 cps; sensitivity, 0.5 v input for 40 w output; dimensions, 13 in. wide by 9 $\frac{1}{2}$  in. deep by 7 in. high. The amplifier is said to work perfectly with reactive loads such as electrostatic speakers. Prices, east of the Rockies: amplifier, \$119.95; accessory case, \$10.

## Turntable Level

Robins Industries has just announced a new spirit level for adjusting turntables and record changers. The *Model TL-1* is a compact but accurate spirit level in a gold-anodized aluminum case. Its price is \$1.15.

## EICO 35-Watt Amplifier

Production of the *Model HF35* power amplifier in both kit and factory-wired versions is announced by Electronic Instrument Company, Inc. The HF35 is essentially a 35-watt version of the EICO HF50 and HF60 amplifiers. Tube lineup is the same (EF86, 6SN7GTB, two EL34 output tubes, and GZ34 rectifier) and the same circuit is used except that the output stage is self-biased. An octal plug is supplied to furnish preamplifier operating voltages. IM distortion is specified as 0.15% at 20 w, 1.5% at 35 w; response,  $\pm 0.1$  db from 20 to 30,000 cps at 35 w; hum level, 90 db below 35 w; sensitivity, 0.43 v input for full

output; dimensions, 7 in. high by 14 wide by 8 deep. Factory-wired price of basic amplifier is \$72.95; kit price, \$47.95; optional enclosure, \$4.50.

## C & M Network Coils

C & M Coils Company offers a complete line of air-core coils for dividing network construction or other purposes. Eighty inductance values from .05 to 12 mh are available in No. 17 Formvar copper wire, and 52 inductance values from 5.0 to 20 mh in No. 16 Formvar. Accuracy is guaranteed better than  $\pm 10\%$  of rated values. According to the manufacturer, all inductors are oven-baked, calibrated, the leads tinned and spaghetti-covered, the coils cotton-wrapped and varnish-dipped, rebaked, and rechecked before going into stock. Typical prices: 1 mh, No. 17 wire, \$2.40; 10 mh, No. 16 wire, \$6.00.

## Sonotone Booklet

A new booklet, "Stereo Simplified," will be given free of charge to anyone requesting it. Published by Sonotone Corporation, the booklet explains stereo recording and reproduction in simple terms, and gives suggestions on assembling stereo high-fidelity systems.

## Challenger Components

Bogen-Presto Division of the Siegler Corporation has announced two new stereo components in the "Challenger"

line: the *Model AC210-A* control amplifier, and the *Model TC200-A* tuner.

The AC210-A has a dual stereo preamp-control section and a power amplifier section which can be used as a 20-watt monophonic amplifier, a 20-watt power amplifier fed by one of the preamp channels, or two 10-watt stereo amplifiers. Full control of inputs and outputs is provided for tape, stereo and mono records, radio, and auxiliary sources. Its basic price is \$99.95; the metal case is \$6.00 extra.

The TC200-A is a true stereo FM-AM tuner; the FM and AM sections can be used separately or simultaneously. AFC and AVC are both supplied. Basic price is \$129.50, with the metal case optional at \$6.00 extra.

## Norelco Enclosures

North American Philips Company, Inc. has three new speaker enclosures designed for Norelco T-7 series speakers but which will, according to the company, work equally well with most other speakers of comparable size.

*Model 1* is a back-loading folded horn enclosure for 12-inch speakers. Dimensions are 26 in. wide by 21 $\frac{1}{2}$  in. high by 17 $\frac{1}{4}$  in. deep, not including the 8-inch legs. It is priced at \$91.00 to \$99.50, depending on finish. With two 8-inch speakers installed, the price is \$149.95 to \$159.95, depending on finish.

*Models 2* and *3* are distributed-ported bass reflex types (without legs) which can be installed horizontally or vertically, or in bookshelves. The *Model 2* is 23 $\frac{3}{8}$  in. by 13 $\frac{1}{2}$  in. by 11 $\frac{1}{2}$  in. deep; prices are \$51.00 to \$59.95, depending on finish. The *Model 3* is 18 $\frac{1}{2}$  in. by 12 in. by 8 $\frac{3}{8}$  in. deep, and priced at \$31.00 to \$35.00, depending on finish.

Finishes available for all enclosures are mahogany, blond, walnut or cherry.

## Multiplex Tuner

Harman-Kardon has introduced an FM-AM tuner, the *Model 250*, which contains a signal connection, power supply, and space within the chassis for the company's FM multiplex adapter. The adapter for current experimental FM multiplex broadcasts is the *Model MA250*.

Incorporating the new Harman-Kardon "Gated Beam" limiter and Foster-Seeley discriminator, the *Model 250* also makes use of a shaded-beam tetrode in the FM front end. Tuning is facilitated by an electronic tuning bar indicator. Eastern prices are: *Model 250* tuner, \$149.50; *Model TC50* enclosure, \$12.50; *Model MA250* multiplex adapter, \$49.95.

*For more information about any of the products mentioned in Audio-news, we suggest that you make use of the Product Information Cards bound in at the back of the magazine. Simply fill out the card, giving the name of the product in which you're interested, the manufacturer's name, and the page reference. Be sure to put down your name and address too. Send the cards to us and we'll send them along to the manufacturers. Make use of this special service; save postage and the trouble of making individual inquiries to several different addresses.*

# COMPARE **Pilot** STEREOPHONIC AMPLIFIERS WITH ALL OTHERS!

**PILOT PROVES** you can have highest quality at low cost with a superb 40-watt stereophonic amplifier at \$89.50—and an equally superb, more powerful 70-watt stereophonic amplifier at only \$139.50. How can PILOT do it? It is *more* than PILOT's 40 years of electronics experience...*more* than PILOT's dedication to engineering for uncompromising quality...and *more* than PILOT's painstaking quality control in production. Combine *all of these* with the fact that PILOT builds every component *completely* within its own plant, and you can readily understand how PILOT can offer *true* quality components at the lowest possible prices.

We invite you to examine the specifications of these two, *systems engineered*, basic PILOT stereo amplifiers. And, read in your favorite technical magazines how highly the experts in the field rate them. Think, too, how much quality must be built into PILOT's integrated stereophonic preamplifier-amplifiers, deluxe stereo preamplifier and deluxe stereophonic tuners and tuner-preamps! They, also, are systems engineered—designed at the outset to be used together for matched performance of the highest caliber. Only with PILOT can you get *more quality at every price*.

THE PILOT 232



**THE PILOT 232**, a superb 40-watt stereophonic amplifier, offers the clean response and freedom from hum you would expect from the leader in its price and power class! Its output transformers are of special, high efficiency design with interleaved windings and grain-oriented steel for maximum power response. The 232 is equipped with an 11-pin socket to power the PILOT 210 stereo preamplifier. With the 210 connected, and a record changer plugged into the 5-pin RC power socket, the *entire system* will, at the user's option, turn off *automatically* with the changer. Power Output: 40 watts total; 20 watts per channel on music wave forms (program material). 80 watts peak. 17 watts per channel continuous, undistorted. Frequency response: Flat, 20 to 20,000 cycles. Harmonic distortion: 1% at full output. Hum: 90 db below full power. Output impedances: 8 or 16 ohms. Sensitivity: 1 volt for full power output. Eight tubes including four EL84 power output tubes. Size: 13½" long x 5½" high x 5" deep. Wt. 20 lbs. Supplied with enclosure. **\$89.50**

**THE PILOT 260** has every feature of the 232 plus greater power, lower distortion and, individual bias and balance controls to accurately match output tube characteristics. Power Output: 70 watts total; 35 watts per channel on music wave forms (program material); 140 watts peak. 30 watts per channel continuous undistorted. Frequency response: Flat, 20 to 20,000 cps. Harmonic distortion: ½% at full output. Hum: 90 db below full power. Output impedances: 8 or 16 ohms. Sensitivity: .8 volt for full power output. 9 tubes including four EL34 power output tubes. Enclosure supplied. 15¾" long x 5¾" high x 7¼" deep. 35 lbs. **\$139.50**

WRITE TODAY FOR COMPLETE PILOT COMPONENT CATALOG

## PILOT SYSTEMS-ENGINEERED COMBINATIONS



210 PREAMP, \$89.50



232 AMPLIFIER, \$89.50



216-A PREAMP, \$199.50



232 AMPLIFIER, \$89.50



690-A STEREO TUNER, \$289.50



260 AMPLIFIER, \$139.50

All Prices Slightly Higher in the West.

**Pilot** RADIO CORPORATION • 37-02 36th STREET • LONG ISLAND CITY 1, N. Y.

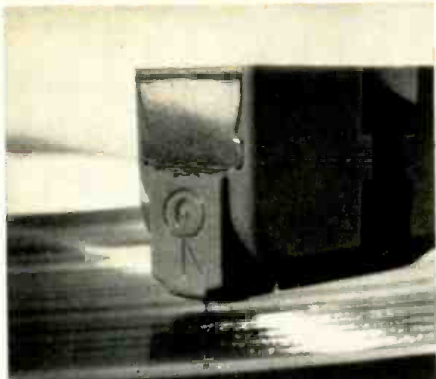

# FREE HOME TRIAL

proves Columbia CD  
stereo cartridge  
sounds better

.....

Now you can prove it to yourself. The Columbia CD is the better stereo cartridge. We believe this so strongly that we have arranged with your CBS-Hytron distributor for you to test the Columbia CD... free in your own home.

We are sure you will agree this cartridge does sound better than any other ceramic or magnetic stereo cartridge. It is superior in linearity... separation... compliance... low mass... freedom from hum... output level... ruggedness. Your ears will tell you quickly what elaborate curves, facts and figures prove. The Columbia CD simply sounds better.

Make sure by your own tests that you invest in the better stereo cartridge. This offer is for a limited time only. Ask your CBS-Hytron distributor to let you try the Columbia CD, Model SC-1D, today!

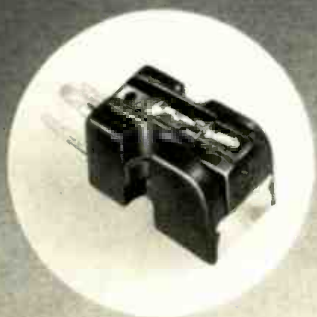

**COLUMBIA** 

Model SC-1D

Cost \$24.25

**CBS-HYTRON**, Danvers, Massachusetts  
A Division of Columbia Broadcasting System, Inc.

## TIPS

*Continued from page 121*

often it is as little as \$10 to \$15. With respect to tubes, Weinberg goes somewhat further and recommends that output and rectifier tubes in the power amplifier, as well as the first stage tube in the control unit, be changed every six months. The remainder should be changed every year. While this will dispose of some tubes with good performance left in them, it will also get rid of others which have not too long to go. "Bear in mind," Weinberg reminds, "that we are concerned not with complete failure but with significant degradation of performance; tubes usually go gradually downhill rather than suddenly out like a light."

Weinberg recommends also that moving parts, such as idler wheels in phonographs and tape recorders, be cleaned every two weeks according to the manufacturer's instructions. Lubrication at the required intervals is very important. So are cleaning and demagnetizing the tape recorder heads.

(5) Many a potential buyer wonders whether tape will give sufficiently better results to warrant the added expense of a tape machine and the higher cost of recorded tapes compared with discs. Weinberg states that the quality of reproduction on the best discs and the best tapes is amazingly similar, and that discs have potentially better frequency response than tape at the extremes of the audio spectrum. Carroll also finds discs as good as tapes but adds that, while discs permit greater ease of handling and require less storage space, tape has greater permanence if manufacturer's instructions are followed closely.

(6) A good monophonic system is costly enough. A stereo system using comparable equipment is 50 to 100% more expensive. Does stereo justify this increase in expenditure, plus the problems of housing more equipment? In no uncertain terms, Carroll and Weinberg insist that stereo is the biggest single development in audio, well worth the extra cost. Both advise prospective buyers not to overemphasize the association between stereo and spatial movement or directionality; they should listen for greater detail and clarity of sound. As for the cost aspect, Weinberg holds that moderate-price stereo systems sound better than high-price monophonic ones, although it is true that a very good stereo installation sounds still better.

(7) Components can be bought separately or in various combinations,

such as a control unit and power amplifier, or a control unit and tuner, or all three on one chassis. What are the pros and cons of individual vs. integrated components? Carroll says, "Our observations show that separate components tend to provide greater versatility and lower distortion." Weinberg agrees, but points out that the integrated unit simplifies the problem of interconnecting components and represents a saving of money, often an important amount of it. In many cases, he finds, a better system over-all can be obtained by putting a given sum into a better speaker instead of separate components. He does not include the FM tuner in this observation, however, admitting that often more is lost than gained by purchasing it as part of a package.

(8) Progress and consequent obsolescence exist in every field of human endeavor. Therefore, the question can be asked with justification, "How soon will any new high-fidelity component become obsolete?" Carroll and Weinberg contend that obsolescence is relatively remote for equipment of good design and construction. The bargain-price item and the component loaded with gimmicks and gadgets are the first to be outmoded. Most changes in audio are relatively minor: true progress is relatively slow and costly. In the long run, though, it is to be expected that such developments as better tubes, increased use of transistors, abandonment of output transformers, new circuits, and new loud-speaker principles and refinements will add up to substantially better performance than we can have now.

How can the audiophile successfully tap the fund of information possessed by the expert audio salesman? "Maintain an open mind, and don't come in with preconceptions that you aren't certain are well founded," states Carroll. "The easiest person to serve is the one who asks for help and admits frankly that he knows little. This fellow also winds up the happiest, because he gives the salesman a chance to do his best." Weinberg suggests that the customer not try to argue the salesman down on points open to question; after all, the customer is not bound to accept the salesman's advice and is consuming the valuable time of both parties in a contest of opinions. Also, he suggests, "Be patient. Show the hard-working salesman consideration and don't yell immediately for the manager if things don't work out as expected right away. While 50% of the salesman's job is to represent the store, the other 50% is to represent you. He will do his best to remedy your troubles, for he expects you back—with your friends."

# Coming

## TO YOUR CITY



# High Fidelity Music Shows

See and hear  
the latest in  
HIGH FIDELITY  
from leading  
high-fidelity  
manufacturers . . .

Don't miss these public showings of Hi-Fi Equipment...from the most economical units for the budget-minded to spectacular home music theatres...compare and enjoy them all. Components and complete systems will be displayed.

## 1959

### HIGH FIDELITY MUSIC SHOW SCHEDULE

PITTSBURGH, PA.—Penn-Sheraton Hotel, April 3, 4, 5, 1959.

BUFFALO, N. Y.—Statler Hotel, April 10, 11, 12, 1959.

### RIGO ENTERPRISES, Inc.

500 North Dearborn Street  
Chicago 10, Illinois

## THIRD CHANNEL

Continued from page 109

developed across the speaker *only* when there is a difference between the stereo signals coming out of the amplifiers. When both amplifiers reproduce identical signals, there is no difference voltage and, hence, no output from the center speaker.

There are several obvious theoretical flaws in this arrangement, not the least of which is the impossibility of phasing the center speaker with both of the main ones. A second objection, theoretical again, is that when signals of equal intensity are reproduced by both channels (a condition which should place the sound midway between them), the center speaker remains mute. The theoretical considerations are stressed here because, in actuality, the A-B system does work, and quite well at that. Although there is still a small area of vagueness right at the middle speaker, the localization of sounds between it and the main speakers is markedly improved.

Phasing of the center speaker is unimportant because neither polarity can phase it with both of the main speakers. Phasing *does* make a difference in the sound, however, so the polarity that sounds better is the one to use.

In Figure 1, the center speaker is shown connected to lower-impedance taps than are the main speakers, and a T-pad is shown in the speaker line. These are simply alternate ways of controlling the level of the middle channel, which should be set no higher than is necessary to achieve satisfactory center augmentation. If proper level can be obtained without resort to the T-pad, so much the better. Because of the phasing problem, the middle speaker should have fairly restricted bass response, so it won't "fight" with the bass from one of the other speakers. A note of caution, though: this A-B hookup may cause instability in some stereo systems. Should this occur, a heavy wire connected between the amplifier output Grounds may correct the condition. If that doesn't help, it may be necessary to utilize an alternative and rather more expensive third-channel arrangement.

Several new stereo amplifiers and control units are equipped with a signal output receptacle marked "3rd Channel" (Figure 2). This supplies a completely blended mixture of the stereo signals (A+B) for feeding a separate amplifier and center fill-in loudspeaker. The advantages of this arrangement are immediately obvious:

Continued on next page

(Advertisement)

# Sound Talk



by John K. Hilliard

Director of Advanced Engineering

## PLACEMENT OF LOUDSPEAKERS FOR STEREO

This much-discussed subject has been confused through attempts at oversimplification. There are a few clear-cut principles that should be followed for good stereo.

Two separate channels, from source through amplification to the speakers, provide the time and intensity difference that develops the spatial quality of stereo. If the speakers are too closely spaced, as in a single enclosure which houses two speakers only a few feet apart, the time and intensity difference is so small that spatial quality is severely limited. Eight feet is considered minimum spacing between speakers for good stereo and they should be placed in a common plane.

Good listening begins the same distance in front of the speakers that they are spaced apart, and continues for twice this distance. For example, if the speakers are placed 8' apart, the good listening area begins 8' in front of the speakers and continues to 16'.

Greater spread between speakers is desirable but the listening area must be moved back proportionately. Listening too close to widely separated speakers creates a "hole in the center" which gives the impression of two distinctly separate sound sources rather than the desired broad front of sound. When speakers have to be too widely spaced or placed in corners, a slightly converging angle will improve the stereo.

The effective dispersion angle at high frequencies is usually limited to 90°. To obtain the benefit of the entire audible frequency range, the listener should remain within this angle.

Both reflected and direct sound is required. However, staccato or transient tones are localized for the stereo effect only through direct sound. Because of this, the speakers should be directed at the listener and not first bounced off side walls or other reflectors.

*Precision engineering and stringent quality control give ALTEC speakers a closely matched loudness over the entire frequency range—eliminating the disturbing phenomenon of sound jumping from speaker to speaker on certain notes.*

Write for free catalogue: ALTEC LANSING CORPORATION, Dept. 4H-B, 1515 South Manchester Avenue, Anaheim, Calif., 161 Sixth Avenue, New York 13, N. Y. 12-51

your  
**STEREO**  
records deserve a good turn!  
— the ONE and ONLY  
magnetic turnover  
cartridge...

**Recoton-Goldring**

"Sound" reasons for using the new Recoton-Goldring Magnetic Turnover Cartridge: because you conserve your Stereo diamond stylus for your delicate Stereo records — and flip it to the LP side for long playing records — and also because the price is right!



**RG745-1SD**  
With diamond stylus for stereo and monaural LP's and sapphire<sup>®</sup> stylus for LP's.

also available  
**RG745-3SD**  
With diamond stylus for stereo and monaural LP's and sapphire<sup>®</sup> stylus for 78RPM.

Audiophile Net \$29.95

\*synthetic

Ask your nearest dealer or write to  
**RECOTON CORPORATION**  
manufacturers of the world's finest diamond • sapphire • osmium styli  
52-35 Barnett Ave., Long Island City 4, N. Y.

## THIRD CHANNEL

*Continued from preceding page*

it is possible to phase the third speaker with *both* of the main channels, and the resulting middle-channel output is a close replica of what might be obtained from an actual third microphone on stage center, feeding a third stereo speaker. This is subjectively the most satisfactory of the three systems formulated to date, in that it gives definite location of center instruments, places them in their original relationship to one another, and has negligible effect upon the spaciousness and breadth of the reproduction. A simple gain control on the third-channel amplifier makes it adjustable to provide any necessary amount of center fill-in, and this can be preset to give ideal spread on a good stereo recording or it can be adjusted to suit each individual recording.

R x

*Continued from page 113*

"A+B" operation; but if it doesn't, the user should seriously consider either adding a blend switch to his phono assembly, or using a separate pickup for monophonic discs.

Figure 1 shows a switching arrangement for paralleling the outputs from a three-terminal cartridge. A single-pole double-throw switch is used to connect together the "hot" outputs from the cartridge, and the point marked "X" indicates where one ground return might be left disconnected in the event that the amplifiers are grounded together elsewhere in the system. The circuit will be identical for a four-terminal pickup except that the two ground leads will go to separate lugs on the cartridge, and both ground leads will connect to their respective amplifiers.

Figure 2 shows the rather more involved circuit needed for stereo-mono switching of a cartridge whose manufacturer recommends series connection for monophonic use. This calls for a four-pole two-position switch, and supplies a monophonic signal to the left-hand amplifier channel only. The switches in both of these diagrams are shown in the stereo position.

The typically lower tracking force of stereo pickups is obtained through the use of lighter and more compliant stylus assemblies, and it is almost axiomatic that the result will be greater physical fragility. A good stereo cartridge should never be cleaned by the

*Continued on page 128*

★ "for the  
closest approach  
to the  
ORIGINAL SOUND"



★ **QUAD**

LISTENERS interested in sound reproduction in the home can be broadly divided into two groups:

1. The music lover who wishes to enjoy music while removing the problems of concert attendance.
2. The listener who derives emotional satisfaction from the sensation of sound, particularly when reproduced under his own control.

For the first group QUAD equipment is designed. The QUAD Electrostatic Loudspeaker, for instance, is completely distortion-free, therefore non-fatiguing. The loudspeaker forms no part of the artistic chain.

The QUAD II Amplifier, either monophonic or stereophonic, is so designed that the enjoyment and appreciation of music is not impeded by "amplifier sound." Similarly with the QUAD FM Tuner.



You are cordially invited to audition the QUAD Home Music System at one of the selected QUAD dealers listed below:  
*California:* HIGH FIDELITY UNLIMITED, 935 El Camino, Menlo Park.  
*Florida:* Charles V. Cooper, 713 Las Olas Boulevard, Fort Lauderdale.  
*Illinois:* William H. Huston, HOME MUSIC SYSTEMS, 4224 N. Keeler Ave., Chicago.  
*Maryland:* HIGH FIDELITY HOUSE, 5127 Roland Ave., Baltimore.  
*New York:* HARVEY RADIO Co., 103 W. 43rd St. HUDSON RADIO CORP., 48 W. 48th St. LEONARD RADIO, 69 Cortlandt St.

For further information, address your inquiries to the personal attention of I. M. Fried.

**ELECTRONICS**

OF CITY LINE CENTER, Inc.

7644 City Line Ave. Phila. 31, Pa.

the Magnificent New

# WOLLENSAK "1515"

## STEREOPHONIC HI-FIDELITY TAPE RECORDER

WITH BUILT-IN PRE-AMPLIFIER

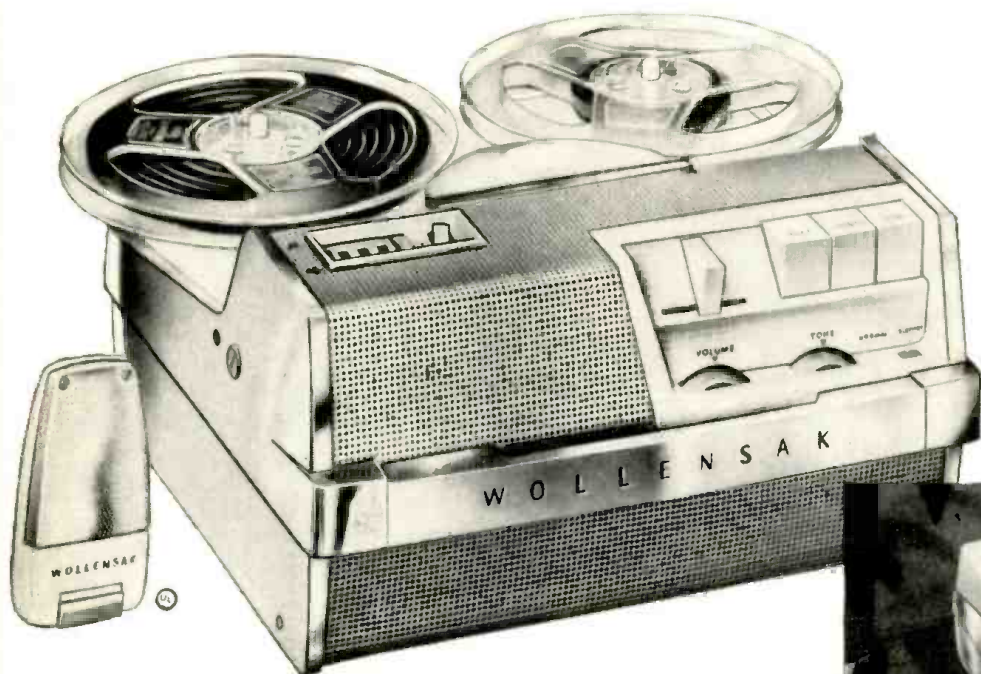

The thrilling presence of a live orchestra in your home... full third dimensional sound!



**ULTRA LIGHTWEIGHT**  
Measures only 6½" x 10¼" x 11¾"; weighs scant 20 lbs. Distinguished design harmonizes with every decor.



**EASY OPERATION!**  
Simplified key-board controls. Handy, strikingly beautiful operating panel provides the utmost in operating ease.

**ULTRA-POWERFUL!**  
10 watts push-pull audio output—four times greater than larger, less portable recorders. Ideal for auditorium use.

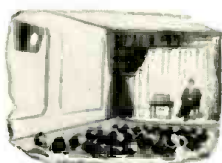

**CONSOLE PERFORMANCE!**  
Tape live music or use in conjunction with a hi-fi speaker and tuner for a fine hi-fidelity system.

Now you may enjoy the realism of three-dimensional sound in a truly portable stereophonic tape recorder! Two separate *in-line* sound channels bring the living presence of a full orchestra into your home. The upper channel permits you to record and play back monaurally. The lower channel, in line with the upper, plugs in directly to the Phono input of your radio, high fidelity system or your television. No auxiliary pre-amp is necessary as the pre-amp is built right into this WOLLENSAK Tape Recorder. Dual speeds, two-level recording indicator, keyboard controls, index counter, high speed rewind lever, etc. MODEL T-1515, complete with microphone, 2 reels (one with tape), cords, \$229.50

**GUARANTEED SPECIFICATIONS** Frequency Response—Upper Channel, 40-15,000 cps. ± 3db. at 7½ ips.; 40-8,000 cps. ± 3db. at 3¾ ips.; Lower Channel: 40-15,000 cps. ± 3db. at 7½ ips. (NARTB Standard Equalization). Wow and flutter less than 0.3%; Signal to noise ratio greater than 50 db.; Signal from lower channel pre-amp output 0.5 — 1.5 volts; Crosstalk — 50 db.

**FREE DEMONSTRATION**—Your authorized Wollensak Dealer will be glad to show you the "1515" and other fine WOLLENSAK Cameras and Projectors. See him now!

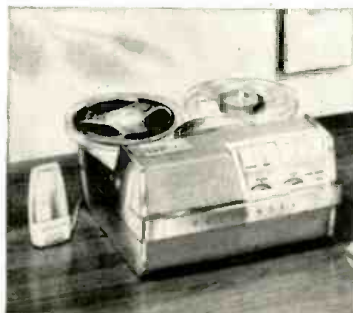

**"1500" HI-FIDELITY DUAL-SPEED TAPE RECORDER**  
Only 6½" x 10¼" x 11¾"; weighs 20 lbs. 10 watts push-pull output is four times greater than ordinary recorders. "Balanced-Tone" high-fidelity; key-board control. Accepts 7" reels; tape speeds of 3.75 and 7.5 ips.; index counter, etc. Complete with microphone, 2 reels, tape and cords, \$199.50

WOLLENSAK OPTICAL CO. • CHICAGO 16, ILL.

for less work and more play

## GET THE TURNTABLE THAT CHANGES RECORDS!



### MIRACORD XS-200

No turntable and no record player, in the history of high fidelity, gives you *more quality and more features* than the famous MIRACORD XS-200!

- heavyweight, professional-type turntable—and a fully-automatic changer!
- plays both stereo and monophonic!
- push-button controlled throughout!
- Magic Wand spindles eliminate pusher platforms and stabilizing arms!
- intermixes 10" and 12": plays all 4 speeds; has a 4-pole motor!
- even as a turntable it shuts off automatically when record is finished and tone arm returns to rest position.

—yet it costs only **\$67<sup>50</sup>** audiophile net



### STEREWIN 200

the stereo cartridge that  
**ELIMINATES HUM!**

STEREWIN is the perfect magnetic hi-fi cartridge for stereo and monaural! It fits all record changers and standard tone arms. And thanks to special construction and MuMetal shielding, it eliminates hum! Instant stylus replacement, too.

NOW **\$44<sup>50</sup>** audiophile net



FAR AHEAD) THE FINEST BY FAR  
Available at selected dealers.

For Free catalogue, please write Dept. H  
**AUDIOGERSH CORP.**

514 Broadway, New York 12, N.Y.

WORTH 6-0800



R x

Continued from page 126

popular expedient of scraping one's finger across the stylus. Use a camel's-hair water-color paintbrush; if the stylus happens to be coated with a particularly tenacious blob of detritus, dip the brush in isopropyl alcohol. Don't get cleaning solutions or antistatic fluids on the surrounding parts of the stylus assembly, though; many damping materials will be chemically affected by the solvents in these solutions.

## SHOPPER

Continued from page 111

only. Since the load resistor value has a great effect on response in many cartridges, check to see if your pre-amp input circuits will load properly the cartridge you want to use; if not, you must have the proper resistors installed.

Piezo cartridges have enough OUTPUT voltage to drive most power amplifiers directly, although few will be used that way. Most will be used with control units or control amplifiers, and the high-level input circuits on these usually have sufficient gain to produce full output from any piezo unit. Magnetic cartridges all require preamplifier stages, of course, but some have output so low that transformers are needed in addition to preamplifiers. It is well to check before you buy a cartridge that the preamp you plan to use with it has enough gain and low enough noise, or that transformers for the cartridge are available.

RESPONSE is a specification that has little practical significance as applied to a cartridge, even when decibel limits are specified. Frequency response varies with the test record used, the load value, and in many cases with the length of cable from the cartridge and the type of preamplifier input circuit.

CHANNEL SEPARATION figures are given to indicate the maximum attainable isolation between right- and left-hand channels with a given cartridge. Usually they show the separation at one specific frequency or a narrow band of frequencies; consequently, an unqualified separation figure alone isn't really very helpful.

The significance of the number of OUTPUT TERMINALS has been explained in previous "HF Shopper" notes, and is further detailed in this issue's article on installation of stereo cartridges (page 112).



## sound without fury in 3 easy steps

Here's a compact, do-it-yourself speaker system that delivers realistic, transparent reproduction without the fury of bass or treble exaggerations. Perfectly matched Electrostatic mid/high range speakers and a dynamic woofer give measurably flat response over the entire audio spectrum. What's more, you need not be an expert cabinet maker. You create high fidelity at a sensible, do-it-yourself cost.

1



### ELECTROSTATIC MID/HIGH RANGE SPEAKER

Model 65, illustrated, uses two JansZen electrostatic elements with a built-in power supply and high-pass filter. Each element contains 176 perfectly balanced, sheathed conductors to give absolutely clean response from 700 to beyond 30,000 cycles. Furnished complete in cabinet at \$86-\$91.50, depending on finish. Slightly higher in West.

Better yet . . . Model 130—considered as THE mid/high range speaker—contains four elements for a broad, 120° sound source. \$161-\$188, depending on finish. Slightly higher in West.

2



### DYNAMIC WOOFER DRIVER

Specifically designed to complement the delicate clarity of JansZen Electrostatic Mid/High Range Speakers, the Model 350 Dynamic Woofer offers clean, honest bass, devoid of coloration, false resonances, hangover or boom. It is the only separately available woofer to give such clean response in so small an enclosure—only 2.2 cu. ft. Response is uncannily flat from 40 to 2000 cycles with excellent output to 30 cycles. Only \$44.50. Slightly higher in West.

3

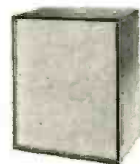

### DO-IT-YOURSELF WOOFER ENCLOSURE

Working with the plans we furnish with each woofer, you'll be able to build your own enclosure with basic tools. The enclosure is a sturdy, yet simple, totally enclosed cabinet. There are no tricky baffle arrangements or adjustments. Size without legs: 19" high x 25" wide x 13" deep. Cost of all materials should run about \$12 to \$18.

Discover JansZen clarity for yourself. Write for literature on JansZen's complete speaker systems and the name of your nearest dealer.

\*including designs by Arthur A. Janszen and made only by  
**NESHAMINY ELECTRONIC CORP.** Neshaminy, Pa.

Export Div.: 25 Warren St., New York 7, N. Y.  
Cable: Simonrice, N. Y.



# music listener's bookshop



Save yourself time and trouble by ordering your books directly from us. Just fill in the coupon below and mail it to us with your remittance.

*The standard reference series for the intelligent purchase of LPs and tapes*

**RECORDS IN REVIEW — 1958** — “*Top-notch guide . . .*” — THE TIMES PICAYUNE

**RECORDS IN REVIEW — 1957** — “*. . . a gratifyingly wide range . . . informative and useful . . .*” — NOTES

**High Fidelity Record Annual 1956**

**High Fidelity Record Annual 1955**

- 1958 #275 — \$5.95
- 1957 #257 — \$4.95
- 1956 #237 — \$4.50
- 1955 #201 — \$4.95

Each of these books, the only ones of their kind, contains reviews of classical and semiclassical music, and the spoken word, that appeared in HIGH FIDELITY Magazine for the twelve months — July through June inclusive — preceding their date of publication. The reviews discuss performances, interpretations, and sound qualities; in addition they compare recordings with earlier versions. Reviewers include some of this country's most distinguished music critics.

**HANDEL: HANDEL BICENTENARY EDITION**  
— by Herbert Weinstock

This greatly revised edition of Weinstock's well-known biography reflects the great advances in Handel scholarship since the first edition was published in 1946. Illustrated \$7.50 #283

**PUCCINI: A CRITICAL BIOGRAPHY** — by Masco Carner

The life and works of Giacomo Puccini presented in detail for the first time in any language. Illustrated \$7.50 #284

**FAMOUS MOZART OPERAS** — by Patrick Hughes

A complete guide to Mozart's five most popular operas: *Don Giovanni*, *The Abduction from the Seraglio*, *The Marriage of Figaro*, *The Magic Flute*, *Così Fan Tutti*. Profusely illustrated with musical examples. \$4.00 #285

**WHAT TO LISTEN FOR IN MUSIC** — by Aaron Copland

The revised edition of a book which made it possible for thousands to increase their enjoyment of music through creative listening. \$3.95 #247

**HIGH FIDELITY: A BIBLIOGRAPHY OF SOUND REPRODUCTION** — Compiled by K. J. Spencer

This book contains approximately 2,600 entries that represent the whole field of published information and research on high quality sound reproduction, from the subject's very early days up to and including 1957. \$6.00 #271

**MAINTAINING HI-FI EQUIPMENT** — by Joseph Marshall

A much-needed book on the specialized approach necessary to service high-fidelity equipment. The author discusses not only electronic

faults, but the mechanical and acoustical defects which cause a hi-fi system to function less than perfectly. The book is clearly written and well indexed. Hard cover, \$5.00 #232  
Soft cover, \$2.90 #233

**UNDERSTANDING HI-FI CIRCUITS** — by Norman H. Crowhurst

Here the audiophile will find the answers to questions often confusing. The chapters are: Special output stages, feedback, damping, inverter and driver stages, input stages, matching, equalization, speaker distribution and crossovers, loudness and volume controls, tone controls. Hard cover, \$5.00 #254  
Soft cover, \$2.90 #255

**HIGH FIDELITY: A PRACTICAL GUIDE** — by Charles Fowler

Here is the practical expert advice needed by everyone who has, or expects to have, a high-fidelity system. Starting with an introduction to sound, the author then describes the various links in the hi-fi chain, explaining their features and specifications so as to provide the most helpful criteria for evaluating, and for selecting and matching components. \$4.95 #234

**Paperbacks**

**THE COLLECTOR'S HAYDN** — by C. G. Burke  
The music of Haydn on records evaluated for musicianship and for sanics. Addendum by Arthur Cohn. \$1.65 #281

**THE COLLECTOR'S CHOPIN AND SCHUMANN** — by Harold C. Schonberg  
A discussion and evaluation of the music on discs of these two masters. \$1.45 #282

**THE COLLECTOR'S BACH** — by Nathan Broder  
Every available (up to time of publication) recording of Bach's music on LP records is discussed and rated. \$1.25 #272

**THE COLLECTOR'S JAZZ** — by John S. Wilson  
This complete guide to LP jazz records analyzes jazz styles up to World War II. \$1.45 #273

**GREAT OPERAS** — by Ernest Newman  
This definitive treatment of the history, stories, and music of the great operas is unique as both guide and armchair companion.  
Vol. I, \$1.25 #279 Vol. II, \$1.25 #280

**Book Department**

**HIGH FIDELITY Magazine**  
2160 Patterson Street, Cincinnati 22, Ohio

I enclose \$\_\_\_\_\_ for which please send me, postpaid, the books indicated by the circled numbers below. (No C.O.D.s or charge orders, please.) Foreign orders sent at buyer's risk. Add 25¢ per book for postage on foreign orders except Canadian.

- Unmarked binders \$2.75 each
- HIGH FIDELITY RECORD REVIEW INDEXES—50¢ each
- 1954  1955  1956  1957

NAME..... 201 272  
232 273  
233 275  
234 279  
237 280  
247 281  
254 282  
ADDRESS..... 255 283  
257 284  
..... 271 285

for Stereo

One of the most reassuring sights you can see on the front of a loudspeaker system is the KLH emblem. It is the symbol of a patient search for extremely high quality.



RESEARCH AND DEVELOPMENT CORPORATION

30 Cross Street — Cambridge, Mass.

ADDRESS DEPT W-109 FOR COMPLETE INFORMATION ABOUT THE MODEL SIX

The results of this search are evident in each KLH product.

## CHORISTERS

Continued from page 48

reed pipe on the stage and marched off with it to serenade Galatea. The critic H. F. Chorley denounced the braying of the trombones, which had somehow insinuated themselves into this miniature score, but refused to say a word against Mozart.

Perhaps the oddest Handel production of the period, however, resulted from Rophino Lacy's praiseworthy attempt to bring the oratorios back to Covent Garden. In 1833, by way of preparation for a stage revival of *Jephtha*, he perpetrated a work called *The Israelites in Egypt*, a compound of *Israel in Egypt* and Rossini's *Mosé*. This went down very well with an audience that included the future Queen Victoria and her mother. But *Jephtha*, like Handel's first oratorio *Esther* a century before, was banned from the stage by the Bishop of London, who—we are told—"had inoculated Queen Adelaide with his pious scruples, and the Lord Chamberlain obeyed their orders." It was not till November 1958 that a Handel oratorio (*Samson*) reached the Covent Garden stage.

The theatre was still the house of ill fame; but excess knew few bounds in church, and none at all at the Crystal Palace, where mammoth Handel Festivals took place triennially from 1859 to 1926. The Westminster Abbey *Messiah* of 1834 employed a mere 644 persons; a preliminary canter at the Crystal Palace in 1857 gathered 2,000 singers and 500 instrumentalists for *Messiah* and *Israel in Egypt*. In 1859 the establishment for the same two oratorios was 2,765 and 460; in 1882 it was 4,000 and 500. Two things are remarkable about these and other Victorian Handel festivals: the narrow range of works chosen, and the appalling quality of the performances. The forty operas had been buried for a century; of the oratorios only *Messiah*, *Israel in Egypt*, *Judas Maccabaeus*, and *Samson* were familiar—two of them untypical and one a potboiler. The "multitudinous dullness" of the performances with their dragged tempos, clumsy dynamics, flaccid rhythms, and "the insufferable lumbering which is the curse of English Handelian choral singing"—not to mention the wholesale corruption of texts—has been vividly described by Bernard Shaw. Sluggish tempos were inevitable with such gargantuan choirs and orchestras, even without the false association with church music. This trouble goes back to the 1784 Commemoration, if not earlier. We know from an article by William Crotch, published in 1800, in which he gave

## Any day in the week



Did you know that Terminal has an important Hi-Fi sale going on *every day*? How come? Well, we found that by going to the factories and grabbing up huge lots of discontinued models, whenever and wherever we could, as often as available, we were able to knock prices way, way down, pass the savings along to you and still make a good profit! (Everybody wins.) So, *any day in the week*, in our busy "mark-down section" you will find an eye-popping bargain priced just right for you. Here are just a few of the items on sale the day we took this picture:

Thorens Manual Player CBA 83N. Regular \$59.95. *Terminal's Special* \$34.95

Scott 121C Dynaural Equalizer-Preamp. Regular \$169.95. *Terminal's Special* \$110.00

Pilot SM244 Stereo Amp., dual 14 watts. Regular \$189.50. *Terminal's Special* \$125.00

Stromberg RF473 12" coaxial Speaker. Regular \$35.00. *Terminal's Special* \$19.95

Regency HF200 20-watt Power Amp. Regular \$99.50. *Terminal's Special* \$32.50

Stromberg AR411 10-watt Amplifier with Pre-amp. Regular \$65.00. *Terminal's Special* \$39.95

Bass Reflex Cabinet for 8" or 12" speaker. Walnut, cherry, blonde or mahogany finish. *Terminal's Special* \$29.95

Plus many others!

Of course quantities of a particular component may be limited and there's no telling in advance *what* specials you may find. But, with Terminal's ability to buy big, and with our knowledge of real value, you're sure to get just the buy you're looking for *anytime* you come in.

So, come in soon, come in often . . .

**TERMINAL**  
RADIO CORPORATION  
85 Cortlandt Street · New York 7, N. Y.  
phone WORTH 4-3311 cable TERMRADIO

the  
choice of those  
who **know**\*  
the difference



## marantz Stereo console

net \$225  
cabinet 24  
Slightly higher in West

### ★ Simplicity itself in use

Even the least technically-inclined person will find it easy to get fine results. In fact, it will seem almost automatic! The controls are grouped in a manner which forestalls confusion.

### ★ Versatility

We carefully considered all possible features (there are dozens!) and rejected those we found had no value in practical use. Yet — here is versatility enough to please the professional! At first glance it is hard to believe there are thirteen controls on the panel. Count them!

### ★ Superlative reproduction

Distortion is so infinitesimal that further reduction would be in the realm of laboratory curiosity. Hum and noise have been reduced toward the vanishing point by the use of a specially designed hum-cancelling transformer, carefully planned wiring layout, and unique circuitry.

### ★ Highest type construction

Typical Marantz quality is evident throughout.

### ★ Attractive, clean-cut appearance

Satin-gold finished panel. Matching machine-turned knobs. Cabinets available in Walnut, Mahogany or Blond, hand-rubbed finish.



### FOR BROADCAST AND RECORDING STUDIOS!

Aluminum-finished standard rack model available to order at additional cost.

For truly unequalled performance, combine with two of the remarkable Marantz 30 watt, model 5 power Amplifiers.

\* At authorized Marantz dealers only.  
Write for literature.

**marantz company**

25-14 Broadway, Long Island City 6, N. Y.

the results of his experiments with a primitive metronome, that parts of *Messiah* were dragged in the eighteenth century. Another hereditary defect, from which we still suffer, is the excessive use of the organ; Handel never used this instrument in the secco recitatives of the oratorios, and very seldom in the airs, except to double the bass in angry or warlike pieces. (He did, of course, use it regularly in the choruses, and sometimes played concertos on it between the acts.) Shaw pointed out that "we know rather less about [Handel] in England than they do in the Andaman Islands, since the Andamans are only unconscious of him whereas we are mis-conscious," and suggested that the only hope of obtaining justice for *Messiah* in a Christian country was to "import a choir of heathens, restrained by no considerations of propriety from attacking the choruses with unembarrassed sincerity of dramatic expression." In another article he recommended "the dispersion of the Handel choir by armed force"—an expedient we still have in reserve—and paid a prophetic tribute to the first clavichord ever made by Arnold Dolmetsch, "on a moderate computation, about forty thousand times as important as the Handel Festival."

This debasement of the currency brought its inevitable sequel. Round about 1900 sensitive musicians in England, familiar with the religious masterpieces of J. S. Bach, began to denounce Handel as a hollow and pretentious fraud—which of course is precisely the image in which he had been presented for generations. His stock sank rapidly, despite a gilt-edged market for *Messiahs* and *Israels*, and has only recently begun to recover. Today we have two contrasted methods of performance. On the one hand senior conductors employ big battalions (but no longer army groups) to spank the life out of two or three old favorites, an exercise that still draws a faithful public. On the other hand there have been attempts to reproduce some of the conditions of eighteenth-century performance, in particular the balance of forces, the spontaneous quality evoked by ornamentation (originally improvised), and the brilliance and variety of Handel's scoring in its true colors. Despite a few misfires, there is no doubt about the success of this movement, which is rapidly gaining momentum in more than one country; besides revealing the vast discrepancy between the historical and the traditional Handel, it has begun to excavate the numerous great works buried

Continued on next page

# DYNACO B&O

## STEREODYNE PHONO PICK UP

This new, unique pickup is made in Denmark by Bang and Olufsen. It features a push pull magnetic principle (patent pending) which permits realization of the full potentialities of the most modern recording techniques. The special attributes which make the Stereodyne an outstanding stereo pickup make it equally exceptional for monophonic discs. On any type of record the Stereodyne offers smooth and natural sound—firm clean bass and sparkling treble—while its light tracking pressure insures negligible record wear.

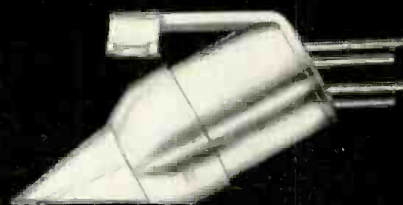

### BEST in every way . . .

- **Wide frequency response**  
Smooth peak free response from 30 cps to over 15 Kc
- **True Stereo**  
Highest channel separation over entire audio spectrum—better than 22 db.
- **Precision balance**  
Both channels identical  
Same high compliance (5 x 10<sup>-9</sup> cm/dyne) in all directions
- **No hum pickup**  
Balanced coil structure plus low impedance plus complete shielding eliminate hum from external fields
- **High output**  
7 millivolts per channel even on low level stereo discs provides gain to spare
- **No magnetic pull**  
Special magnetic circuit eliminates attraction to steel turntables
- **Easy installation**  
Compact size and standard mounting centers simplifies mounting. 4 terminals to avoid hum loops.
- **Low price**  
Only \$29.95 net including .7 mil diamond stylus (replaceable in 2' seconds)

Available from leading high fidelity dealers everywhere

**DYNACO INC.**

617 N. 41st St., Phila. 4, Pa.  
Export Division: 25 Warren St., New York, N. Y.

# Klipschorn

WIDE SCREEN STEREO

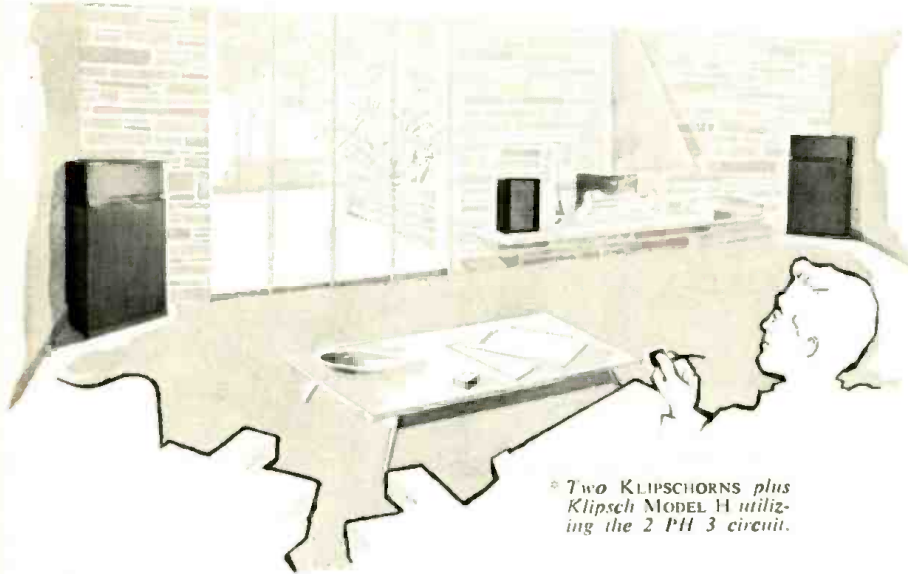

Two KLIPSCHORNS plus Klipsch MODEL H utilizing the 2 PH 3 circuit.

THE MOST ACCURATE PIN POINTING of sound sources occurs when loudspeakers are placed in widely separated corners with a derived third channel speaker between them. Only with this array is it possible to recreate accurately the original tonality and spatial geometry of a musical performance.



Write us for full information.

## KLIPSCH & ASSOCIATES

HOPE, ARKANSAS

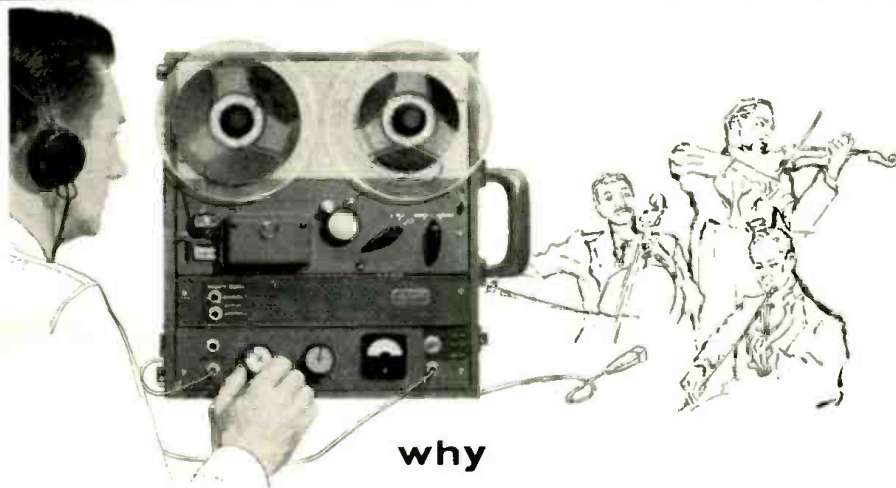

why  
professionals  
choose

the **Roberts**  
STEREO RECORDER  
\$349<sup>50</sup>

Sound engineers select the Roberts because its recording and playback features fulfill the highest standards of professional performance. Precision elements that make for smooth, controlled operation are Roberts calibrated V.U. meter, exclusive, new MULTI-RASE HEAD (for full track erase in stereo recording) and hysteresis synchronous motor. Responding faithfully from 40 to 15,000 CPS, the Roberts satisfies discriminating audiophiles in their most exacting listening and recording needs.

**ROBERTS ELECTRONICS Inc.**  
1028 N. La Brea Avenue, Hollywood 38, California

**NOW! RECORD IN STEREO**

**ROBERTS MATCHING  
RECORDING AMPLIFIER**

PROVIDES IDEAL SECOND CHANNEL  
PLAYBACK AND RECORD.  
COMPLETE WITH ROBERTS  
RECORDER.....

\$499<sup>00</sup>

## CHORISTERS

Continued from preceding page

by the misguided past, and already has driven some of the more discreditable travesties into limbo. It must be added that the gramophone companies (at any rate in England) have so far shown little enterprise. We have recently had an *Israel in Egypt* after Costa and a *Solomon* under Beecham, which, apart from polluting the score with every kind of anachronism including secco recitatives delivered by brass band, reduces the dramatic and musical design of this noble masterpiece to manifest nonsense.

In the theatre Handel is at last beginning to come into his own. The initiative came from Germany soon after the 1914-18 War, when both operas and oratorios reached the stage, though at first in arrangements heavily doctored to tickle post-Wagnerian ears. Oskar Hagen's versions of *Giulio Cesare* and *Rodelinda*, which are still performed, suggest nothing so much as an illicit union between the *St. Matthew Passion* and a Mahler symphony, with secco recitatives scored for full orchestra and the airs chopped about and transposed. It is fatal to the balance and texture of the music, a point to which Handel paid great attention, to distribute the *castrato* parts among tenors and baritones; countertenors or women are the only satisfactory answer. Later German revivals have shown better taste; indeed the Halle Festivals in the last ten years have threatened to out-baroque the baroque by employing far more continuo instruments than Handel himself used.

England has scarcely begun to discover the operas, of which some two dozen have been produced in Germany, but has led the field with the oratorios, which are musically better balanced and much more successful as dramatic wholes. Most of these ventures have been the work of amateur societies or the Universities (especially Cambridge), using professional soloists and sometimes a professional orchestra. They have won high praise, and prepared the way for the recent restoration of *Samson* (though in a sadly misconceived production) to its rightful place at Covent Garden. We must hope that this is only a beginning, and that we will at last be given the chance to recognize Handel for what he was, the creator of the longest sequence of dramatic masterpieces in musical history.



HIGH FIDELITY MAGAZINE

**ENGLISHRY**

*Continued from page 45*

thirteen different copyists have been identified: outside it, were many others. It is small wonder that the man whose music was cherished in so many households became a figure of national interest. The provincial press took a lively interest in his movement and concerts and regularly reprinted



notices about them from the London papers. By the late 1740s Handel's works were frequently played in a score or more of large cities, and in many other places that are unrecorded.

His health consequently became a matter of national concern. The course of his illnesses was followed with anxiety, and with his death, the light seemed to have gone out of English music. Apart from purely musical merit, contemporary accounts make it clear that Handel was esteemed and admired for his integrity, tenacity, simple piety, and deep charity. These very English virtues far outweighed his sometimes uncertain temper and roughness of speech. Clearly, while Handel retained much of his native individuality, he came to regard himself as an Englishman, and an important one. Like many truly great men, he had a humble yet realistic knowledge of his own merits; for the fourth codicil to his will, dated April 11, 1759, reads: "I hope to have the permission of the Dean and Chapter of Westminster to be buried in Westminster Abbey in a private manner at the discretion of my executor Mr. Amyand, and I desire that my said executor may have leave to erect a monument for me there." Thus did the great son of a German barber-surgeon stake his claim to a place in England's national shrine. Today, Handel's monument, carved in marble by Roubiliac, stands as gleaming white in the South Transept of the Abbey as when it was first erected.

**DEWALD** *more for the money*

**STEREO AND MONAURAL HI-FI COMPONENTS** *Double the Quality at Half the Price!*

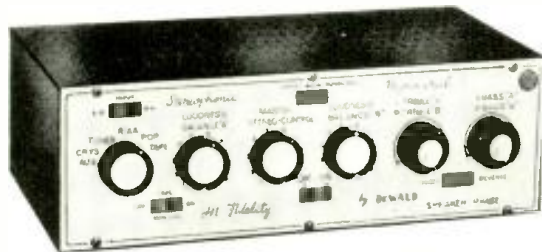

Model M-1200 "CONCERTO," Stereophonic and Monaural Pre-Amp Equalizer and Power Amplifier with "Multi-Phonic" Control. 15 Watts each Channel, Monaural 30 Watts - Tape Monitor - Speaker Phase Reverse. Superior to many instruments selling at much higher prices. Advanced engineering and styling. Complete flexibility - Input from any source!

**\$99.95 List** (CASE INCLUDED)

*"You Never Heard It So Good!"*

Model M-1000 "Ambassador" Stereo & Monaural HI-FI AM-FM Tuner

**\$99.95** (CASE INCLUDED)

Model L-803A "Imperial" FM-AM Tuner

**\$77.95** (CASE INCLUDED)

Model L-5000A "Troubador" 15 Watt Amp-lifier Pre-amp

**\$52.95** (CASE INCLUDED)

**OVER 35 YEARS OF DEPENDABILITY!**

EXPORT DEPT.:  
25 Warren St.  
New York, N. Y.  
Cable Address:  
SIMONTRICE

**DEWALD**   
A DIVISION OF  
**UNITED SCIENTIFIC LABORATORIES, Inc.**  
35-19 37th Ave., Long Island City 1, N. Y.

*Free!*  
**ILLUSTRATED BROCHURE ON REQUEST**

Can you answer this question?

**HOW MANY HOURS HAVE YOU USED YOUR HI-FI NEEDLE?**

EASILY CONNECTED TO ANY RECORD PLAYER



Unless you really know how many hours you have used your needle... you may be damaging your favorite records right now with a worn needle! **NOW YOU CAN STOP GUESSING**

The new RELTON Needle-Timer tells you exactly how many hours your needle has played. Tells you when the "safe-operating-hours" are up so you can replace your needle before your records are damaged. Remember, if you wait until you hear needle noise—you've waited too long.

The RELTON Needle-Timer is an inexpensive way to protect your investment in valuable records. Enjoy your favorite records without worrying about record damage. Order your RELTON Needle-Timer today. Mail coupon below.

RELTON CORPORATION  
99 N. LOTUS AVE.  
PASADENA, CALIFORNIA

**PROTECT YOUR RECORDS FROM DAMAGE BY WORN NEEDLES**

**RELTON**

HI-FI *Needle-Timer*

ONLY \$9.95 POSTPAID

**MAIL COUPON—ORDER TODAY**

**RELTON** CORPORATION 

P. O. Box 5546 PASADENA, CALIFORNIA

Send me a RELTON Needle-Timer postpaid. Enclosed is my check \_\_\_\_\_ or Money Order \_\_\_\_\_ for \$9.95. (No C.O.D.'s please) U. S. Only

NAME \_\_\_\_\_  
ADDRESS \_\_\_\_\_  
CITY \_\_\_\_\_ STATE \_\_\_\_\_

- Comes complete in beautiful ebony plastic case
- Occupies a minimum of space (3½" diam. x 2½" high)
- Easy-to-read dial
- Registers up to 720 hours—easily re-set
- Operates only when turntable is turning
- Complete with 5-ft. cord

Continued from page 52

in the last movement of No. 1, the thoughtful recitative that serves as third movement of No. 2, the jolly fugue that constitutes the finale of No. 4, the lovely opening of No. 5, and the interesting tone color of the fast movements of No. 6, where the violins are muted and the lower strings plucked throughout (the solo instrument was obviously intended to be a harp, though the work was published as for harp or organ). In Op. 7 the high spots are the first two movements of No. 1, which are remarkable chaconnes on different versions of the same theme, the noble *Overture* and attractive finale of No. 2, and especially No. 4 with its brooding and expressive first movement—the darkly colored opening is one of the rare introspective moments in recorded Handel and, to me, one of his great passages—and its hearty, thoroughly English-sounding finale (which, however, is said to be based on a piece by Telemann!).

There are excellent recordings of both sets, and in the case of Op. 4 there is a choice between two good complete sets. It is a choice over which we need not hesitate long. Biggs with the London Philharmonic conducted by Boult (Columbia K2L 258, two LP) is practically ideal. He uses a small English organ built to Handel's specifications; its balance with the orchestra is perfect; and the sound of both is as delicious as a properly chilled, not too dry, white wine. The Vox set (PL 7132, two LP), performed by Walter Kraft with the Pro Musica Chamber Orchestra, Stuttgart, conducted by Rolf Reinhardt, is in many respects first-class too, though in No. 1 the first movement is rather ponderous and the last lacks the grace of the Biggs, and throughout, the orchestra sounds closer to the microphone than the organ. Of interest, too, is the Archive recording of the first four concertos of Op. 4, by Eduard Müller with the Schola Cantorum Basiliensis, conducted by August Wenzinger (ARC 3100). Here, in Nos. 1 and 3, the performers employ the unspecified dotted rhythms that seem to have been commonly used in Handel's time. Müller also goes in for more boldness in ornamentation than Biggs does.

Handel left many indications for *ad lib.* improvisation in these works. Indeed, in Op. 7, Nos. 2, 3, 4, and 6, a whole slow movement is left for the organist to supply. What we hear in such places is, alas, not inspired but, at least in the Vox recording of this set (PL 7202, two LP), made by the

Germany's foremost manufacturer of high quality speakers presents:

## The ISOPHON RONDO

A speaker system with true 360 degree dispersion

The RONDO enclosure uses the Helmholtz principle and is a direct radiator with the speaker facing in a vertical direction, so that true 360 degree dispersion may be accomplished.

- Using the two-way ISOPHON PH 21
- Applying a polarloading technique that achieves a remarkable, low frequency response.
- Eliminating narrow beam radiation of high frequencies.—Independent of room placement.
- Cabinet made of finest West Indian mahogany in various finishes.
- In its size and price class, this unit is an unsurpassed performer for both, stereo and monaural use.

This is just one of many ISOPHON models.

Write for more details and beautifully illustrated brochure.

**ISOPHON SPEAKER DIVISION, Arnhold Ceramics, Inc.**  
1 East 57th Street, New York 22, N. Y.

same performers as that company's Op. 4, it is not so bad as to distract one from the beauties of the music Handel did supply. Here, though the organ still sounds a little distant as compared with the orchestra, performance and recording are first-rate. Presumably there is to be a Biggs-Boult Op. 7 soon.

A single disc that offers two concertos from each set, competently played and well recorded, is that issued by Kapp (KCL 9018), on which Lawrence Moe and the Unicorn Concert Orchestra conducted by Klaus Liepmann perform Op. 4, Nos. 2 and 5, and Op. 7, Nos. 1 and 5.

Because of the unsettled state of the record catalogues, I have listed only monophonic records. No doubt before press time many of these recordings will have been duplicated in stereo.



## IMPERISHABLE WAG

*Continued from page 55*

rious, of that same gentle parson being awakened in the middle of the night by the clatter of horses' hooves and the rattle of a coach, followed by furious bangings on his door; it was Mr. Handel, come helter-skelter, on a moment's impulse, to ascertain the meaning of some obscure couplet.

Usually Handel went straight to the heart of a lyric, to its general import, rarely bothering with the exact shade of hair's-breadth word setting which so fidgets modern composers. In true baroque fashion he was out to set the general *Affekt* of a poem to music; "if some of its feet came on the wrong beat," well, that was just too bad, but it couldn't be helped. The famous chorus in *Messiah*, "For—unto us a child is born," is an excellent example of what might happen to the underlying if words and music came into sharp conflict; it so happened that Handel wished to make use at this point of an earlier work, an Italian duet which gave just the effect he wanted. And how magnificent the resulting chorus is, if you can forgive him for starting off on the wrong foot. Always in a hurry, he sometimes let himself be carried away by one word in a lyric; one of the most engaging examples of this is his setting of "How vain is man," in *Judas Maccabaeus*. I feel sure that Dr. Morell intended this lyric for some sententious tune, reflecting solemnly on the futility of human aspirations; Handel, however, saw fit to read into the text a very

*Continued on next page*

# KT88 by Genalex

a high power tube  
designed for the new  
low distortion amplifiers



MADE BY GENERAL ELECTRIC CO. LTD. OF ENGLAND

**KT88** New high power version of the original KT66. A smaller, more powerful tube for highest possible performance with lowest distortion. For the manufacturer; an impressive sales point, a key to customer satisfaction, a valuable component for high power amplifiers. For the individual; a longer lasting, economical tube to increase day-to-day listening pleasure. Delivers up to 100 watts per pair, fits standard octal socket, same pin connections as KT66 and 6L6 tubes.



For full information, write Dept. XO-29, BRITISH INDUSTRIES CORP., PORT WASHINGTON, NEW YORK

# STEREO WEBCOR



## For matchless performance... choose the 1959 Webcor Regent Stereo Tape Deck!

This versatile, all-new Webcor Stereo Tape Deck provides stereo playback of breath-taking realism... also records and plays back monaurally.

- 3 recording speeds • oper-

- ates in vertical or horizontal position • Dual pre-amplifiers for channel 1 and 2 • Self-contained power amplifier • Edit Key • Tape Counter. Easy to install. About \$170.00.

See your  
hi-fi  
components  
dealer today!



## what's so special about **VITAVOX?**



Made in England  
by Vitarox, Ltd.

**Sound craftsmanship!** In a world of mass production and competition by price there is, fortunately, still room for the individually assembled craftsman-made product. In the field of sound reproduction, Vitavox loudspeakers are renowned for just these characteristics and are prized by the purchaser who places quality of performance and construction above other considerations. The DU120 Duplex Coaxial Full Range Loudspeaker is a fine example of modern audio craftsmanship.

A full range of Vitarox speakers are available to meet individual needs — at leading Hi-Fi specialists.

### **ERCONA CORPORATION**

(Electronic Division)

16 W. 46 St., Dept. 27, New York 36, N. Y.

## IMPERISHABLE WAG

Continued from preceding page

different time, more evocative of a dandy mincing down the Strand than of Morell's moralizings. It may have been an honest mistake, of course, but I'm not sure; I have a sneaking fear that Handel may have been pulling everybody's legs, and not least his librettist's. "Oh, vaat may ve not expect . . . ?"

Those librettists must have had a good deal to put up with, one way or another, when Handel's "great bear" got loose among them, but on the whole they were a mediocre crew, and their sorry verses have not been improved by the passage of time. Dr. Morell was probably the best of a poor lot, but even he sometimes descended to such doggerel as: "Pious orgies, pious airs, Decent orgies, decent prayers . . ." A "decent orgy" comes dangerously near to a contradiction in terms. I would have thought, but no matter; let us pass on, with averted glance, to "See, from his post Euphrates flies . . ." Which makes one wonder, first, to what sort of post one could possibly tether a river, and, secondly, if perhaps the River God was expecting a letter from the local tax collector. Charles Jennens, who is supposed to have assembled the text of *Messiah*, also fancied himself as a poet; one of his gems is in *Saul*, where he makes the heroine, Michal, announce that "A father's will has authoriz'd my love . . ."

Of course, Handel's librettists cannot be blamed for the many changes in the actual meanings of words that have taken place in the last two centuries. No one in Handel's day could have foreseen the eventual sad debasement of the word "awful," which in the eighteenth century still signi-



fied full of awe; if anyone had, even Handel would not have made poor Virtue, in *The Choice of Hercules*, sing "Listen to my awful voice" no fewer than eight times in the course of one aria. Purist as I am, I think that one might make some slight emendation here; otherwise Virtue will go on

Continued on page 138

# vivid

stereophonic  
reproduction!

This is the way your stereo discs were meant to be played — and heard. Alive! Brilliant! Webster Stereo-Ceramic gives you head-turning direction, depth you can distinctly feel. And the fidelity is superb! Monophonic reproduction, too, is better than ever. Plug-in type; fits any standard arm. Response up to 15,000 cps.

**WEBSTER STEREO-CERAMIC**  
two models — and 78 rpm insert . . .

**SC-2D Stereo single needle**  
— with .7 mil diamond  
stylus. \$22.50

**SC-3D Stereo turn-under**  
— with .7 mil diamond and  
3 mil sapphire styli. \$25.00



ELECTRONICS DIVISION

WEBSTER ELECTRIC

our 1st year  
RACINE - WIS  
Franklin ed. 9-131



CALIFORNIA

send for famous Bulletin G . . .  
it's free!

## HIGH-FIDELITY HOUSE

Most complete stock of Audio components in the West

Phone: RYan 1-8171

536 S. Fair Oaks, Pasadena 1, Calif.

## PRESLEEP TAPES

A new book, with step-by-step how-to-do-it data on making remarkably effective self-suggestion tapes for self improvement. \$3 Postpaid.

**ENABLES YOU TO ACHIEVE A NEW, VITAL USE OF YOUR TAPE RECORDER!**

Write for Literature

**PRESLEEP TAPES**

1214 West 30th St. Los Angeles 7, Calif.

NEW JERSEY

### PROFESSIONAL HI-FI REPAIRS

Creeping deterioration or superficial "fixing" is robbing many of full HI-FI enjoyment they paid for. New concept in HI-FI servicing developed by BREMY ELECTRONICS in collaboration with the AMERICAN AUDIO INSTITUTE, an independent testing laboratory. Over 30 precision instruments; new & more exacting test methods. Your equipment restored to peak performance quickly and inexpensively by experienced professionals. Written laboratory test report with every repair job. Bring any make HI-FI phonograph, tuner, tape recorder, amplifier and see one of the finest audio laboratories in the U.S.A. Experts on Stereo. Check-up and test report from \$5.00. Reasonable rates on all repairs. Please pack securely when mailing for service. BREMY ELECTRONICS, 394 E. 18th St., Paterson 4, N. J. Tel. LAmbert 5-1191.

## HI-FI HAVEN

New Jersey's Leading Sound Center

Write for information on unique mail order plan that offers professional advice and low prices

Registered Component Dealer

28 Easton Ave. New Brunswick, N. J.



## RECORDS from YOUR TAPES

Spectrofonics®—HIGH FIDELITY

Your tapes transferred by our skilled engineers using top professional equipment: Ampex 300's—Gramplan Feed-Back Cutters—Thermo Stylus

Write for Free Folder

Recorded Publications Laboratories  
1540-1568 Pierce Avenue, Camden 5, N. J.

NEW YORK

Only a Rich Purple People Eater Does Not ...

Check with **AUDION** before buying HI FI components

Write for free Catalog

**audion** 25-HF-Oxford Road Massapequa, L.I., N.Y.

NEW YORK

## FOR THE TOPS IN VALUE AND THE BEST TRADE-IN ON HIGH FIDELITY EQUIPMENT

Check with Arrow!

# ARROW ELECTRONICS, INC.

65 Cortlandt St., New York 7, N. Y.  
DlgbY 9-4730  
525 Jericho Turnpike, Mineola, N. Y.  
Pioneer 6-8686

## SOUNDTASTIC!



**WRITE FOR FREE SELECTOR & PLANNING BOOKLET LISTING SOUNDTASTIC HI-FI SYSTEMS AT SPECIAL PACKAGE QUOTATIONS**

2057 Coney Island Ave. Brooklyn 23, New York



You can now purchase all your HI-FI from one reliable source and be assured of perfect delivery. Carston makes delivery from NY stock on most HI-FI Recorders and tape within 24 hours. SEND US A LIST OF YOUR HI-FI REQUIREMENTS FOR OUR WHOLESALERE QUOTATION and our FREE wholesale catalogue.

## CARSTON

215 HH E. 88 ST. NEW YORK 28, N. Y.

## TAPE RECORDERS



HI-FI Components

SLEEP LEARN KITS

Unusual Values

FREE 1959 Catalog

MERITAPE Low cost, high quality recording tape, in boxes or cans.

DRESSNER, 69-02 FA, 174 St., Flushing 65, N. Y.

## RECORDING TAPE AT ROCK-BOTTOM PRICES

3408 Hi-Fi enthusiasts, now using F&B recording tape say "why pay more when F&B absolutely guarantees new, fresh, highest quality, hi-fi tape — frequent, 30-15,000 cycles — or your money refunded"

Just Compare These Rock-Bottom Prices

600 Ft. 5" Reel	— Acetate Base — 3 for	\$2.85
900 Ft. 5" Reel	— Acetate Base — 3 for	3.40
900 Ft. 5" Reel	— Mylar Base — 3 for	4.20
1200 Ft. 7" Reel	— Acetate Base — 3 for	4.95
1800 Ft. 7" Reel	— Acetate Base — 3 for	5.25
1800 Ft. 7" Reel	— Mylar Base — 3 for	6.85
2400 Ft. 7" Reel	— Mylar Base — 3 for	10.60

Please Add 15¢ PP & Handling — Per Reel

**FLORMAN & BABB, INC.**  
68 West 45th Street New York 36, N. Y.

World Renowned Speakers

Few areas still open. Moderate franchise requirements.

WRITE • WIRE • PHONE

**HARTLEY PRODUCTS CO.**  
521 East 162nd Street, New York 51, N. Y.  
LU'dlow 5-4239

NEW YORK



## DRAW...

your own conclusions partner, when you receive our special quotations on your Hi-Fi needs. Write too for audio catalog A-10, loaded with double-barreled values.

**Key Electronics Co.**  
120 Liberty St., N. Y. 6, N. Y.  
EVergreen 4-6071

## RECORD COVERS

Round Bottom, Transparent, Polyethylene, for 12" records

**20** for only \$1.00 ppd.  
BONUS OFFER 120 for \$50.00 ppd.  
Send cash, check or M.O. to



**LYON PRODUCTS CO.**  
DEPT. F, BOX 42, PLANETARIUM STATION, N.Y. 24, N.Y.

## LEONARD RADIO, INC.

69 Cortlandt St., New York 7, N. Y. (Cortlandt 7-0315)

ELECTRONICS for HOME and INDUSTRY

**FREE ... !**

128 PAGE HI-FI STEREO CATALOGUE

## "BUCK STRETCHER" HI-FI VALUES!



Expand the buying power of your Hi-Fi dollar at Sun Radio on new and fully guaranteed name brand Hi-Fi components!

Send for our special price quotations and our Hi-Fi package specials!

Dept. 79  
**SUN Radio & Electronics Co., Inc.**  
650 6th Ave., New York 11, N. Y.  
Phone: ORegon 5-8600

# T.T.T. FOR A P.D.Q.\*

\*Talk To Terminal for a Package Deal Quote Come in or write to: Irwin Levy, Mgr., Audio Dept., TERMINAL RADIO CORPORATION 85 Cortlandt Street, New York 7, New York

VIRGINIA

## BUYING HI-FI? GET LOWEST PRICES PLUS RELIABILITY!

For WHOLESALERE quotations, write your list of hi-fi requirements. We promptly ship fresh, late serial (no rejects), sealed cartons, mfg's warranted equipment. Save on shipping!

**LACY'S** WHOLESALERE ELECTRONICS  
1 N. 6th St.—Richmond, Va.



## STEREOPHONIC



### THE ALL NEW BOC STEREO MASTER 7995

Professional Features UNDUPLICATED by Any Other Stereo Control System in the World! So versatile—so flexible—it plays both Stereo and your old Monaural records as they NEVER HAVE BEEN PLAYED BEFORE!

The BOC "STEREO MASTER CONTROL" is not limited to stereo... Play and enjoy all your old conventional mono records with a new brilliance! The infinite control of this precise pre-amp places the conductor's baton in your hand. With all these remarkable features the BOC Stereo Master is so simple to use a child can operate it.

#### SPECIFICATIONS (each channel)

Sensitivity: 5MV for 1V out • Hum & Noise: minus 120 db • Bass Control: -20 db to +20 db • Treble Control: +20 db to -20 db • Response: 10 to 65,000 cps • Distortion: 3 1/2% at 2V output • Max. Output: 5V each channel.

#### FEATURES:

Self Powered • Mode Switch: all functions • Complete Record Equalization • Balance Control • Bass & Treble Control • 0 to -20 db • 14 inputs—4 separate outputs • Phono loading: 100 to 100,000 ohms • Loudness & Volume Controls • Hum Balance • Cathoda follower output • Tubes: Four ECC-83's, 1 rectifier.

See Your Local Dealer or Write Direct! Dealer Inquiries Invited.

**BIGG of California**

2506 W. Washington Boulevard  
Los Angeles 18, California

## IMPERISHABLE WAG

Continued from preceding page

unintentionally evoking some of that "heart-easing mirth" which Handel so joyously hymned in *L'Allegro ed il Penseroso*. This brings us to some of the greater poets with whom Handel found himself collaborating—after their apotheoses, naturally. I am not quite sure if we can blame Milton entirely for that curious couplet in *Samson* which announces glibly that "To man God's universal law/Gave power to keep his wife in awe . . ." Wistful thinking, perhaps? But I feel sure that Handel must have had a quiet little bachelor chuckle when he set that earth-shaking reflection to suitably sententious music. We have seen how he could domineer over prima donnas, but he seems to have been cautious to avoid all danger of matrimonial altercations; the wily old boy didn't even have to try to keep a wife in awe. Milton's younger contemporary, Dryden, left one line which will always give rise to mirth in a musician's soul; what conductor can hear, without apprehension, that wonderful line in *Alexander's Feast*—"Behold, a ghastly band . . ."? Let us draw a kindly veil over this part of the proceedings and tiptoe on.

Hitherto we have mentioned only the more obvious examples of humor in Handel, in connection with vocal works, where word setting and character drawing are concerned. But it can be observed in his purely instrumental works, sometimes overtly, sometimes slightly concealed. Chief among such music comes his crowning instrumental achievement, the twelve glorious *Grand Concertos*, Op. 6. To me these concertos are full of never-failing interest and variety, much more so, say, than J. S. Bach's *Brandenburg* Concertos. In Handel's Opus 6, no single concerto is devoted entirely to one mood, but the individual movements, like his arias, are usually dominated by one broad *Affekt*. Thus we have playful movements (Concerto No. 2, second movement, *Allegro*); boisterous movements (No. 3, third movement, *Allegro*); jolly movements (No. 9, second movement, *Allegro*); mysterious movements (the opening of No. 11); some wistful movements (the second movement, *Allegro*, of No. 12, when it is played at the proper gentle speed); and, of course, plenty of merely vigorous movements and several examples of Handel's own special kind of stately serenity. One movement I never cease to wonder at is the three-eight Presto of No. 5. I remember reading somewhere in the pages of G.B.S. how

## TRADER'S MARKETPLACE

Here's the place to buy, swap, or sell used equipment, records or what have you. Rates are only 45c a word (no charge for name and address) and your advertisement will reach more than 110,000 music listeners. Remittance must accompany copy and insertion instructions. Copy must be received by 5th of 2nd month preceding publication and is subject to approval of publishers.

**HI-FI DOCTOR**—Will solve your hi-fi problems on-the-spot. Acoustic, Audio, Radio Engineer. Stereo Designing. Professional visits, day, evening, New York area, weekdays. William C. Bohn, 550 Fifth Avenue, New York City, Plaza 7-8569.

**PRECISION RECEIVER ALIGNMENT:** AM-54; FM-55; AM/FM-58. Kits a specialty. Telephone ED 4-4490. I. Pollack, Westbury, L. I., N. Y.

**AMPEX 350 Series Record-Playback Electronics Assemblies**, with power supplies. Two complete systems, with all 125J7's select. Both \$775 \$400 singly. Russell Cowles, 809 Adams Place SE, Albuquerque, New Mexico, CHapel 7-1711, Ext. 2867.

**BUY TRADE,** Want McIntosh C85, MC30 or Marantz. Have new guns, or .22-.250 Czech Mauser K10, \$125; Hi Standard, .22 pistol, \$40; Springfield, \$41. Robert Mangus, R. R. 6, Lafayette, Indiana.

**WANTED: HIGH FIDELITY 1 thru 15.** Frank Morabito, 234 W. River Rd., Olean, N. Y.

**McINTOSH C8 preamp \$45.00.** C85 preamp \$55.00. R. D. Brittenham, 12074 Montrose, Detroit 27, Michigan.

**AM-FM Tuner, Craftsman Model C-10.** Excellent Condition. Sacrifice \$65.00. I. S. Nedler, P. O. Box 9263, San Antonio, Texas.

**Berlant 33 stereophonic recorder** in three carrying cases, four heads, sound-on-sound attachment, playback amplifiers and speakers in both record-amplifier cases, low impedance transformers. Factory checked and returned to specs 12 hours ago. Cost over \$1,400.00, sacrifice \$795.00 or best offer F.O.B. Russell A. Austin, 1309 Arnold Avenue, Aberdeen, Washington.

**NATIONALLY ADVERTISED High Fidelity kits**, wired and assembled. Write for quotation. H. D. Tiller, 3504 S. Main St., Anderson, S. C.

**LOWTHER TP-1 and Quad II.** Both \$425 FOB. E. C. Gordon, 17 Granella St., Hampton, Va.

**HI-FI LOWEST** quotes: write for prices. Registered IHFM dealer. R. Bruna, 162 E. Cook Avenue, Libertyville, Illinois.

**INDUCTORS for Crossover Networks, 118 types** in stock. Send for brochure. C & M Coils, 3016 Holmes Avenue, N.W., Huntsville, Ala.

**HIGH FIDELITY components** at rock bottom prices. Brand new, fully guaranteed. All major makes. Amplifiers, tuners, speakers, etc. Our prices can't be beat. Write for quotations. The Ham's Exchange, 228 Stephen Street, Levittown, N. Y.

**HIGH FIDELITY 1-55.** \$20 FOB. E. C. Gordon, 17 Granella St., Hampton, Va.

**UNUSUAL VALUES.** Hi-Fi components, tapes and tape recorders. Free catalogue MF. Stereo Center, 51 W. 35th St., N.Y.C. 1.

**RUSSIAN JAZZ!** Foreign correspondent just back with jazz recordings from Moscow, Leningrad, Black Sea resort night spots! Unique! Collector's item. Only genuine current Soviet jazz LP Album in USA! 14 selections: \$5.50. Posthouse, P. O. Box 1414, Los Angeles 53, Calif.

**CONNOISSEUR turntable** like new—\$66. Brociner Pre-amp needs work—\$12. Dr. S. S. Saltzman, 1221 S. 17th Street, Las Vegas, Nevada.

**SALE:** Opera News, Volumes, 12-22, \$4.00 each, postpaid. Mrs. H. K. Livingston, 1224 E. Newport Pike, Wilmington 4, Del.



## MONARCH of stereo cartridges:

### ESL Gyro/Jewel

The only stereo cartridge approved by the High Fidelity Consumer's Bureau of Standards. This true electrodynamic pickup is years ahead in performance. Insist on the ESL C-100 Series at only \$69.95.



FOR LISTENING AT ITS BEST  
**Electro-Sonic Laboratories, Inc.**

Dept H-35-54 36th St • Long Island City 6, NY

**PS: You'll want the new ESL Gyro/balance stereo arm that makes all cartridges sound better! Only \$34.95.**

# PURCHASING A HI-FI SYSTEM?

Send Us Your List Of Components For A Package Quotation

WE WON'T BE UNDERSOLD!

All merchandise is brand new, factory fresh & guaranteed.

# AIREX RADIO

CORPORATION

64-HF Cortlandt St., N. Y. 7, CO 7-2137

## PARTIAL LIST OF BRANDS IN STOCK

Altec Lansing  
Electrovoice  
Jensen  
Hartley  
University  
Acoustic Research  
Jonszen  
Wharfedale  
Karlson  
Viking  
Concertane  
Bell • G.E.  
Weathers  
Harman • Kardon  
Eico • Pilot  
Sherwood  
Acrosound  
Fisher  
Bogen • Leak  
Dynaak  
H. H. Scott  
Pentron  
Ampro • VM  
Revere • Challenger  
Wallensack  
Garard  
Miracord  
Glaser-Steers  
Rek-O-Kut  
Components  
Norelco  
Fairchild  
Pickering • Gray  
Audio Tape

Full Line of Cabinets

he saw in Beethoven's *Hammerklavier* Sonata a prophetic vision of nuclear theory; I have always felt that in the whirling semiquavers of this unparalleled movement old Handel showed something of the same prophetic insight.

Some of Handel's earlier concertos (the so-called Hautboy Concertos, Op. 3) also have their humorous moments, particularly in the dances—Handel's dances are rarely stiff and formal, but have a broad and earthy life of their own; one has only to think of the *Water Music* to feel the truth of this. Some of his most delightful dances are in the "Frenchified" ballet operas of the mid-1730s (*Ariodante*, *Terpsicore*, *Alcina*): the best example of all is the *Dream Music* in *Alcina*, a psychological pantomime depicting a conflict between good and evil dreams—the good dreams represented by the strings "à 5," the evil by tremendous unisons; the good dreams are startled (oh delicious flutterings, preëchoing those disappearing angels in *Messiah*!) and there follows a battle, to a Lulliste *Air des Combattants*, between good and evil. My description may sound overfanciful, but Handel's music here is remarkable, as those who are fortunate enough to possess Boyd Neel's recording (on Unicorn UNLP 1038) will readily agree.

Many years ago I wrote in a play that to me Handel was The Greatest Common Denominator of all mankind. I still hold to that belief, and I think that it is above all his gift of humor which confirms me in my opinion. Certainly to an Englishman no man can be truly great who has no sense of humor. If you are one of those who have been brought up on what one might call the Messianic theory of Handel and his music, you may feel that I have been poking unnecessary fun at him. Indeed I have not; there is no stauncher Handelian in the world than Charles Cudworth. One does not laugh *at* the Great and Good Mr. Handel; one laughs *with* him.

## FM/Q ANTENNAE

THE FINEST OF ITS KIND . . .  
Get more FM stations with the world's most powerful FM Yagi Antenna systems.

To be fully informed, send 25¢ for book "Theme And Variations" by L. F. B. Carini and containing FM Station Directory.



APPARATUS DEVELOPMENT CO.  
WETHERSFIELD 9, CONN

# WAREHOUSE SALE

SAVE UP TO 63% ON

## SCULPTURE

Masterpieces of

### FAMOUS COMPOSERS

- (Illustrated)
- M-10 "Bust of LUDWIG VAN BEETHOVEN." 1770-1827. White ivory finish. Height 9". Only **8.95**
  - M-11 "Bust of FREDERIC CHOPIN." 1810-1849. White ivory finish. Height 9". Only **8.95**
  - M-17 "Bust of ROBERT SCHUMANN." 1810-1856. White ivory finish. Height 8". Only **6.95**
  - M-16 "Bust of RICHARD WAGNER." 1813-1883. White ivory finish. Height 8". Only **6.95**
  - M-13 "Bust of FRANZ HAYDN." 1732-1809. White ivory finish. Height 11½". Only **9.95**
  - M-18 "Bust of FRANZ SCHUBERT." 1797-1828. White ivory finish. Height 7". Only **6.95**
  - M-14 "Bust of FRANZ LISZT." 1811-1886. White ivory finish. Height 9". Only **8.95**
  - M-12 "Bust of GIUSEPPE VERDI." 1813-1901. White ivory finish. Height 9½". Only **8.95**
  - M-19 "Bust of ANTON RUBINSTEIN." 1829-1894. White ivory finish. Height 7¾". Only **6.95**
  - M-15 "Bust of FELIX MENDELSSOHN." 1809-1847. White ivory finish. Height 7½". Only **6.95**



INTERESTING HISTORY OF COMPOSER INCLUDED  
Complete, fully-illustrated catalog of over 100 sculpture masterpieces sent for \$1.00 (may be deducted when you order any item).

10-Day Money Back Guarantee

CHECK ITEMS DESIRED. ENCLOSE CHECK OR MONEY ORDER AND ORDER DIRECT FROM:

WYNN'S WAREHOUSE Dept. HF-4  
239 Great Neck Road, Great Neck, N. Y.



# THE CASE FOR BETTER SOUND

Why settle for ordinary tape when Sonoram gives you so many exclusive extras—brilliant reproduction, permanent plastic container, 3-way indexing system with pressure sensitive labels and V-slot self threading Selection Finder reel.



**FREE** Tape-time ruler. Gives you footage and recording time on reel. Write Dept. H4

**Ferro Dynamics CORPORATION,**  
LODI, NEW JERSEY

# THE HIFILITE

## BRINGS TRUE HI-FI SOUND OUTDOORS



You can now enjoy Hi-Fi all year 'round!

Summertime can still be Hi-Fi time . . . when you bring true high fidelity sound outdoors with you! For this smart patio lamp conceals a sensitive hi-fi speaker . . . adapts sensibly to your patio decor. Relax outdoors this summer with hi-fi supplied by your new HIFILITE.

Write for your nearest dealer!

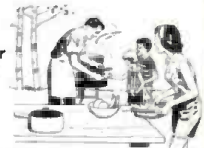

**Lowell MANUFACTURING COMPANY**

3030 LACLEDE STATION ROAD  
ST. LOUIS 17, MO., U. S. A.  
IN CANADA: ATLAS RADIO CORP. LTD.  
50 WINGOLD AVE., TORONTO 19, CANADA



**audio  
exchange**  
IS YOUR BEST SOURCE FOR

**ALL  
LEADING AND  
PROVEN  
COMPONENTS**  
Use this **7** point  
check list and  
compare!

- NEW COMPONENTS**  
lowest competitive prices
- USED COMPONENTS** - for 8 years largest  
supplier of fully guaranteed components
- TRADING OUR SPECIALTY**  
Highest prices. Trade up to Stereo
- COMPLETE STOCK** - all major manufacturers
- KNOW HOW** - Hi Fi is our only business.  
Our people are experts in sales and service
- MAIL ORDER SPECIALISTS** - We boast of  
satisfied customers in 49 states and abroad
- REPAIR AND CUSTOM INSTALLATIONS**  
by Hi Fi Experts - 90 day warranty

Write Dept. HF 59 for our unique Trade-Back  
plan, and Trading information

**audio  
exchange**

THE HI-FI TRADING ORGANIZATION

153-21 Hillside Ave.    367 Mamaroneck Ave.  
Jamaica 32, N. Y.    White Plains, N. Y.

836 Flatbush Ave.    451 Plandome Road  
Brooklyn, N. Y.    Manhasset, L. I.

CLOSED MONDAYS. Parking at all stores

REGISTERED  
COMPONENT  
DEALER

INSTITUTE OF  
HIGH FIDELITY  
MANUFACTURERS  
INC.

ADVERTISING INDEX

Key No.	Page	Key No.	Page
1	Acoustic Research, Inc. .... 16	62	Lacy's Wholesale Electronics .... 137
2	Airex Radio Corp. .... 139	63	Lafayette Radio .... 4
3	Allied Radio .... 9	64	Lansing, James B., Sound, Inc. .... 27
4	Altec Lansing Corp. .... 24, 125	65	Lectronics, Inc. .... 126
5	Angel Records .... 77, 93	66	Leonard Radio .... 137
6	Apparatus Development Corp. .... 139	67	Leslie Creations .... 99
7	Arnhold Ceramics, Inc. .... 134	68	Liberty Records .... 98
8	Arrow Electronics .... 137	69	London Records .... 84
9	Audio Devices, Inc. .... 102	70	Louisville Philharmonic .... 69
10	Audio Exchange .... 140	71	Lowell Mfg. Co. .... 139
11	Audio Fidelity Records .... 99	72	Lyon Products .... 137
12	Audio World .... 137	73	Marantz Co. .... 131
13	Audiogersh Corp. .... 128	74	McIntosh Laboratory Inc. .... 17, 18
14	Audion .... 137	75	Mercury Records .... 65
15	Bigg of California .... 138	76	Mercury Scientific Products .... 95
16	Blonder-Tongue Labs .... 32	77	M-G-M Records .... 75
17	Bogen, David, Inc. .... 22	78	Miller International Music Listeners Bookshop .... 129
18	Book-of-the-Month Club .... 5, 15	55	Neshaminy Electric Corp. .... 128
19	Bozak, R. T., Co. .... 33	79	North American Philips Co., Inc. .... 8
20	Bremy Electronics .... 137	80	Omega Stereophonic Disk .... 92
21	British Industries Corp. .... 40	81	ORRadio Industries .... 21
22	British Industries Corp. .... 135	82	Pickering & Co. .... 2
23	CBS Hytron .... 124	32	Pickwick Sales Corp. .... 80
24	C & D Products Co. .... 99	83	Pilot Radio Corp. .... 123
25	Capitol Records, Inc. .... 73, 81, 95, 96	121	Precision Electronics .... 34
26	Carston Studios, Inc. .... 137	84	Presleep Tapes Professional Directory .... 137
27	Columbia LP Records .... 13	85	RCA Components .... 14
28	Columbia Records 80, 90, 92, 95, 96, 99	85	RCA Victor Division 67, 89, Inside Back Cover
29	Concert Cabinetry .... 136	Record Market .... 99	
30	Connoisseur .... 134	86	Recorded Publications .... 137
31	Conrac, Inc. .... 19	87	Recoton Corp. .... 126
32	Design Records .... 80	88	Reeves Soundcraft .... 100
33	Dewald Radio Manufacturing Corp. .... 133	89	Rel-O-Kut Co., Inc. .... 25
34	Dressner .... 137	90	Relton Corp. .... 133
35	Dyer-Bennett Records .... 90	91	Richmond Records .... 90
36	Dynaco Inc. .... 131	92	Rigo Enterprises, Inc. .... 125
37	EICO .... 11	93	Roberts Electronics Inc. .... 132
38	Electro-Sonic Laboratories .... 135	94	Robins Industries .... 74
39	Electro-Voice Inc. .... Back Cover	95	Roulette Records .... 91
40	Ercona Corp. .... 134	96	Sargent-Rayment Co. .... 12
40	Ercona Corp. .... 136	97	Schober Organ .... 99
41	Fairchild Recording Eqpt. Co. .... 10	98	Scott, Herman Hosmer, Inc. .... 108
42	Ferrodynamics Corp. .... 139	99	Seeco Records .... 95
43	Fidelitone .... 28	100	Sherwood Electronic Laboratories, Inc. .... 20
44	Fisher Radio Corp. .... 30, 31, 38	101	Sonotone Corp. .... 37
31	Fleetwood Television (Conrac, Inc.) .... 19	102	Stromberg-Carlson .... 78, 79
45	Florman and Babb .... 137	103	Sun Radio and Electronics .... 137
21	Garrard Sales .... 40	104	Superscope, Inc. .... 23
22	Genalex .... 135	105	Terminal Radio .... 130, 137
46	Glaser-Steers Corp. Inside Front Cover	106	Thorens Co. .... 6
47	Grado Laboratories, Inc. .... 94	Trader's Marketplace .... 138	
48	Gray Manufacturing Co. .... 26	107	United Artists Records .... 86
121	Grommes .... 34	108	United Audio Products .... 35, 36
49	Harman-Kardon Inc. .... 7	109	University Loudspeakers, Inc. .... 56
50	Hartley Products Co. .... 137	110	Urania Records .... 82
51	Heath Co. .... 103-107	111	Vanguard Recording Society, Inc. .... 83
52	Hi Fi Haven .... 137	40	Vitavox .... 136
53	High Fidelity House .... 137	112	Vox Productions, Inc. .... 68
54	High Fidelity Recordings .... 29	113	Warner Bros. Records, Inc. .... 72
55	JansZen .... 128	114	Washington Records .... 96
56	Janus Records .... 96	115	Weathers Industries .... 39
57	Jensen Mfg. Co. .... 1	116	Webcor, Inc. .... 135
58	KLII Research Development Corp. .... 130	117	Webster Electric .... 136
59	Kapp Records .... 70, 71	118	Westminster Recording Co. .... 58
60	Key Electronics .... 137	119	Wollensak .... 127
61	Klipsch .... 132	120	Wynn's Warehouse .... 139

NEW POP ALBUMS IN GLORIOUS

LIVING | STEREO

ON RCA VICTOR

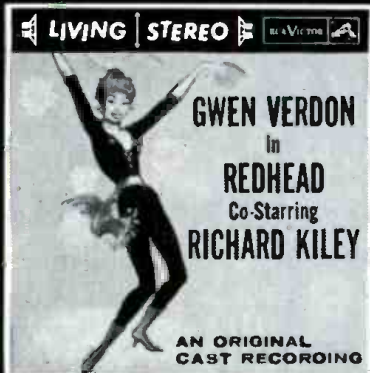

The Original Cast Recording of Broadway's newest hit musical! Gwen Verdon at her best!

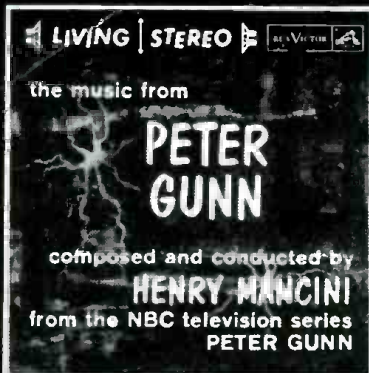

The hottest jazz album of '59, from the great new television hit "Peter Gunn."

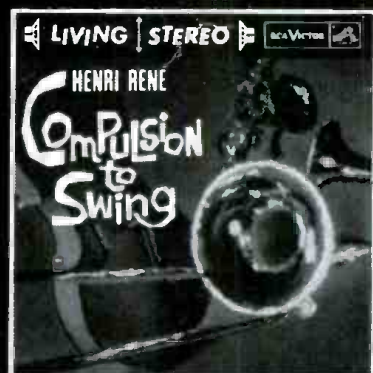

Henri René leads his swingin' quintet through a dozen best-favored standards!

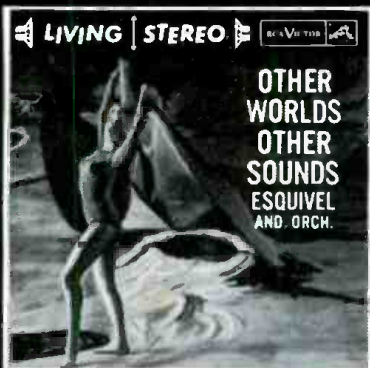

The power of a big band in dazzling Latin rhythms. A sound spree, hi-fi fan's dream!

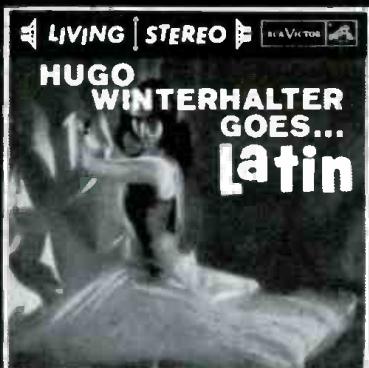

Hugo Winterhalter goes South-of-the-Border for a hot time! Very hi-fi and very fiery!

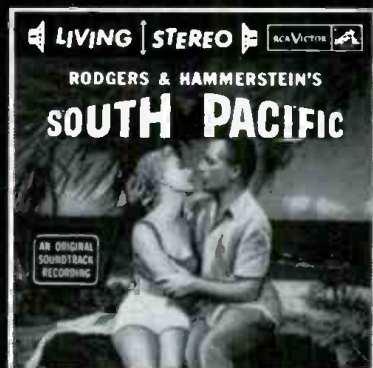

A big best-seller! The original soundtrack recording of the glorious musical hit!

WHEN ORDERING STEREO, SAY... RCA!

ALL OF THESE ALBUMS ARE ALSO AVAILABLE ON REGULAR LONG PLAY.



RCA VICTOR

TRADEMARK © RADIO CORPORATION OF AMERICA



# STEP-UP TO STEREO...ON A BUDGET

with



Stereo's Standard

STEREO'S STANDARD

IF THIS IS YOUR PRESENT or PROPOSED SPEAKER SYSTEM

5 1/2"

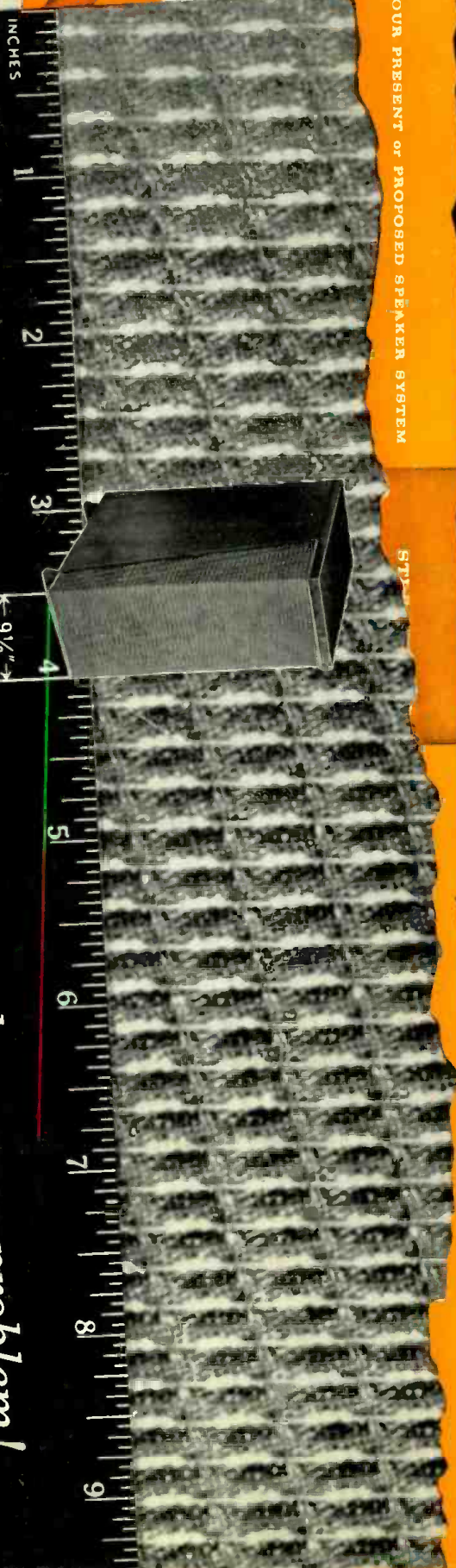

## HOW 9 1/2 inches solves your speaker space problem!

Want a high-efficiency speaker enclosure that uses only 9 1/2" of wall space yet delivers deep fundamental bass tones? The new Electro-Voice Coronet is your answer... it's functional, economical and compact... actually reproduces sounds which, until now, could be had only from larger, much more expensive enclosures. In addition, the flexibility of the Coronet allows you to match high-efficiency systems for stereo. With either the E-V 8" full-range speaker or the E-V separate 2-way 8" system, the Coronet delivers full-range flat response to beyond audibility. And the new E-V vented-back design (see Figure A) actually radiates sound from the back of the enclosure as well as the front, to give you full-bodied fundamental bass tones. You'll like the Coronet's attractive styling too... it will harmonize with any decor. And you can choose from rich mahogany, limed oak or warm walnut veneers. You'll find the Coronet perfect for stereo... ideal for an extension speaker anywhere in your home. Hear its full-fidelity sound reproduction demonstrated at your franchised Electro-Voice dealer. Listen especially to its startling dynamic range. Compare sound... compare price... compare size... and you'll choose the remarkable Coronet... only \$35.50 net (without speaker). E-V Coronet 1A with E-V SP8B 8" coaxial speaker, T35B VHF driver, X36 crossover network and AT37 level control... just \$102.00 net. And write Dept. HR4 for your free illustrated booklet, "Guide to High-Fidelity Speakers for Stereo".

Coronet Enclosure Size:

25" high, 9 1/2" wide  
and 17 3/8" deep.

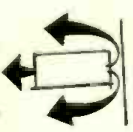

Figure A

**E-V** CORONET BY *Electro-Voice*

Electro-Voice, Inc., Buchanan, Michigan, Superb Products Through Research

NO  
or W

Electro-Voice  
High Fidelity Loudspeakers  
Public Address Speakers, Home Entertainment  
National Electronic Instruments and