

HiFi/Stereo Review's

\$1.25

1966 TAPE RECORDER ANNUAL

EVERYTHING YOU NEED TO KNOW ABOUT TAPE RECORDING
How to Choose a Recorder ★ Roundup of Video Recorders
Tips on Tape Editing ★ Taping Stereo FM ★ Microphones
Picking the Best Tape ★ How to Tape from Discs ★ PLUS:
Directory of Stereo Tape Recorders, Accessories, Mikes

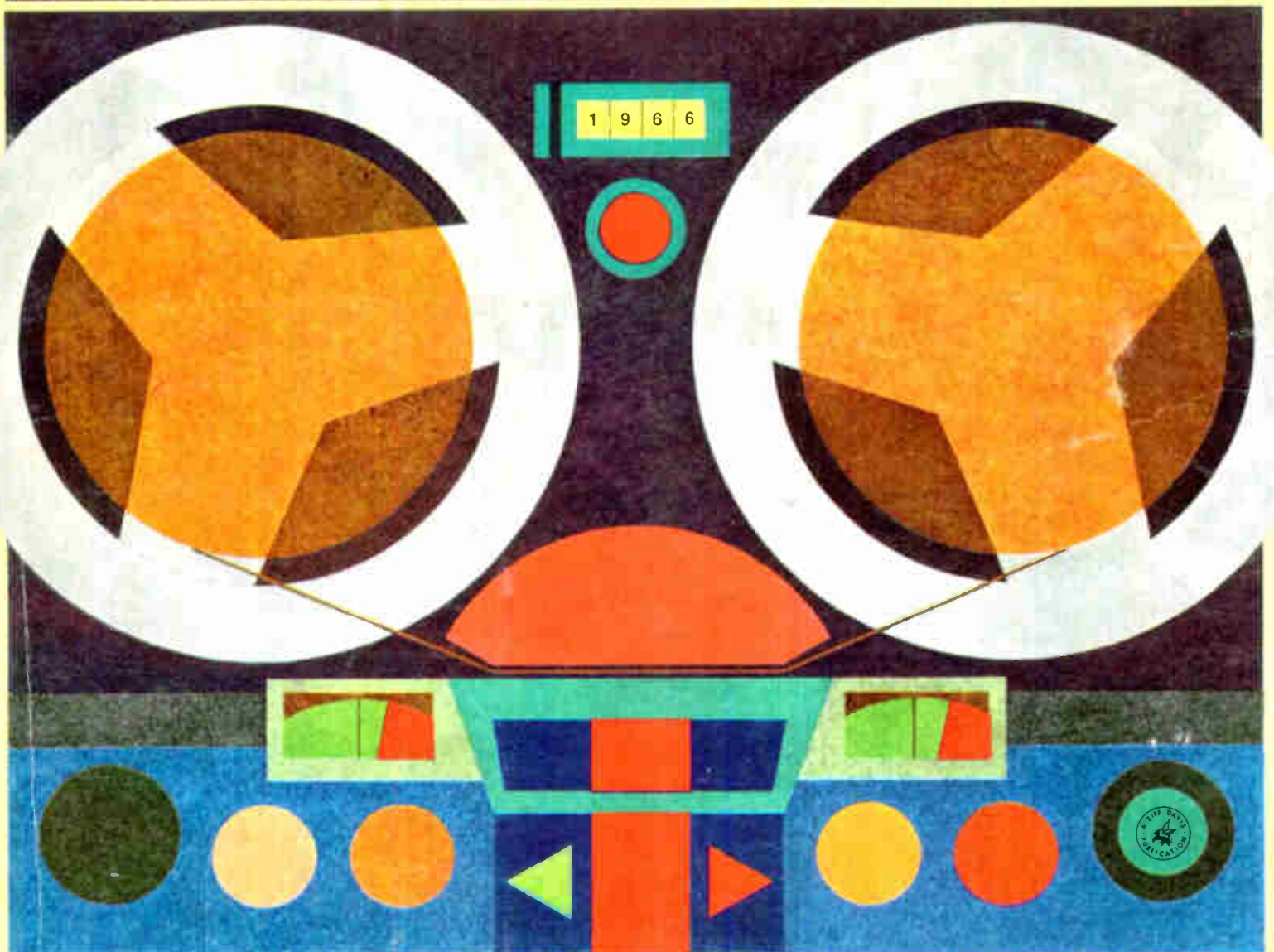

Live Better Electronically With

LAFAYETTE RADIO ELECTRONICS



NEW! LAFAYETTE Criterion® 1000-- PROFESSIONAL 4-TRACK SELF-CONTAINED STEREO TAPE RECORDER

Hi Fi/Stereo Review
MAY 1965 • 50 CENTS

All things considered, I would rate the Criterion 1000 as one of the best under—\$300 recorders I have tested. It sounds fine, looks even better, and sells for \$199.50.

Hi Fi, Stereo Review May 1965

Records and plays 4-track stereo and mono tapes through its acoustically matched 6x4" hi-fi speakers. Three speeds, 7½, 3¾ and 1⅞ ips for up to 8 hours playing time. Six pushbutton tape motion controls. Genuine teakwood cabinet. With 2 dynamic mikes, cables and 7" take-up reel. Imported.
99-1501WX 199.50

LAFAYETTE DELUXE PORTABLE TAPE RECORDER Model RK-142



• Takes Reels Up To 7"

Compact and lightweight, the RK-142 records and plays at 2 speeds, 7½ and 3¾ ips, for up to 4 hours recording time. Built-in 6x4" speaker; lever-type tape motion control; record level indicator. With mike, cables. Imported.
99-1512WX 59.95

WIDELY ACCLAIMED LAFAYETTE 4-TRACK PORTABLE TAPE RECORDER Model RK-137A



2-speeds, 7½ and 3¾ ips. 4-track mono record/playback; adaptable to 4-track stereo playback. With dynamic mike, patch cord, 7" take-up reel. Imported.
99-1511WX 89.50

LAFAYETTE DELUXE PUSHBUTTON 4-TRACK STEREO TAPE RECORDER Model RK-675



Our finest portable. Records and plays back 4-track stereo tapes. Six easy-to-use pushbuttons; 2 speeds, 7½ and 3¾ ips; digital counter; dual record level meters; sound-with-sound recording. With simulated leather case, 2 dynamic mikes, cables, 7" take-up reel. Imported.
99-1504WX 179.95

FREE! ▶▶

NEW 1966 CATALOG NO. 660

Featuring Everything in Electronics for
HOME • INDUSTRY • LABORATORY
from the World's Hi-Fi & Electronics Center

Write to Lafayette Radio Electronics Corp., Dept. TRA-6, P.O. Box 10, Syosset, L.I., N.Y. 11791

How to get any recorded tape at the lowest possible price ...and fast!

Join the Citadel Record Club.

Unlike record stores and clubs that offer discounts on selected specials, Citadel gives across-the-board discounts. All 4-track recorded tapes, all phonograph records.

See for yourself how much money Citadel can save you. Now, for less than the price of a single tape, you can join Citadel for life. Or, at even lower cost, you can try Citadel for one year.

Here is what Citadel Record Club offers to all its members:

Discounts! Tremendous price reductions on all tapes and records; in certain cases you save as much as 55%.

No obligations! You buy as few or as many tapes or records as you wish. No agreements to sign.

All labels! Any tape, record or album that's in print is available at a discount to Citadel members. Your choice is unlimited.

Promptest service! Orders are usually shipped the same day as received, rarely later than the next few days. Citadel is famous for speed.

100% guarantee! Guaranteed factory-fresh, unplayed, defect-free tapes and records; if not, you are entitled to an immediate replacement.

Free Schwann and Harrison catalogs! Every new Tape and Record Division member gets both catalogs free; every new Record Division member gets Schwann's free. The Schwann catalog is the 300-page standard reference guide to nearly 30,000 long-playing records. Harrison's is the standard guide to all stereo tapes.

Citadel Record Club 545 Fifth Ave., New York, N. Y. 10017	TRAG
Please enroll me as a member in the Citadel Record Club. I understand that I am entitled to all membership privileges without any obligation to buy anything, ever. If after 30 days I am not satisfied in every respect, my dues will be immediately refunded. No questions asked.	
<input type="checkbox"/> I am enclosing \$7.00 for lifetime Tape <u>and</u> Record Division membership.	
<input type="checkbox"/> I am enclosing \$5.00 for lifetime Record Division membership.	
<input type="checkbox"/> I am enclosing \$4.00 for a trial-year Tape <u>and</u> Record Division membership.	
<input type="checkbox"/> I am enclosing \$3.00 for a trial-year Record Division membership.	
Name _____	
Address _____	
City _____ State _____ Zip _____	

CITADEL RECORD CLUB

As tracking forces have become lighter, and stylus assemblies more delicate, so has the danger of damage from manual handling increased. To eliminate this hazard, Garrard has built into the Lab 80 an ingenious tone arm cueing control. This feature protects your records as no other turntable can.

The Lab 80 integral cueing control works for you in three important ways:

1. To play a single record: Press the Manual tab. This starts the motor and activates the tone arm cueing control. The arm stays suspended a safe half inch over the record. Position the tone arm over the first (or any) groove. Now, press the cueing control and the stylus lowers gently into the groove.

2. To cue a record during manual or automatic play: Press the Manual tab. The arm rises and stays a half inch above the record. Move the arm to the band or groove desired, and press the cueing control. The stylus lowers slowly and accurately into the groove. With this feature, there is no necessity to lift the arm by hand causing accidental jarring or scraping of the stylus across the record.

3. To pause during manual or automatic play: When you want to interrupt the music, press the Manual tab. The arm rises directly over the record and stays there. The turntable continues to revolve. When you are ready to resume play, press the cueing control. The stylus lowers accurately and safely,

and the music continues from where it left off.

Regarding automatic play: The Lab 80 is a superb transcription turntable for single play. But, in addition, it includes an exceptionally gentle, built-in record changing device, enabling you to play a stack of eight records fully automatically.

**the perfect unit
for taping and
protecting your records**



**The
Garrard[®]
LAB 80
Automatic
Transcription Turntable
is the only automatic...**

that performs on cue!

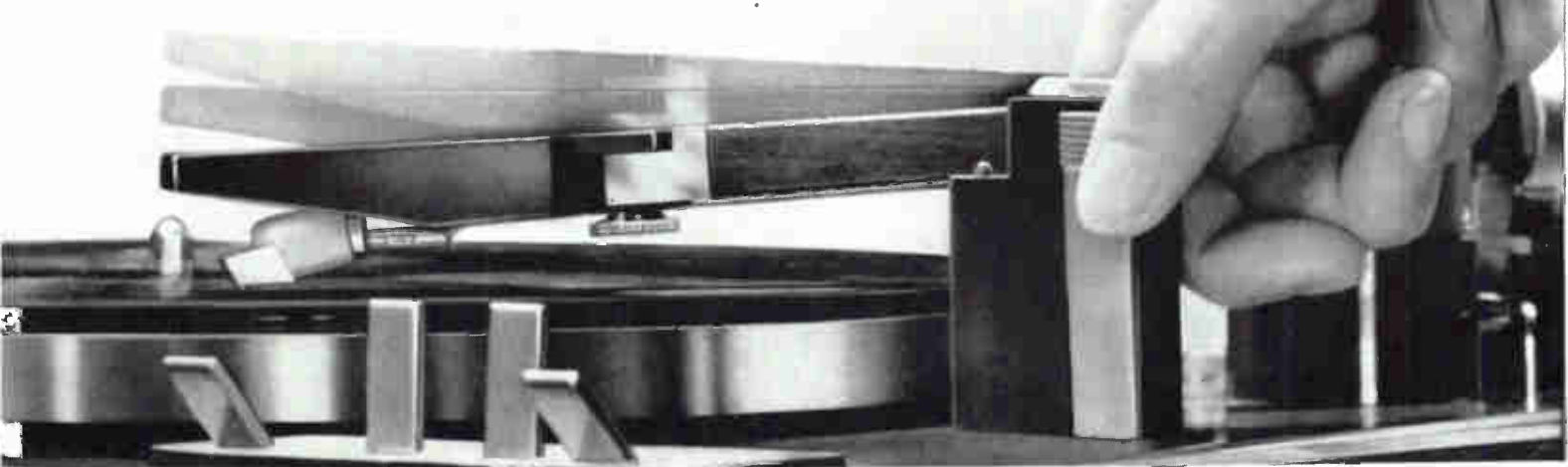

HiFi/Stereo Review's 1966 TAPE RECORDER ANNUAL

SELECTING THE RIGHT RECORDER	JOHN MILDER.....	15
HOW TO CHOOSE A MICROPHONE	J. GORDON HOLT.....	19
A ROUNDUP OF THE NEW VIDEO TAPE RECORDERS	ROBERT ANGUS.....	24
A PRIMER OF TAPE RECORDER MAINTENANCE	HERBERT FRIEDMAN.....	30
WHAT MAKES A GOOD RECORDING TAPE?	BURT HINES.....	32
WHAT YOU SHOULD KNOW ABOUT TAPE HEADS.....	HERMAN BURSTEIN.....	36
HOW TO CREATE YOUR OWN SOUND EFFECTS	ARTHUR ZUCKERMAN.....	40
TIPS ON TAPING STEREO FM.....	J. GORDON HOLT.....	43
TAPE RECORDING AND THE LAW.....	JOHN KOSHEL, JR.....	45
THE SECRETS—AND JOYS—OF RECORDING CHILDREN...BYRON G. WELS...		46
SIGNAL-TO-NOISE RATIO IN TAPE RECORDERS	HERMAN BURSTEIN.....	50
HOW TO SELECT A PORTABLE RECORDER.....	HARVEY V. FONDILLER.....	52
CREATIVE TAPE EDITING	EDWARD TATNALL CANBY.....	55
TRANSFERRING RECORDS TO TAPE	ROBERT ANGUS.....	59

* * *

DIRECTORY OF MANUFACTURERS		5
A TAPE RECORDER GLOSSARY.....		6
TAPE RECORDER DIRECTORY		
Recorders, Players, and Transports		65
Raw Tape		92
Tape Accessories		96
MICROPHONE DIRECTORY		103
PRERECORDED TAPE ROUNDUP		115
ADVERTISERS' INDEX.....		134

PHILLIP T. HEFFERNAN, *Publisher* • WILLIAM ANDERSON, *Editor*
WILLIAM LIVINGSTONE, *Managing Editor* • LARRY KLEIN, *Technical Editor*
BORYS PATCHOWSKY, *Art Director* • ROBERT S. CLARK, *Associate Editor*
LAWRENCE SPORN, *Advertising Sales Manager*



1966 TAPE RECORDER ANNUAL is published by the Ziff-Davis Publishing Company, One Park Avenue, New York, N.Y. 10016. Also publishers of HiFi/Stereo Review, Popular Electronics, Electronics World, Electronic Experimenter's Handbook, Communications Handbook, and Stereo/HiFi Directory. Copyright ©1965 by Ziff-Davis Publishing Company. All rights reserved.
ZIFF-DAVIS PUBLISHING COMPANY, Editorial and Executive Offices, One Park Avenue, New York, N.Y. 10016. Telephone: 212 OR 9-7200. WILLIAM B. ZIFF, Chairman of the Board (1946-1953); William Ziff, President; W. Bradford Briggs, Executive Vice President; Hershel B. Sarbin, Vice President and General Manager; Philip Sine, Financial Vice President; Walter S. Mills, Jr., Vice President, Circulation; Stanley R. Greenfield, Vice President, Marketing; Phillip T. Heffernan, Vice President; Frank Pomerantz, Vice President, Creative Services; Arthur W. Butzow, Vice President, Production. New York Office; Eastern Advertising Manager: Jerry Sweeney. Midwestern Office: 307 North Michigan Avenue, Chicago, Illinois, 60601. Telephone: 312 724-0892. Eastern Advertising Manager: Jerry Sweeney. Western Office: 9025 Wilshire Blvd., Beverly Hills, Calif. 90211. Telephone: 213 CR 4-0265. Western Advertising Manager: Bud Dean.



SOME SHAPES NEVER CHANGE



For example, a spoon, a VW or an 88 Stereo Compact. They are made for a specific purpose and fulfill it so well, the basic design never changes.

Improvements are made though. Spoons are better balanced. VW's have larger tail lights. We've added a pause control to the 88 Stereo Compact. We've improved the automatic stop, included a pilot light and put a push-button on the counter - but we haven't changed the basic design. An 88 is still only 13 x 13 x 7" and fits into most hi fi consoles. 88 Stereo Compacts always deliver smooth tape handling, excellent frequency response, feature off the tape monitoring and separate hyperbolic heads for erase, record and playback.

An 88 Stereo Compact is never obsolete. Ask those who own one - design and quality have endured the test of time. So we didn't change it - we just made improvements.

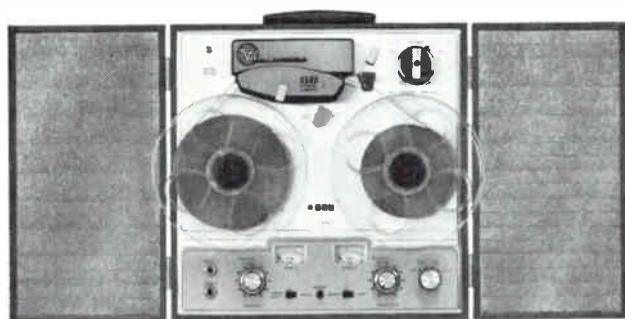

880 Stereo Compact complete with detachable speakers - in portable case.

88 Stereo Compact in modern walnut finish cabinet with hinged cover.



MADE BY SKILLED AMERICAN CRAFTSMEN AT

Viking OF MINNEAPOLIS®
9600 Aldrich Ave. S. Minneapolis, Minnesota, 55420

CANADA: Alex L. Clark, Ltd., 3751 Bloor St. W., Islington, Ontario
Electro Tec Marketers, Ltd., 1624 W. Third Ave., Vancouver, British Columbia
CENTRAL & SOUTH AMERICA: ManRep Corp., P.O. Box 429 N. Miami Beach, Florida, U.S.A.
OVERSEAS EXPORT: International Division Viking of Minneapolis, Inc., 9600 Aldrich Ave. S., Minneapolis, Minn., U.S.A.

DIRECTORY OF MANUFACTURERS

The following is an alphabetical listing of manufacturers whose products are described in this volume. Addresses are furnished for your convenience should you care to write for further information.

ALTEC LANSING —Div. of LTV Ling Altec, Inc. 103 <i>1515 S. Manchester Ave., Anaheim, Calif. 92803</i>	LEAR JET CORP. —Stereo Division 80 <i>13131 Lyndon Ave., Detroit, Mich. 48227</i>
AMERICAN —Greentree Electronics Corp. 92, 93, 96 <i>2135 Canyon Drive, Costa Mesa, Calif.</i>	MAGNECORD —Midwestern Instruments, Inc. 80 <i>P.O. Box 7509, Tulsa, Okla. 74105</i>
AMERICAN GELOSO ELECTRONICS, INC. 65 <i>251 Park Avenue S., New York, N.Y. 10010</i>	MARTEL ELECTRONICS 80 <i>2356 S. Cotner Ave., Los Angeles, Calif. 90064</i>
AMERICAN MICROPHONE CO. — Div. of Electro-Voice, Inc. 103, 104 <i>Buchanan, Mich. 49107</i>	MICROTRAN CO., INC. 96 <i>145 E. Mincola Ave., Valley Stream, N.Y.</i>
AMPEX CORPORATION 65, 66, 68, 93 <i>401 Broadway, Redwood City, Calif. 94063</i>	MIRANDA —Allied Impex Corp. 80 <i>300 Park Ave. S., New York, N.Y. 10010</i>
AMPLIFIER CORP. OF AMERICA 66, 68, 96 <i>398 Broadway, New York, N.Y. 10013</i>	NEWCOMB AUDIO PRODUCTS CO. 80, 81 <i>6824 Lexington Ave., Hollywood, Calif. 90038</i>
ASTATIC CORP., THE 104 <i>Comcast, Ohio 44030</i>	NORELCO —North American Philips Co., Inc. 81, 108 <i>100 E. 42nd St., New York, N.Y. 10017</i>
AUDIOTAPE —Audio Devices, Inc. 93, 96 <i>235 E. 42nd St., New York, N.Y. 10017</i>	NORTRONICS CO., INC., THE 96, 97, 98, 101 <i>8101 Tenth Ave. N., Minneapolis, Minn. 55427</i>
AUDIOTEX MANUFACTURING CO. — Div. of GC-Textron Electronics, Inc. 96 <i>400 S. Wyman St., Rockford, Ill. 61101</i>	OKI —Chancellor Electronics, Inc. 81, 82 <i>457 Chancellor Ave., Newark, N.J. 07112</i>
BRENELL —Fen-Tone Corp. 68 <i>106 Fifth Ave., New York, N.Y. 10011</i>	OLSON ELECTRONICS, INC. 108 <i>260 S. Forge St., Akron, Ohio 44308</i>
BURGESS BATTERY CO. —Div. of Servel, Inc. 93, 94 <i>Freeport, Ill. 61033</i>	RADIO CORPORATION OF AMERICA 82, 83, 94, 108, 109 <i>30 Rockefeller Plaza, New York, N.Y. 10020</i>
BUTOBA —Stanford International 68 <i>569 Laurel St., San Carlos, Calif.</i>	REVERE —Revere-Mincom Div. of the 3M Co. 83 <i>2501 Hudson Road, St. Paul, Minn. 55119</i>
CHANNEL MASTER CORP. 68 <i>Ellenville, N.Y. 12428</i>	REVOX —Elpa Marketing Industries, Inc. 83 <i>New Hyde Park, N.Y. 11044</i>
COLUMBIA RECORDS SALES CORP. — Masterwork Audio Products 68 <i>51 West 52nd St., New York, N.Y. 10019</i>	RHEEM CALIFONE — Div. of Rheem Manufacturing Co. 83, 84 <i>5922 Bowercroft St., Los Angeles, Calif. 90016</i>
CONCERTONE —Div. of Astro-Science Corp. 68, 70, 96 <i>9731 Factorial Way, South El Monte, Calif. 91733</i>	ROBERTS ELECTRONICS — Div. of Rheem Manufacturing Co. 84, 85 <i>5922 Bowercroft St., Los Angeles, Calif. 90016</i>
CONCORD ELECTRONICS CORP. 70, 72 <i>1935 Armacost Ave., Los Angeles, Calif. 90025</i>	ROBINS INDUSTRIES CORP. 101 <i>15-58 127th St., Flushing, N.Y. 11356</i>
CRAIG PANORAMA, INC. 72 <i>3112 S. La Cienega Blvd., Los Angeles, Calif. 90016</i>	SARKES TARZIAN INC. 94 <i>East Hillside Drive, Bloomington, Ind.</i>
CROWN INTERNATIONAL —Subsidiary of International Radio & Electronics Corp. 72, 73, 74 <i>1718 W. Mishawaka Road, Elkhart, Ind. 46517</i>	SAXON ELECTRONICS CORP. — Subsidiary of Kouyoh Int'l. Corp. 85 <i>1200 Santee St., Los Angeles, Calif. 90015</i>
DUAL —United Audio 74 <i>12 West 18th St., New York, N.Y. 10011</i>	SCHOBER ORGAN CORP., THE 101 <i>13 West 61st St., New York, N.Y. 10023</i>
DYNACO INC. 74, 104 <i>3912 Powelton Ave., Philadelphia, Pa. 19104</i>	"SCOTCH" TAPES —The 3M Co. 94, 95 <i>2501 Hudson Road, St. Paul, Minn. 55119</i>
EDITALL —Elpa Marketing Industries, Inc. 96 <i>New Hyde Park, N.Y. 11044</i>	SHURE BROTHERS, INC. 109, 110 <i>222 Hartrey Ave., Evanston, Ill.</i>
EICO ELECTRONIC INSTRUMENT CO., INC. 74 <i>131-01 39th Ave., Flushing, N.Y. 11352</i>	SONOTONE CORPORATION 110, 111 <i>Elmsford, N.Y. 10523</i>
ELECTRO-VOICE, INC. 104, 105, 106, 107 <i>Buchanan, Mich. 49107</i>	SONY —Superscope, Inc. 85, 86, 87, 95, 111, 112 <i>8150 Vineland Ave., Sun Valley, Calif.</i>
FANON-MASCO —Fanon Electronic Industries, Inc. 74, 96 <i>439 Fricklinghousen Ave., Newark, N.J. 07114</i>	SOUNDCRAFT —Reeves Soundcraft 95 <i>Great Pasture Road, Danbury, Conn. 06813</i>
FARGRAM —Fargo Co. 107 <i>1162 Bryant St., San Francisco 3, Calif.</i>	TANDBERG OF AMERICA, INC. 87 <i>8 Third Ave., Pelham, N.Y. 10803</i>
FERROGRAPH —Ercona Corp. 74 <i>432 Park Ave. S., New York, N.Y. 10016</i>	TRUVOX —Benjamin Electronic Sound Corp. 87, 88 <i>89 Swalm St., Westbury, N.Y.</i>
GEM SONIC —Fujiya Corp., Ltd. 74 <i>45 West 21 St., New York, N.Y. 10010</i>	TURNER CO., THE 112 <i>Cedar Rapids, Iowa 52402</i>
GRAETZ —Warman Precision Products Corp. 74, 77 <i>172 Madison Ave., New York, N.Y. 10016</i>	UHER —Martel Electronics Sales, Inc. 88 <i>2356 S. Cotner Ave., Los Angeles, Calif. 90064</i>
INTER-MARK CORP. 77 <i>29 West 36th St., New York, N.Y. 10018</i>	UNIVERSITY —LTV University, Div. Ling-Temco-Vought, Inc. 113 <i>9500 W. Reno, Oklahoma City, Okla. 73101</i>
KNIGHT —Allied Radio Corp. 77, 107, 108 <i>100 N. Western Ave., Chicago, Ill. 60680</i>	VIKING OF MINNEAPOLIS, INC. 88, 89, 90 <i>9600 Aldrich Ave. S., Minneapolis, Minn. 55420</i>
KNIGHT-KIT —Allied Radio Corp. 77 <i>100 N. Western Ave., Chicago, Ill. 60680</i>	V-M CORP. 90 <i>P.O. Box 659, Benton Harbor, Mich. 49023</i>
KODAK —Eastman Kodak Co. 94 <i>343 State St., Rochester, N.Y. 14650</i>	WEBCOR, INC. 90 <i>Chicago, Illinois 60610</i>
KORTING RECORDER SALES CORP. — Div. of Matthew Stuart & Co., Inc. 77, 78 <i>3650 Dure Ave., Bronx, N.Y. 10466</i>	WOLLENSAK —Revere-Mincom Div. of the 3M Co. 90, 91, 92 <i>2501 Hudson Road, St. Paul, Minn. 55119</i>
LAFAYETTE RADIO ELECTRONICS CORP. 78, 80, 96 <i>111 Jericho Turnpike, Syosset, L.I., N.Y. 11791</i>	

ONLY OKI

Gives You Such Great Sound Per Pound!

The Oki 555 lightweight solid-state portable stereo tape system weighs less than 25 pounds, yet gives you better than concert hall sound reproduction. And the price? Only \$349.95* complete with two unique "OKIidizine" Speaker Systems, each containing two speakers with a crossover network. Oki has a fine choice of other solid state tape recorders, starting at \$129.95*. See and hear them now at your Oki dealer.



ONLY OKI 555

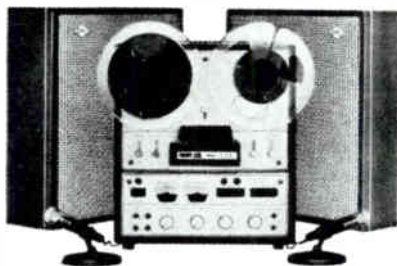

*manufacturer's suggested list price.



Chancellor Electronics, Inc.

457 Chancellor Avenue, Newark, New Jersey 07112
CIRCLE NO. 28 ON READER SERVICE CARD

A TAPE RECORDER GLOSSARY

Understanding manufacturers' specifications

ALTHOUGH such performance criteria as frequency response, distortion, and signal-to-noise ratio are as applicable to tape recorders as they are to other audio components, manufacturers' specifications for tape equipment are notoriously vague. The claims made for some machines appear to have been prompted either by wishful thinking or by the checking of a "lab sample" long since tucked in a vault for safekeeping. Such calculated vagueness often makes the specifications of a cheap recorder look more impressive than those for top-quality professional equipment. The usual criteria *do* count, however, and below are some to look for in a list of specifications—together with some suggestions for interpreting figures. These terms are almost certain to turn up on specification sheets or during conversations with recorder salesmen. All of the technical details may not be of direct importance to you, but they are worth taking a little trouble to understand before you start out on your shopping trip.

● **Distortion.** Specifications for distortion in tape equipment are generally too vague to be meaningful. Even when harmonic distortion at "standard" or maximum recording levels is stated—which is not often—there is no indication of the further distortion added by a recorder's playback preamplifiers. As with signal-to-noise ratio, a listening test through a high-fidelity system provides the most reliable index of quality.

● **Frequency response.** As with all hi-fi equipment, frequency-response specifications for tape equipment are meaningless unless the *uniformity* of response is stated along with the range of response. Without a qualifying "plus-or-minus so many decibels," a claim has no significance. A recorder's *record-playback* response is more important than its playback response alone and should be within ± 3 -4 db over the range stated. A top-quality recorder should hold the tolerance to ± 2 db. Keep in mind that the frequency response given for a complete, self-contained recorder is likely to represent the best the machine can do when used in conjunction with an external hi-fi system.

● **Heads.** One of the earliest electrical discoveries, that the flow of current through a coil of wire sets up a magnetic field around the coil, is the basis for

magnetic tape recording. Tape heads are miniature coils of fine wire wound on a core; they act on, or react to, the magnetism of iron-oxide particles on a strip of recording tape. For recording, a head's fluctuating magnetic field arranges oxide particles into magnetic patterns as tape moves past the head. For playback, the patterns arranged on a tape induce electrical signals in the head. Both of these functions depend on a small break (gap) in the core of the tape head, which permits the action of the coil to be focused on the tape moving past the head. Though a relatively wide gap is best for arranging oxide particles during the recording process, a very narrow gap makes possible the most precise response to a tape's magnetic patterns during playback. Although a single head can serve both for recording and playback, a dual-purpose head obviously cannot be optimum for both functions. For this reason, the best recorders employ separate heads for recording and playback. An erase head is separate in all recorders.

● **Level indicators.** The most critical aspect of tape recording is the setting of the recording level. It must be high enough to get a strong signal on the tape, and yet not so high as to create distortion by overloading the tape. Of the three kinds of level indicators usually found in tape machines, the neon bulb, which indicates only minimum level and severe overload, is the least satisfactory. The magic-eye tube, which is sensitive enough to indicate momentary volume peaks very accurately, is generally both precise and easy to use. The VU meter, used on professional equipment, does not indicate short-term volume peaks as accurately as the magic-eye, but it gives an excellent reading of average recording level. Occasionally, the VU meters used on home recorders are either too small to be read conveniently, or are so badly damped that their needles swing too erratically for the eye to follow.

● **Mixing.** You may want to record two sound tracks simultaneously—perhaps so that you can sing along with a favorite record and record the result. This can be done very simply by assigning each source to a separate channel of a stereo recorder, but the resulting tape will be monophonic. For full stereo mixing a tape machine must have separate inputs on *each* channel for high- and

(Continued on page 8)

Go ahead and read the fine print! This is
ONE RECORD CLUB
WITHOUT RESTRICTIONS:

- Choose any LP, any label—no pre-selections!
- Buy 1 record or 100—no yearly quotas!
- Join once for a lifetime—no annual fees!
- Save at least 1/3—and much more on special sales!

This is the way you want it . . . a record club without restrictions. With the Record Club of America you can order any LP available in the entire Schwann Catalog (over thirty thousand selections) and save on every one! Nobody limits you to one label or two. Nobody sends you a card that means you get an unwanted record if you forget to return it. Nobody says you have to buy 4, 6, or 8 times a year. And nobody asks you to pay an annual membership fee. With Record Club of America you join once—and belong for a lifetime.

Here's HOW Record Club of America Works:

Fill out your Lifetime Membership application. Send it, with your check or money order for \$5 to Record Club of America. By return mail you'll receive your membership card guaranteeing you our regular discount of more than 1/3 off on every record you buy. That means you buy at dealer costs: all \$3.79 LP's at \$2.39; \$4.79 LP's at \$2.99 and \$5.79 LP's at just \$3.69. And our publication, *Disc.*, which regularly supplements Schwann's listings, keeps you informed of the Club's extra-saving "double discount" specials like those featured at right. *Disc.* also presents timely critical reviews by many of the nation's leading authorities. For your convenience we always enclose an order blank. Your order is processed the day we get it. Records come to you factory new. If not completely satisfactory they can be returned, immediate replacement guaranteed. Over 250,000 individual members and many of the nation's leading schools and libraries are today enjoying tremendous savings made possible through Record Club of America. Why not join them . . . and join us, today?

GIFT MEMBERSHIP SPECIAL!

Your membership entitles you to buy or offer gift memberships to friends, relatives and neighbors for only \$2.50 with full privileges. You can split the total between you—the original membership and one gift membership divided equally brings your cost down to \$3.75; one original membership and four gift memberships brings your cost down to \$3 each. Get a gang together—everybody saves!

© 1965 RECORD CLUB OF AMERICA, INC.

TYPICAL "DOUBLE DISCOUNT" SPECIAL SALE!	
LIST PRICE	OUR PRICE
3.79 Capitol, Columbia, RCA Victor Bestsellers	\$1.99
5.79 Westminster, Vox, Everest, RCA Victor Classical Albums	\$1.77
4.79 & 5.79 Audio Fidelity, Command Albums.	\$1.99

CLASSICAL	OPERA
JAZZ	FOLK
COUNTRY & WESTERN	MUSICAL COMEDY

FREE SCHWANN CATALOG
 Over 30,000 selections from more than 300 manufacturers!
 CAPITOL • COLUMBIA • ANGEL
 RCA VICTOR • DECCA • MERCURY
 WESTMINSTER • DEUTSCHE GRAMMOPHON
 VOX • VERVE • LONDON
 ROULETTE • ABC PARAMOUNT
 ELECTROLA • AND HUNDREDS MORE

917-C

Record Club of America
 1285 Princess Street
 York, Pennsylvania 17405



Gentlemen:

Enclosed please find my check or money order for \$5.00 which will guarantee me Lifetime Membership in Record Club of America. I understand that I am under no obligation to purchase at any time, and that any purchases I do make will be at CLUB SAVINGS. I am free to choose any album as listed in the Schwann Record Catalog or Record Club of America's regular publication, *Disc.*

Add _____ Gift Memberships to my request. I enclose a check for _____ at \$2.50 each gift member, and have listed on attached sheet their names and addresses.

Signed _____

Address _____

City _____

State _____

Zip Code _____

Join the more than 250,000 happy members of
RECORD CLUB OF AMERICA

NEVER MONITOR TAPES WITHOUT KOSS STEREOPHONES!

Why? Koss Stereophones tell you what the recording head is putting on your tape. Insures proper volume level, tells you if outside noise is going on the tape, helps you adjust for smooth bass and treble response.

NEVER PLAY BACK TAPES WITHOUT KOSS STEREOPHONES!

Why? Koss Stereophones reproduce all the critical sounds on your tapes. Sensitive frequency response gives you realistic "sound picture" of what is on your tapes — either monaural or stereo — without disturbing others.

NEVER EDIT TAPES WITHOUT KOSS STEREOPHONES!

Why? Koss Stereophones give you personalized listening. You avoid annoying others with the constant replay of material being edited. You aren't annoyed by others either. You actually edit faster because you avoid outside distractions.



SP-3X STEREOPHONES

Wide range 10-15,000 c.p.s. response obtainable only through earphone listening. Sensitive 3 1/2" sound reproducers mounted in each earpiece. Soft sponge foam ear and head cushions. Impedance 4-16 ohms. \$24.95.



PRO-4 STEREOPHONES

Fluid-filled earpads for tight, comfortable seal. A durable phone designed for professionals. 30-20,000 c.p.s. response. \$45.00.

KOSS electronics inc.

2227 N. 31ST STREET • MILWAUKEE, WISCONSIN 53208 U.S.A.
Koss Impetus International • 2 Via Berna • Lugano, Switzerland

low-level sources, and separate volume controls for each input. If the recorder that interests you lacks these facilities, however, you can usually buy a separate mixer at reasonable cost.

● **Signal-to-noise ratio.** This specification is virtually useless as a standard of comparison for any but top-quality recorders. The ratio itself, expressed as the difference (in decibels) between a recorder's residual noise and the loudness of a test tone recorded at "standard" level, depends in great part on the meaning of "standard." Manufacturers tend to be flexible in their interpretation of the term, some choosing a recording level that produces as little as 1 per cent harmonic distortion on tape, others picking a higher level at which distortion may be 5 per cent. Frequently, the ratio given for an excellent machine (based on a low-distortion recording level) may seem inferior to the figure stated for a mediocre unit. Rather than attempt to weight the figures for various machines to compare them, it is better to rely on a listening test conducted with wide-range hi-fi equipment.

● **Sound-on-sound.** In addition to providing tape monitoring, separate heads for recording and playback in a four-track machine may permit you to add new material to the sound already on a tape, for such purposes as dubbing in your own commentary on a recorded event, harmonizing with yourself on tape, or comparing your accent with a foreign-language teacher's. By connecting the output of one channel to the input of another and listening over earphones (listening over speakers would cause acoustic feedback), you can dub in your own voice or any kind of new material in perfect synchronization. By repeating the process from channel to channel, you can make a multiple-track monophonic recording. For full sound-on-sound capability, a recorder must have not only separate heads for recording and playback, but independent preamplifiers for recording and playback, and some provision for the connection of earphones. Other arrangements for making sound-on-sound recordings, such as a switch that deactivates the erase head as you record over the older track, are harder to synchronize and are likely to produce poorer sound quality, but they may permit you to dub on two tracks at once for stereo. Sound-on-sound is a marginal feature for many users, but if it interests you, take time to make sure just how a particular recorder accomplishes it.

● **Speeds.** The majority of home tape recorders operate at either of two speeds: 3 3/4 and 7 1/2 inches per second. There is a trend toward incorporating speeds as low as 1 7/8 and 15/16 ips. In general,
(Continued on page 12)

COLUMBIA STEREO TAPE CLUB
 NOW OFFERS YOU
ANY 5

of these exciting pre-recorded 4-track

STEREO TAPES FOR ONLY **\$2.97**

Value up to \$45.75 at regular Club prices

If you join the Club now and agree to purchase as few as 5 selections from the more than 400 to be offered in the next 12 months

VLADIMIR HOROWITZ
 BEETHOVEN: "Pathétique"
 DEBUSSY: Three Preludes
 CHOPIN: Scherzo No. 1
 COLUMBIA & 2 Studios

1683. "Virile grace... noble simplicity." —*HIFI/Stereo Rev.*

MY FAIR LADY
 AUDREY HEPBURN REX HARRISON
 Original Sound Track

1530. Greater than ever... winner of 8 Academy Awards

MY LOVE FORGIVE ME
 ROBERT GOULET
 This Is All I Ask
 Too Good
 10 MORE

1735. Also: What Kind of Fool Am I?, Just Say I Love Her, etc.

BOB BROOKMEYER
 and Friends
 STAN GETZ • RON CARTER
 HERBIE HANCOCK
 GARY BURTON • ELVIN JONES

1713. A lively session abounding in passion and truth

THE VENTURES PLAY
TELSTAR
 THE LONELY BULL
 10 MORE

1008. Also: Green Onions, Red River Rock, Calcutta, etc.

LORD'S PRAYER
 MORMON TABERNACLE CHOIR
 BATTLE HYMN OF THE REPUBLIC
 THE LORD'S PRAYER • 9 MORE

1090. "This is an extraordinary chorus." —*New York Times*

PERCY FAITH
 Great Folk Themes
 Greenfields • 500 Miles
 10 MORE

1349. Also: Sloop John B., This Train, Darlin' Corey, etc.

TCHAIKOVSKY
 Symphony No. 7
 World Premiere Recording
 ORMANDY PHILADELPHIA ORCH.

1283. "Appealing tunes and lush romanticism." —*Life*

BOBBY HACKETT
 plays MANCINI
 Days of Wine and Roses
 Moon River • Dreamsville
 9 MORE

1161. Also: Baby Elephant Walk, Peter Gunn, Mr. Lucky, etc.

MONK BIG BAND AND QUARTET
 IN CONCERT
 10 MORE

1637. Epitaphy, Four in One, I Mean You, 7 in all

GROFE
 GRAND CANYON SUITE
 Bernstein N.Y. Philharmonic
 10 MORE

1645. Delightful performance of Grofe's soaring tone poem

THE MANY MOODS OF
 Ferrante & Teicher
 Dream of Love • Gigi
 Bewitched • 9 MORE

1640. Also: Camelot, Three Coins in the Fountain, Tili, etc.

RAY CONNIFF
 Speak to Me of Love
 10 MORE

1442. The Sweetest Sounds, You'll Never Walk Alone, 10 more

PETER, PAUL & MARY
 IN CONCERT
 10 MORE

1673-1674. Twin-Pack (Counts As Two Selections.) Blowin' in the Wind, If I Had A Hammer, Five Hundred Miles, 18 in all

TWIN-PACK
 Equivalent To Two Selections

GOLDFINGER
 Original Motion Picture Sound Track
 10 MORE

1704. Featuring the title song sung by Shirley Bassey

Rhapsody in Blue
 An American in Paris
 Leonard Bernstein plays Gershwin
 10 MORE

1098. "Fierce impact and momentum." —*N.Y. World-Telegram*

TONY BENNETT
 Who Can I Turn To
 WRAP YOUR TROUBLES IN DREAMS
 LISTEN, LITTLE GIRL
 10 MORE

1714. Also: Autumn Leaves, I Walk A Little Faster, etc.

ANDRE PREVIN
 My Fair Lady
 10 MORE

1706. A sparkling new jazz treatment of this great score

LATIN THEMES
 For Young Lovers
 PERCY FAITH
 The Girl From Ipanema
 The Lonely Bull
 10 MORE

1772. Also: Spanish Harlem, Manha de Carnaval, etc.

EUGENE ORMANDY
 CONDUCTS THE PHILADELPHIA ORCHESTRA
FIREWORKS
 RIDE OF THE WALKYRIES
 SABRE DANCE • 6 MORE

1661. Also: In the Hall of the Mountain King, etc.

I WISH YOU LOVE
 Andre Kostelanetz
 Maria Elena
 Hello, Dolly!
 Feels Rush In
 9 MORE

1699. Also: I Will Follow Him, Blue Velvet, etc.

DEBUSSY: LA MER
 RAVEL: DAPHNIS ET CHLOE' (Suite No. 2)
 George Szell • Cleveland Orch.

1650. "A stunning accomplishment!" —*American Rec. Guide*

Miles Davis
 in Europe
 10 MORE

1642. Recorded live at the Antibes Jazz Festival

ROGER WILLIAMS
 GREATEST HITS
 Autumn Leaves
 Near You
 Tammy
 9 MORE

1302. Also: The High And The Mighty, I Got Rhythm, etc.

BERNSTEIN
 conducts
TCHAIKOVSKY
 1812 Overture
 Marche Slave
 Capriccio Italien
 NEW YORK PHILHARMONIC
 10 MORE

1603. Bernstein "at top of his form." —*High Fidelity*

Jazz Impressions of Japan
 the Dave Brubeck quartet
 10 MORE

1636. Zen Is When, Rising Sun, Osaka Blues, 8 in all

Barbra Streisand
 People
 Absent Minded Me
 Fine And Dandy
 10 MORE

1646. Also: Love Is A Bore, My Lord And Master, Autumn, etc.

FREE - if you join now
 REVOLUTIONARY SELF-THREADING TAKE-UP REEL



Just drop the end of the tape over this reel, start your recorder, and watch it thread itself! Unique Scotch® process automatically threads up tape of any thickness, releases freely on rewind.

WEST SIDE STORY
 Original Soundtrack
 COLUMBIA Recording
 1037. "The most adventurous musical ever made." —*Life*

IF YOU ARE ONE OF THE FORTUNATE PEOPLE who owns 4-track stereo tape playback equipment, you know the thrill of the near-perfect fidelity, the unsurpassed sound of tape. Now you have an exceptional opportunity to build an outstanding collection of superb stereo tapes at great savings through the most generous offer ever made by the Columbia Stereo Tape Club!

By joining now, you may have ANY FIVE of the magnificently recorded 4-track stereo tapes described here — sold regularly by the Club for up to \$45.75 — for only \$2.97!

TO RECEIVE YOUR 5 PRE-RECORDED STEREO TAPES FOR ONLY \$2.97 — simply fill in and mail the postage-paid card today. Be sure to indicate the type of music in which you are mainly interested: Classical or Popular.

HOW THE CLUB OPERATES: Each month the Club's staff of music experts chooses outstanding selections from every field of music. These selections are described in the Club Magazine, which you receive free each month.

You may accept the monthly selection for the field of music in which you are mainly interested . . . or take any of the wide variety of other tapes offered . . . or take no tape in any particular month.

Your only membership obligation is to purchase 5 tapes from the more than 400 to be offered in the coming 12 months. Thereafter, you have no further obligation to buy any additional tapes . . . and you may discontinue your membership at any time.

FREE TAPES GIVEN REGULARLY. If you wish to continue as a member after purchasing five tapes, you will receive — FREE — a 4-track stereo tape of your choice for every two additional tapes you buy.

The tapes you want are mailed and billed to you at the regular Club price of \$7.95 (occasional Original Cast recordings somewhat higher), plus a small mailing and handling charge.

IMPORTANT NOTE: All tapes offered by the Club must be played on 4-track stereo playback equipment. If your tape recorder does not play 4-track stereo tapes, you may be able to convert it simply and economically. See your local service dealer for complete details.

COLUMBIA STEREO TAPE CLUB, Terre Haute, Indiana

RAY CONNIFF
 INVISIBLE TEARS
 Everybody Loves Somebody
 Honeycomb • 10 MORE

1672. Also: S'posin', Kisses Sweeter Than Wine, etc.

NEW CHRISTY MINSTRELS
 LAND OF GIANTS
 John Henry • Casey Jones
 Joe Magarac • 10 MORE

1644. Also: Natural Man, Paul Bunyon, El Camino Real, etc.

ANDY WILLIAMS
 DEAR HEART
 Red Roses For a Blue Lady
 Who Can I Turn To
 9 MORE

1905. Also: I Can't Stop Loving You, Emily, 12 in all

Elgart au Go Go
 LES & LARRY
 ELGART
 10 MORE

2126. King of the Road, Downtown, Meditation, 9 more

RAY CONNIFF
 and the singers
 MUSIC FROM
MARY POPPINS,
 SOUND OF MUSIC,
 MY FAIR LADY, etc.
 10 MORE

2117. Chim Chim Cher-ee, Feed The Birds, Ocarina, etc.

LATIN FOR LOVERS
 DORIS DAY
 10 MORE

2074. Quiet Nights of Quiet Stars, How Insignificant, 10 more

Romantic Piano Music of
Tchaikovsky
 Philippe Entremont
 10 MORE

1326. Humoresque, Nocturne, Romance, Mazurka, 9 others

Norman Luboff Choir
 MOMENTS TO REMEMBER
 I'll Never Smile Again
 Paper Doll
 The Breeze and I
 plus 9 more

1209. Also: Sleepy Lagoon, Flamingo, Time Was, etc.



EVERYTHING! FOR THE TAPEWORM

SANTA'S CHOICE . . . The perfect gift! The exciting new American Tape Kit contains everything the tape recorder owner needs to fully enjoy his hobby in one beautiful package. No more odds and ends. Only the TAK-100 includes:

- (1) A 1500 ft. reel of American's Professional Length Recording Tape.
- (2) A Stereotape Showcase featuring Frank Sinatra, Dean Martin, Trini Lopez, and many others.
- (3) A handy Mail-A-Tape.
- (4) A complete head cleaner kit.
- (5) A professional tape splicer with splicing strips.
- (6) A 250 ft. reel of leader tape.
- (7) A heavy duty take-up reel.
- (8) A 16 page booklet of Tape Tips.

See your dealer or write to:

AMERICAN RECORDING TAPE

GREENTREE ELECTRONICS
2135 Canyon Drive, Costa Mesa, Calif.



the higher the speed, the better the treble response and the less wow and flutter. For the past few years, 7½ ips has been the accepted speed both for high-quality home recording of music and prerecorded commercial tapes—with lower speeds recommended for less critical uses.

● **Speed consistency.** Fortunately, the specifications for wow and flutter, the most serious kinds of speed variation in a recorder, are fairly straightforward. Both forms of trouble (whether listed separately or together in a list of specs) should be held to less than 0.25 per cent in a high-quality recorder. In some inexpensive machines, an impressive wow figure may have been measured near the middle of a 7-inch reel, since this will give a better result than a check made at the beginning or end of a reel. In general, however, wow and flutter percentages are reliable standards of comparison. Less likely to be stated in specifications (and often relatively unimportant) is the question of a recorder's long-term speed accuracy. A number of machines, including a few expensive models, run slightly faster or slower than their indicated speeds. This may be completely unimportant to anyone who intends to play back only his own recordings. If you intend to invest heavily in prerecorded tapes, however, a machine's nominal playing speeds should be as accurate as possible. Its long-term speed variation, if stated at all, should be less than 1 per cent—and preferably under 0.5 per cent. If not stated, a machine's speed accuracy can be checked with a strobe device.

● **Tracks.** It is not necessary to record across the entire width of a tape. If only half the width of a tape is in contact with the gap of a tape head as it moves past, two separate programs, or tracks—one for each direction of tape travel—can be recorded on the same tape. If each of the gaps is made to contact only one-quarter of a tape's width, four tracks—a stereo pair for each direction of tape travel—can be put on a single tape. Four-track operation, which uses paired tracks for stereo recording or uses them individually for monophonic taping, is now standard for home use.

● **Transport.** A tape transport consists only of tape heads and a basic mechanism for moving tape. It has no built-in electronic circuits, and simply provides for playback of prerecorded tapes through the low-level tape-head inputs of an amplifier. It is possible to add heads and recording and playback preamplifiers to the basic transport and thereby build a complete deck by stages, but the final product is likely to lack both the features and performance of a deck purchased "complete." The transport's primary appeal is for those interested only in playing prerecorded tapes.

Introducing the first solid-state stereo receiver of Fisher quality under \$330.

It is not easy to make an all-in-one receiver that equals or surpasses the performance of comparable separate components. It is even more difficult to adapt the complex new technology of transistor circuits to simple, reliable, integrated stereo receiver design. But to do *both* at a truly moderate price takes almost occult powers. Or Fisher engineering.



It is with exceptional pride and an unprecedented sense of achievement that Fisher introduces the 440-T stereo receiver, a no-compromise, all-transistor instrument suitable for the most advanced audio systems and selling for only \$329.50. (Cabinet, \$24.95.)

On a single, compact chassis only 11 inches deep and occupying only 16 $\frac{3}{4}$ inches of shelf space, the 440-T incorporates a superb, all-solid-state FM-multiplex tuner with automatic mono-stereo switching, an extremely versatile stereo control-preamplifier, and a heavy-duty, silicon-powered stereo amplifier. All the stereo electronics you are ever likely to need, all with Fisher reliability.

The Fisher 440-T fairly bristles with engineering innovations, convenience features and Fisher exclusives. Read the specifications on the right and convince yourself. Then ask your Fisher dealer for a demonstration. We predict you'll walk out with a 21-lb. package under your arm.

Features and Specifications

- No output transformers—therefore no limitation of bass performance or of transient response because of transformer characteristics.
- Silicon output transistors for conservative operation at high power. Massive heat sink. Power output is 70 watts (IHF) at 4 ohms, 50 watts at 8 ohms.
- New all-transistor front end with 4-gang tuning condenser for highest sensitivity and lowest noise, plus overload rejection unexcelled by vacuum-tube front ends. Sensitivity is 2.0 μ v (IHF); signal-to-noise ratio is 68 db at 100% modulation.
- Four wide-band IF stages and three limiters.
- Wide-band (one megacycle) ratio detector of highest linearity and lowest distortion, capable of unusually accurate detection of multiplex signals.
- Exclusive Fisher STEREO BEACON* for automatic switching between FM-mono and FM-stereo modes, and automatic visual indication of stereo broadcasts. No relays, no clicks.
- Professional d'Arsonval-type tuning meter.
- Highly effective muting between stations.
- Convenient speaker selector switch.
- Size: 16 $\frac{3}{4}$ " wide, 5 $\frac{1}{8}$ " high, 11" deep (12 $\frac{3}{8}$ " overall, with knobs). Weight: 21 lbs.

*PATENT PENDING

THE NEW FISHER HANDBOOK



FREE! \$2.00 VALUE! Mail this coupon for your free copy of *The New Fisher Handbook*. This entirely new, revised and enlarged edition of the famous Fisher high fidelity reference guide is a magnificent 80-page book. Detailed information on all Fisher components is included.

FISHER RADIO CORPORATION
11-40 45th Road,
Long Island City, N. Y. 11101

Name _____
Address _____
City _____ State _____

79111

The Fisher 440-T

FISHER RADIO CORPORATION, 11-40 45TH ROAD, LONG ISLAND CITY, N. Y. 11101 OVERSEAS RESIDENTS WRITE TO FISHER RADIO INTERNATIONAL, INC., 11 CITY, N. Y. 11101. CANADIAN RESIDENTS WRITE TO TRIFEL ASSOCIATES, LTD., 55 BRISBANE ROAD, DOWNSVIEW, ONTARIO.



Looks can be deceiving! Just because the new Magnecord Model 1020 has a pretty face and optional walnut base, don't get the idea it's not a professional quality instrument. When your wife starts raving about the way it complements her decor, don't be afraid you're going to miss any of that famous Magnecord quality. If the elegant new appearance fools you, just put

INTRODUCING THE NEW MAGNECORD 1020

the 1020 through its paces. The Model 1020 has Magnecord's unsurpassed ability to record from any program source, gentle and sure tape handling and professional endurance. The new Magnecord may not look like a big, business-like professional tape recorder/reproducer . . . but it sounds like one. ■ See the new Magnecord Model 1020 at your dealer's or write for new brochure.

DECORATOR STYLED WITH A PROFESSIONAL HEART . . .

Magnecord Sales Div. | Subsidiary of the TELEX Corporation
MIDWESTERN INSTRUMENTS | P. O. Box 7509 / Tulsa, Oklahoma 74105



SELECTING THE RIGHT RECORDER

A CONSUMER'S GUIDE TO THE CHOICE
OF A QUALITY HOME TAPE RECORDER

By **JOHN MILDER**

MORE than ever before, today's tape-recorder buyer is faced with an embarrassment of riches. The typical hi-fi showroom offers not only a bewildering assortment of recorders in every price bracket but also a choice of several sharply different *kinds* of tape equipment—all-purpose recorders, tape decks, cartridge



SELECTING THE RIGHT RECORDER

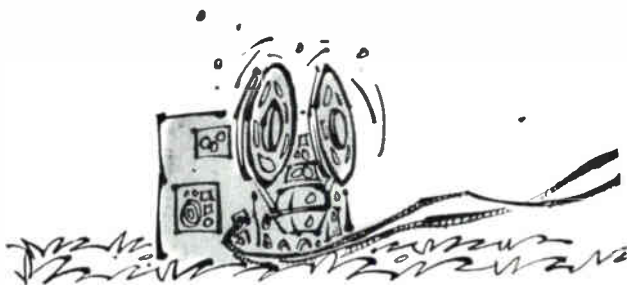

machines, miniature portables, and others. All of which can add up to confusion for an unprepared shopper.

This great variety, however, now makes it possible to find features and quality in moderately priced recorders that once were available only in the most expensive machines. But to make the most of today's possibilities, you should enter a showroom with some idea not only of what to look for and what to expect in a good recorder, but also with a general picture in your mind of the kind of machine that is most likely to suit your personal requirements and budget limitations.

Whether you are about to buy your first recorder or replace an older machine, you should be aware that many of the older accepted guidelines for selecting a recorder are no longer very meaningful. What you may have been advised to look for in a recorder a few years ago may now be irrelevant or misleading. Probably the most important example is the one-time important distinction between "complete" recorders and tape decks (machines without built-in power amplifiers and speakers). Not too long ago, the only way to be sure of getting fully satisfactory results from tape recording with a hi-fi system was to buy a deck. The complete machine, with its mediocre speakers and low-fi amplifiers, was a piece of excess (and usually expensive) baggage. Moreover, its superfluous paraphernalia often severely compromised performance when hooked up to a hi-fi system, causing hum and distortion.

But things have changed radically since then. For one thing, the use of transistors has cut the cost and raised the quality of additional features. For example, a manu-

facturer can now add fairly decent amplifiers and speakers to a basic tape mechanism at only a relatively small increase in cost. The built-in amplifiers and speakers are a convenience for on-location recording—and the lightweight transistor circuits add almost no extra weight to the machine.

This does not mean that the time-honored tape deck is now obsolete or about to become so. It does mean, however, that a self-contained, all-purpose recorder may be entirely comparable in performance. If, for on-location use, you want a recorder that has its own speakers, you should be able to purchase one that will give you high-quality results (when used with a separate playback system), at a cost only a little more than that for a deck of comparable quality.

Another earlier distinction that can now be safely forgotten about is the presence or absence of so-called "professional" features in a recorder. Most of the visually impressive features of studio recorders—such as VU recording-level meters, tape-tension levers, and separate motors for rewinding and fast-forwarding tape—now appear frequently in medium-price home recorders. They are also *not* used in some expensive and excellent machines. What matters, of course, is a recorder's actual performance and ease of operation, and one should not be influenced by gadgetry when judging a tape machine's over-all quality.

Fortunately, there are some concrete indices of quality to look and listen for in a recorder. Before they are examined, however, the various types of tape recorders now available should be described. Assuming that the basic difference between decks and complete recorders is reasonably well defined, and that stereo operation is now the norm for tape equipment, we will concentrate on the variations in the basic *types* of gear, and on the relatively new special-purpose machines on the market.

THE simplest and least expensive form of tape machine is the tape transport, which consists of a tape-drive mechanism and one or two heads. A tape transport lacks any kind of "electronics," and its output must be fed into an amplifier with *tape-head* inputs. Tape-head inputs should not be confused with the standard tape inputs provided for the connection of a recorder or deck that has its own playback preamplifiers.

To permit the recording and erasure of tapes, a recorder must have, in addition to its playback amplifiers, special recording amplifiers. These provide the special bias current needed for taping and erasing, and they also equalize the signal going onto the tape, providing the frequency corrections necessary to make up for losses in the recording process. In less expensive recorders, a single two-channel (for stereo) amplifier does double duty, serving both as a record and playback amplifier. However, the more expensive recorders have separate



twin-channel amplifiers for recording and playback.

If economy is the prime reason for the existence of the tape transport, it is also the *raison d'être* for some recorders that are only partly stereophonic in operation. Some self-contained recorders, although they have a stereo playback head, have only a single amplifier and speaker of their own, and can play back stereo tapes only in conjunction with a hi-fi system or a special amplifier-speaker combination, the latter usually being available as an optional accessory. Other recorders, now very few in number, play back prerecorded stereo tapes but cannot make stereo recordings. It is often impractical—or impossible—to convert these recorders to stereo taping. You should make certain, then, particularly if you are offered a bargain in a discontinued model, just how "complete" a recorder it is, and how easily it can be adapted to full-fledged stereo record and playback operation.

Over the past few years, the standard tape recorder has been joined by the cartridge machine, which does away with the usual reel-to-reel movement of tape in favor of partly or completely automatic tape-handling within a cartridge. At the moment, there are a number of cartridge systems available for special uses, but two systems—the RCA and the 3M-Revere—are the most important for the home listener.

The RCA units resemble conventional recorders except that the tape is enclosed in a plastic cartridge. The machine operates at $3\frac{3}{4}$ inches per second, and uses standard $\frac{1}{4}$ -inch magnetic tape inside the cartridge. The 3M-Revere system is more unusual, in that it is intended to compete with discs as well as reel-to-reel tape. It employs minia-

ture cartridges (containing a special tape made by 3M) that plays at $1\frac{7}{8}$ ips, and the machine is fully automatic in operation. Through the action of its automatic tape-changing mechanism, the 3M-Revere system can provide up to fifteen hours of music without reloading. The RCA and 3M-Revere machines are available as playback-only decks, record-playback decks, and complete recorders (with speakers).

The advantages and disadvantages of the cartridge machines are interrelated. The cartridges themselves are more convenient and easier to handle than conventional reels, but they have the handicap that they cannot be used with standard recorders. And although the slower speeds at which the cartridge machines operate does provide extended playing time, slow-speed operation tends also to involve a slight decrease in fidelity. Essentially, the choice between cartridge and reel-to-reel tape is between extreme convenience and extreme fidelity.

ANOTHER new arrival, made possible by the use of transistors, has been the small battery-operated portable recorder. The reference here is not to the \$29.95 "toy" portables that have been around for some time, but to the new battery-operated machines (selling for about \$75 and up) that are designed for taping in the field, dictation, and other specialized uses. Their fidelity is often surprisingly good, and they thus make interesting "extras" for the owner of a home tape recorder. Tapes made on them can be played on many home machines. It is essential, of course, that the two recorders have a common speed—that is, if the portable recorder operates at $1\frac{7}{8}$ or $3\frac{3}{4}$ ips,

the home unit must also have these speeds. And it is equally essential that the battery-operated recorder have a steady-speed capstan drive.

Although the variety of present tape equipment may seem endless, it is not too difficult to narrow down your range of choice. You should begin with the realization that the lowest price at which you will find generally acceptable performance is from \$150 to \$250—with but few exceptions. Many machines in this range offer both good fidelity and a comprehensive list of features. As you go up in price, however, frequency response, signal-to-noise ratio, distortion, and speed consistency slowly but perceptibly improve. And as you approach the \$450-\$600 range occupied by the top-quality home machines there are definite improvements in construction details that result in ruggedness and long-term dependability.

If you have bought other types of hi-fi components, you probably will want to make "paper" comparisons of various recorders before entering a showroom. If so, you should familiarize yourself with the explanations of tape specifications and how to interpret them contained in the glossary beginning on page 6. Your most important judgments, however, will be the ones you make in a showroom.

The two minimum requirements for acceptable taping are a tolerable level of background noise and reasonable freedom from speed variations (wow and flutter). These are best judged by listening to a recorder through a good, wide-range component system that will reveal flaws instead of masking them. (It is also a good idea to compare recordings taped and played back on the same machine; this can usually give you a realistic picture of any machine's capabilities.)

Frequency response is a tricky consideration. You can expect to find superior response in higher-price machines, because both head assemblies and preamplifiers are better. But some low-price machines may exhibit apparently excellent response. If so, check to see whether seemingly good high-frequency response is produced by peaking the highs more than the normal amount during recording to make up for mediocre playback-head performance. This can be spotted by playing one or two prerecorded tapes, which will sound dull and lifeless over a poor playback head. Also worth watching out for is a "zingy" quality in the highs that indicates distortion.

As you move up the price ladder, one reliable index of quality is the presence of separate recording and playback heads. Although a combination record-playback head can perform very respectably, separate heads provide the relatively wide head-gap necessary for good recording and the very narrow gap needed for best playback results. This means that less electronic compensation is required to make up for head deficiencies, and that better results can be obtained with a wide range of tapes (including

prerecorded ones). A separate playback head also permits direct comparison ("monitoring") of the original signal against the signal as it is recorded on the tape.

As your demands become more critical, direct monitoring off the tape becomes the most effective yardstick of performance in a showroom demonstration. It tells more about a recorder's fidelity than any other technique, revealing subtle differences in frequency response, background noise, and distortion that might otherwise be overlooked. It is likely that some difference between the source and the taped signal will be detectable on even the most expensive machines. The better the machine, however, the less significant the difference will be.

If your inclination is toward a machine from either the upper-middle or the top-quality class, you should pay close attention to the way a recorder handles tape. In a low-price recorder, you can expect little more than on-speed playing and recording. In a better machine, however, you should check for smooth stops and starts at normal playing speeds (without jerking or spilling tape), reasonably fast rewinding and fast-forwarding, effective braking at high speed (without tape breakage or stretching), and foolproof switching from one mode of operation to another without breaking or spilling tape. All but the most expensive machines are less than perfect in one respect or another, but you should definitely avoid any machine that seems prone to jamming, or to damaging tape. And in any recorder above the rock-bottom price category, you should look for consistent, wow-free performance with various tape thicknesses and lengths; this is particularly important for the playing of commercially prerecorded tapes. (It is worth noting that some moderate-price recorders are woefully deficient in handling "long-playing" prerecorded tapes.)

When you have narrowed down your choice of recorders according to their performance, you can and should look for those amenities that can make your taping activities more convenient. Many of today's recorders, for instance, offer automatic reversing during playback, either at the end of a reel or at a point determined by the listener. Others, through the use of an extra set of heads, permit automatic reversal during recording as well as playback. And even in moderately priced recorders you may find such extras as provisions for mixing input signals, sound-on-sound and echo-effect recording, signals to trigger slide projectors, and automatic shut-off at the end of a reel. None of these features should take precedence over basic sound quality, but their presence or absence in machines of similar price may help determine your choice.

Whatever your recording needs, it is likely that several of today's near-incredible variety of recorders will meet them handily. If you take the time to sort out your own requirements, and to make unhurried appraisals of the available equipment, the recorder you take home can become the most versatile component in your audio system.

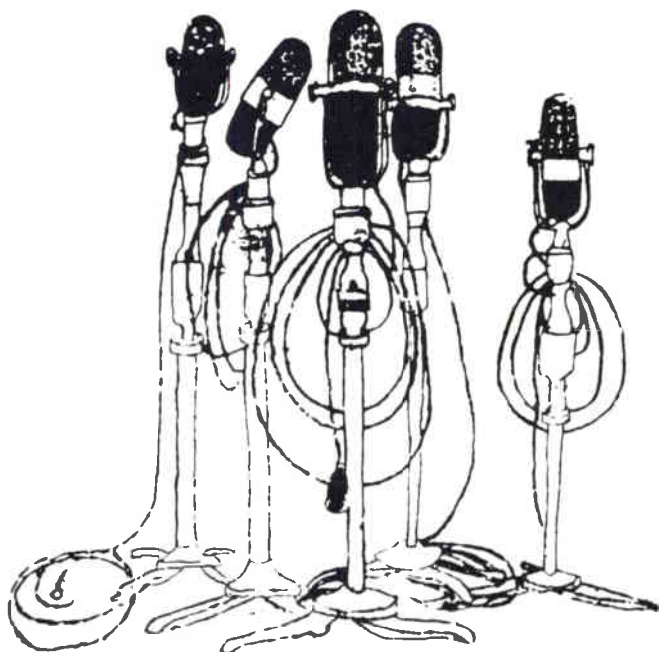

HOW TO CHOOSE A MICROPHONE

By J. GORDON HOLT

PUSH-BUTTON automation has simplified the tape recorder to the point where just about anyone can make a tape. But making a *good* recording demands more than just a recorder, a microphone, and someone capable of punching a record button. It calls for the right microphone, as well as a recordist who knows how to use it to best advantage.

The right microphone doesn't necessarily mean the highest-quality one, either. A microphone should be good enough to meet your fidelity standards, of course, but it must also suit the application to which you will put it. It must be durable enough to withstand the kind of treatment you will give it; it must match your recorder electrically; and it should also be acoustically suited for the kind of recording work you have in mind.

When you first look through the scores of listings in microphone catalogs, the task of finding the one mike that is best suited to your own needs may at first seem staggering. But the job is actually not too difficult as long as you approach the situation logically.

Of the four basic types of microphone you will find listed, the crystal and ceramic varieties are the least expensive, and they range in quality from mediocre to quite good. Dynamic microphones range from cheap and mediocre to very costly and correspondingly excellent. Ribbon microphones range from quite good to excellent, and are priced accordingly. Capacitor microphones, requiring associated electronic equipment, are the highest-priced of the available types. They are the most favored by professional users, mainly because of their outstanding frequency range and transient response.

Which type is best for you? To answer this, ask yourself how often you will be using your

HOW TO CHOOSE A MICROPHONE

microphone and what you will be using it for. There's no sense in spending several hundred dollars for a superlative microphone that may be used a few times to record party guests and daughter's piano practice before it ends up gathering dust in the hall closet. And even if you expect to use your microphone often, it is pointless to buy an expensive one with a 20-to-20,000-cycle frequency response if you're only going to use it to record speech.

In general, your microphone should have about as good a frequency response as your main speaker system. If most of your recordings will be of voices or solo instruments (excluding organ, which is something else again), and you don't demand the *n*th degree of realism, something less ambitious will suffice. On the other hand if you plan to do frequent tapings of local band, orches-

tral, or choral concerts, and aren't happy with anything but the best possible sound, your microphone should have as good a frequency response as you can afford.

A microphone's frequency response, like a loudspeaker's, is usually expressed in terms of a range between whose limits the mike will yield usable output. Response curves, or numerical ratings that include a statement of maximum frequency deviations in decibels, give a more accurate indication of a microphone's capabilities, but since most microphones are far less smooth in response than even the cheapest hi-fi amplifiers, this information is rarely volunteered. When it is, this in itself is often a sign that the response is unusually smooth within its specified limits.

For recording speech only, a microphone's range need not exceed 100 to 5,000 cycles, although a wider-range unit will of course give more natural voice reproduction. For recording music, no microphone is too good, so let your own quality standards and your budget be your guide.

IF YOU'RE buying two microphones for stereo recording, should you buy two modest ones now or should you get one excellent one now (and record mono only for the time being) and add the second matching one later? It is a strong temptation to go ahead and get the two so that you can start right in recording stereo.



Crystal or ceramic microphones work by having a diaphragm concentrate sound pressure on a Rochelle salt crystal or a ceramic slab whose vibrations then generate the signal to be amplified.

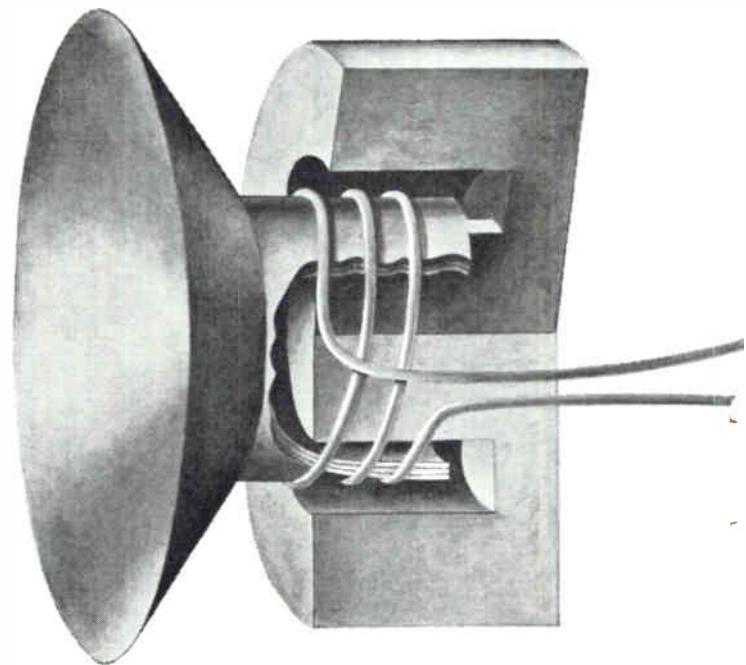

Dynamic microphones work like loudspeakers in reverse. Sound pressure acting on the diaphragm moves a coil within a magnetic field, thereby inducing a voltage proportional to the motion.

If you're quality-conscious, you'd do well to be patient and follow the second course. Two mediocre microphones won't sound any smoother than either one by itself, and if you try to pair nonidentical microphones, you will usually wind up with some unpredictably weird stereo effects.

The best microphone made won't be of much use to you if it spends half its time in the factory's repair department, so it is wise to rule out at the start any units that will not withstand the kind of treatment you're going to give them. Ruggedness is not a measure of quality; some of the finest microphones are exceedingly delicate. The better units often do have some sort of internal shock-absorber arrangement, but by and large, a microphone's ruggedness depends on what kind of moving element it uses to convert sounds into audio signals.

Ceramic microphones, for instance, are exceedingly rugged, and will survive just about anything that doesn't actually break their cases. Dynamics are rather rugged, too, but a hard knock or a drop onto a hard floor can do them serious, and possibly permanent, damage. Capacitor microphones vary in ruggedness, depending on their construction, but most of them are comparable to dynamics in this respect. Crystals, on the whole, are quite fragile, while ribbons are exceedingly so. Ribbons are also very susceptible to wind damage, outdoors or as a result of close talking, but all other types are immune to wind blasts.

Two other aspects of weather—heat and humidity—affect crystal microphones, and even though some models are sealed against humidity their heat sensitivity remains. Prolonged exposure to temperatures above 115 degrees, such as might be encountered in a closed automobile under the summer sun, will ruin any crystal microphone. Ceramics and all other types are unaffected by heat and humidity, although extreme humidity may cause extraneous noises from some capacitor microphones until the unit warms up enough to dry itself out.

A MICROPHONE works best when its internal electrical impedance is properly matched to the tape recorder's input impedance. Microphones come in three widely differing ranges of impedance, which are arbitrarily categorized as high-impedance (Hi-Z), medium-impedance (Med-Z), and low-impedance (Lo-Z). Values of 25 to 50 ohms are considered as Low-Z, 125 to 250 ohms are Med-Z, while anything over 1,000 ohms is Hi-Z. It is not necessary to match a microphone's impedance exactly to the impedance of the recorder, but it is essential that a Hi-Z microphone be used with a Hi-Z input, a Med-Z mike with Med-Z input, and so on.

The first tube in a microphone preamplifier has a high-impedance input, and a high-impedance microphone will match this directly. This mike-to-tube arrangement is

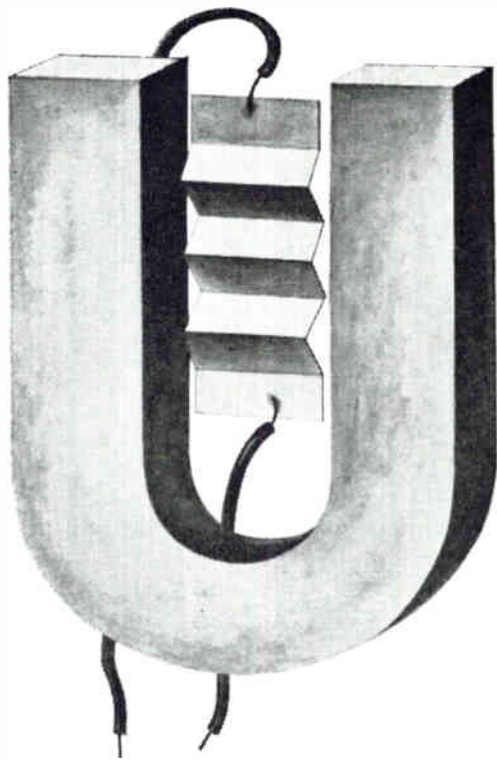

Ribbon microphones have a thin, corrugated metal ribbon vibrating between the poles of a magnet, thus generating a voltage that corresponds to the sound waves striking the metal ribbon.

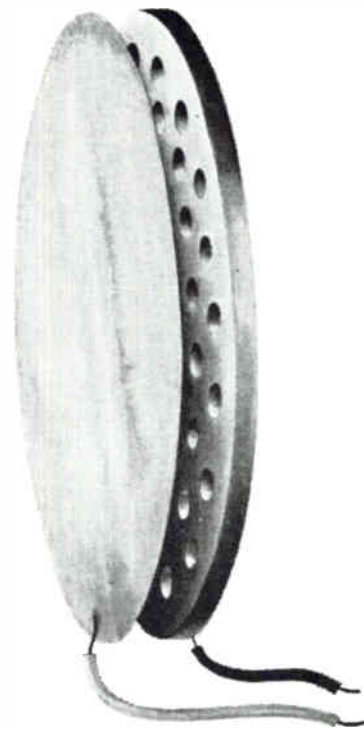

Capacitor microphones consist of two plates whose spacing changes in accordance with varying sound pressures. The corresponding changes in capacitance then effect variations of voltage.

HOW TO CHOOSE A MICROPHONE

standard for nonprofessional tape recorders, so all such recorders normally demand a high-impedance microphone. To match a medium- or low-impedance mike to the preamp tube, the mike's impedance must be raised to Hi-Z. This calls for a special matching transformer, an item that is usually included with a professional tape recorder.

Since all microphones must eventually end up at high impedance, it may seem rather pointless to confuse the issue with Lo-Z and Med-Z models. But there are very good reasons why amateur recorders have Hi-Z microphone inputs and professional ones have Lo-Z or Med-Z inputs. Cost is always a consideration in nonprofessional equipment, and high-impedance operation is the cheapest since it doesn't call for an expensive input transformer. But while Hi-Z microphones are fine in the home, where the microphone is always fairly near the recorder, they are not so good in auditoriums or out of doors, because they don't work well with long cable connections.

THE LOWER a microphone's impedance, the less it tends to pick up hum in its interconnecting cables. If these are short—fifteen feet or less—hum pickup is not likely to be any problem. But the longer they are, the more annoying hum they'll gather in. Crystal and ceramic microphones have extremely high impedance, so they are the most susceptible to long-cable hum interference. Other types of microphones are available in different impedance values, or with built-in facilities for selecting their output impedance. Most professional microphones are available only in medium- or low-impedance types.

Long cables will also affect a high-impedance microphone's frequency response, since the conductors in the cable, being in close proximity to one another, act like the plates of a capacitor. Each running foot of cable provides a certain amount of capacitive coupling between its conductors, so the longer the cable, the higher its total capacitance and the more high frequencies are lost. The effect isn't noticeable with a short cable, because all the losses occur at frequencies above 20,000 cycles. But the longer the cable the lower the frequency at which the losses start to occur, and it doesn't take much cable to cause marked loss of audible high-frequency response.

If you anticipate having to use cables more than fifteen

feet in length, or if you want professional-quality microphones, you must choose from those models that are available in low- or medium-impedance types. And if your tape recorder happens to have a high-impedance microphone input, you will have to add a matching transformer. Some recorders will accept a special plug-in transformer (supplied by the manufacturer), but if yours lacks this provision, you can use an external cable-type transformer such as the Shure A86A or the Electro-Voice 502A. This must be located at the recorder, not at the microphone.

If you expect to use short microphone cables, and don't require professional performance, choose a microphone that will match your recorder's present input impedance. If yours is a nonprofessional machine, it will have high-impedance inputs. If it is a professional or semiprofessional model, it may have high-, medium-, or low-impedance inputs, so check its instruction manual.

ANOTHER aspect of electrical matching that may be important to you is the matter of output. Professional recorders have high-gain, low-noise microphone preamps, but many nonprofessional units are marginal in both these respects. Consequently, if you expect to be recording fairly quiet material, such as speaking voices, you may not be able to use a low-output mike with your recorder.

Output ratings are expressed as a certain number of decibels below some reference level, for a certain intensity of sound. Unfortunately, however, different manufacturers use different reference levels and sound pressures for rating their microphones, so it is not always easy to compare one output rating with another. On the other hand, there is a simple way of telling whether or not your recorder has enough reserve amplification to take a low-output mike.

If your tape recorder is equipped with professional-type three-circuit microphone sockets (see the sketch on the



Recorders that have a three-circuit microphone input of the type shown here usually have enough gain to be used with professional-type low-output microphones.

opposite page), it is safe to assume that it is designed for use with professional-type microphones and will consequently have a high-gain, low-noise preamplifier section. Such a recorder will accept any high-quality microphone.

If your recorder uses RCA jacks or phone-type jacks (see sketch), check it as follows. Using the microphone supplied with it, or any inexpensive microphone, make a recording of a voice speaking at normal volume at a distance of about ten feet in front of the microphone. If you cannot get a full recording-indicator reading, the preamplifier doesn't have much reserve gain. If, on playback, the tape is loaded with hum and hiss, the preamplifier's noise is too high for so weak an input signal, or the microphone may be picking up hum and feeding it to the recorder. To check the latter possibility, short a small wire across the microphone's conductors at the plug and record some tape at the same volume-control setting as before. If the noise level in playback is unchanged, the noise is coming from the preamplifier.

THUS FAR we have assumed that a microphone picks up every sound that reaches it. This is not always true. Some types favor sounds coming from certain directions and discriminate against sounds coming from other directions. A microphone's behavior in this respect is called its directivity characteristic, and this can be plotted as a polar pattern on a graph that resembles a map of the world, with latitude and longitude lines surrounding the North Pole. According to its pickup pattern, a microphone is classified as nondirectional (or omnidirectional), unidirectional (or cardioid), or bidirectional (which indicates a figure-8 pickup pattern).

The average inexpensive microphone that is supplied with a home recorder looks as if its "live" area is in front, where its grille cover is. But such a microphone is, in fact, nondirectional over most of its frequency range. Only at

high frequencies will it exhibit a unidirectional pickup pattern. Nearly all microphones tend to be directional at higher frequencies, which is why polar graphs often show different directivity patterns for different frequencies.

Since an omnidirectional microphone receives sounds equally well from all directions, the only thing you need consider when using one is its distance from the performers. The balance between the instruments is varied by adjusting their relative distances from the microphone, and the ratio of direct sound to reflected sound is purely a matter of the microphone's distance from the entire performing group. For stereo recording, the spacing between the microphones adds another variable, but again distance is the most important consideration.

DIRECTIONAL microphones add complications, because both their distance and their orientation will affect the sound. Directional microphones are considerably more flexible to use than omnidirectional types, and they are a lot more fun to experiment with. But they are also quite a bit trickier to use properly, particularly in making stereo recordings. Of the directional types, bidirectional ones are the most difficult to use to best advantage, because their live area is narrower than that of most unidirectional microphones, and their sensitivity to sounds originating from the rear must be considered when positioning them.

There is, however, one kind of directional microphone that makes an easy job of stereo recording. This is the so-called stereo microphone, which consists of two directional microphones in a single case or mounted on a bracket that holds them a fixed distance apart. These can give excellent stereo, with remarkable good center fill, and their fixed spacing eliminates one variable in stereo mike placement, allowing them to be used in much the same way as a single broad-field unidirectional microphone. They are, in fact, easier to use than a pair of omnidirectional microphones, so if you want the best stereo with the least possible experimentation, a stereo microphone will be your logical choice.

A stereo microphone cannot be used to make hyper-stereo recordings with extreme separation and ping-pong effects. If you want to experiment along these lines you will need separate microphones that can be well isolated from one another. In this case you should choose their directivity on the basis of how much time and experimentation you're willing to devote to learning to use them properly.

Your final choice of a microphone will depend on the points just discussed and, to a lesser degree, on the manufacturer's reputation and the price of the microphone. Although price isn't always an accurate index of a microphone's quality, it usually is, and you're never likely to be sorry for having paid a little more than you originally intended.



Recorders equipped with inputs either of the RCA type (above right) or the phone type (below right) generally do not have enough gain to work well with low-output microphones.



Sony's TCV 2010 (right) includes a miniature TV receiver-monitor.

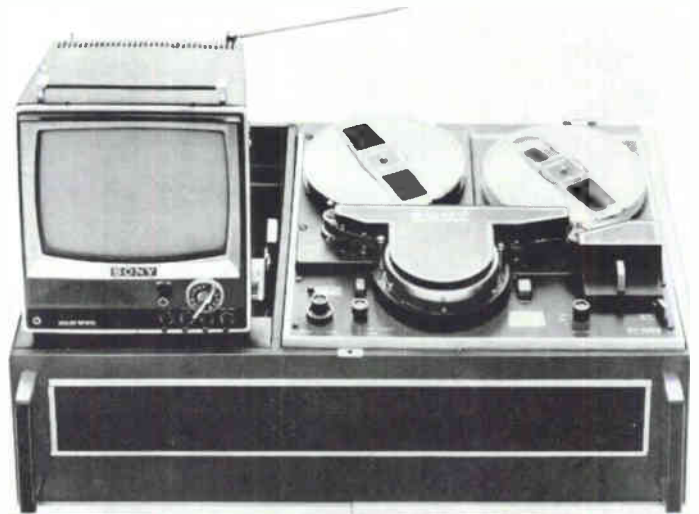

Wesgrove's VKR-500 (below) is a "brute-force" system supplying up to 30 minutes of recording time.



Norelco's EL 3400 (above) has a simple coupling gadget that slips over one of the tubes in the TV set.

Fairchild's VE5001 (below), another brute-force machine, is not yet commercially available.



Ampex' 6000-series video recorders (above) will be available in early 1966.



A Roundup of the New VIDEO TAPE RECORDERS

WHAT THEY ARE AND HOW THEY WORK

By ROBERT ANGUS

WHEN Ampex announced its original video tape recorder for television broadcast use back in 1956, so the story goes, two Texas millionaires were so taken with the idea of making instant home movies and taping the TV antics of Dean Martin and Jerry Lewis that they were willing to pay \$50,000 each for the privilege.

Ever since, tape engineers have dreamed of making a video tape recorder that would be simple enough for the tape hobbyist to operate and cheap enough for him to afford. In back rooms from Princeton, New Jersey, to

Redwood City, California, and in laboratories in Eindhoven, Holland, East Bridgeford, England, and Tokyo, designers have been burning the midnight oil for nearly a decade to create such a recorder.

Putting pictures on tape is something like putting sound on tape—the more tape that goes by the heads, the better the quality. The frequency range of today's better audio tape recorders is approximately 40 to 16,000 cps, and, with few exceptions, 7½ inches of tape per second must go past the playback head in order to achieve this response. To record a black-and-white picture with reasonable fidel-

SOME TERMS USED IN HOME VIDEO TAPE RECORDING

- *Brute Force*: A technique for recording picture and sound on standard quarter-inch recording tape by moving it past a stationary head at high speed.
- *CCTV Camera*: Closed-circuit television camera—a home version of the cameras used in TV studios, this accessory may be wired to your home TV set which, in turn, is wired to your video recorder. CCTV camera prices depend, in part, on the quality of their lenses. A \$350 kit, for example, offers a simple low-cost lens suitable for recording in the living room. A \$1000 camera might offer a zoom lens and a variety of other features. Lenses and other accessories generally are interchangeable with movie cameras.
- *Color Compatible*: Any video recorder now on the market will record color-TV programs in black and white. Ampex claims that all fast-speed recordings made on its 6000 series will be playable in black and white on tomorrow's color decks.
- *Helical Scan*: A technique for recording picture and sound on video tape in which a rapidly rotating head within the housing traces a slanting pattern on the tape as it passes by. The tape—usually wider than standard quarter-inch audio tape—is wrapped around a circular head housing in an omega pattern, with the right leg

lower than the left. Head-to-tape speed is much higher than is practical with brute-force recording.

- *Slant-Track Recording*: Another name for helical-scan recording.

- *Sync or Synchronization*: The technique for providing a stable TV picture. The TV image must be synchronized both horizontally and vertically to prevent the picture from tearing or rolling. A strong pulse signal is added to the tape to keep the picture framed properly. One of the difficulties in home video tape recording seems to be that of putting a strong vertical and horizontal synchronization signal onto tape. Many home video recorder pictures have a tendency to flicker to the left upon occasion—a relatively minor imperfection.

- *Writing Speed*: Tape-to-record head speed. In the case of stationary record/playback heads, the writing speed is the same as that of tape speed. In the case of helical-scan recording, the writing speed is basically determined by the rate of the revolution of the record/playback head or heads.

- *Megacycle*: 1 million cycles per second.

- *Video*: Those frequencies having to do with television-picture reception and playback.

ity, a frequency response better than 150 times as great (at least 2 megacycles) is needed—and even more for color. Although this doesn't necessarily mean using 150 times as much tape, it does mean using a lot more than is needed for sound recording.

An obvious way to get an adequate amount of tape moving by the head is to use a reel of standard recording tape travelling at a very high speed. With this approach, playing time is limited and the transport's mechanical problems intensified. However, if the head itself were to rotate inside a cylindrical housing as a much wider tape passed by outside, it would be possible to achieve a tape-to-head speed of 1,000 ips while the tape transport itself operated at a more reasonable 30, 15, or even 7½ ips.

THUS two approaches to putting pictures on tape have been developed: the so-called brute-force method, in which relatively low-cost equipment could be used to produce pictures by using a great deal of tape, and the helical-scan system, in which a revolving head could trace pictures diagonally on a slower-moving, but wider band of magnetic tape. The latter system, until late last year, was firmly in the hands of the tape professionals, while companies ranging in size from tiny Par Ltd. to Telcan, RCA, and Fairchild strove to make the brute-force system work.

In the near future, it is likely that you will be able to choose among recorders ranging in price from \$794 for the brute-force factory-wired Wesgrove VKR-500 to \$3950 for helical-scan units from Norelco and Loewe-

Opta. Intermediate choices include three more helical-scan recorders—the Concord, to be priced around \$1,000 when it becomes available; Sony's TCV 2010 (\$995, including a miniature TV receiver and monitor), and the Ampex 6100 (\$1095). These may not seem like the sort of gifts you're likely to receive for Christmas, but they're real bargains compared to the \$50,000 to \$60,000 a television broadcast station has to shell out for a video recorder, or the \$12,000 to \$15,000 a school or corporation must pay for an industrial model.

You'll have to wait at least until January 1966 to find the Ampex, Concord, or the Sony at your audio dealer's. These companies feel it will take them that long to get production under way and to set up service facilities in the major metropolitan areas. In the meantime, you can choose from among the Wesgrove, Norelco, Loewe-Opta, and an earlier-model Ampex (VR 303, \$3950) if you'd prefer not to wait. At present, the latter three are being handled by industrial and audio-visual distributors (although Norelco and Ampex say they'll be glad to sell you one direct if you want it). Wesgrove, a British stepchild of Telcan, Ltd., which started the home video-tape sweepstakes two years ago with the announcement of a \$160 video deck, sells in the United States primarily by mail, although the company does have a San Francisco distributor. For the confirmed do-it-yourselfer, Wesgrove has a kit version for \$392.

Just what do the various recorders have to offer? Let's take a look at those reported by their manufacturers to be currently available. Wesgrove Electronics Ltd. has a three-



1. Whether your favorite television show features the fastest gun in the west or the fastest throw from shortstop to first base, both actions are very, very slow when compared to the speed of TV-image formation.

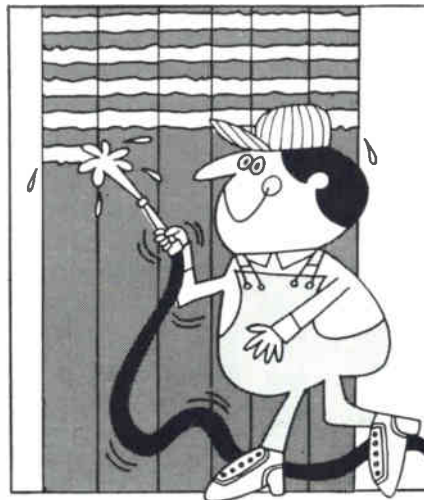

2. It might be compared to spraying your backyard fence with a garden hose. You start at the top left edge of the fence, spraying a thin line of water along the length of the fence. Then you start at the left again, spraying a second "line" right under the top one; then a third line, a fourth, etc. Now, if you could move the hose fast enough, you would finish spraying the last line at the bottom of the fence before the top line had time to dry.

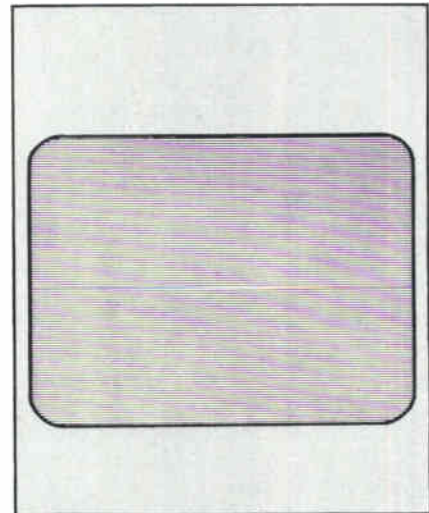

3. The process is much the same in television, and the brightness of the first line (at the top of the picture tube) is retained on the screen even after the "scanner" has completed the 525th line across the bottom of the tube. And speedy it certainly is: all 525 lines in every television picture are "sprayed" onto the picture tube in just 1/30th of a second, which is three times as fast as your fastest blink.

speed (90, 120, and 150 ips) brute-force recorder, slightly larger in size than a conventional tape deck, that the company claims can be wired into most American TV receivers at minimal cost. By using an 11½-inch reel of triple-play tape and recording at 90 ips, you can get up to 30 minutes of uninterrupted recording time, or a total of an hour per reel on the two tracks. Picture quality at the intermediate speed seems marginal when compared with the other home video tape recorders, and sound quality seems slightly inferior to that supplied by an ordinary table-model TV set. The recorder can tape off the air for immediate or later playback through a conventional TV set, or it can be used in conjunction with a TV set and a closed-circuit television camera to make instant black-and-white home movies. As with all home video tape recorders, tape friction wears out the combined record-playback head in a comparatively short time, making replacement necessary. Wesgrove claims 500 hours of combined recording and playback for its head, with a replacement available at a cost of \$2. According to Wesgrove's managing director Jack Jones, the unit is a bit complicated for the average home user to master. He recommends that it be used only by serious hobbyists.

The Loewe-Opta recorder has already found governmental, industrial, and educational uses. Although you can buy one now from the U.S. distributor (the machine is imported from West Germany by Video-Medical Electronics, Inc.), the \$3950 price tag may be prohibitive. Slightly larger than a conventional tape deck, the recorder uses 1-inch video tape on an 8-inch reel to produce

one hour of recording (full track) at a tape speed of 6 ips. Its picture quality is good (although there is a tendency toward darkness at the edges), and audio quality is adequate.

Holland's video-tape entry, the Norelco EL 3400, is similar in size, price, and operation to Loewe-Opta's. Both are fully transistorized, and the latter is push-button-operated with a minimum of controls. It uses 1-inch video tape on a 9-inch reel to record 60 minutes of picture and sound at a tape speed of 9 ips. Its single revolving head has a life expectancy of 500 hours, costs \$100 to replace, and can be replaced quickly and simply by the user. Norelco features the easiest and most convenient of all TV conversion systems: a coupling gadget slips over one of the tubes in the television set, thus converting it into a combined receiver-reproducer for the deck. Controls on the Norelco (start and stop, playback/record, rewind and fast forward) are similar to those found on a Norelco 401 audio tape recorder. The unit uses an eye tube for setting sound and picture level. Norelco's picture quality compares favorably with the TV original, and there are no synchronization difficulties.

The currently available Ampex VR 303 may be used in the home, but Ampex officials suggest that the would-be purchaser consider waiting until early 1966, when the new 6000 series of video recorders will be in full production. The Ampex 6100 operates at a tape speed of 9.6 ips, recording on 1-inch video tape wound on a 9½-inch reel. The result is one hour of uninterrupted recording time at a tape cost of about \$65. Picture quality is excellent.

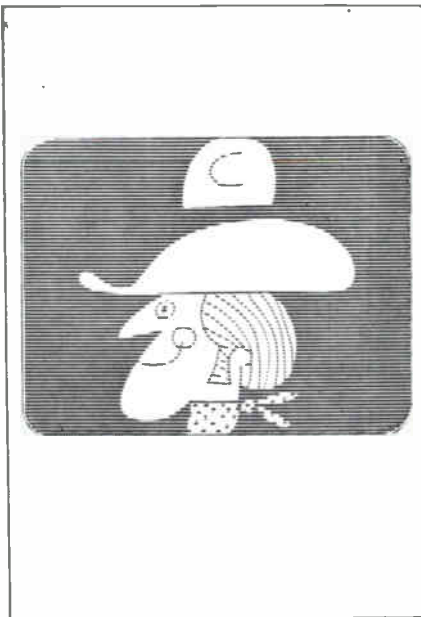

4. Television pictures have to be fast because they are not actually pictures at all, but one continuous line of light crossing your television screen 525 times every 1/30th of a second. At that speed they blend together to make the total picture.

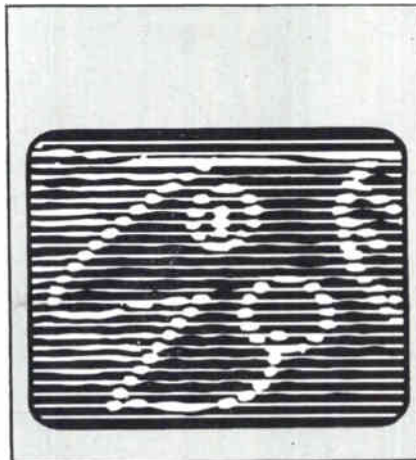

5. If you look closely at the television picture, you will notice that parts of the continuous line are brighter than others, and there are variations ranging from white through grey to black. The reason is that the white powder (the phosphor) painted on the inside of the picture tube gives off different amounts of light according to the electrical strength of the "spray" at every instant, just as a greater force of water from the garden hose would draw a wider wet line on the fence.

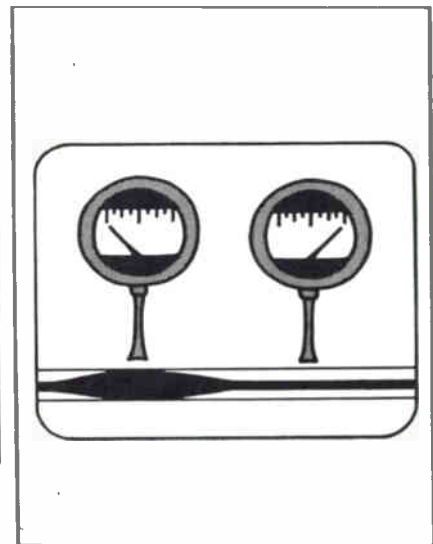

6. These differences in electrical force (voltage) are created in the television camera. A special material in the camera tube "sees" the different shades of light in the subject the camera is covering and interprets these shades in terms of electrical voltages. When the light the camera sees is bright, the voltage is high; when the light is dim, the voltage is low.

Actually, there are six Ampex models, ranging upward in price from \$1095 for the single-speed 6100 to \$2495 for the two-speed (9.6 and 4.8 ips) model 6220, mounted in a console with a 23-inch color TV set. At the slower speed (4.8 ips) the Ampex is said to produce good-quality black and white pictures and to be able to capture two hours of program material on a single 9½-inch reel. Head life, according to Ampex, is more than 1000 hours, with a replacement cost of \$50 or less.

Sony's TVC 2010, at \$995, is currently the least expensive of the helical-scan recorders. It achieves its low price by requiring the record system to work only half as hard as those of comparable units—that is, by recording only every other line in a TV picture made up of 525 lines per inch. For this reason, Sony supplies its own TV monitor receiver that can be used either for playback or for taping off the air. The TVC 2010 uses half-inch video tape wound on 7-inch reels at a speed of 7½ ips. Two combined recording and playback heads rotate within the head housing, each with a life expectancy of 1000 hours. Cost of replacement, according to Sony, is \$30 each. Tape for the Sony recorder will cost about \$40 per hour of playing time.

Concord's video tape recorder, like Sony's unit, will be designed and built in Japan and will use half-inch tape on 8-inch reels. Information has been scarce on this recorder, which produces an excellent picture on conventional TV sets, but a company spokesman says that the U.S. price may be about \$1,000.

Sound quality on all six video recorders leaves some-

thing to be desired—particularly for hi-fi tape users who are used to full-frequency reproduction. All are mono only, and virtually none claims an audio response much beyond 100 to 10,000 cps ± 3 db. A stereo head capable of wider-range reproduction could be added to any of these units, but the manufacturers feel that customers would not be willing to pay the added cost.

JUST what will a video recorder do, anyway? First, it will record any television program (color or black and white) directly off the air, for viewing at a later date in black and white. Some manufacturers have timing accessories available that will turn on the TV set and the video recorder, record a program, then shut everything off—all while you're away from home. With a closed-circuit television camera, a video recorder can make black and white home movies which can be played back immediately. Video cameras cost from \$350 for a Japanese-produced kit to more than \$1000 for some models, and generally are not included in recorder prices. They must be connected to the recorder or TV set by means of a cable, which tends to limit them to indoors, to shots out your living-room window, and to activities on the patio.

A video tape recorder can also be used to play back prerecorded video tapes. It is expected that the first tapes to appear will include off-Broadway shows, concerts and operas taped in Europe, and TV spectaculars produced originally for pay TV. Prospective viewers will probably rent video tapes, rather than buying them outright. However, Wesgrove's Jack Jones anticipates low-cost video

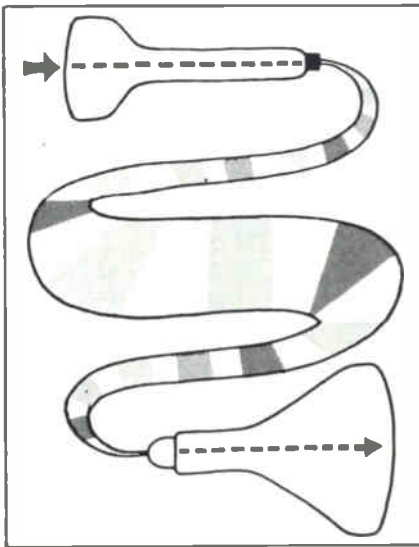

7. These different voltages, which correspond to different brightnesses, are gathered together in a beam that travels across the light-sensitive material in the camera tube in the same way we sprayed that fence—and again, the speed is 525 “scans,” or lines, every 1/30 of a second. This continuous “line” of voltages is fed via the station’s transmitter to your TV set.

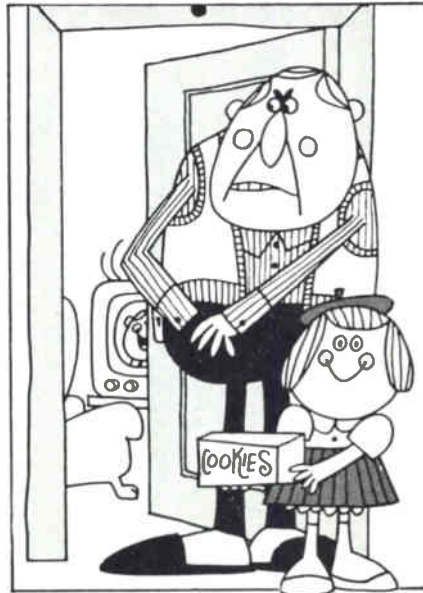

8. Unfortunately, if you are not at your television receiver the same instant the television camera sees the picture, you can miss what might be your favorite program—unless, of course, the pictures being broadcast are also being recorded on tape so that they can be played back later.

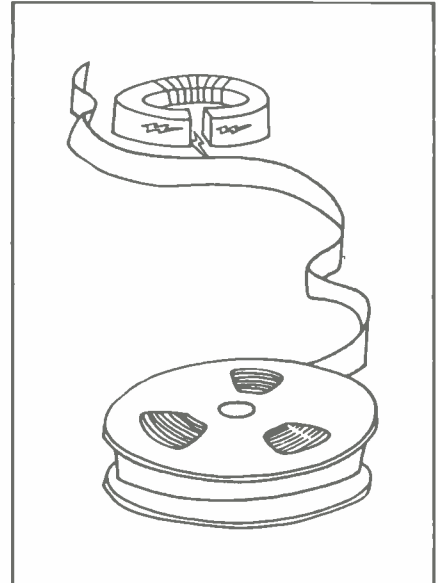

9. You are already familiar with the process by which magnetic tape can record and hold sound indefinitely, and this can be done, of course, because sound can be changed into electrical charges and the electrical charges can be stored on magnetic tape as tiny permanent magnets.

tapes—the Beatles or some other pop group performing for two to three minutes on a recorded video tape that might sell for as little as \$2 or \$3.

At the moment, tapes made on one manufacturer's home video recorder can't be played back on another's unit. In fact, tapes made on some machines can't be played back on another machine of the *same* model. The reason is the variety of speeds, tape widths, and recording techniques now in use. Each manufacturer hopes that his speed and width will become the industry standard, but that's up to the Electronic Industries Association (EIA) and the buying public.

What about color? Almost every manufacturer calls his recorder "color compatible." What this means, in most cases, is that the recorder will record a color program in black and white (much as a conventional black and white TV set reproduces color programs). Ampex, however, has taken the term to mean that tapes made on its 6000 series recorders will be playable on their color video recorders, to be offered at some future date. At present, no home machine is capable either of recording or reproducing color.

Editing, a relatively simple matter with sound recording, can become something of a problem with home video tape. The high speeds used in brute-force recording make it difficult to find the exact spot at which to make a cut. By the same token, if you want to omit a commercial from a TV show you're videotaping, you can't merely stop the machine while the commercial is on, then start it up again. The reason is that it takes brute-force ma-

chines several seconds both to get up to speed and to stop. The problem is simplified with some helical-scan recorders—they can be stopped at a single frame, if desired. Editing then consists simply in cutting diagonally across the tape before and after the commercial, then splicing the tape back together. Since all helical-scan recording is full-track, you don't have to worry about cutting into program material recorded in the opposite direction on the tape.

Because video tape, like audio tape, can be erased and reused again and again, it offers a number of new uses around the home. Like to practice your golf swing, or see yourself delivering that speech before the PTA? You can do it with video tape, rehearsing again and again to get every gesture exactly right. You can tape Olivier's *Hamlet* for repeated viewing sans commercials the next time it's on the Late Show, or build your own library of educational TV programs gleaned from educational TV stations, *Twentieth Century*, or *Profiles in Courage*.

At the time this article was prepared, the six recorders discussed here were the only ones that promised to be readily available. Prices are admittedly high. But developments in home video tape recording have come so thick and fast in the past few years that it's not at all unreasonable to expect at least another half-dozen brands to be available by this time next year. Prices can be expected to drop, too, as manufacturers begin to produce and sell sets in quantity. Concord and Sony aren't alone in predicting a top-quality \$500 video recorder within the next five years.



10. Since a television picture is no more than a series of electrical charges, we should also be able to store these charges on magnetic tape. And we can, but because the individual electrical charges that make up the TV picture move so fast (remember those 525 lines in 1/30 of a second), ordinary sound recorders can't be used. One way, of course, is to move a tremendous footage of magnetic tape—at tremendous speed—past a record (or playback) head, and this is the method of the new so-called "brute force" video tape recorders.

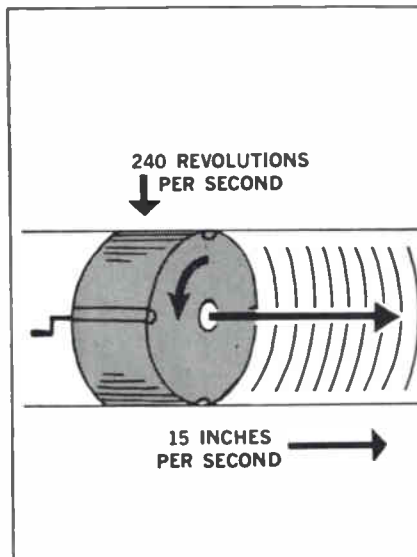

11. Another way is to use much wider magnetic tape (2 inches) and record the electrical charges across the tape as it moves through the machine. In this method, the recording heads are attached to a wheel that turns as fast as 240 revolutions per second, and the tape need move past this wheel no faster than 15 inches per second. This is the "helical-scan" system.

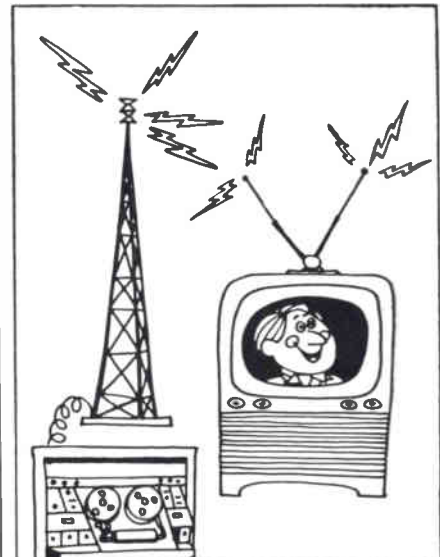

12. Once recorded on tape, the video signal can be played back in a reversal of whichever system was used, the magnetically recorded information changed back into electrical charges, and these charges broadcast to your TV set. Or, if you are the fortunate owner of one of the new home video machines, skip the broadcast—the tape can play directly into your TV set.

A Primer of TAPE RECORDER MAINTENANCE

A REGULAR MAINTENANCE ROUTINE IS THE BEST GUARANTEE
OF GOOD—AND CONTINUING—SERVICE FROM YOUR TAPE RECORDER

By **HERBERT FRIEDMAN**

EVERY PROFESSIONAL recording studio has a standard tape-recorder maintenance routine that is to be followed regularly. And it also behooves the amateur recordist, if he expects to achieve anything like professional results, to set up a check and maintenance system for his own machine.

Periodic maintenance starts with the tape heads. Most recorder manuals stress the importance of keeping the heads clean to avoid problems caused by flaked-off oxide accumulating in the head gaps. If a sufficient oxide deposit builds up (it can happen very easily) the tape is prevented from making close contact with the head gap. On the erase head, this results in partial erasure; on the record and/or reproduce head, the deposit causes both high-frequency loss and reduced volume.

Flake-off isn't the only head-cleaning problem. The grease pencil, that favorite of tape editors, is a notorious culprit. Although the grease usually gets on the head outside the tape gap, it bleeds easily onto the gap area and also results in tape lift-off. Grease-pencil deposits tend to flow when head cleaner is applied and therefore may still remain on the head even when it looks clean.

The best head-cleaning technique is to use a cotton-

tipped swab *slightly* moistened in head cleaner. (Avoid using the brush built into the bottle cap of some cleaners, because the brush returns the contamination to the cleaner.) The soft cotton tip allows you literally to scrub the grease and oxide off the heads. And don't be stingy—use a clean tip for each head. If your recorder uses felt pressure pads, hold them away from the swab-stick, since some cleaners may dissolve the cement that holds the felt pads.

While you're at it, clean the capstan drive assembly and tape guides. Hardened deposits on the capstan assembly cause wow and flutter, and deposits on the guides can scrape the tape, causing excessive oxide flake-off. The rubber capstan-pressure puck can be cleaned easily with rubbing alcohol. Some portable recorders utilize a scored capstan to insure a steady tape drive. Take particular care that the flake-off is removed from the scoring.

After every cleaning, check the tape guides. On low-cost machines they are not made of hardened steel or sapphire and they can suddenly become worn (almost overnight). A worn tape guide will permit the tape to slip out of alignment as it crosses the head, resulting in severe high-frequency loss, fluttering highs, or cross-

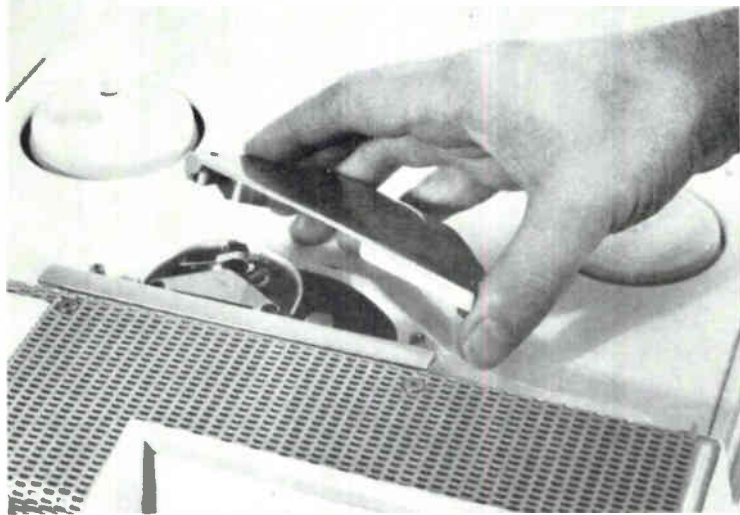

The head cover of most recorders can be readily lifted off, exposing heads, tape guides, and capstan for cleaning. Some models, however, have screws that will have to be removed first.

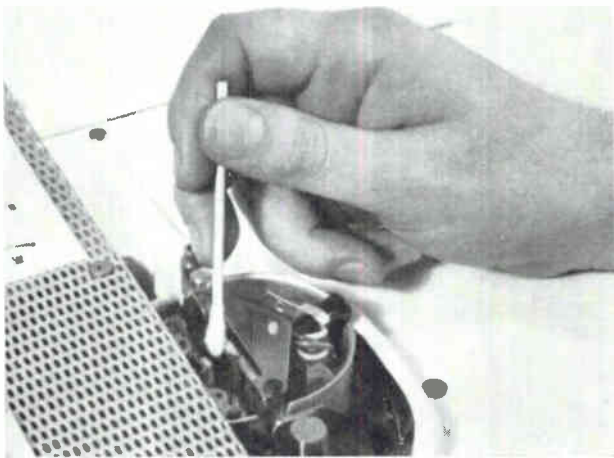

talk on four-track machines. Unless your recorder's instruction book tells you how, don't try to repair or replace worn guides yourself. This is a precision job, and it should be done by a reputable recorder service shop.

Unless your instruction manual specifically recommends oiling, don't! Just *one* drop of oil on a rubber idler-wheel drive will result in excessive wow and flutter. If there are points to be oiled, isolate the oil hole (or fitting) with aluminum foil. Foil will catch and stop oil drippings where a rag may not. If, despite all your efforts, oil does get on any drive belt or idler, do not attempt to operate the machine. Operation will only result in the transfer of oil to other parts—and, unfortunately, cleaning may do the same. Blot off excess oil *carefully* and if necessary replace the part. A good way to avoid spilling is to apply oil either with a single-drop or injector-type oiler; these items are available from most electronic-parts distributors, and they are designed specifically for the kind of delicate oiling operation required by a tape recorder.

PORTABLE battery-powered tape recorders require more than the usual amount of cleaning for their drive mechanisms. Outdoor use is almost certain to result in dust

Any dust, grime, or oxide that accumulates between the capstan and the rubber idler wheel will tend to upset tape speed. These should be carefully cleaned with head-cleaner on a lintless cloth.

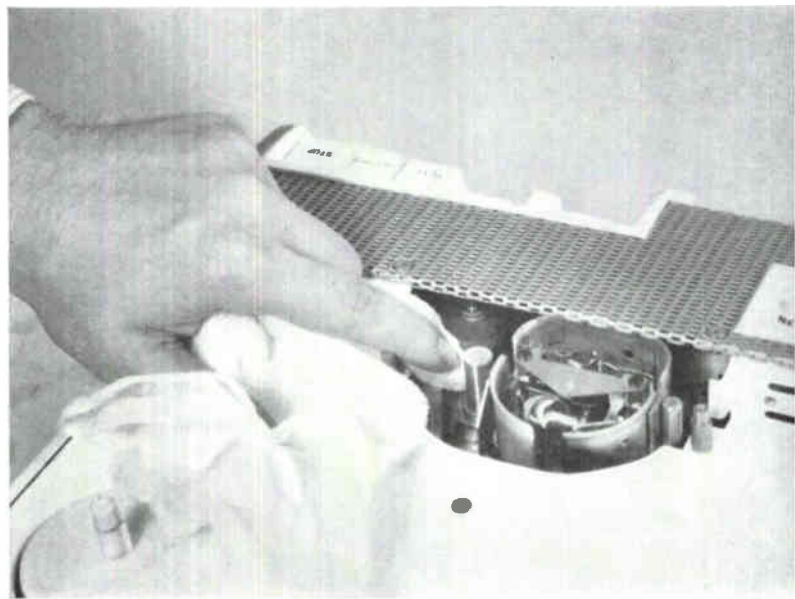

Cotton-swab "Q-tips" slightly moistened (do not soak) with one of the commercial head cleaners serve well for cleaning heads, capstan, and guides—but keep cleaner away from pressure pads.

or dirt accumulations under the tape deck. Since the portable's drive mechanism usually employs a relatively lightweight motor and capstan stabilizer, any dirt in the drive is likely to produce wow and flutter. To avoid difficulty, it is best to clean a portable's drive, when necessary, with a piece of lint-free cloth dipped in rubbing alcohol. Always clean the parts by moving the cloth, not by holding the cloth against the rotating mechanism. A chewed-up cloth can permanently jam a portable's drive mechanism.

An important service point on portables is the battery holder. Some holders present no problems since they virtually dig into the battery. On the other hand, some pressure contacts lose their tension, or accumulate a grease or oxide coating that is essentially an insulator. The cure for loose tension is of course to bend the contacts gently forward—but the contacts should be cleaned whether they are bent or not. A small file or wire brush is the tool to use. Avoid sandpaper, however, since its grit may wind up in the drive mechanism.

As a general rule, excluding electronic or mechanical failure, the recorder's original sound quality is preserved by the *routine* care it receives. Call it just another case of preventive medicine, if you please.

WHAT MAKES A GOOD

A LOOK AT SOME OF THE MOST SIGNIFICANT PERFORMANCE CHARACTERISTICS OF TAPE,

ANYONE who purchases recording tape soon discovers that a "name-brand" tape may cost twice as much as a "white-box" or "non-name-brand" tape. The home recordist quite naturally wants to know what he will get for the extra money he is asked to spend for name-brand tape. For an answer to this question, we must examine the factors that go into the production of a quality recording tape.

In essence, magnetic tape consists of a coating of iron-oxide particles on a plastic base material. The most popular type of home recording tape is wound 1,200 feet to the 7-inch reel, and has a coating about 0.5 mil thick (a mil is one-thousandth of an inch) and a base about 1.5 mils thick. Long-playing tapes have somewhat thinner coatings and much thinner bases.

The magnetic coating for the tape is made by mixing the iron oxide together with resins, binders, solvents, and other additives. These all go into a large tank that looks (and works) something like a cement mixer. In the revolving cylinder of the tank are steel balls that grind and blend the coating materials into an extremely fine viscous mixture. This mixture is applied to the tape base material, which at the time is in the form of rolls about two feet wide. Before the mixture dries, the tape is exposed to a strong magnetic field. This field physically orients the iron-oxide particles in a manner optimum for audio tape recorders—that is, parallel to the length of the tape. (A different orientation, incidentally, is optimum for video tape.) The tape is then slit into 1/4-inch strips and wound onto reels. The winding must be uniform and at constant tension.

A tape's magnetic characteristics determine its frequency response, sensitivity, output, distortion, noise, and print-through. In arriving at a particular oxide formulation, the manufacturer develops what he considers to be an optimum compromise among conflicting performance considerations. For example, extending the high-frequency response might entail a rise in distortion or in

print-through. Or higher output might be achieved at the price of treble loss. The formulation is determined also with an eye to the characteristics of the tape recorders currently available. It obviously would be foolish to design a tape that would be incompatible with the general run of home recorders.

The magnetic performance of a tape further depends on physical factors. These include the even dispersion of the iron-oxide particles in their resin binder, the thickness and uniformity of the oxide coating, and the thickness and uniformity of the base. All of these are highly critical and require elaborate quality-control measures at every stage of manufacturing. One manufacturer, for example, reports that more than one hundred quality-control tests are

Iron oxide is the main ingredient of a tape's magnetic coating.



3M COMPANY



RECORDING TAPE!

AND AT THE WAYS THEY ARE CONTROLLED IN MANUFACTURE

By BURT HINES

made on each batch of tape, from the raw materials to the end product. Each reel must be consistent throughout its length, and standards must be maintained from one reel to another.

Now let us examine the specific effects that various aspects of tape manufacture have on the most important performance characteristics.

High-Frequency Response. Every tape has certain inherent difficulties in recording the higher frequencies. These treble losses are partly or completely compensated for by the machine's record and playback equalization. However, there are limits to the amount of treble-boost equalization that can be used without substantially in-

creasing noise and distortion. By modifying the oxide formulation, however, the manufacturer can boost a tape's treble sensitivity with but small sacrifice of other desirable characteristics. The thickness of the oxide coating also plays a part in the tape's treble response. (Good treble response is also facilitated by certain physical characteristics of the tape, to be discussed later.)

Distortion and Output. These are interrelated characteristics because output denotes the maximum amount of signal that can be recorded on the tape for a given amount of harmonic distortion—usually specified as 3 per cent. The greater the tape's output, the greater the margin in playback between the audio signal and the noise produced by the tape and the machine—in other words, the better the signal-to-noise ratio. The amount of output from the tape is determined by the specific magnetic materials that are used in the oxide coating, and by the thickness of the coating.

Noise. There are two main types of tape noise. One is hiss, which is caused by randomly oriented magnetic groupings in the oxide coating. This noise is inherent in all tapes, but the better the tape, the lower the noise will be on playback. The other kind of tape noise is modulation noise, which occurs only in the presence of an audio signal and varies in intensity with the signal level. Modulation noise decreases the transparency and cleanness of the reproduced sound. It is caused by variations in the thickness and particle distribution of the oxide coating. These oxide variations are reproduced as a fuzziness behind the signal in playback. Tape noise is kept to a minimum by maintaining careful control of the oxide formulation, by dispersing the oxide particles evenly throughout the coating, and by applying the coating with a uniform thickness. It should be noted that the tape manufacturer deals with tolerances of a few millionths of an inch in controlling the thickness of the coating.

Sensitivity. This denotes the amount of signal that is recorded on the tape when a magnetic field of a given

A revolving ball mill blends the coating materials together.

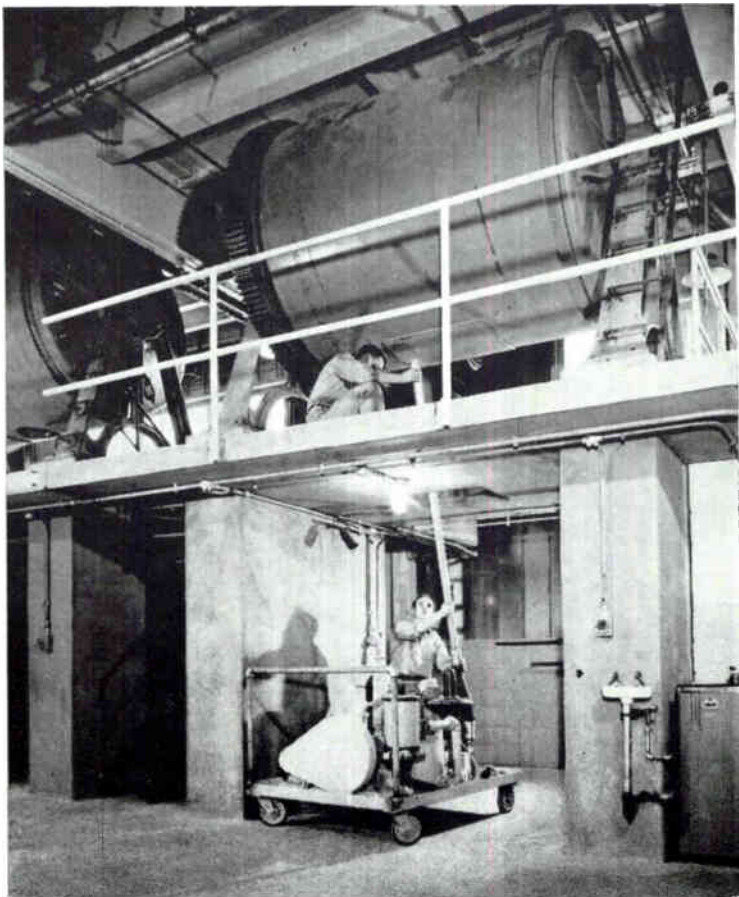

strength (from a record head) is applied. High sensitivity is desirable, for this results in improved signal-to-noise ratios in both recording and playback, but it does increase the risk of print-through. The tape should also be uniformly sensitive. Otherwise there would be variations in output from one section of the tape to another, or from one reel to another. This would be particularly noticeable if tapes from different reels were spliced together. High-quality tapes provide sensitivity that is within $\frac{1}{4}$ db throughout a reel and within $\frac{1}{2}$ db between tape reels of the same type number. The degree and uniformity of sensitivity are determined by the type of oxide and how well it is dispersed. The orientation of the magnetic-oxide particles also contributes to high sensitivity.

Print-through. Because tape is stored in tightly wound layers, there is a tendency for high-level, low-frequency recorded signals to be partially transferred by magnetic action to adjacent tape layers. This print-through sound may not be noticeable immediately after a tape is recorded. However, it intensifies with storage time, so that a month or a year after the recording was made, the print-through may become objectionable. The problem is aggravated by the use of thin-base tape because a thin base offers less of a barrier to print-through than does the conventional $1\frac{1}{2}$ -mil base. Manufacturers cope with print-through by adjusting the oxide formulation and suitably proportioning the thickness of the coating and the base.

Bias Effects. Bias, which is a high-frequency current fed to the tape recorder's record head along with the audio signal, is needed to reduce the distortion and increase the sensitivity of the tape. Unfortunately, it also causes treble

loss. Therefore, the amount of bias current used is the best compromise among the requirements for minimum distortion, maximum tape sensitivity, and acceptable treble loss. (It is perhaps worth noting here that the crossfield head was developed to reduce treble losses during recording.) In any case, it is desirable that the tape perform adequately even if the bias is not optimum. It is also desirable that the amount of bias required, which normally differs from one brand or type of tape to another, remain a consistent value from reel to reel within a given brand and type of tape. Uniformity of the oxide formulation is the answer here.

Dropouts. This refers to brief but definite reductions in signal level during playback, and is caused by variations in coating thickness or dispersion. The problem is more severe in quarter-track operation than in half-track.

IT IS NOT generally appreciated that the base material has as vital a role to play in a tape's over-all performance as does its oxide coating. One of the obvious characteristics to be considered is the base's dimensional accuracy. The tape must be exactly $\frac{1}{4}$ -inch wide. If it is too wide, the tape will not ride properly in the tape guides. If it is too narrow, the tape will follow an erratic path as it crosses the heads. Any deviation from the correct path is equivalent to an incorrect azimuth and therefore results in treble loss. (Azimuth is the angle of the head gap with respect to the length of the tape, and to avoid serious treble loss it is vital that an angle of exactly 90 degrees be maintained in record and playback.) To facilitate steady, straight passage through the guides, the tape edges must

A roll of plastic base material is fed into a coating machine.

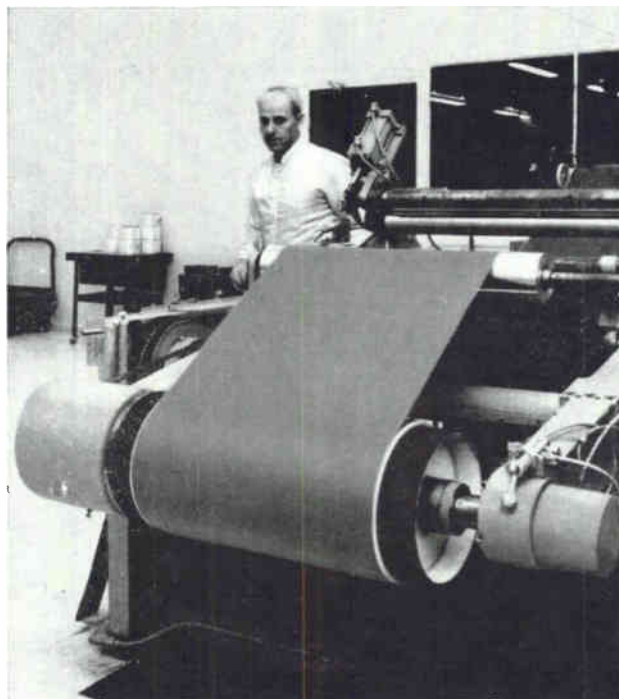

AUDIO DEVICES, INC.

The freshly coated plastic film is passed through a drying oven.

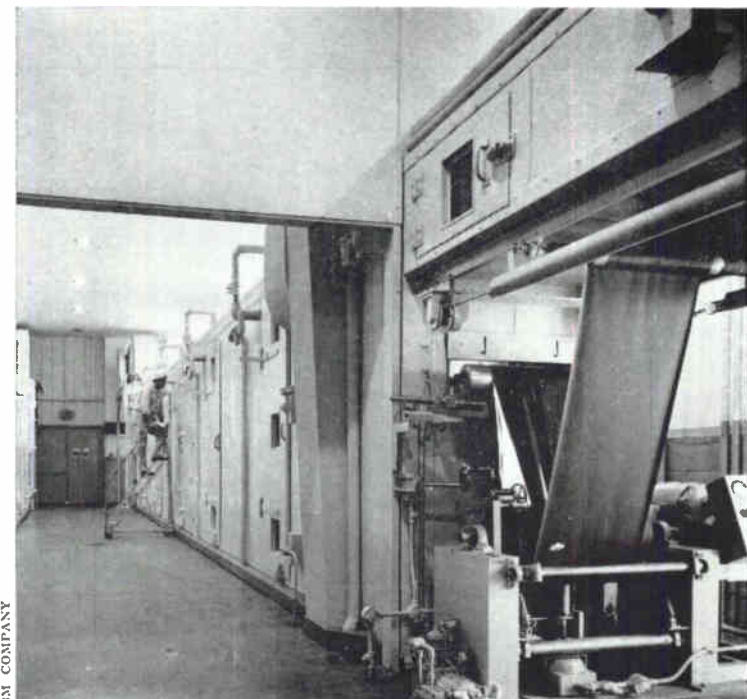

3M COMPANY

also be smooth, without undulations, serrations, or other irregularities. Dimensional stability is also necessary in that if the tape has a tendency to stretch, the recorded signal will be distorted. If the tape tends to curl or cup, close contact between the tape and the heads will be prevented, causing treble loss.

Intimate tape-to-head contact further requires that the magnetic coating be extremely smooth. If the iron-oxide particles tend to clump, or if foreign particles are embedded in the coating, they will prevent the tape from making perfect contact with the heads. Hence meticulous care is needed to insure an even dispersal of the iron oxide throughout the coating material, and in applying the coating to the base. The oxide coating also must be physically tough, for otherwise an excessive amount of it will rub off on the heads, shortening the life of the tape and impairing the performance of the heads. In addition to its toughness, the coating must be smooth enough not to cause excessive head wear through abrasion. For this reason, many tapes contain lubricating agents.

To minimize wow and flutter, tape squeal, and head wear, the oxide coating must contain a suitable amount of lubricant—usually a silicone. Yet it must not have too much lubricant, because this may cause the tape to slip or weave as it passes between the capstan and pressure roller, resulting in unsteady speed.

Abrupt starts and stops, and high-speed shuttling back and forth, subject the tape to sudden changes in tension that tend to break or stretch it. Hence the manufacturer is concerned with "break strength" and "yield strength," which express the pounds of force required to break the

tape or stretch it a given amount. If a tape stretches considerably before it breaks, the stretched section is no longer usable and must be cut out before splicing; in the case of a recorded tape the resultant deletion will be quite noticeable. But if a tape stretches only a little before breaking, the effect on the recorded sound is insignificant. Therefore the manufacturer of a premium tape concentrates on minimizing "permanent elongation."

The physical characteristics of a tape include its ability to withstand the ravages of time, temperature, and humidity. Will these factors deform the tape? Embrittle it? Cause the coating to flake? Lead to tape squeal? The answers depend substantially on the materials and manufacturing processes that have been used.

Whether the superiority of top-grade tape is perceptible and meaningful will depend partly on the user's tape machine and other audio components. A high-quality setup capable of revealing all the nuances of recorded sound will tend to benefit from superior tape and to show up the faults of inferior tape. An inexpensive system, with appreciable built-in noise, distortion, and treble loss of its own, will benefit to a lesser degree from superior tape.

The case for using better tape depends primarily upon the user and his standards. A perfectionist is unlikely to seek out bargain tape. He knows that high fidelity depends upon attention to many details in all parts of the recording and reproduction process. He will not jeopardize the ultimate result by neglecting any detail. If the user has a keen ear and good equipment, he will probably want the best in tape in order to avoid the degradation in performance that will result from using less than the best.

A slitting machine cuts the coated tape into the required widths.

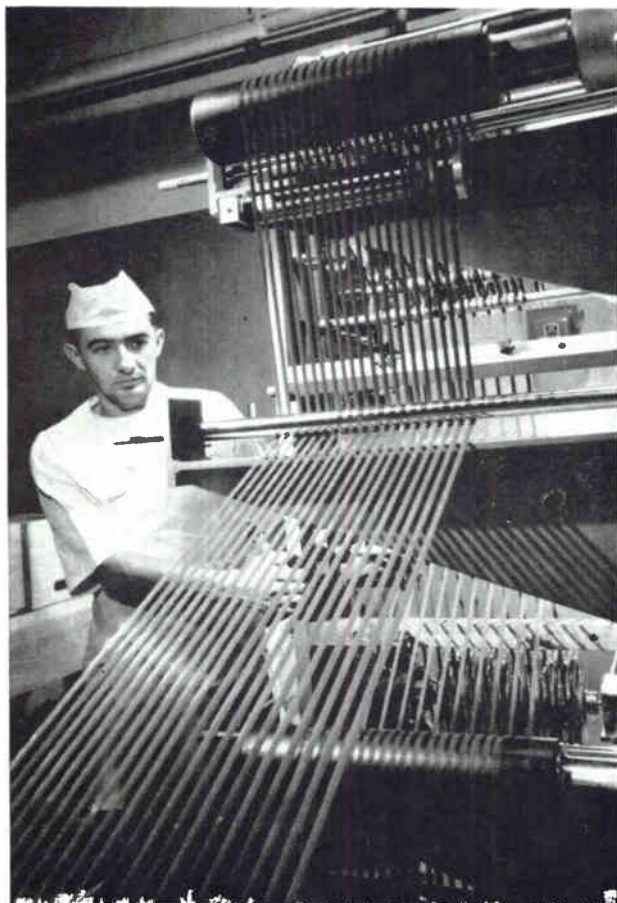

EASTMAN KODAK

Each tape must be inspected for physical and magnetic defects.

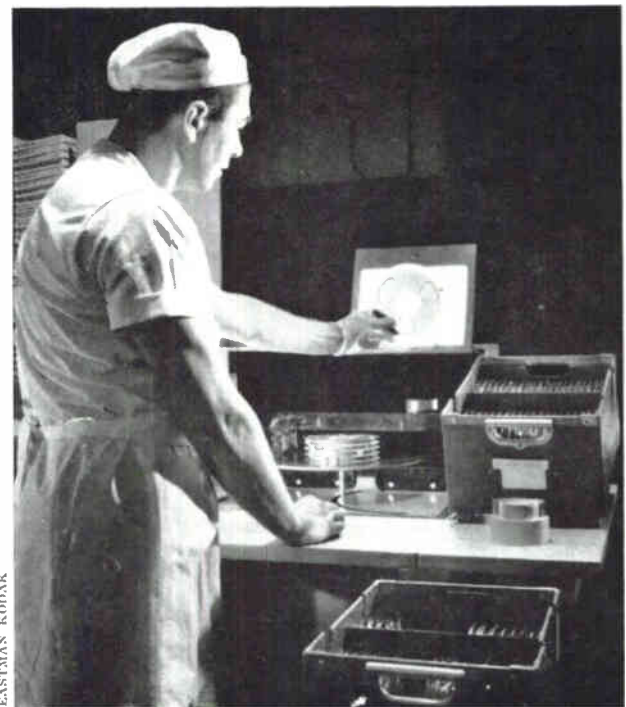

EASTMAN KODAK

WHAT YOU SHOULD KNOW ABOUT TAPE HEADS



A TAPE RECORDER'S PERFORMANCE CAN BE NO BETTER THAN THAT OF ITS TAPE HEADS. HERE ARE THE FACTS ABOUT A LITTLE-KNOWN BUT IMPORTANT SUBJECT.

By HERMAN BURSTEIN

ALTHOUGH tape heads are hardly larger than thimbles and have no moving parts, they are among the most expensive items in a high-quality tape recorder. Some heads cost as much as fifty dollars each, and the high prices of topnotch recorders reflect, in part, the expensiveness of the heads they use. An answer to the question of why high-quality tape heads are so expensive entails a discussion of how heads operate, of the differences among record, playback, and erase heads, and of the factors that spell superior performance for each.

A tape head can be considered an electromagnet—that is, it produces magnetic fields when electrical currents are passed through it. It consists of a roughly circular iron core with a coil of wire wound on it, as shown in Figure 1. This assembly is enclosed in a special type of metal housing that shields the coil, preventing it from picking up hum. The most critical section of the assembly is the gap—the break in the core at the point where the core meets the tape. In recording and erasing, a magnetic field generated by electrical currents flowing in the coil travels through the core, and through the tape, at the gap. In playback, magnetic fields from the tape enter the core at its gap and induce electrical currents in the coil.

Now let us consider each type of tape-recorder head in some detail.

The Record Head. A varying electrical current, which represents the audio signal to be recorded, is fed into the coil of the record head (see Figure 2). The magnetic field that is developed passes through the magnetic coating of the moving tape immediately adjacent to the core gap. The tape thus becomes magnetized in accordance with the fluctuations of the electrical audio signal that is applied

to the coil. The magnetic state of a given section of tape undergoes changes as it travels by the gap, but remains in the state of magnetization existing at the instant it leaves the trailing edge of the gap.

In addition to the audio-signal current, a high-frequency current called "bias" is simultaneously fed to the record head. The role of bias is something like that of a catalytic agent in a chemical reaction. The bias as such is not recorded, but it reduces distortion and increases the amount of signal that can be recorded on the tape. (Unfortunately, bias has an undesirable side effect, in that it causes some loss of high frequencies. The recently developed crossfield-head system, in which the bias is supplied through a separate head gap, is said to minimize or eliminate this effect.)

Because of differences in design and materials, record heads differ in the strengths of the magnetic fields they produce for a given amount of input signal. To produce a desired magnetic field, one head, for example, might require 1 milliamperes of bias current and 0.1 milliamperes of audio current. Another record head might require currents 10 times as great. Not only do the heads' requirements differ, but different tapes also require differing currents for optimum performance. The perfectionist will therefore want to adjust the amount of current fed to the record head of his recorder to suit the tape he customarily uses—although the improvement in performance is generally small.

The Playback Head. The signal recorded on the tape is in effect a series of bar magnets laid end to end, each with a north and a south pole. These "magnets" vary in length (determined by the frequency of the recorded sig-

nal) and strength (determined by the intensity of the original signal). During playback, the varying magnetic fields produced by these magnets when they travel by the playback head's gap induce a varying voltage in its coil. This voltage is the electrical counterpart of the magnetic signal on the tape. When the playback head's gap becomes too wide, and/or the tape speed too slow, treble loss results. The relationship of the gap width and tape speed to the high-frequency response (f) of the playback head is expressed by the formula $f = S/2G$ where S is tape speed in ips and G is the gap width in fractions of an inch. The formula tells us that a typical modern head with a gap width of 0.0001 inch (100 microinches) has a potential usable response to 35,000 cycles at $7\frac{1}{2}$ ips, 17,500 cycles at $3\frac{3}{4}$ ips, and about 8,000 cycles at $1\frac{7}{8}$ ips. Some heads have gaps as narrow as 40 microinches, permitting response to nearly 12,000 cycles at a speed of only $1\frac{5}{16}$ ips. The fact that these theoretical responses are not, in general, realized in practice is due to a number of factors, which were spelled out in detail in the article titled "The Long-Long-Playing Tape Recorder" in the March 1964 issue of *HIFI/STEREO REVIEW*.

The Erase Head. An erase head is designed to produce a relatively powerful alternating magnetic field that destroys any previous magnetic patterns on the tape. First the oxide particles are strongly magnetized in one polarity (north pole facing a given direction), then in the opposite direction, again in the first direction, and so forth. As the particles move away from the erase head, they go through many alternate magnetizations of diminishing strength, gradually trailing away to zero.

The high-frequency signal applied to the record head for bias purposes is nearly always used to energize the erase head as well. The frequency of the bias signal should be higher than 50,000 cps to avoid audible "beating" (in the form of squeals) between the bias frequency and

harmonics of the audio frequencies being recorded. For example, a bias frequency of 50,000 cycles and a strong audio harmonic of 45,000 cycles could produce a beat tone of 5,000 cycles. Unfortunately, erase heads grow less efficient as the bias frequency is increased, and an attempt to improve the performance of the record head by increasing the bias frequency may impair the performance of both heads.

MANY home tape-recorders use the same head for both recording and playback. This usually involves a compromise in performance, because the design requirements are somewhat different for a record and a playback head.

A playback head is designed to convert the magnetic flux in its gap (from the tape) into output voltage. To do this efficiently, and thereby to achieve a good signal-to-noise ratio, the coil must have many thousands of turns of wire. In technical terms, a high-impedance head is required. For the record head, on the other hand, fewer turns—and a lower impedance—are desirable. This is so that a moderate voltage can drive the requisite current through the head and thus develop a magnetic field of the necessary strength. If the same head is to be used for both recording and playback, a compromise impedance must be employed. Incidentally, the erase head is also a current-operated device, and its impedance should also be low for best results.

Another respect in which basic design requirements differ among the three heads is gap width. For high efficiency in recording, a relatively wide gap is desirable, because the magnetic field representing the signal tends to jump directly across a narrow gap rather than take an arc-shaped course through the tape. In other words, the narrower the gap, the less magnetic flux reaches the tape. A head designed solely for recording, therefore, will have a relatively wide gap, ranging from about 250 to 1,000

Figure 1 (left) is a cutaway sketch of the internal construction of a typical stereo tape head. Two independent sets of coils and cores are contained within a single shielding shell. Figure 2 (center) illustrates the process by which the recording tape is magnetized by the audio signal.

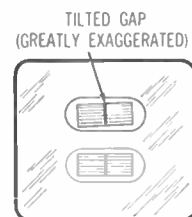
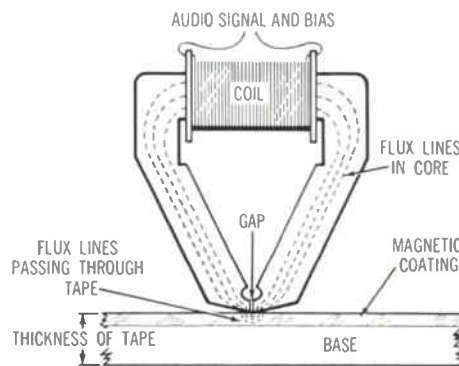
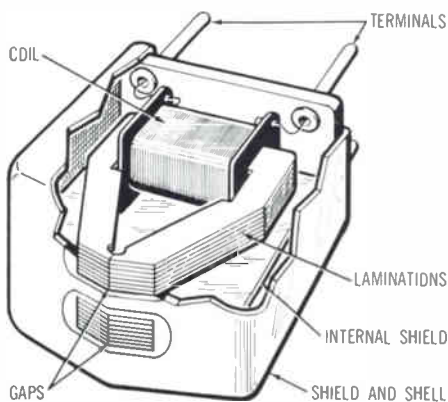

Figure 3 (above) depicts a stereo tape head with one of its two gaps misaligned. This will decrease high-frequency response of one channel.

TAPE HEADS



microinches. But if a head is intended for playback (or record-playback), it must have a gap of 100 microinches or less in order to reproduce high frequencies at tape speeds slower than $7\frac{1}{2}$ ips. On the other hand, if the playback or record-playback head is to be used only at speeds of $7\frac{1}{2}$ ips or faster, its gap can be increased to about 200 microinches for increased efficiency.

An erase head has a relatively wide gap in order to subject each section of tape to the erasing field for as long as possible. A 5,000-microinch gap is typical for an erase head.

Now let us examine some important aspects of tape-head performance, and see what design factors are involved.

Treble response. A playback head must have a narrow gap in order to provide good treble response at low tape speeds. In addition, the edges of the gap must be sharp, smooth, and parallel. Otherwise the gap, although physically narrow, will behave magnetically as though it were much wider. When the machine employs a tape-tension system instead of pressure pads, the shape of the face of the head becomes important, in that treble response is influenced by the closeness of the tape-to-head contact at the gap. Stereo heads pose the problem of gap colinearity, as illustrated in Figure 3. That is, the two gaps must be in exactly the same straight line, or the head cannot be adjusted for accurate azimuth alignment for both gaps. If the gaps are not colinear, treble response must suffer on one channel or the other—or else on both channels if a compromise azimuth adjustment is made.

Low distortion. Because tape magnetization is determined by the trailing edge of the record head's gap, this edge should be extremely straight and sharp. The record head should have a relatively wide gap to permit the lower frequencies to penetrate deeply into the tape's magnetic coating and thereby be recorded at minimum distortion. Use of a narrow-gap dual-function record-playback head for recording purposes may cause distortion at low frequencies. If the record head is poorly made and inefficient—because of the type of core material employed, an excessively narrow gap, or other factors—a large audio

current may be needed to drive it, and such a current is available only at the cost of increased distortion.

Signal-to-noise ratio. The amount of signal voltage generated by the playback head can be maximized not only by using a large number of turns of wire in the coil but also by using efficient magnetic material in the core. Output also depends on gap width: as the gap is made narrower, output decreases. For a given high-frequency response, a laminated-core head permits a wider gap and greater output. It is worth noting that there is nothing to gain and something to lose (signal-to-noise ratio) by using a playback head with a very narrow gap if the machine's slowest speed is $7\frac{1}{2}$ ips.

Hum pickup. The question of hum is part of the signal-to-noise problem, but it merits separate discussion because of its importance. The signal output of the playback head is extremely small and gets smaller as the frequency of the signal goes lower. Bass frequencies therefore require a great deal of boost in the playback amplifier. Any hum picked up by the playback head is also amplified and therefore likely to become annoying. High-quality playback heads are encased in a special metal housing that acts as a shield against hum sources, such as motors and transformers. Further protection against hum may be provided by shielding materials that are interposed between the head assembly and other parts of the machine. The construction of the playback head's coil and core also affects hum pickup.

Crosstalk. The signal in one section of a stereo head tends to leak through to the other section because of interaction between the two separate magnetic fields within the head. To minimize crosstalk, the maker of a high-quality head strives for maximum physical separation between the head sections (consistent with performance requirements), and uses shielding material not only in the casing of the head, but between the two sections, as shown in Figure 1.

Erase. Not all erase heads completely remove previous recordings from the tape. Low frequencies, which penetrate deeply into the tape's magnetic coating, are a particular problem. The effectiveness of the erase head's magnetic field depends in great part upon the head's core

This simplified drawing shows a full-track head before (left) and after (right) excessive wear has widened its critical gap.

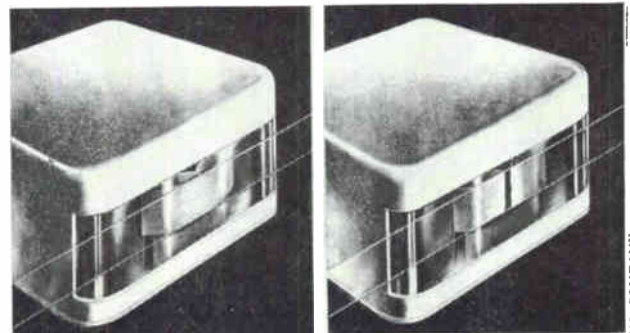

material. It also depends upon an optimum gap width—wide enough to permit the field to span and penetrate an appreciable portion of the tape coating, yet not so wide that the efficiency of the head is reduced. Some heads employ double-erase gaps, side by side, so that the tape is subjected to two erasing fields in succession.

Life expectancy. In addition to greater efficiency, laminated-core construction makes for increased head life because it permits a deeper gap. The deeper the gap, the greater the amount of wear that can be sustained before the gap widens and a new head is needed. A laminated-core head should wear approximately twice as long as a solid-core head.

HAVING examined what a designer does to maximize tape-head performance and life, let us see what steps the home recordist can take toward the same ends.

To maintain good treble response, the heads and pressure pads (if any) should be cleaned and the heads demagnetized after each eight to ten hours of use. The azimuth alignment should be checked perhaps once or twice a year, also in the interest of treble response. To insure long head life, the careful recordist should use tapes of good quality, since low-quality tapes may cause rapid head wear through abrasion. On this same point, avoid tape-to-head contact during fast rewind and fast forward. One manufacturer has noted that head life can be about doubled if the machine uses tape lifters during fast forward and rewind. If a machine has no lifters, the tape can usually be removed from the loading slot and wound directly from reel to reel.

Care must be exercised not to scratch the face of the head during cleaning or demagnetizing. It is a good idea to put cellophane tape around the part of the demagnetizer that contacts the heads. Similarly, precautions must be taken against subjecting the heads to strong external magnetic fields, to temperature extremes, and to mechanical shocks.

Ultimately, the head life a user can expect depends upon his choice of tape machine. The better machines are designed and finely adjusted to minimize head wear. Good mechanical adjustment, aside from influencing flutter, wow, and output, also has a contribution to make in the area of head life. Tape speed is another factor to be considered, in that one can expect more hours of head life for slow-speed operation than for fast-speed.

Except for a performance check by a competent technician with the proper instruments, there is no infallible guide as to when a head should be replaced. The number of hours of use is not a reliable guide because so much depends, as indicated above, on the specific transport mechanism and the tape used.

When the recorder is new, it is a good plan to tape a disc that has good high-frequency response—with cymbals, triangles, and so forth—and compare the tape repro-

duction with the original. Note the difference, if any, and whether the use of the treble tone controls on the amplifier can make the tape sound closer to the original. Note down the control settings and degree of correspondence. Assuming that the recording was made at the tape machine's highest speed (probably 7½ ips), where the fidelity is greatest, and that the treble response was originally satisfactory, the same A-B comparison a year or two later will reveal whether there has been a significant decline in treble response. If there has, the head or heads involved in recording and playback should be inspected for wear. There is, of course, the possibility that treble loss is due instead to dirt on the heads, magnetization of the heads, azimuth misalignment, a change in the bias current fed to the record head, or weak tubes.

One can judge the efficiency of the erase head by ear. Record something on the tape, erase it (by putting it through the record process again, but this time with no input signal), play the tape, and listen for any remaining signal. If the head once erased well and now doesn't, this should be apparent. But although it may appear that the erase head should be replaced, this is not necessarily so. Perhaps insufficient high-frequency current is being supplied to the erase head, because of the deterioration of some electronic component. Perhaps the erase head is mispositioned vertically, so that its gap fails to span the same portion of the tape as the gap of the record head.

In the case of a playback or record-playback head, the gap is ordinarily so fine as to be invisible to the unaided eye. If the gap is readily visible, the head is suspect. If the gap of a record or playback or erase head, when viewed through a magnifying lens, appears ragged rather

The author is grateful to the following people for their kind help in the preparation of this article: Mr. C. J. LeBel, of Audio Devices; Mr. Howard P. Ladd, of Concord Electronics; Mr. Thor Johnson, of the Nortronics Company; and Mr. James J. Cavin, of Thompson Ramo Wooldridge (Bell Sound).

than perfectly straight and sharp, the head is unlikely to perform well. Visual inspection should take into account the general appearance of the face of the head. If the face appears scored or otherwise greatly worn, it may be a candidate for replacement.

It is highly desirable that a replacement head be physically and electrically identical to the original head. Substantial circuit adjustments or changes may be necessary if the replacement head has different electrical characteristics. And even though the replacement is an identical unit, it is a good idea to have a technician check the bias and audio currents fed to the record head, and the high-frequency current fed to the erase head. Should the replacement not be an identical unit, it is *imperative* that these checks be made, followed by whatever circuit adjustments may be necessary.

There is at least one sound effect that can be regarded as truly fundamental—the sound of frying bacon. Take one saltcellar, a scrap of aluminum foil, and shake well.



HOW TO CREATE YOUR OWN SOUND EFFECTS

By Arthur Zuckerman

SOUND EFFECTS are a great deal easier to create than you might think. All you really need do is *suggest* a situation, and then your listener's powers of imagination will do the rest. Here are some ideas that will help you harness this power of audio suggestion.

One of the most basic sound effects is the sound of people walking. Not too surprisingly, a pair of feet will do the job neatly. But the trick is not to pick them up and put them down flatly. In true walking, the heel lands first, followed by instep and toe. So your "walking" must do the same. Leather-heeled shoes for men and high heels for women, marking time on a hardwood floor, are best. A man's tread should be relatively slow, while a woman's requires a quick, staccato pace. Judicious juggling of your recorder's level control will make the walker seem to be either entering or leaving the scene. But in bringing up or dropping the volume, be sure to keep your timing

consistent with the walking pace you have established.

If the walking is supposed to be on gravel, sand, or stone, the real thing can be brought right up to the microphone in a rug-lined tray about six inches deep. When a walk through snow or rain is in order, hands must stand in for feet. If a cornstarch-filled handkerchief is kneaded in walking rhythm, it will do a fine job of simulating someone plodding through snow. For the rain bit, wet a newspaper in a sink and press your hands against it in walking rhythm. The microphone should be covered with a handkerchief and held close to the sink.

If you want to do a story with an aquatic setting, there are a number of trick effects you can use. You can get off to a diving start with a small jar and a tub or bucket. Fill both the jar and the bucket with water, then submerge the jar in the bucket and up-end it. To create the splash of a dive, pull the jar sharply out of the water as



Seaside waves and surf action: baking tin, rice, and a swirl.

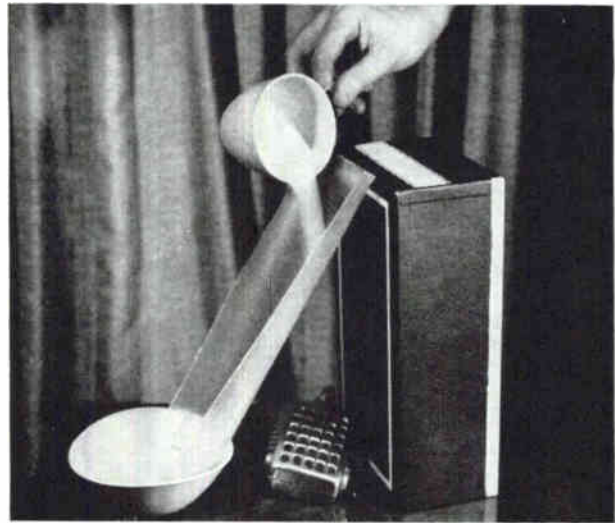

Rain: a box, a bowl, a cup of sugar, a wax-paper trough. Pour.

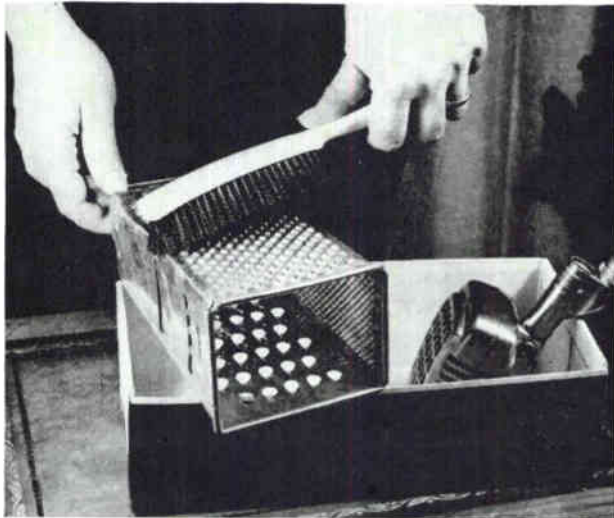

Steam locomotive: a shoe box, a vegetable grater, and a brush.

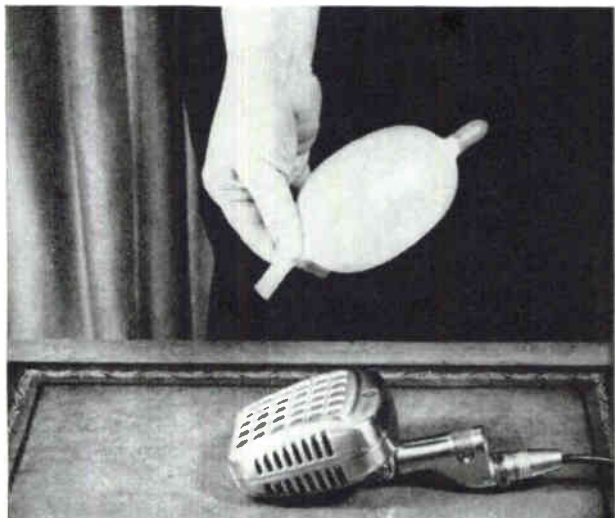

Wind: let the air from a toy balloon escape across the mike.

an assistant holds the microphone just above and to one side. From there on, you can make the diver appear to swim away by doing a bit of hand-splashing in the bucket. If you want him to sound like a hard kicker, hit the water flat-handedly. For the impression of a canoe or rowboat coming out to pick him up, paddle the water with a spatula, holding the microphone in close. And if you want to evoke the image of an outboard motorboat, a model-builder's miniature gasoline engine will do a dandy job.

You may want your characters to open and close a few doors. Again, the answer is the real thing. But watch your microphone placement. You want to avoid picking up the rush of displaced air as you swing the door open or shut. If the portal is supposed to be in a haunted house, a rope trick is in order. Tie a six-foot length of rope to something firm and run a resin-powdered cloth down its

length, squeezing it with your thumb and forefinger. You'll be rewarded with a chilling squeak.

In the event your story calls for a milking scene, try squirting a seltzer bottle into a bucket. If you add a tablespoonful of detergent as the bucket fills, you can create the impression of foam. And if you ever need the sound of frying bacon, you can get it simply by pouring salt from a shaker onto aluminum foil held right over the microphone.

Now let's turn our attention to the elements. Wind can be simulated by permitting air to escape gradually from a balloon held near the microphone. If you want a gale, play the tape back at double the recording speed. How about some thunder? Another balloon, loaded with a few BB shot, will serve. To produce a distant rumble, inflate the balloon and then swirl it around. To get the audio pyrotechnics up to a more spectacular level, try a

Create your own sound effects

single, hard upward shake. The inevitable rainy aftermath can be evoked very nicely with the help of a bowl, a cup, some wax paper, and a shoe box or similar carton. Place the carton on end, and curl the wax paper into a trough that terminates in the bowl. Tape the top of the trough to the top edge of the carton, and place your microphone beneath the trough. Now pour sugar out of the cup and down the trough. Varying the sugar flow will permit you to create anything from a drizzle to a dam-filling down-pour.

THE gurgle of a brook is a cinch if you equip yourself with a glass of water and a couple of straws. All you have to do is blow gently. Should you want the brook to become a river leading to the sea, you should introduce some wave and surf action. Try swirling some rice in a baking tin. A reduced-speed playback will simulate breakers.

Or perhaps you want a waterfall. You can create one in your sink with three or four bricks. Stack them beneath the faucet and spot a few stones around the pile. Water running off the bricks will splash about with realistic irregularity.

The sounds of transportation are often useful. A horse-opera has to have a horse, and an old rubber ball is the classic solution to the problem. Cut it in two and slap the halves against your chest in the desired trotting, cantering, or galloping gait. If it's an old locomotive you want to depict, gather together a shoe box, vegetable grater, and stiff brush. Tape the grater across the top of the box, and place the microphone inside the box. Now run the brush across the grater in choo-choo time. Your listeners will practically see smoke rising from an ancient stack. Want your train to whistle at a grade crossing? Partially fill a cider jug with water. When you're ready, blow across its mouth. You can adjust the pitch by altering the water level. This stunt can also be used to provide the sound of a steamship whistle.

If your story involves a nautical setting, a ship's bell is a must. Hit a medium-pitched bell with a wooden mallet or stick in a twin-beat rhythm. But don't strike more than eight beats if you want to sound authentic. One bell, incidentally, is added for each hour in nautical time-keeping, so you end with a single beat to depict an odd hour. Eight strokes of the ship's bell signify either 8 A.M., 4 P.M., or midnight.

To make the sound of an automobile horn blowing, many a small tin horn can be used effectively, especially

if its pitch is lowered by playing the tape back one speed slower than the one used in recording. Should the driver of the auto suddenly find it necessary to jam on the brakes, the sound can be approximated by running a nail smartly along a piece of glass, pressing down hard. The subsequent crash can be convincingly created by energetically smashing a couple of aluminum plates together.

When a door must be smashed in, a wooden berry box or some plywood strips can be shattered to provide the necessary realism. For more explosive effects, such as a bomb or a packet of dynamite doing its stuff, there's nothing like blowing up a paper bag and bursting it. Recording the burst at high speed and playing it back at low speed adds to the realism. The effect can be enhanced still further with the aid of a BB-loaded balloon, like the one used for thunder. After the big bang, shake the balloon rapidly and let the swirling shot come to rest gradually, to add a lingering quality to the blast.

Fire can be brought to aural life simply by crumpling cellophane near the microphone. A sharper cracking effect can be added by breaking matchsticks at the same time. If you want to enlarge the blaze, take a good-sized bunch of bamboo strips and twist it in your hands. And when the fire engines come on the scene, you can herald their arrival with the aid of an electric bike siren, plus some mallet strokes on a bicycle bell.

Perhaps you want the sound of gunshot. One fairly obvious way to get it is to use a cap pistol. You can also arrive at a pretty fair approximation by hitting a cardboard box with a wooden ruler. The microphone, in the latter case, should be in close.

KNIFINGS are best simulated by stabbing a knife into a head of cabbage while holding the microphone in close. Screaming, gurgling, or grunting are an important accompaniment for this particular effect. A blackjack requires casting a melon in the role of the victim. Give it a tap with a hammer or rolling pin, with the microphone close. Perhaps you'll settle for a fist fight. A rubber sponge is all you need. Hold it in one hand and smash your fist into it, with an accompaniment of appropriate grunts. Such violence results sooner or later in a falling body. Since collapsing on the floor can be a jarring experience, you'll find it more practical to use your arm as a stand-in. Without overdoing the force, slam your elbow on a table, then let your forearm swing down onto the table top.

Though sound effects can really bring a production to life, there is always the temptation to overdo them. Don't give in to it. Effects are scene-setters and highlighters. They should never be permitted to become scene-stealers. Use sound effects only as much as is necessary to suggest the desired picture, unless you want the recording to be a comedy hit—the production of which, incidentally, can be a lot of fun, too.



TIPS ON TAPING STEREO FM

By J. GORDON HOLT

MANY FM stations over the country are transmitting both live and recorded stereo broadcasts, and the expected increase in such broadcasts promises a sort of perpetual bonanza for the home stereo-tape recordist, who traditionally has had to depend largely on borrowed recordings for his source material.

If you are merely going to *listen* to a stereo broadcast, all you need is a stereo FM tuner or receiver (although we will refer to "tuners" throughout this article, almost every suggestion made also applies to stereo receivers). But if you are going to tape the same program, you may occasionally run into trouble. The trouble appears as a continuous background whistle or tone that is recorded along with the desired program. The reason for the interfering tone is a little complicated, but briefly, the story is this. Every stereo tuner or receiver generates or reproduces in its multiplex section a high-level 19-kc or 38-kc tone that serves to synchronize the stereo channels. If any of this tone mixes with the audio signal at the tuner's tape-output jacks, it can cause a continuous whistle to be recorded on the tape. This whistle is not the multiplex tone itself, but results from the interaction of the multiplex tone with the tape recorder's internal bias-oscillator tone. (The recorder's bias oscillator may be designed to operate anywhere in the 50- to 100-kc range.) Before stereo FM recording was common, recorder-oscillator fre-

quency was not a problem. Today, however, to make whistle-free recordings of stereo FM, the tuner must have good suppression of the 19-kc or 38-kc multiplex signal, the tape-recorder bias-oscillator frequency must be high enough (over 80 kc) that it doesn't interact with the multiplex signal, and/or the tape recorder must have multiplex filters in its input circuits. Any *one* of these factors can do the job, and almost all recent tape recorders and tuners will work together without problems. If you have an older-model stereo recorder or tuner and are encountering whistle problems, check with the manufacturer of the unit for suggestions.

High-quality off-the-air recordings are the result of following a number of rules. The once-popular technique of recording from a microphone in front of a loudspeaker is, of course, out of the question. The only correct way to record radio programs, in either stereo or mono, is by a direct electrical connection between the tuner and the tape recorder.

In most installations, the tuner will connect directly to the control amplifier (or preamplifier, if a separate stereo preamplifier and power amplifier are used) and the recorder will take its signals from the amplifier's tape-output jacks. To achieve a consistent right and left channel on your tapes, it is a good idea to color-code (with matching dots of nail polish) the amplifier's right- and left-channel

RECORDING TIMES AND TAPE LENGTHS			
Tape length, feet	Recording time (for single pass in one direction, mono or stereo)		
	1 7/8 ips	3 3/4 ips	7 1/2 ips
150	16 min	8 min	4 min
300	32 min	16 min	8 min
400	42 min	21 min	10 1/2 min
600	1 hr 4 min	32 min	16 min
900	1 hr 36 min	48 min	24 min
1200	2 hr 8 min	1 hr 4 min	32 min
1250	2 hr 12 min	1 hr 6 min	33 min
1500	2 hr 40 min	1 hr 20 min	40 min
1800	3 hr 12 min	1 hr 36 min	48 min
2400	4 hr 16 min	2 hr 8 min	1 hr 4 min
2500	4 hr 24 min	2 hr 12 min	1 hr 6 min
3000	5 hr 20 min	2 hr 40 min	1 hr 20 min
3600	6 hr 24 min	3 hr 12 min	1 hr 36 min

output jacks to match the recorder's right and left input jacks.

To an off-the-air recordist, the fact that the playing time of a four-track stereo tape can be doubled by switching the reels and recording in the other direction is not too important—unless, of course, he has one of the new recorders that will record in both directions without reel switching. With a non-reversing machine it is important to know how long the tape will run without interruption, because broadcasters won't stop the music to let you flip the reels. To estimate the playing time of a musical composition, look it up in the Schwann record catalog and figure a maximum of thirty minutes per 12-inch disc side. Some stations note the exact playing time of each selection in their program booklets, but if the information is not available, you may be able to estimate the length of an unfamiliar work by taking the total time scheduled for the concert and subtracting the approximate length of the more familiar selections. The most convenient approach, however, is to obtain a copy of *Timetable for Classical Repertoire*, a booklet that lists the playing times of over 2,000 compositions. It is available from the Audio Exchange, 203 Mamaroneck Ave., White Plains, N. Y., at \$2.75 postpaid.

If it is evident that you can't fit the whole program on one reel, plan to change reels during a pause between movements. These pauses, particularly in live concerts, will usually be long enough to permit a quick change. Have the fresh tape pre-threaded onto an extra takeup reel; then all you have to do is lift off the reels that are on the recorder, drop the fresh ones on, guide the tape into its travel path, and start the recorder running again. With a little practice, you should be able to complete a reel change in less than five seconds. Use the same brand of

tape for these quick changes or you may find that there is an audible change in frequency response or signal level between reels.

Always load up with more tape than you think you will need. It is easy enough to clip off the blank excess later and use it for something else, but if your tape runs out before the end of the program, nothing can be done about it. You can use thinner tape to give you up to three times the capacity of a reel of standard-play tape. The playing-time chart (left) makes it possible to estimate the amount of "one-direction" recording time you can get from a variety of standard tape lengths.

If the program you want to record starts at 8:30, you'd better be on the job by ten past eight. Turn on all your equipment to give it time to warm up and stabilize. Station tuning is quite critical for optimum stereo reception, so tune carefully. During the warmup, use the preceding broadcast for setting the proper recording level and checking the balance between channels. By the time the clock creeps around to 8:28, everything should be warmed up; then check the tuner one last time for on-the-nose tuning.

Once the program is under way, keep an eye on the record-level indicators. If they seem a bit low or high, resist the temptation to make adjustments for a while, because the station engineer may correct the level at the studio. If level adjustments must be made, though, make them very gradually, and try to follow the expressive contours of the music. For instance, if you must raise the level, wait for a crescendo and then slowly turn up the control along with the swell of music. Remember that the best-engineered recordings are those that show the least evidence of technical tampering.

When the music finishes, let the announcer start talking before shutting off the recorder. This avoids the possibility of shearing off the tail end of the hall reverberation. One exception to this rule is the case of the live-performance broadcast, in which the dying echoes of the last note are often inextricably merged with a rising surge of applause while the announcer's voice comes in simultaneously. In such a case there is no moment of silence, no clean break in continuity to serve as a convenient place for a cut-off. The best way to handle this is to allow a few seconds of the applause to come through at normal volume and then fade out both channels together, reaching zero volume, if you can, before the announcer's voice comes on.

After your recording session is over and you have made some prize tapes, what can you use them for? As far as the law is concerned, you can use them for anything you see fit, as long as you do not (1) play them before a public gathering, (2) charge admission to listen to them, or (3) copy them for resale purposes. It isn't illegal to record radio programs, but if a musician's union or a record company caught you using their creations to make money, you would most certainly be sued, and you would probably lose the case.

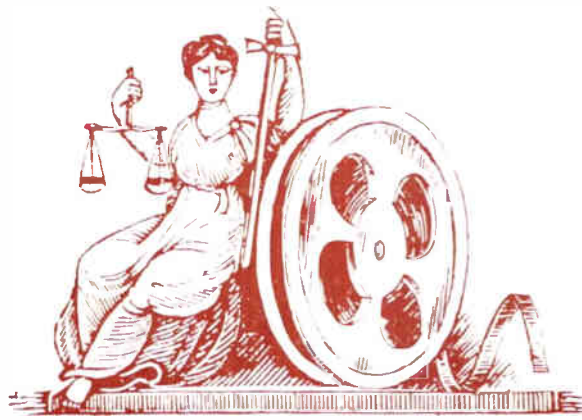

TAPE RECORDING AND THE LAW

By JOHN KOSHEL, JR.

EQUIPPED with a tape recorder and a sufficient supply of tape, the amateur recordist can capture the universe of sound and preserve its myriad fascinations indefinitely. He can tape party hi-jinks, vocal awakenings of his child, or the cacophony of exotic market places.

The tape recorder can capture for repeated playing those radio programs that give great enjoyment, but which, until recently, would vanish with the moment. He can tape live performances that may not be available on commercial records in stores, or he may copy records on tape to preserve the pristine quality of the discs, to make up interesting programs, and to save storage space.

These functions and uses of the tape recorder are taken for granted by the owner of the machine, and apparently by its producer and vendor. Such functions are superficially innocent enough, being indulged in for pleasure, convenience and economy. Yet beneath this tranquil appearance may lie a maze of legal ramifications, since the recordist has actually utilized the creative efforts of many different sources in achieving his end product. There is the subject matter of a performance such as a song or concerto, the unique performance of the artist, the production of the disc recording, the broadcast of the pro-

gram. May all of these be utilized freely and without concern by the tape recordist?

Actually, the strict letter of the law places restrictions on such uses. As a practical matter, however, in spite of the inherent and literal legal violations which may be involved in many activities of the average recordist, the law is rarely applied against a non-commercial amateur. As a matter of everyday practice, what you do in your own home with no other people involved is still pretty much your own affair. However, the moment you acts assume a public nature, and others, particularly those outside your immediate family, come into the picture, so too can the law, for it is the business of that "jealous mistress" to protect the interests of individuals with relation to the public insofar as it pertains to unwarranted invasion of privacy, the ownership of rights in intellectual creations, and the public distribution of artistic performances and productions.

It therefore would be wise for the recordist to bear certain legal points in mind while pursuing his avocation. His hobby can and should be fun, and free of legal entanglements. If he is guided by the following summary, he'll be that much surer of keeping it so.

IF YOU

- A. record yourself, friends, parties, or famous personalities (in person)
- B. copy phonograph records either directly or off the air
- C. tape programs off the air
- D. tape live performances—

DO NOT

sell or distribute your recordings *unless* you obtain

permission to do so from the following, wherever applicable:

1. the persons involved
2. the performer(s) and person, company or agency to which he may be under an exclusive service contract
3. the copyright owner of the subject matter of the performance, if it is a work protected by copyright
4. the program's broadcaster and producer
5. the manufacturer of the record.

The Secrets —and Joys— of Recording Children

TO CAPTURE THOSE FLEETING, MAGICAL MOMENTS OF CHILDHOOD,
SPECIAL RECORDING TECHNIQUES MUST BE CALLED INTO PLAY

by Byron G. Wels

IN MY capacity as a writer and editor, I use a tape recorder for interviews. In my other capacity, that of father of three children, I frequently use a recorder to preserve the voices of my children as they grow toward adulthood. Thus, in the preparation of this article, I have drawn mostly on my own experiences. But I have also received the advice of some professionals in the recording field—the best-known of these being Allen Funt. Mr. Funt is, of course, the creator of the television program called *Candid Camera*, and his specialty is capturing the wonder and wisdom of childhood on film and tape.

When preparing to tape-record children, the first thing to decide is where to put the microphone. There are two schools of thought here. Mr. Funt, representing one school, advocates the use of a concealed microphone, so that the child doesn't know he is being recorded, and is therefore unself-conscious. It has been my experience, however, that a concealed-microphone interview is very tricky to arrange in the typical household. Every family has a routine the children are familiar with, and any departure from it will arouse suspicion. If the children usually do their lessons, or play, or watch television after

dinner, they will know something's afoot if they are suddenly called to the living room and asked a series of questions. Because of this, I have been led to use an exposed microphone (which greatly simplifies the equipment setup), and to explain to the child that we are going to make a recording.

But regardless of whether the microphone is concealed or out in plain view, you will want a long microphone cable. Most tape-recorder microphones come with only about six feet of cable, and this is not long enough for any kind of recording flexibility. You can purchase a ready-made extension cable, you can have one made up for you by a television repairman, or you can make your own. If you wire your own, note that if the microphone has a built-in switch, you may need a cable that has two or more conducting wires in addition to its braided-metal shield. The appropriate cable and connectors can be purchased at any large radio-parts store. The wires in the cable are color-coded, so as long as your extension cable connects the same color of wire to the same pin number on the connectors at each end of the cable, you can't go wrong.

If you decide to use a concealed microphone, *how* you



Some friends of "Candid Camera" man Allen Funt are more relaxed when the mike is hidden—here, it is in a toy train's smokestack.

conceal it will depend on the recording situation and the type of microphone you are using. A simple way of concealing the microphone is to place it inside a familiar object in the room—perhaps in a basket of fruit, or a magazine rack. This is assuming, of course, that a small microphone is used. Larger microphones can also be employed, but disguising them takes a bit more in the way of ingenuity. However, with some paper and some ribbon and wool, you can transform almost any microphone into a toy or a puppet. Examples are shown in the accompanying photographs. Whatever the disguise, be sure that the microphone is sensitive enough to pick up the voices without your having to turn up the tape recorder's volume control so high that hum and noise become obtrusive. Also, when hiding the microphone in something, make certain the sound can get through to the microphone. A piece of porous cloth will pass sound well enough for most purposes. In all cases, of course, you should test out the system thoroughly before putting it to use.

Another very satisfactory technique is to use a wireless microphone, such as the Amphenol (\$49.50), Kinematix (\$50), or Cadre C-50 (\$45). These units, in spite of their

small size (same as a pack of cigarettes) are combination microphones and FM transmitters. They pick up the sound and broadcast it to your FM tuner—which can be several rooms away—without wires. From there, the signal can be fed to your tape recorder.

One of Allen Funt's favorite devices for concealing a microphone is a small toy train. Its smokestack is a disguised miniature microphone. Should the child reach for the train, Mr. Funt reaches for it also, in a natural way. It stays put. My own attempts at hiding microphones have not always been rousing successes, as suggested earlier. On one occasion, I prepared an elaborate scheme to tape-record my young son. I hid one of the Kinematix units in the zip-up stomach pocket of a Teddy bear, and carefully set up everything in the living room. During dinner, we had some family discussions about the importance of "serious conversations," and after dinner, while Mommy did the dishes, my son and I retired to the living room for some "serious talk." Right off the bat, my son spotted the Teddy bear—and dutifully picked it up and carried it back to his bedroom, where it belonged. Then he returned to the living room, saying, "Let's talk!"

(Continued overleaf)

Many potentially fine recordings of children are spoiled by inadequate advance preparation. At a crucial point someone enters the room, or a car passes outside, or the telephone rings. Fortunately, these factors are fairly easy to control. All that is necessary is to close the windows and doors in advance, and put up a sign reading, "Recording in progress—do not disturb." As for the telephone, just lift the receiver off its cradle. Any important callers are sure to try again.

Aside from preparing your recording setup thoroughly, the main secret of recording children is to use plenty of tape. Allen Funt tells me he exposes over forty thousand feet of film for each half-hour show. Then he selects and uses the best. By the same token, you should expect that only about one third of what you record will be worth saving. But don't forget that you can erase and re-use the dull sections of the tape for making other recordings. I am assuming, of course, that you are handy enough with a tape splicer to edit the tapes, separating the good parts from the dull ones. (Incidentally, if you plan to do even simple splicing, you must record *only* in one direction. Otherwise, the tapes will be impossible to splice.)

People quite often develop an interest in tape recorders soon after they have had their first child. They want to preserve the sounds their baby is making, or perhaps send a recording to a doting but distant grandparent. But babies are far from being easy subjects to record. In fact, for a recordist, babies are notoriously uncooperative—if not innately perverse. You can sit there holding the microphone in front of them, tape running out, and they calmly drop off to sleep. At best, you will

get a series of coos and gurgles, and if you are really lucky, an occasional noise that can be interpreted as a "mamma" or "dadda." The parents, meanwhile, are doing all they can to make the baby "talk." What you usually get on tape as a result of this is some pretty awful stuff from the parents and very little, if anything, from the baby.

THE first thing to do, therefore, is get the parents out of the room. Then, using a piece of string, suspend the microphone between the sides of the crib so it hangs down over the baby. It might be well to do some microphone-camouflaging at this point, for many an infant has been known to stare by the hour at a shiny microphone without emitting a peep. You might get things going by tickling the baby's foot. Most infants will react with a chuckle or two. Repeat the tickling when necessary. After you have enough happy sounds, apply a gentle pinch where it will do the most good, and you will get a high-fidelity howl. Obviously, it is best not to have the parents present at this stage.

Preschool children are a special joy to work with. A child's world is full of wonder. How does the milkman know how much milk to leave? Why does water turn to ice in the refrigerator? What makes the toast pop up? It's a wonderful, wonderful world.

Preschool children are often shy, but once you bring them out of their shells, they'll talk on almost any topic, and at length. Allen Funt has a sure-fire way of warming them up. He simply asks the child to blow out a match. When the child blows out the match, he also blows away his inhibitions. And by praising the child for a job well-

One way to get better recordings of preschool children is to disguise the microphones—perhaps making them look like toys or puppets.



MICROPHONES AND MICROPHONING

SPECIAL consideration should be given to the microphones and microphoning techniques used when recording children. The type of microphone used will determine, to some extent, the amount of background noise heard on the tape. When using an omnidirectional microphone (most microphones supplied with tape recorders are omnidirectional), best results—in terms of background noise—will be obtained when the subject is from one to three feet from the microphone. A directional or cardioid-pickup microphone, which has a rather narrow sensitivity pattern, makes it easier to record at a distance, but may make it difficult to pick up both sides of an interview.

Some radio-parts companies offer relatively inexpensive "spy" microphones that look like tie clips or wrist watches. Although these are convenient to use, their limited frequency response may result in an unnatural voice quality, or their output voltage may not be high enough for your recorder. This type of microphone should therefore be purchased only with a money-back guarantee. Also listed in radio-parts catalogs are a number of inexpensive crystal microphone elements and lapel microphones that are useful for unobtrusive microphoning. For example, Lafayette Radio lists a high-output 1 $\frac{3}{8}$ -inch-diameter lapel microphone (Number 99R-1510) for \$1.95.

The most obvious place to record a child—the child's own playroom—is unfortunately one of the worst possible recording locations. A child usually will not stay quietly seated and "on mike" when he is in his own room, and the typical playroom—with its hard floors and unpadded furniture—has terrible acoustics. For this reason, it is best to record in a living room or a bedroom, where drapes, rugs, and upholstered furniture will absorb echoes.

done, you can put yourself on his side. Don't be afraid, incidentally, to argue with a child while making a recording. Go ahead, but do it in such a way that you can edit your voice out of the tape later. And don't settle for "yes" or "no" answers, either. Keep things moving with a "How come?" or "Why?"

Little girls are very clothes-conscious, and a comment about a little girl's dress is almost guaranteed to start her talking. Allen Funt sometimes asks a little girl what books she has read lately, and then acts out a playlet with himself as the hero and the child as the heroine. Remember that in tape-recording children, all is fair. You can even tell a white lie if it will help. For example, I was recently asked to record a youngster who had a curiously deep, gravelly voice. Unfortunately, whenever the tape recorder was turned on the kid would clam up. Finally, I told the child there was a man in the microphone (whose name was, of course, Mike), and that he might be induced

to come out and play. What followed was threats, cajolery, coaxing—anything to get Mike to come out—and the result was a beautiful tape that delineated the child's personality better than any photograph could.

When it comes to recording school-age children, I agree with Allen Funt about concealing the microphone and tape recorder. Most of today's kids are pretty sharp. If you give them an inkling they are being taped, they'll be "on" in no time flat. But you will have to hide the microphone carefully, and then be sure to stay within its pickup range. (Incidentally, Kinematix has available a gadget that adjusts the recording volume automatically—this should be useful in recording children of any age.)

Try engaging a child in a serious conversation. Almost all youngsters know what they want to be when they grow up. Little girls want to be nurses, or ballet dancers, or perhaps just mothers; and little boys run the gamut from policeman to doctor to garbage man and back again. Be sure to ask them why they've chosen a particular occupation. Sometimes you will get some startling answers. Allen Funt, for example, once asked a little boy why he wanted to be a doctor, expecting some noble reply. The answer was, "Because doctors kin stick needles in people."

You'll find that you can do marvelous things with a child and a tape recorder. You will capture irreplaceable moments that would otherwise be lost forever. At the very least you will get new insights into the way children think. And if you are lucky, children may show you the way into their magic world, and you will rediscover, through their eyes, the special wonders that surround them. It will be the greatest discovery of your life. It was for me.

The Kinematix Imp II/M-222 (left) and Cadre C-50 (right) wireless microphones are readily concealable in a cigarette pack.



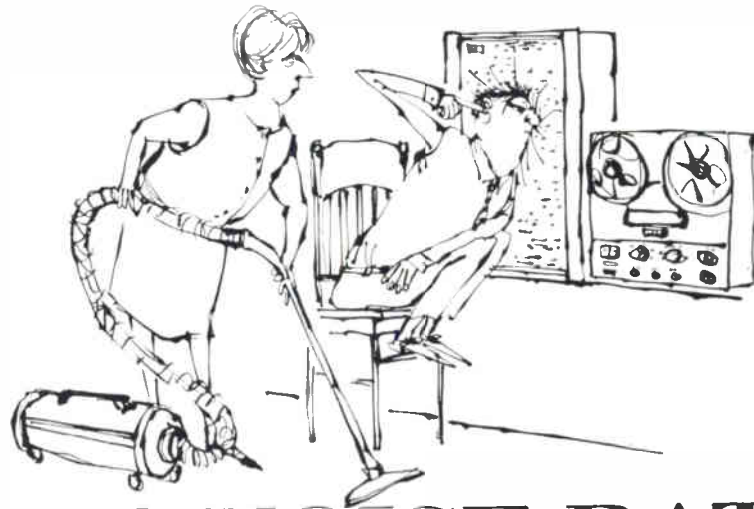

SIGNAL-TO-NOISE RATIO IN TAPE RECORDERS

IS THE RECORDER YOU PLAN TO BUY SUFFICIENTLY FREE OF HUM AND HISS?
HERE ARE SOME SIMPLE CHECKS YOU CAN MAKE IN THE STORE.

By **HERMAN BURSTEIN**

HIGH-FIDELITY buffs are usually far more concerned with a component's frequency response, distortion, or power output than with its noise level. Nonetheless, noise—or, more properly, the absence of it—is an important factor in high fidelity. The signal-to-noise ratio (abbreviated S/N) indicates how the strength of the desired audio signal compares with that of the noise. "Noise" includes hum, hiss, sputter—in fact, any undesired signal—originating either in the amplifying or reproducing equipment.

Noise problems beset all high-fidelity components (and all electronic equipment, for that matter), but they are particularly troublesome in tape recorders. Possibly because of this, S/N specifications of tape recorders are frequently confusing, and sometimes are not given at all.

Noise arises in tape recorders from several causes. To begin with, the maximum output voltage of a tape-recorder head is minute—about one-quarter of that produced by the usual magnetic phono cartridge. This is important because, since all amplifiers either pick up or produce noise, the smaller the input signal, the more likely it is to be overshadowed by noise during playback. And with every reduction in track width (as we have gone from full-track to half-track to quarter-track recording), the head puts out less signal, and the ratio between signal strength and tape-recorder noise level decreases.

Another difficulty results from bass compensation. The signal coming out of a recorder's playback head—like that from magnetic phono cartridges—requires frequency compensation in the form of bass boost. This inevitably and unfortunately accentuates hum. As a matter of fact, at 60 cycles—the frequency at which hum is most commonly troublesome—the NAB 7½-ips tape playback

curve calls for more than twice as much boost as the RIAA disc playback curve.

In addition to the internal noises that trouble all electronic equipment, tape recorders must further contend with noise caused by the bias oscillator. (Bias is the high-frequency signal fed to the record head along with the audio signal in order to lower distortion and improve dynamic range.) Unless the bias waveform is completely symmetrical, high-frequency noise is registered on the tape along with the recorded signal. Also falling into the category of noise are the traces of signal left on the tape by an imperfect erase head.

All of this helps explain why a half-track tape recorder with an S/N of 55 db is considered excellent, even though a 55-db S/N is not particularly remarkable in an electronic component, such as a power amplifier. And if a tape recorder can achieve S/N of over 50 db on a quarter-track (rather than a half-track) basis, this is indeed cause for rejoicing. More commonly, at 7½ ips, quarter-track home tape recorders will have an S/N ranging from 45 to 50 db, which is usually satisfactory.

How does one check S/N? A 400-cps sine-wave test signal is recorded on a tape at a level that produces 3 per cent harmonic distortion of the signal. (On musical material, peak signals generally occur around 400 cycles, and experience has shown that a recording is essentially distortion-free if peak signals do not exceed about 3 per cent harmonic distortion.) The tape is played back, and the amount of 400-cps signal recorded on the tape is measured. The same length of tape is again put through the recording process, but this time with no input signal. The "blank" tape is then played back, and its output level is measured once more. Whatever output there is consists

of hum and hiss produced by the record and playback amplifiers, noise caused by the bias waveform, and imperfectly erased remnants of the previously recorded 400-cps test signal. The ratio of the first measurement to the second, expressed in decibels, is the signal-to-noise ratio.

The above discussion is based on the accepted method of measuring S/N, and is the one used by leading tape-recorder manufacturers. Other methods are also used, and an explanation of these other methods, and how to convert the resultant S/N specifications to the standard, are given in the accompanying box. Unfortunately, in a shopping situation this information may be of slight help. You may find that there are no specifications available, or that what specifications there are appear to have been produced in the manufacturer's advertising department, rather than in the laboratory.

Here, then, are some in-store tests you can make that in all cases should outrank the specification sheets in importance.

Using fresh or bulk-erased tape, set up the machine to record your voice. Use either the recorder's microphone or a standard good-quality unit, and adjust the recording gain appropriately. Usually this will mean that the recording-level indicator will just reach the overload point on the loudest peaks. Record your voice for about a minute, then unplug the microphone (without readjusting any of the controls) and allow the machine to run

for another thirty seconds or so before shutting it off.

Next rewind the tape and play it back through high-quality equipment, adjusting the recorder's playback volume control until your voice is reproduced at lifelike volume. At this volume level, hum and hiss should be barely audible in comparison to your voice. Let the tape proceed to the thirty-second unrecorded portion. If the noise level now drops even further, this indicates that much of the noise originated in the recording room and is not the fault of the recorder.

Now, stop the tape (with the pause control, if one is present), but otherwise leave the machine in the playback mode. Turn up the volume control almost to the maximum, and note the noise level. Now restart the tape. There should be a perceptible increase in noise. This noise comes from the tape, rather than from the machine. If there is no increase in noise when the tape starts running, this suggests that the tape machine is producing excessive noise—so much that the noise from the recorder is masking the normal slight hiss from the tape.

Another test is to record a stereo record on tape, and then play back the original disc and the taped copy simultaneously. Switch back and forth between the two, and listen for how much more hum and hiss is on the taped version than on the original record. The very best recorders will add only a very small—sometimes unnoticeable—amount of noise to the recorded program.

CONVERTING SIGNAL-TO-NOISE SPECIFICATIONS

THERE are a number of ways of specifying S/N in addition to the generally accepted way described in the accompanying article. Sometimes the reference tone on the tape (usually 400 cycles but occasionally 250, 700, or 1,000 cps) is recorded at a 1, 2, or 5 per cent harmonic-distortion level—or is even the maximum signal that can be put on the tape (tape saturation). The reference tone may also be 6 db below saturation or 12 db below saturation.

Fairly often the reference level is described as "0 VU" or, synonymously, as being "at operating level." This applies to machines with VU meters, and means that the reference level is that which drives the VU meter to the 0 mark when recording. Or the reference level may be stated as -10 VU, which is simply 10 db lower than the 0-VU point.

The S/N is occasionally determined on the basis of "a reference tape" or, more explicitly, on the basis of "a reference tone at standard operating level." This refers to a test tape that contains a recorded test tone with which the machine's noise level can be compared.

Various S/N specifications can be compared by converting them to the standard specifications based on 3 per cent harmonic distortion. For example:

Reference tone at 1 per cent harmonic distortion: Add 6 to 8 db. For example, if S/N is rated at 48 db based on a reference tone at 1 per cent distortion, the rating becomes about 54 to 56 db based on 3 per cent distortion.

Reference tone at 2 per cent harmonic distortion: Add 3 to 4 db to the S/N specification.

Reference tone at 5 per cent harmonic distortion: Subtract about 6 db from the S/N specification.

Reference tone at tape saturation: Subtract about 8 db from the S/N rating.

Reference tone 6 db below tape saturation: This is roughly equivalent to S/N based on 3 per cent distortion. But to be on the safe side, subtract about 2 db from the S/N specification given.

Reference tone at 0 VU (or at operating level): Find out from the recorder's specifications or from the manufacturer how much distortion occurs when recording a 400-cps signal at a VU-meter level of 0. If 0 VU corresponds to 1 per cent distortion, add 6 to 8 db to the S/N specification. If 0 VU corresponds to 2 per cent distortion, add 3 to 4 db. If 0 VU corresponds to 3 per cent distortion, add nothing.

Reference tone at -10 VU: First add 10 db to the S/N specification. Then follow the procedure for the reference tone at 0 VU. For example, assume the S/N rating is 35 db relative to -10 VU, and the machine's specifications state that recording a 400-cycle signal at 0 VU results in 1 per cent harmonic distortion. Adding 10 db brings the S/N rating up to 45 db. Adding another 6 to 8 db (because 0 VU denotes 1 per cent rather than 3 per cent distortion) results in S/N of 51 to 53 db.

S/N based on "reference tape" or "reference tone at standard operating level": Generally the test tone referred to is at 1 per cent harmonic distortion. For example, Ampex test tape 31325-01, for use at 7½ ips, contains a 700-cycle "reference tone at operating level" having 1 per cent distortion. Accordingly, add 6 to 8 db to the S/N specification.

No reference given: Write to the manufacturer and ask for the references on which S/N specification is based.

How to select a **PORTABLE RECORDER**

A DECADE ago, battery recorders were a rarity; they were used mainly by radio reporters and by explorers and scientists whose work took them to remote places. During the last few years, however, they have become immensely popular. At present, they are available (at prices ranging from around \$25 to \$1,000 and more) in a multitude of makes and designs.

In selecting one that will suit your needs, you should consider the following factors:

Weight and size. There's as wide a range in these as there is in quality and price. You can buy a 1½-pound variable-speed recorder that just about fits in your palm, or a 12-pound precision instrument that can record tapes of broadcast quality—and which seems to get heavier with every step you take.

Reel capacity. The majority of battery-operated units take 3-inch reels. These reels hold 150 feet of standard 1½-mil tape, providing 7½ minutes of recording time on each of the two tracks at 3¾ ips. If more playing time is required, select a unit that accommodates 5-inch reels (600 feet, 30 minutes per track at 3¾ ips). Such units are usually considerably heavier than most machines with smaller capacity. You can up the running time per reel of any tape recorder 50 per cent by using thinner

extended-play tape; 100 per cent with double-play tape; 200 per cent with the latest triple-play type. Movie-makers seeking lip-synchronization, even of brief scenes, would do better by sticking with 1½-mil polyester tape; it is less prone to stretching and breaking.

Some recorders load with cartridges instead of tape. Such cartridges are relatively expensive, and the tape cannot be easily removed from them for editing, as a general rule.

Accessibility of controls. Convenience of operation is as important in a battery-operated tape recorder as in a camera. After all, it should be designed for use in the field. A mechanism that is clumsy to run does not help you get the "shots" you want. Certainly you should be able to start and stop the recorder, and to adjust the recording volume, without having to open its lid. Some recorders feature automatic volume control, paralleling the electric eye in cameras.

Power source. Tape recorders differ in the number and size of batteries they use. Most models take AA or "penlight" cells, C- or D-size batteries, or a combination of them. This has direct bearing on the cost of operation. AA cells are most compact, but also store comparatively little electricity; D cells cost very little more and have a much



Battery-operated recorders for use in the field are priced from under \$25 to over \$1,000 —here's what you should know before choosing one

By HARVEY V. FONDILLER

longer life—however, they are also considerably heavier and larger. The C cells fit in somewhere between these two.

Beyond size, batteries also differ in their construction: there are the well-known zinc-carbon kind of flashlight fame; the longer-lasting alkaline type; and the new mercury cells, with maximum life. All of these are available in AA, C and D, as well as other sizes. Many tape recorders permit zinc-carbon, alkaline, and mercury cells to be used interchangeably. Some units also take rechargeable batteries; an auxiliary charger may then be required. The latter, as a rule, also adapts the recorder for operation on line current.

Hint to world travelers: it's more practical to carry a spare set of replaceable batteries than to bother with the rechargeable type. You'll save on weight—and anyhow, the charger might not operate on foreign voltages.

Certain recorders can be connected to the storage battery of a car or motorboat.

Tape speed. Most battery-powered recorders can operate at two speeds. The combination of $1\frac{7}{8}$ and $3\frac{3}{4}$ ips is popular, as well as that of $3\frac{3}{4}$ and $7\frac{1}{2}$ ips. Other units provide three or even four speeds, ranging from $15/16$ ips to 15 ips. A few recorders designed for dictation operate at $15/16$ ips.

A speed of at least $3\frac{3}{4}$ ips (and preferably $7\frac{1}{2}$ ips) is required for making tapes of music. To meet broadcast standards, tapes must be recorded at $7\frac{1}{2}$ or 15 ips.

The over-all frequency response improves as tape speed increases. Hence, optimum results are obtained when recordings are made at the maximum possible tape speed. The limiting factor, of course, is the capacity of the reel. A 3-inch reel of double-play tape, recorded on one track at $3\frac{3}{4}$ ips, lasts 15 minutes. The same reel provides only $7\frac{1}{2}$ minutes of recording time at $7\frac{1}{2}$ ips.

Microphone. The quality of a microphone is determined primarily by the range and flatness of its frequency response. A response of about 100-7,500 cps is required for voice recording; a good crystal mike is adequate for this purpose. For recording music, however, a microphone with wider range and good linear response is needed. A good dynamic mike (mind the *good*) meets these requirements; a typical example has a frequency response of 60-9,000 cycles. Even the quality of a recorded voice is distinctly improved when such a microphone is used, for the higher frequencies are reproduced with better fidelity and more realistic timbre.

Don't expect a good mike to be thrown in with a \$50 or \$100 recorder. *(Continued overleaf)*

PORTABLE RECORDER

It is sometimes a good investment to buy a better mike than the one supplied. The benefits are increased response, output, and sturdiness. In some cases, a dynamic mike costing between \$25 and \$60 can substantially improve a recorder's over-all performance.

For dictating and other voice applications, a microphone with a start-stop switch is a great convenience. In locations with a high transient sound level, such as a factory or subway, a noise-reduction microphone is indispensable.

Inputs. A recorder's usefulness is increased if its inputs accommodate a variety of sound sources. Many units have only one input, but if there is a separate one for radio/TV, quality recordings will result when the program source is connected directly to the unit with a patch cord.

Recorders which have inputs accommodating start-stop microphones can also be used with a foot switch for intermittent playback or transcription. Incidentally, almost all battery-powered units are both dual-track and monophonic. There are a few exceptions to this rule, but for the most part, these are high-price units designed for use by professionals.

Outputs. Most recorders have a dual-purpose output jack for connecting to an external amplifier or to earphones. The more expensive units sometimes have sepa-

rate outputs for external amplifier and speaker. The output is a most important feature in a battery-operated recorder. The built-in amplifier and speaker leave much to be desired, so that you will want to copy your recording onto another tape, using a full-fledged machine. That way you can also do any editing you want to without chopping up your original recording.

Speaker. Since the speaker of a battery-powered recorder is seldom larger than 4 inches, the playback quality is limited. Fidelity is decreased by the fact that most units have only one inadequately baffled speaker. The purpose of the integral speaker is for monitoring, so don't expect hi-fi reproduction. An external amplifier and speaker are required for that purpose.

Capstan drive. All recorders but the least expensive have a capstan drive. The capstan is the rotating shaft which presses the tape against the pressure roller and moves it across the recording head. In some recorders, interchangeable capstans with different diameters are used to accomplish tape-speed changes.

Tape counter. The counter enables you to locate any portion of the tape with exactitude. This feature is not found on all battery-powered units.

Accessories (some of which may be supplied as standard equipment) include: carrying case, earphone, extension speaker cable, high-quality microphone, a.c. adapter, microphone extension cables, telephone pickup, and foot switch. These increase the recorder's usefulness; most of them are comparatively inexpensive.

PRICES

In terms of performance, battery-powered recorders can be grouped in three categories which usually coincide with their price range:

Up to \$75. Recorders in this class should be used for voice applications only. The least expensive don't have capstan drive or dynamic microphone. Some models priced as low as \$25 may have a recording meter and other useful features, but quality performance should not be expected.

\$75 to \$150. These are quite satisfactory for voice recording. At the upper end of this category, recorders with a speed of 7½ ips can be used for taping music—but only for uncritical listeners. Many models are supplied with a dynamic-type remote-control microphone. Values vary widely in this group; we have tested a \$100 unit that outperformed one that sells for \$150.

Over \$150. Let's face it—you've got to spend more than \$150 if you want a battery-driven unit for hi-fi music recording or for professional use. There's an invisible quality that you get in this price range—reliability. It stands to reason that the components and workmanship improve as the cost increases. At a price level of about

\$400, the specifications of some recorders approach broadcast standards.

When you've narrowed the field down to two or three recorders, test them by comparison. Record *someone else's* voice on them simultaneously; then compare the sound quality of the playback. Does one recording seem more natural than the others by reproducing the distinctive timbre of the voice? If the recordings sound about the same to you, the recorders don't vary much, for all practical purposes.

If the recorder is to be used for hi-fi music, make a tape of a wide-range selection. (A recording of a full orchestra is good for this purpose.) Play the tape through an external amplifier and speaker and decide whether the reproduction meets your standard.

Aside from the listening test, you should try the controls to determine whether they work smoothly. See whether you can stop and rewind the tape without jerking, spilling, or putting undue strain on it.

A quality recorder can provide many years of enjoyment. A battery-powered unit, capable of operating anywhere, will prove to be a good companion for those who seek adventures in the realm of sound.

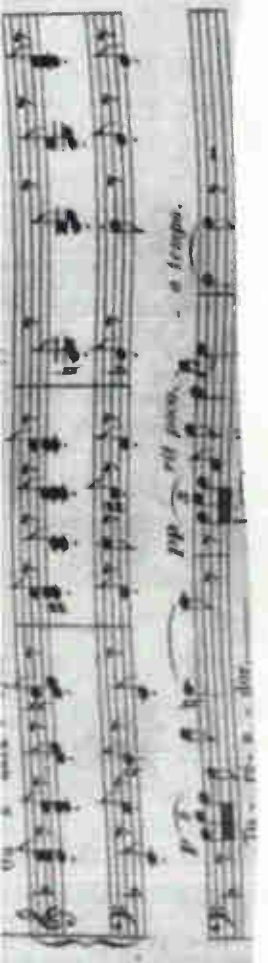

Creative Tape Editing

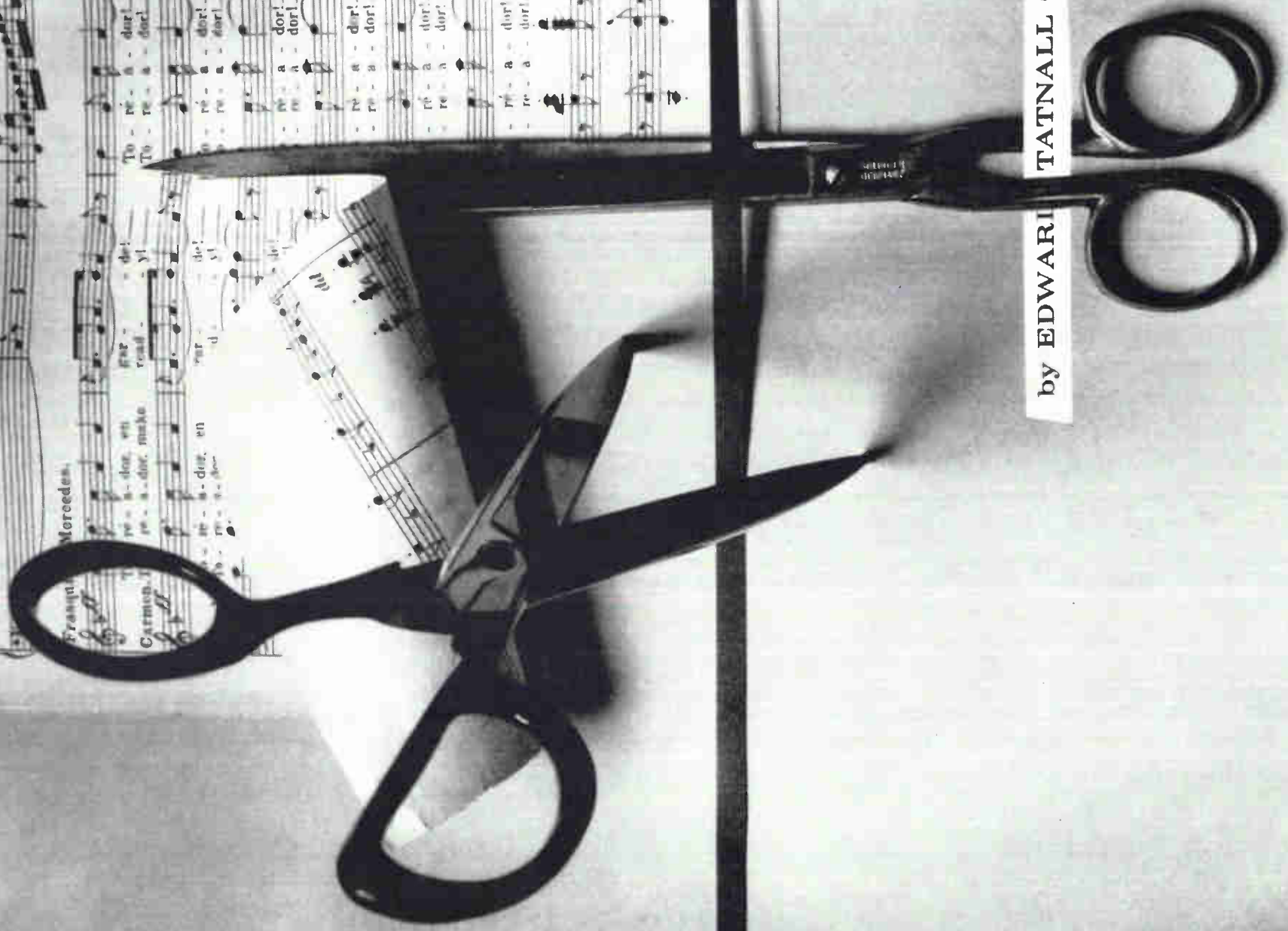
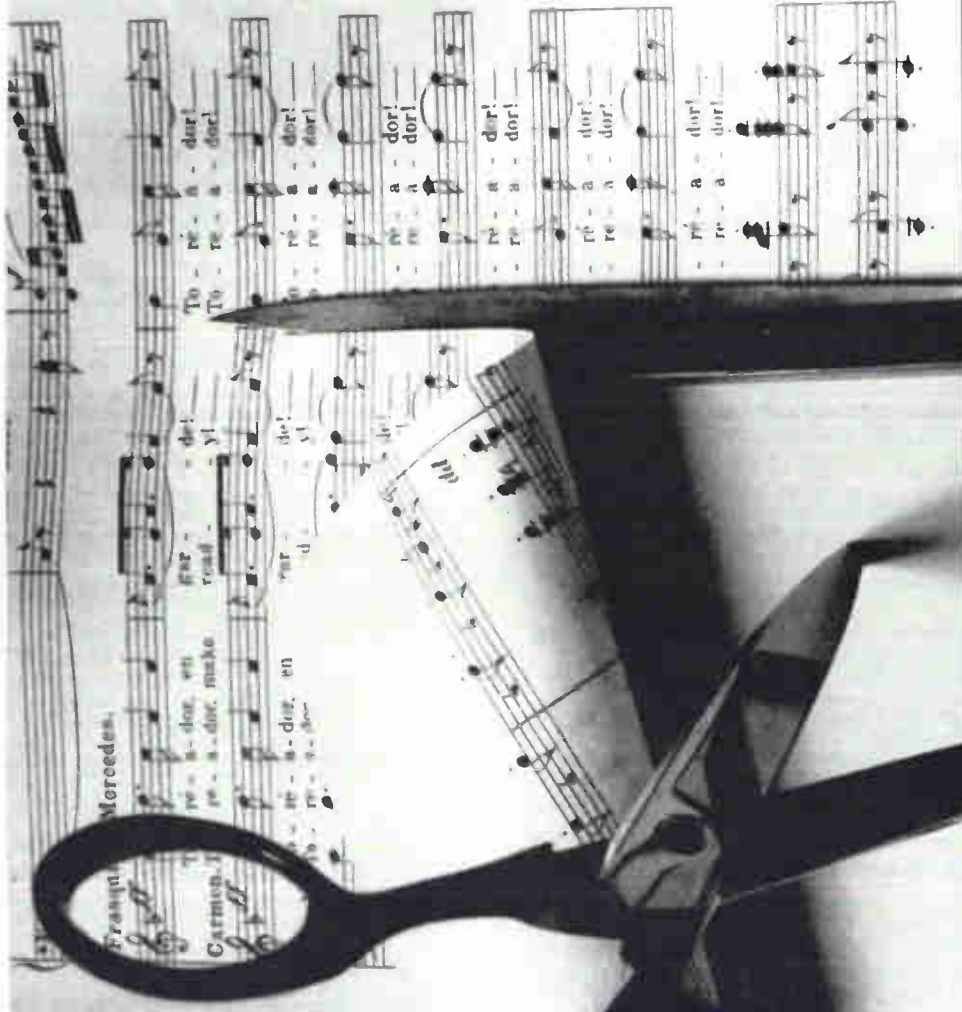

by EDWARD

TATNALL CANBY

A SHORT BUT COMPREHENSIVE COURSE IN THE BASICS OF TAPE EDITING, COVERING BOTH SPEECH AND MUSIC

ONE of the most useful techniques for the owner of a home tape recorder is that of tape editing. It is of tremendous value in making professional-sounding tape recordings, and can be an inspiring and creative hobby in itself.

Perhaps the greatest satisfaction to be gained from learning to edit tape well comes when you play back a smoothly spliced tape, one that is free of the false starts, the pops, squawks, and other extraneous noises that clutter up so many homemade tape recordings.

There is also satisfaction, not to say amusement, in putting into practice the many useful tape-editing tricks that are possible. You can join together on tape the separate sides of your valuable 78-rpm records into a continuous long-play performance. Or you can assemble numerous odds and ends from different reels of tape into one program. And after you become adept at tape splicing, you can try some fancier tricks, such as altering the meaning of a recorded speech merely by transposing some of the speaker's words.

All tape editing, no matter how sophisticated, involves one simple act repeated again and again: the joining together of two pieces of tape. Once this technique is mastered, you will begin to find editing truly exciting. As you discover the tricks of sound-joining, you will find limitless areas for experiment.

The initial step in tape editing is to find the proper place on the tape for the splice. First locate the playback head (the last head in the direction of tape movement) so you can mark the desired spot on the tape precisely as it passes over the head. (Use a black grease pencil for marking.) Look into the tape slot to locate the playback head, then mark its location on the covering cowl above. When you have determined the splicing place by ear, you can lift the tape straight up out of the slot and mark it at the indicated point. For maximum accuracy, however, it is better to remove the cowl and mark the tape directly at the playback head.

On larger, professional-type machines the tape lifters are manually controlled, and you can play the tape slowly by hand to locate the sounds you wish to edit. In fact, most modern home-type recorders have a "pause" position, which allows you to rock the reels back and forth by hand. Machines that do not have this "pause" position raise problems because they allow you to listen to the tape only at normal playing speed. On such machines you have to resort to quick and deft use of the stop control. Experiments will indicate how you should solve this important problem in your own case. The greater your precision, the more you can do in the way of useful and

effective editing, and the fewer mistakes you will make.

The beginning tape editor should concentrate at first on editing speech. Although this is a less exacting area than music editing, it is probably more fun. You can join the different passages, even in the very middle of a word. You can edit out words, whole sentences or paragraphs, or insert new material in place of the old. You can remove grammatical mistakes, hesitations, speech faults, repeats, and hems and haws. You can insert or shorten pauses and thus change the speaker's apparent mood and emphasis.

Here is a basic rule for editing speech (and anything else): edit by joining silences. Look for gaps in the flow of speech, whether at the end of a sentence, in the middle of a thought, or between syllables of a word. You will find what will seem at first an astonishingly large number of these. Some take up perhaps no more than an eighth of an inch on the tape. But that is plenty. Locate the silent place as accurately as you can, and mark the spot with your grease pencil, straight across the tape. Locate another silent place—it may be at the end of a sentence or a word—then slice your tape diagonally (passing the blade through the center of the black marks) at these two points, match up the ends, join them together, and play the tape back. After a few tries, you'll

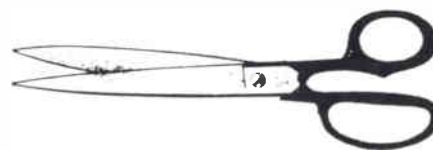

hit a perfect splice—so smooth you cannot hear it—and that's when the fun begins.

As an amusing beginner's exercise, start by making word salads. Take a stretch of spoken recording (or make one on the spot) and hash it up into nonsense. Take out words, join unrelated bits of sentences, transpose sections—always, of course, trying for a natural and convincing effect. When you have completed this bit of frequently riotous lunacy to your satisfaction, try some sober, responsible editing in the same fashion, and you'll be startled at the ease with which you can improve a speech after it has been made.

With no more than this simple silent-place technique—the joining of silences between speech sounds—you can develop surprising skill. The same technique, incidentally, can be applied to recordings of music. Its effec-

tiveness depends on the large amount of silence that is inherent in all speech and in many types of music. The length of the silences may vary from a mere instant to a lengthy pause, and you will soon discover that the quality and length of these silences fulfill a subtle but important function in the conveyance of meaning.

By manipulating these silences, you can alter the sense of speech in astonishing ways. The very syntax of a sentence can be altered through tampering with the pauses and breathing points. Feelings of urgency and nervousness, relaxation and calm can be shifted, all by the simple device of adding or subtracting silences.

But here are two warnings: First, never use blank tape for the insertion of silences. The silences in a recording are never *really* silent. They are colored by the natural background noise of the recording location. Splicing in a piece of blank tape will merely give the effect of a momentary power failure. Instead, use silent places clipped from the recording itself; save up bits of silence that include faint but natural background noise to be spliced in wherever they may be wanted.

Second, never forget that people breathe when they speak. Allow for the intake of breath when you join phrases. Don't remove the breathing unless you want an unnaturally rushed, all-in-one-breath effect. Above all, don't accidentally join two intakes of breath in a row. The person speaking will seem to swell up like a balloon. You will discover that the manipulation of breathing and assorted tongue sounds is a big part of all speech editing.

In addition to splicing in silences, you need only one more basic speech-editing technique: the joining of "sound bumps" (for that is what they sound like when you move the tape slowly across the playback head). You can join a whole assortment of sounds with precision and exactness if you will study the principle of the sound bump, more properly called a transient or percussive sound element. Not all words contain such bumps. You will find, probably to your amazement, that some common sounds that seem definite enough as you listen to them at normal speed—the sounds of the letter *r* or *l*, for example—become utterly vague and meaningless at slow speed, their length spread out as a hideous groan over a long stretch of tape. You simply cannot locate a sharp beginning or ending. They merge into other sounds; hence it is not possible to edit them precisely.

If you do try to cut into these sounds, you will discover a curious thing: your tape will seem to create new percussive consonants of its own. Slice into an *r* and inexplicably it becomes *tr* at the splicing point. A liquid *l*, if you cut into the middle of it, becomes *pl*. These sounds are editing traps. And you will find more of them. Leave them alone.

But let's get back to the sound bumps. They are like road signs to the tape editor. Look for hard consonants,

especially the explosive *t*, *p*, and *k* sounds. They are sharply defined, and they are almost always preceded by a tiny gap of silence. Thus you can locate them, often within a sixteenth of an inch, for perfect editing.

Don't think you are restricted to the handling of words as whole units; indeed, perhaps the most fascinating place to edit by the sound-bump method is right in the middle of a word. Take a phrase like "time to retire." You can break right into the middle of "retire," and you will find a clear silence after the first syllable, followed by a knife-edge *t* sound, running on into an *i* and a liquid *r*. It should be no trouble at all to mark the exact location of the gap and join it to a similar gap at another point on the tape.

Nor are you restricted to joining syllables into exactly the words they originally came from. You can graft together some quite sensible words out of odd syllables on the loose. You can, for instance, join the first part of "time to retire" to an entirely different phrase to make "time to re-taliate in force." And the leftover "-tire" can be spliced in elsewhere to make, perhaps, "I would soon tire of her," or "I had a flat tire." An adroit hand can manufacture such never-spoken phrases in the speaker's own voice, making them sound as natural as they would if actually uttered.

If a mistake is made during a recording session, and you decide to try again, start your second take a sentence or so before the break rather than right at it. Listen to the earlier ending just before you start re-recording, in order to duplicate the tone and pace of the voice in

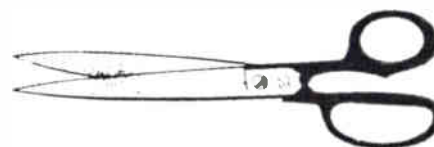

the overlapping repeat. Then, when you splice the two together, you will have a choice of a dozen or so silences or sound bumps at which to make the splice.

MUSIC, needless to say, is edited in much the same way as speech, and you should provide generous overlaps at all points where two passages are later to be joined. By using this overlap technique you can put together a unified performance from as many separate takes as you care to make. Here, too, you begin by looking for silences and for sharp, percussive sounds with clear-cut beginnings and endings that can be precisely located on your tape.

There is one important principle that is peculiar to music editing. The rule is simple, though often disregarded: never cut into an echo. An echo prematurely

cut off is a most obtrusive and quite unpleasant sound.

You can manipulate and transpose echoes, but you have to be careful. You won't want an A Major chord with an echo in G Major; you can try it for kicks, but it will sound very odd indeed. It is possible to join the echo of a chord to the body of a different performance that includes the same chord. However, this kind of patching always carries the risk of creating one of those false percussive effects, a moment of dropout, or a noticeable "bloop" that may render a theoretically workable joint quite useless. It is safer to allow all echoes to run their full course, safely attached to their parent sounds.

Many a poor joint has been made when the editor, torn between the claims of musical rhythm and aural naturalness, has cut off an echo too soon in order to bring in a new section of music on the beat. If an echo is too long, you must wait—you can do nothing else. The music may lag in tempo, but at least the joint will not be noticeable.

Many times you will have to choose between the lesser of two wrongs, and the decision can be agonizing. The

WHAT ABOUT THE OTHER TRACK?

Home tapes usually carry different recordings on a single reel—one or more in each direction. Obviously, you cannot slice through one track without cutting the other as well. There are three ways out of this dilemma:

- 1) Make all your tapes strictly one-way. This sacrifices playing time, but the results, in terms of finished, edited tapes, are worth it.

- 2) If your existing tapes already carry programs in both directions, you may be willing to sacrifice indifferent material in favor of good material. If so, just go ahead and edit the good material and ignore the other.

- 3) If the tape you want to edit contains good material in both directions, and you are unwilling to give up any part of it, team up with someone else who owns a tape recorder and copy tape from one machine to the other. This will provide you with a one-track recording, suitable for editing. Depending on how much quality is sacrificed with each transfer, you can then copy the edited tape on a multiple-track recorder. Naturally, the master tape and the editing copy can be erased and used again.

fate of a precious performance often depends on wise judgment. You can involve yourself deeply in such work, if you wish, and it may fascinate and frustrate you into the small hours of the night. But one really successful splice in a difficult spot can give you a sense of accomplishment that will make up for many hours of frustration.

It is enormously difficult to set up specific rules for music editing because of the variousness of music itself.

Listen to the music critically at normal speed, then at half-speed, keeping your ears open for possible editing spots, for breaks or echo-free silences and percussive bumps. Then play these passages by hand, moving the reels slowly, until you familiarize yourself with their character. Try marking the tape here and there, just to see if you can localize editing points precisely. You can hope to find silences only occasionally. You may have to take advantage of partial silences, as in editing an instrumental solo that begins or ends against an underlying web of sound.

Piano, drums, triangles, sharp string attacks, trumpet sounds, and guitars are your friends. They produce sound bumps that can be marked and cut neatly, providing the musical material permits it.

WITH increasing practice, you can tackle more daring operations. For instance, try converting a piano sound into an oboe sound. Join the beginning of a piano tone onto an oboe tone of the same pitch, and the two will seem to be one sound. You can manufacture all sorts of hybrid instruments and musical phrases in this way. Or you can do tricks with different recordings of the same music, joining them into a continuous performance, but shifting back and forth from one to the other without perceptible transition. You may even run one composition directly into another, imperceptibly mixing two different works, providing you can match up their harmonies.

Given a sure technique, you will find that your success depends largely on your knowledge of the particular music you are editing. If you know how a symphony is put together, where the choruses in a jazz piece begin and end, you can do all kinds of foreshortening, or even lengthening, of the musical structure.

It is remarkable how quickly you can sense the editability of a certain type of music. Beethoven, with his abrupt phrases, is sure-fire for editing; so is Mozart, with his clean-cut melodic figures. Carl Orff, with his rapid percussive patterns, his many repetitions, and frequent breaks in sound, is wonderful for editing. Wagner is very difficult; sound bumps are rare in his music, and silences even rarer. The slow-motion editing technique transforms most Wagnerian music into an unidentifiable mass of sustained howls and groans. Popular music has plenty of percussive sounds, but beware of the big echo. Folk music can often be edited as speech—between stanzas. Blues are easy, but fast jazz is tricky.

Tape editing is comparable to film editing. Yet in many ways, the tape editor's means of shaping the final artistic product are more varied and more subtle. Remember, however, that technique is merely a means to an end. The real challenge of tape editing lies in its expressive possibilities. Here is an invitation to a highly personal and truly engrossing pastime.



TRANSFERRING RECORDS TO TAPE

By ROBERT ANGUS

A record collector explains the whys and hows of dubbing valuable discs on tape

RECENTLY I celebrated my twentieth anniversary as a record collector by beginning a project over which a number of my record-collector friends are shuddering (unnecessarily, I assure you). I'm taping my records.

During those twenty years, I've accumulated a number of irreplaceable 78-rpm singles and albums, some 45's that were withdrawn almost as quickly as they were issued, and more LP's than my wife cares to think about. Periodically, and unhappily, the number is reduced when somebody carelessly drops a 78-rpm album conducted by Richard Strauss, or I just as carelessly scratch a needle across a brand-new and fairly expensive stereo record.

It was to provide protection against just such eventualities that I started the taping project. Tape offered me the opportunity to preserve new mono and stereo discs with the first or second playing, when they are at their peak of perfection. Then I file the discs carefully away and play the tapes, which don't gather dust or become scratched. Likewise, I save my highly breakable 78's from unnecessary wear and tear—and breakage—by transferring them to tape.

Protection, though, is not the only advantage in tape. By doing some advance planning, I can arrange my discs in the order in which I want to play them, rather than in the sometimes arbitrary order selected for me by the record producer. When I began collecting, recordings of complete operas were hardly as common as they are today. It was then a popular hobby among collectors to assemble favorite recordings of arias and choruses from a given opera in proper sequence. Then they'd play them through, from overture to closing chorus. Some collectors, for example, were able on occasion to offer a choice between Enrico Caruso and Giovanni Martinelli as hero. But it was work, with lots of records to put on and take off the turntable. Now I can do almost the same thing with a simple flick of my tape-recorder switch.

With most record collectors, space sooner or later becomes a problem. Tape has helped me toward a solution of that one, too. Take the matter of duplication in the LP reissues of Caruso, for instance. Or, in building a Vivaldi collection, how does one avoid the inevitable overlapping of concertos? The answer is to select the unduplicated items, plus the better of the two or more duplicates in terms of performance and fidelity, and to tape them.

Having determined to start taping my records, the next problem was to look to my materials. My component system includes an integrated stereo amplifier, two loud-

speakers, and a turntable. The latter is preferable to a record changer when dubbing records, because it is easier to locate an exact passage on a record. Of course, the turntable should be free of rumble, since this shows up drastically in stereo-disc dubbings. By the same token, any distortion in your amplifier will show up as distortion on the finished tape. However, if you are using a stereo amplifier in good repair, you should have no difficulty. The more controls your amplifier has, such as scratch and rumble filters, and separate adjustments for bass and treble, the greater ability you have to eliminate or reduce distortion introduced by the record.

IN SELECTING a phono cartridge, you'll want one in which a change of needles, from 78 to LP, is quick and easy. The new crop of stereo cartridges is reliable and should offer no problem in selecting one for dubbing. I can't think of any that won't do a good job, although it is perfectly obvious that the better the cartridge, the better your finished tape.

Selecting the tape deck is a trifle more difficult. Although my tape collection includes a number of two-track monophonic and stereo recordings, I prefer the convenience of a four-track mono recording for long mono works like complete operas, and four-track stereo for tape and storage economy. Most of the machines on the market will record and play back two-track and four-track mono and stereo tapes. The advantage of this type of



recorder, of course, is that I can play back all of my present tapes, and I can enjoy the economy of squeezing twice as much music on each reel of tape without adversely affecting fidelity.

So much for the heavy equipment. As a tape recordist, you will need the necessary accessories—splicing tape, a splicer, a grease pencil with which to mark tapes and reels, patch cords, and some sort of label. This still leaves the choice of tape and the necessity of selecting a leader tape. Leader tape is a paper or plastic strip similar in size and thickness to recording tape. It serves two purposes—it protects the ends of a reel of recording tape from being twisted or broken when you

are threading the machine or handling the tape, and it can be used to identify the contents of the reel.

One of the problems in putting a number of short selections on one tape is finding them later. I solved this, in part, by using colored tape and colored leader tape, wherever possible, to identify selections. Tape is available in blue and green as well as in the traditional brown. The use of a different color of tape for each selection simplifies locating a specific number.

Another way of achieving the same result is to use colored leader tape between selections. Mylar-base leader tape can be had in red, blue, green, yellow, and white. And, for additional convenience, there is white leader marked off at intervals of $7\frac{1}{2}$ and 15 inches. The use of leader tape offers other advantages. It can be cut in advance in time lengths, and it provides complete silence between selections. A good length for a break between selections is three to five seconds— $22\frac{1}{2}$ to $37\frac{1}{2}$ inches of tape at $7\frac{1}{2}$ inches per second. You simply measure it in advance and splice it in where you want it. Of course, this is practical only when recording in one direction.

If, however, you prefer the economy of four-track mono or four-track stereo, marking becomes more complex. Perhaps the most satisfactory method is a sheet enclosed in the box with the tape, listing the contents on each track in order, together with details on the recording. If you have the information, you should include playing time for each selection. Finally, if you set the counter on your tape recorder to zero before you start, you can include a location number for each selection. Then, when you want to find a particular selection, you have only to set your indicator at zero, thread the tape, and speed the tape through until the number you want shows up on the counter.

In addition, it is wise to mark both reel and box. You can use an ordinary china-marking pencil for temporary identification. Simply write directly on the reel and the box. When you want to remove the writing, a piece of absorbent cotton dipped in alcohol will do the job. A neater and more permanent identification method is the use of self-adhering labels, sold by almost any stationer. These are merely pressed in place after the pertinent information has been written or typed on them. They come in rectangles of various sizes, from three-quarters of an inch to three inches or more in size. There are also long narrow strips, which can be applied to the edge of the tape box and on which pertinent information can be typed. These strips are also available at most stationers and hi-fi dealers. Besides being easy to use, they are easy to remove when you change tapes. Just peel off the old labels, type up new ones, and you're in business. Besides using this type of label on the box, you can use it on the reel as well, to avoid the possibility of putting it in the wrong box.

In selecting a recording tape, playing time is an important factor. Chances are that if you're going to do any extensive dubbing, you'll be using more than one type and one length of tape. Tape costs money, so you'll want to have as little blank tape at the ends of your reels as possible. You'll probably be using five- and seven-inch reels of $1\frac{1}{2}$ -mil acetate, or 1-mil acetate or Mylar, and $\frac{1}{2}$ -mil Mylar. In choosing a 1-mil tape for your needs, remember that acetate tapes are cheaper than Mylar, but they have a tendency to wear rapidly at the ends and break under strain. Mylar is more expensive, but it will not flake off at the ends and will withstand much stronger tension than acetate. Most $\frac{1}{2}$ -mil tape nowadays is *tensitized*. This means it is extra-strong and able to cope with most ordinary stresses and strains. The older untensitized $\frac{1}{2}$ -mil tapes had a tendency to stretch like taffy unless they were carefully handled.

SO MUCH for the selection of materials. The next step is to organize the material and begin recording. My first tape was to be a compendium of 78-rpm discs, which I wanted to record primarily as insurance against breakage. The discs came from a variety of manufacturers over the 40-year period from 1905 to 1945. Some were acoustical recordings, made early in the century sans electronic amplifier. Some were cut at 78 rpm, others at 83 or 75 rpm; some had been cut with a 3-mil stylus, others with a 2.8 or a 3.1. Besides all this, every recording curve devised by the mind of man was represented.

I found that a good amplifier was an invaluable help. By careful use of the scratch and rumble filters, I could eliminate many of the most objectionable extraneous noises on the older records. In addition, by manipulating the bass and the treble controls with each record, it was possible to get sounds that were not too dissimilar from



one record to another. My ear and the volume indicator on the tape recorder provided a good check on the taping level.

My turntable, too, was speed-adjustable, which was fortunate, because it helped me compensate for some of my 78's which turned out not to be 78's. I played each record, taking notes of the bass and treble control settings, and keeping track of the volume. In addition, I checked for particularly bad spots in each record which would need additional compensation. The second time through, the tape was running. I played the records with a careful eye on the tone-control settings, to be sure everything was going along all right. Since the discs

TRANSFERRING RECORDS TO TAPE

were all more than fifteen years old, I decided to record them at $3\frac{3}{4}$ ips. As a result, I was able to accommodate more than 30 bulky, heavy 78-rpm discs on a single seven-inch reel of tape, by using two tracks. The originals were then put safely in storage, and now I can listen to the tapes without fear of damaging the fragile and precious recordings.

RECORDING new LP discs is, fortunately, a simpler operation. Recording information on most LP's is fairly complete. All discs issued during the last four or five years, for example, use the RIAA recording curve, which simplifies the setting of bass and treble controls. You may find that you prefer some setting other than RIAA for some recordings, but this starting point does facilitate finding the right compensation for a given recording. For the LP's made earlier, information is usually on the record jacket. In addition, the recording curve of virtually any disc is available from the manufacturer of your amplifier. Unless you're dealing with badly scratched LP's or badly pressed discs, you'll have little use for the scratch filter. And unless your turntable or record changer isn't worthy of the name of high fidelity, you won't need the rumble filter, either. You'll probably have to play the disc through at least once, not only for volume level, but also to get an approximate idea of the playing time. You should know before you start how much tape you will need for a particular composition.

As mentioned before, blank tape at the end of one track of a dual-track recording is usually simple waste. One can tell by looking at a 78 whether it is two minutes long, or whether the playing time is more like $4\frac{1}{2}$ minutes. By adding up your estimates, you can tell approximately how many discs will fit on a reel of tape. Because the playing time of a 78 is relatively short, you'll seldom have one track that's more than a few minutes longer than another.

With LP's, however, it's a different story. One manufacturer put Schubert's eight-minute *Quartettsatz* on one side of a 12-inch LP. A few years later, the same label issued Beethoven's 35-minute Third Piano Concerto, also on one side of an LP. There are short cuts to the timing situation. For example, most major sym-

phonies and concertos run from 25 to 45 minutes in length. Operatic arias usually run about four or five minutes, and most overtures take from seven to fifteen minutes. A detailed guide to playing times of standard works is available for \$2.75 from the Audio Exchange, 153-21 Hillside Avenue, Jamaica 32, N.Y.

Having decided which compositions you intend to record on a given reel of tape, and having made the necessary compensations on the amplifier tone and volume controls, you're set to roll. Be sure the stylus is free of dirt at all times. Then start the record and the tape recorder, and keep an eye on your level indicator. Generally, that's all there is to it, although you may have to boost volume in some parts of the recording and reduce it in others. The notes you made in advance will help you here.

So far, so good. But suppose you want to take selections from several different LP's and put them on one tape or, as I did, insert an aria from one record into the middle of a complete recording of the opera. As with the 78's, this means that volume levels should be as close to each other as possible, and if there is a difference in recording curves, they should be compensated for at the amplifier. Occasionally there is also a difference in pitch. If your turntable permits speed adjustment, this will enable you to match pitch. In the latter case, I recorded the complete opera, then recorded the separate aria and spliced it in. In the former case, I recorded each item separately, then spliced them together. This also can be done directly on one tape. If you'd rather not be bothered with volume settings and tape-recorder meters, you can record a bit of the second selection at the end of the first, then play both selections back and note whether there's an audible difference. If not, record the second piece in its entirety and proceed to the third.

IT is possible to intermix mono recordings by your favorite artist, whether or not they're all the same speed. You can also put them in the order of your choice, although it's not at all necessary to record them in sequence. You can do all the 78-rpm discs first, then move along to 45's and LP's. Determine the order in which you want them, then intersplice recordings. When doing this type of tape, it's even more important to be sure that recording curves match fairly closely, and that volume levels are equal. Obviously, you must do one track at a time.

A word about making connections—read the instructions provided with your tape recorder and your amplifier before proceeding to record. Conditions vary with each tape unit, and with almost every amplifier.

Making recordings from your discs is a good way of making sure that those precious discs stay in good condition, and that you can hear them over and over again at their best. In addition, you can arrange to hear—or to play for guests—what you want the way you want it.

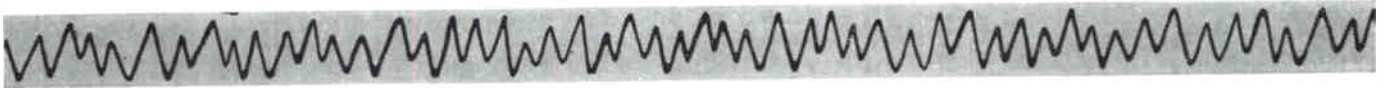

Now, there's a tape that lets you

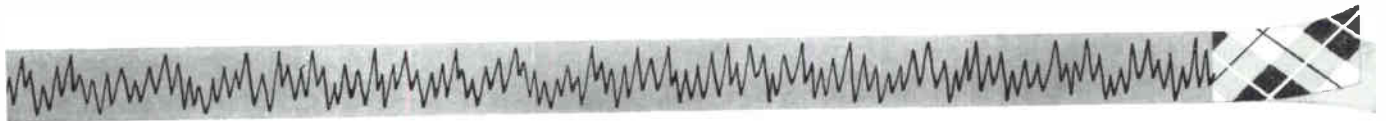

record twice the music per foot.

How? It's so sensitive you can cut recording speed in half with no loss in fidelity. Your budget will applaud.

Savings start with this box.

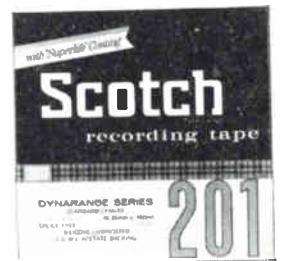

SCOTCH® Brand "Dynarange" Series Recording Tape is the name on the box. The tape that just prepared your recorder for the best performance of its life. This new tape makes all music come clearer, particularly in the critical soprano or high-frequency range. So much clearer, you can now record at $3\frac{3}{4}$ ips and enjoy all the fidelity until now possible only at $7\frac{1}{2}$ on your recorder. Your dealer has a demonstration reel that proves the case.

And by cutting your recording speed in half, you won't need as much tape—can save 25% or more in costs. Or, you can use new "Dynarange" Tape at $7\frac{1}{2}$ —and discover sound quality you didn't know your recorder had.

The technical achievement behind all this...

we've cut background tape noise (what little there is in "SCOTCH" Recording Tape) in half so the listening's better. And we made the wear-life better, too! 15 times greater than ordinary tape. Exceedingly low rub-off keeps equipment clean. Lifetime Silicone lubrication assures smooth tape travel, protects against head wear and extends tape life. Comes in new sealed pack so the tape is untouched from factory to you. Hear new "Dynarange" Tape demonstrated at your dealer. Then try a roll on your own recorder.

"SCOTCH" AND THE PLAID DESIGN ARE REG. TMS OF 3M CO., ST. PAUL, MINN. 55119 ©1965 3M CO.

Magnetic Products Division 



The majestic power of Sony sound

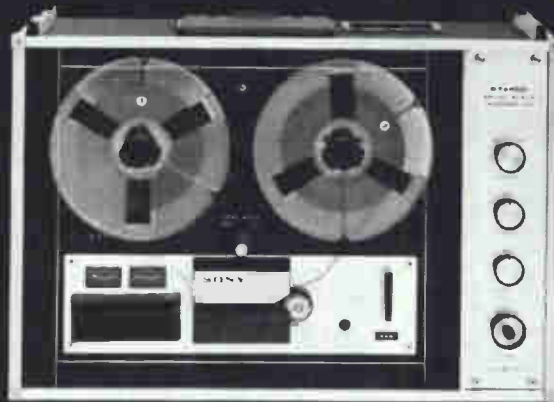

The new Sony Sterecorder Model 260
with radial XL-2* sound projection!

Listen to the soaring splendor of a Cathedral organ sounding Bach's magnificent *Hallelujah* through the sensational new Sony radial XL-2 sound projection speaker systems. From the highest treble piping to the volcanic power of the bass, you hear every breathtaking sound. **Look** — at the precise functional design of the *facia* panel, with finger-tip controls for maximum ease and efficiency. **Touch** — the concentric, computer-type knobs, responsive to the most sensitive adjustment. **Know** — that this superb instrument is from world-famous Sony, perfect for any recording or playback situation. A complete-in-one portable and home four track solid state stereo tape system, with microphones and Sony radial XL-2 stereo sound projection speakers: *All the best from Sony for less than \$249.50!* Other outstanding features of the **Sony Sterecorder 260** include: two professional V.U. meters, automatic shut-off sentinel switch, automatic tape lifters, bass and treble tone controls, vertical and horizontal operation, FM stereo recording inputs, two tape speeds, 20 watts of music power. *An exciting new concept in stereo separation! For nearest dealer write Superscope Inc., Dept. 89, Sun Valley, California.

SONY **SUPERSCOPE** *The Tapeway to Stereo* ®



TAPE RECORDER DIRECTORY

RECORDERS, PLAYERS, AND TRANSPORTS.....	65
RAW TAPE.....	92
TAPE ACCESSORIES.....	96

AMERICAN GELOSO

TR-711 Portable Recorder

Transistorized; dual-speed (3 3/4 & 1 7/8 ips), dual-track mono design. Response 100-6000



cps. .25 w. output; S/N 20 db; wow & flutter .5%. Has combination level & battery condition meter; 2 1/4" speaker. Features monitor facilities when recording; 2 hrs. recording time; uses 6 penlight cells for life of 30 hrs. Supplied with remote-control mic, dual earphone & carrying case. 2" x 6" x 7". Optional equipment includes 117-v. a.c. adapter, telephone pickup & others; less Fed. Ex. Tax.....\$199.95

61 Portable Recorder

Transistorized, mono, battery or a.c. operated; dual speed (1 7/8 & 3 3/4 ips); vu meter, battery condition indicator; radio & mic. inputs; has provision for projector synchronizer. Response 80-7000 cps; S/N 20



db; wow & flutter .3%; 150 mw. output. 2 3/4" x 6" x 7"; wt. 5 lbs. Supplied with dynamic mic, earphone; batteries & carrying case.....\$179.95

4-10 Tape Recorder

3-speed (3 3/4, 1 7/8 & 1 5/16 ips); transistorized, 117-v. operation; 5" reel; mono de-



sign. Response 40-12,000 cps @ 3 3/4 ips; S/N 50 db; wow & flutter .2%; 2.5 w. output. Features output jacks for monitoring, earphone, ext. spkr.; input jacks for remote mic., radio, remote foot pedal, telephone pickup, counter, vu meters. 12 3/4" w. x 5" h. x 11" d. wt. 1 1/2 lbs. Supplied with remote-control mic.....\$269.95

G-258/A Tape Recorder

3-speed (3 3/4, 1 7/8 & 1 5/16 ips) mono, 117-v.. dual-track design. Response 50-12,000 cps; S/N 50 db; wow & flutter .2%. Has level



meter, counter & uses 5" reel. 13 1/2" x 8 1/2" x 6". Weight, 6 lbs. Supplied with mic.\$199.95

AMPEX

PR-10 Series Tape Deck

Two-speed compact design with 4-position head assembly with separate erase, record & playback heads; extra position for optional 4-track stereo playback or special requirements; has 3" vu meters; response 30-15,000 cps ±2 db @ 15 ips, 40-12,000 cps @ 7.5 ips, 40-6000 cps @ 3.75 ips; signal-to-noise ratio 55 db @ 15 & 7.5 ips (half-track or 2-track), 50 db @ 3.75 ips; wow & flutter .15% @ 15 ips, .18% @ 7.5 ips. 25% @ 3.75 ips; output +4 dbm into 600-ohm balanced or unbalanced load; rack space: transport 8 3/4" x 19" x 6" d.; electronics 5 1/4" x 19" x 5 7/8" d.

Model PR-10-1 full or half-track; single channel electronics include built-in mixer to

mix line and mic or two mics; has two inputs—low-imp. microphone & unbalanced bridging with provisions for plug-in line transformer or low-imp. plug-in microphone preamp; without case.

Cat. #96001-09 full track 7.5 & 15 ips.\$1045.00
 Cat. #96001-03 half track 3.75 & 7.5 ips.\$1045.00
 Cat. #96001-01 half track 7.5 & 15 ips.\$1045.00



Model PR-10-2 two channel. fits same rack space as PR-10-1; stereo or mono recording; has one input per channel; inputs are unbalanced bridging with provision for plug-in line transformers or low-impedance plug-in mic. preamps; features sound-on-sound, cue tracks, and other special effects. Cat. #9600-03 two track, 3.75 & 7.5 ips.\$1245.00

Cat. #96000-01 two track 7.5 & 15 ips.\$1245.00
 Remote control (in box with 30' cord)\$85.00

Cat. #4018004-01 four track 3 3/4 & 7.5 ips. Has three 4-track record-erase-playback heads, a 2-track playback head & a head switch. Has 1 line input for each channel. Microphone preamps or line transformers may be used with line inputs.....\$1295.00

Model 2000 Series Tape Recorders

3-speed (7 1/2, 3 3/4 & 1 7/8 ips) design featuring automatic tape threading, automatic end-of-reel tape reverse, and manual switch for tape reverse at any time desired. Machine adds inaudible pulse onto any tape which



is then used to actuate end-of-reel reversal. 2400' tape at 3 3/4 ips will provide 6 hr.

DIRECTORY SECTION

of continuous play. Has automatic shutoff and optional slide-projector actuator, built-in preamps, power amps & speakers. Records 4-track stereo & mono, plays 4-track stereo & 4-track, half-track & full-track mono. Response 30-18,000 cps ± 2 db @ 7 1/2 ips; S/N 52 db @ 7 1/2 ips; power output 8 w./ch, continuous r.m.s. Flutter & wow .08% @ 7 1/2 ips.

Model 2050 tape deck with stereo preamps\$439.00
 Model 2070 portable self-contained system; black vinyl-clad wood cabinet, carrying handle, dust cover, two built-in spkrs. & one #2001 mic.....\$499.00
 Model 2075 same as Model 2070 except has tan finish & walnut cabinet.....\$519.00
 Model 2080 same as Model 2070 except has walnut cabinet.....\$469.00

Model 602-2 Tape Deck

Stereophonic tape recorder using Model 602-1 tape transport and two Model 602-1 electronic chassis for stereo record/playback; two-track erase head, record and

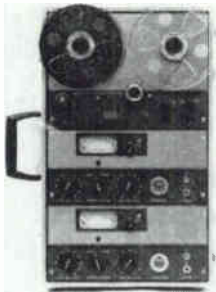

playback heads; all performance specifications identical to Model 602-1.

Cat. # 6022-01 7.5 ips, portable case\$875.00
 Cat. # 6022-07 3.75 ips, portable case\$875.00
 Cat. # 6022-02 7.5 ips, supplied unmounted\$795.00

602-1 Mono Tape Deck

Full-track or half-track recorder; 3 heads; erase, record, playback; frequency re-



sponse: 40 to 15,000 cps, 40 to 10,000 cps ± 2 db, no more than 4 db down at 15,000 cps; wow and flutter under 0.17% r.m.s.; signal-to-noise ratio: full track, over 57 db below peak recording level at 3% total harmonic distortion; half track, over 55 db; vu meter; separate record and playback preamplifiers; reel size: 7"; timing accuracy: ± 3.6 seconds in 30 minute recording; microphone and high level inputs with full mixing provisions; vertical or horizontal operation; separate playback preamp permits instantaneous comparison between incoming program material and actual recording; headphones jack; output:

+4 dbm into 600 ohm load from tapes recorded at program level.

Cat. # 602-01 Half-track, 7.5 ips, portable case\$625.00
 Cat. # 602-17 Half-track, 3.75 ips, portable case\$625.00
 Cat. # 602-03 Half-track, 7.5 ips, unmounted\$575.00
 Cat. # 602-02 Full-track, 7.5 ips, portable case\$625.00
 Cat. # 602-04 Full-track, 7.5 ips, unmounted\$575.00
 Cat. # 602-04 Full-track, 3.75 ips, unmounted\$575.00

800 Series Tape Recorders

Four track stereo, 1/2 track & mono; transistorized: dual capstan drive, no pressure pads; vu meters: 3-speed (7 1/2, 3 3/4, 1 3/4 ips). Response 50-15,000 cps ± 4 db @ 7 1/2 ips. Signal-to-noise -46 db @ 7 1/2 ips. Wow & flutter .2% @ 7 1/2 ips.
 Model 850 deck only with preamps..\$269.00
 Model 860 portable deck with preamps, power amps & 2 #701 mics.....\$289.00
 Model 865 furniture deck with preamps,



power amps & 2 #701 mics.....\$309.00
 Model 890 portable deck with preamps, power amps, finger-tip reversing & 2 #710 mics.....\$369.00

1100 Series Tape Recorders

Four-track stereo, 1/2 track & mono; automatic threading; electronic & manual reversing; transistorized; dual capstan drive, no pressure pads; vu meters: 3 speed (7 1/2, 3 3/4, 1 3/4 ips); has provision for automatic slide projector actuator. Performance at 7 1/2 ips: response 50-15,000 cps ± 4 db, S/N -46 db, wow & flutter .2%.
 Model 1150 deck only with preamps.....\$399.00
 Model 1160 portable deck with preamps,

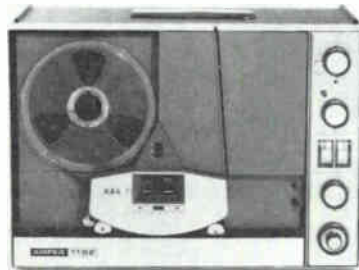

power amps & two #2001 mics.....\$449.00
 Model 1165 furniture deck with preamps, power amps & two #2001 mics.....\$469.00

AMPLIFIER CORP.

Model 312 "Transflyweight" Transistorized Recorders

Operates from small dry replaceable or rechargeable batteries; multi-purpose vu meter; battery-operated amplifier; single head for recording and playback; 5" reel; rewind indicator; 8 lbs.; attache carrying case.

Model 312-AV Dual-track; 15 1/4 ips; 50-



2500 cps; flutter 0.25%.....\$488.00
 Model 312-BV Dual-track; 1% ips; 50-4000 cps; flutter 0.2%\$438.00
 Model 312-CV Dual-track; 3.75 ips; 50-7500 cps; flutter 0.15%\$448.00
 Model 312-TDV Dual-track; 7.5 ips; 50-10,000 cps; flutter 0.1%\$458.00
 Model 312-SDV Single-track; 7.5 ips; 50-10,000 cps; flutter 0.1%\$458.00
 Model 312-EV Single-track; 15 ips; 50-15,000 cps; flutter 0.1%\$498.00
 With aluminum case add\$ 31.00

Model 312-ST "Transflyweight" Stereo Recorder

Portable design; battery operated; will record and play back stereo or mono; 1/4

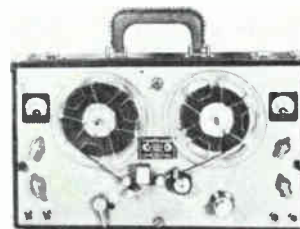

track; 5" reel size; single play/record head; response 50-10,000 cps ± 2 db @ 7.5 ips; signal-to-noise ratio 55 db; wow and flutter .1% @ 7.5 ips; microphone (50/200 ohm) only input per channel with 4 millivolts sensitivity; (15,000 ohm) 2.5 v. output per channel; has 30 transistors; built-in vu meters for each channel; rechargeable batteries; single-speed (1 3/4, 1 1/2, 3.75, 7.5, or 15 ips) design; prices range from \$624.00 to \$684.00. 110 volt a.c. power pack.....\$30.00

Model 612 "TransMagnetite" Transistorized Mono Recorders

Transistorized portable tape recorder; spring-wound motor; multi-purpose vu meter; battery-operated amplifier; 5" reel size; rewind indicator; 17 lbs.

Model 612-AV Dual-track; 15 1/4 ips; 300-



2500 cps; flutter 0.25%\$495.00
 Model 612-BV Dual-track; 1% ips; 100-3000 cps; flutter 0.2%\$445.00
 Model 612-CV Dual-track; 3.75 ips; 50-7500 cps; flutter 0.15%\$455.00
 Model 612-TDV Dual-track; 7.5 ips; 50-10,000 cps; flutter 0.1%\$465.00
 Model SDV Single-track; 7.5 ips; 50-10,000 cps; flutter 0.1%\$465.00
 Model 612-EV Single-track; 15 ips; 50-15,000 cps; flutter 0.1%.....\$505.00
 (Continued on page 68)

SOMEDAY, THERE MAY BE OTHER FULLY AUTOMATIC TAPE RECORDERS LIKE THE NEW CONCORD 994



The 994 gives you automatic reversing Plays or records automatically three different ways Stops by itself where you want it to Threads itself automatically And, the 994 is available now!

With the transistorized 994, Concord introduces a new dimension to tape recording. Some might call it modernization, some might call it automation. We think of it as *convenience*—in playing, in recording, in starting and stopping, in threading, in hours of uninterrupted listening. You can't compare it to anything because the 994 is as different from the conventional stereo recorder as the old crank-type Gramophone is from the modern record changer.



AUTOMATIC PROGRAMMING. You can program the 994 to play or record one side of a tape from beginning to end and stop automatically. Or, to play/record first one side of the tape, reverse, play the other side, then stop automatically. Or, to play/record forward and back, forward and

back, continuously, as long as you like—an hour, six hours, or all day. You may change direction of tape any time you like by merely pressing the direction change buttons. These same lighted buttons automatically show you direction of tape travel.

PUSH-BUTTON KEYBOARD. The operating controls are literally at your fingertips. This is the one recorder you can operate without arm waving, and with one hand! As far as threading, that's even simpler—the 994 threads itself automatically.



After all this, we didn't just stop in designing the 994. We kept going. As a result, the 994 offers superb performance and every conceivable feature required for your listening and recording pleasure. Here's a brief sample: three speeds with automatic equalization, four professional heads, two VU meters, digital tape counter, cue control, sound-on-sound, exclusive Concord Trans-A-Track recording. 15-watt stereo amplifier, professional record/monitoring system. The 994 may also be used as a portable PA system, with or without simultaneous taping.



TWO-WAY STEREO SPEAKERS. The split lid of the 994 houses a pair of true two-way speaker systems, each containing a tweeter, woofer, and crossover network. A pair of highly sensitive *dynamic* microphones is included.



The 994 is priced under \$450.* An identical recorder, Model 990 comes without speakers or microphones and is priced under \$400.* Both are at your dealer's now. So why wait? Drop in for a demonstration and find out for yourself what *fully automatic tape recording by Concord* is all about! Or, for complete information, write Dept. TA.

For Connoisseurs of Sound

Other Concord models from \$50 to \$800.

CONCORD 994

CONCORD ELECTRONICS CORPORATION, 1935 Armacost Avenue, Los Angeles, California 90025
IN CANADA: Magnasonic Industries, Ltd., Toronto/Montreal

*Prices slightly higher in Canada.

THE SIGNATURE OF QUALITY ■ Tape Recorders/Industrial Sound Equipment/Dictation Systems/Communications Devices/Closed Circuit Television

1966 EDITION

CIRCLE NO. 9 ON READER SERVICE CARD

67

DIRECTORY SECTION

In weathertite sealed aluminum case add\$ 50.00

BRENELL

Mark IV & IVB Tape Decks

Tape deck chassis; dual track; takes up to 4 heads for record, playback, and erase; 3 speeds; 3 motors; frequency response: 3.75 ips, 50 to 6000 cps; 7.5 ips, 50 to 12,000 cps; 15 ips, 30 to 15,000 cps (all ± 3 db); flutter and wow less than 0.2%; tuning eye level indicator; dual track operation for up to 7" reel; requires preamp and amplifier; speed change by screw-on 2:1 ratio capstan sleeve and slow-fast stepped flywheel and motor pulley assembly;

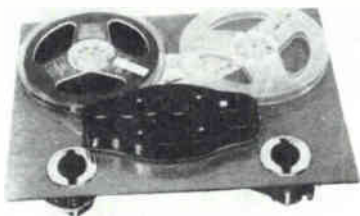

blv; Mumetal heads; mechanical brakes; 2 knob control, interlocked; digital counter; fast rewind; size 15"x11 1/2"x3 3/4" d; mounting: from horizontal up to 85° slant. Mark IV. 1 upper track erase head; 1 upper track record/playback head;\$144.50
Mark IVB. 1 upper, 1 lower track erase head; 1 upper, 1 lower track record/playback head; (staggered stereo).....\$182.87

Mark 5 Series Tape Deck

Four speed (1 1/8, 3.75, 7.5 & 15 ips); two switches control record, playback, wind & rewind; has revolution counter; normally deck is supplied fitted with one erase and one record/playback head (upper track in operation); provision is made for extra heads to be mounted easily when required for special purposes.

Mark 5 Mono record/playback.....\$169.50
Mark 5B Stereo record/playback....\$199.50

Mark 5 Record/Playback Amplifier

Primarily designed for use with Brenell tape decks; frequency compensation is to CCIR standards at 7.5 & 15 ips; 7 watts output; two amplifiers required for stereo operation; has high-frequency tone control; microphone input 2-5 mv. into 2 megohms; tuner-phono 250 mv. into 700-000 ohms; tubes—EF86, ECC83, EL84, EZ80, EM81; size 15" w. x 4 1/2" h. x 5" d.; supplied without power supply.\$ 84.60
With power supply.....\$109.50

BUTOBA

Model MT-5 Portable Tape Recorder

Completely transistorized; two-speed (3.75 & 1 1/8 ips); two-track mono design; made in Germany; has tone controls, volume level indicator; speaker output 1.2 w.; 7 transistors plus 2 diodes; operates from 8 flashlight batteries, accessories available for other power sources; response 50-13,000 cps @ 3.75 ips, 60-5000 cps @ 1 1/8 ips; signal-to-noise ratio 40 db; handles 5" reels; 9" x 12" x 6"; wt. 12



lbs. with batteries; supplied complete with dynamic microphone and carrying strap.\$199.95

Model MT-7 Transistorized Portable Tape Recorder

Transistorized, battery-operated, two-speed (3.75 and 1 1/8 ips); two-track mono design;

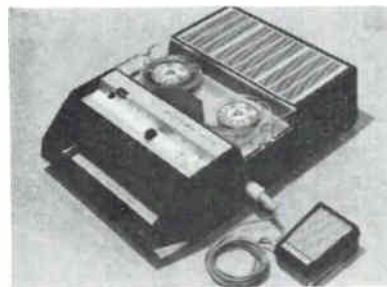

product of West Germany; volume level indicator; operates from 4 flashlight batteries, accessories available for other power sources; response 60-12,000 cps @ 3.75 ips; signal-to-noise ratio 40 db; 3" reels; 12" x 8" x 3"; 7 lbs.; supplied with dynamic microphone and carrying handle; accessories available.....\$99.95

CHANNEL MASTER

"Majorca" 6548 Mono Tape Recorder

3-speed (1 1/8, 3 3/4, 7 1/2 ips), 2-track design featuring automatic level control; 4" x 6"



spkr.; 2.2 w. output; record level indicator; digital counter; 7" reel; pause button; monitor control; response 50-12,000 cps @ 7 1/2 ips; S/N 40 db; wow & flutter .25%. Has automatic tape lifters; 50,000-ohm mic inputs; 8-ohm radio input; 3-megohm phono input. Amplifier can be used as p.a. system. Solid wood vinyl-covered cabinet. 13 3/8" x 14 7/8" x 7 7/8"\$149.95

"Sir Realist" 6470 Tape Recorder

Transistorized; 2-speed (7 1/2 & 3 3/4 ips); 1/4-track, 2-channel stereo record & play-



back; 2-track mono record & playback. Design has 2 vu meters for record & play-

back; digital counter; mic & aux. inputs; 2-1000-ohm line outputs; 2-8-ohm outputs for ext. spkr.; headphone jack & 3 w./ch. power amp. Response 50-15,000 cps @ 7 1/2 ips; S/N 47 db; channel separation 65 db @ 1000 cps; 4" extended-range spkrs. are used in removable lids. Solid wood vinyl-covered cabinet. 14 1/2" x 13" x 13 3/4". Supplied with 2 mics.....\$219.95

COLUMBIA

Masterwork M-810 Tape Recorder

Transistorized 4-track stereo record and playback; 3 speeds; individual controls for microphone and auxiliary inputs; dual recording-level meters; tone controls for each channel; pushbutton switching from stereo to mono; automatic stops; pause lever.



Speakers are in detachable wings and two dynamic microphones are included. The fabric-covered case has a built-in storage compartment\$275.00

CONCERTONE

Model 400 "Cosmopolitan" Radio/Recorder

Portable, transistorized, battery or 117 v. a.c.-operated, 2-speed (1 1/8 & 3 3/4 ips).



half-track design. Uses 5" reels and has 3 1/2" x 2 1/4" speaker; a stop-start dynamic-type microphone equipped with remote-control switch (foot sw. optional). Response 150-3500 cps @ 1 1/8 ips, 150-7000 cps @ 3 3/4 ips. Wow & flutter .6%. Output 300 mw. Has built-in AM receiver that can be used as a radio-only if desired; four 1.5-v. batteries provide 15 hours continuous use. Has dual-purpose recording level & battery condition meter & indexing tape counter. 11 1/16" x 7 7/8" x 3 3/8". wt. 10 pounds.....\$197.50

Series 800 Tape Recorder

Features 6 heads (2 play, 2 record, 2 erase); "Reverse-O-Matic" (play or record 4-track



(Continued on page 70)



Shopping for
a tape recorder?
Here's all
you need to know:

Ampex is the one professionals use!

It's a fact! 'Most all of the music you hear every day was originally recorded on Ampex tape equipment. And now, your nearby Ampex dealer can show you a full line to choose from for home use. Start with our lowest priced #860. Like all Ampex tape recorders, it features dual capstan drive and solid die-cast construction. It makes stereo and mono recordings, plays them back in shimmering high fidelity . . . and costs less than \$300, complete with detachable slide-on speakers. For just a little more,

you can have our #1160, which is even easier to use; it has automatic threading and automatic reversing. (You don't have to switch reels to play the other tracks!) And, if you're a "nothing but the best" believer, believe us: you'll be more than happy with our #2070. It offers sound quality on a par with professional equipment and power enough to thrill a small auditorium. To round out the picture, there's also a full line of accessories . . . all in the professional tradition of Ampex.

800 SERIES

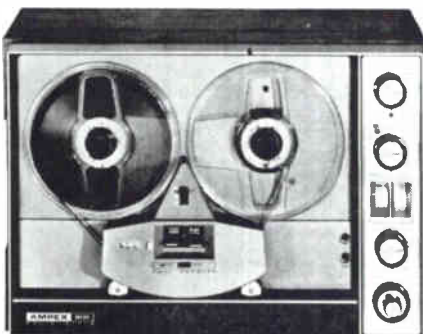

1100 SERIES

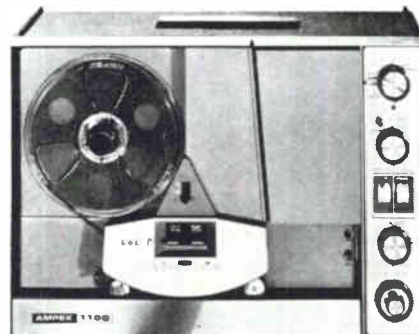

2000 SERIES



tape recorders / speakers / microphones / headsets / blank tape / accessories / stereotapes

AMPEX CORPORATION, 2203 LANDMEIER ROAD, ELK GROVE VILLAGE, ILLINOIS 60007

ask anyone who knows

AMPEX

DIRECTORY SECTION

stereo tapes in either direction automatically). Features remote controllable & built-in add sound and add echo. 2 speed (3 3/4 & 7 1/2 ips). Response 30-18,000 cps @ 7 1/2 ips; Flutter & wow less than .2% r.m.s. @ 7 1/2 ips; S/N 50 db; output level 1 v. Has 2 line & 2 mic inputs & transistorized record & play preamps. 19 1/4" h. x 14 1/4" w. x 8 3/8" d.
 Model 801 is self-contained with integral speakers and 5 w. monitor amplifiers in carrying case, complete with 2 dynamic mics\$499.95
 Model 802 tape deck. Does not have carrying case and speaker/amplifiers; microphones are optional equipment. 14 1/16" h. x 13" w. x 5 7/16" d\$429.95

CONCORD

Model 555 Tape Recorder

Transistorized preamps; 3-speed (7.5, 3.75, 1 7/8 ips) design with built-in amplifiers and speakers; record/playback, 1/4-track stereo or mono; separate erase & record/play stacked heads; response 40-16,000 cps ± 2 db @ 7.5 ips, 50-7000 cps ± 3 db @ 1 7/8 ips; wow & flutter .2% r.m.s. @ 7.5 ips. .35% @ 1 7/8 ips; signal-to-noise ratio better than 50 db; THD less than 2% @ 3 db



below rated output; two inputs/ch. (47-ohm to ext. amp and 8 ohms to ext. spkr.); 30A5 output tubes are used; split speakers in case cover for remote placement; 5w./ch. output; takes up to 7" reels & has 2 vu meters; features sound-on-sound recording; supplied with two dynamic mics. & mahogany carrying case; 11 1/2" h. x 13 3/8" w. x 14"\$249.95

Model 102 Mono Tape Recorder

Transistorized design; 2 speed (7 1/2 & 3 3/4 ips). dual-track mono; response 50-10,000

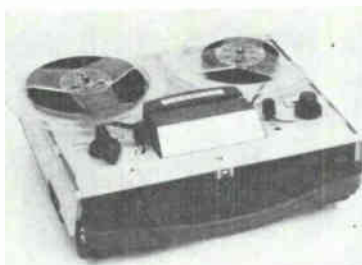

cps; wow & flutter .3 @ 7 1/2 ips. Has mic. & aux. inputs; earphone monitor output; built-in amplifiers with 10" x 2 1/2" spkr.; level indicator; complete with crystal mic. & earphone; 5 1/2" x 12 1/2" x 11"\$79.95

Model 220 Mono Tape Recorder

Three speeds (7.5, 3.75, 1 7/8 ips); permits playing time of 2 hours at 7.5 ips with 2400 foot, 7" tape; response 40-15,000 cps @ 7.5 ips; 40-5000 @ 1 7/8 ips; built-in 4" x 6" speaker; electronic-eye level



indicator; digital tape counter; includes dynamic microphone and earphones; 12" x 13" x 7 1/2"\$149.95

Model 444 Tape Recorder

Same as Model 555 except 2-track design. Response 50-15,000 cps ± 2 db @ 7 1/2



ips. S/N 40 db\$199.95

330 Portable Mono Recorder

All-transistor, battery operated, 2-speed (1 7/8 & 3 3/4 ips), mono, full-track design.



Features automatic voice-operated start/stop; automatic slide advance; automatic movie sync and automatic threading. Optional 117 v. a.c. operation; up to 6 hrs. playing time; 5" reels; vu meter & battery condition indicator. Response 50-10,000 cps. Uses "D" type batteries. Supplied with stop/start mic., leather pouch, earphone, special slide-projector plug, sensing tape. 12" x 8 3/4" x 3 3/4". 6 lbs.\$199.95
 AC-3 117 v. a.c. adapter.....\$ 14.95
 FT-2 Remote foot control\$ 14.95
 TP-2 Telephone pickup.....\$ 7.95
 Model 320. Economy version of 330 without remote control mic.....\$130.00
 VM-10 Remote control mic.....\$ 29.95

Model 884 Tape Recorder



All-transistor, 3-speed (1 7/8, 3 3/4 & 7 1/2 ips) design with separate 1/4-track record & playback heads. Features 2 separate record & 2 playback preamps; A-B switch for comparing source versus tape when monitoring; sound-on-sound, vu meters. Two 7" speakers & 7 1/2 w./ch. stereo amplifier. Response 30-20,000 cps @ 7 1/2 ips; S/N 60 db; wow & flutter .15% @ 7 1/2 ips; HD 1.5% at 30 db below rated output. Input mic (20 kohm) & aux. (100 kohm). Supplied with 2 dynamic mics, extension cord for right-channel extension speaker \$399.95

F-85 "Sound Camera"

1 7/8 ips recording speed. Mono dual-track portable design operated from 4 standard



flashlight batteries (a.c. adapter optional equip.); 12 hours battery life; 2 3/8" max. reel; transistorized circuits similar to Model 330. Has record level & battery life indicator. 5" x 7" x 3"; 2 lbs.; supplied with dynamic mic & carrying case.....\$39.50

120 Mono Tape Recorder

Transistorized, 3 speed (7 1/2, 3 3/4 & 1 7/8 ips); has 6 1/2" x 4" speaker, digital tape



counter, level indicator, mic & aux. inputs & earphone monitor output. Response 50-12,000 cps @ 7 1/2 ips. Supplied with lightweight hardwood case; 14" x 6 1/2" x 11"; 17 lbs.\$79.50

994 Tape Recorder

Automatic, transistorized, 3 speed (7 1/2, 3 3/4 & 1 7/8 ips) stereo design. Automatic opera-



tion provides: record up to 12 hrs. on a single reel without stopping, continuous prescanned play from 1 hr. to all day, plays both sides of stereo tape without changing reels, automatic threading, reverse & stop. Has sound-on-sound, two vu meters, 7 1/2 w./ch. output, tone controls; operates as p.a. system; 4 speakers (2 woofers, 2 tweeters); 2 dynamic mics, output jacks to hi-fi amp, 4 heads (2 record/playback & 2
 (Continued on page 72)

NEW SLEEK LOOK IN SUPERB SOUND—WHAT YOU WANT IS A WOLLENSAK! **3M**
COMPANY

Be sure to show the price tag, because most customers will think it's twice that price! And no wonder—this is the most strikingly beautiful tape recorder at any price. Magnificent walnut furniture six and one-half feet long. Modern sectional construction allows you to hang it on the wall, stack it, or put it in a bookshelf. And this slim styling contains the most advanced solid-state stereo tape recorder and two powerful stereo speakers. AM-FM stereo tuner is optional at extra cost. Uniquely designed Control Central is a sound studio in a hand-span: new power activated push buttons, two VU meters, 4 speed-4 track, four digit tape counter, monitor facility, stereo headphone jack, FM multiplex-ready, finest Wollensak construction. And the biggest advertising promotion in tape recorder history will tell the world about the new Wollensak "Sleek Look" line. So stock up now. Your Wollensak salesman has all the details.

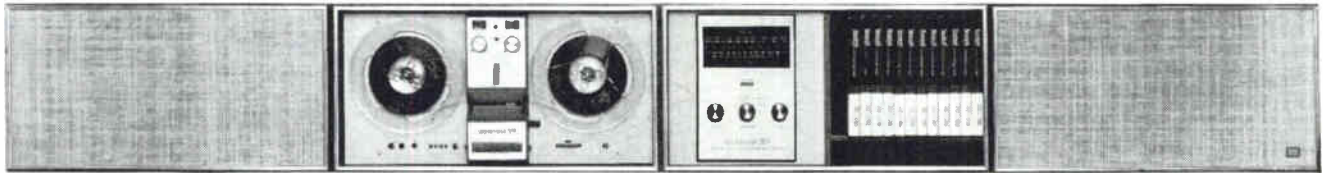

Over six feet of beautiful furniture, most advanced tape features: New Wollensak 5300 Stereo Recorder



DIRECTORY SECTION

erase). Response 40-16,000 cps \pm 2 db @ 7½ ips; S/N 55 db; wow & flutter .15% r.m.s. @ 7½ ips; has mic & aux. inputs; 8 ohm output impedance; 15½" w. x 11½" x 17" d.\$349.50

R-1100 Automatic Tape Recorder

Transistorized design with automatic features similar to Model 994. Has 3 hysteresis

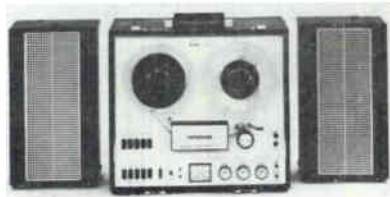

synchronous motors; record & playback preamps; A/B source tape monitoring; two degrees of built-in echo; sound-on-sound; level indicators; automatic tape lifters; 2 mic & 2 line inputs with mixing facilities; each speaker has its own power amp (6 transistors), tone control & an 8-ohm output for external speaker. Features four ¼-track heads (erase, record, 2 playback — ch. 1 & 3, 2 & 4); 2 speed (7½ & 3¾ ips); response 40-16,000 cps \pm 2 db @ 7½ ips; wow & flutter .15% r.m.s. @ 7½ ips; S/N 60 db; 16¾" w. x 14¾" h. x 7½" d.\$479.50
Optional accessories: remote stop/start control & panel assembly for custom installations.

Model R-1000 is same as R-1100 but does not include power amps & speaker systems\$399.50

R-2000 Automatic Tape Deck/Preamps

Designed for studio & broadcast work. Dual speed (7½ & 3¾ ips); four ¼-track heads



(erase, record & 2 playback—ch. 1 & 3, 2 & 4). Equipped with plug-in head assembly that may be replaced as desired (half-track & full-track assemblies available). Response 30-16,000 cps \pm 2 db @ 7½ ips; wow & flutter .12% r.m.s. @ 7½ ips; S/N 60 db; ½ sec. start/stop time; rewind 45 secs for 1200'. Has 2 high-impedance balanced or unbalanced line & 2 (10,000 ohm) unbalanced mic. inputs (can be intermixed); low-impedance cathode-follower outputs; 3 hysteresis-synchronous motors; level indicators; automatic reversal; 4 preamps (2 record & 2 playback); A/B monitoring & remote control up to 10' for rewind, fast-forward, stop, operate, record & reverse play. Accessories available as optional equipment: panel assembly for custom installations, full-track & half-track heads, and 15 & 7½ ips speeds. 17" w. x 15¾" x 7" d.\$695.00

CRAIG PANORAMA

TR-404 Tape Recorder

All-transistor, battery operated; 2" x 5" x 3½", 1½ lbs.; operates on four standard



penlite batteries. Comes equipped with leather carrying case, shoulder strap & microphone\$29.95

"Vista" TR-505 Mono Tape Recorder

Transistorized, battery-operated (6-"D" cells) with self-contained a.c. adapter. 2-speed (1½ & 3¾ ips), double-track design. Has level meter & battery indicator. Up to 4 hours recording on 5" reel; with mic;



phone pickup & foot switch accessories available. 5" x 12" x 10½" d., 10 lbs.\$159.95

"Vista" TR-520 Mono Tape Recorder

Transistorized, battery-operated 2-speed (1½ & 3¾ ips) design. Has vu meter for recording & battery life indicator. Has remote-control mic, earphone & batteries. Available accessories include a.c. adapter, foot switch, telephone pickup. 11½" w. x 9½" d. x 4½", 10 lbs.\$59.95

"Vista" 525 Mono Tape Recorder

Transistorized, 2-speed (1½ & 3¾ ips) featuring automatic level control; ideal for



group discussions. Has level & battery indicator. With mic. 5½" x 11¾" x 9", 8 lbs.\$69.95

TR-490 Mono Tape Recorder

Transistorized, half-track, battery-operated design with built-in mic. & 2¼" speaker.



Supplied with earphone & remote-control mic. Employs self-threading tape cartridge with 30 minutes capacity. 250 mw. output & separate record & play heads. Has leather case & shoulder strap. 6½" x 3¾" x 1½". 2 lbs.\$79.95

C-502 Car Tape Player

Transistorized 2-channel stereo amp, dual-stereo playback heads; electronic track se-

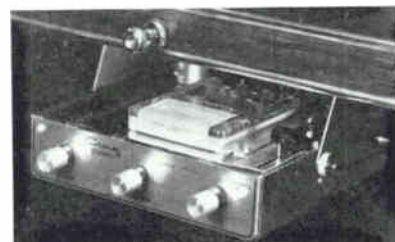

lector & self-activating cartridge system.\$119.00

C-501 Similar design with push-button track changer\$ 99.50

"Vista" 910 Tape Recorder

Features 2-speed (3¾ & 7½ ips), transistorized, 4-track record/play stereo or mono; 2—4" x 6" spkrs.; vu meter; reset counter; radio & mic. Response 50-15,000 cps; 117 v. a.c. operated; 17" x 14" x 5½" d. Supplied with plastic leatherette case....\$179.95

CROWN

SS700 Series Solid-State Recorders

Three heads with push-button transport; operate, fast-forward, rewind, and stop. Three motors, differential magnetic braking, automatic stop, three speeds. Handles up to 10½" reels; wow & flutter .09% @



7½ ips. Synchronous-drive motor. Available with either mono electronics or stereo control center. Performance on quarter-track stereo: response at 7½ ips 50-25,000 cps \pm 2 db; S/N 54 db. Six-channel stereo control center. Basic unit with 6 unbalanced line inputs, 2 mixing inputs per channel with a selection of aux. line, microphone, or

RIAA equalization. Outputs 0 level 600 ohm unbalanced or up to +18 dbm with headphone amp. Controls: input #1, input #2, input #3, input #4, output channel #1, output channel #2, play, record, read bias, read erase channels #1 and #2, three-speed equalization, bass & treble controls, also output selector for source, tape, tape output, or source and tape. Two 5-inch vu meters.

SS701 Full-track mono.....\$750.00
 SS702 Half-track mono.....\$750.00
 SS722 Two-track stereo.....\$895.00
 SS724 Quarter-track stereo.....\$895.00
 Complete series of players-only available.

"Mus-O-Matic" Series



Automatic, self-reversing transport; player only; playback response 30-15,000 cps ± 2 db @ 7.5 ips, 30-11,000 cps ± 3.75 ips; three-motor mechanism with hysteresis synchronous capstan motor; foolproof automatic self-reversing system; standard rack mounting 7.5 & 3.75 ips; controls—rewind, stop, operate, forward; power on/off; operate switch on-off; transistor preamp, cathode-follower output; 19" w. x 7 1/2" d. x 12 1/2" h.

Model "A314" Half-track mono.....\$495.00
 Model "A324" Four-track stereo.....\$520.00

SS800 Series Solid-State Recorders

Can be remote-controlled. Front-panel speed shift, photocell automatic stop. Three



motors, differential magnetic braking, three speeds. Handles up to 10 1/2" reels; wow & flutter .06% at 15 ips, .09% at 7 1/2 ips. Available with either mono electronics or stereo control center. Performance on quarter-track stereo: record/play response at 7 1/2 ips 30-30,000 cps ± 2 db. Six-channel stereo control center. Basic unit with 6 unbalanced line inputs, 2 mixing inputs per channel with a selection of auxiliary, line, microphone, or RIAA equalization. Outputs 0 level 600 ohm unbalanced or up to +18 dbm with headphone amp. Controls: input #1, input #2, input #3, input #4, output channel #1, output channel #2, play, record, read bias, read erase channels #1 and #2, three-speed equalization, bass & treble controls, also output selector for source, tape, tape output, or source and tape; two 5-inch vu meters. Available with low-impedance mic. input and balanced 600-ohm output.

SS801 Full-track mono.....\$1050.00
 SS802 Two-track mono.....\$ 985.00
 SS822 Two-track stereo.....\$1295.00
 SS824 Quarter-track stereo.....\$1295.00

SS844 Four-channel in-line.....\$2800.00
 Complete series of players-only available.

SS1000 Solid-State Recorders

Can be remote-controlled; photocell automatic stop; three motors; differential magnetic braking; three speeds; adjustable braking to accommodate many different types of tape. Accommodates 7 to 10 1/2" reels; wow & flutter .06% @ 15 ips, .09% @ 7 1/2 ips. Synchronous-drive motor. Available with either solid-state mono electronics or stereo control center.

SS1001 Full-track mono.....\$1540.00
 SS1002 Half-track mono.....\$1450.00
 SS1022 Two-track stereo.....\$1780.00
 SS1024 Quarter-track stereo.....\$1780.00
 SS1044 Four-channel in-line.....\$3220.00
 Complete series of players-only available.

700 Series Tape Recorders

Record and play response 20-30,000 cps ± 2 db @ 15 ips; 30-17,000 cps ± 2 db @ 7.5 ips; and 30-9,000 cps ± 3 db @ 3.75 ips; has three-motor transport; differential magnetic braking; automatic stop; separate bass & treble boost on record and playback; d.c. filaments; three-speed record/play equalization; 15, 7.5, & 3.75 ips (1 1/2 ips available); fast forward and rewind, 1200' in 38 sec.; handles up to 10 1/2" reels; maximum wow & flutter: .06% @ 15 ips, .09% @ 7.5 ips, 18% @ 3.75 ips; tim-



ing accuracy 99.8% for synchronous motor; signal-to-noise ratio 56 db @ 15 ips, 54 db @ 7.5 ips, 51 db @ 3.75 ips; overall distortion less than 1.5%; inputs—two high-impedance input channels, mic. or phono and mic or play; cathode-follower-type output; controls—forward, stop, play/record, thread/idle, stop, rewind switch, bias lock, mic. 1 play, mic. 2 phono, treble, bass, play/record, equalization (three speeds), reel size switch.

Model 701 Full-track mono.....\$635.00
 Model 702 Half-track mono.....\$525.00
 Model 712 Two-track stereo.....\$775.00
 Model 714C Four-track stereo with two- and four-track stereo playback.....\$795.00
 Complete series of players-only available.

"BX800" "Broadcaster" Series

Record and playback frequency response 30-28,000 cps ± 2 db @ 15 ips; 30-16,-



000 cps ± 2 db @ 7.5 ips; 30-8000 cps ± 3 db @ 3.75 ips; direct off-the-tape third head monitor; A-B switch; sound-on-sound with stereo models; "Touch" control with all-electric relay and solenoid operation; remote-control facilities; photocell automatic stop in all functions; standard rack mount;

— first choice
 of those who
 demand the best!

SOLID STATE RECORDERS

WITH MODULAR DESIGN FOR THE ULTIMATE IN QUALITY + DEPENDABILITY + PERFORMANCE — PRICED \$495 TO \$5,000

 **SX600 SERIES** — Designed for professional quality and economy price.

 **SS700 SERIES**—Designed for the serious audiophile.

 **SS800 SERIES** — Designed to please the most critical in listening or recording.

 **SS1000 SERIES** — Designed for ultimate in lab, data and other professional recording.

 **SS1400 SERIES** — Designed for extra-duty lab, data and industrial use... 14" reels.

 **SA300 SERIES**—Designed with automatic reversing for continuous background music systems.

 **SA1300 SERIES** — Designed with automatic reversing for extra-long continuous playback... 14" reels.



THE HALLMARK OF CROWN—
 SUPERLATIVE CRAFTSMANSHIP THROUGHOUT!

INDIVIDUAL PERFORMANCE
 RECORD SUPPLIED
 WITH EACH CROWN

Write to **Crown International**
 Box 1000, Dept. TA-10
 Elkhart, Indiana 46517

Put a **Crown** in Your Future!

CIRCLE NO. 11 ON READER SERVICE PAGE

DIRECTORY SECTION

tape speeds 15, 7.5 & 3.75 ips (1½ ips available); handles up to 10½" reels; maximum wow & flutter .06% @ 15 ips, .09% @ 7.5 ips, .18% @ 3.75 ips; timing accuracy 99.8%; signal-to-noise ratio (NAB) 60 db @ 15 ips and 7.5 ips, 55 db @ 3.75 ips; distortion (over-all off tape) less than 1.5%; inputs: two input channels, either low impedance microphone or balanced bridge; output 600-ohm balanced line output and cathode-follower output; controls: push-button—stop, rewind, play, & forward; rotary—mic., phono, record (P and R position), play, A-B, equalization (three speeds); switches—cue, reel size, power on-off; 19" w. x 7½" d. x 14" h.

Model "BX801" Full-track mono \$1035.00
 Model "BX802" Half-track mono \$ 945.00
 Model "BX822" Two-track stereo \$1395.00
 Model "BX824" Four-track stereo \$1340.00

SS1400 Series Solid-State Recorders

Accommodates 14" reels, quarter-inch tape, and half-inch and one-inch tape for industrial models. Can be remote-controlled. Front-panel speed shift, photocell automatic stop in all models; three motors, differential braking; three speeds; adjustable braking to accommodate many different types of tape; wow & flutter .06% @ 15 ips, .09% @ 7½ ips. Synchronous drive motor. Available with either solid-state mono electronics or stereo control center.

SS1401 Full-track mono.....\$1640.00
 SS1402 Half-track mono.....\$1550.00
 SS1422 Two-track stereo.....\$1880.00
 SS1424 Quarter-track stereo.....\$1880.00
 SS1444 Four-channel in-line.....\$3320.00
 SS1483 Three-channel half-inch.....\$3500.00
 Complete series of players-only available.

DUAL

TG12A Four-Track Stereo Recorder

Three-speed (1½, 3.75, 7.5 ips) stereo/mono record/playback with dual-channel amplifiers & speakers; has automatic shut-off; response 40-20,000 cps @ 7.5 ips, 40-16,000 cps @ 3.75 ips; signal-to-noise ratio 52 db @ 7.5 ips; wow & flutter .15% @ 7.5 ips; features sound-on-sound & sound-with-sound; 13" x 15" x 10".....\$349.95
 TG-12 Deck only.....\$245.00

DYNACO

Transistorized Tape Recorder

Imported from B&O of Denmark; fully transistorized, 3-speed complete recorder with built-in power amplifiers; three inputs



(200-ohm mike, RIAA equalized phono, radio tuner) mixed via professional-type slide potentiometers; provision for sound-on-sound and echo; two record-level meters; hysteresis synchronous motor; separate record and playback heads; tape-input monitoring; preamp output; all plug-in circuit boards; 40-16,000 cps ±2 db; r.m.s. flutter

less than 0.075%; peak-to-peak flutter less than 0.2%; S/N ratio 50 db.\$498.00
 Portable version of the above machine includes a pair of monitor speakers built into the case covers.....\$525.00

EICO

Model RP-100 Tape Deck

Provides stereo/mono ¼-track record, playback, erase; also ½-track stereo/mono

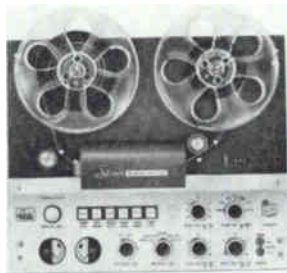

playback; speeds 7½" and 3¾" ips; takes 7" reels; separate record/playback heads; separate record and playback transistor electronics to monitor while recording; permits sound-on-sound recording; dual meters, push-button controls; rewind and fast forward 1200' per minute; frequency response 30-15,000 cps ±2 db at 7½ ips, 30-10,000 cps ±2 db at 3¾ ips; timing accuracy 0.3%; has automatic end-of-tape switch; wow and flutter under .15% r.m.s. at 7½ ips, under .2% r.m.s. at 3¾ ips.\$450.00
 Model RP-100K (semi-kit includes transport assembled, control electronics and stereo playback amplifiers in kit form)\$299.95

FANON-MASCO

FTR-409 "Ambassador" Recorder

3-speed (7½, 3¾ & 1½ ips) 4-track stereo recorder with amplifiers & speakers. Features sound-with-sound; vu meters; counter; automatic shut-off; 6" oval speakers;



pause control. Records 4-track stereo & mono. Response 40-14,000 cps @ 7½ ips; S/N 50 db; separation 50 db. 17" h. x 15" w. x 10½" d. Supplied with 2 dynamic microphones\$299.95

FTR-408 "Envoy" Recorder

Dual-speed (7½ & 3¾ ips) mono, dual-track design. Features 5" reels; level indicator; mic & radio inputs; 4" speaker. Response 200-9000 cps @ 7½ ips; S/N 38 db; 1 w. output; wow & flutter .3%. 12½" x 9" x 6", wt. 11 lbs. Supplied with dynamic mic\$69.95

FTR-404B "Diplomat" Recorder

Dual-speed (3¾ & 7½ ips) mono design; dual track; 7" reels; vu level meter; counter; 6" oval speaker; high-level input. Response 100-12,000 cps @ 7½ ips; 3.5 w. output; S/N 48 db; wow & flutter .25% r.m.s.; separation 45 db; 15" w. x 12½" d. x 6¼" h. Supplied with dynamic mic\$114.95

FTR-403 "Escort" Portable Recorder

Battery operated or a.c. with adapter; 3¾" reels; dual-speed (3¾ & 1½ ips); level meter; battery life indicator; 4 hours recording. Response 150-8000 cps; 250 mw. output; S/N 40 db; wow & flutter .3%. Uses 6 "D" cells with life of 15 hrs. 5" x 9" x 3", wt. 5 lbs. Supplied with remote-control dynamic mic, earphone & radio connector cable. Optional equipment: a.c. power adapter, remote-control foot sw., telephone pickup, leather case with shoulder strap.....\$99.95

FERROGRAPH

Series 5 Mono Recorder

Two-speed (3.75 & 7.5 ips), 3-motor design; wow & flutter .16%; response 40-10,000 cps ±3 db @ 3.75 ips, 40-15,000 cps @ 7.5 ips; dual inputs (.003 v. & 1 v. peak); output speaker or 2½ v. @ 15 ohms; includes amplifier & speaker. Model 5A/N.....\$425.00

GEM SONIC

Model 802 Tape Recorder

Transistorized 2-speed, 4-track stereo/mono record/play; dual 6-watts-per-channel power amplifiers; provisions for sound-on-sound, sound-with-sound, and automatic shut-off. Stereo inputs for microphone and auxiliary, and four outputs for external

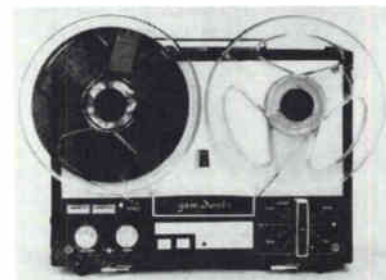

amplifier and speakers. Dual record/playback level meters; three-digit tape counter; separate volume and tone controls for each channel; two dynamic microphones and patch cables included\$229.95

Model 803 Tape Deck

Same as above, but lacks power amplifiers and tone controls\$129.95



GRAETZ

Model M50K Tape Recorder

Four-track, two-speed (7.5 & 3.75 ips) record/play stereo design; has mono or stereo inputs for microphone, radio, phono; external speaker outputs; has provision for foot-control pause accessory; response essentially flat from 40 cps to beyond audibility; wow & flutter less than ±.5%; includes built-in preamp and power amplifier for both channels; 5 watts total output; single speaker; built-in mixing facility; electrical tape end stop; adapter cord available which permits tracks 1 & 3 or 2 & 4 to be played simultaneously through

(Continued on page 77)



Carry-Corder '150' shown 80% of actual size

Norelco® Cordless Tape Recorders



Norelco Carry-Corder® '150'

Tiny tape cartridge loads in seconds, records for an hour

Revolutionary tape recorder, features reusable snap-in cartridges, one button control to start, stop, wind-/re-wind tape. Separate volume controls for record and playback. Weighs only 3 lbs. with 5 flashlight batteries. 1 7/8 ips constant speed capstan drive. Has dynamic microphone with detachable remote switch. Superior sound quality with frequency response of 100 to 7000 cps. Con-

nections for recording and playback directly with radio, phono, TV or another tape recorder. 7 3/4" x 4 1/2" x 2 1/4". **Prepacked in Deluxe Case** with 4 cartridges (each in a dust proof container with index card), microphone, fitted carrying case, mike pouch, patchcord and tape mailer. **CIRCLE 51 ON READER-SERVICE CARD**



Norelco Continental '101'

100% transistorized for on the spot record/playback... up to 2 hours on a single reel. 2 track 1 7/8 ips constant speed machine weighs 8 lbs. with 6 flashlight batteries. Features dynamic microphone, tone control, record/level/battery condition indicator. Includes direct recording patch-cord. Frequency response 80 to 8000 cps. 11" x 3 3/4" x 8".

CIRCLE 52 ON READER-SERVICE CARD

Norelco Continental Tape Recorders

Norelco Continental '401'

The recording studio in a suitcase

Fully self contained 4 track stereo record/playback. 4 speeds, 7 1/2, 3 3/4, 1 7/8, 1/4 ips - up to 32 hours on a 7 inch reel. Has dual preamps, power amplifiers, stereo matched speakers. (2nd speaker in lid). Ganged stereo controls eliminate need for dual knobs and microphones. Special facilities include monitoring, mixing, sound on sound, portable P.A. Frequency response 50 to 18,000 cps; wow and flutter less than 0.14% at 7 1/2 ips. Signal to noise ratio better than -48 db.

Weights 39 lbs. 18 1/4" x 15" x 10".
CIRCLE 53 ON READER-SERVICE CARD



Norelco Continental '201'

New marvel of tape recording versatility

Multi-purpose 4 track tape recorder has every built-in feature for quality recording and playback; 2 speeds, 7 1/2 or 3 3/4 ips provide up to 8 hours playing time on a single 7 inch reel. Fully self contained. Has dual preamps for stereo playback with external hi-fi system. Special facilities include parallel operation, mixing, pause control, tone control, portable P.A. Frequency response 60 to 16,000 cps.

Weights 18 lbs. 15 3/4" x 13 3/4" x 6 3/4"
CIRCLE 54 ON READER-SERVICE CARD



Norelco Continental '95'

Quality engineered, budget priced tape recorder

Compact 3 3/4 ips speed machine provides up to 3 hours playing time. New automatic record control *electronically* sets correct recording volume. Make a perfect tape everytime. Has simple pushbuttons to record, playback, wind, rewind, tape pause and stop; adjustable controls for on/off, volume and tone. Frequency response 80 to 12,000 cps.

Weights 12 lbs. 14 1/4" x 10" x 5".
CIRCLE 55 ON READER-SERVICE CARD

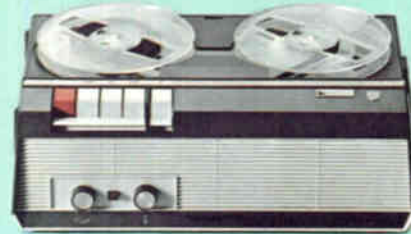

All specifications subject to change without notification.

Norelco Tape Recorder Accessories

FOR MODEL	DESCRIPTION	FOR MODEL	DESCRIPTION
'101'	DL 86 Leather Carrying Case	'95', '101', '150'	TP 86 Telephone Pickup Coil
'101'	CC 86 Texon Carrying Case	'150'	TC 2 x 30 Tape Cartridge
'101'	BE 86 AC Adapter	'201'	EL 3775/21 Monitoring Headset
'101'	RS 86 Remote Mike Switch	'201', '401'	EL 3984/15 Foot Control
'150'	BE 50 AC Adapter	'201', '401'	TP 34/49 Telephone Pickup Coil
'101', '150'	FP 86 Foot Pedal	'401'	EL 3775/37 Stereo Headset
'101', '150'	HP 86 EL 3775/85 Listening Headset	'401'	2A1048 Mike Adapter
'101', '150'	CTM 86 Close Talking Mike		

CIRCLE 56 ON READER-SERVICE CARD

NORTH AMERICAN PHILIPS COMPANY, INC.

High Fidelity Products Department

100 East 42nd Street, New York, N. Y. 10017



the built-in speaker; also available is a polytonal sound blender adapter for trick recordings, sound-on-sound, or sound-with-sound: tubes—6FG6, 2-6227, 2-12-AX7, 2-6AB4, 2-6DL5.....\$399.90

INTER-MARK

"Cipher VI" Tape Recorder

Dual-speed (7½" & 3¾ ips); 4-track stereo & mono record and playback. Has

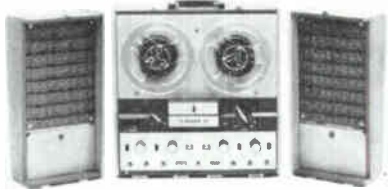

pause control; vu meters; counter; built-in amplifiers & speakers. Response 60-14,000 cps @ 7½ ips; flutter & wow .2% @ 7½ ips; S/N 45 db. Inputs for 2 mics. & 2 high level. Can be used as p.a. system. Complete with carrying case & 2 dynamic microphones. 16" w. x 16" x 11" d.....\$239.95

"Cipher V" Tape Recorder

Two-speed (1½ & 3.75 ips) dual-track mono design; features automatic pause, re-

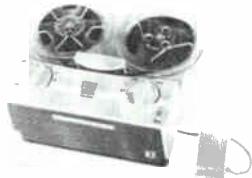

cording level light, 5" reel, 6" x 3" speaker; frequency range 70-8000 cps @ 3.75 ips, 70-4000 cps @ 1½ ips; supplied with dynamic mic, flight-type luggage carrier, earphone; 5½" x 9½" w. x 8½" d.; 9½ lbs.\$79.50

"Cipher I" Tape Recorder

Three-speed (7.5, 3.75, 1½ ips), mono two-track design; features recording level light,



counter, 6" x 4" speaker; output 5 w.; frequency range 70-13,000 cps @ 7.5 ips, 70-4000 @ 1½ ips; supplied with monitoring earphone, dynamic mic, and leatherette cov-

ered wood cabinet; 6½" h. x 13⅞" w. x 13" d.\$129.95
"Cipher I-II" Same as "Cipher I" except for an all-transistor amplifier\$139.95

"Cipher VII-T" Tape Recorder

4-track, 3-speed (7½, 3¾, 1½ ips) with 2 detachable speakers. Has 2 heads, ¼-track stereo/record with ½ & ¼ track stereo playback; 2 vu meters; 2-5" spkrs. Response 35-15,000 cps @ 7½ ips; wow &

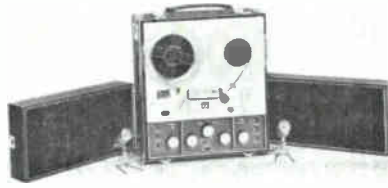

flutter .25% @ 7½ ips; 3 w./ch.; S/N 50 db; Features sound-with-sound and is supplied with 2 dynamic mics.....\$299.95

"Cipher II" Mono Tape Recorder

Transistorized 2-track, 2-speed (7½ & 3¾ ips), 2 w. output; response 100-10,000



cps @ 7½ ips; S/N 40 db @ 1000 cps; has 4" x 6" speaker; mic & radio inputs; ext. speaker & earphone outputs; vu meter; digital counter; 7" reel. Supplied with dynamic mic & earphone. 15¼" x 13¼" x 6"\$109.95

"Cipher VIII-T" Tape Recorder

Transistorized, 4-track, 3-speed (7½, 3¾, 1½ ips) design with detachable



speakers. Has 3 heads: erase, play, record; 5 w./ch.; response 35-15,000 cps @ 7½ ips; S/N 52 db; wow & flutter .2% @ 7½ ips. Features sound-with-sound & sound-on-sound; vu meters; 2-5" spkrs. Supplied with 2 dynamic mics. 20¼" x 15½" x 8½"\$350.00

KNIGHT

KN-4401 Stereo Tape Recorder

Built-in record/playback preamps; 4-track record/play & erase heads; two speeds (7½ & 3¾ ips); response 50-15,000 cps @ 7½ ips; vertical or horizontal mounting; flutter & wow 0.2% r.m.s.; S/N better than 40 db; controls: record-play-off; volume 1 & 2; stereo/mono; mic/tape head. Inputs:

mic/tape-head 1 & 2; high-level 1 & 2 (at rear). Takes 7" reels; 13" x 13" x 6¼"; less base\$169.95
Walnut base.....\$ 15.95



Carrying case.....\$ 19.95

KNIGHT-KIT

"Superba" KG-415 Tape Deck/Preamps

Solid-state stereo design with pre-assembled Viking tape transport. Has six solid-state



plug-in modules, including headphone amplifier and bias test oscillator modules. Features separate monitor switch with monitor-level controls, mixing facilities, push-to-reset digital counter, easy-edit head cover. Three 4-track hyperbolic-contoured heads permit direct tape monitoring, echo, sound-on-sound recording. Six-position "selector" control with record and playback operation shown by illuminated windows. Two vu level indicators for record and playback of each channel. Response: 50-18,000 cps ± 2 db @ 7½ ips; 50-14,000 cps ± 2 db at 3¾ ips. Flutter & wow .2% r.m.s. @ 7½ ips. Signal-to-noise ratio 50 db. Has modular 1-ke test oscillator for precise adjustment of head voltages, dual preamps drive low-impedance stereo headphones. 17 transistors & 6 diodes. 14½" x 14" x 8½".

Kit\$249.95
Walnut Base\$19.95

KORTING

Model 260 Tape Deck/Preamps

Stereo, 4-track with 2 heads; similar to TR3000 but does not include mics, speakers, and power amps; does have preamplifiers for record & playback.....\$219.95
270DC with gray carrying case.....\$229.95

88-B Portable Mono Recorder

Transistorized battery or a.c.-operated; amplifier operates 80 hours & motor up to 20 hours on one set of batteries. Plays 70 min. on ¼" dual-track tape; 2½" reel; 1½ ips; 10 mw. output. Response 100-6000 cps; mic. serves as speaker on playback. Supplied with remote-control mic., earphone. Various accessories, including carrying case, ext. amp-speaker, telephone adapter, foot con-

DIRECTORY SECTION

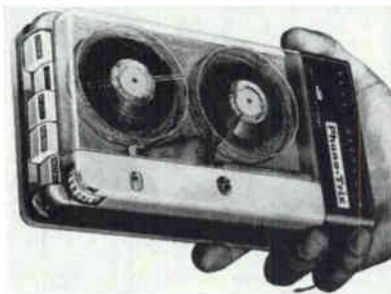

rol, 117-v. a.c. adapter, etc., available. 1 7/8" x 4 1/4" x 7 1/2"\$69.95

TR2000 Tape Recorder

Similar in design & performance to Model TR3000 except has only single channel am-



plifier & speaker; has stereo heads for 2nd channel record & playback; can convert stereo tapes to mono for self playback; 14 1/4" w. x 12 1/2" d. x 7 1/2" h.; supplied with one low-impedance dynamic mic. & gray carrying case.....\$199.95

TR3000 Tape Recorder

Two-speed (7.5 & 3.75 ips); plays 4-track & 2-track stereo & mono; records 4-track



stereo & mono; has stereo amplifiers & speakers; features p.a. amplifier & sound-on-sound dubbing; response 30-20,000 cps ± 3 db @ 7.5 ips, 40-15,000 cps @ 3.75 ips; wow & flutter .2% @ 7.5 ips; S/N ratio 45 db; 10 w. output; 16 1/2" x 12" d. x 6 1/4" h.; supplied with two low-impedance mics.....\$299.95

TR4000 Transistorized Tape Recorder

Three-speed (7.5, 3.75 & 1 1/2 ips); 4-track record & playback with stereo amplifiers & speakers; features 3 heads (erase, record,



playback); separate bass & treble controls in record position; one knob for synchronized dubbing; completely transistorized; record level meters; remote pause; variable echo or reverb effects; response 30-20,000 cps @ 7.5 ips, 40-7000 cps @ 1 1/2 ips ± 3 db; wow & flutter .1% @ 7.5 ips; S/N ratio 45 db; 10 watts audio output; 117 v. operation; 18" x 13" d. x 8" h.; supplied with two low-impedance microphones\$399.95

212 "Conferette" Mono Recorder

Features talk/listen/stop/reverse/review/erase remotely controlled from micro-



phone; battery operated transistorized; for voice only; has battery level indicator; built-in loudspeaker; automatic end-of-reel stop; 6 1/4 lbs.; 3 1/4" h. x 5 1/2" d. x 12 3/4" w.; 117 v.; 12 or 6 v. auto battery adapters available\$169.95
Model 216 Similar to Model 212 but designed for 117 v. a.c. operation or from rechargeable batteries or direct from car battery; has built-in battery recharger.\$199.95

LAFAYETTE

RK-142 Mono Tape Recorder

Two-speed (3.75 & 7.5 ips), dual-track mono record/playback design; has 4" x 6"



speaker, record level indicator, provision for external speaker; signal-to-noise ratio 42 db @ 7.5 ips; wow & flutter .2% or better @ 7.5 ips; complete with dynamic microphone and case; 11 1/4" x 9 7/8" x 7 1/8"\$59.95

"Criterion 1000B" Recorder

Records 4-track stereo and mono; plays 2- & 4-track stereo & 4-track mono. Features



3 speeds (7 1/2, 3 3/4 & 1 1/2 ips); transistorized stereo preamps; automatic shut-off. Response 50-15,000 cps ± 3 db @ 7 1/2 ips; S/N 50 db; wow & flutter .2% @ 7 1/2 ips. Has 2 mic. & 2 high-level inputs; two 6" x 4" oval speakers. 6 w./ch. output; counter; level meters; mic./radio mixer control; record/play & erase heads. Supplied with 2 dynamic mics & teakwood cabinet. 17 1/4" w. x 7 3/4" h. x 12 3/4"\$189.95

Model RK-137A Tape Recorder

Two-speed (3.75 & 7.5 ips) four-track recorder & playback design; features



pause button, electronic switching between tracks 1-4 and 3-2; separate record and erase heads; vu meter; will record and playback mono 4-track; has amplifiers and speaker for single channel playback; will play back stereo with external second-channel audio system that has input for tape head; signal-to-noise ratio 42 db; outputs for extension speaker, monitor, and second-channel stereo playback; furnished complete with removable top cover & microphone; 13 1/2" w. x 6 1/2" h. x 10 3/8" d.\$89.95

Model RK-650 Tape Recorder

Four-track, 2-speed (7.5 & 3.75 ips) push-button operated; will record and play back



stereo or mono; features sound-with-sound recording; automatic tape cut-off switch; separate record/play and erase heads; index counter and level indicators each channel; dual-channel transistorized preamps, vacuum-tube power amps for record and playback (speaker not included); response 40 18,000 cps @ 7.5 ips, 40-12,000 cps @ 3.75 ips; wow & flutter less than .2% @ 7.5 ips; signal-to-noise ratio 45 db; audio output 2 watts/channel; 15 1/2" w. x 6 1/4" h. x 11 1/8" d. (5 1/2" below panel); less case.....\$109.95
With carrying case.....\$124.95

RK-600A Tape Recorder

Two-speed (7 1/2 & 3 3/4 ips), 4-track design. Records 4- & 2-track stereo. Plays 4-



& 2-track stereo, 2-track & full-track mono. Features separate record/playback & erase heads; pause control; individual level indicators; hi & low level inputs for mic., tuners, etc.; monitor outputs; sound-with-sound. Response 40-15,000 cps @ 7 1/2 ips; (Continued on page 80)

NOW YOU CAN EASILY ADD
SOUND TO YOUR SLIDE
OR FILM SHOWS WITH
POPULAR PHOTOGRAPHY'S
EXCITING NEW
"SOUND FOR A
PICTURE EVENING"
RECORD ALBUM

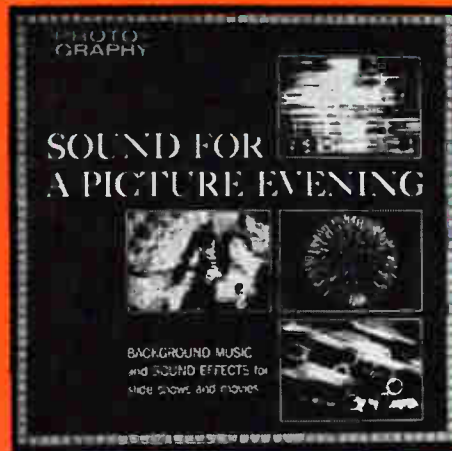

"Sound For A Picture Evening"
Consists of selections from the music masters
of the Capitol Record Hollywood Library
High Fidelity 12-inch vinyl album—33½ RPM
Playing time: 40 minutes
AVAILABLE IN MONAURAL OR ELECTRONIC STEREO
AT NO EXTRA COST

EXPRESSLY CREATED FOR FILM
AND SLIDE SHOWS

No matter how good your film and slide shows are, sound will make them better...more entertaining and certainly more professional. But, it has to be the right kind of sound. Although any musical record can be used as a background for your film and slide shows, few, if any, can match the variety of actions, situations, and scenes inherent in most shows. That's why Popular Photography created this album. It's ideal for almost every mood captured by your camera. Whether your show is simple, elaborate or somewhere in-between—"SOUND FOR A PICTURE EVENING" provides a final, professional touch to make it a complete success.

A POPULAR PHOTOGRAPHY
EXCLUSIVE

The "Sound For A Picture Evening" album has been produced by the editors of Popular Photography exclusively for our readers and is prepared by the Custom Services Division of Capitol Records. This outstanding album cannot be purchased in any store and is available by mail only to the readers of Popular Photography and other Ziff-Davis magazines.

ALBUM CONTENTS:
17 SPECIFIC MOOD MUSIC
BACKGROUNDS
8 TRACKS FOR SPECIAL
SOUND EFFECTS

THEMES TO MATCH YOUR
SUBJECTS... PERFECTLY!

3 FILM OPENINGS: Grandiose, Sweet and Gentle and Dramatic • 3 FILM CLOSINGS: Epic Finale, Hollywood Style and Gentle • 11 THEMES: Happy-Go-Lucky • Gay Party • Vacation Tempo • Traveling • Happy Birthday Party • Pomp of a Parade • Sound of a Carousel • Circus Time • Sentimental Moments • Children's Playtime • Christmas Time

DON'T MISS OUT ON THIS OUTSTANDING OFFER.
FILL IN AND MAIL TODAY

FOR SPECIAL SITUATIONS,
THESE WONDERFULLY REALISTIC
SOUND EFFECTS

Ocean Waves • Train • Jet Planes • Baby Crying • Crowd
In Stadium • Traffic • Dog Barking • Thunder And Rain

FREE! WITH YOUR ALBUM
PURCHASE — IF YOU ORDER NOW

Complete Instruction Booklet—Here, in one comprehensive booklet, is all the information you need to make your film or slide show a resounding success. You will find helpful tips on how to build an effective sound track, choosing the right background selections and sound effects, synchronization, taping, organizing your show, editing and much more.

BAND POINTER—Fits on the top of your record and tells you where to find the exact band you want. Eliminates guesswork, fumbling and wasted time. Lights...Projector...Action!

This wonderful 12" long-playing album
(a must for every slide and film show impresario)
can be yours for

ONLY \$3.49 POSTPAID

MONAURAL OR ELECTRONIC STEREO

... a small price to pay for an album you will enjoy
and treasure for many years. ORDER NOW.

"Sound For A Picture Evening"
POPULAR PHOTOGRAPHY—Dept. SD
One Park Avenue, New York, N.Y. 10016

Please send me _____ albums at \$3.49 each. My
check (or money order) for \$_____ is enclosed. I
understand that you will pay the postage. (Add 75¢ to
partially defray postage costs outside U.S.A.)

CHECK ONE: MONO STEREO

Name _____

Address _____ TRA-66

City _____ State _____ Zip Code _____

Sorry—No charges or C.O.D. Orders

DIRECTORY SECTION

separation 45 db; wow & flutter .25%; S/N 45 db; 1.5 w./ch. output. Supplied complete with built-in amplifiers & two 4" x 6" oval speakers. vinyl covered case & 2 dynamic microphones\$99.88

Model RK-675 Tape Recorder

Deluxe push-button 4-track, 2-speed design (7.5 & 3.75 ips); records 4-track stereo and 4-track mono; features sound-with-sound recording; automatic shut-off of tape transport; two-channel transistorized preamps and vacuum-tube power amps; response 40-18,000 cps @ 7.5 ips. 40-12,000 cps @ 3.75 ips; signal-to-noise ratio 45 db; wow and flutter less than 0.2% @ 7.5 ips; controls: pause, two record buttons with safety interlocks, push-button, rewind/stop/play, stop/fast forward, tone control switch, 2 volume controls; has two 4" x 6" speakers; four input jacks; four output jacks; complete with simulated leather case and two microphones; 16 1/8" w. x 7" h. x 12 1/8" d.\$159.95

LEAR JET

Stereo 8 Cartridge Tape Player

Transistorized design for car, boat, or airplane installation. 8-track stereo or mono, 3 3/4 ips; continuous play design. Has automatic or push-button program selector; up to 2 hrs. and 40 min. mono play. Wow & flutter .3%. Supplied with mtg. bracket & 4 door-mounted speakers with grilles (one for each door in 4-door model cars). 8" w. x 7 1/4" d. x 2 1/4"\$159.00
With AM radio.....\$179.00

MAGNECORD

"1022" Stereo Tape Recorder

Similar to Model "1021" in design & performance but for stereo operation. 2-speed



(7 1/2 & 15 ips); wow & flutter .17% @ 7 1/2 ips, .15% @ 15 ips; response 30-16,000 cps ± 2 db @ 7 1/2 ips & 35-22,000 cps @ 15 ips. Heads: selectable 2-channel erase, 2-channel record, 2-channel play & 1/4-track play\$788.00
With case\$848.00

"1024" Stereo Tape Recorder

Similar in design & performance to Model "1021" except for stereo operation. 1/4-track stereo or 4-track mono operation. Heads selectable 1/4-track erase, 1/4-track record, 1/4-track play. Optional 2-channel stereo play head available installed in 4th head position. Inputs: mic. (50 kohms), high impedance mixing bridge & aux. bridge. Outputs: emitter-follower & aux. emitter-follower (.5 v.).....\$648.00
With 4th head installed.....\$673.00
Case\$ 60.00

"1028" Stereo Tape Recorder

2-speed (7 1/2 & 15 ips) tube design. Wow & flutter .15% @ 7 1/2 ips & .1% @ 15 ips; response 35-16,000 cps ± 2 db @ 7 1/2 ips & 35-18,000 cps @ 15 ips; S/N 55 db; reels 5", 7" & 10 1/2"; rewind time 2400" in less than 1 minute. Inputs: high & low imp. mics & high-impedance balanced & unbalanced bridge. Outputs: cathode-follower, 2.5 v. & 150/600 ohms balanced. 17 1/8" w. x 12 1/2" h. x 12" d.



"1028-2X" 2-track stereo or 1/2-track mono; less case\$ 995.00
"1028-24X" with 4th head (1/4-track stereo play), less case\$1075.00
"1028-4X" 1/4-track stereo or 4-track mono. less case\$ 995.00
"1028-42X" with 4th head (2-track stereo play), less case\$1075.00
Case optional.....\$ 50.00

"1048" Stereo Tape Recorder

Same as Model "1028" except for tape speeds 3 3/4 & 7 1/2 ips; response 40-16,000 cps ± 2 db @ 7 1/2 ips. 12" deep. Available versions & prices same as Model "1028" tape recorder.

"1021" Mono Tape Recorder

Two-speed (3 3/4 & 7 1/2 ips) mono recorder; full-track record & erase and half- or full-



track playback. Wow & flutter .2% @ 7 1/2 ips; response 45-18,000 cps ± 2 db @ 7 1/2 ips; S/N 53db for both speeds. Inputs: low-imp. mic., balanced bridge, unbalanced bridge, mixing bridge & aux. bridge. Outputs: 150/600 ohm balanced & aux. A & B unbalanced. All-transistor design featuring built-in cueing speaker with separate volume control & amp. (amp will drive an external speaker); phone jacks; mixing input with separate gain control; simultaneous record & playback; adjustable impedance input & output transformers; vu meter; remote "start/stop." Transport size 19" w. 10 1/2" h. x 7 1/2" d; amplifier size 19" w. x 5 1/4" h. x 12" d.\$708.00
With case\$768.00

MARTEL

Model 301 Mono Recorder

4-speed (7 1/2, 3 3/4, 1 1/2 & 1 1/4 ips); transistorized 1/2-track portable design. Has dual-purpose record level vu meter & bat-

tery condition indicator, pause control, 5" reel capacity, remote-control mic; radio, phono & mic. inputs: six 1.5-v. "D" batteries; 4" x 5" speaker. Response 60-14,000 cps @ 7 1/2 ips; S/N 40 db; playing time 8



hrs. @ 1 1/2 ips; 12" x 5 1/4" x 10 1/4"; 12 1/2 lbs.\$199.50

MIRANDA

Model "Mirandette C" Portable Recorder

2-speed (3 3/4 & 1 1/2 ips); dual-track, battery or 117-v. a.c. operated. Dual-purpose



recording level & battery quality indicator with digital counter. Response 200-6000 cps ± 5 db; wow & flutter .3%; 2 3/4" x 4" speaker (500 mw. @ 5% dist.); S/N 40 db. Uses 3" reel, 4 D-cell batteries & has 6 transistors & 1 diode; 9 3/8" x 8 3/16" x 3 1/4". wt. 7 1/4 lbs. Supplied with remote-control dynamic mic., leather carrying strap, shoulder grip, and a.c. cord....\$169.95
Carrying case.....\$ 11.95
Foot control.....\$ 6.95
Telephone pickup.....\$ 5.95

NEWCOMB

TX10 Series Tape Deck/Preamps

Features 10 1/2" tape reels; record & playback level meters; mixing controls for dual



mic & line inputs with individual control knobs; sound-on-sound; 3 heads (record, playback, erase); bias indicator lights. Monitor before recording or off the tape; 2-speed (7 1/2 & 3 3/4 ips); 4-digit counter; automatic

shutoff. Response 30-18,000 cps \pm 2 db @ 7½ ips; wow & flutter .15% @ 7½ ips; S/N 55 db; HD 1%; output 5 v. from cathode followers. Size unmounted 12¼" x 16" x 8".

TX10-2 ½-track stereo; 3¼ & 7½ ips; less case.....\$750.00
 TX10-4 ¼-track stereo; 3¼ & 7½ ips; less case.....\$750.00
 TX10-215 ½-track stereo; 7½ & 15 ips (special order only); less case.....\$825.00
 TX10-415 Same as TX10-215 except ¼-track.....\$825.00
 CA-133 Portable case.....\$25.00
 SA-80B Portable 20 w./ch. music power stereo amp with portable case; 8½" x 16¼" x 16¼".....\$199.50
 J-200 Portable 2-way speaker system with tweeter control & case; 14¼" x 20" x 10¼".....\$79.50
 K-400 Portable 3-way speaker system with tweeter control & case; 16⅞" x 23½" x 10¼".....\$129.50
 SA-80B-J2 Complete reproducing system; 1 SA-80B, 2 J-200 with cables, wt. 71 lbs.....\$368.40
 SA-80B-K2 Complete reproducing system; 1 SA-80B, 2 K-400 & cables, wt. 102 lbs.....\$468.40
 Misc. accessories available.

NORELCO

"Continental 101" Portable Recorder

Transistorized, 2-track, 1⅞ ips design. Response 80-8000 cps; S/N 45 db. 6 D-type

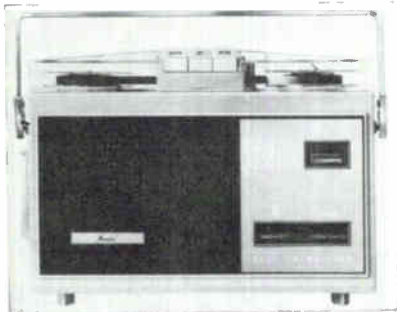

batteries are used to provide 40 hours of recording. Uses 4" tape reel for 3 hrs. recording. Has combination level & battery condition indicator & dynamic mic. Wt. 7 lbs. 11" w. x 3¼" d. x 8".....\$99.50
 Accessories available: Leather carrying case, remote mic. sw., a.c. adapter & headphones.

"Continental 401" Tape Recorder

Completely transistorized, 4-track stereo/mono record & playback; 4-speed (7.5,



3.75, 1½, & 1⅞ ips); includes complete stereo amplifiers & two speakers (1 speaker in cover); can be used as p.a. amplifier, and has interlock pause button, mixing facilities, multiplexing facilities; stacked heads; automatic end of tape stop & sound-on-sound; response 50-18,000 cps @ 7.5 ips, 60-4500 cps @ 1⅞ ips; signal-to-noise better than -48 db; wow & flutter less than .14% @ 7.5 ips.\$219.50

"Continental 201" Mono Tape Recorder

4-track mono record/playback & stereo

head output. Has single channel amplifiers & speaker. 2-speed (7½ & 3¼ ips) design. Response 60-16,000 cps \pm 3 db; wow & flutter .14% r.m.s.; S/N 40 db. Features pause control, magic-eye level indicator;



public address system; tape counter & mixing facilities for mic, radio, or phono. Accessories available: telephone pickup, foot control, headset. Two-tone wood case 15¼" x 13¼" x 6¼".....\$149.50

"Continental 95" Mono Tape Recorder

2-track mono record & playback, 3¼ ips speed. Response 80-12,000 cps; wow & flutter .2%; S/N 45 db. Features pause control, 4" speaker, and automatic record level control. Supplied with dynamic mic.....\$79.50



Model 150 Mono Tape Recorder
 Portable battery-operated design featuring snap-in type tape cartridge. Has 2 tracks,

Model 150 Mono Tape Recorder

1⅞ ips speed; 2 x 30 minutes playing time. Response 100-7000 cps \pm 3 db; S/N 45 db; wow & flutter .35% r.m.s. Supplied with moving-coil mic, carrying case & 4 prepacked ⅞" tape cartridges. Misc. accessories available. Battery life approx. 20 hrs. 7¼" x 4½" x 2¼"; 3 lbs.\$119.50



OKI
 Model 222 Mono Recorder
 4-track, 2-speed (7½ & 3¼ ips) design featuring transistorized OTL amplifier; pause control; counter; vu meter; mic. & aux. inputs; sound-on-sound; sound-with-sound; 5" speaker. Response 50-15,000 cps @ 7½ ips; S/N 47 db; 1.5 w. output; wow & flutter .12% r.m.s. @ 7½ ips. Has 2 heads: ¼-track 2-channel stereo record/play & erase heads for 4-track mono record/play & 4-track stereo playback through external preamps; separation 50 db. 11⅞" x 12⅞" h. x 7" d. Supplied with

OKI Model 222 Mono Recorder

one dynamic mic.List \$179.95

Model 111 Mono Recorder
 2-track, 2-speed (7½ & 3¼ ips) design featuring transistorized, output-transformerless amplifier; pause control; counter; level meter; mic. & aux. inputs; 5" speaker. Response 60-13,000 cps @ 7½ ips; S/N 40 db; 1.5 w. output; wow & flutter .2% @ 7½ ips. Has two heads (½-track record/play & erase). 11⅞" w. x 2¼" h. x 6". With dynamic mic.List \$129.95

Model 111 Mono Recorder

Model 555 Stereo Recorder
 4-track, 2-speed (7½ & 3¼ ips) design featuring transistorized OTL amplifiers;



detachable stereo speakers; sound-on-sound; sound-with-sound; automatic shut-off; counter; 2 vu meters; p.a. operation; dual mic. & aux. inputs. Response 20-22,000 cps @ 7½ ips; S/N 50 db; 3 w./ch. output; ch. separation 60 db; dual 6½" x 2" speakers; wow & flutter .12% @ 7½ ips. Dual heads: ½-track stereo record/playback & erase for 4-track individual mono & stereo record/playback. Supplied with 2 dynamic mics. Optional equipment: transistorized cigarette lighter inverter for 12-v. operation. Over-all size 11⅞" w. x 13¼" h. x 12½" d. with speakers.List \$349.95

Model 555 Stereo Recorder

Model 333 Stereo Recorder
 4-track, 2-speed (7½ & 3¼ ips) design featuring transistorized OTL amplifier, de-



tachable stereo speakers; pause control; sound-on-sound; sound-with-sound; 2 vu meters; dual mic. & aux. inputs; response 50-15,000 cps @ 7½ ips; S/N 47 db; 1.5 w./ch.; two 5" speakers; wow & flutter .12% r.m.s. @ 7½ ips. Has ¼-track record/play & erase heads for 4-track individual mono & stereo record/playback. Supplied complete with 2 dynamic mics. 11⅞" w. x 12⅞" h. x 12½"List \$289.95

Model 333 Stereo Recorder

Model 300 Stereo Recorder
 Solid-state design—two 5" speakers; two heads; 4-track mono and stereo record and



Model 300 Stereo Recorder
 Solid-state design—two 5" speakers; two heads; 4-track mono and stereo record and

DIRECTORY SECTION



playback; dynamic microphones; response 40-15,000 cps @ 7½ ips; signal-to-noise ratio 50 db; speed 7½ ips & 3¾ ips; features sound-on-sound, sound-with-sound; 4-track mono/stereo record/playback; transistorized OTL amplifiers; automatic shut-off switch; 2 record-level meters. Power output 1.2 w./ch. music power; size with detachable speakers 12" w. x 8¼" d. x 11½"; 16 lbs with speakers.....List \$219.95

Model 300-D Tape Deck/Preamps

Similar to Model 300 except does not include power amplifiers & speakers. Response 40-18,000 cps @ 7½ ips. Preamp outputs .05 v. (5000 ohms). 11⅞" x 6" x 10⅞" with walnut base.....\$159.95

Model 888 Tape Recorder

4-track, 3-head transistorized design. Features digital counter, automatic shut-off, vu record-level meters; input sound monitor, sound-on-sound, sound-with-sound; 2 speeds (7½ & 3¾ ips). Response 40-18,000 cps ± 2 db @ 7½ ips; wow & flutter .1% @ 7½ ips; output 3 w./ch. music power; S/N 50 db. 13" w. x 6" x 11¼". Supplied with two SP-888 external speaker systems. Response 40-20,000 cps; 15 w. music power capacity. 8 ohms. Has 5" bass/mid-range driver & 2½" direct metallic radiation dome tweeter (5000 cps crossover). 6⅝" x 7" x 11⅞"\$489.95
SP-888 Speakers.....\$ 69.95

RCA

YGS11 Mono Tape Recorder

Transistorized, battery-operated, 3" reel design. Features vu meter for record level &



battery condition; 2 speed (3¾ & 1⅞ ips); optional adapter for 117 v. operation; 2⅞" 8-ohm speaker. Includes 4 "C" cells, earphone & mic with remote sw. 2¾" x 9¼" x 9¼". 4.9 lbs.\$49.95

YGS21 Mono Tape Recorder

Transistorized, battery-operated; 3" reel with solid-state motor drive (has no gov-



ernors for longer motor life). Features 2-speed (3¾ & 1⅞ ips); 9 v. operation (adapter for 117 v. operation optional); record indicator light; 4" oval speaker. Includes 6 "D" cells, carrying case with shoulder strap & mic with remote sw. 3½" x 10⅞" x 8½". 4 lbs. (less batteries)\$69.95

YGB11 Mono Tape Recorder

Transistorized, cartridge-type design. Features automatic tape & amp. shut-off; vu



meter; 2-speed (3¾ & 1⅞ ips); 4" speaker; response 50-15,000 cps. Supplied with tape cartridge, mic & vinyl-covered wood case. 7⅞" x 16" x 11¼"\$99.95

YGB29 Mono Tape Recorder

Transistorized, cartridge-type design. Features automatic tape & amp shut-off; vu

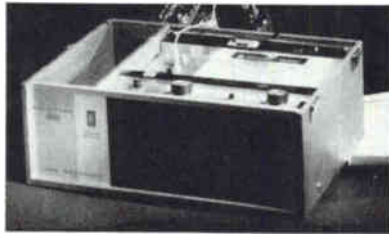

meter; digital counter; 6" x 4" speaker; 2-speed (3¾ & 1⅞ ips); response 50-15,000 cps. Can be used as a p.a. system. Supplied with tape cartridge, mic with remote sw., earphone & vinyl-covered wood cabinet. 7⅞" x 17½" x 11¼"\$129.95

YGH31 Mono Tape Recorder

Transistorized design with pause sw., vu meter, digital counter; 6" x 4" speaker;



response 50-15,000 cps. Has separate controls for volume & tone, and track selector. Can be used as p.a. amp & has "sing-along" sw. for voice transmission through spkr. Supplied with mic & vinyl-covered wood case. 8¾" x 18" x 14"\$129.95

YGD43 Tape Recorder



Transistorized, stereo, cartridge-type design. Has four speakers: two 9" x 6" and two 3½" in swing-out wings with 12' cables. Features automatic tape & amp. shut-off; p.a. & "sing-along" sw. for transmitting through spkrs; sound-on-sound; vu meter; digital counter; 2 speed (3¾ & 1⅞ ips); response 50-15,000 cps. Supplied with tape cartridge, 2 mics & vinyl-covered wood cabinet with tilt-down tape deck. 15½" x 28⅞" x 9¼"\$199.95

YGG45 Tape Recorder

Transistorized, stereo design with 4 speakers: two 9" x 6" & two 3½" in swing-out



wings with 12' cables; features 3 speeds (7½, 3¾ & 1⅞ ips); sound-on-sound; p.a. & "sing-along" sw.; automatic shut-off; vu meter; digital counter. Response 50-15,000 cps; supplied with 2 mics & vinyl-covered wood cabinet with tilt-down tape deck. 15½" x 28⅞" x 9¼"\$199.95

MGC71 Tape Deck/Preamps

Same as YGD43 except does not include



stereo power amplifiers and speakers. Walnut base. 6⅝" x 13⅞" x 11¼"\$149.95

MGG72 Tape Deck/Preamps

Same as YGG45 except does not include



stereo power amplifiers and speakers. Walnut base. 7½" x 13¼" x 14¼" ..\$169.95

"Fortnighter" (1YC1) Tape Recorder

Similar in design & performance to Model 3YD1 except does not include stereo power amps & speakers; preamps are, however, included; 7½" x 9¼" x 11⅞"\$169.95

"Trendliner II" (1YB2) Recorder

Four-track, 2-speed (3.75 & 1⅞ ips) mono record/playback design for use with tape cartridge; features start and stop by remote control (remote switch on microphone); digital tape counter; dual-ray recording monitor; earphone jack; complete with ceramic microphone; similar in appearance to Model 1YB1; response 50-15,000 cps @

DIRECTORY SECTION

3.75 ips at preamp; 7 1/8" h. x 9 3/4" w. x 11 1/2" d.\$129.95

"Prompter" (1YB1) Tape Recorder

Similar in design & performance to Model 1YB2 except does not have remote control; all tape cartridge machines provide 2 hours



playing time at 3.75 ips & 4 hours @ 1 1/8 ips\$ 99.95

"Cordon Bleu" (3YD1) Recorder

Record/playback cartridge design; features stereo & mono 4-track record/playback; 2-

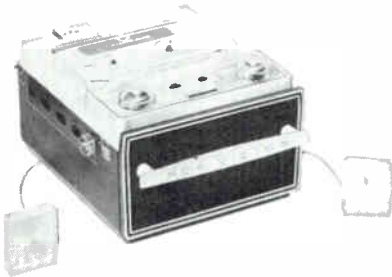

speed (3.75 & 1 1/8 ips); digital counter; has dual speakers, one in removable lid on 10' cord; response 50-15,000 cps @ 3.75 ips at preamp; supplied with 2 ceramic microphones; 17 1/2 lbs. 8 3/4" h. x 9 9/8" w. x 11 3/4" d.\$199.95

REVERE

3000 Mono Tape Recorder

2-track record/playback, dual speed (7 1/2 & 3 3/4 ips); response 40-15,000 cps ± 3



db @ 7 1/2 ips; wow & flutter .3%; S/N 46 db; high & low level inputs. Has 8 w. output & 8-ohm jack for external spkr. Preamp output can be run to aux. amp. Heavy-duty metal & molded plastic case; 7 1/2" x 14" x 14 1/2" with mic. Available only through audio-visual dealers....\$185.00

REVOX

G-36 Tape Recorder

2- or 4-track (7 1/2 & 3 3/4 ips) stereo design. Has 3 heads (record, play, erase); 3 independent motors, direct drive (no belts used); reel sizes up to 10 1/2" with reel size selector; two vu meters. Speed accuracy ± 0.3%; wow & flutter ± 0.1% at 7 1/2 ips. Response 40-15,000 cps at 7 1/2 ips. S/N 50 db. Has record & play amplifiers; 6-watt built in mono amplifier & spkr. (Separate

1966 EDITION



external speaker required for stereo playback.) Sound-on-sound, sound-with-sound, and echo. Includes carrying case. 18 1/2" x 12 1/4" x 11 1/2"\$500.00

RHEEM CALIFONE

3160 Tape Recorder

Features three heads, three motors; fully automatic; sound-over-sound; sound-on-sound; remote control; automatic cut-off; 16 3/4" x 14" x 9"\$499.95

3549 Tape Deck

Three-speed (7 1/2, 3 3/4 & 1 1/8 ips), playback transport; equipped with erase head & rec-

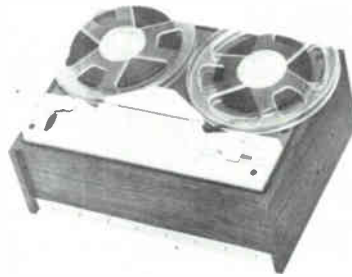

ord lock for those to wish to use their own record amplifiers; three-position digital counter; 12 1/4" x 8 3/8" x 1 11/32" (above mounting surface); 4 1/2" (below mounting surface)\$69.95

3550 Tape Recorder

Features 4-track stereo/mono record/play; vu meter; 3 speeds (7 1/2, 3 3/4 & 1 1/8 ips);

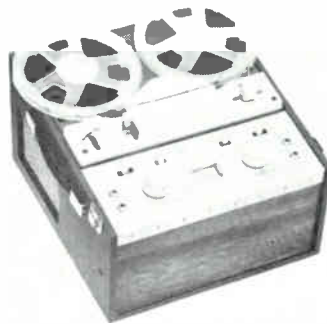

FM-multiplex ready; digital counter; built-in speakers; supplied with 2 mics; 13 1/2" x 9 1/2" x 14"\$169.95

3110 Tape Deck/Preamps

Professional stereo record/play tape deck; top & bottom mtg. bracket; full metal shielding for component area; 40-18,000 cps; monitor amplifier; FM multiplex ready; automatic shut-off; vu meter; 4 speed; 13 1/4" x 13 3/4" x 6 3/4"\$189.95

3170 Tape Recorder

Features three heads, three motors; fully automatic; sound-over-sound; sound-on-sound; remote control; automatic cut-off; features magic replay—plays both directions stereo; entire tape or any selection of

FREE

send today for your money-saving

ALLIED 1966 CATALOG

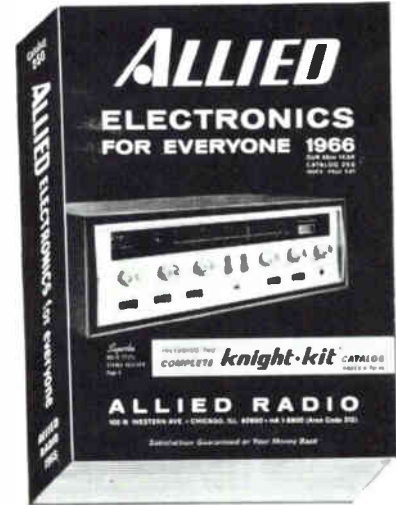

SAVE MOST ON tape recording and stereo hi-fi

508 Value-Packed Pages: See the world's largest, latest selection—over 40 tape recorders, new tape decks, preamplifiers, recording tape, accessories—more than 30 famous makes; plus special buys available only from Allied. Save also on complete stereo hi-fi systems and components; extra savings on exclusive Knight® products. For everything in tape recording and hi-fi, for everything in Electronics, send for your FREE 1966 Allied Catalog today!

SAVE MOST WITH BUILD-YOUR-OWN

knight-kits®

Select from dozens of great easy-to-build kits: Hi-Fi, CB, Hobby, Short-Wave, Amateur, Intercom, Automotive, Test Equipment—all at substantial savings.

EASY TERMS: Use the Allied Credit Fund Plan

FREE Send coupon today for the 1966 Allied Catalog.

ALLIED RADIO, Dept. 55-K
100 N. Western Ave., Chicago, Ill. 60680
 Send FREE 1966 Allied Catalog.

Name _____
PLEASE PRINT

Address _____

City _____ State _____ Zip _____

CIRCLE NO. 1 ON READER SERVICE CARD 83

DIRECTORY SECTION

music; automatic shut-off of all stereo units after playing complete tape both directions; 16 1/4" x 14" x 9".....\$599.95

3200 Tape Recorder

Stereo tape recorder with three-speed op-



tion; edit lever; large high-frequency speakers; sound-with-sound; vu meter; FM multiplex ready; digital counter; frequency response 40-18,500 cps; 16 1/4" x 13 3/4" x 7 1/2"\$269.95

3100 Tape Deck/Preamps

Stereo professional tape deck; top & bottom mounting brackets; full metal shield-



ing for component area; 1/4" lip on deck and amp for ease of mounting; three-speed option; edit lever; sound-on-sound; sound-with-sound; 2 vu meters; FM multiplex ready; frequency response 40-18,500 cps; 2 hi-level outputs; 2 lo-level; low-impedance outputs; 15" x 12 1/2" x 8".....\$249.95

ROBERTS

Model 1600 Tape Recorder

Half-track, mono, 3-speed (7 1/2, 3 3/4 & 1 1/2 ips) design with amp & 4" x 6" (8

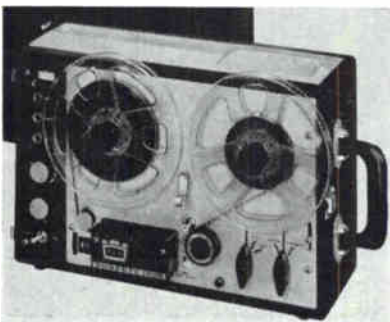

ohm) speaker. Has level meter, edit guide, pause control. 2 heads (record/playback & erase). Response 50-15,000 cps ±4 db;

S/N -45 db; 2 w. output; wow & flutter .2%. 15 1/4" x 10 1/2" x 8 1/2"\$169.95

Model 400X Stereo Recorder

Features 22,000 cps Cross Field record head design; echo-chamber effects; replay double reverse for automatic, continuous 4-track stereo tape replay; repeat (replays any part of tape over & over); sound-on-sound; sound-with-sound; special bias for FM recording. Dual speed (7 1/2 & 3 3/4 ips). Has stereo amplifier, two 6" (8 ohm) speakers; 2 vu meters; automatic stop; edit guide; 3 heads (record-play-erase) S/N -45 db;

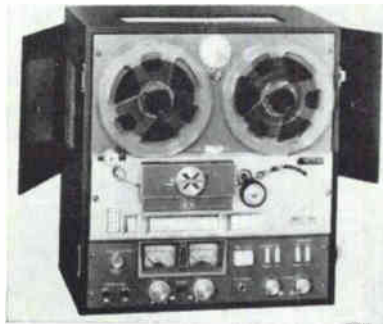

8 w./ch. output; 2 v. preamp output; wow & flutter .1%; channel separation 50 db; 17 1/4" x 16" x 12 1/4".....\$799.95

Model 400 Same except without Cross Field & only amplifiers solid-state. Response 40-18,000 cps ±3 db.....\$699.95

Model 455 Same as 400 Except without automatic forward & reverse play....\$599.95

Model 770 Stereo Recorder

Features 22,000 cps Cross Field record head design; 2 vu meters; 4-digit counter; 3

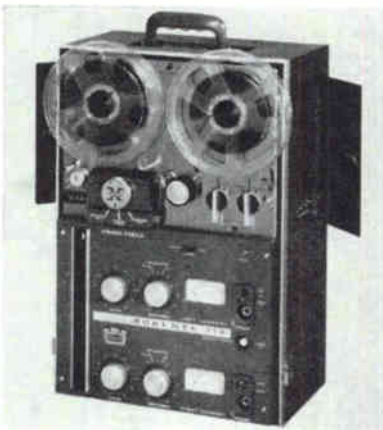

speed (7 1/2, 3 3/4 & 1 1/2 ips); mute-monitor p.a. sw.; automatic stop; pause edit; stereo amplifiers; two 5" x 7" (8 ohm) speakers; 3 heads (record/playback-erase-special bias). S/N -50 db; 3 w./ch. output; wow & flutter .12%; ch. separation 65 db; 20 1/2" x 13 1/4" x 11".....\$449.95

Model 1670 Stereo Recorder

2-speed (7 1/2 & 3 3/4 ips) design with stereo amplifier & two 8" coax. (8 ohm) speakers. Has automatic stop; two vu meters; edit guide; pause control; special bias for FM recording. Response 30-22,000 cps ±3 db; S/N -45 db; 2 1/2 w./ch. output; wow & flutter .2%; ch. separation -55 db. Has 2 heads (record/play, erase); features sound-with-sound; 30" x 14 1/4" x 7"\$359.95

Model 1650 Stereo Recorder

2-speed (7 1/2 & 3 3/4 ips) design with stereo amp & two 5" x 7" (8 ohm) speakers. Has two vu meters; automatic stop; edit guide; pause control; 2 heads (record/playback, erase). Response 30-18,000 cps

±3 db; S/N -45 db; 2 1/2 w./ch. power; wow & flutter .2%; ch. separation -55 db. Features sound-with-sound & 3-way speaker switch. 16 1/4" x 13 3/4" x 7 1/2".....\$299.95
Model 1651. Same as Model 1650 but with detachable, hinged speaker systems..\$329.95

Model 720 Stereo Recorder

Features sound-with-sound; stereo amplifiers; two 4" (8 ohm) speakers; 3-speed

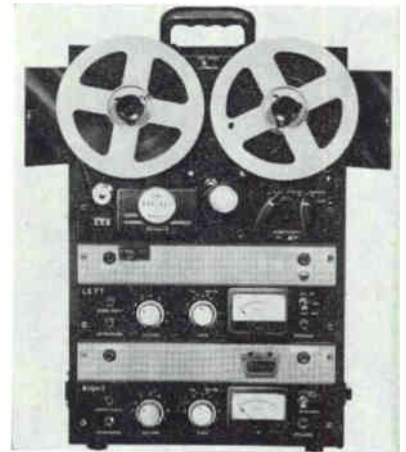

(7 1/2, 3 3/4 & 1 1/2 ips); automatic stop; pause edit; 2 heads (record/playback-erase). Response 40-15,000 cps ±2 db; S/N 50 db; 3 w./ch. output; wow & flutter .12%; ch. separation 60 db; 20" x 14" x 9".....\$339.95

1630 Tape Recorder

Features 3 speeds (7 1/2, 3 3/4 & 1 1/2 ips); stereo design with automatic shutoff; edit/



pause lever; vu meter; digital counter. Response 40-18,000 cps ±3 db @ 7 1/2 ips; wow & flutter .2% @ 7 1/2 ips; S/N -45 db; input sensitivity 150 mv. for phono/radio & 3 mv. for mic. for 0 vu. Has 2 high-imp. mic & 2 high-imp. high-level phono/radio inputs; 13 1/4" x 7 1/2" x 13 1/4"\$229.95

Model 1630W. Same as Model 1630 except with walnut cabinet & without internal speakers\$249.95

6000 Series Tape Recorders

4-speed (7 1/2, 3 3/4, 1 1/2, 1 5/16 ips) portable, battery-operated designs with Cross Field record head system. Response 40-20,000 cps ±2 db @ 7 1/2 ips; S/N -45 db; wow & flutter .18% @ 7 1/2 ips; 4 w./ch. output. Features 3 heads; 1/4-track record & play; 17 hours recording time @ 1 5/16 ips; 5" reel; 4 tracks; 6 v. rechargeable battery (117 v. adapter available); index counter; 32 transistors & diodes. Input sensitivity .1 mv. mic & 60 mv. radio/phono; 4" h. x 9 3/8" x 10" d. 11 lbs., 2 oz. less battery.

Model 6000 M. Mono design with 5" oval spkr., mic & batteries.....\$299.95

Model 6000 S. Stereo design with mike, rechargeable battery, battery charger, a.c.



adapter, 2 power amps, one built-in speaker
\$359.95
 Second spkr. to complete stereo system
\$14.95

Model 1620 Tape Recorder

Complete 4-track mono & stereo record & play system with stereo speakers; vu meter;



digital counter; 2 speed (7½ & 3¾ ips). Response 50-15,000 cps ± 3 db @ 7½ ips; wow & flutter .2% @ 7½ ips; S/N -42 db; input sensitivity .15 v. radio/phono & 3 mv. mic for 0 vu. Has 2 high-impedance inputs for both mic & high-level radio/phono; automatic shutoff; 13¼" x 13¼" x 9½"\$199.95

5000 Tape Recorder

Features 22,000 cycle transistorized professional recording studio Cross Field stereo



operation; takes all size including 10½" reels without adapters. 3 speed; electrical speed change; 4-digit counter; 2 vu meters; hysteresis-synchronous direct-drive capstan motor; 2 large speakers; equalized preamp outputs; 4 heads; 16 w./ch. output..\$699.95

1510 Mono Tape Recorder

Cross Field performance in a pocket tape recorder. Has capstan drive so tapes can be replayed on any other tape machine. Features both standard speeds; 3¼" reels; built-in

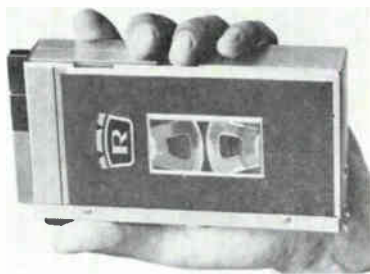

mic and speaker for record & playback; vu meter; battery check; battery & case..\$79.95

Note: All Roberts stereo models, unless otherwise specified, record 4-track stereo, play back 4-track & half-track stereo; record 4-track mono; play back 4-track, half-track & full-track mono. 15 ips speed optional on all models.

SAXON

"555" Mono Tape Recorder

All-transistor, 3-speed (1½, 3¾, 7½ ips) portable design. Has 5" reels, record level meter, counter and will operate from six standard "D" cell batteries, 12 v. auto battery via cigarette lighter, or 117 v. a.c. Response 60-14,000 cps @ 7½ ips. Has inputs for radio, phono, foot-operated remote control, telephone pickup. Mono design with built-in 3" x 6" speaker (3 w. output) & 2 heads-record/play & erase. Complete with dynamic remote-control mic., earphones, leather case, batteries, cigarette lighter connector cord and carrying case. Optional equipment: foot sw., telephone pickup, ext. speaker 11¼" x 10½" x 3½".....\$169.95

"755" Tape Recorder

Transistorized, 3-speed (7½, 3¾ & 1½ ips) battery-operated portable design. Features 3 w./ch., separate record/play & erase heads, two detachable 3" x 6" speakers: ¼-track stereo & mono; high & low impedance inputs; 5" max. reel; vu meter; 15 hr. battery life. Can operate from 12 v. car battery or 117 v. line. Response 50-15,000 cps ± 2 db @ 7½ ips; S/N -45 db; wow & flutter .24% @ 7½ ips. Supplied with 2 mics, earphone & patchcords; 15½" x 12½" x 8½", weight 20 lbs.\$259.95

SONY

777-S2 Tape Deck/Preamps

All-transistorized 2-track record and 2-and 4-track playback; 2-speed (7.5 & 3.75



ips) design; features special "Electro-Bilateral" head construction; three motors; complete remote control; sound-on-sound; mic & line mixing; tape and source monitoring; 3" vu meters; response 50-15,000 cps ± 2 db @ 7.5 ips; signal-to-noise ratio 50 db; flutter & wow less than .15% @ 7.5 ips; has built-in stereo preamp and output jacks for connection to external power

all the vital facts
 about all the latest
 hi-fi/stereo equipment



...in a
 nutshell!

The "meat" in this nutshell is guaranteed to whet the appetite of every audiophile and music lover who plans to buy hi-fi equipment during the next twelve months.

In over 172 fact-and-photo-filled pages, the new 1966 STEREO/HI-FI DIRECTORY gives you all the vital statistics on amplifiers, changers & turntables, cartridges, tonearms & accessories, receivers, tuners, tape machines, speakers & cabinets — on every hi-fi component manufactured today!

With this authoritative guidebook which costs only \$1.25, you can compare similar items, feature-for-feature, dollar-for-dollar, before you buy! You'll avoid making even one costly mistake by making sure, in advance, that you get the best value for your money on everything you buy!

The 1966 STEREO/HI-FI DIRECTORY will help you select the finest equipment in your price range, and derive greater pleasure than ever from your records and tapes. Now, (to ask a redundant question) where else can you get this kind of "satisfaction insurance" for a mere \$1.25?



First Time Ever Offered!
 A DELUXE,
 GOLD-EMBOSSED
 LEATHERFLEX-BOUND
 EDITION
 just \$3.00 postpaid!

This deluxe edition is a permanent, handsomely-bound collector's item that belongs in your hi-fi library! Check appropriate box on coupon!

" FILL IN, DETACH & MAIL COUPON TODAY "

ZIFF-DAVIS SERVICE DIV., Dept. SD
 589 Broadway, New York, N.Y. 10012

Yes! Send me the new, 1966 STEREO/HI-FI DIRECTORY.

\$1.25 enclosed, plus 15¢ for shipping and handling. Send me the regular edition. (\$1.50 outside U.S.A.)

\$3.00 enclosed. Send me the Deluxe Leatherflex-Bound edition. (\$3.75 outside U.S.A.) Allow three additional weeks for delivery. TRA-66

name _____ please print _____

address _____

City _____ state _____ zip code _____

PAYMENT MUST BE ENCLOSED WITH ORDER.

DIRECTORY SECTION

amps; 16" w. x 17 1/4" h. x 9" d.; weight 43 lbs.Less than \$695.00

777-S4 Tape Deck/Preamps

Same as Model 777-S2 except 4-track stereo record and 2- and 4-track playbackLess than \$695.00

Model MX-777 Mixer

Accessory for Models 777-S2 and 777-S4 tape recorders; six-channel all-transistor

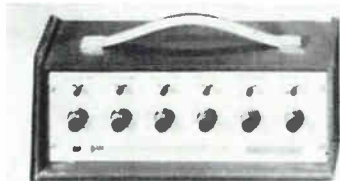

stereo/mono design; contains six matching transformers for balanced microphone inputs and recorder outputs plus individual level controls; channel selector switch for each input; switch for mixing one microphone into both channels; complete with case\$175.00

Model 200 Tape Recorder

Four-track stereo/mono record/playback system; features built-in stereo amplifier &



speakers (15' separation); 2 vu meters; sound-on-sound; two speeds (7.5 & 3.75 ips) & counter; response 50-14,000 cps @ 7.5 ips; flutter & wow less than .19% @ 7.5 ips; signal-to-noise ratio 45 db; inputs: 2 mic & 2 high-level line; supplied with two F-96 dynamic mics....Less than \$199.50

211-TS "Slide Sync" Tape Recorder

Has built-in electronic slide sync pulse generator for programming an automatic slide



projector; does not require metallic stripping on tape; features sound-on-sound; built-in amp & speaker; two speeds (3.75 & 1 1/2 ips); response 70-8000 cps; inputs: mic & high-level; outputs external speaker, high-impedance earphone monitor & automatic projector; 10" w. x 8 1/4" x 4 1/4"; supplied with microphone & projector connecting cord\$89.50

263-E Tape Deck/Preamps

Features 2-speed (7 1/2 & 3 3/4 ips); 4-track stereo or mono; built-in stereo preamps; 3-head design; automatic shutoff; automatic tape lifter; pause control; 7" reels & digital



counter. Response: heads capable of 30-18,000 cps @ 7 1/2 ips; flutter & wow less than .17% @ 7 1/2 ips. Half-track erase. record. playback heads. 14" w. x 11" d. x 6 1/2" h. Walnut cabinet base.....\$129.50

Model SRA-3 Recording Amp

Designed as a companion to Model 263-E tape deck; for 4-track stereo & mono

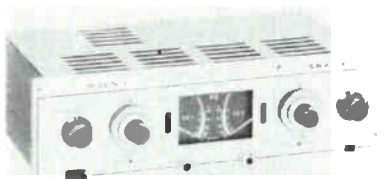

recording & playback. Also compatible with earlier Models 262-D & 263-D tape decks. Has microphone & high-level inputs. Response 30-18,000 cps.....\$109.50

Model 102 Mono Tape Recorder

Two-track mono, 2-speed (7.5 & 3.75 ips) design; features built-in amplifier & speak-

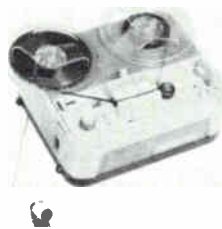

er; mike & line mixing; vu meter; pause control; response 50-12,000 cps @ 7.5 ips; flutter and wow less than .2% @ 7.5 ips; inputs mic. & line; outputs line & external speaker; supplied with F-96 dynamic micLess than \$129.45

Model 600 Tape Deck/Preamps

Four-track stereo/mono record/playback design; features two speeds (7.5 & 3.75 ips); mic. & line mixing; source & tape monitoring; two vu meters (switchable for



reading input or recorded signal); sound-with-sound; sound-on-sound; automatic shut-off; cathode-follower line outputs & special equalized magnetic phono input; response 30-18,000 cps @ 7.5 ips; S/N ratio 50 db; wow & flutter .17% @ 7.5 ips; inputs: two high-level line, 2 mics or magnetic phono (switch selected); outputs: two 600-ohm "0" db line, 600-ohm binaural earphone monitor; supplied with carrying

case & two Model F-87 dynamic cardioid pattern mics; has stereo preamps but does not have built-in power amps or speakersLess than \$450.00

Model 500A Tape Recorder

Four-track stereo/mono record & playback; 2-speed (7.5 & 3.75 ips) design; has built-in stereo amplifiers & speakers which can be detached for 15' separation; features mic & line mixing; sound-on-sound; two vu meters; automatic end-of-reel shut-off; response 50-14,000 cps ± 2 db @ 7.5 ips; S/N ratio 50 db; wow & flutter .17% @

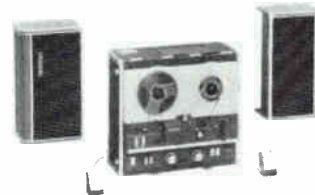

7.5 ips; inputs: 2 mic & 2 high-level aux.; outputs: two 600-ohm line, two 8-ohm ext. speakers, 8-ohm binaural headphone jack; supplied with carrying case & two dynamic microphones\$399.45

Model 905-A "Voice Command" Mono Recorder

Battery operated, transistorized design that starts & stops by voice command. Has



a.g.c. which automatically re-adjusts gain for changes in recording level. Has 4 rechargeable pen-size batteries; monitor speaker; remote stop/start sw. on mic. Features 2-speed (3 3/4 & 1 1/2 ips); mic & aux. inputs; 3 1/4" reels; response 90-9500 cps. Supplied with detachable amplifier/speaker unit, leather case & batteries....Less than \$159.50

250A Tape Deck/Preamps

All-transistor stereo design; with record & playback preamps. 4-track; vu meters; auto-

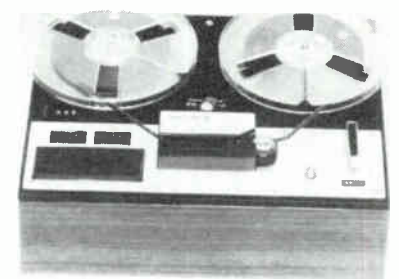

matic shutoff; automatic tape lifters; single-knob operation; 7 1/2 & 3 3/4 ips; flutter & wow .19% @ 7 1/2 ips; response 50-14,000 cps; S/N 50 db. Has mic. & line inputs. 14 1/2" x 6 1/2" x 9" h.Less than \$139.50

135 "Sonymatic" Mono Tape Recorder

Dual-track, 2 speed (7 1/2 & 3 3/4 ips) design; response 90-9500 cps @ 3 3/4 ips; S/N 40 db; flutter & wow .3%. Has a.v.c. (auto-

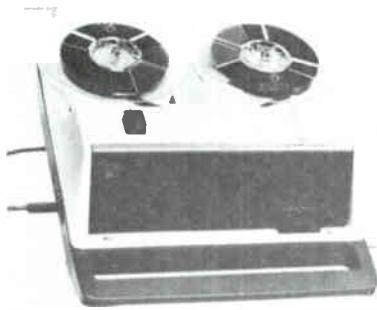

matic record level); 2 inputs (mic. & aux.); 5" max. reel; pause control; tape counter; dynamic mic.; 9½" w. x 11" d. x 5½" h.; with carrying case.....\$59.50

"ServoMatic" 800 Mono Tape Recorder

Battery or a.c. operation; 3 speed (7½, 3¾, 1½ ips); transistorized; 5" max. reel. Re-



sponse 50-12,000 cps @ 7½ ips; flutter & wow .15% @ 7½ ips; has automatic record level (a.v.c.) with defeat sw. for recording music; vu meter for level & battery voltage indication. Supplied with cardioid dynamic mic with remote start/stop sw. 12¼" x 10½" x 4¼".....\$225.00

260 Tape Recorder

Transistorized; 10 w./ch. music power; 4-track, 2-speed (7½ & 3¾ ips) design. Re-



sponse 50-15,000 cps ± 2 db; flutter & wow .17%; S/N 50 db. Has two vu meters; automatic shut-off; automatic tape lifter; 21½" x 15½" x 7." Less than\$239.50

"Tapemates" 123 Mono Tape Recorders

Transistorized, 2-speed (3¾ & 1½ ips); 2 hours record time. Response 80-8000 cps;

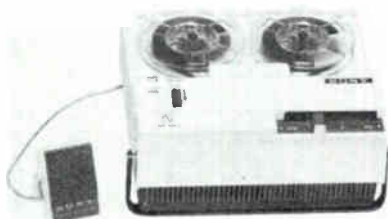

has a.v.c. (self-adjust record level). De-

signed for voice in form of talking letters. therefore recorders are sold in pairs (one to keep & one to give to a friend). Has mic. input & monitor output. 8" x 7½" x 4"; 4 lbs.....ca. \$39.95

900 "Sonymatic" Mono Tape Recorder

Transistorized; either a.c. or battery operated; 2-speed (3¾ & 1½ ips) design. Response 90-9500 cps @ 3¾ ips; flutter & wow .25% @ 3¾ ips. Has automatic record level (a.v.c.) circuit; 3¼" max. reel; 2 hour capacity on reel. Dynamic mic with remote stop/start sw. Vinyl carrying case;



8¼" w. x 8¾" x 3¾"; 5½ lbs.....\$67.50

TANDBERG

Series 8 Mono Tape Recorders

Two-speed (3.75 & 1½ ips) mono design; response 40-10,000 cps ± 2 db @ 3.75



ips, 40-5500 cps ± 2 db @ 1½ ips; wow & flutter better than .2% @ 3.75 ips; built-in 7" x 4" speaker; 3 watt output; signal-to-noise ratio 50 db below max. recording level; has recording level indicator; crystal microphone, four-digit counter; 15" l. x 11½" w. x 6¼" h.

- Model 821 Two-track.....\$208.60
- Model 821F Two-track with built-in solenoids; foot pedal for remote control.....\$279.80
- Model 841 Four-track.....\$225.65
- Model 841F Four-track with built-in solenoids; foot pedal for remote control.....\$296.90
- TC-58 With luggage-type carrying case.....\$24.50

Model 74B Tape Recorder

Three-speed (7.5, 3.75, & 1½ ips), 4-track stereo & mono record/playback with out-



put amplifiers & stereo 7" x 4" built-in speakers; has automatic tape stop, pause control, counter, level indicators. Permits sound-on-sound. Response 40-16,000 cps

± 2 db @ 7.5 ips; 40-10,000 cps @ 3.75 ips & 40-5000 cps @ 1½ ips. Wow & flutter .15% @ 7.5 ips, .2% @ 3.75 ips, .3% @ 1½ ips; inputs 2 mics, .00125 v. r.m.s., 3.3 megohms—2 line, adjustable .007-7 v. r.m.s., 500,000 ohms. Signal-to-noise ratio at least 53 db. Playback outputs 4 ohms. Has teakwood cabinet with TC57B luggage carrying case.....\$449.50
CM-6 Crystal mic. (30-12,000 cps) \$ 15.00

64 & 62 Tape Deck/Preamps

Record/playback machine; three speeds (7.5, 3.75 & 1½ ips); four-track stereo/

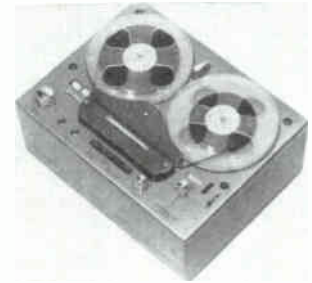

mono record & 2 - and 4-track stereo/mono playback; has separate record, playback, erase heads; built-in facilities for sound-on-sound, echo effects, track adding, direct monitor, and remote control; features FM-MX filter input for direct recording of FM multiplex stereo programs; dual-channel record & playback preamps; response 40-16,000 cps ± 2 db @ 7.5 ips; 40-10,000 cps ± 2 db @ 3.75 ips; 40-5500 cps ± 2 db @ 1½ ips; output 1.5 v. cathode-followers; flutter & wow .1% r.m.s. @ 7.5 ips, .2% @ 3.75 ips, .25% @ 1½ ips; signal-to-noise ratio at least 53 db; has two each microphone, hi-level, & hi-level with filter inputs.

- Model 64\$498.00
- Model 62 All specifications the same as for Model 64 except with half track heads.....\$498.00

Model 65 Stereo Playback Deck

Three-speed (7.5, 3.75, 1½ ips), 4-track stereo playback tape deck; response 30-

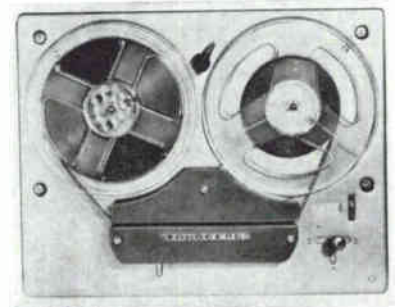

20,000 cps @ 7.5 ips, 30-15,000 cps @ 3.75 ips, 50-7000 cps @ 1½ ips; hysteresis synchronous motor; lever knob for playback, fast forward, fast reverse; 4-digit revolving counter; complete mechanical drive; over-all size of the deck 16" x 12" x 6".\$199.50

TRUVOX

PD-100 Stereo Tape Recorder

Three-speed (7½, 3¾ & 1½ ips) unit with 3 motors; three heads with off-the-tape monitoring during record; built-in echo; sound-on-sound; separate mixing line & mic. inputs each channel. auto-reset 4-digit counter; built-in splicing plate; independent vu meter ea. chan.; monitor headphone jacks. Response 30-20,000 cps ± 3 db @ 7½ ips; 30-12,000 cps ± 3 db @ 3¾ ips; 50-80,000 cps ± 3 db; wow & flutter less than 0.1% @ 7½ ips. Signal-

DIRECTORY SECTION

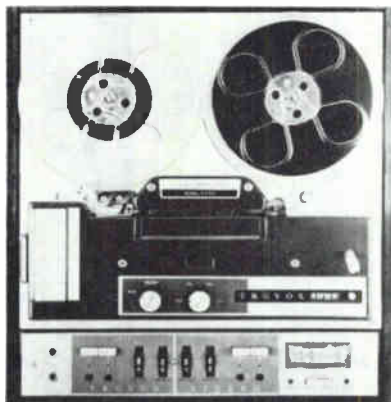

to-noise ratio 50 db; channel separation 55 db. Inputs per channel: 1-mv. 2-meg. mic., and 150-mv 0.5-meg. line. Bias freq. 90 kc. Less microphones & base.....\$399.50
Oil-Finished walnut base.....\$ 20.00

UHER

Model 4000S Portable Tape Recorder
All-transistor. 2-track, 4-speed (7½, 3¾, 1½ & 15/16 ips) mono design; powered by

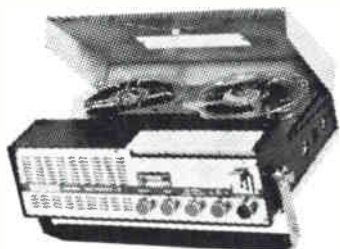

five flashlight cells or rechargeable battery (6-24 v.) or separate 115-volt power supply; electromagnetic start/stop remote control by means of microphone or remote switch; vu meter and power supply indicator; acoustic switch available for sound control for start and stop of tape; response 40-20,000 cps ± 3 db @ 7½ ips; 40-17,000 cps @ 3¾ ips; 40-10,000 cps @ 1½ ips; 40-4500 cps @ 15/16 ips; S/N 56 db; wow & flutter .15% @ 7½ ips; output speaker 1 watt; inputs: microphone .07 mv. @ 2000 ohms; radio 1.3 mv. @ 7000 ohms; phono 25 mv. @ 1 megohm; 4 hours playing time with flashlight cells; 10½" x 8½" x 3¼"; weight without batteries 6 lbs.; complete with remote control dynamic microphone, leather case, shoulder strap, a.c. power unit, battery charger, and "Dryfit" storage battery\$420.00

"Universal 5000" Recorder

All-transistor, 2-track, 3-speed (15/16, 1½ & 3¾ ips), 6" reel design. Response 40-

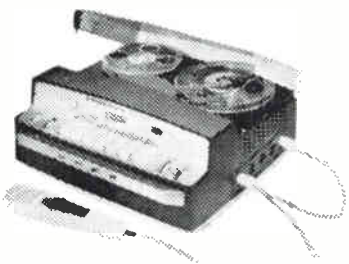

16,000 cps @ 3¾ ips; S/N 50 db; wow & flutter .2% @ 3¾ ips; output 1.5 w. Has

digital counter, automatic recording level control, provisions for automatic slide-projector control; vu meter & inputs for low-impedance mic., radio, phono, telephone pickup, loudspeaker & earphones; 6" x 10" x 12"\$299.95

Model 8000 Tape Recorder

Four-track stereo/mono record & playback; completely transistorized; separate record/playback heads; features built-in impulse transmitter for automatic slide-projector synchronization; echo effect; remote control; sound-on-sound; automatic shut-off; has built-in stereo speakers, 2 w./ch.; 3 mic. inputs; radio & phono inputs; headphone output; 2 remote speaker outputs; 4 speeds (7.5, 3.75, 1½ & 15/16 ips); will accept 7" reels; response 50-20,000 cps ± 3 db @ 7.5 ips & 50-4000 cps @ 15/16 ips; wow & flutter .15% @ 7.5 ips; S/N 50 db; 117-volt a.c. operation, 14" x 15" x 7"; 23 lbs.; supplied with one dynamic mic. & portable case\$420.00

6000 Mono Tape Recorder

Transistorized, 2-track, single-speed (3¾ ips), 7" reel design; response 40-14,000 cps



± 2 db; S/N 45 db; wow & flutter ± .2% r.m.s.; 2½ w. output. Has digital counter, automatic end of tape shut off, vu meter, 3 inputs (mic, phono, radio) and 2 outputs. Speaker & earphones. 14" x 15" x 7"\$160.00

7000 Tape Recorder

Transistorized, 4-track for stereo or mono record/playback, 2-speed (7½ & 3¾ ips); 7" reel design; response 40-18,000 cps ± 3 db @ 7½ ips; S/N 45 db; wow & flutter ± 0.15% r.m.s.; output 2 w./ch. Has 4-

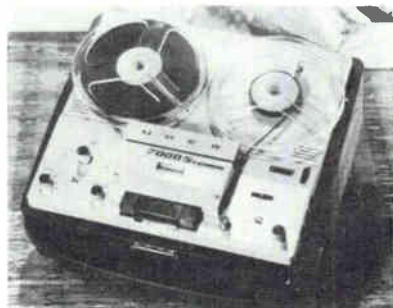

digit counter, automatic end of tape shut off, vu meter, 3 inputs (mic, radio, phono), 2 outputs (speaker & hi-impedance amplifier output). Permits sound-on-sound & has optional, automatic synchronization for slide projectors; 14" x 15" x 7"\$250.00

9000 Tape Deck/Preamps

Transistorized stereo tape deck with preamps. 4-track, 2-speeds (7½ & 3¾ ips). 7" reel design. Response 20-20,000 cps ± 2 db @ 7½ ips; wow ± .08% r.m.s.; flutter ± .11% r.m.s. HI) 0.15%. Has built-in tape cleaner, tape tension equalizer, adjustable azimuth of the playback head for pre-recorded tapes, plug-in amplifier modules,

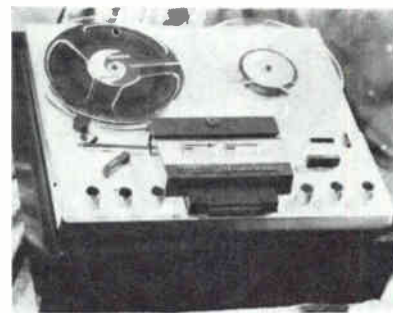

separate level control for each channel, vu meters, end of tape shut off, digital counter, 3 inputs (mic, radio, phono), 3 outputs (earphones, amp outputs with provisions for monitoring off the tape, and amp outputs without monitoring). Permits sound-on-sound\$500.00

VIKING

Model 87 Series Tape Decks

Two-speed (7.5 & 3.75 ips); 4-pole motor (hysteresis synchronous motor available

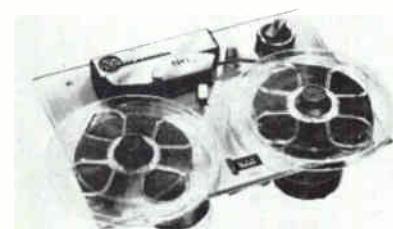

at extra cost); flutter & wow .2% r.m.s.; long-term speed regulation .5%; digital counter and tape run-out switch; handles up to 7" reels; wt. 12½ lbs.; panel size 13" x 9½".

Model 87P Playback only, half-track mono head\$138.00
Model 87R Record/playback, half-track mono, 2 heads.....\$144.00
Model 87Q Playback only ½- & ¼-track mono & stereo, 1 head.....\$141.05
Model 87RQ Record ½-track mono, playback ¼- & ½-track mono & stereo; 3 heads\$165.25
Model 87ES Record/playback ½-track mono & stereo, 2 heads.....\$157.85
Model 87RMQ Record ¼-track, playback ¼" & ½-track mono & stereo, 3 heads\$170.30
Model 87ERQ Record ½-track, playback ¼- & ½-track mono & stereo, 3 heads\$178.65
Model 87ESM Record/playback ½-track mono & stereo, 3 heads.....\$185.50

Prices quoted are for tape decks only; for recording with Model 87RQ, ERQ, RMQ, & ESM, use RP83-3 record/playback amplifier; for other models use RP83. For stereo design, use two amplifiers.

Model 87 "Super-Pro" Tape Recorders

All models supplied with carrying case; additional bottom chassis permits input and output connections to be made from front; center storage compartment; all models record and play mono and stereo; all three-head models permit sound-with-sound and sound-on-sound recording.

Model 87ES tape deck with two RP83 amplifiers\$382.35
Model 87ERQ tape deck with two RP83-3 amplifiers\$407.15
Model 87RMQ tape deck with two RP83-3 amplifiers\$398.80
Model 87ESM tape deck with two RP83-3 amplifiers\$414.00

Model 88 "Stereo Compact" Tape Recorders

Same as "Super-Pro" series except single dual-channel preamp system is used; con-



trols: record/playback, gain control, function selector, stereo microphone inputs, stereo/mono switch, record warning light, normal-duplicate switch (can record directly from heads of another deck); two vu meters; sound-on-sound, sound-with-sound; Series 88 tape decks have head-shift control. Two models available Model 88 RMQ Three 1/4-track heads. Records 1/4-track only, stereo/mono. Plays 1/4- or 1/2-track stereo or mono.....\$339.95 Model 88ERQ 1/2-track erase & record heads, 1/4-track playback head. Records 1/2-track mono or stereo. Plays 1/2-track or 1/4-track mono or stereo.....\$347.95 Oiled walnut enclosure.....\$18.95 Oiled walnut cabinet with folding cover.....\$29.95

Model 880 Stereo Compact

Same as Model 88 except has transistorized

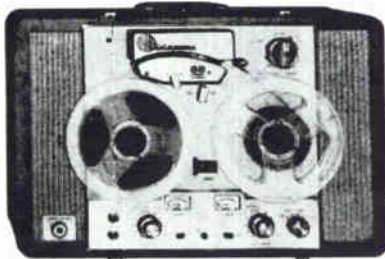

stereo power amplifiers & stereo speakers. Model RMQ 1/4-track record/play....\$425.00 Model ERQ 1/2-track record & 1/2 & 1/4-track play.....\$433.00

Model RP83 Record/Playback Preamp

Response: recording, 30-16,000 cps ±3 db @ 7.5 ips; 30-12,000 cps @ 3.75 ips;

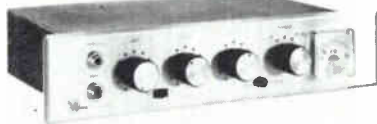

playback, 25-20,000 cps @ 7.5 ips, 25-14,000 cps @ 3.75 ips; output 1 v. to power amplifier; monitor output 1 v. to headphones; high- and low-level inputs with individual level controls; vu meter; 3-position selector switch; playback output level controls; signal-to-noise ratio 50 db @ 7.5 ips with signal recorded 6 db below saturation; harmonic distortion 1%; tube design. 11 1/16" x 2 9/16" x 5 1/2" d. behind panel; two required for stereo operation; for use with 2-head designs.....\$92.50

Model RP83-3 Record/Playback Preamp

Same as Model RP83 except for 3-head designs.\$94.50

"Retro-Matic" 220 Tape Recorder

Features two-directional automatic playback; remote control; simultaneous recording & playback; photoelectric run-out sensor; level meters; 7.5 ips & 3.75 ips dual-speed, quarter-track stereo operation; response 20-25,000 cps ±3 db record/playback @ 7.5 ips; monitor output 6 w./ch. to 4 or 8 ohm speakers or 4 to 600 ohm phones; output to music system 1 v./ch. low impedance; input sensitivity: high level, 100 mv., 250K; low level, 1 mv., 2 megohms; 55 db signal-to-noise ratio; dist. 1% at "0" vu; flutter & wow less than .2% r.m.s. @ 7.5 ips; 7" reel size; 15" h. x 16" w. x 8" d. behind panel.....\$860.00 Remote control center.....\$ 59.95 Walnut case.....\$ 31.95 Portable case.....\$55.75

C-800 Spkr./Amp System

Portable case with built-in power amps & spkrs. for Model 88.....\$99.50

Studio 96 Professional Tape Deck

Rugged design, 10 1/2" reel capacity; choice of dual-speed operation (7 1/2-15 ips, 7 1/2-3 3/4 ips, or 3 3/4-1 1/2 ips). Has connector for remote control of play-stop, fast forward-stop-rewind. Will accept up to 4 heads—any choice. S/N 55 db @ 7 1/2 ips; flutter & wow .1% @ 7 1/2 ips. Face plate 19" x 12 1/4". Price varies depending on heads used—ranging from \$605.95 for a dual 1/2-track design to \$598.95 for 4-head 1/4-track combination.

Model 78 Tape Deck

Two speed (7 1/2 & 3 3/4 ips); 4-pole motor; flutter & wow less than .2% r.m.s.; speed regulation .5%; 7" reel max. Can be used vertically or horizontally. Will accommodate up to 3 separate heads. Panel 13" w. x 9 1/2" h. x 3 3/4" deep behind panel (front knob clearance 1 1/8").

- Model 78P Playback only 1/2-track mono.....\$85.00
- Model 78R Record/play 1/2-track mono.....\$90.00
- Model 78Q Playback only 1/4-track mono or stereo.....\$101.00
- Model 78RQ Record/play 1/2-track mono; play 1/4-track stereo & mono.....\$113.80
- Model 78HQ Record/play 1/4-track stereo & mono.....\$110.50
- Model 78RM Record/play/monitor 1/2-track mono.....\$ 99.05



Model 78S Playback only 1/2-track stereo or mono.....\$102.80 Model 78ES Record/play 1/2-track stereo & mono.....\$113.55 For record/play preamps use Model RP83 or RP83-3.

"Auto-Tape 500" Car Tape Player

Transistorized, 3 3/4 ips speed, 4-track stereo design featuring a self-threading type cartridge. Response 60-10,000 cps. 4 w. output; 9 3/8" w. (10 3/4" with mtg. bracket) x 9" d. x 4" h. with mtg. hardware. Supplied with 2 chrome grille spkrs.; stereo cartridge; mounting hardware. Charcoal black finish.....\$149.95

Your tape head is wearing every time you use your recorder!



The question is — how much is it worn?

You can check for head wear by looking for these obvious defects:

1. Grooves — worn into the head by the tape. Easily recognized by lightly running your finger across the face of the head.
2. Pitting or Open Gap—which can be seen. If pitting is noticeable or if you see a vertical line dividing pole pieces, intimate contact has already been lost and the head must be replaced!

Protect your large investment in tape and equipment by replacing worn heads with full fidelity Nortronics precision quality replacement heads — Remember the tape head is the heart of your recorder!



Restore the brilliant realism of tape that you have gradually lost . . . see your local Nortronics dealer for factory recommended replacement heads!

Nortronics®

8161-H 10th Ave. No. • Minneapolis, Minn. 55427
CIRCLE NO. 27 ON READER SERVICE CARD

DIRECTORY SECTION

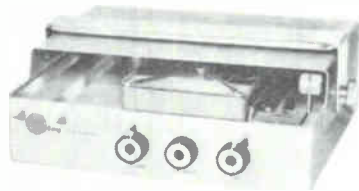

Stainless steel finish.....\$159.95
2 additional speakers.....\$17.95

RP110 Mono Tape Record/Play Amplifier

Transistorized design for use with tape transports having separate erase, record &

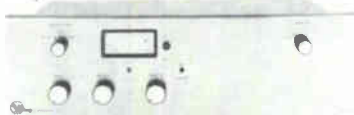

playback heads such as Model Studio 96. Response 30-16,000 cps @ 7 1/2 ips; S/N 55 db below peak recording level @ 7 1/2 ips. Standard model.....\$299.00
There are many variations from Standard in form of options & accessories.

RP120 Tape Record/Play Amp



Similar to RP110 except dual channel (stereo) design.....\$399.00

V-M CORP.

Model 754 Tape Recorder

Transistorized 3-speed (7 1/2, 3 3/4, and 1 7/8 ips); 4-track stereo recorder with integral AM/FM stereo tuner; provisions for direct off-the-air recording; frequency response 50-15,000 cps; inputs for mike, phono, aux; outputs for external amp, speakers, headphones, and V-M slide-projector synchro-



nizer. Full controls include pause switch and dual VU meters, four speakers in detachable enclosures; walnut-grained pyroxylin covered case; all needed accessories included.....\$419.95

Model 744 Tape Recorder

Same as model 754, but without tuner. Covered in black pyroxylin.....\$319.95

"Charger" Model 760 Tape Recorder

Solid-state tape recorder operates up to four hours on its own rechargeable nickel-cadmium battery; half-track; two speeds, 3 3/4 and 1 7/8 ips. Inputs: microphone with remote switch; high level for radio, TV, ceramic cartridge. Outputs: earphone or ex-



ternal speaker; pushbutton controls; combined volume level/charge indicator; 3-inch round speaker. Weighs less than 7 pounds; measures 10 7/8 x 6 x 2 1/4 inches.....\$129.95

Model 733 Tape Recorder

Lightweight, 4-track, mono recorder with automatic shut-off, bass and treble controls,



monitor switch, pause button, up to 7-inch reels. Complete with carrying case and microphone.....\$169.95

Model 739 Tape Recorder

Self-contained 3-speed, 4-track stereo portable recorder; includes "Add-a-Track" fea-



ture and two 4 x 6-inch oval speakers in detachable enclosures.....\$209.95

1471 Tape Deck/Preamps

4-track stereo or mono record/playback system including stereo preamps. Features 3-speed (7 1/2, 3 3/4 & 1 7/8 ips); sound-with-sound; automatic shut-off; pause button; monitor sw.; level indicators; counter; with external power amp & speaker can be used



as a p.a. system. Response 50-15,000 cps; S/N 50 db; separation 50 db; wow & flutter .3% r.m.s. at 7 1/2 ips; inputs permit recording from mic., phono, radio, or TV. 8" h. x 13" w. x 14 1/4" d.....\$179.95
1475 Aluminum tape-deck base.....\$12.50

760 "Charger" Mono Tape Recorder

Transistorized cordless design. Will operate up to 4 hours on its own rechargeable nick-



el-cadmium "power cell"; 1/2-track; 2 speed (3 3/4 & 1 7/8 ips). Inputs: mic. with remote sw.; high-level for radio, TV, ceramic cartridge; outputs: earphone & ext. spkrs. Features combined volume level/charge indicator; 3" speaker; black vinyl-clad aluminum lid & bottom cover plate; 10 7/8" x 6" x 2 1/4"; weight less than 7 pounds.....\$129.95

WEBCOR

2650 "Professional" Tape Recorder

Stereo 4-track, 3-speed recorder with computer-type reels; transparent doors over transport compartment; tilt-out panel; keyboard control; sound-on-sound; digital tape



counter; phono and FM-stereo inputs; dual VU meters; fully transistorized; removable speakers form cover for portable use; includes microphones.....under \$500.00

2522 "Coronet" Recorder

Three-speed recorder with four speakers; 2- and 4-track stereo operation; 10-watt dual

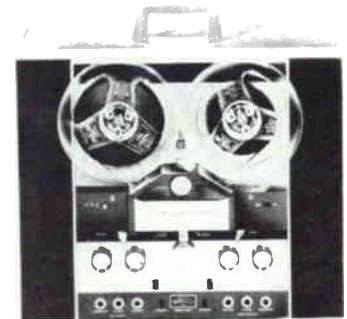

channel amplifier; frequency range 50-15,000 cps.....\$259.95

2520 "Regent IV" Recorder

Stereo 4-track recorder with 3 3/4 and 7 1/2 ips speeds; sound-with-sound; digital tape counter with push-button reset; frequency range 50-15,000 cps.....\$199.95

WOLLENSAK

7100 "Cartridge" Tape Recorder

Completely automatic tape changing system; automatically threads the tape, plays, rewinds, rejects the completed cartridge and repeats the process through as many as 20 stereo music selections during a 15-hour period; speed 1 7/8 ips; cartridge 3 3/4"

TAPE RECORDER ANNUAL



square x 1/2" thick; features new type recording head 1/50th diameter of a strand of human hair; specially developed magnetic tape; precision index counter; wow & flutter 0.3%; S/N ratio 48 db; music power output 9 w. per channel; 5 watts continuous @ 5% HD; inputs: microphone 2 mv. @ 10 megs, phono-radio 1 v. @ 1 meg; outputs: aux. 1 v. nominal, speaker 8 ohms; response 40-15,000 cps ± 3 db @ 1 1/2 ips; 7" x 14 1/2" x 14 1/4" (approx.); weight approx. 32 lbs.

Model 7100 Recorder-player with 2 mics.....\$399.95
 Model 7000 Recorder-player deck model with 2 mics.....\$339.95
 M-30 Player only, deck model.....\$269.00

7200 "Cartridge" Tape Recorder

Automatic cartridge changer. Will play 48 minutes/stereo cartridge & up to 96 minutes/mono (15 hours/loading). Single speed 1 1/2 ips, 2-track stereo or mono record/playback. Response 40-15,000 cps ± 3 db; wow & flutter .3%; S/N 48 db. Has 2 dual-channel inputs (mic & radio/phono) & 2 outputs ea. channel. (Preamp 1 v. & external speaker, 9 w./ch. music power, 5 w./ch. sine wave @ 5% HD). Supplied with 2 ext. speaker systems (ea. 6" x 9" elliptical & 3" tweeter). 19" x 10 1/4" x 5 1/4". Recorder 16" x 15 1/2" x 8 1/2".

Recorder 16" x 15 1/2" x 8 1/2".

1980 Stereo Recorder

Records & plays 2- & 4-track mono & stereo tapes; features digital counter, two- & four-



track head control; external speaker output; external amplifier output; hi-level input; low-level input; sound-with-sound; public address; 3.75 & 7.5 ips speeds; two internal speakers; two external speakers; provision for remote foot pedal; response 40-18,000 cps ± 3 db @ 7.5 ips; 40-13,000 cps @ 3.75 ips; wow & flutter 0.3%; S/N ratio 48 db; crosstalk 50 db; power output 22 watts total (11 watts music power per channel); 5 watts continuous at 5% harmonic distortion; inputs: low-level 2 mv., 10 megohms, hi-level 1 v., 1 megohm; outputs: 8 ohms, preamp 0.5-1.5 volts; 21 1/4" x 13 3/4" x 9 1/16".....\$339.95

1966 EDITION

WHAT IS THERE ABOUT THE NEW UHER 9000 TAPE DECK THAT ALLOWS IT TO CARRY ITS OWN PROOF OF PERFORMANCE?



The new Uher 9000 Tape Deck represents the ultimate in precision and craftsmanship. As documentary evidence of this quality, a test certificate and an original frequency response curve sheet accompany every Uher 9000 that leaves the factory.

For the complete immodest report on this great tape deck write for literature or judge for yourself by hearing a demonstration at your local Hi Fi dealer.

Sound begins and ends with a Uher Tape Recorder (pronounced U-ER).

70, martel

MARTEL ELECTRONICS

LOS ANGELES 2356 SOUTH COTNER, NEW YORK CITY 1199 BROADWAY CHICAGO 5445 NORTH LINCOLN AVE.

CIRCLE NO. 26 ON READER SERVICE CARD



... right into your tape recorder — then play it back and listen to the lively sound of your own voice — so natural, no one can tell the difference. University's new revolutionary Attache' is the smallest cardioid dynamic microphone ever made. Priced right too! Free! "Microphones '66" — a book every owner of a tape recorder should have.

UNIVERSITY SOUND
 Dept. Y631 Box 1056
 Oklahoma City, Okla. 73101



Name
 Address
 City
 State Zip

CIRCLE NO. 3 ON READER SERVICE CARD

NOW... PERFECT FM
 ELIMINATE
FM
 INTERFERENCE!
 With the Sensational
 New! **FINCO**
 FM BAND PASS FILTER



ENGINEERED TO MOUNT ANYWHERE

Get only pure FM signals. Use a Finco FM Band Pass Filter to stop interference and block out unwanted signals from T.V., Citizens Band and Amateur transmitters, motors, autos and fluorescent lamps. Size: 4 1/4" x 2" x 1 1/2". Available at your Finco Hi-Fi dealer. Satisfaction guaranteed!

Model 3007 Only \$6.95 List

THE FINNEY COMPANY
 34 W. Interstate St. • Bedford, Ohio

CIRCLE NO. 16 ON READER SERVICE CARD

THE 1966 PHOTOGRAPHY ANNUAL



PHOTOGRAPHY ANNUAL — the favorite photographic showcase of camera enthusiasts the world over! It's an issue you'll enjoy and learn from...one you'll want to add to your collection of valuable photographic editions! To receive your copy by mail, thereby avoiding any chance of disappointment, be sure to send your order today!

PARTIAL CONTENTS include these portfolios

- Ralph Morse—"Biographer of the Space Age."
- Book Preview! John Rawlings' figure studies.
- Gary Winogrand's amusing "Look at the Animals."
- Story of the Year—dramatic Civil Rights photos.
- An extensive International Portfolio.
- Best News Pictures of the Year...and more!

PLUS...the full story behind each photo

Enjoy the convenience of having this year's edition delivered directly to your home!

\$1.25
only

GET THE EXQUISITE LEATHERFLEX-COVERED EDITION for just \$3.00—POSTPAID!



FILL IN, DETACH & MAIL THIS FORM TODAY!

ZIFF-DAVIS SERVICE DIVISION • Dept. PA
589 Broadway • New York, N.Y. 10012

Please send my copy of the 1966 PHOTOGRAPHY ANNUAL as I've indicated below:

- Send me the regular edition. My \$1.25, plus 15¢ for shipping and handling (25¢ outside U.S.), is enclosed.
- Send me the Deluxe Leatherflex-Covered edition, postpaid. My \$3.00 is enclosed. (Orders outside U.S. add 75¢ to partially defray postage and handling costs.) Allow three weeks additional for binding and mailing.

name please print TRA-66

address

city state zip-code

(Payment must be enclosed with order.)

1288 Tape Recorder

Records in 4-track stereo or mono from any sound source. Features: vu meters, digital



counter, tabular controls. Two-speed operation (3¼ & 7½ ips). Response 50-17,000 cps @ 7½ ips ± 3 db; wow & flutter less than .3%; S/N greater than 48 db. Has two inputs (mic & radio-phono) and two outputs (ext. 8-ohm speaker, preamp). 16¼" x 13" x 7½". Walnut finish with matching separated speakers.....\$259.95

5150 Mono Tape Recorder

Transistorized with four recording speeds: 1516, 1½, 3¼ & 7½ ips. Central control panel, vu meter, 4-digit counter, automatic shut-off. Response 40-17,000 cps ± 3 db @ 7½ ips. Wow & flutter less than .25% @ 7½ ips. Mic, radio-phono inputs, ext. speak-

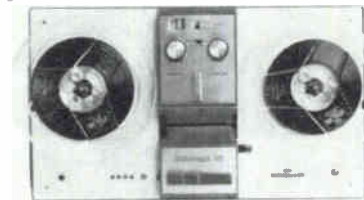

er (8 ohm), preamp outputs. Will accept tuner for playing or recording. 16" x 7" x 10"; with microphone.....\$149.95

5200 Tape Deck/Preamps

For custom installation; all-transistor circuitry; four recording speeds; will record and play back (through external amplifiers & speaker systems) 4-track stereo & mono. Response same as 5150. Two inputs each channel (mic, radio-phono). 18¾" x 7½" x 9¼".....\$179.95

5250 Tape Recorder

Self-contained 4-track stereo recorder with built-in speakers and amplifiers. 2½ w./

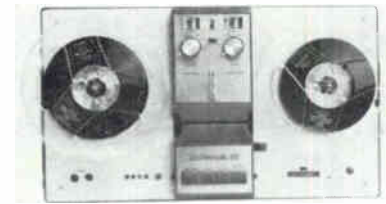

ch. music power. Individual volume & tone controls, vu meters. Accepts tuner for record or playing. Response, etc. same as 5150. 16" x 7" x 10".....\$189.95

5280 Tape Recorder

Walnut cabinetry, detachable stereo wing speakers. Similar to 5250 tape recorder, with stereo headphone provisions. 19¾" x 10" x 10¼".....\$219.95

5300 Tape Recorder

Walnut slim line styling, separated multiple speaker systems featuring electronic cross-over network. Response, etc. same as 5280. Designed for wall mounting. 20" x 8½" x 10½".....\$279.95
Matching AM-FM tuner with MPX & a.f.c., plays through recorder's own amplifier. Instantly ready for recording.....\$169.95
Matching tape storage cabinet.....\$ 34.95
Recorder, tuner, and storage cabinet feature walnut sliding doors that may be removed for equipment operation.

1570 Mono Tape Recorder

2-track record/playback; 18 w. r.m.s. @ 5% HD. Has automatic shut-off. 2 speeds

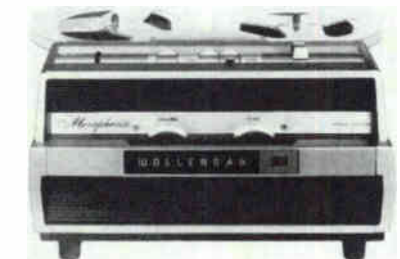

(3¼ & 7½ ips; response 40-15,000 cps ± 3 db @ 7½ ips; wow & flutter .03%; S/N 48 db; mic & radio/phono inputs; outputs .5 to 1.5 v. Preamp & 8 ohms to extension speaker. Has twin built-in speakers. Supplied with slip-over vinyl cover & misc. accessories. 6½" x 10¼" x 11¼". Available only through audio-visual dealers.....\$199.00

RAW TAPE

AMERICAN

Acetate Base (1.5-mil)

1-A 150', 3" reel.....	\$.55
2-A 250', 3¼" reel.....	\$.75
3-A 300', 4" reel.....	\$1.10
6-A 600', 5" reel.....	\$1.75
12-A 1200', 7" reel.....	\$2.75
15-A 1500', 7" reel.....	\$3.50

Acetate Base Long-Play (1-mil)

L-2A 225', 3" reel.....	\$.70
L-3A 350', 3¼" reel.....	\$1.00
L-4A 450', 4" reel.....	\$1.40
L-9A 900', 5" reel.....	\$2.50
L-18A 1800', 7" reel.....	\$4.10
L-20A 2000', 7" reel.....	\$5.17

Mylar Base Long-Play (1-mil)

L-2M 225', 3" reel.....	\$.75
L-3M 350', 3¼" reel.....	\$1.15
L-9M 900', 5" reel.....	\$2.70
L-18M 1800', 7" reel.....	\$4.60
L-20M 2000', 7" reel.....	\$5.80

Mylar Base (1.5-mil)

1-M 150', 3" reel.....	\$.60
6-M 600', 5" reel.....	\$2.10
12-M 1200', 7" reel.....	\$3.35

Mylar Base Double-Play Tensilized (.5-mil)

D-3MT 300', 3" reel.....	\$1.25
D-5MT 500', 3" reel.....	\$1.60
D-6MT 600', 4" reel.....	\$2.30

D-12MT 1200', 5" reel.....	\$4.30
D-18MT 1800', 5" reel.....	\$5.90
D-24MT 2400', 7" reel.....	\$7.50
D-30MT 3000', 7" reel.....	\$9.50
D-36MT 3600', 7" reel.....	\$10.95

Mylar Base Double-Play (.5-mil)

D-12MS 1200', 5" reel.....	\$2.75
D-24MS 2400', 7" reel.....	\$5.10

Acetate High-Output (1.5-mil)

HO-6A 600', 5" reel.....	\$2.25
HO-12A 1200', 7" reel.....	\$3.50

Mylar High Output (1.5-mil)

HO-6M 600', 5" reel.....	\$2.65
HO-12M 1200', 7" reel.....	\$4.25

Acetate Low-Print "Master" (1.5-mil)

LP-12A 1200', 7" reel.....	\$4.40
----------------------------	--------

Mylar Low-Print "Master" (1.5-mil)

LP-12M 1200', 7" reel.....	\$7.70
----------------------------	--------

AMPEX

Series 500 Recording Tape

Available on .5, 1, and 1.5-mil Mylar in regular and slow-speed oxides; designed for super-critical home recording.

Regular Oxide:

Type 531-13 on 1.5 mil, 600', 5" reel.....	\$2.65
Type 531-15 on 1.5 mil, 1200', 7" reel.....	\$4.25
Type 541-13 on 1.0 mil, 900', 5" reel.....	\$3.40
Type 541-15 on 1.0 mil, 1800', 7" reel.....	\$6.20
Type 541-15M on 1.0 mil, 1200', 7" reel.....	\$3.50
Type 551-13 on 0.5 mil, 1200', 5" reel.....	\$5.45
Type 551-15 on 0.5 mil, 2400', 7" reel.....	\$9.50

Slow-Speed Oxide:

Type 536-15 on 1.5 mil, 1200', 7" reel.....	\$4.75
Type 545-15 on 1.0 mil, 1800', 7" reel.....	\$6.90
Type 545-15M on 1.0 mil, 1200', 7" reel.....	\$3.95
Type 556-15 on 0.5 mil, 2400', 7" reel.....	\$10.75

Series 900 Recording Tape

Designed for large-library home recording. Type 911 1.5-mil acetate.

150', 3" reel.....	\$0.65
600', 5" reel.....	\$1.75
1200', 7" reel.....	\$2.95

Type 921 1.0-mil acetate.

225', 3" reel.....	\$0.80
900', 5" reel.....	\$2.50
1800', 7" reel.....	\$4.25

Type 931 1.5-mil Mylar.

600', 5" reel.....	\$2.25
1200', 7" reel.....	\$3.65

Type 941 1.0-mil Mylar.

225', 3" reel.....	\$1.00
900', 5" reel.....	\$2.85
1800', 7" reel.....	\$4.95

Type 951 0.5-mil tensilized Mylar.

300', 3" reel.....	\$1.35
1200', 5" reel.....	\$4.50
2400', 7" reel.....	\$7.95

AUDIOTAPE

Master 1.5-mil Mylar Tape

Made on 1.5 mil Mylar base; durable in wide temperature range.

1966 EDITION

Type 671M, 600 ft., 5" reel.....	\$3.20
Type 1271M, 1200 ft., 7" reel.....	\$5.10

Double Recording (.5-mil tempered Mylar)

Made on tempered Mylar; allows twice as much recording per reel; stronger than double length tape.

Type 331T, 300 ft., 3" reel.....	\$ 1.60
Type 631-T, 600 ft., 3 1/4" reel.....	\$ 2.95
Type 1231T, 1200 ft., 5" reel.....	\$ 5.45
Type 2431T, 2400 ft., 7" reel.....	\$ 9.50

Triple Recording ("tempered" Mylar)

Three times as much recording time per reel as standard plastic-base tape, plus same extra strength as other "tempered" Mylar tapes.

Type 633T, 600 ft., 3 1/4" reel.....	\$2.95
Type 1833T, 1800 ft., 5" reel.....	\$6.95
Type 3633T, 3600 ft., 7" reel.....	\$11.95

Longer Recording (1-mil plastic base)

Provides 50% more recording time per reel; 1-mil cellulose acetate base; maximum economy for applications where high strength is not required.

Type 941, 900 ft., 5" plastic reel.....	\$3.50
Type 1841, 1800 ft., 7" plastic reel.....	\$5.50

Longer Recording (1-mil Mylar)

Made on 1-mil Mylar polyester film; provides 50% more recording time per reel; exceptional strength and durability plus longer storage life.

Type 261, 225 ft., 3" plastic reel.....	\$1.00
Type 961, 900 ft., 5" plastic reel.....	\$3.60
Type 1861, 1800 ft., 7" plastic reel.....	\$ 6.20

Standard Recording (1.5-mil Mylar)

High-strength super-durable magnetic tape that meets the highest professional standards of performance; withstands extreme temperatures; virtually immune to humidity; gives maximum tape life under any conditions of use or storage.

Type 671, 600 ft., 5" plastic reel.....	\$2.65
Type 1271, 1200 ft., 7" reel.....	\$4.25

Double Recording (.5-mil Mylar)

Made on .5-mil Mylar; twice as much recording time per reel as standard plastic-base tape; suitable for extended-play applications where tape tension is not excessive.

Type 1231, 1200 ft., 5" reel.....	\$3.50
Type 2431, 2400 ft., 7" reel.....	\$6.50

Standard Recording (plastic base)

Professional-quality recording tape; maximum fidelity, uniformity, frequency response and freedom from noise and distortion; 1.5 mil acetate.

Type 151, 150 ft., 3" plastic reel.....	\$.70
Type 351, 300 ft., 4" plastic reel.....	\$1.35
Type 651, 600 ft., 5" plastic reel.....	\$2.25
Type 1251, 1200 ft., 7" plastic reel.....	\$3.50

Low-Noise Tape

Provides high signal-to-noise ratio and reduced hiss level; on 1.5-mil plastic base.

Type 1257, 1200 ft., 7" reel.....	\$4.30
-----------------------------------	--------

BURGESS

Series No. 111 1.5-mil Plastic

111-1.5 150', 3" reel.....	\$0.70
111-2.5 250', 3 1/4" reel.....	\$1.25
111-3 300', 4" reel.....	\$1.35
111-6 600', 5" reel.....	\$2.25
111-8.5 850', 5 1/4" reel.....	\$2.85
111-12 1200', 7" reel.....	\$3.50

KEEP YOUR RECORDER IN TIP-TOP SHAPE BY ALWAYS USING TIP-TOP TAPE!

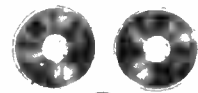

TARZIAN

A good tape recorder deserves good care. Handle yours respectfully, maintain it regularly, and protect it by using brand-name tape exclusively.

Off-brands and "white box" tapes are manufacturer rejects! They give you no assurance of quality in performance, and they may seriously damage the magnetic recording head in your instrument. Brand-name tape protects you and your recorder.

Of course, we hope you'll choose Tarzian Tape. (Triple your tape recording fun; buy it three reels at a time.) The finest materials, most advanced manufacturing techniques, and strictest quality control are your assurance that you can't do better.



FREE: Our brand-new 24-page booklet, "Everybody's Tape Recording Handbook."
Write for your copy.

SARKES TARZIAN, Inc.

World's Leading Manufacturers of TV and FM Tuners
• Closed Circuit TV Systems • Broadcast Equipment
• Air Trimmers • Semiconductor Devices
MAGNETIC TAPE DIVISION • BLOOMINGTON, INDIANA
Export: Ad Auriema, Inc., N.Y.
Canada: E. J. Piggott Enterprises Ltd., Toronto, Ont.
CIRCLE NO. 32 ON READER SERVICE CARD

RAW TAPE

Series No. 190 1.0-mil Extra-Play Plastic

190-2.25 225', 3" reel.....	\$.90
190-9 900', 5" reel.....	\$3.50
190-12 1200', 5 3/4" reel.....	\$4.25
190-15 1500', 7" reel.....	\$4.50
190-18 1800', 7" reel.....	\$5.50

Series No. 102 1.5-mil Mylar

102-6 600', 5" reel.....	\$2.65
102-8.5 850', 5 3/4" reel.....	\$4.25
102-12 1200', 7" reel.....	\$4.25

Series No. 150 1.0-mil Extra-Play Mylar

150-2.25 225', 3" reel.....	\$1.00
150-3.75 375', 3 3/4" reel.....	\$1.75



150-9 900', 5" reel.....	\$3.60
150-12 1200', 5 3/4" reel.....	\$4.65
150-15 1500', 7" reel.....	\$5.15
150-18 1800', 7" reel.....	\$6.20

Series No. 200 .5-mil Double-Length Tensitized Mylar

200-3 300', 3" reel.....	\$1.60
200-6 600', 4" reel.....	\$3.05
200-12 1200', 5" reel.....	\$5.45
200-17 1700', 5 3/4" reel.....	\$7.05
200-24 2400', 7" reel.....	\$9.50

Series No. 290 .5-mil Triple-Length Tensitized Mylar

290-6 600', 3 3/4" reel.....	\$2.50
290-36 3600', 7" reel.....	\$11.95

Series No. 131 1.5-mil Plastic

131-12 1200', 7" reel.....	\$4.40
----------------------------	--------

Series No. 138 1.5-mil Mylar

138-12 1200', 7" reel.....	\$5.10
----------------------------	--------

Series No. 175 1.5-mil Polyvinyl Chloride Film Base

175-6 600', 5" reel.....	\$2.40
175-12 1200', 7" reel.....	\$3.75

Series No. 141 1.5-mil Plastic

141-6 600', 5" reel.....	\$1.75
141-12 1200', 7" reel.....	\$2.95

Series No. 140 1.0-mil Extra-Play Plastic

140-9 900', 5" reel.....	\$2.50
140-18 1800' 7" reel.....	\$4.25

Series No. 142 1.0-mil Extra-Play Mylar

142-9 900', 5" reel.....	\$2.85
142-18 1800', 7" reel.....	\$4.95

Series No. 144 .5-mil Double-Length Mylar

144-12 1200', 5" reel.....	\$4.50
144-24 2400', 7" reel.....	\$7.95

KODAK

Type 31A Low-Print Tape

1.5-mil Durool base.	
31A1 150', 3" reel.....	\$.60
31A6 625', 5" reel.....	\$1.85
31A6NB 625', 5" reel (no box).....	\$1.65
31A12 1250', 7" reel.....	\$2.95
31A12NB 1250', 7" reel (no box).....	\$2.45

Type 21A Tape

1-mil Durool base.	
21A9 900', 5" reel.....	\$2.55
21A9NB 900', 5" reel (no box).....	\$2.20
21A18 1800', 7" reel.....	\$4.35
21A18NB 1800', 7" reel (no box).....	\$3.85

Type 34A High-Output, Low-Noise Tape

1.5-mil Durool base.	
34A6 625', 5" reel.....	\$1.85
34A6NB 625', 5" reel (no box).....	\$1.65
34A12 1250', 7" reel.....	\$2.95
34A12NB 1250', 7" reel (no box).....	\$2.45

Type 21P Tape

1-mil polyester base.	
21P9 900', 5" reel.....	\$2.85
21P18 1800', 7" reel.....	\$4.95

Type 11P Tape

.5-mil polyester base.	
11P4 400', 3" reel.....	\$2.00
11P12 1250', 5" reel.....	\$4.60
11P25 2500', 7" reel.....	\$7.95

Type 12P Triple-Play Tape

.5-mil polyester base.	
12P6 600', 3 3/4" reel.....	\$2.50
12P18 1800', 5" reel.....	\$5.95
12P36 3600', 7" reel.....	\$9.95

RCA

"Red Seal" Series 1-mil Long-Play Acetate Base

10A-2.25 225 feet, 3" reel.....	\$0.55
10A-3.75 375 feet, 3 3/4" reel.....	\$1.15
10A-9 900 feet, 5" reel.....	\$ 3.50
10A-18 1800 feet, 7" reel.....	\$ 5.50

1.5-mil Professional-Grade Acetate Base

15A-1.5 150 feet, 3" reel.....	\$ 0.70
15A-3 300 feet, 4" reel.....	\$ 1.35
15A-6 600 feet, 5" reel.....	\$ 2.25
15A-12 1200 feet, 7" reel.....	\$ 3.50

1.5-mil Professional-Grade Acetate Base

Low-noise, low-print	
15ALN-12 1200 feet, 7" reel.....	\$4.40

Mylar (Polyester) .5-mil Tensitized Extra-Long Play

5TM-3 300 feet, 3" reel.....	\$ 1.60
5TM-6 600 feet, 4" reel.....	\$ 3.05
5TM-6A 600 feet, 3 3/4" reel.....	\$ 2.95
5TM-12 1200 feet, 5" reel.....	\$ 4.75
5TM-24 2400 feet, 7" reel.....	\$ 8.75

Mylar (Polyester) 1-mil Long-Play

10M-2.25 225 feet, 3" reel.....	\$ 1.00
10M-9 900 feet, 5" reel.....	\$ 3.60
10M-18 1800 feet, 7" reel.....	\$ 6.20

Mylar (Polyester) 1.5-mil Professional-Grade

15M-6 600 feet, 5" reel.....	\$ 2.65
15M-12 1200 feet, 7" reel.....	\$ 4.25

"Vibrant Series" Full-Frequency Recordings Acetate (plastic) Base

V15-A-6 600 feet, 1.5-mil, 5" reel.....	\$1.50
V15-A-12 1200 feet, 1.5-mil, 7" reel.....	\$2.50
V10-A-9 900 feet, 1-mil, 5" reel.....	\$1.95
V10-A-18 1800 feet, 1-mil, 7" reel.....	\$3.75

Mylar (Polyester) Base

V10M-9 900 feet, 1-mil, 5" reel.....	\$2.25
V10M-18 1800 feet, 1-mil, 7" reel.....	\$4.25
V5TM-12 1200 feet, .5-mil tensitized, 5" reel.....	\$3.95
V5TM-24 2400 feet, .5-mil tensitized, 7" reel.....	\$6.95

Polyester Base Cartridge Tape

K10M-2.75 Special reel for use with RCA cartridge tape recorder.	
275', 2 3/4" reel.....	\$2.07
10M5.6C Snap-load cartridge, 560'.....	\$4.50

SARKES TARZIAN

"Standard Play" 1.5-mil Acetate Tape

1131-01 150 feet, 3" reel.....	\$.43
1131-06 600 feet, 5" reel.....	\$1.40
1131-12 1200 feet, 7" reel.....	\$2.33
1131-24R 2400 foot reel.....	\$6.83

"Long Play" 1-mil Acetate Tape

1121-02 225 feet, 3" reel.....	\$.60
1121-09 900 feet, 5" reel.....	\$2.10
1121-18 1800 feet, 7" reel.....	\$3.45
1121-36R 3600 foot reel.....	\$8.00

"Long Play" 1-mil Mylar Tape

1321-02 225 feet, 3" reel.....	\$.67
1321-09 900 feet, 5" reel.....	\$2.40
1321-18 1800 feet, 7" reel.....	\$4.13
1321-36R 3600 foot reel.....	\$9.67

"Extra Long Play" .5-mil Mylar Tape

1411-03 300', 3" reel.....	\$1.07
1411-06 600', 3 3/4" reel.....	\$1.93
1411-12 1200', 5" reel.....	\$3.63
1411-24 2400', 7" reel.....	\$5.70
1411-36 3600', 7" reel.....	\$8.70

"SCOTCH" TAPES

No. 111 "All-Purpose" Tape

Excellent freq. response, low modulation noise & high sensitivity; silicone lubrication process; 1.5-mil acetate backing.	
111-150 150', 3" reel.....	\$ 0.70
111-600 600', 5" reel.....	\$ 2.25
111-1200 1200', 7" reel.....	\$ 3.50

No. 102 "All-Purpose" Tape

For applications where extreme toughness & improved resistance to the effects of excessive temperature and humidity change

are required; high-strength polyester film backing; magnetic characteristics identical to No. 111 also features 1.5-mil polyester backing.

102-600 600', 5" reel\$ 2.65
102-1200 1200', 7" reel\$ 4.25

No. 120 "High-Output" Tape

Signal-to-noise ratio of from 6 to 12 db greater than conventional recording tapes; designed for critical recording applications where greater signal strength is essential; 1.5-mil acetate backing.

120-600 600', 5" reel\$ 2.25
120-1200 1200', 7" reel\$ 3.50

No. 131 "Low-Print" Tape

Acetate backing; reduces print-through to a point below noise level on most professional machines.

131-1200 1200', 7" reel\$ 4.40

No. 138 "Low-Print" Tape

Same recording characteristics as No. 131 but has tough 1.5-mil polyester backing.

138-1200 1200', 7" reel\$ 5.10

No. 200 Recording Tape

Double-length, double-strength tape with tensilized polyester backing.

200-1200 1200', 5" reel\$ 5.45
200-2400 2400', 7" reel\$ 9.50

No. 140 "Stereo-Quality" Tape

Extra-length tape which provides 50% more playing time; similar to No. 141; 1-mil acetate backing.

140-900 900', 5" reel\$2.50
140-1800 1800', 7" reel\$4.25

No. 144 "Double-Length, Double-Strength"

Stereo quality, double-strength; .5-mil tensilized polyester backing.

144-1200 1200', 5" reel\$4.50
144-2400 2400', 7" reel\$7.95

No. 190 "Extra-Length" Tape

High-potency oxide coating only half as thick as standard coatings (but with equivalent magnetic properties) coupled with a thinner backing of tough acetate; approximately 30% thinner than conventional acetate tape, nearly 80% as strong; 50% increase in recording and playback time with no noticeable print-through effect; magnetic properties are virtually identical to those of No. 111 magnetic tape.

190-900 900', 5" reel\$ 3.50
190-1800 1800', 7" reel\$ 5.50

No. 150 "Extra-Length, Extra-Strength"

Magnetic recording tape offering 50% more recording time and featuring 1-mil polyester backing for improved resistance to changes in temperature and humidity and also for greater strength.

150-900 900', 5" reel\$ 3.60
150-1800 1800', 7" reel\$ 6.20

No. 290 "Triple-Length" Tape

The tape that gives maximum play on a given reel size. Especially suited for continuous recording of lengthy conferences, meetings, conventions; .5-mil tensilized polyester backing.

290-1800 1800', 5" reel\$ 6.95
290-3600 3600', 7" reel\$11.95

"Living Letters" Tape

Packaged in plastic containers; three tape lengths available for variety of uses, providing up to maximum recording time on a 3" reel. Plastic container provides high-impact, re-usable mailer.

111-150-LL 150', 3" reel\$0.90
200-300-LL 300', 3" reel\$1.85
290-600-LL 600', 3" reel\$2.95

1966 EDITION

"Dynarange" Tapes

Although originally engineered for professional use, these tapes are now available for home recording. Available in 1.5-mil plastic (No. 201) and polyester backings (No. 202), as well as 1-mil polyester (No. 203). Provides high-fidelity recording even at 3 3/4 ips.

201 1.5-mil Acetate
201-1/4 600', 5" reel.....list \$2.80
201-1/4 1200', 7" reel.....list \$4.40
202 1.5-mil Polyester
202-1/4 600', 5" reel.....list \$2.85
202-1/4 1200', 7" reel.....list \$5.10
203 1-mil Polyester
203-1/4 900', 5" reellist \$4.25
203-1/4 1800', 7" reel.....list \$7.35

SONY

PR-150 Recording Tape

Extra-heavy formula Oxi-coat homogenized oxide coating. Polyester backing, "lubri-cushion" impregnated lubricant.

1800', 7" reel.....\$2.95
900', 5" reel.....\$1.75
300', 3 1/4" reel.....\$.95
300', 3" reel (designed for "Tapemates" correspondence; comes in self-mailing box\$.85

SOUNDCRAFT

"Standard" Tape

1.5-mil acetate base; professional quality; economy priced.

S-1 150 ft., 3" reel.....\$0.70
S-6 600 ft., 5" reel.....\$2.10
S-9 900 ft., 5 1/4" reel.....\$2.73
S-12 1200 ft., 7" reel.....\$3.50

"Standard-50" Tape

Long-play version of "Standard" tape on 1-mil acetate base.

S5-2 225 ft., 3" reel.....\$0.90
S5-9 900 ft. 5" reel.....\$3.29
S5-18 1800 ft., 7" reel.....\$5.17

"Lifetime" Tape

For use where utmost strength and quality are necessary; 1.5-mil Mylar base; "Micro-polished" oxide coating for perfect high-frequency response.

L-1 150 ft., 3" reel.....\$0.75
L-6 600 ft., 5" reel.....\$2.65
L-12 1200 ft., 7" reel.....\$4.25

"Plus-50" Tape

Made on 1-mil Mylar for 50% more playing time per reel; combines long play with great tape strength.

PL-2 225 ft., 3" reel.....\$1.00
PL-9 900 ft., 5" reel.....\$3.40
PL-18 1800 ft., 7" reel.....\$5.80

"Triple-Play" Tape

.5-mil Mylar base
TP-6 600 ft., 3 1/4" reel\$2.29
TP-18 1800 ft\$3.40
TP-24 2400 ft., 5 1/4" reel\$6.96
TP-36 3600 ft., 7" reel\$10.00

"Plus-100-X" Tape

Similar to "Triple-Play" but with twice the tensile strength; base is .5-mil Mylar.

XP-3X 300 ft., 3" reel.....\$1.60
XP-18X 1800 ft., 5 1/4" reel.....\$7.48
XP-24X 2400 ft., 7" reel.....\$9.50

"Golden Tone" Tape

High quality special tape; 25% more high-frequency out & 7 db better signal-to-noise ratio; 7" reel.

GTA-12 1.5-mil acetate base, 1200'....\$4.70
GTM-18T 1-mil tensilized Mylar base, 1800'\$7.50
GTM-24T .5-mil tensilized Mylar base, 2400'\$11.40

Don't Let Tape Breakage or Tape Splicing Scare You...

Get the

EDITall® KP-2

The Inexpensive, Simplified
Professional Tape Editing
and Splicing System

It's Easy...

you get Perfect
Results the First Time
... Every Time!

With the exclusive patented EDITabs, the EDITall handy kit, now available for the first time, puts you in the Professional class ... gives you everything you need to splice and edit tapes perfectly... even mend those tiny bits and pieces.

**SAVES YOUR TAPES
AS WELL AS YOUR MONEY!**

Once you've used it you'll agree with the pros... there's no other completely satisfactory method of splicing, repairing and editing tape. Another ELPA Quality Product that saves you time, temper and tape!

The EDITall KP-2 Contains:

- Patented Precision EDITall Splicing Block
- 30 EDITab "instant" Splicing Tabs
- Demagnetized Blade
- Special Tape Marking Pencil
- Introductory Tape Splicing and Tape Editing Guide

**only
\$3.50**



EDITabs® These patented handy splicing tabs join your tapes easily. When used with the EDITall, they assure you of a perfectly butted joint and a perfectly aligned splice. Special formula adhesive coating never oozes out and assures you smooth, sharp tape edges. Each EDITab you use is your guarantee of a perfect splice.

Package of 50 EDITabs... only \$1.50

If not available at your favorite Hi Fi Store, send for your set directly to Dept. TR-66
Add 50c for Postage and Handling.

ANOTHER ELPA QUALITY PRODUCT

ELPA MARKETING INDUSTRIES, INC.
NEW HYDE PARK, NEW YORK

CIRCLE NO. 39 ON READER SERVICE CARD

TAPE ACCESSORIES

AMERICAN

TAK-100 Tape Kit

Includes a 1,500-foot reel of professional-length recording tape and a reel of pre-re-



corded performances by Frank Sinatra, Dean Martin, Trim Lopez, Count Basie, Sammy Davis, Billy Vaughn, Bing Crosby, and Lawrence Welk. Also contains a heavy-duty take-up reel, a 350-foot Mail-A-Tape in a self-mailing container, head-cleaning kit, tape splicer with pre-cut Mylar splicing strips, a reel of leader tape, 16-page booklet of tape tips\$17.95

AMPLIFIER CORP.

Model 150A "Magneraser" Junior

Bulk-type magnetic tape eraser; field intensity 750 gauss; duty cycle on one min.,



off five min.; can also be used to demagnetize sound film up to 35 mm. on plastic or metal reels; 4 3/4" x 4 1/8" x 2 1/2"; 117-v. operation\$18.95

Model 300A "Magneraser" Senior

Heavy-duty design; 800 gauss; on 7 min., off 7 min.; for use on reels up to 10 1/2"



and 1/4" and 1/2" wide tapes as well as

sound films up to 35 mm.; 7" dia. x 3 3/4"; 117-v. operation.....\$49.00

Model 200C "Magneraser"

Bulk tape eraser; operating voltage 100-130 volts; operating frequency 50-60 cps; 2" high, 4" dia.

Model 200C.....\$24.00
Also available: Model 220C, identical in price and specifications except for operating voltage of 200-260 volts instead of 110-130 volts a.c.

AUDIOTAPE

Audio Head Alignment Tape

Prerecorded at 2 kc., 10 kc., 15 kc., recorded at 15" per second; intervals between tones are 5 seconds duration; 300 ft. on 4" reel.....\$10.00

Audio Head Demagnetizer

Demagnetizes tape recorder heads; re-



quires only plug-in to conventional a.c. outlet\$10.00

AUDIOTEX

Model 30-114 Tape Demagnetizer

Handles all reel sizes up to 10 1/2"; erases to -52 db level; complete with 6-foot

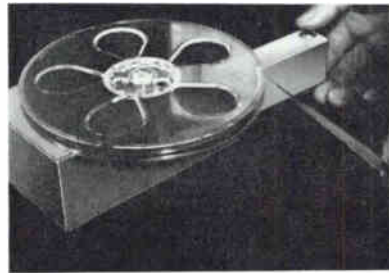

cord; includes an on-off push-button switch\$33.00

Model 30-112 Head Demagnetizer

Has curved top to reach most heads; soft plastic coating on tip to prevent head damage; built-in push-button switch; 6-foot cord.....\$11.95

CONCERTONE

Model 18 Head Demagnetizer

Pencil-type will demagnetize any tape recorder head\$4.95

Tape Timer-Strobe

For determining accuracy of tape speed; uses dial and features strobe for instant visual speed check; times length of tape in minutes and seconds\$19.95

EDITALL

KS-2 Editing Kit

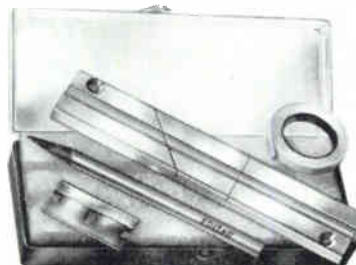

For 1/4" tape. Includes 4" x 3/4" x 1/4" block, marking pencil, roll of splicing tape & cutting blade.....\$7.50
Other versions available.

FANON-MASCO

RA-34 Head Demagnetizer

117-v. a.c. operated; 4 1/2" l. x 2" dia., wt. 8 oz.....\$4.50

RA-33 Bulk Tape Eraser

117-v. a.c. operated; flux density of 3500 gauss @ 1 cm. 5 1/2" x 5 1/2" x 4 1/2" h.\$19.95

LAFAYETTE

99-1516 Bulk Tape Eraser

Provides tape noise level 4-6 db below noise level from recorder erase heads; pilot light; fused; draws 6 1/2 amps; de-



signed for 110-120 volts, 60-cycle a.c. operation\$18.95

MICROTRAN

Model HD-40M Tape Head Demagnetizer



Will remove permanent magnetization; reduces noise level and harmonic distortion; improves signal-to-noise ratio; high-impact epoxy molded; 4" l. x 1 1/4" dia.\$6.15

Model HD-11M Bulk Eraser

Heavy-duty magnetic tape eraser for tapes up to 1/2"; noise level is reduced below



level of standard erase head; accepts reels from 5" to 10 1/2"; high-impact epoxy molded; 7" l. x 3 1/2" w. x 3 1/4" h.....\$18.95

NORTRONICS

Model P-6 Conversion Kit

Converts all Pentron mono and 2-track stereo tape recorders to 4-track stereo playback; patch cord and jack set to connect to external stereo playback amplifier included\$29.70

Model P-7 Conversion Kit

For Pentron recorders; includes 4-track stereo erase head; replaces mono erase head; used with P-6, permits stereo erase

during stereo recording.....\$15.00

Model W-2 Conversion Kit

Converts Webcor Series 210, 2020, 2100, 2600, and 2700 to 4-track stereo playback only; may not be used for recording unless external amplifiers are used (not included)\$27.50

Model W-6 Conversion Kit

Converts all Webcor 2800, 2900, 2000 (old Series, except 2020) to stereo playback; assembly includes head-shifter to play back 2-track and 4-track tapes; original mono recording and playback are retained\$36.00

Model W-7 Conversion Kit

For Webcor 2800, 2900, and old 2000 Series (except 2020); 4-track stereo erase head; replaces mono erase head; used with W-6, permits stereo recording when additional amplifier (not included) is used; original 2-track mono erase facilities are retained\$18.00

Model WR-40 Conversion Kit

Converts all mono Wollensak and Revere tape recorders to 4-track stereo playback;

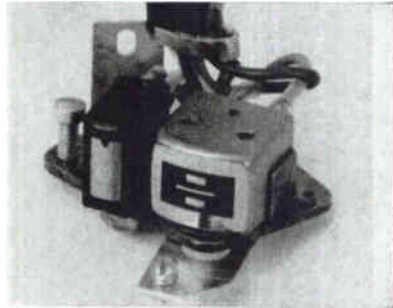

a tape head playback amplifier such as the Model PL-100 is required for playback of second channel (not included in the kit)\$32.50

Model WR-35 Conversion Kit

Converts all stereo Wollensak and Revere 2-track tape recorders to 4-track stereo playback\$25.50

Model WR-60 Conversion Kit

Converts all 2-track Wollensak and Revere models to 4-track stereo; includes three-position head shifter for 2-track stereo, 4-track stereo, and 4-track mono opera-

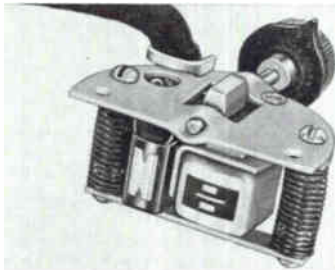

tion; allows stereo recording with additional amplifier (not included).....\$49.50

T60F Oscillator Transformer

For 12AU7A tube circuit use with all record, record/playback, and erase heads listed; freq. range 70-100 kc. depending on impedance\$4.50

Model T60E Oscillator Transformer

65-kc. bias for recording and erase current for either high or low impedance heads; one-tube oscillator circuit diagram included\$4.50

Model T60-T2 Oscillator Transformer

Similar to Model T60E but designed for transistor circuitry; 40-100 kc.; will de-

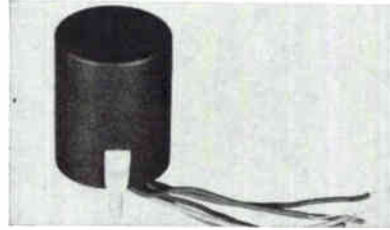

liver 25 to 150 volts to erase and record heads\$4.50

Model AT-100 Alignment Tape

7.5 ips full-track for checking record/play heads of all types; 40-10,000 cps; record-

ed for checking azimuth, equalization, and head wear.....\$4.95

1000 Series Record/Play Heads

Four-track stereo, laminated core, high-quality heads with all-metal hyperbolic face construction; replaces older CSQ, TLB & TLB-1 designs.

#1000—High impedance; 800 mhy. inductance; 100 μ n. gap; for use with vacuum-tube circuits; no-mount type\$21.00

#1001—Medium impedance; 400 mhy. inductance; 100 μ n. gap; for use with vacuum-tube or transistor circuits; no-mount type\$21.00

#1002—Low impedance; 100 mhy. inductance; 100 μ n. gap; for use with transistor circuits; no-mount type\$21.00
All above with rear mount.....\$22.50

(Continued overleaf)

Features never before offered on a stereo headset

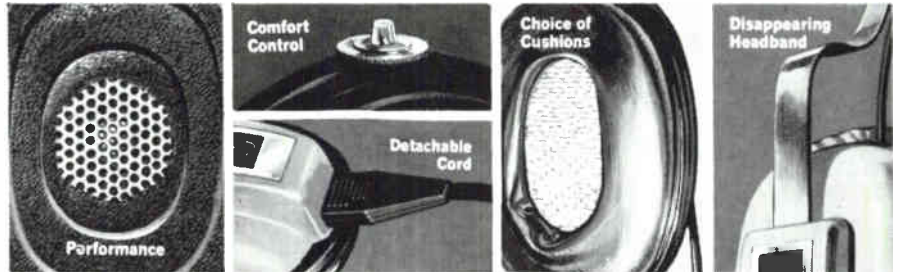

are standard on the new Telex professional quality . . .

Serenata



A TELEX FIRST—Comfort Control . . . knob adjusts earcup pressure for best sound and comfort.

A TELEX FIRST—Electronic Tone Control . . . controls tone according to preference and program.

A TELEX FIRST—Disappearing Headband . . . no bulky exposed adjustment parts. Smooth, clean design, completely adjustable.

A TELEX FIRST—Detachable Cord . . . New convenience. Stores neatly. Add adapter cords for a variety of connections.

A TELEX FIRST—Choice of Cushions . . . liquid-filled are standard, foam cushions optional.

A TELEX FIRST—Choice of Impedance . . . Either 8 or 600 ohms. Use for tape editing or monitoring.

A TELEX FIRST—Performance . . . New all dynamic sound reproducers set a new standard in stereo response. One minute's listening will convince you.

Listen-test Telex Stereo phones and You'll Accept Nothing Less. Ask your dealer to demonstrate the Serenata (\$59.95) or write for full information. See also the three other great Telex stereo headsets. One will match your exact preference—Adjustatone (\$15.95), ST-10 (\$24.95), ST-20 \$29.95.



Products of Sound Research

TELEX

DEPARTMENT 23J, 3054 EXCELSIOR BLVD., MINNEAPOLIS, MINNESOTA
CIRCLE NO. 34 ON READER SERVICE CARD

TAPE ACCESSORIES

Model RPE-20 Replacement Kit

Direct replacement mono record/play and

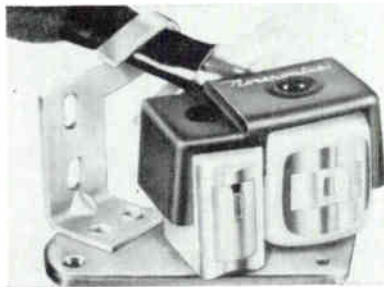

erase kit for Wollensak and Revere recorders; complete assembly mounted on special plate, wired and ready to install \$15.60

Model WR-30 Conversion Kit

Converts all mono Wollensak & Revere tape recorders to full-track record/play.....\$7.00

Model V-6 Conversion Kit

Converts all mono and 2-track stereo V-M recorders to 4-track playback; includes patch cord and jack set for connecting to external stereo playback amplifier.....\$25.50

Model V-7 Conversion Kit

For V-M recorders; 4-track stereo erase head; replaces mono erase head; used with V-6, permits stereo erase during stereo recording; includes synchronizing cable, isolation capacitor, and erase jack \$14.50

1200 Series Record, Record/Play Heads

Four-track stereo, laminated-core heads with all-metal, hyperbolic face construction; replaces older TLB, CSQ, and 1100 styles. Appearance same as Model 1000.

#1200 High impedance; 800 mhy. inductance; 100 μ in gap; for use with vacuum-tube circuits. No-mount type.....\$28.20
 #1201 Medium impedance; 400 mhy. inductance; 100 μ in. gap; for use with vacuum-tube or transistor circuits. No-mount type\$28.20
 #1202 Low impedance, 100 mhy. inductance; 100 μ in. gap; for use with transistor circuits. No-mount type\$28.20
 #1203 Low impedance record only; 50 mhy. inductance; 500 μ in. gap; for use with vacuum-tube or transistor circuits. No-mount type\$28.20
 #1205 Medium impedance; 200 mhy. inductance; 500 μ in. gap; for use with vacuum-tube circuits. No-mount type \$28.20
 #1207 Medium-low impedance; 200 mhy. inductance; 100 μ in. gap; for use with transistor circuits. No-mount type...\$28.20
 Same as above with rear mount.....\$29.70

1800 Series Record/Play Heads

Two-track stereo; laminated core; all-metal heads; hyperbolic face construction; replaces older TLA and TLD-S styles.

#1800—High impedance; 800 mhy. inductance; 100 μ in. gap; for use with vacuum-tube circuits; no-mount type\$23.30
 #1801—Medium impedance; 400 mhy. inductance; 100 μ in. gap; for use with vacuum-tube or transistor circuits; no-mount type\$23.30
 #1802—Low impedance; 100 mhy. inductance; 100 μ in. gap; for use with transistor circuits; no-mount type.....\$23.30

2600 Series Record/Play Heads

Two-track mono; laminated core; heads with all-metal hyperbolic face construction; replaces older SLA style.

#2600—High impedance; 800 mhy. inductance; 100 μ in. gap; for use with vacuum-tube circuits; no-mount type\$15.90
 #2601—Medium impedance; 400 mhy. inductance; 100 μ in. gap; for use with vacuum-tube or transistor circuits; no-mount type\$15.90
 #2602—Low impedance; 100 mhy. inductance; 100 μ in. gap; for use with transistor circuits; no-mount type.....\$15.90
 #2603—Special record only head; 50 mhy. inductance; 500 μ in. gap; for use with vacuum-tube or transistor circuits; no-mount type\$15.90

3000 Series Record/Play Heads

Two-track mono; laminated core, all-metal heads, hyperbolic face construction; replaces older SLS style.

#3000—High impedance; 800 mhy. inductance; 100 μ in. gap; for use with vacuum-tube circuits; no-mount type\$8.40
 #3001—Medium impedance; 400 mhy. inductance; 100 μ in. gap; for use with vacuum-tube or transistor circuits; no-mount type\$8.40
 Same as #3000 and #3001 except rear mount\$9.90

3100 Series Record/Play Heads

Two-track mono; solid core heads with cylindrical metal face construction; center track.

#3100 High imp.; 1000 mhy.; 160 μ in. gap for use with vacuum-tube circuits; no-mount type.....\$8.40
 #3101 Med. imp.; 400 mhy.; 160 μ in. gap; for use with vacuum-tube or transistor circuits; no-mount type.....\$8.40
 Same as above with rear mount.....\$9.90

3200 Series Record, Record/Play Heads

Two-track mono, laminated core heads with all-metal hyperbolic face construction; replaces older SLS style.

#3200 High impedance, 800 mhy. inductance; 100 μ in. gap; for use with vacuum-tube circuits. No-mount type\$15.90
 #3201 Medium impedance; 400 mhy. inductance; 100 μ in. gap; for use with vacuum-tube or transistor circuits. No-mount type\$15.90
 #3203 Low impedance record only; 50 mhy. inductance; 500 μ in. gap; for use with vacuum-tube or transistor circuits. No-mount type\$15.90
 Same as above with rear mount.....\$17.40

4100 Series Record/Play Heads

Full-track mono; laminated core heads with plastic, hyperbolic face construction; replaces older SF style.

#4100—Medium impedance; 250 mhy. in-

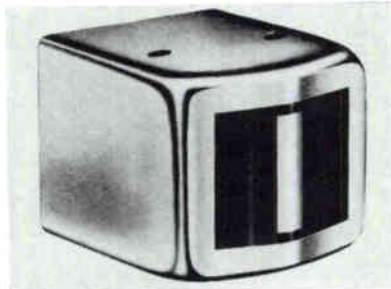

ductance; 160 μ in. gap; for use with vacuum-tube or transistor circuits; no-mount type\$34.70

#4101—Special record only head; 70 mhy. inductance; 500 μ in. gap; for use with vacuum-tube or transistor circuits; no-mount type\$34.70
 Same as #4100 and #4101 except rear mount\$36.20

5601 Series Record/Play Heads

Four-channel; laminated core heads with all-metal hyperbolic face construction.

#5601 Special record-only head; low im-

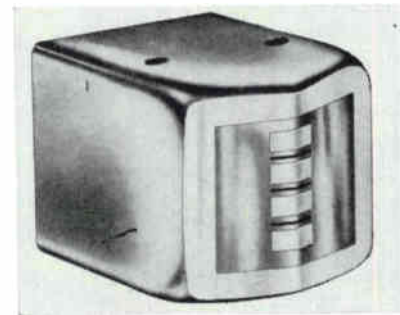

pedance 50 mhy.; 500 μ in. gap spacer; for use with vacuum-tube or transistor circuits; no-mount type.....\$99.00
 #5602 Low imp.; 90 mhy.; 100 μ in. gap spacer; for use with vacuum-tube or transistor circuits; no-mount type.....\$99.00
 #5603 Med. imp.; 370 mhy.; 100 μ in. gap spacer; for use with vacuum-tube or transistor circuits; no-mount type.....\$99.00
 Same as above with rear mount.....\$105.00

5700 Series Record/Play Heads

Three-channel premium hyperbolic face construction. For stereo record/play plus

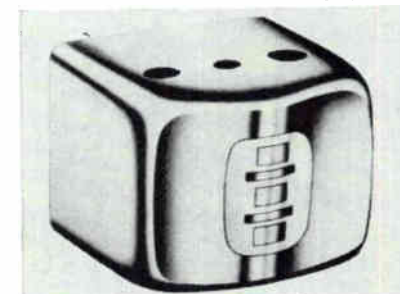

cue channel on broadcast cartridge machines.

#5701 Medium impedance, record/play; 370 mhy., 100 μ in. gap spacer; for vacuum-tube or transistor circuits.....\$99.00
 #5702 Low impedance record/play; 100 mhy., 100 μ in. gap spacer for transistor circuits\$99.00
 #5703 Low impedance record only; 50 mhy., 500 μ in. gap spacer for vacuum-tube or transistor circuits\$99.00

#8000 Series Heads

A series of record/play, record only, and erase heads for professional and broadcast equipment. Available in impedances and track configurations to match Ampex, Brush, Concertone, Crown, Magnecord, Muzak, Presto, and RCA heads or tape transports. Consult your dealer for prices. Erase heads are available in standard case (.560 x .285 face), the "L" case (.620 x .375 face), and the new "B" size (.490 x .578 face) that corresponds to the standard R/P or combination head case size.

1400 Series Erase Heads

Four-track stereo; laminated core; double gap; premium quality with full metal face construction; replaces older SEQ and SE-50 styles.

#1400—High impedance; 80 mhy. inductance 30,000 ohms impedance at 60 kc.; for use with vacuum-tube circuits; 60 kc.

(Continued on page 101)



Why We Make the Model 211 Available Now

Although there are many stereo test records on the market today, most critical checks on existing test records have to be made with expensive test equipment.

Realizing this, HiFi STEREO REVIEW decided to produce a record that allows you to check your stereo rig, accurately and completely, just by listening! A record that would be precise enough for technicians to use in the laboratory—and versatile enough for you to use in your home.

The result: the HiFi STEREO REVIEW Model 211 Stereo Test Record!

Stereo Checks That Can Be Made With the Model 211

- ✓ Frequency response—a direct check of eighteen sections of the frequency spectrum, from 20 to 20,000 cps.
- ✓ Pickup tracking—the most sensitive tests ever available on disc for checking cartridge, stylus, and tone arm.
- ✓ Hum and rumble—foolproof tests that help you evaluate the actual audible levels of rumble and hum in your system.
- ✓ Flutter—a test to check whether your turntable's flutter is low, moderate, or high.
- ✓ Channel balance—two white-noise signals that allow you to match your system's stereo channels for level and tonal characteristics.
- ✓ Separation—an ingenious means of checking the stereo separation at seven different parts of the musical spectrum—from mid-bass to high treble.

ALSO:



- Stereo Spread
- Speaker Phasing
- Channel Identification

PLUS SUPER FIDELITY MUSIC!

The non-test side of this record consists of music recorded directly on the master disc, without going through the usual tape process. It's a superb demonstration of flawless recording technique. A demonstration that will amaze and entertain you and your friends.

1966 EDITION

NOW...GET THE FINEST STEREO TEST RECORD ever produced

for just...\$4.98

Featuring Tests Never Before Available Outside Of The Laboratory

UNIQUE FEATURES OF HiFi/STEREO REVIEW'S MODEL 211 STEREO TEST RECORD

- Warble tones to minimize the distorting effects of room acoustics when making frequency-response checks.
Warble tones used are recorded to the same level within ± 1 db from 40 to 20,000 cps, and within ± 3 db to 20 cps. For the first time you can measure the frequency response of a system without an anechoic chamber. The frequency limits of each warble are within 5% accuracy.
- White-noise signals to allow the stereo channels to be matched in level and in tonal characteristics.
- Four specially designed tests to check distortion in stereo cartridges.
- Open-air recording of moving snare drums to minimize reverberation when checking stereo spread.

All Tests Can Be Made By Ear

HiFi/STEREO REVIEW's Model 211 Stereo Test Record will give you immediate answers to all of the questions you have about your stereo system. It's the most complete test record of its kind—contains the widest range of check-points ever included on one test disc! And you need no expensive test equipment. All checks can be made by ear!

Note to professionals: The Model 211 can be used as a highly efficient design and measurement tool. Recorded levels, frequencies, etc. have been controlled to very close tolerances—affording accurate numerical evaluation when used with test instruments.

DON'T MISS OUT—ORDER NOW

The Model 211 Stereo Test Record is a disc that has set the new standard for stereo test recording. There is an overwhelming demand for this record and orders will be filled by HiFi/Stereo Review promptly upon receipt. At the low price of \$4.98, this is a value you won't want to miss. Make sure you fill in and mail the coupon together with your check (\$4.98 per record) today.

FILL IN AND MAIL TODAY!

Stereo Test Record
HiFi/Stereo Review—Dept. SD
One Park Ave., New York 16, N.Y.

Please send me _____ test records at \$4.98 each. My check (or money order) for \$_____ is enclosed. I understand that you will pay the postage. (Orders from outside the U.S.A. add 50c to partially defray postage and handling costs.)

Name _____
(Please Print)

Address _____

City _____ Zone _____ State _____

SORRY—No charges or C.O.D. orders!

TRA-66

**This
“speaker”
isn’t
listed
in your
Directory.**

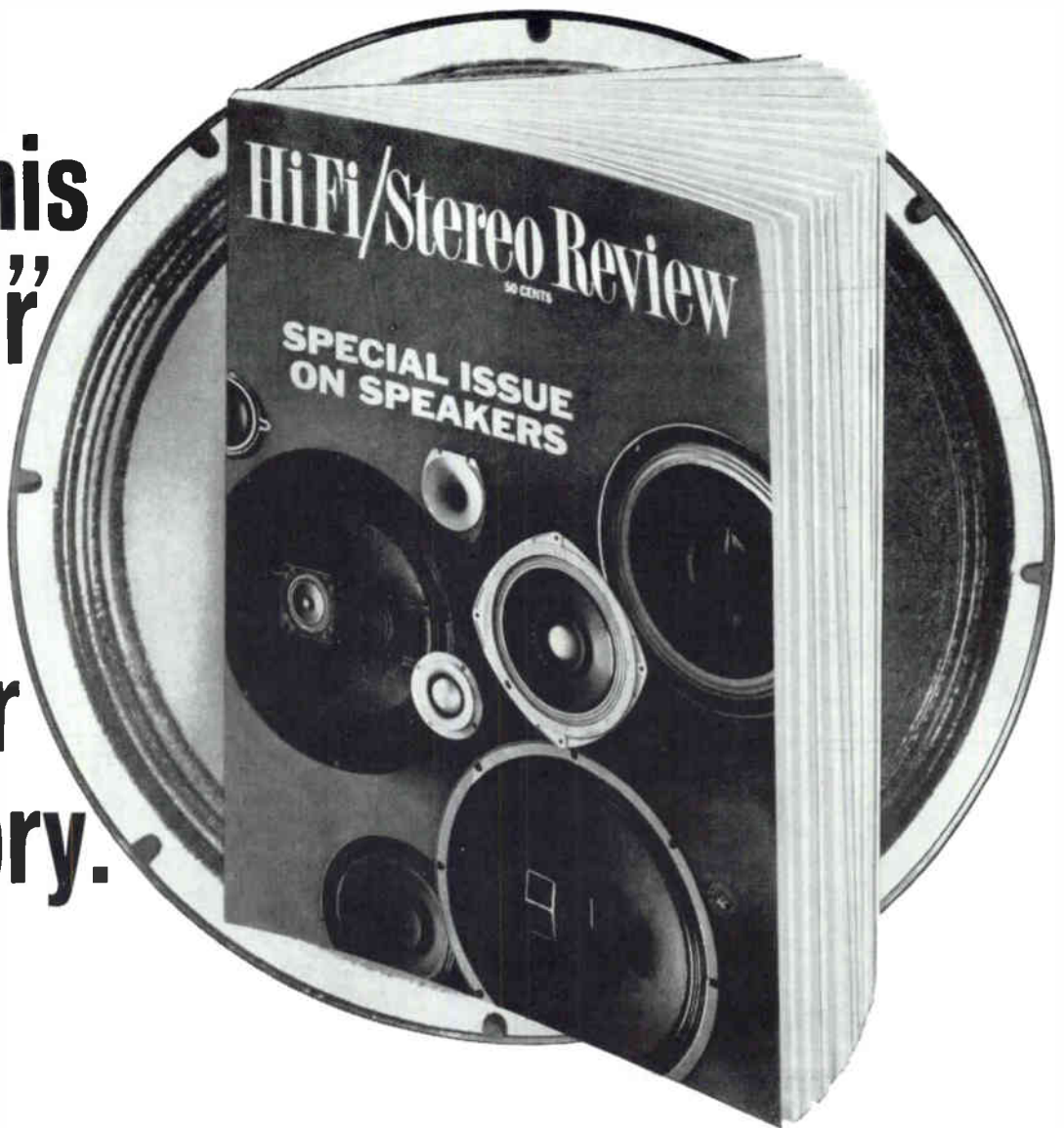

It's *HiFi/Stereo Review*—favorite spokesman on the subject of high fidelity for over 150,000 audiophiles and music lovers everywhere.

And *how* it speaks up! Straight from the shoulder—with impartial laboratory reports on new hifi/stereo equipment. Good verdict or bad, you always get invaluable information that will guide you to the finest components in your price range, throughout the next twelve months!

Our record reviewers are equally outspoken. Each month, they listen to 150 or more of the latest recordings and tapes, mono and stereo, in every musical category from classical to jazz, and report their verdicts unflinchingly. Some releases are praised highly—others are thumbed down. Result? You'll avoid disappointment—make every dollar count—as you add outstanding selections to your music library.

Over 150,000 regular monthly readers like the way *HiFi/Stereo Review* speaks out in their behalf—and so will you! You'll also like the informative profiles on your favorite artists...and the wide scope of engrossing features on the world of music. Lively—abundantly illustrated!

Indispensable for every audiophile and music lover, *HiFi/Stereo Review* is now available to you at a very special low price...

SPECIAL INTRODUCTORY OFFER

12 issues of *HiFi/Stereo Review*
\$2.95 (REGULAR RATES:
 ...only **2.95** \$5 a year—
 50¢ a month)

FILL IN, DETACH AND MAIL THIS POSTPAID CARD TODAY!

Bonus!

If you enclose payment with your order, saving us billing costs, we will add **2 EXTRA ISSUES** to your subscription! That's 14 in all for the same low \$2.95!

If card has already been used, write to:
 HiFi/Stereo Review, Dept. 4078
 Portland Place, Boulder, Colo. 80311

operating voltage: 90-150 volts; no-mount type\$12.00
 #1401—Medium impedance; 10 mhy. inductance; 2800 ohms impedance at 60 kc.; for use with vacuum-tube or transistor circuits; 60 kc. operating voltage: 28-42 volts; no-mount type.....\$12.00
 Same as #1400 and #1401 except rear mount\$13.50

3600 Series Erase Heads

Two-track mono; laminated core; premium quality with full metal face construction; double gap; replaces older MEH and ME-100 styles.
 #3600—High impedance; 80 mhy. inductance; 25,000 ohms impedance at 60 kc.; for use with vacuum-tube circuits; 60 kc. operating voltage: 100-150 volts; no-mount type.....\$8.00
 #3601—Medium impedance; 8 mhy. inductance; 2000 ohms impedance at 60 kc.; for use with vacuum-tube or transistor circuits; 60 kc. operating voltage: 32-48 volts; no-mount type.....\$8.00
 Same as #3600 and #3601 except rear mount\$9.50

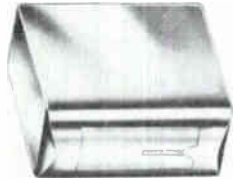

4400 Series Erase Heads
 Full-track mono; laminated core; double gap; premium quality with full metal face construction; replaces older MEF and ME-250 styles.
 #4400—High impedance; 40 mhy. inductance; 12,000 ohms impedance at 60 kc.; for use with vacuum-tube circuits; 60 kc. operating voltage: 100-150 volts; no-mount type.....\$14.00
 #4401—Medium impedance; 3.6 mhy. inductance; 1000 ohms impedance at 60 kc.; for use with vacuum-tube or transistor circuits; 60 kc. operating voltage: 32-48 volts; no-mount type.....\$14.00
 Same as #4000 and #4001 except rear mount\$15.50

2200 Series Erase Heads

Two-track stereo; laminated core; double gap; premium quality with full metal face construction; replaces older SEH and SE-100 styles.
 #2200—High impedance; 80 mhy. inductance, 25,000 ohms impedance at 60 kc.;

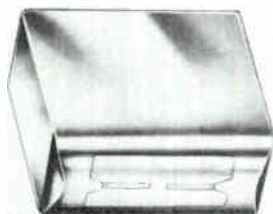

for use with vacuum-tube circuits; 60 kc. operating voltage: 100-150 volts; no-mount type\$12.00
 #2201—Medium impedance; 8 mhy. inductance; 2000 ohms impedance at 60 kc.; for use with vacuum-tube or transistor circuits; 60 kc. operating voltage: 32-48 volts; no-mount type.....\$12.00
 Same as #2200 and #2201 except rear mount\$13.50

"Quik-Kit" Adjustable Head Mounting Assembly

For updating tape decks to use Nortronics

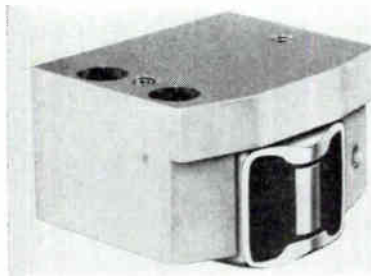

no-mount heads. Includes provision for adjustment of tape head for wrap, height, tilt, and azimuth.....\$2.25

"Quik-Kit" 76 Head Mounting Kit

A precision cast aluminum block and hardware to fit Nortronics heads to the Ampex

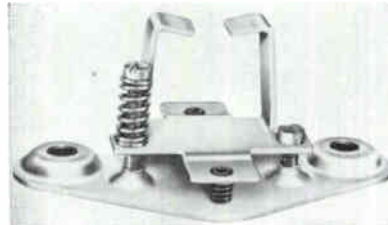

300, 350, 400, 3000, and 3200 series tape transports\$12.00

"Quik-Kit" 82 Head Mounting Kit

Adapts Tandberg Models 6, 64, 74, 84 to use Nortronics no-mount heads.....\$2.00

"Quik-Kit" 116 Head Mounting Kit

To adapt various models of Roberts, Akai, Metzner, and Terracorder to use the Nortronics no-mount heads.....\$12.00

ROBINS

Model ME-55 Eraser

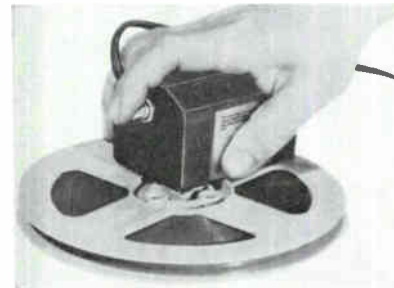

Hand-held bulk eraser for 1/4" tapes\$16.66

Model TK-5 Strobetape Kit

Consists of five lengths of 25-inch nonmagnetic leader tape with strobe markings plus small neon light which flickers at a rate of 120 times per second; designed to be spliced into a roll of tape. The strobe markings will indicate relative speed of the tape machine\$2.25

Model TS-8D Deluxe Tape Splicer

Cuts tape diagonally; features "See-Thru" windows indicating cut and trim positions;



blade centering adjustment; unit has replaceable cutter cartridge and blade.

.....\$12.75

Model TS-4S Tape Splicer

Similar in performance to Model TS-8D. Does not have "See-Thru" windows; sup-



plied with roll of 3/8" x 100" splicing tape\$9.50

TS-6 Tape Splicer

Adjustable for 40° or 90° cut. Complete with 25 cut, self-stick patches\$5.00

Model ME-99 Bulk Tape Eraser

Demagnetize up to 1/2" wide; can erase background noise on old tapes; takes up to



10 1/2" reels; size 3 3/4" x 5 1/4" x 6 3/4"\$43.50

Model ME-77 Bulk Tape Eraser

Low-cost version of Model ME-99; accepts reels up to 7"\$24.50

Model HD-6 Head Demagnetizer

Allows user to demagnetize tape recorder



heads; plugs into a.c. line.....\$10.00

Model HD-3 Head Demagnetizer

Low-cost version of Model HD-6 demagnetizer\$6.00

SCHOBER

RV-3 "Reverbatape" Unit

Electronic reverberation system using a multi-head tape recorder; reverberation time adjustable from 0 to 6 seconds; sensi-

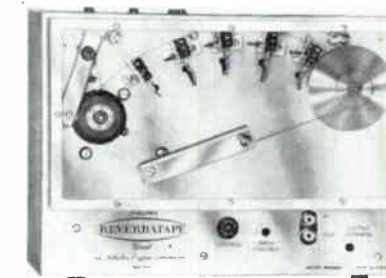

tivity .3 to 3 volts r.m.s. adjustable; 500,000 ohm input impedance; emitter-follower output; gain 1; has 1 record, 3 playback, 1 erase head, and 13 transistors, with walnut case, (through dealers).....\$279.95
 Available in kit form (direct).....\$140.00

For Tough Recording Jobs Choose The Only Microphone With Backbone!

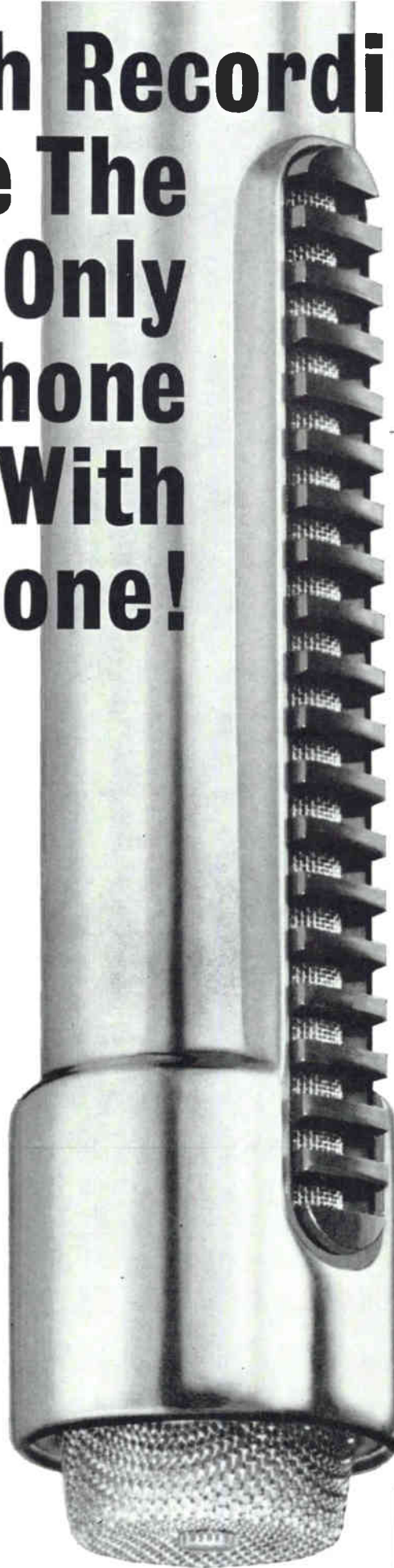

**ELECTRO-VOICE
MODEL 676
DYNAMIC CARDIOID**

EY The backbone of the Electro-Voice Model 676 is no mere decoration. It's visible proof of the most exciting idea in directional microphones—Continuously Variable-D (CV-D)[™].

And it takes a directional microphone to solve your tough recording problems: bad acoustics, audience noise, poor balance between performers.

Here's how CV-D works. We attach a very special tapered tube to the back of the microphone element. This tube automatically varies in effective acoustic length with frequency. It's a long tube for lows — a short tube for highs. All this with no moving parts! The tube is always optimum length to most effectively cancel sound arriving from the back of the microphone, regardless of frequency.

This ingenious solution* is years ahead of the common fixed-path designs found in most cardioid microphones. The 676 offers significantly smoother response at every point—on or off axis—plus more uniform cancellation to the rear. It is also less sensitive to wind and shock. There is almost no "proximity effect"... no boosted bass when performers work extra close.

Long life and smooth response are guaranteed by the exclusive E-V Acoustalloy[®] Diaphragm. And the

676 has unusually high output for a microphone so small. Of course you get dual output impedances, high efficiency dust and magnetic filters—all of the hallmarks of Electro-Voice design that have made E-V a leader for years.

But that's not all. The 676 has an exclusive bass control switch built in. Choose flat response (from 40 to 15,000 cps) or tilt off the bass 5 or 10 db at 100 cps to control reverberation, reduce low frequency feedback and room rumble.

Write today for complete specifications, or visit your E-V sound specialist's to see this remarkable new microphone. And when difficult recording problems must be faced squarely, stand up and fight back with the microphone with a backbone (and CV-D)—the new Electro-Voice 676 dynamic cardioid!

*Model 676 Satin Chrome or TV Grey,
\$100.00 list; in Gold, \$110.00 list.
Shown on Model 420 Desk Stand, \$20.00 List.
(Less normal trade discounts.)*

ELECTRO-VOICE, INC.
Dept. 1052TA, 648 Cecil Street
Buchanan, Michigan 49107

Electro-Voice[®]
SETTING NEW STANDARDS IN SOUND

*Pat. No. 3,115,207

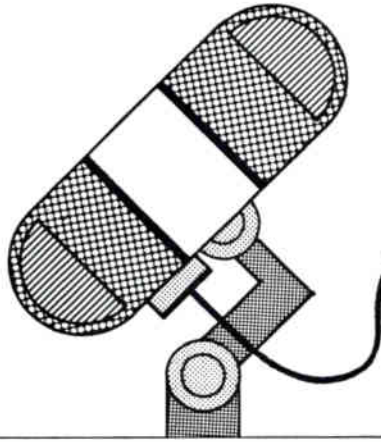

MICROPHONE DIRECTORY

ALTEC LANSING

Model 681A Microphone

General-purpose, moving-coil dynamic design; response 50-18,000 cps; output im-



pedance 150/250 or 20,000 ohms (specify impedance); output -55 dbm/10 dynes/cm.²; omnidirectional; 1 1/8" dia. at top, 7 3/8" long; dark green baked enamel and brushed chrome; comes complete with 15-foot cord\$46.50
Desk stand extra.....\$15.00
"On-off" switch kit.....\$8.25

Model 682A Microphone

Similar in design and style to Model 681A; response 45-20,000 cps; output impedance 30/50, 150/250, and 20,000 ohms (selectable by cable plug); two-tone baked enamel finish, black and dark green or dark brown and platinum, or brushed chrome; has sintered bronze filter for protection against moisture and blasting.....\$54.00

Model 683A Microphone

Similar in style to Model 681A; cardioid dynamic design; response 45-15,000 cps; 30/50, 150/250, and 20,000 ohms (selectable by cable plug); output -54 dbm/10 dynes/cm.²; front-to-back discrimination 20 db; same finishes available as for Model 682A; has sintered bronze filter for protection against moisture and blasting\$76.50

AMERICAN MICROPHONE

B213S Microphones

Ceramic hand-held microphones; response 80-9000 cps; high-impedance; 5-foot coiled



cord; ceramic with d.p.s.t. push-to-talk switch\$10.05

Model D-4 Microphone

Dynamic type; response 60-12,000 cps; output level -52 db; omni-directional;

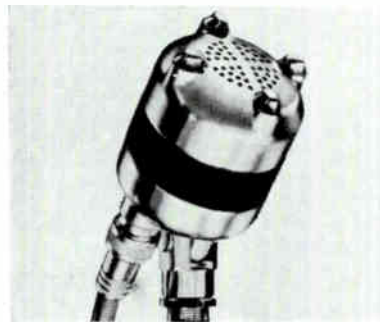

height 4"; 12 1/2' cable; available high- or low-impedance; rugged.....\$18.60

Model D-11 Microphone

Omnidirectional, dynamic hand-held general-purpose type; 80-10,000 cps; push-to-



talk switch; 2 3/8" dia. x 2" x 5"; includes 15' three-conductor shielded cable.
D-1111 high impedance.....\$21.60
D-111L low impedance.....\$21.60

Model D-12 Microphone

Dynamic lavalier type; compact 3 25/32" long; response 60-12,000 cps; output level -55



db @ high-impedance; includes lavalier and accessories.

D-12H high impedance.....\$35.70
D-12L 50 ohms.....\$35.70

D-20 Omnidirectional Microphone

Dynamic design. Response 80-12,000 cps; output -58 db (ref. 1 v./dyne/cm.²);



25,000 ohm imp.; an adjustable 2-pos. desk stand, floor-stand coupler, and lavalier cord assembly are supplied; 6 3/8" x 1 3/4", 5 1/2 oz.List \$20.00

Model D-22 Microphone

Dynamic type; frequency response 50 to 12,000 cps; omnidirectional; output level

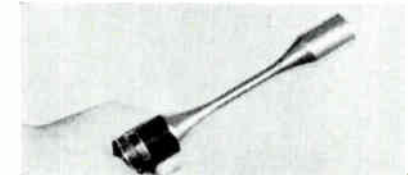

-55 db at high impedance; available in high- or low-impedance; over-all height 8 1/4"; 25' single conductor cable.....\$59.70

Model D-55 Microphone

All-purpose unidirectional dynamic design; 50-12,000 cps; impedance may be changed



to low or high; 7 1/2" long x 1 3/8" dia.\$51.00
D-55 G Same as above in attractive gold casing\$51.00

300 Microphone Clamp

Detachable, lightweight; adapter fits any 1" dia. mic. providing mtg. to 3/8"-27 desk or floor stand.....List \$7.50

301 Snap-in clamp. Similar to 300 but cut back to allow snap-in mtg. of 1" dia. microphoneList \$7.50
310 Similar to 300 but for 3/4" dia. microphonesList \$6.00
311 Similar to 301 but for 3/4" dia. microphonesList \$6.00

MICROPHONE DIRECTORY

513 Filter

For use with low-impedance microphones; has sw. to match 50, 150, or 250 ohms.

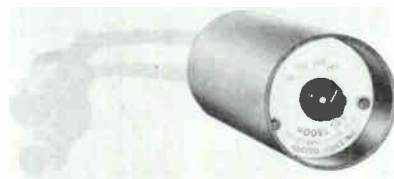

When used in line between preamp & mic it rejects unwanted noise below 100 cpsList \$70.00

ASTATIC

988 "Vogue" Dynamic Microphone

Omnidirectional design with "pop-proof" and "blast-proof" diaphragm; insensitive



to moisture and temperature; convertible from hand to stand to lavalier use; detachable cable connector; response 40-17,000 cps; impedance selector for 50-150-250 ohms; output -56 db at 1 mw./10 dynes/cm.²; furnished complete with 20-foot cable, stand adapter, lavalier assembly; 9 1/2" h. x 1 9/32" dia.....\$150.00

888 "Tempo" Dynamic Microphone

Similar to Model 988 except response 50-15,000 cps; impedance selector for 50-200-



high-impedance; output -58 db.\$110.00

788 "Metro" Dynamic Microphone

Similar to Model 988 except response 60-13,000 cps; impedance 150 or high-imped-



ance; output -58 db; has built-in "on-off" switch\$79.50

Model 77 Series Microphones

Dynamic cardioid design; front-to-back pickup differential 18 db; rugged and insensitive to temperature and moisture; blast-proof diaphragm; essentially flat from 30-15,000 cps; impedance selector



switch: high-impedance position (40,000 ohms), open circuit voltage -48 db @ 1 volt/dyne/cm.²; low-impedance position

(30-50 ohms) power level into 50 ohms -52 db @ 1 mw./10 dynes/cm.²; medium-impedance position (150-250 ohms), -53 db.

Model 77\$82.50
Model 77L\$72.50
Model G77 Complete with grip-to-talk desk stand, 8-foot cable.....\$97.45
Model 77 (Gold finish).....\$92.50
Model 77L (Gold finish).....\$82.50
All "L" models furnished less "on-off" switch, cable, and adapter; intended for use with the company's Model G grip-to-talk desk stand.

DYNACO

Models 50 & 53 Microphones

Both models are ribbon; bidirectional; B & O manufactured; response ±2.5 db 30-13,000 cps; output 56 db below 1 volt/μbar at high impedance or with matching transformer; 7 3/4" x 1 3/16"; switch provides music, close-talk, and off positions.

Model 50 (50 ohms balanced only).....\$59.95
Model 53 (with internally switched matching transformer for 50 and 250 ohms balanced, 40,000 ohms unbalanced)\$69.95
Model SS-1 Stereo spacer & dual mount for 50 or 53 microphones\$14.95
MT-1 matching transformer (50-50,000 ohms)\$14.95

Model 200 Microphone

Dual-ribbon mike designed by B & O for stereo operation; bidirectional with figure-8 pattern; top section can be rotated through 100° with respect to lower section so optimum 90° angle or any point in between may be chosen; lower section includes

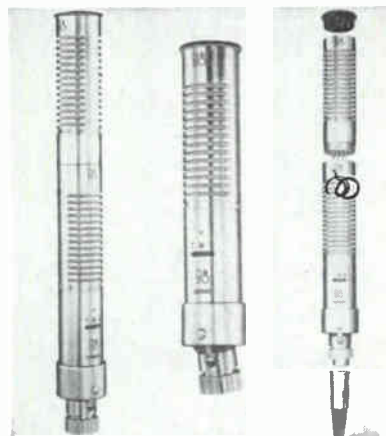

phasing switch and another for muting, normal operation and a close-talk position; unplug top for mono use; response 30-13,000 cps ±2 db; in "talk" position response is rolled off 3 db/octave below 1 kc.; impedance 150/200 ohms; sensitivity Gm = -156 db; 10" x 1 3/16"\$149.95
Model 100 Mono version\$ 89.95
MT-2 Matching transformer (dual-200 ohm to high-Z)\$ 24.95

ELECTRO-VOICE

Model 644 "Sound Spot" Mike

Combination cardioid & distributed front opening have better than 2.5 times the

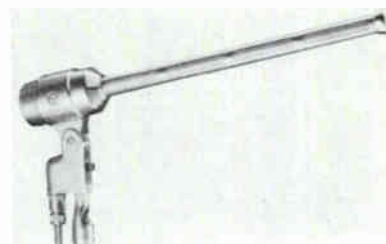

working distance of pressure-type micro-

phone; 20 db cancellation rear & sides above 700 cps; cardioid pattern below 700 cps; response 40-10,000 cps; output -53 db; dual high & low impedance selectable; 2 9/16" x 1 1/2"\$110.00

642 Dynamic Microphone

Highly directional design combining cardioid & distributed front opening design char-

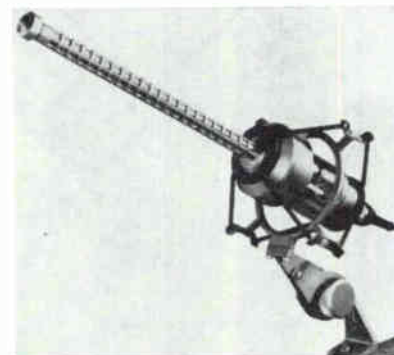

acteristics (unidirectional up to 500 cps, directional beyond). Response 30-10,000 cps or choice of 5 or 10 db low-freq. reduction steps by screwdriver adj.; 50, 150 & 250 ohms imp.; output -48 db; supplied with 30' three-conductor cable, 3 9/16" dia. x 1 7/8". Must be used with Model 356 or 327List \$390.00
Model 356 Suspension shock mount for boom or floor stand when no windscreen is used.....List \$50.00
Model 327 Windscreen package includes shock mount & windscreen.....List \$100.00

668 Cardioid Microphone

For boom use. Has wind screen & built-in equalizer for choice of four response curves in both low- and high-freq. ranges; response 40-12,000 cps; output -51 db; 50, 150 & 250 ohm imp. Supplied with 20' three-conductor cable & shock-isolating boom mount; 3 1/4" dia. x 9 3/8".....List \$495.00
667A Same as 668 except permits selection of 3 low-freq. & 2 high-freq. response curvesList \$345.00

635A Omnidirectional Microphone

Has 4-stage pop & dust filter; for hand or



stand. Response 60-15,000 cps (rising): output -55 db; low-impedance. Supplied with Model 310 clamp & 18' three-conductor cable. 6" l. x 1 3/8" dia., 6 oz.....List \$82.00

Model 666 Super Cardioid

Dynamic; unidirectional; for boom, stand, or hand use; frequency response 30 to



16,000 cps; output -58 db; impedance 150 ohms, taps for 50 and 250 ohms; variable directivity increases working distance yet permits closeup without distortion; cast aluminum case; grey; 20 foot cable; built-in Cannon UA-3 connector; includes clamp-on stand mount with 3/8"-27 thread and 1/2" pipe thread adapter.....\$255.00
 Model 666R Same as 666 with high response rising at high end. For voice work.....\$255.00

Model 665 Cardioid Microphone

Lower cost professional microphone incorporating same design features as Model 666; response 50-14,000 cps; appearance similar to Model 664.....\$150.00

Model 664 Cardioid Microphone

Dynamic; unidirectional; frequency response 40 to 15,000 cps; output -58 db; 150 ohm and high impedance; diaphragm



shielded from dust; filter to minimize wind blast; on-off switch; pressure cast case; assembly includes hinge; 16 foot cable; size 7 1/4" x 1 7/8"; weight 26 oz.
 Chrome finish\$85.00
 Model 664G Gold finish.....\$90.00

Model 676 Cardioid Dynamic Mike

Response 40-15,000 cps; output -58 db; 150 ohms or high impedance, changed in cable connector; has 3-position switch which controls low-frequency attenuation to over-



come rumble & feedback; 7 3/8" x 1 1/4"
 Satin chrome finish.....\$100.00
 Model 676A Non-reflecting grey finish.....\$100.00
 Model 676G Gold finish.....\$110.00

Model 655C Slim-Trim TV Dynamic

Response 40-20,000 cps; output -58 db; can be used on stand, in hand, or on boom; easily concealed in studio props; pop-proof grille; impedances 50, 150, 250 ohms; impedance easily changed; clamp-on stand mount includes 3/8"-27 thread and 1/2" pipe thread adapter; 10 1/2" long, 1" dia.; 20-foot cable\$200.00

Model 636 "Slimair" Dynamic

For p.a., recording, and general use; response 60-13,000 cps; output -58 db; pop-proof head; wide pickup range; on-off switch; satin chrome finish; tiltable head;



Hi-Z or Lo-Z by changing one wire in connector; 16-foot cable; 10 1/4" long including stud; 1 1/8" max. dia.....\$72.50
 Model 636G Gold finish.....\$77.50

Model 654A Slim-Trim Broadcast

Dynamic omnidirectional; frequency response 50 to 16,000 cps; output -58 db;



impedance 150 ohms; gray; 18 foot cable; size 7" x 1"; net weight 15 1/2 oz.\$100.00

Model 630 Dynamic Mike

Response 60-11,000 cps; output -55 db; has "off-on" switch; available in high-im-



pedance or 150 ohms (matches 50-250 ohms); low impedance balanced to ground; 2" x 6 1/2"\$52.50

Model 623 Slim Microphone

Dynamic; omnidirectional; frequency response 60 to 12,000 cps; output -56 db;



high and low impedance; cast case; hinge head; on-off switch; built-in MC-4 connector 3/8"-27 thread; satin chrome; 16 foot cable; size 7 1/2" x 1 1/4"; weight 15 oz.\$57.00

Model 641 Dynamic Mike

Dynamic type; high output level; wide range response; for p.a., home recording,



communications; integral on-off switch; response 70-10,000 cps; output level -57 db; omnidirectional; 16-foot cable; Hi-Z or balanced 150 ohms (matches standard low impedances)\$35.00

Model 638 Microphone

Omnidirectional, dynamic design. Response 70-10,000 cps. Supplied either in 150 ohms



If you go in for "bargain" home recording equipment, then get yourself a plowhorse microphone and forget about the Turner Model 500 Cardioid. But if quality counts with you . . . if your recording equipment is as good as you can make it . . . this trim little filly will do you proud. She's a lady all the way, slim and beautiful, not temperamental. If you're serious about home recording, pick yourself a winner — the Turner 500 Cardioid. She's a thoroughbred.

FREE . . . Full line catalog. Check Reader Service Card.



In Canada: Tri-Tel Associates, Ltd.,
 55 Brisbane Road, Downsview, Ontario.
 Export: Ad Auriema, Inc., 85 Broad Street,
 New York 4, N.Y.

CIRCLE NO. 35 ON READER SERVICE CARD

MICROPHONE DIRECTORY

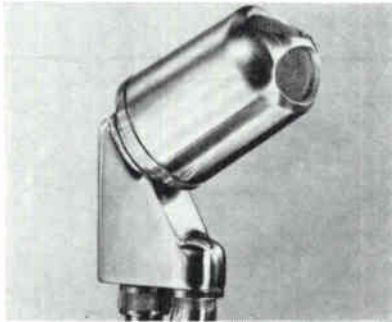

or Hi-Z. Output —57 db. Has 16' cable. 3 1/16" l. x 3 1/16" h.\$33.50

Model 649B Microphone

Dynamic, miniaturized, rugged lavalier design. Response 100-9000 cps ± 5 db;

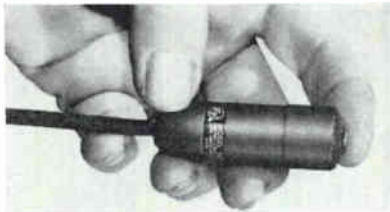

matches all low-impedance 50 through 250 ohms. Line balanced to grd. & phased. Sensitivity —155 db. Omnidirectional. Supplied with neck cord assembly & 30' 2-conductor shielded cable; 2 1/4" long x 3/4" dia.\$105.00

Model 647A Microphone

Omnidirectional, dynamic lavalier design. Response 70-10,000 cps; Hi & Lo imped-



ance selected at cable. Sensitivity —155 db; output (Lo. imp.) —61 db (0 db = 1 mw./10 dynes/cm.²). Supplied with 18 ft., 3-conductor shielded cable, neck cord & belt clip; 3 3/4" long x 3/4" dia.\$82.50

Model 624 Dynamic Lavalier

Response 100-7000 cps; output —56 db; features wire mesh head acoustically treated

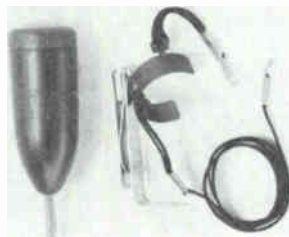

for wind & moisture protection; available in high impedance or 150 ohms; not balanced to ground; 3 5/8" x 1 1/2"\$42.50

Model 729 Ceramic Microphone

Cardioid design; wide-angle front pick-up; response 60-8000 cps; high-impedance; on-off switch; output —60 db; 7 3/4" l. x 1 1/2"

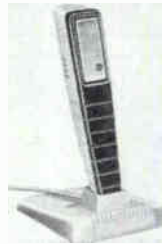

w. x 1 1/8" d.; single-conductor shielded 8 1/2 ft. cable; also available with relay operating switch and three-conductor (one shielded) cable.\$24.50

Model 727 Slim Ceramic

Similar in appearance to Model 729; withstands extremes of temperature and humidity; response 60-8000 cps; output —55 db; high-impedance only; 5-foot cable; available with or without on-off switch; 7 3/4" x 1 3/8" x 1 1/2"; supplied with desk stand and floor stand coupler.\$18.00
Model 727SR With relay control switch\$20.00

Model 715 "Century" Ceramic

Use in any position (in hand, on table, on stand, or overhead); ceramic element; 60-7000 cps; output —55 db; Hi-Z; 5-foot



cable; nondirectional; rugged and light-weight; 3" x 2 3/16" x 1"\$15.00
Model 715S With switch.\$15.00

Model 805 Contact Mike

For guitar, banjo, other stringed instru-



ments; Hi-Z; sealed crystal; chrome finish; 15-foot cable.\$20.00

Model 712 Ceramic Mike

Low-cost ceramic unit; meets need for p.a., home recording, paging, general use; hand-



held; moisture-sealed ceramic; response

70-7000 cps; high output —55 db; Hi-Z; 3" x 2 1/4" x 1 1/8"; 5-foot cable.\$7.50

951 Cardioid Crystal Microphone

Wide-range, all-purpose p.a. mic. Response



50-11,000 cps; output —60 db; high impedance; "on-off" sw.; 16' cable; 1 1/4" dia., 5 3/8" l.; 1 1/4 lbs.List \$54.50

911 Crystal Microphone

Response 50-10,000 cps; output —50 db;



high impedance; 16' cable; 1 1/2 lbs.List \$32.50

926 Slim Crystal Microphone

For general-purpose use; response 60-8000 cps; output —60 db; high impedance; 1 1/16"

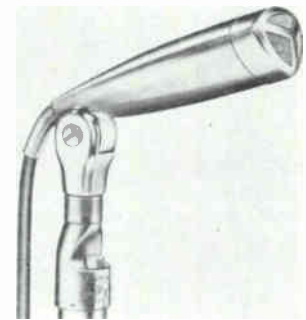

dia. x 1" l.; with tiltable head & 16' cable; 10 oz.List \$29.50

920 "Spherex" Crystal Microphone

Omnidirectional pickup. Response 60-10,000 cps; output —50 db; wire mesh head treated for wind & moisture protection. Has



high capacity & high impedance; 2 1/4" dia., 16' cable; 8 oz.List \$27.50

924 Lavalier Crystal Microphone

Supplied with neck cord, support clip & 18' cable. Has wire mesh head for wind &

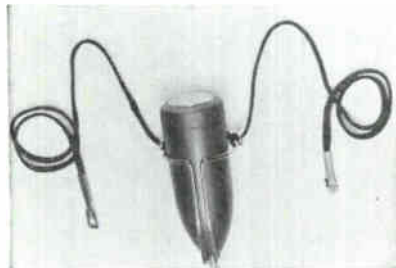

moisture protection. Response 60-8000 cps; output -60 db; high imp.; 1 3/8" dia. x 3 3/8", 8 oz.List \$20.00

Model 335A Blast Filter

Designed for use with Models 630, 641, 638

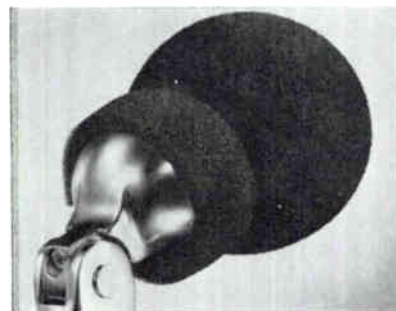

& 634 microphones. Will not affect freq. response\$12.50

Model 355 Windscreen

Designed for use with Models 655C, 654A, 636, 623 & 926. Reduces wind blast with-



out altering freq. response. Acts also as a protective device.....\$11.00

Model 524A Windscreen

Designed for use with Models 664, 665 &



666. Also protects against dust, magnetic particles & mechanical shock.....\$12.00

502A Matching Transformer

For use where long cable runs are required. Designed for low-impedance microphones



(50, 150, 250 or 500 ohms) to 40,000 ohm amplifier input. 30-20,000 cps.....\$17.50

FARGRAM

Parabolic Microphone

Reflector design for use with transistorized battery-operated tape recorders. Spun aluminum 24" reflector with sighting gunsight on microphone. Impedance 200 ohms; re-

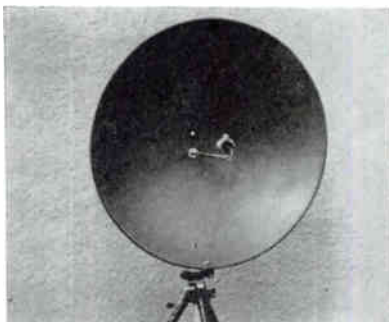

flector depth 5"; wt. 5 lbs; at 100 ft. from 500-5000 cps sensitivity of mic. is increased 15 db with reflector. To be used with any heavy-duty camera tripod with pan-tilt head. Supplied with mic., reflector & gunsight, microphone holder.....\$89.50

KNIGHT

KN-4550 Dynamic Microphone

Features cardioid pattern & two separately tuned chambers. Response 45-14,000 cps



with -55 db output. Has "on-off" sw.; provisions for high or low impedance. 7 1/4" x 1 3/8". Shipped with 18' cable.....\$34.95

KN-4545 Microphone

Recording and p.a. microphone; highly directional; 70-15,000 cps response; dual im-



pedance (250 or 20,000 ohms) "on-off" switch. 6 3/8" x 1 3/4". With desk stand, 8' cable (less connector).....\$24.76

KN-4510 Ceramic Microphone

Lightweight design with high-impedance



output of -56 db. Response 50-11,000 cps. 5 1/8" x 1 3/8". Supplied with swivel-mount stand, 7' cable & 1/4" phone plug.....\$9.50

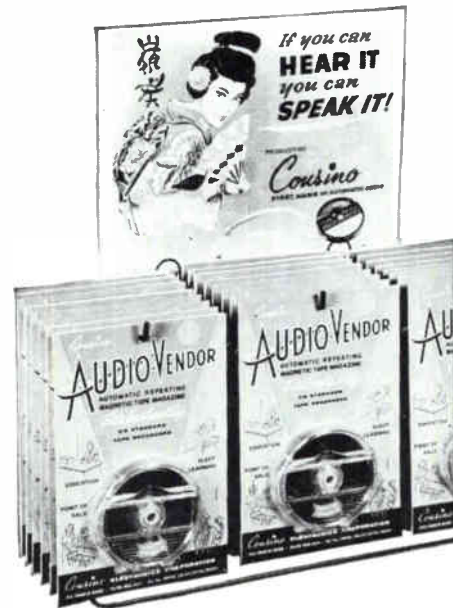

AUDIO-VENDOR
REPEATING
MAGNETIC TAPE
MAGAZINE

Converts most standard tape recorders to continuous operating message repeaters. Loaded for 3, 5, 8, 12, and 15-minute capacities at 3 3/4 ips. Repeats message, lesson, or other recorded material as long as desired. Ideal for sleep learning, language study, or wherever a repeated message is of value. Packed in clear plastic dust-proof, stand-up cases.



AT YOUR DEALERS

first name in automatic audio

Cousino

ELECTRONICS CORPORATION

Dept. TRA

1941 Franklin Ave., Toledo, Ohio 43624

CIRCLE NO. 10 ON READER SERVICE CARD

MICROPHONE DIRECTORY

KN-4520A Microphone

Dynamic element. Mylar diaphragm, and 80-12,000 cps response; for recording, p.a.,



and auditorium use. Output level -57 db. Omnidirectional. Dual impedance (3000 or 25,000 ohms). With desk stand, lavalier cord assembly; 4 1/2' cable. 5" x 1 5/16" dia.\$10.85

NORELCO

D-12 Dynamic Microphone

Directional type with cardioid characteristics. 40-15,000 cps ±3 db. Front-to-back



ratio, 18 db over entire frequency range. Impedance 50-250 ohms. Sensitivity -77 db (1 volt/dyne/cm.²).....\$99.00

D-119ES Dynamic Microphone

Cardioid type; multi-impedance; 5-pin Cannon connector; 40-16,000 cps ±3 db.

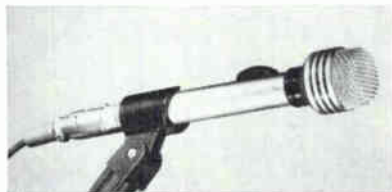

Impedance 50, 200 ohm or Hi-Z. Sensitivity -75 db (1 volt/dyne/cm.²). With speech/music switch\$65.00

D-24B Dynamic Microphone

Directional type with cardioid characteristics. With bass roll-off switch. Frequency range 30-16,000 cps ±2.5 db. Impedance 60 or 200 ohms. Sensitivity -75 db (1 volt/dyne/cm.²)\$150.00

D-19E/200 Dynamic Microphone

Cardioid type 40-16,000 cps ±3 db. Impedance 60 or 200 ohms. Sensitivity -75



db (1 volt/dyne/cm.²). With speech/music switch\$58.00

OLSON ELECTRONICS

M-203 Crystal Microphone

Hand-held design with push-to-talk sw. 2 of 4-wire cable are used to start/stop bat-



tery operated tape recorder. Response 40-6000 cps. Output level -50 db. 5 3/8" x 1 1/2" x 1".....\$2.95

M-164 Dynamic Microphone

Dual impedance (600 & 50,000 ohms); re-



sponse 50-10,000 cps; output -55 db; 2 1/2" diam. x 5 3/4".....\$12.98

RCA

77-DX Polydirectional Microphone

Features uni-directional, bi-directional, or non-directional pickup patterns changed by a selector switch; three frequency response variations on the basic pickup patterns may also be obtained, thus nine different directional characteristics may be utilized; output impedance is factory connected for 250 ohms but may be reconnected for 30 to 150 ohms; effective output levels are -50



dbm in the bi-directional pattern, -53 dbm in the uni- and non-direction patterns (EIA ratings, -144 db, -147 db, and -150 db respectively); response 30-20,000 cps; hum level pickup -128 dbm; supplied with 30 feet of three-conductor shielded cable, less plug; 1 1/2" x 3 3/4" x 2 1/4" d. Satin chrome finish\$206.00
Low-luster gray finish.....\$197.00

BK-6B Dynamic Microphone

Lightweight (23 oz.) microphone 2 9/16" x 1 3/16" in size; effective output level is -67



dbm (EIA rating, -158 db); response 60-15,000 cps; 250-ohm output impedance may be changed to 30 or 150 ohms by a change of cable connections; hum pickup is

low (-112 dbm); supplied with 30' of three-conductor cable, less connector; has lanyard & fastener.....\$86.00

BK-12A Dynamic Microphone

Non-directional, lightweight design. 60-18,000 cps; output -60 dbm (10 dynes/cm.²)

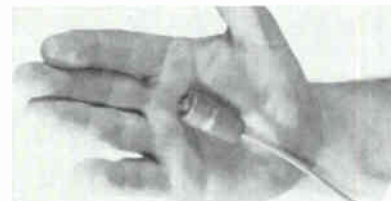

at 1000 cps. 150 ohm. For use with 30 to 250 ohm unloaded inputs. Supplied with clip-type lanyard, tie clip holder & cable clip. 3/4" dia., 1 1/2" long, 30' cable\$95.00

SK-30 Dynamic Microphone

Omnidirectional, lightweight design. 60-12,000 cps; output -56 dbm (10 dynes/cm.²)



@ 1000 cps. 1 1/2" dia. x 4 1/2" long; 20' cable, 50-250 ohm input\$30.00
Model SK-31 30,000 ohm input\$31.00

SK-46 Velocity Microphone

An economy ribbon design for indoor use; has good frequency response (40-15,000 cps) and bi-directional pickup characteristics; output impedance 200 ohms but may be



reconnected to 15,000 ohms; effective output level is -58 dbm at 250 ohms (EIA rating, -150 db) or -60 dbm at 15,000 ohms; supplied with 25' of two-conductor cable, less connector\$54.95

BK-1A Pressure Microphone

Ideal for outdoor use; offers smooth response for both voice and music; provides uniform response from 50-15,000 cps;



swivel mounting can be used to control directional characteristics; vertical position is non-direction, the horizontal position is semi-direction; output impedance is 250 ohms, but 30 and 150 ohm connections are included; effective output level is -56 dbm (EIA rating, -48 db); hum pickup is below -112 dbm; supplied with 30' of three-conductor cable, less connector.....\$73.50

SK-45B Talk-Back Microphone

Ideal for talk-back, cue, and p.a. use; dynamic microphone is essentially non-directional with a -56 db output level (EIA rating, -147 db) when connected for 150 to 200 ohm balanced output, and -58 db when connected for 15,000 ohms output; response 70-12,000 cps; supplied with 25' of cable, less connector.....\$45.00



Inexpensive dynamic microphone for cue and talk-back applications; plastic diaphragm is impervious to moisture and rain; response 60-10,000 cps; output level -55 dbm (EIA rating, -150 db); can be used with amplifiers having 150-250 ohm input; 15 oz.; supplied with 25' two-conductor cable.\$23.40

SK-39A Utility Microphone

General-purpose ribbon design with bi-directional characteristics; response 20-20,000 cps; effective output level -56 dbm @ 1000 cps (EIA rating, -147 db); output



can be connected for 30, 150, and 250 ohm operation; three-position switch permits selection of desired frequency ranges for voice and music.....\$131.25

BK-11A Velocity Microphone

Ribbon instrument designed for high noise areas; maximum sensitivity is in the major mechanical axis producing an extremely directional cardioid pattern; response 30-20,000 cps; effective output level -56 dbm (EIA rating, -150 db); output is connected for 250 ohms but may be changed to 30 or 150 ohms; supplied with 30' of three-conductor cable, less connector; windscreen available for outdoor use.....\$146.50



Dynamic type; uni-directional; frequency response 50 to 15,000 cps; output: -54 db at 35-50 ohms, -55 at 150-250 ohms; -57 at 35,000 ohms; 3-position impedance switch; Alnico V magnet; die-cast zinc case, satin chrome finish; Amphenol MC3M connector equivalent; self-adjust swivel; 5/8" -27 thread; on/off switch; 20 foot 2-conductor shielded cable; size 7 3/8" x 2 1/4" x 3 1/4"; wt. 3 1/2 lbs., shpg. 4 1/2 lbs.\$85.00

SHURE

Model 545 "Unidyne III" Microphone

Dynamic type; cardioid; frequency response 15-15,000 cps; output -57 db low level, -55 db high level; dual impedance; 18' three-conductor shielded cable; 6" x 2"\$85.00



Model 545S "Unidyne III"; as shown above, but mounted on permanent swivel base with on/off switch.....\$89.95

Model 55SW "Unidyne" Microphone

Dynamic type; uni-directional; frequency response 50 to 15,000 cps; output: -54 db at 35-50 ohms, -55 at 150-250 ohms; -57 at 35,000 ohms; 3-position impedance switch; Alnico V magnet; die-cast zinc case, satin chrome finish; Amphenol MC3M connector equivalent; self-adjust swivel; 5/8" -27 thread; on/off switch; 20 foot 2-conductor shielded cable; size 7 3/8" x 2 1/4" x 3 1/4"; wt. 3 1/2 lbs., shpg. 4 1/2 lbs.\$85.00



Model 55S without switch.....\$83.00

580S "Unidyne A" Dynamic Microphone

Unidirectional design; ideal for controlling feedback in p.a. & home recording applications. Has cardioid pickup pattern; shock-mounted element; "on-off" switch; response



50-12,000 cps; output -58 db; choice of hi- or low-impedance models; 6 3/8" x 1 1/4" dia.; 15' cable with strain relief. 580SA High impedance.....\$59.00 580SB 150-250 ohms.....\$52.00 580SA (M) Matched pair for stereo recording; high-impedance; complete with plugs attached\$118.00

576 Omnidirectional Dynamic Mike

Dynamic probe microphone featuring wide-range response for voice & music; ultra-slim 3/4" dia. x 8 3/8" long; response 40-29,000 cps; dual impedance 50 & 150 ohms; out-



put: -60 db; complete with slip-in swivel adapter that permits tilting microphone 90° from vertical to horizontal; also ideal as hand-held mic.; available in matched pairs for stereo, broadcasting and recording\$175.00

578 Omnidyne Ultra-Slim Probe

Designed as a dynamic omnidirectional type p.a. microphone; response 50-17,000 cps;



output: -59 db high impedance, -60 db low impedance; built-in wire mesh "pop" filter reduces breath noises; dual impedance (200 ohms & high); 3/4" dia., 7 3/8" over-all length; complete with "on-off" switch and special slip-in swivel stand adapter; available in matched pairs for stereo recording (matching to ± 1 db in level and ± 1 1/2 db in frequency response).....\$82.50 Model 578S. As above, but mounted on permanent swivel base, with Cannon XL3-11 type cable connector.....\$90.00

578S Dynamic Microphone

Omnidirectional; fixed stand design with "on-off" sw. Response 50-15,000 cps; 50-



250 ohms imp.; open-circuit voltage .10 mv.; EIA sensitivity -155 db; with 18' two-cond. cable; .78" dia.....\$90.00

Model 550S "Probe-Dyne" Microphone

Rugged, omnidirectional, dynamic design. Response 40-15,000 cps; output 57.5 db for low imp. & 58.5 db for high imp.; dual impedance, choice of 50-250 ohms & high; complete with on/off sw., swivel & 18' cable. Chrome finish.....\$69.00 Gold finish.....\$79.00

540S "Sonodyne II" Microphone

Dynamic type; uni-directional; response 60-10,000 cps (provisions for altering response to increase voice intelligibility); output: -57 db at 50-250 ohms, -52.5 db at high impedance; adjusts for high or low

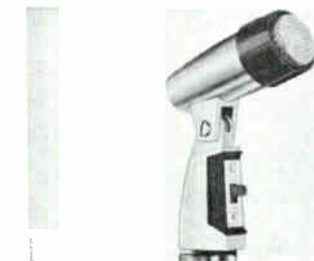

MICROPHONE DIRECTORY

impedance; modern die-cast zinc and Armo-Dur case; satin chrome and black finish; self-adjusting "lifetime" swivel; 15-foot, 2-conductor shielded cable; 6-3/32" x 1-21/32" x 2-9/16".....\$49.95

Model 570 Lavalier Microphone

Miniature size professional-quality dynamic microphone designed for lavalier use; tea-



turns special "shaped" response; output -59 db; reduces pickup of clothing and cable noise; lightweight, flexible, 30' microphone cable attached; response 50-12,000 cps with rising response to 6000 cps; impedance 150 ohms to match low impedance inputs; omnidirectional, 3/4" dia. x 2 1/2" over-all length; net weight 2 oz.....\$95.00
Model 570S, Similar to above, but with on-off sw, 5 3/32" long by 3/4" dia.....\$105.00

570S Dynamic Microphone

Omnidirectional, lavalier design; with "on-off" sw. Response 50-12,000 cps with rising characteristic to 6000 cps; 50-250 ohms imp.; open circuit voltage .085 mv.; EIA sensitivity -152 db; with 30' two-cond. cable; 2 3/32" dia.....\$105.00

571 Dynamic Microphone

An adaptation of Model 570 for stand or hand held use. Can be used as lavalier type



with accessory A571 assembly. Omnidirectional; response 50-10,000 cps; 50 to 250 ohm impedance; open-circuit voltage .085 mv.; EIA sensitivity -153 db; with 30' two-conductor cable; 2 3/32" dia.....\$95.00

560 Dynamic Microphone

Lavalier, dual-impedance design; response 40-10,000 cps with rising characteristic to



4500 cps; high & low (150 to 250 ohms) impedance; open-circuit voltage level 1.48 mv. (high imp.) & .149 mv. (low imp.); with 18' two-conductor cable; 1.356" dia.....\$42.50

333 Uni-directional Microphone

Ribbon design; response 30-15,000 cps \pm 2 1/2 db; output 50 ohm -60 db, 150 ohm

-59 db, 250 ohm -59 db; response at rear down 12-20 db; multi-impedance switch and adjustment for frequency characteristics; shock mounted; supplied with 20-foot cable; 7 9/32" h. x 1 1/4" w. x 1 1/8" d.\$250.00

Model 330 "Uni-Ron" Microphone

Ribbon type; uni-directional; frequency output; -60 db at 50 ohms, -59 db at



150 and 250 ohms; 3-position impedance switch; Alnico V magnet; die-cast zinc case; satin chrome finish; self-adjust swivel; 3/8"-27 thread; live rubber shock mount; Cannon X1-3-11 connector; 20 foot 2-conductor shielded cable; size 3 3/4" x 1 1/2" x 1 1/4"; wt. 1 1/2 lbs., shpg., 3 lbs.\$120.00

Model 300 Bi-directional Microphone

Multi-impedance ribbon design with special anti-breath filter; response 40-15,000 cps \pm 2 1/2 db; output 30-50 ohms -59



db, 150-250 ohms -60 db; high impedance -57 db; equipped with multi-impedance switch for 30-50 ohms, 150-250 ohms, and 35,000 ohms; equally sensitive front and rear with sides down 15 to 20 db; has shock mounting; supplied with 20-foot cable and switch to adjust frequency characteristics; 6" h. x 1 1/16" x 2 1/16" d.\$150.00

Model 315 Gradient Microphone

Ribbon type; bi-directional; frequency response 50 to 12,000 cps; output -59.5 db at 50-50 ohms; -60 db at 150-250 ohms, -57 db at high impedance; 3-



position impedance switch; Alnico V magnet; die-cast zinc case; satin chrome finish; self-adjust swivel; 3/8"-27 thread; Amphenol MC3M connector equivalent; 20 foot 2-conductor shielded cable; size 6" x 1 1/2" x 1 1/4"; wt. 1 lb., shpg., 3 1/4 lbs.\$89.50

Model 315S with switch.....\$91.50

575S "Versadyne" Microphone

Dynamic type; omni-directional; response 40-15,000 cps; output; high impedance



-59 db, low impedance -62 db; choice of high or low impedance versions; black Armo-Dur body with satin anodized cap and stainless steel grille; furnished with special stand adapter; on-off switch; attached 7-foot single-conductor shielded cable; 4 3/4" x 1 1/4".

Model 575S (high impedance).....\$24.00

Model 575SB (low impedance).....\$21.00

Model 275S "Versaplex" (ceramic version)\$15.00

430 "Commando" Microphone

Controlled magnetic type; omni-directional; frequency response 60 to 10,000 cps; output; Lo-Z, -54 db; Hi-Z, -55 db; changeable pin jacks give choice of 2 impedances; 150-250 ohms or high impedance; polystyrene and die-cast zinc case; satin-chrome and gray finish; A25 type swivel adapter; 3/8"-27 thread; Am-



phenol MC2M connector; 15 foot 2-conductor shielded cable; press-to-talk switch, locking plate furnished; size 6 1/2" long; top diameter 1 1/4"; handle 3/4"\$38.50

Model 245 "Uniplux" Microphone

Ceramic type; uni-directional; response 50-7000 cps; output -59 db; high imped-



ance; die-cast zinc case; includes swivel adapter; 15-foot single-conductor shielded cable; 4 3/4" x 1 1/8"; wt. 3/8 lb.\$35.00
Model 245S (with "on-off" switch).....\$37.00

Model 710 Crystal Microphone

Hand-held for voice frequencies; response 60-9000 cps; output 50 db; high impedance; semi-directional.

Model 710A.....\$12.00

Model 710S (with switch).....\$14.00

SONOTONE

Model CM-10A "Ceramik"

Ceramic microphone; frequency response 50 to over 11,000 cps \pm 2 db; sensitivity 56 db below 1.0 volt per microbar; omnidirectional; high impedance; includes 7 feet of shielded cable with phone plug; does not include stand; 5 1/8" x 1 9/16" di-

ameter at grille.....\$17.50
 Model CMS-10 mike stand: table design
\$5.25

Model CM-30 Microphone

Ceramic design for voice frequencies. Response 60-7000 cps; sensitivity —49 db ± 2 db; 2 meg. load impedance. Has push-

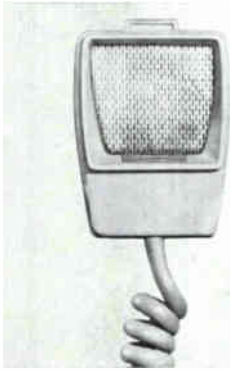

to-talk button, dashboard mounting bracket & spring spiraled 4-conductor cable.\$14.70
 CM-30M with dashboard magnet mount.\$17.35

DM10-200 Dynamic Microphone

Response 80-16,000 cps; sensitivity —63 db ± 3 db; impedance 10,000 ohms; omnidirectional design\$24.50

Model CM-40 Microphone

Ceramic microphone in plastic case; equipped with swing-type stand; —50 db

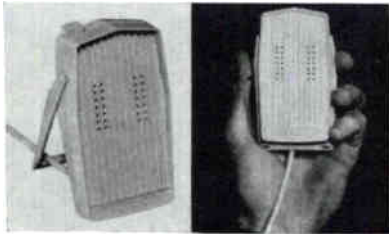

output; response 40-8000 cps; 7-foot, 2-conductor cable.\$10.40

Model CMT-10A or CMT-11A Matched Twin Microphones

For stereo tape use; ceramic type; acoustically matched to 2 db; Model CMT-10A has frequency response 50 to over 11,000 cps; Model CMT-11A has frequency response 80-9000 cps; Model CMT-10A output level —56 db.....\$37.30 pair

CM-1018 Microphone

Low-impedance ceramic microphone for taping and communications applications; response 50-10,000 cps; sensitivity —56 db; impedance 500k (usable to 250k)\$19.45

CM-1050WR Microphone

Wide-range, low-impedance microphone, for voice and music applications; response 50-10,000 cps; sensitivity —58 db; impedance 250k although usable down to 33k\$19.45

CM-1050SR Microphone

Speech range, low-impedance microphone, designed for speech applications; response 170-9500 cps; sensitivity —62 db; impedance 33k although usable down to 10k\$19.45

CMT-1050WR Matched Twin Microphones

Matched twins—low-impedance ceramic

microphones designed for music and speech taping in stereo; acoustically matched to ± 2 db; response 50-10,000 cps; sensitivity —56 db; impedance 250k (usable to 33k)\$39.30

CMC-1050WR Microphone

Wide-range, low-impedance ceramic microphone with matching stand; response 50-10,000 cps; sensitivity —58 db; impedance 250k (usable to 33k).....\$24.70

SONY

F-81 Dynamic Microphone

Same as Model F-87 except has smoother response\$ 29.50

F-32 Dynamic Microphone

Has omni-directional pattern & bass cut switch; with switch in "music" position, response is essentially flat; with switch in "voice" position, response is attenuated 8 db at 50 cps & 60 db at 100 cps....\$ 27.50

F-75 Dynamic Telemicrophone

Highly directional design with transistor monitoring amp built into pistol grip. A 3-pos. sw. permits low-freq. attenuation.



Response 30-14,000 cps; impedance 150, 250, and 10 kohms, balanced or unbalanced. Complete with one 18" sound probe for up to 75' pickup, one 34" sound probe for 150' pickup, headset & carrying case\$395.00

F-87 Dynamic Microphone

High impedance with cardioid directional characteristics; has built-in table stand &



floor-stand adapter insert.....\$ 22.50

F-96 Dynamic Microphone



Wide-range, high-impedance; features thin tapered design\$ 17.50

F-113 Cardioid Mic

Dynamic design featuring switch-selected 150, 250, or 10 kohms impedance, balanced or unbalanced. Response 30-16,000 cps, output —57 db. Complete with desk stand, floor stand holder, windscreen & case\$249.50

F-91 Omnidirectional Mic

Dynamic design featuring switch-selected 150, 250, or 10 kohms impedance, balanced

SELLING HI-FI WORLD WIDE SINCE 1948
 COMPONENTS • RECORDERS
 KITS • SPEAKER SYSTEMS • TAPE

The WORLD'S GREATEST VALUES in the WORLD'S FINEST RECORDERS

- ★AMPEX ★CONCERTONE
- ★CONCORD ★CROWN
- ★MAGNACORD ★OKI ★REVERE
- ★ROBERTS ★SONY
- ★TELEFUNKEN ★UHER ★VERNON
- ★VIKING ★VM ★WOLLENSAK
- ★AND MANY, MANY OTHERS

Write for Price of your Selection

A Wide Variety of

TAPES

ECONOMY—FROM 99¢ ea.
 (satisfaction guaranteed)
 PROFESSIONAL GRADE A from \$2.10 ea.
 (The Most Famous Makes)

• SPECIAL: STEREO DYNE II DIAMOND STEREO CARTRIDGE — \$7.25 ppd.

Send for FREE "MONTHLY SPECIALS" on other Cartridges, Tapes, and Components.

WRITE FOR MONTHLY SPECIALS VISIT OUR STORE
CARSTON Studios

1686-T SECOND AVE. (Nr. 87) N.Y. 10028

CIRCLE NO. 6 ON READER SERVICE CARD

"Which microphone should I use for tape recording?"



Free!

Microphones '66 — a book every owner of a tape recorder should have. Send coupon today!



UNIVERSITY SOUND
 A DIVISION OF LTV LING ALTEC, INC.

Dept. Y631M P.O. Box 1056, Oklahoma City, Okla.

Name _____

Address _____

City _____

State _____ Zip _____

CIRCLE NO. 22 ON READER SERVICE CARD

MICROPHONE DIRECTORY



or unbalanced. Response 40-20,000 cps. Output — 58 db. Complete with desk stand, floor stand holder & case.....\$149.50

TURNER

Model 141-11 Microphone

Lightweight crystal model; ideal for tape recorder use; chrome finish; for use in

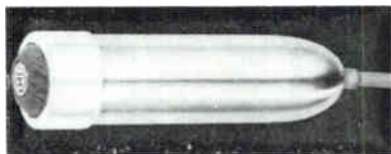

hand, on stand, or as lavalier mic.; response 60-10,000 cps; output level — 52 db; 6' single-conductor cable; molded phone plug and phone plug adapter; accessories extra.....\$ 9.00
L14CH Lavalier assembly.....\$ 3.60
L44-CH Desk stand.....\$ 3.30

Model 304C Ceramic Microphone

Supplied complete with desk stand, stand adapter, lavalier clip, 12' single-shielded



conductor; response 60-10,000 cps; output level — 60 db\$9.90

Model 401 Dynamic Microphone

Omnidirectional design; high-frequency response adjustable from 20,000 cps down to 10,000 cps and low end from 40 to 160 cps; has neutral blue-gray finish with 20' three-conductor shielded cable; choice of

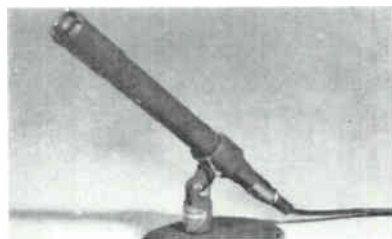

high or 150-ohm impedance; 10 1/2" x 1"; output level — 60 db at high impedance\$75.00

Model 402 Same as 401 but with shorting-type on-off switch.....\$78.00
Model 4022 Matching desk stand.....\$ 4.80

Model 607 Microphone

Response 60-8500 cps; output level — 55 db; high impedance.....\$4.80

Model 707 Microphone

Small tape recorder microphone in satin-chrome finish, die-cast case with 6' cable;



for use as hand or desk unit; response 60-10,000 cps; output — 54 db.....\$ 7.50

Model 403 Dynamic Microphone

Omnidirectional design; response 50-13,000 cps; output level — 60 db; choice of 150 ohms or high impedance; has 20' three-conductor shielded cable with Cannon con-



ductor; available in silver or gold.....\$48.00
Model 404 Same as Model 403 but with on-off switch.....\$51.00

Model 500 Dynamic Microphone

Cardioid design; response 40-15,000 cps; output — 55 db; high or 150 ohm impedance selected at cable end; 20' cable.

.....\$50.40
Model S 500 with switch.....\$53.50
Model C-7 stand.....\$ 5.70

Model 58 & 58A Lavalier Microphone

Dynamic type with essentially non-directional pickup pattern; designed for use where freedom of movement is required; weighs 3 1/2 oz., 4" long.

Model 58 High or 150 ohms, selected at end of cable; output level — 60 db with high impedance; response 60-13,000 cps for high impedance & 60-18,000 cps for low impedance; 3-conductor, 25' shielded cable\$34.20

Model 58A 50 or 200 ohm impedance selected at end of cable; response 60-18,000 cps; 3-conductor, 25' shielded cable\$34.20

Model 95D Microphone

Dynamic p.a. microphone; available with "on-off" switch; complete with 20-foot cable; response 100-10,000 cps; output



— 58 db; choice of 50, 200 or high ohms\$22.50

Model 500-04 Microphone

Matched cardioid dynamic microphone set for stereo or mono recording. Available in satin chrome finish or Roman gold, with phone plugs; response 40-15,000 cps. Choice of Hi or 150 ohms impedance. Output level — 55 db; Has special wind screens for out-of-doors recording. Per set\$99.50

Model 907 & 908 Microphone

Economy unit for tape recorders; durable polystyrene; hand or desk use; weighted to avoid tipping; ceramic model (907) for use where heat and humidity are problems; Model 908 response 60-8500 cps; output level — 45 db; high impedance; Model 907 response 60-8500 cps; output level — 55 db; high impedance design.\$ 4.80

Model 80 on C-4 Stand

For home recording, paging, amateur use; crystal microphone; 7-foot cable supplied;



response 80-7000 cps; output — 54 db; high impedance\$ 9.57
Matching C-4 stand\$ 3.90

Model 44D Dynamic Microphone

Hi-output design with omnidirectional pickup pattern. Response 85-15,000 cps ad-

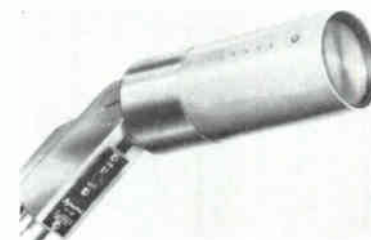

justable to 60-15,000 cps; output — 56.5 db. Complete with 12' cable & "on-off" sw. Hi or 150-ohm impedance available.....\$27.00
Model 44X Same as 44D except crystal element. Response 60-10,000 cps; output — 53 db\$21.00
Model 44C Same as 44D except ceramic element. Response 60-10,000 cps; output — 58 db\$21.00



**Capture the strength
and delicacy
of every sound**

with exclusive new Sony LUBRI-CUSHION[®] recording tape

A revolutionary process from the research laboratories of world-famous Sony has produced a recording tape with a silicone impregnated lubricant which cannot wear off! Intimate head-contact, so essential for full-range true fidelity, can now be maintained — and without excessive recorder head wear.* ■ Sony's new method of tape manufacture includes a special Sony slitting technique, Sony-permatizing, and an extra-heavy homogenized coating (Sony Oxi-Coat) on flexi-strength polyester, which assures a balanced full-frequency recording/playback with no 'drop-outs' of sound. ■ Truly, Sony PR-150 enables you to capture the strength and delicacy of every sound. Visit your dealer today — and *hear* the difference.

*Excessive recorder head wear is caused by inferior tape. Sony PR-150, a professional recording tape, has been developed to eliminate this problem. Send for our informative booklet by writing Sony/Superscope, Inc., Magnetic Tape Division, Sun Valley, California. Dept. 89.



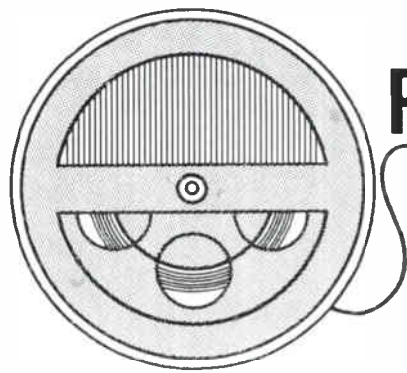

PRERECORDED TAPE ROUNDUP

REVIEWS OF SOME OF THE MOST OUTSTANDING
PRERECORDED STEREO TAPES
RELEASED DURING RECENT MONTHS

Christie Barter • William Flanagan • David Hall
Igor Kipnis • Gene Lees

© BACH: *Harpsichord Concerto No. 1, in D Minor; Harpsichord Concerto No. 2, in E Major*, George Malcolm (harpsichord); Stuttgart Chamber Orchestra, Karl Münchinger cond. LONDON I.C.I. 80147 \$7.95.

Performance: Superb
Recording: Intimate
Stereo Quality: Fine

George Malcolm performs the first two of Bach's seven harpsichord concertos with stunning effect in this only tape issue of these works. His fingerwork is impeccably clear, and his interpretations are sensitive, sympathetic, and vital—and fortunately devoid of the eccentricities of registration change that are often heard on his recordings. Tempos in the fast movements, particularly the finales, are somewhat slower than one hears in other recordings, but the results make far more musical sense. Münchinger and a string complement of the correct size provide strong support, and the recorded sound, close up for both solo instrument and orchestra, has a pleasant, intimate quality. At times, the harpsichord seems swallowed up by the greater volume of the accompaniment, but the balance nevertheless is most realistically accomplished. The disc version (London 6392, 9392) is an example of modern recording at its best; except for a slightly more natural harpsichord tone, the tape version is not noticeably superior—both are examples of first-rate reproduction. There is a very slight pre-echo at the start of each of the concertos, but this does not seriously mar the release. All told, these performances can be recommended as among the very best available. I. K.

© BACH: *St. Matthew Passion*. Peter Pears (tenor), Evangelist; Hermann Prey (baritone), Jesus; Elly Ameling (soprano), First Maid; Pilate's Wife, and soprano arias; Marga Höfgen (contralto), Second Maid and contralto arias; Fritz Wunderlich (tenor); Tom Krause (bass); Heinz Blankenburg (baritone), Peter, High Priest, and Pilate; August Messthaler (bass), Judas; instrumental soloists; the Stuttgart Hymnus Boys' Choir; the Stuttgart Chamber Orchestra, Karl Münchinger cond. LONDON LOV 90097 two reels \$25.95.

Performance: Worthy
Recording: Very good
Stereo Quality: Excellent

On the whole, Münchinger's performance of the *St. Matthew Passion*, released to commemorate the twentieth anniversary of the founding of the Stuttgart Chamber Orchestra, is a very good one. Its best features are the vocal soloists, notably the always sensitive Pears, an excellent soprano, and several fine male voices. Prey, a little aloof, as he was also in the Archive *St. John Passion*, is nevertheless effective as Jesus. The all-male choir does its work very well indeed, though it is not so polished a group as Karl Richter's chorus. The instrumental soloists are first rate with only two exceptions: Johannes Koch, whose gamba playing in No. 66 (about the carrying of the Cross) makes that bass aria even rougher going than it should be; and Eva Hölderlin (one of the two organists), whose dull, unrelieved registration and plodding manner do but little service to the recitatives.

Münchinger is not the most dramatic of interpreters—one misses the intensity and feeling of inevitability that characterize Richter's performances of the Passions. He does, however, infuse a degree of sentiment into the score, one that is not so Romantically personalized as Klempere's or as strangely individualistic as Scherchen's. Yet, for some reason, although the singing and playing were for the most part very enjoyable, I remained uninvolved and somewhat unmoved by it all.

This first tape edition of the Passion, running a total of three and a quarter hours with only three interruptions for reel changes, is certainly worth owning, even if it is not the ideal performance. The tape reproduction is slightly superior to the discs in only a few places, such as where the massed choruses threaten to overwhelm the grooves ("Barabbas," for instance); otherwise either version is extremely good sonically, with very clear-cut separation and atmospheric acoustics. The tape box commendably includes a photographically reduced version of the elaborate text booklet which comes with the discs. I. K.

© BARTÓK: *The Miraculous Mandarin Suite: Music for Strings, Percussion, and Celesta*. London Symphony, Georg Solti cond. LONDON I.C.I. 80149 \$7.95.

Performance: Compelling
Recording: Fine
Stereo Quality: Nicely articulated

For all its violence and lurid brutality, *The Miraculous Mandarin* is full of brilliant in-



"And this is where I keep..."



"... my tape library!"

DAS TON MAGASIN

vention, and Solti brings it off superbly. The ferocious intensity of his performance, with its frequently hair-raising splashes of tonal color, is beautifully projected by the recording and appropriately complemented by the exquisite poetry of the *Music for Strings, Percussion, and Celesta* overture. In both works, stereo definition, keen articulation of instrumental timbres, and wide-range dynamics make for impressive results. This reel is highly recommended, especially to those who, in the case of the *Mandarin*, know what they are in for. **C. B.**

Ⓢ **BEETHOVEN: *Fidelio***. Birgit Nilsson (soprano), Leonore; James McCracken (tenor), Florestan; Tom Krause (baritone). Pizarro; Kurt Böhme (bass), Rocco; Graziella Scutti (soprano), Marzelline; Donald Grobe (tenor), Jacquino; Hermann Prey (baritone), Don Fernando. Vienna State Opera Chorus; Vienna Philharmonic, Lorin Maazel cond. LONDON LOS 90085 two reels \$16.95.

Performance: Exhilarating
Recording: Very good
Stereo Quality: Effective

More than most, *Fidelio* is a conductor's opera. It is not one that just any conductor can bring off successfully, but it will admit of several points of view. And the conductor who can fully convince the listener of the validity of his particular point of view must be a man of strong convictions and penetrating musical insight. Thereby he, more than the singers involved, becomes the determining factor of the personality of the performance. Lorin Maazel's *Fidelio* is as sleek and modern as a new automobile. It also combines power, excitement, and stimulating emotional color on the order of the old Toscanini version, and admirers of the kind of music-making the late Maestro brought to that recording will welcome this tape. Those who prefer the nobility of Klemperer (Angel ZC 3625) or the eloquent deliberation of Knappertsbusch (Westminster WTZ 154) are apt to lose patience with the young conductor and his fast and furious tempos, but there is no denying the strong impact of Maazel's approach.

Birgit Nilsson sings Leonore here as she does in the opera house, intelligently and forthrightly, with warmth, vitality, and no trace of vocal effort. James McCracken is an impressive Florestan (his first major role in any opera recording), Tom Krause a commanding Pizarro, and Kurt Böhme a personable Rocco. Hermann Prey, in his brief appearance as Don Fernando, is just about ideal.

The four-track version has been turned out at a rather low level, so that tape hiss during quieter passages is quite noticeable. The singers, too, seem to be a bit out of focus at times, but the orchestra and chorus sound fine. Act One occupies all of the first reel, with the sequence break at Pizarro's entrance, and spills over onto the second reel at the end of the Prisoners' Chorus. Yet, since this act lasts only a little over an hour, as Maazel takes it, it might have been fitted onto a single reel. Act Two, with a running time of some forty-five minutes, could then have easily filled out one uninterrupted sequence on the second reel. All of this, of course, would have used up more tape, meaning an increase in total cost to the consumer, and it might, as well, have necessitated an inappropriate break in the middle of Act One.

But I wonder. Logic and convenience seem to favor this format over the one we are given, and the higher price could easily be justified on the basis of the material added to fill out the second reel. **C. B.**

Ⓢ **BEETHOVEN: *Symphonies: No. 1, in C Major, Op. 21; No. 2, in D Major, Op. 36***. Cleveland Orchestra, George Szell cond. EPIC EC 843 \$7.95.

Performance: Brilliant Second
Recording: Clean
Stereo Quality: Good

When I heard the disc version of this recording, I noticed that the sound of the Second Symphony seemed more open and warm than that of the First. This difference is less pronounced on the tape—all to the good. Szell takes a rather conservative view of the C Major Symphony when it comes to tempos and dynamic contrasts, but he finds in the D Major a fine show of Beethoven's brand of high spirits. This is easily the best tape version of No. 2. I would nominate Szell's readings of the Symphonies Nos. 3, 5, 8, and 9, all on the Epic label, as the top tape choices also. Presumably, Szell's performances of Nos. 4, 6, and 7 will be released on tape in due course, to make the second complete Beethoven symphony cycle in this medium—the other being Ansermet's for London.

D. H.

Ⓢ **BEETHOVEN: *Symphony No. 6, in F Major, Op. 68 ("Pastoral")***. HAYDN: *Symphony No. 100, in G Major ("Military")*. London Symphony Orchestra, Antal Dorati cond. HAYDN: *Symphony No. 94, in G Major ("Surprise")*. Philharmonia Hungarica, Antal Dorati cond. MERCURY STP 90415 \$11.95.

Performance: Classical and precise
Recording: Excellent
Stereo Quality: Nicely balanced

Dorati interprets the "Pastoral" in a straightforward, no-nonsense manner that brings out the music's classical elements. As a result, beautifully phrased and meticulously played as this reading is, it does not convey the geniality and fervor of Bruno Walter's performance. Rather, Dorati sees the work as a pleasant walk in the country, with no dallying to appreciate the sights—a concept that may have some appeal because of its anti-Romantic character. But for me, the primary value of this double-play tape lies in the Haydn works. Both of these popular symphonies are given firm, vital readings, employing a large but not swollen orchestra. Again, the precision of the playing is outstanding, and the individual instrumental contributions are beautifully realized.

The three recordings were not made together: Number 94 was made in Vienna in 1958, Number 100 in London in 1957, and the "Pastoral" also in London in 1963. Surprisingly, there is little audible difference in microphoning or hall acoustics. The tape is cleanly processed and sonically matches the disc (which pairs the "Pastoral" and the "Military") except for a slight increase in brightness. Stereo placement is first-rate.

I. K.

Ⓢ **BEETHOVEN: *Violin Concerto, in D Major, Op. 61***. Joseph Szigeti (violin); London Symphony Orchestra, Antal Dorati cond. MERCURY STC 90358 \$7.95.

Performance: Late Szigeti
Recording: Superb
Stereo Quality: Good

Joseph Szigeti, in his most recent recording of the Beethoven Concerto, displays all of the musicianship that one has come to expect of the master violinist. But regrettably, at this late stage of his distinguished career, his technical abilities are declining. In particular, there is an unsteadiness in the tone—to some extent always a characteristic of Szigeti's playing—that hampers concentration on the purely musical values of the performance. There is much to be gotten from this essentially introspective reading, particularly from those details of violin phrasing that are a Szigeti specialty, and one cannot help admiring the soloist's interpretation and the beautifully played orchestral accompaniment. But the violin tone, sadly, is quite uncomfortable to the ear. Mercury provides an acoustic setting that is virtually faultless: the solo violin is in perfect relation to the orchestra, and the over-all sound is amazingly clean and realistic. **I. K.**

Ⓢ **BEETHOVEN: *Violin Sonatas: in A Major, Op. 30, No. 1; in D Major, Op. 12, No. 1; in E-flat Major, Op. 12, No. 3***. David Oistrakh (violin); Lev Oborin (piano). PHILIPS PTC 900032 \$8.95.

Performance: Eloquent
Recording: Fair
Stereo Quality: Good

This is the second in a set that promises to bring all the Beethoven violin sonatas to tape on four reels, and in performances by a team that, again here, proves just about unbeatable. Although Oistrakh is the more celebrated and clearly the more commanding artistic personality of the two, he is suitably matched by Oborin, and they work together beautifully. Their playing, as in the previously released Op. 96 and "Kreutzer" Sonatas (Philips PTC 900031), is poised, rhythmically controlled, and at times breath-takingly agile. Oistrakh's tone does not always possess the lyric glow it has been known to have in other recordings, and the transfer to tape from masters produced in Paris in 1962 may have contributed to making his tone sound occasionally gritty. But the trenchant vitality of his playing is admirably conveyed throughout. Stereo balances are generally good, yet the separation between the violin on the left and the piano on the right is to me unduly pronounced. And why, in this medium, must the D Major Sonata be divided between two sequences, when the opening Allegro lasts only six minutes? **C. B.**

BERG: *Wozzeck (excerpts); Lulu—Suite* (see MAHLER)

Ⓢ **BRAHMS: *German Requiem; Variations on a Theme of Haydn, Op. 56a***. Gundula Janowitz (soprano); Eberhard Waechter (baritone); Wiener Singverein; Berlin Philharmonic Orchestra, Herbert von Karajan cond. DEUTSCHE GRAMMOPHON DGP 8928 \$11.95.

Performance: Magnificent
Recording: Excellent
Stereo Quality: Well realized

Ⓢ **BRAHMS: *German Requiem***. Elisabeth Schwarzkopf (soprano); Dietrich Fischer-
(Continued on page 118)

**New!
read
this**

Kodak TAPE IS BACKPRINTED SO YOU ALWAYS KNOW THE KIND OF TAPE YOU'RE USING
(Tape never gets mixed up, even when separated from its box)

Kodak TAPE COMES ON A THREAD-EASY REEL, LOADS INSTANTLY
(No fussing, no fumbling . . . nothing could be quicker)

Kodak TAPE IS MADE CLEANER: RECORDER HEADS STAY CLEANER
(And cleaner tape also means less head wear!)

Kodak TAPE IS MADE IN EVERY STANDARD LENGTH AND THICKNESS
(Even triple-play and high-output tapes)

Kodak TAPE IS NOW AVAILABLE EVERYWHERE
(Electronic Stores, Camera Shops,
Specialty Stores . . . EVERYWHERE)

**Now!
hear
this**

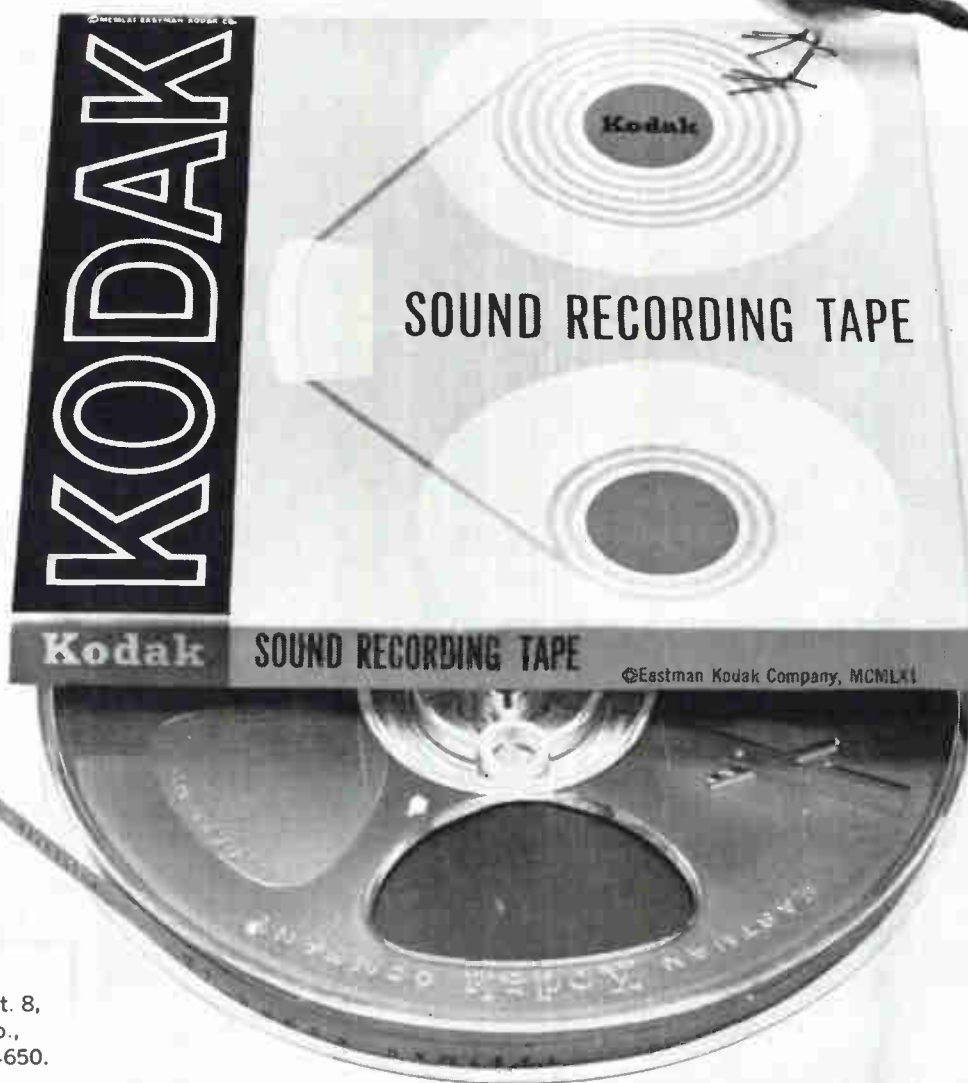

FREE Kodak tape
booklet. Write Dept. 8,
Eastman Kodak Co.,
Rochester, N. Y. 14650.

EASTMAN KODAK COMPANY, Rochester, N. Y.

Kodak
TRADEMARK

Dieskau (baritone); Philharmonia Chorus and Orchestra. Otto Klemperer cond. ANGEL ZB 3624 \$15.98.

Performance: Equally magnificent
Recording: Very good
Stereo Quality: Adequate

Neither the Klemperer *German Requiem*, recorded in England in 1962, nor the more recently made version by Karajan is likely to be superseded for some time to come. Each in its own way is a magnificent reading, though, of course, the two interpretations are very different. Interestingly, the normally slower Klemperer presents the faster performance by some seven minutes; but Karajan does not seem slow nor Klemperer rushed.

To characterize the Angel performance as solid and architectural and the DGG version as warm and dynamic is only to make a superficial comparison, yet this might be the most obvious comment. Of the two, Karajan is the more exciting, and he elicits the widest dynamic range (his opening is virtually inaudible—a remarkable effect that he builds on in the ensuing pages). Klemperer, in spite of a basically more austere reading, brings to the music considerable grandeur and drama (note, for example, the "last judgment" effect of the pointed horn calls of "*Denn alles Fleisch*").

Each team of soloists is splendid, but as far as the choruses are concerned, Karajan's Wiener Singverein (with whom he made his first superb recording in the late Forties) should be awarded the prize for singing that is meltingly beautiful.

Angel's sound is very good indeed, though stereo separation is not very pronounced; DGG's sound is truly exceptional, particularly in regard to fine points of detail. Both tape versions are slightly superior to their disc counterparts in tonal matters, although the DGG discs are quite sensational on their own. Concerning price: the careful buyer will probably choose Karajan, not only because a marvelously sensitive performance of the Haydn Variations is included on that reel, but also because it costs four dollars less. A word of warning: I experienced some difficulty with several copies of the DGG tape (on which there was a fast fluttery loss of highs at the beginning of the reel) before finally finding a copy that was perfect in all respects. DGG includes a text booklet in their box (the container, incidentally, is an oddly shaped package that could conceivably hold two reels), whereas Angel invites the purchaser to send for the full-sized record-album booklet at no charge. I. K.

© BRITTEN: *Albert Herring*. Peter Pears (tenor), Albert Herring; Sylvia Fisher (soprano), Lady Billows; Johanna Peters (contralto), Florence Pike; April Cantelo (soprano), Miss Wordsworth; John Noble (baritone), the Vicar; Edgar Evans (tenor), the Mayor; Owen Brannigan (bass), Superintendent of Police; Joseph Ward (baritone), Sid; Catherine Wilson (mezzo-soprano), Nancy; Sheila Rex (mezzo-soprano), Mrs. Herring; Sheila Amit (soprano), Emmie; Anne Pashley (soprano), Cis; Stephen Terry (treble), Harry. English Chamber Orchestra, Benjamin Britten cond. LONDON LOR 90090 two reels \$21.95.

Performance: Flawless
Recording: A-1
Stereo Quality: Highly effective

Anyone who has ever been exposed to much small-town life, even as a regular summer resident, will find Benjamin Britten's *Albert Herring* a singularly entertaining experience. One of the most striking aspects of Britten's great tragic opera *Peter Grimes* (taped on London LOR 90083) is the unerringly accurate characterization of the various village types living and working in the Borough. *Albert Herring* tells the tale of a mother-bedeveled milquetoast of a lad who is named King of the May (there being no girls in town deemed virtuous enough to be Queen). At the ensuing May Day celebration, Albert's lemonade is spiked with rum, and the village of Loxford is subsequently thrown into an uproar as Albert disappears on an all-night toot. Eventually he does return, somewhat chastened—but also man enough to let his mother know who runs the show from now on.

The opera that Britten has fashioned around this story amounts to a delightful portrait of a country town in action, with all its pomposities and foolishness (Lady Billows), scenes of young love (Sid and Nancy), and moments of pathos (Albert *versus* his mother). Britten's music is apt and clever, and Eric Crozier's beautifully turned text is eminently singable and understandable.

The situations and types that turn up in the course of the action afford Britten a number of opportunities for delicious musical parody, both as to style (the Victorian tone of the Vicar's "Virtue, says Holy Writ") and form (the fugue on "Albert the Good" at the climax of the May Day festivities). The spiking of Albert's rum is accompanied by an apposite musical quote from Wagner's *Tristan und Isolde*. The light touch is preserved in the orchestral texture, which is magically spun out by a mere dozen players under Mr. Britten's baton.

It is impossible to single out any one member of this cast as outstanding. Everyone, from Peter Pears in the title role to the boy treble Stephen Terry, treats his work here as a true labor of love. The recorded sound (and there are special sound effects) is altogether masterly. Two-and-a-half hours may seem long on the face of it for such a lightweight comedy, but once the tape is going, the time goes by as though on wings. D. H.

© BRITTEN: *Matinées Musicales; Soirées Musicales*. RESPIGHI: *Rossiniana*. Vienna State Opera Orchestra, Robert Zeller cond. WESTMINSTER WTC 172 \$7.95.

Performance: Sparkling
Recording: Clean and bright
Stereo Quality: Good

These sharply contrasted treatments of miscellaneous Rossini pieces are all making their first appearances on four-track tape. Britten draws his themes from the *William Tell* ballet music, from songs, and from the small piano pieces of Rossini's old age. The *Soirées* began life as a film score in 1936, and were later reworked for ballet use. Five years later came the *Matinées*, written for Lincoln Kirstein's American Ballet company in 1941. In both sets Britten takes a somewhat brash and cheeky attitude toward the material, which makes for amusing light-vein listening.

The Respighi score was written in 1925, some seven years after the highly successful

Boutique fantasque ballet, which consisted of late Rossini piano pieces orchestrated by Respighi for Diaghilev. Here, in contrast to Britten's choices and to Respighi's for *Boutique*, the Rossini originals are of an almost somber beauty, and quite evocative. The second movement, *Lamento*, is especially striking. With the brief and delicate *Intermezzo*, things brighten up a bit, and in the final *Tarantella* we come back to the familiar Rossini gaiety. Respighi's orchestral fabric is beautifully woven: it is confined to delicate muted tones in the first three movements, but bursts forth in splendid colors in the finale.

American conductor Robert Zeller gives the Britten scorings a zesty performance, and does a thoroughly tasteful job in Respighi's. There is good, bright recorded sound all the way. D. H.

© DEBUSSY: *Pelléas et Mélisande*. Camille Maurane (baritone), Pelléas; Erna Spoorenberg (soprano), Mélisande; George London (bass-baritone), Golaud; Guus Hoekman (bass), Arkel; Josephine Veasey (mezzo-soprano), Geneviève; Rosine Brédy (soprano), Yniold; John Shirley-Quirk (baritone), doctor; Gregore Kubrack (baritone), shepherd; Geneva Grand Theater Chorus; Suisse Romande Orchestra, Ernest Ansermet cond. LONDON LOR 90091 two reels \$21.95.

Performance: Ideal
Recording: Superb
Stereo Quality: The best

It has been a long wait to hear Claude Debussy's epoch-making *Pelléas et Mélisande* in stereo, but at last we have it, and this performance is as close to an ideal realization as can be expected of mere mortals. Viewed from one angle, Debussy's setting of Maeterlinck's drama is an answer to Wagner's *Tristan und Isolde*: it demonstrates another way altogether of conveying, in a *Gesamtkunstwerk* ("total artwork"), the profound pathos of love crushed by harsh circumstance. And, like *Tristan*, Debussy's opera—thanks to the miracle of stereophonic sound—can be experienced more imaginatively and more intensely in a recorded performance than in the opera house, because our illusions are not shattered by the sight of ordinary human beings trying to adapt their gestures and stage movements to the half-reality of Maeterlinck's land of Allemonde. Perhaps an adequate visual realization of this work will come one day, when opera is recorded on video tape and played at home on wall-sized screens. But for the present, we must be grateful for what Ernest Ansermet, his immensely accomplished cast of singers, and his fine orchestra have given us here.

Erna Spoorenberg imparts unerringly the fragility and fearfulness of Mélisande, and Camille Maurane is a youthful and ardent Pelléas. George London is almost too overbearing in his portrayal of Golaud, but his tragedy becomes the more intense thereby. Absolutely outstanding in the difficult role of the child Yniold is the soprano Rosine Brédy, who does the most convincing bit of singing-acting I have ever heard in the scene in which Yniold is lifted by Golaud to the window to spy on the lovers. The crucial role of Arkel is poignantly portrayed by Guus Hoekman, the fine Dutch bass. The smaller roles are all expertly done, and the

orchestral performance under Ansermet's direction is wholly magnificent—full of atmosphere throughout and rising to a pitch of elemental power at the moments of dramatic climax.

The London engineering staff has done a tasteful and effective job of stereo production—most notably in the grotto scene between Pelléas and Mélisande and in the dungeon scene between Golaud and Pelléas. One can almost smell the salt sea air in the one and the stagnant dankness in the other. The performance comes through on tape with utter clarity, and with no discernible background hiss. The two-reel tape format reduces interruptions of continuity to three, as against five for the three-disc set. And the price of the tape version is reasonably close to the \$17.37 for the discs. Notes and a complete libretto are included in London's tape box.

Without question, this version of *Pelléas et Mélisande* represents a recording milestone and is also a monument to the interpretive art of Ernest Ansermet. No one who cares seriously about opera should be without it, whether on discs or tape. **D. H.**

DUKAS: *The Sorcerer's Apprentice* (see RAVEL)

© **FALLA: *The Three Cornered Hat (complete)***. Victoria de los Angeles (soprano); Barcelona Teatro del Liceo Corps de Ballet; Philharmonia Orchestra, Rafael Frühbeck de Burgos cond. ANGEL ZS 36235 \$7.95.

Performance: Brilliantly idiomatic
Recording: Crystal-clear
Stereo Quality: Tasteful and effective

Save for Miss De los Angeles' rather over-refined delivery of the flamenco-style opening chant and the warning of danger to the miller's wife, this tape offers a virtually ideal realization of Manuel de Falla's 1919 ballet based on Alarcón's tale *El sombrero de tres picos*. Conductor Frühbeck de Burgos has underlined cunningly and most effectively the mock eighteenth-century pomp that typifies the lecherous Corregidor and his minions and the earthy rhythms of the *jota*, *farruca*, and *fundango* which are associated with the miller, his wife, and the village folk who take revenge on the Corregidor at the end of the tale. Particularly noteworthy is the way in which orchestral balances have been handled throughout the boisterous final dance, which really moves and sparkles.

All told, this is a recorded performance of *The Three Cornered Hat* that combines witty elegance and earthy vitality in perfect measure. The sound rates superlatives. Despite the fact that the London tape of Ansermet's version of the score offers (for two dollars more) the Albéniz-Arbós *Iberia* as well, I would choose this Angel tape. **D. H.**

© **GRIEG: *Peer Gynt Suite No. 1: Peer Gynt Suite No. 2: Ingrid's Lament: Solveig's Song***. **TCHAIKOVSKY: *Nutcracker Suite No. 1, Op. 71a***. Vienna Philharmonic Orchestra, Herbert von Karajan cond. LONDON LCL 80160 \$7.95.

Performance: Refined yet fresh
Recording: Superb
Stereo Quality: Excellent

These concert-hall staples have been done often and well, not only on discs but also

on tape. In the latter medium, however, this is the only coupling of *Peer Gynt* and the *Nutcracker*. Karajan's handling of these too-familiar scores is quite remarkable: the orchestral playing is wonderfully refined and polished, yet the effect is not in the least slick. The conductor seems to approach the music as though it were new, infusing fresh life into the tired notes. His interpretation is by turns sparkling, charming, violent, and supremely affecting. Here also is some of the lightest, most delicate orchestral playing (for example, in the Tchaikovsky Overture and *Anitra's Dance*) that I have heard since Toscanini retired. London's sonics are a perfect match for the splendid performances, dynamically very wide-range and with an open, beautifully realized stereo spread. The disc version had a slight sonic constriction at the close of the Tchaikovsky side, but the tape is clean throughout. For sound demonstration or strictly for the music, this reel will afford pleasure to even the most jaded of ears. **I. K.**

© **GROFÉ: *Grand Canyon Suite***. New York Philharmonic, Leonard Bernstein cond. COLUMBIA MQ 639 \$7.95.

Performance: Vivid
Recording: Very good
Stereo Quality: Excellent

The tape catalog is not lacking in recordings of Ferde Grofé's *Grand Canyon Suite*. Many may be greater bargains by virtue of whatever piece is coupled with them, but none surpasses this one for color and high gloss. The sound is glorious, not outstandingly brilliant but clean on the top end and true in the bass, with plenty of heft between. Credit Leonard Bernstein and the Philharmonic for breathing new life into a very tired score. **C. B.**

© **HANDEL: *Julius Caesar (arias)***. Joan Sutherland (soprano), Cleopatra; Margreta Elkins (mezzo-soprano), Caesar; Marilyn Horne (mezzo-soprano), Cornelia; Monica Sinclair (contralto), Tolomeo; Richard Conrad (tenor), Sesto; Hubert Dawkes (harpsichord continuo); New Symphony Orchestra of London, Richard Bonyngé cond. LONDON LOL 90087 \$7.95.

Performance: Stylish and spectacular
Recording: Extremely good
Stereo Quality: Well separated

Of the eleven arias selected from this opera, which Handel wrote in 1724, six are sung by Joan Sutherland, the rest dispersed among the remaining four singers (Margreta Elkins is allotted two). The sequence is not that of the opera: the arias have been arranged so that Sutherland's contributions are interspersed with those of the others. The performances are extremely stylish, and there are considerable embellishments of the *da capo* sections of the arias, added cadenzas, and the like. The result is far more spectacular and exciting Handel than one is used to hearing. Sutherland is in her usual form, which means that the vocal pyrotechnics are fabulous, the wilting phrases and mouthed consonants rather less impressive. Her supporting cast is commendable, especially Richard Conrad, whose musicality and technical fluency do much to overcome a basically small and colorless voice. Of the others, the only one I cared little for was Monica Sin-

clair, who is not able to cope with the difficulties of her decorated arias and sounds merely ludicrous. Bonyngé supplies alert accompaniments, and the harpsichord continuo of Hubert Dawkes is brilliantly conceived. The reproduction is exceptionally clean, as it is also on the disc version (London 25876, 5876), and the stereo is well separated, though sometimes the voices, including Sutherland's, seem a trifle distant. The tape processing is excellent. Texts are supplied, but for a list of who is singing what and an explanation of how each aria fits into the plot, one must go to the disc release. **I. K.**

HAYDN: *Symphony No. 100; Symphony No. 94* (see BEETHOVEN)

HONEGGER: *Pacific 231* (see RAVEL)

© **KODÁLY: *Háry János: Suite from the Opera; Orze's Arias; "Poor Am I," and "Once I Had a Brood of Chicks."*** *Dances of Galánta*. Olga Szönyi (soprano); London Symphony Orchestra, István Kertész cond. LONDON LCL 80159 \$7.95.

Performance: Lively and stylish
Recording: Superb
Stereo Quality: Effective and tasteful

In view of the wide popularity of the *Háry János* Suite, as well as of the *Galánta* and *Marosszék* dances, I was shocked to discover that not a single note of Zoltán Kodály's music was to be found on tape before this release. Thanks to London, this omission is now rectified, and in very stylish fashion, too. For Kertész and his instrumentalists turn out wonderfully dashing performances of the atmospheric, comical, and folklike numbers from *Háry János*—which is, properly speaking, not an opera but a play with incidental songs and choruses. The two arias for Háry's fiancée Orze (not Ilka as the liner notes have it) are a welcome bonus. Miss Szönyi sounds a bit wobbly in the nostalgic first song, but she sings the gay second piece with irresistible verve.

The *Galánta Dances*, which Kodály developed from an 1800 volume of "Hungarian Dances after several gypsies from Galánta," also get stylish treatment under the Kertész baton. London's recorded sound can only be described as dazzling.

I am mystified by one thing, however—why the *Háry János* arias were not inserted between movements of the suite instead of being tacked on as a seeming afterthought at the end of the *Galánta Dances*. Perhaps it would then have been possible to add to the tape or disc the shorter and even finer set of *Marosszék Dances*. **D. H.**

© **MAHLER: *Symphony No. 1, in D Major ("Titan")***. London Symphony, Georg Solti cond. LONDON LCL 80150 \$7.95.

Performance: Sturdy
Recording: Excellent
Stereo Quality: Life-like

At last we have a really outstanding Mahler First on tape. Solti is noticeably less concerned with the work's rather quixotic *Surm und Drang* than with its manifest musical qualities and a true realization of its kaleidoscopic sonorities. His tempos are appropriately unhurried in the outer movements, a little snappier than usual in the Scherzo, and admirable in the Funeral March

—in the last he allows room for a pointed exposition of the gallows humor and the occasional flourishes of brass-band vulgarity. At every turn, in fact, Solti conveys a marvelous sense of proportion and dramatic contrast: the music's darker, heavier textures and its moments of gossamer lightness, its impassioned eloquence and its wit, its *misterioso* elements, its mock heroics, and its schmalz are all brought together in a performance notable for pliancy and warmth. The London Symphony plays better than I can ever remember hearing it play—that is, with cracker-jack precision and altogether remarkable virtuosity, severally and together. And the recorded sound is absolutely first-rate. Instrumental timbres are true to life in every register, resonant and full-bodied on the bass end, utterly transparent in the mid-range, and crisp on top. In sum, a job well done by all concerned. C. B.

© MAHLER: *Symphony No. 2, in C Minor ("Resurrection")*. Jennie Tourel (mezzo-soprano); Lee Venora (soprano); Collegiate Chorale; New York Philharmonic, Leonard Bernstein cond. COLUMBIA M2Q 604 \$11.95.

Performance: **Stunningly dramatic**
Recording: **Extraordinary**
Stereo Quality: **The best**

All of the laudatory comments that I made about the disc version of this superior performance receive renewed validation on the evidence of this fine tape processing. It is the awesome finale, with its fresco-like unfolding of Mahler's vision of Judgment Day and the final resurrection, that gains most through transfer to the tape medium, for the chorus, soloists, augmented orchestra, and organ in the final pages come through in all their blinding splendor, unmarred by the inevitable tracking distortion imposed by the physical limitations of discs. And it is good also to be able to experience the hour-and-a-quarter span of this music with but one interruption for turn-over, as against two for the disc version (the fourth side of the disc set offers Mahler's *Kindertotenlieder* sung by Mme. Tourel with Bernstein and the New York Philharmonic).

On a rival Angel tape, Otto Klemperer, the Philharmonia Orchestra, chorus, and soloists offer substantial musical competition for Bernstein and his forces, but Klemperer's noble reading fails to convey the nervous energy inherent in the music to the same extent as Bernstein's. Considering, too, that the Columbia tape is four dollars cheaper, there can be no question which is the greater bargain. D. H.

© MAHLER: *Symphony No. 5, in C-sharp Minor*. BERG: *Wozzeck (excerpts)*. Phyllis Curtin (soprano); Boston Symphony, Erich Leinsdorf cond. RCA VICTOR FTC 7007 \$14.95.

Performance: **Superb Mahler**
Recording: **First-rate**
Stereo Quality: **Fine**

The striking difference between this Erich Leinsdorf-BSO tape of the Mahler Fifth and the earlier one of the First (FTC 2129) lies in the responsiveness of the orchestra's playing. In the few years Leinsdorf has been in Boston he has been increasingly able to get from his men the kind of sound he wants

and the kind of execution he must demand. It shows here, in a performance that is clean, controlled, and remarkably poised. Without catering particularly to the Mahler mystique, it has plenty of emotional heft and dynamic thrust, particularly in the second movement and Rondo-Finale, which in turn are spelled by a warmly sympathetic Scherzo and an Adagietto of beautifully sustained lyricism.

Filling out the second sequence of this double-length reel of tape are the three scenes from *Wozzeck* that Berg himself extracted from his complete score, on the advice of Hermann Scherchen, in 1924. To these Leinsdorf brings his formidable skills as an opera conductor, and soprano Phyllis Curtin her sensitive vocal art. The children's chorus that turns up briefly at the end is unidentified. The high-level, low-noise recording is notable for the kind of distortion-free, open sound we have a right to expect on tape. C. B.

© MOZART: *Piano Concerto No. 20, in D Minor (K. 466)*; *Piano Concerto No. 23, in A Major (K. 488)*; *Concert Rondo, in A Major, for Piano and Orchestra (K. 386)*. Clara Haskil (piano); Vienna Symphony Orchestra, Bernhard Paumgartner cond. MERCURY STC 90413 \$7.95.

Performance: **Warm and sensitive**
Recording: **Good**
Stereo Quality: **Satisfactory**

Considering that the playing time of this tape is a little more than sixty-three minutes, it is an extremely good value. And on musical grounds, both for the quality of the three works and of the performances, the reel could well serve as part of a basic tape collection. The late Clara Haskil's playing is extraordinarily sensitive, warm, and gracious; judging from what one hears here, it is no wonder that she was so beloved for her Mozart interpretations. Even the sometimes heavy-handed Paumgartner succumbs to her spell and provides accompaniments that are lyrical, flowing, and, at the right moments, dramatic.

As far as I have been able to determine, these three performances date back to the earliest days of stereo recording—nearly ten years ago. In this country, they were first released on discs (mono only) by Epic, and now, because of contractual changes, they are again available, but on the Mercury label. To confuse matters still further, Haskil remade K. 466, along with the C Minor Concerto, K. 491, and these performances, with the Lamoureux Orchestra conducted by Markevitch, are also available in tape form (Epic EC 820). The age of the present recordings is not in the least apparent, however: the sound is clean and pleasant. I. K.

MOZART: *Violin Concerto No. 1* (see STRAVINSKY)

© PROKOFIEV: *Symphony No. 3: Suite from Le Pas d'acier*. Utah Symphony Orchestra, Maurice Abravanel cond. VANGUARD VTC 1699 \$7.95.

Performance: **Vigorous**
Recording: **Generally good**
Stereo Quality: **Wide spread**

This is an altogether invaluable coupling of two works that we rarely hear—either on records or in the concert hall. These works

that date from Prokofiev's "revolutionary" period, pre-dating his repatriation to Russia (and the attendant aesthetic restrictions governing the artist's life in the Soviet Union).

The Symphony No. 3, in C Minor, a work made up of materials derived from Prokofiev's opera, *The Flaming Angel* (1919-c. 1927), was composed in 1928, and one sees it in retrospect as very different in some ways yet very much the same as the more recently composed music that has won him a place of such high favor with the general public. Texturally, the music of the Third Symphony is densely polytonal but quite as lyrical and classically structured as, say, the more popular Fifth Symphony. However, its mood is darker by many shades. Its expressive content is somber and it probably will not succeed with those who look for prettiness alone. It requires careful listening, this work, and repeated listening. But, so far as its essential technical devices go, so far as the matter of stylistic identity itself goes, it differs from the composer's later "popularized" manner far less than meets the ear.

The ballet *Le Pas d'acier* was commissioned in 1925, during Prokofiev's Paris years, by Sergei Diaghilev for his celebrated Russian ballet company. The score is a sort of stylistic cousin to *The Scythian Suite*, full of orchestral apings of the sounds of the machine age. If simply as a score it lacks the direct impact of the earlier work, it compensates for this lack by occasional lyrical flights that foreshadow the emphasis that Prokofiev put on pure instrumental song in later years.

The performances by the Utah Symphony and Maurice Abravanel are vigorous, heavy-weight (as they indeed should be), and chock-full of cheerfully earsplitting massed sonorities. The sound is spacious and handsome, although I suspect that the engineers have somewhat overweighted the brass. W. F.

© PUCCINI: *La Bohème*. Mirella Freni (soprano), Mimi; Nicolai Gedda (tenor), Rodolfo; Mario Sereni (baritone), Marcello; Mariella Adani (soprano), Musetta; Mario Basiola Jr. (baritone), Schaunard; Ferruccio Mazzoli (bass), Colline; Paolo Montarsolo (bass), Alcindoro; Carlo Badioli (bass), Benoit; Vittorio Pandano (tenor), Parpignol. Orchestra and chorus of the Rome Opera House, Thomas Schippers cond. ANGEL ZB 3643 \$15.98.

Performance: **Red-blooded**
Recording: **Satisfying**
Stereo Quality: **Realistic**

This new *Bohème*, the third on tape and easily the most compelling, presents the latest pin-up girl of recorded opera in her first starring role. She is, of course, Mirella Freni. Before she recorded Mimi, Miss Freni was heard in lesser roles in London's *Alcina* and in RCA Victor's *Falstaff* and *Carmen*. In each she has made a favorable impression, but here she faces up to some truly formidable competition, and shows herself to be an artist of stature, dramatically forthright and vocally secure. The voice itself is a joy. Miss Freni possesses a beautiful lyric soprano, pure and full in tone and nicely equalized in timbre from top to bottom. This is a voice ideally suited to Mimi by virtue of its enchanting freshness and the conviction it carries continually, from the early moments of tender passion to the supremely moving death scene.

The entire performance, in fact, seems to aim for a credible, emotionally valid denouement, and I defy anyone to remain unmoved by it as it is realized in this recording. The reminiscences that crop up just before Mimi expires do not, for once, sound like coy melodrama but have a ring of truth that is infinitely touching. And for this, as for the impact of the scene as a whole, credit must go ultimately to Thomas Schippers. His conducting is at times unnecessarily aggressive and hard-hitting, especially in the ensembles and recitatives—it is almost as if he were impatient with some of the opera's by-play and anxious to get on to the big moments. When these moments are reached, however, beginning with Mimi's entrance in Act One, he opens up and allows the music to set the scene and the singers to fill it out, step by careful step. You have only to listen to the way Schippers prepares for the duets and the Act Three trio to appreciate his natural feel for the music and for the honest, if not terribly complex, theatrical ends it is meant to serve.

The cast supporting Miss Freni is an entirely capable one. Nicolai Gedda may not be the most dashing of Rodolfos, but his portrayal is marked by warmth and consistent musicianship. Mario Sereni is a commanding Marcello, and Ferruccio Mazzoli a resonant-voiced Colline in the little Coat Song. Mariella Adani's Musetta is effective in the waltz, but otherwise a bit edgy.

Even though the voices are almost always too closely miked, the over-all recorded sound is realistic and dynamically wide in range. In the transfer the whole opera is gotten on a single reel, but the tape is frequently plagued by pre-echo and hiss (the latter appears to stem from the master tape). Libretto and notes are available by mail upon request.

C. B.

© PURCELL: *Dido and Aeneas*. Mary Thomas (soprano), Dido; Honor Sheppard (soprano), Belinda, first witch, attendant; Maurice Bevan (baritone), Aeneas; Helen Watts (contralto), Sorceress; Robert Tear (tenor), spirit and sailor. Oriana Concert Choir and Orchestra. Alfred Deller cond. VANGUARD VTC 1692 \$7.95.

Performance: Stylish
Recording: Excellent
Stereo Quality: Excellent

Alfred Deller once again demonstrates his skill as a conductor with this winning performance of an opera generally regarded as unstageable by impresarios today. Its place in the recorded repertoire, however, is firmly fixed, and sung as well as it is here, its antique charm is irresistible. Mary Thomas as Dido may be a bit light of voice for the needed contrast with Honor Sheppard's Belinda, and she may lack the authority Janet Baker brings to the role in London's competing version (EOL 96002), but where this recording excels is in the Sorceress of Helen Watts, which is most compellingly sung and not intoned. Dynamic level is relatively high throughout, tape noise correspondingly low, and stereo definition, particularly in the double choruses and elfin byplay, enormously effective. I recommend this tape highly.

C. B.

© RACHMANINOFF: *Piano Concerto No. 2, in C Minor, Op. 18; Rhapsody on a Theme of Paganini, Op. 43*. Gary Graff-

man (piano); New York Philharmonic, Leonard Bernstein cond. COLUMBIA MQ 657 \$7.95.

Performance: Splendid *Rhapsody*
Recording: *Rhapsody* more spacious
Stereo Quality: Good enough

When I heard the disc version of this performance of the Rachmaninoff Second Piano Concerto, I was struck most forcibly by two things: the somewhat opaque quality of the recorded sound, and a general tendency toward heavy-handedness on Graffman's part that became most irritatingly manifest at the piano-orchestra *tutti* recapitulation of the first-movement main theme. I ascribed part of my latter impression to the extreme length of the disc side. And, sure enough, on tape the sonic atmosphere clears to a considerable degree—not enough to obviate my reservations about the first-movement passage in question, but certainly enough that I was able to appreciate many details of inner voicing that were not as sharply etched on the disc.

However, it is in the diablerie and brilliance of the Paganini *Rhapsody* that the Graffman-Bernstein collaboration comes superbly into its own. A feeling of uninterrupted lyrical flow is essential to the communication of Rachmaninoff's music: this flow seemed to bog down as the result of overemphasis in the concerto, but things move along at a sparkling pace throughout the *Rhapsody*. The recorded sound is considerably more spacious and transparent, too—which helps considerably.

There is no comparable tape coupling of these two deservedly popular scores. Certainly this reading of the *Rhapsody* stands with the best to be had on either tape or disc. Of the rival tape versions of the concerto, that by Byron Janis, Antal Dorati, and the Minneapolis Symphony on Mercury seems to me preferable.

D. H.

© RAVEL: *Daphnis and Chloë, Suite No. 2*. ROUSSEL: *Bacchus et Ariane, Suite No. 2*. Chicago Symphony Orchestra, Jean Martinon cond. RCA VICTOR FTC 2196 \$7.95.

Performance: Sensitive
Recording: Very good
Stereo Quality: Natural

The Chicago Symphony Orchestra, under its French conductor Jean Martinon, has come up with performances of Ravel's *Daphnis and Chloë* Suite No. 2, and the Second Suite from Roussel's *Bacchus et Ariane* that are models of French elegance and attention to detail. These are among the most arresting versions of both works to be found on tape.

Refinement is the key word here, and there is also evident a particularly acute sense of the music's orchestral coloration. Neither piece is driven or played with the emphasis on virtuosity that most American orchestras strive for, particularly in the case of the Ravel. The result is an X-ray penetration into the fabric of the musical texture itself as well as some of the prettiest orchestral coloring imaginable.

One looks forward to more from the Chicago organization on tape. For this performance, Victor's engineers have produced recorded sound that is first-rate.

W. F.

© RAVEL: *La Valse Boléro*. DUKAS: *The Sorcerer's Apprentice*. HONEGGER:

Ampex Stereo Tapes: the best in music!

**Hi
Kapp
MGM
Verve
ATCO
A & M
Smash
Parrot
Philips
London
Archive
Impulse
Atlantic
Fontana
Mercury
Coliseum
Limelight
Vanguard
Richmond
Command
Buena Vista
Westminster
Four Corners
World Pacific
Audio Fidelity
Aeolian-Skinner
ABC-Paramount
Warner Brothers
Ampex Stereo Samplers
Institute of Language
Study
Deutsche Grammophon
Gesellschaft**

No one can offer you a wider selection of Stereo Tapes than your Ampex dealer.

One year ago we offered you the cream of eighteen record labels on 4-track Ampex Stereo Tape.

**Today you can select
from the best of
thirty-one labels.**

Classical, popular, folk, jazz... music sounds best on tape, and tape sounds best when it's Ampex.

The new Ampex Stereo Tape Catalog lists more than 1300 titles. Get Ampex Tapes... and a catalog... from your favorite tape dealer, or write to:

Ampex Corporation, Department HFSA-1
2201 Landmeier Road, Elk Grove Village
Illinois 60007

AMPEX

CIRCLE NO. 36 ON READER SERVICE CARD
121

Pacific 231. Suisse Romande Orchestra, Ernest Ansermet cond. LONDON LCL 80151 \$7.95.

Performance: Idiomatic
Recording: Fine
Stereo Quality: Good

This tape and its disc counterpart represent a rerecording with the Suisse Romande Orchestra of a highly successful Ansermet program with the Paris Conservatory Orchestra issued some ten years ago by London. Now as then, Ansermet brings to the much-abused Ravel and Dukas scores a sense of proportion and a flair for just instrumental coloration and balance that enable us to experience these pieces as music rather than as orgasmic sonic sensation.

For me, however, the rather neglected Honegger locomotive tour de force gets the most powerful and revealing performance of all—one that makes the score interesting as music, and as well underlines its relationship to the mechanist-abstract paintings of Léger and others of the 1920's. *D. H.*

RESPIGHI: *Rossiniana* (see BRITTEN)

© RIMSKY-KORSAKOV: *Le Coq d'Or—Suite*; STRAVINSKY: *The Firebird—Suite* (1945). Boston Symphony Orchestra, Erich Leinsdorf cond. RCA VICTOR FTC 2168 \$8.95.

Performance: Refined
Recording: Smooth
Stereo Quality: Fine

This tape and its disc counterpart offer the only stereo recording of the extended suite that Stravinsky compiled in 1945 from the *Firebird* score. In addition to the more familiar suite's music, therefore, we get here the *Pas de deux* in which the Firebird is freed by her captor, as well as the pert Scherzo of the princesses and the golden apples. (One would never know this from reading either the program notes or the label copy provided with the tape.) The 1945 Suite represents, in short, all of the best in the *Firebird* score, relieving us of hearing the "furniture-moving" music that makes for such dead spots in the complete ballet (available on tape in versions by Stravinsky and the Columbia Symphony, and Ansermet and the Suisse Romande Orchestra). Leinsdorf's reading is precise, refined, and a bit tame. The Szell-Cleveland Orchestra tape of the shorter 1919 Suite, on Epic, still packs the most excitement and sonic brilliance.

Although again neither liner notes nor label tells us so, the *Coq d'Or* Suite recorded by Leinsdorf is (with some modifications) the four-movement sequence arranged by Rimsky-Korsakov's pupils Alexander Glazounov and Maximilian Steinberg. It consists of the Introduction, Slumber Scene, and Cockerel's Warning; the Prelude to Act II and King Dodon at the Battlefield; the Dance of King Dodon and the Queen of Shemakha; and the Prelude to Act III and Bridal Cortege. Though the program notes explain that the Bridal Cortege ends when the enraged cockerel kills the King, these crucial closing musical pages are altogether missing from the Leinsdorf performance: it is cut short at the point of transition to this episode by a rude unison on A-flat. Leinsdorf's refined and sensuous approach and RCA Victor's lush sound are better suited to Rimsky-Korsakov than to Stravinsky, and despite the

truncated conclusion, the performance is impressive both musically and sonically. *D. H.*

© ROSSINI: *La Cenerentola*. Giulietta Simionato (mezzo-soprano), Cenerentola; Paolo Montarsolo (bass), Don Magnifico; Sesto Bruscantini (bass), Dandini; Ugo Benelli (tenor), Don Ramiro; Dora Carral (soprano), Clorinda; Miti Truccato Pace (mezzo-soprano), Tisbe; Giovanni Foiani (bass), Alidoro. Orchestra and chorus of the Maggio Musicale Fiorentino, Oliviero de Fabritiis cond. LONDON LOR 90084 \$21.95.

Performance: Exhilarating
Recording: Effective
Stereo Quality: Well-defined

La Cenerentola, Rossini's last work in the true Italian *buffa* genre, is one of those pieces opera companies revive from time to time but never seem able to keep in their repertoires. The reason is simple: there are too few Giulietta Simionatos around. The role of Angelina, known as Cenerentola (Cinderella, that is), requires a bravura mezzo-soprano who can purr charmingly at one moment and dart effortlessly into coloratura the next, and they just don't make voices like that in abundance. Miss Simionato, however, has been singing the role for some time and has mastered it in every detail. If the quick runs, arpeggios, and trills do not come to her as naturally and as smoothly as they once did, their old luster is as yet undiminished. The total effect of her performance is one of astonishing brilliance, and she is matched in this by the young tenor who sings Don Ramiro. Ugo Benelli is a rare find. He executes the florid passages flawlessly and with unexpected brio, with apparently all the hearty abandon that his light, well-focused voice permits.

Bruscantini's Dandini will perhaps be remembered from a Glyndebourne recording of this opera once available on LP. Both he and Paolo Montarsolo, the Don Magnifico, find great sport in their assignments. Their work is stylistically magnificent throughout, but not always ingratiating to the ear because of too-close miking. The second sopranos are wholly satisfying.

Orchestra and chorus have a few ragged moments, and so do the principals in some of the strettos, yet veteran conductor Oliviero de Fabritiis manages to keep these to a minimum. He sets a brisk pace and maintains a high level of energy and spirit from beginning to end. Stage movement is exceedingly well defined—the singers seem to move from side to side and from front to back (though when down front they can be a little too close to the mike for listening-room comfort). Tape noise is commendably low, and the sequence breaks, which necessarily occur mid-scene, are confined to appropriate points. A serviceable, easy-to-read libretto accompanies the two reels. *C. B.*

ROUSSEL: *Bacchus et Ariane, Suite No. 2* (see RAVEL)

© D. SCARLATTI: *Sonatas: K. 33, 39, 54, 96, 146, 162, 198, 466, 474, 481, 491, and 525.* Vladimir Horowitz (piano). COLUMBIA MQ 697 \$7.95.

Performance: Superb
Recording: Not entirely clean
Stereo Quality: Natural

Horowitz's Scarlatti—from his earliest recordings of a few sonatas in the Thirties, through a two-record 78-rpm RCA Victor album in the Forties, down to the three pieces included in a 1963 piano recital for Columbia—has always been something very special. Of all pianists today, Horowitz is, I think, most successful in combining his own fantastic finger control, pedaling technique, phrasing, and shading with the expressive demands of this music. Not everything comes out pure Scarlatti—that is, as it might be performed on a harpsichord, nor (thank goodness) does the pianist attempt to emulate the sonorities of that instrument. He does, however, bring to the sonatas the Baroque sense of tension, a vital element of this style that most other pianistic interpreters overlook entirely.

For this latest recital, Horowitz has chosen a program that is less familiar than the usual Scarlatti presentation. (Only a few of the sonatas, such as K. 96, or L. 465, sometimes subtitled "La Chasse," are very well known.) Stylistically, Horowitz adheres more closely in this collection than in the past to eighteenth-century practices in ornamentation and the like (the result, I am told, of discussions with Ralph Kirkpatrick). The combination of all these factors makes this one more Horowitz disc that is a must for every record collector's library.

The sound of Horowitz's piano is drier than on some of the pianist's previous Columbia tapes, but this is in keeping with the material. What is disappointing, however, is the distortion in the upper middle register of the piano here—not a major defect, but one I could not hear at all on the disc version. *I. K.*

© SIBELIUS: *Symphony No. 2, in D Major, Op. 43; Symphony No. 4, in A Minor, Op. 63.* Suisse Romande Orchestra, Ernest Ansermet cond. LONDON LCK 80152 \$11.95.

Performance: Fourth more convincing
Recording: Good
Stereo Quality: Good

With virtually an hour and a half of music, this tape, which combines the most popular and the most problematic of the Sibelius symphonies, represents a remarkable value. As to its musical worth, Eugene Ormandy and the Philadelphia Orchestra on a Columbia tape reveal far more of the drama of the D Major Symphony's "victory-through-struggle" progression than does Ansermet's rather overrefined and not always sure performance. The windswept dissonances and enigmatic pronouncements of the A Minor Symphony provoke a considerably more meaningful response from Ansermet, and though he fails to communicate the uttermost meaning of this music, he does bring out much of the nobility of the slow movement, and the atmospherics of the faster ones as well.

As performances by a major conductor who is not normally associated with Sibelius, these are of more than usual interest—most notably the Fourth Symphony, which has not heretofore been recorded in stereo. The sound is generally excellent, and the Fourth Symphony profits especially from good tape stereo. *D. H.*

© SOLER: *Six Concertos for Two Keyboards.* Erna Heiller (harpsichord); Anton

Heiller (portative organ and harpsichord).
VANGUARD VTC 1689 \$7.95.

Performance: Deft
Recording: Excellent
Stereo Quality: Great definition

There is very little of this kind of intimate music-making on tape, and still less that is brought off with the style and technical excellence the Heillers contribute to these performances. The six short works they offer on this reel were composed in the mid-1700's by a retiring Spanish monk for the "diversion" of the Infante Gabriel de Borbon. Described in manuscript as "concertos for two obligate organs," they are in fact four-hand sonatas that are eminently playable on virtually any pair of keyboard instruments. Three of them are here done on two harpsichords, and three on harpsichord and portative organ. With one exception, they are in two movements, the first binary and similar in sound and effect to the sonatas of Scarlatti, the second a minuet with several variations. They range in mood from the playful and at times highly ornate to the quietly melancholy, as in a passage in Number Six that is reminiscent of Haydn's F Minor *Andante Varié*. All told, they make a charming collection. The recording cannot be faulted, and the stereo separation is sharply defined, as it should be for adequate enjoyment of this music. C. B.

© R. STRAUSS: *Der Rosenkavalier: Introduction and opening scene; Marschallin's monologue and conclusion (Act I); Presentation of the Rose (Act II); Concluding trio and duet (Act III)*. Régine Crespin (soprano), Marschallin; Elisabeth Söderström (soprano), Octavian; Hilde Gueden (soprano), Sophie; Heinz Holecsek (baritone), Faninal; Vienna State Opera Chorus Members; Vienna Philharmonic Orchestra, Silvio Varviso cond. LONDON LOL 90094 \$7.95.

Performance: Fascinating
Recording: Sumptuous
Stereo Quality: A-1

I am not a *Rosenkavalier* buff of the sort represented by some of my friends (most of them from *Mittel-Europa*) who claim to be able to sing all the parts from memory—and who have sometimes attempted to prove it in the course of bibulous social occasions. Strauss' three-hour serving of *Sachertorten* is a bit rich for my taste, and for this reason I have always preferred my *Rosenkavalier* via the Angel Great Recordings of the Century abridged version with Lotte Lehmann, Elisabeth Schumann, Maria Olszewska, and Richard Mayr.

Crespin is a warmly emotional Marschallin, yet very much a woman of the world, in this recording. Söderström's Octavian is an effective foil to Crespin. Hilde Gueden is properly sweet and naïve as Sophie, and Heinz Holecsek does well with his brief bit as papa Faninal. If the emotional atmosphere surrounding the Marschallin and Octavian seems overpoweringly hothouse on this tape, it is in part because one hears the Act I scenes without the interruptions of the *levée* and the intrusion of Baron Ochs. Another contributing factor is that Crespin, in singing for a recording rather than for the opera house, creates an effect of striking, almost uncomfortable, intimacy.

From a purely vocal standpoint, I find the

performance virtually flawless, and the gorgeous playing that Silvio Varviso elicits from the Vienna Philharmonic is a pleasant surprise—I would have expected such results only from the likes of Krauss and Kleiber.

My only real criticism of the recording concerns the rather clumsy opening and closing of the Silver Rose scene: not all of the orchestral prelude is included, and the scene could have been ended on a tonic chord rather than being chopped off just before the subsequent duet. London's sound is glorious from start to finish. D. H.

© STRAUSS: *Die Fledermaus*. Adele Leigh (soprano), Rosalinda; Anneliese Rothenberger (soprano), Adele; Risë Stevens (mezzo-soprano), Orlovsky; Sándor Kónya (tenor), Alfred; Eberhard Wächter (baritone), Eisenstein; George London (bass-baritone), Dr. Falke; Erich Kunz (baritone), Frank; Erich Majkut (tenor), Blind. Chorus and Orchestra of the Vienna State Opera, Oscar Danon cond. RCA VICTOR FTC 7004 \$14.95.

Performance: Ingratiating
Recording: Very good
Stereo Quality: First-rate

The marvelous thing about this recording is that you, the listener, can easily persuade yourself that it is not a recording at all but a live performance unfolding somewhere in the vicinity of your speakers. And in no time at all you can just as easily be swept off your feet by it. "To achieve this feeling of spontaneity," writes coproducer Charles Gerhardt, "we decided to abandon the operatic 'numbered-floor-plan' type of recording and ask the singers to use the large stage area for just that purpose: a stage. We allowed them complete freedom of movement without any dictates from the control room." As he goes on to say, it works like a charm.

During the party sequence "we asked all the principals to be on stage at the same time, plus the chorus and the offstage ballroom musicians. Everyone sang, danced, drank champagne"—everyone here including the rather overbearing Orlovsky of Risë Stevens, the appropriately fatuous Eisenstein of Eberhard Wächter (I could not object any more strenuously that a baritone was cast in this role), the utterly beguiling Adele of Anneliese Rothenberger, and a charming Rosalinda sung by Britain's Adele Leigh.

The champagne, we are told, was real during the nonstop recording of this scene. So, too, are the sounds of popping corks, the chimes of Eisenstein's pocket watch, and the gypsy cymbalom. But even more real is the immediacy of the performance itself, its radiant warmth, its style, and its infectious gaiety, much of which can be credited to the Belgrade Opera's Oscar Danon and the members of the Vienna State Opera Orchestra under his baton. The stereo engineering is absolutely first-rate throughout, the sound on tape bright and beautifully balanced. C. B.

STRAVINSKY: *The Firebird—Suite* (see RIMSKY-KORSAKOV)

© STRAVINSKY: *L'Histoire du soldat*. Jean Cocteau (narrator), Peter Ustinov (Devil), Jean-Marie Ferte (Soldier), Manoug Parikian (violin), Ulysse Delécluse, and Henri Helaerts (bassoon), Maurice André (trumpet), Roland Schnorkh (trombone),

Joachim Gut (double-bass), Charles Peschier (percussion). Igor Markevich cond. PHILIPS PTC 900046 \$7.95.

Performance: Extremely effective
Recording: Good
Stereo Quality: Natural but unimaginative

This valuable recording is unique in that it is the only complete version of *L'Histoire du soldat*—complete in both music and text. (It is available on both tape and discs.) Its various spoken roles are distinguished by the singularly appropriate inflections of the late Jean Cocteau as the narrator, by the sly textual mastery of English actor Peter Ustinov as the Devil, and by the superb *esprit* that Jean-Marie Ferte supplies as the Soldier. All of this makes it a documentation of the work in its original form that is not likely to be bettered in the foreseeable future.

Musically, the performance is excellence itself, so far as Markevich's conception of it goes, although I have heard the work projected somewhat more tellingly in terms of bare instrumental execution. Still, Markevich's grasp of the stylistic identity of the Stravinsky of the Twenties is unexceptionable. Although the recorded sound is clear and resonant, I can imagine a somewhat more fanciful stereo distribution of both the spoken and musical aspects of the work. W. F.

© STRAVINSKY: *The Song of the Nightingale (Symphonic Poem); Scherzo à la Russe; Fireworks; Tango; Four Études for Orchestra*. London Symphony Orchestra, Antal Dorati cond. MERCURY STC 90387 \$7.95.

Performance: High-voltage
Recording: Superb
Stereo Quality: First-rate

This collection represents Stravinsky at his most accessible: *Fireworks*, as well as certain portions of the *Song of the Nightingale*, predate the composer's trio of famous ballets; the *Tango* and the *Études* are orchestrations, done in America, of earlier material; and the *Scherzo* was originally written for Paul Whiteman's band. Every one of these pieces, which range in length from almost twenty-two minutes (*Nightingale*) to as little as three and a half minutes (*Tango*), is a sonic marvel in this recording. The variety and color of the composer's scoring are extraordinarily impressive, especially when captured as realistically and brilliantly as they are here. Mercury's disc version is a startling experience for the ear, even in terms of today's advanced state of the recording art. The tape version is of comparable quality, even though, to my hearing, it has no marked superiority. I advise any tape enthusiast to obtain this reel, not only for the material (only the *Nightingale* was previously available in this medium) and the vivid, full-blown, sharply etched sound, but for the razor-sharp precision of the orchestral playing and the excitement conveyed by conductor Antal Dorati. I. K.

© STRAVINSKY: *Violin Concerto, in D Major (1931)*. MOZART: *Violin Concerto No. 1, in B-flat (K. 207)*. David Oistrakh (violin); Lamoureux Orchestra of Paris, Bernard Haitink cond. PHILIPS PTC 900050 \$7.95.

Performance: Stunning
Recording: Good
Stereo Quality: Good

Both these recorded performances are stereo-tape firsts and dazzling exhibitions of David Oistrakh's virtuosity and musicianship as well. I would never have expected the Soviet violinist to turn in such a brilliant and precise job on the Stravinsky Concerto, in view of the fact that the expatriate Russian master's work has become part of the USSR's concert repertoire only in recent years. But Oistrakh and Haitink make Stravinsky's neo-classic masterpiece glisten like sunlit spun steel—they surpass in finesse and clarity of rhythmic detail even Isaac Stern and the composer, who conducts on Columbia's disc MS 6331, ML 5731.

The lovely and not well-known Mozart B-flat violin concerto has been recorded in stereo by Stern, Yehudi Menuhin, and Oistrakh. (I have not heard the Stern performance.) Even with its slightly cavernous recorded sound, I prefer Oistrakh's version to Menuhin's, because of its rhythmic vitality and precise intonation. In addition, Oistrakh's cadenzas (presumably those written by Joachim) seem more in keeping with the character of the music than those created by Menuhin for his own use. The Menuhin performance has an intimate chamber-music quality, but I find nothing objectionable in the approach adopted by Oistrakh and Haitink—one that would be appropriate to a public concert. The sparkle and vivacity of Haitink's accompaniments in both works are altogether a delight. *D. H.*

TCHAIKOVSKY: *Nutcracker Suite* (see GRIEG)

© TCHAIKOVSKY: *Symphonies: No. 3, in D Major, Op. 29; No. 4, in F Minor, Op. 36*, Vienna Philharmonic Orchestra, Lorin Maazel cond. LONDON LCK 80161, \$11.95.

Performance: Brilliant
Recording: First-class
Stereo Quality: The best

The tautness of Maazel's approach seems more appropriate to the balletic five-movement "Polish" Symphony than to the passionate F Minor. However, of the tape versions that I have heard, this one is by far the most impressive sonically and the most exciting from the standpoint of orchestral playing. This release makes the Third Symphony available for the first time on tape.

The tape is the equivalent of two complete discs, and therefore as sheer value it is a first-rate buy. Incidentally, it comes in one of those odd slipcases with loose outside illustrative covers that Ampex is supplying for its "double-play" releases. I don't like them, and if I were one of Ampex's clients, I'd yell to high heaven for a return to the regular hinged box. *D. H.*

© VERDI: *Manzoni Requiem*. Lucine Amara (soprano); Maureen Forrester (mezzo-soprano); Richard Tucker (tenor); George London (bass-baritone); Westminster Choir; Philadelphia Orchestra, Eugene Ormandy cond. COLUMBIA M2Q 656 \$11.95.

Performance: Broadly lyrical
Recording: Handsomely done
Stereo Quality: Excellent

From the standpoint of the choral and orchestral performances, this twin-pack tape of the Verdi Requiem is the most satisfying

version of this work that I have heard. The orchestral playing is superb, especially in the quiet lyrical passages in which this score abounds; the choral singing has plenty of body, and its rhythmic precision is generally admirable. The stereo sound, moreover, is notable for its illusion of breadth and depth. But for the most part the satisfactions end right there.

Ormandy's tempos are on the slow side—he eschews the elemental sound and fury of the Toscanini and Markevitch discs. This is most noticeable in Ormandy's deliberate pacing of the Tuba Mirum. On the other hand, the lyrical aspect of the music gains. The bass drum strokes in the Dies Irae sound too far off-mike to shake the floor as they should, but the pianissimo entries in the Mors Stupebit are awesome.

If my reservations up to this point seem quibbling, the situation is more serious as regards the quartet of solo singers, an ill-matched and not always very steady lot. Forrester and London are the most dependable and distinguished, though the latter is no match for the late Ezio Pinza in his command of the dark tones needed at the end of the Mors Stupebit. The pitch of the soloists' ensemble goes awry on the words "*Give curam mei finis*" at the end of the Confutatis, and the opening phrase of the Domine Deus is distressingly insecure. But from here on the soloists acquit themselves with competence, if not with ultimate distinction. As for balance, the vocal quartet sounds a bit forward in relation to the chorus throughout the recording.

Even with these shortcomings, it is my guess—in view of the not very satisfying tempos that characterize Fritz Reiner's RCA taping—that this new Columbia tape will remain the best available version of the Verdi Requiem in this medium for some time to come. *D. H.*

© VERDI: *Rigoletto*. Robert Merrill (baritone), Rigoletto; Anna Moffo (soprano), Gilda; Alfredo Kraus (tenor), the Duke; Ezio Flagello (bass), Sparafucile; Rosalind Elias (mezzo-soprano), Maddalena; others. RCA Italiana Opera Chorus and Orchestra, Georg Solti cond. RCA VICTOR FTC 7008 two reels \$21.95.

Performance: Taut
Recording: Gaud
Stereo Quality: Lacks drama

From the very opening of this performance, one is conscious of Georg Solti's taut conductorial hand and keen dramatic sense. There are plenty of opportunities for the singers to use this opera for their own vocal ends and to squeeze all the juice out of the arias, but Solti keeps everybody well in line and concentrates on the relentless sweep and impact of Verdi's dramatic action, from the opening festive scene to the final horrifying denouement.

Robert Merrill in the title role has greatly expanded the human dimensions of his character portrayal over the years. Here intelligence and a fine voice work in splendid harmony, achieving genuine poignancy in the moments of pathos with Gilda. Merrill realizes well the undertones of irony and cynicism too, but in the climactic moment of outrage against the courtiers over the kidnapping of Gilda, Merrill's "*Cortigiani, vil razza dannata*" is strangely lacking in thrust. Indeed, his singing is almost covered by the

violin figuration (this may well stem from faulty engineering). Anna Moffo makes an appealing and vocally lovely Gilda, but Alfredo Kraus sounds a bit threadbare vocally in the role of the Duke—here the Duke is hardly the splendidly accoutered smooth operator that the late Jussi Bjoerling made him. Ezio Flagello as the assassin Sparafucile and Rosalind Elias as his daughter-accomplice Maddalena turn out thoroughly creditable performances.

As an over-all dramatic effort, this *Rigoletto* production packs plenty of punch. However, some elements of the superb facilities of RCA's studio in Rome. I have already mentioned the vocal-orchestral balance in Rigoletto's great outburst. In general the performance, both vocal and orchestral, is rather closely miked and has a very brilliant and "you-are-there" effect, but at the same time it is lacking the varied perspective that one experiences in the opera house, particularly in the kidnapping scene with its "*Zitti, zitti*" chorus, the final encounter of Rigoletto and Monterone as the latter is taken to prison, and the whole of the final act with its action in and around Sparafucile's inn. I would have liked more effective exploitation of stereo directionality and perspective—perhaps even some tasteful exaggeration on occasion. Lastly, it seems to me that the humming chorus that Verdi scored into the storm scene as wind sound-effect is much too much in the "sound picture" to achieve a properly eerie effect.

One inexcusable editorial *gaffe* in the finished recording is the first side-break, which interrupts the musical flow of the Rigoletto-Gilda duet at the point where the Duke is first heard stealing into Rigoletto's house. Surely, on the tape at least, the extra three minutes needed to conclude the scene could have been added to the first sequence.

Metropolitan Opera fans will undoubtedly enjoy this recorded performance, since it shows Merrill and Moffo to fine advantage. But we must wait for some other recorded *Rigoletto* to combine the full potentialities of stereo with the drama of Toscanini's great mono recording of the final act and the musicality of Merrill and Bjoerling in the 1957 RCA Victor recording—or of Callas and Gobbi in the 1956 Angel album. *D. H.*

© WAGNER: *Die Götterdämmerung*. Birgit Nilsson (soprano), Brünnhilde; Wolfgang Windgassen (tenor), Siegfried; Gustav Neidlinger (baritone), Alberich; Gottlob Frick (bass), Hagen; Claire Watson (soprano), Guttrune; Dietrich Fischer-Dieskau (baritone), Gunther; Christa Ludwig (mezzo-soprano), Waltraute; Lucia Popp (soprano), Woglinde; Gwyneth Jones (mezzo-soprano), Wellgunde; Maureen Guy (contralto), Flosshilde; Helen Watts (contralto), first Norn; Grace Hoffman (mezzo-soprano), second Norn; Anita Välkki (soprano), third Norn; Vienna Philharmonic Orchestra and Vienna State Opera Chorus, Georg Solti cond. LONDON LOU 90098 three reels \$36.95.

Performance: A landmark
Recording: Superior
Stereo Quality: Superior

London's recording of the final opera in the Ring cycle is nothing less than a triumph. As a technical achievement it outclasses that

(Continued on page 127)

company's previous spectacular, *Das Rheingold*, while from the standpoint of interpretation this is one of the most stunning recorded productions of an opera that one could ever imagine.

Vocally, the casting is virtually ideal. Windgassen, who sang the title role in the earlier *Siegfried* on London, is not a *Heldentenor* of the caliber of Melchior, but he is a sensitive artist. There certainly is no other *Siegfried* singing today who could turn in a better job. As for Nilsson, I don't believe she has ever sounded quite as magnificent as here—her Immolation Scene is shattering. The other principals, major and minor, are exceptional—Christa Ludwig, subtle and dramatically convincing as Waltraute, and Dietrich Fischer-Dieskau, a far more human Gunther than one ever finds in the theater, are particularly outstanding.

Solti achieves a truly heroic level of playing and of sonority. Though the orchestral sound is suitably robust, the balance between voice and instruments is seldom detrimental to the singers (certainly not when Nilsson is there to cut through the massive fabric). Solti's direction is quite magnificent—keenly dramatic but also intensely lyrical and un-faillingly sensitive to all aspects of this long and complicated score.

As far as special effects are concerned, there are some very spectacular moments: the electronic alteration of *Siegfried's* voice when he is disguised as Gunther (done through changed tape speeds and rerecording); the hazy sonics of the Norns and the addition of echo to Alberich's opening and closing words as they sift to and from Hagen's consciousness; the use of real steerhorns for Hagen's call—as Wagner intended; thunder at the commencement of the Waltraute scene; and, finally, the collapse of the Gibichung hall. None of these seem to me to be overdone, and they enhance the drama without being mere gimmicks.

Stereo placement, as well as effects of distance, both vocal and instrumental, are marvelously realized, and the overall tone of the recording is full-bodied and brilliant, with a properly wide dynamic range. Both the disc version (six records) and the tapes reproduce cleanly, although I cannot say that the reels are superior to the discs, which certainly must stand as among the best London has ever produced. London's excellent libretto is included in reduced form. I. K.

COLLECTIONS

© FOUR ITALIAN FLUTE CONCERTOS: Pergolesi (attrib.): *Concerto No. 1, in G Major*. Sammartini: *Concerto in F Major*. Tartini: *Concerto in G Major*. Vivaldi: *Concerto in A Minor (P. 77)*. Jean-Pierre Rampal (flute); Saar Radio Chamber Orchestra, Karl Ristenpart cond. EPIC EC 844 \$7.95.

Performance: **Virtuosic**
Recording: **Very good**
Stereo Quality: **Fine**

As vehicles for displaying the fabulous technical skill and adeptness at tonal shading of Jean-Pierre Rampal, France's foremost flutist, every one of these four Baroque concertos makes a solid impact. Although no one of them is an out-and-out masterpiece, all of these works are entertaining. The soloist is in wonderful form, and the accompaniments by Karl Ristenpart and a

first-class chamber orchestra (including an imaginative continuo player) are all one could desire. The recording, made originally in France by Erato, permits one to hear details, even though it is fairly reverberant. The disc version, to which I referred for purposes of comparison, was sonically quite acceptable, but without the transparency and glowing string tone that one hears on such outstanding recordings as several of Münchinger's for London. The same holds true for this tape, but here the strings and flutes possess a little more roundness than they do on the Epic disc. I. K.

© CLEVELAND ORCHESTRA: *Encore*. Rimsky-Korsakov: *Capriccio Espagnol, Op. 34*. Ravel: *Pavane for a Dead Princess*. Smetana: *Polka, Furiant, and Dance of the Comedians from The Bartered Bride*. J. Strauss, Jr.: *On the Beautiful Blue Danube*. Cleveland Orchestra, George Szell cond. EPIC EC 842 \$7.95.

Performance: **Fine Smetana and Strauss**
Recording: **Mostly good**
Stereo Quality: **Good**

The music on this tape is drawn from a variety of previously issued Szell-Cleveland Orchestra albums—a relatively recent collection of Strauss dances called "Magic Vienna," a Russian program of rather early stereo vintage, and a French-repertoire album that includes Debussy's *La Mer* and Ravel's *Daphnis and Chloë Suite No. 2*. The present collection makes for a most agreeable forty minutes of pop-concert listening. And although Dr. Szell's handling of the Rimsky-Korsakov and Ravel pieces seems a bit square compared to Bernstein's, Ansermet's, or Munch's, in the *Capriccio* his solo wind players have all their taped competition beaten hands down for sheer tonal beauty and virtuosic refinement.

When it comes to the Smetana dances and the much-abused Strauss waltz, Szell is very much in his own element, and there is no mistaking the relish with which he and his company approach this music. The Strauss, in particular, is perfection.

Despite the varied times of recording, the tape sonics are mostly very good—especially in the Smetana-Strauss sequence. D. H.

© ARTUR RUBINSTEIN: *A French Program*. Ravel: *Valses nobles et sentimentales*. *La Vallée des cloches (No. 5 of Miroirs)*. Poulenc: *Mouvement perpétuels*; *Intermezzo in A-flat*; *Intermezzo in D-flat*. Fauré: *Nocturne in A-flat, Op. 33, No. 3*. Chabrier: *Scherzo-valse (No. 10 of Dix Pièces pittoresques)*. Artur Rubinstein (piano). RCA VICTOR FTC 2188 \$8.95.

Performance: **The old master in top form**
Recording: **Excellent**
Stereo Quality: **Satisfactory**

I had reservations when I listened some time ago to Artur Rubinstein's recent disc of the Chopin waltzes, but I cannot find occasion for any when it comes to this lovely tape of French piano repertoire. The seventy-eight-year-old master has never been in better form. The glitter and elegance of Ravel, the capricious, gay, and serious Poulenc, the sparkling Chabrier, and the pensive Fauré—all emerge with utter rightness of style and with flawless beauty of tone and technique. Without question this recording is a major



**NOW YOU CAN
BUILD A TAPE
COLLECTION AT
DISC PRICES!**

**CAPITOL'S
and
ANGEL'S**

**New & Revolutionary
3 3/4 IPS
TAPES
ARE THE TALK
OF THE INDUSTRY**

See your dealer
today and choose
from nearly
100 RELEASES
of top popular
and classical artists.



addition to the still sparse taped repertoire of solo piano music.

The recorded sound is of top quality throughout. D. H.

© SUTHERLAND/HORNE/CONRAD: *The Age of Bel Canto*. Puccini: *La Buona Figliuola*; *Furia di donna*. Handel: *Atlanta*; *Cave solve*; *Samson*; *With plaintive note*; *Semle*; *Iris bance away*. Lampugnani: *Marsaspe*; *Superbo di me stesso*. Bononcini: *Astasto*; *Mio caro ben*. Arne: *Artaxerxes*; *O too lovely*. Shield: *Rosina*; *Light as thistle-down*; *When William at eve*. Mozart: *Il re pastore*; *Voi che justi*; *Magic Flute*; *O zittre nicht*; *Die Entführung aus dem Serail*; *Ich bane ganz*. Boieldieu-Gail: *Angela*; *Ma Fauchette est charmante*. Rossini: *Semiramide*; *Scrami ognor*. Auber: *La Mulette de Portici*; *Fermetes yeux*. Weber: *Der Freischütz*; *Und ob die Wolke*. Bellini: *Beatrice di Tenda*; *Angiol di pace*; *La Straniera*; *Un ritratto?*... *Veggiam*. Donizetti: *Don Pasquale*; *Torunami a dir*; *Lucrezia Borgia*; *Il segreto*. Verdi: *Attila*; *Santo di patria*... *allor che i forti corrano*. Arditi: *Boler*. Joan Sutherland (soprano); Marilyn Horne (mezzo-soprano); Richard Conrad (tenor); London Symphony Orchestra and New Symphony Orchestra of London. Richard Bonyng cond. LONDON LOK 90088 \$12.95.

Performance: Vocal spectaculars
Recording: Smooth
Stereo Quality: Effective

Joan Sutherland and her two companions present here a nicely varied assortment of operatic excerpts, for the most part arias, but including four duets and two trios, all intended to illustrate both the lyrical and the pyrotechnical aspects of bel canto. The music on this tape spans approximately a century, the earliest pieces dating from the time of Handel. Most of the works are Italian, but there are excursions into the German and French repertoires. Miss Sutherland's enunciation in the first of the Queen of the Night's arias from Mozart's *Magic Flute* and in "Und ob die Wolke" from Weber's *Der Freischütz* leaves something to be desired, nor will her performances of these two erases from my memory the pleasure of the Erna Berger and Tiana Lemnitz recordings. But Sutherland's singing, here and elsewhere, is definitely something every lover of bel canto must hear, particularly for the incredible accuracy and power of the high notes. Though some listeners may not care for the Sutherland trademarks (swooped tones and wilted phrases) to be heard in the slower and more melancholy arias, no one could fail to respond to the virtuoso work. The other two singers are equally brilliant.

The tape, which omits one item of the two-disc release (Conrad's "Ecco vident" from *The Barber of Seville*), is a very long one indeed—over 104 minutes—and is slightly smoother-sounding than the discs. The tape box includes a proportionately reduced version of the elaborate booklet that comes with the record album. I. K.

© RENATA TEBALDI: *Operatic Recital*. Verdi: *Don Carlo*; *Tu che le vanità*; *Un Ballo in Maschera*; *Ecco l'orrido campo*... *Ma dall'arido stelo dilata*; *Morrò, ma prima in grazia*; *Giulietta D'Arco*; *Oh ben s'addice*... *Sempre all'alba*. Puccini: *Turandot*; *In questa Reggia*. Ponchielli: *La Gio-*

conda; *Suicidio*. Puccini: *La Rondine*; *Sogno di Doretta*. Mascagni: *Caualleria Rusticana*; *Voi lo sapete*. Cilea: *L'Arlesiana*; *Esser madre è un inferno*. Renata Tebaldi (soprano); New Philharmonia Orchestra, Oliviero di Fabritiis cond. LONDON I.O.L. 90093 \$7.95.

Performance: Emotionally vivid
Recording: Excellent
Stereo Quality: Average

This fifty-one-minute recital, the equivalent of London OS 25912 in disc form, is an excellent sampling of Tebaldi's art, as well as of the present state of her vocal resources. With the exception of "Voi lo sapete," the soprano had not previously recorded any of the arias in this release, and there are a number of roles here—notably Turandot—that she has never done on the stage. Yet she brings to each selection an amazing degree of dramatic projection. The singing from the standpoint of emotional fervor is thrilling, although one cannot deny that the voice is not what it once was. Louder notes in the high register are a giveaway, and the velvety quality is regrettably no longer there in this range; nor does Tebaldi seem to be able to get a true *mezza voce* on her high notes until nearly the conclusion of the recital. What remains, however, is well worth having, and I must say that the quality of her tone is far more comfortable for the ear than one is liable to hear in some of the more recent Callas performances. Tebaldi is very well supported by her conductor, and London's sound, a bit smoother in the treble on tape than on disc, is first-class. Commendably, the tape box includes both texts and translations. I. K.

ENTERTAINMENT

© HARRY BELAFONTE: *Ballads, Blues and Boasters*. Harry Belafonte (vocals); Ernie Calabria and Jay Berliner (guitar); John Cartwright (bass); Percy Brice (drums); Ralph MacDonald (percussion); Paul Griffin (organ); chorus, Howard A. Roberts cond. *Tom the Bell Easy*; *Blue Willow Moan*; *Ananias*; and eight others. RCA VICTOR FTP 1288 \$6.95.

Performance: Stirring
Recording: Excellent
Stereo Quality: Topnotch

Denis Diderot, one of the Encyclopedists at the time of the French Revolution, wrote a book called (in English) *The Actor and the Art of Acting*. In it he said (long before Stanislavsky was born) that the actor who had to feel moods at the same time he was projecting them was bound to be inconsistent: brilliant on the nights he felt them, lifeless on the nights he didn't. Diderot suggested a more calculated approach: work out the performance from feelings, rehearse it, and then present that rehearsed and perfected performance. Actors who used this approach were more consistent, he said, and of course, on the nights when they felt the moods, the roof went off.

These remain important observations not just on acting but on artistic performance generally. The fact that Harry Belafonte is thoroughly rehearsed bothers folk-music purists, and they have drummed him out of the hippies' league. "Authenticity" is held in high favor even when the resulting

music is bad. I much prefer Belafonte's approach, and respect him as one of the great performing artists of our time. If you want meandering vocal solos, go elsewhere: Belafonte always knows exactly what he's doing by the time he gets in front of the recording microphone.

A fine collection by a fine performer, and the recording has clear, spacious sound. G. L.

© LEONARD BERNSTEIN: *Conducts Bernstein*. *Fancy Free Ballet*; *Three Dance Episodes from On the Town*; *Overture to Candide*; *Prelude, Fugue and Riffs*. Benny Goodman (clarinet); New York Philharmonic. Leonard Bernstein cond. COLUMBIA MQ 698 \$7.95.

Performance: Hip
Recording: Superb
Stereo Quality: Excellent

It is odd and strangely rewarding to hear both *Fancy Free* and the *On the Town* episodes after all these years, especially if they are bound up—as they are for me—with one's student days. Hearing them again in these entirely dazzling performances by their composer, Leonard Bernstein, and the New York Philharmonic, I find that they recall the not-all-that-distant day and golden age of Ballet Theatre, and an era during the Forties when American composers were being commissioned right and left to create for the ballet stage. A list of these works would be of astonishing length.

Getting back to Bernstein, *Fancy Free* is, in a way, a balletic treatment of the plot idea—i.e., sailors on leave in Manhattan—that lay behind *On the Town*, a remarkably visionary Broadway musical that was itself highly choreographic. In both scores, one is astonished anew by Bernstein's musical flair, his simple gift for writing music. They abound quite youthfully and candidly in references—is that the word I want?—to Aaron Copland. But already Bernstein's curiously personal use of jazz is in clear evidence. So, for that matter, is his strongly eclectic musical personality—if I may deal in an apparent paradox. The music, in any case, is listenable, attractive, and downright impressive for a composer who was then still in his twenties.

The overture to *Candide* is a somewhat Prokofiev-like occasional piece of considerable charm and virtuosity, and *Prelude, Fugue and Riffs* is Bernstein dealing in almost pure jazz. The latter work—like Stravinsky's *Ebony Concerto*—was commissioned for Woody Herman's dance band, and was for some reason never performed by it. It should have been, and the fact that it wasn't is Mr. Herman's loss.

The performance is obviously authentic, and brilliant too, and the recorded sound is dazzling enough to all but knock one out of one's chair. W. F.

© JOHNNY CASH: *I Walk the Line*; *Ring of Fire*. Johnny Cash (vocals); Luther Perkins (guitar); Marshall Grant (bass), others. *Ring of Fire*; *What Do I Care*; *I Walk the Line*; *Bad News*; and twenty others. COLUMBIA C2Q 703 \$11.95.

Performance: Virile
Recording: Good
Stereo Quality: Good

Johnny Cash has two immediately apparent

virtues: he is one of the few country-and-western singers with a good voice, and he is totally unsentimental. The material he writes is notably lacking in corn content, and his approach to it is the same. The quality of Cash's voice, in its middle and upper registers, is strikingly like Frank Sinatra's and his throw-away approach to lines is like Sinatra's. This kind of music isn't my groove, but I give at least a measure of respect to both material and performance here. This twin-pack tape, incidentally, contains all the material from two previously released Columbia albums.

G. L.

© NAT KING COLE: *The Nat King Cole Story*. Nat King Cole (vocals); orchestra and trio. *Straighten Up and Fly Right*; *Ballerina*; *If I May*; *Wild Is Love*; and thirty-two others. CAPITOL Y3W 1613 \$14.95.

Performance: Impeccable
Recording: The same
Stereo Quality: Good

Capitol put this package together before Nat Cole's death as a tribute to his remarkable career in American popular music. The running time of this 3 3/4-ips tape is an hour and forty-five minutes. Few singers could sustain listener interest through so long a program. Cole does—not that anyone is likely to listen to it (as I had to, for this review) all in one bash.

Cole's original trio-accompanied performances of *Straighten Up and Fly Right*, *Sweet Lorraine*, and *It's Only a Paper Moon* were re-created for the project. They're not only as good as the originals, they're better, and with the advantage of stereo recording. It is often forgotten that Cole was an important jazz pianist and a genuine influence on other pianists, including Oscar Peterson and Bill Evans. A few bars of his infectious cheerful, lyrical piano style reveal why.

Cole's selection of material over the years (*Lush Life*, *Too Young*, *Night Lights*) showed a shrewd ear for tunes that were both good and commercially exploitable. This perhaps was the explanation for his long parade of hits, starting in the mid-1940's, when he first came to prominence. But his warm, urbane, intelligent, and sensitive singing had something to do with it too. Long though the program is, this is an attractive package. The slow speed of the tape produces no distortion on my equipment, and hiss is low.

G. L.

© SAMMY DAVIS-COUNT BASIE: *Our Shining Hour*. Sammy Davis (vocals); Count Basie orchestra, Quincy Jones cond. *My Shining Hour*; *Teach Me Tonight*; *April in Paris*; and nine others. VERVE VSTC 324 \$7.95.

Performance: Bright
Recording: Good
Stereo Quality: Good

The singing voice, if exercised properly, grows stronger. But if it is exercised improperly, or excessively, it can be injured. If Sammy Davis isn't careful, he's going to ruin his. This album was recorded while the previews of *Golden Boy* were running on Broadway, and Davis was working very hard. There is a scratchiness in his vocal sound which, though not unattractive, hints of trouble. By the time of the recording of the

Golden Boy original-cast album (I imagine it was done later than this disc), the scratchiness had grown more obvious.

Davis' collaboration with the Basie band is in some ways the most successful of the several discs of this kind, made by Frank Sinatra, Tony Bennett, and others. Davis seems to fit himself better to the Basie sound than these other singers. The material is good, especially Cy Coleman and Joseph McCarthy's small masterpiece, *W'by Try to Change Me Now?* I can't understand why this tune isn't recorded more often.

One piece of material deserves discussion—*Blues for Mr. Charlie*, by Bobby Sharp, the title of which is taken from the James Baldwin play. The thesis of the song comes from the play, too: i.e., that the white man (Mr. Charlie) is rotting inside because of guilt for his sins against the Negro. This is one of Baldwin's favorite ideas. Its one flaw is that it's wrong. One of the principal factors of the racial problem is indeed that most white Americans do not feel guilty for, or even fully recognize their share of responsibility in, the mistreatment of the Negro. This white man's-guilt thesis is the wishful thinking of the Negro intellectual. Transferred into song form, in which any statement is of necessity succinct, the idea becomes downright silly. I'm not arguing that most white men aren't bastards—along with most black men, brown men, and yellow men. I am arguing that bastards never believe they're bastards, no matter how much Baldwin, Bobby Sharp, and Sammy Davis would like to think they do.

A much better statement about discrimination here is *Work Song*, which Davis sings well. Originally a jazz instrumental composition, it was given excellent lyrics by Oscar Brown, Jr. Brown's talent is a sometime thing, but in this song he hits home: his simple demonstration of how frustration leads to violence, and violence to punishment on a chain gang, makes the preaching of *Blues for Mr. Charlie* seem very shallow by comparison.

There's a track at the end of this album in which Davis converses with Basie, saying what a gas it's been to work with him, and all that. This is the second instance I've heard in which Davis has recorded his conversation. Not even Frank Sinatra ever had the gall to think he was so magical that the recordings audience wanted to hear him talking. This sort of thing is ill-advised.

Though the tone of this review may seem negative, I liked the album. I like all Davis albums. His is one of the greatest talents in show business today. But it's a talent marred by curious and surprising aesthetic follies.

G. L.

© JACK JONES: *Where Love Has Gone*. Jack Jones (vocals); orchestra, Pete King and Harry Betts cond. *Where Love Has Gone*; *Lush Life*; *The Lovelei*; *People*; and eight others. KAPP KTL 41091 \$7.95.

Performance: Stunning
Recording: Excellent
Stereo Quality: Faultless

Jack Jones is undoubtedly the best of the current younger singers, and this disc is my favorite of all he's made. Jones has a superbly controlled voice with a rich personal quality and a consistency through all its registers.

(Continued on page 130)

NOTICE

TO STEREO & HI-FI BUYERS

BEFORE YOU BUY GET A RABSONS QUOTE... YOU'LL BE GLAD YOU DID!

At Rabsons Competitive Prices, Reliability and Personal Service have been bywords for over 60 years

It's so EASY and SAFE to deal with Rabsons

- Up to 36 months to pay on Easy Pay Plan • Centrally located—as close as your telephone —as near as your mail box • Free Mail Order-Hi Fi Clinic Service • Fast Air Mail Response on Quotation Requests • Franchised Distributor for Hi Fi Lines • 60 Years of business "Know How" to serve you better • Shipments DOUBLE PACKED and FULLY INSURED • "Attractive" Prices • Warehouse on premises • Fast Delivery—Large inventory permits processing and shipment promptly • All merchandise brand new in factory sealed cartons • Save even more on complete system quotes • Export Packing—220 Volts 50 Cycle merchandise a specialty • Free list of monthly specials.

Free RECORD CLOTH (\$1 Value) with every quote

OVER 60 YEARS OF RELIABILITY

RABSONS

57 ST. INC.
119 West 57th Street, New York, N. Y. 10019
Tel. Area Code 212-247-0070

CIRCLE NO. 30 ON READER SERVICE CARD

REVERE/WOLLENSAK

Tape Recorders

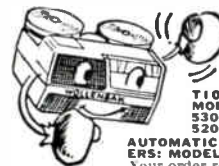

deliver a wallop bigger than many twice their size.

WE HAVE THE MOST COMPLETE SELECTION ANYWHERE. NEW MODELS INCLUDE 1980, 5300, 1288, 5280, 5250, 5200, 1500, 5150.

AUTOMATIC CARTRIDGE RECORDERS: MODELS 7200, 7100 and 7000. Your order receives our prompt attention. FANTASTIC PRICES for name brand and special purpose magnetic tapes!

REQUEST FREE TAPE RECORDER DISCOUNT SHEET



SAVE!
All Steel
CARRYING CASE

4.98
postage prepaid

- Holds 14 tapes (7") in boxes, or 120 records (45's)
- Full length piano-type hinge with 90° stop
- Rustproof bronze finish

SAVE 30-60%

4-track stereo music on tape
Request Free 60-Page Stereo Catalog

SAXITONE RECORDING TAPE

275' Plastic, 3-inch reel	.35
600' acetate (plastic), 5 inch	.70
600' MYLAR 5-inch reel	.75
900' MYLAR (Polyester), 5 inch	.89
1200' MYLAR, 1/2 mil. 5-inch reel	1.18
1200' acetate (plastic), 7 inch	.99
1200' MYLAR, 1/2 mil. (strong)	.98
1200' MYLAR 1/2 mil. tensilized, 5"	1.59
1800' acetate (plastic), 7 inch	1.19
1800' MYLAR, 1 mil. thick, 7 inch	1.59
2400' MYLAR, untensilized, 7 inch	1.99
2400' MYLAR, tensilized, 7 inch	2.79
3600' MYLAR, tensilized, 7 inch	3.89
Revere M-2 blank cartridge tapes	2.85

30% off Revere automatic music tapes
Tape prices plus postage
Greater discounts to quantity buyers

SAXITONE

div. Commission
Electronics, Inc.
1776 Columbia Rd. N.W.
Washington 9, D.C.

CIRCLE NO. 33 ON READER SERVICE CARD

His work is full of engaging nuances, subtle touches in the interpretation of both music and lyrics. I'm told he once was a hippie jazz singer, one of those people with phenomenal musical skill and an even more phenomenal ability to bore audiences. There is evidence of that background in this album, particularly in the departures he sings on *Willow Weep for Me*. But now the skill is under control, and it is anything but boring. Jazz inflections are used now to add color, rather than to distort the character of the tune.

I've noticed something interesting about people's responses to the song *People*: that curious little paean to neurotic dependency; it is usually detested by those of strongly independent character and loved passionately by those afflicted with the masochistically romantic belief that personal happiness lies in someone else's largesse. So much for amateur psychologizing. But Jones sings the hell out of it. His performances of the Burke-Van Heusen *Here's That Rainy Day*, an oddly ersatz tune that nonetheless comes off, and the Cahn-Styne *Guess I'll Hang My Tears Out to Dry*, are the best I've ever heard by anybody. Sinatra not excepted. Incidentally, have you ever paid close attention to the verse of the latter, with its subtle reference to the Statue of Liberty? "The torch I carry is handsome./It's worth its headache in ransom./And when the twilight steals,/I know how the lady in the harbor feels." Now there's a lyric!

Harry Betts and Pete King wrote the charts. All are excellent, but King, whose work I admire more and more, has the edge. The recorded sound is superb. G. L.

© PEGGY LEE: *Mink Jazz* and *I'm a Woman*. Peggy Lee (vocals); orchestra. *It's a Big Wide Wonderful World*; *Whisper Not*; *I'm Walkin'*; *I'll Get By*; and twenty others. CAPITOL Y2T 2237 \$9.98.

Performance: Sensitive
Recording: Very good
Stereo Quality: Good

Twenty-four songs are packed into this 3¾-ips package, drawn from two disc albums. The first, *Mink Jazz*, is the better, mostly because the general quality of the songs on it is superior to that of the second, *I'm a Woman*. The latter finds Miss Lee in her "put-on" frame of mind in several tunes, and although she is effective with humor, it is her sensitive side that makes me so ardent a fan of hers. She's a great singer, and among women no one else can get the meaning out of lyrics the way she can. G. L.

© HENRY MANCINI: *Dear Heart and Other Songs About Love*. Orchestra and chorus, Henry Mancini cond. *Dear Heart*; *Mr. Lucky*; *How Soon*; and nine others. RCA VICTOR FTP 1292 \$7.95.

Performance: Polished
Recording: Very good
Stereo Quality: Likewise

Forthrightly commercial, this album features a good-sized chorus doing tunes by Mancini and others. For what it is, it is very good. For my taste, however, it's too far over into mushy territory. The best track is *Soldier in the Rain*, one of Mancini's exquisite film themes. A haunting piano passage (probably played by Jimmy Rowles) opens it; strings join in, then voices singing wordlessly. It's a weirdly lovely and somewhat disturbing

track that is more typical of Mancini than anything else of his in the album. G. L.

© ROGER MILLER: *The Return of Roger Miller*. Roger Miller (vocals and guitar), plus rhythm section. *Atta Boy Girl*; *Love Is Not For Me*; *In the Summertime*; and ten others. SMASH STC 67061 \$7.95.

Performance: Original
Recording: Very good
Stereo Quality: Brisk

The restoration of American popular music to its former standards of excellence will not come about through the elimination of rock-and-roll and country-and-western music and similar trash. It will come about through their improvement. The process, fortunately, is already under way. The Beatles and Petula Clark (both English, but workers in an American tradition) are cases in point. Johnny Cash is another.

But the most interesting example of the evolution of country-and-western into something that actually can be called music is provided by Roger Miller. Miller's *King of the Road* (which is contained in this album) and *Dang Me* (which isn't) have been big hits. He is a brilliant songwriter whose lyrics have some of the same kind of sane insanity that Victor Borge's comedy does.

Though he works in a cracker accent, both the songs Miller writes and the way he sings them are deeply sophisticated. Under his humor, there's an odd corner-of-the-eye perceptiveness. Though I doubt that he intended it to be, his *You Can't Roller Skate in a Buffalo Herd* is a wonderful put-on and put-down of those idiotic you-can-be-happy-no-matter-how-gray-the-skies songs that Walt Disney uses to marshmallow up his movies.

Miller does curious and interesting things with the English language. *Atta Boy Girl* is an example: the very title is funny. But a gem is this line: "Fall yourself in love and get your teeth kicked in." By turning "fall" into a transitive verb (or more precisely, a reflexive) he gets a really fresh effect.

Miller's singing cracks me up as much as his songs do. He has a hilarious trick of singing "scat" breaks, providing with his guitar parallel lines in sixths, fifths, or thirds. The breaks always end up on some note of wild musical irrelevancy, and they always have a lopsided quality. This is pure clowning, and it's delightful.

Roger Miller is a wonderfully fresh voice in American light music, one that shouldn't be dismissed as another commercial phenomenon set up by the record industry purely for profit. He has something to say, and this album is a good place to start hearing him say it. G. L.

© CARLOS MONTOYA: *Adventures in Flamenco*. *Ritmos Gitanos*; *Caribe Alamecno*; *Toque Musciano*; *Recuerdos de la Sierra*; *Albaicin Flamenco*; *Compás Trianero*; *Variaciones*; *Aires de Santa Maria*. Carlos Montoya (guitar). ABC-PARAMOUNT ABCT 1002 \$6.98.

Performance: Exciting
Recording: Superior
Stereo Quality: Good

This is a recital of flamenco that deserves the attention of anyone interested in this fascinating art. According to ABC-Paramount's promotional copy, Carlos Montoya recorded

these pieces in only one hour and forty minutes, and without preparation. Improvisation, of course, is the very essence of flamenco, but seldom do performers avoid falling back on the clichés of their craft. It is greatly to Montoya's credit that he never seems to resort to stock formulas. Furthermore, his playing, in comparison with the many other brilliant flamenco guitarists on hand today, is breathtaking in its virtuosity. Above and beyond his technical feat, there is the excellence of his compositions, which are thoroughly atmospheric and marvelously gauged to produce mounting tension and climaxes. The recorded sound is enormously effective, albeit high-level (a volume cut is advisable). In playing time—just over thirty-two minutes—this tape is meager, but considering that the contents are flamenco at its very best, one can easily overlook the program's brevity. I. K.

© NINA SIMONE: *In Concert*. Nina Simone (vocals and piano); rhythm section. *Don't Smoke in Bed*; *Mississippi Goddam*; *Go Limp*; and three others. PHILIPS C 600135 \$7.95.

Performance: Biting
Recording: Good
Stereo Quality: Good

It is clear that Nina Simone is full of hate. As if it were not evident in her behavior before audiences, she tells you straight out that she hates your guts because you're white in two songs on this tape. One is Kurt Weill's *Pirate Jenny*, the other *Mississippi Goddam*, a song Miss Simone wrote.

There is a great deal of hate in contemporary American popular folk music and jazz. Most of it is tedious. When I hear a tenor player stand up and scream through his horn for twenty-five minutes that I'm a no-good ofay s.o.b. (actually, the implications of the music are much stronger), I don't get mad or resentful, I just get bored. Hate is the poorest possible raw material for art. The hard-bop movement in jazz was so loaded with hate, and audiences got so bored with being hated, that hard-bop musicians have almost put themselves out of business.

Nina Simone's hatred, however, is curiously exciting theater. Compared with her *Mississippi Goddam*, the protest songs of white "folkie" singers seem like the liberal posings of affected schoolboys. Miss Simone alters *Pirate Jenny* subtly to make it a statement of Negro resentment. She says straight-out who it is she lusts to see dead. When the black pirate ship lands, she tells us, she's going to demand some deaths *right now*. I'm quite sure this is not merely a performance—Miss Simone means every word.

Why doesn't she alienate me, or the audience before whom this recording was made? The answer is effective casting. If you have a play that calls for a horse in one scene, you can of course put two men in a costume—the effect will be like that of Bob Dylan protesting segregation. You're far better off if you cast a real horse in the part, and Nina Simone singing *Pirate Jenny* is just such casting. In *Mississippi Goddam*, Miss Simone tells you that this country is full of lies—a point no sane person can dispute—and that she has no use for you. The title of the song is itself classic. She says she knows about Alabama and Tennessee and all their evils, "But Mississippi? Goddam!"

Songs of hate Miss Simone sings superbly here. Songs of love are no longer her cup of tea. Her *I Loves You, Porgy* is not as good as her 1959 recording of the tune, and her slow, slow reading of Willard Robinson's wonderful *Don't Smoke in Bed*—five minutes, thirty seconds for just one chorus—is ponderously dull. I've never liked Miss Simone's piano playing, and I don't like it here. It is pretentious and, oddly, quite lacking in the jazz feeling one hears in her voice.

This is a unique and electrifyingly powerful tape. G. L.

© FRANK SINATRA: *Point of No Return; Sinatra Sings of Love and Things*. Frank Sinatra (vocals); orchestra, Axel Stordahl and unidentified cond. *When the World Was Young; I'll See You Again; The Nearness of You*; and twenty one others. CAPITOL Y2W 2254 \$9.95.

Performance: Mostly
Recording: Good
Stereo Quality: Good

This 3¾-ips package contains two albums of vintage Sinatra from his years with Capitol. It becomes increasingly apparent that Sinatra's classic discs date from that period, during which he set standards of excellence that will permanently affect American light music. Nothing he has done with Reprise, the label he founded a few years ago, matches the quality of the best Capitol recordings. I think that, oddly enough, the very first disc he did for Capitol—the ten-incher called "Songs for Young Lovers," which dates from the period of his Great Comeback—remains one of the best of all popular recordings.

There are even better albums than these two in the Capitol catalog, but these are nonetheless exceptionally good. Sinatra's readings of *When the World Was Young; I'll Remember April*, and *September Song* are unlikely to be surpassed soon. G. L.

© PAUL WESTON: *Leisure Listening*. Orchestra. Paul Weston cond. *Easy Come, Easy Go; Laura; April in Paris; Time on My Hands*, and forty-four others. CAPITOL Y4T 2201 \$19.95.

Performance: Excellent
Recording: Standard-setting
Stereo Quality: Superb

Musicians and arrangers say that of all the world's major recording centers, the worst place to record, from an engineering standpoint, is New York City. Though New York has some exceptional engineers, too many of the rest are primitive in their techniques and musical perceptions. Some are just lazy. A better standard of recording obtains in London. Los Angeles engineers knock spots off the New York boys as a rule—because. I'm told, Hollywood's engineers were trained in the movie industry. But New York engineers are oriented to recording television-commercial jingles which will be heard through a three-inch speaker. They just don't care.

Five years ago the finest recordings in the world, in my opinion, were coming out of Capitol's Hollywood studios. This company issued a fine series of Paul Weston mood-music discs, and I used to use them to show off my stereo equipment. The presence was striking, the stereo spread beautiful. The orchestra was almost palpably present in

my living room, and there was no hole in the sound.

I no longer have those recordings, so when I picked up this tape, which is a re-issue of four of those discs, I almost ran home in my eagerness to hear it. The sound was as I remembered it, and as a result, I am a little less impressed by London's Phase 4 Stereo than I was before. Phase 4 seems only to have gotten recording back up to the standard set in Hollywood by Capitol several years ago.

Musically, this tape package is pleasant. Weston's scoring is a little old-hat—standard sax, brass, and rhythm sections of the dance-band era, with flutes occasionally added, and a string section. Weston orchestrates almost strictly according to choir divisions, and the rhythm section rarely plays anything more complex than a four-four ballad or dance tempo, and occasionally a hip businessman's bounce. But he writes well. His voice-leading indicates he is a craftsman of a high order. His scores are quite pretty, he can make brass or strings sing when he wants to, and he has the sense to use good jazzmen as soloists (the tenor player sounds like Eddie Miller). Though its contents are bland and of no particular musical significance, I don't care—I like this tape as well as I did the original albums.

At 3¾ ips, we get two hours and twenty-three minutes of mood music, and that's a lot. So the tape is best suited as a background for cocktail parties, teen-age telephone conversations, seductions, and similar *adagio* activities—and, of course, for showing off your stereo equipment. G. L.

JAZZ

© JOE PASS: *For Django*. Joe Pass (guitar), John Pisano (guitar), Jim Hughart (bass), Colin Bailey (drums). *Rosetta; Night and Day; Insensiblement*; and seven others. WORLD PACIFIC WPTC 1022 \$7.95.

Performance: Skilled
Recording: Very good
Stereo Quality: Good

Guitarists tend to be clannish, probably because their instrument has quirks only another guitarist can understand. They also like to play in duo—the combination of two guitars is found in a great variety of musical styles. Django Reinhardt, one of the instrument's most famous jazz exponents, made use of another guitarist in the rhythm section for some of his records. In this album, a tribute to Reinhardt, Joe Pass uses guitarist John Pisano in the rhythm section, in the function that would ordinarily be assigned to a pianist. The combination is effective, and the resulting album contains music of a light texture and an intimate mood.

All the tunes are associated with Reinhardt or, like John Lewis' *Django*, and Pass's own *For Django*, were written in his memory. Three are by Reinhardt—*Fleur d'annui; Catalerie*, and the exquisite *Ma noir de mes rêves*, coarsely titled *Django's Castle* here.

Pass is a technically facile, emotionally warm player with a round tone that is far removed from Reinhardt's thin, tinny, but extraordinarily compelling sound. Yet he is indebted to Reinhardt, as is virtually every jazz guitarist of the last twenty-five years.

This is a very good jazz guitar album, and it wears well through repeated listenings. I suspect it will be particularly attractive to

SAVE over 40% on hi-fi

COMPONENTS & TAPE RECORDERS

- Easy-Pay-Plan—Up to 24 mos. to pay
- 15 day money-back guarantee.
- Franchised all lines, assuring you up to 5 yr. Mfr. Warranty.
- Most items shipped promptly from our \$250,000 inventory.
- Trade-Ins—Highest allow.—Send your list.
- Shipments double packed & fully insured.
- Our Specialty—Export & APO inquiries.
- 21st yr. dependable service—World Wide. Write for our price first. You'll be glad you did.

We own the sharpest pencils in the U.S.A.

PREMIUM RECORDING TAPE GUARANTEED TOP QUALITY

Type	Brand	3-11 12+
166	3M 7" 1200' Acetate	Ea. 1.19 1.09
167	3M 7" 1800' Acetate	Ea. 1.39 1.29
911-15	Ampex 7" 1200' Acetate	Ea. 1.59 1.49
941-15	Ampex 7" 1800' Mylar	Ea. 2.69 2.59
951-15	Ampex 7" 2400' Ten. Mylar	Ea. 4.39 4.09

Minimum Order \$10.00. All prices include shipping USA, APO. Any assortment permitted for best price. 100+ reels deduct additional 5%. Please write for types not listed.



1797-T 1st Ave.

New York, N. Y. • 10028

CIRCLE NO. 18 ON READER SERVICE CARD

Olson



Fill in coupon for a FREE One Year Subscription to OLSON ELECTRONICS' Fantastic Value Packed Catalog—Unheard of LOW, LOW PRICES on Brand Name Speakers, Changers, Tubes, Tools, Stereo Amps, Tuners, CB, Hi-Fi's, and thousands of other Electronic Values. Credit plan available.

NAME _____
ADDRESS _____
CITY _____ ZONE _____ STATE _____

If you have a friend interested in electronics send his name and address for a FREE subscription also.

OLSON ELECTRONICS, INC.

415 S. Forge Street Akron, Ohio 44308

CIRCLE NO. 29 ON READER SERVICE CARD

those who "sort of" like jazz. Though the sound is good, the hiss level of the tape is high. G. L.

© OSCAR PETERSON TRIO: *Plus One*. Oscar Peterson (piano), Ray Brown (bass), Edmond Thigpen (drums), Clark Terry (trumpet and fluegelhorn). *Brotherhood of Man; Jim; Mumbles*; and seven others. MERCURY STC 60975 \$7.95.

Performance: Bright
Recording: Very good
Stereo Quality: Very good

Often a jazz group makes its best recordings when an outsider is added to it as guest soloist. One of the best Oscar Peterson Trio albums, to my mind, is one made for Verve with vibraharpist Milt Jackson. This present tape holds another, with Clark Terry as the "plus one."

Terry is the favorite trumpeter of many musicians. His sly wit, his humor, and his lyricism, all expressed with great technical polish, make him one of the most consistently interesting of jazz players. Obviously Peterson, Brown, and Thigpen enjoyed making this album with Terry, and they—and Terry as well—were in excellent form.

In nightclubs Terry sometimes responds to the cry of friends to "sing the dirty blues, CT!" The "dirty blues" consists of ruminations over the advice grandfather gave him about dealing with women and such. The listener is led to expect some outrageously dirty line, at which point Terry lapses into a mumble that sounds as if he is singing something shocking.

For this album with Peterson, Terry recorded two vocal tracks—both of them utterly unintelligible. One is titled *Incoherent Blues*; the other, *Mumbles*, has already become a hit single. *Mumbles* is one of the funniest things ever to come out of jazz—it shows CT as music's answer to double-talk specialist Al Kelly.

But the humor should not overshadow the music. There are fine musical tracks on this tape, both ballads and swingers, and excellent solos from Terry and Peterson. Too, Brown and Thigpen remain the most propulsive rhythm section to be found in any permanent jazz group. G. L.

© CLARK TERRY: *The Happy Horns of Clark Terry*. Clark Terry (trumpet and fluegelhorn), Phil Woods (alto saxophone and clarinet), Ben Webster (tenor saxophone), Roger Kellaway (piano), Milton Hinton (bass), Walter Perkins (drums). *Rockin' in Rhythm; In a Mist; Perdido*; and nine others. IMPULSE ITC 312 \$7.98.

Performance: Very musical
Recording: Good
Stereo Quality: Good

There's a pretty good case for the opinion, fairly widely held, that Clark Terry has become our best all-around trumpeter. Not that versatility is everything, of course, but Terry has attributes of flexibility that have gone unpraised (except among trumpet players) for far too long. Once I was listening to him in a nightclub with a trumpeter friend who at a certain moment said, "Did you hear that little figure he was just playing? That's a flute figure. It's ridiculously difficult on trumpet, and he played it like the horn was built for it."

And when Terry turns to the fluegelhorn, he plays it on its own terms, making the instrument speak in the warm and vital voice that is its unique characteristic. On fluegelhorn or trumpet, he displays uncanny control of tone, subtly and precisely suiting it to the shape of each phrase.

But Terry isn't merely a flashy technician. His always-melodic playing is warm and humorous—sardonic one moment, gently whimsical the next, and perhaps slapstick a few measures later. Sometimes it is quite pretty and unostentatiously sad. And he swings.

This album presents Terry in an interesting setting of Ellington-derived material. Though improvised choruses are its attraction, this isn't one of those disorganized and interminable "blowing" dates. Someone has written ensemble frameworks that give each number order and shape; unapardonably, no arranger credit is given. Terry's colleagues on the horns—Ben Webster and Phil Woods—are powerful swingers themselves. Woods, known for his fiercely hot alto playing, is heard in some lovely, liquid clarinet work. And Roger Kellaway, one of the best of the post-Bill Evans jazz pianists, acquires himself well in this senior company. Given that the rhythm section is good, how could this be anything but a great album? G. L.

© CAL TJADER: *Soul Sauce*. Cal Tjader (vibraharp), Lonnie Hewitt (piano), John Hilliard (bass), Johnny Rae (drums), Armando Perez and Alberto Valdes (Latin percussion). *Afro-Blue; Pantano; Spring Is Here*; and six others. VERVE VSTC 326 \$7.98.

Performance: Expert
Recording: Excellent
Stereo Quality: Excellent

Although the album's title suggests an adventure in neo-funk, this is a Latin collection and a good one. Tjader can take on this kind of job as well as jazz engagements, and thus has managed to keep his group working when others wither on the vine. But it is not simply money that has put Tjader on this road—his fascination with Latin rhythms is an honest one. He hires good Latin percussionists and has become quite adept at working in (or over, if you prefer) the rhythms they set up. And since he is a tasteful musician, he doesn't fall into monotony.

In *Afro-Blue*, Tjader uses an expanded ensemble that includes trumpeter Donald Byrd, playing with that beautiful, soaring "legit" tone of his; tenor saxophonist Jimmy Heath; and guitarist Kenny Burrell. With Gary McFarland's simple but effective arrangement, this is (for my taste at least) the most interesting track of the album.

The general presentation—with the silly album title and rather garish cover—is misleading. It may increase sales among those buyers who think gold thread is the last word in chic, but it might lose them among those who know better. G. L.

THEATER

© MY FAIR LADY (Alan Jay Lerner-Frederick Loewe). Original movie sound-track recording. Rex Harrison. Audrey Hepburn. Stanley Holloway (vocals); orchestra and chorus. André Previn cond. *Why Can't the English; The Rain in Spain; You Did It;*

and eleven others. COLUMBIA CQ 664 \$7.95.

Performance: Soggy
Recording: A little thin
Stereo Quality: Okay

© ANDRÉ PREVIN: *My Fair Lady*. André Previn (piano), Herb Ellis (guitar), Frank Capp (drums), Red Mitchell (bass). *You Did It; The Rain in Spain; Get Me to the Church on Time*; and seven others. COLUMBIA CQ 705 \$7.95.

Performance: Very good
Recording: Excellent
Stereo Quality: Good

Some weeks ago, I was awakened about eleven a.m. by the telephone. (Normally I get up at the crack of noon, whether I have to or not. It's a discipline.) On the other end of the line was the editor of this magazine. He said, "Do you like the *My Fair Lady* score?"

"Well—yes," I said, a little suspicious, my jungle Jim reflexes having responded instantly to the hidden menace in his amiable voice.

"Well, you're going to hate it when we get through with you," he said. He explained that because the movie version of the show was coming out, I was about to be inundated with *My Fair Lady* albums.

In the ordeal that followed, I listened again to the original-cast album, then to the later stereo original-cast album, which was a bit different from the first. I listened to the movie sound-track album. I listened to the version by Nat Cole (far and away the best album of the score done by a single artist), and to André Previn's instrumental Columbia disc. (I wasn't asked to dig out Previn's *My Fair Lady* album for Contemporary, thank God, though it was the disc that started all the jazz versions of shows.) I listened to the recordings of the score in Spanish, which I understand, and in Hebrew, which I don't. To paraphrase that sensitive old English folk song, *One-Eyed Reilly*, "I listened to it standing, I listened to it lying, and if I'd had wings, I'd a' listened to it flying." And now come the tape versions.

As I said in the review that resulted from those earlier disc versions (December 1964), forget the movie album. The stage versions (the first original-cast and the later original-cast discs, both with Rex Harrison, Julie Andrews, and Stanley Holloway) are far better than the sound-track effort. I said the sound was rotten in the last-mentioned—distinctly low-fi. On tape it is a little better, but still somewhat thin. Somebody goofed.

I said too, in another review (January 1965), that André Previn's was a very good instrumental reading of the score. It still is, and the sound is very good on tape too.

And now—spare me any more MFL recordings, please! G. L.

© BEN FRANKLIN IN PARIS (Mark Sandrich Jr.—Sidney Michaels). Original-cast recording. Robert Preston, Ulla Sallert, others (vocals); orchestra and chorus. *Hic Haec Hoc; I Invented Myself; God Bless the Human Elbow*; and eleven others. CAPITOL ZO 2191 \$8.98.

Performance: Coptivoting
Recording: Excellent
Stereo Quality: Very good

As it is no doubt unnecessary to point out,

this show concerns Benjamin Franklin's trip to Paris to enlist support for the fledgling United States of America, and his embroilment there in a love affair. (In real life, there were a number of such affairs, but the show compresses them all into one.) The music's main purpose is to evoke a period, and Mark Sandrich's songs do this quite well without resorting to the musical vocabulary of the time. Sidney Michaels' lyrics have a happy wit about them, and Philip J. Lang's arrangements are skillful and appropriate.

The mood of the album is laughing and frothy. Robert Preston, who bears the burden of singing the majority of the songs, is quite captivating—and so is the entire package. It holds up well under repeated listenings, too. G. L.

© **GOLDEN BOY** (Charles Strouse-Lee Adams). Original-cast recording. Sammy Davis, Billy Daniels, Paula Wayne, others (vocals); orchestra and chorus; Elliot Lawrence, musical director. *Workout; Night Song; Everything's Great*; and eleven others. CAPITOL ZO 2124 \$8.98.

Performance: Exciting
Recording: Good
Stereo Quality: Unsatisfactory

The more I listen to this score, the more I like it. I'm told the show's weakness lies in the book. I can't say, not having seen it. But there is nothing wrong with the score by itself. I liked Charles Strouse's music on the first hearing, and though I had reservations about Lee Adams' lyrics at first, I'm losing them.

Mr. Adams, I realize now, is in revolt against the prosaic standard of American lyric-writing in recent years. He has recognized that the theater and the song are conventions, and so he has not required his characters to sing in "naturalistic" language. He permits them some poetic fancy, though at the same time he nicely evokes in language the style of New York's streets. The slang of jazz, essentially Negro slang, is something I've become familiar with through long association with musicians, both Negro and white. The use most writers make of it—particularly the "beat" novelists—embarrasses me. Adams has judiciously inserted this argot into his lyrics. His sense of its meaning, its cadences, and its intonation make it work in this music.

Sammy Davis and Billy Daniels make up the backbone of the show. They sing superbly here, even though Davis has a rasp in his voice that suggests he was tired on the days the album was recorded. I like Paula Wayne's singing, too. The show's story of a Negro youth who deadens his sensitivities in order to succeed as a prize-fighter comes across quite well simply through these songs.

The recorded sound is good, but I found the stereo quality a little weird. The music is piled into one channel, as if it were on one side of the stage. I thought there was something wrong with my equipment until, during one tune, Davis moved across to the other channel. I have no idea why the tape was made this way, but the effect is annoying. G. L.

© **I HAD A BALL** (Jack Lawrence-Stan Freeman). Buddy Hackett, Richard Kiley, Karen Morrow, Steve Roland (vocals); orchestra and chorus. Pembroke Daventon cond. *The Other Half of Me; Addie's*

At It Again; I Had a Ball; and eleven others. MERCURY STA 6210 \$8.95.

Performance: Highly polished
Recording: Superior
Stereo Quality: Rich and clear

Jack Lawrence and Stan Freeman, who collaborated on both the music and lyrics of *I Had a Ball*, are well aware of what's wrong with most Broadway musicals. They are quoted in the liner notes: "When we started to write this score, we were determined that it was going to be melodic. That is, every song, if possible, has to be able to stand on its own so that people could walk out of the theater and remember them [sic]."

But knowing what's wrong with Broadway musicals and being able to do something about it are two different things, and Lawrence and Freeman have failed to achieve their goal. Their work is highly professional, but not one of their songs has individuality, not one makes you think. "Ah, there's a charming idea." The comedy songs are better than the ballads, but comedy songs don't have to be particularly tuneful. The patter song *Dr. Freud*, sung by Buddy Hackett, is perhaps the best number in the show. This figure, Freeman is an expert writer of "special material"—those clever songs designed for and best understood by the audiences of chic little East Side New York night spots. Given the broader range of demands of the musical, he apparently can't come up with what's needed, even with the collaboration of veteran Jack Lawrence.

As in *Baker Street*, the performances save the day. Richard Kiley has in recent years become a truly superb singer of show material. His voice is big and virile, and he projects well, yet he doesn't have the stiffness of so many Broadway singers. Hackett is delightful; it is unfortunate that he gets only one full-scale song. Had there been more for him to do musically (he has a lot to say in the show, but it isn't heard here), this would have been a more interesting album. Karen Morrow's voice is all Broadway and a yard wide, and that is not meant as a compliment. She sounds like a junior-grade Ethel Merman, all brass, bellow, and blow. In her ballad numbers she has a more attractive vocal quality, but its appeal may lie in the relief it offers from her other voice.

Philip J. Lang's orchestrations are, as always, models of functional craft and taste. Where he has to, he writes for the strings to follow the voice in unison. (When you hear the orchestra playing the melody behind the singer, that's because the singer can't carry a tune in a bucket and has to have help.) Lang does this for Buddy Hackett, whom we do not, of course, expect to be a singer. At such times, his scoring sounds as routine as most of what has been written for Broadway in recent years. But when he's writing for Kiley, who obviously knows what he's doing, Lang indulges the full range of his taste and skill.

The sound was handled by Phil Ramone, one of the few recording engineers with ears in New York City. A former violinist, Ramone is an immensely musical man, and he's done a striking job of molding a broad, many-voiced score into a coherent recorded whole without losing the details. G. L.

© **THE THREEPENNY OPERA** (Kurt Weill, Bertolt Brecht, and Marc Blitzstein). Sound-track recording. Sammy Davis,

First Time Ever Published

SKIING INTERNATIONAL YEARBOOK 1966



The 1966 SKIING International Yearbook

... a luxuriously illustrated compendium of 1965's important events... a timely forecast of the excitement-packed 1966 season—by the editors of SKIING MAGAZINE. **only \$1.25**

The 166-page Charter Edition of the SKIING International Yearbook is a collector's item that will be relished by every serious skier.

Far more than just a major artistic endeavor (although there are numerous original drawings, dramatic photographs, striking full-color pages and specially designed type, which make for extremely pleasing composition)—the 1966 SKIING International Yearbook enables you to relive the best moments of the past season and to glimpse into the dynamic year of skiing just ahead. For example—

complete reviews of the major European and American Alpine events—pro racing—Nordic events—season's records, U.S. and abroad—plus—

EQUIPMENT: A complete guide, prices and brands!

TECHNIQUE: comparison of the major ski systems.

TRAVEL: complete Guide To Skiing in North America... what the new European season holds in store!

PLUS: "Equipment & The History of Skiing"—illustrated with original art and way-back-when photos.



DeLuxe Gold-Embossed
Leatherflex-bound Charter Edition
... just \$3 postpaid!

A handsome, permanent edition of this brand new yearbook, mailed postpaid!

To order the regular or DeLuxe edition, complete this coupon and mail it today!

ZIFF-DAVIS SERVICE DIVISION • Dept. SIY
589 Broadway • New York, N.Y. 10012

Send me a copy of the 1966 SKIING International Yearbook, as checked below:

\$1.25 enclosed, plus 15c for shipping and handling. Send me the regular edition. (\$1.50 for orders outside the U.S.A.)

\$3.00 enclosed. Send me the DeLuxe Leatherflex-bound edition, postpaid. (\$3.75 for orders outside the U.S.A.) Allow three additional weeks for delivery.

name _____ please print _____ TRA-66

address _____

city _____ state _____ zip code _____

PAYMENT MUST BE ENCLOSED WITH ORDER.

1966 TAPE RECORDER ANNUAL CLASSIFIED

TAPE AND RECORDERS

TENSILIZED MYLAR TAPES. 2400' \$2.59; 3600' \$3.79; 300' 59¢; 600' 99¢. Stereo Music Tapes \$2.95. Add postage: 10¢ a reel. Towers, Lafayette Hill, Pa. 19444.

TAPE RECORDER SALE. Brand new, latest models, \$10.00 above cost. Arkay Sales, 1028-T Commonwealth Ave., Boston, Mass. 02215.

TAPE-MATES makes available to you—ALL 4 Track Stereo Tapes—ALL labels—at TREMENDOUS SAVINGS—also 3 HOUR Long-Play Stereo tape albums—CLASSICAL—POP—JAZZ—DANCE and VARIETY—Top recording artists—ONLY \$9.95 plus a complete CAR-STEREO music library and player—all POSTAGE-FREE to your door—FREE Tape-Mates Membership with initial order—for FREE BROCHURE write TAPE-MATES, 5280 W. Pico Blvd., Los Angeles, Calif. 90019.

AMPEX and 3M recorders, and Ampex recording tape discounted. Collegetown Audio, Box 342, Columbia, Mo. 65202.

SHARE Tape Collection 20s—30s Pops Originals. State Interest. 6-Selection Sampler \$1.00. 2 Tracks, 3 3/4". Doug Martin, 396 Toler, San Leandro, Calif. 94577.

WE buy used tape. We dupe tape perfectly \$2. up; we put records on tape \$1 up; we record and distribute evangelistic sermons \$3.50. Student Aid Recordings; Oakwood College, Huntsville, Alabama.

EQUIPMENT

McGEE Radio Company, Big 1966 Catalog sent Free. America's Best Values. HiFi-Amplifiers—Speakers—Electronic Parts. Send Name, Address and Zip Code Number to McGee Radio Company, 1901 McGee Street, Dept. TRA, Kansas City, Mo. 64108.

COMPONENT quotations—tapes Mylar 1800' \$1.49. Bayla, Box 131T, Wantagh, N.Y.

NEW! EXCLUSIVE! Automatic shutoff controls, tape lifters (head savers), large reel adapters, etc. Free details. Leroi Electronics, Marengo, Ill. 60152.

RECORDS

RENT Stereo LP's. Record Those Tapes Yourself. Details—Varmint Distributing, Silvis, Ill. 61282.

FOR SALE

METERS—Surplus, new, used, panel and portable. Send for list. Hanchett, Box 1898, Riverside, Calif.

MISCELLANEOUS

FREE wine recipes and home brewing supplies catalog. COUNTRY WINEMAKER, Box 243TR, Lexington, Mass.

LEARN WHILE ASLEEP, hypnotize with your recorder or amazing Electronic Educator endless tape recorder. Details, gigantic tape, equipment, recorder catalog FREE! Sleep-Learning Association, Box 24-TS, Olympia, Wash.

IF YOU OFFER SPECIALIZED PRODUCTS geared to the needs of recorded music or electronics enthusiasts, your Classified Advertising belongs in one or more of the Ziff-Davis Electronics Annuals. For complete information on Annuals available, rates, closing dates and other pertinent data, write to: Hal Cymes, Classified Advertising Manager, ELECTRONICS ANNUALS, One Park Avenue, New York, New York 10016.

narrator and streetsinger; George S. Irving. Mack the Knife; Jo Wilder, Polly; Martha Schlamme, Jenny; others. Orchestra, Samuel Matlovsky cond. RCA VICTOR FTO 5027 \$8.95.

Performance: Better solo than team work
Recording: Closely miked
Stereo Quality: So-so

Having listened many times to the original German recording of *The Threepenny Opera* (Telefunken 97012), the 1961 stereo recording of the complete musical score (Columbia O2S 201, O2L 257), and the original New York-cast recording of Marc Blitzstein's adaptation (MGM E 3121)—all featuring Weill's widow, Lotte Lenya—I can attest to the importance of teamwork in putting over the savage irony of the work's music-hall songs and of the drama itself. Sammy Davis cuts an ironically suave figure in his role here—a highlight is his singing of the famous *Mack the Knife*; Jo Wilder is an appealing Polly; and Martha Schlamme is a creditable though not sufficiently savage Jenny. But I was able to sense very little *esprit* in the many choral and vocal ensembles that are the (very Brechtian) core of *The Threepenny Opera*.

The very tight microphoning not only is rather unpleasant to the ear, but also tends to add to the prominence of the solos. *D. H.*

HUMOR

© THE SMOTHERS BROTHERS: *American History and other Unrelated Subjects*. Dick and Tom Smothers (vocals, bass, and guitar). *That's My Song; Eskimo Dog; W'agon W'heels*; and eleven others. MERCURY STC 60948 \$7.95.

Performance: Irresistible
Recording: Good
Stereo Quality: Good

Somebody once defined a comic as one who says funny things, a comedian as one who says things funny. By that definition, the Smothers Brothers are comedians, in the long and noble American tradition of people who say things hilariously. Dick Smothers is the straight man, Tom the "dumb" one. Tom Smothers' furrowed-brow discombooberation is the foundation of their act.

One's response to humor, obviously, is even more subjective than one's response to music. The Smothers Brothers break me up. Whereas Jerry Lewis's portrayals of imbecility are embarrassing (they border on the spastic), there's nothing physical or contemptuous in Tom Smothers' "stupidity"—and nothing malicious. To quote his lines is useless; the point lies in *how* he says them.

In the track titled "Siblings," Tom complains that when they were kids, Dick and the others would never let him play with them. Dick denies this, pointing out that once they let him play hide and seek with them, Tom being "it." "Yeah," he says, "an' I looked for you guys for four months."

If anyone is inclined to feel sorry for Tom Smothers, please note that he writes much of the duo's best material, and he's on his way to the bank. I find it hard to laugh at most recorded humor, but I laughed frequently over this tape. *G. L.*

New tape releases are reviewed each month in HiFi/STEREO REVIEW

ADVERTISERS' INDEX

ADVERTISER	PAGE NO.
Allied Radio	83
American Recording Tape	12
Ampex Corporation	69, 121
British Industries—Garrard	2
Capitol Tape	127
Carston Studios	111
Cipher	4th Cover
Citadel Record Club	1
Columbia Stereo Tape Club	9, 10, 11
Commission Electronics, Inc.	129
Concord Electronics Corporation	67
Cousino Electronics Corporation	107
Crown International	73
Eastman Kodak Company	117
Electro-Voice, Inc.	102
Elpa Marketing Industries, EDITall Division	95
Elpa Marketing Industries, ReVox Division	3rd Cover
Finney Company, The	91
Fisher Radio Corporation	13
Greentree Electronics	12
Hi-Fidelity Center	131
Inter-Mark Corporation	4th Cover
Koss Electronics, Inc.	8
Lafayette Radio Electronics	2nd Cover
Magnecord	14
Martel Electronics	91
Minnesota Mining & Mfg. Co.	63
North American Philips Company, Inc.	75, 76
Nortronics	89
OKI—Chancellor Electronics	6
Olson Electronics, Inc.	131
Rabsons—57th Street, Inc.	129
Record Club of America	7
Sarkes Tarzian, Inc.	93
Saxitone	129
Superscope, Inc.	64, 114
Telex	97
Turner Microphone Company, The	105
University Sound	91, 111
Viking of Minneapolis, Inc.	4
Wollensak	71

Sure it's an ugly brute. All the money went into its guts.

We're proud the new Cipher VI from Japan is not just another pretty-face tape recorder. It won't break your heart with extravagant promises. Or disguise sins of shoddy engineering. We put our money where you can hear it. And you can see the difference in the price. Only \$239.50. Unprecedented for a machine of this caliber.

The Cipher VI is a completely self-contained 4-track stereo recording and playback system. Built with the sort of no-nonsense features only a discerning audiophile could love. Two VU-type meters to assure accurate indication of recording and playback levels. A balanced capstan flywheel, combined with a pure idler drive (no belts!), to assure rock-steady tape motion. An automatic tape lifter in the fast-forward and rewind modes to protect the heads from unnecessary wear. An automatic tape shutoff. Both a digital tape index and a pause control for precise cueing and editing. Two detachable extended-range speaker systems. A matched pair of high-quality dynamic microphones.

Tape speeds are $7\frac{1}{2}$ and $3\frac{3}{4}$ ips; operation may be either vertical or horizontal, with all reel sizes up to 7". And the case may be closed without removing the reels.

But don't let these beautiful facts go to your head. Ask your Cipher dealer for a demonstration.

CIPHER VI \$239.50

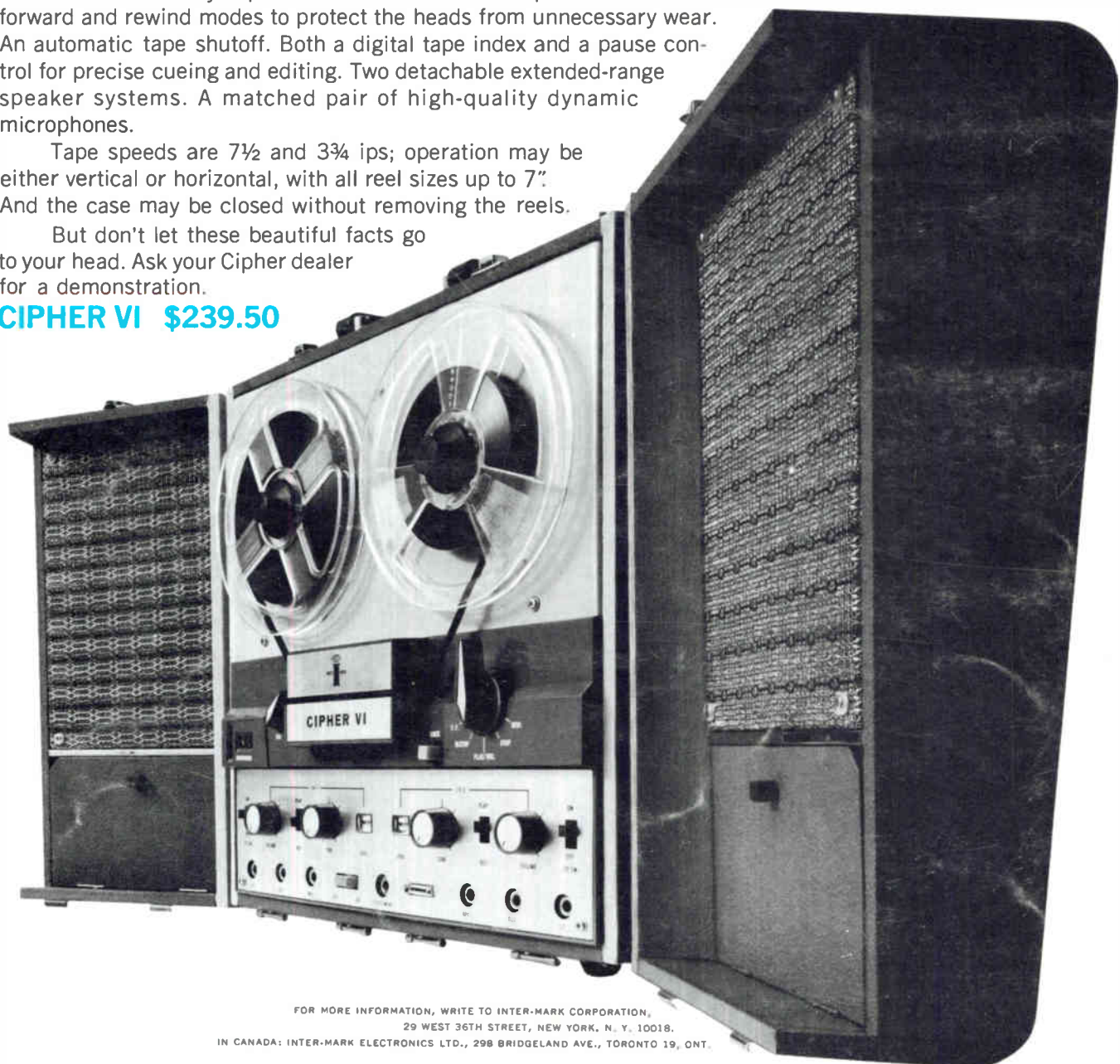

FOR MORE INFORMATION, WRITE TO INTER-MARK CORPORATION,
29 WEST 36TH STREET, NEW YORK, N. Y. 10018.
IN CANADA: INTER-MARK ELECTRONICS LTD., 298 BRIDGELAND AVE., TORONTO 19, ONT.

CIRCLE NO. 19 ON READER SERVICE CARD

The Remarkable REVOX



has finally arrived in the U.S.

You've heard of the remarkable REVOX, of course. You've heard them rave about this recorder in London. Paris. Rome. Johannesburg. Everywhere. But you couldn't buy it in the U. S. until now. Now, finally, REVOX is ready for its American and Canadian debut. Is there another tape recorder anywhere that matches it, feature for feature? Decide for yourself:

Is the REVOX different? Consider these features, found only in the most expensive, professional tape recorders. Each of the two reels has its own Pabst motor. There is also a separate, heavy duty Pabst 6/12 pole hysteresis synchronous capstan motor that electrically changes the number of poles for the speeds. This is a direct drive unit assuring linear tape speed, whether at 3¾ ips or 7½ ips. Direct coupling eliminates wow and flutter; no belts to break or slip. Tension adjustment contrast assures use of any reel up to 10½ inches with assurance that tape will not snap or break. There are three ring-core heads, specially designed and manufactured by REVOX . . . each head performing its own function of record, playback and erase. Other features? All operating modes are switched electrically by push-buttons; you can use remote control on the REVOX; also a highly accurate tape counter; no pressure pads (for long head life); no need for hum-bucking gimmicks. Vertical or Horizontal Mounting.

EXCLUSIVE BENEFITS

The REVOX is the only recorder in its price category that takes a 10½-inch reel. You

can record up to 4,800 feet of LP tape with unsurpassed sound quality. It's a complete 4-track stereo recorder. Exceptionally fast rewind. Oversized, solenoid-operated brakes assure quick and positive braking, even with extremely fast winding speeds. A microswitch senses the end of the tape and automatically stops the motor after a reel has been rewound or where a splice has opened. Tape breakage and tape spill are virtually impossible.

CREATING SPECIAL EFFECTS

With the built in mixing facilities of the REVOX, you can mix and record any two signals. You can also set one channel for playback, while the other is recording, and thus achieve all kinds of multiplay and duoplay effects — sound with sound — even sound on sound with echo.

PROFESSIONAL QUALITY FEATURES

The REVOX G-36 includes two VU meters, one for each channel, for accurate control of recording levels. All operating controls are electrically operated by pushbuttons. There are no gears, belts, levers or friction drives. In its smart gray, portable carrying

case, with pockets for reels (reels not included), the REVOX is built for a lifetime of proud performance. Only \$500.

AN EXPERT'S VIEW

Recently, British critic Geoffrey Horn wrote this about the REVOX: "One can record a piano at 3¾ ips, and if on listening critically to a held chord one detects the slightest waver, then it is likely to be the piano tuner you should send for, not the tape mechanic. This is a superlative machine, quite the best domestic tape recorder I have experienced, and so well worth saving and waiting for."

The REVOX is available only through carefully selected Franchised Dealers. Complete literature and Dealer listings are available upon request. Write Dept. TR-66.

ELPA MARKETING INDUSTRIES, Inc.,
NEW HYDE PARK, N. Y.



REVOX — another Elpa quality product distributed in the U. S., Canada and Puerto Rico.