

Hi-Fi Stereo Review

AUGUST 1968 • 60 CENTS

* SPECIAL SPEAKER ISSUE *

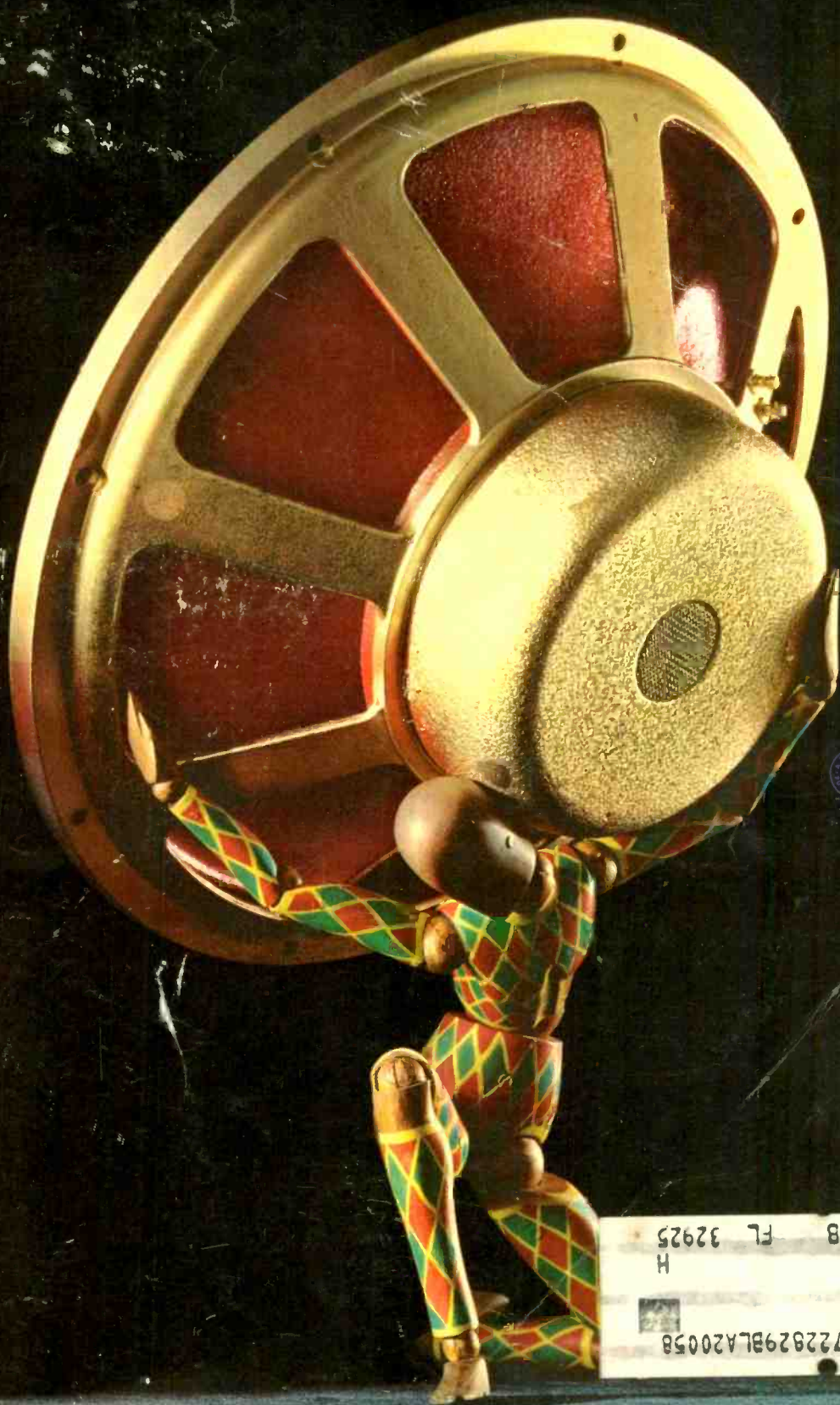

H0369 3513722829BLA20058
BASE LIBR
AFL 2829
PATRICK AFB FL 32925

press comment *on the*

AR-3a

THE
**AMERICAN
record
guide**

(Larry Zide)

"In choral works and other music of relatively 'heavy' content, the AR-3a simply eliminates any mid-range lack of clarity . . . I find myself repeating what I said in 1959 [about the AR-3]. The AR-3a . . . easily succeeds its prototype as a speaker that I consider 'as close to musical realism in the home . . . as the present state of the art permits.' In a word, it's superb."

HIGH FIDELITY

(Norman Eisenberg)

"Our reaction on first hearing the AR-3a was [an] . . . enthusiastic one which has not diminished after weeks of listening . . . in normal use, predominantly fundamental bass is evident to about 30 Hz . . . Tones in the 13 to 14 kHz region can be heard clearly at least 60 degrees off axis . . . at [high] levels, the speakers sounded magnificent . . . On any material we fed to them, our pair of AR-3a's responded neutrally, lending no coloration of their own to the sound."

HiFi/Stereo Review

(Hirsch-Houck Laboratories)

" . . . the best speaker frequency response curve we have ever measured using our present test set-up . . . virtually perfect dispersion at all frequencies — perhaps the most non-directional forward-facing speaker we have ever tested . . . AR speakers set new standards for low-distortion, low-frequency reproduction, and in our view have never been surpassed in this respect."

Chicago's AMERICAN

(Roger Dettmer)

"I have not encountered truer 'fidelity' . . . dull records may sound dull, but brilliant recordings sound singularly brilliant — in three decades of home listening."

The AR-3a is priced from \$225 to \$250, depending on cabinet finish. Literature is available for the asking.

ACOUSTIC RESEARCH, INC., 24 Thorndike Street, Cambridge, Mass. 02141

CIRCLE NO. 1 ON READER SERVICE CARD

Now...for the first time...a brand-new service that offers you stereo tape cartridges—at great savings!

As your introduction, choose

ANY 3
8-TRACK CARTRIDGES
\$5.95
FOR ONLY

if you join now, and agree to purchase as few as four additional cartridges during the coming year, from the hundreds to be offered

GARY PUCKETT AND THE UNION GAP
 FEATURING **YOUNG GIRL**



6480. Also: Lady Madonna, I'm Losing You, Honey, Say You Don't Need Me, etc.

BOOKENDS
SIMON & GARFUNKEL



6366. Includes Mrs. Robinson from "The Graduate," Fakin' It, At The Zoo, etc.

RAY CONNIF
Honey



6509. Also: Love Is Blue, By The Time I Get To Phoenix, 11 in all

FOR YOUR CAR!

FOR YOUR HOME!

YES, IT'S TRUE! You may have any 3 of the best-selling 8-track cartridges shown here—ALL 3 for only \$5.95! That's the fabulous bargain the brand-new Columbia Stereo Tape Cartridge Service is offering new members who join and agree to purchase as few as four additional selections in the coming year. Have you ever heard of a better buy in 8-track cartridges—anywhere?

FREE SUBSCRIPTION TO CARTRIDGE BUYING GUIDE. You'll have no problem selecting four more cartridges because the Service offers you so many cartridges to choose from...all described in the monthly buying guide which you will receive free! You'll find hit 8-track cartridges from every field of music—the bestsellers from many different labels! You may accept the regular monthly selection...or any of the other cartridges offered...or take no cartridge at all that month.

YOUR OWN CHARGE ACCOUNT. Upon enrollment, the Service will open a charge account in your name. You pay for your cartridges only after you've received them—and are enjoying them. They will be mailed and billed to you at the regular Service price of \$6.95 (Classical, occasional Original Cast and special cartridges somewhat higher), plus a small mailing and handling charge.

YOU GET FREE CARTRIDGES! Once you've completed your enrollment agreement, you'll get a cartridge of your choice FREE for every two cartridges you buy! That's like getting a 33 1/3% discount on all the 8-track cartridges you want...for as long as you want!

SEND NO MONEY NOW! Just fill in and mail the coupon!

COLUMBIA STEREO TAPE CARTRIDGE SERVICE

Terre Haute, Indiana 47808

SEND NO MONEY—JUST MAIL COUPON

Columbia Stereo Tape Cartridge Service
 Terre Haute, Indiana 47808

Please enroll me as a member of the Service. I've indicated below the three cartridges I wish to receive for \$5.95, plus postage and handling. I agree to purchase four more selections during the coming year at the regular Service price, and I may cancel my membership any time thereafter. If I continue, I am to receive an 8-track cartridge of my choice FREE for every two additional selections I accept.

SEND ME THESE 3 CARTRIDGES (fill in numbers below)

Name _____
 (Please print) First Name Initial Last Name

Address _____

City _____

State _____ Zip _____

403-1/1C

<p>BARBRA STREISAND Simply Streisand</p>  <p>5896. Stout Wear Men, When Sunny Gets Blue, Lover Man, etc.</p>	<p>THE PHILADELPHIA ORCHESTRA'S GREATEST HITS Vol. 3 EUGENE ORMANDY Conductor</p>  <p>6152. Comedian's Galop, Anitra's Dance, etc.</p>	<p>THE GRADUATE Songs Performed by Simon & Garfunkel</p>  <p>6313. "Like the movie, a hit album!" —Billboard Magazine</p>	<p>JOHNNY CASH AT FOLSOM PRISON Jackson 15 MORE</p>  <p>6418. Folsom Prison Blues, The Long Black Veil, The Wall, etc.</p>	<p>PAUL MAURIAT and His Discs Blooming Hits</p>  <p>6157. Also: Mama, Somethin' Stupid, 10 in all</p>
<p>DEAN MARTIN Welcome to My World PLUS Little Ole Me, Dinner, Me</p>  <p>5546. Also: Pride, Wallpaper, Retas, Turn To Me, 10 in all</p>	<p>PETULA CLARK The Other Man's Grass Is Always Greener PLUS The Cat in the Window Smile • The Last Waltz</p>  <p>6333. Also: Ballad of A Sad Young Man, The Last Waltz, etc.</p>	<p>ROGER WILLIAMS BORN FREE</p>  <p>3679. Also: Strangers in the Night, Sunny, etc.</p>	<p>ANDRE KOSTELANETZ and his Orchestra Scarborough Fair</p>  <p>6511. Plus: I'll Get By, Love Is Blue, The Look Of Love, etc.</p>	<p>MARTY ROBBINS BY THE TIME I GET TO PHOENIX PLUS Love Is In The Air</p>  <p>6592. Also: Until We Meet Again, You Made Me Love You, etc.</p>
<p>NANCY & LEE Nancy Sinatra Lee Hazlewood • Jackson • Some Velvet Morning</p>  <p>6610. Plus: Storybook Children, Summer Wine, etc.</p>	<p>TONY'S GREATEST HITS VOL. III I Left My Heart In San Francisco I Wanna Be Around The Good Life</p>  <p>2150. Here's Tony Bennett singing Wha Can I Turn To, etc.</p>	<p>ANDY WILLIAM Love, Andy</p>  <p>5787. Plus: What Now My Love, The Look Of Love, etc.</p>	<p>ARETHA FRANKLIN RUNNING OUT OF FOOLS The Shoop Shoop Song Walk On By</p>  <p>1716. Also: One Room Paradise, Every Little Bit Hurts, etc.</p>	<p>BOBBY VINTON Take Good Care of My Baby</p>  <p>6565. Also: To Think You've Chosen Me, My Way Of Life, etc.</p>
<p>JOHNNY MATHIS LOVE IS BLUE PLUS By the Time I Get to Phoenix</p>  <p>6343. Also: I Say A Little Prayer, Walk On By, etc.</p>	<p>BILL COSBY To Russell, My Brother, Whom I Slept With</p>  <p>6521. Includes: Baseball, Conflict, The Apple, etc.</p>	<p>Flatt & Scruggs Story of Bonnie & Clyde Plus—Foggy Mountain Breakdown • 9 MORE</p>  <p>6426. Also: Another Ride With Clyde, The Chase, Reunion, etc.</p>	<p>BERNSTEIN Plays Favorite American Classics GERSHWIN: Rhapsody in Blue An American in Paris GROFÉ: Grand Canyon Suite</p>  <p>6238-6239. Twin-Pack Tape (Counts As Two Selections)</p>	<p>SEPTEMBER OF MY YEARS FRANK SINATRA It Was a Very Good Year 12 MORE</p>  <p>2346. Also: Once Upon a Time, Don't Wait Too Long, etc.</p>

How
 Garrard's
 synchronous
 Synchro-Lab
 Motor,TM
 driven by the
 rigidly
 controlled
 60 cycle current
 rather than
 variable voltage,
 guarantees
 unwavering
 musical pitch
 and greatly
 improves record
 reproduction



**SYNCHRONOUS
 MOTOR**

By locking in to the fixed 60 cycle current (rather than the often inexact or variable voltage), this revolutionary new motor provides constant record speed regardless of voltage, record load, warm up and other factors. The synchronous Synchro-Lab Motor is exceptional because it also provides the traditional advantages of the induction type...instant starting, high driving torque and freedom from rumble.

**LIGHT, KINETICALLY
 MATCHED TURNTABLE**

Garrard's synchronous Synchro-Lab Motor obsoletes heavy turntables developed to override fluctuations in the speed of induction motors by creating flywheel action. This relatively light (3 pounds) but magnificently balanced 11½" Garrard turntable, precision matched to the kinetic energy of the synchronous motor, now relieves weight on the all-important center bearing and reduces wear and rumble in this most critical area.

The Synchro-Lab Motor powers five new Garrard automatic turntables—the Synchro-Lab SeriesTM, four of which are illustrated below. (Not shown, the handsome new Module SLx, complete with base and magnetic cartridge and priced at only \$69.50.)

For complimentary Comparator Guide illustrating all Garrard models, write Garrard, Dept. AK5-8, Westbury, N.Y. 11590.

Garrard[®]

SL 55
 Automatic Turntable
 \$59.50



SL 65
 Automatic Turntable
 \$79.50



SL 75
 Automatic
 Transcription Turntable
 \$109.50



SL 95
 Automatic
 Transcription Turntable
 \$129.50



All prices less base and cartridge.

HiFi/Stereo Review

AUGUST 1968 • VOLUME 21 • NUMBER 2

THE MUSIC

LONDON LETTER	
<i>American Music: The New Colonialism?</i>	HENRY PLEASANTS..... 46
THE BASIC REPERTOIRE	
<i>Vaughan Williams' Fantasia on a Theme by Thomas Tallis</i>	MARTIN BOOKSPAN..... 51
RALPH VAUGHAN WILLIAMS	
<i>A timely reassessment of England's greatest symphonist</i>	EDWARD JABLONSKI..... 62
GEORGE M!: THE ORIGINAL—CAST RECORDING	
<i>The star-spangled Broadway hit is a recording event</i>	REFX REFD..... 105
GEORGE M!: THE RECORDING SESSION	
<i>An ear-witness account of the record-making performance</i>	MARTIN WILLIAMS..... 106

THE EQUIPMENT

NEW PRODUCTS	
<i>A roundup of the latest in high fidelity</i>	16
HI-FI QUESTIONS AND ANSWERS	
<i>Advice about readers' technical problems</i>	LARRY KLEIN..... 24
AUDIO BASICS	
<i>Loudness or Contour Controls</i>	HANS H. FANTELL..... 28
TECHNICAL TALK	
<i>Speaker Testing; Hirsch-Houck laboratory reports on the Harman-Kardon Five-Thirty receiver, the Concord 510-D stereo tape deck, and the Heath AR-17 FM receiver</i>	JULIAN D. HIRSCH..... 33
POWER RATINGS OF LOUDSPEAKER SYSTEMS	
<i>An important but little-understood specification</i>	B. N. LOCANTINI AND G. L. AUGSPURGER..... 55
LOUDSPEAKERS CAN BE TESTED	
<i>The case for judging speaker performance objectively</i>	ROY ALLISON..... 59
EXPLODING THREE POPULAR LOUDSPEAKER FALLACIES	
<i>Our fearless technical editor treads near some toes</i>	LARRY KLEIN..... 68
TAPE HORIZONS	
<i>Tape-Letter Tips</i>	DRUMMOND McENNIS..... 113

THE REVIEWS

BEST RECORDINGS OF THE MONTH	71
CLASSICAL	77
ENTERTAINMENT	99
STEREO TAPE	111

THE REGULARS

EDITORIALLY SPEAKING	WILLIAM ANDERSON..... 4
LETTERS TO THE EDITOR	6
GOING ON RECORD	JAMES GOODERFEND..... 42
INTRODUCING THE STAFF: DAVID HALL	PETER REILLY..... 96
ADVERTISERS' INDEX; PRODUCT INDEX	116

COVER: PHOTO BY BRUCE PENDLETON; DESIGN: BORYS PATCHOWSKY

Copyright © 1968 by Ziff-Davis Publishing Company. All rights reserved. HiFi/Stereo Review, August, 1968, Volume 21, Number 2. Published monthly at 307 North Michigan Ave., Chicago, Illinois 60601, by Ziff-Davis Publishing Company—also the publishers of Airline Management and Marketing, Boating, Business & Commercial Aviation, Car and Driver, Cycle, Electronics World, Flying, Modern Bride, Popular Electronics, Popular Photography, Skiing, Skiing Area News, and Skiing Trade News. (Travel Weekly is published by Robinson Publications, Inc., a subsidiary of Ziff-Davis Publishing Company.) One year subscription rate for U.S., U.S. Possessions and Canada, \$6.00; all other countries, \$7.00. Second class postage paid at Chicago, Illinois and at additional mailing offices. Authorized as second class mail by the Post Office Department, Ottawa, Canada, and for payment of postage in cash. SUBSCRIPTION SERVICE: Forms 3570 and all subscription correspondence should be addressed to HiFi/Stereo Review, Circulation Department, Portland Place, Boulder, Colorado 80302. Please allow at least six weeks for change of address. Include your old address, as well as new—enclosing if possible an addressed label from a recent issue.

Hi Fi/Stereo Review

PUBLISHER
PHILLIP T. HEFFERNAN

EDITOR
WILLIAM ANDERSON

MANAGING EDITOR
WILLIAM LIVINGSTONE

MUSIC EDITOR
JAMES GOODFRIEND

TECHNICAL EDITOR
LARRY KLEIN

ASSOCIATE EDITOR
ROBERT S. CLARK

ART DIRECTOR
BORYS PATCHOWSKY

PRODUCTION ASSISTANT
JOYCE PARKER

ASSISTANT TECHNICAL EDITOR
WILLIAM WOLLHEIM

CONTRIBUTING EDITORS

CLIVE BARNES
MARTIN BOOKSPAN
HANS H. FANTEL
WILLIAM FLANAGAN
DAVID HALL
DON HECKMAN
JULIAN D. HIRSCH
GEORGE JELLINEK
IGOR KIPNIS
PAUL KRESH
DRUMMOND McINNIS
REX REED
PETER REILLY
ERIC SALZMAN

EUROPEAN EDITOR
FREDERIC GRUNFELD

LONDON EDITOR
HENRY PLEASANTS

ADVERTISING SALES MANAGER
LAWRENCE SPORN

ADVERTISING SERVICE MANAGER
ARDYS C. MORAN

Editorial and Executive Offices
Ziff-Davis Publishing Company
One Park Avenue, New York, New York 10016
212-679-7200
Eastern Advertising Manager: James J. Sullivan
Paul E. Gelfman, Royce Richard
Midwestern Office
307 North Michigan Avenue, Chicago, Illinois 60601
312-726-0892
Midwestern Advertising Manager: Royce Richard
Western Office
9025 Wilshire Boulevard
Beverly Hills, California 90211
213-939-5500
Western Advertising Manager: Bud Dean
Japan: James Yagi
Ishikawa Mansion
4, Sakuragaoka, Shibuya-ku
Tokyo, Japan
Telephone: 462-2911-3
Circulation Office
Portland Place, Boulder, Colorado 80302
EDITORIAL CONTRIBUTIONS must be accompanied by return postage and will be handled with reasonable care; however, publisher assumes no responsibility for return or safety of art work, photography or manuscripts.
Member Audit Bureau of Circulations



ZIFF-DAVIS PUBLISHING COMPANY
William B. Ziff, Chairman of the Board (1946-1953)
William Ziff, President
W. Bradford Briggs, Executive Vice President
Herschel B. Sarbin, Senior Vice President
Philip Sine, Financial Vice President
Walter S. Mills, Jr., Vice President, Circulation
Stanley R. Greenfield, Vice President, Marketing
Phillip T. Heffernan, Vice President,
Electronics Division
Frank Pomerantz, Vice President, Creative Services
Arthur W. Butzow, Vice President, Production
Edward D. Muhlfield, Vice President, Aviation Division
Irwin Robinson, Vice President, Travel Division
Furman Hebb, Administrative Vice President

By WILLIAM ANDERSON

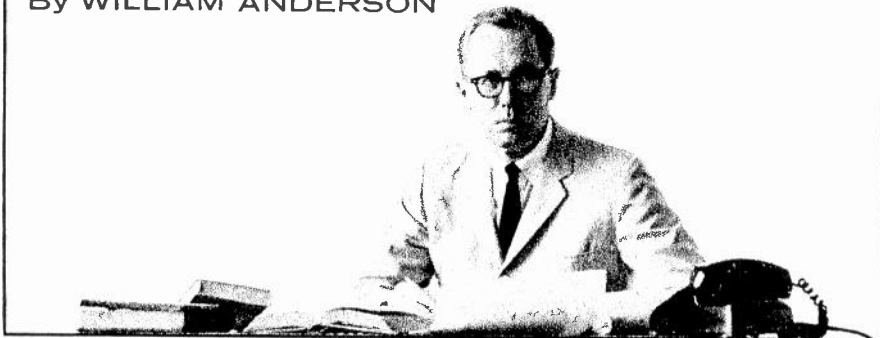

EDITORIALLY SPEAKING

MONO IS WHAT CLOSSES OUT OF TOWN

AN ANTIQUE, according to U. S. Government tariff regulations, is something that is one hundred years old. This is perhaps capricious, very likely uninformed, and certainly arbitrary, but the line has to be drawn somewhere. Short though its history may be, the record history has its "antiques" too, defined by a line almost as capricious, uninformed, and arbitrary. It used to embrace only Edison cylinders and 78's, but it has recently and startlingly been redrawn to include—monophonic recordings! No matter; even given our infatuation with youth and modernity, we still retain a lingering respect for age and antiquity, and thus the artistic products of earlier times continue to find their perceptive buyers.

Several antique recordings are reviewed in this issue, and they are of two kinds: the restored and the modernized. Columbia and producer Miles Kreuger are to be congratulated not only for restoring to us a brilliant album of Ethel Waters favorites, but for having the courage to offer them in mono only. Everest's Archive of Piano Music is likewise to be congratulated for giving us an admirable Wanda Landowska piano recital in stereo. Electronic trickery? No. The original recordings were on Duo-Art piano rolls, and Everest's engineers sensibly decided that since they were working with a "live" piano, stereo techniques were entirely in order.

Two other recordings, however, have been "modernized," one of them quite preposterously: the Thomas Alva Edison Foundation is offering "Gems from the Edison Diamond Amberols," old *cylinder* recordings of a number of long-gone singers—in *stereo*! And RCA has released the Toscanini-Herva Nelli *Aida* in mono and electronic stereo [electronic stereo in the RCA catalog is indicated by a small (e) following the album number]. These releases seem to indicate that, for at least two record producers, mono is what closes out of town, and pasting a stereo facade on worthy antiques will somehow guarantee that they get to open on Broadway.

Since the business of business is to stay in business, I sympathize with record-company efforts to cut costs and neaten inventories by avoiding mono/stereo duplication in new recordings. And I am further willing to face up bravely to the sacrifices involved in discontinuing many artistically valuable but sadly uneconomic mono antiques. But when a company decides to reissue a recording originally made in mono, I go purist all over and insist that they remain faithful to the original artistic intent and avoid stereo falsification. An antique is an antique, and there should be respect for the aesthetic under which it was created. Patch, repair, mend, and clean all you want, but do not "modernize." Record companies are the custodians of countless recorded treasures of the past, and when they choose to put them on public view, they should do so with as much integrity as museum curators. We would scarcely have the effrontery to restore the arms of the Venus de Milo and add Passion Pink fingernail polish; we would not adjust the faulty perspective of an early Renaissance painting; and we would not install Venetian blinds at Monticello. The line has to be drawn somewhere, and I suggest that it be laid down well south of that point at which we classify all recording teams of the mono era as amiable bumbler who knew not what they were doing.

Setting the record straight!

"The PE-2020 worked well in all modes of operation. It is gentle on records, simple to use, and highly flexible. The vertical stylus-angle adjustment does just what it was intended to do, and *the purist will find that this novel automatic turntable will meet his most exacting requirements . . .*"

**Excerpt, HiFi/Stereo Review, May, 1968*

"This clearly indicates the virtue of the adjustable vertical tracking angle in reducing distortion from the record, and in combination with the variable skating-angle compensation shows that the PE-2020 is well equipped to reduce distortion to a practical minimum. As a consequence, *the vertical tracking angle adjustment is not merely a gimmick . . .*" **Excerpt, Audio May, 1968*

The exclusive 15° Vertical Tracking Angle feature places the NEW ELPA PE-2020 ahead of all automatic turntables on the market.



 Don't be switched to yesterday's turntables. See and hear it yourself at any PE franchised dealer or write for complete specifications to:
ELPA MARKETING INDUSTRIES, INC. NEW HYDE PARK, N.Y. 11040.

**Complete reprints of articles available upon request.*

CIRCLE NO. 22 ON READER SERVICE CARD

The First Outdoor Speaker

Still the Finest The BARD by Bozak



Nearly a decade after its introduction, Bozak's BARD outdoor speaker system remains distinctly superior to its many imitators.

Distinguished in Reproduction. BARD's bass is rich and full; there's none of the "tinny" or "one-note" bass which plagues so many "outdoor" speakers. BARD's reproduction qualities stem from the fact that every component — from driver to enclosure — is specifically designed for natural listening outdoors.

Distinguished in Appearance. BARD's hemispheric enclosure adds a quiet accent to the outdoor setting. Its versatility permits it to stand or be hung from a ceiling.

Distinguished in Ruggedness. Despite its high level of reproduction quality, despite its attractive appearance, the BARD is totally weatherproof. Once you install it, you never need move it. If you're looking for an outdoor speaker this summer, get the one that will give you pleasure all year-round, year after year — Bozak's BARD.

Bozak

Darien, Connecticut

*Registered



LETTERS TO THE EDITOR

Dynamic Range

● I wish to thank Craig Stark for his article "The Dynamic Range of Music" in the June issue. Seldom is the subject of dynamic-range compression treated with the seriousness that it deserves.

STANLEY STUMP
Indianapolis, Ind.

● I must send my thanks for the article "The Dynamic Range of Music" by Craig Stark. Although I am a nonprofessional, this subject is of great interest to me.

As to whether music that was *not* compressed dynamically would find favor in the average home, I would definitely say yes. The last live concert I attended was a Mantovani concert, and, having several of his albums, I was amazed at the difference in the dynamic range. Recorded music has come a long way since the days of Edison; I feel sure that in the years ahead techniques will be found to make recorded music still more lifelike.

CHARLES STEPANEK
Schenectady, N. Y.

● Craig Stark should be complimented. He had the guts to speak out against "true concert-hall realism" in the home. I too think that this is all but impossible to achieve with our limited know-how today.

Would anyone try to crowd a large symphony orchestra into his living room, and tell them to go to it? Why then should we expect the same effect from a group of electronic devices? Wouldn't it be more to the point to expect a reasonable facsimile? To me, reproduced music is fine up to a certain volume. After that it becomes noise.

HERMAN LOEWENTHAL
Orlando, Fla.

The Harp

● I wish to comment on a statement made by Blanche Pattison in her article on the harp in the June issue. The harp was used in the "modern" orchestra long before Gluck's time, contrary to what Miss Pattison suggests. Scholars believe that the harp may have been used in the Baroque orchestra as a continuo instrument, and certainly this would figure into the tonal concept of the time. Apart from numerous instances when the harp was used *with* the orchestra (e.g., in solo concerti with orchestra, such as Han-

del's Harp Concerto), the harp was used *in* the orchestra as early as Monteverdi's time; he employed it in the opera *Orfeo*.

CHRISTOPHER BRODERSEN
Birmingham, Mich.

Miss Pattison replies: "Oh, that word 'modern'! I doubt that either of us has defined it right."

● I enjoyed Blanche Pattison's article on the harp very much and agree with her that the harp has been neglected. However, I am in disagreement with the statement, "A harpist can play a fugue . . . with the kind of control over individual voice lines that a pianist has and a harpsichordist or an organist has not." Granted that a harp has the capacity for subtle shadings and dynamics; but as far as control over individual voice lines is concerned, harpsichords and organs use different stops on two or more manuals to achieve individuality of different lines. After all, think of all the contrapuntal music written by J. S. Bach and his contemporaries when there was no piano.

WILLIAM J. CALL
Belmont, Mass.

Miss Pattison replies: "When the composer puts two or more voice-lines in the same hand, the organist or harpsichordist has no dynamic control over the individual lines."

● The fine article on "The Harp" by Blanche Pattison in the June issue was very timely from my point of view. Just recently I "rediscovered" harp music after enjoying the wonderful playing of Harpo Marx many years ago.

I am embarked on a program of obtaining all the harp music available on records today, and it is surprising that such an extensive harp literature exists and is recorded. To augment the list contained in the article of composers who have written for the harp I might add those I have come across in my research. Most of these discs are to be found in the Schwann catalog and are readily available.

The composers are: Albrechtsberger, D'Alvimare, Beethoven, Bochsá, Boieldieu, Dandrieu, Dittersdorf, Eichner, Haydn, Hotterre, Jadin, Krumpholz, Mayer, Nadermann, Pachelbel, Petriní, Purcell, Rosetti,

(Continued on page 8)



Most of the features of this \$89.50 Dual were designed for more expensive Duals.

You'd expect a big difference in performance between the \$129.50 Dual, the \$109.50 Dual, and the \$89.50 Dual.

There isn't a big difference.

The higher-priced models have a few more features, but no more precision. Play all three through comparable hi-fi systems and we defy you to tell which is which, from the sound alone.

To achieve this similarity, Dual simply did what other manufacturers would get sued for doing. We copied the most expensive Dual.

We eliminated some things that weren't essential to the good performance. But we kept everything that was essential.

So, though we're about to describe the \$89.50 Dual, the Model 1015, everything we say about it is also true of the more expensive Duals.

The 1015 has a low-mass, counterbalanced tonearm that tracks flawlessly with a force as low as half a gram. (Vertical bearing friction is .01 gram; horizontal bearing friction is .04 gram.)

The tonearm settings for balance, tracking force and anti-skating are continuously variable and dead-accurate.

The cue control is gentle and accurate, and works on both automatic and manual start.

(Rate of descent is 0.5 cm/sec. The cueing is silicon-damped and piston-activated.)

The motor maintains constant speed within 0.1% even if line voltage varies from 80 to 135 volts.

Rumble, wow and flutter are inaudible, even at the highest volume levels.

If all we say about the \$89.50 Dual is true, you may wonder why anyone would pay the extra \$40 for the Dual 1019.

Perhaps there's something appealing about owning the very best there is.

United Audio Products, Inc.,
535 Madison Avenue,
New York, N.Y. 10022.

Dual 1015

Schulze, Seixas, and Vivaldi. Good listening to other harp enthusiasts!

KENNETH S. ROBERTSON
Oxnard, Calif.

"Passing Parade"

● Quite a few years ago on radio there was a program by John Nesbitt called "The Passing Parade." The theme song of the program was, I believe, taken from a well-known classic. Would any of your readers happen to know what it was?

F. C. LINDAMAN
Brooklyn, N. Y.

Stokowski

● The article on Stokowski by Herbert Russell in the May issue was excellent. There was more Stokowski and less sensational-

ism than in any other piece on him I have ever read. (The Maestro himself, though, emphatically denies that his mother was Irish.) Thank you for "Color It Stokowski." There will never be another like him!

WILLIAM P. FISCHER
Wynnewood, Pa.

Brave New World of Music

● Re "The Brave New World of Music," William Anderson's June editorial: With the possible exception of Eileen Farrell's right to sing the blues, I couldn't agree with him more. Lennon and McCartney may very well be as good, doing "their own thing," as Shakespeare was doing his. The point is that they belong to different species.

F. B. LAND
Anderson, Ind.

● As a composition major (now enrolled at the Oberlin Conservatory of Music) who is nonetheless hoping to make his career in rock, I have had the pleasure of following the development of both rock and "serious" music closely. For this reason, I am writing to commend William Anderson on his fine editorial in the June issue concerning the differences between what one would classify as popular music and as serious music.

It is good to see that there are actually some groups around who really know something about serious music (the Mothers of Invention stand out) and are trying to use their knowledge to better their music. But for well-informed critics and composers to say, as Ned Rorem has, that the Beatles are writing songs as good as those of Schubert is terrifying. I find unbelievable many of the comments of respected American composers to the effect that the Beatles and other groups are as good as most serious composers. Could it be that our critics, composers, and performers, in an attempt to show they are "with it," are grabbing at straws? Luciano Berio may be happy to see that rock musicians are employing great amounts of electronic sound and *musique concrète*, but why does he overlook the fact that, in general, these sounds have been manipulated in an unsophisticated and gaudy fashion by these musicians? And these people are always talking about the Beatles as though there were no one else. Could this be because they really don't know anything much about rock today?

Yes, there still is a definite line between popular music and serious music, and there is nobody, in my opinion, who can now successfully straddle the line.

C. Rouse
Oberlin, Ohio

Heifetz

● Dear Mr. Flanagan: I've read your review (February) of Heifetz's latest recording. Look, sonny boy, you don't speak of Heifetz in those terms.

First of all, he *works* for a living. Try it. It won't hurt you. Second, what he does is play some of the very finest music ever heard by man or beast. Heifetz is an Artist! Where I work there's a picture of Heifetz on the wall. Under it one of my fellow musicians inscribed two words: THE BOSS. It's to your credit that you note Heifetz plays with great technical accuracy, but your comparison of him with a computer is obviously sarcastic and seems to indicate that you can't differentiate between the computer and the virtuoso's technique. Learn to. As for it being a "late date" in Heifetz's career, there is a word we can apply to great art and artists: the word is timeless. Study it. Pronounce it. Learn to spell it. Write it a hundred times on the blackboard. Then go to a Heifetz concert. And *listen*. And, if he plays *Mary Had a Little Lamb*, try hard to forget whether or not it's a transcription and listen to how beautifully he plays it. As for how music is degraded by being transcribed for the fiddle, or what the common man looks for in music, I'll leave that for some time when you may have emerged from swaddling clothes.

FREDERICK VOGELGESANG
New York, N. Y.

Mr. Flanagan replies: "(1) Tabulation of
(Continued on page 10)

uniCLUB

saves you more
on more of what you want!

RECORDS TAPES STEREO GEAR BOOKS



Here are 10 facts about uniCLUB. They are 10 reasons to clip the coupon and join now!

1. Any LP or tape on every U.S. or foreign label available. Columbia—Capitol—RCA—London & 350 more. No exceptions.
2. You save a minimum of 35% on LP's; 33% on tapes and 25% on books.

LP's LIST	uniCLUB
\$1.98	\$1.35
2.98	1.95
3.79/98	2.49
4.79/98	3.09
5.79/98	3.79

3. You can save even more by taking advantage of the regular extra discount "Specials." Save up to 80% off list price. Right now, for example, the entire RCA Red-Seal catalog is \$2.75 mono; \$3.25 stereo. The Vox \$4.98 series is \$1.75 mono and stereo.

4. Never a requirement to buy. No monthly "stop-order" forms to return. You receive just what you order.

5. LIFETIME MEMBERSHIP

The club membership fee is \$5. This is for lifetime privileges which are increasing all the time.

6. FREE CLUB MAGAZINE

Members regularly receive "uniGUIDE" advising them of the latest releases, recommended best-buys and extra discount "Specials." When you join you receive a free 300-page Schwann record catalog listing every available record and its price. You receive a free Harrison tape catalog if you specify.

7. FASTEST SERVICE ANYWHERE

Your orders are not only processed but shipped the same day we receive them. This unique service is possible because your orders are picked from an inventory of over 250,000 LP's & tapes. You get factory-new sealed albums and tapes only. Defects are fully returnable at no charge.

8. SAVE UP TO 50% ON STEREO GEAR

Individual components or complete systems—

uniCLUB supplies hi-fidelity equipment of virtually every manufacturer at tremendous savings. This month's "Hi-Fi Special" is a Garrard SL95 turntable; List \$129.50, to members only \$83.00.

9. BOOKS OF ALL PUBLISHERS

The Book Division—only uniCLUB has it—offers members at least 25% off on any book in print.* You get only original publishers' editions. uniGUIDE lists best-sellers, just-published works and book "Specials."

*Texts are reduced 10%.

10. FOUR CLUBS IN ONE

uniCLUB is really a time-saver. It makes joining many clubs unnecessary. Now you can buy all your records, tapes, auto-cartridges, books and stereo-gear from one convenient source. We hope you'll join today!

SAVE MONEY EVEN ON YOUR MEMBERSHIP FEE

Give gift memberships with full lifetime privileges for only \$2.50 each. Splitting the cost with one other person lowers cost to \$3.75; enrolling five at a time brings cost down to only \$3 each.

Send my Free Schwann catalog; order blanks & uniGUIDE by return mail.

\$5 enclosed guarantees me:

1. LIFETIME MEMBERSHIP in uniCLUB
2. 35%-80% savings on LP albums, 1/3 off on tapes, 25% on books.
3. No requirements ever to buy anything. Nothing will ever be sent until I order it.

I must be delighted with uniCLUB or within 30 days I will let you know and receive a full refund.

uniCLUB Inc.

255 West 42nd Street
New York, N. Y. 10036

DEPT. HS88

NAME _____
ADDRESS _____
CITY _____ STATE _____ ZIP _____

- Send gift memberships at \$2.50 each to names and addresses listed on attached sheet.
 I am also interested in pre-recorded tapes.

CIRCLE NO. 59 ON READER SERVICE CARD

The Scottie

THE NOW
SOUND OF SCOTT

Own a complete Scott AM/FM stereo system right now! The new Scottie comes complete with a matched pair of Scott air-suspension speakers, and costs only \$199.95 complete. Incorporating the same electronic wizardry found in Scott's most expensive systems, the new Scottie is small enough to fit on a bedside table. And, for extra take-along convenience, the Scottie will even operate off a 12-Volt battery!

- All-silicon circuitry with Field Effect Transistors and Scott Integrated Circuits.
- New Full Complementary Output stages provide virtually undistorted sound at even the lowest listening levels.
- Exclusive Automatic Variable Bandwidth AM.
- Connections for record player and tape cartridge player.
- Automatic stereo switching.
- Operates from either 110-Volt house current or 12-Volt battery for car/boat use.

THE SCOTTIE AM/FM STEREO SYSTEM ONLY \$199.95

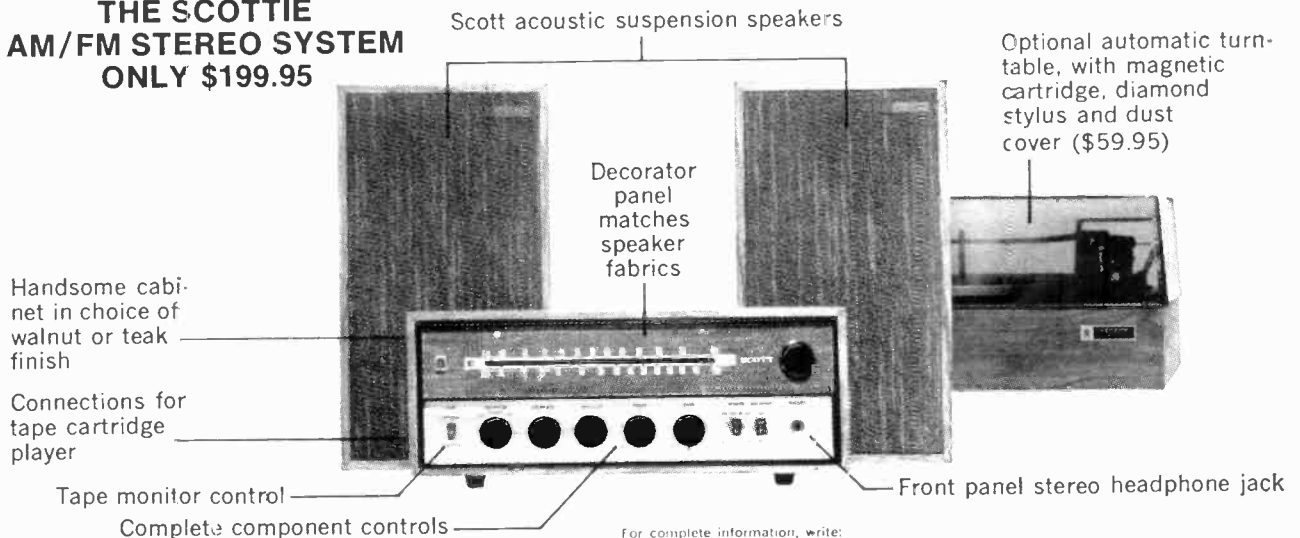

For complete information, write:

SCOTT

H. H. Scott, Inc., 111 Powdermill Road,
Maynard, Mass. 01754
Export: Scott International, Maynard, Mass. 01754

CIRCLE NO. 100 ON READER SERVICE CARD

my earnings from this magazine, royalties on theater scores, scattered freelance writing, advances on two books I am in the process of writing, and money paid for commissioned original concert works demonstrates beyond doubt that I, even as Heifetz, 'work' for a living. (2) The Boss has played some of the 'very finest music' ever written, true. But I do question that any 'beast' has ever given it serious attention. (3) Ultimate virtuosity may either serve or smother even the 'very finest music' ever written. (4) I used the term 'late date' to suggest that the violinist's star reputation and box-office power are by now unavailable. But if the current record is a fair sample, his choice of program material—even now he may be recording Mary Had a Little Lamb—is a sad reflection on his musical taste. (5) Mr. Vogelgesang's implication that virtuosic perfection is more significant than the music performed is, I venture, a notion that would be repellent even to Heifetz himself. (6) Having passed to the nether side of forty, I am delighted by the appellation 'sonny boy,' but (7) garbed in 'swaddling clothes' though I may be, I feel I must bring this reply to an end if I am, in one lifetime, to complete my own work and also learn to spell 'timeless' by writing it one hundred times on the blackboard."

Hi-Fi and Health

● Recently I was re-reading your August 1967 issue on loudspeakers when I realized that the high-fidelity industry is contributing to a serious health problem, that of air pollution in our cities.

The acoustic suspension loudspeaker has

come to dominate the loudspeaker field. One has only to check the advertisements in your magazine to discover that, for the most part, these speaker systems are being manufactured in areas of the country where the air is relatively pollution-free. The volume of the average acoustic suspension speaker is around two cubic feet. Now multiply this volume by the thousands upon thousands of such speaker systems being made, and you will realize that the industry is methodically swallowing up a sizable percentage of America's dwindling clean country air!

Therefore, I am going to write my Congressman to introduce a bill that would confine the manufacture of acoustic suspension speakers to our major cities, where the air that is trapped in the sealed cabinet would not be a loss to mankind, as it is unbreathable anyway.

PETER A. THRIFT
Takoma Park, Md.

Nancy Sinatra

● Rex Reed is bound to be deluged by letters from members of the Nancy Sinatra International Fan Club for his devastating attack on "Movin' with Nancy" (April).

Although not a rabid fan of Miss Sinatra's, I can't go along with Reed's judgment that she has "no conceivable talent." The worst criticism of Miss Sinatra that I can muster is that she has been oversold and sadly misguided in her career. Her sexy *Boots* image has obscured the real woman under that bleached, stringy hairdo. Her forte is the slow, easy number, in which she can be either innocent or sexy.

Listen to her sing *Jackson*, or *Sugartown*, or *W'bat'll I Do?*, Mr. Reed. She *does* have a voice, no matter what you think. And this—not the family name or the publicity—is what has made her popular.

STEPHEN PEITHMAN
Evanston, Ill.

● Rex Reed's review of the new Nancy Sinatra record in your April issue is indeed a most accurate description of a singer who consistently performs with a high level of incompetency.

ERIC STRICKLAND
Pontiac, Mich.

● Please tell Rex Reed to keep up the great work—such as his recent review of Nancy Sinatra's latest album. I think I have spent more time turning down the car radio since this lass hit the big time than I have listening to it. I hope the review will make some of the people who buy her records and who say what a talent we have there realize that they are only being fooled by the fame of Papa.

NANCY ANN REILLY
Woodland, Calif.

Miklós Rózsa

● Since your "Entertainment" pages do not normally deal with composers of the stature of a Miklós Rózsa, I am not really disturbed by Paul Kresh's estimate of his latest collection (April). I have read the same opinions so many times in the past twenty years that I actually enjoy the inevitable string of asperities now.

(Continued on page 12)

SAVE 1/3

ON EVERY CARTRIDGE TAPE
4-TRACK, 8-TRACK AND CASSETTE



Here's your chance to SAVE big money on tapes... every 4-track, 8-track and cassette available... a complete library of over 6,000 to choose from... all at savings of at least 1/3 off list price. These savings are yours only as a member of the Cartridge Tape Club of America. And, there's still more. You get reduced prices on home and auto tape players. A bi-monthly magazine with complete tape listings, feature stories, news, photos, tape reviews, top selling tapes, etc. Monthly top tape and new release newsletters. Bonus offers. Special gifts. Nothing is ever sent unless you want it. No minimum purchase required. There's no other club of its kind. No other club offers you the complete choice of tapes. Write for complete details. Or join today. Send just \$5 for a lifetime membership plus the members cost of any tapes you might order from the sample listing... receive a special FREE gift and our complete catalog.

If coupon is missing, write Cartridge Tape Club of America, 1509 S. Michigan, Chicago 60605.

NO.	TITLE	PRICES					
		8-Track		4-Track		Cassette	
		Re-tail	Mem-bers	Re-tail	Mem-bers	Re-tail	Mem-bers
550	CHOPIN IN STEREO	6.98	4.66	NA	NA	4.98	3.33
549	SCHEHERAZADE—Rimsky-Korsakoff	6.98	4.66	NA	NA	4.98	3.33
547	THE ARTISTRY OF MARIA CALLAS	6.98	4.66	NA	NA	5.98	3.99
556	ARTHUR LYMAN'S GREATEST	6.98	4.66	5.98	3.99	5.98	3.99
558	LOVE IS BLUE—Les Baxter	6.98	4.66	5.98	3.99	NA	NA
561	SUNDAY SAX—Boots Randolph	6.98	4.66	5.98	3.99	5.98	3.99
548	UP POPS RAMSEY—Ramsey Lewis	6.98	4.66	5.98	3.99	5.98	3.99
545	PERSUASIVE PERCUSSION	6.98	4.66	5.98	3.99	5.98	3.99
546	THE SORCERER—Gabor Szabo	6.98	4.66	5.98	3.99	5.98	3.99
532	COUNTRY MUSIC SOUND—Buck Owens	5.98	3.99	5.98	3.99	5.98	3.99
551	THE BEST OF GLEN YARBROUGH	6.98	4.66	5.98	3.99	5.98	3.99
553	VALLEY OF THE DOLLS—Dionne Warwick	6.98	4.66	5.98	3.99	5.98	3.99
544	ROTARY CONNECTION—Rotary Connection	6.98	4.66	5.98	3.99	5.98	3.99
395	THE KINGSMEN GREATEST HITS	6.98	4.66	5.98	3.99	5.98	3.99
333	THE TURTLES GOLDEN HITS	6.98	4.66	5.98	3.99	5.98	3.99
554	CRY LIKE A BABY—The Box Tops	6.98	4.66	5.98	3.99	5.98	3.99
555	WE'RE A WINNER—The Impressions	6.98	4.66	5.98	3.99	5.98	3.99
557	LIKE IT IS—Donovan	6.98	4.66	5.98	3.99	NA	NA
316	FAREWELL TO THE FIRST GOLDEN ERA— The Mamas & The Papas	6.98	4.66	5.98	3.99	5.98	3.99
559	GROOVIN'—The Soulful Strings	6.98	4.66	5.98	3.99	5.98	3.99
405	ALL MITCH RYDER HITS	6.98	4.66	5.98	3.99	5.98	3.99
332	THE BEST OF THE RIGHTEOUS BROS.	6.98	4.66	5.98	3.99	5.98	3.99
562	SKIP A ROPE—Henson Cargill	6.98	4.66	5.98	3.99	5.98	3.99
560	I GOT THE FEELIN'—James Brown	6.98	4.66	5.98	3.99	5.98	3.99
453	STRIKE UP THE BAND—Bennett & Basie	6.98	4.66	5.98	3.99	5.98	3.99

CIRCLE NO. 11 ON READER SERVICE CARD



Please Specify: 4-track 8-track Cassette

Cartridge Tape Club of America
1509 S. Michigan • Chicago 60605
Dept. 8F

Here is my check for \$_____ covering the \$5 lifetime membership fee plus the _____ tapes I have ordered and circled.

Name _____
Address _____
City _____
State _____ Zip _____

316	546	556
332	547	557
333	548	558
395	549	559
405	550	560
453	551	561
532	553	562
544	554	581
545	555	

CIRCLE NO. 31 ON READER SERVICE CARD →

LOUDSPEAKERS CAN BE BEAUTIFUL!

JBL loudspeaker enclosures are designed, built, and finished to be positive decorative assets, fully compatible with the finest furniture. They come in a wide variety of styles, all as flawlessly executed as the precision JBL loudspeakers they contain. For example: **1** The elegant, powerful, bookshelf-size JBL S99 Athena with hand-carved wood fretwork grille... **2** The JBL Olympus S7R... professional studio monitor sound for the home... **3** The award-winning Nova, shelf-size contemporary concept... **4** Traditionally styled Sovereign III equipment cabinet, here flanked with a stereo pair of Sovereign II speaker systems... **5** The delightful JBL Caprice... tiltable rosewood or walnut cubes with brushed metal grilles, chrome stand... **6** The Sovereign I S8R, as close to pure perfection as any loudspeaker system ever made... **7** JBL loudspeaker components are beautiful objects in themselves — designed and precision-crafted with only one objective: total re-creation of original performance. Write for a description of the JBL 1968 collection: JBL, 3249 Casitas Avenue, Los Angeles, Calif. 90039.

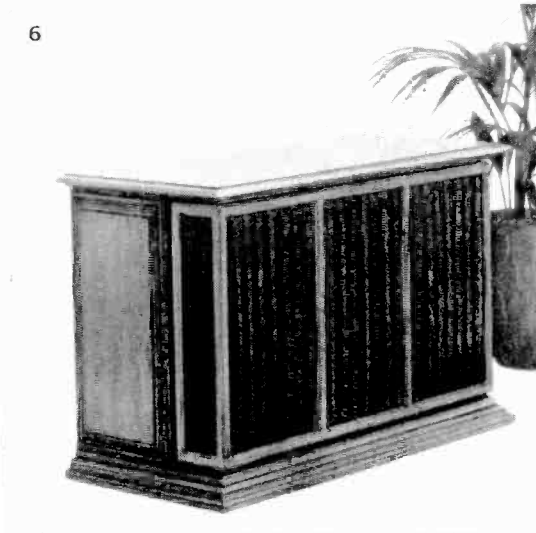
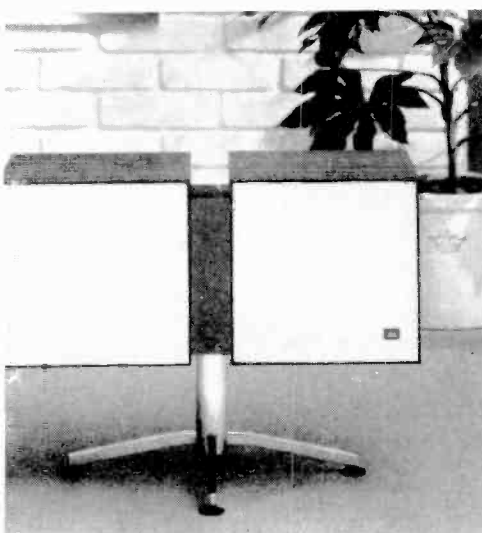
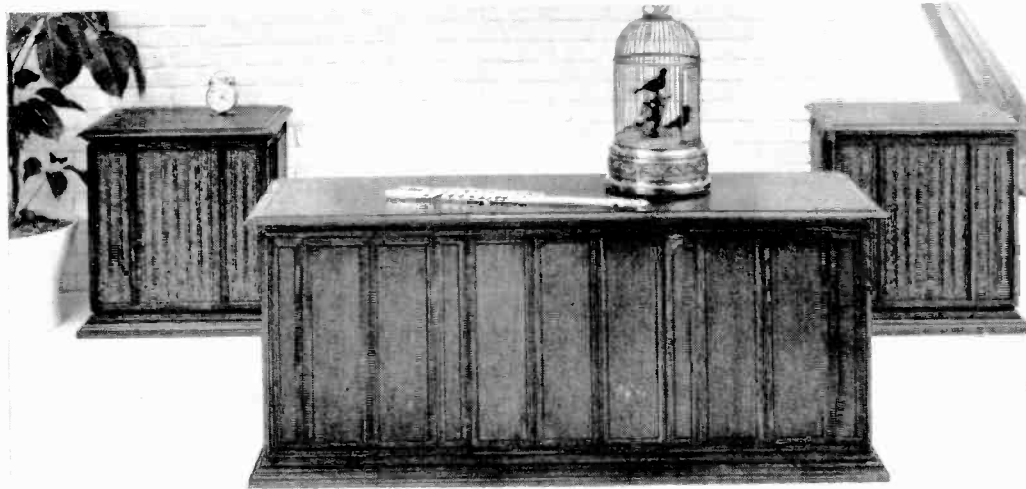
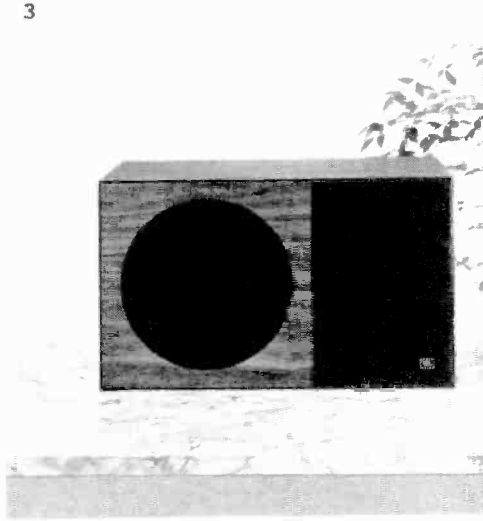
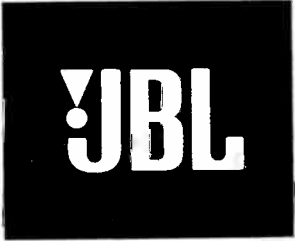

This is the long-playing cartridge

1,000-play test prove it keeps your records new... indefinitely

The Empire 999VE is the *only* cartridge that gives you laboratory-test proof that even 1,000 playbacks produce no audible sign or record wear.

With virtually weightless playback, only the 999VE gives you total record protection. High frequencies stay clean and perfect: even a 20K Hz tone is only —3 db

after 1,000 plays. Distortion is below audibility: 0.1% at a groove velocity of 14 cm/sec after a full 1,000 plays.

If you value your record collection, ask your dealer for the EMPIRE 999VE \$74.95



Empire Scientific Corp., Garden City, N.Y.

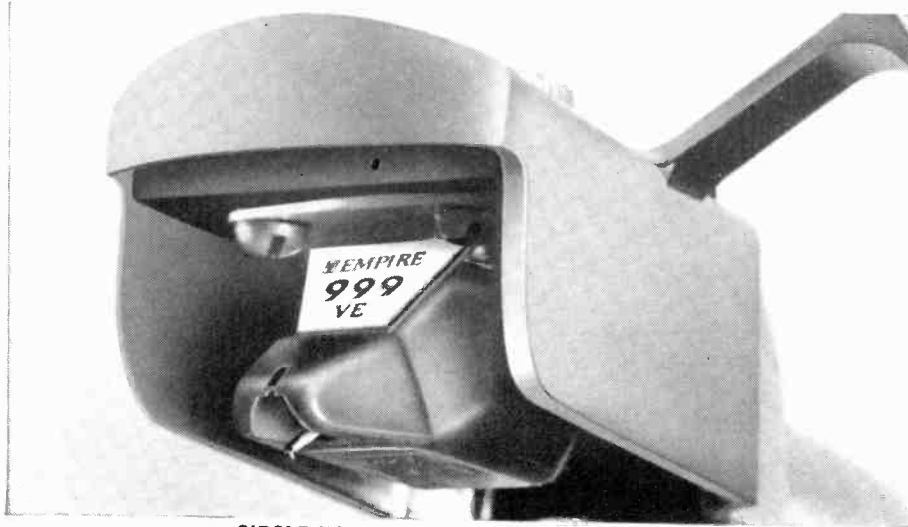

CIRCLE NO. 24 ON READER SERVICE CARD

But there are other elements in Mr. Kresh's review that must be deplored. Since when are jacket notes an art form worthy of half the space in any review? And that bit about "the same score"—the quality Mr. Kresh refers to is known as an individual style, often recognizable in serious composers. Although I have only heard thirty-one of Rózsa's eighty-four film scores, I have no trouble identifying any of them. "They all sound the same" has always been the excuse of the person who simply refuses to listen carefully.

JOHN FITZPATRICK
New York, N. Y.

Mr. Kresh replies: "Whether listed under 'classical' or 'entertainment,' the movie music of Miklós Rózsa bears the same relation to real music that fool's gold does to the real thing. I quoted the jacket notes because they revealed the empty pretentiousness of the whole project so eloquently. I, too, heard much of Rózsa's music, on the air as well as in movie palaces, during long winters in Hollywood. If anything, I am suffering not from too little exposure to the film scores of Rózsa but from too much. Even if Mr. Fitzpatrick has the marvelous gift of being able to identify them, I suspect he is confusing hollow monotony with the hallmark of style."

Boléro

● I call Martin Bookspan's personal preference in recorded *Boléros* ("Basic Repertoire," June) nothing but favoritism. Granted that Leonard Bernstein is a thoroughly dynamic interpreter of Beethoven and Mahler, a heart-warming personality, and a composer of great gifts, but this does not mean that he eclipses all other equal, if not better, conductors in the symphonic literature, where he is truly weak. Bernstein's Columbia recording of the Ravel work is, to my ears, permeated with slick showmanship and completely devoid of lasting value.

On the other hand, Mr. Bookspan dismisses Munch's most stunning rendition of *Boléro*, the second (1963) Boston Symphony Dynagroove stereo recording, by calling it "matter-of-fact and casual." Munch has long been considered by many as one of the prime exponents of Ravel's music.

VAUGHN ACKERMANN
Manchester, N. H.

Mr. Bookspan replies: "The credentials of Charles Munch as a worthy exponent of the music of Ravel have no bearing on the matter at hand. For I was reviewing the performance of *Boléro*, not Mr. Munch's reputation as an interpreter. I stand by my original characterization of the Munch *Boléro* performance as casual and matter-of-fact. If Mr. Ackermann will re-read the June 'Basic Repertoire' piece, he will find that I stated that this recording is a great disappointment to me, because I well remember several superb performances of the music that Munch conducted in the concert hall.

"Concerning my preference for the Bernstein *Boléro*, Mr. Ackermann is again off the mark: Mr. Bernstein's excellence in other repertoire does not prevent him from turning in what for me is the most acceptable performance of *Boléro* to be found in the current catalog."

(Continued on page 14)

Now YOU can buy ANY
RECORD OR TAPE
on ANY LABEL!
WORLD'S LARGEST SELECTION
AT LOWEST DISCOUNT PRICES
thru KING KAROL'S World Famous MAIL ORDER SERVICE!



NO CHARGE FOR MAILING OR HANDLING **EVER!**

THE PRICE OF THE RECORD IS ALL YOU EVER PAY! YOUR ORDER GETS INSTANT SERVICE—PROCESSED DAY RECEIVED!

KING KAROL ALWAYS HAS ALL THE RECORDS AND TAPES ALL THE TIME!

YOU NAME IT—WE'LL GET IT FOR YOU!
ORDERS PROCESSED DAY RECEIVED

List Prices	Your Price
\$1.89 to 1.98	\$1.35
2.19 to 2.60	1.65
2.79 to 2.98	1.95
3.50	2.30
3.79 to 3.98	2.50
4.79 to 4.98	3.20
5.79 to 5.98	3.90
6.79 to 6.98	4.40

TAPES — ¼ OFF CATALOG PRICE!

FREE Shipping Anywhere in USA and APO & FPO Addresses! (Add 15% for Foreign Shipments—Minimum Charge \$1.50) Send check or M.O. with order.

KING KAROL RECORDS Dept. SR8
P.O. Box 629, Times Sq. Station, New York, N. Y. 10036

Enclosed find \$ _____ Send to:
NAME _____
ADDRESS _____
CITY _____ STATE _____ ZIP _____

*N.Y. State residents please include local Sales Taxes

CIRCLE NO. 34 ON READER SERVICE CARD

CIRCLE NO. 38 ON READER SERVICE CARD →

A Marantz stereo component isn't built for the mass market.

(That's what's so good about it!)

Marantz isn't the name that most people think of first when they think of components. It's understandable. The price of Marantz equipment is simply beyond them.

On the other hand, price is the very reason a Marantz component can be as good as it is. (Nobody can give you something for nothing.)

Quite frankly, our philosophy is to let our engineers design a piece of equipment as best as they know how. Not as cheaply. (There are enough other manufacturers doing that already.)

We believe that the four superb stereo components illustrated here are the finest

performing stereo components available anywhere in the world. The Marantz SLT-12U Straight-Line Tracking Turntable (\$295). The Marantz 7T Solid-State Stereo Preamplifier Console (\$325). The Marantz 15 Solid-State Stereo Power Amplifier (\$395). And the Marantz 10B Stereo FM Tuner (\$750).

As soon as you examine these components, we know you will appreciate what goes into making a Marantz a Marantz. That's why your local franchised Marantz dealer will be pleased to furnish you with complete details together with a demonstration. Then let your ears make up your mind.



marantz[®]

Designed to be number one in performance... not sales.

HINGEPOWER, CRAZY!

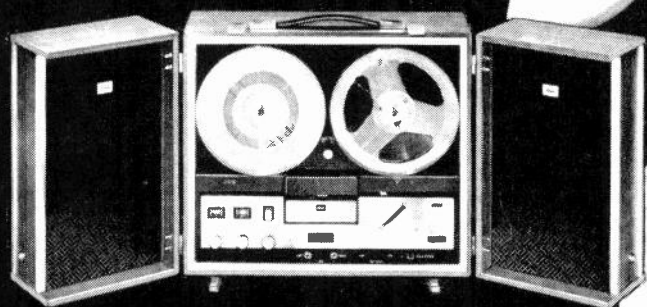

Unique Toshiba "Electro-Hinge" speaker mountings permit play in open or closed position without cables. Everything about it is just as unusual. ToshibaMatic single knob tape control for sure, one-handed operation. Live pause-edit control. Has all professional studio quality features. Walnut veneer. It's the really new Toshiba solid state 4-track stereo tape recorder.

The Genoa, GT-840S. \$219.50 Mfrs. Sugg. Retail Price.



THE INTERNATIONAL ONE

CIRCLE NO. 58 ON READER SERVICE CARD

Before you send money to any record club, join the best one for 3 months, free!



THE CITADEL RECORD CLUB

SYMPHONETTE SQUARE • LARCHMONT, N. Y. 10538

Please enroll me for 3 months, without charge or obligation, as a member of the Citadel Record Club. Prove to me that it is the one club with every single advantage and none of the disadvantages of all the others. I understand that I am entitled to all membership privileges, including large discounts on records of all labels, without any obligation to buy anything, ever.

Name _____

Address _____

City _____ State _____ Zip _____ 775-013

CITADEL RECORD CLUB

CIRCLE NO. 13 ON READER SERVICE CARD

Just in Time

● David Hall's comments in his review of Vaughan Williams' Symphony No. 6 (June) on the deterioration of current recorded sound as compared to earlier reproduction appeared just in time for me. As a classical reviewer for the Fort Wayne *News Sentinel*, I had begun to think that my equipment was shot (tests proved otherwise), my hearing was shot (tests indicated the contrary), or I was fast approaching senility (at thirty-seven?).

I didn't want to give in to the "they're-not-recording-them-like-they-used-to" syndrome, but when new recordings of major orchestras start to sound like Mantovani, I worry. Sharpness of detail, perspective, and a wide dynamic range seem to be absent from some of these releases. (Of course, every label produces superb-sounding discs, too.)

On the other hand—and this is a most discomforting thought—perhaps it's just Mr. Hall and I who are hearing this difference! Is it?

E. DAVID DEVOE
Fort Wayne, Ind.

Janáček

● It's disillusioning to learn that nobody reads liner notes—particularly when you've written them yourself. In the case of William Flanagan's review of the Angel release of an all-Janáček program (April), it seems that the notes were read, forgotten, then remembered inaccurately.

The whole point of the notes was that Janáček did *not* marry Mrs. Kamila Stössel. He remained married to his wife, who, incidentally, outlived both her husband and Mrs. Stössel. In my opinion, Janáček's rejuvenation would never have happened if he had in fact married Mrs. Stössel (as Mr. Flanagan thinks he did). It is my thesis that, denied the sexual and emotional outlets of marriage, Janáček found his creative gift triggered into extraordinary directions.

ROBERT T. JONES
Los Angeles, Cal.

Fan Mail

● I arrived home at eight P.M. tonight and picked up the May copy of your magazine. I skimmed it, enjoyed it, and plan to read it thoroughly within the week. I feel I must write to you now, however, in response to a letter to the editor by Mr. Sidney J. Claunch which you captioned "The Subjectivity of Criticism." I disagree thoroughly with Mr. Claunch that, if we wanted only guidance from your record reviews, we'd prefer a panel of judges rating each record from "Loved it" to "Hated it," and that what we are really after is moral support for our opinions. Of course I have prejudices, and I love it when yours jibe with mine, but I think my greatest delight comes from what I learn from the reviews. My training in musicology is sparse; I have little time to check things in *Grove's Dictionary*, and even less time to listen to numerous recordings of the same piece. Most of your reviews suggest new critical views of a piece or remind me of things I've forgotten. I look to your reviewers for guidance and for education, tempered always by the knowledge that in the long run my own preferences, made more sophisticated, I hope, will prevail.

JUDITH A. HUNT
Berkeley, Cal.

HIFI/STEREO REVIEW

If saving money sounds "in" to you, you ought to hear the sounds of University.

High quality, fair price. That's what makes University the "in" line. If the quality is no good... why even bother about the price, right? Right! But if the quality is outstanding, wouldn't you like to save a little more too? Then you owe it to yourself and your pocket-book to check out University speakers. Here's how to do it the hard way:

Take any one of University's many speaker systems. For example, try the luxurious Sorrento or the classic-style Mediterranean. Ask your dealer to play either one along side another speaker listed at the same price. Next, compare University's quality with a little higher priced speaker. Then try still a higher priced speaker. Your ears will tell you to stop comparing, and your eyes will tell you the bargain you got.

If you go along with the idea that saving money is "in", even with hi-fi equipment, you'll be amazed at how sensational University speakers really do sound, dollar-wise and sound-wise.

While you're at it, check out University's one and only Studio Pro-120 Solid-State FM/Stereo Receiver. The specs are so unbelievably good, we had them certified by an independent testing lab. They meet or beat any of the top-of-the-line receivers of the Big 5, at a most attractive middle-of-the-line price!

Now you know why University is the "in" line. Check it out. It's a good way to cash in.



UNIVERSITY[®] SOUND
A DIVISION OF LTV LING ALC. INC.
9500 West Reno • Chickasha City, Oklahoma 73126

UNIVERSITY saving money never sounded better

CIRCLE NO. 61 ON READER SERVICE CARD

NEW PRODUCTS

A ROUNDUP OF THE LATEST HIGH-FIDELITY EQUIPMENT

● **Bose** has introduced a novel stereo speaker system, the Model 901, which radiates 89 per cent of its sound output indirectly to simulate the acoustic characteristics of live music. The speakers (sold only in pairs) come with an a.c.-powered, solid-state "Active Equalizer," which electronically alters the inherent frequency characteristics of the system to achieve the flattest response. The equalizer is connected between the preamplifier and the power amplifier—or to the tape-output and tape-input jacks of a receiver or integrated amplifier. In the latter arrangement, the tape recorder is then connected to the equalizer, which has its own switching for tape-monitoring. The equalizer has multi-position switches for contour-

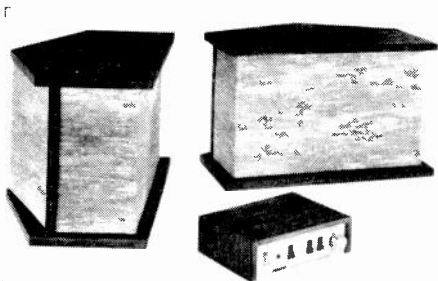

ing of the mid- and high-frequency response curves. There is also a low-frequency filter switch.

Each of the pentagonal speaker enclosures contains one driver facing forward, and eight others radiating from the two angled rear panels. All nine drivers are identical, having 4-inch, high-compliance cones and 10-ounce ceramic magnets. All are driven with the same signal; there are no crossover networks. Overall frequency response in an average room is 25 to 20,000 Hz. Power-handling capacity of the system is 200 watts per channel; minimum power required is 20 watts per channel. Overall dimensions of the speakers are $12\frac{3}{4} \times 20\frac{1}{16} \times 12\frac{7}{8}$ inches. The equalizer control box measures $2\frac{3}{4} \times 9\frac{1}{4} \times 6\frac{3}{4}$ inches. Price for two speaker systems and equalizer control box: \$476.

Circle 149 on reader service card

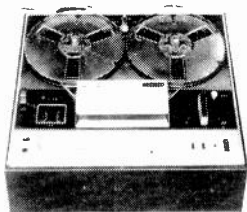

● **Sony's** Model TC-355 is a solid-state, quarter-track stereo tape deck for use with home stereo systems. The three-head machine has three speeds ($7\frac{1}{2}$, $3\frac{3}{4}$, and $1\frac{7}{8}$ ips) and can be operated either vertically or horizontally. Frequency response is 20 to 22,000 Hz at $7\frac{1}{2}$ ips, 20

to 17,000 Hz at $3\frac{3}{4}$ ips, and 20 to 9,000 Hz at $1\frac{7}{8}$ ips. The signal-to-noise ratio is 52 dB. Wow and flutter are 0.09 per cent at $7\frac{1}{2}$ ips, 0.12 per cent at $3\frac{3}{4}$ ips, and 0.17 per cent at $1\frac{7}{8}$ ips. The deck has a special flutter filter between the erase and record heads and a pinch roller that retracts into the surface of the deck to simplify tape loading. The transport is controlled by a single large bar lever and a separate pause control. The record-level controls and the microphone-input jacks are concealed beneath a sliding door on the deck's top panel. Two slide switches permit monitoring either the tape or the input on each channel. There is a stereo headphone jack and a four-digit, pushbutton-reset tape counter. A switched high-fre-

quency filter is provided to eliminate tape hiss. The deck comes installed on a walnut-finish base. Price, with dust cover: less than \$229.50.

Circle 150 on reader service card



● **RCA** has introduced the "Starmaker" line of dynamic microphones. The Starmaker 96 (shown) has a cardioid pick-up pattern and a frequency response of 50 to 15,000 Hz. It has a three-position bass roll-off switch and a five-pin connector that can be reversed to provide an output impedance of 200 or 15,000 ohms. The microphone comes with a windscreen, a slip-on swivel mount, 20 feet of shielded cable, and a carrying case. Its overall dimensions are: $9\frac{3}{4}$ inches long and $1\frac{1}{2}$ inches in diameter. Price: \$50. The Starmaker 97 has the same specifications as the 96, but comes with an on/off switch and without the bass roll-off switch. It is $7\frac{1}{2}$ inches long and 2 inches in diameter. Price: \$40.

The Starmaker 98 has an omnidirectional pick-up pattern and a frequency response of 40 to 17,000 Hz. It has an on/off switch and a reversible connector for either 200- or 15,000-ohm output impedance. It comes with a windscreen, slip-on fixed mount, 20 feet of cable, and a carrying case. The Starmaker 98 is 8 inches long and 2 inches in diameter. Price: \$40.

The Starmaker 99 is a low-impedance cardioid microphone with a frequency response of 80 to 10,000 Hz. It has an on/off switch that can be used to control tape recorders having remote-control capabilities. It comes with a plastic desk stand and 6 feet of cable and measures 5 inches in length and 1 inch in diameter. Price: \$8. The Starmaker 100 is high impedance with an omnidirectional pick-up pattern and a frequency response of 100 to 8,000 Hz. It has the same features and dimensions as the 99, but is constructed of metal instead of plastic. Price: \$8.

Circle 151 on reader service card

● **Jensen's** new TF-3B is a four-driver, three-way speaker system with a frequency response of 25 to 20,000 Hz. The enclosure is a modified acoustic-suspension design of bookshelf size. The drivers are a Jensen Flexair 10-inch woofer, two $3\frac{1}{2}$ -inch mid-range units, and a Sono-Dome phenolic-diaphragm tweeter. Crossover frequencies are 2,000 and 10,000 Hz. Input impedance is 8 ohms, and

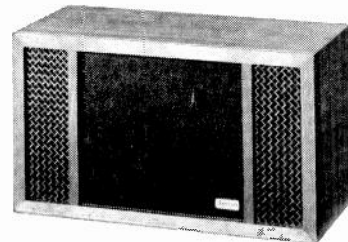

amplifier power required is 10 to 25 watts. A continuously variable tweeter-level control is on the back of the enclosure. The TF-3B is finished in walnut and measures $13\frac{1}{2} \times 23\frac{3}{4} \times 11\frac{3}{8}$ inches. Price: \$122. The system is also available in unfinished walnut for \$109.

Circle 152 on reader service card

(Continued on page 20)

Now...in every price range, every tracking force range

from \$67.50 to \$25.00...

from $\frac{3}{4}$ grams to 5 grams

With the introduction of our extremely low cost new M32E elliptical stylus cartridge (\$25.00 net, $2\frac{1}{2}$ to 5 gms. tracking, 20 to 17,500 Hz), and M31E elliptical stylus cartridge (\$27.50 net, 1 to 2 gms. tracking, 20 to 18,000 Hz), you can now get Shure quality in the broadest possible spectrum of prices and specifications. Given our "druthers", we would prefer you bought the Shure V-15 Type II Super Trackability cartridge at \$67.50. We feel it's the world's finest cartridge, and independent critics the world over agree with us. However, if your equipment or your exchequer dictates another cartridge, be assured that Shure makes a really complete line of best-in-their-price-class cartridges. Note for instance, the impressive line-up of elliptical styli cartridges below. Detailed literature on the *complete* Shure group with the reason for each is available at no cost: Shure Brothers, Inc., 222 Hartrey Ave., Evanston, Illinois, 60204.

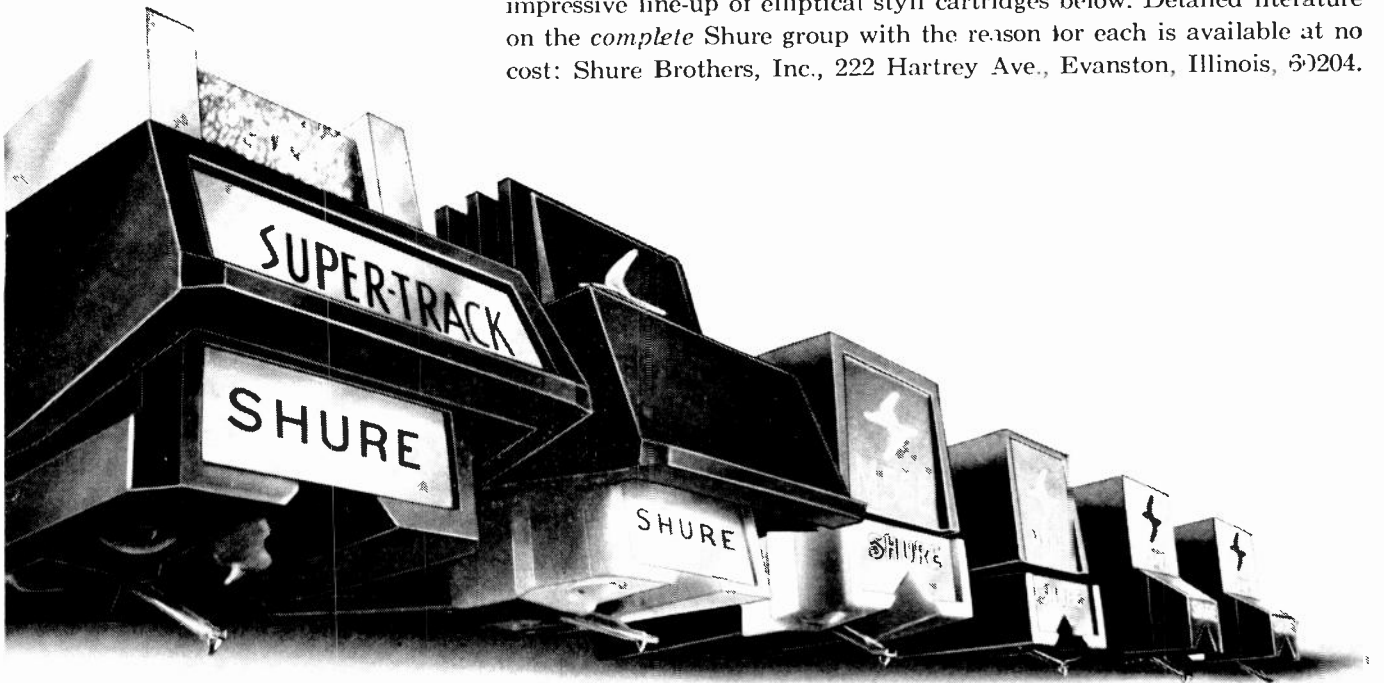

V-15 TYPE II
\$67.50
 $\frac{3}{4}$ to $1\frac{1}{2}$ gms.

M75E
\$39.50
 $\frac{3}{4}$ to $1\frac{1}{2}$ gms.

M55E
\$35.50
 $\frac{3}{4}$ to $1\frac{1}{2}$ gms.

M44E
\$34.50
 $1\frac{3}{4}$ to 4 gms.

M31E
\$27.50
1 to 2 gms.

M32E
\$25.00
 $2\frac{1}{2}$ to 5 gms.

NEW PRODUCTS

A ROUNDUP OF THE LATEST HIGH-FIDELITY EQUIPMENT

- **Craig's** Model 3203 "Four Plus Four" is a complete, a.c.-powered, four-/eight-track stereo tape-cartridge play-



back system with built-in solid-state amplifiers and a pair of external speaker systems. The transport will play either four- or eight-track cartridges automatically. Track switching is automatic; an indicator lights to show which track is being played. Controls include two pushbuttons for program selection and cartridge eject. Three knobs control volume, balance, and tone. Specifications include a frequency response of 70 to 10,000 Hz, a signal-to-noise ratio of better than 45 dB, and stereo separation of 35 dB. Amplifier power output is rated at 6 watts per channel. Wow and flutter are less than 0.25 per cent. The tape transport-amplifier unit measures $9\frac{1}{2} \times 4 \times 11\frac{1}{2}$ inches. The speakers each measure $9\frac{1}{2} \times 11\frac{1}{2} \times 4\frac{1}{2}$ inches. Price: \$144.95.

Circle 153 on reader service card



- **Uher's** 4400 is a quarter-track stereo version of the 4000L portable tape recorder. It can be powered by five "D" cells, nickel-cadmium batteries, an automobile battery, or the 120-volt a.c. line. The recorder has four speeds ($7\frac{1}{2}$, $3\frac{3}{4}$, $1\frac{7}{8}$, and $\frac{1}{16}$ ips) and capstan drive with an eight-transistor speed-control circuit. Reel diameters up to 5 inches can be accommodated. The frequency response is 40 to 20,000 Hz at $7\frac{1}{2}$ ips, 40 to 17,000 Hz at $3\frac{3}{4}$ ips, 40 to 10,000 Hz at $1\frac{7}{8}$ ips, and 40 to 4,500 Hz at $\frac{1}{16}$ ips, all within ± 2 dB. Signal-to-noise ratio is 50 dB and wow and flutter are ± 0.1 per cent rms. The recorder has two built-in 1-watt power amplifiers and one speaker with an output jack for the connection of a second speaker. There is a three-digit pushbutton-reset tape counter. The transport uses piano-key controls for rewind, play, pause, record, stop, and fast-forward. Each channel has a recording-level meter, one of which also serves as a battery-condition indicator. There are input jacks for microphone, radio, and phono, and output jacks for an earphone and connection to an external power amplifier. Another jack is provided for connection to either foot- or hand-operated remote-control units. Price: \$450. Among the many accessories available are a rechargeable battery for \$20; cardioid microphone with windscreens and start-stop switch, \$60; and foot-operated remote control, \$17.

Circle 154 on reader service card

- **Allied Radio's** Model 365 solid-state AM/stereo FM receiver is rated at 65 watts IHF music-power output, 25 watts continuous-power output per channel at 8 ohms. Power bandwidth is 15 to 30,000 Hz and harmonic distortion is less than 1 per cent at rated output. IM distortion is 1 per cent; hum and noise are -60 dB at the magnetic-

phono inputs, -75 dB at the high-level inputs. FM-tuner sensitivity is 2 microvolts (IHF). Other specifications include a capture ratio of 2.5 dB, stereo separation of 35 dB at 1,000 Hz, and a signal-to-noise ratio of 65 dB. Stereo FM switching is automatic; an indicator lights when the receiver is tuned to a stereo broadcast.

Controls include a six-position selector switch, power on/off, a four-position speaker-selector switch, balance, volume, separate bass and treble controls for each channel, and a six-position tape monitor/mode switch. Three rocker switches control loudness compensation, AFC, and



high-frequency filter on/off. A front-panel headphone jack is provided. The signal-strength tuning meter works on both AM and FM. A built-in safety circuit protects the output transistors against short circuits. Overall dimensions of the receiver are $5 \times 16 \times 12$ inches. Price, with metal case: \$229.95. A wood case is \$19.95.

Circle 155 on reader service card

- **Teac's** Model A-4010S solid-state, quarter-track two-speed stereo tape deck has three motors and automatic reverse. The reversing mechanism uses a foil-sensing system and works only on playback. Frequency response is ± 5 to 15,000 Hz ± 2 dB at $7\frac{1}{2}$ ips, 50 to 7,500 Hz ± 3 dB at $3\frac{3}{4}$ ips. Wow and flutter are 0.12 per cent at $7\frac{1}{2}$ ips, 0.15 per cent at $3\frac{3}{4}$ ips. Other specifications include a signal-to-noise ratio of 55 dB, channel separation of 50 dB, and a fast-wind time of approximately 100 seconds for a 1,200-foot reel of tape. The deck has a four-digit, pushbutton-reset tape counter. Each channel has input



jacks and independent recording-level controls for microphone and high-level line signals. There are two VU recording-level meters. Pushbuttons are used to control the transport, select the tape speed, and to adjust the tape tension for the thickness of the tape. A slide switch permits monitoring either the tape or the input signal. There are output jacks for a stereo headphone and connection to an external power amplifier. The transport shuts off automatically at the end of the tape. The deck comes installed in a wooden cabinet and measures $17\frac{1}{2} \times 17\frac{1}{2} \times 9\frac{3}{4}$ inches. Price: \$169.50.

Circle 156 on reader service card

6 reasons why the new Jensen TF-3B should be your next bookshelf speaker

1. It's Great Sound in a Compact Size

The TF-3B proves that impressive sound can come in a compact enclosure. The popular shelf

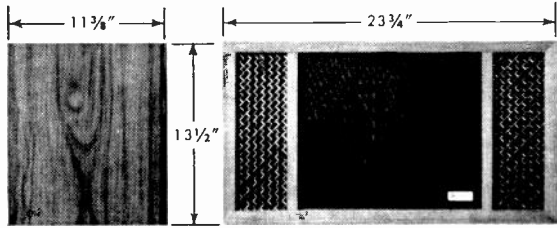

size gives you true high fidelity anywhere—home, studio, lounge or theatre.

2. It's a 4-Speaker 3-Way System

The TF-3B uses four speakers to provide flawless reproduction of the entire sound spectrum.

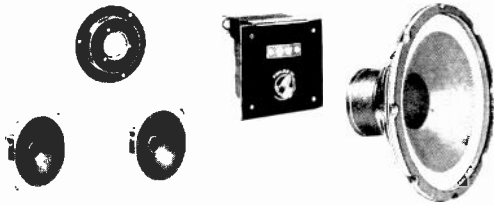

A 10" FLEXAIR® Woofer supplies massive well-damped low tones from 2000 cps. to below 25 cps. In the middle register, 2000 to 10,000 cps., clean smooth output is achieved with two special 3½" direct radiator units. Crystal clear uniform highs from 10,000 to beyond 20,000 cps. result from the exclusive Jensen SONO-DOME® direct radiating dome-type ultra-tweeter.

3. It has an Air Suspension Bass Superflex Enclosure

A specially designed airtight acoustic enclosure,

with tube-loaded vent, provides a distortion-free l-f range. For this size bookshelf system, research has proven the superiority of the TF-3B's tube-loaded vented enclosure.

4. It has the famous FLEXAIR Woofer

One of the big secrets in the TF-3B is its outstanding low frequency performance. Amplitudes must be large for the lower frequencies and the FLEXAIR Woofer permits a total motion in excess of ¾ inches . . . without distortion!

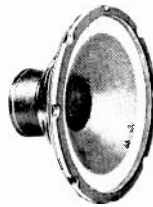

5. It's excellent for Mono or Stereo

With the TF-3B you can obtain fine mono reproduction. Two TF-3B's make a superb stereo system. Place cabinets six to eight feet apart. Cabinets can be set on end or horizontally.

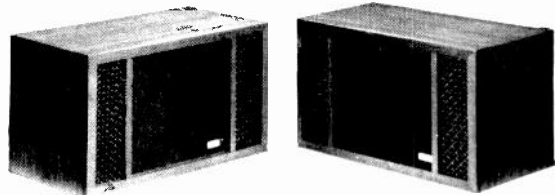

6. It's Fine Furniture

A handsome walnut cabinet makes this system compatible with every room decor. Attractive grille complements the wood grains. . . . \$122.00 Also available unfinished—rattan grille, perimeter frame \$109.00

There's more to tell . . . get the full TF-3B story from your Jensen dealer or write, Jensen Manufacturing Division, The Muter Company, 5655 West 73rd Street, Chicago, Illinois 60638.

jensen

Jensen Manufacturing Division, The Muter Company, 5655 West 73rd Street, Chicago, Illinois 60638
CIRCLE NO. 32 ON READER SERVICE CARD

Two Great Music Makers Get Together



KENWOOD TK-140 . . . Solid state, stereo, AM/FM automatic receiver with Field Effect Transistor and 130 watts of power, enjoys the acclaim of music lovers everywhere. The performance and beauty of this exceptional instrument are evidence the engineering genius behind TK-140 knows the importance of creative and technical control, as well as the consistent attention to detail essential to achieve superior results.



MAURICE JARRE . . . Composer of the musical scores for "Lawrence of Arabia" and "Dr. Zhivago," both Academy Award winners, is perhaps the most in-demand composer in the world. His genius also created the scores for "Grand Prix" and other screen, television and stage successes. This gifted young man knows the importance of control over talent and technique, and the attention to detail essential to achieve superior results.

the sound approach to quality



KENWOOD

3700 S. Broadway Plc., Los Angeles, Calif. 90007

69 41 Calamus Avenue, Woodside, N. Y. 11377

Exclusive Canadian Distributor — Perfect Mfg. & Supplies Corp.

CIRCLE NO. 33 ON READER SERVICE CARD

Be an expert on how to select the best automatic turntable.

A true hi-fidelity automatic turntable is a precision built mechanism with many many parts, each of which has a very special function to perform. Very often, to save money in manufacturing, some companies either compromise on the quality of these parts, or leave certain of them out. The turntable will still operate of course but forget about getting maximum high-fidelity. How can you tell when a turntable has everything? Use our BSR McDonald 600 as an example of perfection. It has all of these essential features that a professional quality automatic turntable must have to insure peak performance.

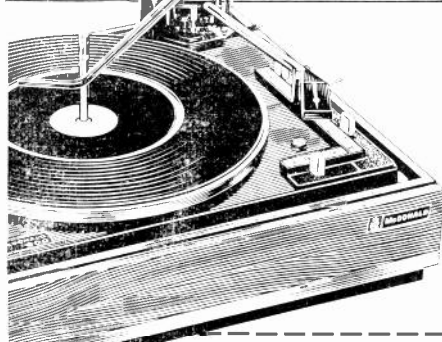

Please send FREE detailed literature on all BSR McDonald automatic turntables.

Name _____
 Address _____
 City _____ State _____ Zip _____



McDONALD

PRECISION CRAFTED IN GREAT BRITAIN
 BSR (USA) LTD., BLAUVELT, N.Y. 10913
 CIRCLE NO. 6 ON READER SERVICE CARD

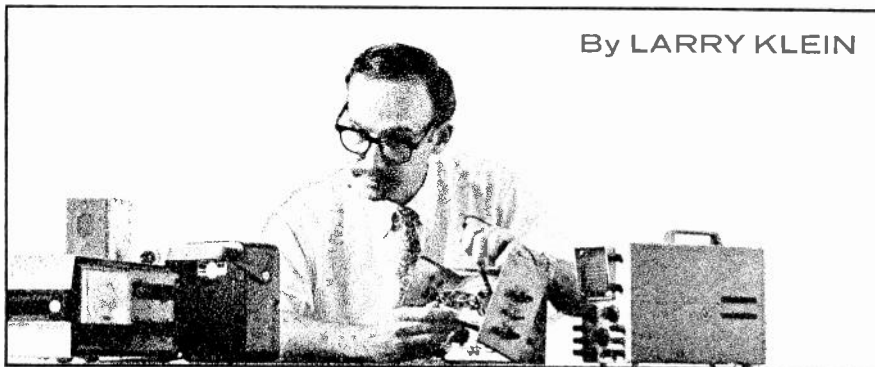

By LARRY KLEIN

HIFI QUESTIONS & ANSWERS

Bookshelf-Speaker Installation

Q. I want to install a pair of bookshelf speakers in a pair of Mediterranean-style commodes that are in my living room. The door panels have a grillwork backed up by a tapestry type of material. Is it possible to put a bookshelf system in such a piece of furniture without degrading its sound? If so, how do I go about it?

DON E. FRANCISCO
 Chapel Hill, N.C.

A. There are several things to watch out for. Unless you intend to use the speakers only when the commodes' doors are open, you must make sure that there is not excessive blockage of the speaker's radiators by the door of the cabinet. In most furniture of the kind you describe, the cloth behind the grille is a heavy fabric that is fairly opaque to high frequencies. In such a case, replace the fabric with a suitable open-weave material. You can check to see whether treble losses occur with the new fabric by playing music that has a strong treble content (cymbals, triangles, etc.) or by using interstation noise from your FM tuner. Listen to the speakers with the doors both open and shut. It may be that by turning up the tweeter control on your speakers you will be able to make up for any losses caused by an excessively heavy door fabric.

Install each speaker as close to the front door of the commode as possible. This will avoid exciting cavity resonances within the compartment in which the speaker is sitting. But it may be necessary to pack fiber glass in the areas along the sides of the speaker to prevent imparting a sort of boomy, hollow coloration to the sound. You can check this by playing a mono program alternately through one speaker inside the commode and the other one outside it. Switch between the two speakers with your amplifier's balance control and note any differences in sound quality. You may also want to have the speaker system sit on a 2- to 3-inch layer of plastic or rubber foam to prevent rattles or buzzes caused by transmission of vibration to the commode.

Why Preamplify?

Q. What is a preamplifier and why is it necessary?

EVERITT CHILDS
 Boston, Mass.

A. A preamplifier, as its name indicates, is intended to amplify (and modify the frequency characteristics) of an audio signal before it reaches the remainder of the amplifier. The preamplifier may be part of a receiver or an integrated amplifier, or it may be a separate component.

As it is now used, the term is somewhat imprecise because it also covers the tone-control and switching func-

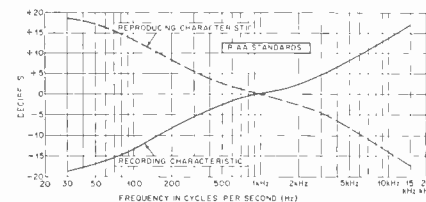

tions. Originally the expression referred only to the circuits that provided the extra amplification and the special frequency equalization required by magnetic phonograph cartridges. Magnetic cartridges have an output of perhaps 0.003 volt (3 millivolts) while an FM tuner may have an output 100 times as great, or 0.3 volt. It is the task of the preamp to make up this difference and at the same time to compensate for (or equalize) the special "tilted" frequency-response characteristic built into the phonograph record.

Records are cut with a non-flat frequency response for two reasons:

1. To minimize the high-frequency surface noise during playback, the highs recorded on discs are boosted (about 14 dB at 10,000 Hz). In playback, the preamplifier supplies a complementary high-frequency cut (treble roll-off) that greatly reduces the record-surface noise while restoring a flat response.

2. At the other end of the frequency spectrum, the low-frequencies, or bass notes, are cut back greatly (about 12 dB

(Continued on page 26)

There's nothing unusual about paying \$370, \$400 or \$450 for a Fisher compact stereo system. We've sold thousands at those prices.

But the new Fisher 120 FM stereo radio/phono system costs much less than that. It sells for only \$299.95.* It's the first compact Fisher stereo system ever priced under \$300.

And it contains the same features that made more expensive Fisher compacts worth their price.

The receiver is solid-state and delivers 40 watts music power (IHF). It's virtually free of distortion.

The 4-speed automatic turntable comes with a magnetic cartridge and diamond stylus.

And the system includes a pair of Fisher's new XP-55B 2-way speaker systems, which reproduce the audio spectrum from 37 Hz to 20,000 Hz. (The speakers alone sell for \$49.95 each.)

By now you may be wondering how we are able to manufacture this stereo compact for such a low price.

Manufacturers are also wondering.

(For more information, plus a free copy of the Fisher Handbook 1968, an authoritative 80-page reference guide to hi-fi and stereo, use coupon on page 27.)

Introducing the first Fisher compact under \$300.



The Fisher 120

*ALSO AVAILABLE, THE FISHER 125, IDENTICAL TO ABOVE BUT ALSO INCLUDING AM, \$329.95.

FISHER RADIO CORPORATION, INC., 11-35 45TH ROAD, LONG ISLAND CITY, N. Y. 11101 OVERSEAS AND CANADIAN RESIDENTS PLEASE WRITE TO FISHER RADIO INTERNATIONAL, INC., LONG ISLAND CITY, N. Y. 11102.



You can even hear the violinist breathing.

Put a Rectilinear speaker to every listening test.

Jungle drums. Cymbals. Bells. Anything. We're not test shy.

Guitar music? You'll hear the finger snap across the string. Most speakers aren't sensitive enough to pick-up split second sounds like that.

1812 cannons? We'll give you real boom. Without "boom". Rectilinear tells it like it is.

So does Hi-Fi Stereo Review*.

They said, "In our opinion, we have never heard better sound reproduction from any speaker of any size or price".

When you get straight talk like that from the professionals, you really ought to listen.



A Development of Rectilinear Research Corp., 30 Main Street, Brooklyn, N. Y. 11201

*Julian Hirsch Equipment Reports, Hi-Fi Stereo Review, Dec., 1967

CIRCLE NO. 47 ON READER SERVICE CARD

at 100 Hz; in the signal engraved on the disc. This is done because if the bass notes were recorded on the disc in their full strength, the record groove would swing too widely for the phono stylus to follow it easily. In addition, not only would there be less playing time on the record, but there would be a danger of breakthrough between adjacent grooves. As with the treble frequencies, the pre-amplifier restores the original signal balance by providing the proper amount of bass boost.

The goal of frequency equalization is a "flat" or even response over the frequency range covered. For many years now recording companies have equalized their discs to be played back with the RIAA (Record Industry Association of America) compensation curve shown on page 24.

Slow-Blow Fuses

Q. The instruction manual for my power amplifier says that if the line fuse blows, it must be replaced with a special "slow-blow" fuse. Why is this so? I thought that if an amplifier had a short circuit, its fuse should blow as fast as possible.

ANTON BRUDER
Pittsburgh, Pa.

A. You are right—the fuse should blow as fast as possible if the amplifier has a short circuit. The problem is this: when an amplifier with a silicon-diode power supply (and this includes all transistor amplifiers) is first turned on, there is a very large surge of current drawn from the a.c. line. This occurs because of the charging current of the large capacitors used in the power supply of the amplifier. Since, with the usual amplifier, the current drawn from the a.c. line at the moment of turn-on may be several times the amplifier's normal rating, the only way to prevent premature blowout of the fuse is to use a fuse that has, in effect, a built-in time delay. Long-term, high-current drain or very high current drain such as would result from a short circuit will therefore blow the fuse while short-term high-current drains (at turn-on) will not.

Incidentally, the fuses used in speaker lines or in the circuits of the driver or output transistors should be of the fast-action type. It is therefore important when making replacements not only to install a fuse with the correct amperage rating, but also one with the proper characteristics. Use the exact type number recommended by the manufacturer.

Because the number of questions we receive each month is greater than we can reply to individually, only those questions selected for this column can be answered. Sorry!

Introducing the first Fisher AM-FM stereo receiver under \$329.95.

\$80 under.

Fisher makes a number of AM/FM stereo receivers. They all cost \$329.95 or more. With the exception of the new solid-state Fisher 175-T receiver at \$249.95*.

The 175-T is almost as powerful and virtually as sensitive as the other Fisher AM/FM stereo receivers.

The amplifier has 65 watts IHF music power (at 8 ohms!), which is enough to drive nearly all bookshelf speakers at full volume without distortion.

The FM-tuner section has 2.0 microvolts sensitivity. The AM tuner section has 10 microvolts sensitivity. Both are sensitive enough to bring in weak

signals as if they were strong, local stations.

We included two FET's and two IC's. And we incorporated the important Fisher exclusives, such as our patented Stereo Beacon**, which signals the presence of stereo stations and automatically switches to the stereo mode, and our exclusive Transist-O-Gard® overload protection circuit. The control panel is exceptionally versatile.

It would take a well-trained ear to tell the new



Fisher receiver apart from our other models, when connected to a pair of bookshelf speaker systems.

So if there's any doubt which one you're listening to, check the price tag.

The Fisher® 175-T



Mail this coupon for your free copy of The Fisher Handbook 1968. This 80-page reference guide to hi-fi and stereo also includes detailed information on all Fisher components.

Fisher Radio Corporation
11-35 45th Road
Long Island City, N.Y. 11101

Name _____

Address _____

City _____ State _____ Zip _____ 028681

*Walnut cabinet, \$24.95.

**U.S. Patent Number 3290443.

©Registered trade mark of the Fisher Radio Corporation.

a special
report...



Switchcraft ends the mix- up over Sound Mixers

Confused as to what a sound mixer should do for your sound system? Or wondered why some mixers cost only a few dollars while others run into the hundreds?

Get all the facts from Report 307TR direct from Switchcraft's Research Dep't. Find out why you should have a pre-amp mixer... why equalization for magnetic phono cartridges is a must... the advantages of a stereo/monaural mixer, plus many other searching questions that will help you decide on the equipment that's best for your sound system.

The report is free. So is a look at Switchcraft's Studio Mix MASTER 4-channel, stereo/monaural sound mixer at your local dealer.

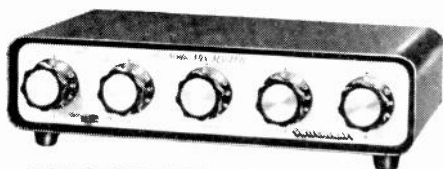

MIXER SPECIFICATIONS:

- * Portable, battery powered, with completely solid state circuitry.
- * Four channels, accepts 1 to 4 monaural inputs or up to 2 stereo inputs. Separate volume control per channel plus master volume control.
- * Two channels equalized for monaural or stereo magnetic phono cartridges. Auxiliary inputs for high level input signals.
- * Distortion 1% max. at 1.5 v. output. Frequency response 20Hz to 20KHz. Signal to noise ratio 60 db referred to 1 mV. input. Up to 2 v. R.M.S. output.

GET AN INDEPENDENT PERFORMANCE REPORT ON SWITCHCRAFT'S MIX MASTER PUBLISHED BY AUDIO MAGAZINE. WE'LL GLADLY SEND IT ALONG WITH OUR REPORT 307TR.

SWITCHCRAFT

5597 N. ELSTON AVE.
CHICAGO, ILLINOIS 60630

CIRCLE NO. 55 ON READER SERVICE CARD

By HANS H. FANTEL



AUDIO BASICS

LOUDNESS OR CONTOUR CONTROLS

IF it can be agreed that the whole point of high fidelity is "natural" sound, then it follows that it is best to hear reproduced music at the same subjective volume as you would in the concert hall. But this doesn't mean that your speakers must pump out as much energy as a symphony orchestra. After all, your living room is a lot smaller than the concert hall. What matters is that the level of sound *at your ears* should be about the same as it would be if you were sitting in a good seat at a concert. But those non-music lovers next door may have other things for their ears to do, and understandably ask that you turn down the volume. When you do, something odd happens. The music doesn't just get softer; its tonal balance changes too. The orchestra suddenly sounds as if the cellos and basses had gone on strike, leaving the sound texture without its due weight and sonority.

Why should a change in volume also bring about a change in the character of sound? The reason lies in a peculiar quirk of human hearing known as the Fletcher-Munson effect—named after the two American scientists who explored it by audiometric techniques. They discovered that, at different volume levels, the frequency sensitivity of the ear changes radically: as the sound is made softer, we tend to hear much less bass and a little less treble.

If the original music itself is soft, this subjective loss of lows is part of the intended musical effect—the psychological quality of a *pianissimo* depends partly on the way the ear registers soft sounds. But if the original music is loud and the volume is reduced in playback, the same subjective factor distorts its psychological effect.

Fortunately, audio engineers have come up with a special kind of tone control to counteract this tricky volume/frequency nonlinearity in sensory perception. Known as loudness compensation, or contour, this circuit is found in a number of amplifiers. Its principle is simple: it is intended to boost the bass at low volume by approximately the same amount that the human ear suppresses it. The net result, ideally, is that the subjective impression of the music remains realistic, regardless of the volume at which you play it. You switch on the loudness control (usually with a slide switch) and, presumably, you can achieve both frequency-range balance and peace with the neighbors.

The hitch is that not everyone's hearing conforms perfectly to the Fletcher-Munson average, and the loudness-compensation circuit is designed with the "average" hearing characteristic in mind. This is akin to fitting everyone with an average-size shoe. Furthermore, there is no certainty that the program is being played back at the volume for which the compensation curve was calculated. Obviously, any amplifier that has loudness compensation should also have some provision for switching it out. Otherwise the combination of high playback volume and low volume-control setting (caused by a strong input signal and high-efficiency speakers) may produce boomy, muddy sound. If, for these reasons, the results don't seem satisfactory, you can roughly adjust loudness compensation to your own taste by boosting the bass (and perhaps the treble also, but only very slightly) with the regular tone controls to the point where the music sounds full and properly balanced to you.

Introducing the Fisher twofers.

A Fisher twofer isn't some kind of hybrid between a tweeter and a woofer.

It's the very low-priced XP-44 bookshelf speaker system. So low priced, in fact, that it costs only half the \$89 you'd expect to pay for a 2-way Fisher speaker which reproduces the audio spectrum from 39 to 18,000 Hz. without peaks.

The twofer has a 6-inch woofer with a 2-pound magnet, and a 2½-inch

tweeter with a low-mass cone. It weighs just 15 pounds.

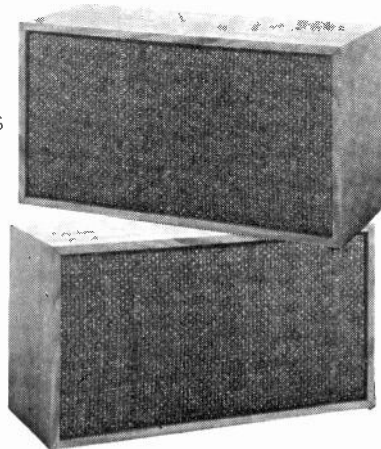

At last a Fisher speaker so inexpensive you can afford two!

(For more information, plus a free copy of The Fisher Handbook 1968, an authoritative 80-page reference guide to hi-fi and stereo, use coupon on page 27.)

**The Fisher
XP-44's.
Two for \$89.**

Fisher Audio Company, 10000 Wilshire Blvd., Beverly Hills, CA 90210. © 1968 Fisher Audio Company.

from the world's finest stereo receiver...

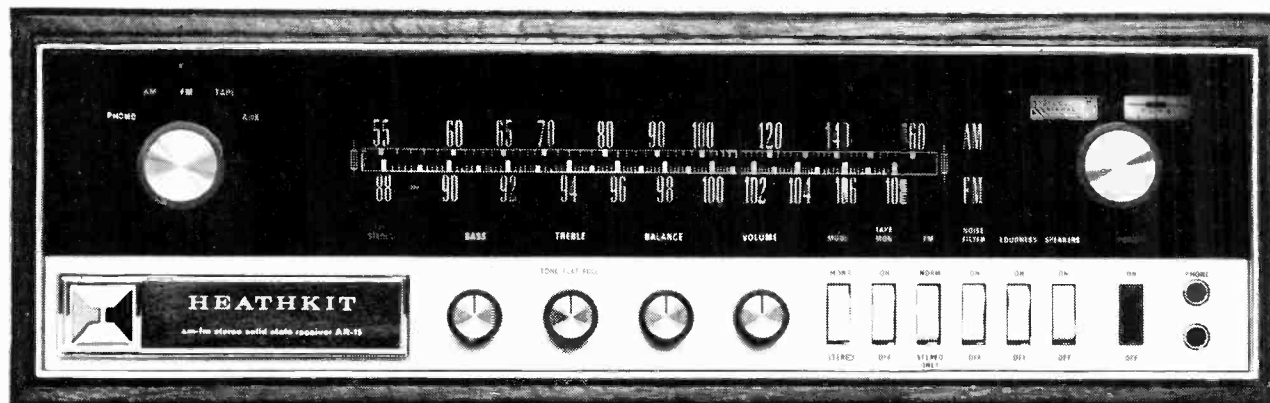

comes the world's finest stereo tuner...

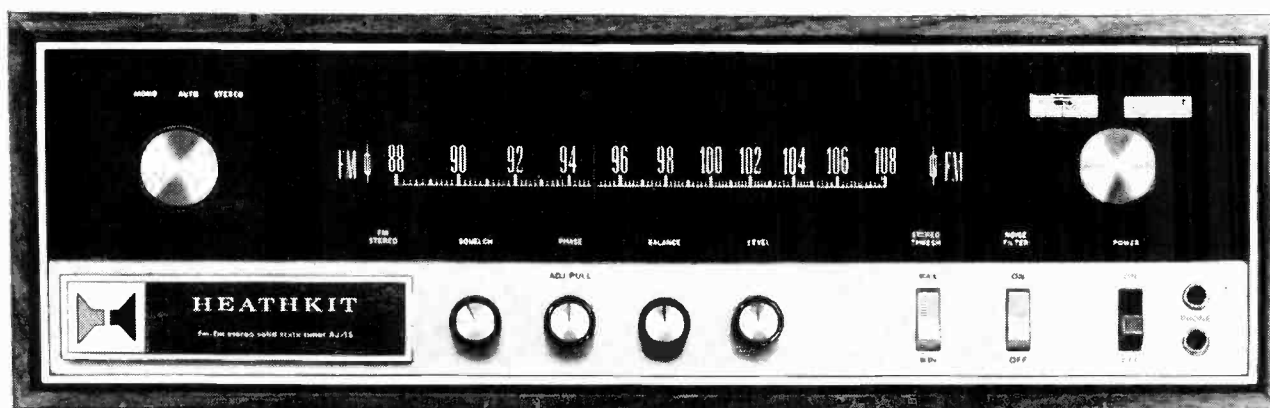

and the world's finest stereo amplifier...

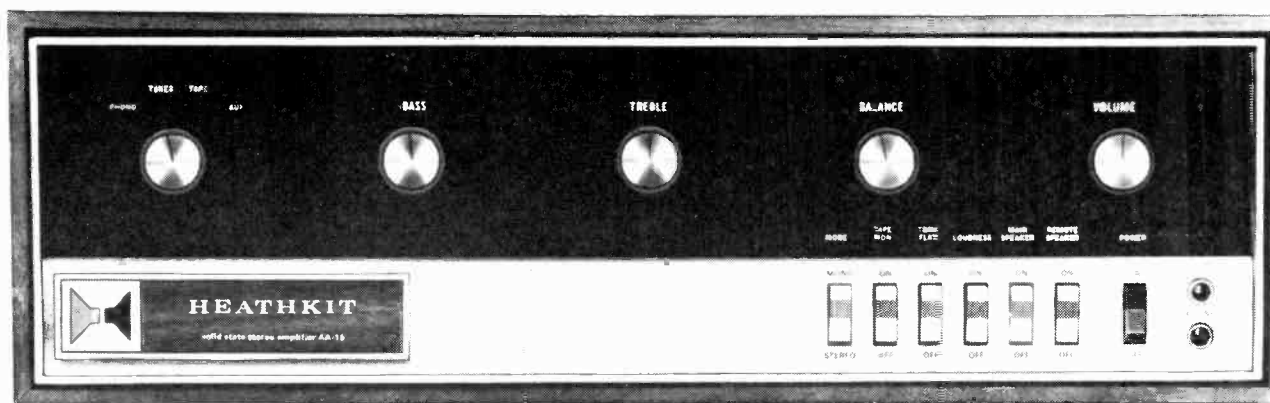

**for the man who already owns a
fine something or other.**

Heathkit® AR-15

Every leading electronics magazine editor, every leading consumer testing organization, and thousands of owners agree the Heathkit AR-15 is the world's finest stereo receiver. All give it top rating for its advanced design concepts and superior performance . . . all give it rave reviews such as these:

. . . "an audio Rolls Royce" . . . "engineered on an all-out, no compromise basis" . . . "cannot recall being so impressed by a receiver" . . . "it can form the heart of the finest stereo system" . . . "performs considerably better than published specifications" . . . "a new high in advanced performance and circuit concepts" . . . "not one that would match the superb overall performance of the Heath AR-15" . . . "top notch stereo receiver" . . . "its FM tuner ranks with the hottest available" . . . "it's hard to imagine any other amplifier, at any price, could produce significantly better sound" . . . "a remarkable musical instrument."

The Heathkit AR-15 has these features: exclusive design FET FM tuner for best sensitivity; AM tuner; exclusive Crystal Filter IF for best selectivity; Integrated Circuit IF for best limiting; 150 watts music power; plus many more as shown below.

Kit AR-15, \$339.95; Assembled ARW-15, \$525; Walnut Cabinet AE-16, \$24.95

New Heathkit® AJ-15

For the man who already owns a fine stereo amplifier, and in response to many requests, Heath now offers the superb FM stereo tuner section of the renowned AR-15 receiver as a separate unit . . . the new AJ-15 FM Stereo Tuner. It features the exclusive design FET FM tuner with two FET r.f. amplifiers and FET mixer for high sensitivity; two Crystal Filters in the IF strip for perfect response curve with no alignment ever needed; two Integrated Circuits in the IF strip for high gain and best limiting; elaborate Noise-Operated Squelch to hush between-station noise before you hear it; Stereo-Threshold switch to select the quality of stereo reception you will accept; Stereo-Only Switch rejects monophonic programs if you wish; Adjustable Multiplex Phase for cleanest FM stereo; Two Tuning Meters for center tuning, max. signal, and adjustment of 19 kHz pilot signal to max.; two variable output Stereo Phone jacks; one pair Variable Outputs plus two Fixed Outputs for amps., tape recorders, etc.; all controls front panel mounted; "Black Magic" Panel Lighting . . . no dial or scale markings when tuner is "off"; 120, 240 VAC.

Kit AJ-15, \$189.95; Walnut Cabinet AE-18, \$19.95

New Heathkit® AA-15

For the man who already owns a fine stereo tuner, Heath now offers the famous stereo amplifier section of the AR-15 receiver as a separate unit . . . the new AA-15 Stereo Amplifier. It has the same deluxe circuitry and extra performance features: 150 Watts Music Power output . . . enormous reserves; Ultra-Low Harmonic & IM Distortion . . . less than 0.5% at full output; Ultra-Wide Frequency Response . . . ± 1 dB, 8 to 40,000 Hz at 1 watt; Ultra-Wide Dynamic Range Preamp (98 dB) . . . no overload regardless of cartridge type; Tone-Flat Switch bypasses tone controls when desired; Front Panel Input Level Controls hidden by hinged door; Transformerless Amplifier for lowest phase shift and distortion; Capacitor Coupled Outputs protect speakers; Massive Power Supply, Electronically Filtered, for low heat, superior regulation . . . electrostatic and magnetic shielding; All-Silicon Transistor Circuitry; Positive Circuit Protection by current limiters and thermal circuit breakers; "Black Magic" Panel Lighting . . . no dial markings when unit is "off"; added features: Tuner Input Jack and Remote Speaker Switch for a second stereo speaker system; 120 240 VAC.

Kit AA-15, \$169.95; Walnut Cabinet AE-18, \$19.95



FREE HEATHKIT CATALOG

Now with more kits, more color. Fully describes these along with over 300 kits for stereo/hi-fi, color TV, electronic organs, electric guitar & amplifier, amateur radio, marine, educational, CB, home & hobby. Mail coupon or write Heath Company, Benton Harbor, Michigan 49022.



HEATH COMPANY, Dept. 40-8
Benton Harbor, Michigan 49022
In Canada, Daystrom Ltd.

Enclosed is \$ _____ plus shipping charges.

Please send _____ (quantity & model)

Please send FREE Heathkit Catalog.

Name _____

Address _____

City _____ State _____ Zip _____

Prices & specifications subject to change without notice.

HF-217

CIRCLE NO. 28 ON READER SERVICE CARD

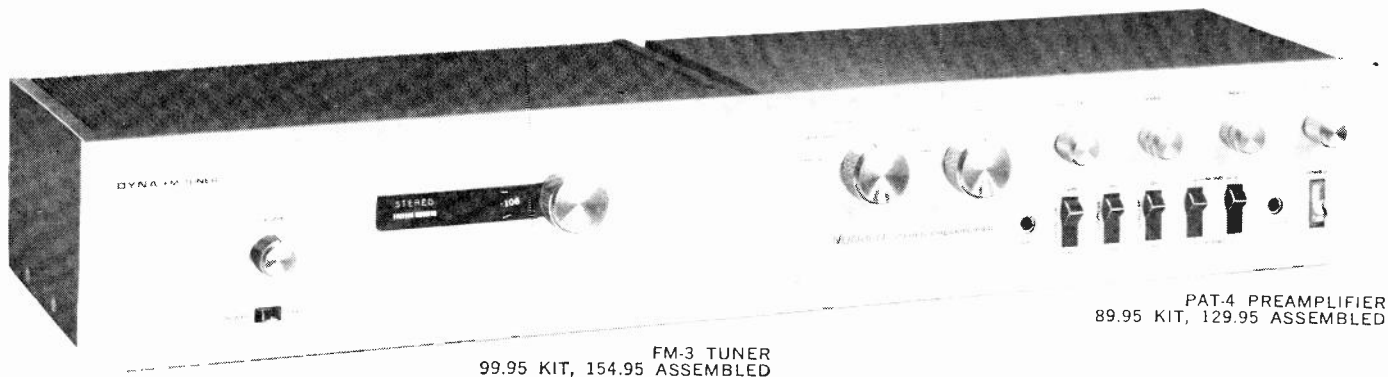

ENDURING EXCELLENCE

In the evolution of high fidelity, there have been some "revolutions"—the stereo record, FM multiplex, and transistorization, to give some examples. Each of those changes left its trail of obsolete equipment, frequently replaced with much higher priced models. Through these periods of change, Dynaco has maintained a level of quality so high that our equipment is always current, never obsolete, and always adaptable to the newest useful innovations.

Dynaco's underlying philosophy is to deliver exceptional performance from designs so carefully and progressively engineered that they defy obsolescence. We add new products only when we feel that they can make a contribution of value to music reproduction. In each Dynaco high fidelity component the total value of the separate parts is greater than what you pay for the finished product, and you can save even more by buying the kit.

Dynaco's separate components give you the ultimate in flexibility and ease of installation. They can be interchanged with full compatibility, not only with Dynaco units, but with any other similar designs which are generally accepted as being of the finest quality. No industry innovation can make your **system** obsolete, and future changes, such as an

increase in amplifier power, can be easily and economically accomplished.

The quality of performance obtained with the FM-3 tuner, PAT-4 preamplifier, and the Stereo 120 power amplifier cannot be matched in any single package regardless of promotional claims. Other Dynaco units which can interchange with this system will also give similar results at lower power, or with a bit less control flexibility at still lower cost, depending on the units chosen.

Whether you compare Dynaco with others by listening or by laboratory test, you will find that Dynaco gives sound closest to the original—with lucid clarity, without murkiness, noise or distortion. Every unit—whether purchased as a kit or factory assembled, is assured of delivering the same specified quality, for our reputation has grown through directing our design efforts towards perfection rather than to the planned obsolescence of yearly model "face-lifts."

You may find that your dealer does not have some Dynaco equipment in stock, however, for the demand greatly exceeds our ability to produce for a rapidly growing audience. Quality is our first consideration, so we must ask your patience. We believe you will find it is worth the wait.

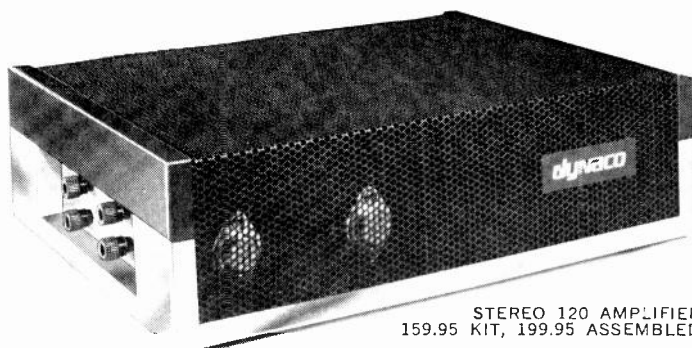

STEREO 120 AMPLIFIER
159.95 KIT, 199.95 ASSEMBLED

Write for descriptive literature and complete specifications.

dynaco inc.

3060 JEFFERSON STREET, PHILADELPHIA, PA. 19121
IN EUROPE WRITE: DYNACO A/S, HUMLUM, STRUER, DENMARK

TECHNICAL TALK

By JULIAN D. HIRSCH

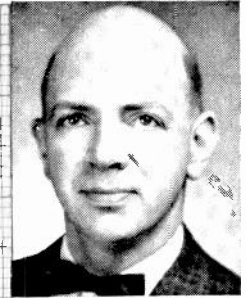

● **SPEAKER TESTING:** I don't know how to test speakers. That statement may sound odd coming from one who has tested dozens of speakers, and who has been offering critical comment on speaker performance for over fourteen years. It is not, however, an expression of self-doubt, but rather a way of emphasizing the formidable problems encountered in speaker testing. Let me explain.

I use the word "test" to mean an objective procedure for defining, within known limits of measurement error, the *sound quality* of a loudspeaker. The same difficulties exist to some degree in the testing of other audio components, but nowhere are they so severe as with the loudspeaker, which is the only component that has to produce sound.

The measurement of speaker parameters such as frequency response, distortion, polar pattern or dispersion, efficiency, and such matters has been treated extensively in the technical press. Perhaps too extensively, since there are almost as many different test techniques as there are workers in the field. The real problem is that none of these tests, or any combination of them of which I am aware, can describe unambiguously, even to a skilled interpreter, precisely what a given loudspeaker will sound like in a typical home listening environment.

Some may dispute this statement—in fact, you don't have to look any further than Roy Allison's article elsewhere in this same issue. But speaking for myself, I cannot tell from test data what a speaker is going to sound like, and am very skeptical of anyone's claiming to be able to do so. Of course, a speaker system whose curves show broad dips and peaks at certain frequencies is going to have a sound character that reflects these disabilities. But what we are concerned with here are the more subtle differences that separate the very good from the truly excellent.

Before we can measure or define the performance of a speaker, it is first necessary to decide what it is *supposed* to do. There is, however, no universal agreement even on this seemingly basic point. Is it supposed to recreate exactly in a listening room the total sound of the original performance? I happen to consider this notion preposterous. Any instrumental group larger than a string quartet would be intolerably loud in a home—or at least in mine.

No speaker I have ever heard can achieve this "original-performance" goal, and I'm not sure I would want one if it existed.

What about "transporting" the listener to the concert hall by recreating its acoustic environment? This seems to me to be a more attainable and realistic goal, but the rub here is that the listening room always adds its own coloration to the sound, no matter how faithfully the original may have been recorded and reproduced. Further, the wide diversity of acoustic characteristics found even within the same hall suggests that an unwary listener may confuse various speaker aberrations with the acoustic properties of the recording environment.

A more practical goal might be to have the speaker recreate the sound-pressure pattern that existed at the diaphragm of the recording microphone. If the listening room were anechoic (a depressing thought), this might come close to transporting the listener to the original microphone location. However, all microphones are directional to some degree (yes, even the "omni-directional" types), and speakers are also directional, though not at all in the same way. Unless the speaker and microphone have similar frequency-response curves in all directions (covering the full sphere), one cannot expect the speaker to reproduce what the microphone "hears." Even if this ideal could be attained, what happens when a different type of microphone is used?

Despite these seemingly unresolvable questions, I do not consider the matter to be hopeless. In my opinion, a speaker should create an *illusion* of reality in the listener's mind. The distinction between bringing the music to the listener (by close miking, which allows the listening room to make a proportionately greater contribution) and bringing the listener to the concert hall (by distant miking and lots of "hall" sound) lies properly in the hands of the recording engineer, who can suggest either condition with remarkable success.

In any case, a good speaker should not offend the listener's sonic sensibilities. It should not screech, hiss, honk, or boom. The sound of the music should be free of harsh or unnatural distortions. It may even persuade the listener to accept it as a substitute for live music if he doesn't try to be too objective in his listening. (*Continued overleaf*)

REVIEWED THIS MONTH

●
Harman-Kardon Five-Thirty Receiver
Concord 510-D Stereo Tape Deck
Heath AR-17 FM Receiver

Let there be no mistake—the speaker has yet to be made that can provide, in all aspects, the experience of a live performance. If anyone doubts the truth of this statement, I suggest that he attend a live concert, close his eyes, and try to imagine that same sound emerging from his own prized loudspeakers. This can be an ego-deflating experience, especially for someone with dogmatic views and a large investment in speaker systems.

I do this regularly, and it keeps me sane and sober. When I return home, my own system seems pallid, to say the least. Fortunately, it doesn't take long for me to become used to it again, and I can once more delude myself into believing that my system is really very close to "the real thing." It isn't, by a long shot.

Many of you have attended demonstrations of live *vs.* recorded sound at audio shows. These can be very convincing, and I have often been unable to detect the transition from recorded to live sound. I have also set up this sort of comparison myself, with considerable success. Does this not prove that the speakers in question are capable of complete, true fidelity? Not quite. Obviously, if they are convincing, they must be of very high quality. Irregularities in frequency response, a narrow polar dis-

persion, or non-linear distortion will disqualify a speaker for this sort of comparison immediately. Great care must be taken in making the original recording to eliminate the acoustics of the recording room (close miking, or use of an anechoic chamber or the outdoors). Microphone and speaker positions must be carefully coordinated to preserve the spatial illusion. Levels must be matched with extreme precision, and the changeovers must occur at logical places in the music.

These are all matters of technique, and there is really no trickery involved. Nevertheless, a speaker setup that is able to simulate a string quartet flawlessly in such a live *vs.* recorded test will never convince you that the performers are in your own living room *unless* you use the original, specially prepared tapes. As soon as you listen to a commercial recording, or to an FM broadcast (no matter how high the fi), you will have no doubts concerning the source of the program. The best that can be hoped for is an *illusion* of reality, as I mentioned before. However, we still do make objective measurements on speaker systems, and they are by no means worthless. When coupled with careful subjective listening tests, I find they make possible a reasonably accurate appraisal of speaker quality.

≈ EQUIPMENT TEST REPORTS ≈

By Hirsch-Houck Laboratories

HARMAN-KARDON NOCTURNE FIVE-THIRTY RECEIVER

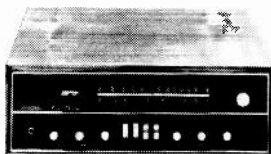

● HARMAN-KARDON's new Nocturne receivers are distinctively styled, with a black panel and knobs set off by accents of gold. The dial scale, tuning meter, and stereo-indicator light are invisible when the set is off, but become clearly illuminated when it is switched on.

Integrated circuits are used in the i.f. amplifier section and MOSFET's (metal-oxide silicon field-effect transistors) are used in the front-ends of both the FM and AM tuners. The MOSFET offers a genuine, often audible, advantage over the ordinary bipolar transistors used in many tuners of older design. They deliver high gain with low noise, and are highly resistant to overload from strong signals. As a result, cross-modulation from nearby transmitters is unlikely to occur in a properly designed MOSFET tuner.

There are two models in the Nocturne series: the Five-Thirty (which we tested) and the Five-Twenty, which is identical but lacks an AM tuning section. The Five-Thirty has selector-switch positions for phono, tape/aux, FM, and AM. The function switch can set up the amplifiers for stereo or mono phono playback, and the tuner for either mono or automatic FM stereo/mono operation. When a stereo broadcast is received, the word STEREO is illuminated to the left of the tuning meter, and the multiplex circuits of the receiver go into operation. The tuning meter is of the zero-center type for FM, and is tuned for maximum deflection in AM reception.

A pair of bass and treble tone controls serve both

channels. The bass control, at intermediate settings, boosts or cuts the response below about 200 Hz; at extreme settings it operates below about 500 Hz. There are separate volume and balance controls. A four-position speaker-selector switch turns on either or both of two pairs of stereo speakers, or turns off all speakers for headphone listening via the front-panel jack.

Four rocker switches control loudness compensation, high-cut filter, tape monitoring, and FM interstation-noise muting. On the rear panel are a switched a.c. outlet and the four output transistors, whose heat is dissipated through the metal structure of the receiver. (They ran quite cool, even during our full power tests.) As a result of this effective heat transfer, the Five-Thirty requires a minimum of ventilation and can therefore be mounted in any position.

We felt, early in our preliminary listening tests, that the Harman-Kardon Five-Thirty was a very fine receiver. It was obviously sensitive, with complete freedom from cross-modulation, and had a distinctively "live" FM sound. The laboratory measurements supplied explanations for most of these observed characteristics.

The IHF sensitivity of the Five-Thirty was 2.2 microvolts. The limiting curve was quite steep, so that all signals stronger than about 5 microvolts were received with equal quieting and freedom from distortion. The FM distortion at 100 per cent modulation was 0.65 per cent. The muting worked well, with only a slight "thump" when tuning off a station. There is no external variable adjustment of muting threshold, but only the weakest signals required disabling the muting in order to make them audible.

The FM frequency response was ± 2 dB from 30 to 15,000 Hz. The slight high-frequency drop-off shown in

(Continued on page 36)

Our most-honored receiver





*Sherwood Electronic Laboratories
 proudly announces
 that its most-honored FM receiver,
 the Model S-8800, has been further enhanced
 with the addition of Field-Effect Transistors.*

The highly-rated Sherwood S-8800 now features Field Effect Transistors (FET's) in the RF and Mixer stages to prevent multiple responses when used with strong FM signals.

Among the Model S-8800's many useful features are two front-panel switches for independent or simultaneous operation of main and remote stereo speaker systems.

Visit your Sherwood dealer now for a demonstration of those features which make Sherwood's new Model S-8800-FET receiver so outstanding.

With Sherwood, you also get the industry's longest warranty—3 years, including transistors.

Model S-8800 custom mounting \$369.50
 Walnut leatherette case \$378.50
 Hand-rubbed walnut cabinet \$397.50

Compare these Model S-8800 specs: 140 watts music power (4 ohms) • Distortion: 0.1% (under 10W_r)
 • FM sensitivity: 1.8 μ v (IHF) • Cross-modulation rejection: -95db • FM hum & noise -70cb.

CIRCLE NO. 50 ON READER SERVICE CARD

Sherwood

Sherwood Electronic Laboratories, Inc.,
 4300 North California Avenue,
 Chicago, Illinois 60618. Write Dept. R8

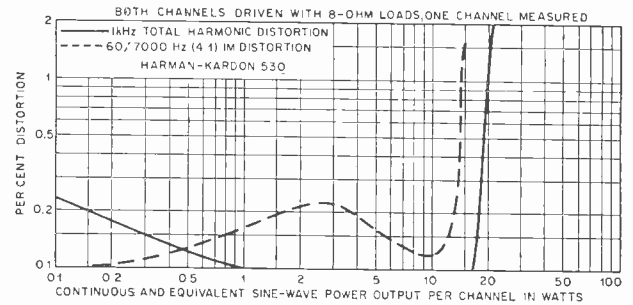
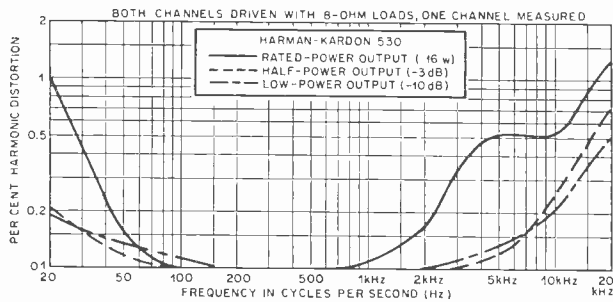

the graph was apparently due to a very effective ultrasonic filter in the tuner outputs, since we found little trace of 19-kHz or 38-kHz signals in its audio outputs. This prevents the "birdies" which are sometimes heard when tape-recording stereo broadcasts. Stereo FM channel separation was better than 30 dB in the mid-range and exceeded 20 dB from 100 to 10,000 Hz. The AM section of the Five-Thirty, incidentally, is quite good as such tuners go, though by no means of hi-fi quality.

The high-cut filter had a 6-dB-per-octave slope above 2,500 Hz, which, though fairly effective in noise reduction, dulled the program sound noticeably. The loudness control had a shelved characteristic, with the response below 150 Hz boosted about 10 dB relative to the higher frequencies at normal volume-control settings. The RIAA phono equalization was very accurate, within ± 0.8 dB from 30 to 15,000 Hz.

The audio performance of the Harman-Kardon Five-Thirty was impressive. It is not, by modern standards, powerful, delivering about 16 watts per channel into 8 ohms with less than 1 per cent distortion between 20 and 15,000 Hz. At power outputs only slightly below the maximum, the distortion was extremely low (less than 0.1 per cent) between 100 to 3,000 Hz. At half-power or less, the distortion was under 0.2 per cent from 20 to 9,000 Hz, reaching a maximum of about 0.8 per cent at 20,000 Hz.

At 1,000 Hz, the harmonic distortion was under 0.25 per cent from 0.1 watt to 18 watts, and under 0.1 per cent from 1 watt to 17 watts. The IM distortion was under 0.25 per cent for all powers below 14 watts.

Within its modest power rating, the audio system of the Five-Thirty ranks with the best in its distortion and frequency-response characteristics. It never seemed to strain when driving speakers of moderate efficiency even at a maximum volume-control setting. It is worth noting that the speaker systems manufactured by Harman-Kardon are 4-ohm types, into which the Five-Thirty's amplifier will deliver about 27 watts per channel continuous power. The manufacturer rates the receiver as a 70-watt unit, or 35 watts per channel (4 ohms), by the IHF Dynamic-Power

method, which appears to be quite consistent with our own test findings.

We commented earlier on the Five-Thirty's airy, "live" sound. Repeated exposure to it, and comparison with other receivers, convinced us that this was not an illusion. The slight rise in the FM frequency response at upper-middle frequencies (although it amounts to only about 2 dB) might explain some of this quality. However, the Five-Thirty sounds much the same from tape and disc inputs. The sound quality does not appear to result from distortion, and the frequency response is as flat as one could desire. A few years ago, the Five-Thirty might have been put forward as an example of "transistor sound." Today, we would simply call it one of the cleanest, open-sounding receivers we have heard. The Harman-Kardon Five-Thirty sells for \$349, and the Five-Twenty (without AM) is \$315. An oiled walnut enclosure is \$29.95 additional.

For more information, circle 157 on reader service card

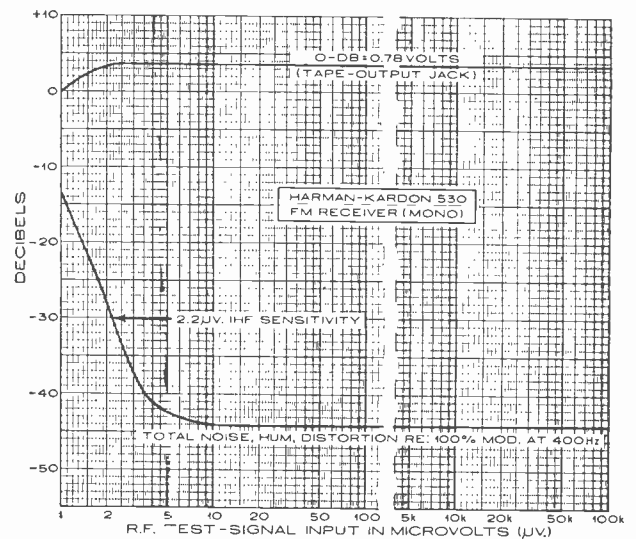

CONCORD 510-D STEREO TAPE DECK

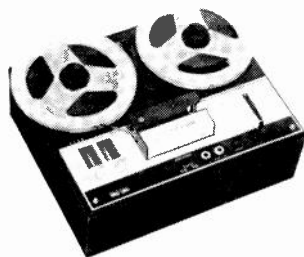

● The Concord 510-D is a compact, solid-state tape deck meant to be plugged into the tape-output and -input jacks of any stereo amplifier or receiver. The 510-D comes in-

stalled on a wooden base, ready to use either vertically or horizontally. The transport has three speeds ($7\frac{1}{2}$, $3\frac{3}{4}$, and $1\frac{7}{8}$ ips) and, unlike some low-price decks that require changing a capstan bushing, a single lever (located between the reels) selects the operating speed and the correct equalization.

The 510-D is a two-head machine, with separately switchable record/playback preamplifiers. This gives it the capability of making sound-on-sound recordings, copying one channel onto the other while adding new program material from a microphone or from some other external program source. A three-position slide switch sets up the electronics for normal operation, copying channel 1 onto

(Continued on page 38)

A new Angel Record is the sum of the creative efforts of many individuals. Orchestra, soloists and engineers must be scheduled many months in advance, and are frequently brought together over great distances to make the recording. Engineering at the recording session and during the transfer from tape to disc requires great care and precision. Each stage of the process, and the way in which it is carried out, influences the musical values in the recording finally released.



AR^{INC.} components are used by executives at Angel Records to hear first pressings of new releases.

As responsible executives of one of the world's largest recording organizations, the men who conduct Angel's operations can afford any equipment except that which distorts or falsifies the quality and content of a recording. The executive conference room at Angel Records is equipped with AR high-fidelity components. Write for a catalog of AR products.

Suggested retail prices of AR components shown: AR amplifier, \$225; AR turntable, \$78; AR-3a speaker systems, \$225-\$250, depending on cabinet finish.

ACOUSTIC RESEARCH, INC., 24 Thorndike St., Cambridge, Mass. 02141

CIRCLE NO. 1 ON READER SERVICE CARD

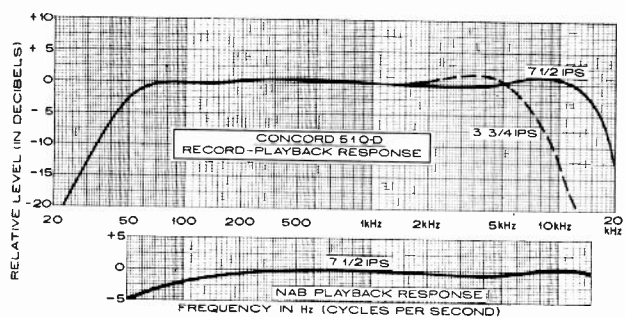

channel 2, or vice versa. No external cable jumpers are required.

In the rear of the recorder are high-level input and output jacks, and a pair of microphone jacks are located on the front panel. The microphone signals are mixed with any signals fed into the rear jacks. A pair of illuminated meters monitors both the recording and playback levels. A "0-dB" playback level on the meters corresponds to a 1.2-volt output signal (per channel) to the external stereo amplifier. Since the 510-D has no playback-level controls, the volume must be controlled from the external amplifier. Concealed behind a sliding door on the panel are two red pushbuttons, interlocked with the transport's control lever, which must be pressed in order to record. Recordings can be made on either channel alone or on both simultaneously.

The transport's control lever has positions for FAST FORWARD, REWIND, PLAY, STOP, and CUE. The CUE position stops tape motion, but does not disengage the recording function. This is convenient when one wants to set recording levels when the tape is not in motion. The tape is lifted from the heads when in fast forward or rewind, and the transport shuts off automatically if the tape breaks or runs out. There is also a four-digit pushbutton-reset indexing counter.

We measured the 7½-ips playback frequency response of

the Concord 510-D with the Ampex 31321-04 quarter-track test tape as +0.3, -4.5 dB from 50 to 15,000 Hz, with the roll-off occurring at the lower frequencies. The overall record-playback frequency response was very good: +1, -2.5 dB from 50 to 15,000 Hz. At 3¾ ips, the record-playback frequency response was +1.5, -3 dB from 45 to 7,000 Hz. The 1⅞-ips tape speed was suitable only for speech, with a frequency response of ±1.5 dB from 40 to 800 Hz, falling to -11 dB at 3,000 Hz.

The sound quality at 7½ ips was essentially indistinguishable from the incoming program. At 3¾ ips, a dulling of the higher frequencies could be heard, although the sound was quite adequate for popular or background music. (These tests were made with Scotch Type 111 tape. The use of an extended-range tape would doubtlessly bring up the high-frequency performance on record-playback). At the slowest speed we found it necessary to use the tone controls on the external amplifier to restore a reasonable tonal balance on speech.

Wow and flutter were negligible. They measured, respectively, 0.06 and 0.07 per cent at 7½ ips, and were both 0.08 per cent at 3¾ ips. The signal-to-noise ratio was 48 dB referred to the 0-dB recording level, and the noise consisted essentially of hiss that was inaudible during normal use. The play and record speeds were slightly fast, with a timing error of approximately 15 seconds in 30 minutes playing time. In the fast-forward mode, 1,200 feet of tape was handled in 140 seconds; in rewind, 170 seconds was required.

The 510-D was very easy to use. The controls were well identified, and it was possible to operate it without reference to the instruction manual. The sound-on-sound feature worked well. All in all, we found the Concord 510-D to be a versatile adjunct to a home-music system. Its quality, particularly at 7½ ips, was compatible with the highest-quality audio components. The Concord 510-D sells for under \$160.

For more information, circle 158 on reader service card

HEATH AR-17 FM RECEIVER



● THE Heath AR-17 receiver is an excellent example of "value" engineering. The goal of its designers was evidently to produce a good-quality stereo FM receiver at a rock-bottom price. On the basis of our tests, we would say that the Heath engineers have hit their target squarely. Most of the essential features of more expensive receivers have been retained in the Heath AR-17. An obvious economy move was the reduction of audio-power output. In a day when power outputs of 20 to 50 watts per channel are commonly advertised, Heath frankly rates the AR-17 at 5 watts (continuous) or 7 watts (music power) per channel. This makes possible the use of inexpensive epoxy-cased power transistors and an appreciably smaller and less expensive power supply.

A second economy move was the elimination of the usual pair of tone controls. A single tone control, operating on both channels, provides a flat output at its full clockwise setting. Rotating the tone knob counter-clockwise provides a moderate high-frequency roll-off of about 12 dB at 10,000 Hz. The tone control is combined with the on-off switch, which is operated by pulling out the knob.

The volume controls are concentric, with a slip clutch to

permit balancing the two channels. The two control sections tracked well, and we found no need to readjust balance as the volume was changed. The input-selector switch has both stereo and mono positions for each of the three inputs: FM, PHONO, and AUX. Although such features as filters, loudness compensation, and speaker switching are lacking, the Heath AR-17 does have a front-panel headphone jack. Because of the relatively low power of this re-

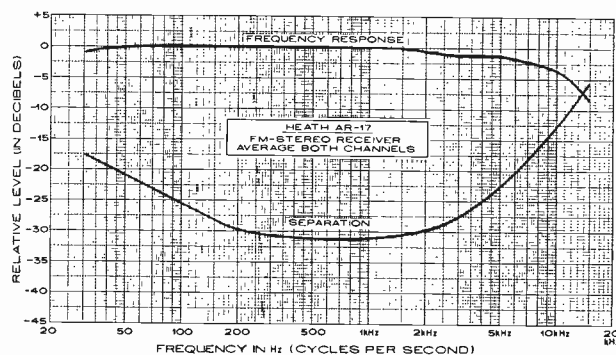

ceiver, the phones are connected directly to the speaker-output terminals, which permits headphone listening at ear-shattering levels if one desires. The speakers are automatically disconnected when phones are plugged in.

(Continued on page 40)

The more music system.

The SC-2520 is a compact stereo music system that does everything but fly.

It plays monaural and stereo records.

It plays monaural and stereo FM broadcasts.

And it will record and play back monaural and stereo tapes.

Stated simply, it will produce more music, in more ways, than any compact music system ever made.

For example: The New York Philharmonic Orchestra is presenting a special program on FM stereo radio. You not only want to hear it, but wish to record it for posterity. Simply insert a tape cartridge (cassette) into the SC-2520, tune to the station, activate the tape mechanism and enjoy the program while your music system records it for future listening.

For example: Your friend has an extraordinary recording that is out of print. You want to record it. All you do is start the tape cassette player and play the record on the automatic turntable. In minutes, that rare recording is part of your collection.

It would take a small novel to outline all of the possible functions of the SC-2520. So suffice it to say if it has anything to do



with sound, you can capture it and faithfully reproduce it with this amazing music system.

The SC-2520 has solid-state electronics throughout, including newly developed integrated micro-circuits.

It has a defeatable contour switch that restores bass frequencies at low volume levels.

It has a unique speaker selector switch that allows you to connect stereo speaker systems in two rooms and select between them. Or use them all simultaneously.

It also has a headphone

receptacle on the front panel for personal listening.

And a center of channel tuning meter so you can locate FM stations quickly and accurately.

In short, here is a total music system that is really total.

And beautiful.

And easy to use.

And sensibly priced.

The SC-2520 is at your Harman-Kardon dealer now. He will be happy to give you a complete demonstration.

Visit him soon.

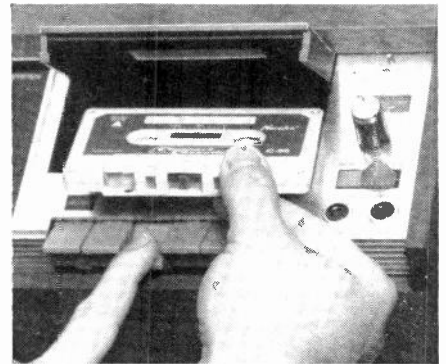

We want you to hear more music.

For more information write to Harman-Kardon, Inc., 55 Ames Court, Plainview, N.Y., Box # HFSR-8



harman kardon

A subsidiary of Jervis Corporation

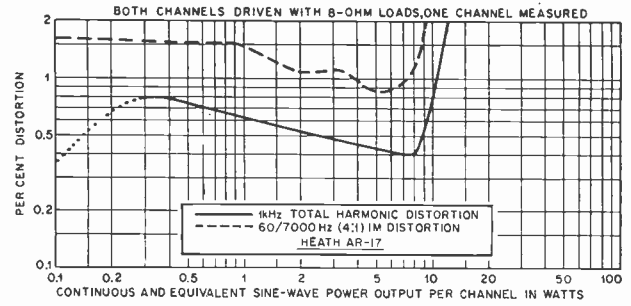
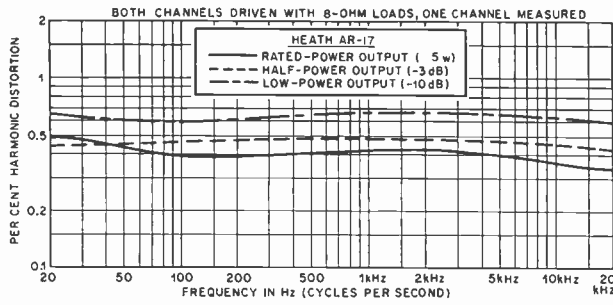

Although the AR-17 lacks tape-recorder output jacks, an attenuator can be added externally to the speaker outputs or to the headphone jack to enable it to feed a tape recorder. This is much less satisfactory, however, than fixed outputs ahead of the volume controls.

The FM tuner, which is rated by Heath at 5 microvolts IHF usable sensitivity, has automatic mono-stereo switching. Although there is no tuning meter, by tuning for lowest noise or for brightest illumination of the stereo lamp one can easily achieve distortion-free response.

Because of our past experience with Heath high-fidelity components, we were not surprised to find that the AR-17 met or exceeded all its performance specifications by a comfortable margin. Nevertheless, it is so conservatively rated that special comment is in order. For example, the FM tuner sensitivity checked out at 2.3 microvolts, rivaling many far more expensive receivers. This was after instrument alignment, but even without this it was substantially better than its rated 5 microvolts.

The tuner operated well at any received signal level, but became distorted when driven by extremely high-level signals (near 100,000 microvolts) from our signal generator. Such levels would be encountered only rarely and in very strong signal areas. We found no trace of cross-modulation from strong alternate-channel signals (400 kHz removed from the desired signal).

The stereo-FM separation was better than 30 dB from 200 to 2,000 Hz, falling to 17.5 dB at 30 Hz and to 10 dB at 10,000 Hz. The basic amplifier frequency response was +0, -1 dB from 30 to 20,000 Hz. RIAA equalization was flat above 800 Hz, falling slightly to -2.5 dB in the 30-

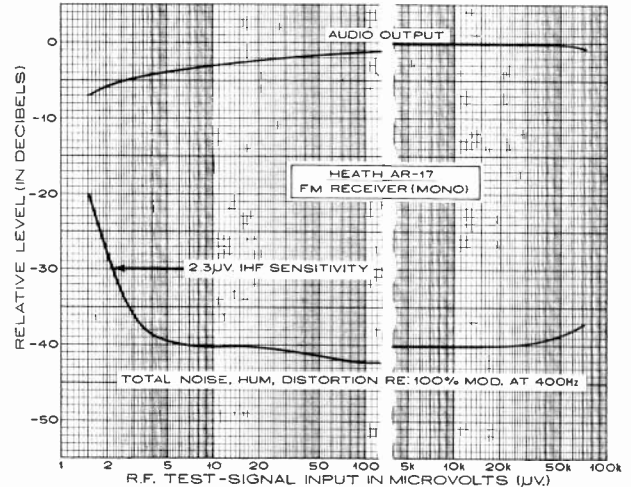

100-Hz region. This is well within RIAA specification tolerances.

The audio output was about 10 watts per channel at the clipping point, with both channels driven into 8-ohm loads. At the rated 5 watts or less, harmonic distortion was below 0.7 per cent at any frequency from 20 to 20,000 Hz. IM distortion was about 1.5 per cent below 1 watt, dropping slightly at higher powers and rising to 2 per cent at 9 watts. Into 16-ohm loads, the available power was reduced about 50 per cent and into 4 ohms it went up about 43 per cent.

A signal of 5.2 millivolts was needed at the phono inputs to drive the amplifier to a 5-watt output per channel. Although medium- to high-output cartridges would be preferable with the AR-17, it worked well with a high-quality cartridge having less than 3 millivolts output. Hum and noise were 58 dB below 5 watts at the auxiliary input, and 49 dB below 5 watts at the magnetic-phono input. This could be heard at high volume-control settings as a low-level hum when the cartridge was off the record surface. Under normal playing conditions, no hum or noise was audible.

The Heath AR-17 was an enjoyable receiver to use. Its sound at reasonable listening levels with medium- to high-efficiency speakers would be difficult, if not impossible, to distinguish from that of most receivers selling for several times its price. Of course, it cannot be "pushed." This receiver will not provide a signal to rattle windows or reproduce music in the home at concert-hall levels. But it is certainly more than adequate for a large number of installations, particularly those of students and beginners with limited budgets.

Sold only in kit form, the Heath AR-17 is supplied with all critical circuits pre-assembled and pre-aligned. Most of the receiver is constructed on a single, large, easy-to-wire circuit board. Our kit builder reports that the instructions are up to Heath's usual high standards and that it should take perhaps two to three evenings to construct. The AR-17 costs \$72.95. A metal cabinet is available for \$3.50, and a walnut-veneer wooden cabinet is \$7.50.



For more information, circle 159 on reader service card

CIRCLE NO. 35 ON READER SERVICE CARD →

LAFAYETTE® Award-Winning LR-1500T

has four features you'd expect to find only in

a \$500 receiver. . . . 4 INTEGRATED CIRCUITS! — 2 FIELD EFFECT TRANSISTORS!

175 WATTS POWER OUTPUT!

Exclusive COMPUTER-MATIC T.M.
Overload Protection! PAT. PENDING



Yet, it's priced at only **299⁹⁵**



175-WATT SOLID STATE AM/FM STEREO RECEIVER

With simulated
wood-grain metal
enclosure

Are IC's, F.E.T.'s and special transistor overload protection circuits really necessary? They are—if you want unexcelled FM stereo reception and freedom from worries about possible output transistor burn-out. Of course, this receiver has a lot more besides. Things like automatic FM mono-stereo switching, automatic interstation muting on FM and AM, built-in AM and FM antenna systems, and an outstanding audio section that rivals some of the finest component stereo amplifiers. We didn't skimp on power either...with 175 watts (IHF), you'll be able to drive any speaker systems around—with power to spare! And, we included every input and output you could possibly need, plus a formidable array of controls and switches for unlimited flexibility of operation.

So, if you want the kind of performance, features and power you usually find only in a much higher-priced receiver, we suggest you seriously consider the LR-1500T at only \$299.95. And remember, every Lafayette receiver is backed by a 2-year parts warranty (1 year on semi-conductors).

SPECIFICATIONS: FM Sensitivity: 1.5 μ V (IHF). Capture Ratio: 1.25 db. FM Distortion: 0.3%. FM Stereo Separation: 40 db. Cross Modulation Rejection: 90 db. FM S/N Ratio: 68 db. Stereo Power Output: 175 watts (IHF), 140 watts (RMS). Total Harmonic Distortion: Under 1% at rated output. Power Bandwidth: 12-40,000 Hz. Dimensions: 16 $\frac{1}{4}$ " W x 5" H x 14 $\frac{3}{4}$ " D. **99-0190WX**

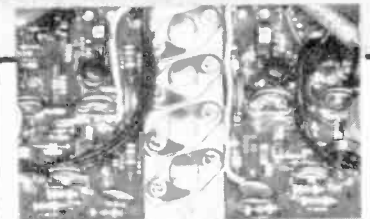

**Advanced "COMPUTOR-MATIC"
Overload Protection Circuit**

A new fuseless computer-type overload protection circuit (Patent Pending) that automatically guards against damage to drivers and output transistors. Not only is this protective circuit hundreds of times faster than a fuse or circuit breaker, but it is also self-restoring. When the cause of overload is removed, the circuit automatically restabilizes, allowing resumption of normal operation.

1969 LAFAYETTE CATALOG

FREE!

Just Off the Press!
Over 500 Pages

Your Complete Buying Guide from one dependable source. Everything in Electronics, Stereo Hi-Fi, CB, Tape Recorders—at money saving prices. Send for your copy today.

NO MONEY DOWN—UP TO 2 YEARS TO PAY

LAFAYETTE Radio ELECTRONICS
Dept. H-H-8, P.O. Box 10
Syosset, L.I., N.Y. 11791

Please send the FREE 1969 LAFAYETTE Catalog 690 **H-H-8**

Name

Address

City State

Zip

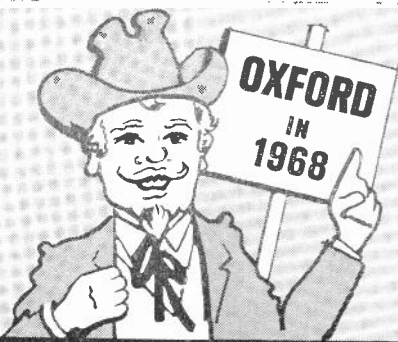

**This year, cast
your ballot for
the speaker
that will do you
the most good . . .
Oxford,
of course!**

No idle convention promises here, Oxford speakers deliver the performance that merit your confidence and vote.

Designed for full range sound reproduction, Oxford speakers will greatly improve the audio quality of any radio or TV, with rich bass, clear, sharp highs, the full tone fidelity your set was designed to deliver.

Why take chances, cast your vote for Oxford, and hear those promises ring out loud and clear. See your nearby Oxford dealer today!

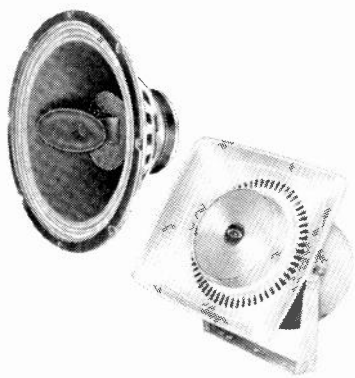

OXFORD
TRANSDUCER COMPANY
A Division of
Oxford Electric Corporation
3911 S. Michigan Avenue
Chicago, Illinois 60653

MEMBER



CIRCLE NO. 43 ON READER SERVICE CARD

By JAMES GOODFRIEND

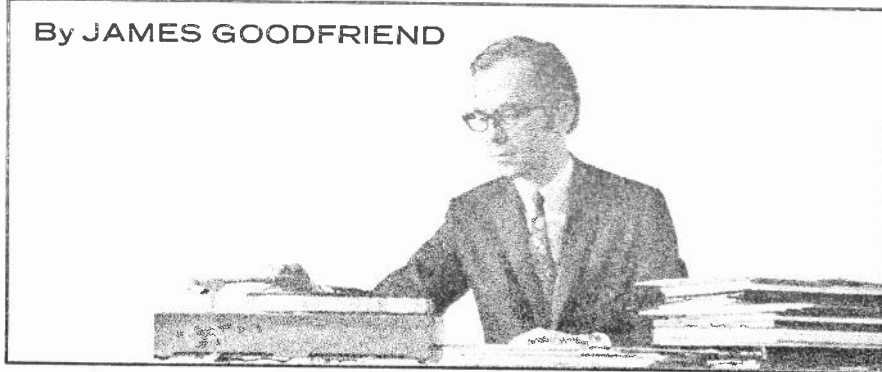

GOING ON RECORD

THE VINTNER OF OUR DISCONTENT

AS MANY collectors must know, there are a fair number of pages (thirteen, at last count) in the Schwann Long Playing Record Catalog devoted to recordings of things other than music. We review a few such records each month in *HiFi/STEREO REVIEW*, but every so often one comes along that requires a background of experience so specific that the record must search for its reviewer, rather than the other way round. Such is the case with a new MGM release: "Alexis Lichine's The Joy of Wine" (MGM E-4519, two discs, \$7.79, mono only). As I am the duly chosen consultant on oenophilic matters for this publication, the album has fallen to my lot.

It isn't difficult to find a connection between music and wine. The correlation is in the connoisseur, and I find it indubitable that the man who relishes Beethoven's Op. 59, No. 2, should also, with proper and sufficient experience, find a world of sensual and intellectual joy in savoring a Château Palmer 1937, or an un-meddled-with Cognac of great if undetermined age. It is a little like knowing, without having to be told, that a political candidate who reads and appreciates poetry is not, if elected, going to do something stupid about our national parks. Taste, which is the major achievement of connoisseurship of any sort, is transferable in its object.

So much for music and wine. A connection between recordings and wine is, perhaps, a more difficult bridge to build. Specifically, the question is: what is there (if, indeed, there is anything) about a record that makes it a more suitable medium than—or even as suitable as—a book in which to convey thoughts about wine? Granted that some people who are physically able to read books prefer to have them read to them—that is a childishness of our time. A record can be, and often is, nothing more than the recitation of bookish matter. This one is not, but owing to some severe lapses in taste and technique, it might have been better had it been so.

Alexis Lichine is among the most eminent professionals of wine today. He is

the proprietor of Château Lascombes and Château Prieuré-Lichine in Bordeaux (two of the sixty or so officially rated "great" châteaux in the area), and he has holdings in several of the great vineyards of Burgundy. He has a company that exports wines from France, and he has written extensively on the subject of wine, most notably in *Wines of France*, and most recently in an *Encyclopedia of Wines and Spirits*. He is a member (the only American one) of the Académie des vins de Bordeaux, and a Chevalier of the Légion d'Honneur.

Perhaps the best way I can describe this recording to you is to say that it sounds exactly like the soundtrack for a low-budget documentary film on wine (which, presumably, does not actually exist). There is a very definite sense of something missing throughout the listening experience, something that would make the simple recitation of names ("Château Latour, Château Pichon-Longueville, Château Mouton-Rothschild . . ."), or the enumerating of actions ("The boys are loading the cases onto the trucks. These trucks will take the cases to the piers. . .") a little more meaningful. The confusion of media is just too plainly obvious when M. Lichine says, "This is a case of fine wine from the Medoc . . ." and the ear listens in vain to the hubbub recorded in the wine *chai* for the identifying sound of that particular case.

The album contains a good deal of rather bibulous singing of what I gather are traditional French and German drinking songs, and there is an obsessively repeated fragment of Jean-Joseph Mouret's *Première Suite de Symphonies*. Such music is all to the good for bridging purposes, but it does go on. More important, the album contains spoken contributions by a number of people who should have something telling to say about wine: Baron Philippe de Rothschild (of Château Lafite), Prince Paul von Metternich (of Schloss Johannisberg), Bernard Ginestet (of Château Margaux), cooking expert James Beard,

(Continued on page 44)

CIRCLE NO. 52 ON READER SERVICE CARD →

It just can't compromise good design. It can't be rushed. You've been patient. We've been patient. Now we're both going to be rewarded. The new Sony 6060 receiver is a superb performer on FM stereo, AM broadcasts, records and tapes.

FM, even the weakest, fuzziest stations sound like the strong ones. They don't get clobbered by the strong ones. Stations you or knew existed suddenly appear.

stereo? Superb. All the separation necessary for full, rich stereo sound. And the 6060 automatically switches to stereo operation.

Engineering innovations made this possible: the front end combines the newly developed Sony field-effect transistors with a 5-gang variable capacitor to provide an unprecedented combination of low internal noise, high sensitivity ($1.8\mu\text{V}$) and low cross-modulation. The IF section uses six solid-state filters instead of conventional tuned

circuits. Even AM broadcasts are better, because of the special care devoted to this portion of our receiver.

The powerful amplifier section delivers 110 watts IHF into 8 ohms without the slightest trace of distortion (0.2% at rated output). Plenty of power to drive any speaker system with plenty in reserve for difficult passages. A unique heat-sensing circuit protects the 6060 from overload.

Not only is the 6060 a pleasure to hear, but it is also a pleasure to use. It has a full complement of controls and conveniences: zero-center tuning meter; front-panel headphone jack; switches for tape monitoring, muting, speaker selection, tape head or Aux. input, loudness—the works.

At \$399.50 (suggested list), it outperforms receivers selling for as much as \$500. But don't take our word. Hear for yourself at your hi-fi dealer.

Sony Corporation of America, 47-47 Van Dam St., L.I.C., N.Y. 11101.

Now, aren't you glad you waited?



SONY[®]

just
what
you've
always
wanted...

a
Tandberg[®]
tape deck
for only
\$79.50

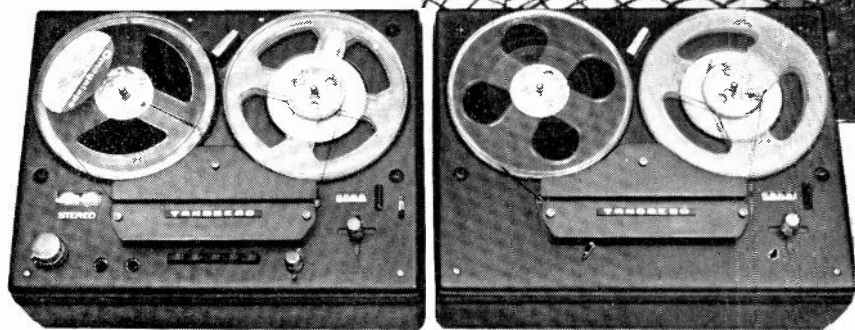

SPECIAL OFFER

Here's a remarkable opportunity for you to own the superb Tandberg Model 64X stereo tape recorder (at the regular price) and along with it — a Tandberg Stereo Playback Deck for just \$79.50 additional!

Do it today! Ask your dealer to demonstrate why the 64X with its famous Norwegian precision is rated as the "highest caliber". Then, when you purchase the 64X, you will receive a gift certificate from your dealer. Send this certificate, plus your guarantee card, and \$79.50 to Tandberg direct. The Tandberg 65, with teak cabinet — a \$235.45 value, will be yours for just \$79.50!

(Offer good through Sept. 30, 1968 at franchised Tandberg dealers in U.S.A. only.)

Model 64X — True high fidelity . . . even at 3 3/4! Features 3-speeds, 4-heads, FM stereo multiplex, sound-on-sound, echo effects, add-a-track, direct monitor, remote control. . . . \$549.00

Model 65 — Duplicate 15 tapes for your own use — and the "65" pays for itself! Complete with cabinet, 4-track playback head, 3-speeds, 4-digital counter. Limited offer . . . (with purchase of 64X)..\$79.50

Ask your dealer for the latest independent Test Report on Tandberg!

for better, clearer more natural sound . . .

Tandberg[®]
TANDBERG OF AMERICA, INC.

P.O. BOX 171, 8 THIRD AVE, PELHAM, N.Y. 10803

CIRCLE NO. 56 ON READER SERVICE CARD

and others. But the information for which M. Lichine asks them, and with which they respond, is that general sort of statement that one finds in tourist brochures or liquor-store giveaways. Thus, Baron Rothschild, instead of giving us something specific out of his manifold experience as a wine-maker and connoisseur, talks of "ze earth, ze air, ze bottle" in a slow, bemused speech. James Beard, after some good points about cooking with wine, is reduced to joining M. Lichine's inexplicable crusade to get people to drink anything with anything, making their selection on the basis of their own, as yet untrained, tastes.

Included with the album are wine maps of Germany and France, a vintage chart, an explanation of how to read a Bordeaux label, a pronouncing glossary, and Alexis Lichine's suggested reclassification of the red wines of Bordeaux as brought up to date (quite a few changes from his earlier version). Oenophiles will notice the unexpected absence of certain wine names from both the printed and the spoken parts of the album and the obsessive ubiquity of others. For example, sherry is briefly discussed, but neither port nor Madeira is so much as mentioned. In speaking of the wines of the Rhône valley, the best of them, Côte Rotie and Hermitage, are not given a word. Échézeaux, Fixin, and Volnay are absent from both the glossary and the discussion of Burgundy, and in the updating of the Bordeaux classification, two exceedingly eminent châteaux, Château Cantemerle and Château Cos d'Estournel, seem to have gotten lost altogether (were this intentional it would be comparable to dropping Schubert and Chopin from the musical repertoire).

On the other hand, there is the seemingly naïve persistence of M. Lichine in pushing his own product. Everywhere one looks or listens there is Château Lascombes, Château Prieuré-Lichine, or "Shipped by Alexis Lichine & Co." And when he says, "I want you to know the names of the great vineyards of the Medoc. . . . Château Margaux, Château Lascombes, Château Prieuré-Lichine," and then takes a long pause, the whole business begins to look a little shoddy. Surely he ought to be above this.

In short, then, the record is an attempt, but not a success. Perhaps a really fascinating record on wine could be made, perhaps not; we won't know more until the next person tries it. For those interested in the subject of wine, I suggest buying M. Lichine's book *Wines of France*. Those who insist upon listening rather than reading should be additionally warned that the recording here, even that part ostensibly done *not* on location but in a studio in New York City, strikes me as vintage 1939. Which, as I remember, was not even a particularly good year. *Santé!*

It's the Greatest!



The New Pioneer SX-1500T AM-FM Stereo Receiver with FET Front End and 4 IC's

Here's Why:

- Power: 170 watts (IHF)
- Sensitivity: 1.7 uv (IHF)
- Harmonic distortion: less than 0.1%
(at 1,000 Hz 30 watts 8 ohm load)
- Signal-to-noise ratio: 65 dB (IHF)
- Power bandwidth: 15 to 70,000 Hz
- Capture ratio: 1 dB (at 98 mHz)
- Channel separation: 37 dB (at 1,000 Hz)

This is a magnificent receiver, certainly one of the finest in the world. At its price it is the greatest value you can buy. Now, ONLY \$360.

Get complete specifications at your Hi-Fi dealer, or write directly to Pioneer.

PIONEER ELECTRONICS U.S.A. CORP., 140 Smith Street, Farmingdale, L.I., N.Y. 11735 • (516) 694-7720



CIRCLE NO. 44 ON READER SERVICE CARD

Pocket the
world's
smallest
35mm camera!

ROLLEI 35
FROM HONEYWELL



You'll carry it everywhere! Not much bigger than a pack of cigarettes, the great little Rollei 35 fits pocket or purse, yet it takes full-sized, full frame 35mm pictures. The results are magnificent—razor-sharp color slides or sparkling prints—because this is a Rollei, built in the famous Rollei quality tradition.

Big-camera features include a superb f/3.5 Zeiss Tessar lens, a highly accurate exposure meter by Gossen, and a Compur shutter with 9 speeds up to an action-stopping 1/500 second. It's easy to use, too, even for beginners.

Beautifully made and meticulously finished, the jewel-like Rollei 35 costs about \$190, depending upon accessories. See it at your Honeywell dealer's soon, or mail the coupon for free literature.

Honeywell takes the guesswork out of fine photography

Honeywell Photographic 294
Mail Station 209, Denver, Colo. 80217
Please send Rollei 35 literature to:
Name _____
Address _____
City/State/Zip _____

Honeywell

CIRCLE NO. 30 ON READER SERVICE CARD



ATLANTIC RECORDS

Aretha Franklin: pop-popular in Hammersmith

LONDON LETTER

**AMERICAN MUSIC:
THE NEW COLONIALISM?**

By Henry Pleasants

EVERY American student here, and elsewhere in Great Britain, has his own story to tell about anti-Americanism among his fellow students, most of it centered, of course, on Vietnam.

It's there, all right; and for those who do not live among students there is the evidence of the ritual Sunday haranguing from Nelson's monument in Trafalgar Square and the recurrent picketing and occasional rioting in front of the American Embassy.

But none of this hostility, curiously, carries over into the feelings of the British young about the music of youthful America. Some 40,000 of them turned out for Jazz Expo '67 last fall. And the past few months have produced a similar demonstration of enthusiasm for a varied concourse of American minstrels ranging from Johnny Cash and Bill Haley through Aretha Franklin and Lou Rawls to Simon and Garfunkel and a sumptuous package combining Andy Williams and Henry Mancini.

It is impossible to appreciate the dimensions of this enthusiasm without noting some vital statistics. The Royal Albert Hall seats 6,000. Johnny Cash, Bill Haley, Lou Rawls, and Simon and Garfunkel all sold it out; and the Williams-Mancini show sold it out three evenings in succession, with tickets obtainable only by mail order. Aretha Franklin sold out the Odeon Theater in Hammersmith, capacity 3,800, twice in one night.

In other words, about 50,000 in all. And this in London alone. Several of the groups toured the provinces, probably doubling the total. Some allowance

must be made for duplication, but not much. I was present at most of the London events, and can testify that each artist and each category seem to have their own followings, drawn from a special age group or from a specific level of both musical and intellectual sophistication.

What has impressed me most forcefully is the affectionate relationship between audience and artist. Without exception, these people come to hear in person an artist they have learned to love on records—or, as in Andy Williams' case, on both records and TV. An opening chord, or an introductory rhythmic pattern, is usually enough to set off a round of delighted applause. And the artists have responded in kind, singing their hearts out, and not disdaining repertoire favorites of which they must be heartily tired.

Almost needless to say, this is having a profound effect on Great Britain's own music. Just about every type of American music has its British counterpart. For Lou Rawls and the late Otis Redding there are John Mayall, Eric Clapton, and Peter Green. For Ray Charles there is Tom Jones. For Ella Fitzgerald and Lena Horne there are Cleo Laine and Shirley Bassey. For Frank Sinatra and Andy Williams there are Val Doonican and Engelbert Humperdinck. For the white American songstresses there are Petula Clark, Dusty Springfield, and Cilla Black. For Bob Dylan there is Donovan. And for the new school of American film-score composer-arrangers there are Johnny Dankworth, John Barry, and Johnny Keating.

(Continued on page 48)

CIRCLE NO. 7 ON READER SERVICE CARD →

EXPOSED!

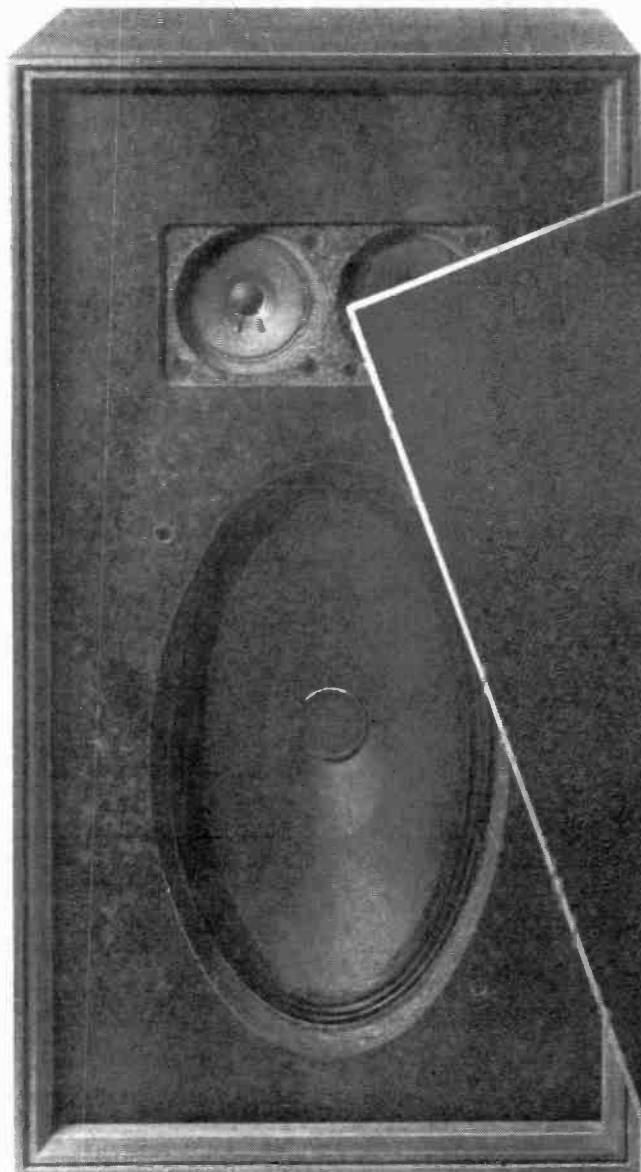

How come EMI bookshelf speakers don't sound like bookshelf speakers?

Look behind the grille. See the elliptical woofer? It has a lot to do with it.

With an elliptical shape, you can squeeze more sound-generating cone area into a small enclosure than with a round one. And it follows that the bigger that cone area, the bigger the sound.

It's almost too simple. But that's how EMI gets "big" sound out of small enclosures.

Take the EMI-62. Cone area is almost 13% larger than the conventional 8-inch round speaker. Yet it is priced at only \$79.95.

The EMI-92 has bigger elliptical woofer. Cone area is 32% larger than an 8-inch speaker; 10% larger than a 10-incher. Price is only \$109.95.

The EMI 629, shown above, goes even further than the 92; a considerably larger woofer magnet and a voice-coil system, and two tweeters instead of one. Hence the higher price, \$164.50. You can hear the difference, too.

Ingenious? But understandable when you consider that EMI is short for Electric & Musical Industries Ltd., one of the world's largest producers of recording and playback equipment, and is the parent company of Angel and Capitol records.

Compare the "big" natural sound of EMI with the bookshelf units of any other maker. At your hi-fi dealer, or write: Benjamin Electronic Sound Corp., Farmingdale, New York 11735. (also available in Canada) **Go elliptical with EMI**

POWER PLAY.

50 watts of it. That's the power handling capacity of Altec's latest bookshelf speaker. And that's just the beginning of the power play you get. For example, the LF speaker is powered by a massive 10-lb. magnetic structure. (No other speaker this size can boast such strength. Except the Bolero. And that's made by Altec, too.) The high frequency end includes a compression-driven horn of cast aluminum. The sound is clear and brilliant over the entire range: from 45-18,000 Hz. It's all yours in an attractively-styled cabinet of hand-rubbed walnut with snap-on grille. Ask for the Madera (style 892A) at your Altec dealer's. Just \$149.50. Or ask us for your free Hi-Fi catalog.



A Division of *SPV* Ling Altec, Inc., 1515 So. Manchester Ave., Anaheim, Calif. 92803

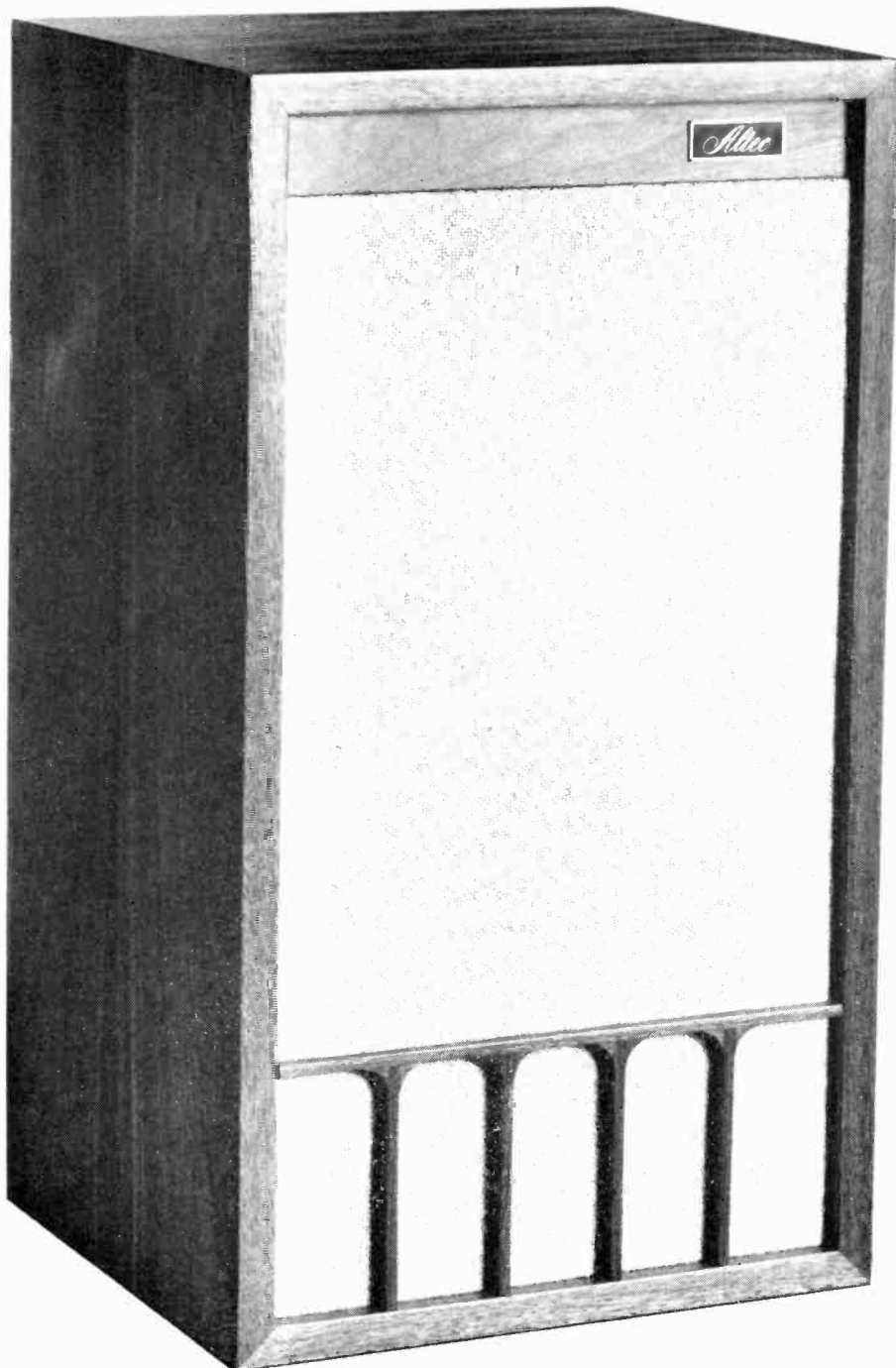

VISIT ALTEC LANSING AT BOOTHS 203A-209A AT THE NEW YORK HI FI SHOW BEING HELD AT THE STATLER HILTON, SEPTEMBER 19-22.

CIRCLE NO. 4 ON READER SERVICE CARD

The significance of these parallels is, I believe, that the flow of musical influence outward from America, dating from the European tours of Sidney Bechet, Louis Armstrong, and Duke Ellington in the 1920's, though interrupted for a time by the reverse influence of the Beatles, now continues as pervasively as ever.

The most important element, apparently, is rhythm-and-blues—or urban blues, or soul music, or whatever you want to call it. A British audience's reaction to Otis Redding, Lou Rawls, or Aretha Franklin has to be experienced to be believed. Delirium. Camp meetin' on the Thames. No teenybopper screams enveloping the Beatles, but real participation—clapping, stamping, swaying, shouted encouragement, shared ecstasy!

And, inevitably, imitation, some of it very good. Time and again, on artist-interview programs on radio and TV, I have been astonished to hear young English boys *talking* cockney, or north country, or Welsh, and then breaking into song with an almost flawless approximation of the vocal production, vowel colorings, diphthongs, phrasings, inflections, accentuations, and cadences of American urban Negroes. It's uncanny. And more remarkable, I think, than the often excellent British imitation of jazz, if only because it is vocal rather than purely instrumental. Only the rhythmic tension escapes them, as is generally true of British jazz, too.

THE pop groups are flabbergasted. They themselves originated, to be sure, from a haphazard mixture of country, blues, folk, and music hall; but beginning with the Beatles' "Revolver" album, the best of them have tended to become increasingly highbrow, earning critical applause but also alienating some of their following. Now the sudden wide popularity of a kind of music closer to the real thing than pop ever was is forcing the pop groups to choose between courting the critics with esoteric lyrics or with adventurous instrumental backings on the one hand and the cultivation of the big beat on the other. It is not an easy decision, and it may well be that a decision either way may prove unsatisfactory.

My own feeling is that we may be witnessing a phenomenon roughly parallel to the transatlantic recognition and acceptance of Bechet, Armstrong, and Ellington nearly half a century ago, with British and Europeans again quicker than Americans to distinguish between the vigorous artistry of a Negro original and the relative artistic anemia of a white dilution. If this speculation should prove to be valid, then halos may be in order for B.B. King, Otis Redding, Aretha Franklin, Little Walter, Willie Dixon, Muddy Waters, and Howlin' Wolf.

CIRCLE NO. 57 ON READER SERVICE CARD →

Cassette stereo finally goes first class.

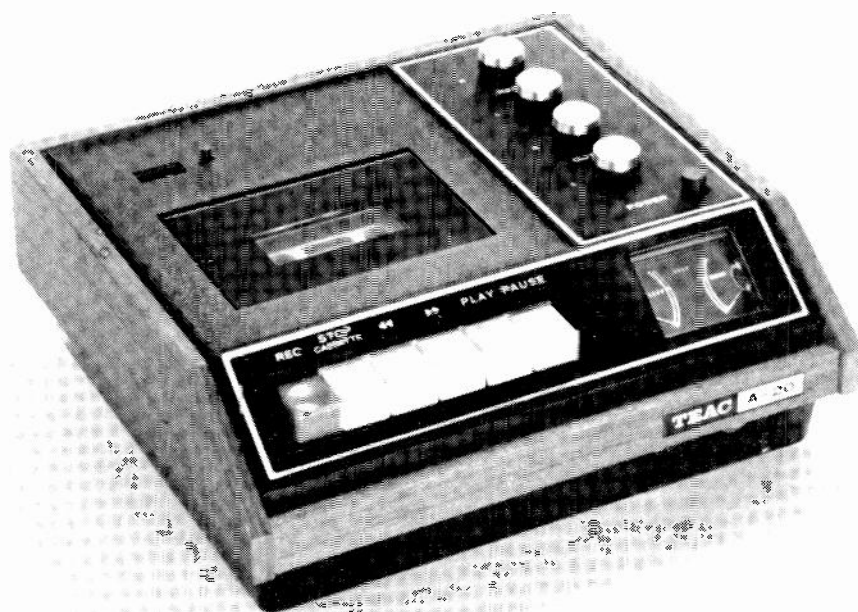

If the muddy, muffled sound you've heard from cassettes has turned you off, turn on this TEAC. A stereo cassette deck, **A-20**.

TEAC has made special heads—cassette heads. The result is sound that equals the best from quality reel decks. Really.

With an all silicon transistor amp and pre-amp, dual VU meter, Pause Control, Digital Counter, and double action Stop-Cassette Off button.

And these specifications: 4 track, 2 channel stereo,

Tape: C-50, C-90, C-120 cassette tape, **Tape Speed:** 1 $\frac{7}{8}$ ips, **Wow and Flutter:** less than 0.2%, **Recording:** AC bias, **Frequency Response:** 60-10,000 Hz, **SN Ratio:** 45 dB, **Input:** MIC 600 ohm - 70 dBs, LINE 120K ohm - 20 dBs **Output:** LINE 50K ohm 0 dBs HEAD PHONE 8 ohm 0.1 mV **DIN Connection,** **Microphone:** Directional MIC (included)
TEAC styling. TEAC sound.
Cassette stereo has finally arrived.

TEAC®

TEAC CORPORATION OF AMERICA 1547 18th St. Santa Monica, Calif. 90404

* THIS IS A TAPE PLAYER/RECORDER HEAD . . .
carefully designed to reproduce frequencies of
 $\frac{3}{4}$ hz to 2.36 KHz (+1 to -18db: 6 hz to 6.5 hz)—
hyperbolic type, 4 track, 2 channel.

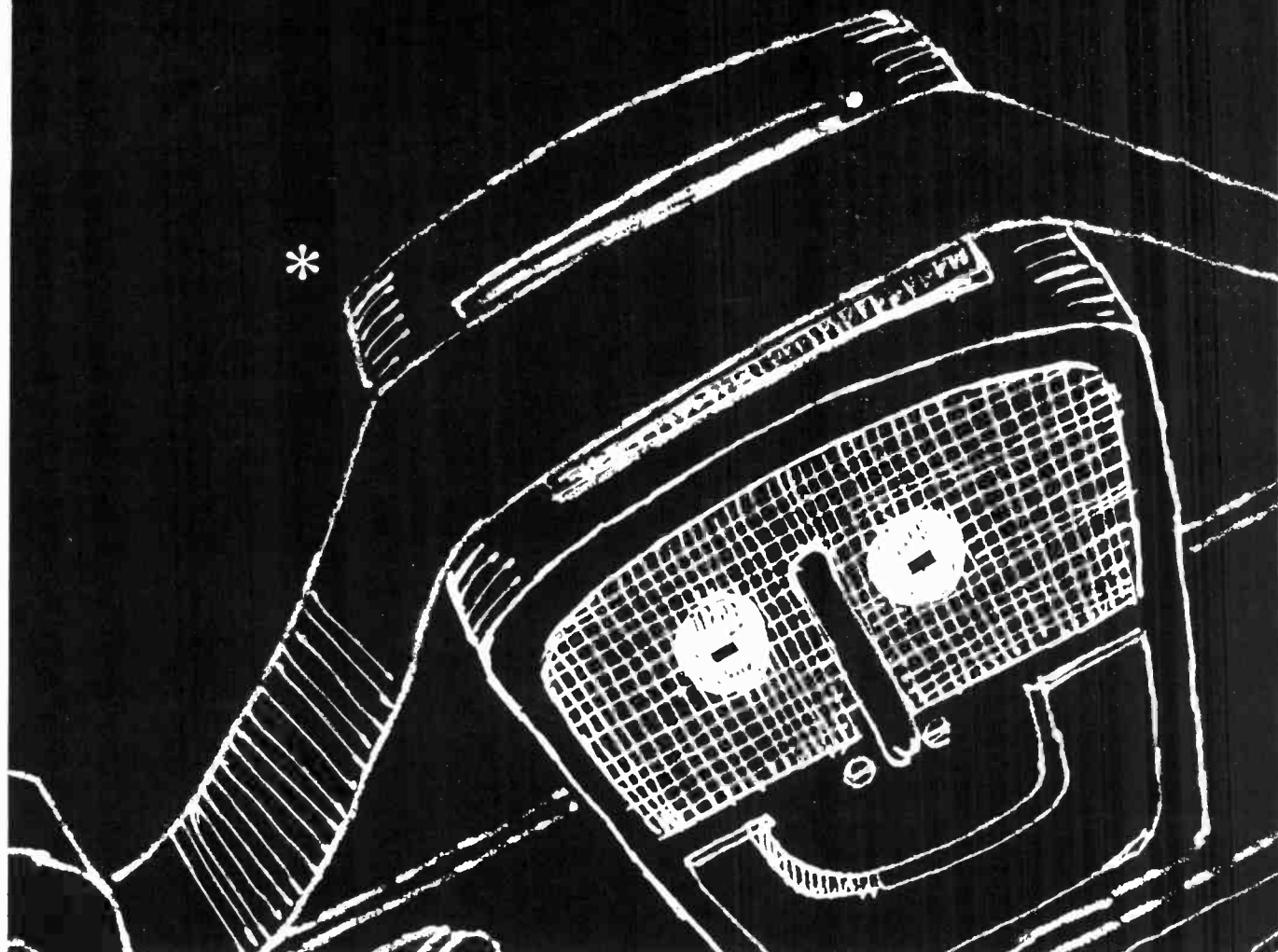

get it through your head . . . Ampex Stereo Tape is better sound!

Ampex pre-recorded stereo tapes are engineered to give you the *ultimate sound* . . . to make your tape equipment realize its full potential! Only Ampex brings you a catalog of thousands of selections including Pop, Rock, Folk, Jazz, Classical and Soundtracks . . . on Open Reel, 4-Track Cartridge, 8-Track Cartridge and Cassette.

AMPEX
STEREO TAPES

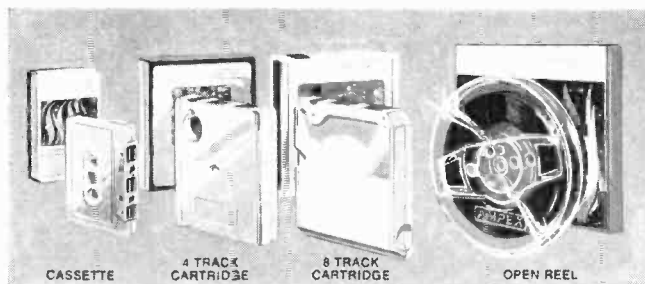

Ask your dealer for the *new Ampex Catalog* or write:
AMPEX CORPORATION
2201 Lunt Avenue, Elk Grove Village, Illinois 60007



Thomas Tallis (1505-1585), supplier of a sixteenth-century theme for a twentieth-century masterwork.

Vaughan Williams'
**FANTASIA ON A THEME
 BY THOMAS TALLIS**

FOUR YEARS hence we shall be celebrating the centennial of the birth of Ralph Vaughan Williams. But there are heartening signs now that this most underrated symphonic composer of the twentieth century is already having something of a revival. As with the recent rediscoveries of Ives, Mahler, and Nielsen, the record industry is playing a key role: all nine of the Vaughan Williams symphonies are currently being re-recorded—by three different conductors. Edward Jablonski's fresh look at Vaughan Williams on page 62 of this issue contains details of these recording plans.

Although the symphonies reveal Vaughan Williams to be one of the most heroic and profound of musical thinkers, his most-heard works are two smaller pieces: the tender and moving *Fantasia on "Greensleeves"*, a concert adaptation of his setting of the famous old English popular song that he first included in his opera *Sir John in Love*, and the *Fantasia on a Theme by Thomas Tallis*, written for the Gloucester Festival in England in 1910 and first performed at the Three Choirs Festival in Gloucester Cathedral on September 6 of that year.

Thomas Tallis was a sixteenth-century English composer who wrote mainly for the church. In 1567 he composed eight tunes, each in a different ecclesiastical mode, for the *Metrical Psalter* of Matthew Parker, Archbishop

of Canterbury. Each of the eight modes was associated with certain specific characteristics; the theme that served Vaughan Williams as the basis for his *Fantasia* is supposed to display qualities of rage and braying. One has difficulty thinking of Vaughan Williams' seraphic score in those terms—serene and majestic are much more fitting descriptions.

Vaughan Williams explained that the *Fantasia on a Theme by Tallis* "is scored for string orchestra divided into three sections: (1) full body of strings; (2) small orchestra of nine players; (3) solo quartet. These three bodies of players are used in various ways, sometimes playing as one body, sometimes antiphonally, and sometimes accompanying each other." The score carries the following further instruction concerning the number and disposition of the second orchestra of nine players: "Two first-violin players, two second-violin players, two viola players, two cello players, and one contra-bass player—these should be taken from the third desk of each group (or in the case of the contra-bass by the first player of the second desk) and should if possible be placed apart from the orchestra. If this is not practicable, they should play sitting in their normal places. The solo parts are to be played by the leader in each group."

The tempo marking of the piece is *Largo sostenuto*.
 (Continued overleaf)

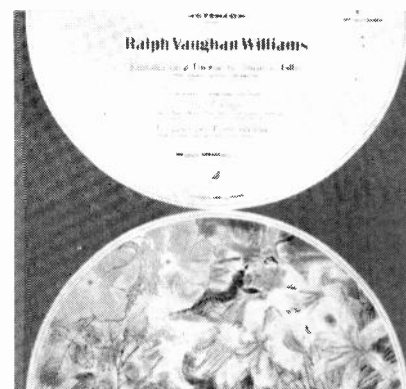

Two of the currently available stereo performances of Vaughan Williams' *Fantasia on a Theme by Tallis* bring the listener into intimate involvement with the work: Morton Gould's (RCA) and Sir John Barbirolli's (*Angel*). Maurice Abravanel's reading (*Vanguard Cardinal*) is more objective, yet full of tension where the music requires it.

The music begins quietly with chords for the full orchestra, while the lower strings follow with a foreshadowing of the Tallis theme. The violins then arrive at *tremolo* chords, and the theme itself is proclaimed majestically by the low strings. There is a restatement with an ornamental figure in the second violins followed by a cadence. Then there is an antiphonal section in which phrases are played alternately by the first (full) orchestra and by the second with mutes. As the two orchestras alternate, a portion of the principal theme is developed by the solo viola and then by the solo violin. The solo string quartet then adds to the various textures, and a rich tapestry of tone color is produced by the alternation and combination of large and small groups and solos. The ending is pure magic: the final chord is arpeggiated and held for a long and tension-packed diminuendo.

FIVE of the six currently listed recordings of the *Fantasia on a Theme by Tallis* also include performances of the *Fantasia on "Greensleeves"*; they are the versions conducted by Maurice Abravanel (*Vanguard Cardinal* VCS 10025, stereo only), Sir John Barbirolli (*Angel* S 36101), Sir Adrian Boult (two of them—the earlier one is on *Vanguard* 1093, the more recent on *Westminster* WST 14111, XWN 18928), and Morton Gould (*RCA Victor* LSC/LM 2719). Sir Malcolm Sargent's performance with the *Philharmonia Orchestra* (*Capitol* SP 8676) has coupled with it the *Capriol Suite* by Peter Warlock and the *St. Paul's Suite* by Gustav Holst.

The Boult-*Vanguard* disc is an English Pye-originated recording that was first released in this country by *Westminster* and subsequently superseded in the *Westminster* catalog by the stereo-mono version listed above. Boult has recorded the music at least three different times, an earlier performance with the *BBC Symphony Orchestra* having done yeoman service in the 78-rpm era. In general, Boult's approach to the score has changed very little over the years: a "cool" conductor by and large, he is content to present the music objectively but nonetheless compassionately. The strings of the *Vienna State Opera Orchestra* in the later recording have more bloom to their sound than do those of the *Philharmonic Prom-*

nade *Orchestra*, but the *Vanguard* disc offers an impressive bonus in the form of the only available recording of Vaughan Williams' evocative *Norfolk Rhapsody*.

Sir Malcolm Sargent's performance resembles Boult's way with the music—it is clean and straightforward, superbly played by the strings of the *Philharmonia Orchestra* and well recorded by the British engineers of *EMI*. The Abravanel performance, too, has about it an air of detached objectivity, but the Salt Lake City conductor is more successful than either Boult or Sargent in building to the tension-packed climaxes in the music. It is extremely well reproduced by the *Vanguard* engineers.

The two remaining recordings—Barbirolli's and Gould's—are for me more successful than Sargent's or any of the Boult performances, and they nose out Abravanel's as my preferred versions of the score. Both Barbirolli and Gould bring a quite personal dynamic attitude to their performances, and both create an atmosphere that alternates between relaxation and tension, riveting the listener's attention and forcibly bringing him into intimate involvement with the music. Both orchestras are superbly disciplined, and the recorded sound in both cases is fine, with *RCA*'s having a slight advantage in richness of texture. I would not wish to put either performance above its rival; both are examples of creative music-making at its best. Similarly, both performances of the *Fantasia on "Greensleeves"* are excellent. Perhaps the other couplings will dictate a choice: Barbirolli's disc offers, in addition to the two Vaughan Williams scores, Elgar's *Introduction and Allegro for Strings* and his *Serenade in E Minor for Strings*; Gould includes another Vaughan Williams work, the *Suite of English Folk Songs*, and Eric Coates' *London Suite*.

Tape collectors have available to them the Barbirolli performance (*Angel* Y2S 3668, 3¾ ips), the second of the two available Boult disc performances (*Westminster* C 148), and Gould's (*RCA* FTC 2164). Again, a choice between Barbirolli and Gould is nearly impossible: it may be that the sound of the *Angel* tape is marginally less cleanly focused than that of the *RCA* reel, but either offers a splendid performance of a work that is one of the glories of twentieth-century musical creation.

REPRINTS of the latest review of the complete "Basic Repertoire" are available without charge. Circle number 160 on reader service card.

Watt for Watt Spec for Spec Dollar for Dollar Sansui offers you more...



This is the new Sansuifidelity 2000. 100 watts (IHF) of music power... 36 watts/channel RMS... harmonic distortion of less than 0.8% at *all* rated outputs... FET Front End... 1.8 μ V (IHF) FM Sensitivity... frequency response from 15-40,000 Hz. If you are an expert in audio equipment you will know what these specifications mean; if you are not, ask any sound engineer; he will tell you. He will also tell you that specifications alone do not make a great receiver. There is the perfection of every component, the most exacting quality control, the integrity and pride of the manufacturer, and that extra care and extra imagination that make a truly great product.

Your Franchised Sansui Sound Specialist invites you to see and listen to the Sansuifidelity 2000: Watch the exclusive Sansui blackout dial light up when you listen to AM or FM broadcasting and change when you switch the selector to phono or tape or auxiliary; notice the ease with which the controls let you choose exactly the blend of music you want to suit you and your personal taste. All this and much more at the unbelievable price of **\$299.95.**

Sansui

Sansui Electronics Corporation • 34-43 56th Street • Woodside, N.Y. 11377 • Telephone 446-6300
Sansui Electric Company, Ltd., Tokyo, Japan • Electronic Distributors (Canada), British Columbia

CIRCLE NO. 49 ON READER SERVICE CARD

Does WHARFEDALE still use sand in its speaker systems?

YOU BET WE DO! For example, you'll find over 7 pounds of fine, white sand densely packed between layers of hardwood in our W70D speaker system... even more in the W90D... a little less in the W60D. Why sand? Because to create the famous Wharfedale *Achromatic* sound, we know a speaker cabinet must remain absolutely inert. It must be more than just hardwood, for even the thickest wood baffles can resonate. The Wharfedale sand-filled construction damps all vibrations and eliminates spurious resonances, no matter how deep or intense the bass energy. The result is distortion-free, superior sound. Rap the back cover of a sand-filled Wharfedale and hear the low, dull "thud" in contrast to the resonant sound of equally large plywood panels normally used in other systems.

MORE COSTLY TO BUILD... AND WORTH IT!

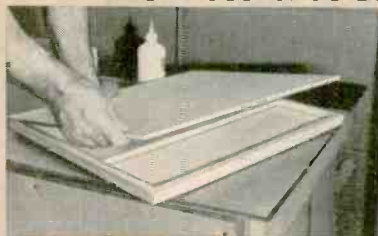

1. Cabinet back cover being assembled. Heavy plywood walls are further strengthened by thick wood braces, forming a strong, rigid panel with cavities.



2. Panels are stacked on specially designed vibrating machine. Note small, round openings on top edges, forming a strong, rigid panel with cavities.



3. Sand is poured on, filtering slowly through small openings into panel cavities. Vibration machine eliminates air pockets, insures maximum compression.



4. Feed holes are sealed with wood plugs. Panel becomes totally inert to the back waves of sound which will be projected against it in the speaker enclosure.

HEARING... AND SEEING... IS BELIEVING. Once you hear the sound of Wharfedale *Achromatic* Speaker Systems, you will understand why Wharfedale has earned the loyalty of the most knowledgeable listeners in music and audiophile circles. *Achromatic* sound is rich, full, realistic sound reproduction, uncolored by extraneous modulations. The speakers and cabinet perform together as a single unit in correct acoustical balance to provide a truly faithful duplication of the original performance. It's the result of unique and exclusive construction features and techniques developed by Wharfedale.

What's more, you'll be delighted by Wharfedale cabinets: decor-conscious proportions; fine furniture finish; tasteful grille fabrics, removable at will; design that is a refreshing departure from conventional "boxy" shapes.



Wharfedale
ACHROMATIC SPEAKER SYSTEMS

Write for Comparator Guide and Dealer List to: Wharfedale Div., British Industries Corp., Dept. HF-2, Westbury, N.Y. 11590.

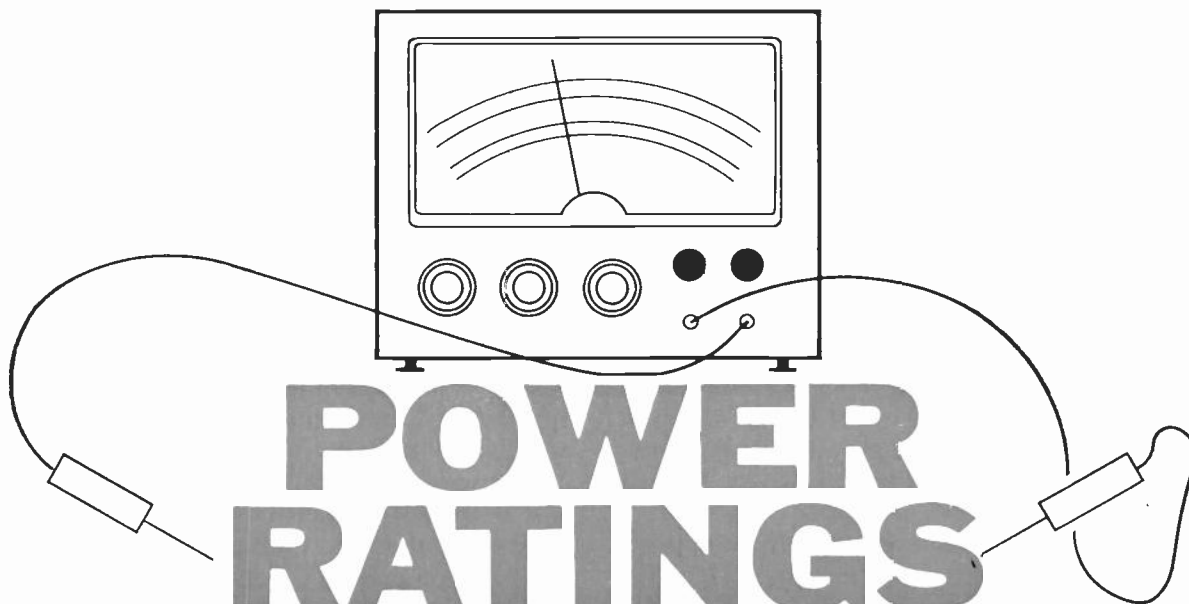

POWER RATINGS of LOUDSPEAKER SYSTEMS

FACTS, FIGURES, AND FUSING (IF NECESSARY)
TO ALLAY YOUR FEARS OF BLOW-OUT

By **B. N. LOCANTHI** and **G. L. AUGSPURGER**

THOUGH it sometimes appears that modern household-appliance technology has made us into a nation of expert switch-flickers, button-pushers, and dial-twiddlers, there are moments when confidence and courage fail us and our electronic servants seem to be either slightly confusing or downright dangerous. And that is why manufacturers of stereo components quite often receive letters from new customers who are intimidated by their latest audio acquisition—they aren't sure just how to install a unit or to operate its controls without damaging something.

Loudspeaker manufacturers probably get the bulk of this anxiety-motivated correspondence, perhaps because many people are mystified by loudspeaker power ratings and their relationship to amplifier power ratings. To clear the air at the start, the timid should be assured that unless a stereo rig is plagued by loose jacks and plugs, or is being used by unsupervised teen-agers (whose notions of reasonable loudness approach the threshold of pain), the chances of blowing out loudspeakers are

really very slight. Since high-quality loudspeakers are generally far more rugged than the cheaper types, you really have to go out of your way to damage the usual hi-fi speaker. Most mishaps simply never would have happened if audiophiles had been careful to observe the following *don'ts*

1. Don't use ordinary household a.c.-line plugs for speaker connections. If you do, sooner or later someone will plug one of your loudspeakers into a wall outlet. The resulting sound output is highly dramatic, but short-lived and expensive.

2. Don't turn up the bass control *and* switch on the loudness compensation *and* crank up the volume all at once. Because of the ear's relative insensitivity to very low frequencies, greatly amplified turntable rumble doesn't sound very loud. But it can overdrive and possibly damage your speakers. For the same reason, be careful when you use test records with low-frequency test tones. Cone excursion doubles for every octave reduction in frequency, and it is therefore very easy to overdrive a speaker in an attempt to achieve an adequately loud signal at the very lowest frequencies.

3. Don't plug or unplug tubes or audio-cable connectors while the system is turned on. The sudden loud ZAP may be the last sound your speakers ever produce.

It seems logical to assume that accidental damage can be avoided by matching your amplifier to your speakers, so that a loudspeaker rated at 30 watts is used with a 30-watt amplifier, and so on. But things aren't that simple. To understand why, let's look at a few facts about loudspeaker *vs.* amplifier ratings.

Loudspeaker power ratings actually refer to two separate factors: (1) the minimum amount of amplifier power that is required to bring out the best in a speaker under average playing conditions, and (2) the maximum amount of power that can be applied to a speaker without the risk of electrical or mechanical damage. We will discuss the latter point first.

Technically minded readers are probably aware that a loudspeaker presents a complex reactive load to the amplifier. Because the magnitude and phase angle of a speaker's impedance varies so widely over its frequency range, the actual power drawn while reproducing program material is very difficult to measure. However, for our purposes, it really doesn't matter how much actual power is involved. We can calculate power on the basis that a loudspeaker's impedance is equivalent to a simple resistor of the same value. This is valid because the frequency range in which the peak program energy occurs is the same frequency range in which a loudspeaker's actual impedance is nearly equal to its rated impedance.

By common agreement, loudspeaker power ratings are

calculated using the rated impedance of the speaker at 1,000 Hz. "But," you say, "I don't listen to 1,000-Hz tones, I listen to music. My speakers are rated at '35 watts program.' Exactly what does that mean?" Chances are it doesn't mean *exactly* anything. There is no standard method for rating a loudspeaker's power capacity, and each manufacturer has his own notions of how to arrive at meaningful (or suitably impressive) figures. Here are a few typical examples of loudspeaker power ratings taken from ads and specification sheets: "8 watts program" (measuring method not specified); "30 watts integrated program material" (measuring method not specified); "recommended amplifier power—10-50 watts"; and "150 watts instantaneous peak power" (how long is "instantaneous"?).

It is obvious that such ratings serve only as general guides (see the box "Loudspeaker Power-Rating Terminology" on page 58). But at best, power *capacity* is only half the story. After all, we really are not as interested in what can be put into a loudspeaker as in what comes out. And so we get into the question of efficiency—which is a measure of what percentage of the electrical power input to the speaker is converted to acoustical power output from the speaker. High-quality loudspeaker systems designed for home use run from about 0.25 per cent efficient to perhaps 20 per cent. Most bookshelf systems average around 0.5 to 1 per cent efficiency, while the larger systems are usually 3 to 5 per cent. Considered only in terms of the amount of sound it will put out, and all other factors being equal, a 3 per cent efficient loud-

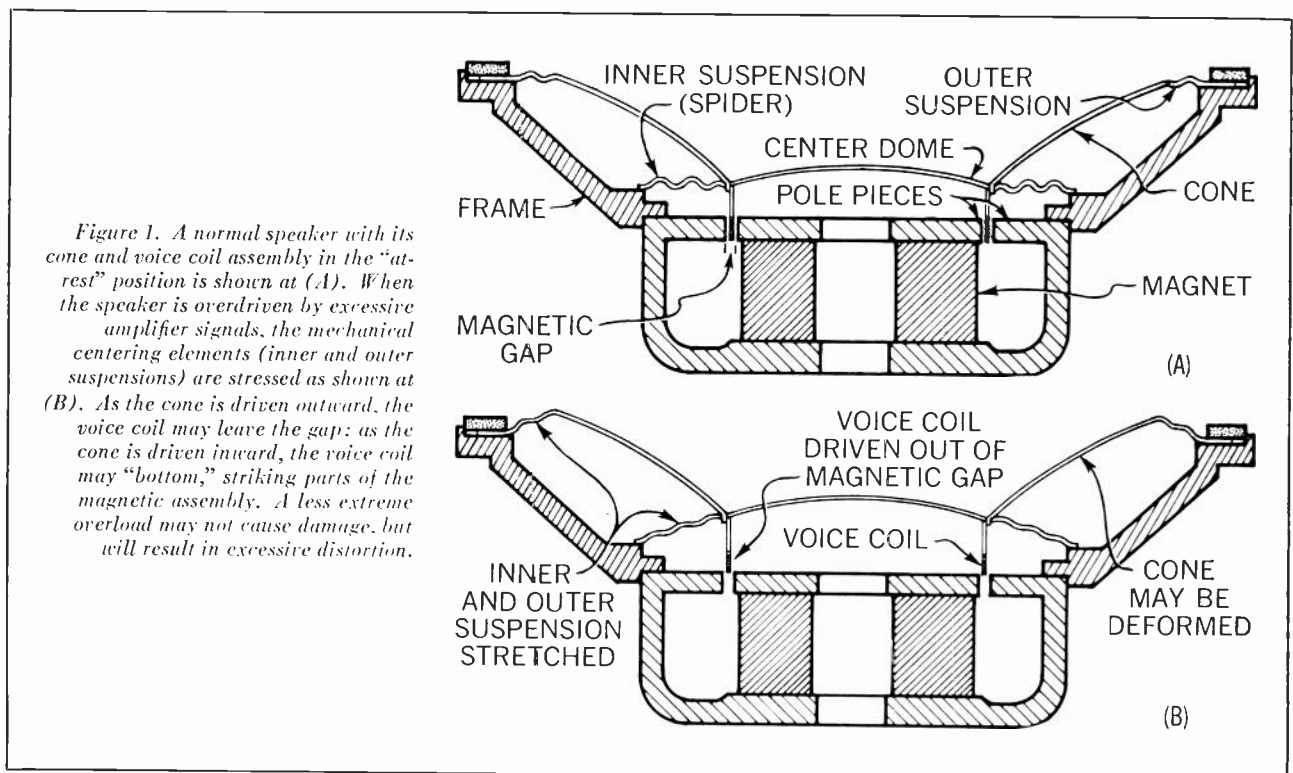
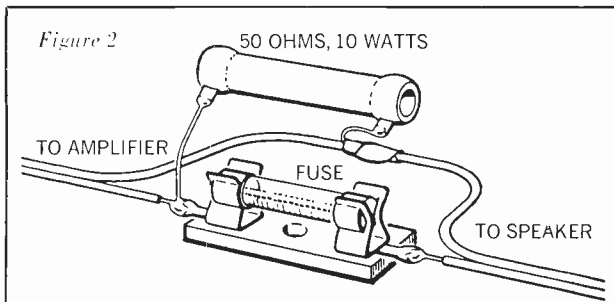

Figure 1. A normal speaker with its cone and voice coil assembly in the "at-rest" position is shown at (A). When the speaker is overdriven by excessive amplifier signals, the mechanical centering elements (inner and outer suspensions) are stressed as shown at (B). As the cone is driven outward, the voice coil may leave the gap; as the cone is driven inward, the voice coil may "bottom," striking parts of the magnetic assembly. A less extreme overload may not cause damage, but will result in excessive distortion.



Speaker power rating		Fuse rating in amperes		
		4-ohm speaker	8-ohm speaker	16-ohm speaker
7-10 watts	Safest	1/2	1/4	1/8
	Good	1	1/2	1/4
	Maximum	2	1	1/2
10-15 watts	Safest	3/4	3/8	1/4
	Good	1 1/2	3/4	3/8
	Maximum	3	1 1/2	3/4
15-25 watts	Safest	1	1/2	1/4
	Good	2	1	1/2
	Maximum	4	2	1
25-35 watts	Safest	1 1/2	3/4	3/8
	Good	3	1 1/2	3/4
	Maximum	6	3	1 1/2
35-50 watts	Safest	2	1	1/2
	Good	4	2	1
	Maximum	8	4	2
50-75 watts	Safest	2 1/2	1 1/2	3/4
	Good	5	3	1 1/2
	Maximum	10	6	3

Use standard 3AG fuses, not slow-blow types. Start with the "safest" recommended value. If this blows on loud passages, substitute the corresponding "good" value. If you try to use a fuse of higher amperage than "maximum," chances are that it will offer no protection at all.

speaker system capable of handling 20 watts of power will put out more usable sound than a 0.5-per cent system that can take 40 watts of amplifier power.

Your high-fidelity dealer can provide rough comparisons between efficiencies of the various loudspeakers he sells. He knows from experience that brand A, for example, generally requires an amplifier twice as powerful for equivalent undistorted loudness as brand B, and that, on the other hand, brand C is more efficient than A or B, but distorts badly before it reaches even a moderate loudness level.

While a loudspeaker's maximum power rating is usually based on the strongest short-term signal that can be handled without permanent damage, an amplifier's power rating is based (or should be) on its long-term power output at a specified distortion. A good 50-watt amplifier can produce 50 watts at low distortion through the full audible-frequency range. In the 1,000-Hz region it probably can produce 60 watts before clipping. If a strong signal drives the amplifier into the clipping region, it may conceivably feed 85 watts of power—mostly distortion, but power nonetheless—into the loudspeaker! This is why the power rating of an amplifier cannot be relied upon to protect the associated loudspeaker system. Under

certain conditions, a loudspeaker system can be damaged when driven by a signal *below* its rated power capacity. This can occur when there is sufficient single-frequency energy fed to one of the drivers in a two- or three-way system, such as when an amplifier oscillates ultrasonically and burns out a tweeter, or when high-level sine-wave test tones are fed to a system.

So much for "matching" the power ratings of loudspeakers and amplifiers. As a matter of fact, many audiophiles use very powerful amplifiers with speakers rated at only 25 or 30 watts so that there is sufficient amplifier power reserve to handle fleeting transient peaks without distortion. As long as normal precautions are observed, such combinations are perfectly safe.

WHAT happens to a loudspeaker when things go wrong? Since only a small part of the electrical power fed to a speaker is converted to sound, it follows that most of the power is dissipated as heat. Excessive heat may expand or physically distort the voice coil until it touches the pole pieces (see Figure 1), it may weaken the bond between the voice coil and the cone assembly, and in extreme cases actually melt solder connections or a portion of the voice coil itself.

Heavy-duty woofers, with their large copper voice coils and massive magnetic assemblies (which act as heat sinks) can dissipate considerably more heat than smaller, more delicate tweeters. Fortunately, ordinary musical material has relatively little energy above 2,000 Hz or so, and a tweeter doesn't need to handle as much power as a woofer. But if something other than normal program material is amplified—say, test tones, spurious oscillations, or the signal produced when a tape is re-wound at high speed without being lifted from the playback head—a high-frequency loudspeaker may burn out without warning.

The woofer has its own problems at very low frequencies, where a comparatively small signal results in long cone travel. If the cone is repeatedly forced beyond its normal limit, mechanical damage results (Figure 1B). The cone may develop cracks or tears, the voice coil may be driven out of the magnetic gap and "freeze," or the cone can be deformed so that the voice coil is forced out of concentricity and scrapes against the pole pieces.

In regard to protecting your loudspeakers, make sure to observe the three "don'ts" at the beginning of this article. If possible, it is a good idea to check the low-frequency-loudspeaker cone visually when the system is operating at high volume levels. Remove the grille-cloth frame or shine a strong light through it so that you can observe the motion of the cone. You may be surprised to find that even with a quiet turntable, it doesn't take much bass boost to produce substantial cone excursions. A good low-frequency loudspeaker can stand occasional cone excursions that you might think were impossible if

Loudspeaker Power-Rating Terminology

LOUDSPEAKER power ratings are even more confused than amplifier ratings. If a loudspeaker is rated at 30 watts with such qualifications as "program power," "integrated program material," or "continuous program," this is not the same thing as 30 watts of continuous sine-wave signal. Music and speech are made up of irregular bursts of high-level energy separated by longer stretches of relatively low-level material which gives the speaker a chance to "cool off." Therefore, the program-power rating of a loudspeaker is two to ten times its maximum safe sine-wave input. However, if a manufacturer rates a loudspeaker at "30 watts" with no qualifying phrases, you can be pretty sure that it is a program-power rating.

If "peak power" or "instantaneous peak power" is given, this may be exactly twice the program-power figure (using the most common definition of peak power), or it may be several times the program-power rating. In the latter instance, the manufacturer may state that his program-power rating is based on measurements of program-power taken with a standard VU meter. Since program peaks too brief to be indicated by the meter are 6 to 10 dB greater than what is shown, the seeming discrepancy can be defended.

There is also the question of power *vs.* frequency. The greatest energy in speech or music is concentrated within a few octaves of 1,000 Hz. A loudspeaker that can easily handle 30 watts of normal program material may nonetheless be damaged if this much power is fed to it at very low or very high frequencies.

It can be seen that a given loudspeaker might legitimately be rated at 10 watts (steady-state sine-wave), 40 watts (continuous program), 80 watts (peak program), or as much as 150 watts (momentary peak or instantaneous peak), but it would be helpful to users if manufacturers were to spell out the basis of their ratings. It would also make things much easier if all loudspeakers were rated for power input *vs.* distortion, but there are just too many problems in setting up uniform loudspeaker measuring techniques to make such a rating method feasible at present.

you hadn't actually seen them. But if you discover that, for one reason or another, the woofer cone *continually* strains at its moorings, you may be sure that it is only a question of time before it finally tears loose. If the cone constantly pumps back and forth a quarter of an inch or so when in normal use, there may be excessive turntable rumble, poor turntable shock mounting, acoustic feedback from loudspeakers to phono pickup, amplifier instability, or a combination of these ailments.

What about fuses? Fusing offers some protection, although massive overloads can blow out a speaker and its associated fuse simultaneously. Moreover, to fully protect against overload, the fuse may also blow on loud musical passages that the speaker could have safely reproduced. However, if you want to take every possible precaution, follow the recommendations in Figure 2.

From time to time, special speaker-protection circuits are published in audio journals. These may use relays,

Zener diodes, controlled rectifiers, and other voltage- or current-limiting devices. The trouble with all these circuits is that nothing short of a full-size computer could keep track of exactly how much signal is safe at each and every frequency. Consequently, to be reasonably positive in action, any practical protective device must also put a top limit on the dynamic range of the speaker system.

As stated earlier, loudspeaker power ratings usually cover both *maximum* power (which we have just discussed) and *minimum* power. There's a great deal of misunderstanding about the relationship of the two ratings. Simply stated, it is the difference between how much power the speaker will take without damage, and how much power the speaker needs in order to perform at its best. The second factor has to do with efficiency, the first does not. There is no reason why a 5-watt amplifier can't be used to drive a loudspeaker system with a 50-watt-maximum rating. If a loudspeaker manufacturer recommends that some particular model be used with amplifiers having an output of at least 20 watts, it means that a less powerful amplifier may produce excessive distortion or loss of low bass and high treble when the combination is played very loudly. It does *not* mean that 20 watts are needed to get any sound at all from the speaker system.

Ten years ago, a 15-watt amplifier was thought to be a very powerful amplifier indeed, and only a few eccentrics insisted on having brutes capable of producing 25 or 30 watts at less than 5 per cent distortion. Today's loudspeaker systems have in general sacrificed efficiency for smoother and more extended response, and at the same time the dynamic range of records and tapes has steadily increased. This means that amplifiers and loudspeakers must reproduce momentary peaks of considerably greater intensity than were likely to be encountered a decade ago. If you like to play your stereo system at concert-hall intensity now and then, your amplifier should be able to put out at least 25 watts per channel with less than 1 per cent distortion. If you expect to run additional extension loudspeakers throughout the house, proportionally more available power is desirable.

In conclusion, it should be emphasized that loudspeakers are rarely overdriven in home-music installations. Playing your system every day at loud levels (within reason) won't "tire" the loudspeaker systems. A fine loudspeaker is, in many ways, like a fine piano or other musical instrument. It thrives on continued usage, and occasional overloads will not change its performance qualities. As long as you use a little care in the operation of your stereo installation, you simply don't have to worry about blowing out your loudspeakers.

B. N. Locanthi and G. L. Augspurger are both associated with J. B. Lansing, Inc. Mr. Locanthi is Vice President, Engineering, and Mr. Augspurger is the Professional Products Manager.

LOUDSPEAKERS *CAN* BE TESTED

AN EVALUATION OF THE OBJECTIVE AND SUBJECTIVE APPROACHES TO LOUDSPEAKER TESTING

By ROY ALLISON



AS ANY close observer of the audio scene is by now aware, mysticism and illogic are not restricted solely to the followers of the eastern philosophies. An impartial observer would have to conclude that there is an unusually large proportion of people among manufacturers, equipment reviewers, and audiophiles who, while rational in other respects, tend to become quite irrational when they discuss loudspeaker systems.

Explanations for this failure of good sense are not hard to come by. Acoustics is still a relatively young science, one that, until very recently, was thought to be of little practical utility in comparison with other scientific disciplines. Universities are not set up to turn out acoustical engineers in the same way that they are organized to produce mechanical, civil, and electronics engineers, and only a few have the facilities for graduate research programs in acoustics. As a result, there are only a small number of engineering and research personnel available with any academic background in acoustics. Those who are available are most often occupied in fields not connected with high fidelity at all—noise control, underwater sound, architectural acoustics, and the like.

A "general-purpose" electronics engineer doesn't have much difficulty adapting himself to designing component amplifiers, tuners, and receivers, and though there may be some disagreement concerning what the design goals for such components should be, arguments generally center on matters of degree rather than substance. Once the amplifier designer is given a set of design goals, however, he has no doubts about his ability to make meaningful, objective tests that will tell him whether he has in fact reached these goals. The people who review and comment on the results of his work have confidence in their ability to make similar objective tests, and they have confidence also that the results of these tests are valid indicators of how well the amplifier will do in reproducing music accurately. Usually their confidence is well founded. In short, there is no basic disagreement on how to judge the performance of an amplifier.

It is quite a different matter for an engineer trained in another area to undertake the design (or evaluation) of loudspeaker systems. A considerable amount of self-

education is required. All the necessary information is available in print, but it isn't always easy to choose between information and misinformation; further, once this choice has been made, it is often tedious to absorb the data and to understand their implications. Add to these problems the facts that: (1) loudspeaker tests *are* more complicated to make and interpret than tests on other high-fidelity components; (2) the test equipment and facilities required *are* more expensive and take up more space; and (3) loudspeaker systems in general *are* further away from perfection than other components. Given all the above facts, the strong tendency to treat loudspeaker design and evaluation as an art rather than a science becomes understandable. And it is also possible to understand why there are so many "authorities" who insist that there can be no standard for judgment of loudspeaker performance other than individual taste.

BUT if most loudspeakers fail to meet a high standard of performance, that is no reason to deny the *existence* of any standard, nor is the difficulty of evaluating a system's quality by objective test procedures a legitimate reason to deny the *validity* of objective testing. Let's return for a moment to first principles: what is a speaker system supposed to do? Is its purpose to be a "flat" reproducer, part of a chain of components that is intended to recreate faithfully sounds that were sensed by microphones at the beginning of the chain? Or should loudspeakers be designed to sound "pleasant," or "dramatic," or "brilliant"—that is, to superimpose various tone colorations of their own on all the music that is fed to them?

If you say "yes" to the last question, then logically the design of loudspeakers *must* be mostly art. The speaker designer would put himself in competition with musical-instrument makers, and the selection of a "good" loudspeaker would become entirely a matter of taste. "High fidelity" then becomes a phrase without relevance to this kind of system since the aim is not fidelity to the original, but an appeal to individual taste.

Well, what's wrong with catering to variations in taste in sound timbre? In the short run, nothing at all. But remember that the design of musical instruments has

been refined through centuries to make them sound as they do. It is for good aesthetic reasons that the relatively minor acoustical differences between a violin costing \$50 and one costing \$50,000 are considered so important. Composers write music for the predictable sound of live instruments. If loudspeakers are *not* made to reproduce these sounds as accurately as possible, their users are sacrificing the benefits of hundreds of years of dedicated musical craftsmanship. As listeners' tastes are seasoned by musical experience they find that a consistently mellow sound becomes boring, artificially bright sound becomes irritating, and that only a close facsimile of the original musical sound gives long-term pleasure.

It has been pointed out that the sound of live music is not the same from one concert hall to another, or even from seat to seat in the same hall. Isn't this clear justification for making different-sounding speakers for the man who customarily sits in the front row and the man who prefers the second balcony? There are two major flaws in this approach. First, it is based on an incorrect premise—namely, that the difference between front-row and second-balcony sound at a live concert is mostly a matter of the relative amplitudes of the various frequency ranges. Such differences do exist, but they are much less significant in terms of aural impression than other differences: the ratio of direct to reverberant sound energy, the time delay between direct sound and first echo, and so on. No amount of juggling with frequency response can change these acoustic relationships on a recording. They are determined by the recording microphone locations.

A second flaw in the question is the assumption that a loudspeaker's frequency-response peaks or valleys are likely to provide suitable "correction" for the live-sound frequency-balance differences at various places in the concert hall. But such differences occur gradually, not abruptly. To whatever extent a listener feels the need for making such corrections, he can do it far more naturally with his amplifier's tone controls. Tone-control corrections have the advantages of being predictable, infinitely variable, of providing gradual rather than abrupt response changes, and—perhaps most important—they permit instant restoration of flat response.

It is a fact that the acoustical properties of a listening room have a major influence on the sounds produced within it. It is also true that the location of the sound source in the room has a substantial effect on just how the room will modify the sound source's output. (For a full discussion of these matters, see "Controlling Listening Room Acoustics," *HIFI/STEREO REVIEW*, February 1964—a free reprint of the article is available from Acoustic Research, Inc., 24 Thorndike St., Cambridge, Massachusetts 02141.) These room influences affect *all* sound sources—all kinds of speaker systems, and even live sounds generated in the room. Is it logical to assume, therefore, that one ought to try to find speakers that will

compensate for listening-room deficiencies, and thereby "match the speaker to the room"?

The answer depends on the kind of room problem we're talking about. If the difficulty lies in the presence of one or more sharp room resonances—the kind that occur at bass and lower-middle frequencies—the answer is an unqualified "no." It would be hopelessly optimistic to expect to find speaker systems with dips in response at frequencies that coincide with your room peaks, and peaks that coincide with your room dips. You have a far better chance of minimizing this kind of room problem if you start with speaker systems having a neutral personality (no sharp response aberrations), and tame the room peaks by judicious speaker placement and/or modification of the room's acoustical character.

If the room is simply too bright or too dead, if it tends to emphasize or depress a broad range of frequencies, your best choice is still a speaker system with smooth and uniform output. Very good compensation for the room's deficiencies can then be gained by suitable adjustment of the speaker system's mid-range and tweeter-level controls, by the amplifier's tone controls, or a combination of both.

How does one go about finding a speaker with a smooth and uniform output, a "neutral personality"? Are there objective instrument tests which, properly interpreted, can be used to predict the performance of a speaker system when reproducing speech or music? Yes, there are—if one makes the right kinds of tests. If there are inconsistencies between the test results and listening results, one cannot logically conclude that speaker measurements are therefore of no value. The wrong factors must have been tested—or the right factors tested wrongly.

ONCE we have agreed that a speaker system's job is to reproduce faithfully what is put into it, most of the apparent mystery in selecting appropriate test procedures disappears. If the goal is to produce an acoustic output that is precisely proportional in all respects to an electrical input, we have only to consider all the ways in which the output *could* differ from the input, and then devise valid ways to measure such differences. Through careful live-*vs.*-recorded listening tests we can discover empirically which differences are audible and which are not, and under what circumstances a certain amount of difference is audible. Then we have valid and reliable tests that are sensitive enough to measure every kind of significant difference, and we can use these tests to evaluate the performance of loudspeaker systems objectively.

Note that the key to the entire process is the validation of instrument tests by listening tests. I cannot emphasize too strongly, however, that these *must* be on-the-spot, instantaneous, direct comparisons of live sound *vs.* the reproduced sound. Trying to relate a fading memory of live music in one acoustic environment to reproduced



"... Good Lord, man, have you no conscience?"

music in another is futile. Of course, gross departures from accurate reproduction can be detected without a direct comparison. But nobody—no matter how golden eared—can, simply by comparing the sound of two speakers, determine which is only "very good" and which is close enough to the original to fool the ear completely. To make a valid judgment, the original reference sound must be available for A-B comparison.

In order to make such a distinction with any assurance of being right, one must abandon the quick-and-easy "golden-ear" or "trained-listener" concept and resort to scientific method. There are two ways to go about this, both legitimate if carried out properly. The first is the live-*vs.*-recorded comparison technique. This method cuts directly to the heart of the matter—how accurately the speaker system can reproduce the original sound—because the original is there at hand for instant aural comparison. Acoustic Research has produced dozens of public concerts in recent years at which live music was played in alternation with a special recording of the same music made previously. But this technique, when used as a tool for speaker testing, doesn't require live musicians. All it requires is a readily available, repeatable "reference" source of sound with wide dynamic and frequency range, and a good recording of the reference sound for playing through the speaker to be tested. Since the reference sound need only be repeatable on demand—not conform to any quality standard—it can even be tape-recorded music played through another speaker!

The recording of the reference source must be carefully made, of course. It must be an accurate representation of the total sound power output *vs.* frequency; and, in order to avoid doubled room reverberation in the speaker under test, the recording must be made anechoi-

cally. Rigorous descriptions of live-*vs.*-recorded test techniques have been published in technical journals. As far as I know, however, only one manufacturer (AR, Inc.) and one test organization (Consumers Union) are using this very powerful and simple evaluative system.

The second method of distinguishing between the "very good" and the "near perfect" speaker is to devote the requisite time and effort to making valid objective measurements. This approach yields quantitative data; the live-*vs.*-recorded test does not. If one expects to extract trustworthy information from objective test data, however, the test techniques must be good to start with. For example: frequency-response curves can provide very useful information. But response curves made on a speaker system in a living room are not useful, because, at most frequencies, room reflections and resonances completely swamp the speaker's response to sine-wave test-signal inputs. Moving the microphone even a short distance significantly changes the combined speaker/room response curve. Even when many microphones are used, it is impossible to know with certainty what is a room peak and what is a speaker characteristic.

To get useful response data, the speaker must be measured under anechoic conditions—in a large room with completely sound-absorbent walls, or out of doors in a large open area. To get an accurate picture of the dispersion at high frequencies and the total sound power output *vs.* frequency, the speaker's response must be measured at all angles, not just directly in front. The same procedure must also be used to check that the speaker does not have a suddenly uneven frequency response at a particular angle.

Distortion *vs.* frequency at various power-input levels, transient response *vs.* frequency, and electro-acoustic efficiency can all be measured reliably. All have a bearing on audio performance. A skilled engineer can put these test results together and come up with an accurate assessment of how well the speaker will do as a reproducer of music—as well as what its weaknesses will be. These objective tests accomplish precisely what the corresponding tests on an amplifier are designed to do: compare the input with the output, and assess the differences between them. In the case of the live-*vs.*-recorded technique, this comparison is made instantaneously, by the ear, on a qualitative basis; in the case of objective measurements, the comparison is made by test instruments on a quantitative basis. The two methods can be used separately or combined, one method checking the conclusions of the other. When they do not agree, it is most often because a *true* measurement of the speaker's "output" has not been made.

Roy Allison, a regular contributor, is responsible for product development and manufacturing at Acoustic Research, Inc., and is author of the book High Fidelity Systems: A User's Guide.

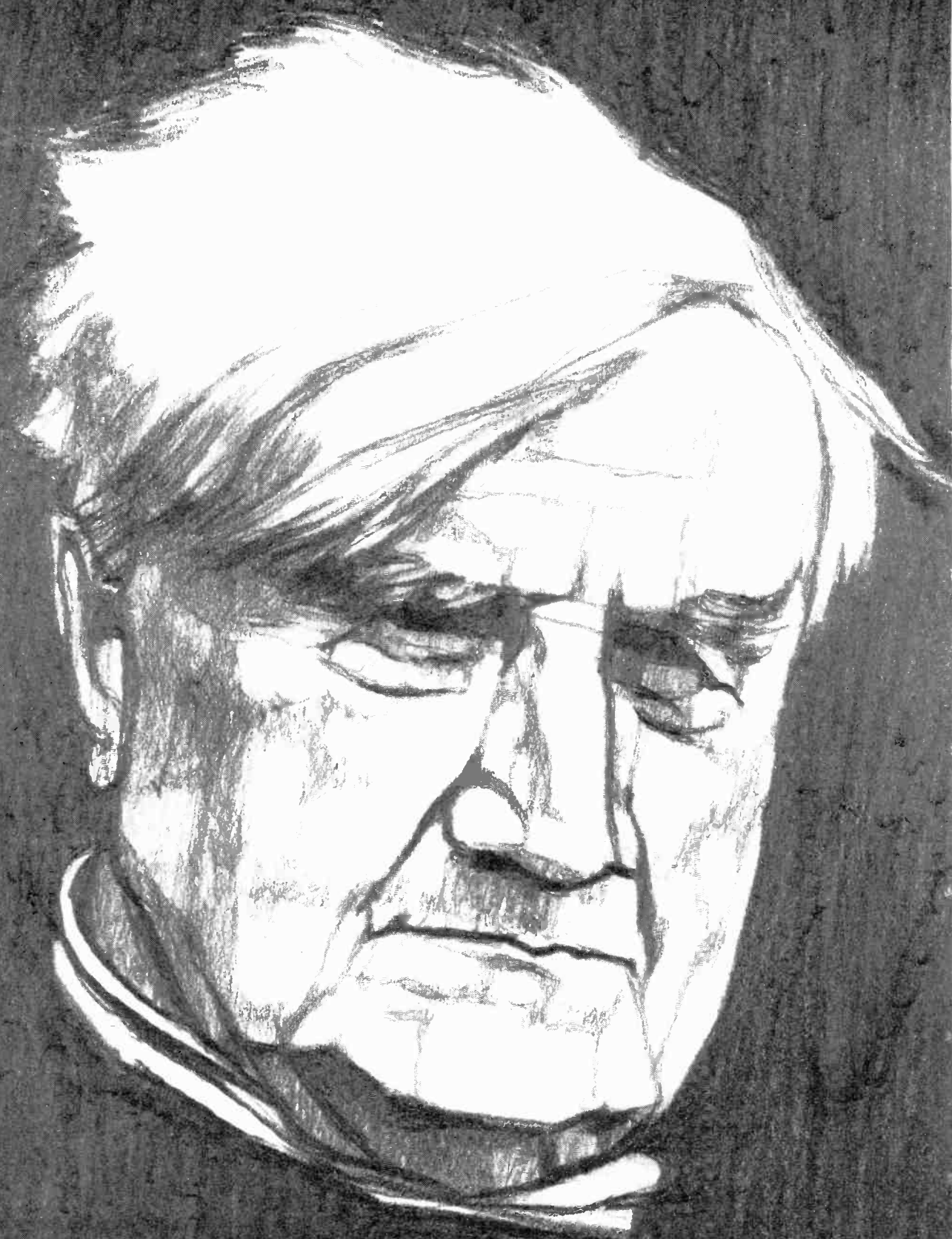

Mozelle

Ralph Vaughan Williams

England's greatest symphonist

By EDWARD JABLONSKI

THERE WAS A TIME in Britain, during the mid-Fifties, when it was modish to look upon Ralph Vaughan Williams, then in his eighties, as the "Foxy Grandpa" of contemporary music, the man who was getting away with everything because of his patriarchal status. Vaughan Williams' was an imposing figure: massive, untidy, white-thatched, and lovable. But his music was not at all fashionable; it did not "compute," and it sounded just *too* English to all the country's Bright Young Things (the composer called them the "exquisites"). It is curious that an earlier generation of critics had found just such nationalism very much to their *own* taste, while at the same time fearing that Vaughan Williams' "Englislry" would mitigate the exportability of the music. Both ideas have subsequently proved equally empty.

Vaughan Williams' music, youthful and enterprising, inventive and fresh, poured from him until his death at eighty-six. In fact, on the morning he died (August 26, 1958) he was to have attended the recording sessions of his Symphony No. 9, in E minor (Everest S 3006, 6006). Despite the sad news with which the musicians were greeted at the studios, the recording, conducted by the composer's old friend Sir Adrian Boult, proceeded as planned. No one was so fatuously obvious as to have remarked that "he would have wanted it this way"—but he would have.

The Ninth Symphony, the last in a series composed over a period of fifty years, is one of the most impressive achievements of modern music. Taking it and the previous eight into account, history may well acclaim Vaughan Williams as the greatest symphonist of this century. His last full-scale orchestral statement (which he off-handedly referred to as "a tune") was warmly greeted by most critics, though the exquisites had their reservations: all that red English beef—sweepingly tuneful melodies, modal harmonies, rustic, language-rooted rhythms—was too much for them. Those in a position to do so felt impelled to "expose" the Grand Old Man (alas, he was afflicted with that patronizing epithet too) as a musical humbug who preyed on their emotions instead of appealing to their intellects. This amused Vaughan Williams, for he had been through all that before. When his *Pastoral* Symphony (No. 3) was introduced in 1922, the critic Philip Heseltine (who was also the pseu-

donymous composer Peter Warlock) observed that the symphony evoked the image of "a cow looking over a gate." If so, what a lovely cow, and what a magnificent gate!

If the *Pastoral* Symphony incited a storm, the next, the contentious Symphony No. 4, in F Minor, was an even more tempestuous cup of tea. Unlike the preceding works—*Sea*, *London*, *Pastoral*—it had no allusive title. But it was a furiously "angry" utterance, and critics (somewhat after the fact) suggested that it was a tonal prediction of the Second World War. The composer evidently did not concur, as he wrote later:

I feel angry with certain critics who will have it that my Fourth Symphony means "war" and my Fifth means "peace" and so on. If people get help in appreciating music from this descent from the general to the particular, good luck to them. But the opposite can be equally true. It is said that Beethoven's *Muss es sein* movement in his last quartet arose out of a quarrel with his landlady!

The Fourth Symphony erupted amid controversy in April, 1935, under Boult's direction, its grinding harmonies and jagged themes promptly unleashing a storm of reaction and query. Had the bucolic dreamer of the *Pastoral* gone contemporary with a vengeance? (After conducting a rehearsal of the work one day, Vaughan Williams put down his baton and announced, "Well, gentlemen, if that is modern music, you can have it." And on another occasion he remarked, "I don't know whether I like it, but that's what I meant.") There were those who wondered, too, whether the master folklorist had gone recondite; much of his reputation at the time, especially internationally, rested upon the charmingly innocuous *Fantasia on "Greensleeves"*, the hauntingly beautiful masterpiece *Fantasia on a Theme of Thomas Tallis*, a handful of early songs such as *Linden Lea* and *Silent Noon*, and the song cycle *On Wenlock Edge*. Most of the speculation, however, centered on the "meaning" of the symphony.

"Music means itself," is a typical Vaughan Williams statement—as typical as the Symphony is. Conceding that the "tune" may have reflected "unbeautiful times," the composer tendered no other explanation. Whatever its meaning, it is one of the major musical creations of this century; once heard, even if not loved, it is never

forgotten. The strength of its musical ideas—relentless, even harsh, but always under masterly control—reveals a tough-minded humanist at work. Vaughan Williams had not quit musical poetry (the symphony is filled with it), but he had revealed another aspect of it and of his protean mind.

The Symphony's very notoriety contributed to its popularity, second only to the gentler *London*, and for a long while these were the only two of his symphonies to be recorded. Vaughan Williams' own version of the Fourth was done in 1937. During the recording session he was approached by a member of the orchestra who felt that his part contained a wrong note. The composer peered suspiciously at the passage, looked up and said, "It *looks* wrong, it *sounds* wrong—but it's right."

Vaughan Williams inherited his sense of what was right and wrong naturally, for he came from what might vulgarly be called "good stock," with members of both sides of his family noted for their strong-mindedness, individualism, and originality. His father's family had produced distinguished clergymen, lawyers, and judges. His mother's family united two celebrated English names: Wedgwood and Darwin.

The son of a village vicar, Ralph Vaughan Williams was born October 12, 1872, in Down Ampney, Gloucestershire, in a typical rural English setting. When her husband died (Ralph was then a little over two), Margaret Vaughan Williams took her small family (two boys and a girl) to live in her father's house, Leith Hill Place, in Surrey. The scenery remained graciously pastoral, but London was not far away. A lively family life, with comings and goings, Christmas parties, and streams of relatives contributed to the moulding of a self-sufficient, serene, and independent character. The tenor of this background is well illustrated by an anecdote Vaughan Williams used to tell. When he was about six, he visited his grand-uncle Charles (*Origin of the Species*) Darwin. Darwin's three-year-old grandson Bernard entered the library announcing that he had just struck his nurse.

"Why did you do that?" Darwin asked the child, as young Ralph stood by waiting for the ax to fall.

"Because I wanted to," replied Bernard.

"A very good reason too," was Darwin's response.

Vaughan Williams' first composition, a four-bar piano piece titled ("heaven knows why") *The Robin's Nest*, dates from this time, shortly after he had begun studying music with his aunt Sophy Wedgwood. Although acceptable as an accomplishment, music was not regarded as a proper vocation for a proper middle-class Englishman during Vaughan Williams' youth. The church, perhaps, or the services (the Royal Navy being the more socially acceptable), but music, no. It is a mark of the family's open-minded liberalism, then, that Vaughan Williams' early musical inclinations were not discouraged.

At eighteen he was enrolled in the Royal College of Music in London for courses in organ, harmony, and composition; two years later he was at Cambridge continuing in organ and composition. That his interests were wider than music is indicated by the fact that after taking his Mus. B. degree in 1894 he spent the next year pursuing a B. A. in history, after which he returned to the Royal College of Music. He was awarded his doctorate in music by Cambridge in 1901.

HE WAS fortunate in his major teachers: Sir Hubert Parry and Sir Charles Stanford, both of whom contributed greatly to the flowering of English music in our time. Though little of their own music is heard today, their musical point of view reached its finest expression in the works of Elgar, and their influence on many of England's leading musicians has been profound. Parry was kindly and Stanford was irascible, but both were outstanding musicians (if not first-rate creative artists) and superb teachers. Parry, ever seeking goodness, always tried to find something of value, something "characteristic" as he called it, in his students' efforts. Stanford was not so beneficent ("Damnably ugly, my boy. Why do you write such things?"). They were



BETTMANN ARCHIVE

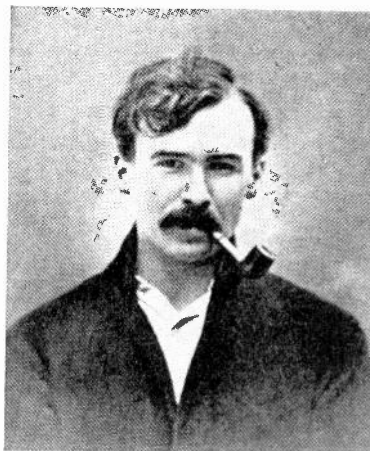

EDWARD JABLONSKI

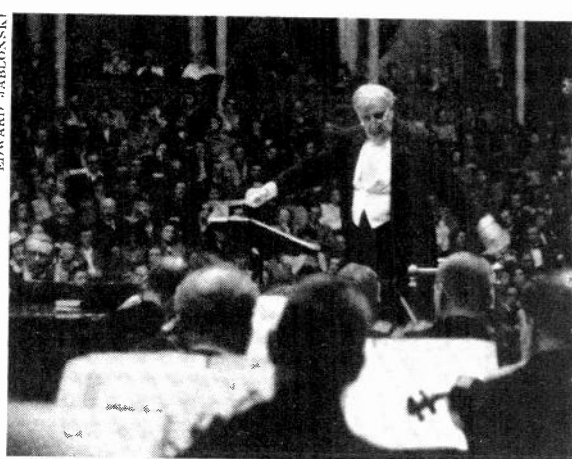

in agreement on one thing, however (the phrase is Parry's): "Style is ultimately national."

Nonetheless, Vaughan Williams later went abroad to study: with Max Bruch in Germany and with Ravel (orchestration) in France. Bruch, to his surprise, encouraged him—"I had never had such encouragement before." It was a never-forgotten comfort to the young composer, and when, in later years, he became a teacher at the Royal College of Music, he was careful to practice it himself. "Sometimes a callow youth appears who may be a fool or may be a genius," he once said, "and I would rather be guilty of encouraging a fool than discouraging a genius."

He was not soft, however. He had little patience with any number of human foibles or with what he regarded as imperfections or puerility—the "wrong note" school of composers, for example. He admitted that "Schoenberg meant nothing to me—but as he apparently meant a lot to a lot of other people, I daresay it is all my own fault." And he did not dismiss the new music out of hand. Once, in fact, he asked his friend Alan Frank of Oxford University Press to gather up a number of scores by "wrong note" composers so that he could study them. To the list he drew up he appended Mahler's "Resurrection" Symphony—"not for its wrong notes—his notes all sound painfully right to me." But during Vaughan Williams' last visit to the United States he encountered a "calow youth" who belonged to the "wrong note" school. The young composer presented himself one day and played his work. When the piece, bristling with ear-wracking sounds and wisps of non-themes, was finished, Vaughan Williams said, "Interesting. If a tune should ever occur to you, my boy, don't hesitate to write it down."

Tunes were Vaughan Williams' forte. Despite the polishing of his rustic edges by Bruch and Ravel, the influences that shaped his art were home-grown and "ultimately national": English folk song; early English music, particularly by the Tudor composers Byrd, Dowland, Tallis, *et al.*; and *The English Hymnal*, which he

re-edited in 1904-1906 and which brought him into "close association with some of the best (as well as some of the worst) tunes in the world . . . a better musical education than any amount of sonatas and fugues."

He learned the practical side of music-making by doing. He played a church organ (though he did not like keyboard instruments in general and detested the sound of the harpsichord), and conducting afforded him many valuable insights. His association with the Bach Choir and the Leith Hill Musical Festival also gave him the opportunity to become intimately acquainted with new works by contemporary composers (not only English) and to explore the classical choral repertoire (with emphasis on his favorite Bach) as well.

Vaughan Williams' musical friendships also contributed immeasurably to his musical personality. Performing musicians, professional virtuosos as well as his beloved amateurs, were his friends, and so were such folk-lovers as Cecil Sharp and Maud Karpeles. But his closest friends were composers, and of these Gustav Holst was pre-eminent. In a remarkable give-and-take, which they called "field days," they discussed each other's works in progress, taking them apart, arguing, and offering blunt and honest opinions. Their personal idioms were dissimilar, but their aesthetic views were not. Another good friend was George Butterworth (best known for his song cycle *A Shropshire Lad*), whose remark, "You know, you ought to write a symphony," led to the *London* Symphony, which is dedicated to him. Butterworth's own immense musical promise was cut short when he was killed in action in World War I.

V AUGHAN WILLIAMS was forty-two when the war broke out, and he characteristically enlisted in the Royal Army Medical Corps instead of a combat unit. He did not embrace war as any "great adventure," nor was he an ideal soldier (" . . . his cap was never straight . . . his puttees were his nightmare. . . "). But he bore the stupidity, waste, and privation without



From far left: two of Vaughan Williams' close friends, the British composers Gustav Holst and George Butterworth; Vaughan Williams in action, conducting the London Symphony Orchestra in his *London* Symphony in 1946; the composer, as rarely seen in photographs, in an irascible mood, a physiognomical reflection that all is not serene in his music; Vaughan Williams in a more accustomed light with his wife Ursula and conductor Sir John Barbirolli.

The symphonies of Vaughan Williams are currently being reinterpreted for records. Sharing the task for Angel are Sir John Barbirolli (left) and Sir Adrian Boult (center); tackling the entire set for RCA is the American conductor André Previn.

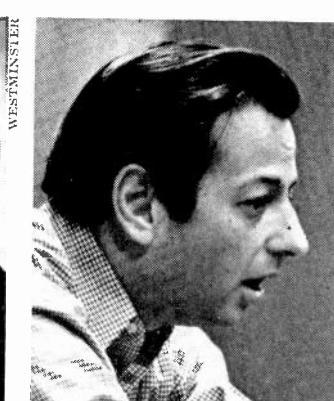
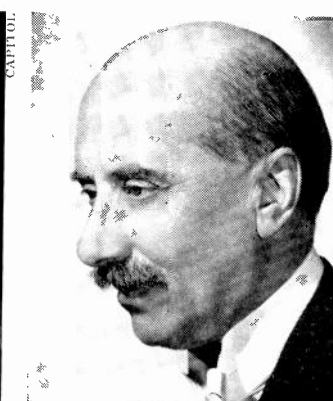

a whimper. According to Henry Steggle, his friend of that period and after, "the trenches held no terrors for him. . . . He had no knowledge of fear, and was more at peace with himself in the fighting areas, for we were getting on with the war, not forming fours in squad drill."

On the drive between the trenches and the station, near Ecoives in France, a steep hill provided a beautiful view of a valley—"a wonderful Corot-like landscape in sunset" the composer called it—which helped sustain his musical imagination. So did the sound of a practicing bugler, echoing through the hills and the valley. It was here that the *Pastoral* Symphony was born (so it may have been a French cow rather than an English one that upset Philip Heseltine!).

When World War II erupted, Vaughan Williams was sixty-seven. His music had already been banned in Germany because of his outspoken political views. Hitler was a greater evil than the Kaiser had ever been, and Vaughan Williams felt deeply about the war. He was active in various kinds of war work, from collecting trash to addressing envelopes in his all but undecipherable handwriting. There were other preparations: "I went and practiced fire fighting the other day—they staged a *real* fire with lots of smoke and I had to crawl about on my stomach with an axe in one hand and a nozzle and a hosepipe in the other."

He was active on the Dorking Committee for Refugees from Nazi Oppression (formed in 1938, before the war). The coming of the war ironically transformed the refugees into enemy aliens, and internment followed. Vaughan Williams worked as zealously to deliver them from his own government as he had worked to rescue them from the Nazis. A militant adversary of all forms of injustice, he had no qualms against standing up to authority. He testified in court in defense of the composer Michael Tippett, who had refused, as a pacifist, either to fight or to contribute to the war effort by working on a farm. Although Vaughan Williams found Tippett's views "entirely wrong," he had to "respect him very much for holding them so firmly."

During the same period another friend, Alan Bush, an avowed Marxist, had had his music banned from the BBC because he had signed some left-wing petition

or other. Vaughan Williams whipped off one of his classic letters to the BBC. So far as his friend's political opinions went, he wrote, he was "strongly opposed to them," but he could not stand by while Bush was "victimised" for his private views. That was not all: The BBC had commissioned a work from Vaughan Williams. He returned the commission and withdrew the composition. It was a "characteristic" gesture, and it would have delighted his old teacher Parry.

It was Parry who had given Vaughan Williams the sturdy advice: "Write choral music as befits an Englishman and a democrat." Vaughan Williams never failed him. That he might be called the Shakespeare of English music is forcibly demonstrated in the wide-ranging world of his choral compositions. Vaughan Williams was an unashamed *Gebrauchsmusiker*, and fashioned literally dozens of choral works, ranging from simple ones for amateur groups (he believed with Holst that "if a thing is worth doing at all, it is worth doing badly") to oratorios of grand proportions.

Happily, through the new resurgence of Vaughan Williams' music in the recording studios, the one-time gap in his choral discography is being filled. This began in 1965 with the release of *Hodie* ("This Day," Angel S 36297), the magnificent Christmas oratorio completed in 1954. The earlier, more modest *Fantasia on Christmas Carols* of 1912 is hidden away in an album entitled "On Christmas Night" (Argo ZRG 5333) and was also recorded more recently on Capitol SP 8672. The Mass (dedicated to Holst), one of his major works, is happily available on both London (CS 25271) and Angel (S 36014). Especially welcome are the recent Vanguard releases, conducted by Vaughan Williams enthusiast Maurice Abravanel, which include the sensual *Flos Campi* for viola, orchestra, and chorus, and the moving *Dona Nobis Pacem* ("Grant Us Peace"), both on VSD 71159.

No longer available is the roistering *Five Tudor Portraits* (once on the Capitol label in a not very good performance), which bustles with an Elizabethan lust for life and love. The rather raunchy words by John Skelton (1460-1529) led to an "incident" at the first performance in 1936. About midway through the tumultuously racy first movement, *The Tunning of Elinor*

Rumming, the austere Countess of Albemarle stood up in the first row, exclaimed, "Disgusting!" and stalked, with dignity, from the hall. Vaughan Williams, busy conducting, hadn't noticed, but when he heard about it he commented that it rather pleased him that the choir's diction had been so good.

The newly aroused recording activity bodes well also for the symphonies. Although the old London recordings, done (through No. 8) under the composer's supervision, are still available and perfectly fine, they were recorded before stereo. Now under way is RCA's major project to record all the symphonies under the direction of the young conductor André Previn. The first disc, *Sinfonia Antartica* (No. 7), has been released in England, and its reception by English critics leaves no doubt that Previn is a Vaughan Williams interpreter of considerable stature. In the spring of this year he returned to London to record the Sixth and Eighth Symphonies, plus, as a possible filler, the *Three Portraits from "The England of Elizabeth"* (a film). Previn will continue this project through 1972—Vaughan Williams' centenary—when the last of the series will be recorded.

ENGLAND'S EMI—Angel Records here—seems also to have embarked on a project to record a complete set of the symphonies, with the conducting chores being shared by two devoted interpreters—Sir Adrian Boult and Sir John Barbirolli. Boult's magnificent Sixth (coupled with the lovely *The Lark Ascending*) was recently issued here (Angel S 36469, reviewed in the June issue), and he has also recorded for future release both the Symphony in F Minor and the *Pastoral*. (In passing: Columbia has in its icebox Leonard Bernstein's exciting version of the F Minor also, though no release date has been set.) Barbirolli's new recording of the *London* has recently been released (Angel S 36478, reviewed in this issue).

Angel has also just recorded *Sancta Civitas*, the composer's own favorite of his choral works, in a performance by John Shirley-Quirk, Ian Partridge, and the Bach Choir conducted by David Willcocks. It will be coupled with the beautiful *Benedicite*, sung by Heather Harper; the release date is tentatively January 1969.

The major discographic deficiency now lies in the operatic branch of the Vaughan Williams catalog. There is the ballad opera *Hugh the Drover* (1924) in which for the first time—to my knowledge—a boxing match was set to music. There is the Falstaffian romp *Sir John in Love*, from which only the oft-recorded *Fantasia on Greensleeves* (in an arrangement by Ralph Greaves) is generally known. *Riders to the Sea* (1931), an almost word-for-word setting of the play by John Millington Synge, is a masterpiece in which the orchestra, rather than any of the vocalists, is the protagonist, setting the

NOTE: I would like to thank Ursula Vaughan Williams, John Owen Ward of Oxford University Press, and J. Alexander Murray, founder of the English Music Society and a champion of Vaughan Williams, for their unselfish help with this article. For a fuller understanding of Vaughan Williams the man and his music, I urge the reader to see *National Music and Other Essays*, by Ralph Vaughan Williams (a paperback containing all his major writings on music); *R. V. W.*, by Ursula Vaughan Williams; and *The Works of Ralph Vaughan Williams*, by Michael Kennedy; all published by Oxford University Press. E. J.

mood of the scenes, delineating character and emotion, and commenting on the action. *The Pilgrim's Progress*, completed in 1951 after nearly three decades of work, is a major if not a popular work. Perhaps one day, after the record companies have done the complete Wagner operas twice over, they will come around to Vaughan Williams'.

The composer's impatience with virtuosity restricted his concerto output, but now and then a friend coaxed him into such a labor—always with attractive results. The violin and oboe concertos (of which only the first remains in the catalog) are not grand statements in the romantic manner, but they are musically and instrumentally solid. The violin work is rather rustic in a neo-classical framework (but with a typically poetic middle movement), and the oboe piece is gently pastoral. Unfortunately, the Piano Concerto (also transcribed for two pianos and orchestra) is no longer available on records. It is one of the composer's important creations, though difficult in places for both listener and soloist. Not difficult but altogether winning are the Romance for Harmonica (written for and recently recorded by Larry Adler for RCA) and the Tuba Concerto. Both are worthy of an Englishman and a democrat even if they are not for voices.

Vaughan Williams' music is a monument to the human spirit because he was not only a great composer but also a great man. He believed, and he practiced his belief, that "the composer should not shut himself up and think about art. He must live with his fellows and make his art an expression of the whole life of the community." He asked, "... may we take it that the object of all art is to obtain a partial revelation of that which is beyond human senses and human faculties—of that in fact which is spiritual?" That is what the music of Vaughan Williams "means." It is not "Englishry," but universality. It is art without any "ism" except humanism. It is music of such beauty and authority that if we could put it into words it would make us all wonderfully wise.

Edward Jablonski, who is the author of biographies of popular American composers George Gershwin and Harold Arlen, is now at work on a new book, Masters of Twentieth Century Music.



LARRY KLEIN EXPLODES **THREE POPULAR**

IF YOU are above the age of puberty, someone at some time has placed a hand firmly on your shoulder and said, in a voice gentle with wisdom, "Son, never argue about religion or politics." My own experiences of the past fifteen years have taught me that it might be wise to add "or loudspeakers" to this injunction. In general, I find that all I have to do to disqualify myself immediately and totally as an "expert" in *every* area of audio is to pooh-poo some long-cherished speaker-system shibboleth. And to tell an avid audiophile that his speakers do not sound quite as good as they might—especially if he has built them himself—is to commit an enormity that is the emotional equivalent of informing him that he has an ugly wife, a stupid child, and no sense of humor.

Although I've learned something about loudspeakers over the years, I've obviously remained oblivious to the fine art of diplomacy in inter-personal relationships, for I am about to embark on yet another small crusade for better sound by tackling three of the currently cherished, but fallacious, ideas about loudspeakers. These have to do with the matters of "big" sound, electronic crossovers, and do-it-yourself speaker enclosures.

For some time now I have been trying to puzzle out just what it is that the advocates of "big" sound are referring to. Although the term is usually used as an indicator of

approbation, my ears lead me to suspect that the "bigness" of the sound coming from a speaker makes no contribution to its fidelity, that it may, as a matter of fact, be fighting against it.

First of all, we can assume that big sound is not simply a product of the volume at which a speaker is being played. Although some systems are obviously more efficient than others, and some systems are capable of a greater acoustic output than others, I think we can discount both of these factors in home use. Speaker efficiency is not an important matter these days, since amplifiers are available with sufficient power reserve to drive even the lowest-efficiency speakers to very loud levels. And in respect to speaker output power, your eardrums will probably give out before the cones of most speakers.

What else, then, can "big" sound be? A matter of dispersion? The natural laws of acoustics provide excellent dispersion below about 200 hertz for *any* speaker system that can put out energy in that frequency range. As we get higher in frequency, the angle of dispersion tends to become narrower and narrower, and this tendency must be counteracted either by some kind of diffusion device in front of the speaker or through the use of a very small radiator. In any case, some of speakers which measure exceptionally well in terms of wide-range, high-

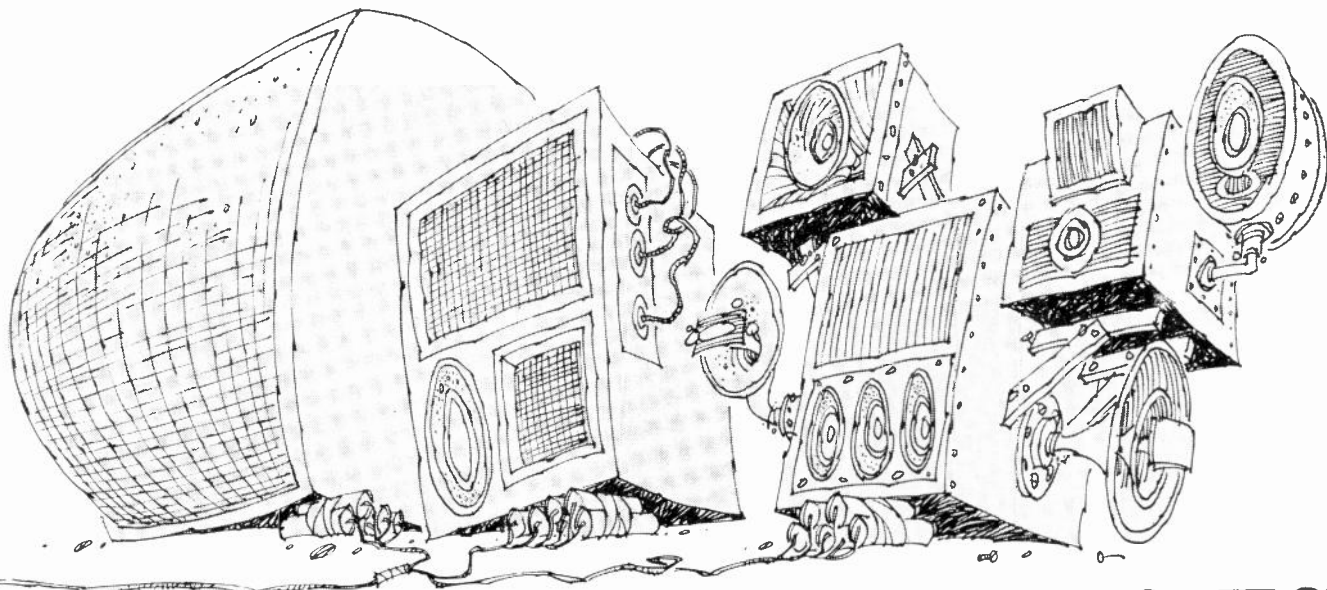

LOUDSPEAKER FALLACIES

frequency dispersion are not classed by advocates of big sound as being in their group of preferred systems.

What do we have left? It isn't acoustic-power output, it isn't efficiency, and it isn't dispersion. As far as I have been able to discover, those who like "big" sound are responding to a spurious resonance in the upper bass and, quite probably, to a peak in the upper mid-range. This is what the big-sound speakers, by and large, sound like to me. The smoother the response and the less coloration a system has, the less chance it has of having "big" sound. In short, to my ears, big sound is bad sound.

EVER since Julian Hirsch discussed electronic crossovers for speakers in his March 1968 Technical Talk column, he and I have been receiving queries about how to build such units, what speakers to use, what crossover points are optimum, and the like. Since most of these questions are unanswerable in the form in which they come to us, and since they usually exhibit some degree of misapprehension on the part of their senders, let's take a look at the problem of loudspeaker crossover systems, electronic and otherwise.

I agree with Julian Hirsch that a properly set up electronic-crossover system will frequently sound somewhat better than a stereo system using normal inductance-

capacitance crossovers for the speakers. However, two questions come to mind: does such a system sound good *because* of the use of an electronic crossover, and is the average audiophile technically equipped to set up such a crossover—particularly when using speaker systems not specifically designed for it?

One of the major technical problems facing the designer of a two- or three-way speaker system is the establishment of the crossover points. The difficulties are these: a speaker intended primarily to reproduce the bass frequencies usually has a very irregular frequency response, poor dispersion, and a tendency toward cone breakup at the upper end of its bass range. It is therefore desirable to cross over to a smaller (and differently constructed) mid-range speaker *below* those frequencies at which the woofer runs into trouble. However, if operated at too *low* a frequency, a mid-range unit suffers from many of the same problems as the woofer at its high-frequency end. In addition, because of its physical structure, the mid-range's low-frequency power-handling capacity is somewhat limited, and its high-frequency dispersion is usually not as good as might be desired. In general, the same factors that make it possible for a mid-range driver to handle the lower frequencies in its range tend to make it a poor reproducer of the very high frequencies. There-

fore, we have to go to a tweeter for the job. It is not all that difficult to design a tweeter to work at the very high frequencies, but if it is to take over at a fairly low crossover point (before the mid-range unit runs into trouble), the same problems of dispersion and power-handling capacity have to be dealt with.

The inductance-capacitance crossover network (in addition to its major task of channeling the appropriate frequency bands to the woofer, mid-range, and tweeter) is also frequently used to adjust the slope of the frequency response of the individual drivers. This is a different and separate matter from adjusting the frequency of the crossover, the steepness of the roll-off at the crossover frequency, or even the relative efficiency of each driver within its operating range—all of which the network, in one way or another, also has to handle.

The above discourse is not intended simply to illustrate the problems of designing a conventional three-way speaker system, but to indicate also that one cannot install a woofer, mid-range, and tweeter in a cabinet, drive them with separate amplifiers fed by an electronic crossover, and expect to come up with a speaker system that will be better than (or even equal to) one with a non-electronic crossover. Almost all of the problems encountered in designing conventional crossovers must still be handled—and they are just as difficult to resolve—with electronic crossovers. However, if you have the time, energy, and cash required, go to it. You just might—although the odds are against it—come up with something worthwhile.

ASSUMING that you are still with me and your blood pressure remains at a manageable level, let's take a look at another area where the mythology has the sanction of antiquity. I am referring to that hobbyist's delight, the home-built speaker system. About seven or eight years ago I designed over a dozen build-it-yourself speaker systems that appeared in several magazines under a variety of pen names. The last such enclosures I designed for any publication (I have since done a few more for manufacturers) appeared in *HIFI/STEREO REVIEW* in the August 1963 and 1964 issues. All of them, with few exceptions, were of bass-reflex design, tuned and damped by the techniques I described in the August 1965 issue.

In those early days, when the floor of my workshop was usually littered with sawdust and impedance-curve tracings, I would maintain, perhaps somewhat immodestly, that I could take almost any commercially produced hi-fi speaker system and, with a few tricks (mostly adjusting the damping and the tuning), make it sound better than the original manufactured product. At the time I made that claim it was probably true; it is no longer. By and large, commercially produced speaker systems have improved to the point that a do-it-yourself system can rarely compete on a cost/quality basis. One very good reason for this is that a manufacturer can buy raw loud-

speakers at a price perhaps one-fifth of what the audiophile would pay for an equivalent over-the-counter unit.

But if a manufacturer could buy (or produce) a driver at a cost far below that which an audiophile would have to pay, why did my equivalent-cost build-it-yourself systems *ever* sound better than the commercial products? The answer is a simple one: most manufacturers were designing speaker systems—insofar as they knew how—to cater to a taste that apparently had been conditioned by juke boxes in corner bars. Specifically, this meant lots of big-sound mid-bass boom, a mid-range peak, and no treble above about 9,000 Hz. In the last several years, however, the sales figures among competing brands of speakers have shown a significant trend toward those systems that have a relatively smooth, uncolored sound and wide-range frequency response. The mounting sales of the smoother-sounding speakers apparently convinced a number of manufacturers that there was a buck to be made by designing for natural sound. (To my surprise, I still encounter engineers who don't really believe that smooth, uncolored sound is good sound, but who are willing to produce smooth-sounding speakers only because that, at the moment, is what the public is buying.)

To return to my point, I find it astonishing that so many audiophiles are still willing to expend the time, effort, and money necessary to put together a speaker system that most probably will not be the sonic equal of some commercial systems selling for half its cost. Don't misunderstand me: any given home-built speaker system might very well sound better than 50 per cent of the equivalent-price units on the dealer's shelves. But the odds are tremendously against its sounding anywhere as good as the *best* equivalent-price speakers we have reviewed in these pages. There's no reason why, if the spirit of adventure is strong within you, you can't fool around and come up with some pretty good sound—if you keep the total cost of your plywood and drivers below about \$35. At about this point, however, the economics of the enterprise become infeasible, because it is right here that the better commercial systems become very difficult to compete with sonically. I should make one exception, however: it is possible to come up with a rather good-sounding unit if one follows the manufacturer's enclosure plans for a *particular* driver or set of drivers. But anyone who picks up \$25 to \$50 worth of miscellaneous drivers from John's Bargain Counter expecting to work up something worthwhile is kidding himself.

As a consolation to those who may have been wounded by my treading heavily on some cherished belief, I might point out that there are those still in the grip of other fallacies just as serious. I will be getting around to some of them as they rear their ugly heads in my monthly Questions and Answers column. If in the above discussions I've hurt some feelings, I'm sorry, but The Truth Shall Make You Free—of bad sound, that is.

HI FI/STEREO REVIEW'S SELECTION OF THE TOP RECORDINGS BEST OF THE MONTH



CLASSICAL

CABALLÉ'S ROSSINI: TRANSPLENDENT RADIANCE

RCA's "Rossini Rarities" establishes the Spanish soprano as the first lady of bel canto

IN THE three years since her meteor-like appearance in April 1965 in the American Opera Society's concert presentation of Donizetti's *Lucrezia Borgia*, Montserrat Caballé, Spain's most recent gift to a splendid tradition of vocal art, has made substantial contributions to the American recording scene. We have had her impressive portrayals in the complete *Lucrezia Borgia* and *La Traviata*, a sumptuous *zarzuela* collection, a welcome selection of Verdi rarities, and a sampling of choice Bellini and Donizetti arias—an enviable list of achievements. With her new "Rossini Rarities" album for RCA, however, the soprano has surpassed them all, for in this recording—it is itself a rarity—she establishes her claim to the title of foremost exponent of the art of *bel canto* for our day.

The choice of the program is not only timely, in view of this year's Rossini centenary, but also stimulating: three of the selections appear to be entirely new to records, and the other three, though relatively unfamiliar to the larger audience, have long been celebrated by connoisseurs as representative of Rossini's best vocal writing. "*Di tanti palpiti*," from *Tancredi*, is particularly outstanding in this respect, for the popularity of this aria following the opera's 1813 premiere was nothing less than spectacular: it took all Italy by storm, and was sung literally everywhere. And a delightful discovery here also is that the arias from *La donna del lago* (1819, based on Sir Walter Scott's poem *The Lady of the Lake*) and *L'assedio di Corinto*

EASTMAN HOUSE COLLECTION



GIOACCHINO ROSSINI (1792-1868)
Portrait by Etienne Carjat

(1820) are distinguished by the same kind of exquisite melodic invention. I am, however, less enthusiastic about the *Armida* excerpt, in which the florid elaborations seem to me rather overpowering.

The singing of Montserrat Caballé has never been heard to better advantage. The voice is rich, warm-hued, even, and effortless. Her phrases are beautifully molded, her pronunciation retains its clarity through even the most florid and intricate passages. And though her trills may not be perfect, the natural ease of her technique, and the ravishing results she can obtain with it, must fill all other sopranos with envy. It all seems unforced and natural: chromatic runs, *gruppetti*, *staccati* follow one another not like showy ornamentation, but as inseparable parts of the musical design. The famous Caballé *pianissimo* is, of course, also evident;

a really breathtaking example of it appears at the conclusion of the *Otello* Willow Song. I must also add that the artist's intonation—not completely dependable previously—is entirely beyond reproach in this recording.

A strong plus in the artistic preparation of the disc was ensured by engaging harpsichordist Randolph Mickelson to edit and, in some instances, compose the appropriate *bel canto* cadenzas for Madame Caballé. All the versions presented here appear to be in accord with the performance practices of Rossini's time, and they sound eminently right.

Carlo Felice Cillario conducts discreetly and with well-chosen tempos. The chorus fulfills its subordinate role competently, and



RCA

MONTSERRAT CABALLÉ

Nothing too good for this kind of singing

the engineers have surrounded the diva with warm and velvety sonics. Nothing, of course, can be too good for this kind of singing!

George Jellinek

MONTSERRAT CABALLÉ: *Rossini Rarities. La donna del lago: Tanti affetti in tal momento. Otello: Assisa a piè d'un salice (Willow Song). Stabat Mater: Inflammatus et accensus. Armida: D'amore al dolce impero. Tancredi: Di tanti palpiti. L'assedio di Corinto: Giusto ciel! In tal periglio.* Montserrat Caballé (soprano); RCA Italiana Opera Orchestra and Chorus, Carlo Felice Cillario cond. RCA © LSC 3015, (M) LM 3015* \$5.79.

THE PIANO MUSIC OF CHARLES IVES

An industrious scholar-pianist discloses an important body of twentieth-century piano music

WOULD YOU believe that, outside of the relatively well-known sonatas, most of the music on Desto's stylish new four-disc release devoted to the piano works of

Charles Ives was totally unknown—unpublished, unperformed, unstudied—before scholar-pianist Alan Mandel dug it out? Ives was born in 1874, and virtually all of the music on the recording was written before 1920, but these are not, for the most part, second-rate or trivial works that deserved their obscurity. With one or two exceptions, they are among Ives' most imaginative, stirring, and successful pieces.

The irony is that this music was not "lost" at all, but has been readily available for inspection in the Yale music library ever since the Ives collection was catalogued (1960) by John Kirkpatrick. Yet no musicologist, student, critic, or performer, in a country where musicology is a widely pursued and respectably endowed profession, ever took the trouble to pass on this precious part of our American musical heritage. For a comparable case, one would have to imagine easily accessible manuscripts of major poems by Walt Whitman remaining unpublished.

Well, hats off to Mr. Mandel! Not only did he have the good sense to go up to Yale and transcribe the material (under the inspiration of Wayne Shirley of the Library of Congress, one of the few pioneers in this field), but also the ability to play it and put it across with fine Ivesian spirit and style. A good part of the unpublished material comes from a bundle of piano studies that Ives evidently planned as a set, probably of twenty-four—his own *Well-Tempered Clavier*! A few of these were published separately, but most of them had to await Mr. Mandel's discovery. They have remarkable character and extraordinary range; they are not sketches or "experimental" studies, but fully realized works of great impact.

Some of the other works, most notably *The Celestial Railroad*, *Rough and Ready*, *The Seen and Unseen*, and *Storm and Distress*, are equally of major interest. A few—but only a few—are of an unredeemable awkwardness or banality, and one or two are obviously juvenilia.

The larger portion of the album is, of course, taken up with the three sonatas—the *Concord*, the scarcely less imposing First Sonata, and the shorter Three Page Sonata—and these provide the clearest test (because of their familiarity, as well as size, scope, and difficulty) of the young pianist's ability to shape this music and get it across. His level of achievement is high. (Incidentally, Mr. Mandel plays the newly designed Baldwin concert grand, and it stands up to the punishment that he and Ives deal out very well indeed. Its clangorous tone seems particularly adapted to the big ringing sonorities that Ives so often builds up.) The recorded sound is variable in quality: there are places where Ives, Mandel, and the engineer (singly or together) engender odd and sudden switches in treble and bass ambiance that produce an effect of two pianos or of overdubbing. Otherwise, the sound is adequate to good.

A few other cavils: the awkward length of the *Concord* leads Mr. Mandel to begin the work in the middle

of one side and end it in the middle of another—an unsatisfactory solution. Also, the pianist's enthusiastic program notes tell us little or nothing about his rescue operations. We are not told clearly which pieces are newly discovered and which are being played in variant manuscript readings. Obviously Mr. Mandel had a good deal to do with putting these pieces in performable shape, but he is coy about it—why? At the very least we have a right to know why he plays only Studies Nos. 2, 5-9, 15, 18, and 20-22 of a cycle billed as "complete." There is undoubtedly a good explanation (probably the unfinished state of the other works), but it would seem to me that it is the function of the record notes to supply it.

But we still have much to crow about. The soloist's playing offers the maximum in tonal variety, and he has succeeded in revealing Ives as a composer of one of the major bodies of twentieth-century piano music—comparable perhaps only to that of Debussy and Bartók—no mean achievement, that.

Eric Salzman

IVES: Piano Music. Piano Sonata No. 1; Piano Sonata No. 2, "Concord"; Three Page Sonata; Song without (Good) Words; Studies Nos. 2, 5, 6, 7, 8, 9 ("The Anti-Abolitionist Riots"), 15, 18, 20, 21 ("Some Southpaw Pitching"), 22 (called "22"); Rough and Ready; Scene Episode; Waltz-Rondo; Marches in G and D ("Here's to Good Old Yale"); The Celestial Railroad; Seen and Unseen ("Sweet and Tough"); Anthem-Processional; Bad Resolutions and Good; Storm and Distress; Allegretto (Invention); Baseball Take-off; Varied Air and Variations (Six Protests). Alan Mandel (piano and celesta); unidentified flute, viola, and drum. DESRO © DST 6158, 59, 60, 61 four discs \$23.25.

ENTERTAINMENT

ETHEL WATERS: UNIQUE AND INDISPENSABLE

A new Columbia album is an enduring memento of a great and influential singer at her best

ETHEL WATERS is, flatly, one of the greatest performers the American theater has ever produced. As a singer she is without equal. Just how much she has influenced popular singing in this country cannot be accurately measured, but time and again new albums by famous and currently popular singers appear in which can be heard a bent phrase, an inflection, a vocal leap, or a lyric turn that originated with Waters. She was able to make her voice do almost anything she wanted it to, and Columbia's newly issued "Ethel Waters on Stage and Screen," bringing together a number of recordings she made during her glorious vocal prime (1925-1940), is a fascinating documentation of that ability as well as enduring entertainment.

MILES FRIEDGER



*Ethel Waters portraying Josephine Baker in the 1933 musical *As Thousands Cheer**

With the single exception of the memorable *Supper-time* (a song about the widow of a lynch victim preparing supper for her children, from the 1933 musical *As Thousands Cheer*), the album contains what to me is the essential Waters. Here are her classic performances of *Dinah*, *Stormy Weather*, *Am I Blue*, *Heat Wave*, and *Harlem on My Mind*. The happiest surprises, however, are the four bands from the John Latouche-Vernon Duke Broadway musical of 1940, *Cabin in the Sky*. In these recordings (originally made for Liberty Music Shops in New York), Waters is in full and luxuriant flower, whether strutting humorously to *Honey in the Honeycomb*, insinuating slyly in *Love Turned the Light Out*, swinging free, easy, and wondrously in *Taking a Chance on Love*, or just singing, poignantly and superbly, *Cabin in the Sky*. These last two songs are perhaps her most captivating performances, rich in the particular glow she could so effortlessly lavish on a song. *Taking a Chance on Love*, in particular, is sung with such freedom, such relaxation, and such positive joy that it is hard to understand how so many other singers have permitted it to collapse in high, but empty, spirits. *Cabin in the Sky* may well be her unique masterpiece. In it she uses almost every variation her voice is capable of, from deep-bottomed growls to squeals of pleasure, yet at no point does she lose the thread of a truly touching lyric. It

is the kind of total musical communication one hears only rarely.

And a word should be added about Ethel Waters' abilities as a comedienne. *Birmingham Bertha*, the saga of a lady who is "like the police—I never release my man," may sound a little Aunt Jemima in 1968, but it certainly is funny. Her skill as a parodist is hilariously evident in *You're Lucky to Me*, which caricatures Rudy Vallee, and also in *Memories of You*, a dead-on send up of Mlle. Josephine Baker complete with bird-like trills, an "I have almost forgotten how you speak the English" kind of diction, and kissing-one's-own-shoulder grandeur.

The old discs have been admirably transferred (refreshingly in mono only) to LP and edited by George Engfer: the sound is more than acceptable by today's standards. But the level of artistry consistently achieved by Miss Waters is unique by the standards of any era. This is an indispensable addition to every record collection.

Peter Reilly

ETHEL WATERS: *On Stage and Screen 1925-1940.* Ethel Waters (vocals), various orchestras. *Dinah; I'm Coming Virginia; Am I Blue?; Birmingham Bertha; You're Lucky to Me; Memories of You; You Can't Stop Me from Loving You; Stormy Weather; Heat Wave; Harlem on My Mind; Hottentot Potentate; Thief in the Night; Taking a Chance on Love; Honey in the Honeycomb; Cabin in the Sky; Love Turned the Light Out.* COLUMBIA ® CL 2792 \$4.79.

ALI AKBAR KHAN, MASTER SARODIST

Connoisseur Society successfully surmounts the difficulties of recording the long-playing raga

ONE OF THE problems of recording Indian classical music is the simple mechanical restriction on playing time imposed by the phonograph disc. When performing in concert, it is not unknown for Indian artists to improvise for hours at a time. In the past, performances of this magnitude have not been available on recordings, making it difficult to deny the allegations of those who have suggested that Indian music on discs is only a pale approximation of the "real thing." Connoisseur Society has attempted to remedy the situation by recording master sarodist Ali Akbar Khan in a performance that reaches to the time limits of the long-playing record. It was an extraordinarily good decision.

The separation between the *alap* (the rhythmically free opening section of a *raga*) and the *gat* (the rhythmically delineated section in which the tabla joins the solo instrument) provides a natural break in the music which is used

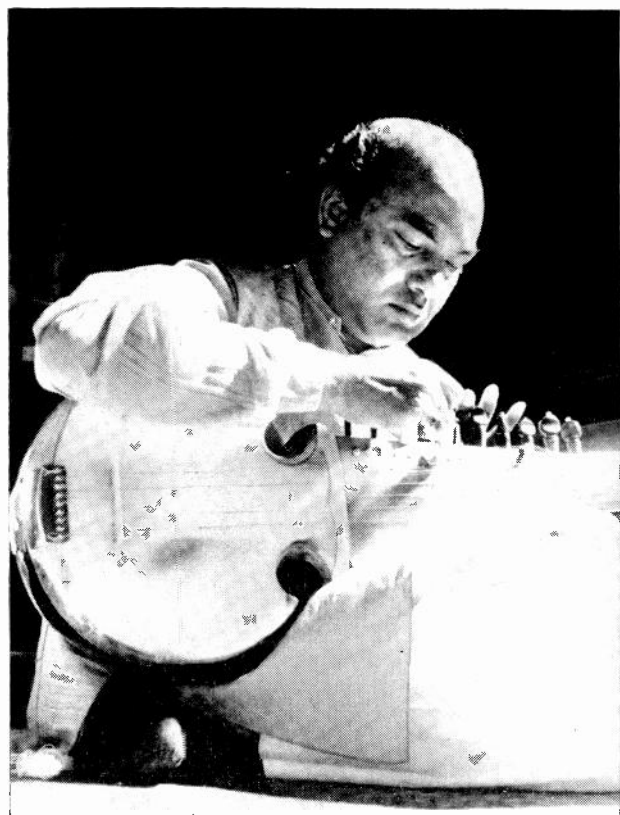

ALI AKBAR KHAN

A classic performance of Indian music

as the turnover point for the record. Khan responds to the extended playing opportunity by creating what he describes as the fullest expression of his art ever recorded. I hasten to agree. Only rarely in his live performances and never before in his recordings have I heard him play with the brilliance and spirituality that enliven the *alap*. And in the *gat*, Mahapurush Misra, apparently stimulated by the occasion, urges Khan into stunningly passionate flights of rhythmic and melodic beauty.

I should note, by the way, that Khan plays *Marwa*, one of the most demanding *ragas*, and one that requires of the sarodist the maintenance of a difficult two-string finger stop throughout the entire improvisation. But mechanical difficulties and the precise pitch placement demanded by the *raga* fail to bother Khan. He has often been described by his followers as the finest Indian classical musician in the world, a description that has been difficult for American fans—more familiar with the assertive and, I'm afraid, sometimes superficially glossy playing of Ravi Shankar—to appreciate fully. This record should remedy all that. I am convinced that it is one of the classic performances of Indian music.

Don Heckman

USTAD ALI AKBAR KHAN: *The Forty Minute Raga.* Ali Akbar Khan (sarod); Mahapurush Misra (tabla); accompanied by tambura. *Raga Marwa (Part One, Alap); Raga Marwa (Part Two, Gat).* CONNOISSEUR SOCIETY © CS 2008 \$5.79.

Stop scratching Beethoven.

If you have a phonograph, you have scratched records. It can't be helped. Every time a phonograph needle travels the length of a record, it scrapes away a bit of the surface.

Tape recording is different. There's no way to scratch a tape, so the sound is always pure and clear. In fact, a tape actually gets *better* after the first several playings.

But to get the full advantage of tape, you need a top-quality recorder/player. And that's where the Ampex 2161 comes in.

The 2161 is loaded with engineering features only Ampex offers. Like Deep-Gap heads. They deliver peak music performance five to ten times longer than other kinds. So we back them with the longest guarantee in the business.

Another Ampex exclusive is Dual Capstan drive. Most recorder manufacturers use a single capstan to drive the tape. We use two. This virtually eliminates wow and flutter, and does away with pressure pads that cause extra wear on tapes and heads.

Then there's Rigid-Block suspen-

sion. The recording and playback heads are securely anchored to a precision-machined metal casting. Consequently, tapes and heads align to one thousandth of an inch. You won't find better alignment anywhere.

So much for the things that make the tape sound better. The 2161 also has a few features that make it a lot easier to play. Automatic threading, for example. You just slip the tape into a slot and press the "play" button. Takes about two seconds. And automatic reverse. Lets you listen to a complete four-track stereo tape without switching reels. You can play

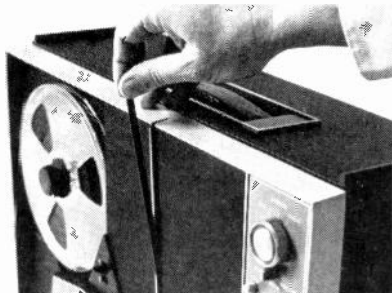

This is how easy it is to thread the Ampex 2161 tape recorder.



the same tape indefinitely—and never touch the machine.

But perhaps the most important feature of the 2161 is one you can't see. It's Ampex's experience in making the tape recorders most professionals use. All the big broadcasting networks, most local radio and TV stations, and almost all commercial sound studios use Ampex recorders as standard equipment.

That means the 2161 isn't really a home recorder. It's a home version of a professional recorder.

There's a big difference.

Ampex. The people who started it all.

STEREO TAPE BONUS. Select \$100 worth of Ampex stereo tapes for just \$39.95 with the purchase of any Ampex stereo tape recorder/player. Tape offer good only in U.S.A.



AMPEX

Ampex Corporation, Consumer and Educational Products Division 2201 Lunt Ave Elk Grove Village, Ill. 60007

Continuous Performances

Red Seal and Victrola albums that carry forward the traditions of musical greatness.

Carl Weinrich and Arthur Fiedler

continue their brilliant collaboration on the organ concerti of Handel with this two-record set of high Baroque splendor. Recorded sound sparkles.



John Browning and the Boston Symphony Orchestra under Erich Leinsdorf

add to their recordings of the piano concerti of Serge Prokofieff. Sound throughout captures Prokofieff's wide range of orchestral color.



Toscanini/NBC Symphony Orchestra

Coupled on one album: Mendelssohn's 4th Symphony ("Italian") and the Weber Overtures to DER FREISCHUTZ, EURYANTHE and OBERON. The other Toscanini album offers Elgar's ENIGMA VARIATIONS and Respighi's FESTE ROMANE. Both albums, available for the first time in electronically reprocessed stereo, are on the low-priced Victrola label.

Morton Gould/Chicago Symphony Orchestra Symphonies by Rimsky-Korsakoff and Miaskovsky

This unique album couples the only available recording of Rimsky-Korsakoff's Symphony No. 2 ("Antar") and the first recorded performance of Miaskovsky's Symphony No. 21.



The Guarneri Quartet

"The ranking quartet in this country," writes B. H. Haggin of the glistening Guarneri Quartet. This new album begins an exciting project—the recording of the complete Beethoven Quartets! Extra! This is a special low-priced album.

RCA



HIFI/STEREO REVIEW'S CHOICE OF THE LATEST RECORDINGS

CLASSICAL

Reviewed by WILLIAM FLANAGAN • DAVID HALL • GEORGE JELLINEK • IGOR KIPNIS • ERIC SALZMAN

BARTÓK: *The Miraculous Mandarin—Suite*. HINDEMITH: *Nobilissima Visione*. Chicago Symphony Orchestra, Jean Martinon cond. RCA VICTOR Ⓢ LSC 3004, Ⓜ LM 3004* \$5.79.

Performance: Both good
Recording: Splendid
Stereo Quality: Good

Having supervised the 1954 Chicago Symphony Mercury recording of the Bartók score with Antal Dorati, I can speak with some authority about the problems of recording this luridly exciting and fascinating score. And this is the first stereo recording of *The Miraculous Mandarin* concert suite that recaptures for me the wild ferocity of that Mercury disc. Like Dorati, Martinon gives the score a tautly brilliant treatment, stressing at the same time utmost clarity of the complex fugal textures at the opening and close, and nicety of nuance in the three episodes in which the feminine decoy lures her male clients to their unpleasant fates. However, I would urge those readers who do not already own the Dorati London Symphony complete version of the *Miraculous Mandarin* score to acquire that as a supplement to the present recording, for there is more to both the music and the drama than the climactic chase-*fugato* that concludes the concert suite.

Nobilissima Visione, which Paul Hindemith extracted from his 1938 *St. Francis* ballet, is for me one of the finest of his post-*Mathis der Maler* scores, crowned as it is by the superb passacaglia evocative of the Saint's *Canticle of the Sun*. That there has been no stereo recording of the work until now I find rather shocking, though we have had a Seraphim reissue of Klemperer's noble 1955 mono-only reading originally issued on Angel. Like Klemperer's, Martinon's performance possesses ample richness and transparency of texture, and his even broader pacing of the passacaglia lends added weight and impact to the blazing final pages.

As with all the Martinon Chicago Symphony recordings, this release offers an ideal blend of richness and brilliance. D. H.

BEETHOVEN: *Piano Sonata No. 29, in B-flat, Op. 106 ("Hammerklavier")*. Vladimir Ashkenazy (piano). LONDON Ⓢ CS 6563 \$5.79.

BEETHOVEN: *Piano Sonata No. 29, in B-flat, Op. 106 ("Hammerklavier")*. Egon Petri (piano). WESTMINSTER Ⓜ W 9350 \$4.79.

Performance: Ashkenazy romantic, Petri classic
Recording: London—splendid stereo; Westminster—middle-50's mono
Stereo Quality: London excellent

The most monumental (some would say monstrous!) of the Beethoven piano sonatas has received relatively few stereo recorded

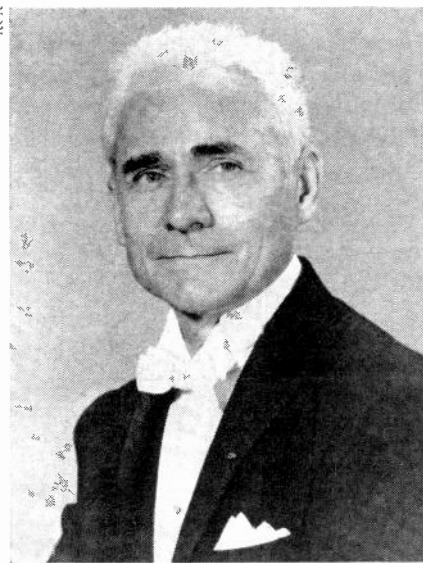

JEAN MARTINON
Ferocity for Bartók, richness for Hindemith

performances beyond the complete sonata sets by Wilhelm Kempff (DGG) and Alfred Brendel (Vox). Indeed, for some time there has been no stereo recorded performance of major distinction generally available as a separate disc other than the already deleted Charles Rosen reading released by Epic in 1965. Rosen's represented the most successful realization of a powerfully disciplined purist's approach to this vast and complex work and Kempff's an honorable middle-of-the-road version. Vladimir Ashkenazy's new recording, on the other hand, is an all-out attempt at a valid romantic interpretation of the music. Indeed, one can almost imagine Franz Liszt playing the "Hammerklavier" in this fashion, with pointed ritards in a broadly conceived opening movement, with careful attention to tonal coloration in the mercurial scherzo and profoundly poignant slow movement, and with an extra demonic emphasis on the vicious trills that punctuate the entries in the fugue-textured finale.

Whereas Ashkenazy underlines expressive context, the late Egon Petri, a Busoni pupil, strove in his *c.a.* 1956 recording to realize what might be called the "architecture" of the music. As opposed to Ashkenazy's rather freewheeling tempo changes and stress on coloration, Petri opts for a tight-knit realization in relatively fast tempos throughout. He succeeded most convincingly in the slow movement, and did give one a full sense of what he was driving at in the other movements, even though his at that time septuagenarian fingers failed to follow through at times where unraveling of knotty passage work or absolute steadiness of rhythm was required.

London's piano sound is richly sonorous, while Westminster's mono sonics are a bit thin.

Which up-to-date version of the "Hammerklavier" is it to be then? Beethoven buffs should try to get Rosen's Epic disc (BC 1300, BN 3900) to compare it with the legendary Schnabel attempt along the same lines. Kempff's is for me the most generally satisfactory of currently available readings (and can be obtained separate from the DGG set). But if you're a daring individualist in taste and enjoy highly colored virtuosity and a search for lyrical expression at all costs, all beautifully recorded into the bargain, then Ashkenazy is for you. The Petri, with his other Westminster discs, is a souvenir of a musical mind of singular power and integrity. D. H.

BEETHOVEN: *Piano Sonatas: No. 23, in F Minor, Op. 57, "Appassionata"; No. 27, in E Minor, Op. 90. 32 Variations on an Original Theme, in C Minor*. Ivan Moravec (piano). CONNOISSEUR SOCIETY Ⓢ CS 2000 \$5.79.

Performance: Solid
Recording: Two-thirds good
Stereo Quality: Ditto

These are sturdy performance with which I have one or two quarrels (why should the opening of the "Appassionata" be noticeably slower than the main tempo of the movement?), and for which I have a good deal of respect (listen to the way Moravec goes from the end of the development back into the recap of the first movement of Op. 90). The sonatas, recorded in this country, have a sturdy, dark-ish, resonant acoustic that corresponds well to the character of the performances. The Variations, recorded by Supraphon in Czechoslovakia, are, on the contrary, all highs—brilliant but with little bass response. In spite of this, the performance of the Variations is a high point of the record: it has overwhelming drive and a su-

Explanation of symbols:

- Ⓢ = stereophonic recording
- Ⓜ = monophonic recording
- * = mono or stereo version not received for review

MS 7107



AN ENTREMONT ALBUM WITH A THIRD SIDE

It would be enough of an achievement for most pianists just to "revive the music of Mozart with all the freshness, grace, vivacity or lyricism that is due it."* But Entremont has done more. He conducts it as well! Very well indeed.

*Musica/Paris

There's also a lot to be said for these new releases.

Waltz of the Flowers—The Philadelphia Orchestra, Eugene Ormandy, Conductor MS 7133**

Brahms: Serenade in A—The New York Philharmonic, Leonard Bernstein, Conductor MS 7132

Othmar Schoeck: Notturmo/Samuel Barber: Dover Beach—Dietrich Fischer-Dieskau and The Juilliard Quartet KS 7131

The Music of Arnold Schoenberg, Volume 8—Robert Craft, Conductor M2S 780 (A 2-Record Set)

Stravinsky Conducts Histoire du Soldat Suite and Pulcinella Suite—Columbia Symphony and Columbia Chamber Ensemble MS 7093

The Sound of Genius on Columbia Records
CIRCLE NO. 14 ON READER SERVICE CARD

being told that Pears' voice, simply as an instrument, isn't what it used to be, he sings with such sensitivity, honesty, and sheer style that I keep forgetting it. This is far and away the best recorded performance of *Les Illuminations* that you are likely to come by now and in the foreseeable future.

The Variations, a precocious early work that did much to establish Britten's reputation, are performed with equal perfection. There is no feeling that the composer-conductor is making something more (in stylistic hindsight) of the work than it is, nor is there any sense of the composer himself being bored by it. The performance is direct, lucid, impeccable—a total delight as, indeed, the work itself remains.

The sonics are excellent. H. F.

CIMAROSA: *Concertante, in G Major, for Two Flutes and Orchestra*. HAYDN: *Overture, in D Major (Hob. Ia, No. 4); Divertimento, in C Major, "Der Geburtstag" (Hob. II, No. 11)*. *Surprise Mystery Selection*. Jayn Rosenfeld and Gerardo Levy (flutists); The Master Virtuosi of New York, Gene Forrell cond. MASTER VIRTUOSI RECORDING SOCIETY © MV 5701S, (M) MV 5701M* \$3.50 (available from The Master Virtuosi of New York, 157 West 57 St., New York, N. Y. 10019).

Performance: **Pleasing**
Recording: **Excellent**
Stereo Quality: **Very good**

This disc, which marks the recording debut of one of New York's newest chamber orchestras, appears to consist mostly of recording premieres, though the Cimarosa has been recorded before. The repertoire is pleasant and often scintillating (as in the Haydn overture), although there are no earth-shaking masterpieces. Longest is the *galant* Cimarosa, but Haydn devotees will be far more intrigued by that composer's occasional piece, a birthday Divertimento whose *raison d'être* is no longer known. Also included is a four-and-a-half-minute "mystery selection," which the listener is invited to identify. The performances feature some excellent work on the part of the small orchestra, the conducting is sympathetic (if not, perhaps, as keen stylistically in matters of phrasing as the best to be heard in this area), and the recording is first-rate. (It should be noted that the disc is available only from the above address and in a few selected stores.) L. K.

DVOŘÁK: *Romance in F, Op. 11* (see TCHAIKOVSKY)

DVOŘÁK: *Symphony No. 5, in F Major, Op. 76; Carnival Overture, Op. 92*. London Symphony Orchestra, Witold Rowicki cond. WORLD SERIES © (M) PHIC 9088 \$2.50.

Performance: **Lively**
Recording: **Good**
Stereo Quality: **Good**

This, the first mature symphony among Dvořák's nine, is a zestful charmer of a work; and the zest in particular gets full measure in this well-recorded performance. István Kertész's disc for London represents the only stereo competition, and at more than double the price. Kertész does bring more lyrical intensity to his reading, but there is much to be said for the rhythmic momentum and transparent texture that Rowicki's reading offers. Despite the somewhat perfunctory *Carnival*

Overture reading that serves as filler, the WS disc represents a splendid buy at \$2.50. The recorded sound is crisp yet full-bodied—much the best I've heard from any WS compatible disc thus far—and there are no tracking problems, either. D. H.

RECORDING OF SPECIAL MERIT

EATON: *Microtonal Fantasy; Prelude to "Mysbkin"; Songs for R. P. B.; Piece for Solo Syn-Ket No. 3*. John Eaton (piano and Syn-Ket); Michiko Hirayama (soprano); Richard Trythall (piano). DECCA © DL 710154 \$5.79.

Performance: **Authentic**
Recording: **Composer-supervised**
Stereo Quality: **Excellent**

John Eaton is an American composer who has been living and working in Europe for a



Next Month in

Hi Fi/Stereo Review

American Composers Series:

LOUIS MOREAU GOTTSCHALK

by Robert Offergeld

Wanda Landowska:

An Appreciation

by Igor Kipnis

What Does Your Component
Dollar Pay For?



number of years. He has made a living and a reputation as a jazz pianist and composer (he made a couple of experimental jazz albums for Columbia a few years back), but he has been increasingly involved in non-jazz experimental and electronic music in recent years. He is one of a number of composers (most of them in this country) who have systematically expanded the tuning palette by playing "in the cracks"—hence the lead piece which gives this album its title. This "Microtonal Fantasy" is a kind of *tour de force* in concert, since Eaton sits kitty-cornered between the keyboards of two grand pianos tuned a quarter of a tone apart and whams the daylights out of both. Obviously the visual virtuoso aspects of the performance are missing in the recorded version; however, the piece holds up very well as sheer sound and, for once, the microtonal matter really sounds to be intentional and essential, not just out-of-tune wimble-wamble. A still more effective work, a set of songs on texts by Hart Crane and R. P. Blackmur, uses microtonal intervals in the voice along with other striking and effective vocal techniques superbly realized by Mich-

iko Hirayama, a Japanese soprano living in Rome. The "accompaniment" consists of extravagant sounds mostly extracted from the insides of a grand piano. The piece also uses—somewhat gratuitously—electronic sounds produced by a miniature sound synthesizer called the Syn-Ket. This instrument, which Eaton plays on "live" as a performing instrument, is heard to better advantage in two other works, which are purely electronic in origin and make inventive use of the medium. Oddly enough, the jacket presentation plays down the electronic aspects of the record—its most effective and obvious selling point, I would have thought. The songs probably provide the most musical highpoints, but I found all of it inventive and well managed. The recordings, from various European originals, are good, and make an especially impressive use of stereo. No texts. E. S.

FRICKER: *Symphony No. 1, Op. 9*. Louisville Orchestra, Robert Whitney cond. LOUISVILLE FIRST EDITION RECORDS © LOU-S 675 \$8.45, (M) LOU 675* \$7.95.

Performance: **Mostly convincing**
Recording: **Good**
Stereo Quality: **Good**

Peter Racine Fricker (b. 1920) is an English composer—respected in his native land but little known here—who is now a member of the faculty of U.C.L.A. His Symphony No. 1, Op. 9, was composed during the late 1940's while the composer was approaching thirty. Considered in terms of Fricker's age, it is an impressive accomplishment. Taken simply at face value, there is still much to be said in its behalf. But there are some (admittedly few) points to be made against it.

In general, it is a representative example of the kind of Big Symphony that was internationally *à la mode* during the Forties. Its harmonic texture is freely (tonally) dissonant; its technique of continuity relies heavily on long melodic lines and neo-Baroque polyphony; its formal molds are "classical"; its expressive gesture is elevated and serious. Typical of the style, the orchestration is expert but rather severe and conventional. Certain aspects of the symphonic works of the same decade by our own Walter Piston are comparable. Hindemith occasionally comes to mind and—here the English touch—so do moments of Nordic rumination out of Sibelius. In general, the official British gesture of Vaughan Williams, Elgar, and occasionally Britten is elaborately avoided.

Fricker's *Symphony*, in particular, is most impressive throughout its first two movements. The opening *Alla breve* has handsome, long, free-flowing lines of genuine character. The ensuing *Adagio con molto passione* starts straight off with a lyrical sensitivity that is warm and spontaneous in effect, even if, like the first movement, its apparently spontaneous flow of melodic invention soon gets bogged down and neutralized (expressively) by stolid part-writing and an overinsistent bass movement.

The going from there on in is less winning. A third movement *Tableau and Dance* strikes me as heavy-handed, even laborious in what I take to be an attempt to provide the work with a contrasting light touch. That the similarly disappointing *Moderato-allegro* (it closes the work) seems oddly diffuse makes me wonder—mind you, just

(Continued on page 82)

First Point Of Vantage Five More Times

HEINRICH SCHÜTZ
Symphoniae sacrae
8 Concertos from Book II (1647)
Soloists & Instrumentalists
under the direction of Helmut Rilling
H-71196 Stereo

JOSEPH HAYDN
Overture to an English Opera;
Symphony No. 63 in C ("La Roxolane");
Symphony No. 78 in C minor
The Little Orchestra of London
Leslie Jones, cond.
H-71197 Stereo

ANDREW RUDIN
Tragoedia/a composition in 4 movements
for electronic music synthesizer
(a Nonesuch Records commission)
H-71198 Stereo

KENNETH GABURO
Music for Voices, Instruments & Electronic Sounds
(Antiphony III; The Wasting of Lucretetia;
Antiphony IV; Fat Millie's Lament)
The New Music Choral Ensemble;
Members of The University of Illinois
Contemporary Chamber Players; Gaburo cond.
H-71199 Stereo

YANKEE ORGAN MUSIC
Works by James Hewitt, Charles Ives,
John Knowles Paine, George Whitefield Chadwick
Richard Ellsasser at the organ of
The Hammond Museum, Gloucester, Massachusetts
H-71200 Stereo

Suggested Retail Price \$2.50
For complete catalogue, write to
NONESUCH RECORDS
1855 Broadway, New York, N. Y. 10023

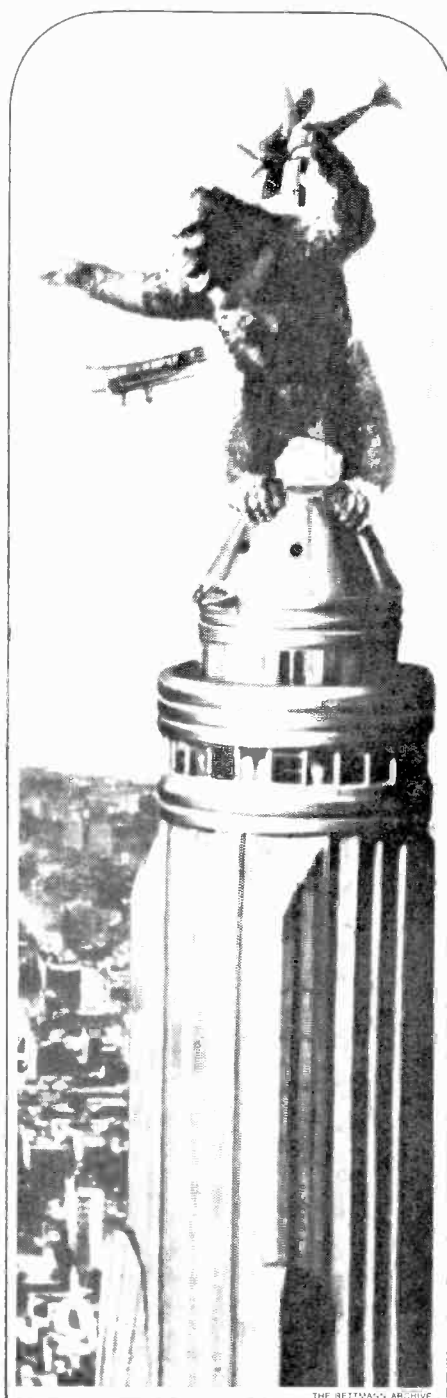

THE BETTMANN ARCHIVE

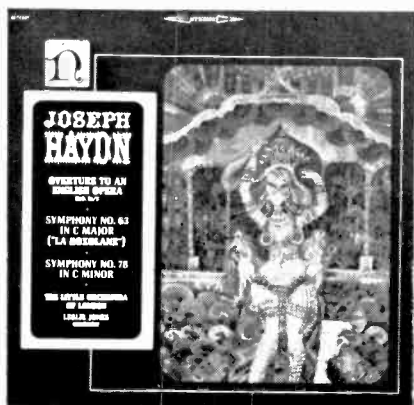
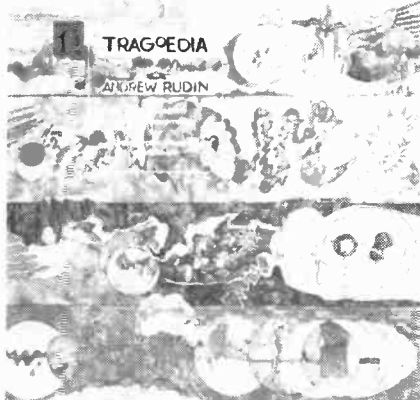

CIRCLE NO. 21 ON READER SERVICE CARD

wonder—if the performance is ideal. But because I have no score to consult, and because the Louisville Orchestra has never sounded better on records, it must remain a speculation. At any rate, the symphony is a formidable work for so young a composer, it deserves the time and attention it has been given here, and it makes one long for a wider acquaintance with Fricker's work.

Recorded sound and stereo quality are both very good. *W. F.*

HAYDN: *Cello Concertos: C Major (Hob. VIIb, No. 1); D Major (Hob. VIIb, No. 2)*. Pierre Fournier (cello); Lucerne Festival Strings, Rudolf Baumgartner cond. DEUTSCHE GRAMMOPHON (S) SLPM 139 358 \$5.79.

Performance: Smooth as silk
Recording: Intimate
Stereo Quality: Good enough

I find the rediscovered C Major Cello Concerto of the 1760's a far more lively (if less refined) listening experience than the well-known D Major of 1783. Indeed, I find the latter so dull that I'm almost inclined to accept C. G. Burke's theory that Anton Kraft, Haydn's principal cellist at Esterháza, did in fact write the music and that Haydn signed his name to the score out of misplaced kindness. There are seven other currently available disc versions of the D Major Concerto and five of the C Major, but only one (Telefunken), besides this new DGG version, pairs the works.

Fournier and Baumgartner's Lucerne Festival Strings (augmented by paired woodwinds here) take a polished chamber-music approach to both works, and the recorded sound is appropriately intimate. This is an impeccably clean and refined pair of performances, but with neither the beautifully pointed phrasing and rhythmic pulse given the C Major by Rostropovich and Britten on their London disc, nor the lyrical expansiveness found in the Gendron version of the D Major on Philips with Casals conducting. In short, my reservations concerning this new recording are a matter of personal taste. If you want these works smoothed out and refined to an almost uniform dynamic, this is the disc for you. I'll stick with Rostropovich and Gendron. *D. H.*

RECORDING OF SPECIAL MERIT

HAYDN: *Horn Concerto No. 1, in D Major*. **HOFFMANN** (attrib. Haydn): *Flute Concerto, in D Major*. Erich Penzel (horn); Hans-Martin Linde (flute); Collegium Aureum. RCA VICTROLA (S) VICS 1324, (M) VIC 1324* \$2.50.

Performance: First-class
Recording: Excellent
Stereo Quality: Fine

Neither of these concertos can be considered top-flight Haydn, and the flute concerto, which has been credited to Haydn on an on-again, off-again basis, is now considered to be a work by his contemporary Leopold Hoffmann (the Victrola program notes comment on this, but the jacket lists both as Haydn pieces). The horn concerto, incorrectly described in the notes as the *only* surviving Haydn horn concerto, is actually the first of two that have come down to us (the third is lost). Both concertos for flute and horn are pleasant to hear, and one cannot imagine better performances than they receive here

(although Barry Tuckwell, playing both horn concertos on Argo ZRG 5498, is equally virtuosic). It is nowhere mentioned in the notes, but Linde plays his work on a Baroque flute, and if one believes that this one-keyed instrument was incapable of being played in tune, he should hear Linde's marvelous playing for himself. The Collegium Aureum, an elegant, small chamber orchestra made up of some of the best free-lancers in Europe, provides excellent accompaniments. *I. K.*

HAYDN: *Overture, in D Major; Divertimento, "Der Geburtstag"* (see CIMA-ROSA)

HINDEMITH: *Nobilissima Visione* (see BARTÓK)

HOFFMANN: *Flute Concerto in D Major* (see HAYDN)



PIERRE FOURNIER
Impeccably clean and refined Haydn

HOLMBOE: *Quartet No. 8, Op. 87* (see NIELSEN)

HOLST: *St. Paul's Suite* (see VAUGHAN WILLIAMS)

IVES: *Piano Music—complete* (see Best of the Month, page 72)

IVES: *Symphony No. 1, in D Minor (1896-98); Three Places in New England (1903-14)*. Philadelphia Orchestra, Eugene Ormandy cond. COLUMBIA (S) MS 7111 \$5.79.

Performance: Full-blown
Recording: Full-bodied
Stereo Quality: Good

If we take into account the newly issued Harold Farberman album of all four Ives symphonies for Vanguard's Cardinal series, this Ormandy disc becomes the third available version of the American master's Yale graduation thesis written to satisfy the requirements of his German-oriented mentor, Horatio Parker.

Bearing in mind that young Ives had already received a thorough musical training from his bandmaster father, as well as having inherited a magnificently incorrigible experimental bent, then the First Symphony becomes for us today a delightful essay in one-upmanship—an attempt on Ives' part

to show Parker that whatever Paine, MacDowell, Chadwick, and the rest did, he could do as well or better. All the German nineteenth-century "right things" are in this piece, but kicked along from time to time (in the finale especially) with a sense of urgency that gets them out of the academic strait-jacket. From the bolder pages of this symphony's last movement to the hymn-and-patriotic-tunes evocation of the Second seems but a short step—were the English horns in the slow movement and the *stretto* climax in the last pages done with tongue in cheek?

As for the recorded performance, Morton Gould's 1966 version with the Chicago Symphony is both more lithe and more lively than Ormandy's; but the Philadelphia maestro's climaxes pack a bit more wallop, and the recorded sound is decidedly richer. As filler, Gould offered a rather unstylistic reading of *The Unanswered Question* and the somewhat smart-alecky William Schuman orchestration of the delightful *America* organ variations written by Ives as a teenager. Ormandy for his part offers as filler the *third* recoupling (a bit much!) of his 1964 recording of *Three Places in New England*. This is, however, the only Columbia issue of the *Three Places* in which the notes include in full Ives' own poetic epigraphs for each of the pieces.

While Ormandy has a tendency to lean rather hard on the "big tunes" at the expense of the overall texture of simultaneous events, his remains, for the moment, the most generally satisfactory of the complete recorded versions of the *Three Places*. However, for an idea of how much more can be brought out of the immensely complex goings on in *Putnam's Camp*, I recommend a hearing of the Morton Gould/Chicago Symphony disc (RCA Victor LSC/LM 2959) which offers also the virtually unknown and altogether remarkable Orchestral Set No. 2. *D. H.*

MENDELSSOHN: *Trio No. 1, in D Minor, Op. 49* (see BEETHOVEN)

MESSIAEN: *Quatuor pour la fin du temps*. Huguette Fernandez (violin), Guy Deplus (clarinet), Jacques Neilsz (cello), Marie-Madeleine Petit (piano). MUSIC GUILD (S) S 150 \$2.39.

Performance: Excellent
Recording: High-quality
Stereo Quality: Effective

Recently a younger European colleague, not a Frenchman and not a pupil of Messiaen, was trying to explain to me the importance of this French master. "Every country has to have its Mahler, its Ives. For us Latins, Messiaen is our Mahler, our Ives." Messiaen, much younger than the composers just mentioned, has served as a remarkable link between the older new music and the post-war avant-garde, and his importance in the history of recent music is unquestionable. His self-confessed mysticism involves such matters as Hindu rhythms, bird calls, lush and static clusters of sound, repetition, great length, references to medieval-modal style, the utmost in vulgarity and the utmost in introspection and meditative mysticism. All or nearly all of these elements are present in this fifty-minute *Quartet for the End of Time* written, if memory serves (no score could be found and the test pressing came with-

(Continued on page 85)

out notes), in a concentration camp during World War II! The movement titles suggest something about aesthetic intention: "Liturgy of crystal, Vocalise for the Angel who Announces the End of Time, Abyss of the Birds, Praise to the Eternity of Jesus, Dance of the Fury for the Seven Trumpets, Disorder of the Rainbows for the Angel who Announces the End of Time, Praise to the Immortality of Jesus." Within this are the extremes of meditative beauty, sonorous fantasy, awkward repetitiousness, creative furor, boredom, violent excitement, and just plain ugliness. I guess you're either tuned in or you aren't. I am moved by the idea of Messiaen writing this work in Auschwitz and I am moved by those titles, but I am not moved at all by the musical interpretation of it all. Good performance, a little lacking in the divine afflatus perhaps, but well recorded. *L. S.*

MOUSSORGSKY: Boris Godounov (highlights). Ivan Petrov (bass), Boris Godounov; Valentina Klepatskaya (mezzo-soprano), Feodor; Georgy Shulpin (tenor), Shuisky; Mark Reshetin (bass), Pimen; Anatoly Mishutin (tenor), a Boyar. Chorus and Orchestra of the Bolshoi Theater, Alexander Melik-Pashayev cond. MLL0DVA, ANGLI © SR 400 19 \$5.79.

Performance **Authentic-sounding**
Recording **Very good**
Stereo Quality: **Very good**

We get the usual big *Boris* scenes here: the Finale of the Coronation Scene, the conclusion of Act II (from the monologue "I have attained supreme power" to the end of the Clock Scene), and the entire second scene of Act IV, ending with the Tsar's death. The production is not entirely unfamiliar, for it uses the same Shuisky, Pimen, and Boyar who appeared with George London in Columbia's 1963 Moscow recording. The two versions share the same conductor, Melik-Pashayev; since he died about three years ago, there are reasons to believe that the present performance followed shortly after Columbia's.

Ivan Petrov is the Bolshoi's leading basso today. He is an internationally known artist, and it is only fitting that his name be added to the distinguished line of recorded Borises. The disc is entirely his show—his colleagues are all competent, but they are no scene stealers. Only the Bolshoi chorus and orchestra operate on Petrov's level of excellence here.

The characterization Petrov offers is out of the traditional mold: intense, grippingly theatrical, but at the same time artistically controlled. He makes all the dramatic points without beclouding the musical ones—put another way, he *sings* rather than shouts. His voice is a dark, powerful instrument, colorfully used and flavored with a few Slavic mannerisms; there is some strain in the upper extreme of his range, but never a sign of distress. The total effect is strong, deeply felt, and memorable.

As is the case with Russian recordings, the voices are favored in the balances—particularly in the Clock Scene, where the orchestra sounds remote. But the overall sound is impressive, with some fine clangorous effects in the Coronation Scene and the moments preceding the death of Boris. *G. J.*

(Continued on next page)

Have a tape-in.



When Bob Dylan wrote "Times they are a changin'" he probably meant it for everyone in the world except record lovers. You see, record lovers are record savers. A stubborn group who just won't face progress...the new Uher 7000 tape deck.

The first four track tape deck designed to outperform any other in its price range as well as those two and three times the price. (This was determined by an independent consumer laboratory survey, not us.)

Uher 7000 offers more than great

music. No more scratched records, or worn out grooves. And you save money with tapes.

In addition, there are two speeds to give you hours and hours of enjoyment on one tape; sound on sound and full fingertip control for complete ease of operation.

These are just a few of the reasons why more and more music lovers are going with Uher. As for those record lovers, "Times they are a changin'."

Hear the 7000 at a franchised dealer or write for literature.

Uher 7000 by Martel

The easy-to-love tape deck

Martel Electronics Inc. Sole U.S. Importers. 2339 S. Cotner Ave., L.A., Calif. 90064; New York, Chicago. **CIRCLE NO. 39 ON READER SERVICE CARD**

NEW WATTS BOOK IS HERE!

PROFESSIONAL METHODS FOR RECORD CARE AND USE — The tremendous potential of today's advanced record playing equipment — more sensitive tonearms, higher compliance cartridges, elliptical styli, reduced tracking forces — all require more sophisticated methods of maintenance. If you've read the basic Cecil E. Watts book and/or your equipment is the finest and the undistorted sound of music is important to you, this long awaited book is "must" reading. Price: 50¢

HOW TO CLEAN, MAINTAIN AND PROTECT RECORDS by Cecil E. Watts—The basic book on record care, this has been a guideline for thousands on the essential care of every record collection. Subject matter includes a discussion of dust, static, static behavior, handling records, how to use record changers properly, and how to rejuvenate records. Excellent as a starter course in record care or, with the book above, an "insurance policy" for all the records you'll ever own. Price: 25¢

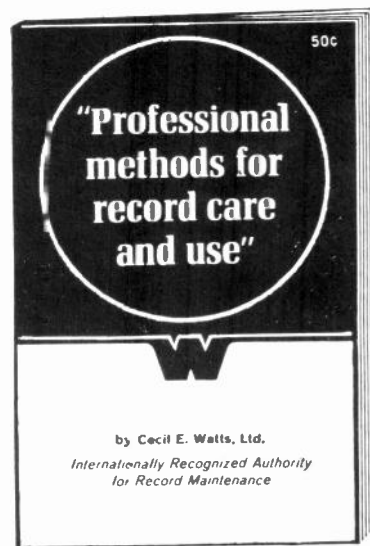

Get your copy at any hi-fi dealer, or mail coupon to order direct.

ELPA MARKETING INDUSTRIES, INC.
New Hyde Park, N. Y. 11040

Dear Sirs:
Please send the following book(s)
on record care

- Professional Methods for Record Care and Use. Price: 50¢
 How to Clean, Maintain and Protect Records. Price: 25¢

Enclosed is _____

Name _____

Address _____

City/State/Zip _____

Please do not send stamps. No C.O.D.'s

S8

CIRCLE NO. 23 ON READER SERVICE CARD

RECORDING OF SPECIAL MERIT

MOZART: *Fantasia in C Minor* (K. 475), and *Sonata in C Minor* (K. 457); *Sonata in B-flat* (K. 570). Ivan Moravec (piano). CONNOISSEUR SOCIETY © CS 2002, (M) 2002 \$5.79.

RECORDING OF SPECIAL MERIT

MOZART: *Piano Sonatas (complete), Volume One. Fantasia in C Minor* (K. 475), and *Sonata in C Minor* (K. 457); *Sonata in B-flat* (K. 281); *Sonata in G* (K. 283). Lili Kraus (piano). EPIC © BC 1382 \$5.79.

MOZART: *Piano Sonatas (complete), (K. 283)*. Lili Krasus (piano). EPIC © BC *Volume One. Sonatas in C* (K. 279), *in F* (K. 280), *in B-flat* (K. 281), *in E-flat* (K. 282), and *in G* (K. 283). Glenn Gould (piano). COLUMBIA © MS 7097 \$5.79.

Performances: Listed in descending order of success

Recording: Varied

Stereo Quality: Varied

Both the Moravec and Lili Kraus performances have a good deal to recommend them. In some ways these are very similar readings; both pianists have a sensitive, poetic approach to C-Minor Mozart. Both miss some of the *Sturm und Drang*, those *opera seria* theatrics (in the best sense) which are an essential part of these works. Epic's jacket notes even make a big point about the lighter sound of Mozart's piano, and, although this is factually accurate, it tends to obscure the real point—that Mozart and his contemporaries liked to write for the forte-piano because it could make strong and dramatic dynamic contrasts. Moravec's shading is generally well contrasted, but he neglects the device of the *forte-piano*—that is, the short, sharp chop which is in fact a major feature of this music. Otherwise his is an impressive performance of great clarity and beauty, and of major scope. The B-flat Sonata on the overside is the relatively unfamiliar work originally published with what is now believed to be a spurious violin part. Here Moravec is brilliant, and my only qualification is the slightly inferior Czech sound; the C Minor Fantasia and Sonata, recorded in this country, are far superior sonically.

Miss Kraus is not a structuralist but rather a lyric poet. In matters of detail she is nearly always engaging, and often she produces a Mozartian poetry of a deeper order. She is a little more consistent than Moravec on matters of ornamentation (although she is no expert in these matters either), and she is far more introspective. The earlier Sonatas are, if anything, even more attractive than the C Minor (the demands and the expectations are, of course, considerably less), and this is a well-made disc.

With regard to the summit meeting of Mr. Gould and Mr. Mozart, I can only throw up my hands in hopeless despair. It would be an exaggeration to say that everything is played uniformly staccato and at breakneck speed—but not much of an exaggeration. Mr. G. polishes off K. 282 in (hold your breath now) seven minutes and thirteen seconds, which is *five minutes and forty-one seconds* less than Miss Kraus takes to traverse the same music! Even granting that Mr. Gould does not take repeats, the differ-

ential is staggering. I must assume that Mr. Gould's interpretive decisions are carefully made, but I do not even find them to be consistent. One example among a dozen: the alternating *forte* and *piano* ideas which close the main subject of the Rondo of K. 281 and which are dynamically reversed by Gould against Mozart's clear specific direction and in defiance of any possible structural or stylistic interpretation of the passage. Gould has argued very persuasively about the recording medium as a means for musical communication today, but mannered performances like these suit the nature of the recorded medium very poorly indeed. The message simply does not get through the medium. E. S.

MOZART: *The Impresario*. Reri Grist (soprano), Madame Silverklang; Judith Raskin (soprano), Miss Sweetson; Richard

CONNOISSEUR SOCIETY



IVAN MORAVEC
Mozart playing of major scope

Lewis (tenor), Eiler; Sherrill Milnes (baritone), Buff; Leo McKern (speaking role), Frank the Impresario. The English Chamber Orchestra, André Previn cond. RCA VICTOR © LSC 3000, (M) LM 3000* \$5.79.

Performance: Good

Recording: Good

Stereo Quality: Lively

In 1786, while working on a more serious project (*Figaro*), Mozart accepted a commission from Emperor Josef II, and promptly delivered a little *Singspiel* called *Der Schauspieldirektor* for performance at Schönbrunn. It was—for Mozart—a simple enough affair: an overture, two showy arias for soprano, and an elaborate finale ensemble. Tying the pieces together was a libretto of sorts—wordy, not particularly witty, and full of allusions to theatrical matters of the time. Mozart collected a modest sum for his efforts, and the overture soon became quite popular, but the rest of the opera never really caught on, its later and more sophisticated Italian title—*Il Impresario*—notwithstanding.

The present recording, like many others before it, attempts a twentieth-century transplantation, but these things don't really work. The fault is not with the performers—conductor Previn leads the work with brightness

and a good sense of style, and the singers are all capable. But Dory Previn's modern and slick-sounding libretto clashes with the music's Rococo flavor at such moments that the singers deliver their lines with sufficient clarity. In any case, there is no serious damage: a really good *Impresario*, in my judgment, is unattainable. The overture is a gem and the rest of the music has bounce and sparkle, but a "comic" opera that is unamusing is in serious trouble. G. J.

NEPOMUCENO: *Quartet No. 3, in D Minor* (see VILLA-LOBOS)

NIELSEN: *String Quartet No. 4, in F Major, Op. 44*. **HOLMBOE:** *Quartet No. 8, Op. 87*. Copenhagen String Quartet. TURNABOUT © TV 3-4217 \$2.50.

Performance: A-1

Recording: Good

Stereo Quality: Good

For all the flair he had in the art of large-scale instrumental architecture and linear writing, Carl Nielsen never produced work in any of his four string quartets that is comparable in power and fascination to that of his symphonies. All the quartets are beautifully crafted, rather lightweight pieces, about on a par with better Mendelssohn in substance if quite a bit different in style. The highly agreeable Quartet No. 4 is no exception.

With this disc, Turnabout completes its issue of the four Nielsen quartets, and gives us too the Eighth Quartet (1965) of Vagn Holmboe (b. 1909), the most formidable Danish composer in large musical forms of the post-Nielsen generation. Together with the Swede Hilding Rosenberg, who has written a dozen fine string quartets, Holmboe has added significantly to the literature of major works in this form since the death of Bartók, whose six form the backbone of the post-1910 repertoire. (All of the Holmboe Quartets up to No. 8 have been recorded, save for No. 5, and Nos. 2 and 3 were once available here on the London label. Presumably Turnabout will be releasing the Copenhagen String Quartet performances of Nos. 1, 4, and 7.) The Eighth Quartet represents, in its five movements, a thoroughly refined example of the post-Bartókian manner (with Nielsenish overtones) developed by Holmboe in his quartet writing. Besides his use of self-generating and metamorphic techniques in his handling of motivic material, Holmboe has an unerring sense of texture and color (the use of glissandos adds a piquant touch). Yet he stays well away from the "unstringlike" devices and gimmicks favored by today's more "advanced" composers. On initial hearings, this Eighth Quartet seems a little over-elaborate for its substance, at least when compared to Holmboe's earlier works in the form. The hoped-for release of the First and Fourth Quartets will, I believe, afford a better idea of Holmboe's creative stature. The present recorded performances are splendid in every way. D. H.

OFFENBACH: *La Fille du Tambour Major (highlights)*. Liliane Chatel and Nadine Sautereau (sopranos); Suzanne Lafaye (mezzo-soprano); Remy Corazza and Thierry Peyron (tenors); Michel Dens, Dominique Tirmont, and Jacques Pruvost (baritones); Choeurs René Duclos and Orchestre de la Société des Concerts du Conservatoire, Felix

Nuvolone cond. PATHÉ Ⓢ CPTA 352 \$5.79.

Performance: **Zestful**
Recording: **Good**
Stereo Quality: **Effective**

La Fille du Tambour Major (1879) was the last entry in Offenbach's incredible corpus of ninety operettas, and some of the melodic felicities of *Les Contes d'Hoffmann* (1881) are anticipated in this sprightly score. The plot of *La Fille* takes us to Italy anno 1800 during the Napoleonic wars, a period memorably captured in Puccini's *Tosca*. But don't don't look for Scarpia or Spoletta here—there are the usual operetta complications, but merriment reigns. The tested ingredients of this particular confection include a girl of uncertain family origins, and soldiers who are related to the military men of Donizetti and Gilbert and Sullivan. There are mistaken identities, surprising confrontations, couplets, quartets, an enchanting waltz, and a rollicking tarantella. In a more unusual vein, there is a confession scene (in 6/8 time) involving a mock-Monsignor. The finale, with echoes of both the *Marseillaise* and Berlioz's *Rákóczy March*, is a rousing glorification of France that would probably make De Gaulle quiver with pride. This is great fun for those who like the genre. The one outstanding voice on the disc belongs to baritone Michel Dens; the others are acceptable singers and thoroughly seasoned performers. Notes and synopsis are given in French only.

G. J.

PERGOLESI: *Stabat Mater*. Galina Pisarenko (soprano); Irina Arkhipova (mezzo-soprano); RFSR Russian Chorus and Moscow Chamber Orchestra, Rudolf Barshai cond. MELODIYA/ANGEL Ⓢ (M) SR 40044 \$5.79.

Performance: **Too many effects**
Recording: **Excellent**
Stereo Quality: **Fine**

There is nothing especially remarkable about this performance, unless it is that the performers of this Italian eighteenth-century work are Soviet. The soprano is the better of the soloists; Irina Arkhipova just doesn't have the right voice quality to handle this kind of music. The chorus does its work quite well, but I found the playing of the Moscow Chamber Orchestra somewhat irritating in its interpretive ideas: soft and hushed at one moment, nervously dramatic at the next. Much seemed just too contrived to be convincing. The reproduction is excellent, and text and translation are supplied.

I. K.

RECORDING OF SPECIAL MERIT

RIMSKY-KORSAKOV: *Operatic Scenes and Arias*. *Sadko: Aria and Scene of Lyubim* (Larissa Avdeyeva, mezzo-soprano); *Song of the Venetian Merchant* (Yuri Mazurok, baritone); *The Legend of the Invisible City of Kitezh: Feronia's Aria* (Tamara Milashkina, soprano); *The Snow Maiden: Fairy Spring Aria and Two Songs of Lel* (Irina Arkhipova, mezzo-soprano); *The Tsar's Bride: "Young Hops"* (Bolshoi Theater Chorus); *Scene and Duet* (Irina Arkhipova and Viktor Nechipailo (bass)); *Mosul's Aria* (Galina Vishnevskaya, soprano); *Sobakin's Aria* (Ivan Petrov, bass). The Bolshoi Theater Chorus and Orchestra, Yevgeny Svetlanov, Asen Naidenov, Mark Erm-

ler, Boris Khaikin, Alexander Melik-Pashayev, and Gennady Rozhdestvensky cond. MELODIYA/ANGEL Ⓢ SR 40052 \$5.79.

Performance: **Good to excellent**
Recording: **Very good**
Stereo Quality: **Very good**

There have been several complete recordings of Rimsky-Korsakov's operas, but all have had second-rate sonics—a lamentable state of affairs that automatically guarantees this Bolshoi package a warm welcome. It is, indeed, about as good as a "highlight" disc can be. Certainly, the representation accorded *Sadko*, the composer's masterpiece, is hardly adequate; on the other hand, the little-known *The Tsar's Bride* (1899) is generously represented and, on the strength of these excerpts, it bears investigation.

The singing is very good by any standard. Arkhipova turns in performances of characteristic strength and beauty, Petrov and Milashkina—old friends of American opera lovers by now, thanks to Melodiya/Angel—are in excellent form, and Vishnevskaya, though less steady here than in some previous appearances, has much to offer still. But the real find is Mazurok, the excellent Prince Yeletsy in the *Pique Dame* set: his singing of the Venetian song from *Sadko* is brilliant. You don't have to be Russian to like this release!

G. J.

RECORDING OF SPECIAL MERIT

SATIE: *Piano Music, Volume Three*. *Embryons desséchés*; *Trois saubandes*; *Préludes flasques (pour un chien)*; *Rêverie de l'en-*

VANGUARD

NEW POPULAR STEREO RELEASES

COUNTRY JOE & THE FISH



"Rediscover America now with your tour guides, Country Joe and the Fish, on their third LP: **TOGETHER**. The whole Fish thing is recognizing the world and using it joyfully. They're really the best underground newspaper around." Sandy Darlington, San Francisco Express Times

TOGETHER
VSD 79277



100% Nashville 100% Buffy Sainte-Marie

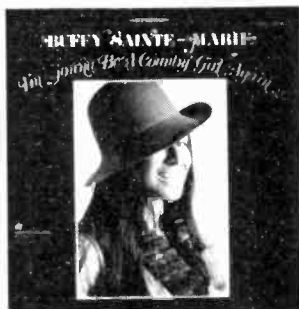

I'm Gonna Be A Country Girl Again
VSD 79280

"An artist of varied and vastly impressive achievements"
New York Times.

RECORDINGS FOR THE CONNOISSEUR

NEW RELEASES FROM CARDINAL
\$3.50 Stereo, also playable in mono
In line with the "New Look" of today's "Liszt Revival"
Cardinal offers thrillingly fresh interpretative performances by two of the world's most distinguished pianists

THE DAEMONIC LISZT
Reminiscences of Robert le Diable—
Valse Infernale
Gnomesreigen (Dance of the Gnomes)
Mephisto Polka
Mephisto Waltz
Reminiscences of Don Juan
Waltzes from Gounod's "Faust"
EARL WILD, piano
"Almost superhuman mastery . . . Wild's accounts of the Ballade and the Liszt thriller are quite as triumphant as his way with the Paganini Variations . . ." Allen Hughes, New York Times (ref. to Wild's previous Cardinal recording of Brahms and Liszt). Recorded with the Dolby System
VCS 10041

LISZT: HUNGARIAN RHAPSODIES
(Nos. 2, 3, 8, 13, 15, 17)
& **CSARDAS OBSTINE**
ALFRED BRENDEL, piano
"Alfred Brendel sounds magisterial in this music, which will be no surprise to those who remember his Liszt in Jordan Hall." Michael Steinberg, Boston Globe (ref. to Brendel's previous Cardinal recording of Schumann's music).
VCS 10055

BAROQUE CANTATAS
Handel: "Dietro L'Orme Fugaci" and "Lucrezia"
Piooco: Lamentatio Secunda
A. Scarlatti: Su Le Sponde Del Tebro
NETANIA DAVRATH, Soprano
Anton Heiller, conductor
"Netania Davrath has a truly beautiful voice, marked by purity and grace and enhanced by musicianship of the highest order." Saturday Review
VCS 10028

MUSIC FROM THE COURT OF LOUIS XIV
Marin Marais: Suite from "Alcione"
Pièces de Viole, Book 2
François Couperin: Second Concert from "Concerts Royaux"
Jacques Hotteterre: First Book of Pièces for Transverse Flute
CONCENTUS MUSICUS
Mikolaus Harmoncourt, Director
"An ensemble of musicians of consummate mastery of Renaissance and Baroque instruments." The New Recorder.
VCS 10029

J. S. BACH: 18 CHORALE PRELUDES (BWV 651/668)
ANTON HEILLER, organ
"Heiller's performances are simply thrilling in their virtuosity, and they are superbly stylish . . ." American Record Guide 2 Discs, VCS 10039/40

CIRCLE NO. 63 ON READER SERVICE CARD

Janne de Pantagruel: Les pantins d'argent; Pavane; Le piège de Méduse; Menuis propos enfantins; Enfantillages pittoresques; Peccadilles importunes; Pièces froides; Prélude en Lapidserie. Aldo Ciccolini (piano). ANGEL © S 36485 \$5.79.

Performance: **Above reproach**
Recording: **Excellent**
Stereo Quality: **Ditto**

Comparing this third recorded volume of Erik Satie's piano music with the one that preceded it, I find the man's music becomes more of a mystery to me even as his influence on major composers who followed him becomes more clear. The mystery is that the music, no matter how elementary or outlandish or banal its materials, steadily holds interest. Something of it can be explained by the eccentricity of title, to be sure. Would I listen so intently to a fragment called *March of the Grand Staircase* if the music itself suggested anything but the opposite of grandeur? Perhaps yes, perhaps no. What is probably closer to the truth is that the notes never quite do what I expect them to do—except for the moment when I have accepted that theory with such certainty that my interest is caught up by the fact that the notes are suddenly *overdoing* exactly what I might expect them to do.

An illustration of this last point dovetails conveniently with an earlier one regarding Satie's influence, in this particular case, on Debussy. *Trois sarabandes* (1887) is a set of three pieces of startlingly Impressionistic expressive *ambiance* and harmonic technique. One is particularly aware of the use of seventh and ninth chords in parallel motion, a technique much identified with Debussy—except that Debussy used the technique selectively, while Satie goes on with it to a point that even a modern harmony teacher might slap his hands with a ruler.

I also hear more specific source material for some of Virgil Thomson's music on this recording than I had been aware of. Thomson's penchant for irrelevant horn calls can be heard in *Embryons desséchés*, just as his fondness for triadic rhetoric and parody of Baroque forms can be traced to a work like *Pavane*.

It is also a bit of a surprise to come upon a somewhat more bare-textured suggestion of that aspect of Maurice Ravel's music so miraculously evocative of childhood: I am thinking, of course, of works like *Ma Mère l'Oye* or parts of *L'Enfant et les sortilèges*. And at this particular moment I wouldn't be thinking of them at all if I hadn't just heard Satie's *Enfantillages pittoresques* (especially its lovely *Berceuse*) or *Menuis propos enfantins*.

For those who think of Satie's piano music as mostly effete tinkling, *Pièces Froides* will change that. For this set of pieces, composed in 1897, is insinuatingly chromatic, elegant, rich—even lush—in harmonic texture; certain passages, moreover, are not without presagings of the sinister atmosphere that lies just beneath the surface of the glitter and brilliance of Ravel's *Valses nobles et sentimentales* or *La valse*.

I must admit to having known relatively little of Satie's work until recently—*Socrate*, the *Gymnopédies*, and a few other pieces. If there was ever a more slippery musical personality than his, I have yet to encounter it.

The performance is utterly convincing in every detail, and the sonics are excellent.

Altogether, the record is a treasure. And, I am happy to report, Volume I of the series, available some years ago in mono only, has been rerecorded in stereo and released concurrently with this album. *W. F.*

SCHOENBERG: Five Pieces for Orchestra, Op. 16. WEBERN: Cantata No. 1, Op. 29. Anita Westhoff (soprano); Gürzenich Chorus (in the Webern); Gürzenich Symphony Orchestra of Cologne, Günter Wand cond. **STRAVINSKY: Dumbarton Oaks Concerto for Chamber Orchestra.** Members of the Lamoureux Concerts Orchestra, Günter Wand cond. NONESUCH © H 71192 \$2.50.

Performance: **Good Schoenberg-Webern/
bad Stravinsky**
Recording: **Subdued but good**
Stereo Quality: **Good**

Of all the "great" twentieth-century modernists, Arnold Schoenberg and Anton Webern

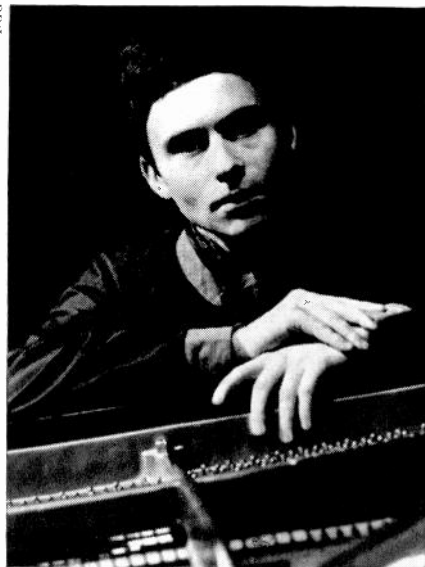

CHRISTOPH ESCHENBACH
A pianist with a rare gift for Schumann

(in different ways, for different reasons) are the ones to whom the Big Public appears to be most perennially resistant. To neither has the so-called fifty-year time lag (the time it takes for the public to see the light) apply, nor does it even seem to be *beginning* to. But the Big Public has long since made a repertoire staple of Stravinsky's *Le Sacre du printemps* and, in accordance with the time lag, even some of Stravinsky's cool, austere neo-classical works are making their way.

Public resistance to Schoenberg, for example, is an unassailable fact—Schoenberg, Father of Atonality and, like it or not, the most revolutionary composer of *composed* music of our century. The atonal and especially the twelve-tone pieces send your regular, everyday subscription concertgoer up the aisle prepared to belt the management in the chops. There is but one exception among Schoenberg's atonal works: audiences *will* sit still for the *Five Pieces for Orchestra*—and I suspect I know why. For one thing, although the piece is not nearly so atonal as many pretend, its admitted departure from normal tonality is confined to five relatively brief pieces. The suggestion—made by many—that atonality is rejected by the human ear just as the human body rejects organic transplants is less applicable because its self-re-

sembling continuity is confined here to short, expressionistic mood-music statements. Furthermore, the composer's inclination to force twelve-tone variational techniques into classical forms—a practice that, at its worst, would come to be maddening—is, by definition, absent in this work. Color, instrumental fantasy, Freudian *ambiance*—all of these qualities make the work an easy one to take. Schoenberg's greatest creative successes were the theatrical ones; Schoenberg the revolutionary classicist is, for me, a perennial bore.

It is precisely Anton Webern's freedom from twelve-tone academicism and his more extreme break with tradition that makes his music more attractive to me. Tell me from now 'til the day he is as popular as Beethoven that he was obsessively mathematical in his approach to music, and I'll still insist that the music is more sensitive and beautiful than Schoenberg's. He composed beautifully for the voice, and the *Cantata No. 1* is a succinctly lovely work, filling out one disc side that, altogether, makes as good a case for atonally composed music as you could ask for.

Such a good case, as a matter of fact, that the unfortunate performance of Stravinsky's neoclassic, unmitigatedly tonal *Dumbarton Oaks Concerto* seems like some sort of twelve-tone conspiracy. For this neo-Baroque delight, which should be played with taut animation and the dryness of good champagne, is heavy-handed, slow-motion-like, and without character here. The recorded sound is good enough. *W. F.*

SCHUBERT: Sonata in A Major, Op. posth., D 959; Twenty-One Waltzes and Ländler. Bruce Hungerford (piano). VANGUARD © VSD 71171 \$5.79.

Performance: **Impressive**
Recording: **Very good**
Stereo Quality: **Ditto**

This is a strong, thoughtful, and genuinely poetic performance of the A Major Sonata. Hungerford's poetry is of the architectural kind: he sets the piece out on a scale that matches the dimensions of the music. The Sonata, for once, does not seem oversized by a note. Hungerford is never mannered, yet his playing has immense resources of suppleness and nuance; out of this he builds big forms of great insight and (for all the intellectuality) dramatic power. There are few of the lyric-pastoral qualities generally associated with Schubert, but instead a kind of Beethovenian scope and intensity. As for the filler material, though it is pleasant to have some of Schubert's dance music taken seriously, the waltzing and *Ländlering* is pretty heavy-footed. But I must say it again: the Sonata is magnificent.

This is, on the whole, an even better example of Dolby-System piano recording than the concurrently issued Vanguard-Hungerford Beethoven sonatas. Surfaces here seemed quiet, and there was much less echo. However, toward the inner grooves of the review copy, a small but definite increase in noise began to show up in the otherwise beautiful Dolby quiet. The recorded piano sound itself is praiseworthy.

P.S.: The undersigned could not—as claimed on the sleeve notes—have lauded Mr. Hungerford in the *New York Times* in 1965, since he left that newspaper in 1962; the review in question appeared in the *New York Herald Tribune*. *E. S.*

RECORDING OF SPECIAL MERIT

SCHUMANN: *Kinderscenen, Op. 15; ABEGG Variations, Op. 1; Six Intermezzi, Op. 4; Waldscenen, Op. 82; Eintritt im Walde, Einsame Blumen, Vogel als Prophet, Abschied.* (Christoph Eschenbach (piano)). DEUTSCHE GRAMMOPHON © SLP.M 139183 \$5.79.

Performance Superb
Recording A-1
Stereo Quality Good

If this disc is a fair sample, then young Christoph Eschenbach is truly deserving of the Clara Haskil Prize which he won in Lucerne in 1965. Good Schumann playing by young pianists is a scarce commodity in our day; Eschenbach's performances here are in the finest tradition of Romantic pianism, reminding one of Cortot in his prime. The familiar *Kinderscenen*, for example, are played with exactly the right blend of delicacy and manliness; the famous *Prophet Bird* episode from *Waldscenen* becomes here an altogether magical poetic evocation. An added merit of this disc is Eschenbach's inclusion of unfamiliar early Schumann repertoire—the only currently available versions of the lovely ABEGG Variations and the interesting, though somewhat unevenly inspired, six intermezzi of Op. 1. The recorded sound is absolutely first-rate. D. H.

SPONTINI: *La Vestale*. Renato Gavarini (tenor), Licio: Maria Vitale (soprano), Giulia; Alfredo Fineschi (baritone), Cinna; Giuliano Ferrein (bass), Pontifex Maximus; Elena Nicolai (mezzo-soprano), High Priestess; Albino Gaggi (bass), Consul, Orchestra and Chorus of Radio Italiana, Fernando Previtali cond. EVRLEST S, S 151/2/3 three discs \$9.94.

Performance Adequate
Performance Fair
Stereo Quality Synthetic

Gasparo Spontini's *La Vestale* (1807) stems from the period of transition from the classicism of Gluck to the Romanticism of Meyerbeer and his contemporaries. Spontini was an Italian, but, like his contemporary Luigi Cherubini, he is more properly associated with France. He was an extremely influential and highly respected figure of his age—Napoleon and Wagner lead the list of his admirers—but thereafter his operas gradually lost their appeal. Occasional revivals, particularly of *La Vestale*, still take place—though not in France, but in Italy. *La Vestale's* libretto is reminiscent of *Noirmis's*, with a not wholly convincing happy ending. The music consists of a series of effective arias, solemn and not very imaginative recitatives, and some rather stereotyped choruses. Spontini's harmonies sound old-fashioned even for his time, but his use of the operatic orchestra was distinctive, with a sweep that is sometimes Beethovenian.

Maria Callas and Rosa Ponselle both performed the title role of *La Vestale* during their careers, and both have left recordings of the principal arias (Callas can be heard on Angel 35304; the Ponselle recordings are currently unavailable). Their brand of singing is what the opera needs to hold the stage today. The cast of the present recording—which dates from around 1950, when it first appeared on the Cetra label—is made up of well-schooled but not really first-rank

Take a poke at your favorite FM station

That's all you have to do to hear the new ADC FM stereo receiver with advanced Dio-Matic push button tuning. This electronic tuning section allows you to preset any five FM stations and have music as you like it. Instantly. Effortlessly. This powerful, modular-constructed, solid state 100 watt unit includes an FET front end for perfect FM tuning. The ADC 1000 has

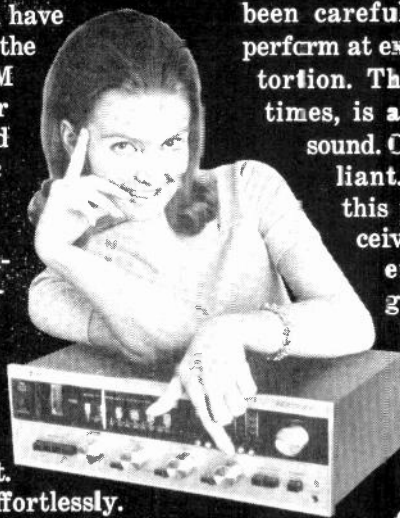

been carefully designed to perform at extremely low distortion. The result, at all times, is a more superior sound. Crisp. Alive. Brilliant. What's more, this professional receiver is completely engineered for greater ease, greater enjoyment, with positive, smooth action push buttons throughout plus facilities for all programming sources. For a live demo, visit your ADC dealer or write for complete information.

The ADC 1000
Push Button Stereo Receiver

Audic Dynamics Corp., New Milford, Connecticut 06776

CIRCLE NO. 5 ON READER SERVICE CARD



the picture hasn't changed
there's still nothing
like a LEICA

No one ever made a finer 35mm camera. You may prefer the new rangefinder Leica M4—or a Leicaflex® the reflex camera with Leica quality. Let your Franchised Leica Dealer show you both.

E. Leitz, Inc., 468 Park Avenue South, New York, N. Y. 10016
© 1967

Leica®

CIRCLE NO. 36 ON READER SERVICE CARD

Are you aware
that the finest
**STEREO
SOUND**
is available in a
superb and varied
catalogue on
LONDON
STEREO *Treasury* SERIES
at low price!

Here are some of the artists and
composers already released.

Ernest Ansermet
Ataulfo Argenta
Sir Adrian Boult
Julius Katchen
Wilhelm Kempff
Hans Knappertsbusch
Josef Krips
Rafael Kubelik
Peter Maag
Jean Martinon
Karl Münchinger
Fritz Reiner
Georg Solti

The Israel Philharmonic Orchestra
The London Philharmonic Orchestra
The London Symphony Orchestra
L'Orchestre de la Suisse Romande
The Paris Conservatoire Orchestra
The Vienna Philharmonic Orchestra

Beethoven
Berlioz
Brahms
Chopin
Debussy
Dvorák
Falla
Grieg
Massenet
Mendelssohn
Mozart
Respighi
Roussel
Schubert
Schumann
Shostakovich
Strauss
Stravinsky
Tchaikovsky

singers. They convey some of the music's grandeur without rendering it full due. Previtali's eloquent conducting is the most rewarding aspect of the enterprise. Technically, the recording shows its age; the choruses, in particular, sound thin and diffused. But the set fills a gap, especially since another recording of *La Vestale* may not be forthcoming for a long time. Everest's price is attractive, and a full libretto is supplied. *G. J.*

RECORDING OF SPECIAL MERIT

STRAVINSKY: *Concerto for Piano and Winds*; *Capriccio for Piano and Orchestra*. Philippe Entremont (piano); Columbia Symphony Orchestra, Igor Stravinsky cond. (in Concerto) and Robert Craft cond. (in Capriccio). COLUMBIA © MS 6947, Ⓜ ML 6347 \$5.79.

Performance: Exuberant
Recording: Good
Stereo Quality: Fine

It could be some kind of personal obsession with me, but each new Stravinsky- (or Craft-) conducts-Stravinsky disc in Columbia's series in some way baffles me. In this case, the question posed itself: how—and how come?—was the unlikely liaison between the rather undisciplined romanticism and "establishment" virtuosity of pianist Philippe Entremont and the rigid, disciplinarian interpretive attitudes of both Stravinsky and Craft brought about? One would have thought Charles Rosen a far more likely choice—one whose approach to contemporary music is more attuned to Stravinsky's current one.

Mind you, I'm not complaining—because I like the results. Either through osmosis or through a certain yielding to Entremont's temperament, the performance of the ordinarily sternly neoclassical Concerto is here more expansive, sweeping, and flashy than anything that Stravinsky has conducted on records in ages. As a matter of fact, the overall line and expressive *ambiance* of the music is so relaxed that this tautly written work at moments takes on something close to grandeur here. I like it this way.

I could be wrong, but it seems to me that even Robert Craft is out for a flashy and attractive—rather than a "significant"—performance of the Capriccio, but again I wouldn't envy the conductor who would try to play down or against Entremont's keyboard sparkle.

This release, then, is infectiously light-hearted and full of fun in its overall effect. In the context of some of the recent products of Stravinsky's recording team, the contrast is itself a surprising pleasure. And the recorded sound and stereo quality are suited to the occasion. *W. F.*

STRAVINSKY: *Dumbarton Oaks Concerto* (see SCHOENBERG)

RECORDINGS OF SPECIAL MERIT

TCHAIKOVSKY: *Concerto In D, Op. 35, for Violin and Orchestra*. DVOŘÁK: *Romance in F, Op. 11*. Itzhak Perlman (violin); Boston Symphony Orchestra, Erich Leinsdorf cond. RCA VICTOR © LSC 3014, Ⓜ LM 3014* \$5.79.

Performance: Excellent
Recording: Good
Stereo Quality: Good

It's rather nice to discover that this sort of fiddle playing is not entirely dying out with the older generation. Within certain limits, Perlman essays the grand style, and by and large succeeds at it. He is not overly Romantic in the Iman manner, but then that kind of playing would seem very affected today—like old silent-film acting. But Perlman has a good, rich sound, plenty of swing in his bow arm, and all the grand rhetorical gestures in good working order. Leinsdorf and the orchestra are right there with him; Leinsdorf lets the sentiment in the music take care of itself, but that's quite all right with me. I am, I must admit, no Tchaikovsky Concerto connoisseur, but I enjoyed this performance. The Dvořák, although a little overlong in its dogged Dvořákian lyricism, is a pleasant extra, and the sound is as good as or better than anything that RCA has come up with from Boston. *E. S.*



ITZHAK PERLMAN
The grand style in good working order

TOCH: *Piano Concerto, Op. 38*. Ernest Toch (piano), Vienna Symphony Orchestra, Herbert Haefner cond. *Concerto for Cello and Chamber Orchestra, Op. 35*. Frédéric Mottier (cello), Forum Group, Zürich, Fred Barth cond. CONTEMPORARY © S 8014 \$5.79.

Performance: Authentic
Recording: Dated
Stereo Quality: "Enhanced" mono

There are a few highly regarded contemporary composers about whom I invariably find it difficult to write, such as Wallingford Riegger, Frank Martin, and in this instance Ernst Toch. Considering Toch anew with reference to this recording of two estimable extended works I find the mastery of technique and the control of material to be unsailable. I don't feel that I am either uncomprehending or unsympathetic where his musical intentions are concerned, and I concede a highly respectable eclectic "originality." But the music—always perfectly listenable as it is—leaves me utterly cold. And the only reason I can give involves the use of a phrase that has been all but banished from the sophisticated critical lexicon: the music lacks urgent "personal expressivity."

Both these concertos date from the mid-Twenties, and the Piano Concerto, in particular, must have seemed like pretty wild stuff

in its day. The technique and sensibility of both works is rooted in a sort of Central-European neoclassicism; the harmonic and melodic technique is chromatic in a typically diagrammatic way (in no way dodecaphonic, however); and although the formal molds are classical, the music is not academic.

Of the two pieces, I find the piano work much the more entertaining. Although the Cello Concerto predates it by only a year, it is far milder, and it tries for a lyricism that—my own problem though it may be—I don't believe. The Piano Concerto, it *seems* at least, was written with the idea, conscious or otherwise, of shaking its audience up a little. There's a good bit of brash, yowling dissonance that may or may not be at odds with the basic conventionality of the musical structure it adorns. But it's always fun to hear an essentially stuffy composer kicking up his heels a little.

The present performance is by the Vienna Symphony, with the composer at the piano, and it was transferred from a taped air-check made in 1950 which was discovered after the composer's death in 1964. The Cello Concerto, in a reading supervised by the composer, was similarly recorded during a Zürich performance in 1958. Just as we must assume both performances to be authentic, we must assume as well (and the ears back this up) that we're getting far from the latest thing in recorded sound. *W. F.*

RECORDINGS OF SPECIAL MERIT

VAUGHAN WILLIAMS: *Fantasia on a Theme by Thomas Tallis*. HOLST: *St.*

Paul's Suite. WARLOCK: *Capriol Suite*. Philharmonia (in the Vaughan Williams) and Royal Philharmonic Orchestras. Sir Malcolm Sargent cond. CAPROL (S) SP 8676 \$1.79.

Performance: Mostly superb
Recording: A-1
Stereo Quality: Very good

VAUGHAN WILLIAMS: *Fantasia on a Theme by Thomas Tallis*; *Five Variants of "Dives and Lazarus"*; *Fantasia on "Greensleeves"*; *Flos Campi, for Viola, Small Orchestra, and Wordless Choir*. Sally Peck Lentz (viola); University of Utah Chamber Choir; Utah Symphony Orchestra. Maurice Abravanel cond. VANGUARD CARDINAL (S) VCS 10025 \$3.50.

Performance: Fine
Recording: Very good
Stereo Quality: First-rate

There is an embarrassment of riches here—not the least of it the noble and shatteringly beautiful *Tallis Fantasia*, which gets its two finest recorded performances to date, in my opinion. Both readings avoid the tendency on the part of some conductors to "Tristanize" the music. The late Sir Malcolm Sargent has the better string players, and the recorded sound he gets is gorgeous to a fault; but the Vanguard Cardinal engineering staff have done things in their stereo miking that achieve, for the first time, a true spacial differential between the solo quartet, small string orchestra, and large string orchestra specified by Vaughan Williams in his scoring.

The Sargent disc offers the only currently available stereo recordings of two other English delights: the wonderful *St. Paul's Suite* of Gustav Holst, written for the string orchestra of the girls' school where he taught, and based largely on English folk-song material; and the delicious *Capriol Suite* composed by the tragically short-lived Philip Heseltine (Peter Warlock was his composing pseudonym) on melodies from Thoinot Arbeau's sixteenth-century dance treatise *Orchésographie*. The Holst gets a stunning performance; the Warlock gets off to a heavy-handed *legato* start, but is redeemed splendidly thereafter.

Flos Campi, Vaughan Williams' evocation of the Biblical *Song of Songs*, is unquestionably the most sensual music ever written by the great English composer. Abravanel's recorded performance is altogether splendid, and Sally Peck Lentz rates a special compliment for the dark, sensual sound of her viola playing. The "Dives and Lazarus" Variants and familiar "Greensleeves" Fantasia are minor chips from the Vaughan Williams workbench, but no less appealing for all that. In the affectionate and well-recorded performances here, they make fine foils for the bigger works in this package. (The *Flos Campi* was previously on a regular Vanguard disc, coupled with Vaughan Williams' cantata *Doni Nobis Pacem*.) *D. H.*

RECORDING OF SPECIAL MERIT

VAUGHAN WILLIAMS: *Symphony No. 2, "A London Symphony."* Hallé Orches-

Add LIFE to your color TV, stereo radio and electronic equipment

DELWYN™
Whisper Fan®

- Made especially for cooling transistors, tubes and other heat generating components
- Helps guard against part failure
- Ensures trouble-free life — peak performance
- Costs only a few pennies to operate — saves dollars in repair bills
- So quiet and noise-free, you have to feel the breeze to know it is at work
- Quickly and easily installed

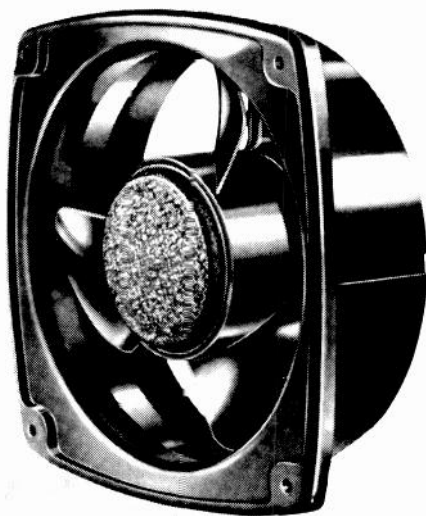

Only
\$14.85
Complete!



Ask your dealer to demonstrate how the Delwyn Whisper Fan will pay for itself in savings on just one heat-caused repair bill.

DELWYN BOX 195 B, Route 28
Kingston, New York 12401

CIRCLE NO. 17 ON READER SERVICE CARD

tra, Sir John Barbirolli cond. ANGEL © S 36178 \$5.79.

Performance: Unmatchable
Recording: Superb
Stereo Quality: Excellent

The day may yet arrive, but one can't, as of now, book passage on a first-class flight to London at \$5.79, flying time about forty minutes. Until it does come, Sir John Barbirolli's evocative, flawlessly idiomatic new recording of Vaughan Williams' "A London Symphony" is as good a substitute as any.

Needless to say, this durable work by this anything but fashionable composer is scarcely in need of good recorded performances. If memory doesn't fail me, Barbirolli did a modern stereo performance of the work for Vanguard not too many years ago. But Sir John has a flair for the music of the pre-Britten English romantics—Elgar is another one—that is in a class by itself. Since the symphony is something of an impressionistic picture of London (yet cast in something like classical formal molds), far too many conductors let the "picturesque" qualities of the music get the better of its structure. But Barbirolli's line is clean, vigorous, and strong, his rhythms precise and animated. These disciplines give the work a smart, cohesive structural clarity it all too frequently lacks. And Barbirolli achieves it without injury to the quasi-impressionism the composer seems to have had in mind.

The orchestra plays superbly. The recorded sound and stereo treatment are respectively a bit flashier and more calculated than Angel's typical product, but you'll read no complaint from me on either point. *W. F.*

VERDI: *Aida*. Herva Nelli (soprano), Aida; Eva Gustavson (mezzo-soprano), Amneris; Richard Tucker (tenor), Radames; Giuseppe Valdengo (baritone), Amonasro; Norman Scott (bass), Ramfis; Dennis Harbour (bass), the King; Virginio Assandri (tenor), Messenger; Teresa Stich-Randall (soprano), Priestess. NBC Symphony Orchestra and Robert Shaw Chorus, Arturo Toscanini cond. RCA VICTROLA © VIC 6113(e), Ⓜ VIC 6113* three discs \$7.50.

Performance: Exciting
Recording: Fair
Stereo Quality: Synthetic

Rehearing this 1949 performance for the first time in a number of years—and after hearing a number of distinctly inferior *Aidas* on records and in the theater—I find that I have two observations: (1) its artistic values seem stronger than ever, and (2) it is all the more frustrating that so much excellence should be blunted by dated sonics. There is no point in comparing the sonics of this *Aida* with the glittering products of the stereo age. It will be shunned by those who crave the latest and loudest, and treasured by those who search in vain today for the kind of exacting and inspiring leadership that Toscanini provides here.

There is a certain imbalance, of course, when one finds the orchestral underpinning more fascinating than the vocal accomplishments in a Verdi opera. Unquestionably, this is Toscanini's show: his direction is a miracle of vitality, incisiveness, and ensemble control. Details are positively revelatory. His merciless demands on the singers work wonders, and there are only two instances (the ensemble just before "Ritorna vincitor")

and the "Ab no, Juggamo" portion of the Nile Scene) when he asks for too much and they, consequently, are unable to give it to him.

Although the singing is overshadowed by the conductor and slighted by the engineers, it cannot be completely dismissed. Tucker, at his youthful lyrical best, sings fervently and phrases artistically; Nelli is not particularly exciting, but never below acceptable; and Valdengo gives one of the two best performances of his life (the other occurred in the Toscanini *Falstaff*). Neither the Amneris nor the Ramfis is quite up to the occasion, but the King is quite good, and in a small role Teresa Stich-Randall showed a promise she has amply fulfilled since.

A product of NBC's notorious Studio 8-H, this recording was never an engineering landmark. Balances are erratic, with over-prominent brass and percussion, a distant chorus, and some indistinct ensemble voices.



GIUSEPPE VERDI
Engraving (1867) by C. Deblois

In spite of everything, though, this is the *Aida* by which all others must be judged. RCA followed wise counsel in arranging the disc sides in such a way that no scene is interrupted: we get sides of varying length, but also welcome continuity. *G. J.*

VERDI: *Songs*. *Non l'accostare all'urna; More, Elisa, lo stanco poeta; In solitaria stanza; Il tramonto; Il mistero; Il poveretto; Brindisi*. **WAGNER:** *Songs*. *Karneralslied; Der Tannenhain; Die Rose; Die beiden Grenadiere; Wesendoncklieder: Schmerzen, Träume*. Sándor Kónya (tenor); Otto Guth (piano). DECCA © DL 79432, Ⓜ DL 9432* \$5.79.

Performance: Good
Recording: Dry
Stereo Quality: Not noticeable

With the exception of the two Wesendonck songs, these are trifles from the apprentice years of two geniuses. Verdi's little *romanze* come from the period 1838-1847; there is not much in them to suggest that *Nabucco*, *Ernani*, and the first version of *Macbeth* stem from the same years. The Wagner songs, written between 1838 and 1840 while he was at work on *Rienzi*, have a bit more substance, though they are awfully square harmonically.

But devotees of these two composers won't mind: they'll enjoy the program, and will be particularly delighted to discover incidentally that, for *In solitaria stanza*, on the words "Salvate o dei pietosi," Verdi wrote, just fifteen years before *Trovatore*, one of the key phrases of "Tacea la notte"—the rising line first heard on the words "Dolci s'adire e flebili"—or that Wagner anticipated Schumann by a year or so in introducing the theme of the *Marseillaise* into his version of *Die beiden Grenadiere*.

I wish I were fonder of Sándor Kónya's vocal sound here: is it the cracklingly dry acoustic of the disc that makes his lower register sound stifled and his upper register at the *forte* level sound hard and unresonant? The material doesn't allow Kónya much in the way of interpretation, but such as there is is intelligent—he eschews crypto-operatic mannerisms in favor of an attractive simplicity. His accompanist is good.

The center-fold album is a model of handsome presentation: texts, translations, and notes (the last two by George Jellinek of this magazine's staff) are thoughtfully done.

Robert S. Clark

VILLA-LOBOS: *Quartet No. 17*. **NEPOMUCENO:** *Quartet No. 3, in D Minor ("Brasileiro")*. Brazilian String Quartet. ODYSSEY © 32 16 0176, Ⓜ 32 16 0175 \$2.49.

Performance: Capable
Recording: Fine
Stereo Quality: Good

Both of these string quartets by Brazilian composers are easy enough on the ear. Villa-Lobos' Quartet No. 17 (1959), composed shortly before his death, is pretty much par for this composer's course. The writing is mostly glib and facile, but it all works, and, unsurprisingly, the piece has a slow movement with one of Villa-Lobos' opulent, shapely long-lined tunes in it.

Alberto Nepomuceno (1864-1920) is a composer of whom even *Brazilians* knew little until 1956, when three string quartets were unearthed. I rather suspect that the music is more interesting to that country's musicologists and, perhaps, musicians than it is to anyone geographically far afield. The Third Quartet is, according to *Odyssey's* sleeve annotation, notable as the "first characteristic Brazilian work to introduce a well-defined folk song. . . ." One is supposed to hear it in the second movement, but I'm not sure which tune it is, and this is probably because I hear nothing characteristically Brazilian about its setting or about the work as a whole. It was written when the composer was in Berlin at age twenty-seven; it sounds fit to me.

The performances seem fine, and the recorded sound and stereo treatment leave no room for complaint. *W. F.*

WAGNER: *Songs* (see **VERDI:** *Songs*)

WARLOCK: *Capriol Suite* (see **VAUGHAN WILLIAMS**)

WEBERN: *Cantata No. 1, Op. 29* (see **SCHOENBERG**)

COLLECTIONS

USTAD ALI AKBAR KHAN: *The Forty-Minute Raga* (see Best of the Month, page 74)

RECORDING OF SPECIAL MERIT

E. POWER BIGGS: *Historic Organs of Spain*. Soler: *The Emperor's Fanfare*; *Sonata "for the clavichord"*; Dandrieu: *Duo "en cors de chasse sur la trompette"*. Anglès: *Aria in D Minor*. Seixas: *Sonata in G Minor*; *Toccata in D Minor*. Anonymous: *Seven Fabordons*. Cabanilles: *Batalla Imperial*. Pasquini: *Puntate sopra la aria della Jolia de Espagna*. Milan: *Paranna*. Valente: *La Romanesca*; *Lo ballo dell'intoncia*. E. Power Biggs (organs in Toledo, Segovia, Salamanca, and Madrid, Spain). COLUMBIA © MS 7109 \$5.79.

Performance: **Intensely colorful**
Recording: **Superior**
Stereo Quality: **Excellent**

Each new Biggs album devoted to historic organs turns out to be a revelation. There is usually an uncannily good choice of repertoire, one that is perfectly designed to show off the instruments. And the instruments themselves are well set off against one another, so that even the uninitiated are able to understand the distinguishing characteristics of the instruments. All this is true of this latest Spanish collection, in which Mr. Biggs displays the "Emperor's Organ" at Toledo Cathedral, organs at Segovia and Salamanca, and the organ in the Royal Palace of Madrid. The most obvious characteristic of all of these is the Royal Trumpet stop, an extremely penetrating sound. But also highly individualistic are the many reeds to be heard. The *Batalla Imperial* by Juan Cabanilles is an eye opener in this respect. The

entire collection, though musically of not always the highest significance, is exceptionally entertaining. Mr. Biggs is in fine fettle here, and the recorded sound, including some startling stereo placement effects among different organ registers, is splendid. I. K.

MONTSERRAT CABALLÉ: *Rossini Rarities* (see Best of the Month, page 71)

RECORDING OF SPECIAL MERIT

DUETS FOR COUNTERTENORS. Morley: *Sweet Nymph, come to thy lover*; *Miraculous lover's wounding*; *I go before, my darling*. Purcell: *Love's Goddess* (1692); *Sweetness of Nature*. Schütz: *Erlöbe mich, wenn ich rufe*; *Derr Hen ist gross*. Jones: *Sweet Kate*. Anon. (c. 1500): *Ab, my dere Son*. Monteverdi: *Currite populi*; *Angelus ad pastores ait*; *Fugge, fugge, anima mea*; *Salve Regina*. Blow: *If my Celia could persuade*; *Ab Heav'n! What is't I hear?*. Deering: *O bone Jesus*; *Gaudet in coelis*. Alfred and Mark Deller (countertenors); Ensemble of Baroque Instruments. VANGUARD CARDINAL © VCS 10022 \$3.50.

Performance: **Quite lovely**
Recording: **Excellent**
Stereo Quality: **Very good**

Those interested in the countertenor voice (I number myself among them, although I realize that a good many listeners are put off by its characteristics) will find the present collection a source of considerable fascination, since there are not one but two evenly matched countertenor voices to enjoy. Pre-

viously, the best example of Deller and son at work was that spectacular display piece, "Sound the trumpet," (from Purcell's *Comedies of art*) in the Vanguard recording. The repertoire here is not quite on the level of that brilliant work, but the artistry of the Dellers (Alfred's abilities are well known, his son's rather less so) is uncommonly satisfying and consistently rewarding. The material is divided fairly evenly between sacred and secular, with some of the latter examples (Blow's *Ab Heav'n! What is't I hear?*, for instance) providing the same kind of titillation as the aforementioned Purcell does. Alfred Deller, incidentally, has two solos to himself. Monteverdi's *Currite populi* and his *Salve Regina*. The reproduction is most satisfactory, and the jacket provides all texts and translations. I. K.

GEMS FROM THE EDISON DIAMOND AMBFROLS. Arias from *Rigoletto*, *La forza del destino*, *Lobengrin*, *Le Prophète*, *La Sonnambula*, *Pescatori di perle*, *Samson et Dalila*, *Don Pasquale*, and *Pagliacci*. Johann Strauss: *Voci di Primavera*. Flégier: *Le Cor*. Chopin: *Nocturne, in E-flat, Op. 9, No. 2*. Maria Galvany, Melitta Hemm, Marie Rapold, Celestina Boninsegna, and Lucrezia Bori (sopranos); Marie Delna and Carolina Lazzari (contraltos); Alessandro Bonci, Giuseppe Anselmi, and Giovanni Martinelli (tenors); Paul Payon (bass); Moriz Rosenthal (piano). EDISON © (!) Volume 1 \$5.00 postpaid (available from Thomas Alva Edison Foundation, Inc., 2000 2nd Avenue, Detroit, Michigan 48226).

(Continued on next page)

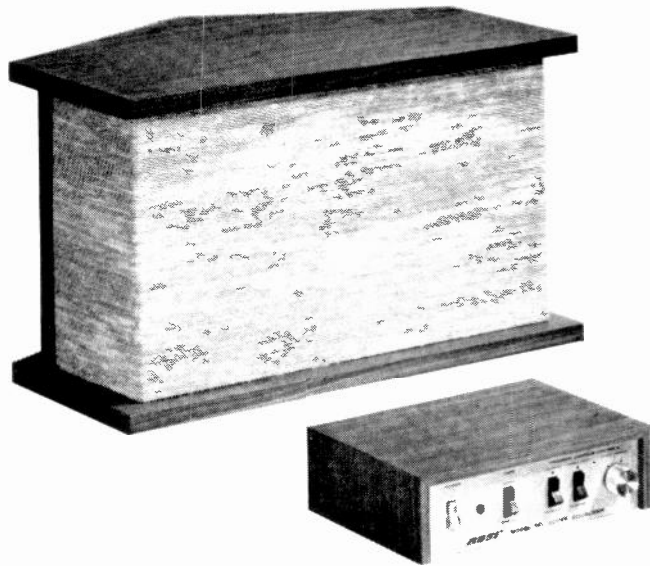

The BOSE Corporation has introduced a new loudspeaker system—the Direct/Reflecting BOSE 901. Knowledgeable people in high fidelity who have heard it—dealers, editors and enthusiasts—say that this loudspeaker system literally shocked them with a clear, immediately apparent superiority over the best speakers they had heard. It incorporates a number of major advances in acoustic technology, any one of which would be a significant improvement over present day speakers. These advances are covered by patents issued and applied for.

The closer approach of this speaker to the duplication of the actual performance provides a listening experience which requires that you A-B the BOSE 901 against speakers you respect—the best speakers you know, regardless of size or price—in order fully to appreciate the scope of this achievement.

CIRCLE NO. 9 ON READER SERVICE CARD

You don't really want to hear how it was done until you hear what it does.

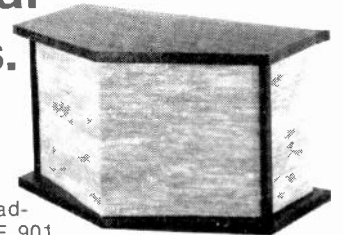

There is no point in explaining here the nature of the advantages embodied in the BOSE 901.

Until you have heard the system, anything we say will inevitably be translated into the familiar terms of the speakers you have heard and the things you have been told about them. After you hear it, ask your dealer for our brochure explaining the new design concepts which have made possible the performance you experienced.

All we want to say here is that until you have heard the BOSE 901 in comparison tests with the best speakers currently available, you have lost touch with the state of the art in loudspeakers.

THE **BOSE** CORP.®

East Natick Industrial Park
Natick, Mass. 01760

THE FABULOUS EDISON CYLINDER. Arias from *Otello*, *Luisa Miller*, *La forza del destino*, *L'Africana*, *Les Huguenots*, *Le Prophète*, *Le Cid*, *La Bobème*, and *Mignon*. Proch: *Theme and Variations*. Lucrezia Bori, Frieda Hempel, Blanche Arral, and Julia Heinrich (sopranos); Marie Delna (contralto); Florencio Constantino, Leo Slezak, Carlo Albani, Alessandro Bonci, and P. Asselin (tenors); Mario Laurenti (baritone). Orchestral accompaniments. ODYSSEY Ⓜ 32 16 0207 \$2.49.

Performance: **Variable**
Recording: **Caveat emptor!**

Long after flat discs had won the battle for public acceptance as a medium for reproduction, Thomas Alva Edison stubbornly clung to the cylinder, a device he had pioneered as far back as 1877. Owing to his tenacity, cylinders remained on the market well into the 1920's, and Edison's great reputation continued to attract celebrity artists to his studios. Eventually, cylinders became hobbyists' relics. But now we have LP's from two sources, offering disc transfers from the Edison catalog for latter-day music-lovers' evaluation.

Unencumbered by nostalgia—having arrived on the scene too late to have my discomfition threatened by the cylinder medium—I find nothing on these discs to make me lament the cylinder's passing. The vocal sound preserved in these performances is certainly no better than what is offered by the acoustical discs of the period—generally between 1908 and 1922—and the orchestral sound is even more primitive. As for the artistic achievements, they run the gamut from the impressive to the depressing. The Edison disc is superior: it has a very charming example of Bori's art (*Don Pasquale*), Boninsegna in her characteristic tonal opulence, the rarely heard but remarkable basso Paul Payan, and a few other interesting performances. Strangely, surface noise is most noticeable in the 1929 recordings of Martinelli (*Vesti La giubba*) and pianist Moritz Rosenthal.

On the Odyssey disc, only contralto Marie Delna (in Meyerbeer's *Ab, mon fils*, which is duplicated by Edison) and soprano Frieda Hempel (in the Proch Variations) can be listened to with enjoyment. The disc is afflicted with pitch fluctuations, probably due to the difficulty of transfer. The same problem is present in the Edison disc to a somewhat lesser degree.

Curio fanciers will be drawn to these releases—their historical interest is undeniable. Other listeners should approach them with caution. G. J.

WANDA LANDOWSKA: Piano Recital. Beethoven: *Andante favori*, in *F Major*; *Sonata No. 12*, in *A-flat Major*, Op. 26 (*"Funeral March"*). Lanner (arr. Landowska): *Waltzes Viennoises*. Mozart: *Sonata No. 17*, in *D Major* (K. 576). Wanda Landowska (piano). EVEREST ARCHIVE OF PIANO MUSIC Ⓢ Ⓜ X 915 \$4.98.

Performance: **Posthumous (piano rolls)**
Recording: **Excellent**
Stereo Quality: **Very good**

This disc is part of Everest Records' series devoted to reproductions of piano-roll recordings. Landowska made these Duo-Art rolls about 1917, and those familiar with her later Haydn and Mozart piano disc performances will recognize many of the same

individual touches in her interpretations here. There is some tendency in the present recording towards woodenness, however, both in rhythm and phrasing, and, on occasion, one is aware of smudged passages, something one might never expect to hear in Landowska's technically immaculate playing. This, I am afraid, is due either to the condition of the rolls or the reproducing piano. The conception of the Mozart sonata here is almost identical to the 1937 disc version available on imported Pathé, but in the latter there is a conspicuous absence of such technical hitches. The Everest recording is nevertheless better in this respect—and in the important matter of correct speed—than many of the previous discs in this series, and the general quality of the piano reproduction is extremely good. For most listeners, the greatest curiosity will be Landowska's Beethoven, and this turns out to be quite Romantic, the most enjoyable part of the collection. I. K.



OPERA ARCHIVES
LUCREZIA BORI
Memorable art from the Edison cylinders

LOTTE LEHMANN: Songs of Vienna. Strauss-Dostal: *Heut' macht die Welt Sonntag für mich*. Leopoldi: *Wien, sterbende Märchenstadt*. Benatzky: *Ich muss wieder einmal in Grinzing sein*. Arnold: *Da draussen in der Wachau*. Stolz: *Im Prater blüß'n wieder die Bäume*. Siczynski: *Wien, du Stadt meiner Träume*. Mendelssohn: *Auf Flügeln des Gesanges*; six others. Lotte Lehmann (soprano); Paul Ulanowsky (piano). ODYSSEY Ⓜ 32 16 0179 \$2.49.

Performance: **Intimate**
Recording: **Fairly good**

This is the third disc to be issued in honor of Lotte Lehmann's eightieth birthday, and it is most welcome. The selections listed above are reissues from the Columbia catalog. Contrary to the liner-notes' assertion, however, the other six appear to be released here for the first time, since they are not listed in the pre-LP Columbia catalogs. Nor do they have anything to do with Vienna: four are French folk songs, one is the English song *My Lovely Celia*, and one is Haydn's setting of Shakespeare's *She Never Told Her Love*.

Assuming that the annotations are correct in at least one respect, these selections were recorded in 1941, a period after the years of

Lehmann's vocal prime, but nonetheless when the voice was still able to support the enchantments of her interpretive art. I find her performance of the French-English group no less colorful and insinuating than that of the familiar Viennese favorites. If her technique is not always flawless and the intonation at times less than dead-center, her coloring of phrases, sly inflections, and all-pervading charm are still treasurable. The recorded sound is serviceable, and Ulanowsky's pianism matches the delicacy of the singing. G. J.

MUSIC FROM SWEDEN. Blomdahl: *Suite from Sisyphos*. Rosenberg: *Voyage to America: Intermezzo*; *The Railway Fugue*. Berwald: *Sinfonie capricieuse*. Stockholm Philharmonic Orchestra, Antal Dorati cond. RCA VICTROLA Ⓢ VICS 1319, Ⓜ VIC 1319* \$2.50.

Performance: **Sounds fine**
Recording: **Good**
Stereo Quality: **Good**

About the only generalization I can make about this collection of Swedish music is that I detect little that is Swedish about it so far as characteristic sound goes. Even so, I rather like the middling chromaticism, the jazzy overtones, and the sharp, bright scoring of the Suite from *Sisyphos* by the late Karl-Birger Blomdahl (b. 1916). And the piece has a wonderfully wanton ending.

Hilding Rosenberg (b. 1892) is represented by two pieces from *Voyage to America*, a suite adapted from an unsuccessful opera dealing with an immigrant's life in the New World. Its musical style is, at bottom, conservative and unremarkable. But its expressive overtones are enough to make any prospective immigrant cash in his boat ticket. Granted things weren't all they might have been on this side of the Atlantic when the opera was composed in 1932 (or now), the dirge-like tolling of chimes and the doom-ridden sound of the timpani opening the *Intermezzo* are pretty lugubrious (but maybe this is the Scandinavian brooding we hear so much about!). *The Railway Fugue* uses rather unpleasantly slanted neo-Baroque contrapuntal techniques with the intention of evoking our mechanized society. Strange. Deprived of its tell-tale title, both its polyphonic style and its slightly jazzy, *energico* rhythmic animation remind one of dozens of Mennin-cum-Schuman-cum-Harris American pieces that (in their inferior manifestations) lots of us were beating off like flies during the Forties.

Franz Berwald (1796-1868) takes us back a bit, of course. His *Sinfonie capricieuse* has a number of surprising things about it. For one thing, premonitions of Brahms loom large; for another, Berwald succeeded in blending other Continental influences into a style that is attractively personal. The piece is, moreover, solidly and masterfully crafted. It may not be one of those works that people like to live with forever, but it is, for one listener, a surprisingly accomplished and still-fresh product of nineteenth-century Sweden.

Both sonics and stereo quality are good. W. F.

RECORDINGS OF SPECIAL MERIT

THE NEW MUSIC (Vol. 2). Boulez: *Sonatine for Flute and Piano*. Severino Gaz-

zelloni (flute); Frederick Rzewski (piano). **Haubenstock-Ramati:** *Interpolation, Mobile for Flute (1, 2, and 3)*. Severino Gazzelloni (flute). **Maderna:** *Concerto for Oboe and Chamber Orchestra*. Lothar Faber (oboe); Soloists of the Rome Symphony Orchestra, Bruno Maderna cond. RCA VICTROLA Ⓢ VICS 1312, Ⓜ VIC 1312* \$2.50.

THE NEW MUSIC (Vol. 3). Nono: *Y su sempre ja viene cantando for Flute, Strings, and Percussion*. Fukushima: *Hi-kyō for Flute, Piano, Strings, and Percussion*. Berio: *Serenade I for Flute and Fourteen Instruments*. Lehmann: *Quanti for Flute and Chamber Orchestra*. Severino Gazzelloni (flute); Soloists of the Rome Symphony Orchestra, Bruno Maderna cond. RCA VICTROLA Ⓢ VICS 1313, Ⓜ VIC 1313* \$2.50.

Performance **First-rate**
Recording **Good**
Stereo Quality **Good**

Severino Gazzelloni is to new European flute music what Marcello Mastroianni is to new Italian movies: he doesn't create the stuff, but he sure helps to put it across. Gazzelloni's contributions to the developments of the past decade have been not only "musical" in the traditional sense, but also a matter of showmanship; indeed, in Europe it was Gazzelloni who started the trend toward treating contemporary musical performance as a kind of theater. The two new discs in RCA Italiana's contemporary series (issued here—lucky us!—on low-priced Victrola) are essentially Gazzelloni recitals. The exotic Kazuo Fukushima work and the almost equally exotic Nono, the open-form works of Haubenstock-Ramati and the young Hans Ulrich Lehmann, the free-form, elegant Berio, and the early, highly organized, but imaginative Boulez Sonatine are brilliantly performed by Gazzelloni with the young American composer-pianist Frederick Rzewski. Lothar Faber, the German oboist and a frequent Gazzelloni collaborator, is the soloist in Bruno Maderna's intense, lyrical serial Concerto. The Maderna-Gazzelloni collaborations are equally happy ones, and both recordings are of attractive clarity and quality. *E. S.*

NEW MUSIC FROM JAPAN. Miyoshi: *Concerto for Orchestra*. Takemitsu: *Texture*. Mayuzumi: *"Mandala" Symphony*. NHK Symphony Orchestra, Hiroyuki Iwaki cond. ODYSSEY Ⓜ 32 16 0152, Ⓜ 32 16 0151 \$2.49.

Performance: **Good**
Recording: **Attractive**
Stereo Quality: **Good**

Japanese music is right up there with it these days and, in the field of new music, the Japanese orchestras put our own to shame. These are excellent, idiomatic performances of difficult new music; the very considerable sonorous imaginations of these composers are realized with great vitality and assurance. Of the three works, the Takemitsu is easily the most fascinating—and, I think, objectively the best as well. An orchestra of seventy-three musicians is stereophonically divided down the middle, with a piano in between. The work is, as advertised, a study in textures, but these textures are wide-ranging, fascinating, and strikingly imaginative; they also work not merely as sensuous sound, but also as part of a larger pattern of fixed and open ele-

ments, increasing and decreasing densities and intensities. The general idea suggests a cross between Penderecki, one of the younger French composers, and Earle Brown—but with an indigenous dash of Oriental originality. Best of all, the piece builds as a form and as an experience; and the apocalyptic finish is quite overwhelming. The stereophonic effect seems a little overly (artificially?) emphasized on the recording; otherwise this is a brilliant performance.

The Miyoshi Concerto, as "well-written" as any of the three, is also the most derivative. The first movement is an obvious rewrite of the first of the Schoenberg Five Orchestral Pieces and the second movement is also well within the orbit of Vienna circa 1912; the third movement breaks out of the mold—and right into a hard-driving rhythmic straight-jacket. The Mayuzumi "Mandala" Symphony is a tough one to deal with. It is a big, portentous, pretentious work for large orchestra, including what I presume are Oriental instruments. It moves from post-Webern twitches to great Varèse-ian percussion *fortissimos*, from *Sacre du printemps* thwacks to old Japanese *ostinati*, from great Impressionistic swatches of color to big, crunching, atonal dissonances and simple Oriental modalities. I don't mind the eclecticism, but I do mind the pretension. In the end, all these various ideas and materials, many of them set forth with the utmost inventiveness, do not serve to illumine the varieties of experience they might represent and emerge as nothing more than a long series of imposing, eccentric flashes of inspiration. Again let me emphasize the excellence of the performance and the recording. *E. S.*

NEW PHILHARMONIA CHORUS: *Recital*. Bruckner: *Five Unaccompanied Motets*. Wolf: *Morgenhymnus*. Van Nuffel: *In concertando Dominus*. Brahms: *Nänie*, Op. 82. Mozart: *Ave, verum corpus*. (K. 618). Beethoven (orch. Mottl): *Die Ebre Gottes aus der Natur*. New Philharmonia Chorus and New Philharmonia Orchestra, Wilhelm Pitz cond. ANGEL Ⓢ S 36128 \$5.79.

Performance: **Excellent**
Recording: **Good**
Stereo Quality: **Good**

This is an imposing showcase for the redoubtable New Philharmonia Chorus, a pillar of many distinguished recordings since 1957, when it was formed as the just plain Philharmonia Chorus. Through a varied program the excellence of choral and orchestral execution remains constant: the attacks are sharp, dynamics are beautifully graded, textures pure and perfectly balanced. As is often the case with choral recordings, however, the pronunciation is not always clear—probably the result of hall acoustics. As for the music, the Mozart and Beethoven selections are familiar short masterpieces, and Wolf's *Morgenhymnus* is a brief, bombastic, but very effective paean that rises to a thrilling climax on the words "Es werde Licht!" *Nänie* is a lovely choral-symphonic setting of a Schiller poem in brooding Brahmsian colors. *In concertando Dominus* by the Belgian composer Jules van Nuffel (1883-1953) is a competent work of no discernible originality. Bruckner's five unaccompanied motets are intricately polyphonic, but, I am afraid, rather dull. *G. J.*

(Continued on page 97)

A Season in the Sun with



Deutsche
Grammophon
Gesellschaft

If you can't make it to Europe for the festivals this season, DGG brings you its own summer festival beginning with the history-making recording of Tristan und Isolde recorded live at Bayreuth.

39 221-5; Stereo 139 221-5 (5 records)

Wagner: *Die Walküre*—Régine Crespin, Gundula Janowitz, Jon Vickers, Thomas Stewart; Berlin Philharmonic, Karajan, cond. 5 records. 39 299-233; Stereo 139 229-233

Schubert: *Die Schoene Muellerin/Seven Songs*—Fritz Wunderlich, tenor; Hubert Giessen, piano. 2 records. 39 219-20; Stereo 139 219-20

Mozart: *The Magic Flute*—Roberta Peters, Evelyn Lear, Dietrich Fischer-Dieskau, Fritz Wunderlich in "a splendid production" (High Fidelity). Berlin Philharmonic, Karl Boehm, cond. 3 records. 18 981-3; Stereo 138 981-3

Beethoven: *Songs*—Dietrich Fischer-Dieskau, "the foremost Lieder singer of the day,"; Joerg Demus, piano. 39 197; Stereo 139 197

Dvorak: *Symphony No. 8*—(Former No. 4) Berlin Philharmonic; Rafael Kubelik, cond. 39 181; Stereo 139 181

DGG Records are distributed by MGM Records, a division of Metro-Goldwyn-Mayer Inc. Free on request! The new illustrated DGG/Archive Catalog. Write MGM Records/Classical Division, 1350 Avenue of the Americas, New York City, 10019.

CIRCLE NO. 18 ON READER SERVICE CARD



PHOTO HANS FANTTEL

Second in a new series of short biographical sketches of our regular staff and contributing editors, the "men behind the magazine"—who they are and how they got that way. In this issue, our dean of record critics:

DAVID HALL

By PETER REILLY

THROUGHOUT the American record industry, opinion is astonishingly uniform about David Hall, senior record reviewer for HiFi/STEREO REVIEW. That opinion can best be summed up by the words of the sales director of a major record company: "David Hall? There is a man who really loves records. I've used his books, particularly *The Record Book*, as my bible for years. He probably knows more about records than anyone else in the world."

For the past twenty-five years, critic Hall has been one of the world's foremost authorities on recorded music. He views his role of record critic as a catalytic one: "Anyone who is at all serious about communication realizes that its purpose is to impel others to action or to thought." And, as a critic, David Hall has been doing just that. To take an example, his definitive article on the long-neglected American composer Charles Ives, which appeared in HiFi/STEREO REVIEW almost four years ago (September, 1964), went a long way toward sparking the revival of interest in Ives' music, an interest which eventually gave companies the kind of sales figures for Ives recordings that they had thought possible only for such war horses as the *1812 Overture*.

At his alma mater, Yale College, David Hall was a psychology major, and he feels that his studies in psychology have been of great value to him in his function as a music critic. "That training made me realize that there are many factors which enter into a musical listening experience other than the purely musical. Ives once said, 'You cannot set art off in the corner and hope for it to have vitality, reality and substance. The fabric of existence weaves itself whole.' My training in the social sciences helps me, I think, to view art in the total fabric of human existence."

THE fabric of David Hall's life is tightly woven with a busy work schedule. In addition to his post as head of the Rodgers and Hammerstein Archives of Recorded Sound at Lincoln Center, New York—a gigantic reference collection of records and tapes covering the complete spectrum of recorded sound—he is a member of the board of directors (and past president) of Composers Recordings, Inc., a trail-blazing record company which specializes in the recording of seldom-heard but deserving contemporary music, and a trustee of the American-Scandinavian Foundation in New York. He is also a trustee of the National Acad-

emy of Recording Arts and Sciences. He lives in Wilton, Connecticut, with his artist-wife, who shares his interest in the arts of Scandinavia—but the visual arts. "I have a large and completely equipped studio at home, and it is there that I write most of my reviews."

In December 1966, David Hall received one of Finland's highest official honors: he was made a Knight First Class of the Order of the Lion of Finland in recognition of his cultural exchange work in the field of Scandinavian music. "I wanted everyone who was involved in the project there with me," he says. "The work was as much theirs as it was mine. I was merely the instrument."

MODESTY and dedication are integral parts of David Hall's character. Attesting to the latter quality, and rendering the former more remarkable, is the fact that his dossier is one of the most impressive of any contemporary musical journalist's. He has been Musical Director of the Classics Division of Mercury Records, Music Editor of HiFi/STEREO REVIEW, and Chairman of the Board of Judges for the Naumburg Recording Award at the time of its establishment in 1949. While Director of Mercury's Classics Division, he was responsible for creating a substantial body of first recordings of works by contemporary composers. The archive he created at Mercury still stands as a unique contribution in the burgeoning fortunes of the record industry. He was also co-founder and director of the American-Scandinavian Foundation's Music Center, and has been Chairman of the Recording Services Committee of the National Music Council, and *Rapporteur* of the Cultural and Intellectual Exchange Committee of the International Co-operation Year (1966) White House Conference.

David Hall is also the author of that "bible" for record collectors specializing in the 78-rpm electrical era, *The Record Book*, which has appeared in three editions—the first published in 1940, when the author was twenty-three; *Records, 1950*; and *The Disc Book*. He is currently working on a book he has tentatively titled *A Cycle of Scandinavian Music*. About this last he says, "I might want to write this one and not necessarily have it published. It would be enough that it is there for reference. Anyway, it doesn't matter, really. After all, you don't write a serious book on music to make money. You do it as a matter of conscience." And it is perhaps this same conscience that keeps a turntable constantly at hand, even in his summer home at Castine, Maine.

ORGAN MUSIC OF FRESCOBALDI, SWEELINCK, BACH. Bach: *Prelude and Fugue in A Major* (BWV 536); *Canonic Variations on "Vom Himmel hoch"* (BWV 769). Frescobaldi: *Capriccio on "Fra Jacopino"*; *Toccata for the Elevation*; *Toccata No. 1* (*Primo Libro*, 1637). Sweelinck: *Toccata No. 23*; *Variations on "Mein junges Leben hat ein End."* Lawrence Moe (organ). CAMBRIDGE © CRS 2513 \$5.79.

Performance: Best in Frescobaldi and Sweelinck
Recording: Superior
Stereo Quality: Lifelike

This recital is divided into two parts, with Lawrence Moe playing the Bach on a 1958 classic-style Holtkamp organ at the University of California in Berkeley and the Frescobaldi and Sweelinck on the university's 1783 chamber organ, manufactured in Germany by Ibe Peters Iben. The latter organ makes a particularly good impression in Mr. Moe's commendable performances.

The modern instrument sounds good, too, although the playing is not terribly interesting, and, in comparison with such a vital rendition of the Canonic Variations as that by Helmut Walcha, Moe makes the piece sound entirely too didactic. The quality of sound is extremely realistic, however, with an exceptionally clear and solid bass and very pure and never strident-sounding higher registers. I. K.

PORTUGAL'S GOLDEN AGE—Classical Music of the 16th to 18th Centuries. Seixas: *Toccatas in D Minor, C Major, F*

Minor, G Minor, and E Minor; Sonatas in C Major, A Minor, and C Minor; Minuet in F Minor. Da Silva: *Sonata in C Major.* Elias: *Sonata in E-flat Major.* Jacinto: *Tocatta in D Minor.* Avondano: *Sonata in C Major.* Carvalho: *Tocatta in G Minor; Allegro in D Major.* Ruggero Gerlin (harpsichord). Carvalho: *L'Amore Industrioso: Overture.* Da Silva: *Sinfonia in D Major.* Seixas: *Sinfonia in B-flat Major; Harpsichord Concerto in A Major.* Ruggero Gerlin (harpsichord); Gulbenkian Chamber Orchestra, Renato Ruotolo cond. Morago: *Motets: Quem vidistis pastores; Oculi mei; Gaudete cum laetitia; Jesus Redemptor II; Laudate Pueri II.* De Christo: *Motets: O magnum mysterium; Quae tamen cum pastoribus.* Gulbenkian Foundation Chorus, Olga Violante cond. Cardoso: *Mass for Six Voices ("Misereere mihi Domine").* Gulbenkian Foundation Chorus, Pierre Salzmann cond. Carreira: *Fantasia.* Coelho: *Five Versets on "Ave Maris Stella."* Seixas: *Fugue in A Minor; Sonata in A Minor.* Carvalho: *Allegro in D Major.* Jacinto: *Tocatta in D Minor.* Dos Reis: *Variations on "Ave Maris Stella"; Concertos Nos. 22, 24, 30, and 31.* Geraint Jones (organ of St. Vincent's Church, Lisbon.). MERCURY © SR 4-9122 four discs \$23.16.

Performance: Accomplished
Recording: Very good
Stereo Quality: Excellent

This extensive survey of Portuguese music from the sixteenth through the eighteenth centuries is divided into four sections: harpsichord works, orchestral music, sacred choral works, and organ pieces. In several cases

composers are represented in more than one section, for example Carlos Seixas (1704-1742), a slightly younger contemporary of Scarlatti, whose music may be found among the organ, harpsichord, and orchestral works. The earliest repertoire is the choral material—some fine motets by Estêvão Lopes Morago and Pedro de Christo, and a Mass by Manuel Cardoso—all dating from the late sixteenth or early seventeenth century. The organ collection ranges from that same period (Manuel Rodrigues Coelho's Five Versets on "Ave Maris Stella" is the longest and most impressive offering) to the *galant*, light-weight keyboard pieces of the eighteenth-century—João de Sousa Carvalho, Seixas, and a monk whose name has come down to us only as Jacinto. The harpsichord selections are exclusively eighteenth century: with the exception of Seixas, they belong to the second half of that century. The same applies to the orchestral music: a pleasant harpsichord concerto by Seixas, one of his three-movement symphonies, an opera overture by Carvalho, and a Haydn-esque symphony by João Cordeiro da Silva. None of these eighteenth-century works are out-and-out masterpieces, but they are tuneful and unpretentious, and they invariably convey the flavor of the country of their origin. The older material—I am thinking particularly of the choral pieces—seem curiously old-fashioned in style, but they are very much worth hearing. The performances are all of high quality and quite stylish, and the album contains extensive (if not always very idiomatic) notes in English. The reproduction is very good, barring a bit of high-level constriction.

"Now, satisfy the
EYE!"



12" ACOUSTIC SUSPENSION SYSTEM Price: \$189.00 Net
12" Woofer has Impedance: 8 Ohms
30 oz. magnet Power Handling: 60 Watts peak
Midrange horn, Presence and Brilliance controls
Compression Response: 35/20,000 HZ.
tweeter L. C.
Crossover network

AS-8 Credenza

Only after sound perfection was reached from this 3-way Hi Fi Speaker System was UTAH ready to incorporate it into fine furniture cabinetry. After all, UTAH'S primary business is engineering and developing the epitome of sound perfection. Well, Sir, the "brass" (they're the sound engineering experts) said that the sound is there. We believe that you, the expert at choosing fine furniture will agree the eye appeal is there.

This provincial model is one of a family of three. There's an Early American version as well as a Contemporary style.

See your dealer, or write UTAH for complete information.



HUNTINGTON, INDIANA

CIRCLE NO. 62 ON READER SERVICE CARD



ARCHIE SHEPP — THE
MAGIC OF JU-JU
AS-9154



ELVIN JONES/RICHARD DAVIS — HEAVY
SOUNDS AS-9160



MEL BROWN — THE
WIZARD AS-9169

THE VITAL JAZZ



ABC RECORDS, INC.
NEW YORK/BEVERLY HILLS
DIST. IN CANADA BY SPARTAN OF CANADA

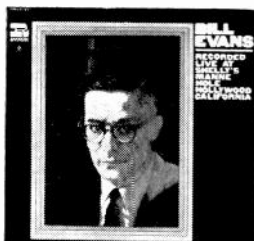

BILL EVANS RE-
CORDED LIVE AT
SHELLY'S MANNE
HOLE, HOLLYWOOD,
CALIF. RS-3013



WES MONTGOMERY —
TRIO 'ROUND MID-
NIGHT RS-3014



THELONIOUS MONK —
THELONIOUS MONK
PLAYS DUKE RS-3015



JOHNNY LYTLE —
MOON CHILD RS-3017



MAX ROACH / Booker
Little — DEEDS NOT
WORDS RS-3018



THELONIOUS MONK —
TWO HOURS WITH
THELONIOUS RS-3020

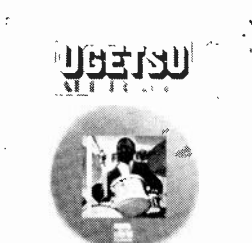

ART BLAKEY—UGETSU
RS-3022

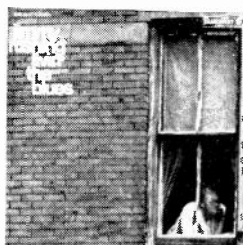

JIMMY RUSHING —
LIVIN' THE BLUES
BLS-6017

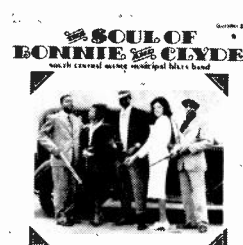

SOUTH CENTRAL
AVENUE MUNICIPAL
BLUES BAND — THE
SOUL OF BONNIE &
CLYDE BLS-6018

For FREE catalog write
Advertising Dept. C, ABC
Records Inc., 1330 Ave. of
the Americas, New York,
N.Y. 10019.

CIRCLE NO. 64 ON READER SERVICE CARD



HIFI/STEREO REVIEW'S CHOICE OF THE LATEST RECORDINGS

ENTERTAINMENT

POPS • JAZZ • FILMS • THEATER • FOLK • SPOKEN WORD

Reviewed by CLIVE BARNES • DON HECKMAN • PAUL KRESH • REX REED • PETER REILLY

USTAD ALI AKBAR KHAN: *The Forty Minute Raga* (see Best of the Month, page 74)

BRUNO: *An Original by Bruno*. Bruno (vocals); orchestra, Artie Butler cond. and arr. *Yesterday*; *Slow Up*; *That Lucky Old Sun*; *Small Town Bring Down*; *My Yellow Bird*; *The Grass Will Sing for You*; *Helena*; and five others. CAPITOL Ⓢ ST 2857 \$4.79.

Performance: **Yeuccchhh!**
Recording: **Good**
Stereo Quality: **Good**

What havoc has Capitol wrought this time? According to their ad-promotion campaign, Tony Bruno is "the most compelling song stylist of this decade!" Well, if you find a voice which is a cross between early Wallace Beery and a honky-tonk Frankie Laine compelling, then Bruno is you know what. On this disc, he gravels his way through numerous unoriginal songs he has composed himself and several others by talented writers. His performance of *Yesterday* is a poor imitation of Ray Charles, and Tallulah Bankhead's version of *I'll Be Seeing You* is truly "divine, dahlings" compared to Bruno's. His attempt to modernize *That Lucky Old Sun* with lyrics such as "That lucky old sun has nothing to do but goof around, groove up there in Heaven" is a riot. The arrangements are monotonously similar, with each song concluding in an echo-chamber fadeout. Once was already too many. **R. R.**

THE BUCKINGHAMS: *Portraits*. The Buckingham (vocals); instrumentalists, James William Guercio cond. *Hey Baby*; *Susan*; *The Mail*; *C'mon Home*; and ten others. COLUMBIA Ⓢ CS 9598, Ⓜ CL 2798 \$4.79.

Performance: **Oversaturating**
Recording: **Excellent**
Stereo Quality: **Sadistic**

If success is to be measured in decibels, then the Buckingham are away beyond the competition. Not content with accompaniments by guitar and what sounded at times like a full symphony orchestra gone clean out of its musical mind, they also add to their crooning, whining, and yodeling interpretations of insipid songs such extras as canned sound effects, banks of swooning strings, and whole

episodes of what they are pleased to describe as "electronic collage." The appeal of their big hits like *Hey Baby*, *They're Playing On Song* and *Susan* is instantly comprehensible, but the exhibitionism of their arrangements becomes increasingly burdensome as the record pursues its noisily interminable way through raids on every style from rock to Baroque. There were times when, even with the volume turned down, I found that I just couldn't concentrate on my algebra homework. The boys have thoughtfully provided an address in Hollywood where you can send your fan mail. **P. K.**

quiet success stories of a talent that moves to stardom almost laterally. One has the feeling he's going to be around for a long time **P. R.**

GEORGE JESSEL: *Songs My Pals Sang*. George Jessel (vocals); orchestra, Gerald Alfonso cond. *Suavce*; *April Showers*; *Mangie*; *Making Whoopee*; and eight others. AUDIO FIDELITY Ⓢ AFSD 1708, Ⓜ AFLP 708 (with a 45-rpm record of the voices of Eddie Cantor, George M. Cohan, and Al Jolson) \$4.79.

Performance: **Misguided**
Recording: **Good**
Stereo Quality: **Pointless**

George Jessel is a great toastmaster and justly admired as a raconteur, but a singer he ain't. While he was supplying versions of these songs more distinguished for affection than for skill in vocalizing, I got so absorbed in his written account of his friendships with Cantor, Jolson, and Cohan that I had to start the record all over again—for the album notes here surpass in interest and quality the goods they were written to sell. Did you know that when Jessel was ten he was singing in Atlantic City with a partner named Walter Winchell? That it was Jessel who originated the role of the Jazz Singer which Jolson played on the screen? That Jessel was a pall-bearer at George M. Cohan's funeral in St. Patrick's Cathedral? I would like to tell you a lot more about George Jessel and his friendships with the Greats of show business, but I see that our time is about up, and I don't want to leave without mentioning the little 45-rpm bonus that you can get only if you buy the big album. This contains Al Jolson singing *Suavce*, Cantor doing *Ma, He's Making Eyes at Me* and *Making Whoopee*, and Cohan offering *Give My Regards to Broadway* and *Yankee Doodle Boy*. The seven-inch disc supplies only snippets which fade out just as one's appetite is whetted, but it does make one thing abundantly clear: these fellows may be much imitated, but they remain inimitable. **P. K.**



REPRISE

JONI MITCHELL

She transforms the everyday into poetry

RECORDING OF SPECIAL MERIT

GLEN CAMPBELL: *Hey, Little One*. Glen Campbell (vocals and guitar); orchestra, Al De Lory cond. *Hey, Little One*; *Elusive Butterfly*; *Break My Mind*; *Take Me Back*; *I Wanna Live*; *It's Over*; and five others. CAPITOL Ⓢ ST 2878 \$4.79.

Performance: **Very good**
Recording: **Good**
Stereo Quality: **Excellent**

Glen Campbell is a very good singer. He has taste, intelligence, and an excellent voice. He performs traditional country-and-western music with fine vitality and style and easily makes it over the hurdle to straight pop singing. His best performances here are the title tune, which he sings with fine resonant authority, and John D. Loudermilk's *I Wanna Live* in an inventive arrangement by Al De Lory. Campbell's seems to be one of those

RECORDING OF SPECIAL MERIT

JONI MITCHELL: *Song to a Seagull*. Joni Mitchell (piano, guitar, banshee), Stephen Stills (bass), Lee Kiefer (banshee). *I Had a King*; *Michael from Mountains*; *Night in the City*; *Marcie*; *Nathan La Frenna*; *Sisontoubill Lane*; and four others. REPRISE Ⓢ RS 6293, Ⓜ R 6293 \$4.79.

Performance: **A brilliant new talent**
Recording: **Very good**
Stereo Quality: **Very good**

(Continued on next page)

Explanation of symbols:

- Ⓢ = stereophonic recording
- Ⓜ = monophonic recording
- * = mono or stereo version not received for review

NOW FREE!

STEREO INFORMATION

FM Station Directory

The directory lists 1571 FM stations in the United States and Canada. All the stations broadcasting in stereo are listed.

Test Reports

Test reports full of facts. The test reports were made by independent laboratories. Tests cover tuners, preamps, power amp/preamps. Read the facts from test experts.

Big 36-Page Catalog

You get a 36 page catalog. It tells you about tuners, power amplifiers, preamplifiers, pre-amp/power amplifier combination and tuner preamps.

ALL FREE

McIntosh

PLEASE SEND ME YOUR CATALOG
McIntosh Laboratory, Inc.

1 Chambers St. Binghamton, N. Y. 13903

NAME _____
STREET _____
CITY _____
STATE _____ ZIP _____

CIRCLE NO. 42 ON READER SERVICE CARD
100

Those of us who write about popular music have been saying for some time now that we are witnessing a period of unparalleled musical creativity, but I wonder if the real extent of this explosion of talent has been fully understood. Until very recently, it appeared that the new pop music of the Sixties was experiencing another injection of life-giving vitality from folk music, Negro rhythm-and-blues, and gospel music. The obvious parallel is with the change in American popular songs that took place in the Twenties, when such song writers as George Gershwin and Irving Berlin modified and adapted new musical sounds that were brought to the cities via the emigration to the North by Southern Negroes. The most creative manifestation of that emigration was the evolution of jazz, and, to a lesser extent, the emergence of a superb group of blues singers. Thus a pattern was established in American popular music: its seminal vitality almost always stems from the transformation of European musical techniques by the American Negro, which, in turn, is diluted and popularized by white musicians.

It seems to me, however, that we are now experiencing a development in popular music which is significantly different. The most important distinction is that its base is drawn from a wider source area, not from just one aspect of American music but from a variety of sources—from the hill songs of the Appalachians and the rural blues of the South to the uniquely personal interpretations of the American experience made by such composers as Gottschalk and Ives. True, I am describing what is at the present only a beginning—and possibly an abortive one at that. But I suspect that the work of such young composer/performers as Van Dyke Parks, Randy Newman, and Joni Mitchell may signal a way out of the deadly cycle of exploitation and regeneration that has griped popular music since the Twenties.

Miss Mitchell is a surprisingly solid performer with a soprano voice that I prefer to those of, say, Joan Baez or Judy Collins. She provides her own well-crafted guitar accompaniments, wrote both music and lyrics for all the songs on the album, and even did the art work on the cover. Superficially, the songs could be mistaken for folk music. But a closer listening reveals the complexity of their melodic contours and the brilliant imagery of their language. Miss Mitchell has not yet produced melodies and harmonic progressions that reach heights comparable to her lyrics, but I doubt that her musical senses will continue to be satisfied by ordinary solutions.

"Song to a Seagull" can be viewed as a total work, in fact as a kind of personal odyssey which is divided into two parts: "I came to the city" and "Out of the city and down to the seaside." Side one takes the everyday events—sometimes banal events—of the life of a young person living in the city and transforms them into musical poetry. Side two is equally impressive, perhaps most notably in a song entitled *Cactus Tree*, presumably a personal statement.

Miss Mitchell's work—along with that of Parks and several other new young people—sounds particularly original at a time when so many white performers are desperately mimicking the inflections of a musical style and language that is not their own. Whether or not it will lead to a new direction in

American popular music remains to be seen. For the moment, her talent is undeniable and should be heard.

D. H.

MOTHERS OF INVENTION: *We're Only in It for the Money*. Mothers of Invention (vocals and instrumentals). VERVE. © V6 5045X \$4.79.

Performance: **Good** for laughs and music
Recording: **Excellent**
Stereo Quality: **Excellent**

As with any recording by the Mothers, there are so many aspects to report on that one hardly knows where to begin. The album cover, for example, is obviously patterned after the Beatles' "Sgt. Pepper." It includes a set of lyrics printed on a red background, and a four-color picture of the group in which they are surrounded by superimposed pictures of celebrities, comic heroes, and political figures. The cover's reverse side frames the Mothers against a bright yellow background—again in imitation of the Beatles. One difference: the Beatles are dressed in currently fashionable military uniforms, while the Mothers are rigged up in high drag (that's right, ladies' clothes). Since I have always felt that album covers were less interesting than the music they contain (and I have occasionally been proved to be too optimistic), I will simply suggest that you make your own judgment about why an important American pop group should devote time, energy, and expense to the production of an album whose cover mimics—however satirically—the cover of an album by an important English pop group.

The music is in classic Frank Zappa style. Included are electronic sounds, vocals, dialogue, parodies, rock improvisation, and even some snatches of jazz. Zappa's lyrics continue to be his strongest work. More than most pop composers, he has purged traditional poetic imagery from his writing, depending instead upon a straight-from-the-shoulder, no-nonsense, say-it-like-it-is style that works because of its very literalness. Equally important, he has written better melodies than on either of the earlier releases. Zappa and the Mothers may not exactly please you, especially if you belong to the now-legendary over-thirty generation; but what they say is heard with great interest by the young audience and, no doubt, reflects many of the attitudes, feelings, and points of view of that audience. If you can get past your annoyance at *what* the Mothers are saying, you will hear some very fine music and some hilarious humorizing. D. H.

RANDY NEWMAN: *Randy Newman*. Randy Newman (vocals); orchestra. *Love Story; Bet No One Ever Hurt This Bad; Laughing Boy; Cowboy; So Long Dad; Dui; the Fat Boy*; and five others. REPRISÉ. © RS 6286, ® R 6286* \$4.79.

Performance: **Good**
Recording: **Excellent**
Stereo Quality: **Excellent**

As a performer, Randy Newman is only a moderate success. As a composer and arranger—on the evidence of this album of his own songs—he is a complete success: his songs have intelligence, style, and wit. Unfortunately, as I have implied, I don't think he is the ideal interpreter of them. His voice is stifled-sounding, and he has an affected Guthrie-style delivery and a morose quaver.

HIFI/STEREO REVIEW

He's okay on something like *Davy the Fat Boy* or *So Long Dad* (both superior songs), but I got a little fed up with his Elsinoring on *Love Story* and *Linda*, for example. The production by Lenny Waronker and Van Dyke Parks is exemplary. P. R.

PEACHES AND HERB: *Golden Duets*. Peaches and Herb (vocals). *Two Little Kids; Love Is Strange; Mockingbird; I Want 'o Stay Here*; and eight others. DATE © TES 1007, (M) TEM 3007* \$4.79.

Performance: **Sweet and slack**
Recording: **Good**
Stereo Quality: **First-rate**

This is the third album generously offered to an apparently doting public by Peaches and Herb, who call themselves the "sweethearts of soul." They present a dozen duets here in an easy, agreeable, rather shuffling style. Ac-



RANDY NEWMAN

A complete success as composer-arranger

ording to the program director of WOOK Radio in Washington, D.C., who effuses through three columns of liner notes about Peaches and Herb, every one of their duets was originated by some other pair—Steve Lawrence and Eydie Gormé, Chuck Jackson and Maxine Brown, Mary Wells and Marvin Gaye, Brook Benton and Dinah Washington, Betty Everett and Jerry Butler, and the father-daughter institution of Frank and Nancy Sinatra—but Mr. Herb and Miss Peaches have the "stature" to turn this material into something else. They do, indeed—it all sounds pretty much the same, and there's a lot of it. P. K.

RECORDING OF SPECIAL MERIT

SPANKY AND OUR GANG: *Like to Get to Know You*. Spanky and Our Gang: Spanky (Elaine) McFarlane, Nigel Pickering, Malcolm Hale, John (Chief) Seiter, Kenny Hodges, and Lefty Baker; with additional musicians, including Little Brother and Montgomery and the Blue Band. *Sunday Mornin'; My Bill; Prescription for the Blues; Stardust; Like to Get to Know You; The Swingin' Gate*; and five others. MERCURY © SR 61161 \$4.98.

Performance: **Fantastic!**
Recording: **Excellent**
Stereo Quality: **Excellent**

If such a thing is possible, Spanky and Our Gang's second album is even better than their first. Nothing eludes them. There's Spanky herself, maybe the best blues singer since Ma Rainey and Lizzie Miles, leaning in there, funk-ing it up over the edge of the piano in a drafty Chicago recording hall, kicking the sawdust on the floor with the toe of her buckled shoe, and wailing *Prescription for the Blues* with Montgomery and the Blue Band turning music to pickle juice behind her. Almost immediately, the group is back, jazzing it up on *Three Ways from Tomorrow* like the Swingle Singers at a square dance. On *My Bill*, the gang has at the crazy world of bill collectors, singing the form letters and the pre-addressed envelopes ("and you don't need a stamp, no-no-no") that solicit your remittance by return mail.

Simply Nutsville, which is the bag Spanky and the Gang groove in. No social preaching, no third-stream smut and violence. Just good, plain fun and inventive, intelligent musical joy. From the looks of this disc, the direction the gang seems to be moving in is more of a many-faceted collage of show-business professionalism than the suffocatingly tiny and dismally amateur world of rock.

On the other hand, they do dip into the folk idiom on *Echoes* and Leonard Cohen's *Suzanne*. The former is pure poetry, as natural and free-flowing as breath. The latter is still as phony and pretentious as anything Cohen ever wrote, but after hearing Cohen's and Noel Harrison's versions, I am convinced the gang sings it right for the very first time.

Like to Get to Know You, a backstage look at some of the parties of the Sixties, shows what Mike Nichols and Elaine May might have produced if they had written songs. And finally there is *Sunday Mornin'*, the supreme achievement in the album. I have seldom heard anything as close to symphonic sound in the vocal line. Wonderful organ work by Artie Schroeck provides a soulful heartbeat for the Gang's hair-raising chord changes as they pour forth the stained-glass Holiness in Jazz equivalent of the Mormon Tabernacle Choir singing arrangements by Dave Brubeck.

There is nothing myopic about Spanky and Our Gang. They see into and through everything, all the sham and all the truth around them. They have the answers within their voices, along with musicality, taste, wit, dignity, and integrity. This album spans an incredibly broad spectrum of musical styles and attitudes. They are simply the best vocal group on the current scene, and the Russians will be growing mangos in Siberia before anyone convinces me otherwise. R. R.

T-BONE WALKER: *The Truth*. T-Bone Walker (vocals and guitar); various other musicians. *Treat Your Daddy Well; You Ought to Know Better; Let Your Hair Down Baby; Old Time Used to Be; You Don't Love Me and I Don't Care*; and six others. BRUNSWICK © BL 75-1126 \$4.79.

Performance: **Strong, assertive blues**
Recording: **Very good**
Stereo Quality: **Good**

Texas-born T-Bone Walker is one of the first post-war blues singer-guitarists to reach a wide audience, and an important figure in the growth of modern blues. Purists probably will find his blues-singing style a little

COMMAND HAS DONE IT AGAIN!

SOUND IN THE EIGHTH DIMENSION

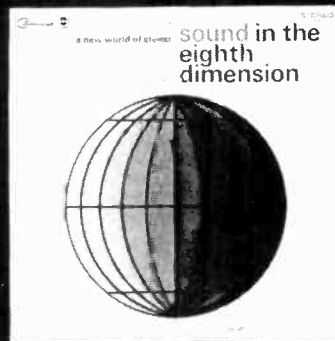

THE MOST STARTLING NEW SOUND INNOVATION SINCE STEREO RECORDING BEGAN

Through the miracle of 8-channel recording . . . and 1½ year's experimentation . . . and the development of a special "mixing and mastering" technique . . . **COMMAND** has broken the shackles of 2-channel and 3-channel reproduction. For the first time — using a regular 2-speaker stereo phonograph, or component units — an orchestra can be heard with *individual instruments* — and *whole sections* — seemingly heard not only on the left — the right — and the middle . . .

BUT ALSO . . . IN BETWEEN . . . IN FRONT OF . . . AND BEHIND . . . THE RESULT . . . A WHOLE NEW DIMENSION IN RECORDED SOUND . . . A DIMENSION NEVER BEFORE HEARD ON RECORDS . . . A LIVE "IN PERSON" ILLUSION THAT IS BREATHTAKING! A NEW WORLD OF STEREO RECORDING . . .

"SOUND IN THE 8TH DIMENSION"

NOW AVAILABLE WHEREVER RECORDS ARE SOLD

WORLD LEADER IN RECORDED SOUND
Command

abc
RECORDS

1330 Avenue of the Americas, New York, N. Y. 10019
CIRCLE NO. 15 ON READER SERVICE CARD



The Action Camera never misses a shot

Lenses switch in seconds. Meter (behind the lens and on the mirror) responds instantaneously. The only camera that works without warm-up even at 4 degrees below zero.

BESELER TOPCON D-1



Charles Beseler Co., 219 S. 18th St., E. Orange, N.J. 07018
CIRCLE NO. 8 ON READER SERVICE CARD

DISCOUNTS



SELLING HI-FI
NATION-WIDE
WORLD
WIDE
SINCE
1948

COMPONENTS • RECORDERS
KITS • SPEAKER SYSTEMS • TAPE

- LOWEST PRICES
- SAME DAY REPLY TO YOUR INQUIRY
- MFRS. SEALED CARTONS
- DOUBLE BOXED WHERE POSSIBLE
- FAST, INSURED SHIPMENTS
- PACKAGE DEALS SAVE YOU MORE
- FRANCHISED DISTRIBUTORS FOR OVER 50 MFRS.
- OPEN MONDAY THRU SATURDAY
- TEN CENT 1-HOUR PARKING METERS AT PREMISES
- TELEPHONES (212) 369-6212-3

WRITE FOR SPECIALS VISIT
OUR SHOWROOM/WAREHOUSE
CARSTON Studios

1686 Second Ave. (Nr. 87), N.Y. 10028

CIRCLE NO. 10 ON READER SERVICE CARD

slick and his ensemble backings too close to rhythm-and-blues. And he makes no concession with his choice of material, since he prefers to work with "originals." Like many blues performers, his songs usually consist of assemblages—sometimes random, sometimes not—of familiar lines. *Treat Your Daddy Well* and *You Don't Love Me*, for example, are identical, except that one is in C and the other in E-flat. Yet I must admit I find his performances entertaining. Although he cannot be described accurately as a jazz guitarist, his playing is closer to a jazz articulation and rhythmic statement than to the blues style of, say, Chuck Berry or B. B. King. If you haven't heard Walker, this well-rounded collection will provide a good introduction.

D. H.

ETHEL WATERS: *On Stage and Screen 1925-1940* (see Best of the Month, page 73)

MARGARET WHITING: *Pop Country*. Margaret Whiting (vocals); orchestra. Arnold Goland cond. and arr. *Release Me; I Hate to See Me Go; You Don't Know Me; Gentle On My Mind*; and six others. LONDON (S) PS 527, (M) LL 3527* \$4.79.

Performance: The usual

Recording: Good

Stereo Quality: Good

Maggie is Margaret again. She pleasantly handles the country tunes on this disc in much the same way Eydie Gormé handled hers on her Columbia album of pop-country songs, although the Gormé album had a bit more vitality. There isn't much left to do with songs like Hank Williams' *I Can't Help It if I'm Still in Love with You*, except sing them straight and hope they find the right market. Miss Whiting interjects very few shtabs at interpretation, which is probably all for the best. Arnold Goland's arrangements are pure Billy Vaughn and only add to the blandness of the recording. I admire Margaret Whiting, but this latest effort is only for folks to play before and after the Lawrence Welk show.

R. R.

COLLECTIONS

SOUND IN THE EIGHTH DIMENSION. Orchestra, Robert Byrne cond. *Limbohouse Blues; Ebb Tide; Talk to the Animals; This Heart; Spanish Eyes*; and six others. COMMAND (S) RS 928 SD \$5.79.

Performance: Good

Recording: Excellent

Stereo Quality: Superb

This attempt by Command to present recorded sound in deep audio perspective is, in the main, a success. Using six recording channels instead of the more usual two or three employed for stereo recording, the producers, Loren Becker and Robert Byrne, hoped to create a true facsimile of live concert hall listening. Their claim that "we are not interested in doing it just for the effect," but that "our interest is in doing what is musically correct," doesn't seem to mean very much when one is confronted by the repertoire heard here, but it is true that they have created an effective curtain of proscenium sound. The effect might be described as aural Cinetama—which is very fancy recording footwork technically. For audio buffs and those who want to lead a band.

P. R.

JAZZ



CHARLIE CHRISTIAN. Charlie Christian (guitar), Dizzy Gillespie (trumpet), Thelonious Monk (piano), other personnel. *Swing to Bop; Stompin' at the Savoy; Up on Teddy's Hill*; and five others. ARCHIVE OF FOLK MUSIC (S) FS 219 \$5.79.

Performance: Invaluable historical material

Recording: Below standard

Stereo Quality: In name only

Guitarist Charlie Christian's meteoric jazz career, brief though it was, had enormous influence. His long-limbed melodic lines and uncluttered rhythmic articulation can be



MILES DAVIS

Durable jazz from a quintet of virtuosos

heard in the playing of virtually every guitarist who has come to maturity in the years since World War II. Fortunately, Christian's work has been well documented, despite his death from tuberculosis at the age of twenty-three.

In 1941, Christian was one of many musicians—Dizzy Gillespie, Charlie Parker, and Thelonious Monk included—who participated in jam sessions at an uptown nightclub called Minton's. Some of that music, which we now know was a kind of precursor of bop, is preserved in this collection, recorded on the spot by an amateur jazz fan armed with an old-fashioned disc machine.

There is some uncertainty about the participants, but general opinion in the jazz community agrees that they include Gillespie and Joe Guy on trumpet, Thelonious Monk and Ken Kersey on piano, Kenny Clarke on drums, and Don Byas on tenor, in addition to Christian and various other unidentified players. Regrettably, Guy, a mediocre player, takes a major portion of the solo space, but the rare bits and pieces by Gillespie are worth listening for. Christian's playing is a model of clarity; viewed

in the context of the late Thirties, it makes one vividly aware of what a truly revolutionary jazz musician he was.

These tracks have been issued before on Esoteric, Counterpoint, and Everest, though never with electronic stereo reprocessing. I don't see that the artificial stereo is of much consequence, but the sound is certainly better than on the original LP release. *D. H.*

RECORDING OF SPECIAL MERIT

MILES DAVIS: *Nefertiti*. Miles Davis (trumpet), Wayne Shorter (tenor sax), Herbie Hancock (piano), Ron Carter (bass), Tony Williams (drums). *Nefertiti; Fall; Hand Jive; Madness; Riot; Pimocchio*. COLUMBIA (S) CS 9594, (M) CL 2794* \$4.79.

Performance: A classic jazz group
Recording: Excellent
Stereo Quality: Excellent

The current Miles Davis group has become as well integrated musically as any he has had since the Coltrane-partnered quintets of the middle and late Fifties. If Wayne Shorter is not the powerful musical *alter ego* for Davis that Coltrane was, he is nonetheless a strong player with an intensely personal artistic outlook. The rhythm section is surely one of the best that jazz has ever seen, with each member a virtuoso soloist in his own right. That such excellent individual performers can subordinate their talents to the rigors of accompaniment is remarkable indeed.

The recording is a characteristic example of what Davis has done with this group. Rarely has it produced the immediately memorable performances of past Davis Quintets. This may be due to the fact that the material is almost always original—usually by Shorter or Hancock—instead of the ballads and standard pop tunes favored by Davis in the Fifties. But if these performances are not so directly accessible, they may survive in a fashion that pop-tune interpretations do not.

Unlike most other important jazz players, Davis no longer appears to be interested in composition (a shame, since he has written several excellent jazz melodies). But he recognizes that the most lasting jazz performances are usually those that spring from original works. To his credit, he has been willing to permit those works to come from the young performers in his group. I think he has made a wise decision, and his music has benefited accordingly. Virtually everything produced by Davis is worth your attention. "Nefertiti" is no exception. *D. H.*

JAMES MOODY: *Moody and the Brass Figures*. James Moody (tenor sax, flute), Kenny Barron (piano), Bob Cranshaw (bass), Mel Lewis (drums), brass ensemble. *Smack-a-Mic; Bess, You Is My Woman Now; Cherokee; Love, Where Are You?; The Moon Was Yellow*; and four others. MILESTONE (S) MSP 9005, (M) MLP 1005 \$4.79.

Performance: Fine improvisations
Recording: Very good
Stereo Quality: Very good

I suppose every reviewer has his special favorites, and I must admit that James Moody's playing is one of mine. An excellent all-purpose woodwind player (who is especially good on alto), he limits himself

Another new stereo? No!



This is *the* new stereo. See it, hear it, read the price tag, and stereo won't be a toss-up any more. The difference? Grundig RTV 320 Receiver has automatic multiplex stereo FM *plus* short wave and AM. *Plus* every control-panel refinement from switchable automatic frequency control to VU meter and stereo indicator light. *Plus* matching hideaway hi fi speakers. *All* included at \$259.95*, today's solid value in solid state. Listen at your Grundig dealer's. With Grundig, hearing is believing.

*SUGGESTED RETAIL, WEST COAST SLIGHTLY HIGHER

GRUNDIG ELECTRONIC SALES, INC.
355 Lexington Avenue, New York, New York 10017
7238 Atoll Avenue, North Hollywood, California 91605
In Canada: Perfect Manufacturing & Supplies Corp., Montreal

CIRCLE NO. 26 ON READER SERVICE CARD

Why?

DO THOUSANDS OF HI-FI
ENTHUSIASTS BUY FROM
AUDIO UNLIMITED

It's Obvious!

- LOWEST PRICES
- FAST SERVICE
- FACTORY SEALED UNITS
- FULLY INSURED SHIPMENTS
- PACKAGE DEALS—SAVE MORE
- FRANCHISED DISTRIBUTORS

Write for **FREE** Listing today

SEND US YOUR LIST
FOR OUR AIR MAIL
QUOTE TODAY

Visit Our Showroom and Warehouse
CLOSED MONDAYS

 **AUDIO** unlimited, inc.
715-S Second Ave. (Nr. 38), N.Y., N.Y. 10016

WRITE FOR QUOTATION

FACTORY SEALED CARTONS
FRANCHISED DISTRIBUTOR
QUICK SHIPMENT

WE GIVE
DISCOUNTS
ON HI-FI
COMPONENTS

**SOUND
REPRODUCTION
INC.**

436 CENTRAL AVENUE
East Orange, New Jersey 07018
(201) 673-0600

CIRCLE NO. 54 ON READER SERVICE CARD

ROBERTS 450 THREE HEAD STEREO TAPE DECK

...that looks as good as it sounds

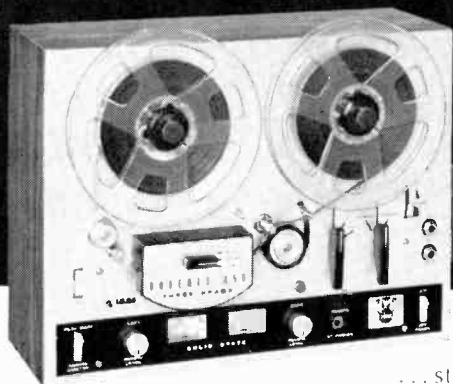

.....superb
professional sound
quality to add to
your existing
hi-fi system

...stunning walnut cabinet encloses professional four-track stereo or monaural recording and playback tape deck with solid state circuitry. Three heads for erase, record and playback. Two speeds. Sound-with-sound, and a multitude of other outstanding features. Available at better stores everywhere for less than \$199.95.



the Pro Line
ROBERTS
Los Angeles, Calif. 90016

Division of
Rheem Manufacturing
Company

CIRCLE NO. 48 ON READER SERVICE CARD

ABOUT YOUR SUBSCRIPTION

Your subscription to HiFi/STEREO REVIEW is maintained on one of the world's most modern, efficient computer systems, and if you're like 99% of our subscribers, you'll never have any reason to complain about your subscription service.

We have found that when complaints do arise, the majority of them occur because people have written their names or addresses differently at different times. For example, if your subscription were listed under "William Jones, Cedar Lane, Middletown, Arizona," and you were to renew it as "Bill Jones, Cedar Lane, Middletown, Arizona," our computer would think that two separate subscriptions were involved, and it would start sending

you two copies of HiFi/STEREO REVIEW each month. Other examples of combinations of names that would confuse the computer would include: John Henry Smith and Henry Smith; and Mrs. Joseph Jones and Mary Jones. Minor differences in addresses can also lead to difficulties. For example, to the computer, 100 Second St. is not the same as 100 2nd St.

So, please, when you write us about your subscription, be sure to enclose the mailing label from the cover of the magazine—or else copy your name and address exactly as they appear on the mailing label. This will greatly reduce any chance of error, and we will be able to service your request much more quickly.

LOW PRICES

All merchandise shipped same day from our warehouse, fully insured in factory sealed cartons. Our one aim is your complete satisfaction, —merchandise-wise, price-wise! That's why we're one of the East Coast's largest component distributors.

From Hi-Fi components to complete stereo systems, if it's nationally advertised, We have it! Discounts of course! Right now, write now . . . for your special quote. Savings are bigger than ever in honor of our recent expansion.

STEREO

CORPORATION OF AMERICA

2122 UTICA AVE., BROOKLYN, N. Y. 11234 (212) 338-8555

CIRCLE NO. 40 ON READER SERVICE CARD

on this recording almost exclusively to tenor. On five tracks a small brass ensemble is added to the accompanying rhythm section. Since Moody is pretty much a straight-ahead, no-nonsense improviser, the brass accents simply get in the way, and things aren't helped much by the fact that Tom McIntosh has contributed pedestrian arrangements. Every now and then Moody gets loose, however, and when he does he's a hard man to stop. His most appealing quality is an explosive sense of phrasing, in which whole sequences of notes seem to come bursting out of his horn. As an example, notice his piercing shout at the start of Thelonious Monk's *Ruby, My Dear*, and the streams of up-tempo eighth notes that dominate the faster solos.

Moody was once an active recording artist, but in recent years has spent most of his time playing second banana to the irreplaceable Dizzy Gillespie. Hearing him in a situation that allows him some stretching out is gratifying, but I hope his next recording has fewer production ideas. Why not just let him play, play, play? *D. H.*

RECORDING OF SPECIAL MERIT

JOE WILLIAMS AND THE THAD JONES-MEL LEWIS ORCHESTRA. Joe Williams (vocals). *Get Out of My Life; Woman's Got Soul; Gee Baby, Ain't I Good to You; Evil Man Blues; Come Sunday; Smack Dab in the Middle; It Don't Mean a Thing*; and five others.

SOLID STATE © SS 18008 \$5.79.

Performance: Sails across the ceiling
Recording: Excellent
Stereo Quality: Brilliant

Many are the paeans of praise that have already been written about Joe Williams' genius, and you won't get any image-deflating from me. Never before, however, has Joe wailed quite the way he wails on his new label, Solid State. Producer Sonny Lester has obviously infected everyone here with his good-humored will to break new ground, and the result (this time around is a disc that is probably the singer's greatest accomplishment.

Whether he is singing from the soul, warm and with great feeling, as he does on the Ellington-Mahalia Jackson *Come Sunday* (listen to the way he holds the word "Pleeceez"—hair-raising!) or scating his way across the top of the ceiling like a trumpet blowing its brains out, as he does on the ultra-modern arrangement of Ellington's *It Don't Mean a Thing*, Joe is at the top of his form. And teaming him with the popular East Coast big band of Thad Jones and Mel Lewis was a stroke of genius that matches his own. The band swings some of the best arrangements I've heard in years, with Mel Lewis tucking in the edges of the sheets like a professional hospital orderly.

And just as exciting as the teamwork in this album is the way it has been recorded. The highest and most creative engineering standards have been observed, so that the listener gets the best possible stereo separation on record. I interchanged this disc with three of Joe Williams' efforts for other "major" labels, and the comparison was quite startling. Solid State has the best sound of any label currently on the market. Joe Williams deserves the best, and there is no compromise here. *R. R.*

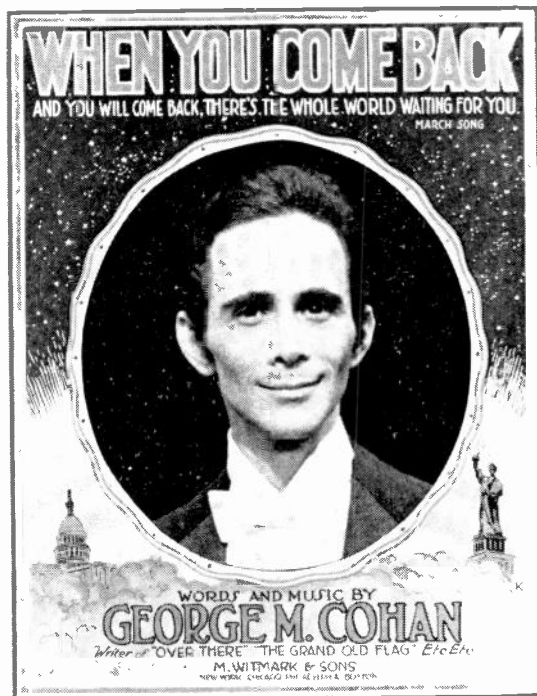
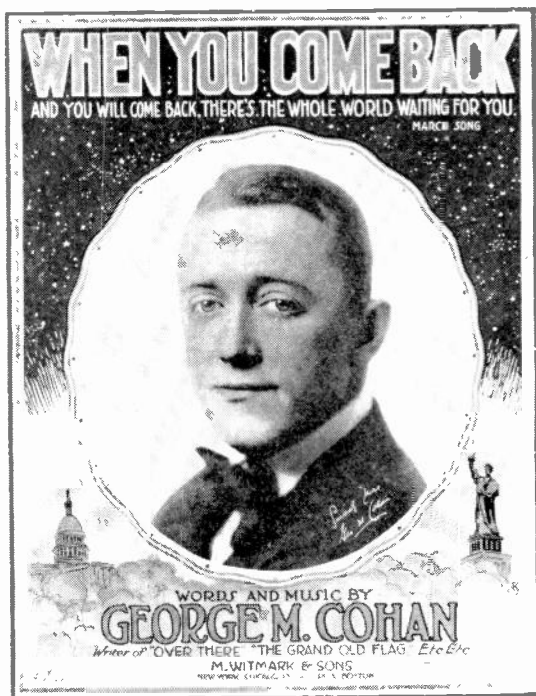

★★★★★ **GEORGE M!** ★★★★★★

The Original-cast Recording

Reviewed by REX REED



PROBLEM: how to make new musical history out of the old-fashioned turn-of-the-century songs of George M. Cohan, the man who once owned Broadway. Solution: hire Joel Grey. Strutting like the cock of the Irish boardwalk, tap dancing his way across the stage like an entire Busby Berkeley chorus line, and singing his heart out to engulf the second balcony in a spring tide of razzmatazz, Joel Grey is currently overloading the Broadway circuits with enough kilowatts to cause another blackout. In Columbia's original-cast album of the show, he leads a cast of slysters in shimrocks and broads in bustles in a red, white, and blue tribute to the golden era of Broadway that is easily the best musical recording of the year.

Not every Cohan song was a great one (he wrote twenty musicals), but there are enough of the good ones in this album to assure his place in the Hall of Fame as a songwriter who knew how to send an audience out of the theater singing. When Cohan was good, he was very, very good. *Yankee Doodle Dandy*, *You're a Grand Old Flag*, *Over There*, and *Give My Regards to Broadway* are justly immortal, and they are sung within an inch of their star-spangled lives in this recording. It is, in fact, one of the best-recorded show albums I've ever heard, bringing the listener right up to the stereo speakers for an orchestrate perspective. Listening to it was a much more enjoyable experience than I remem-

ber having in the theater on opening night. The disc is as Cineramic as records are likely to get for some time to come—nothing is spared to put you right into the Vitaphone picture, stand you next to the old Pathé rooster, and bathe you in the warmth of the footlights.

Joel Grey makes theatrical history with *My Town*, the song that symbolizes Cohan's arrival in the New York he was later to conquer. The show is, in a sense a chronological discography of the Cohan career, an occasional updating of the lyrics serving to encompass several years at a time. One Cohan show, *Little Johnny Jones* (1904), is shown building in tempo from the audition stage through the rehearsals of a production number called *Push Me Along in My Probsant*, blending in slow cinematic fades through *Rosie*, and driving on into *Populizity*, a fabulous show-stopping dance number that gives a good idea of the frenetic, fever-pitch pace of Broadway musicals of the era. By the time they get to *Give My Regards to Broadway*, the entire cast is on stage, complete with boat whistles, dialogue from the actual Cohan show, and about a thousand tap shoes clacking away all over your living room floor.

George M!, in short, recaptures the whole Cohan saga in music, song, and an occasional tear, pouring it all out of a superbly recorded cornucopia of theatrical and musical excitement. There are rollicking

choruses by Floradora Girls, huge production numbers, auditions on drafty stages, backstage excitement, medleys of rhythm songs, patriotic songs, and spirited songs, plus an epilogue in which George M. Cohan himself *speaks* through a historic recording of his voice!

COHAN may not have been the adorable all-American guy James Cagney made him in the movie classic *Yankee Doodle Dandy* (daughter Mary Cohan was the technical advisor on *George M!*, so Georgie must have been the hard-driving, ambitious, callous scoundrel the show says he was), but all wrapped up in the stars and stripes of this dazzling musical production, his image remains legendary. The orchestrations are dandy, the taps are neatly fitted to the tap shoes, the chorus is full-bodied and zestful, and the cast includes some of the freshest, most talented newcomers to the Broadway stage in many moons. The whole adds up to a glorious and incredibly joyous evening of entertainment. An absolute firecracker of an album, one that should put a smile on your face—and keep it there for some time to come.

GEORGE M! (George M. Cohan). Original-cast recording. Joel Grey, Betty Ann Grove, Jerry Dodge, others (vocals); Jay Blackton, musical direction and vocal arrangements. COLUMBIA Ⓢ KOS 3200 \$6.79.



PHOTOS: FREEMAN-ABELLES

★★★★★ GEORGE M! ★★★★★★

The Recording Session

By MARTIN WILLIAMS

APRIL 14 was Easter Sunday, and it fell in mid-Passover. It was also the first Sunday after the successful opening of the Broadway musical based on the career of song-and-dance man George M. Cohan, the first available time for the players, the orchestra, and the director to record the show's original-cast album for Columbia Records, and therefore very much a working day for the cast of *George M!*

The call was for 10 A.M., but by 9:45 the huge semi-circle of chairs set up inside Columbia's 30th Street studios was half-filled with musicians. As they gathered, chatted, looked over their music, engineers were doing some last-minute moving of booms, adjusting of microphones, and placing of baffle boards, and a lone female French horn player crossed the room to take her seat among the trombones.

By 9:55, the show's musical director, Broadway veteran Jay Blackton, a small, dark, and constantly enthusiastic presence, had taken his place in the center of the musicians. And at exactly 10:00, an associate called out loudly, "Hold it, fellows! Please!" The buzz of conversation subsided. "Please don't run around during the playbacks. And also be quiet. It's going to be a tough day for Jay. So please. . . .!"

Blackton looked around the room, and seeing his players for the first time under bright studio lights rather than the darkness of the orchestra pit, quipped, "So that's how you look!"

It promised to be more than a tough day for Blackton. It promised to be a day and an evening—possibly a late evening—for everyone. *George M!*, a kaleidoscopic account of the whole of Cohan's career, contains some eighteen musical numbers, involving over twenty-seven songs. And

original-cast recordings are never as simple to tape as the uninitiated might assume. For one thing, the pit band's size is usually almost doubled for recording by augmenting the strings, brass, and percussion. For another, numbers involving vocal duets, trios, quartets, or the whole chorus—and, in the case of *George M!*, tap dancing as well—present special problems of recording balances, usually very different from one number to the next.

By 10:03, the assemblage had finished a mass tune-up, and Columbia's recording engineer Fred Plaut—working, he announced, on his hundred and fortieth original-cast recording—asked over a studio loudspeaker from his glass-paneled booth, "George, could I hear you alone?" One of the players responded with a toot. "Good. Now, Eddy, could I hear you?"

Five minutes later the orchestra was into the show's overture, and familiar (and unfamiliar) Cohan fragments marched by—*You're a Grand Old Flag*, *Over There*, *Yankee Doodle Dandy*—or they waltzed by—*Forty-five Minutes from Broadway*, *Nelly Kelly*, *Push Me Along in My Pushcart*. At the end, recording director Tom Shepard offered his thanks over a loudspeaker, and on the question of recording balance, requested, "Just give us a few moments."

As mike booms were being adjusted and baffle screens moved, Blackton was addressing his musicians: "Watch that downbeat at bar fifty-three, and trumpets, a little more *subito* there." Once again Shepard's voice boomed into the studio, "Would you like to run one down all the way and tape it, then we'll have a little break for playback? But first, could I hear each percussionist separately?" Drums,

timpani, bells, xylophone, and piano responded in turn. Then Plaut started the tape rolling and Shepard announced, "Okay. *George M!* Overture. Stand by. Take one." The medley went by with spirited, three-minute efficiency. "Thanks. Will you take ten, gentlemen?"

"I'd like to see the Marine Band sound like that!" a trombonist remarked, giving his legs a stretch.

Technical and musical adjustments followed. "I need a very solid attack at bar twenty-one," Blackton announced. "However, that other part should sound as if it's coming from outside the door over there."

By now the other performers were beginning to arrive. Singers were warming up their voices in a small soundproof room next to the control room, and dancers were dutifully doing their morning bends and exercises. By 11:20 and the fourth try, Shepard was announcing, "That's a beautiful take. The overture is wrapped up. Thank you."

Almost immediately, Jacqueline Alloway quietly took her place beside one of the singers' microphones at the rear of the studio, Blackton signaled his orchestra, and they were into a run-through of the grand old opening bars of *Mary*. Satisfied with the balance of the singer's voice and the orchestra, Shepard called for a take. And at its end, he seemed to speak for everyone in the studio as he announced quietly over the speaker, "Beautiful, beautiful." He added, "One more for safety, not because there was anything wrong with it—but could I ask you, in the opening, 'for . . . it . . . was . . . Mary', not to leave quite so much space? Make it all one phrase."

It was 11:40. The star of *George M!*,

Joel Grey, walked quietly through the musicians, headed for the singers' microphones. Dressed in a modified-Mod beige suit and a vertical-striped sport shirt, he greeted the accordionist, Bob Creash, an old friend from his previous show, *Cabaret*. He smiled slowly as one of the drummers took his picture, and Blackton announced, "I want you to meet One-take Grey here."

The next number was *Billie*, sung by Jill O'Hara in the role of Agnes Nolan, the young lady who was to become Cohan's second wife. In the show, it is done as an audition introduced with a bit of dialogue by Grey ("Your name? . . . Sing.") Shepard interrupted. "Joel, if you could sound a bit more like you're shouting, so we'll get the idea on the record. And at the end of her song, give the line about 'That's fine, Miss. Ben, get her to wardrobe.'" Two takes did it, and at the end Grey strolled casually back through the musicians, remarking slyly, "See ya, fellas," as if his work for the day were done.

He was to see them sooner than the remark implied: they were about to undertake the show's opening vocal medley, a presentation of three songs by the "Four Cohans" of early vaudeville days, with young George M. as a performing master of ceremonies. The sequence involved vocal solos, duets, trios, and a quartet—plus solo and ensemble tap dancing. It was per-

formed by a group of youngsters—most of them raised on rock-and-roll—in a musical idiom—jaunty waltz-clogs and robust marches—that properly belonged to their grandparents. But they played it as if they had been born to it.

First was *Musical Moon*, done by Jerry Dodge and Betty Ann Grove playing Cohan's parents. At the end of the take, Shepard requested one more. Grove confessed, "I blew the lyrics." Dodge volunteered a mock-serious, "Huh!" Shepard announced, "I love that energy!", and Dodge countered, "You'll get it."

Next it was Joel Grey's task to introduce Bernadette Peters as the youngest Cohan, Josie, in *Oh, You Wonderful Boy*. "Joel, when you make your next announcement, remember that you're fifteen and a half, not seventeen." As the tape began to roll, Grey shouted out in a high-pitched falsetto that broke up the room.

The final number in the opening medley was the spirited *All Aboard for Broadway*: because it involved tap dancing, a large rectangle of special flooring was placed under the singers' microphones. Grey stepped forward in his white tap-shoes during the orchestra's run-through, and began singing energetically half-way across the room. As the Four Cohans ran through the number, another special consideration of record-making asserted itself. On stage, *All Aboard for Broadway* is carried by

spectacle, dance, and melody, and the tempo is fast. But for recording, it became evident that the piece had to be slowed down a bit in order to make the words more intelligible.

Four takes did it, although it was necessary to make a special intercut, to be spliced in later, of Grey's tap dance so as to get the balance right. Grey's drive and energy filled the large room; if there had been a real "house" there, his performance would have brought it down. "We got it. Thank you," Shepard announced. Time for lunch. Be back at 2:00."

When the afternoon session began, there were more visitors in the studio and more performers. The full chorus was there, several of its members fresh from Easter services and sporting spring finery. With so many performers involved, the show's director-choreographer, Joe Layton, who had spent most of the morning in the engineering booth sitting beside Shepard, took a more active part. "Joel," he announced at one point from the back of the room, "don't forget the . . ." (executing a quick tap step) "before the . . ." (executing another).

Soon they were into the more familiar Cohan numbers: *Forty-five Minutes from Broadway*, *You're a Grand Old Flag*, *Over There, Havigan*. "On *Nelly Kelly I Love You*, at bar 164," Blackton instructed the musicians, "a little less *lamentoso*, a little more Bowery, please."

"Axiom number one," Shepard reminded the percussionists, "is never to use a wood block with tap dancing. It may work fine in the theater pit, but it is confusing on a recording."

By 5 P.M. Shepard's voice on the loudspeaker asked, "Do you want an hour or an hour and a half for supper?" And inside the studio an almost unanimous shout went up, "An hour!"

Fifty minutes later the studio seemed to be full of violinists tuning up, but over in one corner a lone pianist was playing some of Bud Powell's jazz pieces—music that seemed out of place at the moment.

"Jay, you know we're on *Give My Regards to Broadway*. Come on, kids! Come on!", Layton encouraged. "We'll start routine *Musical Comedy Man*." It was a bit harder to get back to work this time, but once into the music, the energy was still there.

As the chorus assembled, Grey, at one side, tapped a bit and discussed with Betty Ann Grove the quality of the chicken soup available in the vending machine in the hall. By 7:35, one of the chorus girls was saying excitedly, "The Epilogue next? Oh, that's my last number!" And someone offered the opinion that it would be wrapped up by 10 o'clock. On the sidelines a visitor was reading a full-page ad from the early edition of the morning papers. "George M!", read the headline, quoting Clive Barnes' review in *New York Times*, "can have a personal Tony award from me. And Joel Grey can have a couple." And he hadn't even heard the original-cast recording yet!

Martin Williams is a prominent critic and author of many books in the field of jazz.



Playing George M. Cohan is obviously hard work for Joel Grey, caught (above left) wanly waiting during a pause in the day's recording occupations. No lack of zing is evident on stage, however: above, Grey, as Little Johnny Jones, is about to give his regards to Broadway, and left, he appears as one of the Four Cohans with Bernadette Peters, Jerry Dodge, and Betty Ann Grove.

DEFA ELECTRONICS

DEFA'S ONCE-A-YEAR SUMMER PACKAGE SPECIAL

ADC 606 90 WATT SOLID STATE FM STEREO RECEIVER
Bookshelf depth. Oiled walnut cabinet incl. Complete playback and monitoring facilities. Musical instrument input. 2 yr. warranty.

2 ADC 303A BRENTWOOD SPEAKER SYSTEMS
Bookshelf or free-standing. Oiled walnut. Delivers full 35-20,000 CPS. Highly rated Full 5 yr. warranty.

DUAL 1015 4 SPEED AUTOMATIC TURNTABLE
Many new features and built-in tone arm, mounted with leather touch. Stack Shift. P. S. STANTON 500L

Professional Stereo Cartridges. Professional pick-up with magnetic shield. Most styl for the most demanding applications at a low packing rate of 2.5 grams.

TOTAL SALE PRICE IF UNITS PURCHASED SEPARATELY \$604.35
YOU SAVE **\$369.95** OFFER
\$234.40 ON THE FULL PACKAGE EXPIRES 8/25/68
ALL INTERCONNECTING CABLES SUPPLIED FREE

STEREO SYSTEMS—COMPONENTS AT LOW DISCOUNT PRICES
Send For Our Quote Today!
We Carry All the Famous Brands.

DEFA ELECTRONICS CORP.
2207 Broadway, N. Y., N. Y. 10024
PHONE 874-0900 & 874-0901

CIRCLE NO. 16 ON READER SERVICE CARD

We Own The Sharpest Pencils In Town!



YOU SAVE MORE ON HI-FI COMPONENTS & TAPE RECORDERS

- We invite your test of our "We Will Not Be Undersold Policy."
- 15-day money-back guarantee.
- 2-yr. unconditional guarantee parts & labor no charge, at local warranty station, or factory.
- Trade-ins-highest allow. Send your list.
- Most items shipped promptly from our \$250,000 inventory, fully insured.
- Our specialty—APO & Export.
- 23rd yr. dependable service world wide.

RATED #1 SERVICE—SATISFACTION ACCORDING TO NATION WIDE SURVEY.

Write For Our Price First
You'll Be Glad You Did

HI-FIDELITY CENTER
"The House of Low Low Prices"

239-A East 149th St.,
New York, N.Y. 10451

CIRCLE NO. 29 ON READER SERVICE CARD

108

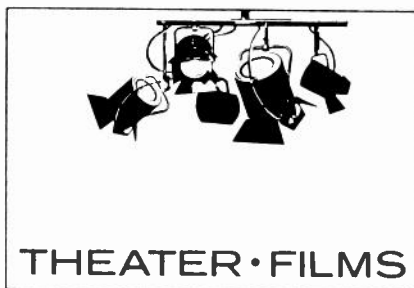

HERE WE GO ROUND THE MULBERRY BUSH. (Music by Traffic, the Spencer Davis Group, and Andy Ellison.) Original-soundtrack recording. UNITED ARTISTS (S) UAS 5175, (M) UAL 4175* \$5.79.

Performance: *Passable after a couple of listens*
Recording: *Very good*
Stereo Quality: *Very good*

Clive Donner, producer of this rotten little sex-and-games teen-age film, decided that all of the background music should be pop-oriented, performed by top groups just as if they were actually recording hit discs for the consumer public. This is not a wholly original idea. Rock music has recently cropped up more frequently in film scores than the customary strings or soft jazz backgrounds, and both of the Beatles films had their soundtracks turned into commercial recordings.

The music for this film was performed primarily by two of England's top pop groups, Traffic and the Spencer Davis Group. With the exception of a few of the songs, most of this soundtrack is worth enough listens to get used to it. I particularly liked the rocking title tune, *Looking Back*, *Possession*, *Am I What I Was or Was I What I Am?*, and *It's Been a Long Time*, which is performed by an unknown (to me) singer named Andy Ellison. Most of the songs contain intelligent lyrics, some of which you can even understand. R. R.

HOUSE OF FLOWERS (Truman Capote-Harold Arlen.) Revival-cast recording. Yolande Bavan, Thelma Oliver, Hope Clarke, Josephine Premice, Robert Jackson, Charles Moore, Novella Nelson, others (performers); chorus and orchestra, Joseph Raposo cond. UNITED ARTISTS (S) UAS 5180, (M) UAL 4180* \$5.79.

Performance: *Sub-tropical*
Recording: *Good*
Stereo Quality: *Good*

Flowers are not particularly advisable materials to build houses out of, but if anyone could make such a structure stay up at all, it would probably be Truman Capote. The original house didn't last too long, although it's always being referred to wistfully by chroniclers of musical-comedy history. The singularly pleasant score, with its nods to the colors and rhythms of the Caribbean, is something else again: it has survived. It got definitive treatment in a 1963 album from Columbia with a scratch cast that included such singers as Pearl Bailey, Diahann Carroll, and Juanita Hall as the Haitian ladies of the red-light cafe on the Port-au-Prince waterfront, where the show is set. The Columbia album even offered a bonus of a seven-inch record with a commentary by the author. Such a package would be hard to beat, but the new "original"-cast album, taken

from the revised version of the show as performed at the off-Broadway Theatre De Lys in New York last winter, does manage to stand on its own without wobbling too badly. The score, rearranged and juggled about, some pieces cut and others altered in various ways, still puts forth such fragrant blooms as *Smellin' of Vanilla*, *Two Ladies in de Shade of de Banana Tree*, and *I Neiter Has Seven Snow*, along with a couple of what seem to be new ones—*Madame Tango's Particular Tango* and *Somethin' Cold to Drink*. The ladies of the house who appear in the revival, and are heard to good advantage here, are Josephine Premice in the role of Madame Fleur, Yolande Bavan as Otilie, Thelma Oliver as Pansy, and Hope Clarke as Tulip. They do a lot of justice to Mr. Arlen's happy songs and his and Mr. Capote's intelligent lyrics, and it's just not fair to compare them with the triple-threat people who



JOSEPHINE PREMICE AS MADAME FLEUR
Decorating a done-over House of Flowers

did the earlier job for Columbia. The gentlemen of the cast do not show up quite as well, although Robert Jackson excels in the title number and in a wise little item called *Woman Never Understand*. And one thing more is to be said in praise of *House of Flowers*: without it, there might never have been that other tuneful (if trivial) musical which succeeded it called *Jamaica*. P. K.

LIVE FOR LIFE (Francis Lai). Original-soundtrack recording. UNITED ARTISTS (S) UAS 5165, (M) UAL 4165 \$4.79.

Performance: *Insistent*
Recording: *Good*
Stereo Quality: *Average*

Mr. Lai, evidently prepared, for the rest of his career, to write endless variations on that haunting theme from *A Man and a Woman*, has turned in another stylish score for this film by Claude Lelouch. As in the earlier score, he relies on the insistent repetition of a seductive melody to build up the cinematic tension, like the pulse of a frustrated lover marking time until waiting becomes unendurable. It's a familiar approach, but still effective. There are two vocals in the score—a typical self-pitying *chanson* called *Now You Want to Be Loved* and a pseudo-rock item with insane lyrics by another composer, Raymond Le Senechal. Both are altogether fashionable—and terrible. P. K.

HIFI/STEREO REVIEW

SPOKEN WORD



RECORDING OF SPECIAL MERIT

THE APPLE TREE THEATRE: Playback. John and Terence Boylan (writers, directors, and performers), with Chuck Israels, Garry Sherman, Larry Coryell, Joe Butler, others (performers). **VERVÉ/FORCAST** (S) FTS 5012 \$4.79.

Performance **A pleasant surprise**
Recording **Excellent**
Stereo Quality. **Unusually clever**

The album notes accompanying this item are so arch that I found myself removing the record from its jacket with the same feeling that one has as he helps an unwelcome guest out of his overcoat. I'm glad to report that the guest, in this case, turned out to be a rewarding one. The Messrs. Boylan, although perhaps too eager to please, make for pleasant company in this musical review, which is characterized by a high nuttiness quotient and a refreshing approach to light satire. Things start with a prompter trying to help out an actor who keeps forgetting the opening lines of the Book of Genesis, and proceed from there to mod, mad skits and songs dealing with such matters as a young man calling on a coked-up girl, subway rides, spoofs of pompous chorales "with didactic chorus," a surprise attack on country-music corn in a hilarious piece entitled *I Been Spending Too Much Money at the Country Fair*, and a documentary accurately depicting what you're likely to get twisting the dial on a car radio. The people who put this one together were especially bright about their use of stereo to point up the sounds of their satire rather than just wrap you in them. P. K.

RECORDING OF SPECIAL MERIT

LANGSTON HUGHES: Simple. Seven stories from *The Best of Simple and Simple's Uncle Sam*. Ossie Davis (reader). **CAEDMON** (M) TC 1222 \$5.95.

Performance **Beguiling**
Recording **Excellent**

Langston Hughes was a Negro writer more observant than angry. For more than forty years from the publication of his first book of poems in 1926 until his death in 1967, he explained black man to black man, and black man to white man. His tolerance was easy-going and even genial, but beneath that tolerance there was always the certain knowledge and the veiled warning that it could be, as James Baldwin put it, the fire next time.

In 1912, Hughes, writing for the *Chicago Defender*, stumbled across the character of Jesse B. Semple, of Harlem, known to his friends as Simple. Simple soon became a Negro Everyman—despite his fiery Indian blood, the subject of the first excerpt here.

To meet Simple is a pleasure, and from his wisdom and understanding we can learn much. Superficially there is an Uncle Tom touch here, a lovability of the Negro that the Caucasian soul can softly identify with, but beneath this, Hughes tells it as it is.

This record introduces us to Simple in all his moods, both philosophic and perturbed. Lovable and honest, Simple would not deny that he is an African, but equally he is certainly an American. The episodes here have been admirably chosen, and Ossie Davis, with his voice veering between the calm of narrative and the exclamation fever-points of hotly reported speech, is splendid. Simple's is a voice that should be heard during the coming summer, which may be both long and hot. Mr. Davis gives that voice an uncommon attractiveness. C. B.

STEPHEN SPENDER: Selected Poems. Stephen Spender (reader); Arthur Luce Klein, director. **SPOKEN ARTS** (M) SA 953 \$5.95.

Performance **Proper**
Recording **Lucid**

It is curious, but few poets have suffered such a reversal of reputation as have Stephen Spender and his English colleagues of the Thirties. Of course, Auden of those times has survived, as has, more surprisingly if only because more powerfully, Isherwood; but of the rest—brave poetic souls all—little remains. Louis MacNeice is dead, Cecil Day Lewis is poet laureate and mystery story writer, and Stephen Spender is an erstwhile editor of *Encounter*.

The present record of selected poems by Spender has the undeniable interest of being a widely ranged and personally selected anthology of all his works with a special introduction to each work. Ironically, his special introductions are occasionally more rewarding than the poems themselves.

What perhaps is interesting in this selection is the manner in which their tone becomes more nostalgic with the passing of time. Spender has a lyric gift and often his poems have lines to strike the heart. But it is a minor talent. Spender himself reads his poems well—with understanding and with modesty. C. B.

BILLIE JEAN PARKER: The Truth About Bonnie and Clyde. Billie Jean Parker (narrator). *What Kind of People Were Bonnie and Clyde?*; *The Time They Needed Guns*; *Billie Jean with Bonnie and Clyde*; *Who Did They Rob?*; and eight others. **RCA VICTOR** (S) LSP 3967, (M) LPM 3967* \$4.79.

Performance: **Grotesque**
Recording: **Okay**
Stereo Quality: **Okay**

The Bonnie and Clyde phenomenon grows curiouser and curiouser. Why was this album made, for example? It is a rather ghoulish endeavor by all concerned, and has practically no value, even as a social document. Billie Jean Parker, who is Bonnie's sister, is obviously trying to cash in on her sister's new notoriety and has found willing accomplices here in the persons of Jud Collins, who interviews her, and Felton Jarvis, who produced the album. It includes a "bonus" in the form of a photo of Bonnie and Clyde "suitable for framing," which just about sums up the aura of Transylvanian camp that hovers over the entire enterprise. P. R.

THIS

OVER **62 YEARS**
OF RELIABILITY

IS WHY STEREO & HI-FI
BUYERS CAN BE SURE OF
SAVINGS
AT RABSONS

At Rabsons Competitive Prices, Reliability and Personal Service have been bywords for over 62 years.

It's so EASY and SAFE to deal with Rabsons. Up to 36 months to pay on Easy Pay Plan. As close as your telephone — as near as your mailbox. Fast Air Mail Response on Quotation Requests. Franchised Distributor for Hi-Fi Lines. All merchandise brand new in factory sealed cartons, shipped double-packed, fully insured promptly from our warehouse. Greater savings on complete systems. Export packing. 220 Volts, 50 Cycle merchandise a specialty. Free list of monthly specials.

BEFORE YOU BUY GET A RABSONS QUOTE... YOU'LL BE GLAD YOU DID!

RABSONS 57 ST. INC.
119 West 57th Street, New York, N. Y. 10019
Tel. Area Code 212-247-0070

CIRCLE NO. 46 ON READER SERVICE CARD

PURCHASING A HI-FI SYSTEM?

TRADE-INS OK—TIME PAYMENTS
Up to 3 years to pay!

Send Us
Your List of
Components
For A
Package
Quotation

Altec Lansing
Electrovoice
Jensen • Muller-Craft
University
Acoustic Research
Janszen • Viking
Wharfedale
Marantz*
Harman-Kardon
Eico • Ampex*
Sherwood*
Crown Recorders*
Superscope
Scotch Tape
Dual Changer*
Bogen
Dynakit • Fisher
H. H. Scott • Leak*
ECL • Roberts
National
Sony • Challenger
Garrard
Miracord
Rek-O-Kut • Finco
Fairchild
Pickering • Sonar
ADC Cartridges
Audio Tape
Magnecord*
ADC Speakers
*Fair Traded

Visit our 3 N.Y. Showrooms
FOR SPECIAL 152-Page Hi-Fi,
CB, Communications Catalog,
send 25¢—COIN OR STAMPS

Mail orders accepted
Send inquiries to main store
at 132 Nassau St., New York, N.Y. 10038

AIREX RADIO

69 West 23 St., New York, N.Y., 10011
132 Nassau St., N.Y., N.Y., 212-964-1820

CIRCLE NO. 2 ON READER SERVICE CARD

How to recognize a stacked deck.

The Choice of Experts. This is the improved successor to the famous Sony Model 350 which was picked as "a best buy" by the nation's leading consumer reporting service!

Professional 3-Head Design. The ultimate in versatility. Such wanted features as Tape and Source Monitoring, Sound-on-Sound, Sound-with-Sound, and other special effects!

Instant Tape Threading. Exclusive Sony Retractable pinch roller permits simple one-hand tape threading. An automatic tape lifter protects heads from wear during fast forward and reverse!

Vibration-Free Motor. An important new Sony development utilizing "floating" shock absorber action to completely isolate any motor vibration from the tape mechanism!

Sony Model 355. Priced under \$229.50. For your free copy of our latest tape recorder catalog, please write to Mr. Phillips, Sony/Superscope, Inc., 8146 Vineland Avenue, Sun Valley, California 91352.

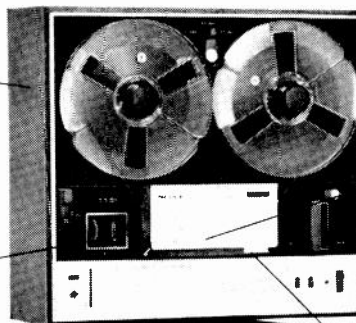

Scrape Flutter Filter. Special precision idler mechanism located between erase and record/playback heads eliminates tape modulation distortion. This feature formerly found only on professional studio equipment!

Non-Magnetizing Heads. Head magnetization buildup—the most common cause of tape hiss—has been eliminated by an exclusive Sony circuit which prevents any transient surge of bias current to the heads!

Unprecedented Frequency Response. Achieves true high fidelity performance even at slower speeds!

20-22,000 Hz @ 7½ ips
20-17,000 Hz @ 3¾ ips
20- 9,000 Hz @ 1⅞ ips

Noise Suppressor Switch. Special filter eliminates undesirable hiss that may exist on older recorded tapes. Filter does not affect the quality of sound reproduction!

Three Speeds. 7½, 3¾ and 1⅞ ips. Additional features include: Four-track Stereophonic and Monophonic recording and playback. Seven-inch reel capacity. Stereo Headphone Jack. Automatic Sentinel Shut-off. Two VU Meters. Pause Control. Four-Digit Tape Counter. Record Interlock. Vertical or Horizontal Operation. And more!

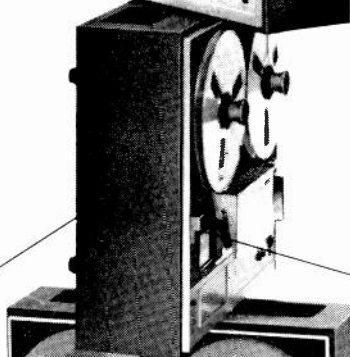
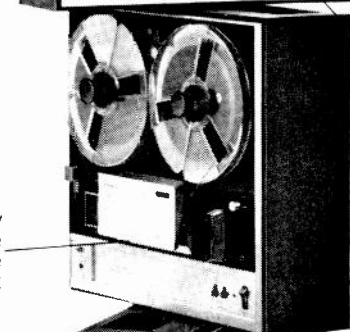

You never heard it so good.

SONY **SUPERSCOPE** *The Topway to Stereo*

© SUPERSCOPE, INC., 1968

CIRCLE NO. 53 ON READER SERVICE CARD



HIFI/STEREO REVIEW'S CHOICE OF THE LATEST RECORDINGS

STEREO TAPE

Reviewed by WILLIAM FLANAGAN • DAVID HALL • IGOR KIPNIS
PAUL KRESH • REX REED • PETER REILLY • ERIC SALZMAN

RECORDING OF SPECIAL MERIT

BACH: *Trio Sonatas (complete, BWV 525-30)*. E. Power Biggs (pedal harpsichord). COLUMBIA (S) MQ 975 \$7.95.

Performance: **Worthy**
Recording: **Excellent**
Stereo Quality: **First-rate**
Speed and Playing Time: **7½ ips; 74'23"**

The pedal harpsichord, a two-manual instrument with a pedal mechanism, makes a very good impression here in Bach's six trio sonatas, which are more usually heard on the organ. True, this instrument does not have the sustaining power or the variety of registers that the organ does, but Biggs succeeds in making the pedal harpsichord an effective alternate (there is some possibility that the sonatas might have been intended originally for either a pedal harpsichord or pedal clavicord). The instrument has been recorded extremely vividly here, and I am delighted that Columbia has chosen to release the tape (minus the disc album's two solo concertos, BWV 592/3) at a speed of 7½ ips, rather than at a slower speed, which might likely have resulted in flutter. *J. K.*

BEETHOVEN: *Concerto No. 5 in E-flat, Op. 73 ("Emperor"); Concerto No. 4 in G, Op. 58*. Artur Schnabel (piano); Boston Symphony Orchestra, Erich Leinsdorf cond. RCA VICTOR (S) TR3 5019 \$10.95.

Performance: **Good**
Recording: **Good sound but lots of hiss**
Stereo Quality: **Okay**
Speed and Playing Time: **3¾ ips; 70'37"**

I like these performances, particularly that of the "Emperor." Oddly enough, Schnabel is often at his best in (for him) less familiar repertoire—where the mannerisms have not formed over the years. He approaches this music with a fresh combination of dignity and zest; there is no false reverence for "classical" style but the kind of straight-forward brio that allows the pianist's remarkable natural musicianship to come through. The orchestral approach is—the usual cliché about Leinsdorf the super-technician notwithstanding—rather hearty and gruff, and this is not inappropriate to the "Emperor" (it doesn't work quite so well in the G Major).

As in the case of the recent tape transfers of the Schnabel-Leinsdorf Brahms concertos, you get a lot of music on a reel but also

a lot of hiss. If you are as sensitive to tape hiss as I am, you may want to cut the treble even at the cost of sacrificing some of the highs. Otherwise the recorded sound is good, and the transfers are generally superior to those of the Brahms concertos. *E. S.*

BEETHOVEN: *Symphony No. 3, in E-flat, "Eroica," Op. 55*. BBC Symphony Orches-

tency of a bulldozer, Barbirolli gives us a majestic but rather leisurely opening movement (in which the startling dissonances are rather softened by the ensemble balance), and a slow-movement *Marcia funebre* played at a tempo that would have its presumptive marchers dropping in their tracks before the great fugal passage—which itself is played with a lack of drive and intensity.

In short, the work is in a number of ways robbed of its revolutionary aspects by a curiously benign and leisurely approach to one of the boldest, toughest scores in the history of music. Recorded sound and stereo are fine. *W. F.*

RECORDING OF SPECIAL MERIT

ELGAR: *Cello Concerto in E Minor, Op. 85*. Jacqueline du Pré (cello); London Symphony Orchestra. Sir John Barbirolli cond. **DELIUS:** *Cello Concerto*. Jacqueline du Pré (cello); Royal Philharmonic Orchestra, Sir Malcolm Sargent cond. ANGEL (S) Y1S 36490 \$7.98.

Performance **A-1**
Recording **Good**
Stereo Quality **Good**
Speed and Playing Time: **3¾ ips; 54'41"**

There are pluses and minuses here. A big plus is the decision to pair on the same tape Miss du Pré's eloquent performances of the taut and passionate Elgar and sweetly rhapsodic Delius concertos, rather than copy the disc versions, which in the first instance was filled out with recital encores, and in the other with a late Delius choral work. While it is possible that those who admire the disciplined strength and beauty of Elgar's 1919 masterpiece will find the Delius work of two years later a bit too sweetly drawn out, Miss du Pré's beautifully phrased and tonally ravishing readings provide a wholly convincing binding thread. Both accompaniments, by Sir John Barbirolli and by Sir Malcolm Sargent (he conducted the world premiere of the Delius), are impressively satisfying. The recorded sound is full and warm, but would have been even finer had the tape speed been 7½ ips instead of 3¾—a feasible matter in view of the 29' 58" length of the Elgar and the 24' 43" running time of the Delius.

In any event, these are the only tape versions of the two concertos, and certainly represent a better buy as a single package than the two discs. *D. H.*

VERDI: *Aida*. Birgit Nilsson (soprano), Aida; Mario Sereni (baritone), Amonasro; Franco Corelli (tenor), Radames; Grace Bumbry (mezzo-soprano), Amneris; Ferruc-



E. POWER BIGGS
Effective Bach on the pedal harpsichord

tra, Sir John Barbirolli cond. ANGEL (S) Y1S 36461 \$7.95.

Performance: **A little bland**
Recording: **Excellent**
Stereo Quality: **Fine**
Speed and Playing Time: **3¾ ips; 54'15"**

Although Barbirolli's approach to the "Eroica" is, I suppose, a perfectly valid one, it isn't my idea of what the work is all about. Like so many innovative landmarks in the history of music, the Beethoven Third is what one might call a masterpiece that, in sum, doesn't quite come off. The length of its slow movement is disproportionate and, since the heart of the work lies here and in the unprecedented structural originality of the first movement, the piece tends to vitiate itself in the comparatively ordinary gestures of the last two movements.

Toscanini's legendary performance of the piece skirted (or minimized) these problems about as effectively as anyone's ever has. Whereas the late conductor drove through the score with the unabating power and in-

Explanation of symbols:

- (S) = stereophonic recording
- (M) = monophonic recording

cio Mazzoli (bass), the King; other soloists; Orchestra and Chorus of the Opera House, Rome, Zubin Mehta cond. ANGEL Y3S 3716 \$17.98.

Performance: Uneven
Recording: Very good
Stereo Quality: Moderate
Speed and Playing Time: 3¾ ips; 140'07"

I find myself very much agreeing with George Jellinek's thoughtful disc review, in the March issue of this magazine, about the merits of this particular *Aida*. The cast is certainly spectacular, there is plenty of excitement and dramatic tension, and the recording is technically first-class. Yet the overall impression—whether because of Mehta's inconsistencies, his generally superficial approach, or his occasional inability to generate a suitable atmosphere—is disappointing. The stars are invigorating (even though Nilsson sounds out of her element), but as my colleague points out, again with reference to the direction, "cantare" and "sostenere" are sadly missing. The 3¾-ips speed reproduces the music extremely well, although I found a treble boost helpful; stereo placement is not particularly adventuresome. The package includes the usual postcard enabling the purchaser to send for the libretto. I. K.

COLLECTIONS

RECORDING OF SPECIAL MERIT

ENRICO CARUSO: *The Best of Caruso*. Verdi: *Aida: Celeste Aida; La Forza del Destino: Solenne in quest'ora; Rigoletto: Questa o quella, La Donna è mobile, Bella figlia dell'amore; Trovatore: Ai nostri monti; Otello: Sì pel ciel*. Handel: *Xenxia: Ombra mai fu*. Donizetti: *L'Elisir d'amore: Una furtiva lagrime; Lucia di Lammermoor: Chi mi frena in tal momento?*; Puccini: *La Bohème: Che gelida manina, O soave fanciulla; Tosca: Recondita armonia*; ten other arias and ensembles by Ponchielli, Leoncavallo, Lully, Meyerbeer, Bizet, Massenet, Halévy, and Flotow; eight songs. Enrico Caruso (tenor); Antonio Scotti, Giuseppe De Luca, and Titta Ruffo (baritones); Marcel Journet (bass); Amelita Galli-Curci, Geraldine Farrar, Frances Alda (sopranos); other soloists; orchestral and piano accompaniment. RCA VICTOR (M) TR5 5024 \$10.95.

Performance: Legendary
Recording: Good considering source
Speed and Playing Time: 3¾ ips; 109'35"

There is something rather strange about hearing, through the tape medium, recordings that were made acoustically. The contents of this reel, derived from two disc collections, fully live up to the title. Here are all the favorites, mostly solo arias, of course, but also some of those marvelous ensemble recordings which were the pride of our music-loving parents and grandparents. The first sequence is the most satisfying; the reverse track includes eight songs, ranging from "O soave mio" to *Over There*. No matter: it's all first-rate Caruso, and the recorded sound, dating originally from between 1904 and 1920, has been processed with considerable clarity and presence. I noticed a trace of pre-echo at the outset, and it's a pity that RCA Victor doesn't provide any more information about the recordings than just a list of titles. Outside of these minor objections, I

can welcome this tape with great pleasure; I hope RCA is planning to issue similar historical material, both vocal and instrumental, in this medium. I. K.

ENTERTAINMENT

ED AMES: *Try to Remember; When the Snow Is on the Roses*. Ed Ames (vocals); orchestra, Ray Ellis, Claus Ogerman, Hal Mooney, Mort Garson and Perry Botkin Jr. cond. and arr. *If Ever I Would Leave You; Before I Kiss the World Goodbye; Somewhere; Try to Remember; They Were You; Where You Are; May in the Morning; Two for the Road; Seasons of Love; What Kind of Fool Am I?; As Long as She Needs Me; My Love Is Gone; Timeless Love; Strangers; I'll Get By*; and eight others. RCA VICTOR (S) TP 5041 \$9.95.

Performance: Romantic but flavorless
Recording: Good
Stereo Quality: Good
Speed and Playing Time: 3¾ ips; 56'45"

I have nothing against Ed Ames. He has a



IAN AND SYLVIA
Respect for the listener's intelligence

rich, pleasant baritone voice and he sings in tune. But without much concentration on my part at least twenty-five other singers come to mind who would sing the twenty-three songs on this tape exactly the same way—blandly, straight from the shoulder, and without much originality or depth. All of them are durable but none of them are ever likely to be represented on my record shelves. Ames never seeks to make a song his own. He mouths the lyrics, but he neither interprets nor inspires. Therefore, *What Kind of Fool Am I?* sounds exactly like *If Ever I Would Leave You*. *Try to Remember* sounds exactly like *As Long as She Needs Me*, and so forth. So buying this tape depends largely on how big an Ed Ames fan you are. If you like his schmaltz, you'll get more of the same. If you have more demanding tastes, you won't be interested for more than two cuts. An Ed Ames record is an Ed Ames record. . . . An Ed Ames tape is the same. R. R.

RECORDING OF SPECIAL MERIT

IAN AND SYLVIA: *So Much for Dreaming*. Ian and Sylvia (vocals); Ian (guitar and autoharp), David Rae (guitar), Robert

Bushnell (electric bass), Al Rogers (drums). *Circle Game; So Much for Dreaming; Wild Geese; Child Apert*; and eight others. VANGUARD (S) VGX 9241 \$5.95.

Performance: Bright-eyed
Recording: Good
Stereo Quality: Artful
Speed and Playing Time: 3¾ ips; 40'01"

Ian and Sylvia are a Canadian couple who sing folk songs and compose creditable facsimiles of them in a familiar vein. They won't raise the roof of your house or crack glasses trying to inspire awe of their vocal powers, but they may win you over, as they easily won me, through the rare, secret ingredient in all their albums: respect for the intelligence of the listener. The program here deals with unpretentious matters: grey winter mornings, love gambled on a woman and "lost like summer wages," the flight of geese, the dreams of children. The sell is soft, the rhythm gentle, the tone humane and serious. A civilized cheer for Ian and Sylvia. P. K.

TOM JONES: *Green, Green Grass of Home*. Tom Jones (vocals); orchestra. *A Taste of Honey; Kansas City; That Old Black Magic; My Mother's Eyes; When I Fall in Love*; and seven others. PARROT (S) PTX 79009 \$5.95.

Performance: Good
Recording: Good
Stereo Quality: Good
Speed and Playing Time: 3¾ ips; 38'48"

Tom Jones, who is bigger than both of us, offers some not so rare bits Welsh style on this new tape. Stolidity of approach and execution are Jones' main faults, and when he gets to something rather delicate like *A Taste of Honey* he is apt to smother it with his heaviness. The lumbering sentimentality of *My Mother's Eyes* almost (I said almost) made me long for George Jessel's version. Forget this one. P. R.

WAYNE NEWTON: *The Greatest*. Wayne Newton (vocals); orchestra. *The Common People; How Loud a Sound; Green Green Grass of Home; Monday, Monday*; and seven others. CAPITOL (S) YIT 2847 \$6.98.

Performance: Grinning
Recording: Good
Stereo Quality: Good
Speed and Playing Time: 3¾ ips; 27'35"

Wayne Newton is a clear-eyed, stocky young man with very white teeth (I hope his own) and a tendency to smother his performances in a kind of bear-hug of bucolic enthusiasm. Even when he's singing about poverty-stricken little girls who don't own a single dress without a patch, as in *Love of the Common People*, or lonely nights when "I've paced the floor—the phone doesn't ring, no knock on the door," and even when he's mourning a girl named Happy who apparently has departed this world because "the heavenly garden needed a rose," he seems unable to prevent himself from exuding good cheer. "I'm standing in the ruins of our old cold love affair," he reports in one number, but manages somehow to sound remarkably resilient about the whole thing. He is accompanied by the usual sighing chorus, and an instrumental group with a vaguely Dixieland style. P. K.

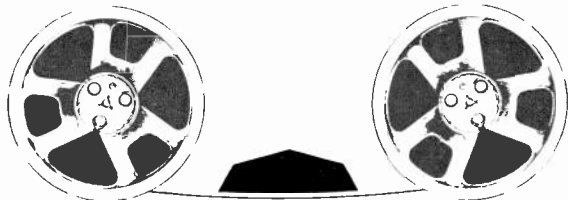

TAPE HORIZONS

By DRUMMOND McINNIS

TAPE-LETTER TIPS

IN MY experience, 'tis better to send than to receive. At least it seems to be true of a number of tape letters I've heard, including some of my own early efforts. Bad tape letters are, I think, the result of treating them too much as if they were just tapes, and not enough as what they are—letters. Some of the following hints and suggestions may help to make your tape letters more interesting, concise, and successful.

Letter-writers don't leave large blanks between their sentences. But many letter-talkers record the blanks between their thoughts, trailing off into an "er . . . ah . . . um . . ." and a few moments of silence before picking up the thread again. Most tape recorders have a pause switch. Use it.

Further, you should have some idea of what you're going to say before you start to say it. If possible, outline your letter on paper before you pick up the mike. I don't mean that you should write a script—you'll sound stilted and unnatural if you're reading, rather than ad libbing, and if you're going to write everything down, why not just mail that? My system is to keep a few file cards in my pocket, and when I think of something that should be in my next letter to one friend or another, I jot it down—just a key word or two—as a reminder. I make a few more jottings as I listen to their tapes to me. Then, just before I start recording, I number the items in approximately the order that I'll use them and think each one over for a few seconds. That way I can speak spontaneously, without forgetting what I want to talk about or what I have to say about it.

But don't be a slave to your outline either. If you think of something that's not on your list, go ahead and talk about it. Follow the topic wherever it leads you. If you hit a conversational dead end, you can always go back to the next topic you've outlined.

Your letter, no matter how interesting and well-expressed, means nothing if it can't be heard. Learn correct microphone technique: make a test recording varying your distance from the microphone, then play it back and have *somebody else* choose the distance that sounds most natural. (Eight to 18 inches is about right for most microphones.) Sometimes, you may not want a natural effect: speak softly and very close to some microphones, and you'll get a bass-heavy, breathy effect that's hardly "natural"—but it's perfect for love letters.

Take full advantage of the flexibility of tape. Your letter can also include messages from nearby friends and relatives (even messages taped over the phone) or sounds suggestive of what's going on around you (crickets, traffic, babies, typewriters, lawn-mowers, and artillery, to name a few I've heard). Or sounds that mean something special to the recipient of your tape—my cousin in Vietnam, for instance, dots on recordings of the sports car he left behind.

You can even throw in sounds selected just for fun. One of my correspondents starts his letters with a trumpet fanfare, and illustrates his anecdotes with such sounds as a babbling brook (his fishing trip), a wave of applause (his son's piano recital), and a funeral march (the day his car broke down for good).

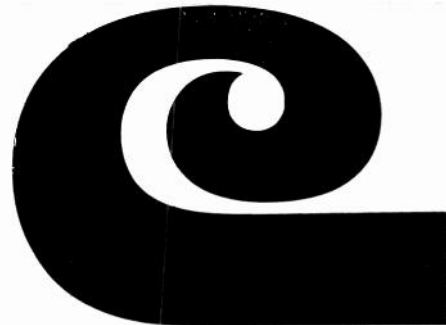

CELANESE Acetate

When you think high fidelity, think acetate. No other film base has taken the place of acetate for fidelity of reproduction . . . resistance to stretch . . . freedom from print through. With all these advantages, acetate based tapes cost less.

Celanese does not manufacture recording tape. It produces and supplies acetate film for this purpose to leading tape manufacturers.



CELANESE

CELANESE PLASTICS COMPANY

CIRCLE NO. 12 ON READER SERVICE CARD

HI-FI COMPONENTS TAPE RECORDERS

TAPES, ACCESSORIES
SLEEP LEARN KITS
MERITAPE

SAVE MONEY

- LOWEST PRICES
- INTEGRITY • SERVICE
- FRANCHISED DISTRIBUTORS

WRITE FOR OUR VERY LOW
PACKAGE QUOTATIONS
Nationally Advertised Brands
Factory Sealed Cartons

Write for **FREE CATALOG**
Visit Our Showrooms

DRESSNER

1523 G JERICO TPKE.
NEW HYDE PARK, N.Y.
11040

CIRCLE NO. 20 ON READER SERVICE CARD

HI FI/STEREO REVIEW CLASSIFIED

COMMERCIAL RATE: For firms or individuals offering commercial products or services. 75¢ per word (including name and address). Minimum order \$7.50. Payment must accompany copy except when ads are placed by accredited advertising agencies. Frequency discount: 5% for 6 months; 10% for 12 months paid in advance.

READER RATE: For individuals with a personal item to buy or sell. 45¢ per word (including name and address). No minimum! Payment must accompany copy.

GENERAL INFORMATION: First word in all ads set in bold caps at no extra charge. Additional words may be set in bold caps at 10¢ extra per word. All copy subject to publisher's approval. **Closing Date:** 1st of the 2nd preceding month (for example, March issue closes January 1st). Send order and remittance to: Hal Cymes, **HiFi/STEREO REVIEW**, One Park Avenue, New York, New York 10016.

EQUIPMENT

WRITE for quotation on any Hi-Fi components: Sound Reproduction Inc., 34 New St., Newark, N.J. 07102, Mitchell 2-6816.

Hi-Fi Components Tape Recorders, at guaranteed "We Will Not Be Undersold" prices. 15-day money-back guarantee. Two year warranty. No Catalog. Quotations Free. Hi-Fidelity Center, 239 (HC) East 149th St., New York 10451.

FREE! Send for money saving stereo catalog #H8R and lowest quotations on your individual component, tape recorder, or system requirements. Electronic Values, Inc., 200 West 20th St., N.Y., N.Y. 10011.

KIT Experts—Dynaco Specialists—Kits at reasonable prices are our specialty. Also custom wired kits guaranteed to exceed factory standards at substantial savings. Beautiful handcrafted Walnut cases for complete Dynaco line, plus everything in audio. Kitcraft, Dept. HS-868, 738 Washington Avenue, Brooklyn, N.Y. 11238. MA 2-5230.

TAPE recorders. Hi-Fi components. Sleep Learning Equipment tapes. Unusual values. Free catalog. Dressner, 1523R Jericho Turnpike, New Hyde Park, N. Y. 11040.

LOW, Low quotes: all components and recorders. HiFi, Roslyn, Penna. 19001.

GOVERNMENT Surplus Receivers, Transmitters, Sniperscopes, Radios, Parts, Picture Catalog 25¢. Meshna, Nahant, Mass. 01908.

DON'T THROW YOUR OLD CARTRIDGE AWAY. Send us \$19.95 and any old cartridge. We will ship **PREPAID** any one of the following top rated elliptical diamond stereo cartridges **NEW:** Pickering V15AME3, XV15AT, Empire 888SE, Shure M55E, Shure M80ED (for Lab 80), M80ED19 (for Dual 1019). Write for lowest quotations all stereo components. **DEFA ELECTRONICS**, 2207 Broadway, New York, N.Y. 10024.

BUY Hi-Fi direct from England. Save up to 40%. Quad, A & D., Decca, S.M.E., Revox, Garrard, etc. Catalog \$1 Bill (\$2 Air Post) Goodwin Ltd., 7, Broadway, Wood Green, London, N.22.

KLIPSCH, Tannoy, Altec, Rectilinear, AR, Inc., Wharfedale, Dynaco, Sherwood, Kenwood, TEAC, UHER, Benjamin, Garrard, Audio Originals, Toujau, Superior Sound, 621 S. Main St., N. Syracuse, New York 13212.

GARRARD, DUAL, MIRACORD OWNERS factory authorized. Your changer restored to original mech. operating condition with six months warranty. \$25.50 postpaid. Ship unit to us and we will return C.O.D. Limited time offer expiring October 1st, 1968. Audio Servicercenter Inc., 963 East 233 St., Bronx, N.Y. 10466.

THE Price Is Right! Hi-Fi Components. J. Wright Co., 65-B Jensen St., East Brunswick, N.J. 08816.

VARNER'S PIANO SHOP. In business over 25 years. Impeccable reputation and knowledgeable audio advice. Low quotes with friendly, sincere service. Special: two AR2ax speakers, one ARX turntable, one AR Model A amplifier, one Shure V15 Type II cartridge, and Sherwood Model S-2300FET AM/FM tuner—\$620, not including freight. Box 215, Delaware, Okla. 74027.

DECCA/LONDON FFs Cartridges individually checked-guaranteed. Creighton Labs., Haven Pl., Linden, N.J. 07036.

ACOUSTIC RESEARCH, Dyna, Koss, Shure discount specialists. Write for free catalog. Stereo Component Systems Corp., 95 Vassar Street, Cambridge, Mass. 02139.

FOR SALE

SURVEILLANCE COUNTERMEASURES BROCHURE \$1.00. **ENGINEERING LABORATORIES**, BOX 1036, ANDERSON, INDIANA 46015.

WATCHES AND CHRONOGRAPHS—Import from Switzerland, save 50%. Color catalog. DFI, West Dennis, Massachusetts 02670.

PROXIMITY switch. Detects nearness of human body! Free information. Claremont Products, 860 Reed, Claremont North, Calif. 91711.

SURVEILLANCE EQUIPMENT, latest devices, also construction plans, free catalog. **FISHER ELECTRONICS**, Box 350, N. Miami Beach, Florida 33160.

ELECTRONIC Bargains—Diodes, Transistors, Tubes, Courses. Free Catalog—Immediate Shipment. Cornell, 4215-H University, San Diego, Calif. 92105.

DISPOSAL—\$80,000.00 hi-fidelity retail store inventory. New/used equipment: Ampex, Marantz, Fisher, others. Hewlett-Packard test equipment. Free-list—Marco Electronics, Box 336-C, Winter Park, Fla. 32789.

NEW Sensitive Treasure Metal Detectors. New low prices. Professional models from \$29.95 to \$129.50. Write for free catalog today. Jetco Electronics, Box 132-E, Huntsville, Texas 77340.

REGULATED Power Supply Range 3.6V to 18V 5A short circuit protection with schematic \$9.95. 115VAC 1000W photocell units \$4.95. Alphatronics, 14251 East Colfax, Aurora, Colorado 80010.

RADIO SUNGLASSES, sensitive 3 transistor circuit. Sturdy frames, great for beach, ballgames, etc. \$19.95 Postpaid . . . 3 Star, 152 W 42 St., Suite 536, New York, N.Y. 10036.

WHOLESALE components: Manufacturers and distributors only. Request free catalog on business letterhead. WESCOM, Box 2536, El Cajon, California 92021.

TAPE AND RECORDERS

BEFORE RENTING Stereo Tapes try us. Postpaid both ways—no deposit—immediate delivery. Quality — Dependability — Service — Satisfaction — prevail here. If you've been dissatisfied in the past, your initial order will prove this is no idle boast. Free catalog. Gold Coast Tape Library, Box 2262, Palm Village Station, Hialeah, Fla. 33012.

Hi-Fi Components Tape Recorders, at guaranteed "We Will Not Be Undersold" prices. 15-day money-back guarantee. Two-year warranty. No Catalog. Quotations Free. Hi-Fidelity Center, 239 (HT) East 149th St., New York 10451.

SCOTCH Recording Tapes. Tape Recorders. Catalog 10¢. Tower, Lafayette Hill, Pa. 19444.

RENT STEREO TAPES—75¢ week. Catalog. Art's Tape Service, 1613 1/2 North Mariposa Ave., Hollywood, Calif. 90027.

TAPEMATES makes available to you **ALL 4-TRACK STEREO TAPES—ALL LABELS**—postpaid to your door—at tremendous savings. For free brochure write: **TAPEMATES**, 5727 W. Jefferson Blvd., Los Angeles, California 90016.

CASH for your unwanted prerecorded tapes and LP recordings. Reder, 81 Forshay Road, Monsey, New York 10952.

RADIO YESTERYEAR. Complete broadcasts of all the old favorites. One Hour sample tape \$5. Catalogue \$1 (refundable). B. Charmer, Box 11, Highbridge Station, Bronx, New York 10452.

WHOLESALE — 4-8-track STEREOTAPES — Car, Home **PLAYERS**—CB, Recorders. **MUSICO**, Box 11045, Montgomery, Alabama 36105.

STEREO TAPES, Save 30% and up; no membership or fees required; postpaid anywhere U.S.A. Free 70-page catalog. We discount batteries, recorders, tape/accessories. Beware of slogans, "not undersold," as the discount information you supply our competitor is invariably reported to the factory. **SAXITONE**, 1776 Columbia Road, N.W., Washington, D. C. 20009.

RENT 4-track open reel tapes—all major labels—3,000 different—free brochure. Stereo-Parti, 55 St. James Drive, Santa Rosa, CA. 95401.

SCOTCH RECORDING TAPE, lowest prices **TAPE CENTER**, Box 4305, Washington, D.C. 20012.

TAPE RECORDER SALE. Brand new nationally advertised brands, \$10.00 above cost. Amazing discounts on stereo components. Arkay Electronics, 1028-A Commonwealth Ave., Boston, Mass. 02215.

AC/DC two speed capstan drive tape recorders. Exceptionally wide frequency range. 5" reel capacity. Complete with all accessories. **WITH WALNUT BASE!!! FULLY GUARANTEED!** \$55.00 postpaid. J.A.S. Co., Postbox 403, Queens, New York 11379.

I MIL, Highest quality Lowest Price Polyester splice free tape, instrument grade, 1800 feet 7" Reel & Box, \$1.89 prepaid. Certified Tapes, Inc., 610 Clayton Street, Orlando, Florida 32804.

RECORDS

HARD to find collectors LPs, like new. Lists 25¢. Records, Hillburn, New York 10931.

PROTECT YOUR LPs: Heavy poly sleeves for jackets 5¢; poly lined paper sleeves for LPs 10¢; round bottom inner sleeves 3 1/2¢; Record jackets white 20¢, colors 25¢; supplies for 45's. Minimum order \$5.00. Record Supplies, Hillburn P. O., New York 10931.

COLLECTORS JOURNAL—valuable data, varied record mart. Six issues—\$1.50. Record Research, 65 Grand Ave., Brooklyn, N.Y. 11205.

PROTECT YOUR RECORDS. Pure white, cardboard replacement covers, plastic lined inner sleeves with window, 78 and 45 covers, adjustable record holders. Free catalog, samples 50¢. Cabco, Dept. 120, 89 East Woodruff, Columbus, Ohio 43201.

SPECIAL INTEREST RECORDS AVAILABLE, PRODUCED BY THE EDITORS OF THE WORLD'S LEADING SPECIAL INTEREST MAGAZINES. SEND FOR FREE CATALOG. RECORD CATALOG-HF, ZIFF-DAVIS PUBLISHING COMPANY, ONE PARK AVENUE, NEW YORK, N.Y. 10016.

"**HARD To Get**" records—all speeds. Record Exchange, 842 Seventh Avenue, New York, N.Y. 10019.

RECORDS!!! 45 rpm—15¢; LP's \$1.00. Details \$2.00. Records, 129 Carol Avenue, Aberdeen, Maryland 21001.

UNBELIEVABLE rarities. Catalogue **FREE!** M.I.-T.M. 271 Autumn Avenue, Brooklyn, NY 11208.

OLDIES—45RPM. Original hits. Over 1500 available. Catalog 25¢. C & S Record Sales, Box 197, Wampsville, N.Y. 13163.

REPAIRS AND SERVICES

SPEAKER REPAIR. Hi-Fi, guitar, organ speakers reconed good as new at fraction of new speaker price. For details and Reconciling Center in your area write: Waldom Electronics, Inc., Dept SR, 4625 W. 53rd St., Chicago, Ill. 60632.

PINS, BUSHINGS, SCREWS Made To Order. 21225 Vandike, Warren, Michigan 48089.

CUSTOM RECORDING

CUSTOM Recording—Monaural, Stereo, Tapes, Discs. Mastering—all speeds—reasonable quotations. Son-Deane Records, Hartsdale, N.Y. 10530.

TUBES

RECEIVING & INDUSTRIAL TUBES, TRANSISTORS, All Brands—Biggest Discounts. Technicians, Hobbyists, Experimenters—Request **FREE** Giant Catalog and **SAVE!** **ZALYTRON**, 469 Jericho Turnpike, Mineola, N.Y. 11501.

AUTHORS' SERVICES

AUTHORS! Learn how to have your book published, promoted, distributed. Free booklet "ZD," Vantage, 120 West 31 St., New York 10001.

RUBBER STAMPS

RUBBER ADDRESS STAMP \$1.50. SIGNATURE \$3.50. FREE CATALOG. JACKSON, BOX 443-G, FRANKLIN PARK, ILL. 60131.

STAMPS

RUSSIA HIGH-VALUE COLLECTION. 32 different Russia—some over 50 years old! Commemoratives, Czarist Issues, Airmails. Catalog price \$2.99. Special Get-Acquainted Offer—all for only 10¢! H. E. Harris, Dept. GG-13, Boston, Mass. 02117.

WOW! 110 All Different Germany 10¢—Commemoratives, Airmails, High Values. Big catalog, Bargain lists also, fine stamps from our approval service, which you may return without purchases and cancel service at any time. Jamestown Stamp, Dept. A88EG, Jamestown, N.Y. 14701.

BUSINESS OPPORTUNITIES

INVESTIGATE ACCIDENTS: Earn to \$1000 monthly. Men urgently needed. Car furnished. Business expenses paid. No selling. No college education necessary. Pick own job location. Investigate full time or earn to \$8 hour spare time. Write for **FREE** information. No obligation. Universal Schools, CZ-8 6801 Hillcrest, Dallas, Texas 75205.

\$200.00 DAILY In Your Mailbox! Your Opportunity To Do What Mailorder Experts do. Free Details. Associates, Box 136-L, Holland, Michigan 49423.

I MADE \$40,000.00 Year by mailorder! Helped others make money! Start with \$10.00—Free Proof. Torrey, Box 318-N, Ypsilanti, Michigan 48197.

FREE BOOK "990 Successful, Little-Known Businesses." Work home! Plymouth-245H, Brooklyn, New York 11218.

INSTRUCTION

LEARN Electronic Organ Servicing at home. All makes including transistors. Experimental kit—trouble-shooting. Accredited NHSC, Free Booklet. Niles Bryant School, 3631 Stockton, Dept. A, Sacramento, Calif. 95820.

R.E.I.'s famous (5) week course for the First Class Radio Telephone License is the shortest, most effective course in the nation. Over 98% of R.E.I. graduates pass F.C.C. exams for 1st class license. Total tuition \$350.00. Job placement free. Write for brochure Radio Engineering Incorporated Schools, 1336 Main Street, Sarasota, Florida 33577—or 3123 Gillham Road, Kansas City, Missouri 64109—or 809 Caroline Street, Fredericksburg, Virginia 22401.

ASSOCIATE Degree in Electronics Engineering earned through combination correspondence-classroom educational program. Free brochure. Grantham Technical Institute, 1505 N. Western Ave., Hollywood, California 90027.

HIGHLY effective home study course in Electronics Engineering Mathematics with circuit applications. Earn your Associate in Science Degree. Free literature. Cook's Institute of Electronics Engineering, P.O. Box 36185, Houston, Texas 77036. (Established 1945).

WANTED

QUICKSILVER, Platinum, Silver, Gold. Ores Analyzed. Free Circular. Mercury Terminal, Norwood, Mass. 02062.

AMPEX F-44 cabinet wanted. Mfrs. standard model. Quote price including shipping. E. Goldstein, 5715 Ellsworth Avenue, Pittsburgh, Pa. 15232.

MOVIE FILMS

16mm **SOUND-Projectors, Films, New, Used for Sale, Free Catalog.** National Cinema, 333 W. 57 St., N.Y., N.Y. 10019.

PRINTING

FREE LITERATURE: 1000 Address Labels \$1.00, 1000 Business Cards \$4.95. Printing, Rubber Stamps. Jordan's, 552 West O'Connor, Lima, Ohio 45801.

PERSONALS

MAKE FRIENDS WORLDWIDE through international correspondence. Illustrated brochure free. Hermes, Berlin 11, Germany.

SPEECH diagnosis including Craig Recorder, \$48; Communications Research, Cortez, Florida 33522.

FREE Catalog low priced, high performance sub-miniature listen-in devices direct from manufacturer. Dealers included. Audiotronix-H, 156 Fifth Avenue, New York, N.Y. 10010.

PHOTOGRAPHY—FILM EQUIPMENT, SERVICES

SCIENCE Bargains—Request Free Giant Catalog "CJ"—148 pages—Astronomical Telescopes, Microscopes, Lenses, Binoculars, Kits, Parts, War surplus bargains. Edmund Scientific Co., Barrington, New Jersey 08007.

MEDICAL FILM—Adults only—"Childbirth" one reel, 8mm \$7.50, 16mm \$14.95. International H, Greenvale, Long Island, New York 11548.

WORLD'S largest buying guide for cameras and photo equipment, 800 illustrations, 176 pages, send 50¢ (deductible with order)—Olden Camera, 1265 Broadway, N.Y., N.Y. 10001.

HYPNOTISM

FREE Hypnotism, Self-Hypnosis, Sleep Learning Catalog! Drawer H400, Ruidoso, New Mexico 88345.

HYPNOTIZE SUCCESSFULLY—or money refunded! Complete illustrated course—including Self-Hypnosis \$1.00. Arthur Fowler, Box 4396, Woodbury, New Jersey 08096.

HYPNOTIZE SUCCESSFULLY! "Instantaneous—One Word—Against Will". Methods Exposed! Complete illustrated course including "Secret Nerve Pressure Technique—Self-Hypnosis"—10" Hypno-Disk. \$2.00. **RESULTS ABSOLUTELY GUARANTEED.** Fowler, Box 4396, Woodbury, N.J. 08096.

EDUCATIONAL OPPORTUNITIES

LEARN While Asleep, hypnotize with your recorder, phonograph. Astonishing details, sensational catalog free! Sleep-Learning Association, Box 24-ZD, Olympia, Washington 98501.

LEARN WHILE ASLEEP. Miraculously build Mind Power, achieve Self Confidence, improve Health, gain Success. Method 92% effective. Details free. ASR Foundation, Box 7021EG Henry Clay Sta., Lexington, Kentucky 40502.

GOVERNMENT SURPLUS

JEEPS Typically From \$53.90 . . . Trucks From \$78.40 . . . Boats, Typewriters, Airplanes, Multimeters, Oscilloscopes, Transceivers, Electronics Equipment, Used. 100,000 Bid Bargains Direct From Government Nationwide. Complete Sales Directory and Surplus Catalog \$1.00. Deductible First \$10.00 Order). Surplus Service, Box 820-L, Holland, Michigan 49423.

PLANS AND KITS

BUILD-IT-YOURSELF. Save big dollars, Transistor stereo amplifiers, Color organs, Speakers. Write Workshop, Box 87, Bethpage, New York 11714.

MISCELLANEOUS

WINEMAKERS: Free illustrated catalog of yeasts, equipment. Semplex, Box 7208, Minneapolis, Minn. 55412.

TEN Winemaking Recipes and Winemaking supplies catalog 10¢ Country Winemaker, Box 191E, RFD 1, Mattapoisett, Mass. 02739.

Deluxe HiFi/STEREO REVIEW MAGAZINE CASES

DESIGNED TO HOLD A FULL YEAR'S COPIES

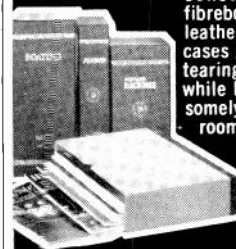

Constructed of reinforced fibreboard and covered in rich leatherette, these durable cases guard against soiling and tearing of your magazines while lending themselves handsomely to the decor of any room. The magazine cases are available with embossed gold lettering in either all black or attractive maroon back with black sides.

These decorative cases are just what you've been looking for to keep your copies of HiFi/Stereo Review in easy-to-find order.

\$3.50 ea., 3 for \$10, 6 for \$19
FULLY GUARANTEED

Ziff-Davis Publishing Co., Dept. SD
1 Park Ave., N.Y., N.Y. 10016

Please send me _____ HiFi/Stereo Review

Magazine Files as checked below:

- All black, gold embossed
 Maroon back, gold embossed/black sides

NAME _____

ADDRESS _____

CITY _____

STATE _____ ZIP _____

Enclosed is \$_____ at \$3.50 per case, 3 for \$10, 6 for \$19 (Quantity prices apply for combination orders of more than one title). Orders outside U. S. A. \$4.50 ea., 3 for \$13, 6 for \$25.

(Payment must accompany order)

HiFi Stereo Review SUBSCRIBER SERVICE

Please include an address label when writing about your subscription to help us serve you promptly. Write to: Portland Place, Boulder, Colo. 80302

CHANGE OF ADDRESS:

Please let us know you are moving at least four to six weeks in advance. Affix magazine address label in space to the right and print new address below. If you have a question about your subscription, attach address label to your letter.

TO SUBSCRIBE:

Check boxes below.

- New Renewal
 5 years \$21
 3 years \$15
 1 year \$6

SPECIFY:

- Payment enclosed—
You get 1 extra issue per year as a **BONUS!**
 Bill me later.

AFFIX LABEL

If you have no label handy, print OLD address here.

name
address
city
state
zip-code

please print

[Add 1 postage: \$1 per year outside U.S., its possessions & Canada.]
0592

name _____ please print

address _____

city _____

state _____ zip-code _____

HI FI/STEREO REVIEW ADVERTISERS' INDEX

READER SERVICE NO.	ADVERTISER	PAGE NO.
64	ABC Records Corp.	98
1	Acoustic Research, Inc.	2nd Cover, 37
2	Airex Radio Corporation	109
3	Allied Radio	83, 84
4	Altec Lansing, Division of LTV Altec, Inc.	48
	Ampex Corporation (Pre-Recorded Tape)	50
65	Ampex Corporation (Tape Recorders)	75
5	Audio Dynamics Corporation	89
	Audio Unlimited, Inc.	103
6	BSR (USA) Ltd., McDonald Div.	24
7	Benjamin Electronic Sound Corp—EMI Loudspeakers	47
8	Beseler Co., Charles	102
9	Bose Corporation	93
	Bozak, R. T.	6
103	British Industries—Garrard	2
101	British Industries—Wharfedale	54
10	Carston Studios	102
11	Cartridge Tape Club of America	10
12	Celanese Plastics Co.	113
13	Citadel Record Club	14
14	Columbia Records	79
	Columbia Tape Cartridge Service	1
15	Command Records	101
16	Defa Electronics	108
17	Delwyn	91
18	Deutsche Grammophon (DGG)	95
20	Dressner	113
60	Dual	7
	Dynaco, Inc.	32
7	EMI Loudspeakers	47
21	Elektra Records	81
19	Electro-Voice, Inc.	4th Cover
22	Elpa Marketing Industries, Inc., Perpetuum-ebner Div.	5
23	Elpa Marketing Industries, Inc., Watts Div.	85
24	Empire Scientific Corp.	12
25	Fisher Radio Corp.	25, 27, 29
26	Grundig Electronics Sales, Inc.	103
27	Harmon-Kardon, Inc.	39
28	Heath Company	30, 31
29	Hi-Fidelity Center	108
30	Honeywell Photographic Products	46

Classified Advertising 114, 115

READER SERVICE NO.	ADVERTISER	PAGE NO.
31	JBL International	11
32	Jensen Manufacturing Company	21
33	Kenwood Electronics, Inc.	22, 23
34	King Karol Records	12
35	Lafayette Radio Electronics	41
36	Leitz, Inc., E.	89
37	London Records	90
38	Marantz, Inc.	13
39	Martel Electronics	85
42	McIntosh Laboratory, Inc.	100
21	Nonesuch Records	81
43	Oxford Transducer Co.	42
41	Pickering & Company, Inc.	3rd Cover
44	Pioneer Electronics Corp.	45
45	RCA Victor Records	76
46	Rabson—57th Street, Inc.	109
47	Rectilinear	26
48	Rheem Roberts	104
49	Sansui Electric Co., Ltd.	53
100	Scott, Inc., H. H.	9
50	Sherwood Electronic Laboratories, Inc.	35
51	Shure Brothers, Inc.	19
52	Sony Corporation of America	43
53	Sony/Superscope, Inc.	110
54	Sound Reproduction	103
40	Stereo Corporation of America	104
55	Switchcraft, Inc.	28
56	Tandberg of America, Inc.	44
57	Teac Corporation	49
58	Toshiba America, Inc.	14
39	Uher by Martel	85
59	uniClub, Inc.	8
60	United Audio Products, Inc.	7
61	University Sound	15
62	Utah Electronics	97
63	Vanguard Records	87

HI FI/STEREO REVIEW PRODUCT INDEX

As an additional reader service, we list below, by classifications, the products advertised in this issue. If there is a specific product you are shopping for, look for its listing and turn to the pages indicated for the advertisements of manufacturers supplying that equipment.

CLASSIFICATION	PAGE NUMBERS
Accessories	91, 97
Amplification Systems	13, 30, 32, 37, 53
Cameras	46, 89, 102
Cartridges	12, 19, 3rd cover
Catalogs	83-84, 100
Multiple: Adaptors	28
Music Systems (Compacts)	25, 39

CLASSIFICATION	PAGE NUMBERS
Receivers, Stereo	23, 27, 30, 35, 41, 43, 45, 89, 103
Records	76, 79, 81, 87, 90, 95, 98, 101
Record and Tape Clubs	1, 8, 10, 14
Speakers and Speaker Systems	2nd Cover, 6, 9, 11, 15, 21, 26, 29, 42, 47, 48, 54, 93, 4th Cover
Tapes, Pre-recorded	50
Tape Recorders and Decks	44, 49, 75, 85, 104
Tuners	30, 32
Turntables and Changers	2, 5, 7, 13, 24, 37

The X factor in the new Pickering XV-15.

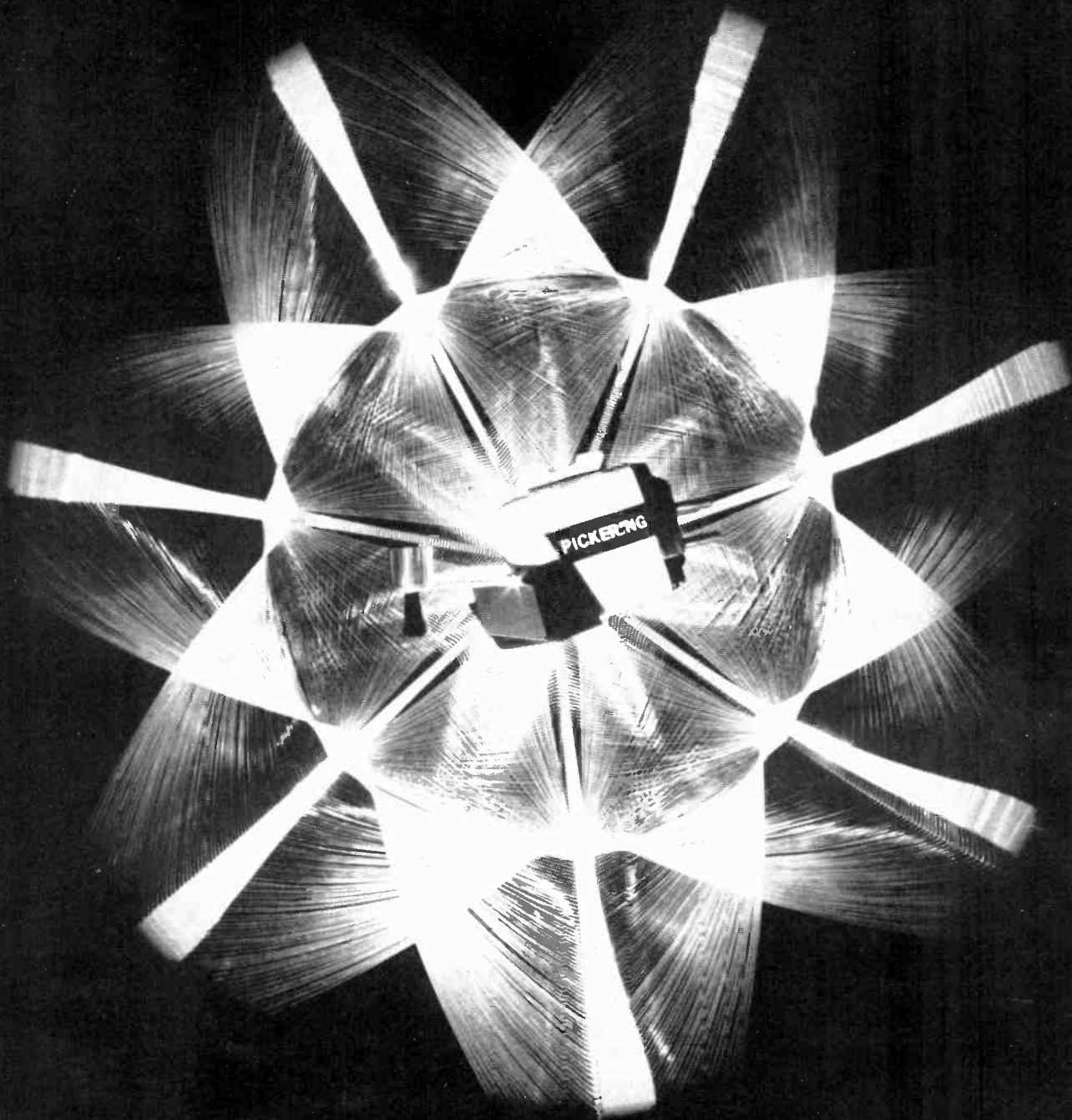

The X in the new Pickering XV-15 stands for the numerical solution for correct "Engineered Application." We call it the Dynamic Coupling Factor (DCF).SM

DCF is an index of maximum stylus performance when a cartridge is related to a particular type of playback equipment. This resultant number is derived from a Dimensional Analysis of all the parameters involved.

For an ordinary record changer, the DCF is 100. For a transcription quality tonearm the DCF is 400. Like other complex engineering problems, such as

the egg, the end result can be presented quite simply. So can the superior performance of the XV-15 series. Its linear response assures 100% music power at all frequencies.

Lab measurements aside, this means all your favorite records, not just test records, will sound much cleaner and more open than ever before.

All five DCF-rated XV-15 models include the patented V-Guard stylus assembly and the Dustamatic brush.

For free literature, write to Pickering & Co., Plainview, L.I., N.Y.

SM Dynamic Coupling Factor and DCF are service marks of Pickering & Co.

CIRCLE NO. 41 ON READER SERVICE CARD

When we put this
four layer voice coil
in the new E-V FIVE-A
we knew it would
sound better...

we never dreamed
it would lower
your cost of stereo
by \$94.00, too!

ⓔⓋ. The voice coil is the heart of any speaker. A coil of wire. It moves the cone that makes the music. And in most speakers, that's all it does. But in the new E-V FIVE-A we've found a way to make this little coil of wire much more useful. Instead of one or two layers of wire, we wind the E-V FIVE-A woofer coil *four* layers deep.

Voila!

Now the coil actually lowers the natural resonance of the 10" E-V FIVE-A woofer. And lower resonance means deeper bass with any acoustic suspension system.

In addition, with more turns of wire in the magnetic field, efficiency goes up. But it goes up faster for middle frequencies than for lows. This means we must reduce the amount of expensive magnet if we are to maintain flat response.

It's an ingenious approach to woofer design, and it works. E-V engineers point out that their efforts not only resulted in better sound, but also cut \$47.00 from the price of the E-V FIVE-A.

So now you can compare the \$88.00 E-V FIVE-A with speakers costing up to \$135.00 ... and come out \$94.00 ahead in the bargain for a stereo pair! The difference can buy a lot of Tschaikovsky, or Vivaldi, or even Stan Getz.

And after all, more music for your money is at the heart of high fidelity!

Hear the E-V FIVE-A at leading audio showrooms everywhere. Or write for your free copy of the complete Electro-Voice high fidelity catalog. It is filled with unusual values in speakers, systems, and solid-state electronics.

P.S. If you think the E-V FIVE-A woofer is advanced—you should hear the tweeter. But that's another story.

high fidelity systems and speakers • tuners, amplifiers, receivers • public address loudspeakers • microphones • phonograph needles and cartridges • organs • space and defense electronics

ELECTRO-VOICE, INC., Dept. 884F; 616 Cecil Street, Buchanan, Michigan 49107
CIRCLE NO. 19 ON READER SERVICE CARD

Electro-Voice®