

# HiFi/Stereo Review

APRIL 1964 • 50 CENTS

A SPECIAL  
ISSUE ON  
**BAROQUE  
MUSIC**

INCLUDING  
AN EXCLUSIVE  
RECORDING OF  
GLENN GOULD'S

*So You Want  
to Write a Fugue*

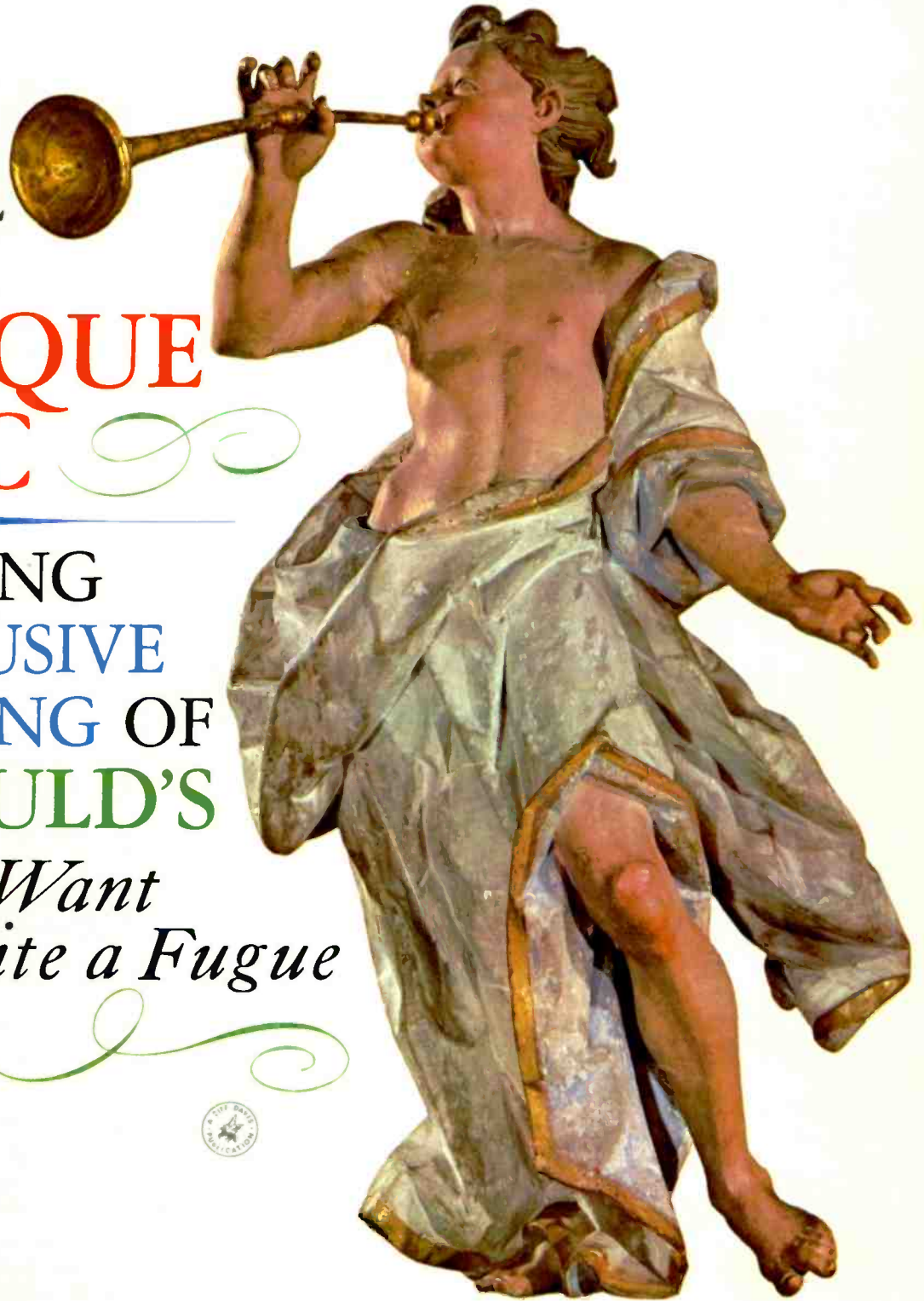

# er/Amplifier . . . ip you expect from Scott cted low price

the panel. The integrity and dedication in craftsmanship mean quality not just where it shows, but where it counts.

The 345 Tuner/Amplifier adds lustre to the proud Scott tradition. The real distinction, as with all Scott products, is that it will work well when new . . . and *continue to work well indefinitely*.

## UNIQUE 2 YEAR WARRANTY

Scott offers a unique two year warranty on all its products. This is one reason Scott re-

ceives innumerable unsolicited letters from delighted owners and why leading audio experts and critics give Scott products exceptional plaudits. *Audio* magazine called the Scott 340B "a top-notch tuner amplifier . . . in fact a top-notch tuner *and* a top-notch amplifier". *Electronics World* said "... the Scott 340 must certainly be classed as one of the finest integrated stereo tuner-amplifiers we have tested." The new Model 345 will merit equivalent praise and recommendation as a triumph even by Scott standards.

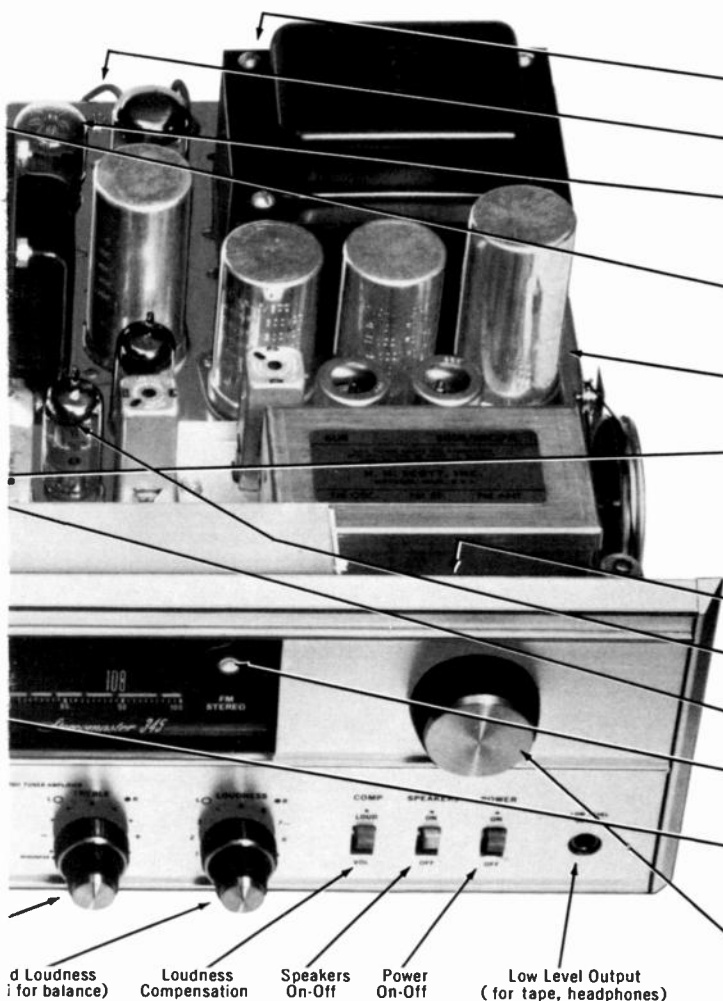

## FEATURES

- 1 Tape head input for any popular tape deck.
- 2 Lower-impedance tape output for full frequency response on tape recordings.
- 3 Unique Scott phase-inverter using compactron tubes for low distortion, cooler operation, and good overload recovery.
- 4 Thermodynamically designed vents assure constant air circulation over tubes for long, trouble-free life.
- 5 Aluminum chassis for high conductivity and hum suppression.
- 6 New Series-Gate multiplex section for amazing stereo separation. FM and multiplex circuits out of circuit when listening to phono or tape. (This assures low noise and cleaner tape recordings.)
- 7 Smooth operating ball-bearing flywheel drive.
- 8 Effectively four stages of limiting for quiet FM listening.
- 9 DC filaments on all preamplifier tubes for lowest hum.
- 10 Fast-acting stereo indicator instantly shows when you have tuned to a stereo broadcast. Works even in the monophonic control setting.
- 11 A separate tuning indicator reliably shows when you have tuned station properly. (Ordinary tuner-amplifiers combine this feature with the stereo indicator.)

d Loudness  
i for balance)

Loudness Compensation

Speakers On-Off

Power On-Off

Low Level Output (for tape, headphones)

Tuning

R 100 FOR MORE INFORMATION

# New 345 Tune the engineering leadership at an unexpected

The 345 is an exceptional accomplishment . . . even for Scott. It combines the features, the performance, the specifications of separate tuners and amplifiers costing nearly \$100 more. Achieving this rare combination of top performance and top value took many long months of painstaking research and around the clock work from the most imaginative engineering minds in high fidelity . . . The Scott Advanced Development Group.

Their achievement is based on an entirely new approach to tuner/amplifier design. This new instrument delivers better than

50-watts of power all the way down to the lowest frequencies where it is most needed for true, deep bass . . . its stereo separation is better than 30 db . . . FM sensitivity is better than 2.2 uv . . . yet the price is less than \$350.00.

## HANDSOME NEW STYLING

The 345 is an extraordinarily handsome piece of equipment. It will bring you a music center that adds quiet dignity and pride to any home. But, while styling is important, the real reason for buying Scott lies *behind*

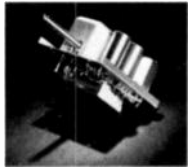

### AMAZING SENSITIVITY

Scott's new "pulse suppression limiting" circuit provides effectively four stages of limiting for improved suppression of impulses such as ignition noise, apartment house elevators and refrigerators. The 345 utilizes the same silver plated front end as the professional Broadcast Monitor

Scott tuner used in the now famous Telstar tests. Scott tuners have an exceptional reputation for reliability. This is why they are selected by the experts for critical off-the-air monitoring, broadcast relaying and other professional applications. Scott's high cross-modulation rejection guarantees that strong local stations will not blot out weak distant stations.

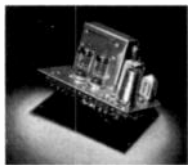

### LIFE-LIKE STEREO

The stereo separation of the Model 345 is probably the greatest of any combined tuner-amplifier ever produced. Scott-developed Time-Switching multiplex circuitry made stereo broadcasting a practical reality. The unquestioned superiority of this circuit led to its rapid adoption by most

other leading manufacturers of hi-fi equipment. Now Scott engineers have attained the theoretical limit of possible present performance with a new Series-Gate version of the Time-Switching circuit. Stereo separation of the 345 exceeds that of most FM stereo broadcasts! Once again Scott engineering innovations and leadership set a new standard for the industry.



### FULL POWER

Scott has developed a completely new circuit utilizing compactron tubes, described by the engineers as ". . . low impedance, symmetrical drive." This means that you get power enough for any speaker system, cooler operation, complete stability with any speaker load (or even with no load),

and virtually unmeasurable distortion. Many amplifiers can provide plenty of power at the midrange frequencies, but this is not where the power is needed. It is in the critical bass region that reserve power is essential. It is here that this new Scott circuit, combined with massive output transformers, provides the solid sound that separates the best amplifiers from more ordinary equipment.

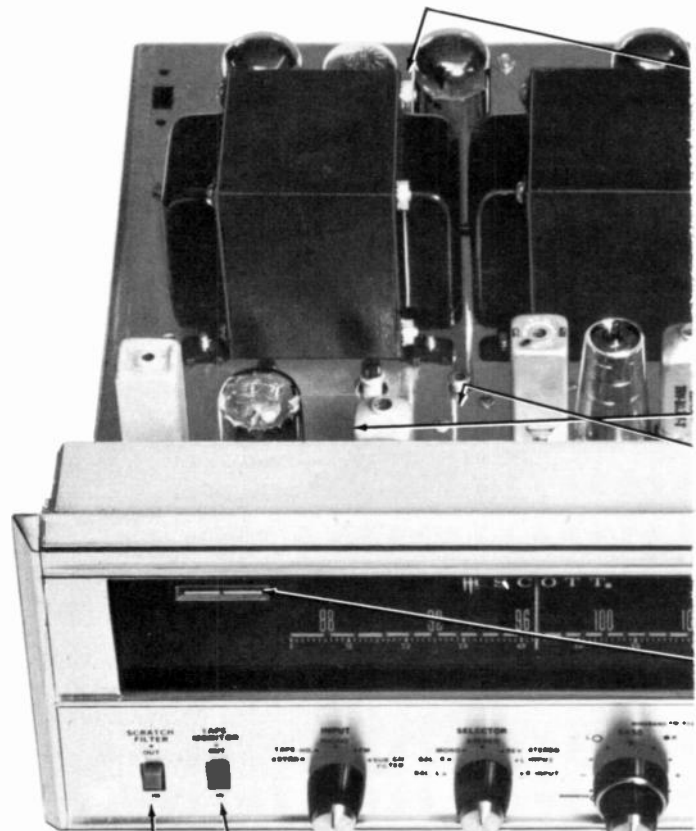

CONTROLS

Scratch Filter  
Tape Monitor

Input

Selector

Dual Bass

Dual Treble

Clutches (clutches)

CIRCLE READER SERVICE NUMBER

Setting by George Clark Associates, Boston



*A magnificent setting for the superb new Scott 345 tuner/amplifier. The classic simplicity of line graciously accents the finest decor, be it traditional or contemporary. At less than \$350, the 345 will truly delight you, your wife, and your wallet.*

# 3 remarkable engineering developments in the new Scott 345 Tuner/Amplifier give you more performance for more years at lower cost

1. Low Impedance, Symmetrical-Drive for more power, longer life, cleaner sound.
2. Series-gate time-switching multiplex for the ultimate in life-like stereo.
3. Pulse-suppression limiting for quiet, noise-free FM listening.



H. H. SCOTT INC., 111 POWDERMILL ROAD, MAYNARD, MASS. DEPT. 24504

Rush me complete details on the new 345 stereo tuner/amplifier. Be sure to include your new 1964 Guide to Custom Stereo.

NAME \_\_\_\_\_

ADDRESS \_\_\_\_\_

CITY \_\_\_\_\_ ZONE \_\_\_\_\_ STATE \_\_\_\_\_

Export: Scott International, 111 Powdermill Road, Maynard, Mass., TWX HIFI.  
Canada: Atlas Radio Corp., 50 Wingold Ave., Toronto.

## consider this...

Whatever the other components—most music systems today start with a Garrard Automatic Turntable!

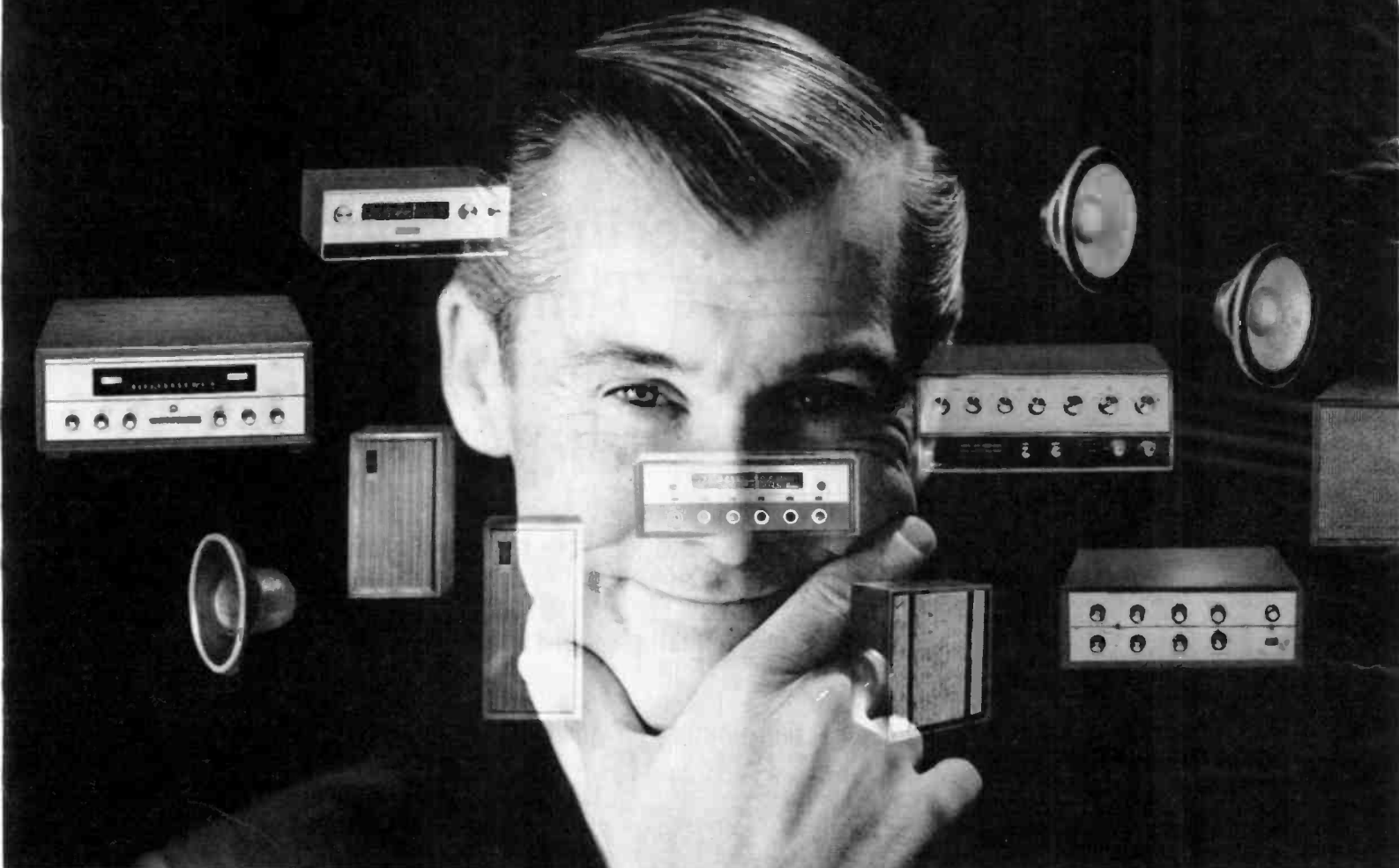

## What makes the Garrard so special?

Is it creative engineering, quality control, Garrard's 50 years of experience? Is it features?

Admittedly—the counterweight-adjusted tone arm; the heavy balanced turntable; the Laboratory Series® motor; the ability to track your choice of cartridge at the lightest specified pres-

sure; the convenience of single and automatic play, either at your service when you want it—all play their parts.

But a Garrard is more than the sum of such parts.

A Garrard is a pleasure to own.

A Garrard is an enduring source of pride and satisfaction!

This is why more dealers recommend Garrard, and more people are buying Garrard, than any other component!

There is a Garrard Automatic Turntable for every high fidelity system. Type A, \$84.50; AT6, \$59.50; Autoslim®, \$44.50. For literature, write department GD-124, Garrard, Port Washington, N. Y.



**Garrard**<sup>®</sup>  
WORLD'S FINEST

CIRCLE NO. 7 ON READER SERVICE CARD

# HiFi/Stereo Review

APRIL 1964 • VOLUME 12 • NUMBER 4

## THE MUSIC

- 32** THE FUGUE  
*An introduction to a pre-eminent musical form . . . .* FREDERIC GRUNFELD
- 37** THE BASIC REPERTOIRE  
*Bach's Magnificat in D . . . . .* MARTIN BOOKSPAN
- 41** THE STRANGE APPRENTICESHIP OF J. S. BACH  
*An iconoclast attacks Bach's popular image . . . . .* ROBERT OFFERGELD
- 47** A PORTFOLIO ON FUGUE BY GLENN GOULD  
*Editor's introduction by Robert Offergeld*
- 48** THE MUSIC OF PROTEUS  
*Notes on the subjective character of fugal form . . . . .* GLENN GOULD
- 51** SO YOU WANT TO WRITE A FUGUE  
*An editorial recording—words and music by . . . . .* GLENN GOULD
- 55** THE MAN BENEATH THE WIG  
*The physical reality behind a faded stereotype . . . . .* ROBERT OFFERGELD
- 58** IMAGES OF THE BAROQUE IN MUSIC  
*Essential recordings of Baroque music . . . . .* IGOR KIPNIS
- 58** IMAGES OF THE BAROQUE IN ART  
*Characteristic examples of the humanistic style . . . . .* CLIFFORD ROBERTS
- 67** BEST OF THE MONTH  
*Reviews of outstanding new releases*
- 104** ENGLISH BAROQUE POETRY ON RECORDS  
*A roundup of the best recordings . . . . .* PAUL KRESH

## THE EQUIPMENT

- 14** SOUND AND THE QUERY  
*Answers to your hi-fi technical questions . . . . .* LARRY KLEIN
- 24** AUDIO BASICS  
*Definitions, Part Three . . . . .* HANS H. FANTL
- 27** TECHNICAL TALK  
*Lab reports on the Sony TC-500 tape recorder  
and the EMI 319 speaker system . . . . .* JULIAN D. HIRSCH
- 66** INSTALLATION OF THE MONTH  
*Breakfront Stereo*

## THE REVIEWS

- 73** CLASSICAL
- 91** JAZZ
- 97** ENTERTAINMENT
- 107** STEREO TAPE

## THE REGULARS

- 4** EDITORIALY SPEAKING
- 8** LETTERS TO THE EDITOR
- 20** JUST LOOKING
- 116** ADVERTISERS' INDEX; PRODUCT INDEX

COVER: "ANGEL WITH TRUMPET," WOOD SCULPTURE BY AN UNKNOWN SOUTH GERMAN MASTER, CIRCA 1716, AUGSBURG MUSEUM. PHOTOGRAPHY BY PETER ADEIBERG, EUROPEAN ART COLOR SLIDE CO.

Copyright © 1964 by Ziff-Davis Publishing Company. All rights reserved. HI-FI STEREO REVIEW, April 1964, Volume 12, Number 4. Published monthly by Ziff-Davis Publishing Company at 131 South Wabash Ave., Chicago, Illinois 60605. Subscription rates: one year United States and possessions, \$5.00; Canada and Pan-American Union Countries, \$5.50; other foreign countries \$6.00. Second-class postage paid at Chicago, Illinois and at additional mailing offices. Authorized as second class mail by the Post Office Department, Ottawa, Canada, and for payment of postage in cash.

# HiFi/Stereo Review

**PUBLISHER**  
PHILLIP T. HEFFERNAN

**EDITOR**  
FURMAN HEBB

**MANAGING EDITOR**  
WILLIAM ANDERSON

**MUSIC EDITOR**  
ROBERT OFFERGELD

**TECHNICAL EDITOR**  
LARRY KLEIN

**ART EDITOR**  
BORYS PATCHOWSKY

**ASSOCIATE EDITOR**  
ROBERT S. CLARK

**CONTRIBUTING EDITORS**

CHRISTIE BARTER  
MARTIN BOOKSPAN  
HANS H. FANTEL  
WILLIAM FLANAGAN  
JOE GOLDBERG  
DAVID HALL  
NAT HENTOFF  
JULIAN D. HIRSCH  
GEORGE JELLINEK  
IGOR KIPNIS  
PAUL KRESH  
GENE LEES

**EUROPEAN EDITOR**  
FREDERIC GRUNFELD

**ADVERTISING SALES MANAGER**  
LAWRENCE SPORN

**ADVERTISING SERVICE MANAGER**  
ARDYS C. MORAN

**ZIFF-DAVIS PUBLISHING COMPANY**  
Editorial and Executive Offices (212 Oregon 9-7200)  
One Park Avenue, New York, New York 10016  
William B. Ziff, Chairman of the Board (1946-1953)  
William Ziff, President  
W. Bradford Briggs, Executive Vice President  
Herschel B. Sarbin, Vice President and General Manager  
M. T. Brennan, Jr., Vice President and Treasurer  
Walter S. Mills, Jr., Circulation Director  
Stanley R. Greenfield, Vice President  
Phillip T. Heffernan, Vice President  
Midwestern & Circulation Office (312 Wabash 2-4911)  
431 South Wabash Avenue, Chicago, Illinois 60605  
Advertising: Jerry Sweeney  
Western Office (213 Crestview 4-0265)  
9025 Wilshire Blvd., Beverly Hills, Calif. 90211  
Western Advertising Manager: Bud Dean  
Foreign Advertising Representative  
D. A. Goodall Ltd., London, England

**SUBSCRIPTION SERVICE:** All subscription correspondence should be addressed to HiFi Stereo Review, Circulation Department, 434 South Wabash Avenue, Chicago, Illinois 60605. Please allow at least six weeks for change of address. Include your old address, as well as new—enclosing if possible an address label from a recent issue.  
**EDITORIAL CONTRIBUTIONS** must be accompanied by return postage and will be handled with reasonable care; however, publisher assumes no responsibility for return or safety of art work, photographs, or manuscripts.

Member Audit Bureau  
of Circulations



## EDITORIALLY SPEAKING

by FURMAN HEBB

I would imagine that by the time you read this, you will have already turned to page 51 to examine the paperbase editorial recording that is included in this issue. This is an important milestone in the life of HiFi/STEREO REVIEW, and, indeed, a noteworthy one in the history of magazine publishing. This is not only the first time a music magazine has included a recording in its pages, but one of the few times any publication has done so.

The idea of publishing a recording was first considered about a year ago, when Music Editor Robert Offergeld was researching an article about the Canadian pianist Glenn Gould. (The article appeared in the June 1963 issue.) In the course of his investigations, Mr. Offergeld saw Mr. Gould's CBC television program illustrating aspects of the fugue. The high point of the program was an entertaining and instructive fugue (written by Mr. Gould) about—of all things—writing a fugue. Mr. Offergeld was so taken with the piece that he asked permission to print it in HiFi/STEREO REVIEW, and Mr. Gould assented with enthusiasm. Exploration of the best means of presenting the fugue soon suggested that it be done on an actual paperbase recording—and in a special issue devoted to Baroque music. Mr. Gould volunteered to write an article about fugue to accompany the recording, and Columbia Records graciously agreed to rerecord Mr. Gould's composition specially for HiFi/STEREO REVIEW.

Other facets of the projected Baroque-music issue then began to fall into place. Mr. Offergeld had been working for some time on a re-examination of the genius of Johann Sebastian Bach, and had, in doing so, run across some little-known but fascinating material relating to Bach's physical appearance: here were two more articles for a Baroque issue. Igor Kipnis, our regular reviewer of Baroque recordings, agreed to do an article that would discuss general aspects of Baroque music and the best available recorded examples of it. For our front cover, Peter Adelberg, a New York photographer, was engaged to photograph a Baroque statue of an angel trumpeter in Augsburg, Germany. After much scheming and scheduling, the myriad other pieces of our Baroque jigsaw puzzle were finally fitted into place. The result of our efforts you now hold in your hands. At this point, we can only say, a little out of breath, that we hope you like it.

\*\*\*\*\*

Coming in May's HiFi/STEREO REVIEW—On Sale April 20

**THE "BASIC REPERTOIRE"  
BROUGHT UP TO DATE: PART ONE**

**THE LEGENDARY JEAN DE RESZKE**

**ENGINEERING OPINION ON TRANSISTORIZED HI-FI  
ROUNDUP OF TRANSISTORIZED HI-FI EQUIPMENT**

\*\*\*\*\*

HiFi/STEREO REVIEW





INTRODUCING  
THE  
INCOMPARABLE  
CONCERTONE  
CARAVELE

CONCERTONE  
REVERSE-O-MATIC

◀ FAST      FAST ▶      RECORD      ◀ OPERATE ▶      STOP

PULL ON      PULL TO RECORD      PULL TO RECORD      PULL FOR ADD-O-MATIC/ECHO

A      MIC      REL.      MIC      REC.      B

OUT. LEVEL      REL. LEVEL      REC. LEVEL      OUT. LEVEL

RECORD OVER  
Transcript

And beyond compare it is. There's simply no other way to describe the new Caravelle. It's unique in the stereo tape recorder field. Only the Caravelle has six heads. (Lets you record or play in both directions continuously without flipping reels.) Reverse-o-matic® plays any tape automatically to and fro for as long as you wish. Simple, too. Easy push button operation. Built-in echo control, sound

on sound control, twin speakers, three motor system, center capstan drive. And there's more. In fact, we have a brochure crammed with facts. Send for it. You'll be amazed that the incomparable Caravelle gives you so much for less than \$399. For details and name of nearest dealer write to Concertone, Box 3227, South El Monte, California.

**CONCERTONE** 

# The easy way to own three top-rated components.

## **“The power amplifiers**

of the Fisher 500-C were noteworthy for their output, bandwidth, and low distortion.”

— HiFi/Stereo Review, January, 1964

## **“An audio control center**

. . . in addition to the usual complement of audio controls . . . enables the user to operate, and control, five speaker systems at the same time; truly an exciting prospect for audiophans . . .”

— Audio, December 1963

## **“The FM tuner,**

featuring the ‘Golden Synchrode’ front end, is . . . among the top ranks of FM tuners in regard to sensitivity.”

— Electronics World, February, 1964

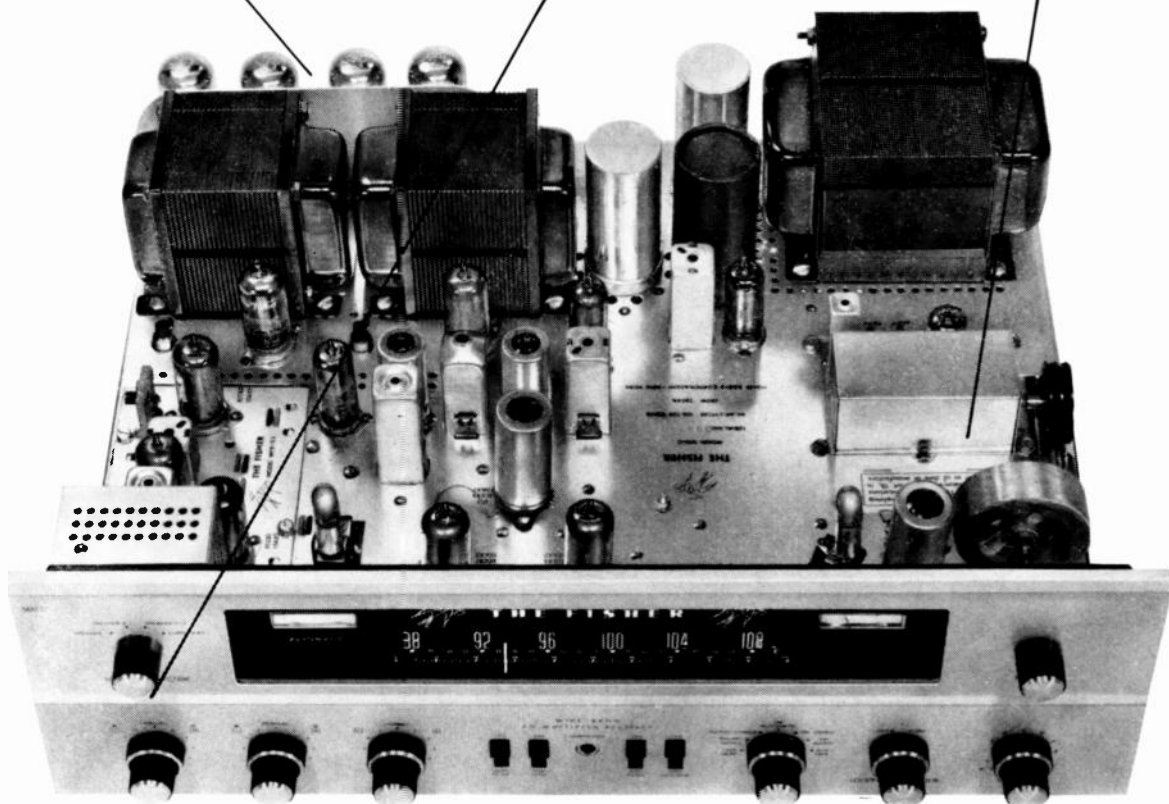



"The Fisher 500-C incorporates a 75-watt (IHF) stereo amplifier, an FM-stereo tuner, and an audio control center all on one 36½-lb. chassis," says the 'Equipment Profile' column of *Audio*. And, it should be added, the entire unit measures only 17½" wide by 5¾" high by 13½" deep. That means you can have all of the electronics of an advanced stereo system in less space than you need for a dozen books.

"The FM tuner is rated at 1.8 microvolts IHF usable sensitivity . . . The Fisher GOLDEN SYNCHRODE\* front end uses a low-noise triode RF amplifier and a dual-triode oscillator-mixer. A double-tuned RF transformer (not often found in home FM receivers) achieves excellent rejection of images and other spurious signals. There are four IF stages (which also serve as limiters) and a wide-band ratio detector. Because of the excellent stability of the front-end circuits, AFC is not needed . . . Stereo separation was excellent, exceeding 30 db between 90 cps and 9,500 cps, and reaching 42 db in the 1,000 cps region. Like all the Fisher tuners I have tested, the Model 500-C had no detectable warm-up drift, and its FM hum level measured as low (-61.5 db) as my test equipment would check." (Julian D. Hirsch in *HiFi/Stereo Review*.)

"The most convenient feature is automatic switching between stereo and mono FM reception; all one does is tune in an FM station and the 500-C does the rest: If the broadcast is monophonic, the receiver sets itself for monophonic playback; if the broadcast is stereo, the receiver automatically switches to stereo playback, and turns on a light to tell you about it." (*Audio*.) This is accomplished by the famous STEREO BEACON\*, a Fisher invention.

"A headphone jack is located on the front panel, with suitable level pads so that stereo phones will not be overdriven by the amplifiers . . . The receiver has a unique switching system for use with a three-head tape recorder . . ." (*Electronics World*.) The latter is the exclusive Fisher DIRECT TAPE MONITOR\*, which permits both recording and playback with full use of all applicable controls and switches—without any change in cable connections.

"The audio section is rated at 75 watts total IHF music

power or 60 watts total continuous output with both channels driven. We measured the continuous output as . . . 70 watts with 1% distortion . . . All in all, the unit proved to be a top-notch stereo receiver, just about as sensitive as they come, and with amplifiers of sufficient quality and power output to do justice to any type of speaker systems." (*Electronics World*.)

". . . It is our opinion that one would have to pay considerably more to get performance equal to the 500-C in separate components." (*Audio*.)

The Fisher 800-C will be preferred by those who live in areas where AM stations are still an important source of music. It is completely identical to the 500-C except for including, in addition, a high-sensitivity AM tuner section with adjustable (Broad/Sharp) bandwidth plus a ferrite-rod AM antenna.

The Fisher 400 is in all important respects similar to the 500-C, with slightly lower power output, at substantially lower cost.

Prices: The Fisher 500-C, \$389.50. The Fisher 800-C, \$449.50. The Fisher 400, \$329.50. Walnut or mahogany cabinet for any model, \$24.95. All prices are slightly higher in the Far West.

\*PAT. PENDING

**FREE! \$1.00 VALUE!** Mail this coupon for your free copy of the new 1964 Fisher Handbook, a lavishly illustrated 52-page reference guide to custom stereo. It includes complete data and specifications on all Fisher high fidelity components.

Fisher Radio Corporation  
21-40 44th Drive  
Long Island City, N.Y. 11101

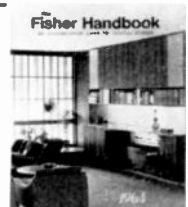

02401

Name \_\_\_\_\_

Address \_\_\_\_\_

City \_\_\_\_\_ State \_\_\_\_\_

OVERSEAS RESIDENTS WRITE TO FISHER RADIO INTERNATIONAL, INC., LONG ISLAND CITY, N.Y. 11101. CANADIAN RESIDENTS WRITE TO TRI-TEL ASSOCIATES, LTD., WILLOWDALE, ONT.

# The Fisher

Every performance comes alive on *allegra* by Grommes . . . music you can almost see.



*allegra 106* (illustrated above) FM-AM Stereo Tuner..... \$119.95\*

*allegra 25* 25 watt Stereo Amplifier... \$ 89.95\*

*allegra 40* 40 watt Stereo Amplifier... \$119.95\*  
\*less case

Write Grommes for complete information and address of your local dealer.

**Grommes**

Division of Precision Electronics, Inc.  
9101 King Street, Franklin Park, Illinois

*allegra*  
means  
lively



# LETTERS TO THE EDITOR

## High-Style Monteverdi

● Igor Kipnis' review of the Cambridge release of the Old North Singers' performance of Monteverdi's *Messa a 4 Voci* (November) puzzled me—what did he mean when he cited "a generally apparent lack of Monteverdi's high neoclassical style," and noted that the performance suffers from "fast pacing"? I auditioned this disc rather carefully, and have also heard this group perform the Monteverdi work, among others. I would like to know how Mr. Kipnis applies the term "neoclassical" to Monteverdi, and why the pacing bothers him.

SYDNEY McEACHERN  
Boston, Mass.

*Mr. Kipnis replies: "The stile rappresentativo, originated by the Florentine reformers in the closing decades of the sixteenth century, was based, they contended, on Platonic theories and adulation of classical Greek music—which, of course, was completely unknown at the time. They considered their emphasis on 'word, rhythm, and then tone, and not the other way around,' as Caccini put it, to be a neoclassical reform. Monteverdi followed and expanded this school's practices in both his secular and sacred music.*



*In his liturgical works, the 'affection' or stylized emotion was derived from the drama of the liturgical action. The emphasis in performance should therefore be on the text, through declamation and affective accentuation; on the shifting tonalities; and on the intruding dissonances, which are a hallmark of Monteverdi's style. On the recording in question, Mr. Fesperman's excellent chorus performs in a polyphonic manner more appropriate to Palestrina than to Monteverdi. This style, which Monteverdi consciously avoided, consists musically of harmonic movement of large blocks of sound and textually of ascetic restraint in emotion.*

*"Regarding the tempos adopted by the Old North Singers, they seem to me throughout too rapid to catch the subtlety of Monteverdi's dramatic musical setting. Interested readers might listen to the recent all-Monteverdi recording by the Choir of the Carmelite Priory, London (L'Oiseau-Lyre SOL/OL 263), under George Malcolm's direction. It illustrates, better than any verbal explanation, all of the points I have mentioned."*

## Record-Cleaning

● Hell hath no fury like a woman scorned, and few scorned women have the screeching wrath of an executive vice-president, such as Mr. H. A. Bodkin of Walco Electronics, who begins his February letter by noting that his firm is a "sporadic" advertiser and concludes with a paragraph that delicately threatens blacklisting.

Mr. Milder, whose article in the November issue indicated something less than total enchantment with Walco's product, could not possibly be more in the right, whether he has a degree in chemistry or not.

I am not even a sporadic advertiser in your magazine, nor do I intend to be. However, I will stack my qualifications as an unprejudiced empiricist (whatever that is) against Mr. Bodkin's any day. I do have a degree in chemistry, and am daily involved in technology more complex than Mr. Bodkin is likely to encounter. I not only would not use Walco's product, I wouldn't even give it to someone as retaliation for some grievance.

It's a sad thing to contemplate: Mr. Milder's humble honest opinion stacked against the battery of technologists, chemists, and assorted other scientists under Mr. Bodkin's command.

Let us hope that HIFI/STEREO REVIEW will never again expose us to skeptical comment concerning a potential, or even a sporadic, advertiser. Mercy, no!

C. ERWIN, M.D.  
Chicago, Ill.

● We should all be grateful for Mr. Bodkin's letter in the February issue. At last we have the truth about record-cleaning. Mr. Bodkin's statement was a most welcome antidote to Mr. Milder's "piece of shoddy journalism combining truths, half-truths, and downright distortions." It is indeed unfortunate that Mr. Milder presumed to write such an article without having doctorates in both chemistry and physics.

(Continued on page 10)

One-year subscriptions to HIFI/STEREO REVIEW may be purchased in Australian pounds (2/16); Belgian francs (310); Danish kroner (433); English pounds (2/4/3); French francs (311); Dutch guilders (23); Indian rupees (311); Italian lire (3,900); Japanese yen (2,100); Norwegian kroner (45); Philippine pesos (25); South African rand (4.50); Swedish kroner (33); Swiss francs (27); or West German marks (25). Ziff-Davis Publishing Company also publishes *Popular Photography*, *Popular Electronics*, *Electronics World*, *Popular Boating*, *Car and Driver*, *Flying*, *Modern Bride*, *Amazing* and *Fantastic*.

HIFI/STEREO REVIEW

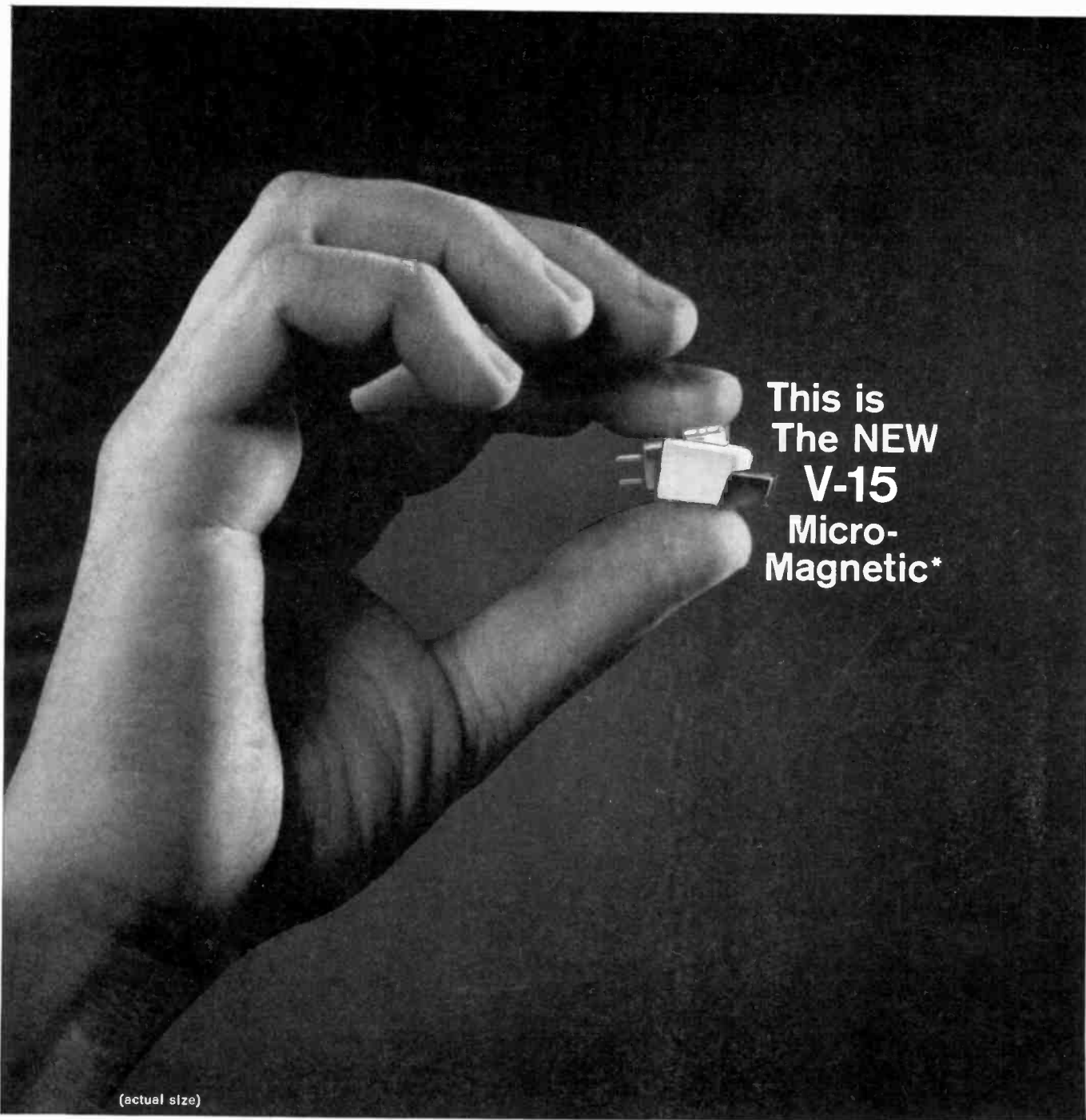

This is  
The NEW  
V-15  
Micro-  
Magnetic\*

(actual size)

## PICKERING'S NEW SUPER-LIGHTWEIGHT PICKUP

Here's a magnetic cartridge that's radically different. You can hear the difference. You can see the difference. Pick up the V-15. Note its lightness—only 5 grams. Perfect for low mass tone arm systems. The V-15, because of its high compliance, high output and rugged construction can be used in either manual turntables or record changers. Hear how it outperforms pickups two and three times its size. A revolutionary new magnetic structure provides an exceptionally flat response (20 cy to 20 KC), 7.5 mv per channel output at standard recording levels, low IM and harmonic distortion with 15° vertical tracking angle.

Now, take a close look. See how Pickering's exclusive "Floating Stylus" and patented replaceable V-Guard assembly protects your record and diamond as it plays.

See the V-15. Hear the V-15. Your local Pickering dealer has it.

FOR THOSE WHO CAN **HEAR** THE DIFFERENCE

Pickering and Company, Inc., Plainview, New York.

# Pickering

\* Trade Mark of Pickering and Co., Inc.



*This album will  
reveal the full  
potential of  
your stereo  
equipment*

Not since PERSUASIVE PERCUSSION  
has there been a record with  
such EXPLOSIVE musical impact as  
**ROME 35/MM**

Remember how Command Records  
created a whole new field of musical  
recordings with PERSUASIVE PER-  
CUSSION?

Remember how Command Records re-  
vealed previously undreamed of poten-  
tialities in realistic, true-to-life sound  
reproduction in its first album recorded  
on Stereo 35mm film?

Enoch Light was the producer behind  
both these milestones in the musical and  
technological advance of recording.

And now . . . with ROME 35/MM . . .  
Enoch Light has moved ahead again.

ROME 35/MM is the ultimate mixture  
of:

. . . the great musical creativity that  
went into PERSUASIVE PERCUS-  
SION starring Terry Snyder and pro-  
duced by Enoch Light

. . . the very latest and most advanced  
technical achievements of the engineers  
who developed Stereo 35mm

. . . plus the everlastingly gorgeous mel-  
odies of the most romantic country in  
the world, Italy

. . . played by the conductor who has cre-  
ated an entire new concept of musical  
excitement and adventure, Enoch Light.

ROME 35/MM is one more reason why  
COMMAND is the most exciting name  
in stereo recording.

**SELECTIONS INCLUDE:**

O SOLE MIO; VIA VENETO; ARRIVEDERCI, ROMA;  
PER TUTTA LA VITA (I Want To Be Wanted);  
TANGO DELLE ROSE; 'NA VOCE, 'NA CHITARRA,  
E'O POCO 'E LUNA; SCALINATELLA (Stairway To  
The Sea); PARLAMI D'AMORE, MARIU' (Tell Me  
That You Love Me); ANNA; CIUMACHELLA (from  
"Rugantino"); NON DIMENTICAR (Don't Forget);  
NINA.

AVAILABLE IN STEREO,  
MONAURAL AND 4-TRACK TAPE

Write for FREE full color  
brochure of all COMMAND releases



1501 BROADWAY, NEW YORK 36, N.Y.

CIRCLE NO. 63 ON READER SERVICE CARD  
10

Mr. Bodkin states that "the type of article written by Mr. Milder, which pitches a particular pet product, is not in the interest of your readers. It certainly is not in the interest of your advertisers, present and potential." In the first place, Mr. Bodkin might have better protected his interests if he had hired an ad man to help him write a less obvious letter. In the second, I think Mr. Milder's article was properly in the interest of your readers, as are all of his honest, informed, and objectively written articles. The anti-static liquids and dust cloths are, in my experience, ineffective in keeping records free of dust. Incidentally, Mr. Milder did more than "pitch a particular pet product." He mentioned a number of products as being effective in cleaning records.

Of course, Mr. Bodkin's statement that Mr. Milder's article "certainly is not in the interest of your advertisers, present and potential" is a threat that he may deprive you of his business. Bankruptcy is just around the corner. But let me add my own threat: all the advertising in the world is worthless if it is not read, and your magazine will have no readers if it caters to its advertisers. HiFi/STEREO REVIEW is much more than merely a "supplement to the music and recording industry," as Mr. Bodkin calls it. HiFi/STEREO REVIEW performs a vital service in trying to keep its readers informed about the technical aspects of high fidelity. Its record critics help the reader to select worthy recordings. I don't agree with them in every case, but they have directed me to many fine recordings.

No, Mr. Bodkin, HiFi/STEREO REVIEW's primary obligation is not to you, but to its readers.

JAMES L. RAUCH  
Chicago, Ill.

*Amen, Brother Rauch.*

**De Gustibus**

● In your December issue was a review of "Bach's Greatest Hits," by the Creative Swingle Singers, who present Bach in swing versions. It seems to me that anyone who would intentionally jazz up Bach, or, for that matter, the great works of any composer, is either impossibly ignorant or insane. I cannot understand why fourth-rate crackpots feel the urge to drag great music down to their levels. It is sacrilegious! Why can't people leave music the way it's written—as the composer intended it?

JIM CLARK  
Anniston, Ala.

● I find "Bach's Greatest Hits," by the Creative Swingle Singers, one of the most delightful records I possess. It is very seldom that I come across a record that gives me as much pleasure as this one. I hope this letter will encourage Mr. Swingle and Philips to make more records like this one. One dozen will not

be too many, considering the almost inexhaustible source in Bach's compositions. Good luck and congratulations to both Mr. Swingle and Philips.

DAVID FONSECA  
Chattanooga, Tenn.

**More on Bandwidth**

● Leon Kuby and I have been having a series of letters concerning our conflicting views on amplifier bandwidth. In his latest message (February HiFi/STEREO REVIEW), Mr. Kuby tries to show that I have inconsistencies and errors in my thinking. Unfortunately, in this attempt to discredit my argument, he has completely ignored the points which should decide the issue.

Originally, Mr. Kuby made the statement that equipment which had a response of 200 kc and higher "sounded better" because such response permitted excellent reproduction of square waves. He claimed that this, in turn, indicated that the equipment would have audibly better transient response.

I pointed out that no program material can be played back without exhibiting a falling response about 20 kc, due to the pre-emphasis and de-emphasis used in the production of recordings and broadcasts. Because of this, greatly extended amplifier bandwidth could not affect the sound. I mentioned that we had found that a bandwidth of 10 cps to 40 kc was adequate to cover the range in which sound is affected. I have no objection to



wide bandwidth—in fact, our Dynaco equipment generally has wide bandwidth—but I object to using ultrawide bandwidth as a sales and advertising point when it is a rather useless attribute.

Again, I repeat my offer to Mr. Kuby to make a controlled listening test. I do not accept his claims that he has made these tests and found that "broadband, low-distortion equipment always sounded better." He is merely saying that not all equipment sounds the same. This is not the question at issue, which is whether wide bandwidth makes an amplifier sound better.

I suggest that Mr. Kuby put his listening tests on a scientific basis—a basis in which all factors are held constant except the one under observation, the bandwidth. Mr. Kuby has made the mistake of comparing one amplifier with another.

*(Continued on page 12)*

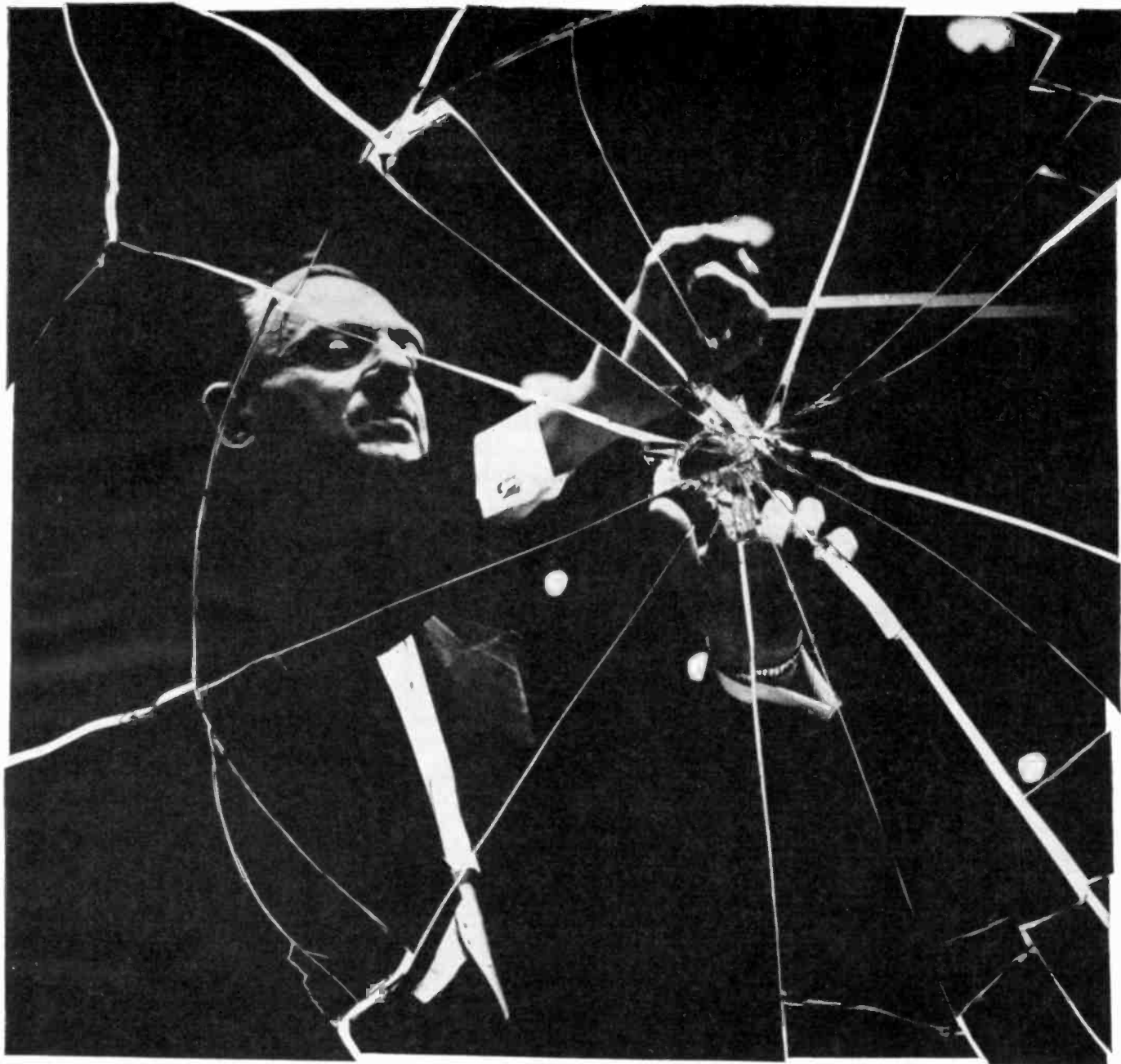

## *Smashed sound in your symphony?*

*...then "bargain" recording tape's no bargain!*

How does *cheap* recording tape get that way? It may be made cheap to sell cheap. Or it may become cheap because the maker goofed on quality, then sells the tape at cut-rate prices under unknown names. Dangers for audiophiles: Poor tape-to-head contact that causes losses or variations in frequency response. Background hiss. Squeal from poor tape lubrication. Or worse—abrasive wear to your recorder. In short, no bargain at all!

What to do? Easy. Pick SCOTCH® BRAND Recording Tapes and make crystal-clear recordings a certainty. These tapes must pass a battery of quality tests that bargain tapes just couldn't—over 100 in all to earn their "SCOTCH" BRAND.



Uniform, high-potency oxides permit thinner, more flexible coatings with this result: Intimate tape-to-head contact, sharp resolution, identical full-frequency sensitivity, inch after inch, tape after tape. Exclusive lifetime Silicone lubrication protects against head and tape wear, assures smooth squeal-free tape travel. Complete selection—from standard to triple tape lengths (up to 6 hours recording time at 3¾ ips). *See your dealer. Ask to see the new "SCOTCH" Self-Threading Reel. And remember . . . on "SCOTCH" Recording Tape, you hear it crystal clear.*

Magnetic Products Division **3M** COMPANY

"SCOTCH" AND THE PLAID DESIGN ARE REG. TMS OF 3M CO., ST. PAUL 19, MINN. © 1964. 3M CO.

**A** is for 

**a faster lens** The new Honeywell Pentax H1a is equipped with a brilliant new 55mm f/2 six-element lens. Benefits to you: brighter viewing and focusing, added versatility under poor lighting conditions!

**A** is for 

**automatic diaphragm** Standard on the new H1a is a fully automatic, instant-open diaphragm with depth-of-field preview feature. Benefits to you: fewer missed pictures; viewing and focusing at full aperture, or taking aperture, as you choose.

**A** is for 

**automatic counter reset** On the new H1a, the exposure counter returns to zero when you reload. Benefits to you: the counter always indicates the exact number of pictures you've taken, keeps constant check on film supply.

**A** is for   
the Honeywell  
Pentax H1a

a brand-new model which retains all of the traditional Pentax quality features: brilliant eye-level pentaprism viewing, shutter speeds to 1/500 sec., short-throw film advance lever, FP and X flash synchronization, "cocked" indicator, and rapid-rewind crank. These features plus classic, functional styling make the new H1a the outstanding single-lens-reflex value at just \$169.50. See it at your dealer's soon, or write for full-color folder to: John Thornton, Honeywell, Denver 10, Colorado.

**Honeywell**  
PHOTOGRAPHIC PRODUCTS

CIRCLE NO. 26 ON READER SERVICE CARD

As a consequence, perhaps instead of comparing varying bandwidths, he has compared high power vs low power; or transistors vs tubes; or triode vs pentode; and so on. Many factors may account for differences in sound, but to test the hypothesis that extreme bandwidth is important, Mr. Kuby should listen to *one* amplifier in which the bandwidth is varied. I will be happy to set up this test (with wagers if Mr. Kuby desires) to let him demonstrate his supersonic hearing acuity.

Aside from the fact that this discussion can be resolved by a listening test, there are some technical points to indicate that Mr. Kuby is letting his dogmatic belief in wide bandpass becloud the logic of his arguments.

He says that phase shift at supersonic frequencies will cause phase shift at audio frequencies, and consequent deterioration of tone quality. This is a subjective, unsubstantiated statement that is in conflict with many authorities. It has been demonstrated that phase-shifting a square wave does not change its sound. Whether the same situation exists with true transients (again I point out that Mr. Kuby mistakenly calls a square wave a transient) I do not know, as there seems to be no conclusive evidence on this point. However, the phase shift which already exists in all program material is so much greater than the amount in the audio spectrum of most better-quality amplifiers that the effect of the amplifier's phase characteristic might readily be masked.

Mr. Kuby also tries to separate frequency response from phase characteristic, as if these were independent qualities. He overlooks the fact that conventional amplifier circuitry is composed of elements which approach the classification of minimum phase-shift networks. In this case, the phase is predictable from the amplitude, and *vice versa*. The square wave is wholly defined by the frequency characteristic. Again I must point out that the problem of transient response cannot be solved by examination of the amplifier alone. It is the *system's* frequency and phase characteristics that affect the sound.

Mr. Kuby suggests that I am adhering to an old philosophy while he has adopted a new one. On the contrary, I used to subscribe to Mr. Kuby's philosophy, and I changed my viewpoint as I extended my experience. Perhaps I will change again, someday, when new evidence can be brought to bear on the subject. Meanwhile, however, I offer Mr. Kuby the chance either to convert me by demonstration or to learn for himself that a high-frequency cutoff at 50 or 60 kc is inaudible.

DAVID HAFLER, PRESIDENT  
Dynaco, Inc.  
Philadelphia, Pa.



**Bravo Magazine's  
high fidelity expert  
says:**



**“When the sky’s the limit”**

“If music is so deeply your passion that it makes you intolerant of all compromise and able to look unflinchingly at a four-figure price tag, you may enter that rarefied area of audio where nothing matters but the dedicated pursuit of perfection. Assuming your living room is spacious enough to let a sound system of such excellence be heard to full advantage, you will notice subtle transparencies of orchestral texture normally lost in reproduced music, an effortless authority in a sudden *sforzando*, and a feeling of unrestrained openness of sound that one critic has described as ‘sonic bloom’. The splendors of the orchestra pass virtually undiminished through this generous amplifier (Citation II B) which represents the ultimate frontier of the audio art, and the speakers (AR-3’s) are scrupulously respectful of the individual timbre and character of every voice

and instrument. This is the kind of system that enables you to tell a Baldwin from a Steinway, sight unseen.”

**HERE’S THE MUSIC SYSTEM**

Acoustic Research	
turntable and arm .....	\$ 68.00
The Stanton 481 cartridge .....	49.50
Harman-Kardon Citation A	
solid state preamplifier .....	350.00
Harman-Kardon Citation II B	
power amplifier (60 watts per	
channel) .....	269.95
2 Acoustic Research AR-3	
speakers (walnut) .....	450.00
	<u>\$1,187.45</u>

For complete literature on these and other fine components, write to Dept. 101, Stereo Components, 444 Madison Avenue, New York 22, N.Y.

# MOSLEY FR-1



Makes  
Every Room  
A Family Inter-  
tainment Center

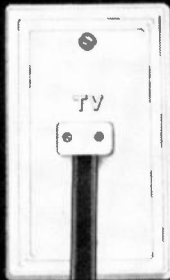

MOSLEY FR-1  
TV/FM DISTRIBUTION OUTLET

Mosley FR-1, TV/FM Outlet makes every room a "Family Entertainment Center". Designed to put true portability in Your TV/FM Distribution System. Up to eight outlets make a complete system without couplers or boosters. Easy to install. Available in ivory or brown polystyrene. FR-1 is perfect for home, apartment, motel use or anywhere the finest TV or FM reception is needed and at a "penny-pinching price".

Please send me information on how the Mosley FR-1, Distribution Outlet, will improve my TV/FM enjoyment.

Name \_\_\_\_\_

Address \_\_\_\_\_

City/State \_\_\_\_\_

**Mosley Electronics, Inc.**

4610 N. Lindbergh Blvd.  
Bridgeton, Mo. 63044

CIRCLE NO. 39 ON READER SERVICE CARD

14

# S&Q

## SOUND AND THE QUERY

PRACTICAL POINTERS  
ON THE INSTALLATION  
AND MAINTENANCE OF  
HOME MUSIC SYSTEMS

BY LARRY KLEIN

### Standing-wave Hum

**Q.** I have a most peculiar condition in my hi-fi setup. When I adjust the controls on my equipment and put on a record everything sounds fine. However, when I go over to the easy chair from which I do most of my listening, I hear hum. When I go back to the equipment cabinet, the hum disappears. Am I somehow neutralizing the hum when I'm near the equipment?

JAY HARRISON  
Knoxville, Tenn.

**A.** You aren't neutralizing the hum; it just isn't audible in the area of your equipment cabinet. Your listening chair is probably situated in an area of maximum sound pressure for a 60-cps standing wave. If you walk about the room you will notice areas where you can hear the 60-cps hum and others where you cannot. You may also notice the hum level differs depending upon whether you are standing up or sitting down. To cure the condition, I would suggest that you first go through the hum-minimizing procedures recommended in your equipment's instruction manuals. If this does not achieve sufficient hum-reduction, you had best move your listening chair to a hum-free area.

### Unbalanced Balance Controls

**Q.** I have to operate my amplifier (on both tuner and phono) with the balance control turned to about the 2 o'clock position. Can you tell me what's wrong?

AVERY MARKEL  
Quincy, Indiana

**A.** First of all, see if the mid-range level control (if present) on one of your speakers may not have been accidentally turned down. Unlike the tweeter control, the mid-range—sometimes called "presence"—control also affects the loudness of the speaker. (I assume, of course, that you are using speakers of the same make and model.) Next check the input level controls of your power amplifier to determine if they are set for equal output from the two channels. If neither of the above factors is responsible for your problem, then it is probable that your problem lies in the relative gain of the two channels. Since your balance control is not offset severely, it may be that normal gain variation between the right and left channels of your

pre-amplifier and basic amplifier are responsible. For example, if the right channels of both the pre-amplifier and the power amplifier are slightly low, the total effect could result in an audibly lower gain in that channel. Assuming that the same factors responsible for the slight loss of gain are not also causing distortion, you can effect a simple cure by interchanging the two shielded leads connecting your pre-amplifier and basic amplifier. This will connect one high-gain channel to one low-gain channel and probably restore the gain balance between the two channels. Correct right- and left-speaker positioning can be restored by switching the right- and left-channel speaker leads at the power amplifier.

### Anode and Cathode Followers

**Q.** I have frequently seen the term "anode follower" used. How does this differ from the "cathode follower," and does it have any special advantages?

PETER SWEENEY  
Greenwich, Conn.

**A.** The anode follower (or plate follower) is best described by comparing it with the cathode follower. Simply explained, the cathode follower is a vacuum-tube circuit in which the output signal is taken not from the plate of the tube, as is usual practice, but from the cathode. When the signal is taken from the low-impedance cathode rather than from the high-impedance plate, long shielded cables can be used without causing the loss of high frequencies (through cable capacitance). Also, the cathode follower usually has a very high input impedance, which is advantageous when the load on the preceding stage must be minimized. These advantages, however, are realized at the expense of amplification, in that the cathode-follower circuit not only provides no amplification, but even causes a slight loss of gain. The circuit is called a cathode follower because the output signal at the cathode "follows" (is in phase with) the input signal at the grid of the tube.

The anode-follower circuit, which can be designed to have the same advantages as the cathode follower, usually consists of a single triode with heavy negative feedback from its output plate to its input grid. The anode-follower configuration is flexible, in that the feedback circuit can be designed to include a certain

(Continued on page 16)

HIFI/STEREO REVIEW

## WHERE CAN YOU BUY 40 SOUND QUALITY FEATURES?

1. Modular construction featuring complete plug-in record amplifier, reproduce amplifier, and bias oscillator 2. Fully solid-state electronics 3. Hysteresis synchronous metering capstan drive 4. Solenoid operated tape gate, brakes and pressure roller 5. Separate reel drive motors 6. Safely handles all tape, including half mil 7. Front panel microphone jacks 8. Mixing inputs for high level line 9. Front panel mode switch with tally lights 10. Monitoring from tape or source 11. Separate channel monitor and output switches 12. Durable, easily cleaned, easy-on-the-eye professional vinyl finish 13. Standard readily available American transistors and components 14. Superior tape guiding 15. Military type fail-safe differential band brakes 16. Sturdy die-cast main plate 17. Signal switching available at remote socket 18. Position for optional fourth head 19. Remote "start-stop" 20. Local-remote front panel control 21. Pushbutton transport controls 22. Record safety interlock 23. New "cue" transport control 24. Large, rugged hardened stainless steel capstan 25. Ball bearing inertial stabilizer flywheel 26. Payout compliance arm and tape break shut-off 27. Automatic capstan motor stop for tape run-out 28. Take-up compliance arm 29. Regulated power supply 30. Emitter follower outputs 31. Stereo-mono front panel earphone switch 32. Simultaneous record and playback 33. Double flywheel capstan drive 34. Switchable equalization 35. Auxiliary emitter-follower outputs 36. Auxiliary high impedance inputs 37. Standard "hi-fi" connectors 38. Large "operator" type knobs 39. Earphone monitor jack on front panel 40. V.U. meter for each channel

---

FULLY SOLID-STATE ELECTRONICS

---

SOUND-ON-SOUND & SOUND-WITH-SOUND

---

FOR QUARTER-TRACK STEREO  
OR MONAURAL OPERATION

---

TAPE SPEEDS: 3.75 and 7.5 inches per second

REEL SIZE: 5-, 7- and 8-inch E.I.A. hubs.

HEADS: Four. Selectable 1/4-track Erase, 1/4-track Record and 1/4-track Play are Standard. Accessory two-track Stereo Play available as fourth head.

DIMENSIONS: 19" wide, 15-3/4" high, 12" deep.

---

Unprecedented in our industry, Magnecord, America's first manufacturer of magnetic tape recorders, now introduces a unique model. The NEW Magnecord 1024 offers you the highest possible quality at the lowest conceivable price! For professional sound, design simplicity, moderate price, engineered performance and quality throughout — BUY the most versatile of them all . . . BUY the NEW 1024!



# Buy the **NEW**

**M**agnecord  
1024

ONLY  
**\$595.**

for further information write

**MAGNECORD SALES DEPARTMENT**  
MIDWESTERN INSTRUMENTS, INC.  
P. O. BOX 7509 • TULSA 35, OKLAHOMA

# They call us "fanatics." (Because we are.)

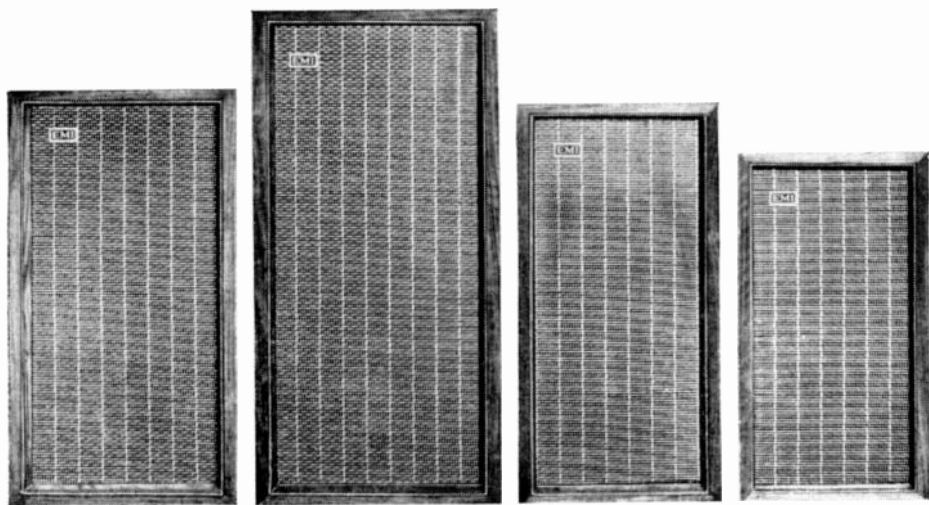

We achieved standards of perfection in our \$159.00 *dangerous* bookshelf speaker that are fanatical. And as soon as we accomplished the impossible, we did it again at \$99.50. And again at \$69.75.

We even created a professional studio monitor at \$249.\*

Little wonder they call EMI's world-famous designer, Dr. G. F. Dutton, many other names, too, back home in England. "Indomitable." "Brilliant." "Formidable competition."

Some people complain that our speakers are as relentless as we in exposing the subtlest musical transients and the slightest flaws in other components. But EMI's musical reproduction is pure glory. Live, robust, thoroughly realistic with smooth, balanced response to beyond audibility.

Other fanatics appreciate this greatly. And we invite one and all to private demonstrations at their EMI dealers.

\*All prices slightly higher in South and West.

## EMI

(makers of *The Dangerous Loudspeaker*)

exclusively from Scope Electronics Corporation  
(subsidiary of Lynch Corporation),  
235 East 42nd Street, New York, N. Y. 10017

amount of frequency correction and also to permit a small amount of tube gain. Any gain in the circuit, however, is obtained at the expense of the low output impedance and distortion reduction. An improved version of the plate-follower configuration uses a dual-triode tube (such as a 12AX7 or 12AU7), with negative feedback from the output plate of the second tube to the cathode of the input tube. This "feedback-pair" arrangement has the advantage of being able to handle a large amount of distortion-reducing negative feedback and at the same time provide amplification.

### Tone-Arm Grounding

**Q.** Every time I touch the tone arm on my record player a loud hum comes through my speakers. I've grounded the arm as outlined in the manufacturer's instructions, but the hum persists. Do you have any suggestions?

STANFORD DENLEY  
Palo Alto, Calif.

**A.** There are certain precautions one should observe when setting up a tone arm. To minimize induced hum, avoid having the shielded leads from the tone arm cross under or alongside the turntable motor. You can check whether the motor is responsible for hum problems by leaving the tone arm in the normal playing position on the record and shutting off the turntable motor. If the hum ceases when the motor is turned off, obviously the hum field from the motor is causing the trouble. If the turntable motor or mounting plate has a grounding point, try soldering a lead to it, and then connect the other end of the lead to the chassis of the preamplifier under a convenient screw head. Keep this lead as short as possible to prevent more hum pickup.

Incidentally, the designated grounding point on an amplifier (usually a ground lug or terminal post) is not necessarily the best place to connect the ground lead. In my own particular setup, for reasons I've not been able to ascertain, there is least hum when neither the turntable nor the tone arm is grounded to the preamplifier through a separate lead.

Of course, along with the connecting and disconnecting of leads from the turntable and tone arm, try reversing the line plugs of all your equipment, including the tuner. When testing for hum reduction, a clearer indication will be obtained if your volume and bass controls are both turned up higher than normal.

Because the number of queries we receive each month is greater than we can reply to individually, only those questions selected for this column can be answered. Sorry!

# A MAJOR BREAK-THROUGH IN SOUND PURITY

... BY **SHURE**

THE SOUND FROM THE NEW SHURE V-15 STEREO DYNETIC® CARTRIDGE WITH ITS REVOLUTIONARY BI-RADIAL ELLIPTICAL STYLUS HAS NEVER BEFORE BEEN HEARD OUTSIDE AUDIO LABORATORIES

by S. N. SHURE, President, Shure Brothers, Inc.

The sound from the new Shure V-15 Stereo Dynetic Cartridge is unique. The unit incorporates highly disciplined refinements in design and manufacture that were considered "beyond the state of the art" as recently as the late summer of 1963. The V-15 performance specifications and design considerations are heady stuff—even among engineers. They probably cannot be assimilated by anyone who is not a knowledgeable audiophile, yet the sound is such that the critical listener, with or without technical knowledge, can appreciate the significant nature of the V-15 music re-creation superiority. It is to be made in limited quantities, and because of the incredibly close tolerances and singularly rigid inspection techniques involved, it is not inexpensive. Perfection never is.

## THE BI-RADIAL ELLIPTICAL STYLUS

The outstanding characteristic is that the V-15 Stylus has two different radii . . . hence the designation Bi-Radial. One is a broad frontal plane radius of 22.5 microns (.0009 inch); while the actual contact radii on each side of the stylus are an incredibly fine 5 microns (.0002 inch). It would be impossible to reduce the contact radius of a conventional spherical/conical stylus to this micro-miniature dimension without subjecting the entire stylus to "bottoming" in the record grooves.

The Shure Bi-Radial elliptical stylus, because of its larger frontal radius of 22.5 microns (.0009 inch), cannot bottom . . . and as you know, bottoming reproduces the crackling noise of the grit and static dust that in practice cannot be eliminated from the canyons of record grooves.

## TRACING DISTORTION MINIMIZED

The prime objective in faithful sound re-creation is to have the playback stylus move in exactly the same way as the wedge-shaped cutting stylus moved when it produced the master record. This can't be accomplished with a spherical/conical stylus because the points of tangency (or points of contact between the record grooves and the stylus) are constantly changing. This effect manifests itself as tracing distortion (sometimes called "inner groove distortion"). Note in the illustration below how the points of tangency (arrows) of the Bi-Radial elliptical stylus remain relatively constant because of the very small 5 micron (.0002 inch) side contact radii:

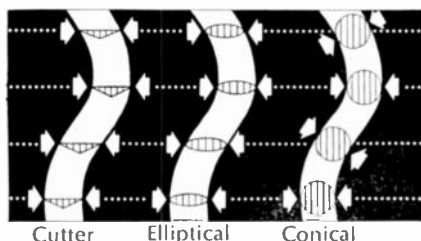

The Shure Bi-Radial Stylus vastly reduces another problem in playback known as the "pinch effect." As experienced audiophiles know, the record grooves are wider wherever and whenever the flat, chisel-faced cutting stylus changes directions (which is 440 cycles per second at a pure middle "A" tone—up to 20,000 cycles per second in some of the high overtones). An ordinary spherical/conical stylus riding the upper portion of the groove walls tends to drop where the groove gets wider, and to rise as the groove narrows. Since stereo styli and cartridges have both vertical and horizontal functions, this unfortunate and unwanted up-and-down motion creates a second harmonic distortion. The new Shure Bi-Radial elliptical stylus, on the other hand, looks like this riding a record groove:



You'll note that even though it has a broad front face with a frontal plane radius of 22.5 microns (.0009 inch), and it measures 30 microns (.0012 inch) across at the point of contact with the groove, the small side or contact radii are only 5 microns (.0002 inch). This conforms to the configuration of the cutting stylus and hence is not as subject to the up-and-down vagaries of the so-called "pinch-effect".

## SYMMETRY, TOLERANCES AND POSITIONING ARE ULTRA-CRITICAL

Frankly, a Bi-Radial elliptical stylus, however desirable, is almost impossibly difficult to make CORRECTLY. Diamond, as you know, is the hardest material . . . with a rating of 10 on the Mohs hardness scale. It's one thing to make a simple diamond cone, altogether another to make a perfectly symmetrical Bi-Radial stylus with sufficiently close tolerances, actually within one ten thousandth of an inch! Shure has developed unprecedented controls, inspections and manufacturing techniques to assure precise positioning, configuration, dimensions and tolerances of the diamond tip. It is a singular and exacting procedure . . . unique in the high fidelity cartridge industry. And, unless these inspection techniques and safeguards are used, an imperfectly formed elliptical configuration can result and literally do more

harm: than good to both record and sound.

## THE V-15 IS A 15° CARTRIDGE

The 15° effective tracking angle has recently been the subject of several Shure communications to the audiophile. It conforms to the effective record cutting angle of 15° proposed by the RIAA and EIA and now used by the major record producing companies and thereby minimizes tracking distortion.

The major features, then, of the V-15 are the Shure Bi-Radial Elliptical Stylus, the singular quality control techniques and standards devised to produce perfection of stylus symmetry, and the 15° tracking angle. They combine to reduce IM and harmonic distortion to a dramatic new low. In fact, the distortion (at normal record playing velocities) is lower than the inherent noise level of the finest test records and laboratory measurement instruments! In extensive listening tests, the V-15 proved most impressive in its "trackability." It consistently proved capable of tracking the most difficult, heavily modulated passages at a minimum force of 3/4 grams (in the Shure-SME tone arm). The entire V-15 is hand-crafted and subject to quality control and inspection measures that result in space-age reliability. Precision machined aluminum and a special ultra-stable plastic stylus grip. Exact alignment is assured in every internal detail—and in mounting. Mu-metal hum shield surrounds the sensitive coils. Gold plated terminals. Individually packaged in walnut box. The V-15 is a patented moving-magnet device—a connoisseur's cartridge in every detail.

## SPECIFICATIONS

The basic specifications are what you'd expect the premier Shure cartridge to reflect: 20 to 20,000 cps., 6 mv output. Over 25 db separation. 25 x 10<sup>-6</sup> cm. per dyne compliance. 3/4 gram tracking. 47,000 ohms impedance, 680 millihenries inductance per channel. 650 ohms resistance. Bi-Radial stylus: 22.5 microns (.0009 inch) frontal radius, 5 microns (.0002 inch) side contact radii, 30 microns (.0012 inch) wide between record contact points.

But most important, it re-creates music with a transcendent purity that results in a deeply rewarding experience for the critical ear.

Manufactured under U.S. Patents 3,055,988; 3,077,521 and 3,077,522. Other Patents Pending.

\$62.50 net

SHURE BROTHERS, INC.  
222 Hartrey Avenue, Evanston, Illinois

# speaking of the DUAL 1009 Auto/Professional Turntable



in *American Record Guide*, Jan. '64  
"... the only automatic thus far tested that I feel justified in suggesting for the finest systems... bids fair to reduce the 'superiority' of manuals from fact to fiction."

in *Audio*, Nov. '63

"... tracked perfectly well with the table tilted to almost 90°, with warped records and with eccentric records... means that the arm is balanced in all planes... the ability to vary speed is a real asset."

in *Electronics World*, March '64

"... fully capable of operating with a tracking force of 0.5 grams, as rated. The trip mechanism operated flawlessly at this force, with no evidence of side thrust on the cartridge..."

in *HiFi/Stereo Review*, Jan. '64

"... will function as well as any good separate tonearm... the most compliant cartridges, operating at the lowest forces for which they are designed, can be used..."

in *High Fidelity*, Nov. '63

"... Variations in line voltage, as well as in the number of records placed on the turntable, had very little effect on the speed, so that speed accuracy and speed constancy (under a wide range of operating conditions) were truly excellent."

in *Popular Science*, Feb. '64

"... I can drive a pair of AR3 speakers with full bass boost on the amplifier and still not hear objectionable turntable rumble. (When I try this with most record changers, they make a sound like a subway train rolling through my living room.)"



Complete reprints of these sensational reviews are yours for the asking. Better yet, see the Dual 1009 demonstrated at your audio dealer. An outstanding value at \$99.50.



**UNITED AUDIO**  **DUAL**  
12 WEST 18TH ST., N.Y. N.Y. 10011  
CIRCLE NO. 53 ON READER SERVICE CARD

# JUST LOOKING

... at the best in new hi-fi components



● **Concertone** announces the Caravelle, a two-speed, four-track stereo recorder. The three-motor transport system provides automatic two-direction record and play ("Reverse-O-Matic") through the use of six heads, three for each direction. Solid-state record and playback preamplifiers are used, and all deck functions have push-button control with an optional remote-control unit available. The recorder has dual VU meters, built-in



automatic echo and sound-on-sound switching, and monitoring in both directions. Mounted in a portable carrying case with built-in stereo amplifier and speakers and including two microphones and reels, the Caravelle Model 801 sells for less than \$399. The Model 802, designed for custom installation (without a case and amplifier system) sells for \$349.95.

circle 182 on reader service card

● **Concord's** Model 884 is a three-speed, four-track stereo tape recorder with four separate transistorized preamplifiers. The unit has three heads, illuminated VU meters, and a stereo-headphone output jack. Switching facilities include an A-B switch for comparing



source to tape when monitoring, and built-in sound-on-sound switching. The 15-watt stereo amplifier in the machine drives two speakers, one built into the case, the other mounted in the recorder cover. Specifications list a frequency response of 40 to 16,000 cps ( $\pm 1.5$  db) at 7½ ips, a signal-to-noise ratio of better than 60 db, and flutter and wow under 0.15 per cent. A jack makes possible the connection of external amplifiers or external speakers for operation as part of a hi-fi system. The unit comes with two dynamic microphones. Price: under \$450.

circle 183 on reader service card

● **Eico's** Model 2400 tape deck is a four-track stereo machine with two speeds. The three-motor transport mechanism uses electrodynamic braking, and has wow and flutter figures of under 0.2 per cent at 7½ ips. There are separate controls for microphone and auxiliary inputs, thus permitting mixing. Frequency response is 30 to 17,000 cps  $\pm 3$  db at 7½ ips; signal-to-noise ratio is 45 db. The

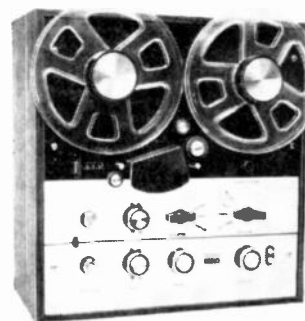

unit is designed to feed a hi-fi system, and each channel has 0.7 volt average output at 5,000 ohms output impedance. Size is 12¾ x 12¾ x 6½ inches. The price for the kit is \$189.95; the factory-wired unit is \$269.95.

circle 184 on reader service card

● **Fisher's** Model 70 Fisher-Lincoln automatic turntable can be set to play both sides of each record automatically. The unit handles 7-, 10-, and 12-inch records intermixed in any order at 33½ rpm. Up to ten records can be placed on the machine, for over 8 hours of continuous music. Since the changer mechanism places each disc on the turntable individually and removes it when it has finished playing, there is no possibility of slipping or

(Continued on page 22)

# now you can use a triple play tape... without loss of output



if it is this one!

Triple play recording tapes require thinner oxide coatings. Ordinarily, tapes with thinner coatings lose output or volume. *This is not so with Reeves Soundcraft Triple Play Tape!* A special magnetically active oxide coating on the durable DuPont Mylar base does it! Extra output is built into the coating...at least 5 db more than other triple play tapes! Even when you splice Soundcraft Triple Play with quality standard play tapes, you won't hear any change in playback level between the two! A 7" reel of Soundcraft Triple Play contains 3600 feet of tape...gives you triple the playing time of a reel of standard tape.

If you want the convenience of greatly extended recording time without sacrifice in performance, insist

on Soundcraft Triple Play Tape. Write for literature.

TYPICAL RECORDING TIMES PER 7" REEL.		
	1 7/8 IPS	7 1/2 IPS
Mono single track dual track four track	6 hrs. 24 min. 12 hrs. 48 min. 25 hrs. 36 min.	1 hr. 36 min. 3 hrs. 12 min. 6 hrs. 24 min.
Stereo dual track four track	6 hrs. 24 min. 12 hrs. 48 min.	1 hr. 36 min. 3 hrs. 12 min.

FOR YOUR VERY SPECIAL RECORDINGS TRY REEVES GOLDEN TONE—the world's most impressive tape...for the discerning ear and most exacting equipment.



**REEVES SOUNDCRAFT**  
DIVISION OF REEVES INDUSTRIES INC

Main Office: Danbury, Connecticut • New York • Chicago • Los Angeles • Export: C.B.S. International, N.Y.C. • Canadian Reps: Vancouver • Toronto • U.K. Reps: Soundcraft Magnetic Ltd.

APRIL 1964

CIRCLE NO. 43 ON READER SERVICE CARD

R-217

21

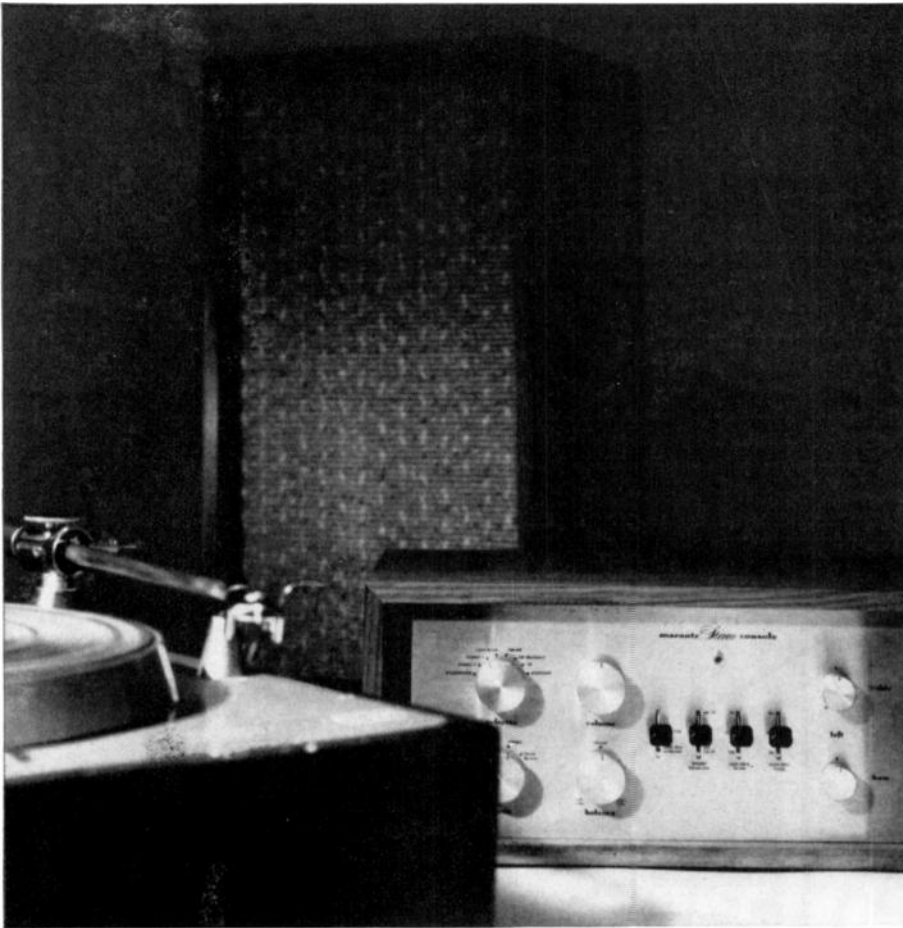

A ceramic  
cartridge in a  
system like  
this?



Absolutely!

We're talking about the new Sonotone Velocitone Mark IV. Use the high compliance Mark IV in the finest tonearm, on the finest turntable, playing through the finest amplifiers and speakers. It has everything the finest magnetic cartridges have, including a compliance of  $15 \times 10^{-6}$  cm/dynes in all directions. Capable of tracking at the low forces required by modern, professional turntables, it is equally well suited for use in record changers.

What's more, it offers a number of innerent advantages not possible with magnetic cartridges. There's a stylus that's virtually indestructible—the exclusive SONO-FLEX<sup>®</sup>. There's complete—but complete—freedom from magnetically-induced hum.

That's why we say: There's **one** ceramic cartridge that's worthy of the finest equipment—the Velocitone Mark IV. You don't have to make any change in your equipment to install it, either. The Mark IV comes complete with factory-matched equalizers that you can plug right into any magnetic input.

Mark IV with dual diamond styli, \$24.25\*; with diamond/sapphire, \$20.25\*. Hear the new Velocitone Mark IV at your hi-fi dealer. \*SUGGESTED LIST

# Sonotone

Sonotone Corporation, Electronic Applications Division, Elmsford, New York  
Cartridges • Speakers • Microphones • Headphones • Hearing Aids • Batteries

CIRCLE NO. 48 ON READER SERVICE CARD

damage caused by friction between the records. The turntable is belt-driven by a SynDuction motor, and the change sequence is triggered by a magnetic proximity switch. The tone arm is designed

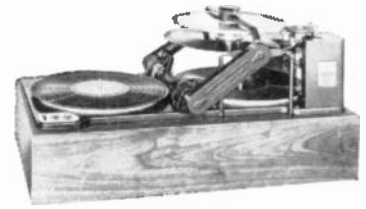

for standard cartridge mounting; all tone-arm adjustments are reachable from above. The unit measures  $27 \times 15\frac{3}{8} \times 19\frac{1}{4}$  inches high. Price: \$299.50.

circle 185 on reader service card

● **Hartley** is producing the Concertmaster, a full-size multiple-speaker system that includes the Model 218MS 18-inch woofer, which has bass response down to 16 cps. Crossover is at 400 cps; the middle and high frequencies are

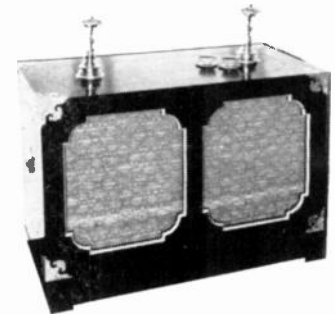

handled by the 10-inch Hartley 220MS. Both speakers employ the Hartley-Luth magnetic-suspension principle in their design, and utilize a tri-polymer cone construction. The Hartley-Luth Concertmaster is available as a Chinese chest enclosure (40 x 28 x 20 inches) or as a modern oiled walnut cabinet (36 x 36 x 18 inches). The Chinese chest is priced at \$795; the oiled walnut style at \$595.

circle 186 on reader service card

● **H. H. Scott** announces its model 370B stereo FM tuner. The unit includes the Sonic Monitor circuit, a magic-eye

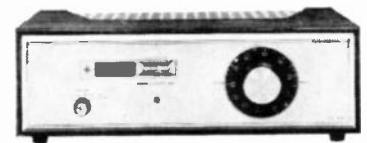

tuning indicator, and a cascade r.f. stage with three-gang tuning condenser. IIF sensitivity is 3.5 microvolts, signal-to-noise ratio is 50 db, harmonic distortion is under 1 per cent, and drift is 0.02 per cent. The capture ratio is 6 db, spurious-response rejection is 75 db, separation is 28 db. Dimensions in accessory case are  $15\frac{1}{2} \times 5\frac{1}{4} \times 13\frac{1}{4}$  inches. Price: \$159.95.

circle 187 on reader service card



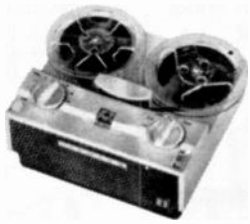

CIPHER V a high-fidelity tape recorder of minimum size, complete with dynamic microphone and monitoring earphone, tape speeds  $3\frac{3}{4}$  and  $1\frac{1}{2}$  ips; up to 5" reels; automatic pause control; "flight luggage" carrying bag; \$79.50.



CIPHER I a remarkable high fidelity tape recorder with automatic push-button control, tape speeds  $7\frac{1}{2}$ ,  $3\frac{3}{4}$  and  $1\frac{1}{2}$  ips up to 7" reels, dynamic microphone, monitoring earphone, digital tape index, pure idler drive (no belts), \$139.95.



CIPHER VII a 4-track stereo recorder with detachable speakers and 2 dynamic microphones, tape speeds  $7\frac{1}{2}$ ,  $3\frac{3}{4}$  and  $1\frac{1}{2}$  ips, 2 VU meters, automatic shutoff, plays horizontally or vertically. \$274.95 (Also available as the VII-D deck)



CIPHER 800 a professional 4-track stereo recorder with 3 hysteresis-synchronous motors and 3 heads; plug-in head assembly (2-track also available); no pressure pads, tape speeds  $7\frac{1}{2}$  and  $3\frac{3}{4}$  ips, solenoid controlled, 2 VU meters, \$499.95.

## These are the amazing Cipher tape recorders from Japan. Don't wait for expensive American or European imitations.

It's no secret that the Japanese tape recorder industry has made astonishing progress in recent years. Now, with the unique Cipher line, Japan can be considered to have passed the rest of the world in tape recorder design and execution.

The four Cipher models shown here are without question the most thoroughly engineered Japanese recorders seen so far. They differ greatly in purpose, complexity and cost—but each would have to sell at a significantly higher price if made in the United States, England, Germany, Holland, Scandinavia or Switzerland. By the same token, com-

parably priced recorders from these countries can be expected to rate significantly lower in performance.

Hard to believe? Ask any recording engineer who has tried the superb Cipher 800. Or any housewife, for that matter, who has used the little Cipher V. And don't forget to compare the Ciphers with other Japanese machines, either!

(For further information, write to Inter-Mark Corporation, 29 West 36th Street, New York, N.Y. 10018. In Canada: Inter-Mark Electronics Ltd., 1550 Avenue Road, Toronto 12, Ont.)

**CIPHER**



by HANS H. FANTEL

### DEFINITIONS—III

ONWARD with our definitions of basic audio concepts, which will continue in alphabetical order for the next several months.

• **Compliance** describes the amount of force that must be applied to the stylus of a phono cartridge to deflect the stylus a given distance. Compliance is expressed numerically—for example,  $15 \times 10^{-6}$  cm/dyne. This means that if 1 dyne (a basic unit of force) is applied to the stylus, it will be deflected one 15-millionth of a centimeter. When comparing cartridge specifications, make the first number—the one before the multiplication sign—your basis for comparison. As a rough guide, remember that a compliance of  $10 \times 10^{-6}$  cm/dyne is quite good, while  $20 \times 10^{-6}$  is excellent indeed.

• **Crossover networks** are used in loudspeakers to separate the treble from the bass in order to feed high-frequency tones to the tweeter and low-frequency tones to the woofer. The simplest type of crossover is a high-pass filter, which merely keeps the bass notes out of the tweeter, thus preventing tweeter damage. A more complex crossover, consisting of one or more coils and capacitors, also keeps the highs from entering the woofer, where they might be distorted. The frequency above and below which the frequencies are routed to the woofer and the tweeter is called the crossover point. A well-designed crossover network must be matched to the characteristics of the speakers so that a smooth transition will occur at the crossover point. For speaker systems with a separate mid-range speaker, a more elaborate three-way crossover network is used to divide the total frequency range into three portions—bass, mid-range, and treble—each going to its appropriate speaker.

• **Crosstalk** is a term originated by telephone technicians to describe interference between two phone calls on adjacent wires. When applied to audio, crosstalk means that some left-channel signal is leaking into the right channel, or vice versa, thereby reducing stereo separation. Commingling of the left and right signals is not wholly avoidable, and is practically unnoticeable if the intruding signal is at least 25 db lower in volume than the signal rightfully belonging to the channel. Crosstalk is most often stated in terms of stereo separation. A separation of at least -25 db (the higher the negative figure, the better) in the specifications of a cartridge, amplifier, or tuner therefore signifies that there will be no audible crosstalk between the channels.

• **Decibel**, abbreviated "db," is the standard measure of loudness. It is a *relative* measurement, used to compare two different loudness levels. For instance, if a loudspeaker is "5 db down at 40 cycles" (usually written "-5 db"), the sound it produces at a frequency of 50 cycles per second is 5 db softer than the sound it produces at a standard reference frequency—usually 1,000 cps. The smallest readily apparent loudness difference in music is 3 db, though sharp-eared listeners may discern differences as small as 1 db.

(To be continued next month)

## The New Empire Grenadier

Divergent Lens Speaker System

Exclusive Sonic Column — Totally Rigid Without Resonance. Two years in the making . . . the Grenadier's shape is a function of its performance . . . its performance, an achievement of design. Virtually, no matter where or how you listen, the new Empire Grenadier gives you acoustically flat frequency response.

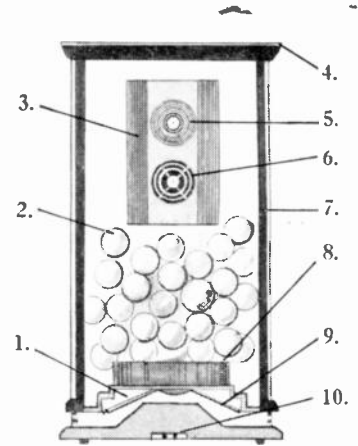

1. Mass loaded woofer with floating suspension and four inch voice coil.
2. Sound absorbent rear loading.
3. Die-Cast Mid Frequency-High Frequency Full Dispersion Acoustic Lens.
4. Polyester Laminate surface.
5. Ultra-Sonic Domed Tweeter.
6. Full Presence Mid Range Direct Radiator.
7. Totally damped acoustic fibre enclosure.
8. World's largest speaker ceramic magnet structure (18 lbs.).
9. Front loaded Horn with 360° aperture throat.
10. Terminals concealed underneath.

**Freedom From Distortion.** A unique combination of electrical and acoustical crossovers and cutoffs avoid woofer cone break-up and mid range response dips. The woofer, mid range and tweeter combine at mathematically correct crossover frequencies.

**Aesthetically Designed** to fit any decor . . . from warm elegance to stark modern. Fits in corners or against walls. Truly a beautiful and functional achievement of sight and sound.

See & Hear the Grenadier today . . . visit your Hi Fi dealer. Grenadier Price: \$180.

**Technical Specifications Model 8000** — Frequency Response: 30-20,000 cps • Nominal Impedance: 8 ohms • Power Handling Capacity — Music Power: Maximum undistorted 100 watts • Sine Wave Power: 30-450 cps 60 watts • 450-5000 cps 40 watts • 5000-20,000 cps 20 watts • Components — Woofer: 12 in. High Compliance with 4 inch voice coil • Mid Range: Direct Radiator • Hi-Frequency Ultra Sonic Domed Tweeter • Mid & Hi coupled to Die-Cast Acoustic Lenses • Overall Dimensions — Dia. 15 1/4" x Ht. 29" • Weight 65 lbs. • Rich Satin Walnut Finish with Mar Proof and Stain Proof Surface.

Write for complete literature.

**EMPIRE**

"World's Most Perfect High Fidelity Components"

Empire Scientific Corp. • 845 Stewart Ave., Garden City  
Export: EMEC, Plainview, L. I., N. Y. • Canada, Empire  
Scientific Corp., Ltd., 1476 Eglinton West, Toronto

The New Empire  
*Grenadier*  
 Divergent Lens Speaker System

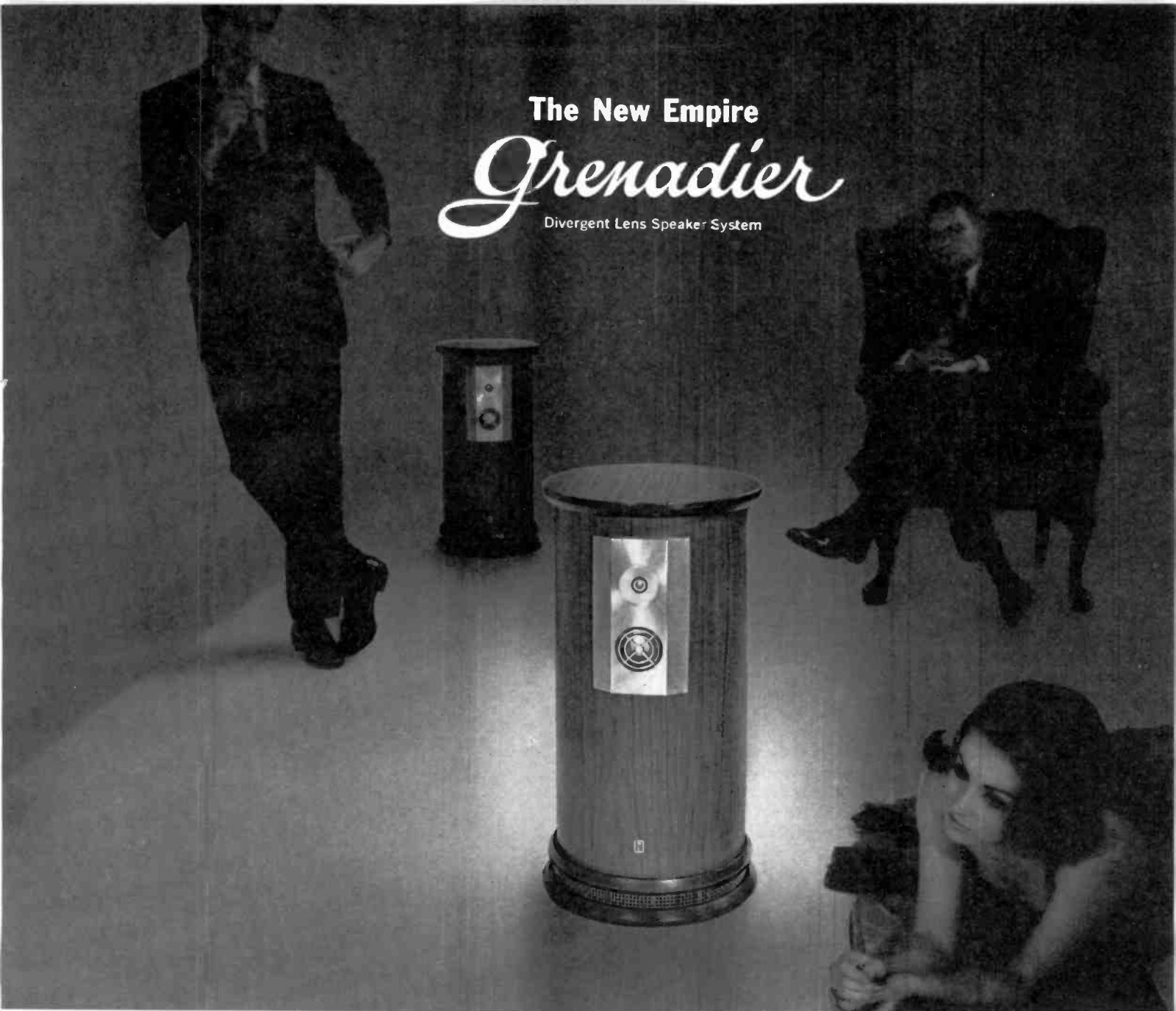

# Lets you sit anywhere— Hear everything

The first speaker system designed and engineered for stereophonic sound. Three acoustic lenses allow you to enjoy phenomenal stereo separation and the highest fidelity of music anywhere in the room. Speaker placement non-critical.

CIRCLE NO. 18 ON READER SERVICE CARD



The Empire Grenadier cabinet gives you discipline of sound while virtually eliminating cabinet vibration. Formed from acoustic material and completely wrapped with walnut to delight the eye.

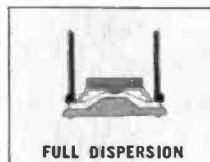

A downward woofer, close to the reflecting floor surface, feeds through a front loaded horn with full circle aperture throat. This provides 360° sound dispersion and prevents standing waves.



The full presence mid-range direct radiator and the low-mass ultrasonic tweeter in combination with the die-cast divergent acoustic lens, achieve broad sound propagation.



Massive three driver magnetic structure totaling one million lines of force produces the needed high efficiency, yet handles up to 100 watts of music without overload or burn-out.

"World's Most Perfect High Fidelity Components" **EMPIRE**

Are separate  
tuners and  
amplifiers passé ?

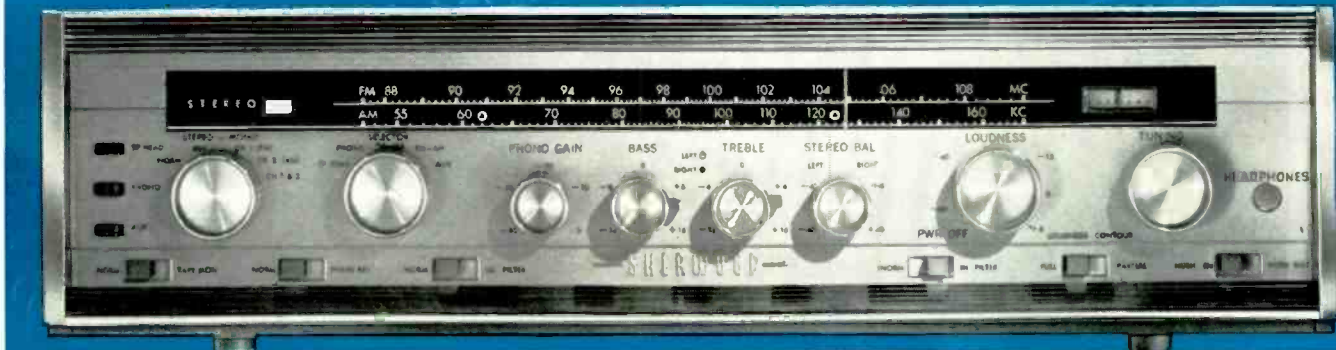

An outstanding new combined tuner/amplifier component . . . the S-7700II AM/FM/FM Stereo 80-watt Receiver.

Nothing duplicates the installation flexibility of separate components. This is one of many reasons why Sherwood sells so many of them. But for those who do not need this flexibility, Sherwood engineers have created an outstanding single component, which without compromise of fidelity, combines both functions.

The new S-7700II AM/FM/FM Stereo Receiver combines the 1.8 microvolt sensitivity and 2.4db capture effect of Sherwood's finest tuner with the 80-watt dual channel music power of Sherwood's highest-rated high fidelity amplifier. The size is a space-saving 16 1/4" x 4" x 14". You enjoy all the tuning surety of Sherwood's D'Arsonval zero-center tuning meter and 8" long professionally calibrated dial scale. And, you have front panel control of all stereo amplifier functions for phono, tape—plus a stereo headset jack. As trim as the size, is the less-than-separate-components price of \$374.50 (slightly more on the West Coast).

**Sherwood low-distortion speaker systems  
for high fidelity music systems**

Ravinia: 3-way/48—17,500 cps/\$139.50 · Newport: 2-way/48—17,000 cps/\$79.50 · Berkshire: 3-way/53—17,500 cps/\$99.50 · Tanglewood: 4-way/29—17,500 cps/\$199.50

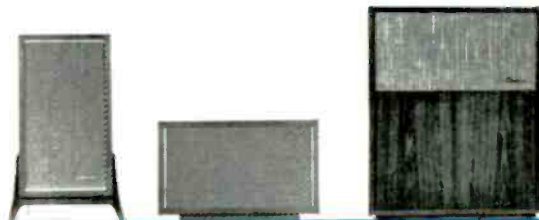

**FREE** . . . A \$1.00 VALUE  
INFORMATION KIT  
AT YOUR SHERWOOD DEALER

Take this coupon to your Sherwood dealer and receive:

- Time-Saver Shopping Guide—detailed comparative specifications on components offered by major manufacturers.
- 64-page book, *An Introduction to Hi-Fi & Stereo* published by the Institute of High Fidelity.

- FM & FM Stereo Station Finder—listing current and proposed stations.
- Photo file—a pictorial review of how different systems have been installed.
- Descriptive literature on Sherwood components.

If you prefer, send 25¢ in coin direct to Sherwood, together with your name and address. Your package will be sent by return mail.

Name \_\_\_\_\_

Street \_\_\_\_\_

City \_\_\_\_\_ State \_\_\_\_\_ Zip Code \_\_\_\_\_

Sherwood Electronic Laboratories, Inc., Dept. R-4  
4300 North California Avenue, Chicago, Illinois 60618

*Sherwood*  
HIGH FIDELITY

- STEREO RECEIVERS ■ TUNERS ■ AMPLIFIERS
- STEREO INDICATOR LIGHTS ■ SPEAKER SYSTEMS ■ CONTEMPORARY CABINETRY



● **LOUDSPEAKER MEASUREMENTS:** Loudspeaker performance is ideally measured in a free-field environment—that is, one that has a negligible effect on the measured pressure response of the speaker. In practice, this requires mounting the speaker and microphone on a tower or boom well away from the ground and adjacent buildings, or in an anechoic chamber (a room designed to absorb all reflected sound).

However, since we rarely listen to high-fidelity loudspeakers out of doors or in anechoic chambers, good measurements under nonreverberant conditions are no guarantee of good performance in the home. This fact is recognized in the IEEE *Recommended Practices on Loudspeaker Measurements (1961)*, which states that measurements “are not a complete guarantee that subjective performance will be satisfactory. Wherever it is possible, the quality of reproduction should be checked by means of listening tests. . . .”

Several years ago, I made my speaker-performance measurements out of doors. However, I found that, aside from the difficulties of noise from wind, passing airplanes, and lawn mowers, plus the vagaries of weather, this measuring technique was not fair to speaker systems that depended on corner placement for bass reinforcement, or that had an omnidirectional response, or in other ways utilized wall reflection.

I therefore transferred my loudspeaker-testing operations to a garage measuring approximately 12 x 30 feet. The variety of shop equipment and other impedimenta that seem to find their way into garages was augmented by numerous panels of felt padding, which resulted in an acoustic, if not aesthetic, environment approximating that of many living rooms. A speaker under test, if its size permits, is placed on a shelf against one end wall, simulating a bookshelf installation. Large speakers are placed on the floor, but not in a corner unless they are specifically designed for that position.

Anyone who has tried to measure the indoor frequency response of a speaker knows how irregular the resulting curve is likely to be. Because of room reflections and standing waves, measurements taken at one

point in the room may bear little or no apparent relation to measurements taken at some other point. At many frequencies, the output rises at some locations and falls at others. However, if the response is taken at a number of points in the room (I use from six to ten locations) and plotted on a graph, a pattern emerges. Much of the irregularity vanishes, and definite response trends appear. At low frequencies, room resonances may still overshadow the true response of the speaker, but placing the microphone close to the speaker (within one foot) helps to determine whether room reflections or the speaker are responsible for any low-frequency irregularity.

This measurement technique is preferable to an axial pressure response taken in a free field or dead room, not only because it simulates actual listening conditions, but also because it gives an indication of total radiated power. Much, if not most, of the sound reaching the listener is reflected from room surfaces. Since a speaker radiates sound over a wide arc, it is desirable to measure the total energy output of the speaker rather than that portion radiated in any single direction. Measuring the pressure response at many locations and averaging the results gives a curve more representative, in my opinion, of the speaker's total output.

I CANNOT emphasize too strongly that this method of measurement gives *relative* results. The curves I obtain are indicative of *trends* in frequency response, they reveal peaks and valleys, and they usually correlate well with the sound of the speaker. To insure against missing any sharp peaks or dips in the response, I use an automatic chart recorder that plots several sets of data on a single sheet of graph paper. The measurements taken at some fifty discrete frequencies are averaged to produce a single curve.

Harmonic distortion is usually measurably significant only at the lowest frequencies. I measure it at frequencies below 100 cps and with a 1-watt input to the speaker. The frequency below which the distortion rises sharply is clearly the lower useful limit of the

#### REVIEWED THIS MONTH

Sony TC-500 Tape Recorder



EMI 319 Speaker System

speaker's response, regardless of the shape of its response curve. After all, one can correct for a drooping response with a tone control, but only up to the point at which distortion becomes objectionable. Intermodulation-distortion figures, incidentally, are not necessarily meaningful, since it is always possible to pick some combination of frequencies that makes the IM distortion of a particular speaker appear to be low.

One of the best indications of a speaker's performance is its response to tone bursts. An audio signal that drives the speaker is electronically switched on and off at a rapid rate, such as 20 to 30 times per second. The acoustic output of the speaker, as picked up by a microphone placed close to the speaker, is examined visually on an oscilloscope, while the audio test frequency is varied between 100 and 10,000 cps. Since all speakers necessarily have less than perfect transient responses, any speaker will ring slightly, or deliver at least some output in the "off" time between the bursts of tone. Sometimes the frequency of the ringing will be different from the frequency of the original burst.

The tone-burst response of a speaker varies with frequency—that is, a speaker has a better transient response at some frequencies than at others. Although tone-burst tests do not lend themselves to numerical or graphical expression, they tell me more about the quality of a speaker than any other test—except extended critical listening.

The ultimate test, as I have stated previously, is listening to all types of programs, from records and FM radio, in my own home. If one of my measurements suggests an unusual characteristic, I try to identify it by ear. Conversely, if the speaker has any particular coloration, I look for a correlation with the measurements. Usually there is good agreement between all the test data, in that a speaker that measures bad invariably sounds bad, and vice versa. But occasionally I find a speaker that measures fairly well and sounds mediocre, or vice versa. So far, I have no explanation for these anomalies, but they do help to make speaker evaluation a fascinating activity.

### SONY TC-500 TAPE RECORDER



● SONY's new Model TC-500 tape recorder is a portable four-track stereo machine with built-in dual 3-watt playback amplifiers, two detachable speakers (which also serve as its cover), and a pair of cardioid dynamic microphones. Although intended for use in

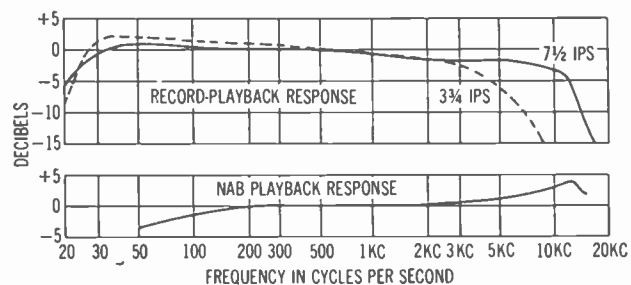

the home, the Sony TC-500 is constructed in a manner that would do honor to many a professional machine.

The TC-500 is a two-head machine (erase and combined record-playback) with a single amplifier in each channel serving both the recording and playback functions. The auxiliary inputs (one for each channel) have separate recording-gain controls, thus permitting mixing of the microphone signal with other program sources. The microphone-gain controls also serve as playback-gain controls.

Twin VU-type illuminated meters indicate both the recording and playback levels. Individual push buttons permit recording on either channel or on both together. By connecting the output of one channel to the input of the other, sound-on-sound recordings can be made. An interlock between the RECORD button and the tape-motion level makes accidental erasure of tape almost impossible. Red warning lights also indicate when the unit is in the RECORD mode.

The tape-motion control has FORWARD, STOP, and REWIND positions. For FAST FORWARD, a separate concentric control is turned while the tape is in normal forward motion. An automatic feeler-type shut-off switch turns off the transport when the tape has run through in either direction.

Other front-panel controls include the speed selector (3 $\frac{3}{4}$  and 7 $\frac{1}{2}$  ips), a PAUSE lever, a bass-boost switch for the playback amplifiers, a speaker cut-off switch, and a tape counter. The counter has a novel push-button reset—one press and all digits return to zero. The microphone jacks (which take miniature phone plugs) are on the front panel, the headphone jack is on the side, and the other inputs, outputs, and power connector are behind a hinged door in the rear of the recorder. The recorder operates equally well horizontally or vertically.

One of the striking features of the TC-500 is the detachable speakers, each of which forms half the cover of the portable unit. The loudspeakers are fully enclosed, and are obviously of small size, yet when driven by the TC-500's built-in 3-watt monitor amplifiers they produce sound of an astonishing quality. Not only are the Sony's speakers among the best-sounding I have ever heard in a portable tape recorder, but they compare favorably with some of the low-price bookshelf systems. With the bass boost switched in, the speakers appear to go down cleanly to about 50 cps, and have a nicely balanced over-all sound.

The two Sony F-87 microphones, which are stored  
(Continued on page 30)

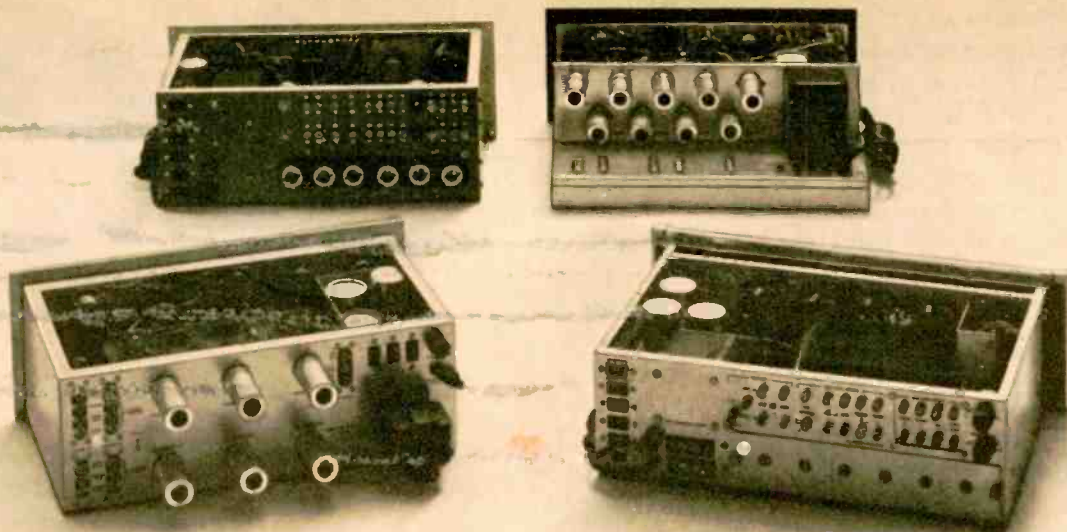

**THERE ARE FOUR EXCELLENT VACUUM TUBE  
STEREO CONTROL CENTERS ON THE MARKET TODAY.**



**WHY DOES THE NEW CITATION A SURPASS THEM ALL?**

Part of the answer is suggested by an authoritative report which appeared recently in High Fidelity Magazine. Here are some excerpts:

- "Marks a major breakthrough in the application of semiconductors to high fidelity sound."
- "Superb response characteristic is not matched by any other known preamplifier."
- "Citation A literally has flat response to beyond one million cycles and distortion that is non-measurable by the usual methods."
- "Excellent transient characteristics and virtually no phase shift throughout its extremely wide range."
- Harmonic distortion is "actually less than the resid-

ual distortion of the measuring equipment."

□ "Its listening quality is superb.... The overall effect of listening to Citation A is simply, more music and less fatigue."

□ "Should meet the demands of the most critical listener and audio perfectionist."

□ "It suggests that... a sound path could be set up that approaches the classic goal of amplifier design—that is, a straight wire with gain."

For a complete folio of reports and test evaluations of this remarkable new instrument, write Citation Division, Dept. R-4, Harman-Kardon, Inc., Plainview, New York.

**harman kardon**

HK 100

A subsidiary of THE JERROLD CORPORATION

CIRCLE NO. 24 ON READER SERVICE CARD

in the speaker cases, also sounded a good deal better than the microphones usually supplied with tape recorders. They have an excellent cardioid pattern and do a creditable job of recording music or voice.

The playback response of the Sony TC-500, measured with the Ampex 31321-04 (7½ ips) alignment tape, was ±3.5 db from 50 to 15,000 cps, with a slight droop at the low end and a rise at the high end. The record-playback frequency response was very smooth but not as wide, measuring ±3 db between 20 and 12,000 cps at 7½ ips, and between 23 and 4,000 cps at 3¾ ips. The signal-to-noise ratio was 45 db, and wow and flutter were 0.03 and 0.1 per cent at 7½ ips, 0.1 and 0.13 per cent at 3¾ ips. The FAST-FORWARD and REWIND speeds were relatively slow, requiring 2 minutes and 40 seconds to handle 1,200 feet of tape. Some caution was needed when switching to REWIND to avoid tape breakage.

I consider the Sony TC-500 to be very well suited for portable applications, playing through its own speakers. For such use, it does as good a job as any recorder I have used. It lacks some features desirable in a permanent installation due to the lack of separate playback monitoring heads and amplifiers and the fact that the signal voltages for feeding an external hi-fi system are taken from special windings on the output transformers rather than from the preamplifiers.

The sound quality of the Sony TC-500 played through a hi-fi system was generally excellent, although the impossibility of making direct A-B comparison between the incoming and recorded material made an accurate determination of its fidelity rather difficult. Although the sheen of the upper register seemed slightly dulled, the over-all sound remained clean and very much of high-fidelity caliber. At 3¾ ips the loss of highs was more apparent, but no other ill effects were audible.

The Sony TC-500 recorder, complete with speakers and microphones, sells for under \$400.

#### EMI 319 SPEAKER SYSTEM

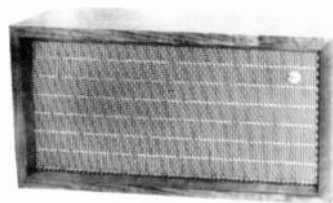

● UNLIKE MANY so-called bookshelf speaker systems, the EMI Model 319 is actually small enough (23 x 11½ x 10¾ inches) to fit on a typical bookshelf. Like its well-known big brother the DL529, the 319 is fully enclosed and heavily damped internally. Its 13½ x 8⅞-inch elliptical woofer has an aluminum cone and a high-compliance plastic suspension. High frequencies are handled by a 3⅞-inch sealed-back cone tweeter.

My frequency-response measurements, taken indoors and averaged from seven different microphone positions, showed a generally smooth characteristic (within

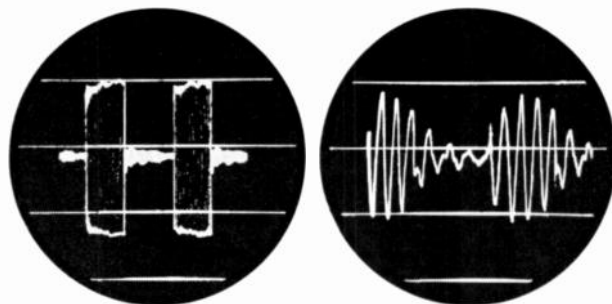

A 9-ke tone burst (left) reveals excellent high-frequency response. Tone burst of 120 cps (right) displays some ringing.

approximately ±5 db) from about 80 cps to 5,600 cps. The mid-range frequencies between 300 and 2,000 cps were within ±1.5 db, and the frequencies below 90 cps sloped downward at about 10 db/octave. There was also a 7-db dip between 6,000 and 9,000 cps. At 15,000 cps the response was back to the 0-db reference level. A peak at 120 cps appeared at all of the microphone positions, but it is difficult to separate low-frequency room resonances from the inherent response of the speaker system.

Transient-response tests performed with tone bursts revealed excellent high-frequency characteristics and fairly good response at the low and middle frequencies. There was some ringing at frequencies between 100 and 1,000 cps, but no spurious frequencies were generated. Harmonic distortion at a 1-watt input level was under 3 per cent down to 70 cps, but rose substantially at lower frequencies.

Listening to the EMI 319, with swept sine-wave test signals as well as musical and vocal programs, confirmed that it had a very smooth, if somewhat elevated, mid-range response and plenty of clean, well-defined highs, even when played at a high level. The low-frequency output fell off smoothly but without distortion at any reasonable volume. I would say the speaker's lower limit would be about 60 cps.

One might think that the depressed high and low ends indicated by the measurements reflected a dulled, thin, sound. Subjectively, however, the ends of the spectrum seemed to be well represented. In over-all sound, the EMI 319 can best be described as having a tight, clean bass (though it does not extend to the lowest musical octave), a crisp mid-range with strong presence, and a bright, well-dispersed treble. To suit my personal listening taste, I had to use bass boost and some treble cut in my amplifier. The result was a pleasing and musical sound. The very fact that the speaker's response could be successfully modified with tone controls is a sign that it is basically a good reproducer, since no amount of equalization can get good sound out of a bad speaker. The EMI 319 speaker system, in an oiled walnut finish, is priced at \$99.75. It is also available in unfinished gumwood for \$94.75.

For additional product information, use the reader service card. Circle number 188 for the Sony TC-500 tape recorder, number 189 for the EMI 319 speaker.





*collector's item*



The Concord 884 transistorized stereo tape recorder is designed for the connoisseur of sound, the collector with tastes and demands above the ordinary. No other recorder, regardless of cost, has all the Concord 884 professional quality features.

Three separate heads—one record, one playback and one erase—assure professional quality reproduction from FM multiplexing, stereo records and live performances. Four completely separate preamps—two record and two playback—and full transistorization assure maximum reliability. A flip of the AB monitor switch lets you compare source vs. tape while recording.

A few of the other features are: built-in sound-on-sound switch for effects such as electronic echo chamber; stereo headphones output; automatic reel-end shutoff; 3 speeds; 2 lighted VU meters. All push-button operation; 15 watt stereo power amplifier and separate 7" full range speakers complete your 884 stereo system. Model 884 under \$450.\* Other models from \$100.\*

\*Prices slightly higher in Canada.

*For Connoisseurs Of Sound*

# CONCORD 884

CONCORD  ELECTRONICS CORPORATION 809 N. Cahuenga Blvd., Dept. F, Los Angeles 38, Calif. / In Canada / Regal Industries Ltd., Montreal-Toronto

THE SIGNATURE OF QUALITY ■ Tape Recorders/Industrial Sound Equipment/Dictation Systems/Communications Devices/Closed Circuit Television

CIRCLE NO. 12 ON READER SERVICE CARD

## "MASS" REVOLUTION NOW IN PROGRESS

ADC Achieves Lowest Mass  
In Cartridge Design With  
POINT FOUR\*, 660 & 770

(\*Elliptical Stylus Now Available)

What are the characteristics of the ideal stereo phonograph cartridge? Stylus mass will have to come down . . . compliance will be concomitantly increased . . . vertical tracking angle will be standardized . . . tracking force will be exceptionally low.



### WHAT ADC HAS DONE

ADC recognized these ideals some time ago. We knew that marginal upgrading of existing designs would not attain these goals. From this decision came the concept of the INDUCED MAGNET TRANSDUCER. In short order we had prototypes of this new class of magnetic cartridge that shattered old technical limitations. What followed were three startlingly new cartridges that incorporated this principle: the ADC POINT FOUR, recommended for manual turntables; the ADC 660 and 770, recommended for automatic turntables and record changers—NOT YEARS HENCE, BUT TODAY.

### YEARS AHEAD PRINCIPLE, TODAY

"Significantly reduced mass" was the key advantage, we said—months before the spotlight was turned on this factor. The use of a fixed magnet, separate from the moving system, inducing its field into an armature of extremely light weight, slashed mass to "half or less than that of systems previously regarded as low-mass designs" we also noted. The tubular, aluminum stylus arm or cantilever connected to the stylus to move this negligible mass was made even lighter. We were then able to match this low mass with a suspension of exceptionally high compliance. Minimum tracking force suggested is 3/4 gram, but we have tracked the POINT FOUR perfectly at 1/2 gram. "Obtaining the now established tracking angle of 15° is no problem" with the pivot point of the arm brought close to the record surface by the new physical configuration.

### OTHER ADVANTAGES

There are others. We stress a few of the many because they involve factors designated for an idealized cartridge of the future. And we ask you to compare the ADC cartridges AVAILABLE TODAY with these eventual goals. We believe you'll agree that these are the most advanced cartridges available anywhere. We can only hope that you try them with equipment that will do them justice.

Price: ADC POINT FOUR . . . . . \$50.00 \*  
ADC 660 . . . . . \$46.50  
ADC 770 . . . . . \$29.50

(\*Slightly higher with elliptical stylus)



**AUDIO DYNAMICS  
CORPORATION**

PICKETT DISTRICT ROAD,  
NEW MILFORD, CONNECTICUT

CIRCLE NO. 5 ON READER SERVICE CARD

## THE FUGUE

**THE FUGUE is one of those formidable forms**

**THE FUGUE is one of those**

**THE FUGUE is one of those formidable**

By **FREDERIC GRUNFELD**

THE fugue is one of those formidable forms with which music professors like to frighten their students. For the average listener, it has the reputation of being impossibly complex. Actually, its grammar may be a trifle complicated, but the language itself can be understood by any music lover, particularly if he takes the trouble to practice fugal listening—starting with canonic and fugue-like passages in Bach's *Inventions*, then proceeding to his *Well-tempered Clavier* and, later, to *The Art of the Fugue*. Basically, all fugues are only an extension of a musical method we all mastered by the time we were in the first grade—remember *Frère Jacques* and *Three Blind Mice*?

Rounds and canons fascinated the fathers of the fugue in the fourteenth century, and they delight children today, perhaps because the whole sounds greater than the sum of its parts. Anyone capable of carrying the smallest scrap of a tune can join in this game of follow-the-leader and feel himself part of an intricate web of harmonies and rhythms. Of course, this rudimentary kind of counterpoint is pretty much confined to the children's corner. A round is a round is a round, as Miss Stein might say, and is bound to repeat itself after a few measures. But even the more sophisticated canons, whose voices may enter off beat and several tones above or below the original, rarely manage to sustain a long line or to achieve dramatic continuity.

In a fugue, the simple devices of the round and canon are raised to the *n*th power and harnessed to the mightiest of contrapuntal forms. Although the individual voices still pursue each other—*fuga*, in Latin, means "flight"

—the rules are modified so that the second line need not imitate the first continually. This gives composers the freedom to extend, vary, and develop.

Take-off and landing, as might be expected, are the most rigidly controlled parts of a fugue's flight plan. Once the theme is airborne, the composer can steer a fairly unrestricted course. At the outset—in the exposition—the first voice states the brief but all-important theme, the subject, on which the entire fugue is based. Then the second voice enters, usually five steps higher on the scale, with what is called the answer. In outline these two melodies are nearly identical. Baroque composers referred to them as *dux* (the leader) and *comes* (the companion).

The third and fourth voices, when they enter, are again *dux* and *comes*. Any number within reason can play, but the great majority of fugues are in three, four, or five voices. They may be for instrumental as well as human voices, and in the great keyboard fugues, each is simply a separate melody line.

As the second voice makes its appearance, the first proceeds to an extension of the subject, the countersubject, which all other voices must take up in their turn. The whole exposition, then, follows a predictable course, each voice entering with the subject and moving into the countersubject as a successive voice takes up the subject at a higher or lower pitch.

The voices need not enter from top to bottom—for example, their order of appearance might just as well be tenor, soprano, alto, bass. Nor do they follow each other with the clockwork regularity of *Frère Jacques*. Normally,

(Continued on page 34)



Now, Enjoy the  
Musical  
Perfection of

# PLAYBACK<sup>®</sup>

## ALTEC ALL-TRANSISTOR 360A ROYALE II STEREO AMPLIFIER

### TYPICAL PROFESSIONAL USE OF ALTEC PLAYBACK:

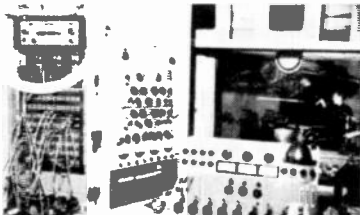

The 360A is used by Dave Sarsers and Skitch Henderson's famous "Studio 3" in New York.



Perfect partners! Rack-mounted Altec 360A works with Altec 314A Emperor Royale FM Multiplex Tuner at Sim-O-Rama Sound Recording Studio, N. J.



The film production service at Virginia State Department of Education relies on the 360A for power in conjunction with other Altec PLAYBACK amplifiers and controls.



United Recording Studios (Hollywood) uses Altec A-7 "VOICE OF THE THEATRE" Speaker Systems for 3-channel PLAYBACK monitoring.



Interior of Columbia Records Studio (Hollywood) and Altec 605A "Duplex" loudspeakers used for PLAYBACK.

### FIVE YEARS IN THE MAKING

At a time when most amplifiers were of the vacuum-tube type, we marketed our first all-transistor power amplifier for PLAYBACK applications. Today, the 351B model is credited as the most advanced single-channel amplifier of its type in the professional field, and has earned a reputation for reliability and quality to the extent that the three largest manufacturers of motion picture sound equipment have standardized on it for theatre work. Shortly after the 351, we introduced the now famous 708A "Astro"—the only all-in-one stereo center with all-transistor power output stages. Now, after five years of actual production experience with solid state circuitry, we take pride in introducing the 360A all-transistor stereo pre-power amplifier.

The difference in quality between the all-transistor Altec 360A and even the finest vacuum tube amplifier becomes most readily apparent through comparative A/B listening tests. Bass frequencies assume life-like solidity seldom heard outside a concert hall. Transient distortion, background hiss, and microphonics just aren't there. Even at loudest volumes, hum is so completely inaudible our engineers have concluded that it is totally absent. (In fact, we urge you to compare this feature with that of any other amplifier on the market!) Highs are so crisp, clean and transparent that listening to them approaches a new and revealing musical experience. You hear the highest frequencies in complete purity for the first time, since this amplifier neither contains nor needs the built-in bass boost found in ordinary units—one which affects the *entire* frequency spectrum.

### NEW CONTROL CONVENIENCE

The new Altec 360A Royale II Amplifier contains the *first* "KEYBOARD" control console. This exclusive Altec feature groups operating controls at one central location to eliminate confusion that is commonly found with the usual multiplicity of switches. Another convenience feature: "Proscenium Illumination" casts an even glow across the "keyboard" control console to provide clear visual selection of control keys even in the most softly lighted room.

### PLAYBACK—THE CONSIDERED CHOICE OF PROFESSIONALS

Genuine PLAYBACK equipment is the considered choice of famous recording and broadcast studios—Capitol, ABC, Universal Recording, Columbia, and many others of equal stature. Just a few are illustrated at left. Professional studios depend for their income on the quality, the technical excellence, of the equipment they use. Shouldn't the equipment you select for your home reflect this same dedication to quality? If you agree, visit your nearest Altec Distributor (Yellow Pages) and hear the finest equipment in the world of sound: Altec PLAYBACK equipment. Be sure to ask for your courtesy copy of Altec PLAYBACK and Speech Input Equipment for Recording and Broadcast Studios. Though prepared specifically for the recording/broadcast industry, the conclusions to be drawn about your own home music center will be obvious. Or, for free copy write Dept. SR4.

**FEATURES:** POWER • 70 watts (IHFM); 35 watts per channel.  INPUTS • 12, stereo or mono: magnetic or ceramic phono, tape head, stereo microphones, tape, radio, auxiliary.  OUTPUTS • 7, stereo or mono: left, right and center speaker outputs, left and right channel recorder outputs, center channel voltage output for auxiliary amplifier, headphone output jack.  KEYBOARD CONTROLS • Rumble filter, stereo-mono switch, tape monitor, channel reverse, hi-low gain, volume contour, scratch filter, phase reverse, headphone-speaker output switch.  OTHER FRONT PANEL CONTROLS • Input selector, channel reverse, independent bass and treble controls (friction coupled), blend control, balance control, volume control.  REAR PANEL CONTROLS • Magnetic-ceramic phono input selector, speaker impedance selector.  PRICE • \$366.00 including cabinet. Only 5½" H, 15" W, 11¼" D.  SPECIAL FEATURES • Automatic reset circuit breakers for over-current protection of each channel and AC line. Diffused keyboard illumination plus daylight power indicator. Both headset and speaker monitoring for tape recording on front panel. Variable crossover type bass tone control for bass boost independent of mid-range.



©1964 ALTEC LANSING CORPORATION

**ALTEC LANSING  
CORPORATION**

*LTV* A Subsidiary of  
Ling-Temco-Vought, Inc.  
ANAHEIM, CALIFORNIA

# NEW!

## GRADO TRACER BEAM

STEREO CARTRIDGES

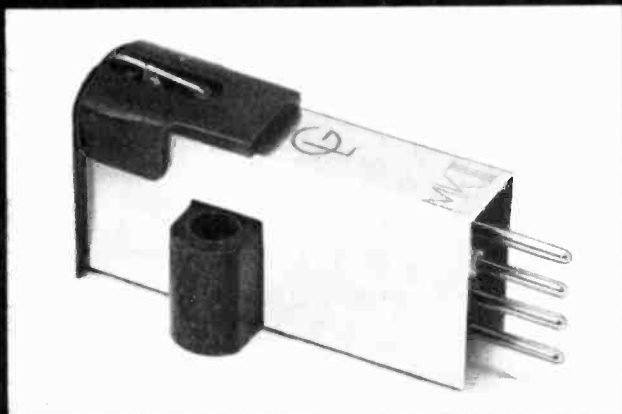

### THE GRADO TRACER BEAM STEREO CARTRIDGES MEET ALL OF THESE REQUIREMENTS!

Eliminate inner groove distortion.

Eliminate completely "Shattering," and buzzing during playback.

Play both stereo and monaural records.

Be completely non-critical to installation problem and still perform superbly.

Track in a good tone arm at 1 gram or less (not just make sound but trace with low distortion!)

Work in all record changers and automatic turntables at up to 6 grams.

Have IM distortion of no more than 2% at the highest recorded levels and maintain 1% or less IM distortion for normal recorded levels.

Have a high frequency response to at least 24,000 CPS or better.

Have a FLAT frequency response down to 10 CPS.

STYLUS ASSEMBLY REPLACEABLE BY CONSUMER!

**TRACER BEAM MK I STEREO CARTRIDGE \$75.00**  
**TRACER BEAM MK II STEREO CARTRIDGE \$49.50**  
**TRACER BEAM MK III STEREO CARTRIDGE \$37.50**  
**TRACER BEAM MK IV STEREO CARTRIDGE \$27.50**

For further information please write

**GRADO LABORATORIES, INC.** 4614 Seventh Ave., B'klyn 20, N.Y.

short interludes for the other voices are inserted before the third and fourth join the pattern.

The exposition, sounding rather like a canon, serves to fix the main theme firmly in our memory. This theme is then explored and developed in detail throughout the middle section, in which the composer uncovers the inner possibilities of his theme much as a sculptor reveals the figure "hidden" in a block of marble. The subject returns repeatedly, but always in some new role or different manifestation. Alternating with it are free episodes that follow no particular protocol, but are usually based on an idea or fragment taken from the opening measures.

As the fugue draws to a close, its lines may converge in a *stretto*—a "narrowing" in the flow of counterpoint—so that the voices seem to catch up with each other, the answer treading on the subject's heels. The fugue, in effect, has reached home port, and the composer pushes his themes together as a sea-captain shuts up a telescope. Everything is resolved in the coda, with a last ringing statement of the subject, and no doubt is left in anyone's mind that something definite has been accomplished.

And, of course, it has. The finest fugues contrive to hold us so spell-bound with their poetry that we are hardly conscious of the superb technique that has gone into them. A fugue, like a master game of chess, involves a double triumph of mathematical logic and creative imagination. And, again like a chess master, the composer has a vast choice of moves and gambits, some unusual, but almost all duly classified in musical literature. They include imitation, which has one voice doggedly mimicking the other; augmentation, which doubles the time value of the notes—eighths into quarter notes, for example—thus presenting the theme in slow motion; diminution, which speeds up the theme by cutting the note values in half; and inversion, which turns the melody upside down. This last is rather hard to spot unless you have exceptionally well-trained ears. Even more difficult are the cancrizans or crab canons, which reproduce the theme as though it were held up to a mirror. But it takes very little practice to hear a fugue in depth, and to become conscious of how its common devices determine the shape of each work.



PHOTOGRAPHED IN NEW YORK SHOWROOM OF DUA INCORPORATED

WHO WANTS TO  
SEE A TAPE RECORDER  
IN A LIVING ROOM

?  
YOU DO  
(if it's Miranda®!)



**Two magnificent new stereo tape recorders featuring major electronic advances... plus the beauty of genuine teakwood cabinetry!**

**MIRANDA Sorrento** Sophisticated solid-state circuitry, comprising an impressive array of 21 transistors and 19 diodes. Electronic matrix-type push-button switching positively and instantaneously controls every mode of tape transport. Tape-handling mechanism includes automatic tape lifters and tension bars. Other features include: built-in 4" x 6" full range dual speakers, automatic shut-off for motors and amplifiers, three motors plus servo motor for remote control, illuminated VU meters, pause switch, electronic switching delay, 3 $\frac{3}{4}$  and 7 $\frac{1}{2}$  ips., records and plays 4-track stereo. *Priced at \$400.00*

**MIRANDA Nocturne** Hysteresis synchronous motor assures unflinching constancy in tape movement. Smoothly operating push-button controls make it a pleasure to operate. Each channel is provided with individual volume and tone controls, VU meter, two input jacks, output jacks for external speakers. Single switch allows the Nocturne to be used for either stereo or mono playback. Ten clean actual watts of audio power (5 per channel) plus matched 4" x 6" speakers give rich, full-bodied reproduction. The Nocturne records and plays 4-track stereo and mono in 1 $\frac{7}{8}$ , 3 $\frac{3}{4}$  and 7 $\frac{1}{2}$  ips. *Priced at \$250.00*

**SORRENTO REMOTE CONTROL:** All tape transport controls plus separate channel volume controls, and 16 ft. cable. *Priced at \$35.00*

At last... the first truly practical design in tape recorders. Miranda is housed in genuine teakwood cabinetry that blends with and enhances any decor. No glaring chrome trim... no jagged outline disturbs its simple, classic elegance. More than a fine tape recorder, Miranda is also a fine piece of furniture that you can display with pride. Write for free literature to Dept. HFSR-4.

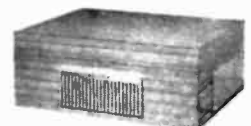

ALLIED IMPEX CORPORATION, 300 PARK AVENUE SOUTH, NEW YORK 10, NEW YORK \* CHICAGO 45, ILLINOIS \* DALLAS 7, TEXAS \* LOS ANGELES 10, CALIFORNIA

# WILL YOUR ULTIMATE PRECISION LOUDSPEAKER BE

## A JBL LINEAR-EFFICIENCY SYSTEM

?

To the concept of long linear cone excursion James B. Lansing Sound, Inc., adds JBL precision workmanship, extremely close tolerances, and the largest voice coils made anywhere. When Linear-Efficiency transducers are mounted in a *compact* enclosure, the full-range coverage they provide is miraculous indeed. And when the same principles are applied to a full size system, "ultimate" is a most apt description.

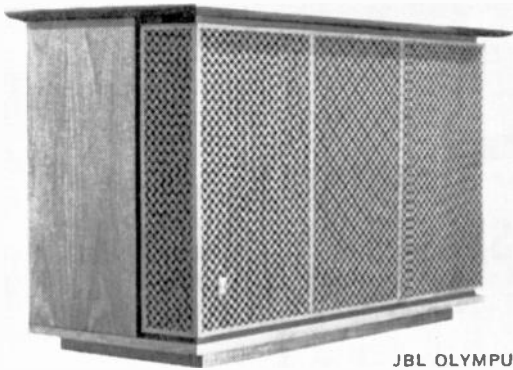

JBL OLYMPUS

## ...OR A JBL HIGH EFFICIENCY SYSTEM

?

JBL makes the most efficient loudspeakers in the world, the only transducers with four-inch voice coils. JBL efficiency is the result of advanced magnetic circuitry, tight tolerances, and the large amount of conductor in the gap provided by large voice coils made of wire ribbon wound on its narrow edge. This gives them a dynamic range, transient response, presence, and an evenness of coverage without equal.

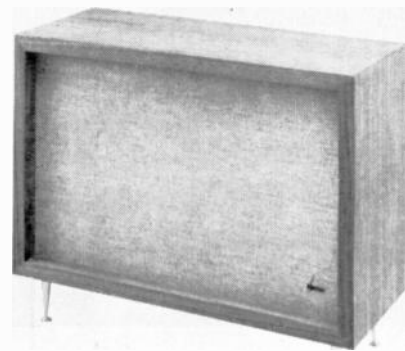

JBL C37

## ALL JBL SPEAKER SYSTEMS ARE AVAILABLE SELF-POWERED

In a JBL Energizer/Transducer, loudspeakers and power source are engineered as a unit, perfectly matched to reproduce a preamplified signal with a purity that has no precedent. All-solid-state construction is used in the energizer. Generating negligible heat, non-microphonic, it can be mounted in and become a part of the acoustical enclosure.

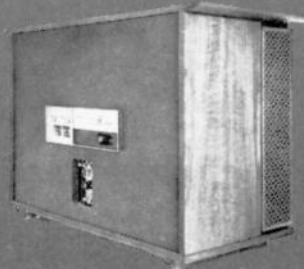

It is without hum, and distortion in any form approaches the vanishing point. It is not subject to the creeping degeneration common in vacuum tube devices. With custom matching of energizer and transducers, exactly the right damping is provided at all frequencies. Transient response of an Energizer/Transducer has never been equalled.

## JBL OFFERS YOU MORE WAYS TO MAKE YOUR SYSTEM YOUR VERY OWN

JBL recognizes the fact that the serious participant in the art-science of high fidelity is an enthusiastic individual. He wants his very own system, one not quite like any other he has known. To serve the need of each individual, JBL offers two basic types of loudspeakers in many models. They can be used in large systems or small systems, built-in or free-standing. JBL provides enclosures for every taste—

infinite baffle, bass reflex, folded horn ... acoustically excellent, at the same time beautiful furniture. You will find that JBL makes equipment you will find nowhere else — acoustical lenses, a passive radiator, integrated stereo... All have one thing in common: JBL products are precision built for the talented listener who is implacably determined to own the finest. Write for a free copy of the JBL complete catalog.

JAMES B. LANSING SOUND, INC.

JBL

LOS ANGELES, CALIFORNIA 90039



J.S. BACH'S  
**MAGNIFICAT**  
 in D

*Commemorating Mary's meeting with her cousin Elizabeth—the occasion of the Magnificat uttered in Luke—Albrecht Dürer's woodcut, "The Visitation," comes from his Great Book of the Life of the Virgin, and has been dated 1503.*

**T**HE Song of the Blessed Virgin Mary, a hymn of praise recorded in Chapter One of the Book of St. Luke in the New Testament, served several times to fire the creative imagination of Johann Sebastian Bach. The ultimate demonstration of the strength of this inspiration is the brilliant and joyous *Magnificat* in D Major.

Albert Schweitzer, in his comprehensive biography and guide to Bach's music, mentions an earlier *Magnificat* for soprano solo, supposed to have been studied by one of the first editors of the *Bachgesellschaft* about 1855, more than a hundred years after Bach's death. This score disappeared, apparently right from under the noses of the Bach scholars of the nineteenth century, and to this day its problematical existence defies and frustrates the best musical sleuths. There is also an earlier version of the D Major *Magnificat*, composed, it is thought, for the Christmas Day service in Leipzig's Thomaskirche in 1723, Bach's first year as Cantor there. This setting of the text is in E-flat Major, and several sections have been inserted between the

verses that are not part of the traditional text. Some students of Bach have conjectured that he composed this version as stage music to accompany the representation of the scene in the manger at Bethlehem. Sometime during the next decade Bach completed the final version of the score, omitting the interpolations and transposing the music down to D Major.

The *Magnificat*, which was placed just after the sermon in the Lutheran service of the time, is a confident, exultant outburst—the opening words are "*Magnificat anima mea Dominum*" ("My soul doth magnify the Lord"). Because it was the climax of the service, the *Magnificat* had to be relatively brief to have the proper effect, and the spare concentration of Bach's score is one of its most extraordinary features. Although short in duration, the work creates an effect of splendor and magnificence. It is written for five-part chorus, five vocal soloists, and the full, colorful orchestra of Bach's time: three trumpets, two flutes, two oboes, strings, timpani, and continuo instruments.

*(Continued overleaf)*



The grand and exuberant performance of Bach's *Magnificat* led by Leonard Bernstein and recorded by Columbia in clear and brilliant stereo sound is outstanding in every way. On both the Deutsche Grammophon recording (in the Archive series) and the Vanguard Bach Guild disc, this Baroque masterpiece is heard in musicianly readings.

In form and substance, the *Magnificat* may well have served Bach as a preliminary exercise for the mighty task of composing the Mass in B Minor.

Of the *Magnificat's* twelve sections, five are for chorus, and another—the setting of “*Suscepit Israel*” (“He has helped His servant Israel in remembrance of His mercy”)—calls for sopranos and altos in choir. The opening chorus, written for five parts, is one continuing jubilation, developed and repeated in the spirit of the first words. Following this is an aria for the second soprano, “*Et exultavit*,” accompanied by a contrapuntal line of melting sweetness and tenderness in the strings, and then the aria “*Qui respexit*,” a moving dialogue between the first soprano and the oboe. At its conclusion comes an extraordinary dynamic contrast: a headlong intrusion by the chorus intoning the “*Omnes generationes*” (“Generation after generation will bless the Virgin Mary”).

Next comes the first appearance of the bass soloist, in the slow, florid aria “*Quia fecit*,” and after it the duet for alto and tenor, “*Et misericordia*,” one of the chief glories of the score. Its gently rocking rhythm gives it the character of a lullaby, and the flutes and muted strings of the orchestral accompaniment impart to it a particular poignancy. Again there is a sharp contrast as the music continues without pause into the brilliant chorus “*Fecit potentiam*,” a magnificent exposition of the might of the Lord. The momentum is suddenly arrested, and a descending chromatic passage for solo violin leads to the tenor aria “*Deposuit potentes*” (“He has put down the mighty from their thrones”). In the accompaniment of the succeeding number, the alto aria “*Esurientes*,” the flutes return to the foreground. Near the end of the aria the soloist sings the word “*inanes*” (“empty”) and Bach at this point dispenses with accompaniment altogether, leaving the word to be heard unadorned.

The next section is the “*Suscepit Israel*,” one of the most haunting of all the *Magnificat's* movements, with a particularly memorable use of unison oboes above soprano and alto voices. This is followed by the two concluding choruses, “*Sicut locutus est*” and “*Gloria Patri*.” The former is the only full-fledged fugue in the work, and the concluding chorus is again a mag-

nificently vibrant and exciting expression of unbounded joy. One of its chief features is the alternation between the sound of the massed chorus and the imitative entries of the individual choirs. The concluding words are “*Sicut erat in principio*” (“As it was in the beginning”), and here Bach brings back the music of the opening chorus.

EIGHT recordings of the *Magnificat* are listed in the current Schwann catalog, five of them in mono only, and three others in both mono and stereo. For a work of this nature, stereo is a vital ingredient in the overall impression, and since none of the five mono-only versions is in any way outstanding, it is from the remaining three that the reader will want to make his choice. The performances for Vanguard and Deutsche Grammophon Archive, conducted respectively by Felix Prohaska (BGS 5005, BG 555) and Karl Richter (ARC 73197, 3197), are solid, tasteful accomplishments, with better solo vocalists in the Archive recording. The technical aspects of both recordings are good without being exceptional.

For the exceptional in every respect, one must turn to the performance conducted for Columbia by Leonard Bernstein (MS 6375, ML 5775). Together with the New York Philharmonic, the Schola Cantorum directed by Hugh Ross, and five distinguished vocal soloists, Bernstein turns in a reading of sustained grandeur, excitement, and exuberance. The choice of soloists is surprising: the second soprano part is sung by mezzo-soprano Jennie Tourel, and the alto solos are given to the countertenor Russell Oberlin. Miss Tourel has a little trouble with some of the higher-lying passages, especially in her first solo, “*Et exultavit*,” but it is difficult to think of another singer who could invest the part with such perceptive and sensitive musicianship. The other soloists are soprano Lee Venora, tenor Charles Bressler, and bass Norman Farrow. All contribute to the success of the performance, and the Columbia engineers have produced recorded sound of clarity and brilliance.

Bernstein's *Magnificat* is not only one of the conductor's most impressive recordings: it is one of the finest performances of Baroque music in the current catalog.



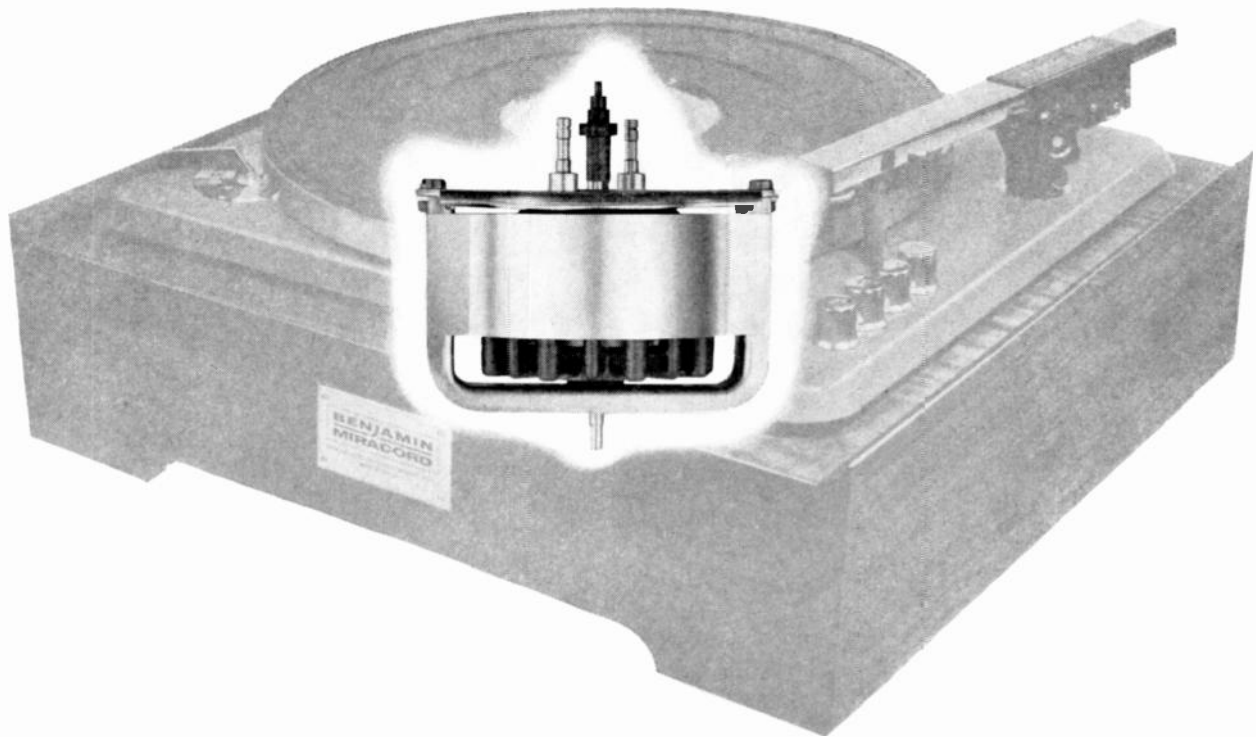

## world's only automatic with hysteresis-synchronous motor

The motor is the heart of turntable system. Unless it assures smooth, steady, constant motion, the quality of the remaining mechanism is to no avail. There is probably no finer motor than the famous Papst hysteresis-synchronous, used in the finest studio turntables and tape transports. The speed of this motor is synchronized to the frequency of the power line. And it rotates at a constant, accurate rpm, even with extreme variations in voltage and load conditions.

The Miracord 10H is the only automatic that offers the speed reliability of a hysteresis motor, and the only one equipped with a Papst. The smooth, steady motion this imparts to the turntable is one of the major reasons for the distinctively natural quality of sound associated with the Miracord 10H.

There are other reasons, too: a mass-counter-balanced, freely responsive tone arm using no springs—and a heavy, one-piece die cast turntable, 12 inches in diameter, precisely machined and weighted for dynamic balance.

The Miracord is incredibly gentle to your records, as a manual turntable, an automatic turntable, automatic record repeater or automatic record changer. Four FEATHER-TOUCH push buttons reduce automatic operation to utter simplicity.

Model 10H with Papst hysteresis motor, \$99.50; Model 10 with induction motor, \$89.50 (less base and cartridge). Hear the Miracord with the new Elac cartridge: the Stereo 322 or Mono/Stereo 222. For details, write:

**BENJAMIN  
MIRACORD**

BENJAMIN ELECTRONIC SOUND CORP., 80 Swalm Street, Westbury, New York sole U. S. distributor for Miracord turntables, Elac cartridges, and other Electroacoustic® audio components

# An FM tape stereo system of comparable quality would cost up to \$850

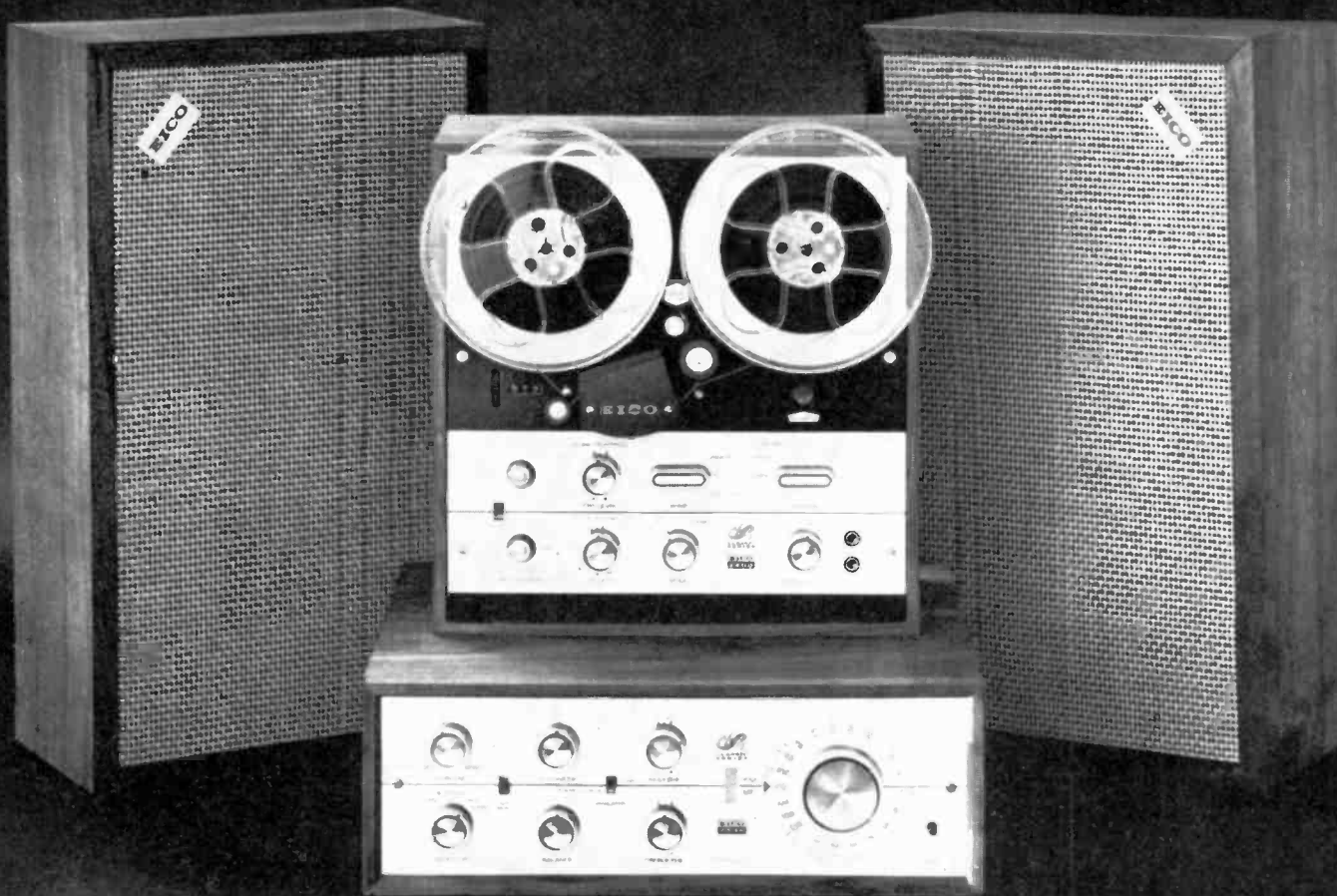

## start with the Eico Receiver Kit — only \$154.95

You can build a complete, high quality FM tape stereo system from the new Eico Classic Speed Kit package for only \$445. This system includes the Classic 2400 stereo/mono 4-track tape recorder; Classic 2536 FM MX stereo receiver and two HFS-8 2-way high fidelity speaker systems.

Completely wired you'd save nearly \$300 on this system over other makes of comparable quality—factory wired price \$570. You can also select any individual component at a remarkably low price.

Here's why it's so easy to build these superb components. The 2400 tape recorder comes with the transport completely assembled and tested—only the electrical controls and amplifiers need be wired. The 2536, is without doubt the easiest-to-build receiver ever designed. The front end and the IF strip of the tuner section are supplied completely pre-wired and pre-aligned, and high quality circuit board and pre-aligned coils are provided for the stereo demodulator circuit. Speaker systems are completely assembled in fine oiled finish walnut cabinet.

**EICO CLASSIC 2400 STEREO/MONO 4-TRACK TAPE RECORDER** Performance on a par with recorders selling at twice the price. 3 motor design enables each motor to be optimized for its particular function.

□ 3 heavy-duty 4-pole motors, capstan motor with integral fan □ DC braking of reel motors □ Standby operation between all transport modes prevents tape spillage, provides slur-free starts, permits easy cueing & editing □ Automatic end-of-tape switch & digital counter □ Jam-proof belt shift mechanism selects 7½ or 3¼ ips speed. □ Requires no head wearing pressure pads □ New combination erase and record-play

4-track stereo head □ Equalization selector provides uncompromised equalization on both speeds. □ Mixing mike and line level controls □ Dual electron-ray level indicator tubes □ Made in U.S.A. □ Oiled finish walnut base incl. in price of both semi-kit and wired versions. Semi-kit (transport assembled & tested) \$199.95; wired \$269.95.

**EICO CLASSIC 2536 FM-MULTIPLEX STEREO RECEIVER** Makes every other stereo receiver seem overpriced. Combines stable sensitive FM stereo tuner plus a virtually distortion-free 36-watt stereo amplifier with remarkable overload, transient and regulation characteristics.

**AMPLIFIER SECTION** □ all program sources—magnetic phono, adapted ceramic phono, tuner, tape □ Full control facilities—bass, treble, blend and balance □ Tape monitor switch □ Distortion at 10-w/channel 40 cps—0.5%; IHF, power bandwidth at 1% distortion, 30 cps—20 kc.

**TUNER SECTION** □ Low noise, shielded & temperature compensated front-end for drift-free performance □ 4 amplifier-limiter stages & ultra-wide-band ratio detector. □ Electron-ray tuning bar & stereo program indicator □ Velvet-smooth rotary tuning □ IHF usable sensitivity 3 μv (30db quieting); 1.5 μv (20db quieting). □ IHF distortion 0.6%; IHF capture ratio 3db. Kit \$154.95; wired \$209.95 (Incl. FET)

**EICO HFS-8 2-WAY SPEAKER SYSTEM** Compact 2-way speaker system in handsome oiled finish walnut cabinet. Full transparent bass; clean, smooth middles and highs. Two speakers: 8" high-gap energy woofer-mid-range transducer, and matched 2" tweeter. Wired only, \$44.95.



2036



2200



2050

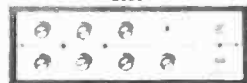

2080

**OTHER NEW EICO CLASSIC SERIES COMPONENTS** 2036—36-watt stereo amplifier. Kit \$79.95; wired \$109.95. 2200—FM/MX Stereo Tuner. Kit \$92.50; wired \$119.95 (Incl. FET.) 2050—30-watt stereo amplifier. Kit \$92.50; wired \$129.95. 2080—80-watt stereo amplifier. Kit \$112.50; wired \$159.95. Optional oiled finish walnut cabinet for the 2536, 2036, 2200, 2050 and 2080 are available for \$19.95. Add 5% in West

Eico Electronic Instrument Co., Inc., 131-01 39th Ave., Flushing, N.Y. 11352 Export: Robura Agencies, 431 Greenwich St., N.Y. 13, N.Y.

CIRCLE NO. 14 ON READER SERVICE CARD



FREE 1964 CATALOG  
Dept. HR-4



In the nineteenth century this engraving was erroneously assumed to be a youthful representation of the great composer. It is actually a portrait from life of his grandson and namesake who was studying art in Leipzig when it was made—probably in the year 1770, when he was twenty-two. Reasons are given in the accompanying article and elsewhere in this issue for supposing that Bach as a boy much resembled this portrait. The artist responsible for it was a highly esteemed teacher of engraving named Stock who had already instructed the young Goethe.



## **THE STRANGE APPRENTICESHIP OF J. S. BACH**

IN AN IMAGINARY INTERVIEW, A BIOGRAPHICAL ICONOCLAST ATTACKS  
THE POPULAR IMAGE OF BACH  
AND PROPOSES A FRESH LOOK AT SOME OLD BELIEFS

By **ROBERT OFFERGELD**

**MR. OFFERGELD:** Rumor says you've been circulating some outrageous gossip about old Bach, of all people.

**Mr. Agonistes:** More accurately, about *young* Bach. And if my notions about him are gossip, I can only say that all my facts are in the ordinary Bach sources. I've simply examined them from a new point of view.

**Mr. O:** What brought on your "new point of view?"

**Mr. A:** I was suffocating from the old one. So was Bach. The poor man has been embalmed for two centuries in the wrong kind of veneration.

**Mr. O:** Is this a reflection on Bach scholarship?

**Mr. A:** There's no lack of Bach scholarship around. Just a lack of Bach. He's the Ten Most Missing Composers. Nobody seems to have wondered much about the special nature of his creative habits. Nobody has even attempted to penetrate Bach's sense of his own identity. And he has less actual physicality today than

*(continued overleaf)*

# J. S. BACH

the smile that detached itself from Alice's cat. Everybody seems to have settled contentedly for Albert Schweitzer's dictum that Bach is unknowable.

*Mr. O:* I take it you disagree with this conclusion.

*Mr. A:* I disagree with it even more when Schweitzer substitutes for his own "unknowable" Bach a handy but questionable figure that can only be called Bach-Schweitzer—a companion piece to his later but similarly constructed Jesus-Schweitzer. I only remind you that in order to bring off the latter composition, Schweitzer had to junk two-thirds of the canonical Gospels. At any rate, Bach's personality has been considered untaxable church property ever since Schweitzer took him in hand. Recently I heard Bach described as "the world's greatest composer of devotional music." If that's all he amounted to, a lot of fairly devout people wouldn't cross the street to hear him.

*Mr. O:* That may be, but you probably won't deny that Bach wrote great religious masterpieces.

*Mr. A:* Bach wrote great music that was designed for religious uses, which is not the same thing. I believe it was Ezra Pound who remarked that if Bach had cared to—which mostly means, if he had been hired to—he could have written just as fervently about his dinner being late as he did about losing his Jesu. In fact, he wasn't always terribly fervent about *that*, and Mattheson, Bach's otherwise admiring contemporary, censures him for his declamation, his perfunctory way of repeating, "I, I, I, I had much grief, I had much grief, in my heart, in my heart. I had much grief, etc." This particular criticism wasn't addressed to an early apprentice work, as it happens, but to the *St. Matthew Passion*.

*Mr. O:* You doubt Bach was sincerely religious?

*Mr. A:* In any unqualifiedly naïve sense, yes. Sincerity in art and in life are two different things. Hegel rightly observes that in eras of general piety you don't have to be religious yourself to write great works of religious art. All you have to be is a great artist.

*Mr. O:* How do you explain Bach's numerous public allusions to God, all complimentary—not to mention the eighty-three theological volumes found in his library? He owned Luther's complete works in two different editions.

*Mr. A:* He also owned the mystical sermons of the Dominican monk Tauler, not to mention a number of Pietistic works considered heretical by Catholics and Protestants alike. Don't forget that Bach's public role depended on his gainful employment in a succession of orthodox Reformation parishes, than which none on record have been nosier. Under similar circumstances,

people who worked for the Communists used to own the complete works of Josef Stalin.

*Mr. O:* Just the same, Bach strikes me as devout.

*Mr. A:* In their own way, most first-rate minds are, but when it comes to Bach's public expressions in such matters, we must remember that in his day both the social and religious forms of address were extremely florid and are to be scanned with care. Bach even referred his brief manual of students' thorough-bass "to the Glory of God"—an odd gesture on the face of it. Either a little fulsome or a little simple, and Bach was neither.

*Mr. O:* You think it has another meaning?

*Mr. A:* I do. I think that at a certain moment in his apprenticeship—and probably toward its close, to judge by the change in his art—Bach received a dazzling revelation of the meaning of thorough-bass *for his personal creative method*. For the rest of his life he kept insisting on the marriage of "harmony in four real parts" and an expressive counterpoint. Henceforth each of these sciences was to exist only in the other, and for it. As an outsized intellectual feat, this particular rapprochement—in Bach's demonstration of it—can be compared to Aquinas' marriage of Aristotle and medieval theology, and it gave music the miraculous Bach texture we marvel at today. So I think that Bach's gratitude was heartfelt but essentially professional—"of the craft." In this sense his whole life work is an Offering, but his notes on thorough-bass were not dedicated to the disciplinary God who inspired Reformation preachers. They acknowledge the rather less moralistic deity who informs the creative tribe—the original Maker.

*Mr. O:* In sum, then, you attribute Bach's collection of sectarian devotional books to mere social and professional compliance?

*Mr. A:* Not entirely. Bach was more complex than that. I believe he really read his tracts—but not, heaven help us, for the "relaxation" that C. S. Terry so wildly suggests. I've sampled these homilies and most of them are as lethal as the four-hour church services and the full-hour sermons they supplemented. They plunge you into a moral and physical stupor—the kind from which

*Topping an unauthorized four-month's absence, Bach dismayed...*

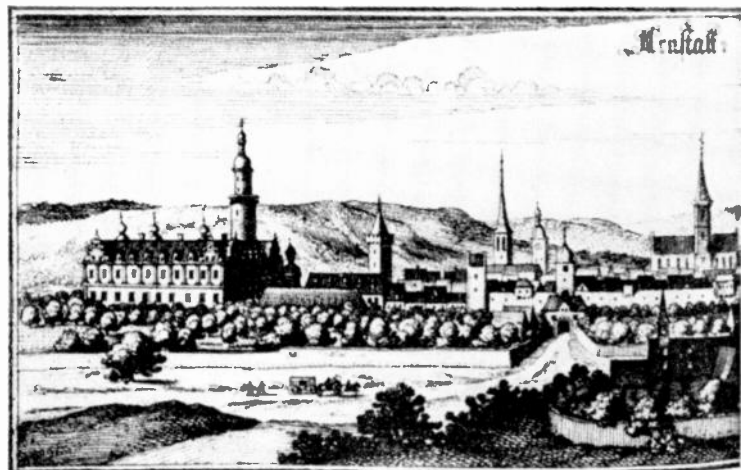

Bach notoriously blasted his congregations with his unseemly pagan thunders on the organ.

*Mr. O:* To wind up the books: why *did* he read them?

*Mr. A:* Since you insist, then. . . I think that behind his familiar mask as Cantor and—

*Mr. O:* Excuse me, there is now a “mask” in here?

*Mr. A:* There is. We know what an unshakably reserved person Bach was, unconfiding even with his sons. And his Meiningen relative, the painter Gottlieb Friedrich, who made a portrait of him, remarked that there was something “*etwas blöd*” about his expression. A possible translation of “*blöd*” is “stupid,” but in that sense the remark, even if thought, would scarcely have been uttered. It also can mean weak-sighted, but we know that Bach was not myopic. I believe that the painter’s real sense was “stolid”—a look withdrawn and inexpressive. As with many unusual minds, I think this expression of Bach’s was one aspect of a mask he found it politic to assume, and I think that one of its functions—for it had others—was to stand off an uncomprehending professional and domestic world that was necessarily alien or even hostile to his fantastically ambitious creative intention. You’ll recall that a similar oxlike stolidity about Aquinas got him jeered by his fellow-students. Behind it was the busy brain that erected the Summas.

*Mr. O:* I’ll accept your mask provisionally—in the function you describe for it.

*Mr. A:* I can give you another one. Behind his mask as Cantor and paterfamilias, then, I think that Bach was by nature an extremely sensual and wilful man—a contention which remains to be explored, but of the truth of which I am convinced. Like many another genius committed to playing a highly virtuous public role, he no doubt suspected that he really ought to be more saintly than he in fact was. I suggest that he dismally ploughed through a lot of the sanctimonious mileage on his shelves as a form of penance and self-mortification—did it sincerely, too, if you still like the word.

*Mr. O:* If you’re serious, and if your theory has any basis, how could this alarmingly ambiguous image of

...his Arnstadt church with his wildly unorthodox organ playing.

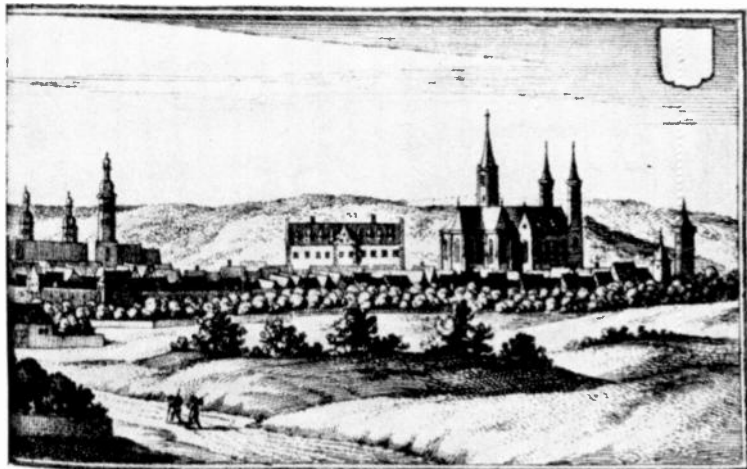

Bach have escaped everyone’s attention until now?

*Mr. A:* It was the *lack* of ambiguity in Bach’s popular image that first made me suspect the biographies. Genius isn’t all that innocuous and homespun and four-square unless it conspires to seem so. The thing that disturbs me most in the official Bach literary portraits is their lack of jarring detail. I miss the discordant, the irrepressibly lawless human note, especially with regard to Bach’s footloose early years. Where is the unofficial, pre-wig Bach? The over-all picture seems awfully tidied up, and I can give you one very good reason for that. The early Bach story was in fact heavily censored, first of all in the telling of it by Bach himself. Later it was even more severely pruned, in compliance with Bach’s expressed wish, in the memoirs of his sons and their friends. Long after his death they scarcely had the nerve to allude vaguely to the “many other adventures” of the young Bach, adding apologetically that the old man sternly disapproved of the tales in question. The astonishing thing is that twentieth-century biographers have meekly submitted to the same stricture. And since they ignore the clues that *did* escape censorship, they have had to derive Bach’s personal character by means of a back-formation from his music, an operation piously conducted on their knees. Terry in fact begins by complaining about Spitta’s great work that Bach himself is eclipsed by the writer’s “pitiless” exposition of the music. Terry then collects thousands of facts about hundreds of Bachs you never heard of and declines to speculate at any real psychological depth about his principal subject.

*Mr. O:* Which leaves Schweitzer where?

*Mr. A:* In this “back-formation” sense, Schweitzer is the most misleading of all. He has neither Terry’s facts nor Spitta’s selfless dedication. Schweitzer’s book is primarily a tract demonstrating his theory that Bach wrote “descriptive” or “pictorial” music, but it also tends to confirm a dangerous popular impression that music owes more to ethical forces of sweetness and light than it does to the less lovely primary energies of humanity. I find this kind of missionary effort even more meddlesome than most others, and it forces me to protest with Gide that fine feelings are the stuff of which bad art is made.

*Mr. O:* You deny that Bach’s music is “descriptive?”

*Mr. A:* I deny that Bach wrote it to describe the things that Schweitzer happens to like two centuries later. No other Bach biographer puts his own cart *that* far in front of the horse. But Schweitzer inflicts the final indignity on Bach with general propositions like these: “Bach himself was not conscious of the extraordinary greatness of his work . . . his immense strength functioned without self-consciousness, like the forces of nature. . . .” We apparently are to understand that the composer with the most conspicuous muscles in music

# J. S. BACH

didn't even know he had them, being not only humble but curiously unreflective to boot. Any Baroque carpenter or stonemason well knew his own worth, but the composer of the *Goldberg Variations* didn't.

*Mr. O*: Objections noted. What picture would you put in the place of the ones you question?

*Mr. A*: The final picture is necessarily up to you, but I can give you some fresh subject matter for it. Ever since Bach's remains were examined in 1894, leading to the systematic collation of his portraits, we know a great deal about his appearance and probable physical history. Bach was just under five feet seven and unusually stalwart. He had a rather largish head but it did not seem so because of his wide shoulders and extremely powerful arms. Because the back of his skull was much more developed on the left side than on the right, he held his head a little to the right and thrown slightly back in compensation. Bach's hands were ripely muscled and very plastic, the wrists fairly heavy, but jointed elegantly. Upon a rather delicate or "leptosomic" bone-structure inherited from his mother's line, he displayed the firm and compact body-type that is known as pyknic, and that appeared generation after generation in Bach males. The combination is often seen strikingly in dancers and athletes. Bach had a high fresh coloration and a dazzling complexion, even in maturity. His eyes were a clear blue in youth, darkening in their background to a greyish hazel as he aged. His forehead was unusually narrow and so high that he was probably fairly bald before he was thirty, a condition apparently not due to any dermatological morbidity but resembling the so-called "male-pattern" baldness that is sometimes ascribed nowadays to an excess of male hormone. Bach's forehead sloped back noticeably from a jutting fleshy band just above his eyes, and this band was so thick just above his nose that it formed a deep lateral cleft or break there. His nose was prominent and fleshy but well-modeled, with the arched nostrils that were then thought to indicate high passions, and in combination with firm lips and an aggressive jaw—Bach's "bite," as dentists say, did not overlap, but met—it gave his face a look of great force. His throat was full, his neck muscular and rather bullish, like his father's. Incidentally, a physiognomist-astrologer of Bach's own day would have spotted him at a glance as a classic physical type of the Ram, and if we correct Bach's Eisenach Old Style birth date for the present Gregorian century, his birthday in fact stands at the height of Aries in the first week of April. By far the most striking feature of Bach's expression was his glance, and this was due to a hereditary condition—in

his male line—called blepharochalasis, a pronounced fullness of the overlid that extends down to the lashes and almost extinguishes the upper lid proper. It is sometimes seen temporarily in very young children who have been sleeping, and in Bach's boyhood it gave his face the rather dreamy, animal look of the just-awakened faun that is beloved by Renaissance painters and sculptors. You will see a graphic summary of many of these facts, which were developed from sources unrelated to it, in Stock's profile portrait of Bach's grandson and namesake, and for reasons which remain to be discussed, we may conclude that most Bach males when young shared this appearance to a large degree. In view of popular legend, I should repeat that Bach was definitely not myopic. He was near-sighted in youth and far-sighted in age, a normal development. But he probably bore retinal scars resulting from a scrofulous inflammation in childhood, a condition that would explain his chronic absenteeism from school and would result in his "seeing spots" in maturity, a serious inconvenience for a musician. And in view of Bach's domestic history, it may also be worth remarking that tuberculous inflammations in childhood have been observed to coincide with a precocious development of the sexual organization and a subsequent overheating of the erotic economy.

*Mr. O*: I have noted several times that you seem to assume a significant relation between Bach's physicality and his character.

*Mr. A*: I do. To observe the roots of this relation, let us go, as they say, to Thuringia at the close of the Thirty Years War—a conflict so frightful that historians despair of describing it. The province had lost an estimated three-quarters of its inhabitants, and travellers reported an uncannily silent landscape that was pale with the ashes of thousands of burned towns, monasteries, and palaces. In this desolation the Bach tribe inexplicably arose and flourished, a tribe so incredibly progenitive that within three generations young Bachs swarmed the countryside like seventeenth-century Jukes and Kalikaks. It was as if the Bach men had decided to repopulate the country as a family project, and whereas most families think of offspring in terms of units, the Bachs thought in terms of dozens. You'll re-

*After three years at Arnstadt. Bach went at twenty-one to...*

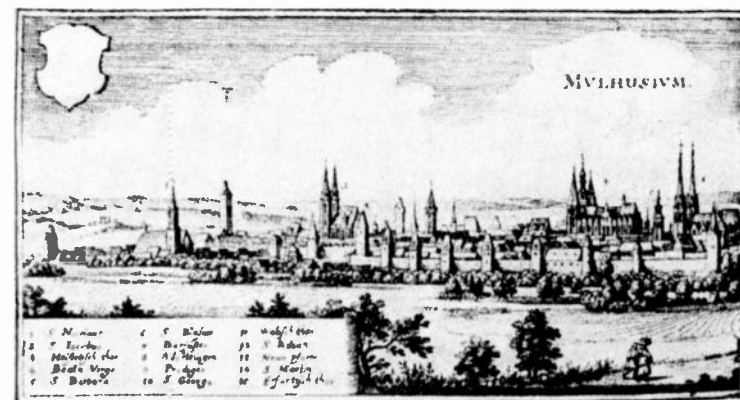

call that Bach himself had twenty children that we know of.

*Mr. O:* That we *know* of! Surely you don't mean—

*Mr. A:* Oh, not at all. I'm merely noting that the only reason for supposing that the number *need* have remained twenty was disinclination, a rare phenomenon among Bach males.

*Mr. O:* What next. . . .

*Mr. A:* Next we might examine this conspicuously physical family under the agonizing pressures of Reformation theology, which stated that God dislikes us intensely to begin with and that good works on earth avail you nothing in heaven. Barring the unlikely intervention of God's grace, consequently, there was nothing to be done about it but await your doom with resignation. As you might expect, this unlovely doctrine produced a flood of public sanctimony, a stepped-up suicide rate, and a high incidence of outright imbecility, especially among women exhausted by chronic pregnancy. Few Reformation families lacked their quota of idiots and religious hysterics. Bach's aunt incurred this tribute—a dazzling example of pastoral tact—in her funeral sermon: "Our sister was simple, not knowing her right hand from her left." And Bach's son Heinrich, "a genius who remained a child," is the real human wreck behind an apocryphal son David, who is said to have played the clavier with little art but with a stormy grief so powerful that it brought tears to listeners' eyes.

*Mr. O:* A while back you mentioned anecdotal "clues." Did you have anything specific in mind?

*Mr. A:* Not only specific but numerous. We might reassess Bach the unconscionable absentee and nonconformist, forever in hot water with Rectors, Councils, and Highnesses, writing long official alibis for his sins of omission and commission. The raging Bach who while conducting hurled his wig at an offending musician, and the choleric Bach who insulted an obnoxious scholar in the street and went for him with his sword. Then there is the mulish young Bach whose pig-headedness got him thrown in jail for a month when he defied Duke Wilhelm Ernst of Weimar. I must confess I'm rather taken with the picture of Bach as an ex-convict, and I would also like to know a great deal more about the Bach who at twenty was discovered in the

. . . Mühlhausen, promptly taking sides in a partisan squabble.

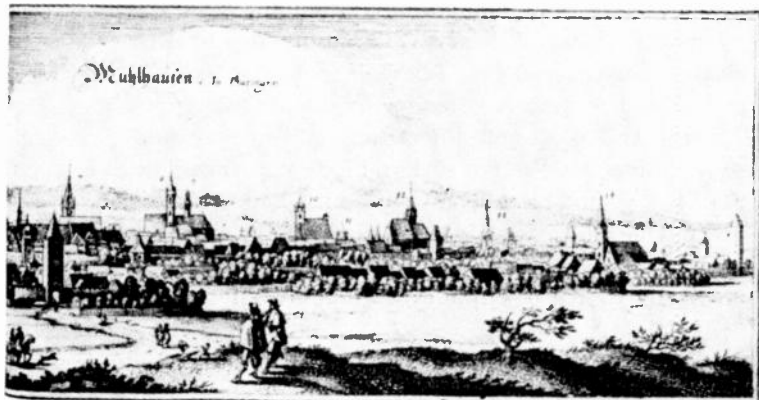

choir-loft with the "strange maiden." Poor Spitta was so upset by this last episode that he wrote whole pages in a desperate try to make it legal, insisting that this girl later became Bach's first wife, though there isn't a shred of evidence for the notion.

*Mr. O:* As you are probably aware, certain critics might accuse you of simply rummaging the Bach sources for anything discreditable.

*Mr. A:* I might even confess to that—but only if *they* confess that they find "discreditable" what is in fact wholly human. Biographers have no business shocking easily, and I'm prepared to go even further. I observe that Bach also had a deep streak of the apparently necessary callousness with which genius keeps itself from being swamped by the more bathetic human sympathies. In the presence of companions, Bach made a practice of baiting beggars, first engaging their expectancy and then giving them an extremely tiny alms. The beggars' cries in response were extremely dissonant. Bach then gave them a little more, the cries now becoming less dissonant. Finally, with a certain additional sum in an amount that Bach predicted, the cries became a perfect consonance. This is a perhaps rather amusing musical experiment performed on human material. But it is not precisely humanitarian.

*Mr. O:* I grant your point—although, really, the tale is of the sort ordinarily brushed off as a harmless prank.

*Mr. A:* Harmless pranks when told as such are often the most revealing ones, especially when the ingenuousness is laid on with a trowel, as in the "good-fortune" story about the herrings. In his age, Bach told this tale repeatedly and almost compulsively, apparently under the impression that he had censored it beyond recognition. The summer he was sixteen, Bach hitch-hiked to Hamburg—where among other things he established that fondness for opera which he indulged unobtrusively all his life, even after he had become respectable. In the course of his trip, he was standing one day near an inn, extremely hungry, when a window opened noisily above him and a pair of herring heads were thrown at his feet. Bach picked them up and found a Danish gold ducat in each. He at once bought himself a good meal and pocketed the change, with which he subsequently financed more expeditions of the same sort. End of story—if you care to believe that.

*Mr. O:* I must confess that I don't follow you.

*Mr. A:* A Danish single ducat contains a little under four dollars in gold at present rates, but its buying-power in Germany in Bach's time, according to numismatic guesses, was probably in excess of twenty-five dollars. Bach's unseen benefactor, or benefactress, had made him a present of at least fifty dollars, a very handsome handout indeed. You'll note that Bach obviously felt he had it coming to him, making no attempt to return it to its source. Of course, he was not the first—

# J. S. BACH

or the last—poor but likely youth who has had to explain a sudden access of wealth to a cynical world. And if the tenderness of his years distresses you in this context, recall that this was a picaresque age and read *Tom Jones*—or at least see *Rosenkavalier*.

*Mr. O*: I think I can now say I've heard everything.

*Mr. A*: Not yet, you can't. The real scandal about Bach is an intellectual one, and it deserves a book to itself. It is the story of his professional apprenticeship, and I suppose you could say that its moral would be that genius is always horribly unjust to mere talent. It would examine the way Bach imperturbably made a triumphant and wholly Bachian music from the awkwardly realized creative agonies of lesser men. He was perhaps the greatest transmitter of substance in the annals of art, and in this activity he exercised no more morality than an alchemist. An acute early critic of Bach observes that he made a brilliant contemporary music out of his "old dark burrowings"—a marvelous phrase that hits off his creative method to a T. For Bach wrested his craft directly from the body of extant music as Poussin did his from traditional painting. Like the timelessly classical landscapes of the latter, Bach's music sheds a sourceless light that has little to do with Nature and even less with Personality. Spengler notes, as have others, that in the arts of Bach's time, "The destiny of the (art) form lay in the race or school, not in the private tendencies of the individual." The miracle is that Bach during his apprenticeship created for himself the "school" that trained him. We can watch him creating it from the outset, for he begins it in the celebrated tale about the forbidden music. After his father's death, Bach lived with his older brother, who had a collection of clavier scores that he kept locked in a latticed cabinet. At eleven or twelve years, Bach defied his brother, extracted the scores, and spent six months copying them in secret—by moonlight, we're told. His brother discovered the completed copy and appropriated it—a "disagreeable" or tyrannical act that has much displeased several biographers. Now by all accounts, Bach's brother was a kindly man, and I don't think his act was punitive in any sense. I think he was worried to death. He was the first man on earth to have seen the incorrigible will of Johann Sebastian Bach. And he had seen it under the most chilling circumstances possible, in the eyes of a child.

*Mr. O*: I know that Reformation family discipline was severe, but you seem to think that what Bach's brother saw was more than ordinary disobedience.

*Mr. A*: I think it was much more. I think the boy was already irritated to distraction with his predetermined

function as an anonymous unit in a clan—with his unavoidable attendance at the incredible Bach family reunions, for example. I ask you to imagine them: dozens of people all named Bach performing each other's almost indistinguishable compositions amidst a beery welter of clanging harpsichords, bawling infants, and bad Thuringian puns. To summarize it briefly: I think that when the boy defied his brother, he had already resolved to stop being *a* Bach and to become *the* Bach. And I believe that when he left his brother's home a year or so later, he methodically carried into effect a plan that was in fact long laid. In his subsequent *wanderjahre*, he gathered to himself a veritable museum of other men's music and in the realest possible sense devoured it. North German music and South German, Protestant hymns and Catholic, the Italian style and the French, secular songs and Gregorian chant—like nobody else in his age he mined it all. With some of the same rapacious, stop-at-nothing, trans-European curiosity that Nietzsche found "sinister" in Leonardo, he laid hands on everything valuable that had preceded him—copied it, digested it, rewrote it, and finally, in his own mature account of it, managed to render it superfluous. His youthful self-confidence was so nerveless as to be appalling, and he apparently had no concern whatever about contaminating in himself what today we revere as "originality." The working habits established in his apprenticeship were conclusive, and for the rest of his life, unlike later composers, he disliked to invent anything *ab ovum*. He even disliked to perform "cold" as an improviser, asking to see scores before him, any scores, with which to feed transubstantiating energies so radical that I can only call them demonic. He particularly delighted in taking the most shopworn material and reshaping it. In realizing its aborted possibilities, he of course placed it irretrievably on the Bachian shelf, one more glowing trophy of his own prodigious craft. On occasion he did this to other composers' music in their presence, and he was not at all averse to astonishing the crowd with demonstrations of his own vast superiority. You will excuse me if I am skeptical when people say that a man with a mind like this did not know precisely who and what he was. I think he knew it before he was twenty, and if you imagine he didn't know it at the end, study the fierce old Conquistador in the late portraits, when the mask was all but off. Those are the eyes of an eagle used to Himalayan forays. I can only smile when I hear him discussed as if he were a home-loving Thuringian goose.

*Mr. O*: This is all very interesting, and in fact quite provocative. But I'm not sure you have convinced me.

*Mr. A*: I should be rather surprised if I had. After all, an "unknowable" Bach is much easier to live with. But it may be time to get acquainted with another—which one being your problem and your opportunity.



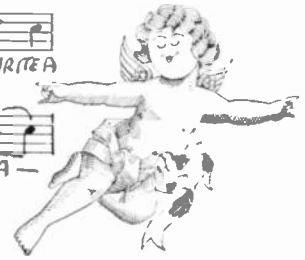
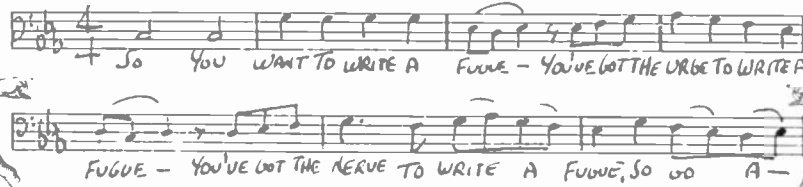
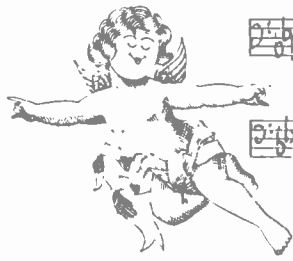

**E**DITORIAL INTRODUCTION: *The musical quote above is the "subject" of Mr. Gould's fugue (which can be heard in its entirety on the recording on page 51), and the deceptive naïveté of this genial tune illustrates a paradox of the fugal style. For the first few seconds of its existence a fugue—any fugue—is perhaps the simplest looking piece of music there is. In fact, the subjects of most fugues, from Frescobaldi to Bach, can be played recognizably on the piano with one finger. And it is perhaps at this point that any trusting, one-finger fugue-player who happens to read these lines should turn to Mr. Grunfeld's reassuring primer of fugue on page 32. For after a fugue has been under way for ten or fifteen seconds, it becomes a horse of a different color altogether. It is of the*

*be found in that than in the religions and religious books of all the world together."*

*Item: "The fugal style was fulfilled," says Oswald Spengler in his magisterial two-volume obituary for Western culture, "when Newton and Leibniz, about 1670, discovered the Infinitesimal Calculus."*

*Item: Fugue, says Webster (the noun having been happily borrowed by the medical fraternity from the musical one), is a "prolonged pathological condition, characterized by wandering and other unusual actions, of which, afterward, the individual is not conscious." No medico-musical humor is intended there—and since the psychiatrists, for their part, were not to be cheated of any concept so rich in semantic promise, we can now also read about "fuguing dreams."*

## A PORTFOLIO ON FUGUE BY GLENN GOULD

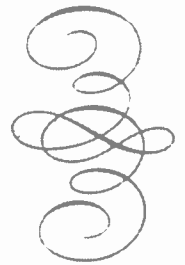

*character of fugue that it begins with a tune that anyone can whistle and winds up with an apparent free-for-all of several tunes that only an expert can unravel. But in pursuing this course, fugue also obeys a psychological axiom common to, let us say, the Dialogs of Plato, the Oedipus Rex of Sophocles, Michelangelo's staircase in the Laurentian Library, and the Special Field Equations of Albert Einstein. Like these, and unlike much Romantic music, fugue moves on principle from the known to the unknown, and it explores the "unknown" with a dynamic logic so daring and so rewarding that it has interested a variety of non-musical observers far from the churches and concert halls in which fugues ordinarily are heard. In the twentieth century, fugue has become an intellectual symbol of absorbing interest to novelists, mathematicians, poets, cybernetics experts, and cultural historians, among others.*

*Item: "There has been demonstration," says English belle-lettrist Sacheverell Sitwell, "of the universal truth by fugue, and it may be that more wisdom is to*

*And finally: Fugue, said J. S. Bach, is like a well-conducted conversation between gentlemen—a remark as demurely ironic as any Bach ever made, since he well knew that he alone commanded "gentlemen" who were capable of the kind of cosmic conversation he wrote: gentlemen with names perhaps more familiar to poets and medieval mystics than to most others, such as Raphael, Gabriel, or Israfel. . . .*

*Meanwhile, as it happens, the poet who wrote the most literal and accurate description of the "horizontal" fugal style was Milton, who died eleven years before Bach and Handel were born:*

... His volent touch  
Instinct through all proportions, low and high,  
Fled, and pursu'd transverse the resonant fugue.

*In the following pages, Mr. Gould explores some of the reasons why the "resonant fugue"—the musical form that is, after all, the most "purely" musical of any—should for three centuries have continued to fascinate, under such various guises, a collection of minds as diverse as these.* —Robert Offergeld

# THE MUSIC OF PROTEUS

## Being Some Notes on the Subjective Character of Fugal Form

by GLENN GOULD



IN THE pages ahead you will find a recording that is, in effect, a five-minute, fourteen-second singing commercial. An *unsponsored* commercial, let it quickly be noted, and a rather special one in other ways too, for it light-heartedly recommends a product not ordinarily packaged. What it plugs is one of the most durable creative devices in the history of formal thought and one of the most venerable practices of musical man. The device in question is called fugue, and the process in question is fugue-writing, and since these began a century before Columbus sailed west, they are almost as old as the practice of singing rounds, a less sophisticated creative activity than fuguig but one that somewhat resembles it in its earliest days. With its play of words and tunes, the composition recorded here takes the form of a fugue

*about* the writing of fugues. Alluding to the joys, satisfactions, hazards, nuisances, and even to the terrors long associated with this tough but intriguing kind of contrapuntal acrostic, my fugue becomes a musical conversation among four vocalists, aided and at moments contradicted by the comments of a string quartet. As the announcers used to say of forthcoming soap-opera programs, this chapter Asks The Question, "So you want to write a fugue?" The question is proposed initially in the bass, and in textbook terms the tune that proposes it is, of course, the "subject" of the fugue.

As the other voices "answer" or repeat this tune in a rising sequence (tenor, alto, soprano), a debate is developed concerning certain special qualities required by this peculiar enterprise. The basso begins by suggesting that a certain degree of courage is involved: "You've got the nerve to write a fugue, so go ahead." The tenor is concerned with the utility of the finished product: "—so go ahead and write a fugue that we can sing." The contralto, even though her own contrapuntal demeanor is beyond reproach, advocates an audaciously anti-academic method: "Pay no mind to what we've told you, give no heed to what we've told you, just forget all that we've told you and the theory that you've read." To this point of view, the soprano—though equally guiltless, at least at this point, of any offending lapse of fugal discipline—lends her support. These sentiments—"Pay no mind, give no heed," etc.—form countermaterial to the original subject, "So you want to write a fugue." The latter now appears in a variety of keys identified with this further notion: "For the only way to write one is to plunge right in and write one, just ignore the rules and write one, have a try." The heady intoxication of this radical admonition at last becomes reflected to a modest degree in the musical structure. The vocalists, their parts ever more closely overlapping, plunge into a

precarious sequence of imitative strettis. And here, at last, the stern hand of academic justice demands forfeit of their freedom. Even as they render tribute to the patron saint of fugue-writing—"the fun of it will get you, and the joy of it will fetch you, you'll decide that John Sebastian must have been a very personable guy"—the bass and tenor surrender their self-respecting autonomy to the hollow ravages of parallel fifths, a contrapuntal debacle that any primer of the art will tell you is perfectly ghastly. As a gesture of tribute (as well as a summons to sobriety), the string quartet now renders a quodlibet of four of Bach's more celebrated themes (you'll note, among them, the second Brandenburg Concerto). Then, appropriately, the quartet turns to the contralto for a brief lecture on the perils of exhibitionism: "—but never be clever for the sake of being clever." This, with its attendant warning—"For a canon in inversion is a dangerous diversion and a bit of augmentation is a serious temptation"—creates an entirely new thematic substance. Hereupon the string quartet renders a grandiose if minor-inflected quotation from *Die Meistersinger*—the archetypical example of musical cleverness—after which all concerned engage in a joyous recapitulation. The bass and tenor return to the thematic substance of "So you want to write a fugue." The contralto and soprano accommodate to it the newly exposed counter-theme—"but never be clever for the sake of being clever." And the strings keep up their own incessant dialogue of baroque-ish fragments.



BEFORE pursuing further some of the larger implications of the fugal activity of these performers, a parenthesis is in order here regarding nomenclature. In these paragraphs I use, without defining them, a number of terms indispensable to the discussion of fugue: "exposition," "development," "recapitulation," "subject," "answer," et cetera. I do not define them because they are self-explanatory to anyone even casually interested in musical form. Certain other terms are main entries in college-level dictionaries (in addition to having been in student texts on counterpoint for three centuries).

But as fugue crosses the semantic forests of the twentieth century, it is increasingly subject to verbal analysis of a much more disconcerting sort than was possible with the simple and accessible nouns listed above. You will hear it said, for example, that fugue is not a *thing* but a *process*, and even that it is not a *form* at all, but a *texture*. And if you speak of "tunes" or "melodies" in relation to fugue, you will certainly be frowned upon down at the fugal equivalent of City Hall. It is true that such terms can be misleading. In ordinary reference, a tune or melody—*Yankee Doodle*, let us say—is explicit, self-sufficient, and complete: it has a beginning, a middle, an end. But fugue does not and cannot use such melodies, because it stops itself dead in its tracks if it does. Fugue must perform its frequently stealthy work with continuously shifting melodic fragments that remain, in the "tune" sense, perpetually unfinished. And to bring up an even more critical current issue, what are we to say of contemporary fugues that arise in that unposted harmonic wilderness where familiar tonality has vanished but is somehow still remembered, even by those who disown it? Such contingencies recommend our caution, and we consequently use more abstract but safer concepts, such as "motivic material" in place of "tunes," and "linear strands" in place of "melodies"—and even "nonoriented tonality" in place of the bald "atonality" that was fashionable just ten years ago. Unless we are very careful, such verbal egg-stepping leads us also to outright jargon, a fancy hermetic language of questionable usefulness even to specialists. But the temper of the intellectual times forces this risk upon us, and so you may be sure that, in just a moment, the word "aleatory" will be upon us with it.

Returning now to our performers, we find that the final result of their labor (except for the irreverent quotes from Bach and Wagner) is a fairly typical example of the academic fugue tradition. In its exposition, in its modulative sequences, in the introduction of its counter-theme material, and in the superimposition of these elements in its recapitulation—throughout its course the piece rigorously observes the protocol of fugal tradition. Centuries of contrapuntal legislation comprise this tradition, and if you mean to write a fugue you unquestionably yield to it. Even as the text was mischievously snooting the requirements of bookish counterpoint, the music was taking refuge be-

hind the protective cloak of approved academic procedure. This particular wrap is stained and weather-beaten from exposure to generations of unimaginative abuse, but it still shelters a prodigious variety of musical activity. Even in our own vigorously anti-academic generation, fugues are blasted out by jazz combos and improvised or approximated by aleatory charts. Indeed, fugues are even being attempted within the nonoriented tonality of serial composition. In any of these novel situations, of course, fugues present something of a contradiction in terms, because the unique organizational method of fugue has very much to do with the key-signature tonal system, and that system now appears to be in the process of dissolution. Yet the persistence of fugue is evidence of the degree to which, acoustically and psychologically, certain devices peculiar to its structure—devices of subject and response, of statement and answer—are imbedded within the consciousness of modern man. Although it was a tonal preoccupation which lent them balance and gravity and a certain kind of equilibrium, they have survived as part of an effective organizational method even beyond the general collapse of this preoccupation. And perhaps the main reason for this is that they are not devices native to tonality at all. All of the effects of fugue (except that of the vertical gravitation of key and key-contrast) were effects formulated in the early years of the Renaissance—in the generations before the tonal grammar of tension and relaxation had been made articulate. And their participation in the poise and balance of centrifugal harmony, the web-like detentions of cadence structure, seem largely the result, at most, of a synchronicity that was voluntary on their part.



IT'S THE ancient experience of linear antecedents pre-dating tonality has enabled fugue to continue to exist in the uncertain vista of our post-tonal present. And it is the consequent familiarity of these fugal devices with situations which are not (in the post-Renaissance sense) tonally committed that provides for fugue its extraordinary relation to the chronological development of tonality. For the fact is that, to a very large extent, the construction of fugue has managed to defy the harmonic concerns of any particular generation—especially those generations not oriented to a tenaciously contrapuntal point of view. In periods when a concern for the integrity of linear structure was considered outmoded, such fugues as were written tended to resist any easy harmonic confirmation which would reveal them conspicuously as the servant of the times. This explains to some degree why it requires only a very slight lapse of analytical judgment in order to attribute a fugue by Mozart to Brahms, a fugue by Mendelssohn to Miaskowsky—or, as Joseph de Marliave once ungenerously suggested, a fugue by Beethoven to a demon. Even in my little piece, the harmonic allegiance draws upon a surprisingly wide fund of idiomatic reference. Its over-all harmonic effect—which is to say, its most frequently observed dissonance-consonance ratio—is determinedly Mendelssohnian; indeed, the piece subscribes to that resonant but supremely polite brand of chromatic endeavor which, emanating from Mendelssohn, went to the opera with Humperdinck and Saint-Saëns, to the choir loft with Sir John Stainer and Sir Arthur Sullivan, and to the concert hall with Anton Rubinstein, becoming for a time the nineteenth century's most widely travelled set of harmonic components. But if one could apply to this fugue the musical equivalent of a stop-frame camera technique, one would find that there also exists within its boundaries several other significant areas of stylistic allusion. Its opening exposition, for instance, is decidedly Bachian with its propulsive bar-line dissonances and its concentration of imitative figuration at such times as the main thematic strands have lapsed into transition or episode. On the other hand, in the last measures prior to the coda all of the vocalists work themselves up into a frenzied motivic conflict supporting the frustration of the soprano (who shrieks "Write us a fugue that we can sing, come along now"). And these hectic measures could, but for the very un-Hofmannstalist lyrics, have been lifted from any reasonably flamboyant page of Richard Strauss.

A major difficulty in analyzing the harmonic environment of fugue becomes apparent if we compare it to a radically different creature, the classical symphony. In fugue the preoccupation with form is of an altogether more subjective nature than is the case with symphony. In fugue the dis-

position of modulating harmonic plateaus is not customarily committed to any one species of developmental criteria or legislation. It is true that the subject matter of fugue can, and indeed must, appear in sequences of sharply contrasted harmonic focus. But these harmonic areas are not likely to be subject to categorical legislation comparable to the tonic-dominant, masculine-feminine polarities of the classical symphony—polarities which tend to telescope the structural concerns of the symphony very conveniently within the ruling harmonic preoccupations of the late eighteenth or early nineteenth century. We note that the preoccupying formality of the classical symphony becomes progressively more involved with what might be called tactics of delay, with an attempt to erect substantial spans linking islands of contrast and temperament—*islands* which are almost, if not quite, self-sustaining. In contrast to this, fugue-writing tends to be deeply involved with relatively confined areas of musical expanse and with an intense subjective concentration upon the concern of the moment—a concern which it seeks to magnify and to project urgently into every fibre of the work. Thus we note that fugue is not involved to any great degree with broad aspects of dramatic altercation, or with elaborate shifts of texture or dynamics, such as render the classical symphonic structure so explicit. Rather, fugue is involved with the adjustment of a certain number of semi-autonomous linear patterns which it proposes to maintain at a more or less constant density. Among these patterns, the effect of textural variety is fostered by a sensation of pregnant pause within one or other of the contributing voices—and not, as in the mannerisms of the classical symphony, by a sense of utterly unpredictable contour, by violent theatrical interruption, or by the haunting presence of an unresolved thematic residue.

The idea to which fugue is most conspicuously the servant is a concept of unceasing motion. It is this nonstatic concept which makes fugal structure the perfect vehicle for the adventurous and subjective harmonic traffic of Baroque art. And since this concept is carried forward into other eras, it offers us a partial explanation of the extraordinary historical unification of fugal practice. And it is the alliance of this concept of unceasing motion with our previous notion of consistent density that really determines the shape of fugue. For within this forward movement and this consistent density, each phrase, each musical sentence, will inaugurate its own special problem, its own unique cause for anxiety. Each of these will be open to a series of more or less expedient solutions, and each will relate in some cohesive way to the fundamental motivic propositions of the piece. The events involved in these solutions will, of necessity, demonstrate a certain kind of developmental procedure. But here again we note that fugal development is not the kind which is elaborated in the major cyclic forms. It avoids the vivid alternation of a sense of relaxation (as manifested in transitions) with the accumulation of tension (inspired by modulation) that we find for example in a Beethoven sonata. Rather, fugal events will be required to provide some specific contribution to the original subjective idea from which the fugal structure sprang. They will furthermore be expected to combine the original motivic proposition with subsidiary thematic notions, and these combinations will not, if the fugue is properly done, recur in precisely the same relationship at any subsequent time. In other words, a sense of constant variation is the ideal of fugue, but variation of a particularly *nomadic* order—variation which leaves the impression that the thematic concepts with which we have to deal in fugue belong to a special, generic store of musical ideas, and that they can, in some ruthlessly self-preoccupied mathematical way, implicate a wide variety of contrapuntal choices.



IN THE CASE of *So You Want to Write a Fugue?*, both the opening subject and the main subsidiary material—"but never be clever for the sake of being clever"—were designed as relatively uncomplicated motivic strands. They do not, when examined independently, necessitate any one series of harmonic progressions. Instead, their innocence of any untoward chromatic suggestion makes it possible for them to endure together through a variety of metrical displacements and through a series of pitch transpositions (relative, that is, to the basic distance between them). Before writing the piece, it was necessary for me to be aware that the moments of structural

emphasis in this work had to be designed in compliance with those forthcoming occasions when I could first introduce some major variant in the disposition of these themes. Most fugal structure is responsive to subjective considerations of this kind. In Bach's *Well-tempered Clavichord*, a great many of the fugues choose as their moment of highest tension that occasion when, for the first time, the primary subject is heard, or seen, in one of the contrapuntal strands turned upside down. The prerequisite of contrapuntal art, more conspicuous in the work of Bach than in any other composer, is an ability to conceive *a priori* of melodic identities which, when transposed, inverted, made retrograde, or transformed rhythmically, will yet exhibit, in conjunction with the original subject matter, some entirely new but completely harmonious profile.



It is this fascination with motivic experimentation which links all the practitioners of fugue into an unorganized but very genuine guild of spirit. This guild counts among its members those skeptical natures who are uncomfortable without the shelter of a discipline which is to some degree susceptible of proof. Many of these are composers who feel somewhat ill at ease with the concept of the star-gazing artist waiting upon some hallucinatory seizure of inspiration that will determine the shape and intent of his next work. When they happen to be resident in periods which promote this Romantic concept as a fundamental article of the artistic temper (as was to a large extent surely the case at the turn of the last century), then these gentle misfits—among whom one might number composers like Reger or Miaskowsky—find in fugue a welcome shield from the pressures of fashion. In fugue they submit to a discipline in which each successive decision demands that intensive scrutiny which excludes all concerns beyond the burden of the moment. Meanwhile, the fuguing guild also includes those who, while living in an age hostile to the contrapuntal persuasion, become involved with their own personal renaissance of fugue (Beethoven is perhaps the best example), and who weld its concepts firmly into the structural criteria of other forms. And finally, this guild includes those happy figures who are really fuguists to the manner born. All aspects of their thought occur initially in the form of contrapuntal dialogue, and because of their constant preoccupation with the subjective commitment of form, they are able, as was Bach, to mount a glorious defiance to the domination of an historically hostile chronology.

Now that the tonal system and its governing polarities have become the victims of a nonoriented harmonic ideal, it is very difficult to visualize the future permutations of fugue or even the certainty of its survival. Even though major figures like the late Paul Hindemith may devote a lifetime to nourishing the ancient linear values within a daringly altered tonal perspective, it becomes difficult to predict whether this represents something other than simply a facet of the intense baroque revival of the present. But without doubt, the persistence of fugue through the centuries does suggest that it draws upon conceptions as permanent as any that the still-young art of music may be said to own. There is the great fascination that it holds as a form within which a mystique of numbers can unravel its secrets. There is, to the composer, the enormous satisfaction of dealing with a musical form in which the form *itself* becomes the servant of a subjectively manipulated concept of thematic relation. And then, perhaps, beyond even these considerations is the fact that fugue arouses some primeval curiosity which seeks to uncover in the relations of statement and answer, of challenge and response, of call and of echo, the secret of those still, desert places which hold the clues to man's destiny, but which predate all recollection of his creative imagination.

---

BACH RECORDINGS BY GLENN GOULD (ALL ON COLUMBIA RECORDS)

The Goldberg Variations  
 The Six Partitas  
 Partitas Nos. 1 and 2; Italian Concerto in F Major  
 The Art of the Fugue, Volume One, Fugues 1-9  
 Partitas Nos. 3 and 4; Toccata in E Minor  
 Partitas Nos. 5 and 6; Fugues in F-sharp Minor and E Major

Well-tempered Clavier, Book One: Preludes and Fugues 1-8  
 Well-tempered Clavier, Book One: Preludes and Fugues 9-16  
 Harpsichord Concerto No. 1: Glenn Gould (piano); Columbia  
 Symphony Orchestra, Leonard Bernstein cond.  
 Harpsichord Concerto No. 5: Glenn Gould (piano); Columbia  
 Symphony Orchestra, Vladimir Golschmann cond.

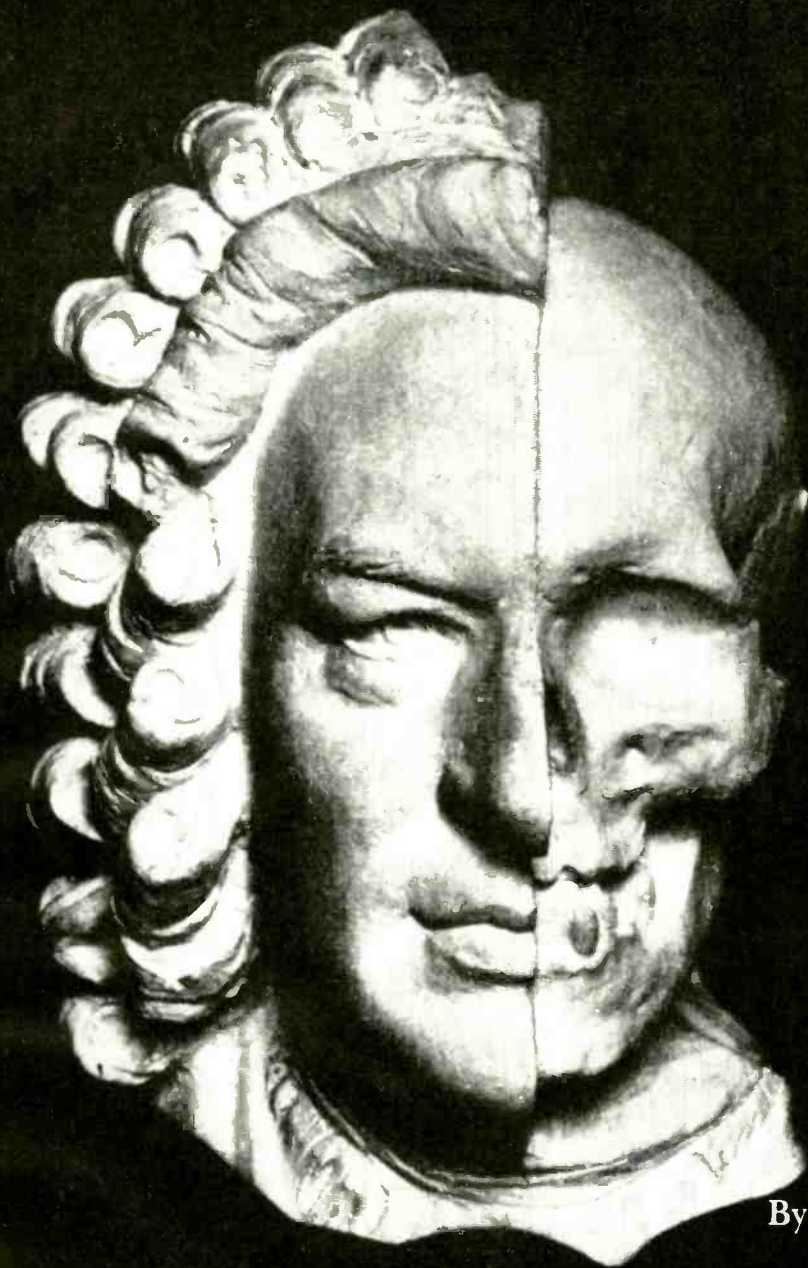

*Cutaway section of Seffner's Bach mask on a cast of the skull discovered by the Leipzig commission.*

## THE MAN BENEATH THE WIG

By ROBERT OFFERGELD

**I**N 1894, some proposed alterations to the Leipzig Church of St. John reminded Leipzigers that the city's most famous former resident was buried somewhere in the graveyard adjacent to the church. The oldest tradition, as preserved in the Spitta biography, said that in 1750 the body of J. S. Bach had been interred near the church door approximately six paces from the south wall. The grave had never been marked by a tombstone, the area had long since been put to secular use, and all trace of the grave had vanished in the intervening century and a half. However, since the proposed *Johannis-Kirche* alterations would destroy this site forever, a distinguished Leipzig commission headed by the anatomist Wilhelm His determined to search for Bach's remains.

The commission began its search on a rainy autumn day of the same year, and it would probably have

pleased Bach to know that the workmen employed were so well aware of his fame that their competitive eagerness had to be restrained. The commission had discovered one additional fact of great significance in the church register. Out of fourteen hundred *Johannis-Kirche* burials credited to the year 1750, only twelve persons had been interred in oak coffins and one of these was Bach. In a relatively shallow grave at the spot indicated by tradition, three coffins were presently uncovered. Two of the coffins, badly disintegrated, were of pine, one of them containing the remains of a woman. The third coffin was of oak and contained the almost perfectly preserved skeleton of an elderly male, less than average in height but unusually broad and strikingly well-proportioned. The skull was massive, with a receding forehead, shallow eye-sockets, and prominent

*(continued overleaf)*

jaws, the lower one in particular being very heavy.

In the weeks following this discovery, one of the most interestingly conducted detective assignments in biographical annals was pushed to a successful conclusion by a team of scientists and artists. The measurements of the remains were charted with incredible minuteness by Dr. Herman Stieve, Director of the Anatomical Institute of Berlin's Humboldt University. These data were collated with the known facts about Bach's physical appearance and with the authenticated Bach portraits, and an extraordinary test was devised for the validity of the relations established during this procedure. It was felt that if a convincing and anatomically correct facial mask could be applied to a plaster cast of the putative Bach skull, it would dispel any reasonable doubts as to the authenticity of the remains. Anatomically correct norms for the depth of tissue on the bony parts of the face were well-known, but none had ever been established for the fleshy areas. These latter norms were now developed by the examination of thirty-seven male examples in the fifty-to-sixty age group. Under the direction of Professor His, these norms were next applied to the Bach cast. Following them precisely from point to point, the sculptor Karl Seffner and the modeler Steger created an anatomically correct facial mask (see Figure 4). It not only corresponded strikingly with the authenticated Bach portraits but possessed a lifelike vitality of expression that moved the commission members profoundly.

Not content with this, however, the commission de-

vised a further test. The sculptor now attempted to apply Handel's face (which had been sculpted from life) to the Bach skull, and to apply Bach's face to still another skull *not* Bach's. Both of these experiments failed, the bony areas of the presumed Bach skull protruding through the Handel mask, and the other skull requiring padding far beyond the norms established for the fleshy areas. Concluding the commission's work, Professor His published an exhaustive report<sup>1</sup> in Leipzig in 1895. The scientific community conceded that the remains were undoubtedly Bach's, and they were transferred to their present site beneath the altar of the *Johannis-Kirche* in a simple and massive limestone sarcophagus with the inscription:

JOHANN SEBASTIAN BACH  
1685—1750

In the seventy years since the publication of the His report, its findings have continued to be regarded as conclusive by the scientific, artistic, and musical communities. And in Heinrich Bessler's definitive book<sup>2</sup> on the Bach portraits (published in 1956), the His report serves as the point of departure for contemporary scientific investigation of a highly illuminating nature, particularly in the field of ophthalmology. Perhaps its most interesting line of investigation concerns an eye-condition that proves to have been hereditary in the Bach

<sup>1</sup> Wilhelm His: *Johann Sebastian Bach. Forschungen über dessen Grab-tatte, Gebeine, und Antlitz.* Leipzig, 1895.

<sup>2</sup> Heinrich Bessler: *Fünf Echte Bildnisse Johann Sebastian Bachs.* Barenreiter-Verlag, Kassel und Basel, 1956.

Figure 1: Bach in his late twenties or early thirties.



STADTISCHER MUSEUM, ERFURT

Figure 2: Bach as he appeared at thirty-five or forty.



BACHHAUS, EISENACH



male line. This eye condition is known as blepharochalasis (see page 44), and in relation to the structurally shallow and slightly asymmetric eye-sockets discovered in the Bach skull by Dr. Stieve in 1894, its presence in examples of Bach portraiture may be taken as primary evidence of their authenticity. The condition is displayed in a pronounced fullness of the overlid of the eye, which with age becomes so exaggerated as to conceal the upper eyelid and the lashes. This condition, including the asymmetry, is clearly discernible in the anonymous 1690 portrait of Bach's father. It is repeated in the earliest portrait of his famous son (see Figure 1), painted by Johann Ernst Rentsch the Elder. This portrait shows Bach in his late twenties or early thirties, and the more pronounced blepharochalasis of the right eye is already plainly evident, as are the high narrow forehead and strong chin indicated by Dr. Stieve's 1894 skull measurements. In the Bach portrait by Johann Jacob Ihle (see Figure 2), which shows the composer's appearance between the ages of thirty-five and forty, the blepharochalasis is more advanced and the asymmetry more noticeable. And in the portrait painted the year of Bach's death by an unknown artist (see Figure 3), the high narrow forehead, the asymmetric blepharochalasis, the prominent nose and the aggressive jaw are all synthesized with finality in a powerful figure of unquestioned validity.

Bach in turn passed on the structural asymmetry and the lid condition to his sons, and both traits are to be clearly noted in the pastel portrait of Carl Philipp

Emanuel by Johann Philipp Bach, and in the famous portrait of Johann Christian Bach by Gainsborough. The fact that Carl Philipp Emanuel bequeathed these physical traits to his own sons may be inferred from Stock's profile portrait of Bach's grandson and namesake, J. S. Bach II (see page 41).

In the His report of 1895, which was never adequately utilized in the subsequent biographies, and in the 1956 Bessler book on the portraits, future Bach biographers possess two critical sources of an importance that can hardly be overestimated. Any student of these sources will be struck by the infallibility with which a combination of musical talent and certain physical traits were transmitted in the Bach male line. To those familiar with general studies of heredity, this faithful and repetitious transmission of physical and psychic traits suggests the inheritance condition known to stock-breeders as prepotency—a condition in which one parent, the "prepotent" one, is invariably more effective than the other in stamping the character of offspring. On the evidence cited above, there can be little doubt that Bach males were strongly prepotent, and this suggests the desirability of a future reappraisal of the entire Bach heredity in terms of the new information and the modern critical techniques now available. Nothing would contribute more to a general illumination of the man beneath the wig, a genius of inestimable cultural significance whose person, personality, and temperament have remained too long in the nebulous realm of physically unoriented biographical conjecture.

Figure 3: Bach portrait painted the year of his death.

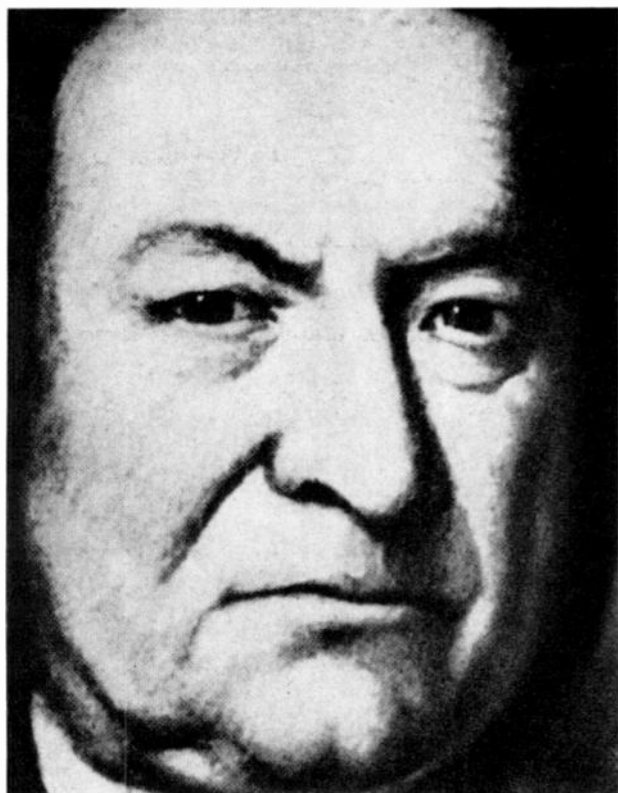

WALTHER R. VOLLMACH, FORT WORTH

Figure 4: Bach mask developed by sculptor Karl Seffner.

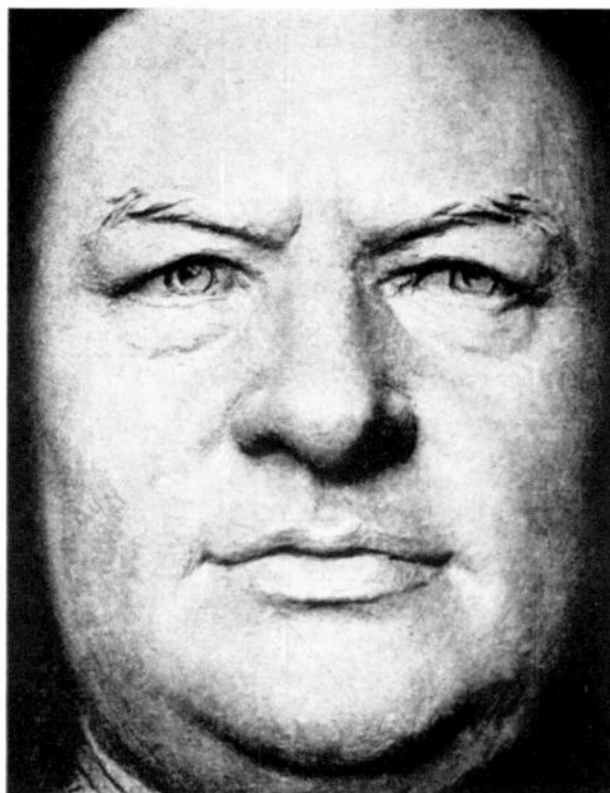

# Images of the Baroque in Music

By IGOR KIPNIS

## and in Art

By CLIFFORD ROBERTS

*AS ART HISTORY GOES, the popularity of Baroque is fairly recent. At the close of the last century, masterpieces of the style were still taken pretty much for granted or viewed with outright distaste. For one thing, they weren't in the least scarce, examples of High Baroque being exceedingly numerous from Madrid to Vienna. Since they were three centuries old at most, they were also in disconcertingly good repair, and the chief popular test for value in a work of art was that it should have survived several centuries of catastrophe and show it. It was also noted that whereas a mutilated Greek or Gothic statue for some reason looked noble and "interesting," a Baroque saint without a head merely looked unlucky. Furthermore, the greatest Baroque attractions—St. Peter's Basilica, for example—were far too resplendent and far too exuberant to seem spiritually sincere. Consequently a highly romantic generation took its cultural medicine in the edifying gloom of Gothic cathedrals or clambering over the certified rubble of the best Classic ruins. In these activities it received a lot of critical encouragement. It was in fact the lovers of critically presanctified Gothic, with Ruskin as*

AS A CRITICAL term in English, the word "Baroque," meaning irregularly shaped, was first applied (in 1867) in reference to architecture. It did not come into use in connection with music until the beginning of the present century. Today, in the historical sense, Baroque is used rather vaguely to categorize music of the period from the beginning of the seventeenth century to the middle of the eighteenth. But Baroque is not really a period but a *style*, and works of music, architecture, sculpture, or painting that one can describe as Baroque appeared well before 1600 and after 1750. Descriptively, the term suggests the bursting out of emotion from the formal elements of art that previously had contained it. But this emotion is not uncontrolled, because it is always presented within a rigid framework of accepted musical practice. This interaction produces a tension, between heaven and earth, as it were, that is the driving element of the Baroque in all the arts. This tension can be seen in Bernini's statue "The Ecstasy of St. Teresa" in the church of Santa Maria della Vittoria in Rome, and it can be heard in Bach's Mass in B Minor.

During the period in which most musicians wrote in the style we now call Baroque, there were, of course, subdivisions of styles and types. The two main in-

fluences upon all Baroque composers were the French and Italian styles, the first sophisticated and even mannered, the second less subtle and restrained, with more clear-cut passions. Toward the beginning of the eighteenth century emerged the *galant* style, emotionally expressive, yet finically elegant. This age also saw the rise of opera, the oratorio, the cantata, the beginnings of the concerto in its many forms, and instrumental music of all kinds.

The renewal of interest in Baroque music in our own time began as a counteraction against the excesses of Romanticism during the closing years of the last century and the first few decades of this one. The stringent forms of Bach and his predecessors—fugues, canons, concerti grossi—appealed to those who had had their fill of the surging melodies of Wagner, and enthusiasm soon spread from the familiar Bach to the unfamiliar Vivaldi and the even more obscure Froberger and Schütz—not to speak of Renaissance composers. Performances of this music were apt to be of two kinds: either very "classically" pure and restrained, in a total reaction against Romanticism, or very lush indeed, in the style of nineteenth-century music. In the latter situation, the fault lay with the training of the performers, who were almost invariably taught to



Detail of Giovanni Bernini's  
"Ecstasy of St. Teresa"

## Images of the Baroque in Music

apply the same standards of interpretation—Romantic ones—to all composers without bothering about historical differences.

In time a new historical outlook emerged, one that did not conceive of everything written in the past only in terms of the present, one that considered the older instruments, such as the harpsichord, the recorder, or the Baroque organ, as perfectly valid in their own right and not just imperfect antiquities. Musicians—and audiences—also discovered that the sound of these instruments revealed the music of the Baroque in an entirely new light.

Study of Baroque performance practices demonstrated still further the entirely different attitude toward music held by Baroque composers. In contrast to the complex scores of today, with their detailed notation of instrumentation, dynamics, and tempos, and their attendant lack of latitude for performers, the scores of the Baroque masters were remarkably free of directions. It was a kind of do-it-yourself period, in which instruments could often be substituted for one another, the player was expected to embellish freely on a given melody or a singer to render a spectacular

improvised *da capo* cadenza in an aria, and the composer understood that most of the indications for dynamics, tempos, and phrasing did not have to be provided because the performer would know the conventions and take care of these interpretive details himself. Still, artistic license in expressing the ardent passions of the Baroque was held in constant check by the formality and discipline of the rules of harmony, counterpoint, phrasing, and articulation. Many of today's performances of this music fail to reveal the interaction and conflict of these two forces, the result being a cool blandness without the necessary tension. Take, for example, the "insignificant" matter of the trill. In the Baroque era, the trill began on the note *above* the melodic note, emphasizing the former and thereby creating a discord; if the trill commences on the main note itself (a practice common among today's interpreters, who are accustomed to a later style), no such clash occurs.

The list that follows has been drawn up to represent (1) a selective and admittedly far from complete introduction to Baroque music, with emphasis on works about which I am particularly enthusiastic; and (2) those performances that to my mind are most satisfactory from a stylistic viewpoint. The second prin-

## Images of the Baroque in Art

their moralizing chief, who gave Baroque a Victorian bad name. They were shocked to discover that Baroque often balances an architecturally real window with a fake one for the sake of design, and that it also puts a handsome false front on a plain church simply to give pleasure to the eye. Besides demonstrating a cheap love for theatrical effect, such devices were downright dishonest, and the instinctive reaction of the missionary Gothicist was that somebody ought to call a policeman. It was only after the critical tide had been turned by the labors of such scholar-connoisseurs as Burckhardt, Wölfflin, and Bernard Berenson that the specious ethical arguments of the anti-Baroque faction were defeated. At last it became obvious that Ruskin's hostility to Baroque was not aesthetic at all but moral. It was based ultimately on the style's irrepressible sensuality—a sensuality that was first released with the humanistic energies of the Renaissance and was later smuggled even into the public pruderies of the Counter Reformation. Indeed, an examination of Bernini's "Ecstasy of St. Teresa" (previous page) lends a certain point to Ruskin's exasperation. The enraptured saint is garmented from head to foot, but her attitude of bodily transport and her arresting facial expression are nothing if not physi-



Milanese palace façade designed by sculptor Leone Leoni

Facing page. "The Vision of St. Jerome," by painter Jan Lys

ciple has caused me to omit some obvious items, such as *Messiah*, French clavessin music, and the best examples of Vivaldi's concerto writing, for lack of ideally performed recordings.

**BACH: *Brandenburg Concertos*.** Philomusica of London, Thurston Dart cond. L'OISEAU-LYRE SOL 60005/6, two 12-inch discs \$5.98 each; OL 50167 (Nos. 1, 2, and 4), OL 50160 (Nos. 3 and 5; Concerto in D Minor for Two Violins), OL 50159 (No. 6; orchestral Suites 3 and 4), \$4.98 each (mono only).

**BACH: *Mass in B Minor*.** Maria Stader (soprano), Hertha Töpfer (contralto), Ernst Haefliger (tenor), Dietrich Fischer-Dieskau (baritone), Kieth Engen (bass); Munich Bach Choir and Orchestra, Karl Richter cond. DEUTSCHE GRAMMOPHON ARCHIVE ARC 73177/8/9, three 12-inch discs \$20.94, ARC 3177/8/9 \$17.94.

**BACH: *Tocatta and Fugue in D Minor (S. 565); Prelude and Fugue in C Major (S. 547); Trio Sonata No. 1, in E-flat Major (S. 525); Trio Sonata No. 6, in G Major (S. 530)*.** Helmut Walcha (organ of St. Laurenskerk in Alkmaar, Holland), DEUTSCHE GRAMMOPHON ARCHIVE ARC 73124 \$6.98, ARC 3124 \$5.98.

**BACH: *Italian Concerto; Partita in B Minor (Overture in the French Manner)*.** Ralph Kirkpatrick (harpsichord), DEUTSCHE GRAMMOPHON ARCHIVE ARC 73155 \$6.98, ARC 3155 \$5.98.

These four items represent many if not all of the varied

facets of Bach's music, which, I think, can undeniably be described as the pinnacle of the Baroque. With so many good performances of the *Brandenburgs* to choose from, I have selected Thurston Dart's, which I find the most stimulating. In conducting, instrumental playing, and in the scholarship involved, Dart's imaginative handling of Bach's greatest and most ingeniously varied orchestral works is one of the most satisfying versions I have ever heard.

The grandeur and tension of the Baroque often find their most effective expression in sacred music, particularly those works that involve large forces. Such is the magnificent *Mass in B Minor*, with its vocal soloists, choruses, instrumental obbligatos, and orchestra. It has been successfully demonstrated in performance that the smaller-size orchestra and chorus customary in Bach's time reveal the music with far more clarity than do the bloated forces that still participate in so many romanticized concert-hall renditions today. One has only to hear Karl Richter's vital interpretation to realize the fallacy of the kind of thinking that begins with the often-heard premise "If Bach had only had the use of a larger orchestra and chorus. . . ."

The clarity of contrapuntal lines demanded by the vocal works serves the organ compositions equally well,



*cal. The profoundly humanistic involvement of such Baroque forms—many of them more abstract than this one but no less ecstatic—was summarized in a celebrated witticism about the Bernini group by the worldly Charles de Brosse: "If this is divine love, I know it well." Another and almost equally objectionable element of Baroque art was its turbulent wilfulness—or rather, the wilfulness of the unmistakably self-aware artists who created it. The Gothic cathedral and the Gothic cottage alike were felt to be charmingly anonymous. It was easy to pretend that they just grew out of mass religious or domestic feeling—mystically appropriate communal expressions of devout but simple-minded artisans. There is nothing anonymous or simple-minded about the male caryatids designed by the sculptor Leone Leoni for his palace front in Milan, nor is there anything communal or devout about the ragingly sensual forms in "The Vision of St. Jerome" by Jan Lys. No Ruskinian was really surprised to learn that the former was a homicidal roughneck with a long criminal record or that the latter did his painting as quickly as he could between prolonged bouts of debauchery. It was therefore not only in the painting of that notorious wild man Caravaggio that Ruskin detected "definite signs of evil desire ill repressed." And it was only after intemperate moral judgments were no longer felt to be relevant to art that the crisp*

## *Images of the Baroque in Music*

and can be achieved only on a Baroque-style instrument. Through the efforts of Albert Schweitzer and others, interest has returned to the organs of the past (where they still exist), and modern builders have attempted to duplicate their sound properties. There is a world of difference between the pristine but forceful sound of the Toccata in D Minor played on the St. Laurenskerk organ, built by Arp Schnitger, Bach's contemporary, and a performance of it on one of the late-nineteenth-century Cavallé-Coll monsters. Helmut Walcha, the blind German organist, has recorded virtually all the Bach organ works for DGG and is now engaged in remaking them in stereo. The disc selected is one of the best examples of his art.

The influence of both the Italian and the French styles can be heard on Ralph Kirkpatrick's harpsichord record, which serves as an illustration of Bach as a composer for this important Baroque keyboard instrument. Kirkpatrick's performance is a model of vigor, technical skill, and scholarship.

**BUXTEHUDE:** *Nine Works for Organ*. Hans Heintze (Schnitger organ in Steinkirchen, Germany). DEUTSCHE GRAMMOPHON ARCHIVE ARC 3115 \$5.98.

The most celebrated German organist of the time just before Bach was Dietrich Buxtehude (1637-1707), whose effect on the younger man can be unmistakably traced not only in Bach's treatment of chorales, but in his organ technique, particularly on the pedals. Hans Heintze's robust interpretations of this admirably chosen selection from among Buxtehude's many organ pieces are solid but never staid.

**CORELLI:** *Concerto Grosso, in D Major, Op. 6, No. 7*.  
**TORELLI:** *Concerto Musicale, in D Minor, Op. 6, No. 10*.  
**LOCATELLI:** *Concerto Grosso, in D Major, Op. 1, No. 9*.  
**ALBICASTRO:** *Concerto a 4, in F Major, Op. 7, No. 6*.  
**HANDEL:** *Concerto Grosso, in G Minor, Op. 6, No. 6*.  
Academy of St. Martin-in-the-Fields, Neville Marriner cond.  
L'OISEAU-LYRE SOL 60045 \$5.98. OL 50214 \$4.98.

The concerto grosso was to the Baroque period what the symphony was to the Classical and Romantic eras. The countless concerti grossi composed in this period—each composer generally published sets of twelve—have proved a boon for the many chamber ensembles presently appearing before the public, for the scores are in most cases not difficult for players accustomed to the technical and rhythmical intricacies of Stravinsky, Schoenberg, or Bartók. A Corelli concerto grosso, too, is a fine means for showing off a string orchestra's lush tone, precision bowing, and, in the zippy fast movements, ensemble

## *Images of the Baroque in Art*

good sense of a Geoffrey Scott (in *The Architecture of Humanism*) could make itself heard. Evoking an analogy between Baroque art and Baroque music, Scott says, "The baroque is not afraid to startle and arrest. Like Nature, it is fantastic, unexpected, varied, and grotesque. But, unlike Nature, it remains subject to the laws of scale and composition. . . . It is not, therefore, in any true sense accidental, irregular, or wild. It makes—for the parallel is exact—a more various use of discords and suspensions, and it stands in a closely similar relation to the simpler and more static style that preceded it, as the later music to the earlier. It enlarged the classic formula by developing within it the principle of movement. But the movement is logical." And when Scott goes on to say of Baroque that "It intellectualized the picturesque," he enunciates a principle common to arts as distant from each other as the music of Bach and the theatrical drawings of the great Bibiena family. Even Bach's musical calligraphy reveals both the surging inner movement of his thought and the inexorable discipline that orders it. And the most picturesque of the Bibiena drawings are abstractly just as logical as the Inventions of the great contrapuntist. It was perhaps inevitable that in an age of artists as powerful and as individual as



A musical autograph of Johann Sebastian Bach

speed. Yet — and unfortunately — today's interpretive thinking often goes no further than these comparatively elementary aspects of performance. It rarely includes any study of the performing conventions of the Baroque era — such stylistic details as separate bowing, tightening of dotted rhythms through double-dotting, correct ornamentation (particularly in the cadences, where the omission of the unwritten trill is somewhat akin to omitting a period or a comma in a sentence), and perhaps most neglected of all, embellishment by solo instruments in slow movements and the repeats of sections. Unfortunately, most chamber groups consider that they achieve a Baroque-style performance simply by adding a harpsichord to their ensemble. The English orchestra of the Academy of St. Martin-in-the-Fields is one of the few that knows what to do with the invigorating concerti grossi of Corelli and his illustrious fellow composers.

COUPERIN: *Concert Royal No. 3, in A Major*. LECLAIR: *Sonata No. 8, in D Major, for Flute, Violin, and Continuo*. BOISMORTIER: *Trio in D Major, Op. 50, No. 6; Concerto in E Minor, Op. 37*. Camerata Instrumentale of the Telemann-Gesellschaft Hamburg. DEUTSCHE GRAMMOPHON ARCHIVE ARC 73148 \$6.98, ARC 3148 \$5.98.

Even Baroque buffs occasionally cavil at French Baroque music, for it is the most stylized writing, in its convoluted ornaments and rhythmical subtleties, that one can find

for the time. The rewards that come with familiarity, however, are well worth the additional listening effort. The four French Rococo chamber works on this disc were published between 1722 and 1734. The courtly air of this music is most aptly illustrated by the third *Concert Royal* by François Couperin, Le Grand, written for the Sunday concerts of Louis XIV. The most entertaining piece, however, is the perky Concerto in E Minor by the less well-known Joseph Bodin de Boismortier (1691-1755), which combines sophistication with the aristocratic passion for rural naïveté. The late oboist Hermann Tætcher contributes almost jazz-like improvised embellishment to this performance of the work.

FROBERGER: *Clavichord Music*. Thurston Dart (clavichord). L'OISEAU-LYRE SOL 60038 \$5.98, OL 50207 \$4.98.

The most intimate keyboard instrument of the Baroque period was the clavichord. Though its tone is incredibly soft, it can express a wealth of emotions impossible on either the organ or harpsichord, whether in the music of Bach, his sons, or such predecessors as Kuhnau, Pachelbel, and Johann Jakob Froberger (1616-1667). Thurston Dart's uncommonly sensitive account of a selection of Froberger's music includes several suites and the moving *Tombeau de M. Blancheroche*, an elegy on the death of a famed French lutenist. Keep the volume control on your

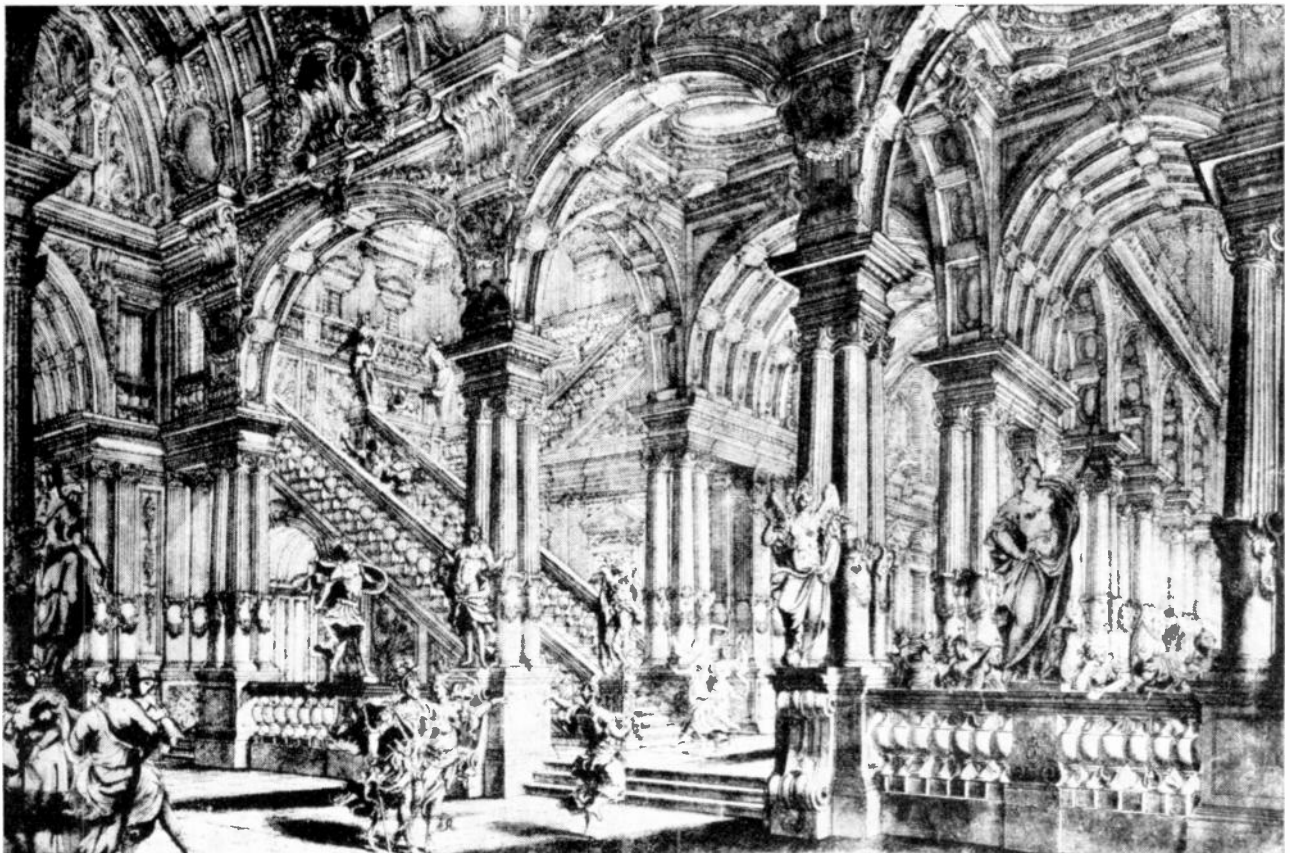

Drawing by a member of the Bibiena family (probably Giuseppe)

## Images of the Baroque in Music

amplifier down if you wish to reproduce successfully the very small-scale sonorities of this instrument.

HANDEL: *Royal Fireworks Music; Concerto No. 2, in F, for Two Wind Choirs, Strings, and Continuo*. Winds and percussion band; Pro Arte Orchestra, Charles Mackerras cond. VANGUARD BGS 5046 \$5.95, BG 630 \$4.98.

HANDEL: *Water Music (complete)*. Philomusica of London, Thurston Dart cond. L'OISEAU-LYRE SOL 60010 \$5.98, OL 50178 \$4.98.

The application of Baroque performance principles to Handel's music is crucial, for Handel often left much to be filled in by the performer in accordance with the spirit and musical conventions of the times. And we are fortunate to have more than the usual quota of stylistically commendable Handel interpretations on records. As examples of Handel's vocal writing, for instance, there is the London *Alcina* (OSA 1361, A 4361) and the fine disc of Handel arias by Russell Oberlin (Decca 79407, 9407), complete with embellished *da capos* and vocal cadenzas. My favorite record for demonstrating proper Handel performance practices is Hermann Tuetcher's fantastically agile elaborated playing of two oboe concertos on DGG Archive 3059, but this is coupled with a mediocre performance of the *Royal Fireworks Music*. The

beginning Baroque collector could not do better than to obtain the two orchestral discs listed above: the first is the splendid wind-band version of the *Royal Fireworks* (coupled with a fine wind and string concerto), and it should make the listener's hair stand on end; the second is a delightful performance of the *Water Music* in its entirety. I cannot think of two other Baroque recordings that I could recommend more unreservedly.

PURCELL: *Dido and Aeneas*. Janet Baker (soprano), Dido; Patricia Clark (soprano), Belinda; Monica Sinclair (contralto), sorceress; Raimund Herincx (tenor), Aeneas; John Mitchinson (tenor), sailor. Thurston Dart (harpsichord continuo); St. Anthony Singers and English Chamber Orchestra. Anthony Lewis cond. L'OISEAU-LYRE SOL 60047 \$5.98, OL 50216 \$4.98.

Written in 1689, *Dido and Aeneas* is justifiably Henry Purcell's most popular work and the greatest opera written in England before Handel's arrival in 1710. Sprightly choruses, sparkling dances, and moving arias make it a must for fanciers of both the Baroque and opera. This English performance is stylistically impeccable.

D. SCARLATTI: *Twenty Sonatas*. Wanda Landowska (harpsichord). ANGEL COLH 73 \$5.98.

The Schwann catalog lists two categories of Scarlatti sonata performances, one played on the harpsichord and the other on the piano, thereby giving the impression that

## Images of the Baroque in Art

these, a general intellectual curiosity should be awakened about the nature of artists themselves and the histories of their various crafts. And it was in fact in the Baroque era that the artistic temperament was first widely noted as constituting a special and problematic psychic category. Artists were thought to be under the rule of Saturn, the Saturnine temperament was melancholy, and the native "element" of all such was the earth. On an engraving by Jacob de Gheyn that allegorizes this state of affairs, the explanatory Latin verse is by the celebrated juriconsult Hugo Grotius, and to the Baroque mind it seemed just as reasonable for the greatest legal light of the age to take an interest in the melancholy temperament of artists as for the Jesuit priest Athanasius Kircher to write a book about music, philosophy, mathematics, medicine, architecture, and acoustical experiment, among other things. The virile and venturesome curiosity of the Baroque era ended with the skepticism of the eighteenth century and the much drier age called enlightened. The unabashed grandiosity of the last great monumental style gave way to the graceful ironies of Rococo, and an intellectualized sensuality in art was never to achieve such triumphant public harmonies on so vast a scale again.



"Allegory of Melancholy," by etcher Jacob de Gheyn



the composer wrote separate works for the two instruments. But, in truth, all of the over five hundred and fifty sonatas, written for the diversion of Maria Barbara, Queen of Spain, were conceived for the harpsichord. This is not to say that their performance on the modern piano cannot be enjoyable. Indeed, it can even be asserted that the sonatas sound good on the clavichord, the organ, and the old forte-piano, and that there were probably performances of them on these instruments even in Scarlatti's day. Yet the harpsichord is the only instrument that conveys the full brilliance, color, and pathos of the vast majority of these sonatas. In spite of many fine available recordings on the harpsichord, the only one that—to my mind—comes near expressing the full scope of Scarlatti's virtuosity and imagination is Landowska's, taken from the 1935 set of 78-rpm discs. The transfer is not particularly good, but the magic comes through all the same.

**SCHÜTZ:** *Weihnachtsbistorie*. Soloists and instrumentalists; Westfälische Kantorei. Wilhelm Ehmann cond. CANTATE 650201 \$6.95, 640201 \$5.95.

This "History of the joyful and gracious birth of Jesus Christ, the Son of God and Mary," written in 1664, is one of the most delightful Christmas pieces I know. Less severe than Schütz's passions, the score has a colorful instrumental complement, including recorders, trumpets,

trombones, and gambas, and, on the vocal side, an evangelist (whose oratorical style anticipates Bach), other characters, and a four- to six-part chorus. Wilhelm Ehmann, a Schütz authority, leads the most convincing performance imaginable.

**TELEMANN:** *Concerto. in D Major. for Four Violins; Concerto. in E Major. for Flute, Oboe d'Amore, Viola d'Amore, Strings, and Continuo; Concerto. in B-flat Major. for Three Oboes, Three Violins, and Continuo; Concerto. in E Minor. for Recorder, Flute, Strings, and Continuo*. Emil Seiler Chamber Music Circle. DEUTSCHE GRAMMOPHON ARCHIVE ARC 3109 \$5.98.

Telemann, born four years before Bach, lived well into the period of change in musical tastes, when the contrapuntal music of the Baroque was already considered old-fashioned and the elegant *galant* style held sway. As eclectic as Bach in his writing, Telemann created his music in Italian, French, and even Slavic molds and was well ahead of Bach in adapting to contemporary tastes. If he is seldom profound, he is invariably entertaining. Those who think Telemann merely a prolific producer of pleasing background music would profit from listening to the four varied concertos on this disc, each a masterpiece. Emil Seiler's splendid small chamber ensemble includes the ubiquitous oboist Hermann Tattcher, whose playing and improvised ornaments are pure delight.

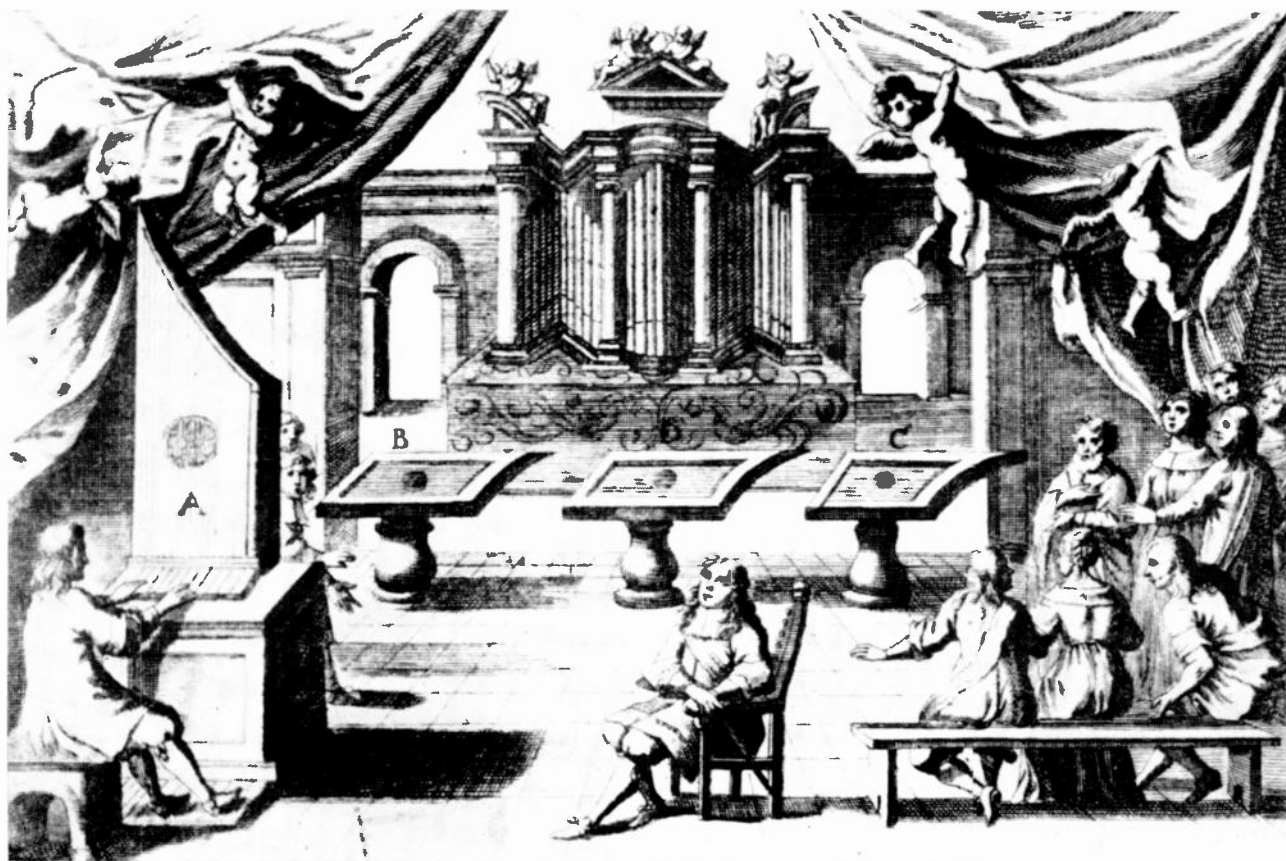

Acoustical experiment illustrated in the *Phonurgia Nova* of Athanasius Kircher



INSTALLATION OF THE MONTH

# BREAKFRONT STEREO

**W**HEN the William Souders first moved into their home in the Chicago suburb of Winnetka, Mrs. Souder hit upon the idea of housing their new stereo components in a pair of antique breakfronts that would flank the archway leading out of the living room. However, when an industrious search of antique shops failed to turn up an appropriate pair of breakfronts, Mr. Souder contacted Robert Sands, the manager of Allied Radio's custom division, who arranged to have breakfronts made to Mrs. Souder's design. An AR-3 loudspeaker was installed in each in special compartments designed to prevent acoustic feedback.

The other equipment in the Souder's stereo system includes a Scott 355 tuner-amplifier located at a convenient height, a Scott 208 placed behind the 355, a Miracord Model 10 record player with an Empire 880 cartridge, and a Sony CS-300 tape recorder.

The breakfront on the right-hand side, which houses the main components, also provides storage space for tapes and records. The other breakfront houses the second speaker and also has a section for books.



# BEST OF THE MONTH



## AUDACITY AND ART IN *THE WELL-TEMPERED CLAVIER*

*Glenn Gould brings a fresh stylistic excitement to Bach's timeless masterpiece*

**I**F GLENN GOULD, at the trim age of thirty-two, can be said to have left behind him his years as Boy Genius, his new Columbia recording from Bach's *Well-tempered Clavier* (Book I, Preludes and Fugues 9-16) tells us that neither the passage of time nor the maintenance of a shiny newsworthiness has in any way modified what must, in the last



*A disputed portrait of J. S. Bach at thirty-eight by E. G. Haussmann.*

analysis, be seen as his most treasurable endowment. I refer, of course, to his daring, his willingness—even eagerness—to flout the rules and take the long chance. I hasten to add that I do *not* refer to the acrobatic chance—the breakneck, “impossible” tempo, for example, deliberately chosen to astonish an audience.

But as you listen to Mr. Gould's *Well-tempered Clavier* (this is the second volume in a projected six-volume set), you should perhaps forewarn yourself not to look in his performance for a confirmation of what you already know—or think you know—about this timeless, self-contained masterpiece. For if a masterpiece can be at least partially defined as a work of art that creates its own unique, self-functioning world, then it can also be said that Mr. Gould approaches each of these preludes and fugues as if it were

his first, awe-inspired discovery of that world. Hollow academicism and dubious musical scholarship—the “safe” approaches—hold no interest for an artist such as this.

The results are exciting and often astonishing. The usual technical problems in playing Bach on the piano seem not to exist for Mr. Gould. Inner voices emerge effortlessly, with none of that punched-out, look-Ma-I'm-playing-counterpoint emphasis that sometimes sullies the playing of even our best Bach specialists. One would think, as Mr. Gould plays, that not only were these works actually composed

*(continued overleaf)*



with the piano in mind but that, somehow, the piano had been specially and particularly invented for the sole purpose of playing them. Some of the preludes, in particular, are coloristically as evocative as any of Debussy's, and quite a few of the more complex, dissonant fugues seem as startlingly modern as any late work by Arnold Schoenberg. Above all else, Mr. Gould understands that, in Baroque music, climax is not principally a matter of playing louder, but of accumulating harmonic tension. More than once, the pianist reaches and passes such a climax without a significant alteration of dynamics.

The record buyer should be reminded that self-styled Bach purists may very well look upon much of what Mr. Gould has achieved on this extraordinary release as a gross betrayal of Johann Sebastian Bach, if not of the entire Baroque age. But listeners who are prepared to leave matters of orthodox Bach style to those who imagine they know what it is are advised to expose themselves without delay to the high adventure of this performance. I found the recording impeccable.

*William Flanagan*

© © BACH: *The Well-tempered Clavier, Book I, Preludes and Fugues 9-16*. Glenn Gould (piano). COLUMBIAS MS 6538 \$5.98, ML 5938 \$4.98.

## LOHENGRIN: A MUSICAL CHALLENGE ANSWERED

*Rudolf Kempe leads a sensitive and distinguished performance*

**M**ORE THAN ten years have passed since Wagner's *Lohengrin* was last recorded, and the best that one can say for the sets that have served us during that period (London 4502 and Decca 131) is that they creditably filled an interim need. Angel's new stereo version—recorded in Vienna's historic Theater an der Wien—goes far beyond that: it is distinguished by alert, firmly controlled direction, exceptional choral and orchestral contributions, and a cast of front-rank international favorites that admirably fulfills its challenging assignment.

The opera is full of knotty interpretive problems. The role of Lohengrin, a composite of heroic strength and melting tenderness, is one of them. In a relatively brief career, Jess Thomas has developed a mature and vivid portrayal that has

the dramatic requirements well in hand. Vocally, too, he is satisfying, both in point of style and in textual delivery. There is some tightness in his tone production around A, and the graceful legato that his illustrious predecessors in this role (Völker, Wittrisch, and the young Melchior) brought to the music's tender moments is not yet within his reach. But in today's vast wasteland of Wagnerian singing, Thomas holds promise of true Heldentenor glory.

My reservations about Elisabeth Grümmer's Elsa will concern only those who find that a rapid vibrato and a slight metallic edge are serious detriments to vocal perfection. Surely this is singing of extraordinary beauty—consistently pure, and with the rapturous quality so appropriate to Elsa's music. A knowing and sensitive interpreter, Miss Grümmer gives us a fully realized and extremely affecting portrayal.

Dietrich Fischer-Dieskau, as Telramund, overcomes his physical limitations through the compelling force of his artistry and imagination. Although his light, lyrical voice is no more suited to Telramund's music than it was to that of the Dutchman or Orest (in Strauss' *Elektra*), his portrayal is nevertheless memorable—as is everything this artist undertakes—in its emphasis on the tragic rather than the villainous side of Telramund's character. It is effectively paired with the powerful Ortrud of Christa Ludwig, an interpretation that leaves no doubt as to the true source of evil in this unholy combination.

King Henry's pompous pronouncements are often surrounded by mighty orchestral waves that threaten to drown the luckless basso, but it is to Gottlob Frick's credit that he manages to keep his sonorous tones above the flood. Otto Wiener's stylish performance as the King's Herald rounds out the cast.

Kempe's reading is in general broadly paced, vigorous, and responsive to the score's more lyrical pages. He brings clarity as well as firmness to his reading—as evidenced by the revelation of the inner voices in the complex finale of Act I. The stereo reproduction of chorus and orchestra are most impressive, but stereo has otherwise been used with perhaps too much restraint. The opening scene of Act II, for example, would have benefited from more pronounced separation between Ortrud, Telramund, and Elsa. But, as with the other critical observations about this set, this detail is minor when compared to the importance of the total accomplishment. The album contains, in addition to the German libretto and parallel English translation, an essay on the sources (in



DIETRICH  
FISCHER-DIESKAU  
(TELRAMUND)  
AND JESS THOMAS  
(LOHENGRIN)

legend and mystery play) upon which Wagner drew for his version of the story. *George Jellinek*

© ® WAGNER: *Lohengrin*. Jess Thomas (tenor), Lohengrin; Elisabeth Grümmer (soprano), Elsa; Dietrich Fischer-Dieskau (baritone), Telramund; Christa Ludwig (mezzo-soprano), Ortrud; Gottlob Frick (bass), King Henry; Otto Wiener (baritone), Herald; Chorus of the Vienna State Opera; Vienna Philharmonic Orchestra, Rudolf Kempe cond. ANGEL S3641 five 12-inch discs \$29.90, 3641\* \$24.90.

## MOZART'S DRAMATIC ASPECT REVEALED

*Artur Rubinstein provides a definitive reading of the D Minor Piano Concerto*

**F**OR THOSE of us who began our concert-going in the 1930's and before, Mozart's D Minor Piano Concerto is—as Irving Kolodin so rightly points out in his notes for RCA Victor's magnificent new recording with Artur Rubinstein as soloist—the Mozart concerto. And, if the Gieseking-Rosbaud mono recording for Angel can be said to represent the definitive interpretation of this music in its lyrical aspect, then it is to this new recording by Artur Rubinstein and Alfred Wallenstein that we must turn for the fullest realization of the concerto's dramatic aspects.

The darkly brooding first movement fairly crackles with drama and suspense under Rubinstein's fingers, and Wallenstein's orchestra plays superbly. The touching *Romanza* slow movement finds Rubinstein equally responsive to Mozart's lyrical utterance, though there is a slight falling off of tension and fluency in the stormy middle episode. In the finale, with its lightning contrasts of protest and joy, Rubinstein is in peak form from beginning to end: both he and the orchestra address themselves to its pages with contagious energy and dash. The Beethoven cadenzas are used here and are played with unusual spaciousness and breadth, which may account for the final movement's spilling over to a second side.

The wonderful Haydn Variations in F Minor, composed in 1793 when Haydn was at the peak of his creative powers, fills out the disc. Here again, Rubinstein emphasizes the dramatic elements so strongly inherent in the music, but he does this well within the bounds of style and of good taste.

The recorded sound is excellent throughout, with the orchestra nicely— but not exaggeratedly— spread out and the piano placed half-way between the speakers.

*David Hall*

© ® MOZART: *Piano Concerto No. 20, in D Minor (K. 466)*. HAYDN: *Variations, in F Minor*. Artur Rubinstein (piano); Symphony Orchestra, Alfred Wallenstein cond. RCA VICTOR LSC 2635 \$5.98, LM 2635\* \$4.98.

*(Continued overleaf)*



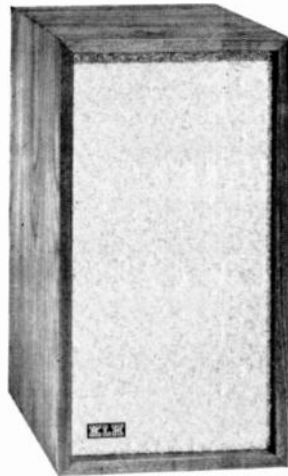

***We made it a fine speaker . . .***

***YOU made it a classic***

The classified advertisements are the graveyard of speaker claims. It is no accident that all but a handful of speakers available four or five years ago have disappeared from the market.

Among that favored handful — almost alone in its price range — is the KLH Model Six, the most imitated speaker ever designed.

Because of the smoothness, clarity and musical balance of this classic speaker system, it is used as a monitor by hundreds of radio stations, recording studios and concert halls; it has been the *final* choice of many thousands of knowledgeable listeners — an increasing number each year. Yet it is inexpensive enough for most beginning systems. (\$119 to \$134 according to finish; slightly higher in the far west).

That's why we call the Model Six:

the lowest priced speaker  
you can be satisfied with  
for the rest of your life.



KLH RESEARCH AND DEVELOPMENT CORPORATION  
30 CROSS STREET, CAMBRIDGE 39, MASSACHUSETTS

# SONY introduces a new era in listening pleasure



## ***THE FIRST FM/AM RADIO USING THE REMARKABLE ESAKI DIODE***

You can expect virtually concert hall realism when you switch on the magnificent new EFM-117. A series of remarkable developments by SONY is responsible for sound quality unsurpassed in any receiver in its class. The EFM-117, for instance, uses an Esaki diode among its complement of 11 transistors and 6 diodes, to make for considerably greater sensitivity and stability. In addition, a special low-resonance oval speaker designed for this set is capable of reproducing a greater frequency range than comparable transducers. Other

outstanding features include new "Rotary Disc" FM tuning, Automatic Frequency Control to eliminate drift, double tuned IF transformers to end interference from adjacent stations, and continuous tone control for bass or treble stress. Operation is simple, with pushbutton band selection, slide rule tuning, dial illumination, distance-local switch, and a variety of jacks for earphone, multiplex, audio input and detector output. Complete with batteries and earphone. Case optional.

**SONY**<sup>®</sup>  
RESEARCH MAKES THE DIFFERENCE





HIFI/STEREO REVIEW'S CHOICE OF THE LATEST RECORDINGS

# CLASSICAL

Reviewed by WILLIAM FLANAGAN • DAVID HALL • GEORGE JELLINEK • IGOR KIPNIS

Ⓢ Ⓜ BACH: *Cantata No. 29, "Wir danken dir, Gott, wir danken dir"; Cantata No. 135, "Ach Herr, mich armen Sünder."* Herrad Wehrung (soprano), Emmy Liskén (contralto), Johannes Hoellin (tenor), Jakob Stämpfli (bass), Arno Schönstedt (organ obbligato in No. 29); Süddeutscher Madrigalchor, Stuttgart; Deutsche Bachsolisten, Wolfgang Gönnerwein cond. CANTATE 651216 \$6.95, 641216\* \$5.95.

Ⓢ Ⓜ BACH: *Cantata No. 43, "Gott fähret auf mit Jauchzen"; Cantata No. 182, "Himmelskönig, sei willkommen."* Friederike Sailer (soprano), Claudia Hellman (contralto), Helmut Krebs (tenor), Jakob Stämpfli (bass), Erich Wenk (bass); Heinrich Schütz Chorale of Heilbronn; instrumental soloists and Pforzheim Chamber Orchestra, Fritz Werner cond. Epic BC 1276 \$5.98, LC 3876\* \$1.98.

Interest: Continuing Bach projects  
Performance: Both very good  
Recording: Epic slightly superior  
Stereo Quality: Both fine

The latest releases in two separate Bach cantata projects (Cantate Records is out to do them all, and Epic now has four discs conducted by Werner) show once again that the composer, even as humdrum duty, could turn out work of consistently high quality, invariably far more inspired than that of his contemporaries. None of these four cantatas can be said, however, to be among his greatest pieces. Number 29, written in 1731 for the annual changing of the Leipzig town council, is of particular interest, because two sections are reworkings of portions of the B Minor Mass, and the cantata uses for its opening sinfonia an arrangement for organ and orchestra of the Praeludium from the third violin partita. A fine recording of this work, coupled with Cantata No. 12, is available on Vanguard

BGS 5036, BG 610. The other work on the Cantate disc is the contemplative No. 135, composed in 1721 for the third Sunday after Trinity. Of the two on the Epic coupling, Cantata No. 182, written in 1714 or 1715 at Weimar, was intended for Palm Sunday and is pastoral-sounding and poignant, and the second work, No. 43, an Ascension Day cantata, is appropriately triumphant in instrumentation and mood.

For the Bach cantata collector, both recordings are well worth owning. The



LUDWIG LUSTIG

JUDITH RASKIN  
*Noteworthy in the Easter Oratorio*

level of instrumental playing on each is extremely high, and the vocalists are generally very satisfactory. Neither of the tenors is superior—Hoellin is monochromatic, Krebs sounds a little worn—but both do have an excellent sense of Bach style. The choral work in each case is very fine, and the conductors present the music with great conviction.

Cantata's sonics are slightly inferior to the excellent standard of their past pressings. The reproduction is cleaner on the Epic disc, which also boasts unusual warmth and body. Texts and translations are supplied with both. I. K.

Ⓢ Ⓜ BACH: *Easter Oratorio.* Judith Raskin (soprano), Maureen Forrester (contralto), Richard Lewis (tenor), Her-

bert Beattie (bass); John de Lancie (oboe), Murray Panitz (flute), Louis Rosenblatt (English horn); The Temple University Concert Choir, Robert E. Page director; Philadelphia Orchestra, Eugene Ormandy cond. COLUMBIA MS 6539 \$5.98, ML 5939 \$4.98.

Interest: Ormandy's Bach  
Performance: Spirited and unaffected  
Recording: Rich  
Stereo Quality: Fine

In the past, Ormandy's treatment of Baroque works has suffered from a heavily Romantic approach. In this recording of Bach's *Easter Oratorio*, an exuberant cantata derived (as James Goodfriend points out in his excellent program notes) from a previously composed secular piece, Ormandy does not give us a performance in the authentic manner of Karl Richter, for example, but he does do away with much that was plainly not stylistic in his previous recordings of the music of Bach. This *Easter Oratorio* is rendered in a straightforward manner; the low strings of the Philadelphia Orchestra sound too weighty, but the musical phrases are well articulated and there is little unidiomatic long-line phrasing. The performance led by Couraud on Epic BC 1244, LC 3811 is better Bach stylistically, but what is particularly appealing about the present performance is the inspired *spirit* of the interpretation. The fast sections, in particular, move along with an irrepressible verve. The excellent soloists, too, are unusually satisfying, Judith Raskin most notably. Both chorus and orchestra make a really "joyful noise," and the recording in both versions is warm and brilliant. Texts and translations are included. I. K.

Ⓢ Ⓜ BACH: *Goldberg Variations.* George Malcolm (harpsichord). L'ORFÈVE -LYRE SOL 261/2 (two 12-inch discs) \$11.96, OL 261/2\* \$9.96.

Interest: Goldbergs with repeats  
Performance: Stresses virtuosic aspects  
Recording: Disappointing  
Stereo Quality: All right

(Continued on page 74)

Explanation of symbols:

- Ⓢ = stereophonic recording
- Ⓜ = monophonic recording
- \* = mono or stereo version not received for review

Like pianist Rosalyn Tureck's soporific treatment of the *Goldberg Variations* on Capitol GBR 7131, George Malcolm's new performance on the harpsichord is absolutely complete—the single-disc versions omit many or all of the repeats. His interpretation, however, in contrast to Tureck's, is anything but dull. Malcolm is a powerhouse of technique, and the most technically difficult variations—those involving crossed hands and both manuals—are spectacular. His tempos in general are on the fast side, and his registration tends to extreme effects; the use of graded dynamics through the application of pedal half-stops, something that has plagued Malcolm's previous recordings, is noticeable only now and then. Altogether, this is a remarkably good performance, though not one that plumbs



GEORGE MALCOLM  
*A powerhouse in the Goldberg Variations*

the depths Landowska and Kirkpatrick reveal in such richly meditative variations as Nos. 15 and 25. The recording is rather a disappointment: close-up miking, some evidence of distortion, and harpsichord sound badly marred throughout by a rapid flutter that makes Malcolm's instrument sound something like fast vibrato on a guitar. I. K.

© ① BACH: *Suite No. 1, in C Major; Suite No. 2, in B Minor*. Orchestra of the Saar, Karl Ristenpart cond. **COUNTERPOINT/ESOTERIC**: 5603 \$5.95, 603\* \$4.98.

© ① BACH: *Suite No. 3, in D Major; Suite No. 1, in D Major*. Orchestra of the Saar, Karl Ristenpart cond. **COUNTERPOINT/ESOTERIC**: 5601 \$5.95, 604\* \$4.98.

Interest: The four orchestral suites  
Performance: Mostly very impressive  
Recording: Poorly processed  
Stereo Quality: Adequate

DECCA RECORDS

Were it not for the unrelieved shrillness that plagues the recording throughout these four sides, these performances of the four Bach orchestral suites led by Karl Ristenpart might be considered along with the best of the several fine recordings of these works now available. Though he does not attempt double-dotting of the opening overtures, this conductor does show an awareness of stylistic niceties that is almost unmatched elsewhere, particularly in regard to articulation within the phrase and execution of that problematic ornament, the appoggiatura. Listeners accustomed to other readings, in which the appoggiaturas are treated as short grace notes or are excised altogether, will be surprised to hear how harmonically effective they sound when given the correct longer duration. And Ristenpart does wonders with the dances, imbuing them with splendid Baroque flavor. The orchestra, including the unnamed but first-rate flutist in the second suite, is highly satisfactory, and the stereo version provides a good perspective of the chamber ensemble. Even a severe top-cut cannot, however, eliminate the raucousness and unclear, cramped sound of these pressings. I. K.

© ① BACH-VIVALDI: *Concerto, in A Minor, for Four Harpsichords and Strings*. LEO: *Cello Concerto, in A Major; Adagio*. A. MARCELLO: *Oboe Concerto in C Minor*. VIVALDI: *Flute Concerto, in D Major, Op. 10, No. 3 ("Il Gardellino")*. Ferruccio Vignanelli, Hedda Illy, Riccardo Castagnone, and Anna Maria Pernaelli (harpsichords); Benedetto Mazzacurati (cello); Renato Zanfini (oboe); Pasquale Rispoli (flute); Virtuosi di Roma, Renato Fasano cond. **ANGEL S** 36153 \$5.98, 36153 \$4.98.

Interest: The Baroque concerto  
Performance: Intermittently idiomatic  
Recording: Not very clean  
Stereo Quality: Helpful

Entitled "The Baroque Concerto," this disc provides three typical examples of the Italian concerto in the early part of the eighteenth century, plus an equally standard, aria-like slow movement from one of the cello concertos by the Neapolitan-based composer Leonardo Leo (1691-1711). Except for the latter, the works are all quite familiar in recorded performances. The playing of both the soloists and the ensemble is on a high technical level and the readings have splendid vitality and spirit, but, as with so many Virtuosi di Roma discs, the stylistic requirements of this kind of music are largely overlooked. The well-known oboe concerto (attributed variously to either of the two Marcello brothers, Alessandro and Benedetto, or to an

(Continued on page 76)

## THE SOUND OF GENIUS

PROKOFIEV CLASSICAL SYMPHONY  
LOVE FOR THREE ORANGES SUITE  
LIEUTENANT KIJE SUITE  
THE PHILADELPHIA ORCHESTRA  
EUGENE ORMANDY

ML 5945/MS 6545\*

VLADIMIR HOROWITZ

In His First Recordings of:  
Beethoven: "Pathétique" Sonata  
Debussy: Three Preludes  
Chopin: Two Etudes  
Chopin: Scherge No. 1 in B Minor

ML 5941/MS 6541\*

Volume 2 of a Series  
BACH  
GLENN GOULD  
The Well-Tempered Clavier  
Book 1  
Preludes and Figures 9-16

ML 5938/MS 6538\*

Tommy Walter CONDUCTS  
SCHUBERT: UNFINISHED SYMPHONY  
BEETHOVEN: FIFTH SYMPHONY  
NEW YORK PHILHARMONIC / COLUMBIA SYMPHONY ORCHESTRA

BONUS LP INCLUDED

ML 5906/MS 6506\*

MAHLER SYMPHONY No. 5 IN C-SHARP MINOR  
LEONARD BERNSTEIN - NEW YORK PHILHARMONIC  
MAHLER: KINDERTÖTENKLIEDER JENNIE TÖRREL, WELZZO-SOPRANO

M2L 298/M2S 698\* 2-Record Set

## ON COLUMBIA RECORDS



All Stereo albums are also available in Guaranteed High Fidelity (Mono).  
\*STEREO © COLUMBIA MARCAS REG. PRINTED IN U.S.A.

## THE JOY OF BEING ISAAC STERN

He brings the same enthusiasm to an impromptu recital for his children as to the concert stage. To a Brahms sonata or a discussion of politics or baseball. To reviving a neglected concerto or preserving Carnegie Hall. His exuberance and warmth are as distinctive in his music as in his personality.

He is the total musician. One critic described his playing like this: "Violinism that has everything—stupendous technique, infinite variety of tone, limitless dynamics and the intellect to apply them...architecture with a brain, with a heart."

His performances of the great violin masterpieces are universally acclaimed. Now hear his mastery bring new meaning to two Mozart concerti, the First (K. 207) and Fifth (K. 219), in a single album. In this brilliant recording, George Szell conducts the Columbia Symphony Orchestra.

## ISAAC STERN ON COLUMBIA RECORDS



ML 5957/MS 6557



# Sensational FUJICA Offer



**You get a full refund on both camera and color film if you are not fully satisfied with the pictures you take!**

## Why do we dare make this offer?

The new Fujica is the first camera with a built-in computer electric eye. Patented. It makes all settings for you . . . both speeds and lens openings. You can't make an exposure mistake even if you try. If the light is too bright or too dim, the computer speeds up or slows down the shutter speed . . . instantly! Automatically! You just press the button. Perfect exposure every time.

## Professional effects also automatic.

A simple dial turn does it. Soft backgrounds. Sharp backgrounds. Catch incredibly fast action . . . and to top it all, you can switch from fully automatic operation to manual control and make any combination of settings you wish. Speeds are up to 1/500th second.

## Takes perfect pictures indoors.

The superb f/2.8 lens gets pictures in light so low, other cameras require flash . . . and if the light is too dim to give you a perfect picture, the Fujica locks . . . won't fire. No more blurs, blanks or wasted shots.

## Preview your finished picture.

The viewfinder-rangefinder shows you big, bright and beautifully clear, what your finished picture will look like. You get exactly what you see.

## How much does this FUJICA cost?

Less than \$100, and with the money back guarantee . . . you risk nothing.

Like to see how easy it is to operate? . . . just ask your favorite camera dealer or write for **FREE** booklet today.

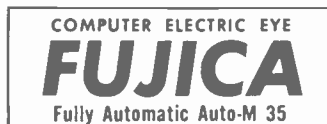

**FUJI PHOTO OPTICAL PRODUCTS INC.**  
111 Fifth Ave., Dept. A-79, New York 3, N.Y.

A subsidiary of Ehrenreich Photo-Optical Industries Inc.

CIRCLE NO. 21 ON READER SERVICE CARD

76

(anonymous composer) is played here in an edition whose parts I suspect are bowdlerized; its second movement, with its curious, unidiomatic inner voices, sounds as if it were the work of a late-nineteenth-century adapter. Only the playing of the perky "Bullfinch" Concerto of Vivaldi makes a stab at stylistic practices with a set of spectacular cadenzas in the outer movements, but the slow-movement repeats are played just as plainly the second time around as the first. The Bach-Vivaldi is done very satisfactorily, although there is no double-dotting at the beginning of its slow movement. And finally, there is the everlasting quarrel with the Virtuosi di Roma over the correct execution of ornaments. The high-level recording, in both mono and stereo, does not play back without traces of distortion, particularly at the side-ends; the soloists are generally too close-up, but the harpsichord continuo is relegated to the far background. Stereo is well managed, especially in the multiple-harpsichord concerto. *I. K.*

## RECORDING OF SPECIAL MERIT

© ® CAMBRA: *Te Deum; Ecce Panis Angelorum*. Denise Monteil (soprano); André Mallabrera and Georg Jelden (tenors); Georges Abdoun (baritone); Phillipe Caillard Chorale; National Orchestra of the Monte Carlo Opera, Louis Frémaux cond. WESTMINSTER WST 17041 \$5.98, XWN 19011 \$1.98.

Interest: French Baroque  
Performance: Festive  
Recording: Generally very good  
Stereo Quality: Splendid

André Campra (1660-1744), whose grandiose Requiem is available on Westminster WST 17007/XWN 19007, was the most important French opera composer between Lully and Rameau. He was equally influential in the sacred music of the day as music director at the Cathedral of Notre Dame. Both the *Te Deum* and the motet *Ecce panis angelorum* are works in the high French Baroque tradition, full of Rococo pomp and festive atmosphere. These vital performances are extremely idiomatic and characterized by unusually clean choral singing, and the soloists are most satisfactory, but the greatest pleasure for me came from the splendid orchestral playing and such first-rate instrumentalists as the trumpet soloist. The stereo version is preferred because of the antiphonal effects in the choral part, and the reproduction, with its full bass response, is good though a bit hard. Texts and translations are included for the *Te Deum* only. *I. K.*

© ® CORELLI: *Concerto Grosso, in G Minor, Op. 6, No. 8*. LOCATELLI: *Concerto Grosso, in F Minor, Op. 1,*

*No. 8*. MANFREDINI: *Concerto Grosso, in C Major, Op. 3, No. 12*. TORELLI: *Concerto a 4, in G Minor, Op. 8, No. 6*. Günter Kehr and Doris Wolff-Malm (violins); Herbert Blendinger and Volker Kircher (violas); Reinhold Buhl (cello); Iwona Salling (harpsichord continuo); Mainz Chamber Orchestra, Günther Kehr cond. DEUTSCHE GRAMMOPHON ARCHIVE ARC 73147 \$6.98, ARC 3147\* \$5.98.

Interest: Christmas concertos  
Performance: A bit too Romantic  
Recording: Rich  
Stereo Quality: Fine

All four of these concertos bear the subtitle "Christmas," and were originally intended for performance during Midnight Mass on Christmas day. Though



ANDRÉ CAMBRA  
*In the grand tradition of the French Baroque*

they all have movements entitled *Pastoral* or the like, and are traditionally associated with the holiday, their enjoyment is not restricted to that season. Furthermore, listeners familiar only with Corelli's work will find that the remaining three composers are no less inspired by their subject. (The same program as this one, incidentally, may be heard played by I Musici on Philips 900025/500025, and by several ensembles on Vox 10500, the latter in mono only.) The pastoral flavor of these performances is apt, but the general stylistic approach, surprisingly for an Archive release, is not. The treatment is not flagrantly Romantic, but the swelling string tone and variegated dynamic slitherings can by no stretch of the imagination be called good Baroque style. In addition, almost no attempt is made to embellish the scores at cadences and the like. The harpsichord continuo—an organ might have been preferable in these works—is audi-



# HAYDN

MAX GOBERMAN

Conducts the Vienna State Opera Orchestra

"These Haydn symphonies sparkle. Library of Recorded Masterpieces disks are among the best of their kind. It is very unlikely that any other record company will offer them competition."—Paul Henry Lang, N.Y. Herald Tribune.

"Recordings of exceptional quality. Mr. Goberman has an extraordinary knowledge of Haydn's style."—London Times.

Selected "Best of the Month" three times and "Recording of Special Merit" six times by HiFi/Stereo.

32 Haydn masterpieces are now available—in mono and stereo with the finest recording techniques—including the "Morning, Noon and Night" cycle, "Maria Theresia," "La Passione," "The Schoolmaster," "Il Distratto," "Lamentatione," and "The Philosopher." Some recorded for the first time; others for first time in stereo; many for the first time correctly played from original scores with authentic instrumentation supervised by the noted Haydn scholar, H. C. Robbins Landon. As with its famous VIVALDI, LRM includes the complete orchestral scores with each record.

You will agree with High Fidelity Magazine: "Goberman seems to be as authoritative a spokesman as Haydn has had in many years. The performances are wonderfully true to the spirit." You are invited to send now for full details.

Write today for free Prospectus, "HAYDN"

Library of Recorded Masterpieces, Dept. ST-3  
150 W. 82nd St., N.Y. 24, N.Y.

CIRCLE NO. 34 ON READER SERVICE CARD

**ROCK  
BOTTOM  
STEREO • HIGH FIDELITY  
PRICES**

**GET  
OUR  
QUOTE**

**PLUS THESE RABSONS EXTRAS**

- Established 1905 58 Years of Reliability
- Franchised Protection Plus
- Rabsons Special Two Year Guarantee
- Easy Payment Plan Up to 24 Months to Pay
- Each Component Double Packed to Ensure Safe Arrival . . . At no extra charge
- Rabsons Sells ONLY Factory Fresh Merchandise in Original Factory Sealed Cartons

**SO WRITE RABSONS**  
Whatever your HI-FI requirements and receive

**FREE  
RABSONS** -57 ST. INC.  
119 West 57th St., New York 19, N.Y.  
Area Code 212 Circle 7-0070  
Diagonally opposite Carnegie Hall

A \$1.00 genuine Miracle Record Cleaning Cloth with EVERY Quotation from Rabsons on a component or system of your choice.

CIRCLE NO. 42 ON READER SERVICE CARD

Interest: Major oratorio  
Performance: Best available on discs  
Recording: Not ideal  
Stereo Quality: Excellent

This oratorio, written in 1738—three years before *Messiah*—is preponderantly choral, of the highest class musically, and not a whit inferior to the later classic. The first part, in particular, presents a great deal of vivid musical painting—the flies and lice invading Egypt, the hailstones, the almost impressionistic depiction of deep darkness, the smiting of the Egyptian first-born, the Israelites being led forth (like sheep—thus a pastoral), and the Red Sea thunderously overwhelming Israel's enemies.

Frederic Waldman properly views the whole as a drama, and his interpretation is precise and extremely effective, especially in the vigorous fast sections. His use of a small orchestra—a first-class body, by the way—and small chorus is stylistically commendable. Everything considered, this performance is the best of the four now available on records. At the same time, there are some curious discrepancies: "The Lord is a Man of War," a duet for two basses, is inexplicably given to the low voices of the men's chorus; the French-style overture to *Solomon*, used here because *Israel in Egypt* has no overture of its own, should have been double-dotted; the practice of interpolating short vocal cadenzas at the end of arias is observed only in those of the soprano and tenor in the second part, and not in the top alto arias. Though all the soloists are adequate, neither of the two sopranos sounds fully comfortable vocally, McCollum is bright-voiced but rather too Midwestern-sounding, and Kopleff combines good tonal qualities with a poker-player's inexpressiveness. The women's chorus occasionally has an unwelcome vibrato, but the choral work in general is good, and so is that of the two keyboard continuo instruments. Unfortunately, the discs have more distortion than is acceptable, particularly in the heavy choral portions. The stereo pressing features excellent separation—it is especially effective in "Their land brought forth frogs"—but the first two sides of the review set were noisy. A well-documented booklet with complete text is enclosed. I. K.

#### RECORDING OF SPECIAL MERIT

© ® HAYDN: *Concerto, in E-flat Major, for Trumpet and Orchestra; Divertimento, in D Major, for Flute and Strings; Divertimento, in E-flat Major, for Strings ("Echo"); Quartet No. 17, in F Major, Op. 3, No. 5: Andante Cantabile ("Serenade")*. Bernard Jeannotot (trumpet); Kurt Redel (flute); Pro Arte Chamber Orchestra of Munich, Kurt Redel cond. ANGEL S 36148 \$5.98, 36148 \$4.98.

Interest: Familiar and unfamiliar Haydn  
Performance: First-rate  
Recording: Very good  
Stereo Quality: Well-defined

This disc is calculated to please the connoisseur as well as the neophyte. In addition to the well-known trumpet concerto and the familiar serenade (originally for string quartet but equally effective as played here by a larger ensemble), there are two virtually unknown divertimentos written by Haydn in his twenties. The most intriguing of these is the "Echo" Divertimento, which makes use of a second, smaller ensemble copying phrases of the first—a device particularly effective in stereo. But this music may seem too repetitious; the lively divertimento for flute and strings is more

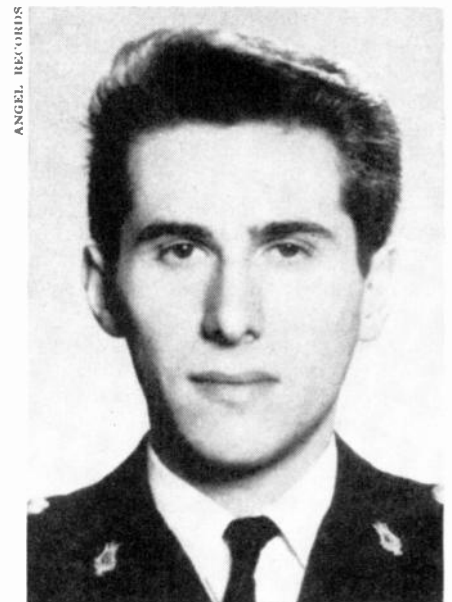

BERNARD JEANNOTOT  
*Unexcelled in Haydn's trumpet concerto*

entertaining. The performances are all first-rate, and even after hearing such an oft-recorded work as the trumpet concerto I am left with the impression that it could not have been better done. Trumpeter Jeannotot plays the work with as much technical skill as can be heard on records and far more stylistically than most, particularly in regard to trills and articulation. Kurt Redel is excellent both as flutist (he provides some delightful ornaments in the D Major Divertimento) and as conductor. Taken as pure, unprofound entertainment, the disc will give great pleasure. The stereo is very effective, though the mono achieves an unusually satisfactory balance even in the "Echo" Divertimento. I. K.

#### RECORDING OF SPECIAL MERIT

© ® IVES: *Pieces for Chamber Orchestra; Songs, Over the Pavements; The Rainbow; Tone Roads No. 1; The In-*

dians; *The Pond*; *Tone Roads No. 3*; *Hymn*; *Halleluc'en*; 1, 2, 3; *Religion*; *An Election*; *The Cage*; *Three Page Sonata*; *Ich grolle nicht*; *General Booth Enters Into Heaven*; *A Farewell to Land*; *Ann Street*. Corrine Curry (soprano); Luise Vosgerchian (piano); Boston Chamber Ensemble, Harold Farberman cond. CAMBRIDGE CRS 1801 \$5.98, CRM 801 \$1.98.

Interest: More Ives  
Performance: Dedicated  
Recording: Good  
Stereo Quality: Okay

Slowly but surely the music of Charles Ives—America's most formidable musical talent so far—is making its way into the long-playing catalog. Not long ago CRI offered the record-buying public a full side of unfamiliar Ivesiana. Now Cambridge Records goes CRI one better with two sides of the New Englander's fantastic musical ruminations.

Cambridge's program has been chosen, it seems to me, daringly and successfully. The first side is devoted exclusively to instrumental music: we hear *Over the Pavements*, a thumping, opaque descriptive piece couched in a knotty polyrhythmic atonal language; *The Rainbow*, one of those quasi-impressionistic lyrical pieces that Ives excelled in; and *Tone Roads No. 3*, composed in 1915 and so complex and dense in atonal texture that it surely would have brought Arnold Schoenberg up quite short with astonishment. And though *The Pond* was also among the works recorded by CRI, we hear it here with solo soprano rather than with solo instrument—a form that is, if anything, even more haunting.

The second side is given over mostly to songs. *General Booth Enters Into Heaven* and *Ann Street* are comparatively familiar by now, but the remaining specimens are no less interesting.

It is by now a truism that Ives was, above all, a pioneer, one incomprehensibly ahead of his time, so that it has been difficult to observe anything other than this fact about his work. But the works—apart from their technical interest—become more personal and musically expressive when we gain the sort of familiarity with them that records of this sort alone make possible.

The performances are, of course, difficult to pass judgment on, but it would be hard to believe that conductor Harold Farberman and the Boston Chamber Ensemble have been anything less than scrupulous. And Corrine Curry's unmistakably homegrown singing seems more suited to the music than any one of several better voices that come to mind.

The recording is fine; Cambridge can be proud of this enterprise. H. F.

(Continued on page 81)

# NO MORE CARTRIDGE COMPROMISES...



## NOW YOU CAN USE ORTOFON'S "TOP-RATED" CARTRIDGE EVEN WITH "AUTOMATIC TURNTABLES"

There was a time when we did not recommend the use of an Ortofon SPU/T Stereo Cartridge in an "Automatic Turntable". It was considered too fine, too delicate and too sensitive for any but the finest manual turntables... then, two things happened—

First, leading rating services published reports calling the Ortofon the best pickup they ever tested. They said it had the widest, smoothest frequency response, with unusually fine detail in the highs, clean, clear sound, and best protection against record wear due to the lowest stylus tip mass available today. It has been internationally acclaimed the finest stereo cartridge.

Following the last of these reports, we consulted three leading manufacturers of "Automatic Turntables" and were advised that the tracking force of 2 grams, recommended for the Ortofon SPU/T is compatible for use with their equipment. This means you need never again sacrifice playback quality with a 'so-called' "changer cartridge" when you own an "Automatic Turntable" with a counter-weighted arm. Only Ortofon gives you this complete versatility... the same cartridge... the same stylus... for professional use or with an "automatic". *Why settle for less?*

The Ortofon SPU/T costs \$50. (If the diamond stylus ever wears out, send the cartridge back to us. We will replace it for only \$15.) Does it pay to spend \$50 for your pickup? Think of it this way. The pickup you use, not only affects profoundly

the sound you hear, but also the life of your records.

Why subject your ear and your record collection to compromises? Protect your equipment and your investment with the pickup unquestionably judged "the best on the market". You'll be upgrading your entire system and you'll get more of what you bought hi-fi for. Isn't that worth a little extra, too?

### SPECIFICATIONS

- Frequency Response..... 20 to 30,000 cps. plus or minus 2 db to 22,000
- "Septra Spectrum" Channel Separation (over entire audible range) ... 20 to 25 db
- Impedance (load) ..... 50,000 ohms
- Output per channel (at 1 KC/cm) 7 Millivolts
- Compliance ..... 10 x 10<sup>-6</sup> cm/Dyne
- Equivalent Mass (at stylus point) .... 1 milligram
- Directional Force (at stylus point) ..... 10 milligrams/micron
- Stylus Pressure ..... 2 grams recommended
- Terminals ..... 4 pin
- Nominal Transformer Output Impedance ..... 15 K ohms
- Ortofon Model SPU/T ..... \$50.00
- Ortofon Model SPU/GT (mounted in shell) fits only Ortofon and SME tone arms ..... \$50.00
- Ortofon Elliptical Stylus Model—SPE/T ..... \$75.00
- Ortofon Elliptical Stylus Model SPE/GT (mounted in shell) Fits only Ortofon and SME tone arms ..... \$75.00

**DON'T BE SWITCHED!** If your dealer doesn't qualify for an Ortofon Franchise, go to a dealer who does. HEARING IS BELIEVING!

Write for catalog



Elpa Marketing Industries, Inc.  
Dept. HS-4 Ortofon Division  
New Hyde Park, N. Y.

**ONLY JENSEN'S  
NEW DL-220  
GIVES YOU  
ALL THESE  
EXTRA  
VALUE  
FEATURES!**

1. Exclusive low-distortion FLEXAIR® suspension.
2. Super-low 25-cycle resonance for rock-bottom bass.
3. Circular horn wide-angle compression tweeter.
4. Fully adjustable HF-balance control on 30" cable.
5. Precision SYNTOX-6® magnetic system.
6. Die-cast metal housing for permanent alignment.
7. Binding post terminals for quick, easy connections.
8. Stable spider suspension for positive voice-coil centering.

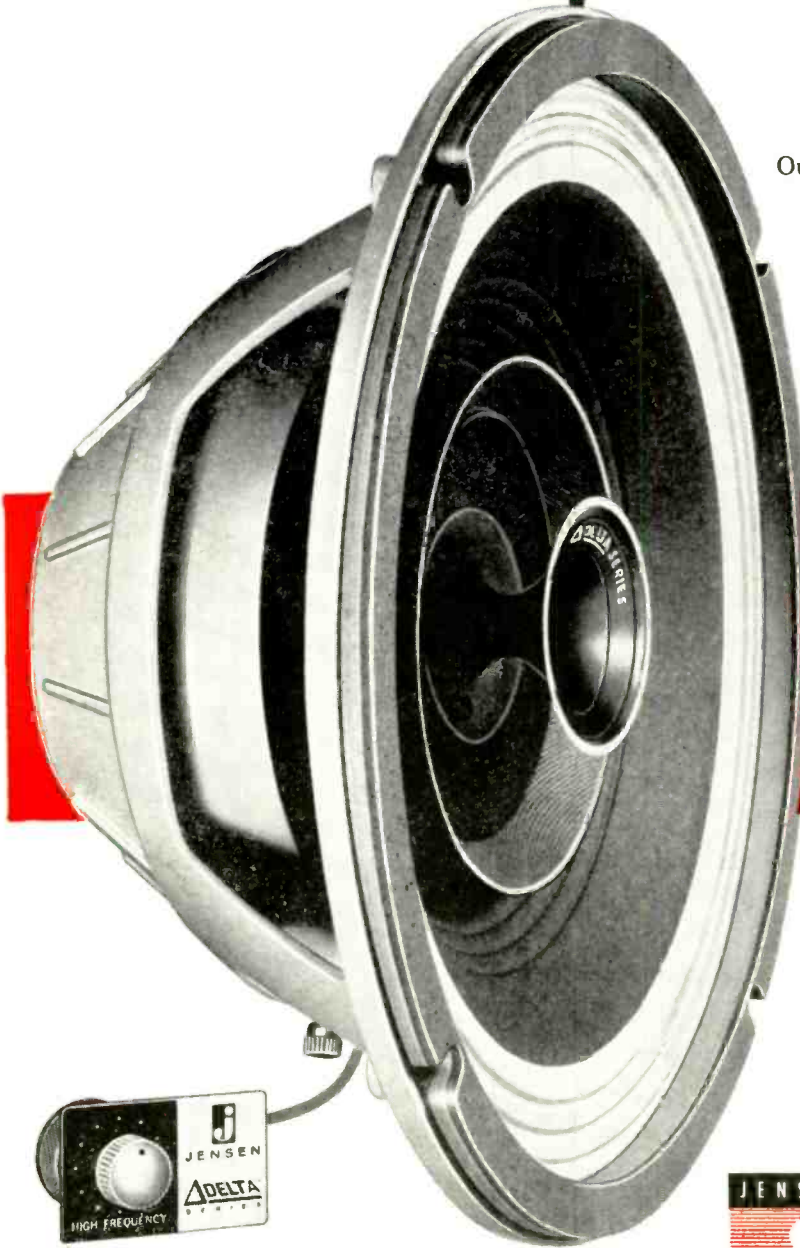

**Model DL-220**

**3-ELEMENT 12" FLEXAIR® COAXIAL**

Outstanding performance at phenomenally low cost! Genuine compression HF unit and heavy-duty 12-inch woofer with mid-range radiator add up to smooth, full response. Power capacity, 20 watts. Frequency range, 25-16,000 cps. Resonance, 25 cps. HF balance control on 30" extension cable.

**NEW FROM JENSEN**

**DELTA** T.M.  
**S E R I E S**

**YOUR BEST SPEAKER VALUE**

**Model DL-120**

Dual-Cone 12" FLEXAIR® 12-inch, high-performance two-way loudspeaker similar to DL-220 but without coaxial HF unit. Frequency Range, 40-15,000 cycles; 20 watts.



**Model DL-80**

Dual-Cone 8" FLEXAIR® A quality 8-inch high-fidelity unit for cost minded enthusiasts who demand Jensen quality. 50-15,000 cps; 20 watts.



Write for free brochure MY



get more hi-fi  
performance  
with the  
**Jensen TF-4**  
5-speaker  
4-way system

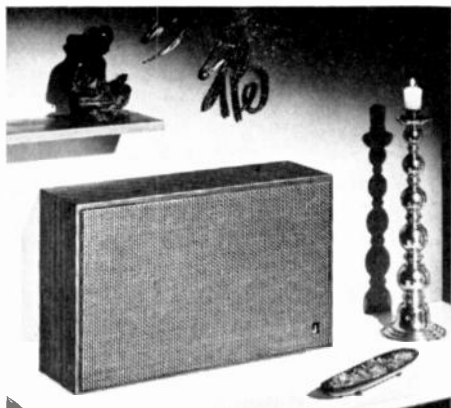

Your choice of two decorator fabrics: the popular all-over rattan or the exclusive custom-woven two-tone pattern.



how? . . . by expertly blending five finely balanced speakers into full-range reproduction: a high-compliance, long travel FLEXAIR™ woofer; a special 8" midrange; two direct radiator tweeters; and Jensen's SONO-DOME® ultra-tweeter for frequency extension beyond audibility. Listen and compare . . . you'll agree there's more hi-fi performance in the TF-4 . . . and you'll get full-size gracefully slender cabinetry that combines big speaker performance with elegant appearance. Genuine walnut veneer in oil finish. (Available, too, in the money-saving unfinished gum hardwood for custom finishing or building-in.) Cabinet measures 16" H, 25½" W, 8½" D.



**TF-4  
5-SPEAKER  
4-WAY SYSTEM**

8 ohms. Power Rating, 25 watts.  
In Oiled Walnut . . . . . \$114.50  
In Unfinished Hardwood . . . . . 97.50



Write for free catalog 165-J.

JENSEN MANUFACTURING COMPANY  
Division of THE MUTER COMPANY  
6601 S. Laramie Ave., Chicago 38, Illinois

Canada: Radio Speakers of Canada, Ltd., Toronto  
Argentina: Ucoa Radio, S. A., Buenos Aires  
Mexico: Fapartel, S. A., Naucalpan, Mex

LEO: *Cello Concerto, in A Major; Adagio* (see BACH-VIVALDI)

LOCATELLI: *Concerto Grosso, in F Minor, Op. 1, No. 8* (see CORELLI)

**RECORDING OF SPECIAL MERIT**

Ⓢ Ⓜ MAHLER: *Songs from Des Knaben Wunderhorn. Revelge; Das irdische Leben; Lob des hohen Verstandes; Rheinlegendchen; Der Schildwache Nachtlied; Wer hat dies Liedlein erdacht; Verlor'ne Muh; Der Tamboursg'ssell; Trost im Unglück; Wo die schönen Trompeten blasen; Des Antonius von Padua Fischpredigt; Lied des Verfolgten im Turm; Urlicht.* Maureen Forrester (contralto); Heinz Rehfuss (bass-baritone); Orchestra of the Vienna Festival, Felix Prohaska cond. VANGUARD VSD 2154 \$5.95 VRS 1113 \$4.98.

Interest: Early Mahler  
Performance: Expert  
Recording: Perfect  
Stereo Quality: Excellent

Many American listeners owe their discovery of the unique songs Gustav Mahler fashioned from the German folk collection *Des Knaben Wunderhorn* to a recording Vanguard issued about a dozen years ago (VRS 421). Now we have a new one from the same source and under the same conductor, and it reveals Mahler's uniquely inventive orchestrations in glowing colors. As the songs emerge in Mahler's settings, they are by turns bitter, bizarre, and affecting.

Both interpreters are knowing and authoritative. Within a rich orchestral framework the creamy voice of Miss Forrester is a glowing instrument, though I missed the touch of twinkling humor Christa Ludwig brought to her *Rheinlegendchen* and *Fischpredigt*. Rehfuss, too, does his demanding share impressively, despite the limited effectiveness of his voice in the higher reaches. Prohaska conducts with vigor and authority. The recording cannot be praised too highly: it is a miracle of clarity, immediacy, and balance.

G. J.

MANFREDINI: *Concerto Grosso, in C Major, Op. 3, No. 12* (see CORELLI)

MARCELLO: *Oboe Concerto in C Minor* (see BACH-VIVALDI)

**RECORDING OF SPECIAL MERIT**

Ⓢ Ⓜ MOZART: *Divertimento No. 2, in D Major (K. 131); Symphony No. 33, in B-flat Major (K. 319).* Maurice Sharp (flute); Marc Lifschey (oboe); George Goslee (bassoon); Myron Bloom, Martin Morris, Roy Waas, and Ernani Angelucci (horns); Cleveland Orchestra, George Szell cond. Epic BC 1273 \$5.98, LC 3873\* \$1.98.

Interest: Minor masterpieces  
Performance: Stunning  
Recording: First-rate  
Stereo Quality: Excellent

Although it is not one of his best-known symphonies, Mozart's Number 33 is nevertheless a perfect gem, a buoyant piece that ranks among the composer's minor masterpieces. The divertimento, written when Mozart was sixteen and scored for flute, oboe, bassoon, four horns, and strings, is equally felicitous, a bubbly bit of entertainment that is completely captivating in this performance. This divertimento was one of Beecham's specialties—though he was given to substituting for one of its minutes another of later vintage—and his interpretation was charming and gra-



RCA VICTOR

MAUREEN FORRESTER  
*Knowing interpretations of Mahler songs*

cious George Szell is no less delightful, and stylistically he is far sounder in both works. Perhaps what is most impressive about the Cleveland performances is the sparkling playing of the orchestra: fast movements are scintillating, and the slow ones have a marvelous *galant* air. The instrumental soloists, moreover, perform in a truly breathtaking manner. Szell's careful phrasing and insistence on articulation yield a clarity of line that could serve as a model for many conductors of Mozart. The reproduction is on the same level of excellence as the performances, and stereo separation is well handled.

I. K.

Ⓢ Ⓜ MOZART: *Symphony No. 41, in C Major (K. 551, "Jupiter"); Serenade, in G Major (K. 525, "Eine kleine Nachtmusik").* Boston Symphony Orchestra, Erich Leinsdorf cond. RCA Victor LSC 2691 \$5.98, LM 2691 \$1.98.

(Continued on page 82)

—AND TO BE PERFECTLY HONEST, I LOVE THEM TOO. I'M STRICTLY FOR PEOPLE WHO ENJOY HAVING GOOD PICTURES, BUT WHO FRET ABOUT THE MECHANICAL BUSINESS OF TAKING THEM. MOST CAMERAS IN MY PEER GROUP TEND TO MAKE PEOPLE WARY, POSSIBLY EVEN NERVOUS, BUT NOT I. SIMPLY SET MY SHUTTER SPEED AND I'LL TAKE OVER THE LENS-OPENING ADJUSTMENTS, AUTOMATICALLY. THAT WAY YOU GET CRISP COLOR SLIDES OR BLACK-AND-WHITE PRINTS FROM EVERY SCENE YOU SHOOT. □ LATER ON, WHEN YOU'VE GOT THE HANG OF IT, YOU JUST RESET ME SO YOU CAN CHOOSE YOUR OWN LENS SETTINGS. I'M AUTOMATIC OR NOT, JUST AS YOU LIKE. □ MAY I GET TECHNICAL FOR A MOMENT? JUST LONG ENOUGH TO SAY THAT I HAVE A FAST f/2.8 COLOR-PANTAR LENS, AND A PRONTOR-MATIC SHUTTER (1/30 TO 1/125 SEC. AND TIME EXPOSURE). □ FOR LESS THAN \$100 I COME IN A HANDSOME KIT THAT INCLUDES AN EVEREADY CASE, IKOBLITZ 5 FLASH GUN, AND LENS SHADE. □ PERHAPS I SHOULD HAVE GIVEN YOU MY NAME EARLIER. I'M THE ZEISS IKON

CONTESSAMAT 35  
AUTOMATIC.



WRITE DEPT. 26 FOR LITERATURE.  
CARL ZEISS INC., 444 FIFTH AVENUE, NEW YORK 18, N. Y.  
IN CANADA, CARL ZEISS CANADA LTD., 60 OVERLEA BLVD., TORONTO 17, ONTARIO

SYMBOL OF EXCELLENCE  IN WEST GERMAN OPTICS

Interest: Basic Mozart  
Performance: Expansive and polished  
Recording: Good  
Stereo Quality: Good

With this Erich Leinsdorf-BSO recording, and the recent London release with Karajan and the Vienna Philharmonic, the currently available stereo versions of the Mozart "Jupiter" Symphony number one dozen. Like his recent RCA recording of the "Eroica" with the Boston Symphony (LSC/LM 2644), Leinsdorf's reading of the "Jupiter" is expansive and virile, aimed at setting forth the symphony's structure on the largest scale. (As a means to this end, he takes all the repeats in the first, second, and final movements.) In the first movement and in the poignant slow movement, Leinsdorf is 100 per cent successful, but in the minuet and in the colossal sonata-fugue that serves as the finale, I miss the lift and drive that he brought a decade ago to his Rochester Philharmonic performance, once available on Columbia's low-price Harmony label. Of course, the orchestral playing and the recorded sound throughout this new release are infinitely more revealing of detail and nuance than either of Leinsdorf's previous recordings of the "Jupiter," for Harmony and Westminster. But I find his present approach to the minuet and finale fastidious to the point that the music's vitality suffers. Even with this reservation, however, this recording takes its place beside the very different versions by Walter, Toscanini, and Schmidt-Isserstedt as a most distinguished "Jupiter" performance.

For me, the most attractive music-making on this disc is the treatment of the thrice-familiar and ceaselessly abused serenade *Eine kleine Nachtmusik*. Only the late Erich Kleiber's prewar Telefunken 78's offer such a combination of elegance and spontaneity in this piece. Leinsdorf wisely uses a reduced string section here. It should also be noted that he plays the beginning of the fifth measure in the minuet with an acciaccatura, or short appoggiatura, in accordance with modern editions of the score, rather than with the usually heard even series of eighth-notes. In this he is preceded by the late Felix Weingartner, who played it thus in his wartime performance with the London Symphony on 78's. D. H.

#### RECORDING OF SPECIAL MERIT

© ® RAMEAU: *Keyboard Works, Volume Three: Pieces in A (1706); Suite in E (1721)*. Albert Fuller (harpsichord). CAMBRIDGE CRS 1603 \$5.98, CRS 603 \$1.98.

Interest: Fascinating Rameau  
Performance: Superb  
Recording: Impressive  
Stereo Quality: Good

This album, together with Cambridge's CRS 1601/601 and CRS 1602/602, makes available in stereo the complete harpsichord works of Rameau, the bulk of which the French master published in three volumes in the years 1706, 1724, and (circa) 1730. Renowned primarily as one of the greatest theorists of his day, Rameau did not achieve a popular success until he turned to composing opera and ballet in 1733, by which time he was already fifty years of age. Yet it has been the earlier keyboard works that have kept Rameau's name living among performers, as harpsichordist Albert Fuller tells us in his comprehensive and informative program notes.

I have not heard Fuller since his recording of a half-dozen years ago on the Washington label, and this new Cambridge series shows that he has developed from a gifted but rather prim player into an artist of stature. From the very first notes of the Prelude in the 1706 pieces, we are made to realize that there is nothing stuffy or precious about Rameau's music. We sense immediately the composer's flair for the large gesture that was later to reveal itself in his operatic recitative. In the dance movements, Fuller makes the most of the coloristic possibilities by imaginative but tasteful registration changes—quite correctly taking his cue from Rameau's remarkable orchestral writing. There is little doubt in my mind that those who cannot afford the whole of Fuller's Rameau set will be more than happy to settle for Volume Three, if only because the Suite in E includes the most popular of all Rameau's music—*La Villageoise*, *Le Rappel des oiseaux*, the *Musette en rondeau*, and the *Tambourin*. They are played with superb brio and color here.

The recorded sound, as has been the case with almost everything of late from the small but enterprising Cambridge label, is absolutely first-rate. D.H.

#### RECORDING OF SPECIAL MERIT

© ® TELEMANN: *Concerto, in D Major, for Flute, Strings, and Continuo*; *Concerto, in G Major, for Two Violins, Strings, and Continuo*; *Concerto, in E Major, for Flute, Oboe d'Amore, Viola d'Amore, Strings, and Continuo*; *Suite Concertante, in G Minor, for Three Oboes, Bassoon, Strings, and Continuo*. Josef Steinhilber and Georg Retyi (violins); Kurt Redel (flute); Wilhelm Grimm (oboe, oboe d'amore); Munich Pro Arte Chamber Orchestra, Kurt Redel cond. WESTMINSTER WST 17042 \$5.98, NWN 19012 \$4.98.

Interest: Stylish Telemann  
Performance: Worthy  
Recording: Good  
Stereo Quality: Excellent

There is plenty of variety in this Telemann collection, which ranges from the suite concertante, an overture in the French style much like the Bach orchestral suites, to the three Italianate concertos for various instruments. The music, furthermore, offers additional proof, if anyone needs it, of the high quality to be found in the work of this extraordinarily fecund composer. Along with Italian and French influences one may discover a most attractive rhythmic buoyancy, typically Polish—so characteristic of Telemann's music as to be a positive means of identifying it. Yet the suite concertante occasionally reminds

me in its harmonies of Purcell, and one of its dance movements, the *Loure*, resembles the echo chorus "In our deep vaulted cell" from *Dido and Aeneas*.

Those familiar with Kurt Redel's previous recordings, notably the Handel Opus 6 on Vox and the Brandenburg Concertos once available on the Westminster label, will recognize the forty-five-year-old German conductor as an unusually skillful interpreter of Baroque music and a splendid stylist. He is first-class, too, as a flutist in the Concerto in D, and his knowledge of Baroque practices results in some perfectly delightful

(Continued on page 81)

## RECORDS AT COST through our Special Membership Plan...

**BUILD YOUR RECORD LIBRARY INEXPENSIVELY, QUICKLY, CONVENIENTLY — NO "AGREE TO PURCHASE" OBLIGATION — CHOOSE THE RECORDS YOU WANT**

The Citadel Record Club is a membership club that entitles its members to purchase singles, hi-fi and stereo albums at cost; classical, popular, jazz, show hits, folk.

All are available and at prices that never vary from our published price list. There are never any "list price" purchases through Citadel.

**CITADEL MEMBERSHIP — THE PROVEN METHOD OF RECORD BUYING USED BY THOUSANDS OF SATISFIED CLUB MEMBERS BECAUSE . . .**

- \* **YOU DECIDE ON YOUR PURCHASES** — You are not obligated to purchase any particular quantity of records. Buy as few or as many records as you want . . . the choice is yours. Citadel has no "agree to purchase" requirement.
- \* **YOU HAVE COMPLETE FREEDOM OF SELECTION** — Virtually any record or album, by any artist on any label is available including all major labels plus hundreds of smaller labels as well as most imports. Again, the choice is completely up to you. Citadel has no "pre-selected" list of recordings for you to choose from.
- \* **PROMPT SERVICE** — Many orders are shipped the same day received, rarely later than the next several days. In the event of a delay, partial shipments are made and your order completed as soon as the record is available and, of course without any additional cost to you.
- \* **PERIODIC SPECIALS** — Periodically you receive a list of hit albums from all categories of music at prices up to 55% off list. The selections depend on those special purchases we have been able to make. Again, you are under no obligation to purchase any of these selections.
- \* **FREE! SCHWANN RECORD CATALOG** — With your membership you receive this quick reference to over 25,000 albums. This easy-to-use catalog contains separate sections for classical, popular, ballet, opera, musical shows, folk music, jazz, etc., and lists a separate section for all new releases. You are not restricted to this catalog, it is simply a handy guide.
- \* **100% GUARANTEE** — Citadel completely guarantees their records against defects or damages of any sort. If a damaged or defective record does get through our inspection, we shall immediately replace with a perfect copy.

Membership dues is \$3.00 a year . . . a nominal amount if you reflect for a moment on the record purchases you have made within the past year and the prices you have paid. AS A CITADEL MEMBER BUYING RECORDS AT COST, YOUR DUES WILL BE PAID FOR WITH VIRTUALLY THE FIRST PURCHASE YOU MAKE THROUGH THE CLUB. Additional savings quickly mount up, permitting you to buy many more albums on your record budget.

If you have been faced with the problem of a

complete record source . . . may we suggest that you give Citadel Record Club an opportunity of proving its value to you. You enter no obligations, take no risks . . . simply complete the coupon below, include your \$3.00 yearly membership dues and upon receipt we shall immediately forward all club membership material to you. We cordially invite you to join thousands of other satisfied Citadel members who are purchasing their records at cost price through their Citadel Club membership.

**SATISFACTION GUARANTEED** Try membership in the Citadel Record Club for 30 days. If at the end of that time you are not completely satisfied, simply request your membership dues back, and it will be immediately refunded.

**FREE!**

Act now. Fill out the coupon, enclose your dues and we will include a free quality record cleaning cloth as a gift. This is our way of thanking you for your confidence in us.



### CITADEL RECORD CLUB

545 Fifth Avenue, New York 17, N. Y. S-44

Enroll me in Citadel for one year. I am under no obligation to purchase any particular quantity of records, but those that I do purchase will be at member prices . . . NEVER more. I am to receive a current Schwann catalog immediately and subsequent periodic lists of specially priced hit albums. I understand that if, after trying membership in Citadel for 30 days, I am not completely satisfied I can get my full membership dues back immediately. Also, include the free quality record cleaning cloth as a gift. \$3.00 dues enclosed.

FULL NAME \_\_\_\_\_

STREET \_\_\_\_\_

CITY \_\_\_\_\_ ZONE \_\_\_\_\_ STATE \_\_\_\_\_

solo embellishment. One small quibble: some might have preferred that the specified viola d'amore be used in the E Major Concerto, rather than the muted violin substituted here. The orchestral playing is vigorous and enthusiastic, though not quite as beautifully polished and refined as the German Bach Soloists' in the E Major Concerto on Cantate 57703/47703. The full-bodied reproduction is generally satisfactory if not entirely clean, and the stereo version is well gauged for natural separation. I. K.

**TORELLI: Concerto a 1, in G Minor, Op. 8, No. 6 (see CORELLI)**

**VIVALDI: Flute Concerto, in D Major, Op. 10, No. 3 (see BACH-VIVALDI)**

## COLLECTIONS

### RECORDING OF SPECIAL MERIT

© ① **ACADEMY OF ST. MARTIN-IN-THE-FIELDS: Second Recital.** Avison: *Concerto, in A Major, Op. 9, No. 11.* Manfredini: *Concerto, in G Minor, Op. 3, No. 10.* Albinoni: *Concerto a 5, in A Minor, Op. 5, No. 5.* Handel: *Concerto Grosso, in G Major, Op. 6, No. 1.* Telemann: *Musique de Table, Set 2: Concerto in F Major.* Neville Mariner,

Normal Nelson, Gerald Jarvis, and Anthony Howard (violins); Kenneth Heath (cello); John Churchill (harpsichord continuo); Academy of St. Martin-in-the-Fields, Neville Marriner cond. L'OISEAU-LYRE SOL 264 \$5.98, OL 261\* \$4.98.

Interest: British chamber ensemble  
Performance: Exceptionally fine  
Recording: Superbly balanced  
Stereo Quality: Advantageous

Among the recordings I recommend for a basic library of Baroque music in this issue is a group of concerti grossi performed by the Academy of St. Martin-in-the-Fields (L'Oiseau-Lyre SOL 60045/OL 50214), a British chamber ensemble that takes its name from a London church. The Academy is aurally one of the most stunning groups of its kind on records, and this second volume, I am delighted to report, is every bit as good as the first. The five concertos included here give evidence of the strong influence exerted on Western music by the Italians during the early and middle parts of the eighteenth century. The best piece is unquestionably the Handel, but Baroque enthusiasts will also enjoy the sprightly Telemann dining music and the gravely flowing sections of the Manfredini concerto. Stylistically, these performances are of a very high order, and instrumentally these players are impeccably precise, tonally elegant, yet never slick. The recording features a particularly natural-sounding balance between the solo instruments and accompanying forces. I. K.

### RECORDING OF SPECIAL MERIT

© ① **CLEVELAND SINFONIETTA: Romances and Serenades.** Vaughan Williams: *The Lark Ascending.* Sibelius: *Romance in C, Op. 42.* Delius: *Serenade from Hassan.* Warlock: *Serenade for Frederick Delius.* Françaix: *Serenade for Small Orchestra.* Rafael Druian (violin); Cleveland Sinfonietta, Louis Lane cond. Epic BC 1275 \$5.98, LC 3875 \$4.98.

Interest: Delectable listening  
Performance: With loving care  
Recording: Good  
Stereo Quality: Good

Cleveland's Louis Lane has done it again! As on his previous discs with the Sinfonietta and the Cleveland Pops ensemble, he has here put together a musical program of singular interest, taking care to include two real gems from off the beaten musical track—the exquisite Vaughan Williams romance for solo violin and orchestra, and the impudent little Françaix serenade. His musicians play the works with loving care and impeccable musicality, and Epic has done a  
(Continued on page 86)



## VANGUARD

Current and Choice Recordings for the Connoisseur



**MAHLER**  
**SYMPHONY OF A THOUSAND**  
(Symphony No. 8 in E flat major)  
8 Soloists  
Combined University of Utah Choruses  
Utah Symphony Orchestra  
Maurice Abravanel, conductor

2 discs boxed with full texts & notes.  
VRS-1120/1 (Mono) & VSD-71120/1 (Stereo)

**JANACEK**  
**SINFONIETTA FOR ORCHESTRA**  
**PRELUDES TO OPERAS**

(Katya Kabanova, House of the Dead, Makropulos Affair, Jealousy)

Charles Mackerras, conductor  
Pro Arte Orchestra of London

VRS-1116 (Mono) & VSD-71116 (Stereo)

**BAROQUE**  
**MUSIC IN SALZBURG**

Chamber Works of Biber and Muffat  
Concentus Musicus  
Ensemble of Renaissance & Baroque Instruments  
BG-652 (Mono) & BGS-70652 (Stereo)

**GOLDMARK**  
**RUSTIC WEDDING SYMPHONY**

Maurice Abravanel conductor  
Utah Symphony Orchestra  
VRS-1104 (Mono) & VSD-2142 (Stereo)



**NEWPORT FOLK MUSIC FESTIVAL, 1963**  
(Recorded Live)

**NEWPORT BROADSIDE**  
(Topical Songs)

Joan Baez, Bob Davenport, Bob Dylan, Freedom Singers, Jim Garland, Sam Hinton, Peter La Farge, Ed McCurdy, Phil Ochs, Tom Paxton, Jean Redpath, Pete Seeger.

VRS-9144 (Mono) & VSD-79144 (Stereo)

**BLUES AT NEWPORT**  
Brownie McGhee & Sonny Terry, John Hammond, John Lee Hooker, Mississippi John Hurt, Rev. Gary Davis, Dave Van Ronk.

VRS-9145 (Mono) & VSD-79145 (Stereo)

**COUNTRY MUSIC AND BLUEGRASS**

Doc Watson, Clarence "Tom" Ashley with Clint Howard & Fred Price, Jim & Jesse with The Virginia Boys, Morris Brothers, Mac Wiseman & The Country Boys, New Lost City Ramblers, Tex Logan.

**OLD TIME MUSIC**

Dock Boggs, Maybelle Carter, Clarence "Tom" Ashley, Dorsey Dixon, Clint Howard, Fred Price, Doc Watson

VRS-9147 (Mono) & VSD-79147 (Stereo)

**EVENING CONCERTS**

Vols. I & II

Joan Baez, Jean Carignan, Rooftop Singers, Ian & Sylvia, Pete Seeger, Dave Van Ronk, Bob Dylan, Bessie Jones with John Davis & The Georgia Sea Island Singers, Mississippi John Hurt, Sam Hinton, Theodore Bikel & Judy Collins, and others.

VRS-9148 & 9149 (Mono) & VSD-79148 & 79149 (Stereo)

### Critical Hurrahs



**HAYDN on VANGUARD**

Antonio Janigro, conductor  
Orchestra of Radio Zagreb  
*Sturm und Drang Symphonies*

No. 44, *Trauer* and No. 45, *Forewell*  
VRS-1106 (Mono) & VSD-2145 (Stereo)  
No. 46 in B & No. 47 in G  
VRS-1107 (Mono) & VSD-2146 (Stereo)  
No. 48, *Maria Theresia*  
No. 49, *Passione*  
VRS-1108 (Mono) & VSD-2147 (Stereo)

"The world can well use a conductor of his discrimination, sensitivity and knowledge... the kind of performance that justifies preservation on records, which automatically distinguishes it from 90% of the average year's production."  
Irving Kolodn, *Saturday Review*

"Remarkable conducting powers... He literally conducts his players from one note to the next in a marvelously sensitive shaping and articulating of the music in a flow with un-failing cohesive tension, continuity and structural coherence."  
B. H. Haggin, *New Republic*

David Blum, conductor  
Esterhazy Orchestra  
Symphony No. 60, *Il Distretto*  
& No. 52 in C minor  
VRS-1105 (Mono) & VSD-2143 (Stereo)

"There is no doubt that the 28-year-old Blum and his 25-man orchestra are splendid musicians who have much to give us."  
J.W.B., *American Record Guide*

# Which Stereo Receiver Is Your Best Value?

BRAND	IHF M POWER	TUNER	CIRCUIT	PRICE
A	70 Watts	AM-FM FM Stereo	Transistor	\$369.95
B	80 Watts	FM Stereo	Tubes	\$319.50
C	Not available (32 watts continuous power)	AM-FM FM Stereo	Tubes	\$154.90
D	70 Watts	FM Stereo	Tubes	\$429.90
E	66 Watts	AM-FM FM Stereo	Transistor	\$195.00
F	60 Watts	FM Stereo	Tubes	\$354.45
G	60 Watts	AM-FM FM Stereo	Tubes	\$273.90
H	100 Watts	AM-FM FM Stereo	Transistor	\$579.90
I	36 Watts	FM Stereo	Tubes	\$174.90

## If You Choose E, Go Direct to the Coupon & Collect \$89 to \$385 Savings!

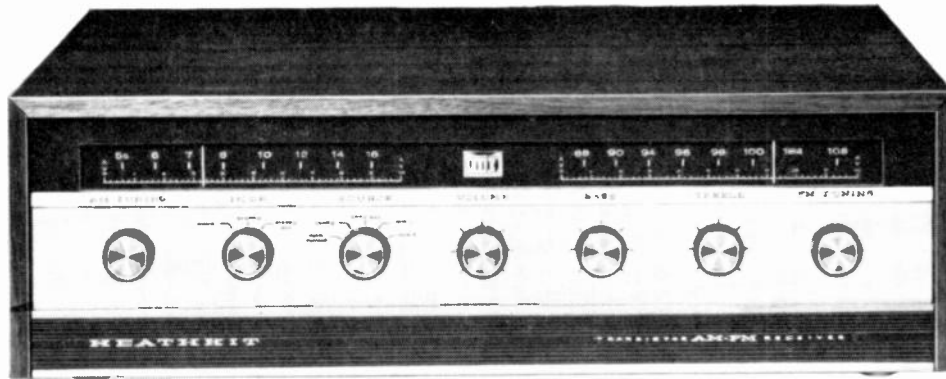

Why is the exciting new Heathkit All-Transistor Stereo Receiver your best value? A glance at the above chart will tell you. Compare E's performance features and price against the others.

With the Heathkit AR-13 Stereo Receiver, you enjoy cool, fast, "hum-free" operation; long, trouble-free life; and the quick, clean, unmodified response of "transistor sound" . . . characteristics unobtainable in vacuum tube types. Enjoy sensitive, wide-band AM, FM and FM STEREO tuning for distortion-free reception to please the most discriminating ear. Enjoy 66 watts of pure, uncompromising music power, 40 watts of continuous sine-wave power . . . plenty to drive even the most inefficient speaker system! Enjoy traditional Heathkit savings . . . \$174 and \$385 over the other two transistorized models! Let's examine the Heathkit AR-13 more closely. Inside its luxurious walnut cabinet, there are two 20-watt power amplifiers . . . two separate preamplifiers . . . plus wide-band AM, FM, and FM STEREO. You have all the electronics necessary for a complete stereo system . . . just add two speakers!

In addition to the AR-13's advanced 43 transistor, 18 diode circuitry, there are advanced features such as *automatic* switching to stereo; automatic stereo indicator light; filtered tape recorder outputs for

direct "beat-free" recording; dual-tandem controls for simultaneous adjustment of volume, bass, and treble of both channels; three stereo inputs; and a separate control for balancing both channels. The AM tuner features a high-gain RF stage and high-Q rod antenna, the FM tuner has a built-in line cord antenna—plus external antenna connectors.

Other quality features include a local-distance switch to prevent overloading in strong signal areas; a squelch control; AFC for drift-free reception; flywheel tuning; tuning meter; and lighted AM and FM slide-rule dials. For added convenience the secondary controls are concealed under the hinged lower front gold aluminum panel to prevent accidental system setting changes. And the preassembled, prealigned FM "front-end" and 3-stage AM-FM I.F. strip aid construction which requires about 35 hours (not recommended for beginners).

Now you know why for advanced design & performance, superb quality, and a truly easy-to-afford price, your best value in stereo receivers is the Heathkit AR-13. Order yours now!

Kit AR-13, 30 lbs. . . . . \$195.00

**SPECIFICATIONS—AMPLIFIER:** Power output per channel (Heath Rating): 20 watt / 8 ohm load. (IHF M Music Power Output): 30 watt / 8 ohm load. **Power response:** ±1 db from 15 cps to 30 kc @ rat'd output. **Harmonic distortion:** (at rat'd output) Less than 1% @ 20 cps, less than 0.3% @ 1

kc. Less than 1% @ 20 kc. **Intermodulation distortion:** (at rat'd output) Less than 1%, 60 & 6,000 cps signal mixed 4:1. **Hum & noise:** Mag. phono, 50 db below rat'd output. Aux. inputs -65 db below rat'd output. **Channel separation:** 40 db. **Input sensitivity:** Mag. phono, 6 MV. **Outputs:** 4, 8, & 16 ohm and low impedance tape recorder outputs. **Controls:** 5-position Selector, 3 position Mod., Dual Tandem Volume; Bass & Treble Controls, Balance Control, Phase Switch, Input Level Controls, Push-Pull ON/OFF Switch. **FM:** **Tuning range:** 88 mc to 108 mc. **IF frequency:** 10.7 mc. **Frequency response:** ±3 db, 20 to 15,000 cps. **Capture ratio:** 10 db. **Antenna:** 300 ohm balanced (internal for local reception). **Quieting sensitivity:** 3½ uv for 30 db of quieting. **Image rejection:** 30 db. **IF rejection:** 70 db. **Harmonic distortion:** Less than 1%. **STEREO MULTIPLEX:** **Channel separation:** (SCA Filter On) 30 db, 50 to 2,000 cps. **19 KC & 38 KC suppression:** 45 db down. **SCA rejection:** 35 db down from rated output. **AM:** **Tuning range:** 535 to 1620 kc. **IF frequency:** 455 kc. **Sensitivity:** 30 uv @ 600 kc, 9 uv @ 1000 kc. **Image rejection:** 40 db. **IF rejection:** 55 db @ 1000 cps. **Harmonic distortion:** Less than 2% with 1000 uv input, 400 cps with 30% modulation. **Hum and noise:** 40 db. **Overall dimensions:** 17" L x 5½" H x 14½" D.

**FREE CATALOG**

Send for your Free copy today! Fully describes over 250 exciting Heathkits at savings of 50% or more! Choose from the world's largest selection of quality instruments in easy-to-assemble kit form!

**HEATHKIT**

**HEATH COMPANY** 40-4-1  
Benton Harbor, Mich. 49023

Enclosed is \$195.00 plus freight. Please send Model AR-13 Stereo Receiver.

Please send Free 1964 Heathkit Catalog.

Name \_\_\_\_\_

Address \_\_\_\_\_

City \_\_\_\_\_ State \_\_\_\_\_ Zip \_\_\_\_\_

HF-157

TO J. P. RAMEAU  
1683 - 1764

Now complete:

Albert Fuller's recording of all the harpsichord works of Rameau.

Vol. 3  
Pieces in A (1706)  
Suite in E

Vol. 2  
Pieces in G  
"Cinq Pièces"  
"La Dauphine"

Vol. 1  
Suite in A  
Pieces in D



"... judging by Nathan Broder's review of Vol. 1 and the high quality of Vol. 2, this would seem to be a marvelous enterprise, realized with imagination and taste..." Eric Salzman in HIGH FIDELITY.

"The fact that Fuller successfully conveyed each mood from coquetry to biting satire is eloquent testimony to his superb technique." THE BOSTON GLOBE on Albert Fuller's recent Boston recital.

Rameau has been dead just 200 years; you'd never guess it from these records.

CAMBRIDGE RECORDS INC.  
471 Washington Street, Wellesley 81, Mass.

CIRCLE NO. 62 ON READER SERVICE CARD

MORE and BETTER

FM Stereo Multiplex  
BROADCASTS  
FOR YOU

with a

FINCO®

AWARD-WINNING FM Antenna



Model FM-4  
\$24.90 List

World's Most Complete  
line of HI-FI Phased  
FM ANTENNAS

Write for Catalog 20-213.

THE FINNEY COMPANY  
34 WEST INTERSTATE BEDFORD, OHIO  
DEPT. H.D.

CIRCLE NO. 19 ON READER SERVICE CARD  
86

first-rate recording job for all concerned.

Rafael Druian's violin soars effortlessly and eloquently in the Vaughan Williams, and I hope that he will be given further disc opportunities as soloist with both large and small Cleveland ensembles.

Finally, I wish only to remind Louis Lane of what he must already know: that there is a wealth of small-orchestra material by contemporary and near-contemporary composers—American, English, Scandinavian, French, and Central European—all viable and most of it unrecorded. In other words, Mr. Lane, let's have more. D. H.

© IGOR KIPNIS: *Harpsichord Recital*. Dussek: *The Sufferings of the Queen of France, Op. 23*. Handel: *Suite No. 5, in E Major* ("The Harmonious Blacksmith"). Soler: *Fandango*. Bach: *Toccata, in E Minor (S. 914)*; *Prelude, Fugue, and Allegro, in E-flat (S. 908)*; *Fantasia, in G Minor (S. 917)*; *Prelude, in E Major, from The Well-tempered Clavier, Book I, No. 9 (S. 854)*; *French Suite No. 6, in E Major (S. 817)*. Igor Kipnis (harpsichord). GOLDEN CREST 4071 two 12-inch discs \$11.96.

Interest: New artist, unusual program  
Performance: Generally imaginative  
Recording: Reasonably good

Thirty-three-year-old Igor Kipnis, son of the great Russian basso and a regular reviewer for this magazine, is the latest of several young harpsichordists—among them Rafael Puyana and Albert Fuller—to make disc debuts over the past half-dozen years and to demonstrate most conclusively that the harpsichord is likely to be around for a good many generations to come. All three of these artists—on their records at least—display a flair for imaginative programming: Fuller gave us a marvelous set of Kuhnau *Biblical Sonatas* on the Washington label some years ago, complete with English narration; Puyana, for Mercury, has offered remarkable and virtually unknown works of Besard, Philip, Frescobaldi, and Picchi; and now Igor Kipnis gives us—as companion pieces to a substantial helping of Bach and Handel—a fascinating bit of musical journalism from the pen of Jan Ladislav Dussek (based on the execution of Marie Antoinette) as well as the first harpsichord recording of the brilliant and lengthy *Fandango* attributed to the eighteenth-century Spanish priest-musician, Padre Antonio Soler.

If memory serves, Kipnis' program duplicates that of his New York debut as solo recitalist at Carnegie Recital Hall last season. The press reaction on that occasion was interested and favorable, and I can understand why after several hearings of these discs. Although I do not think Kipnis achieves the exciting rhythmic

dynamism and exactitude of Fuller and Puyana in the faster dance movements here, he does display a remarkable flair for imaginative treatment of declamatory and recitative episodes, as in the Prelude to the Handel suite and the opening of the Bach toccata. Fascinating, too, is Kipnis' use of registration—he uses lute effects to beautiful advantage in the Dussek work and in the Bach Prelude, Fugue, and Allegro. His playing throughout the four sides represents something of a reaction against the abuse—for spectacular effect—of the sixteen-foot stop and coupled manuals. In keeping with the general practice among today's younger Baroque recitalists, he improvises ornamentation in the repeated passages of the dance movements, but these are not obtrusive. The best single performance in

NEW YORK PUBLIC LIBRARY



J. L. DUSSEK (1760-1812)

*A musical adieu to Marie Antoinette*

this album is his exhilarating treatment of the battered variations from the Handel Suite known familiarly as "The Harmonious Blacksmith." The brilliance he brings to its concluding pages indicates the kind of performer Kipnis will grow to be, given the experience and artistic opportunity.

The Golden Crest recorded sound is clean and true. D. H.

© SIX CENTURIES OF THE VIOLA. Anonymous: *Gagliarda veneziano; Lamento di Tristano; Salterello*. Schumann: *Märchenbilder, Op. 113*. Lazarof: *Inventions for Viola and Piano*. Britten: *Lachrymac, Op. 48*. Milton Thomas (viola); Georgia Akst (piano). COUNTERPOINT/ESOTERIC 5605 \$5.95, 605\* \$1.98.

Interest: Mixed bag  
Performance: Best in moderns  
Recording: Unkind to viola  
Stereo Quality: Wide separation

(Continued on page 88)

# Here's Your Only Middleman With...

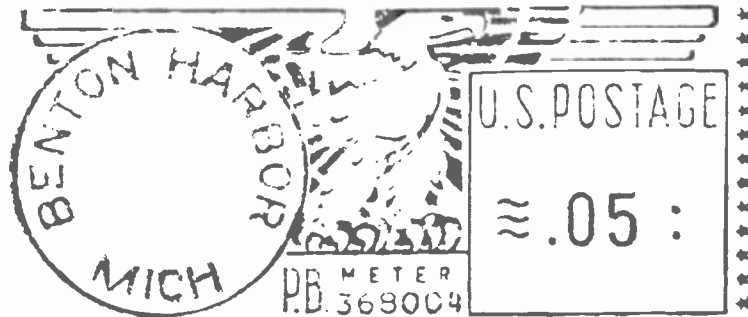

## Heathkit Deluxe All-Transistor Stereo

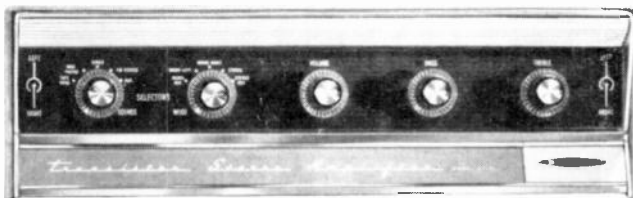

**All-Transistor Stereo Amplifier \$139.95**

**Direct Factory-To-You Savings!** Just a few postage stamps is all it takes to deliver your Heathkit from factory to you. No dealers . . . no distributors . . . no expensive "middleman" costs! Just quick, direct-to-your-door convenience. With Heathkit you invest your money in the product, *not* its distribution. This means better quality and performance at lower cost!

**Other Advantages!** Close, personal contact with the people who designed your kit . . . people who are interested in its performance as a finished product. Free consultation and personal assistance are available to answer your questions about selection, construction, and use. Original replacement parts and factory repair!

Add to these the significant savings of "do-it-yourself," and you'll see why Heathkit is your best buy!

**Advanced "Transistor Sound"!** With Heathkit's Deluxe All-Transistor "Stereo Twins," you enjoy the quick, unmodified response of "transistor sound." No fading, no faltering . . . just the pure, uncompromising sound that only transistors can produce! In addition you enjoy cooler, faster, "hum-free" operation . . . longer life . . . and lower power consumption!

**Advanced Performance Features!** Both units feature extras like the unique "push-push" on/off switch; concealed secondary controls to prevent accidental system

changes; and handsome matched tan vinyl-clad steel cabinet with polished aluminum trim and soft refracted lighting . . . complements any decor! Just a few of the reasons why you should move up to this all-transistor duo now!

**AM, FM Stereo Tuner...AJ-43!** Enjoy extra convenience features like automatic switching to stereo; automatic stereo indicator light; filtered stereo tape recorder outputs for direct "beat-free" recording; Stereo Phase Control for maximum separation, minimum distortion; Automatic Gain Control for constant volume; 25-transistor, 9-diode circuitry for "transistor sound" performance; individual AM & FM tuning meters; effortless flywheel tuning; transformer operated power supply; and preassembled FM tuning unit & 4-stage FM I.F. circuit board for *fast* assembly.

**70-Watt Stereo Amplifier...AA-21!** Features full 70 watts of continuous power, 100 watts music power at  $\pm 1$  db from 13 to 25,000 cps! In addition you enjoy 26-transistor, 10-diode circuitry for cool, "hum-free" operation, smooth power delivery, and fast effortless "transient response," complete freedom from microphonics; front-panel mounted 5-position dual concentric source switch, 5-position mode switch, and dual concentric volume, bass, and treble controls; circuit breaker protection of output transistors and AC power; and encapsulated preamplifier cir-

cuits in 6 epoxy-covered modules, all factory wired and sealed, ready for *easy* installation!

**Experience The "Transistor Sound" Of Tomorrow** by ordering these advanced all-transistor units *today!*

Kit AA-21, Amplifier, 29 lbs. . . . . \$139.95  
Kit AJ-43, Tuner, 18 lbs. . . . . \$119.95

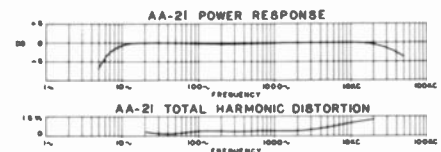

Prices & specifications subject to change without notice.

**FREE 1964 HEATHKIT CATALOG**  
See these and over 250 other exciting Heathkits available in easy-to-build kit form. Save 50% or more by doing the easy assembly yourself! Send for your free catalog today!

**HEATHKIT**  
*By Daystrom*

**HEATH COMPANY** 40-4-2  
Benton Harbor, Michigan 49023  
In Canada: Daystrom, Ltd., Cooksville, Ont.

Enclosed is \$\_\_\_\_\_ plus postage. Please send model(s)\_\_\_\_\_.

Please send my Free 1964 Heathkit Catalog.

NAME \_\_\_\_\_  
ADDRESS \_\_\_\_\_  
CITY \_\_\_\_\_ STATE \_\_\_\_\_ ZIP \_\_\_\_\_  
HF-164



## BIRGIT NILSSON ANOTHER RECORDING TRIUMPH...

following her award  
winning recordings of  
*Tristan und Isolde, Salome  
and Siegfried*

## BIRGIT NILSSON SINGS GERMAN OPERA

Wagner: *Tannhäuser—Dich, teure  
Halle; Die Walküre—Der Männer  
Sippe; Du bist der Ienz. Lohengrin—  
Elsa's Dream. Weber: Oberon—  
Ocean, du Ungeheuer; Der Frei-  
schütz—Leise, leise. Beethoven: Fi-  
delio—Abscheulicher. The Orchestra  
of the Royal Opera House, Covent  
Garden—Edward Downes*  
Stereo OS-25807 Mono 5807



The selections on this disc are mostly worthy, though the fourteenth- and sixteenth-century pieces, arranged here for unaccompanied viola, are much better served stylistically by someone such as Noah Greenberg. The Schumann, typically and romantically effervescent, is seldom played. The Britten, so far as I know, is a first recording—subtitled *Reflections on a Song of Dowland*, it was composed in 1950 and consists of ten variations facetiously written in Britten's customary style. The *Inventions for Viola and Piano*, according to the program notes, was written for the present performers in 1962, but there is no word about Henri Lazarof, its composer. The piece utilizes serial techniques compactly and effectively, providing a not uninteresting display for the two instruments. Thomas interprets with a great deal of enthusiastic vigor—perhaps, as in the lyrical Schumann, a little excessively—and with what sounds like solid technical equipment. Unfortunately, it is impossible to judge accurately the quality of the violist's tone, for the close-up, irritatingly harsh recording makes the sound of the string instrument virtually unlistenable. The viola and piano are too widely separated in the stereo. *I. K.*

### RECORDING OF SPECIAL MERIT

#### ⑤ ⑩ TEN CHRISTMAS CAROLS.

Works by Crappius, Schein, Freundt, M. Praetorius, Scheidt, and others. Margot Guillaume (soprano); Helmut Krebs (tenor); Boys Choir of the Secondary School, Eppendorf; Town Choir of Hamburg; Instrumental Ensemble of the Archive Production, Adolf Detel cond. DEUTSCHE GRAMMOPHON ARCHIVE ARC 73216 \$6.98, ARC 3216\* \$5.98.

Interest: Renaissance carol settings  
Performance: Spectacular  
Recording: Splendid  
Stereo Quality: First-rate

This collection of ten Protestant carols, all in arrangements from the time of Michael Praetorius (1571-1621), adds up to a most stimulating listening experience. The variety of scoring is incredibly diverse: *Gelobet seist du, Jesu Christ*, for example, is performed in seven verses, each by a different composer and each featuring a different instrumentation. If you are tired of *Silent Night* or the like in twentieth-century arrangements, try *In Dulci Jubilo* with an early seventeenth-century combo: three choirs, a battery of clarinos, recorders, trombones, crumhorns, plus viol, lute, dolcian, bass-bombarde, regal (organ), cello, violone, and harpsichord for continuo instruments. Spectacular is the word for it, and the recording, with spatial effects ideally gauged for stereo, is a perfect match. Texts and translations are included. *I. K.*

## If The Uher 8000 By Martel Did Not Feature:



**AKUSTOMAT:** You simply speak and the machine records... you stop speaking — machine stops. Audio Magazine reported... we know of no other machine which has this feature.

**FULLY TRANSISTORIZED:** Professional • 4 Speeds • 3 Heads • 2 VU Meters

**DIA-PILOT:** Built-in impulse transmitter for fully automatic control of slide projectors and animated displays.

### ECHO EFFECTS

**AUTOMATIC:** End of reel shut-off disengages pressure roller.

**MULTI-PLAY:** Allows transfer of recording to a parallel track while simultaneously superimposing a new recording to the original track by the turn of a knob.

**CONSOLE SOUND:** Featuring two built in speakers for perfect separation.

**4 TRACK STEREO — 4 TRACK MONO:** With built in mixer control for both channels.

**Audio Magazine Report:** "... Practically any use that can be imagined is possible with the Uher 8000."

## Then It Would Be Just Like Any Other Tape Recorder.

By the way... it took Audio Magazine 1457 words to describe all the features on the Uher 8000 — for complete review write

**MARTEL ELECTRONICS**  
 Hollywood 645 N. Martel Avenue Phone (213) 938-2803  
 New York City 1199 Broadway Phone (212) 684-0943  
 Chicago 1141 Merchandise Mart Plaza Phone (312) 644-0430



# New 1964 Heathkit® All-Channel\* Color TV



GR-53A  
**\$399<sup>00</sup>**

(Includes chassis, all tubes, VHF & UHF tuners, mask, mounting kit, & special speaker)  
 Optional cabinet \$49.00

## Everything you need for the best in color TV viewing— Build it in 25 hours—Save hundreds of dollars!

**\*FCC Requires UHF As Of April 30!** A new Federal law requires that all TV sets built or imported after April 30, 1964 be equipped to receive *all* VHF & UHF channels, 2 thru 83.

**Heathkit Has Everything For All-Channel Reception In One Complete Unit!** As a result, Heathkit now offers you a *new* model consisting of chassis, tubes, face mask . . . a *new* wall mount . . . a *new* all-transistor UHF tuner . . . and a special 6" x 9" speaker . . . everything you need for complete high fidelity *all-channel color* and *black & white* TV reception . . . for only \$399!

**Cabinet Or Custom Installation!** After assembly, simply slip the *complete* unit into the handsome walnut-finished hardboard cabinet! Or if you prefer, mount it in a wall or custom cabinet.

**Anyone Can Build It!** No special skills or knowledge required! Here's what one Heathkit Color TV owner, Mr. Thomas R. McMahan of Cincinnati, Ohio says about the manual: "I would consider the manual to be equal to a lifetime of warranties with an ordinary television." All critical assemblies are factory-built & tested! Simple step-by-step instructions take you from parts to picture in just 25 hours!

**Exclusive Built-In Service Center Eliminates Maintenance Costs!** You align, adjust and *maintain* the set yourself with the degaussing coil, service switch, and built-in dot generator! No more costly TV service calls! No other set has these self-servicing features!

**No Expensive Service Contract!** Since *you* service and maintain the set, there's no need for a costly service contract. Heath warrants picture tube for 1 year, all other parts for 90 days!

**Keep Your Present TV As A "Second" Set!** Many manufacturers require your present set as a trade-in to qualify for their advertised price. With Heathkit, *no* trade-in is required! Your present set becomes a handy "second" set for use in den, children's room, bedroom, etc.

**Quality & Performance Comparable To Sets Costing \$600 & More!** In addition to the features already mentioned, compare these to other, more expensive models: • 26-tube, 8-diode circuit • Deluxe Standard-Kollsman nuvistor tuner with "push-to-tune" fine tuning for individual channels • High definition RCA 70° 21" color tube with anti-glare bonded safety glass • 24,000 volt regulated picture power • Automatic color control and gated AGC for peak performance • 3-stage high gain video I.F. • Line thermistor for longer tube life & thermal circuit breaker for component protection.

**Enjoy Complete TV Reception Now!** Start enjoying *complete* TV viewing by ordering the *new* 1964 Heathkit 21" High Fidelity Color TV now!

GR-53A, chassis, tubes, mask, VHF & UHF tuners, mounting kit, speaker,  
 132 lbs. . . . . \$399.00  
 GRA-53A-1 walnut finished cabinet,  
 70 lbs. . . . . \$49.00

**Limited Supply Of "VHF Only" Models Left!** Our previous "VHF only" model and its accessories are still available on a *limited quantity basis*. If you want a color set *without* UHF, hurry and order from the price list below, now!

Kit GR-53, chassis & tubes, 118 lbs. \$349.00  
 GRA-53-1, walnut-finished cabinet,  
 70 lbs. . . . . \$49.00  
 GRA-53-3, custom mounting kit (order for wall or custom cabinet installation)  
 10 lbs. . . . . \$4.00

**FREE 1964 HEATHKIT CATALOG**  
 See these and over 250 other exciting Heathkits available in easy-to-build kit form. Save 50% or more by doing the easy assembly yourself! Send for your free catalog today!

**HEATHKIT** 40-4-3  
**HEATH COMPANY,**  
 Benton Harbor, Michigan 49023

Enclosed is \$\_\_\_\_\_, plus freight.  
 Please send model(s) \_\_\_\_\_.

Please send my Free 1964 Heathkit Catalog.

Name \_\_\_\_\_  
 Address \_\_\_\_\_  
 City \_\_\_\_\_ State \_\_\_\_\_ Zip \_\_\_\_\_

CL-174

# YOU COULD SPEND \$100 MORE AND NOT GET BETTER PERFORMANCE

(or better features, or better quality.)

INTRODUCING the new Rek-O-Kut R-34 playback system—a complete 2-speed turntable, tonearm, and base unit. WITH A 5 YEAR WARRANTY ...unheard of in the audio industry! When we say our turntables are built to take it—we mean it.

**INSTANT SPEED SELECTOR.**  
A mere flick of your finger changes its speed from 33 $\frac{1}{3}$  to 45 rpm. An exclusive Rek-O-Kut feature.

**HYSTERESIS SYNCHRONOUS MOTOR.** Pabst is its name. Pioneered by Rek-O-Kut. For constant speed no matter what the variation in line voltage. It's the first time *this* motor (used in our higher-priced units) has been used in a system at *this* price.

**ISOLATION SUSPENSION:** Totally eliminates acoustic feedback. Makes vertical rumble a negative factor. No need for complicated spring devices to shock-mount your playback system. Ever.

**S-340 TONEARM.** A modified version of the S-320 professional tonearm. Tracks at less than one gram! Resonance factor is *below* 12 cycles. Ruggedly constructed, its removable cartridge shell handles *any* standard cartridge. Available separately at \$24.95.



**SOLID OILED-WALNUT BASE.** Fine furniture crafted.

**SPECIFICATIONS.** Noise and rumble: —60 db below average recorded level (@ 7 cm/sec. @ 1000 cps). Flutter & wow: .08% RMS. Dimensions: 15" x 14 $\frac{5}{8}$ " x 5 $\frac{1}{2}$ " (overall height, including tonearm).

**ONE-PIECE CAST ALUMINUM TABLE.** Full-size, 12 inch, professional quality. Dynamically balanced. Its weighted rim provides all the necessary flywheel motion for perfect rotation at constant speed.

**EXCLUSIVE REKOTHANE BELT.** Polyurethane. Individually ground to precision tolerances, this belt reduces noise and rumble *minus 6 db lower than any other belt.* And unless you actually cut or tear a Rekothane belt it should work for the life of the unit.

**SIGNIFICANT PRICE. ONLY \$89.95!**

A most modest price for such quality. See your dealer for a comparison demonstration. Only then will you know why you could spend \$100 more and not get better performance (or better features, or better quality).

REK-O-KUT, the world's largest manufacturer of turntables. 38-19 108 Street, Corona 68, New York

Export: Morhan Exporting Corp., 458 B'way, N.Y.C. Canada: Atlas Radio, 50 Wingold Ave., Toronto 19

HIFI/STEREO REVIEW'S  
CHOICE  
OF THE LATEST  
RECORDINGS



# JAZZ

Reviewed by JOE GOLDBERG • NAT HENTOFF

Ⓢ Ⓜ **KENNY CLARKE/FRANCY BOLAND:** *Clarke-Boland Big Band.* Benny Bailey, Roger Guerin, Jimmy Deuchar, Ahmed Muvaffak Falay, Idrees Suleiman, and Edmund Arnie (trumpets); Ake Persson, Nat Peck, Eric Kleinschuster, Raymond Katarsynski, and Frederic "Keg" Johnson (trombones); Derek Humble (alto saxophone); Karl Drevo, Billy Mitchell, and Ronnie Scott (tenor saxophones); Sahib Shihab (baritone saxophone, flute); Francy Boland (piano); Jimmy Woode (bass); Kenny Clarke (drums); Joe Harris (timpani); Sadi (bongos). *Long Note Blues; Sonor; Speedy Reeds; Old Stuff;* and two others. ATLANTIC SD 1404 \$5.98, 1401\* \$4.98.

Interest: International jazz  
Performance: Bristling and big  
Recording: Vibrant  
Stereo Quality: Well-balanced

A sequel to the previous Clarke-Boland big-band session, "Jazz Is Universal" (Atlantic SD 1401/1401), this set provides even more emphatic proof that European jazz is coming into its own. The multinational band includes American expatriates and visitors, together with players from England, France, Sweden, Belgium, Austria, Turkey, and elsewhere. The musicians achieve a remarkable unity despite the fact that they do not regularly work as a group. The ensemble playing is crisp and well blended, and there is a consistent enthusiasm that some American bands might very well emulate.

Boland's arrangements are not original in conception, but he understands the modern-jazz language completely, and his scores spur rather than stifle the improvisers. Among the most expressive soloists are trumpeter Benny Bailey, an American living in Sweden, tenor saxophonists Karl Drevo of Austria and Billy Mitchell of America, and alto saxophon-

ist Derek Humble of England. The key musician, however, is drummer Kenny Clarke, a long-time American-in-Paris expatriate, who sparks the band throughout the session. N. H.

## RECORDING OF SPECIAL MERIT

Ⓢ Ⓜ **BENNY GOODMAN:** *Together Again!* Benny Goodman (clarinet), Lionel Hampton (vibraphone), Teddy Wilson (piano), Gene Krupa (drums). *Who Cares; Dearest; I'll Get By; Four Once More;* and six others. RCA VICTOR LSP 2698 \$4.98, LPM 2698\* \$3.98.

Interest: Masters regrouped  
Performance: Cool perfection  
Recording: Excellent  
Stereo Quality: Good

Twenty-five years ago, one of the brightest fixtures of jazz life was the Benny Goodman Quartet. It consisted of clarinetist Goodman, his regular drummer Gene Krupa, and two others who worked with the quartet but not the big band—pianist Teddy Wilson and vibraphonist Lionel Hampton. They played with cool, light, careful precision, but their performances were often marred by the insensitive drumming of Krupa, a misfortune accentuated by the unusual absence from the ensemble of a bass. The identifying characteristics of the group were the liquid, exercise-like improvisations of Goodman, the almost architectural structure of Hampton's solos, and the brilliant, reserved style that made Teddy Wilson the model for nearly every cocktail pianist in the country.

The famous four, now old masters, have recently met again, and producer George Avakian recorded this meeting. Everything that could be said about them twenty-five years ago can be repeated. Goodman and Wilson still play indelibly. Hampton has been thrown only partially into the shadow by Milt Jackson, and Krupa still seems not to understand what chamber jazz is. For the listener, nostalgia is inevitable, but in addition it is still a delight to hear such impeccable, complex but yet uncomplicated-sounding music, un-angry and truly pleasant. None of the players has altered his style to any

noticeable degree, but no one except Krupa needed to—they were right the first time. J. G.

## RECORDING OF SPECIAL MERIT

Ⓢ Ⓜ **LIGHTNIN' HOPKINS / JOE TURNER / TRIXIE SMITH / OTHERS:** *Out Came the Blues.* Lightnin' Hopkins, Georgia White, Cousin Joe, Kokomo Arnold, Red Nelson, Memphis Mimie, Oscar Woods, Joe Turner, Trisie Smith, Johnnie Temple, Scrapper Blackwell, Peetie Wheatstraw, Sleepy John Estes, Rosetta Crawford (vocals); instrumental accompaniment. *Bad Things on My Mind; Wild Water Blues; Freight Train Blues; Crazy with the Blues;* and ten others. DECCA DL 4434 \$4.98.

Interest: A feast for collectors  
Performance: Diverse  
Recording: Competent

Decca, which has reissued few jazz and blues albums from its valuable archives in recent years, deserves huzzas for this anthology of rare blues performances recorded between 1931 and 1953. Jazz critic Stanley Dance and Belgian blues expert Yannick Bruynoghe have chosen a generous and representative selection from the period, and their notes place each singer properly in the total perspec-

RCA VICTOR RECORDS



THE BENNY GOODMAN QUARTET: impeccable, as ever

### Explanation of symbols:

- Ⓢ = stereophonic recording
- Ⓜ = monophonic recording
- \* = mono or stereo version not received for review

tive of blues development. Many of the formidable blues storytellers of the 1930's and 1940's are included—notably Peetie Wheatstraw (*The Devil's Son-in-Law*), Sleepy John Estes, Kokomo Arnold, Memphis Minnie, Lightnin' Hopkins, and Big Joe Turner. Most of the songs are what Jimmy Rushing has described as "men and women" blues, but each performer adds a tartly personal note to this endlessly absorbing theme. *N. H.*

#### RECORDING OF SPECIAL MERIT

Ⓢ Ⓜ **ETTA JONES:** *Love Shout*. Etta Jones (vocals); Kenny Burrell and John Pizzarelli (guitars); Kenny Cox and Sam Bruno (piano); Jerome Richardson (tenor saxophone, flute); George Tucker, Peck Morrison, and Ernest Hayes (bass); Jimmy Smith, Oliver Jackson, and Bobby Donaldson (drums). *Love Walked In; It's Magic; If I Loved You; Old Folks;* and six others. PRESTIGE 7272 \$1.98.

Interest: Superior jazz singer  
Performance: Excellent  
Recording: Live and clear

Although she has been recording intermittently for twenty years, Etta Jones has yet to acquire a large following. Even among jazz collectors, Miss Jones is underestimated. Yet, as this most recent of her Prestige albums confirms, she is one of the most compellingly personal singers in jazz today. Her voice is warm but her approach is thoroughly unsentimental. The personality she projects is intelligent, wry, and tough, but not calloused. In this respect, and in occasional turns of phrase and pitch, Miss Jones is reminiscent of Billie Holiday, but her style is essentially her own.

Even in the songs here that are not the best jazz material (*Hi Lili Hi Lo, If I Loved You, Some Enchanted Evening*), Miss Jones brings new connotations to the overfamiliar lyrics. Her phrasing is subtle and always musically logical, and her beat is not only unerring but remarkably flexible. Considering the scarcity of first-rate jazz singers, the near-neglect of Miss Jones is all the more inexplicable. *N. H.*

Ⓢ Ⓜ **LAMBERT, HENDRICKS AND BAVAN:** *At Newport '63*. Dave Lambert, Jon Hendricks, and Yolande Bavan (vocals); Coleman Hawkins (tenor saxophone); Clark Terry (trumpet, fluegelhorn); Gildo Mahones (piano); George Tucker (bass); Jimmie Smith (drums). *Watermelon Man; Sack O' Woe; Walkin';* and five others. RCA VICTOR LSP 2747 \$4.98, LPM 2747\* \$3.98.

Interest: Same old stuff  
Performance: Same old stuff  
Recording: Good  
Stereo Quality: Good

DON SCHULTZ



ETTA JONES  
*Intelligent, wry, and tough*

By now, I imagine everyone knows what Lambert, Hendricks and Bavan do—that is, sing lyrics Jon Hendricks writes for jazz instrumentals. This is at bottom a trick, and whatever charm it had wore thin even before Miss Bavan replaced the talented Annie Ross in the group. Sometimes the tempo of a piece is slow enough that one can make out the lyrics. This is unfortunate, for Hendricks is seldom more inventive or incisive than Edgar Guest. But then what can you expect from trying to work poems around tune titles that were often tacked on arbitrarily—as, for example, *Yeh-Yeh!* For this album, recorded at Newport, they come up with versions of instrumentals that have gotten on the popularity charts (Hendricks finds time to consult

CONTEMPORARY RECORDS



ANDRÉ PREVIN  
*Dexterous, but elusive*

both *Roget* and *Billboard*), and the results are slimmer than ever in interest. Both Clark Terry and Coleman Hawkins play splendidly in support, and the album's cover painting is wonderful. *J. G.*

#### RECORDING OF SPECIAL MERIT

Ⓢ Ⓜ **GERRY MULLIGAN:** *The Essential Gerry Mulligan*. Gerry Mulligan (baritone saxophone), Bob Brookmeyer (valve trombone), Clark Terry (trumpet), Stan Getz (tenor saxophone), Paul Desmond (alto saxophone), others. *Israel; Blueport; Line for Lyons; Utter Chaos; Manoir de Mes Rêves;* and three others. VERVE V68567 \$5.98, V8567\* \$4.98.

Interest: Fine introduction to Mulligan  
Performance: Uniformly expert  
Recording: Good  
Stereo Quality: Good

This release comes remarkably close to outlining on a single record the great diversity of Gerry Mulligan's work in jazz. The record's scope is even more remarkable when one considers that all his early work—the Miles Davis Nonet, the quartet with Chet Baker, the Tentette, and so forth—is not available to Verve. Nonetheless, astute choices have created a disc that is an excellent cross-section.

*I Believe in You* is a quartet track with Bob Brookmeyer, probably the most sympathetic of Mulligan's regular fellow hornmen. The tracks with Stan Getz and Paul Desmond, both reworkings of Mulligan pieces recorded earlier, admirably indicate the baritonist's skill in playing single-time assignments with a wide variety of musicians. Then there are the pieces from the Concert Jazz Band repertoire—*Funny Valentine* has one of Mulligan's finest solos, and is further a reprise of what was, in its first form, his biggest hit. And finally, there is former Mulligan quartet member Art Farmer's *Blueport*, impressive at first hearing for the witty, quotation-filled romp between Mulligan and Clark Terry, but even more important for its brilliant display of Mulligan's technique of deploying parts of a big band so that it never sounds unwieldy.

I should think that Mulligan would be pleased to be represented by this collection, and if anyone around is still unfamiliar with Mulligan's work, here is the place to begin. There is slightly more depth in the stereo pressing. *J. G.*

Ⓢ Ⓜ **ANDRÉ PREVIN:** *The Essential André Previn*. André Previn (piano), Red Mitchell (bass), Shelly Manne (drums); David Rose and his Orchestra; others. *Should I; Black and Blue; Guido's Blackhawk; Little Girl Blue;* and eight others. VERVE V68565 \$5.98, V8565 \$4.98.

Interest: Previn heard—but not well  
 Performance: Varies  
 Recording: Good  
 Stereo Quality: Good

"The Essential André Previn" might be thought by some to be the most paradoxical album title of the season. Others may even believe that the title holds a promise that we will finally find out just what Previn's musical personality is. But on this album he is still elusive, doing eight things at once dexterously, always sounding vaguely like someone else.

The set includes several tracks previously released by MGM on which Previn is backed by David Rose and a large string orchestra. These include the famous *Like Young*, and a *Young Man's Lament* that is heavily indebted to Alex North's film music. There are also some trio tracks with Red Mitchell and Shelly Manne, and others featuring a combo in which trumpeter Blue Mitchell plays the disc's most interesting music.

Many have remarked on Previn's appropriation of Horace Silver's style—on some of these bands he sounds like Silver attempting an amiable parody of Dave Brubeck. Previn has made far better recordings than this one. The sound on the monophonic pressing is clearer than on the stereo. *J. G.*

© ® JIMMY WOODS: *Conflict*. Jimmy Woods (alto saxophone), Carmell Jones (trumpet), Harold Land (tenor saxophone), Andrew Hille (piano), George Tucker (bass), Elvin Jones (drums). *Conflict; Aim; Coming Home; Apart Together; Pazmuerte; Look to Your Heart*. CONTEMPORARY S 7612 \$5.98, M 3612\* \$4.98.

Interest: Rising composer-altoist  
 Performance: Coltrane-ish  
 Recording: Very good  
 Stereo Quality: Very good

Altoist Jimmy Woods' first album for Contemporary, called "Awakening!," established him as a fresh, promising voice. Now here is his second disc, made with musicians of wider reputation than those of the first. Although it is far above the usual run of today's jazz music, Woods' work has begun to fall into standard categories.

There is, over-all, a strong Coltrane influence—only partially because of the presence of Elvin Jones and George Tucker. Harold Land, too, sounds more and more like Coltrane. The routine treatment of the title track, *Conflict* (Wood is credited with all the compositions), is remarkably reminiscent of a piece called *Light Blue*, recorded by Coltrane in the middle Fifties, with pianist Andrew Hille here playing what was given to the guitar earlier.

(Continued on page 94)

APRIL 1964

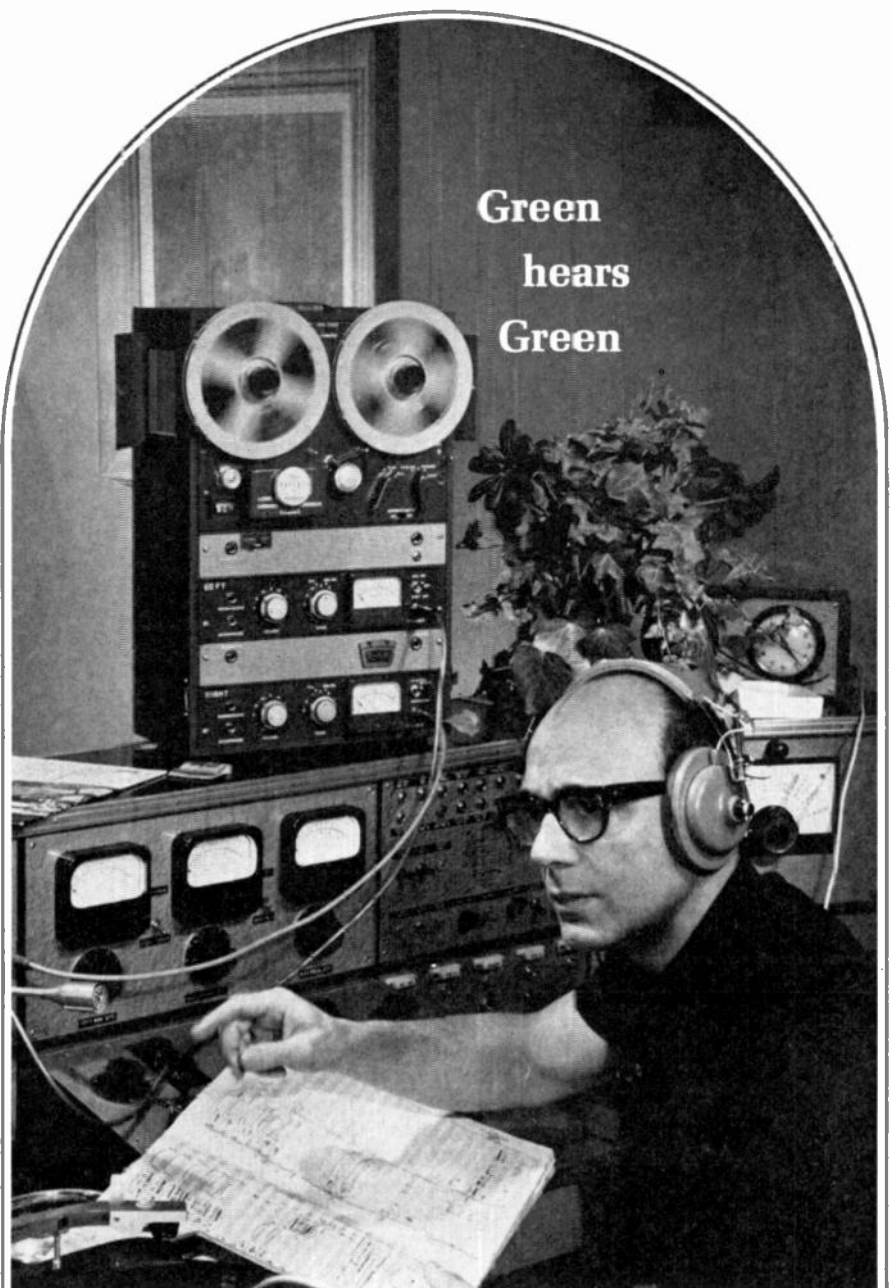

Green  
 hears  
 Green

complete stereo  
 sound system  
 NEW  
 ROBERTS 720

John (Johnny) Green—composer, conductor, lecturer—a musical master who never settles for less than perfect performance. It's

only natural for Mr. Green to work with the 720, Roberts' newest professional recorder. A costly 2-speed, electrically switched hysteresis synchronous motor minimizes wow and flutter. The non-nonsense simplicity of Roberts' famous transport mechanism gives Mr. Green

instant control of all record and playback functions. The 720 "duet" feature permits invaluable sound-with-sound recording. An

exclusive "set and forget" switch automatically turns off all electronics at end of tape. Four-track stereo and monaural. Reproduces 40 to 15,000 cps at 7 1/2 ips. Three speeds: 7 1/2, 3 3/4, 1 7/8 ips. (15 ips optional). A professional quality instrument priced at only \$399.95.

ROBERTS® 

Send for FREE BOOKLET! "40 and more ways to use a Roberts Tape Recorder" and complete details on 720.

Roberts Electronics, 5922 Bowcroft  
 Los Angeles, Calif., 90015, Dept. HFS-4

Name \_\_\_\_\_  
 Address \_\_\_\_\_  
 City \_\_\_\_\_ State \_\_\_\_\_

IN CANADA: J. M. Nelson Electronics, Ltd., 2149 Commercial Dr., Vancouver 12, B.C. (Prices slightly higher)

CIRCLE NO. 45 ON READER SERVICE CARD

**Who has  
Sutherland,  
Baez,  
The Duke,  
Ansermet,  
Mantovani,  
and a thousand  
other  
stereo tape  
selections?**

The pick of 16 major recording companies—featuring Peter, Paul & Mary, Stan Getz, Stokowski, Montoux, Sutherland, the D'Oyly Carte—in short just about everybody who is anybody in the popular, jazz, folk, classical, opera and oratorio fields.

**Your Ampex  
Master Tape Center**

**ARIZONA**  
PHOENIX  
Bruces World of Sound  
2711 E. Indian School Rd  
**CALIFORNIA**  
AZUSA  
Rancho Sound Co  
18532 E. Alosta Ave  
BEVERLY HILLS  
Discount Record Center, Inc  
9484 Wilshire Blvd  
CARDENA  
Stereo Hi Fi Center  
13996 S. Crenshaw Blvd  
HOLLYWOOD  
Wallacha Music City  
Sunset and Vine  
LOS ANGELES  
California Music Co  
2933 W. Pico Blvd  
Crenshaw Hi. Fi  
107 Santa Barbara Plaza  
MENLO PARK  
McDaniels Hi. Fi, 935 El Camino Real  
OAKLAND  
Starway to Music, 4150 Broadway  
REDONDO BEACH  
Griffey Electric, 235 N. Pacific Coast  
SAN DIEGO  
Wrights House of Hi. Fi  
5140 El Cajon  
SAN FRANCISCO  
Lakeshore Hi. Fi, 222 W. Portal  
Walter Willey, 691 Market St  
WHITTIER  
Oxbow Electronics  
15419 E. Whittier Blvd  
**COLORADO**  
DENVER  
Empire Radio & TV, 1100 Broadway  
**CONNECTICUT**  
HARTFORD  
The Stereo Shop, 227 Asylum St  
**DISTRICT OF COLUMBIA**  
WASHINGTON  
Commissioned Electronics  
1776 Columbia Rd., N.W.  
Electronic Wholesalers, Inc  
2345 Sherman Ave., N.W.

For a catalog of the complete selection of tapes, write Ampex Corporation, Consumer Products Division, 2201-B Landmeier Road, Elk Grove Village, Illinois. In Canada, Ampex of Canada Ltd., Rexdale, Ontario.



CIRCLE NO. 60 ON READER SERVICE CARD  
94

It may be of some significance that the most successful and original track, the charming waltz called *Look to Your Heart*, is also the only number on which Woods plays without the other horns. It is as if here he does not have to conform to the styles of his more established peers, but can go his own adventurous and melodic way.

The notes, which are by and about Woods, carry the concept of jazzman as tortured philosopher a little too far.

J. G.

**COLLECTIONS**

© Ⓜ OUTSTANDING JAZZ COMPOSITIONS OF THE TWENTIETH CENTURY. Johnson: *Jazz Suite for Brass*. Lewis: *Three Little Feelings*. Giuffre: *Pharaoh*. Russell: *All about Rosie*. Macero: *Sounds of May*. Prince: *Avakianas Brasileiras*. Charles: *Swinging Goatsherd Blues*. Mingus: *Revelations—First Movement*. Giuffre: *Suspensions*. Shapero: *On Green Mountain*. Ellington: *Idiom '59 (Parts I-III)*. Babbitt: *All Set*. Schuller: *Transformation*. Various players. COLUMBIA C2S 831 two 12-inch discs \$9.98, C2L 31\* \$7.98.

Interest: **A Jazz cross-section**  
Performance: **Generally expert**  
Recording: **Good**  
Stereo Quality: **At times questionable**

The title of this album, "Outstanding Jazz Compositions of the Twentieth Century," is not justified. Columbia has compiled this two-volume collection largely from albums no longer in its catalog, and the result is only a very limited indication of the significant achievements in contemporary jazz composition. Omitted, for example, are Thelonious Monk, Ornette Coleman, Cecil Taylor, Gil Evans, and John Benson Brooks. Furthermore, included are two classical composers (Harold Shapero and Milton Babbitt) who have not been involved with jazz since the compositions played here were commissioned for the 1957 Brandeis University Festival of the Arts. Nor, to my knowledge, were Shapero and Babbitt deeply concerned with jazz before then.

The quality of the pieces varies considerably, but is seldom exceptional. J. J. Johnson's *Jazz Suite for Brass* is more interesting for the composer's idiomatic textural coloring than for its form or emotional content. John Lewis' *Three Little Feelings* is characteristically conservative in structure and melodically attractive, but essentially static. In both, Miles Davis' improvisations on flugelhorn and trumpet supply the most vital elements of the performances. Jimmy Giuffre's *Pharaoh* is also intriguing texturally, but its melodic and rhythmic ideas are unremarkable.

The most successful composition in the

set is George Russell's *All about Rosie*, based on a motif from an Alabama Negro children's game. Particularly impressive are its tautly propulsive first and third sections, and the superbly shaped and emotionally exciting piano solo contributed by Bill Evans in the final movement. The tape manipulation of vocal lines in Teo Macero's *Sounds of May* is provocative, but the juxtaposition of these sounds with the "live" small combo lacks sufficient organic cohesion. Bob Prince's *Avakianas Brasileiras* is a factitious exercise in fusing jazz and quasi-classical forms, and Teddy Charles' *Swinging Goatsherd Blues* is innocuous in both conception and execution.

Charles Mingus' *Revelations—First Movement* is an overdeliberate, somewhat ingenuous, but nonetheless powerful and individualistic composition. Giuffre's *Suspensions*, like his *Pharaoh*, was written during one of the least creative periods in his mercurial development and is more a practice-book sketch than a fully developed work. Harold Shapero's *On Green Mountain (Chaconne after Monteverdi)* is a nimble but overextended set of variations on a musical pun and is given whatever strength it has by the solo improvisations of the jazzmen present.

Ellington's *Idiom '59* (still available in "Festival Session," Columbia CS8200) makes me suspect that it was included to fill out the set. It is one of that composer's flimsiest, least important compositions. Milton Babbitt's tightly designed *All Set* is a fascinating and subtle mosaic, much more closely related to moderately avant-garde classical music than to jazz.

Gunther Schuller's *Transformation* is a provocative but rather self-conscious illustration of the gradual transmutation of nonjazz introductory material into a "third stream" musical experience. (I use Schuller's definition of "third stream": music composed of both jazz and classical elements but with an identity of its own.) *Transformation*, incidentally, antedates the coining of "third stream," and is more valuable as an historical piece than for its musical merits.

In sum, only the Russell work is "outstanding." The other compositions are varyingly instructive about some of the directions that were being taken between 1956 and 1959 in the more ambitious use of jazz by composers both inside and outside the idiom. Considering the jazzmen here alone, however, the collection provides an extremely narrow perspective of developments in jazz composition within the past decade.

Stereo quality is uneven, and there are sections that sound as if they may have been "electronically rechanneled for stereo sound," to use Columbia's phrase. But on the whole, the recording standards are high.

N. H.

*"Only the Music is Present...When the Classics Speak"*

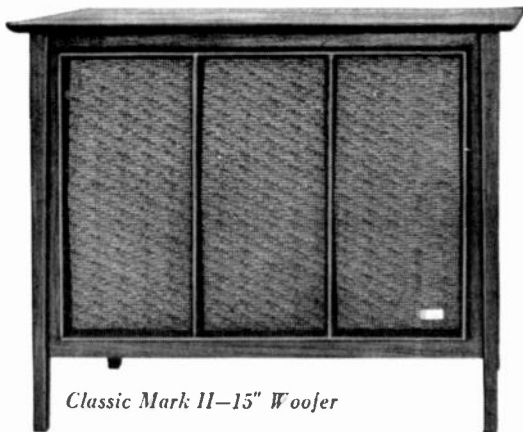

*Classic Mark II-15" Woofer*



*Classic Dual 12-12" Woofer*

*(they look like this when the music stops)*

It's a phenomenon of great speakers. Reproduction is so faithful you're totally absorbed in sound...unaware of its source. You'll find this particularly true when you hear the University Classic Mark II 3-way system. There is absolutely no distortion, no coloration... up to 40,000 cps. According to Julian D. Hirsch, Hirsch-Houck Laboratories, "...The University Classic Mark II justifies substantial claims that the manufacturer has made for it. It is one of a limited group of speakers to which I would give an unqualified top notch rating." Cabinetry in oiled walnut. \$295. Classic Dual 12 3-way system, finished in oiled walnut—\$229.50. Write today for your free "Guide to Component High Fidelity": Desk D-4, LTV University, 9500 West Reno, Oklahoma City, Oklahoma.

**LTV UNIVERSITY** A DIVISION OF LING TEMCO-VOUGHT, INC. 9500 West Reno, Oklahoma City, Oklahoma

CIRCLE NO. 54 ON READER SERVICE CARD

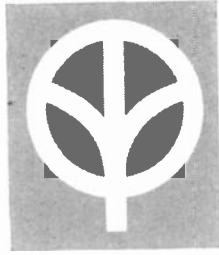

...the sound approach to quality

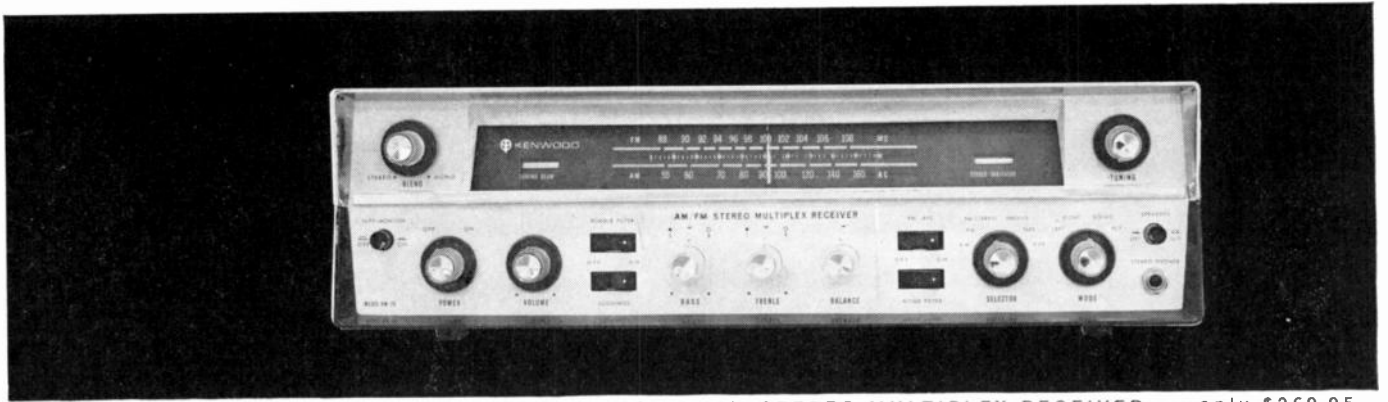

KENWOOD MODEL KW-70 AM/FM STEREO MULTIPLEX RECEIVER ... only \$269.95

# KENWOOD

## AM/FM STEREO MULTIPLEX RECEIVERS

*3 WONDERFUL WAYS TO GO STEREO AND GET THE BEST PERFORMANCE OUT OF YOUR BUDGET, TOO*

Every refinement that can contribute to the experience of your total listening enjoyment has been engineered into our Kenwood Receivers ... systems incorporating three superb sound components on a single functionally designed chassis with all these quality features as "standard equipment": • Kenwood's exclusive Stereo Indicator brings you simplicity and convenience in FM stereo broadcasting • Receives AM, FM and FM/stereo broadcasts, stereo and monaural records, tape in stereo and monaural • Kenwood's tremendous sensitivity brings out the weakest stations • Filters and special circuits eliminate rumble, hum and noise with separate tone controls for each channel.

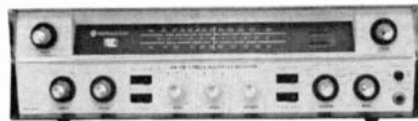

KW-50 AM/FM Stereo Multiplex Receiver ... only \$229.95



KW-30 AM/FM Stereo Multiplex Receiver ... only \$189.95

*See the complete line of Kenwood Receivers, Tuners, Amplifiers and Accessories at your High Fidelity dealer, or write direct for descriptive catalog to:*



KENWOOD ELECTRONICS INC., DEPT. HFR, 3700 S. BROADWAY PL., LOS ANGELES, CALIF. 90007





HIFI/STEREO REVIEW'S CHOICE OF THE LATEST RECORDINGS

# ENTERTAINMENT

POPS • HUMOR • FILMS • THEATER • FOLK • SPOKEN WORD

Reviewed by JOE GOLDBERG • NAT HENTOFF • PAUL KRESH • GENE LEES

Ⓢ Ⓜ TOMMY DORSEY ORCHESTRA: *Recorded Live at the Royal Box of the Americana, New York.* Sam Donahue (tenor saxophone and leader); Helen Forrest, Pied Pipers, and Jeannie Thomas (vocals); Charlie Shavers (trumpet); Larry O'Brien (trombone); orchestra. *A Song of India; Body and Soul; Marie; That Lonesome Road;* and eight others. RCA Victor LSP 2830 \$4.98, LPM 2830\* \$3.98.

Interest: Ghost band  
 Performance: Unimpressive  
 Recording: Good  
 Stereo Quality: Well-balanced

This is the "new" Tommy Dorsey orchestra, directed by Sam Donahue. Many of its arrangements are those of the original Dorsey band, and the effort to summon nostalgia is further underlined by the presence here of the Pied Pipers and Helen Forrest. (Miss Forrest didn't sing with Dorsey, but she is of his era.) Apparently for contractual reasons, the band's most publicized link with the past, Frank Sinatra, Jr., does not participate.

The musical results of this attempt to recapture the Dorsey magic are lusterless, partly because the new sidemen are not up to the caliber of Dorsey's and partly because today's young players cannot fully re-create a style that grew out of such different musical and social circumstances. The most accomplished instrumentalist in the orchestra, Charlie Shavers, is technically formidable as usual, but his conception is brittle. Helen Forrest, once a model of restraint, now overdramatizes, and Sam Donahue, formerly an efficient sideman, has let his playing become pompous. Jeannie Thomas, the second female singer here, is one more in a long line of characterless band vocalists. Tommy Dorsey does "live on," as the notes proclaim, but in his own recordings, not through this band.  
 N. H.

*Explanation of symbols:*

- Ⓢ = stereophonic recording
- Ⓜ = monophonic recording
- \* = mono or stereo version not received for review

Ⓢ Ⓜ ETHEL ENNIS: *This Is Ethel Ennis.* Ethel Ennis (vocals); orchestra, Sid Bass cond. *He Loves Me: As You Desire Me; The Moon Was Yellow; Who Will Buy?;* and eight others. RCA Victor LSP 2786 \$4.98, LPM 2786\* \$3.98.

Interest: Jazz singer turned pop  
 Performance: Attractive  
 Recording: Very good  
 Stereo Quality: First-rate

When Ethel Ennis was first heard on records in the late 1950's, she revealed a singular though undeveloped skill at jazz singing. Today, as her first Victor album demonstrates, Miss Ennis' technique and self-assurance have grown. She has also retained the warmth, taste, and rhythmic ease of her earlier style. Unfortunately, however, her current aim—or the one RCA Victor has chosen for her—is to be a sophisticated pop singer. Sid Bass' slick arrangements encourage her to skim along the surface, so that there is little of the affecting poignancy or the personal tenderness that used to inform her singing. Miss Ennis has the

equipment to succeed as an above-average interpreter of pop and show tunes, but I hope she has not abandoned her strong jazz individuality.  
 N. H.

Ⓢ Ⓜ AL HIRT/ANN-MARGRET: *Beauty and the Beard.* Al Hirt (trumpet, vocals), Ann-Margret (vocals), Gerry Hirt (trombone), Pee Wee Spitzler (clarinet), Eddie Miller (tenor saxophone), Red Norvo (vibes), Al Hendrickson (guitar), Lowell Miller (bass), Jimmy Zitano (drums). *Bill Bailey; Little Boy; The Best Man; Baby, It's Cold Outside;* and eight others. RCA Victor LSP 2690 \$4.98, LPM 2690\* \$3.98.

Interest: Self-conscious duets  
 Performance: Cute  
 Recording: Intimate  
 Stereo Quality: Excellent

Ann-Margret, a lissome screen actress who also sings, does not appear to take the latter vocation very seriously. She has a clear, pleasant voice and adequate musicianship, but her style is mannered



BEAUTY AND THE BEARD: AL HIRT AND ANN-MARGRET

RCA VICTOR RECORDS

**The Easily Installed  
Wall Outlet**

**BY  
MOSLEY**

**Is The Ultimate In  
Beauty And Function**

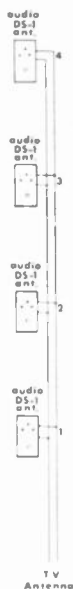

The Mosley DS-1 duo-sound wall outlet consists of isolating networks that enable the TV Antenna System to be used for transmission of Audio Signals simultaneously over the antenna wiring along with the TV signal.

The system shown will enable the owner to use four TV Sets operating independently and still use the Antenna Wiring to carry one Audio or Hi-Fi Signal between any two or more outlets.

As an example - A TV Set could be connected to Station 2 and 4 and operated without interference with each other, and an FM Receiver could be connected to the Antenna Outlet of Station 1 and the Speaker Output connected to the Audio Jack of Station 1. This will feed the FM Audio to all 4 Outlets and a speaker may be plugged into any of them.

Please send me FREE of charge and obligation, literature on the DS-1 Wall Plate Outlet. Form No. DS-1

Name .....  
Address .....  
City/State .....

**Mosley Electronics, Inc.**  
4610 N. Lindbergh Blvd. Bridgeton, Mo. 63044

to the point of trickiness. Al Hirt, in addition to playing in a characteristically overstated and overbusy way on his trumpet, also functions in this set as Ann-Margret's vocal partner. Actually, Hirt's "singing" is most often a diffident recitative, and this is a sideline he would be well advised to abandon. The accompanying small combo is lively, but the coy posturing in the foreground makes this album very expendable. *N. H.*

© ® ROSE MADDOX: *Alone with You*. Rose Maddox (vocals); band. *White Lightning: If You See My Baby; Long Black Limousine*; and nine others. CAPITOL ST 1993 \$1.98, T 1993 \$3.98.

Interest: Country-and-western  
Performance: Good  
Recording: Excellent  
Stereo Quality: Good

These tunes are directed toward people who do not live in cities, a minority that is growing smaller and smaller in this country—and one that is increasingly difficult for urbanites to comprehend. These songs are inevitably corny, but they *are* about reality. The full implications of the success of this kind of music simply have not gotten through to the people in our so-called Tin Pan Alley.

I found this record mildly fascinating and often unintentionally hilarious. One of the funniest pieces I have ever heard is the dead-serious *Long Black Limousine*, the story line of which is as follows: You done left me, baby, to go to the city and hang out with your rich friends. ("Rich" probably means somebody who makes more than \$4,000 a year.) You said you'd come back for me in a big shiny car. And then you got into a race on the highway, and didn't see that turn. And so now you've come back: there's a line of mourners coming up the street, and you're laid out in a long black limousine.

You can break your friends up by playing this track at cocktail parties. But there's a serious point to be made here: as amusingly ingenuous as this song and its kind are, they are much more in touch with the daily life and death of Americans than any of the slick songs about effete romantic emotions that you find on, say, a Vic Damone record.

As for Miss Maddox, some of the more highly touted jazz and pop singers could learn a few things about singing from her. Would that all of them sang with her strong breath support and clean, direct intonation. *G. L.*

© ® GEORGE MAHARIS: *Make Love to Me*. George Maharis (vocals); orchestra, Marty Manning cond. *You Better Go Now; You're My Thrill; C'mere Baby; The Touch of Your Lips; Make Yourself Comfortable; Try a Little*

*Tenderness*; and six others. EPIC BN 26079 \$4.98, LN 24079\* \$3.98.

Interest: Abnormal psychology  
Performance: Schizoid  
Recording: Good  
Stereo Quality: Okay

Having heard that George Maharis was one of the few television actors-turned-recording artists who could really sing, and having enjoyed what few songs I had heard done by him, I looked forward to this new disc. But it is a disturbing experience. The title, *Make Love to Me*, indicates the approach. On some of the numbers, Maharis seems to be making himself coyly available, and the unsettling implication is that he is somewhat



ROSE MADDOX  
*Fresh corn delivered clean and straight*

daintily resisting advances. He has a slight problem with pronunciation, and sounds like at least four different people at various times on this disc, sometimes changing character from one line of a song to the next. *Make Yourself Comfortable*, for these reasons, is almost a travesty. He is further impaired by a vibrato that would put Judy Garland's to shame. But worst of all are his spoken interpolations between phrases, which are probably supposed to be sexy. Only *All or Nothing at All*, which permits nothing but the taking of breath between phrases and requires a certain amount of concentration, is a successful performance. For the rest, Maharis has created a disturbingly schizoid album, half James Dean, half Russ Columbo, that many may find just downright funny. *J. G.*

© ® BEN TUCKER: *Baby, You Should Know It*. Ben Tucker (bass), Victor Feldman (piano), Ray Crawford and Tommy Tedesco (guitar), Larry Bunker (vibes), Bobby Thomas (drums), Carlos Valdez and Raphael Lemos (latin percussion). *Ramblin' Rover; For Hear-*

en's Sake; Capricious; The Message; Heartaches; and four others. AVA AS 27 \$4.98, A 27\* \$3.98.

Interest: Pop jazz  
Performance: Bland  
Recording: Good  
Stereo Quality: Adequate

"When we say that this is a commercial album," read the liner notes for bassist Ben Tucker's new disc, "no apology is intended." Perhaps one is due, however, for there are some very good musicians involved in the recording quintet Tucker has assembled, and none of them is playing at anything like his best. Tucker has appropriated the instrumentation of the George Shearing Quintet, and is going all pleasant and bland like his model. Along the way, the listener finds bossa nova, light funk, and a waltz version of *Liebestraum*. This is music that semi-adventurous disc jockeys call "tasty," even though all flavor has been removed from it. Tucker is a fine bassist, and has done much better than this. Despite other drawbacks, it is worthwhile to listen to the fine guitar solos. J. G.

## THEATER

© ® THE NEW MOON (Sigmund Romberg-Oscar Hammerstein II). Gordon MacRae, Dorothy Kirsten; Roger Wagner Chorale; orchestra, Van Alexander cond. CAPITOL SW 1966 \$5.98, W 1966 \$4.98.

Interest: Hardy perennial  
Performance: Respectful  
Recording: Reverberant  
Stereo Quality: Vivid

The stout-hearted men are marching again, Robert's heart still aches for Marianne, and the moon is still rising softly to a Romberg tune over eighteenth-century New Orleans in this revival of a deservedly favorite perennial. MacRae and Miss Kirsten are in such good voice that they take the curse off many a choppy lyric, and though Wagner's men are not always as lusty as they ought to be, the sound of their ensemble is invariably ingratiating. The best tune of all (stolen shamelessly from Tchaikovsky's *June* in his piano suite *The Months*, is still *Lover Come Back to Me*, and Miss Kirsten gives a winning, if not very sexy, account of it. In the finale, practically all the tunes are heard again, with lots of reverberation. They certainly hold up well. P. K.

© ® THE PRINCE AND THE PAUPER. (Verna Tomasson-George Fischeff). Original-cast recording. Budd Mann, Joe Bousard, Joan Shepard, Robert McLaffey, Carol Blodgett, Flora Elkins, John Davidson; ensemble, Burt



*the sparrow has flown...*

**BUT HER SONG REMAINS**, and this is the album she will be most remembered by: **PIAF AT THE OLYMPIA**, recorded in Paris. Includes "Milord" and "Le Diable de la Bastille." A new release, and her last. Also, *Potpourri par Piaf*, *Piaf/Chansons*, *Piaf and Sarapo at the Bobino* and other records by the late "little sparrow" of France.



(S)T 10368

CAPITOL RECORDS

CIRCLE NO. 8 ON READER SERVICE CARD

**NEW! LAFAYETTE AM/FM STEREO RECEIVER Model LA-230**



**139<sup>50</sup>** LA-230

The beautiful LA-230 makes an ideal heart for your stereo system. Features a sensitive AM and FM stereo tuner with "Stereo Searcher" circuit for easy station location; a 24-watt stereo amplifier with a clean response of 20-20,000 cps and complete stereo preamp facilities. Just add speakers for complete stereo system.

Imported

**Free!** LAFAYETTE Radio ELECTRONICS  
Dept. HMD-4, P.O. Box 10,  
Syosset, L.I., N.Y. 11791

Rush me FREE Giant 422 Page 1964 Cat. 640

LA-230WX AM/FM Receiver \$..... Enclosed

Shipping Charges Collect

Name .....

Address .....

City ..... State ..... Zip .....

CIRCLE NO. 32 ON READER SERVICE CARD

\* **P.L.'S know**



full 20-20,000 cps range  
**SUPEREX**  
stereo/phones

ST-M \$29.95

\* 'PRIVATE LISTENERS' usually aren't big talkers... seems they're fully occupied with 'total enjoyment' with the ONLY separate woofer/tweeter stereo/phones! Send for latest catalog.

**SUPEREX** stereo/phones  
6 Radford Place • Yonkers, N.Y.

CIRCLE NO. 51 ON READER SERVICE CARD

# HOW GOOD IS THIS WINEGARD FM STEREOTRON ANTENNA?

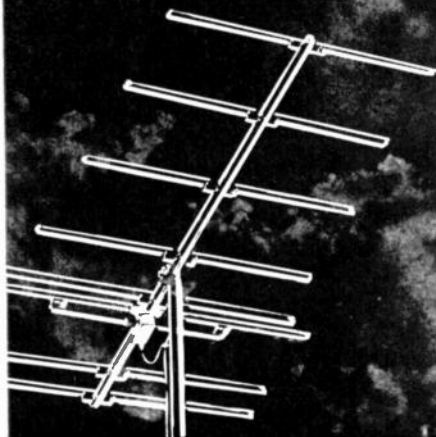

## SO GOOD IT'S GUARANTEED!

**GUARANTEED** to be the most effective, best built FM antenna made —

**GUARANTEED** to bring in 85% of all FM stations in a 200 mile radius when used with the Stereotron antenna amplifier

**GUARANTEED** you will be 100% satisfied or your money back.

The Winegard Stereotron FM antenna will improve the performance of even the most expensive FM or FM stereo tuner. It is the most powerful receiving device you can own and will bring in FM signals up out of the hiss and noise with utmost clarity. Stereotron has an exceptionally high front to back ratio which shuts out multi-path distortion. Has extremely high gain and is highly directive.

If you want the very finest in FM or FM stereo sound, get a **GUARANTEED Stereotron** today.

**STEREOTRON ANTENNA Model SF-8** — \$23.65. Stereotron nuvistor amplifier Model AP-300—input 300 ohms, output 300 ohms. Can be used with any FM antenna—\$39.95.

Amplifier Model AP-375 for use with coax cable, input 300 ohms, output 75 ohms — \$44.95

Write now for technical specs, gain charts, polar patterns, VSWR, etc., and get **FREE FM STATION LOG AND MAP.**

World's most complete line of FM and TV antennas, FM-TV couplers and amplifiers.

## Winegard Co.

3014-B Kirkwood Blvd., Burlington, Iowa

CIRCLE NO. 57 ON READER SERVICE CARD  
100

Faber cond. LONDON AMS 98001 \$4.98,  
AM 28001\* \$3.98.

Interest: Children's musical  
Performance: Sparkling  
Recording: Good  
Stereo Quality: Splendid

Miss Tomasson and Mr. Fischhoff have created a musical for children based on the Mark Twain classic with more delightful moments in it—for listeners of any age—than most of the recent crop of musicals for adults. The story of the urchin from Garbage Court, in the London slums, who changes places with the Prince of Wales is decorated with smooth bouncy tunes and trim lyrics, and is given a production of considerable sparkle. Joan Shepard as the urchin and Carol Blodgett as the prince are convincing as the boys, Miss Shepard being particularly beguiling in the persuasive songs *In a Storybook*, *Why Don't We Switch?*, and *Do This, Do That*. The rest of the cast is up to this mark, especially Joe Bousard as the Cockney father of the little pauper, and John Davidson as Miles Hendon. *Everybody Needs Somebody to Love* is a charming ballad, and the comic numbers, too, are tasteful and original. P. K.

© ® **THREE BILLION MILLIONAIRES.** Jack Benny, Carol Burnett, Wally Cox, Bing Crosby, Sammy Davis, Jr., Judy Garland, Danny Kaye, George Maharis, Terry Thomas, the Murray Sheck Children's Chorus; orchestra, Ray Ellis cond. UNITED ARTISTS UNS 54 \$5.98, UN 54\* \$4.98.

Interest: Plea for UNICEF  
Performance: Variable  
Recording: Variable  
Stereo Quality: Good

I am naturally sympathetic to a project such as this, which is a plea for racial tolerance, the UN, and UNICEF—the proceeds of the record's sale to go to the last. I wish my sympathy could override my aesthetic sense so that I might praise this disc, but, alas, I can't.

With the exception of one long and remarkable track by Danny Kaye, this is a confused and confusing piece of work, even down to the liner notes, which tell us in assertive bold-face type that this is "a complete, original musical comedy . . . the first musical comedy ever created expressly for the record medium." It is *not* a musical comedy, nor is it terribly original, and it has neither continuity nor style. Though the album is packaged in a fold-over sleeve, which provides four hundred square inches of space on which to clarify its purpose, it took two full listenings to the album for me to sort out what was going on. (I concluded that it's for children, and takes a dim view of racism and intolerance

and other bad things.) Half the liner is given over to telling how hard everybody had to work to round up all the stars. The rest is devoted to biographies of producer Arnold Michaelis, composer Robert Allen, orchestrator Ray Ellis, and Diane Lampert and Peter Farrow, who wrote the "book" and lyrics for this "musical comedy." The notes are egotistical, terribly show biz, and terribly dull.

Allen's music turns out to be competent but not distinguished. The skits are sticky, and the lyrics exhibit some sloppy craftsmanship, including a quaint rhyme of "Jehovah" and "over."

On the first side Bing Crosby sings with everlasting Crosbyishness, George Maharis sings quite well, and Judy Garland sings with a vibrato so broad that you will think your turntable has a wow, and so out of phase with chorus and orchestra that the veriest square will know this is a dub-over job, and a poor one. Carol Burnett does an icky skit and song called *The Newly Organized Brotherhood of Marching Babies*.

The second side is another story. Adlai Stevenson opens it with a modest speech loaded with statistics about the comparative costs of peace and war. After this talk, Kaye narrates a fable called *The Round Green Garden*—a parable of man's long struggle from the depths of primitive savagery to his current high plane of sophisticated savagery. It ends with an understated plea that we start treating our children at least as well as animals treat theirs. The subject is obviously dear to Kaye's heart—he has done much work for UNICEF—and he is at his best in this narration.

Everyone connected with the project contributed his time and effort. I only wish they had contributed a little more talent. G. L.

## FOLK

© ® **BALLET FOLKLORICO DE MEXICO.** Dancers, singers, and instrumentalists, Celestino Gorostiza and Ramon Noble, directors. *Los Dioses; Los Tascalos; Fiesta en Veracruz; Danza del Venado*; and seven others. RCA Victor MKSA 30 two 12-inch discs \$9.96, MKLA 30\* \$7.96.

Interest: Wealth of Mexican folklore  
Performance: Generally absorbing  
Recording: Good  
Stereo Quality: Spacious

The Ballet Folklórico de Mexico, founded by choreographer Amalia Hernandez, is the country's national company. This two-disc program of the music for their ballets is consistently arresting because of the range of Mexican folk traditions represented. A handsome illustrated booklet provides information

about the backgrounds and story lines of each ballet, though not, unfortunately, translations of the lyrics. Regional instruments, some of them made by the performers themselves, supply authentic coloration for such vivid re-creations as a religious festival in Tuxpan, a Christmas celebration in Jalisco, an Indian dance of the Yaqui tribe, and a fiesta in Veracruz. The panorama of distinctive local styles, together with the various results of the fusion of European and Indian influences, make for an unusual listening experience. As a whole, this is a valuable addition to the discography of Mexican music.

N. H.



SHOSHANA DAMARI

*Sensuous evocations of the Middle East*

Ⓢ Ⓜ SHOSHANA DAMARI: *Shoshana!* Shoshana Damari (vocals); orchestra, Gershon Kingsley cond. *The Girl and the Miller; How Goodly Are Your Tents; Stillness; Rise, Oh Flame;* and eleven others. VANGUARD VSD 2144 \$5.95, VRS 9126 \$4.98.

Interest: Professional folk  
Performance: Brilliant  
Recording: First-rate  
Stereo Quality: Superb

Shoshana Damari is an Israeli singer of extraordinary musicianship and dramatic power. In this program, eight of the songs are Israeli; the others are Yiddish, Yemenite, Arabic, Turkish, and Rumanian. There is even an Inca melody, sung in Spanish. A primary element in Miss Damari's capacity to draw the listener into her mood is the sensuous quality of her deep, rich voice—as in *Come My Love*. The sensuousness, however, can turn into anger and anguish, as in *Es Brent*, a description of the destruction of a village. She is also skilled at making

vivid a landscape or a time of day, as in *Evening Has Come* and *Stillness*, and can communicate a splendid religious faith (*I Will Ask of the Lord*). In the Yemenite, Arabic, and Turkish numbers, she plunges into the undulating rhythms as if she were dancing as well as singing the songs.

Hearing Miss Damari in this international program is a striking listening experience and a reminder that professionalism in folk singing need not be achieved at the expense of passion.

N. H.

Ⓢ Ⓜ MANUEL FERNANDES MARIA DO ESPIRITO SANTO: *Fados of Portugal*. Manuel Fernandes, Mario do Espirito Santo (vocals); Francisco Carvalhinho (Portuguese guitar), Martinho d'Assuncao (Spanish guitar). *Eternal Song; Maria of the Sea; I Will Never Tell You; The March of the Sweethearts;* and eight others. MONITOR MFS 406 \$4.98, MF 406\* \$4.98.

Interest: Scope of the fado  
Performance: Expert  
Recording: Clear and live  
Stereo Quality: Good

This most recent Monitor collection of Portuguese fados is divided between Manuel Fernandes and Maria do Espirito Santo—each artist has one side of the album. Both live in Lisbon, and both are among the most popular singers in Portugal. As is required of fado interpreters, they are more than accomplished musicians; they are subtly skillful actors. Their intelligent handling of the lyrics and their sense of narrative style make of each song a sharply outlined scene or the exact distillation of a mood.

All fados are not melancholy, and in this set, mingled with tales of uncertain and vanished love, are exuberant declarations of national and local pride. There is even one love story that promises to end well. Monitor has provided complete Portuguese texts and English paraphrased translations.

N. H.

Ⓢ EWAN MAC COLL/PEGGY SEEGER: *The New Briton Gazette, Volume Two*. Ewan MacColl (vocals), Peggy Seeger (vocals, guitar, banjo). *No Agents Need Apply; The Ballad of Jimmy Wilson; Needle and Thread; When I Was Young;* and eleven others. FOLKWAYS FW 8734 \$5.95.

Interest: Contemporary folk songs  
Performance: Appealing  
Recording: Good

This second volume in "The New Briton Gazette" series documents the growth of topical folk-song writing in Britain. In this program, the composers are also the performers. For some songs, new lyrics have been set to traditional tunes; for



## DYMO LABELMAKER

Make permanent, raised letter plastic labels...in seconds. Professional quality labels for pennies. Dial letters, numbers, symbols, squeeze handle. ■ 1001 uses for the hi-fi enthusiast. ■ At fine stores everywhere. Suggested price \$9.95



FREE: Label samples and literature. Write: Dymo Industries, Inc., Dept. SR-4-4, Box 1030, Berkeley, Calif. Priced same in Canada.

CIRCLE NO. 13 ON READER SERVICE CARD

others, both music and words are new. Peggy Seeger is a member of that energetic American musical family that also includes Pete and Mike. Her husband, Ewan MacColl, is an actor as well as a folk performer and composer. A number of his songs have already become staples in America and Britain.

Some of the pieces in this collection are long on message and short on fresh imagery, but the majority have been shaped—and are sung—with skill and sensitivity. Besides the expected denunciations of the bomb, there are a description of the frustrations of London traffic, a sardonic portrait of an agent

specializing in folk singers, an angry song about race prejudice, and a contemporary chronicle of a British miner on the order of John Henry. Especially interesting are an organizing song commissioned by the National Union of Tailor and Garment Workers and an account of a successful 1960 rent strike in London. Clearly, the British broadside tradition is still briskly alive. An accompanying booklet contains complete texts. *N. H.*

© © ODETTA: *One Grain of Sand*. Odetta (vocals, guitar), Bill Lee (string bass). *Moses, Moses; Roll On, Buddy;*

*She Moved Through the Fair; Cool Water;* and ten others. VANGUARD VSD 2153 \$5.95, VRS 9137 \$4.98.

Interest: Diversified folk program  
Performance: Dignified  
Recording: Warm and clear  
Stereo Quality: Good

Acting upon her conviction that she need not be limited to Negro material, Odetta on this disc interprets songs with British roots and one cowboy tune along with Negro blues and religious material. Throughout the collection there are signs of her increasing ease in performance. Her phrasing flows, her beat is supple, and she varies vocal texture to heighten different moods, all to a greater extent than on any previous recorded recital. There remains, however, an occasional self-consciousness, a certain holding back. The liner notes make much of Odetta's dignity, and this indeed characterizes her work. But dignity can also accompany complete emotional immersion in a song, as witness Joan Baez. In Odetta's case, however, there is sometimes a constriction of passion that leads to intermittent moments of heaviness in her performances.

Odetta's voice itself is so compelling that she is a singularly evocative vocalist, and she is increasingly demonstrating that she can release her feelings. The likelihood is that in the years ahead she will evolve into a more effective performer than even her strongest partisans now find her to be. *N. H.*

#### RECORDING OF SPECIAL MERIT

© © RAVI SHANKAR: *India's Master Musician*. Ravi Shankar (sitar), Kanai Dutt (tabla), Nodu Mullick (tamboura). *Raga Hamsadhvani; Dhun Kafi; Raga Ramkali*. WORLD-PACIFIC S 1430\* \$4.98, 1430 \$4.98.

Interest: Fascinating improvisation  
Performance: Expert  
Recording: First-rate

In this recital of Hindu rāgas, recorded in London, Ravi Shankar again unfolds the seemingly limitless rhythmic and melodic subtleties of Hindu music. On the multistringed sitar—there are six to seven main strings and thirteen sympathetic resonating strings—Shankar invents astonishingly complex patterns that are also emotionally evocative. The moods he spins are so intense and the rhythms so mesmeric that the Western listener may find himself finally quite moved by these unfamiliar permutations of time and melody. The disc is made especially instructive by the unsigned notes, an unusually clear description of the basic elements of this form of Indian music. *N. H.*

# THE CHAD MITCHELL TRIO

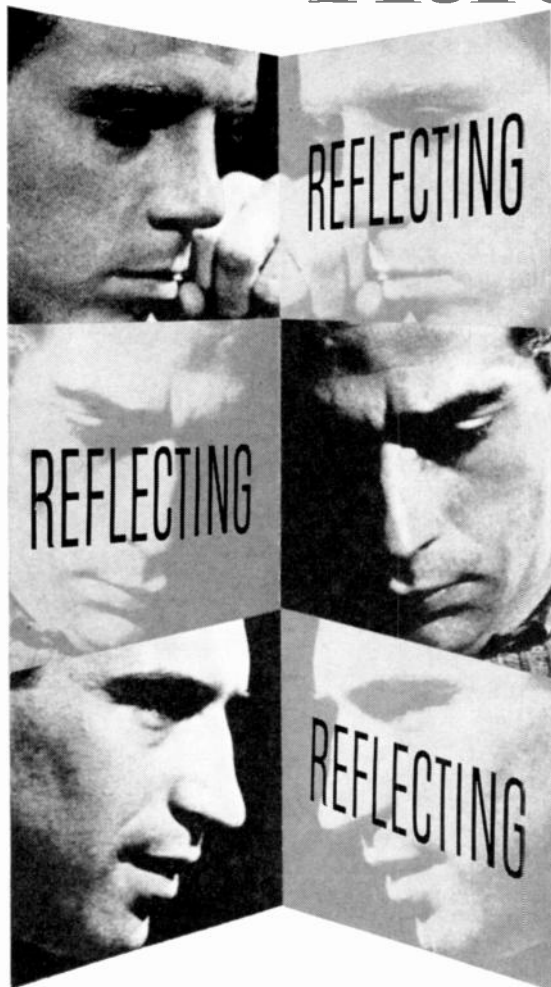

When our founding fathers declared for intellectual freedom they must have had the Chad Mitchell Trio in mind. In their first Mercury album, "Singin' Our Mind", they shattered tradition, fractured clichés all over the place.

Now...in their new release, "Reflecting", fresh imagery abounds in both music and lyrics. A Mitchell album is required listening with both melody and meaning lingering on . . . ad infinitum.



Your record dealer is reflecting too—because how come so many people like the Chad Mitchell Trio?



Foremost in Fine Recording

## SPOKEN WORD

Ⓢ SHAKESPEARE: *Scenes from the Tragedies, Volume One. Julius Caesar, Romeo and Juliet, Othello, Macbeth.* Marlowe Dramatic Society, George Rylands director. LONDON 5786 \$4.98.

Ⓢ SHAKESPEARE: *Scenes from the Tragedies, Volume Two. Hamlet, King Lear.* Marlowe Dramatic Society, George Rylands director. LONDON 5789 \$4.98.

Ⓢ SHAKESPEARE: *Scenes from the Comedies, Volume One. The Merchant of Venice, Midsummer Night's Dream, Twelfth Night, The Tempest.* Marlowe Dramatic Society, George Rylands director. LONDON 5787 \$4.98.

Ⓢ SHAKESPEARE: *Scenes from the Histories, Volume One. King John, Richard II, Henry IV Part One, Henry IV Part Two, Henry V.* Marlowe Dramatic Society, George Rylands director. LONDON 5788 \$4.98.

Interest: Shakespeare highlights

Performance: Varied

Recording: Fine

These cleverly edited discs are more successful than most efforts to scale down Shakespeare, since they offer not condensations of whole plays or anthologies of disembodied speeches, but great scenes (sometimes intact) of contrasting moods. At the same time, they reveal tellingly both the strengths and weaknesses of the Marlowe Society's approach. The strongest is "The Histories." The Marlowe troupe is at its best projecting the English character in moments of impassioned eloquence. The scenes from *King John*, *Richard II*, *Henry IV*, and *Henry V* carry power and a sense of absolute conviction. In the comedies, low buffoonery is done with deftness—the company of Athenian craftsmen at Bottom's rehearsal in *A Midsummer Night's Dream*, and the carousal of Sir Toby Belch and Sir Andrew Aguecheek in *Twelfth Night* unfold with Hogarthian sharpness. But when it comes to fantasy, to the airy delicacy of enchanted immortals, to young love, or to moments of mystery, one is invariably let down. In the tragedies, one encounters more of the same. Hamlet, Othello, and Antony send their mighty words winging sturdily, but Macbeth does not convincingly convey his mood of maddened distress, and his lady is earthbound. Two exceptions to this pedestrian pace in the tragedies are the flawless acting by Desdemona and the Moor in the murder scene from *Othello* and a series of big moments from *King Lear*.

One misses in all these highlights the extra dimension stereo adds in the albums from which the scenes have been dubbed.

P. K.

(Continued on page 105)

Industrial Design Magazine used these words to describe the functional beauty of the AR turntable:

# "noteworthy for elegant simplicity".

The AR turntable's simplicity of basic design, in engineering as well as in looks, makes possible a combination of professional quality, reliability, and low price. Percy Wilson writes, in the British publication *The Gramophone*: "I have, in fact, only one criticism of the AR turntable and arm: it is greatly under-priced. For its high standard it could well be double the price."

We believe that the AR turntable at double the price would keep its position of leadership in the field. Its wow and flutter were reported by HiFi/Stereo Review as being the lowest ever measured on any turntable, irrespective of price; its speed accuracy was the best of any fixed speed turntable tested by High Fidelity; its design was described in *Modern Hi-Fi* as being the best answer to the interrelated problems of rumble and acoustic feedback; and *Gentlemen's Quarterly* included the AR turntable in its selection of a ne plus ultra stereo system costing \$3824.



The AR turntable at New York's Industrial Design Show. Products in the show were selected by Industrial Design as representing the best designs of American industry.

**\$68<sup>00</sup>** complete with arm, oiled walnut base, and dust cover, but less cartridge, 33 $\frac{1}{3}$  and 45 rpm

5% higher in the West and Deep South

**ACOUSTIC RESEARCH, INC., 24 Thorndike St., Cambridge, Mass. 02141**

# ENGLISH BAROQUE POETRY ON RECORDS

By PAUL KRESH

IN THE seventeenth century, the new ideas in religion and science that shattered the certainties and harmonies of the Renaissance not only hastened the appearance of the Baroque age in architecture, music, and the plastic arts, but brought about a new style in poetry and literature as well. How could man relate to the eternities of time, nature, and divinity if strange continents sprawled beyond the seas, if the laws of astronomy and even of the human body were more complex and unfathomable than was ever dreamed, if the man-centered universe of Copernicus no longer existed? Although the seventeenth century, the "century of genius," continued to produce writers who wrote well in earlier styles, the masters of the day, especially in England, were the Baroque lyricists. Pondering life, death, and love in an anxious age of transition, immediate and personal in their tone, extravagant in their use of astonishing imagery and unexpected metaphors, they were at once sensual and ascetic: juxtaposing opposites, inventing new forms, employing elastic rhythms.

From the oblique, witty, intense love lyrics of Donne to the truly Baroque grandeur, symmetry, and formality of Milton's epic *Paradise Lost* is itself an enormous leap. Some critics account for this by finding Donne, Henry Vaughan, George Herbert, Andrew Marvell, and the other "metaphysical" poets (as well as the early Milton) to be exponents of a transitional style known as mannerism. The compressed, personal, shifting and troubled qualities of this poetry—which has strongly influenced the temperamentally related verse of our own time in the works of T. S. Eliot, Dylan Thomas, Archibald MacLeish, and others—are thus shown to have burgeoned in the later Milton into a far more formal, balanced, and grandiose aspect, opening, like the paintings this poetry resembles, into enormous vistas in which the glories of heaven and of earth are conjointly celebrated.

On records, to date, the "metaphysical" poets of the Baroque age—Eliot has defined them well as men who "feel" their thoughts "as immediately as the odour of a rose"—are sparsely but superbly represented. Both the love poems and the religious verses of Donne are available. Milton's "Lycidas" (considered by some to be the greatest lyric in the English language) and lengthy passages from two of the eleven books of *Paradise Lost* are in the catalog, as well as a treasury of his shorter masterpieces.

There are also exceptionally fine interpretations of striking and memorable verses from the writings of George Herbert, William Browne, Sir John Suckling, Richard Lovelace, William Cartwright, William Strode, Thomas Traherne, Henry Vaughan, Richard Crashaw, Abraham Cowley, and Andrew Marvell. Occasionally the better-known poems of Donne, Marvell, or Milton also turn up in more inclusive anthologies, but considered here are commercially available albums devoted wholly or substantially to Baroque lyric poetry.



"Carpe diem, quam minimum credula postero." (*The Odes of Horace*, I, xi, 8)

**Metaphysical and Love Lyrics of the Seventeenth Century.** Sir Cedric Hardwicke and Robert Newton, readers. Howard Sackler, director. CAEDMON TC 1049 \$5.95.

A brilliantly edited selection, compellingly read. The measured, mature tones of Hardwicke alternate with the impassioned approach of Newton in a vivid presentation. Especially exciting is Newton's intense reading of George Herbert's tortured, pleading prayer, "Sighs and Groans." Also included are Marvell's "To His Coy Mistress," Crashaw's "The Flaming Heart," Cowley's troubled "Ode to Doctor Harvey" (who had just disturbed the world by discovering about the circulation of the blood) and other masterpieces of the period. Handsomely printed text.

**Hearing Poetry: Volume One—Chaucer through Milton.** Hurd Hatfield, Frank Silvera, Jo Van Fleet, readers. Mark Van Doren, narrator. Howard Sackler, director. CAEDMON TC 1021 \$5.95.

The second side of this beautiful album offers appropriately gentle, rather than orotund, readings by Silvera and Hatfield of Donne's "Death Be Not Proud" and "The Bait," Herbert's anguished

"The Collar," and Milton's "Lycidas," totally devoid of the usual pomposities, elegiacally intoned in full by the silken-voiced Hatfield. There are also earlier English poems by Marlowe, Shakespeare, Dekker, and Chaucer, with Miss Van Fleet contributing some sound readings. Mr. Van Doren provides informative spoken introductions.

**Treasury of John Donne.** Robert Speaight, reader. SPOKEN ARTS 859 \$5.95.

The passion for unity—which Donne pursued first as dashing lover with his mistresses, later as a divine with God, and ultimately in dialogues with death—is evident in this balanced program of songs, sonnets, hymns, and elegies, read in the subdued, thoughtful, and utterly clear style of actor Speaight.

**Love Poems of John Donne.** Richard Burton, reader. CAEDMON 1141 \$5.95.

With his supple voice and acerbic approach, Mr. Burton, who concentrates on the early poems, emphasizes the immediacy and wit of these lyrics far more than Mr. Speaight, although a lack of tenderness cools the ardor of such lovely lyrics as "The Good-Morrow."

**Milton: *Paradise Lost*.** Anthony Quayle, reader. CAEDMON TC 1093 two 12-inch discs \$11.90.

Included are all of Book One, dealing with the fall of Satan, and Book Four, lines 1-357, 358-588, 776-903, and 917-end, centering on the fall of man. The genius of Milton at its height provides an opportunity for a remarkable actor to show the startling variety of his powers. Mr. Quayle seizes the listener's attention, manipulating the flaming imagery and titanic dialogues out of which the poet constructed his gigantic Biblical word-painting through constantly varying tones of voice, changes of pitch, pace, and mood.

**Christian Poetry and Prose.** Alec Guinness, reader. FOLKWAYS FLJ 9893 \$5.95.

An absorbing selection, made by actor Guinness, of interest in the present context because of two characteristically understated but arresting performances of Baroque religious lyrics. One is Henry Vaughan's "The Night," employing typical imagery of the style (God's "locks are wet with the clear drops of night") and expressing an intense longing for communion with his Creator. The other is a passage of dazzling fervor from Crashaw's masterpiece, "To St. Teresa."



© ® SHAKESPEARE: *Love's Labour's Lost*. Marlowe Dramatic Society: Derek Godfrey, Gary Watson, Robert Eddison, Max Adrian, Tony Church, Michael Bates, Janette Richer, Prunella Scales, Susan Merryott, Diana Rigg, Patsy Byrne. George Rylands director. LONDON OSA 1363 three 12-inch discs, \$17.94, A 4363\* \$14.94.

Interest: Instructive comedy  
 Performance: Expert  
 Recording: Superior  
 Stereo Quality: Markedly good

In this instructive comedy, Shakespeare summons a glib collection of fops, pedants, wits, and pretenders to the court of the young King of Navarre for a "civil war of wits" that is really a brief drawn up against superficiality and sham. The King has decided to transform his court into an academy of learning and to persuade his attendant lords—Berowne, Longaville, and Dumaine—to fast, study, and forswear the company of women for three years. Unfortunately, he is required to suspend this plan because the Princess of France is due in on a diplomatic mission and she cannot very well be barred. Even though the king decides to lodge the princess outside the palace, he cannot prevent the lords and ladies from circumventing his austere decrees and dallying in games of love—which take the form of witty speeches, sonnets, and songs bandied like shuttlecocks across the stage. These airy exchanges, revels, and deceptions move the play forward to its unexpected ending: the princess is called home by the sudden death of her father. The king must go to a hermitage, the mocking Berowne visit the "speechless sick" for a year to make the dying smile if he can, and Don Armado, a high-flown and hollow *poseur*, must spend three years "at the plough" to win the country wench Jaquenetta. As Berowne (who, A. L. Rowse has recently insisted, is and should be played as Shakespeare himself) puts it, "Our wooing doth not end like an old play; Jack hath not Jill." Nimble tongues, games of words, flirtatious postures are not enough—life is more than a tennis match.

This fanciful, ingenious, and lyrical play calls for a cast with an abundance of the very elements it holds up for mockery: lightness, suppleness, and fluency, an exact sense of subtle exaggeration, eloquency, clarity, and speed. All these the Marlowe Society brings to this production. Every player is fittingly cast (would that they will soon start telling us who plays whom!). Contrapuntal moments, as in the reading of a letter and the comments on it in Act Four, Scene Two, are enhanced by stereo, and the episodes are charmingly framed by musical interludes. The album as a whole is uncommonly satisfactory. P. K.

# Who says a professional-grade, ribbon-type mike has to cost a small fortune?

Most audio engineers agree that microphones with ribbon-type generating elements give the best acoustic performance obtainable... the smoothest, most distortion-free response over the broadest frequency range.

Most ribbon-type mikes are therefore quite expensive... up in the hundreds of dollars.

But not the RCA SK-46. It gives you a frequency-response of 40 to 15,000 cps

...and it costs only \$49.50\*

## What's so special about ribbon-type mikes?

There are 7 basic types of microphone generating elements: ribbon, condenser, magnetic, dynamic, ceramic, crystal and carbon. RCA sells all 7, so we can be relatively impartial about the advantages of the ribbon type.

A typical ribbon element (special aluminum alloy foil 0.0001" thick) weighs only about 0.25 milligram—hundreds of times lighter than generating elements in, say, dynamic and condenser mikes. The ribbon, in fact, is as light as the air mass that moves it, which accounts for its exceptional sensitivity.

In fact, of all 7 types of generating elements, the ribbon-type element is superior in:

- ★ Smoothness of response
- ★ Breadth of frequency range
- ★ Immunity to shock and vibration
- ★ Adaptability to various impedances



RCA SK-46 ribbon-type microphone

- ★ Low hum pickup
- ★ Immunity to temperature and humidity variations

That's why most of them cost so much.

**But now you can get the remarkable RCA SK-46 bi-directional ribbon-type mike at Your Local Authorized RCA Microphone Distributor — For Only \$49.50\*.**

For full technical information—or the name and address of your nearest distributor—write: RCA Electronic Components and Devices, Dept. 451, 415 So. 5th St., Harrison, New Jersey.

\*Optional Distributor Resale Price

RCA Electronic Components and Devices, Harrison, N. J.



The Most Trusted Name in Electronics

The commanding presence of Sony sound



Now enter the world of the professional. With the **Sony Sterecorder 600**, a superbly engineered instrument with 3-head design, you are master of the most exacting stereophonic tape recording techniques.

Professional in every detail, from its modular circuitry to its 3-head design, this superb 4-track stereophonic and monophonic recording and playback unit provides such versatile features as: ■ vertical and horizontal operating positions ■ sound on sound ■ tape and source monitor switch ■ full 7" reel capacity ■ microphone and line mixing ■ magnetic phono and FM stereo inputs ■ 2 V.U. meters ■ hysteresis-synchronous drive motors ■ dynamically balanced capstan flywheel ■ automatic shut off ■ pause control and digital tape counter—all indispensable to the discriminating recording enthusiast. Less than \$450, complete with carrying case and two Sony F-87 cardioid dynamic microphones. **Multiplex Ready!**

**SUPERSCOPE®** The Tapeway to Stereo

Sony tape recorders, the most complete line of quality recording equipment in the world, start at less than \$79.50. For literature or name of nearest dealer, write Superscope, Inc., Dept. 8, Sun Valley, Calif. Selected by the "House of Good Taste" New York World's Fair.



HIFI/STEREO REVIEW'S CHOICE OF THE LATEST RECORDINGS

# STEREO TAPE

Reviewed by CHRISTIE BARTER • DAVID HALL

Ⓢ BRUCKNER: *Symphony No. 8, in C Minor*. Munich Philharmonic Orchestra, Hans Knappertsbusch cond. WESTMINSTER WTP 165 \$11.95.

Interest: Massive Bruckner  
Performance: Inadequate execution  
Recording: Lacks spaciousness  
Stereo Quality: Good enough

The craggy grandeur of Bruckner's huge Eighth Symphony is illuminated with convincing eloquence by veteran Bayreuth conductor Hans Knappertsbusch here. Though his reading takes a good five minutes more than the disc interpretations of Karajan (Angel) and Mravinsky (MK), he makes of the first three movements a wholly absorbing experience. He achieves a more than usually effective integration of polyphonic and dynamic detail with extended phrasing and the projection of structural line. Only in the finale, which demands genuine thrust, does Knappertsbusch's predilection for slow tempos let the music down.

Were this my only reservation, I should be able to give this first four-track taping of the symphony a strong recommendation. But regrettably, even the finest things here must be apprehended through recorded sound that lacks the spaciousness and tonal warmth so essential to the communication of Bruckner's musical language. And, too, the composer is at the mercy of an orchestra that is not always equal to the demands of the score—compare Karajan's Berlin Philharmonic and Mravinsky's Leningrad.

Though I appreciate having the music accommodated on just two tape sides, I was not happy to find the turn-over occur midway in the slow movement. *D. H.*

## RECORDING OF SPECIAL MERIT

Ⓢ DVORÁK: *Symphonies No. 4, in G Major, Op. 88; No. 5, in E Minor, Op. 95 ("From the New World")*. Vienna Philharmonic Orchestra and London

### Explanation of symbols:

- Ⓢ = stereophonic recording
- Ⓜ = monophonic recording

Symphony Orchestra, István Kertész cond. LONDON LCK 80133 \$11.95.

Interest: Top-grade Dvořák  
Performance: Splendid Fourth  
Recording: Good  
Stereo Quality: Good

Its box titles to the contrary, this tape does not include the *Scherzo Capriccioso* that came as a filler with the Kertész reading of the Dvořák Fourth Symphony disc. Nevertheless, this twin-pack tape of-



LONDON RECORDS

ISTVÁN KÉRTÉSZ  
*Free-wheeling, fiery brilliance*

fers a most generous and vital helping of Bohemian symphonism at its best. Kertész is rather free-wheeling in his approach to the "New World," compared to Toscanini, Kubelík, Walter, or Reiner, all of whose performances are on tape, and his rather hectic reading with the Vienna Philharmonic here offers no compensating illumination of the music's expressive or structural substance. The G Major Symphony is something else again, for the Kertész flair for brilliance of execution and intensity of expression beautifully fits the bracing tunes and insistent rhythms of this music. The rival tape reading by Szell and the Cleveland Orchestra is top-notch in its own more con-

trolled way, but I must confess to being completely carried away by the fiery treatment of the younger conductor, the superb playing of the London Symphony, and the superior recorded sound. *D. H.*

## RECORDING OF SPECIAL MERIT

Ⓢ HAYDN: *Mass No. 9, in D Minor ("Nelson")*. Sylvia Stahlman (soprano), Helen Watts (contralto), Wilfred Brown (tenor), Tom Krause (baritone); King's College Choir, Cambridge; London Symphony Orchestra, David Willcocks cond. LONDON LOL 90064 \$7.95.

Interest: Great post-symphonic Haydn  
Performance: Vital and authentic  
Recording: Spacious  
Stereo Quality: Good

This recorded performance eloquently communicates the splendor and poignancy of the Haydn "Nelson" Mass, the final movement of which is said to have been composed to celebrate Admiral Horatio Nelson's victory in 1798 over Napoleon's fleet in the Battle of the Nile. Haydn himself subtitled the work *Missa in angustiis* ("Mass in Time of Anguish"), referring to the terror that the conquering French armies had brought to all of Europe. Indeed, its expressive power and brilliant instrumentation drive home the realization that the tour de force that is Beethoven's *Missa Solemnis* could not have been accomplished nearly twenty-five years later had the younger man not been thoroughly familiar with Haydn's work in the idiom. This music is no mere historic document, however. It stands as gloriously triumphant in musical value as any of the Haydn symphonies and quartets, and this recording, done in the King's College Chapel of Cambridge University, re-creates beautifully the atmosphere of a performance that might have taken place in Haydn's day. Soloists, conductor, and orchestra—trumpets especially—cover themselves with glory, as does the recording staff that took on an acoustically difficult and tricky assignment. *D. H.*

Ⓢ MOZART: *Clarinet Concerto, in A Major (K. 622); Flute and Harp Con-*



## Do you own one of these fine tape recorders?

If you do — and you don't own a set of Koss Stereophones — you've got a lot of fun still coming!

Koss phones are perfect for monitoring and editing in either stereo or monaural. Now you can group your favorite selections on one tape with no disturbance to or from others in the room.

Check the chart for the Koss phone which plugs directly in to your own recorder. If you don't see your recorder below, write us for a complete listing.

And for playback listening — well, prepare for an emotional lift! Just plug your Koss phones into your recorder's output jack and you'll be soaring on a solo flight of perfect sonic bliss. You'll hear every sound with startling clarity and a new "up-closeness" you've never experienced before.



SP-3X, SP-5NS, SP-5VW  
\$24.95

PRO-4 STEREOPHONES  
\$45.00



KOSS SP-3X  
or PRO-4

SP-5NS  
or SP-5VW

	1	2	3	4	5	6	7	8
	Viking	Roberts	Sony	Wollensak	Concertone	Ampex	Concord	Norelco
KOSS SP-3X or PRO-4		330 770 997	CS300 500				884	
SP-5NS or SP-5VW	220	440 990 1040	200 600 777	1580 T1980	510	970 1270 4470		400 401

## KOSS electronics, inc.

2227 N. 31st Street • Milwaukee, Wisconsin 53208

CIRCLE NO. 31 ON READER SERVICE CARD

*certo, in C Major (K. 299)*. Alfred Prinz (clarinet), Werner Tripp (flute), Hubert Jelinek (harp); Vienna Philharmonic Orchestra, Karl Münchinger cond. LONDON: LCL 80130 \$7.95.

Interest: Carefree Mozart  
Performance: Vital  
Recording: Good  
Stereo Quality: Good

Although there are half a dozen currently available discs of Mozart's flute and harp concerto, a product of his stay in Paris during his twenty-second year, this recording marks its first appearance on tape. The music is not top-drawer Mozart, but the unusual solo combination makes for enjoyable listening. The performance here is zestful and very well recorded.

In musical quality, the clarinet concerto is much superior, for this music represents the peak of Mozart's mature lyrical expression. Indeed, the major interpretive problem posed by the Mozart clarinet concerto is that of preventing its "sweetness long drawn out" from cloying. Soloist Alfred Prinz and conductor Karl Münchinger find their solution in emphasizing rhythmic vitality and keeping the music moving, though they artfully avoid any signs of undue haste. This approach works particularly well in the delightful last movement, and though Gervase de Peyer and Peter Maag on their London tape bring more warmth and subtlety of phrasing to the other movements, the present performance is very good on its own terms. Excellent sound throughout.

D. H.

### RECORDING OF SPECIAL MERIT

⑤ **RESPIGHI: *The Pines of Rome; The Fountains of Rome***. Suisse Romande Orchestra, Ernest Ansermet cond. LONDON: LCL 80129 \$7.95.

Interest: Respighi's Rome  
Performance: Poetic  
Recording: Very good  
Stereo Quality: Excellent

This is the fourth four-track tape coupling of Respighi's two most popular Roman tone poems, and it is one of the best. Ansermet, with singular felicity, projects the evocative poetry of these works and minimizes elements of questionable taste. The result is distinctly refreshing to an ear jaded by attempts at making *Pines* and *Fountains* vehicles for stereo and conductorial wow techniques. Not that Ansermet cannot generate a good floor-shaking climax, as the end of the *Pines* attests. Special praise must go to Ansermet's solo wind players and to London's engineers for a job well done.

D. H.

(Continued on page 110)



## Now... a Kodak tape for every recording need

All give you unexcelled quality because of their new high-performance oxide layer. The smoother surface reduces background tape noise and, with the lubricant, minimizes recorder head wear. Toughness and stability of Kodak tape assure long life.

It's easy to select the Kodak tape that best fits your needs. Just pick the reel size, recording time and tape base you prefer.

Reel Size	Tape Length	Recording Time			Tape No.
		1 $\frac{7}{8}$ I.P.S.	3 $\frac{3}{4}$ I.P.S.	7 $\frac{1}{2}$ I.P.S.	
3 Inch	150 ft.	16 min.	8 min.	4 min.	31A1
	400 ft.	42 min.	21 min.	10 $\frac{1}{2}$ min.	11P4
5 Inch	600 ft.	1 hr. 4 min.	32 min.	16 min.	31A6
	900 ft.	1 hr. 36 min.	48 min.	24 min.	21A9
	1250 ft.	2 hr. 12 min.	1 hr. 6 min.	33 min.	11P12
7 Inch	1200 ft.	2 hr. 8 min.	1 hr. 4 min.	32 min.	31A12
	1800 ft.	3 hr. 12 min.	1 hr. 36 min.	48 min.	21A18
	1800 ft.	3 hr. 12 min.	1 hr. 36 min.	48 min.	21P18
	2500 ft.	4 hr. 24 min.	2 hr. 12 min.	1 hr. 6 min.	11P25

Reel size is usually the largest accepted by your recorder—unless you plan to make shorter recordings.

**Choice of base**—DUROL triacetate—extra strong, yet breaks clean, in case of accident, with little or no loss of recorded sound. In 1 $\frac{1}{2}$ -mil thickness for standard play, 1-mil for 50% additional play. Polyester Base—thinner for extended play. The  $\frac{1}{2}$ -mil thickness gives double the standard recording time.

**Back Printed**—throughout the tape length the name Eastman Kodak Co. and the manufacturing control number are printed repeatedly to provide your assurance of quality.

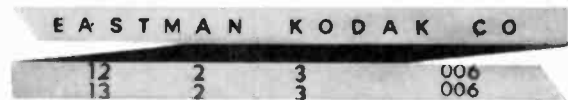

**KODAK Thread-Easy Reel**—Every 7-inch roll of KODAK Tape comes on the exclusive KODAK Thread-Easy Reel. Just pull the tape through the slot—it's threaded. For added convenience there are splicing jigs and index scales on both sides of the reel.

Try the new KODAK Sound Recording Tape today. See your Kodak dealer.

© Eastman Kodak Company MCMXLII

**Kodak**  
TRADEMARK

EASTMAN KODAK COMPANY, ROCHESTER, N. Y.

# What do you hear from your FM?

Just as much as your FM  
antenna lets you hear!

*That's a fact.*

The antenna built into your FM receiver can pull in only very close stations. And it may not do that with always complete clarity. If you'd like to tune in more (and more distant) FM stations clearly, you definitely need a high gain outdoor FM antenna. Kitchen table model or expensive stereo rig, the story's the same.

FM stereo, in fact, is a *weaker* signal than monaural FM; it "cries for" an antenna. A directional antenna, too, for clean FM stereo reception, since your built-in antenna pulls in signals from *all* directions and may lose your stereo effect.

Inexpensive, lasting solution! The totally new RCA 500 FM antenna just developed by experts with long, long electronics experience. This 8-element yagi-type antenna receives 88 to 108 MC, has a VSWR of 1.25:1 and a flat-frequency response across the entire band with an average 8 db gain. Acute directivity removes interference.

Your RCA dealer will happily explain in words of one syllable what better things you'll hear from your FM with an RCA 500 FM antenna.

**Listen!**

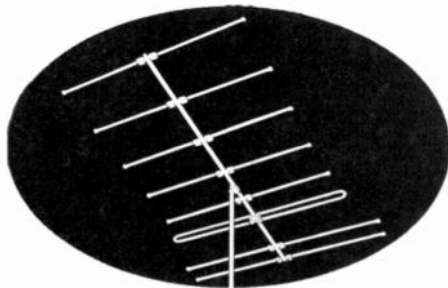

RCA Parts and Accessories



The Most Trusted Name  
in Sound

CIRCLE NO. 41 ON READER SERVICE CARD  
110

© STRAUSS: *Thus Spake Zarathustra*, Op. 30; *Death and Transfiguration*, Op. 21; *Till Eulenspiegel's Merry Pranks*, Op. 28; *Salome: Dance of the Seven Veils*. Vienna Philharmonic, Herbert von Karajan cond. LONDON LCK 80128 \$11.95.

Interest: Strauss omnibus  
Performance: Impressive  
Recording: Very good  
Stereo Quality: Okay

As a twin-pack coupling, this Strauss collection is clearly a bargain. It also offers the only uninterrupted performance of *Zarathustra* on tape and the most satisfying one next to Reiner's (Victor FTC 2115). Strength and clarity of line distinguish Karajan's interpretation of *Death and Transfiguration*, as well as a deep understanding of the work's metaphysical content, but *Till Eulenspiegel* and *Dance of the Seven Veils* tend to be a little too studied. Fine sound. C. B.

#### RECORDING OF SPECIAL MERIT

© VERDI: *Scenes from Aida*. *Ritorna vincitor!*; *Aida-Amneris duet*; *Qui Radames verrà!*; *Nile Scene*; *Tomb Scene*. Birgit Nilsson (soprano); Grace Hoffman (mezzo-soprano); Luigi Ottolini (tenor); Louis Quilico (baritone); Covent Garden Royal Opera House Orchestra and Chorus, John Pritchard cond. LONDON LOL 90073 \$7.95.

Interest: Verdi and Nilsson  
Performance: Handsome  
Recording: Superb  
Stereo Quality: A-1

Perhaps it is true that, in the role of Aida, Birgit Nilsson cannot convey pitiable heartbreak and terror in the manner of Price or Tebaldi. But she does bring to the role a special element of fiery nobility that matches a similar element in the music Verdi wrote. This comes out most notably in the Nile duets with Amonasro and Radames, roles very ably sung by Messrs. Quilico and Ottolini. The sheer brilliance with which Miss Nilsson sings the opening of "*Ritorna vincitor!*" eclipses the tenderness and poignancy she brings to its later pages, but her confrontation scene with Amneris is enhanced by the formidable vocal characterization of the latter by Grace Hoffman. The final Tomb Scene, too, is sung with great dramatic intensity by all the principals. The orchestral and choral support under John Pritchard's direction measure up fully to the vocal work, and the stereo sonics are superb. D. H.

#### COLLECTIONS

© BAND OF THE GRENADIER GUARDS: *Pomp and Circumstance*. Wagner: *Tannhäuser: Grand March*.

# Why?

DO THOUSANDS OF HI-FI  
ENTHUSIASTS BUY FROM  
AUDIO UNLIMITED

## It's Obvious!

- LOWEST PRICES
- FAST SERVICE
- FACTORY SEALED UNITS
- FULLY INSURED SHIPMENTS
- UP TO 2 YEAR MANUFACTURERS' WARRANTY
- TIME PAYMENT PLAN
  - only 10% down
  - up to 36 months to pay
- FRANCHISED DISTRIBUTORS

Write for FREE Catalog Today

SEND US YOUR LIST  
FOR OUR AIR MAIL  
QUOTE TODAY

Visit Our Showroom and Warehouse

**AUDIO** unlimited, inc.

715-S Second Ave., (Nr. 38) New York 16, N.Y.  
3 blocks from the U.N.

CIRCLE NO. 6 ON READER SERVICE CARD



## be an angel

write to us in London for a free back issue of RECORDS and RECORDING—the illustrated English monthly magazine which is absolutely devoted to records and equipment.

Or send for a trial year subscription,  
only \$5.25

HANSOM BOOKS

16 BUCKINGHAM PALACE ROAD  
LONDON SW1, ENGLAND

HIFI/STEREO REVIEW

Sibelius: *Karelia Suite: Alla Marcia*. Meyerbeer: *Le Prophète: Coronation March*. Schubert: *Marche Militaire*. Elgar: *Pomp and Circumstance March No. 1*. Halvorsen: *Entry of the Boyards*. Beethoven: *The Ruins of Athens: Turkish March*. Berlioz: *The Damnation of Faust: Hungarian March*. Ippolitov-Ivanov: *Caucasian Sketches: Procession of the Sardar*. J. Strauss, Sr.: *Radetzky March*. Verdi: *Aida: Grand March*. Band of the Grenadier Guards, Capt. R. B. Bashford cond. LONDON LPM 70074 \$6.95.

Interest: Bandmasters' staples  
Performance: Exemplary  
Recording: Bright  
Stereo Quality: Ample

There will always be an England as long as the men of the Grenadier Guards Band keep on playing with the vigor and precision they bring to this program of classic marches. Though most of the selections figure prominently in the repertoire of any band worth its military stripes, at least two, the *Turkish March* of Beethoven and the march from Sibelius' *Karelia Suite*, are infrequently heard in such form. But the arrangements in every instance are appropriate. The well-engineered recording emphasizes the crisp brilliance of the band's brass section and the transparency of its winds, but the heft of the big bass drum, in all but the *Hungarian March* by Berlioz, is left in the background. C. B.

#### RECORDING OF SPECIAL MERIT

© PHILADELPHIA ORCHESTRA: *Finlandia*. Sibelius: *Finlandia; Valse triste*; Grieg: *Peer Gynt: Suite No. 1*; Alfvén: *Midsommarvaka — Swedish Rhapsody*; Liszt: *Hungarian Rhapsodies Nos. 1 and 2*; Enesco: *Roumanian Rhapsodies Nos. 1 and 2*. Mormon Tabernacle Choir; Philadelphia Orchestra, Eugene Ormandy cond. COLUMBIA M2Q 575 \$11.95.

Interest: National romantic pops  
Performance: Mostly superb  
Recording: Good  
Stereo Quality: Good

This twin-pack omnium-gatherum of musical nationalism from Northern and East Central Europe falls pleasingly and stirringly on the ear in these propulsive and richly colored performances from Ormandy and his Philadelphians. I might take mild exception to a touch of heavy-handed lushness in *Peer Gynt*, and question whether there is any musical gain in having the Mormon Tabernacle Choir interpolate an English version of the *Finlandia* hymn into Sibelius' durable tribute to his native land—but these are minor reservations. The delightful Alfvén rhapsody

# Command Performance at your fingertips ...



... every time you capture the magnificent world of full fidelity sound on tape.

Taped sound retains full fidelity even after hundreds of playbacks ... yours to enjoy always ... on VIKING tape components, naturally.

A VIKING invests you with unlimited versatility to record live programs or off the air including F.M. multiplex, duplicate, put sound on sound and edit with perfect ease.

**Retro-matic 220** — ultimate performance with tomorrow's features for discriminating audiophiles and professionals only.

Two-directional playback, quarter track stereo at two speeds. "Feather-touch" push buttons, remote control, 12 watt amplifier, simultaneous record/playback with 20-25,000 cps frequency response. Independent channel controls, "luma-touch" record buttons and illuminated VU meters. Photo electric run-out sensor, four heads, hysteresis capstan motor plus two reel drive motors and digital counter. Superbly styled with stainless steel face plate this compact operates vertically or horizontally.



**88 Stereo Compact**—for connoisseurs of the fine things in high fidelity stereo sound.

Two speed tape recorder with choice of half or quarter track stereo. Three new type hyperbolic heads—no more old-fashioned pressure pads. New design amplifier with excellent 30-18,000 cps frequency response, lets you monitor off the tape with "A-B" comparison switch. Independent channel controls and VU meters, two motors, record indicator light, counter, automatic tape shut-off. With its attractive, brushed aluminum face panel, the 88 Compact fits any installation for vertical or horizontal operation.

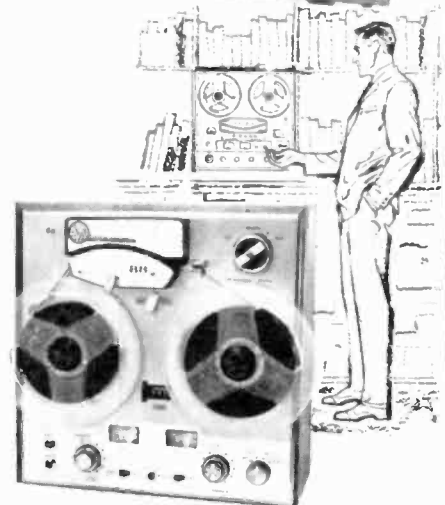

Put Command Performance at your finger tips with VIKING tape components — made by skilled American craftsmen.

Tape recorders, transports, cartridge players—even for your car or boat—at reputable high fidelity dealers most everywhere.



**Viking** OF MINNEAPOLIS, INC.

9600 Aldrich Avenue South, Minneapolis, Minnesota, 55420

Your assurance of Quality in Tape Components

# PURCHASING A HI-FI SYSTEM?

TRADE-INS O.K. TIME PAYMENTS

Up to 2 years to pay!

Send Us  
Your List Of  
Components  
For A  
Package  
Quotation

**AIREX  
WON'T BE  
UNDERSOLD**

All merchandise is  
brand new, factory  
fresh & guaranteed.

Visit our showroom  
Free cabinet brochure  
& Hi Fi Catalog

**AIREX  
RADIO**

CORPORATION

85-MR Corlandt St., N.Y. 7, WO 4-1820

CIRCLE NO. 2 ON READER SERVICE CARD

Jim Lansing\*  
Altec Lansing  
Electrovoice  
Jensen • Leak\*  
University  
Acoustic Research  
Janszen  
Wharfedale  
USL Citizen Band  
International Crystals  
Hallcrafters  
Texas Crystals  
Concertone • Viking  
Bell • G.E.  
Weathers  
Harman—Kardon  
Eico • Pilot  
Sherwood\*  
Superscope  
Dual Changer  
Bogen • RCA  
Dynakit • Fisher  
H. H. Scott  
KSC Speaker Systems\*  
ADC Speakers  
Finco • ECI  
DeWald  
Sony • Roberts  
Challenger  
Browning • National  
Garrard • Norelco  
Miracord  
General Radio  
Rek-O-Kut  
Polytronics  
Tandberg\*  
Fairchild  
ADC Cartridges  
Pickering • Sonar  
Audio Tape  
Magnecord\*  
Rockford Cabinets  
\*Fair Traded

## MOVING?



If you've recently changed your address or plan to in the near future, be sure to notify us at once. Place magazine address label here and print your new address below.

**NEW ADDRESS:**

NAME \_\_\_\_\_ PLEASE PRINT

ADDRESS \_\_\_\_\_

CITY \_\_\_\_\_ ZONE \_\_\_\_\_ STATE \_\_\_\_\_

Please fill in moving date below: \_\_\_\_\_

If you have any other questions about your subscription be sure to include your magazine address label when writing us.

Mail to: HiFi/STEREO REVIEW, 434 So. Wabash Avenue, Chicago 5, Illinois

sody comes off brilliantly here, and no one could ask for more idiomatic and colorful, or more beautifully recorded, versions of the Liszt and Enesco chestnuts. As a combination of pop-concert favorites, this tape is one of the very finest buys in the catalog. *D. H.*

## ENTERTAINMENT

© **RAY CHARLES:** *Recipe for Soul.* Ray Charles (vocals, piano); orchestra. *Busted; Where Can I Go?; Born To Be Blue; That Lucky Old Sun;* and six others. ABC-PARAMOUNT ATC 833 \$7.95.

Interest: Voice of despair  
Performance: Introspective  
Recording: Okay  
Stereo Quality: Adequate

This tape makes particularly evident blues singer Ray Charles' remarkable ability to make every ballad over into a personal statement of misfortune and despair. His renditions of Mel Tormé's *Born To Be Blue* and Beasley Smith's *That Lucky Old Sun* are cases in point. Charles can, however, let his emotions get out of hand, as he does here in the two songs that frequently tempt lesser artists into excesses—*Of Man River* and *You'll Never Walk Alone*. Preferable by far are his more outgoing treatments of *In the Evening, A Stranger in Town,* and *Of Man Time*, arranged by Benny Carter and Sid Feller. But the orchestrations by Marty Paich and Johnny Parker and the whooping choral effects provided by the Jack Halloran Singers are at odds with the introspective mood Charles so effectively establishes elsewhere. Good sound. *C. B.*

© **ODETTA:** *It's a Mighty World.* Odetta (vocals, guitar); Bruce Langhorn (second guitar); Leslie Grinage (bass). *Come a Lady's Dream; Sweet Potatoes; Chevrolet; Love Proved False;* and eight others. RCA VICTOR FTP 234 \$7.95.

Interest: Sermons in song  
Performance: Stirring  
Recording: Good presence  
Stereo Quality: Incidental

Almost none of the songs Odetta sings on this reel, her third, is particularly well known, and the liner notes tell us little of their origins. On the whole they may be described as songs of affirmation, ranging from the quiet simplicity of *Reminiscing* to ballads of hopeful expectation such as *I've Been Told* and *Got My Mind on Freedom*. The only digressions occur in the deeply moving *Love Proved False* and in the rather cute turn on one of those times America loves best—*John Brown's Baby (Has a Cold upon His Chest)*, subtitled *Camphorated Oil*. Once again, in all she sings, Odetta proves her-

self an artist of rare talent blessed with a strong voice and a fund of honest musicianship. She accompanies herself on the guitar, but is ably seconded by Bruce Langhorn with the discreet backing of Leslie Grinage on bass. The stereo engineering is impeccable. *C. B.*

## RECORDING OF SPECIAL MERIT

© **JAN PEERCE:** *Yiddish Folk Songs.* Jan Peerce (tenor); orchestra, Abraham Ellstein cond. *Sha, Shtil; Mai-Ko-Mashma-Lon; Vu Iz Dus Gesele; Vus Vet Zain As Meschiach Vet Kumen;* and eight others. VANGUARD VTC 1675 \$7.95.

Interest: Welcome repertoire  
Performance: Inspired  
Recording: Very good  
Stereo Quality: Acceptable

This reel offers, for the first time on tape, a full program of Yiddish folk music, in vocal-orchestral settings by Abraham Ellstein reminiscent of Joseph Canteloube's *Songs of the Auvergne*. These are not the songs of a specific



ODETTA

*Affirmation from a gifted artist*

region, but the songs of a people. Nor are they specifically songs of the past. Ivanovici's *Anniversary Waltz* is still sung at Jewish weddings the world over, and the Mahler-like *Partizaner*, a Partisan song of the Warsaw ghetto by Pokrass, is clearly of painfully recent origin. A few date back to the eighteenth-century Chasidic movement, but the majority were probably sung by the Eastern European Jew and the Jewish-American immigrant at the turn of the century. Jan Peerce sings them beautifully, at once revealing their simple beauty and great humanity. Helpful English translations are provided, though nothing is said in the notes of the songs themselves, of their peculiar relevance to Jewish history, or of their meaning to the men and women who *(Continued on page 115)*



# HiFi / STEREO MARKET PLACE

## SAVE MONEY ON HI-FI COMPONENTS

**TAPE RECORDERS  
TAPES, ACCESSORIES  
SLEEP LEARN KITS**

### MERITAPE

Low cost, high quality recording tape, in boxes or cans.

SEND FOR FREE CATALOG

**DRESSNER** 1523 JERICHO TPKE,  
NEW HYDE PARK 21, N.Y.

**PROMPT DELIVERY**

**LOW PRICES**

**AMPLIFIERS — MULTIPLEX —  
TAPE RECORDERS, TUNERS  
SPEAKER SYSTEMS, ETC.  
AIR MAIL QUOTES — COMPARE  
WRITE FOR CATALOG**

**AUDIO DIVISION  
L. M. BROWN SALES CORP**  
Dept. S-242 West 10th Street • New York 14, N. Y.

Write for our price now. You'll be glad you did. Easy pay plan. Up to 24 mos. to pay

- 15 day money-back guarantee
- Full 2 yr Warranty-Parts & Labor.
- Factory Franchised all lines. We ship from stock.
- Trade-ins Highest allowance-Send your list.
- Citizens Band, P.A. Systems in stock.
- 19th year of reliable service-world-wide.
- We guarantee "WE WILL NOT BE UNDERSOLD."

Best Buy, Hi-Fi List Free.

**HI-FIDELITY** CENTER  
"The House of Low Low Prices"

1797-H 1st Ave  
N.Y., N.Y., 10028

WRITE FOR QUOTATION  
ON ANY HI-FI COMPONENTS

**SOUND  
REPRODUCTION, INC.**

34 New Street, Newark 2, N. J.  
Mitchell 2-6816

**WOLLENSAK**  
Tape Recorders  
deliver a wallop bigger than many twice the size.

ATTN: SCHOOLS & GOVERNMENT PURCHASING AGENTS. We have the most complete selection anywhere. New models include: 524, 1400, 1440, 1500, 1515-4, 1570, 1700, 1580, 1980, 1981 and 422, & SA-421 speaker/amplifiers. Whether you order 1 or 1000 units, your order receives prompt attention.

REQUEST COMPLETE TAPE RECORDER DISCOUNT SHEET

**SAXITONE RECORDING TAPE**

275'	plastic, 3" (in malleable box)	.35
600'	acetate (plastic), 5 inch	.70
900'	MYLAR 5 inch reel	.75
900'	MYLAR (Polyester), 5 inch	.89
1200'	MYLAR, 1/2 mil, 5 inch reel	1.18
1200'	acetate (plastic), 7 inch	.99
1200'	MYLAR, 1 1/2 mil, (strong)	1.09
1800'	acetate (plastic), 7 inch	1.19
1800'	MYLAR 1 mil, thick, 7 inch	1.59
2400'	MYLAR, untensitized, 7 inch	2.49
2400'	MYLAR, tensitized, 7 inch	2.79
3000'	MYLAR, tensitized, 7" reel	3.89

Plus Postage (Greater discounts to quantity buyers)

Save 30-60%  
4-track Stereo music on tape. FREE 50-page catalog

**SAXITONE**  
div. Commission Electronics, Inc.  
1776 Columbia Rd. N.W., Washington 9, D.C.

**How to edit your mother-in-law — instantly!**

Treat yourself to a precision EdiTall Tape Editing and Splicing Block and do things with tape you've never done before. EdiTall's patented curved groove lets you splice, edit, reassemble without clips or gadgets. You cut and splice where you want to—quickly, undetectably. Used professionally all over the world, EdiTall is the standard editing block—so simple, so accurate, you'll become an expert tape editor in no time. And think how proud your mother-in-law will be! S-2 (Adhesive-Mount) \$6.50 • KS-2 (Complete Kit)—\$7.45 • S-3 (Mounting Holes) \$8.00 • KS-3 (Complete Kit)—\$8.95. At your dealers or write:

**THE TALL COMPANY**  
27 East 37th Street • New York, N. Y. 10016

**RENT GO**

**STEREO TAPES**

- Over 2500 different, 4-track
- No deposit on tapes rented
- Postpaid 2 to 5 day delivery (48 States)

FREE BROCHURE **stereo-parti**  
1616-B Terrace Wy, Santa Rosa, Calif.

**TAPEMATES**  
Makes available to you:

- ALL 4-Track Tapes
- ALL labels
- POSTPAID to Your Door

At **40%** Savings

FREE BROCHURE 5280-B West Pico Blvd. Los Angeles 19, Calif.

**What is ZIP Code?**

ZIP Code is a five digit distribution code designed to speed mail deliveries by cutting down on the steps now required to move a letter from sender to addressee. The code will also aid materially in the manual distribution of mail and will pave the way for mechanized distribution in post offices.

Ask your letter carrier or your post office for your ZIP Code—remember, it will speed your mail to you!

**FAST SHIPMENTS**

**COMPONENTS • KITS**

**TIME PAYMENTS**

- BEST-BY-COMPARISON PRICES
- FACTORY SEALED CARTONS
- SEND FOR "QUOTES" ON PACKAGE DEALS AND SAVE MORE

WRITE FOR MONTHLY SPECIALS  
VISIT OUR STORE  
**CARSTON Studios**  
125-H East 88 St., New York 28, N. Y.

**BRITISH HI-FI COSTS LESS WHEN YOU BUY DIRECT**

FROM **C. C. GOODWIN (Sales) Ltd.**  
The U.K. Hi-Fi Mail Order Specialists

All equipment carefully packed, insured and shipped promptly at minimum cost.

Send \$1 bill for illustrated catalogue (refundable on first purchase) and details of HiFi equipment required to:

DEPT. HS, 7, BROADWAY, WOOD GREEN, LONDON, N. 22, ENGLAND

**DIXIE**

**HIGH FIDELITY WHOLESALERS**

Largest discount High Fidelity component distributors in the South. Wholesale prices on package or individual components. Latest models in factory sealed cartons. Special attention given to Audio Clubs, Churches and Schools.

Are prices too high?—Write  
**DIXIE HI-FI**  
703 Horton Drive, Silver Spring, Md.

# HI FI/STEREO REVIEW CLASSIFIED

**COMMERCIAL RATE:** For firms or individuals offering commercial products or services. 50¢ per word (including name and address). Minimum order \$5.00. Payment must accompany copy except when ads are placed by accredited advertising agencies. Frequency discount: 5% for 6 months; 10% for 12 months paid in advance.

**READER RATE:** For individuals with a personal item to buy or sell. 30¢ per word (including name and address). No Minimum! Payment must accompany copy.

**GENERAL INFORMATION:** First word in all ads set in bold caps at no extra charge. Additional words may be set in bold caps at 10¢ extra per word. All copy subject to publisher's approval. **Closing Date:** 5th of the 2nd preceding month (for example, March issue closes January 5th). Send order and remittance to: Martin Lincoln, HI FI/STEREO REVIEW, One Park Avenue, New York, New York 10016.

## EQUIPMENT

**LOW**, Low quotes: all components and recorders. HiFi, Roslyn 9, Penna.

**WRITE** for quotation on any Hi Fi components: Sound Reproduction Inc., 34 New St., Newark, N.J. Mitchell 2-6816.

**SALE** items—tapes—recorders—component quotations. Bayla—Box 131R—Wantagh, N.Y.

**BEFORE** You Buy Receiving Tubes, Test Equipment, HiFi Components, Kits, Parts, etc. . . . send for your Giant Free Zalytron Current Catalog, featuring Standard Brand Tubes: RCA, GE, Etc.—all Brand New Premium Quality Individually Boxed, One Year Guarantee—all at Biggest Discounts in America! We serve professional servicemen, hobbyists, experimenters, engineers, technicians. Why Pay More? Zalytron Tube Corp., 461 Jericho Turnpike, Mineola, N.Y.

**TRANSISTORIZED** Products importers catalog, \$1.00 Intercontinental. CPO 1717, Tokyo, Japan.

**CANADIANS**—Giant Surplus Bargain Packed Catalogs. Electronics, HiFi, Shortwave, Amateur, Citizens Radio. Rush \$1.00 (refunded). ETCO, Dept. Z, Box 741, Montreal, CANADA.

**HI-FI** Components, Tape Recorders at guaranteed "We Will Not Be Undersold" prices. All brands in stock. 15 day money back guarantee. 2 year warranty. Write for quotation, your requirements. No Catalog. Hi-Fidelity Center-1797 1st Ave., N.Y. 28, N.Y.

**"BUY British—Buy Best!** For the finest in all High Fidelity Equipment write for our quotation first. The Hi-Fi Export Specialists! Send \$1 for catalogue. When in England call and see us. Telesonic Ltd. 92 Tottenham Court Road, London, W.1. England."

**TAPE** recorders. Hi-Fi components. Sleep Learning Equipment, tapes. Unusual values. Free catalog. Dressner, 1523HF Jericho Turnpike, New Hyde Park 9, N.Y.

**THE Price is Right!** Hi-Fi Components. J. Wright Co., 65-B Jensen St., East Brunswick, N.J.

**KIT Experts—DynaCo Specialists—Kits** at reasonable prices are our specialty. Also custom wired kits guaranteed to exceed factory standards at substantial savings. Beautiful handcrafted Walnut cases for complete Dynaco line starting \$16.95 each. Plus everything in audio. Kitcraft, Dept. HS464, 738 Washington Avenue, Brooklyn, N.Y. 11238, MA 2-6946.

**WALL** To Wall Stereo 12 Feet Wide. Loaded with Components. Exclusive. Locascio, 8420 51 Ave., Elmhurst, N.Y.

## FOR SALE

**ATTENTION**—Antique Edison Cylinder Phonographs, released from storage. All like new, complete—concert horn, stand, cylinders . . . Each \$80.00. Whitlock Storage, 114 State, Brewer, Maine.

**MULTIPLE** stereo 14 channel computer tape recorder, amplifier, etc. offers considered. Photo \$1.00. F. Jensen, 400 Ladera, Monterey Park, Calif.

**HI FI** Auction—Here's your chance to buy HiFi equipment at your own price. New—Tradeins—demonstrators. Send for our bid list. Knox Electronic, Dept. 344, Galesburg, Ill.

## TUBES

**BRAND** New Tubes. World's lowest prices on Radio, TV-industrial-special purpose tubes. Write for free parts catalog. United Radio, Newark, N.J.

## RECORDS

**RARE** 78's. State Category. Write Record-Lists, P.O. Box 2122, Riverside, California.

**"HARD** To Get" records—all speeds. Record Exchange, 812 Seventh Avenue, New York, N.Y.

**LPs** Like new, top labels. \$1.00 for lists refunded first order. Records, Hillburn P.O., Hillburn, N.Y.

**THE** Record Collector Journal—comprehensive, valuable data, varied record mart. Introductory six issues—\$1.50. Record Research, 131 Hart, Brooklyn 6, N.Y.

**CASH** for unwanted LPs. Reder, 81 Forshay Rd., Monsey, N.Y.

**SUPRAPHON** RECORDS AT ONLY \$2.45 EACH, plus postage. Dvorak, Janacek, Honegger, Shostakovich, etc. List of 500 titles mono/stereo available free. Also large deletions list, or 78 r.p.m. vocals, 50 pages air mail \$1.00. The Gramophone Shop, 901, Dumbarton Rd., Glasgow, W.1. Gt. Britain.

**LIFETIME** Listening Treasure! Herman Chittisc— "That's All." Magnificent Treasury of all-time favorites by one of the true piano greats of our time. Reminisce as Herman plays songs like Little Girl Blue, Smoke Gets in Your Eyes, Why, Tangerine, Easy to Remember, Touch of Your Lips, Dancing on the Ceiling, and Funny Valentine. Comes to you in astounding stereo (\$5.98), Monaural (\$4.98). L'Elegant, Suite 600HF, 110 W. 47th, NYC 10036.

**KIT:** Chemically treated static-free cleansing cloth. (Washable ten times.) Detergent tablets and dielectric sponge for washing, rinsing records. Brochure for care of Hi-Fi-Stereo records and needles. Non-Allergenic: \$1.00 PP. Nivol, Box 91, Brooklyn 19, N.Y.

## TAPE AND RECORDERS

**RENT** Stereo Tapes—over 2,500 different—all major labels—free brochure. Stereo Parti, 1616-G Terrace Way, Santa Rosa, California.

**SAVE** 30-60% Stereo music on tape. Free bargain catalog/blank tape/recorders/Norelco speakers. Saxitone, 1776 Columbia Road, Washington, D.C.

**SELF-Hypnosis.** New concept teaches you quickly by tape or LP-recording. Free literature. McKinley Publishers, Dept. T4, Box 3038, San Bernardino, Calif.

**TAPE** Recorder Sale. Latest models, \$10.00 above cost. Arkay Sales, 22-11 Riverside Ave., Medford 55, Massachusetts.

**BEFORE** renting Stereo Tapes try us. Postpaid both ways—no deposit—immediate delivery. Quality—Dependency—Service—Satisfaction prevail here. If you've been dissatisfied in the past, your initial order will prove that this is no idle boast. Free Catalog. Gold Coast Tape Library, Box 2262, Palm Village Station, Hialeah, Florida.

**TAPE** Recorders Traded! Free Recorders-Tape Catalog! Towers, Lafayette Hill, Penn. 19444.

**RECORDS** To Tape: lps or singles, stereo or monaural, 2t or 4t, 7½ or 3¾ips, 2t to 4t, send me a sample lp I'll tape same for you in 2t at \$3.00, 4t \$2.70, price list free, Tapes; 509 East Wells St., Milwaukee, Wisconsin 53202.

**"TWO** New Revere T 2200 companion units \$50. @ original cartons. Also big discounts Revere Tape Cartridge systems." Ferris TV, Aust.n, Minn.

**HIGHEST** quality 1800' Mylar 5 9.45, 2400' 4/10.55 postpaid, guaranteed. Unusual values, components, recorders. Catalog. Pofe, 1716-N Northfield, Muncie, Indiana.

**JUDY GARLAND** FANS: Rare tapes never previously recorded commercially. For information, write: Garland Tapes, 2657 Bedford St., Los Angeles 34, Calif.

**RECORD** more sales by placing your ad in these columns. An order form is printed at the end of this section. Send it in today to: Martin Lincoln, 1 Park Ave., New York, N.Y. 10016.

## REPAIRS AND SERVICES

**TAPE** Recorder and HiFi repairs. Amplifiers, tuners, turntables. All American and foreign makes serviced. Estimates in 48 hrs. after receiving equipment from any part of U.S. Macken Electronics, 5 West Post Road, White Plains, N.Y., WH9-9777.

**ALL** Makes of Hi-Fi Speakers Repaired. Amprite, 168 W. 23 St., N.Y.C. 10011, CH 3-4812.

**TV** Tuners Rebuilt and Aligned to Specifications. Guaranteed All Makes, One Price. \$9.50 Complete. Plus Shipping. Valley Tuners, 5641-H Cahuenga Blvd., North Hollywood, California.

**HI-FI** Problems solved by "The Hi-Fi Doctor" on the spot. Audio, Acoustic, Radio Engineer, Professional visits, day, evening. New York area. William Bohn, Plaza 7-8569.

**TELEFIXIT** Alltime Bestseller Nontechnical TV Repair Book with Famous Troubleshooting Charts, 60¢ postpaid 2 for \$1.00. Telefixit, Box 714, Manhasset 4, N.Y.

## MUSIC

**POEMS** wanted for songs and records. Send poems. Crown Music, 49-RB West 32, New York 1.

## PATENTS

**INVENTIONS:** Ideas developed for Cash/Royalty sales. Raymond Lee, 2104G Bush Building, New York City 36.

## BOOKS

**AUTHORS!** Learn how to have your book published, promoted, distributed. Free booklet "ZD," Vantage, 120 West 31 St., New York 1.

**"POSTAGE** Saving Guide!" \$1.00. Billera, 38 Circle Drive, Syosset, New York 11791.

## MAGAZINES

**COMPLETE** set HiFi-Stereo Review magazines. Best offer. Rossow, Rt. 1, Box 307, Mission, Texas.

## BUSINESS OPPORTUNITIES

**INVESTIGATE** Accidents—Earn \$750 to \$1,000 monthly. Men urgently needed. Car furnished. Business expenses paid. No selling. No college education necessary. Pick own job location. Investigate full time. Or earn \$6.44 hour spare time. Write for Free Literature. No obligation. Universal, CZ-4, 6801 Hillcrest, Dallas 5, Texas.

**I MADE** \$40,000.00 Year by Mailorder! Helped others make money! Start with \$10.00—Free Proof. Torrey, Box 3566-N, Oklahoma City 6, Oklahoma.

**MAKE** \$25-\$50 weekly clipping newspaper items for publishers. Some clippings worth \$5.00 each. Particulars free. National, Box 718, Long Beach, N.Y.

**\$100** weekly possible. Address-mail letters featuring real merchandise. Get \$10 orders in every mail-keep \$8 profit. Everything furnished. Details free. National Plans, Box 718, Long Beach, N.Y.

## EMPLOYMENT INFORMATION

**FOREIGN** Employment. Construction, other work projects. Good paying overseas jobs with extras, travel expenses. Write only: Foreign Service Bureau, Dept. D, Bradenton Beach, Fla.

## EDUCATIONAL OPPORTUNITIES

**LEARN** White Asleep, hypnotize with your recorder, phonograph. Astonishing details, sensational catalog free! Sleep-Learning Association, Box 24-ZD, Olympia, Washington.

**HIGHLY**-effective home study review for FCC commercial phone exams. Free literature! Wallace Cook, P.O. Box 10682, Pittsburgh, Pa. 15235.

LEARN While Asleep. Remarkable. Scientific, 92% Effective. Details Free ASR Foundation, Box 7021, Dept. e. g., Lexington, Kentucky.

## STAMPS

U.S. STAMPS Plus Complete U.S. Catalog. All for 10¢—Four sensational offers in one: 1. Genuine centennial postage stamp, picturing first U.S.A. (issued 117 years ago!) 2. Valuable collection all-different U.S.—Ancient 19th Century, \$1.00 stamp, etc. 3. Collection beautiful commemoratives: American Revolution, Wild West, 1893 Columbian, many others. 4. Collector's Guide; exciting stamp offers for your inspection; Big new U.S. Bargain Catalog. Send only 10¢. Act Now! H.E. Harris, Dept. C-605, Boston 17, Mass.

WOW! 110 All Different Germany 10¢! Zeppelins, Semi-Postals, Airmails, High values, etc. Giant Catalog, bargain lists included with beautiful approvals. Jamestown Stamp, Dept. A44EG, Jamestown, N. Y.

## HELP WANTED

EARN Extra money selling advertising book matches. Free samples furnished. Matchcorp., Dept. MD-44, Chicago 32, Illinois.

## PHOTOGRAPHY—FILM EQUIPMENT, SERVICES

SCIENCE Bargains—Request Free Giant Catalog "CJ"—148 pages—Astronomical Telescopes, Microscopes, Lenses, Binoculars, Kits, Parts. War surplus bargains. Edmund Scientific Co., Barrington, New Jersey.

MEDICAL FILM—Adults only—"Childbirth" one reel, 8mm \$7.50; 16mm \$14.95. International H, Greenvale, Long Island, New York.

## GOVERNMENT SURPLUS

GOVERNMENT Surplus Receivers, Transmitters, Snooperscopes, Parabolic Reflectors, Picture Catalog 10¢. Meshna, Nahant, Mass.

JEEPS \$64.50, boats \$6.18, typewriters \$4.15, airplanes, electronics equipment, thousands more, in your area typically at up to 98% savings. Complete directory plus sample Surplus Marketletter \$1.00. Surplus Service, Box 820-L, Holland, Michigan.

## MISCELLANEOUS

WILD Labels, bumper strips! Strange, startling, unconventional! Krazy Labels, Box 15-H, Olympia, Washington.

BEER, Like Bread, Is Better Homemade. New Homebrew kit makes it for 2¢ a bottle. Easy, step-by-step instructions, plus hydrometer for perfect carbonation, no guesswork. \$3.00, no C.O.D. Satisfaction guaranteed. Evinco-J, Box 382, Ann Arbor, Michigan.

## REAL ESTATE

CANADIAN Lands, seized and sold for taxes. Our 47th annual series of lists, describe many choice properties, situated from coast to coast, acquired by us through Tax Sale. Priced as low as five dollars per acre, guaranteed perfect title, small monthly payments, no mortgage. Beautifully situated hunting and fishing camps, where there is real sport; summer cottage sites, heavily wooded acreages. Now is the time to invest in Canada's minerals, forests and farms. Write today for free twenty page booklet with full explanation. Tax Sale Service, Room 301-Z, 85 Bloor St., E., Toronto 5, Canada.

## WANTED

QUICKSILVER, Platinum, Silver, Gold. Ores Analyzed. Free Circular. Mercury Terminal, Norwood, Mass.

TWO new Electro-Voice Regency kits. Write: Fritzsche Navshipco, APO 285, New York, N. Y. Air Mail.

sang them. The recorded sound is entirely satisfactory. C. B.

© KATE SMITH: *At Carnegie Hall*. Kate Smith (vocals); orchestra and chorus, Skitch Henderson cond. *When the Moon Comes Over the Mountain; Who Cares?; I'll Be Seeing You; Moon River*; and eleven others. RCA Victor FTP 1248 \$7.95.

Interest: Nostalgic occasion  
Performance: Heartwarming  
Recording: Very good  
Stereo Quality: Balanced

It has been some time since we have heard or seen the words "Ted Collins Presents. . ." Radio audiences will remember them, however, and so will television viewers of more recent years, for Ted Collins presents none other than Kate Smith. And so he does again with this tape release documenting Kate's first personal appearance on stage in over thirty years, at Carnegie Hall last fall. The recording inevitably stirs memories of times past—songs such as *When the Moon Comes Over the Mountain* and *God Bless America*, sung by the woman who introduced them (the latter on Armistice Day in 1938), are bound to. But there is more to this reel than nostalgia. Miss Kate Smith is still a formidable artist endowed with vocal resources that are sufficient to move any mountain the moon won't rise over. She brings the same warmth and enthusiasm to the oldies—*Who Cares?*, *Margie*, *Carolina Moon*—and to the newcomers—*This Is All I Ask*, *What Kind of Fool Am I?*, and

*As Long as He Needs Me*. Unlike many singers today who aim at the listener's viscera, Miss Smith aims straight at the heart and scores a hit every time. Because of fairly close miking she sometimes overpowers the sizable orchestra under Skitch Henderson's direction, but the recording is notable for balanced, full-bodied sound. C. B.

© KAI WINDING. Kai Winding (trombone); orchestra. *Get Lost; Only in America; Hey, Girl; The Lonely One*; and eight others. VERVE VSTC 305 \$7.95.

Interest: Commercial pops  
Performance: Punchy  
Recording: Robust  
Stereo Quality: Distinct

This package is what is known in the business as a rack job—a collection of miscellaneous pops put together to sell in drugstores and supermarkets on the assumption that the name of the top tune or featured artist will attract buyers. That name here is Kai Winding, a trombonist best known to jazz fans for his work with Stan Kenton, Miles Davis, and J. J. Johnson. The music is frankly commercial, consisting mostly of rhythm-and-blues dance numbers that never really come to an end. Like old soldiers, they simply fade away, an annoying device that seems to please the juke-box trade. Winding himself is credited with one tune (*Far Out East*) and has arranged several of the others, including the theme from television's *Mr. Novak*, but his solo contributions are minimal in both quantity and quality. C. B.

## CLASSIFIED ADVERTISING ORDER FORM

Please refer to heading on first page of this section for complete data concerning terms, frequency discounts, closing dates, etc.

1	2	3	4	5
6	7	8	9	10
11	12	13	14	15
16	17	18	19	20
21	22	23	24	25
26	27	28	29	30
31	32	33	34	35

\_\_\_\_\_ Words } @ .30 Reader Rate } = \$ \_\_\_\_\_  
 } @ .50 Commercial Rate }  
 Insert \_\_\_\_\_ time(s) Total Enclosed \$ \_\_\_\_\_

NAME \_\_\_\_\_

ADDRESS \_\_\_\_\_

CITY \_\_\_\_\_ ZONE \_\_\_\_\_ STATE \_\_\_\_\_

SIGNATURE \_\_\_\_\_

WORD COUNT: Include name and address. Name of city (Des Moines) or of state (New York) counts as one word each. Zone or Zip Code numbers not counted. (Publisher reserves right to omit Zip Code if space does not permit.) Count each abbreviation, initial, single figure or group of figures or letters as a word. Symbols such as 35mm, COD, PO, AC, etc., count as one word. Hyphenated words count as two words. HF-464

# HIFI/STEREO REVIEW ADVERTISERS' INDEX

READER SERVICE NO.	ADVERTISER	PAGE NO.
1	Acoustic Research, Inc.	103
2	Airex Radio Corporation	112
3	Allied Impex Corporation	35
59	Altec Lansing Corporation	33
4	Ampex Corporation	3rd COVER
60	Ampex Corporation	94
5	Audio Dynamics Corporation	32
6	Audio Unlimited, Inc.	110
61	Benjamin Electronic Sound Corp.	39
7	British Industries—Garrard Brown Sales Corp., L. M.	2 113
62	Cambridge Records, Inc.	86
8	Capitol Records Carston Studios	99 113
9	Citadel Record Club	83
10	Columbia Records	74, 75
63	Command Records Commission Electronics, Inc.	10 113
11	Concertone	5
12	Concord Electronics Corporation Dixie Hi-Fi Dressner	31 113 113
13	Dymo Industries, Inc.	101
64	Eastman Kodak Company	109
14	EICO Electronic Instr. Co., Inc.	40
15	Electro-Voice, Inc.	4th COVER
16	Elpa Marketing Industries, Ortofon Division	79
17	EMI (Scope Electronics Corp.)	16
18	Empire Scientific Corp.	24, 25
19	Finney Company, The	86
20	Fisher Radio Corporation	6, 7
21	Fuji Photo Optical Products, Inc. Goodwin (Sales) Ltd., C. C.	76 113
22	Grado Laboratories, Inc.	34
23	Grommes, Division of Precision Electronics, Inc. Hansom Books	8 110
24	Harman-Kardon, Inc.	29
25	Heath Company Hi-Fidelity Center	85, 87, 89 113
26	Honeywell Photographic Products	12
27	Inter-Mark Electronics Ltd.	23
28	Jensen Manufacturing Company	80, 81
Classified Advertising		114, 115

READER SERVICE NO.	ADVERTISER	PAGE NO.
29	KLH Research and Development Corp.	71
30	Kenwood Electronics, Inc.	96
31	Koss Electronics, Inc.	108
32	Lafayette Radio Electronics	99
33	Lansing Sound, Inc., James B.	36
34	Library of Recorded Masterpieces London Records	78 88
35	Magnecord	15
36	Martel Electronics	88
37	Mercury Records Minneapolis-Honeywell (See Honeywell)	102 11
38	Minnesota Mining & Manufacturing Co.	14
39	Mosley Electronics, Inc.	98
66	Mosley Electronics, Inc.	9
40	Pickering and Company, Inc.	9
65	RCA Electronic Components and Devices	105
41	RCA Parts and Accessories	110
42	Rabsons—57th Street, Inc.	78
43	Reeves Soundcraft	21
44	Rek-O-Kut Company, Inc.	90
45	Roberts Electronics, Inc. Saxitone	93 113
100	Scott, Inc., H. H.	2nd COVER, 1
46	Sherwood Electronic Laboratories, Inc.	26
47	Shure Brothers, Inc.	19
48	Sonotone Corporation	22
49	SONY Corporation of America Sound Reproduction, Inc.	72 113
50	Stereo Components Stereo-Parti	13 113
51	Suporex	99
52	Superscope, Inc. Tall Company, The Tapemates Club	106 113 113
53	United Audio Products	20
54	University Loudspeakers	95
55	Vanguard Records	84
56	Viking of Minneapolis, Inc.	111
57	Winegard Co.	100
58	Zeiss, Inc., Carl	82
Classified Advertising		114, 115

## HIFI/STEREO REVIEW PRODUCT INDEX

As an additional reader service, we list below, by classifications, the products advertised in this issue. If there is a specific product you are shopping for, look for its listing and turn to the pages indicated for the advertisements of manufacturers supplying that equipment.

CLASSIFICATION	PAGE NUMBERS
Accessories	14, 98
Amplification Systems	6, 7, 8, 13, 26, 29, 40, 87
Antennas, FM	86, 100, 110
Cameras	12, 76, 82
Cartridges, Phonograph	9, 13, 19, 22, 32, 34, 79
Headphones	99, 108
Label Maker	101
Microphones	105
Portable Radios	72

CLASSIFICATION	PAGE NUMBERS
Records	10, 74, 75, 78, 83, 84, 86, 88, 99, 102
Speakers and Speaker Systems	13, 16, 24, 25, 26, 36, 40, 71, 80, 81, 95, 4th Cover
Tapes, Prerecorded	94
Tape, Recording	11, 21
Tape Recorders and Decks	5, 15, 23, 31, 35, 40, 88, 93, 106, 111, 3rd Cover
Tuners and Tuner-Amplifiers	2nd Cover, 1, 6, 7, 8, 26, 40, 85, 87, 96
Turntables and Changers	2, 13, 20, 39, 90, 103
TV	89

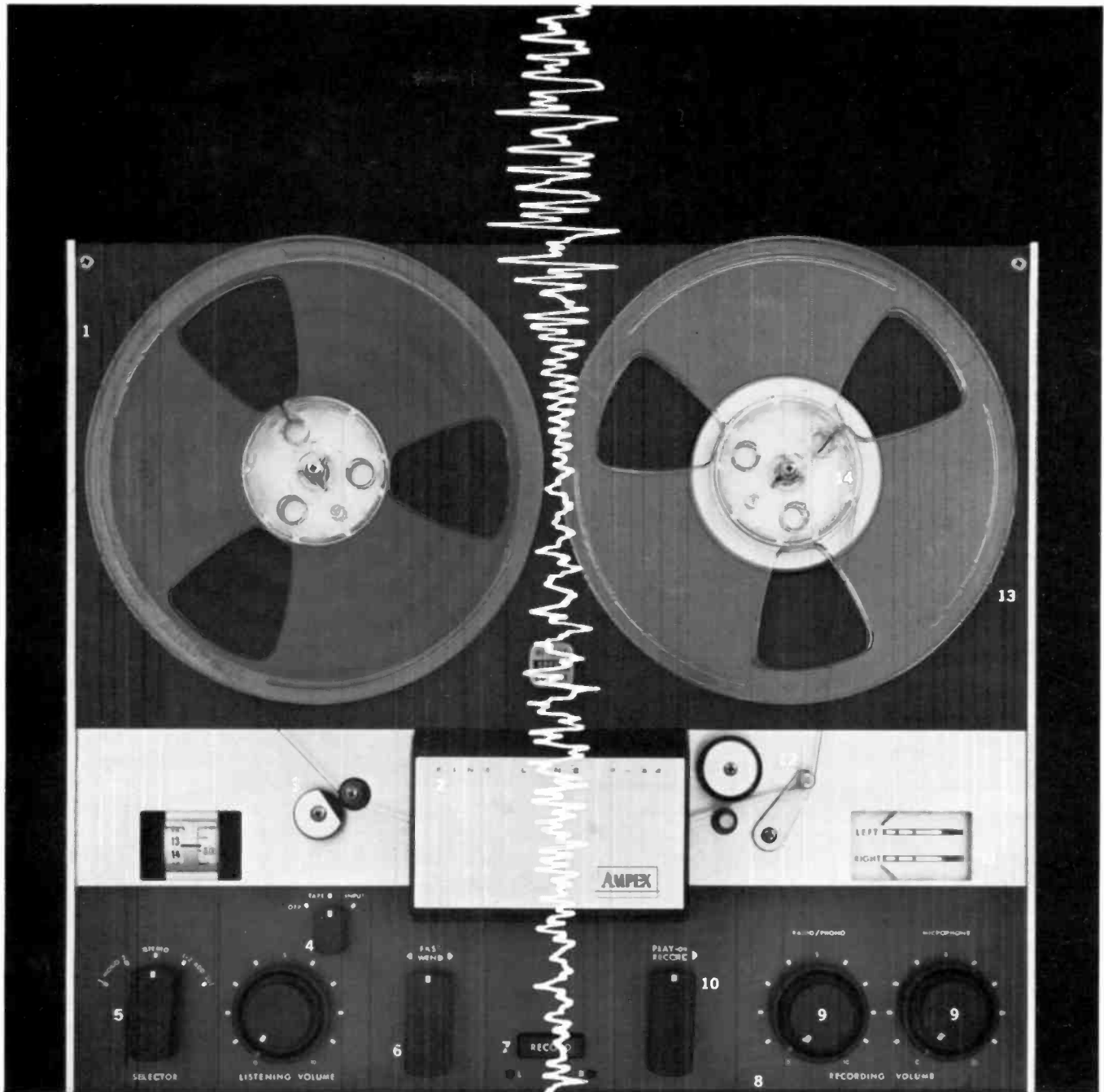

## Fourteen ways to save money on your next tape recorder

Before you buy, compare the features of the Ampex F-44 with those of any other recorder in its price range. Note the features the F-44 has that the others don't. Then compare price, and you'll see what a bargain the F-44 actually is. In fact, if you can find a better bargain, buy it. 1) *Professional Electronics*. Each F-44 recorder is individually tuned and adjusted by Ampex technicians to meet or exceed the following standards: Overall frequency response 50-15,000 cps  $\pm$  2db at 7½ ips; 50-10,000 cps + 2-4 db at 3¾ ips. Signal-to-noise ratio: better than 53 db. Flutter and wow: 0.12% rms at 7½ ips; 0.18% rms at 3¾ ips. 2) *Three separate heads*. Each head in the F-44 is built to perform its own individual task (recording, playing or erasing), with no compromise of purpose in attempting to make one head serve several functions. Precision engineered head shielding virtually eliminates crosstalk. 3) *Advanced tape-tension system* eliminates the use of pressure pads, by feeding tape or transporting it past the

heads under constant tension adjusted at the factory. 4) *New, separate power and monitor switch* makes it possible to monitor both source and playback while you're recording. 5) *Master selector switch* permits simple changes from stereo to mono, choice of individual track, multiple generation sound-on-sound-on-sound.

6) and 10) *New compartmentalized mode-to-mode controls*. Two knobs control all transport actions, permit going from one mode to another quickly and safely. 7) *Record indicator lights*. One for each channel. 8) *Die-cast frame*. Micro-milled for meticulous alignment. 9) *Built-in mixer*, with separate volume controls for recording of 4 inputs. 11) *Separate record level meters*. 12) *Exclusive unattended shut-off*. 13) *New hysteresis synchronous motor*. 14) *Automatic tape take-up*. Makes threading easy. For brochure, write Ampex Corporation, Consumer and Educational Products Division, 2201-B Landmeier Road, Elk Grove Village, Illinois. In Canada, Ampex of Canada Ltd., Rexdale, Ontario.



# Resolved: The Conflict Between Compact Size and Big Speaker Performance!

The E-V SIX represents an entirely new trend in speaker system design: a creative synthesis of big system performance and compact convenience in an enclosure that fits all but the very smallest listening rooms.

The development of the E-V SIX was unique. As with all new E-V speaker systems, the initial concept underwent rigorous testing in the Electro-Voice laboratories. The prototype E-V SIX then went "on the road" for extended listening tests by a wide cross section of expert listeners. This testing probed for weak spots in sound character that cannot be revealed by the most exacting laboratory analysis. The final result left no doubt in the minds of listeners and engineers alike that here was a speaker system of moderate size, but with the performance attributes of a much larger system.

If this sounds like a new E-V doctrine, let's clarify a bit: we have always said — and still say — that, the larger the system, the better the sound in the fundamental first three octaves. While great strides have been made in reducing the limitations of small woofers and enclosures, a good big system is, all other factors being equal, much to be preferred over an equivalent small system. We know. We make them both. And now, with the E-V SIX, a third size emerges that combines the advantages of both sizes.

To get down to cases, only the E-V SIX uses an 18-inch woofer, over 2¼ times larger in area than the typical woofer in bookshelf-size systems. It is primarily this increase in area that contributes to unusually smooth bass response, extended range, and increased efficiency. The 18-inch diameter foam-plastic cone, combined with a long-throw voice coil, high flux magnetic system, and high compliance acoustic suspension allows the E-V SIX to move up to five times more air than competitively priced systems.

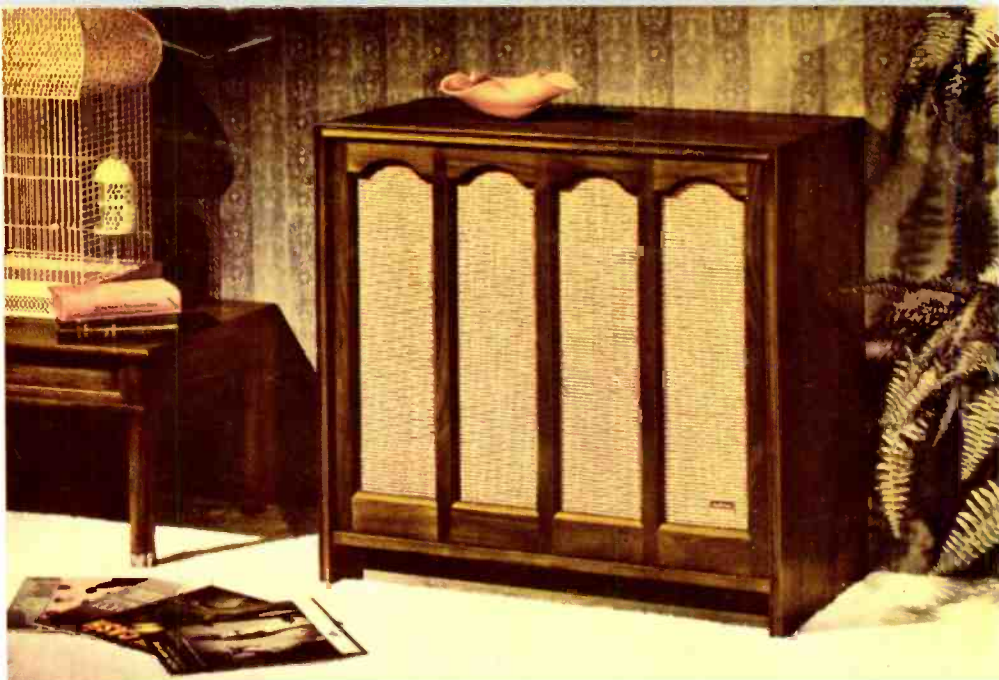

Distortion reduction is the result of about 50% less cone motion at every sound level. This means minimum nonlinearity due to excessive cone excursions. And you can hear this difference. Bass is "effortless" in sound as well as in fact. There is virtually no bass "doubling" that increases loudness at the expense of authenticity.

But a woofer properly designed for optimum bass performance cannot do justice to higher frequencies. In the E-V SIX there are three other component speakers — equally sophisticated — to handle the higher ranges.

Mid-bass frequencies from 250 to 800 cps are developed by a specially designed 8-inch speaker whose characteristics exactly complement the 18-inch woofer. From 800 to 3,500 cps a true compression-loaded driver with diffraction horn preserves the vital presence tones that add definition to both voice and music. The diffraction horn ensures uniform dispersion of sound throughout the listening area. The driver employs a "ring" diaphragm (lacking a central dome that is the frequent cause of distortion in this range.)

From 3,500 cps to beyond audibility (20,000 cps) a deluxe compression-loaded driver and diffraction horn completes the E-V SIX speaker complement. And all of these specialized audio instruments are combined and controlled by an electrical crossover network that utilizes the latest techniques in etched circuit board construction. A 5-position control is provided to discreetly balance the output of the E-V SIX to your listening room characteristics.

And what about E-V SIX appearance? No photograph can do justice to its hand-rubbed walnut or mahogany finish, or to the elegance of its traditional styling. And the moderate E-V SIX dimensions allow great flexibility of placement. Height is but 30 inches, width is 32 inches and depth only 17½ inches. The price is equally moderate: just \$330.00 in either finish.

We believe the E-V SIX heralds a new era in speaker system design, based on greater emphasis on performance. The task of providing a distinct improvement in sound quality with but a modest increase in size has proved both stimulating and rewarding. We urge you to consider carefully the advantages of the E-V SIX for your high fidelity system. You can hear it now at your Electro-Voice showroom. Write today for free catalog and name of the E-V dealer nearest you.

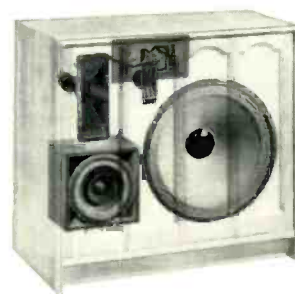

*E-V SIX components include:  
18-inch acoustic suspension woofer  
8-inch mid-bass speaker | Etched circuit crossover  
Ring-diaphragm mid-range driver  
Compression-loaded diffraction VHF driver*

**ELECTRO-VOICE, INC.**  
Dept. 444F, Buchanan, Michigan

CIRCLE NO. 15 ON READER SERVICE CARD



E-V TWO  
\$108.00



E-V FOUR  
\$136.00



REGINA  
\$96.00



E-V SIX  
\$330.00

**Electro-Voice**<sup>®</sup>  
SETTING NEW STANDARDS IN SOUND