

110/12

HiFi/Stereo Review

DECEMBER 1963 • 50 CENTS

RICHARD WAGNER:
TWILIGHT
OF A GOD

ROUNDUP OF
MEDIUM-PRICE
HI-FI EQUIPMENT

RECOMMENDED
RECORDS FOR
CHILDREN

A TRIBUTE TO
BRUNO WALTER



“...one of the finest...stereo tuner/amplifiers we have tested...”

Hirsch-Houck Laboratories — *Electronics World*

“...a caliber of sound which should satisfy the most critical listener...”

*Hi-Fi/Stereo Review**

The experts enthusiastically support Peter Arnow's experience with the remarkable 340. Here is a tuner/amplifier that sets new performance standards. The unbeatable sensitivity of Scott tuners and the solid power of Scott amplifiers have been combined without compromise. Every worthwhile feature is here to satisfy the most demanding audio enthusiast — silver-plated, wide-band front end — oversized output transformers — aluminum chassis for low hum and cool operation. Auto-sensor circuitry swiftly and automatically switches the mode of operation to stereo when you tune to a stereo broadcast. Front panel indicator signals you when this happens.

The 340B may work like a laboratory instrument, but it doesn't look like one. The sculptured front panel, handsome new knobs, the easy-to-read slide-rule dial — will please the most fastidious decorator.

To sum up the merits of this exciting new instrument, in the words of Peter Arnow:

“The 340B is a remarkable achievement. It is extremely sensitive, comparable to the finest separate FM tuners

we've checked. The tuning action is the smoothest I've ever seen. Esthetically the 340B is a perfect piece of hi fi equipment; it performs like a dream! But then we've never had a piece of Scott equipment that didn't.”

SPECIFICATIONS:

Dimensions : 16 $\frac{3}{4}$ "W, 5 $\frac{1}{2}$ "H, 13 $\frac{5}{8}$ "D. Dimensions in accessory case: 17 $\frac{1}{2}$ "W, 6 $\frac{1}{4}$ "H, 16 $\frac{3}{4}$ "D. Tuner Section: Usable Sensitivity (IHF) 2.2 μ V; Signal: Noise Ratio (db below 100% mod) 60; Harmonic Distortion 0.8%; Drift 0.02%; Frequency Response (cps + 1 db) 20-20,000; Capture Ratio 6.0 db; Selectivity 35 db; Spurious Response Rejection 80 db; AM Suppression 55 db; Tuning Range 87 to 109 mc; Accuracy of calibration 0.5%; Separation better than 30 db. Amplifier Section: Music power each channel 35 watts; Steady state power each channel 30 watts; Power bandwidth (IHF) (\pm 1.0 db) 20-20,000; Harmonic distortion 0.8%; Hum and Noise 80 db. Price: \$399.95.

Prices slightly higher west of Rockies. Accessory cases extra.

*For the complete reviews from which these excerpts were taken, refer to *Electronics World*, Feb. 1963, and *HiFi/Stereo Review*, June 1963.

NEW AM-FM MODEL 380



If you desire superb AM as well as FM Stereo reception, the new Scott 380 should be your choice. It provides Scott Wide-Range AM as well as all the features and performance of the 340B. Hirsch-Houck Laboratories acclaimed Scott's AM circuitry as “the finest . . . we know of on the current market.” AM reception is virtually indistinguishable from FM thanks to Scott's bandwidth switch. Distant stations can be received with minimal noise and low distortion by moving the bandwidth switch to the distant position. Here is a tuner/amplifier that satisfies every requirement for varied program material combined with superb quality. **\$459.95**



H. H. Scott, Inc.

111 Powdermill Road
Maynard, Mass.

Dept. 245-12

Send me complete information on the Scott 340B and your new 1964 Guide to Stereo.

Name _____

Address _____

City _____ Zone _____ State _____

Include names of interested friends, and we'll send them duplicate materials.

Export: Morhan Exporting Corp., 458 Broadway, N.Y.C.
Canada: Atlas Radio Corp., 50 Wingold Ave., Toronto

“The performance of the 340B was amazing!

It's the first tuner/amplifier good enough to monitor our broadcasts in the canyons of Manhattan.”

Peter Arnow, Director of New York's pioneer multiplex station WDHA-FM



The remote broadcast station installation of WDHA-FM at the recent New York High Fidelity Show. Mr. Arnow, at the controls, is using the Scott 340B as a station monitor.

WDHA-FM faced a serious reception problem while operating remotely at the New York Hi Fi show. Signals from their transmitter located in Dover, N. J. were extremely difficult to receive due to the surrounding steel-framed buildings, and space was at a premium. Peter Arnow, the station's director, chose a Scott 340B for this critical task. He was able to make perfect off-the-air checks at this remote location.

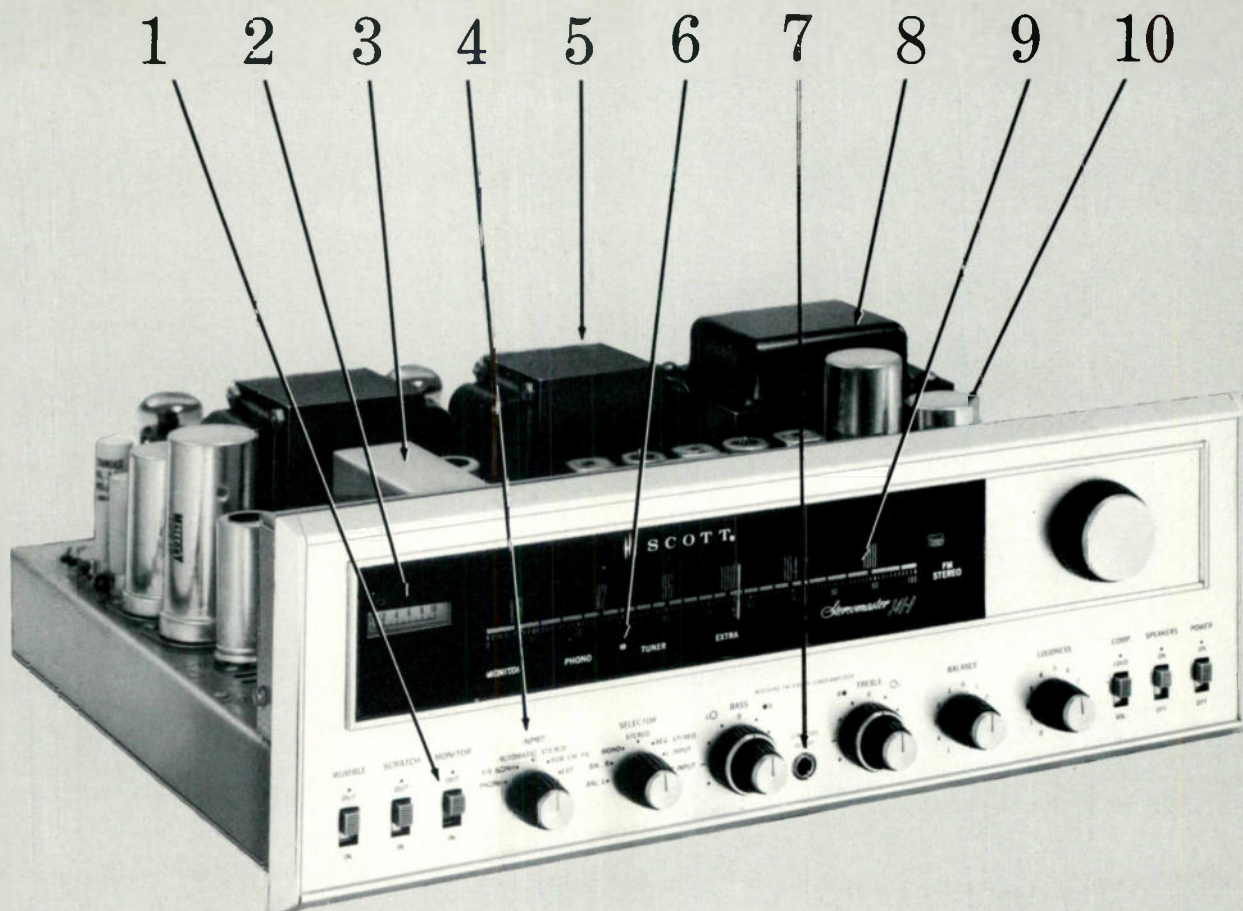

Unique Features of the Remarkable 340B

- 1 Complete tape monitoring facilities. All controls operate on playback.
- 2 Precision illuminated d'Arsonval meter for pinpoint tuning of all signals.
- 3 "Time-Switching" multiplex circuitry provides full frequency response with extremely low distortion. Separation exceeds FCC specifications.
- 4 Auto-Sensor circuitry instantly and automatically chooses correct mode of operation.
- 5 Powered third channel for direct connection of remote speakers or for a three-channel system.
- 6 Unique indicator lights prevent inadvertent use of Tape Monitor control.
- 7 Convenient front panel low level output for monitoring of program.
- 8 Massive power and output transformers to assure the superb performance ordinarily found only with separate components.
- 9 Easy-to-use, easy-to-read precision slide rule tuning mechanism, with convenient logging scale.
- 10 Silver-plated RF circuitry, the same used in the tuner selected by Bell Laboratories for one of their pioneering Telstar experiments.

“my daddy bought us
a Garrard Automatic
Turntable...he says
it's worth a million!”

“my daddy
bought us a boat...
he says it's worth
\$20,000”



What makes a Garrard worth a million? Pleasure . . . the pleasure of an incomparable experience in sound. Why? Because the Garrard Automatic Turntable integrates a dynamically balanced tone arm, counter-weight adjusted . . . a full size turntable, cast heavy and balanced . . . correct torque stemming from the Garrard Laboratory Series® motor. The Garrard arm takes your choice of cartridge . . . even the ultra-sensitive, high-compliance types labeled “professional”. This arm brings out the best in any cartridge . . . tracking and tripping at the lowest pressure specified by the cartridge manufacturer. The unit is quiet . . . speed even . . . sound pure, undefiled by rumble or resonance.

Garrard offers the convenience of automatic play and automatic shut-off even after single records. And, should your Garrard ever need maintenance, you will find that it is supported by the industry's best stocked, best trained, authorized service network. There is a Garrard for every high-fidelity system. Type A, \$79.50; AT6, \$54.50; Autoslim, \$39.50. For literature, write Department GX-123, Garrard, Port Washington, N.Y.



Garrard[®]
WORLD'S FINEST

CIRCLE NO. 16 ON READER SERVICE CARD

HiFi/Stereo Review

DECEMBER 1963 • VOLUME 11 • NUMBER 6

THE MUSIC

- 31** THE BASIC REPERTOIRE
Prokofiev's Peter, Saint-Saëns' Carnival..... MARTIN BOOKSPAN
- 35** WAGNERDÄMMERUNG
Observations on the dethronement of a god..... FREDERIC GRUNFELD
- 43** A CHRISTMAS GUIDE TO CHILDREN'S RECORDS
A few words for wise parents..... HERBERT MITGANG
- 48** A GIFT OF SOUND
A panorama for the armchair shopper..... ROBERT OFFERGELD
- 50** BRUNO WALTER'S LAST RECORDING SESSIONS
A memoir of a remarkable man..... THOMAS FROST
- 59** BEST OF THE MONTH
Reviews of outstanding new releases
- 72** A FINAL LEGACY FROM BRUNO WALTER
A critical examination of eight recordings..... DAVID HALL

THE EQUIPMENT

- 12** SOUND AND THE QUERY
Answers to your hi-fi technical questions..... LARRY KLEIN
- 22** BEGINNERS ONLY
FM Tuners—Part One: Sensitivity..... HANS H. FANTEL
- 25** TECHNICAL TALK
Lab reports on the Scott LK-30 amplifier kit and the KLH Model 14 speaker system..... JULIAN D. HIRSCH
- 47** INSTALLATION OF THE MONTH
Solving a Decorator's Dilemma
- 55** THE PRICE COMES DOWN
Surveying moderate-price stereo components..... JOHN MILDER

THE REVIEWS

- 65** CLASSICAL
- 101** JAZZ
- 111** ENTERTAINMENT
- 127** STEREO TAPE

THE REGULARS

- 4** EDITORIALY SPEAKING
- 6** LETTERS TO THE EDITOR
- 16** JUST LOOKING
- 138** ADVERTISERS' INDEX; PRODUCT INDEX

COVER: VIRGIN IN MANDORLA WITH ANGEL MUSICIANS. BY JEAN COLOMBE. BOURGES, FIFTEENTH CENTURY. COURTESY PIERPONT MORGAN LIBRARY.

Copyright © 1963 by Ziff-Davis Publishing Company. All rights reserved. HI-FI/STEREO REVIEW, December 1963, Volume 11, Number 6. Published monthly by Ziff-Davis Publishing Company at 434 South Wabash Ave., Chicago, Illinois 60605. Subscription rates: one year United States and possessions \$5.00; Canada and Pan-American Union Countries \$5.50; other foreign countries \$6.00. Second-class postage paid at Chicago, Illinois and at additional mailing offices. Authorized as second class mail by the Post Office Department, Ottawa, Canada, and for payment of postage in cash.

Hi Fi/Stereo Review

PUBLISHER
PHILLIP T. HEFFERNAN

EDITOR
FURMAN HEBB

MANAGING EDITOR
WILLIAM ANDERSON

MUSIC EDITOR
ROBERT OFFERGELD

TECHNICAL EDITOR
LARRY KLEIN

ART EDITOR
BORYS PATCHOWSKY

ASSOCIATE EDITOR
ROBERT S. CLARK

PRODUCTION EDITOR
MEL SCHINASI

CONTRIBUTING EDITORS

CHRISTIE BARTER
MARTIN BOOKSPAN
HANS H. FANTEL
WILLIAM FLANAGAN
STANLEY GREEN
JOE GOLDBERG
DAVID HALL
NAT HENTOFF
JULIAN D. HIRSCH
GEORGE JELLINEK
IGOR KIPNIS
PAUL KRESH

**ADVERTISING
SALES MANAGER**
LAWRENCE SPORN

**ADVERTISING
SERVICE MANAGER**
ARDYS C. MORAN

ZIFF-DAVIS PUBLISHING COMPANY

Editorial and Executive Offices (212 Oregon 9-7200)
One Park Avenue, New York, New York 10018

William B. Ziff, Chairman of the Board (1946-1953)

William Ziff, President

W. Bradford Briggs, Executive Vice President

Hershel B. Sarbin, Vice President and General Manager

M. T. Birmingham, Jr., Vice President and Treasurer

Robert F. Breeding, Circulation Director

Stanley R. Greenfield, Vice President

Phillip T. Heffernan, Vice President

Midwestern & Circulation Office (312 Wabash 2-4911)

434 South Wabash Avenue, Chicago, Illinois 60605

Advertising: Jerry Sweeney

Western Office (213 Crestview 4-0265)

9025 Wilshire Blvd., Beverly Hills, Calif. 90211

Western Advertising Manager: Bud Dean

Foreign Advertising Representative

D. A. Goodall Ltd., London, England

SUBSCRIPTION SERVICE: All subscription correspondence should be addressed to HiFi Stereo Review, Circulation Department, 434 South Wabash Avenue, Chicago, Illinois 60605. Please allow at least six weeks for change of address. Include your old address, as well as new—enclosing if possible an address label from a recent issue.

EDITORIAL CONTRIBUTIONS must be accompanied by return postage and will be handled with reasonable care; however, publisher assumes no responsibility for return or safety of art work, photographs, or manuscripts.

Member Audit Bureau of Circulations

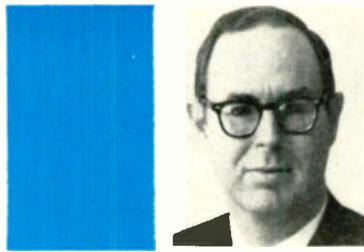

EDITORIALLY SPEAKING

by FURMAN HEBB

ABOUT twice a month I receive telephone calls from readers who are having trouble with their playback equipment, and who want to know what they can do about it. My first response always is to ask where they bought the equipment, thinking to suggest that they discuss their problems with their hi-fi dealer. The strange thing is that, whenever I ask this question, they respond as if I had changed the subject. Immediately they forget about their ailing equipment and begin telling me, with considerable pride, about how they shopped around and finally got a really terrific deal from so-and-so. Then, when I suggest that the retailer should be responsible for the equipment, the answer is, "Oh, they don't know anything about hi-fi equipment—they just sell it!"

In few other fields is a close relationship between seller and buyer more important, for audio equipment requires the services of a skilled technician not only to handle emergencies, but also to make sure, periodically, that the equipment is working at its best. The principal factor responsible for the trend toward separating hi-fi sales from hi-fi service is, of course, the rise of discounting. A retailer operating on a margin of, say, ten per cent simply cannot afford to provide service.

Let me make one thing clear: I have nothing against discounting. It is an efficient means of distributing goods, and it is what the public wants—otherwise it wouldn't exist. But at the same time, it should be pointed out that certain types of highly specialized equipment—stereo components among them—are ill-suited to being sold on the basis of price alone. A customer's satisfaction with a sound system, for example, depends on at least three other factors. In the first place, the selection of the components should be made, if at all possible, after they have been demonstrated by a knowledgeable salesman, and in an acoustical environment that in some way corresponds to that of a home listening room. Second, the system should be installed by someone who knows how to set it up for optimum performance under the special set of circumstances presented by the listening room in question. Third, the equipment should be serviced, when necessary, by a skilled professional audio technician—the local TV repairman won't do. The point is, these are all services that only the audio specialist can offer.

Although everyone may love a bargain, a stereo system that is not functioning properly is not a bargain—or even a good investment.

Coming Next Month in HiFi/STEREO REVIEW

A PROFILE OF ERICH LEINSDORF
by Hans H. Fantel

THE IDEAL LISTENING ROOM
by Roy Allison

THE BEST RECORDS OF 1963



NEW

Solid State

CONTROL CENTER
FOR SERIES 800, 1000
AND 1400 MODELS

DOUBLES
former performance

Quarter-Track Record/Play Data

ips	db	cps	s/n
7-1/2	±2	50 — 30,000	56db
3-3/4	±2	30 — 20,000	52db
1-7/8	±3	30 — 16,000	50db
15/16	±3	30 — 10,000	48db

The most complete recording instruments ever designed for stereo use. Audio circuitry, ±1/4 db from 10-100,000 cps; extended range, 5-500,000 cps. Plug-in circuit modules are printed on epoxy and gold plated. Engineered to space craft reliability.



THE HALLMARK
OF CROWN —
SUPERLATIVE
CRAFTSMANSHIP
THROUGHOUT!

INDIVIDUAL PERFORMANCE
RECORD SUPPLIED
WITH EACH CROWN

WRITE DEPT. HI-12



CIRCLE NO. 22 ON READER SERVICE CARD

LETTERS TO THE EDITOR

Sherlock Holmes Condensed

● Although I enjoyed your September issue very much, I must take exception to Paul Kresh's review of Basil Rathbone's reading of two Sherlock Holmes tales, *The Adventures of the Speckled Band* and *The Final Problem*. Instead of praising these Hollywood-ized versions, Mr. Kresh should have denounced or ignored them. These tales cannot undergo, as Mr. Kresh puts it, "considerable but discreet cuts" and "fat-trimming" without destroying their flavor and atmosphere. Edmund Wilson, among others, has pointed out that much of the tales' effectiveness derives from terseness and lack of padding. Having been privileged to hear some of the complete Sherlock Holmes recordings made for the blind, I can attest to the great effectiveness of verbatim readings. Far from the tales' being, again in Mr. Kresh's words, "period pieces" and "quaintly arresting" (and, by implication, in need of editing for modern readers), they are, I am pleased to learn from librarians and high-school teachers, rediscovered by each new generation of readers.

JOHN SIMMS
St. Louis, Mo.

The Masterpiece Sweepstakes

● William Flanagan deserves praise for refusing, in his September review of Britten's *War Requiem*, to enter the "masterpiece sweepstakes" set off at the work's premiere. The masterpiece-mongering of critics and reviewers (on both sides of the Atlantic) is insulting to the musical intelligence. How can these gentlemen, after a few hearings and an evening spent over the score, pronounce as a masterpiece music that has been heard by only a tiny segment of those listeners, present and future, whose consensus alone can assign a work its place in musical history? Yet such immoderation has greeted, within my memory, Honegger's *Roi David*, Bartók's string quartets, Poulenc's *Dialogues des Carmélites*, Stravinsky's *Canticum Sacrum*, Elliot Carter's Second String Quartet, and others.

On this listener, at least—and I confess I have only heard the work three times—the *War Requiem* has had no strong effect, and the fault in its inspiration may be a further unfortunate effect of the masterpiece complex. To commission an eminent composer to write a dedicatory work for a church is an old and honorable tradition. But the occasion is one of celebration and strengthened hope, calling for exhortations to the saints to bless and pro-

tect, and so forth. Apparently Britten did not feel it necessary to fit his work to the occasion: he chose in effect to memorialize the destroyed Coventry Cathedral rather than to hail the new one. Why? Since the *War Requiem's* didactic intent is unmistakable, we must conclude that Britten felt an urge to sermonize in music—"warn" is the word he places at the head of his score.

Whatever the motive behind the work, for me the *War Requiem's* structural innovation—juxtaposition of the traditional Gregorian sections with the Wilfred Owen poems—seems too obvious, and the music's expressiveness insufficient to sustain interest throughout its considerable length.

CHARLES REDMOND
Silver Spring, Md.

More on Bandwidth

● The September issue of *HiFi/STEREO REVIEW* had a commentary by Leon Kuby of Harman-Kardon concerning my July letter on bandwidth requirements for amplifiers. I was pleased to see that Mr. Kuby agrees with me that the tests which count most in evaluating amplifier

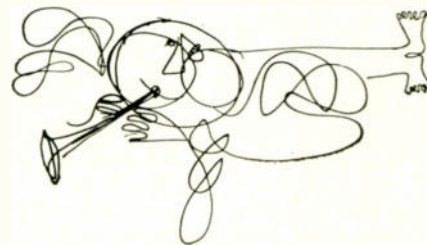

performance are listening tests, but I was amused at the flight of fancy by which Mr. Kuby tried to justify extreme wide-band amplifier response.

It is not sufficient to say, as Mr. Kuby does, that response to 200,000 cps makes some instruments "seem to have more space around them." Mr. Kuby ignored the main point of my previous letter that no program source has a flat response outside the audio range. In playback, there is a minimum drop-off of 20 db at 200,000 cycles (even with a perfectly "flat" amplifier). I think I am also correct in stating that there is no program source that has audio frequencies below 20 cycles.

Since we listen to a *system* which has as its first link the microphone(s) and includes the recording and transmission process on through to playback loudspeakers, the bandwidth is limited by the

(Continued on page 8)

One-year subscriptions to *HiFi/STEREO REVIEW* may be purchased in Australian pounds (2/15/12); Belgian francs (310); Danish kroner (33); English pounds (2,4/0); French francs (321); Dutch guilders (22); Indian rupees (31); Italian lire (3,000); Japanese yen (2,100); Norwegian kroner (45); Philippine pesos (25); South African rand (4,50); Swedish kronor (33); Swiss francs (27); or West German marks (25). Ziff-Davis Publishing Company also publishes *Popular Photography*, *Popular Electronics*, *Electronics World*, *Popular Boating*, *Car and Driver*, *Flying*, *Modern Bride*, *Amazing*, and *Fantastic*.

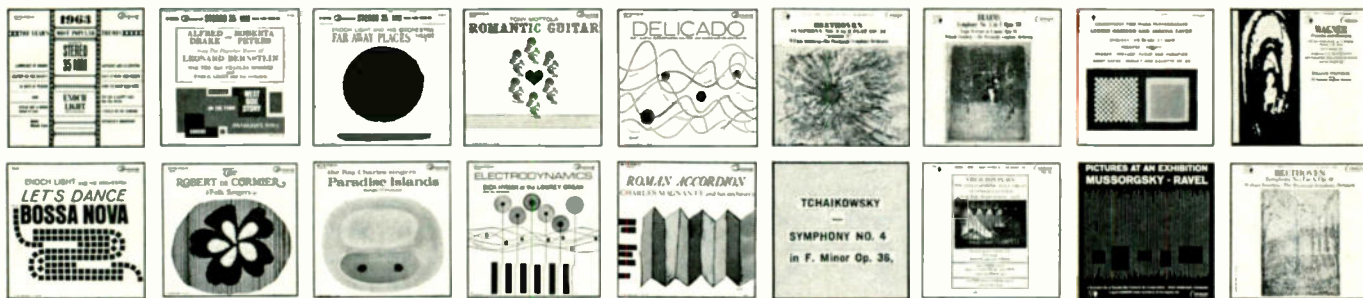

JUST RELEASED NEW SAMPLER OFFER FROM COMMAND

**12 COMPLETE SELECTIONS
FROM 10 NEW BEST SELLING
COMMAND POPULAR ALBUMS.
YOURS FOR ONLY \$2.98.**

**Also available 8 complete selections
from 8 new Command Classical Albums. \$2.98.**

Command Records has just released two new special-edition sampler albums to acquaint you with the best of Command albums . . . both popular and classical. These magnificent albums will open your eyes to the broad scope and magnitude of Command recordings . . . will reveal to you the unparalleled technical advances Command engineers have achieved in master recording on tape and on 35 mm magnetic film.

Here is your opportunity to savor the full range of Command artistry. The POPULAR SAMPLER contains 12 of the most exciting selections from 10 different Command Popular Albums. The CLASSIC SAMPLER contains 8 magnificent selections from 8 different Command Classical Albums. Unlike many sampler albums, Command Albums were created to give you full, uninterrupted musical pleasure. There is no sales message . . . no talk. The musical selections in the Popular Albums are complete — not excerpts! In the Classical Album, great care was taken to select complete movements for your greatest possible enjoyment.

For the first time you will hear music reproduced in all its full power and glory, with all of its widest, widest breadth, and with every last element of imposing depth. You will hear sound so intensely real that you can actually feel the presence of each instrument. In fact, Command records capture such astonishing realism that manufacturers of stereo sets use Command records to demonstrate the full potential of their equipment.

THESE ALBUMS ARE NOT AVAILABLE IN STORES

The complete albums from which these selections were chosen are available at all record stores. However, to obtain your Command Sampler Albums (which are not sold in stores), simply mail coupon today. You may select either the Popular or the Classical Album for only \$2.98 each. (Command Stereo Albums are sold nationally up to \$5.98 each.) If you wish, you can take advantage of an additional saving by ordering both albums for only \$5.00. Your albums will be shipped postpaid — Command pays all postage and handling. And, you may order as many albums as you wish, but don't delay . . . mail your order today!



NEW POPULAR SAMPLER

12 Complete Selections From 10 Different Popular Albums

- PUT ON A HAPPY FACE (1963 The Year's Most Popular Themes)
- TONIGHT (The Popular Music of Leonard Bernstein)
- LUCKY TO BE ME (The Popular Music of Leonard Bernstein)
- ISTANBUL (Far Away Places — Vol. II)
- MITZI (Romantic Guitar)
- ALONE TOGETHER (Delicado)
- BIG BEN BOSSA NOVA (Let's Dance the Bossa Nova)
- DANCE, BOATMAN, DANCE (The Robert De Cormier Folk Singers)
- GEE, OFFICER KRUPKE (The Popular Music of Leonard Bernstein)
- BEYOND THE REEF (Paradise Islands)
- STOMPIN' AT THE SAVOY (Electrodynamics)
- GUAGLIONE (Roman Accordion)

NEW CLASSIC SAMPLER

8 Complete Selections From 8 Classical Albums

- BEETHOVEN — SYMPHONY NO. 3 in E Flat, Op. 55 ("Eroica"), 3rd Movement — Steinberg . . . The Pittsburgh Symph. Orch.
- BRAMHS — SYMPHONY NO. 3 in F. Op. 92, 3rd Movement — Steinberg . . . The Pittsburgh Symph. Orch.
- POULENC — SONATE, 1st Movement "PRELUDE" Leonid Hambro and Jascha Zayde.
- TCHAIKOWSKY — SYMPHONY NO. 4 in F. Minor Op. 36, 3rd Movement — Steinberg . . . The Pittsburgh Symph. Orch.
- WAGNER — INTRODUCTION TO ACT III — LOHENGRIN, Steinberg . . . The Pittsburgh Symph. Orch.
- MESSIAEN — DIEU PARMY NOUS, Virgil Fox . . . The Philharmonic Organ at Lincoln Center.
- MUSSORGSKY-RAVEL — PICTURES AT AN EXHIBITION, Vandevoort . . . L'Orchestre de la Societe des Conservatoire.
- BEETHOVEN — SYMPHONY NO. 7 in A, Op. 92, 4th Movement — Steinberg . . . The Pittsburgh Symph. Orch.

MAIL COUPON TODAY

**COMMAND RECORDS, Dept. HSR-12
1501 BROADWAY, NEW YORK 36, NEW YORK**

Gentlemen: Please send me the Command Sampler Albums I have checked below. I understand Command pays all postage and handling costs.

QUANTITY	ALBUM	PRICE	TOTAL
___	POPULAR SAMPLER	<input type="checkbox"/> STEREO or <input type="checkbox"/> MONAURAL \$2.98 ea.	___
___	CLASSICAL SAMPLER	<input type="checkbox"/> STEREO or <input type="checkbox"/> MONAURAL \$2.98 ea.	___
___	SPECIAL OFFER (Both Popular & Classical)	<input type="checkbox"/> STEREO or <input type="checkbox"/> MONAURAL \$5.00	___

Enclosed is \$_____ (Check or Money Order)

NAME _____

ADDRESS _____

CITY _____ ZONE _____ STATE _____

(Continued from page 6)

how to be number one in fine cartridges and stay there

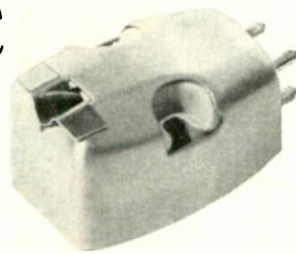

Today's cartridge talk is all about high compliance, low tracking force, low stylus mass and optimum vertical tracking angle.

ADC delivered this in 1960... 3 years ahead of anybody!

ADC cartridge owners recognize the value of these engineering firsts. They know that the popular ADC-1 cartridge performs with brilliance, clarity and presence at a tracking force of less than 1 gram.

They know that ADC's up-to-date knowledge of recording techniques and ability to select the proper materials were behind the startling revolution in quality cartridge design.

They know that high compliance, low tracking force, low stylus mass and optimum vertical tracking angle have advanced the art of cartridge design.

Naturally, ADC continues to refine and improve the products that bear its name. The new R-30 stylus, for example, is recommended for the most modern stereo recordings and has a stylus tip radius of .00035".

ADC owners expect to be years ahead. If you contemplate buying a fine cartridge, you owe it to yourself to investigate how beautifully an ADC cartridge can improve your present high fidelity system. **ADC-1 Mark II \$49.50 (incl. R-10 stylus); ADC-130 \$69.50 (incl. R-10 and new R-30 stylus); R-30 Stylus \$22.50.** Also available, the ADC-2A at \$46.50 and the ADC-3 at \$37.50.

SPECIFICATIONS—ADC-1 with R-10 and R-30 Stylus: Type—Miniature moving magnet. Sensitivity—7 millivolts per channel plus or minus 2 db at 1,000 cps. (5.5 cm/sec. recorded velocity). Frequency Response—10 to 20,000 cps. ± 3 db. Useful response extends to 30,000 cps. Channel Separation—30 db. 50 to 7,000 cycles. Stylus Tip Radius—R 30 .00035"; R 10 .0006" (accurately maintained). Stylus Tip Mass—.5 milligrams. Lateral & Vertical compliance—R 30 40×10^{-4} cms/dyne minimum. R 10 30×10^{-4} cms/dyne minimum. Vertical Tracking Angle— 14° to 17° (proposed international standard is 15°). Recommended Load Impedance—47 - 100K ohms. Note—This value is not critical and may be varied to adjust high frequency response, higher values giving slight treble increase and vice versa. Inductance—240 millihenries. Recommended Tracking Force—R 30 .4 to 1.5 grams. R 10 .5 to 2 grams. Mounting Centers—Standard $\frac{1}{2}$ " and $\frac{3}{8}$ " centers. Units adapt to virtually all tone arms. Connections—4 pin connector with removable ground strap and spring. For monophonic or stereophonic records. Actual Weight—6.8 grams.

 **AUDIO DYNAMICS CORPORATION**
Manufacturers of the Famous SERIES 1 ADC Speaker Systems
PICKETT DISTRICT ROAD, NEW MILFORD, CONN.

CIRCLE NO. 10 ON READER SERVICE CARD

weak links in the system. It is obvious that if we added a perfect link in the audio chain, it could not improve the reproduction from the imperfect links, which set the limitations on audio quality. Now it is true that if distortion is added on top of distortion, or phase shift on top of phase shift, or frequency discrimination to frequency discrimination, we are worse off than before the addition. That is why nobody suggests limiting the response of an amplifier to 30 cps to 15,000 cps—the range that encompasses practically all musical signals. If amplifiers had this limitation, there might be adverse effects *within* this range. However, once the frequency response is extended several octaves past the normal audio spectrum, an amplifier that is well-designed in other respects cannot affect the sound. The differences that listeners hear between amplifiers of differing bandwidths are heard because of differences in other than frequency response

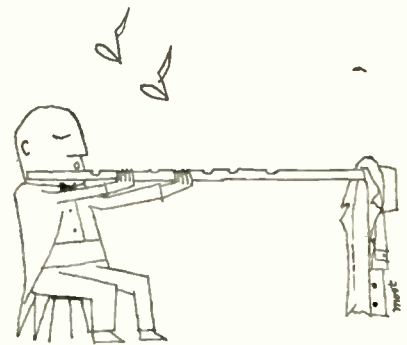

alone. This can be demonstrated by listening to a wideband amplifier with filters switched to change the bandwidth.

Mr. Kuby uses some pseudo-scientific mention of square waves, rise time, and transient response to attempt to justify his position. He argues that wideband response produces fast square-wave rise time, which somehow produces good transient response (without defining the latter). Actually, the response of an amplifier can be used to predict its square-wave characteristic and vice versa. One does not cause the other, but both are manifestations of the same thing.

The point that Mr. Kuby fails to mention is that the capability of the *system* to reproduce transient waveforms is determined by the amplitude and phase characteristics of the entire system, from original sources to speaker. The system, in this case, cannot possibly have fast rise time. Even if the entire system could accurately reproduce a square wave, this would not necessarily mean that the system would have what Mr. Kuby calls "good transient response." This is because a square wave is not a transient waveform (which by definition must be nonrepetitive)

(Continued on page 10)

"It's the greatest tuner I have ever listened to. I recorded FM Stereo 360 miles out to sea and could still get a fairly good signal 475 miles south of L. A. The Fisher 500-C is all that they say it is. Great."

—EARL HILL, 2nd MATE, S/S SANTA MALTA

Naturally, considering this:

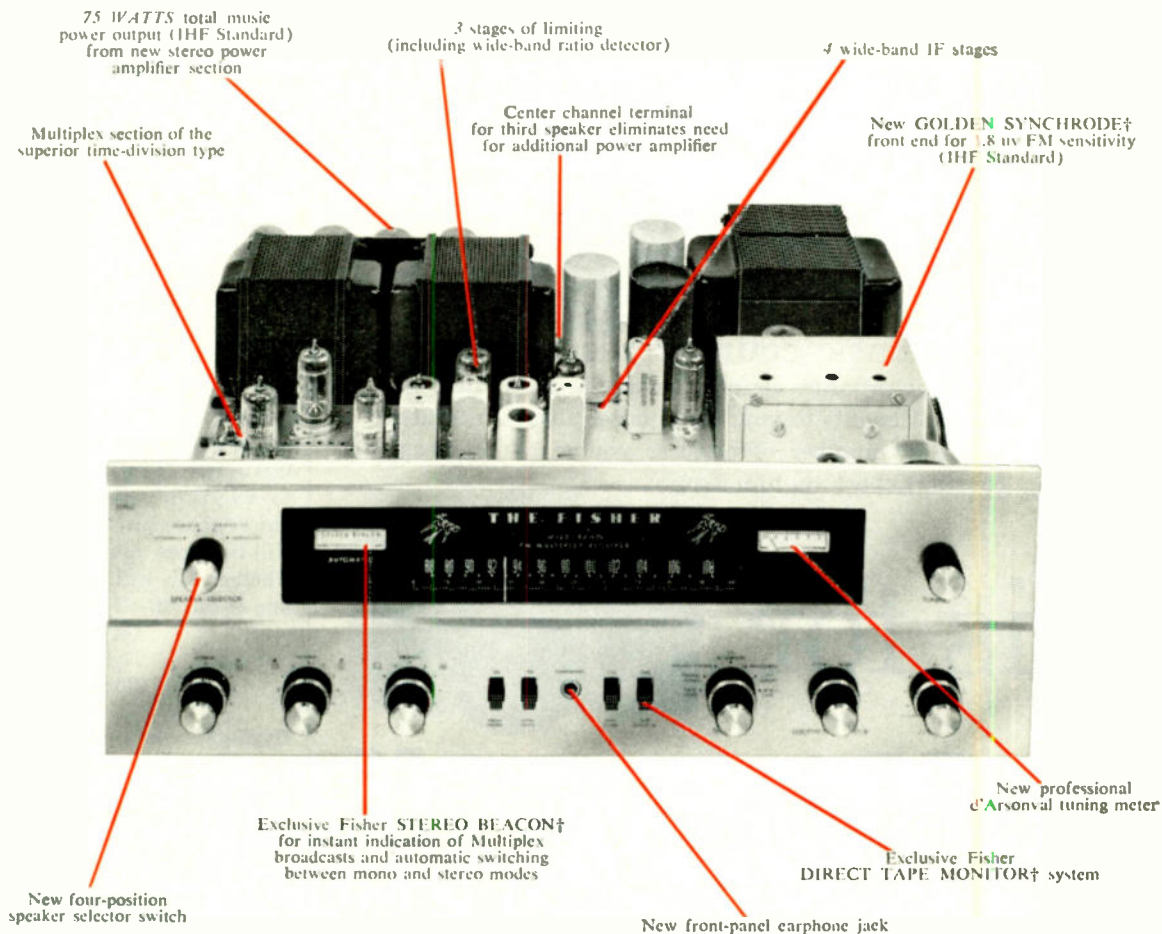

EXCEPTIONAL SENSITIVITY is just one of the outstanding characteristics of all Fisher tuners (even on dry land). But the Fisher 500-C is far from just a tuner. It's a completely integrated, single-chassis stereo receiver...one of a series that sets a new standard even for Fisher. Never before has so much amplifier power, so many advanced control features, such an over-all degree of engineering sophistication and such high tuner sensitivity been offered on any single chassis.

Each section of the 500-C: the tuner, the Multiplex converter, the stereo

control-preamplifier, the stereo power amplifier—is built to meet *the same performance standards Fisher demands of its separate components.*

The Fisher 500-C is truly everything you need—on one compact chassis. Just connect a pair of speaker systems for truly fine stereo reproduction. The price, \$389.50*. The Fisher 800-C (with FM and AM), \$449.50*. Fisher 400 (FM only), \$329.00*.

The Warranty That Means More And Does More For You. In striking contrast to the industry-wide standard of 90

days, the Fisher Warranty is extended to all tubes, diodes and parts for a period of one year from date of purchase.

\$1 VALUE ONLY 25¢!

Please send me the new 1964 edition of the Fisher Handbook, an illustrated guide and idea book for custom stereo. I have enclosed 25¢ double-wrapped to cover cost of handling and mailing.



FISHER RADIO CORPORATION
21-37 44th Drive, Long Island City 1, N.Y.

Name _____
Address _____
City _____ Zone _____ State _____

021201

The Fisher

A is for 

a faster lens The new Honeywell Pentax H1a is equipped with a brilliant new 55mm f/2 six-element lens. Benefits to you: brighter viewing and focusing, added versatility under poor lighting conditions!

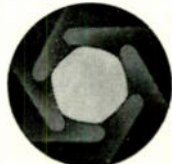
A is for 

automatic diaphragm Standard on the new H1a is a fully automatic, instant-open diaphragm with depth-of-field preview feature. Benefits to you: fewer missed pictures; viewing and focusing at full aperture, or taking aperture, as you choose.

A is for 

automatic counter reset On the new H1a, the exposure counter returns to zero when you reload. Benefits to you: the counter always indicates the exact number of pictures you've taken, keeps constant check on film supply.

A is for 
the Honeywell
Pentax **H1a**

a brand-new model which retains all of the traditional Pentax quality features: brilliant eye-level pentaprism viewing, shutter speeds to 1/500 sec., short-throw film advance lever, FP and X flash synchronization, "cocked" indicator, and rapid-rewind crank. These features plus classic, functional styling make the new H1a the outstanding single-lens-reflex value at just \$169.50. See it at your dealer's soon, or write for full-color folder to: John Thornton, Honeywell, Denver 10, Colorado.

Honeywell

PHOTOGRAPHIC PRODUCTS

CIRCLE NO. 44 ON READER SERVICE CARD

(Continued from page 8)

tive). What I interpret as Mr. Kuby's "transient" is what I call the "attack," the start of a percussive signal, for example. Unfortunately for Mr. Kuby's theory, a very fine attack can be achieved with a nonlinear amplifier that produces a very poor square wave. Anyone who wants to verify this in a rudimentary way can do so by turning the treble control of his equipment to the full-boost position.

Since Mr. Kuby and I agree on the merits of listening tests, I propose to him a test to determine whether he can hear the difference between what I consider adequate response and what he claims is necessary. This is the same test I have proposed to other people who claim to have supersonic hearing ability. Mr. Kuby can perform this test with any equipment he chooses, and I will let him

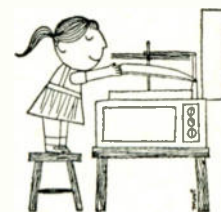

listen while I switch in high-frequency cut-offs at various frequencies up to 100,000 cycles. He will have the opportunity to select the condition that results in "more space around the instruments." I will be happy to make some wagers as to whether this will be the "wide-open" or one of the cut-off conditions.

DAVID HAFLER, PRESIDENT
Dynaco, Inc.
Philadelphia, Pa.

Dynagroove

● I agree at every point with John Armbrust, whose letter about Dynagroove recordings was published in your September issue. I am the unhappy owner of the RCA Victor recording of Gould conducting Sibelius (LSC/LM 2666), which was reviewed most justly in the same issue. I find that many of my RCA recordings of pre-Dynagroove vintage are highly superior to the latest releases.

KIP HAMM
Winfield, Kansas

Maazel Mismatched

● I wonder if anyone at Angel Records has noticed that you erroneously assign their new recording of Strauss' *Also Sprach Zarathustra*, with the Philharmonia Orchestra conducted by Lorin Maazel, to Deutsche Grammophon.

G. A. ROMANO
Philadelphia, Pa.

The brilliant recording is actually Angel S 35994/35994.

HIFI/STEREO REVIEW



Dollar for dollar, no one makes a tuner with greater sensitivity than the Fisher FM-100-B.

Except Fisher.



The Fisher R-200, \$299.50*



The Fisher FM-200-B, \$299.50*



The Fisher MF-300, \$359.50*



The Fisher FM-1000, \$429.50*



The Fisher MF-320, \$513.95*

FISHER CURRENTLY manufactures nine FM-Stereo-Multiplex tuners. And each is unquestionably the world's finest at its price. One comes in kit form (the KM-60). Another incorporates AM (the R-200). Two others have for some time been the world's only tuners with integral wire or wireless remote control (the MF-300 and MF-320 respectively).

The FM-100-B, though popularly priced, yields to no other in its ability to receive even the weakest broadcast signals with optimum noise suppression and interference rejection. Its sensitivity is 1.8 microvolts (IHF). Capture ratio: 2.2 db (IHF).

Only Fisher could improve on Fisher. For example: the FM-200-B has a sensitivity of 1.6 microvolts and a capture ratio of 1.5 db. And so on right up the

line. The most expensive (the FM-1000) is unquestionably the world's finest.

Needless to say, exceptional sensitivity is an outstanding characteristic of *all* Fisher tuners, regardless of price. There are, of course, other singular advantages. Each Fisher tuner shown employs the superior Time-Division Multiplex circuitry. Each Fisher tuner shown incorporates STEREO BEACON†, the exclusive Fisher development which signals the presence of FM Stereo programs, and automatically switches the tuner between the stereo and mono modes of operation.

The all-new remote control tuners feature absolute center-of-channel tuning, at the push of a button, with an order of accuracy that exceeds the most careful manual tuning of *even a Fisher*.

If there are still any doubts in your mind as to which tuner is best for you (which *Fisher*, that is), see your dealer.

All Fisher tubes, diodes, and parts are guaranteed for one year from date of purchase. (The industry-wide standard is 90 days.)

\$1.00 VALUE! ONLY 25¢!
Please send me the new 1964 edition of The Fisher Handbook, a 52-page reference guide, idea book and component catalogue for custom stereo. I enclose 25¢, double-wrapped, to cover cost of handling and mailing.



FISHER RADIO CORPORATION
21-37 44th Drive, Long Island City 1, N. Y.

Name _____
Address _____
City _____ Zone _____
State _____

021202

* WALNUT OR HAWGANY CABINET, \$24.95. PRICES SLIGHTLY HIGHER IN THE FAR WEST. FOREIGN RESIDENTS WRITE: FISHER RADIO INTERNATIONAL, INC., LONG ISLAND CITY 1, N. Y. CANADIAN RESIDENTS WRITE: TRI-TEL ASSOCIATES, L. G. J. H. L. ALAIE, ONT. [PAT. PEND.]



It must be Amphora

AMPHORA, the cool, calm tobacco from Holland that soothes the spirit and relaxes the mind. AMPHORA, fragrant and rich, slow-burning to the bottom of the bowl — mild, full-bodied Cavendish at its best. AMPHORA, the right tobacco for the young man who takes up a pipe, and for the veteran who seldom sets one down. This pipeful and the next, it must be AMPHORA, America's biggest-selling Dutch tobacco...still only 40¢.



Douwe Egberts
Royal Factories
Utrecht, Holland

SPECIAL OFFER: Imported Sheffield Steel 3-IN-1 knife-style pipe tool PLUS full 2-oz. pouch of AMPHORA for \$1.00. Mail to Romick's Int'l., Inc., Dept. 85, P.O. Box 3033, North Hollywood, Calif.



CIRCLE NO. 23 ON READER SERVICE CARD

S&Q

SOUND AND THE QUERY

**PRACTICAL POINTERS
ON THE INSTALLATION
AND MAINTENANCE OF
HOME MUSIC SYSTEMS**

BY LARRY KLEIN

Hi-Fi Fusing

Q. Because my line voltage sometimes goes as high as 135 volts, I want to fuse all my hi-fi components that do not already have fuses built in. What would be the most convenient way of doing this, and how does one figure the proper fuse rating?

A. HILLER
Angola, Ind.

A. The easiest way to fuse your equipment is to install a fuse plug that is designed to substitute for the usual a.c. wall plug. These fuse plugs, available at most radio-parts stores, use the same type of miniature glass-cartridge fuses that are employed in most hi-fi equipment. Your equipment will either have a label that indicates the wattage it draws from the a.c. line, or the information will be found in the instruction manual. A unit such as a tuner or a turntable, drawing 50 watts or less, requires two 0.5-ampere 3 AG-type fuses (for use in the fuse plug) with a voltage rating of 125 or 250 volts. In general, for every hundred watts of power drawn by the equipment, add an ampere to the fuse rating.

Note that unless each piece of equipment is individually fused, the equipment will not be fully protected. For this reason, considering your special problem with high line voltage, it would be best not to use the convenience a.c. outlets on the back of your preamplifier or amplifier, but rather to plug each instrument into the a.c. line through its own fuse plug.

Also check the current rating of the fuse presently in your amplifier, since it was probably calculated to include the current drawn from the unit's convenience outlets. You may be able to use a lower-current fuse by determining the actual power consumption of the unit and applying the 100-watts-equals-1-amp rule; this will provide a greater safety margin. However, if your power amplifier draws its power from a switched outlet on the preamplifier, the preamplifier fuse should be able to handle the sum of the current drawn by the preamp and power amplifier.

Heavy Bass

Q. The bass response of my speaker system is too extreme, and disturbs the mid-range and treble balance. Applying bass cut with the tone controls does not really solve the problem

because this also suppresses the mid-range somewhat. Do you have any suggestions for a cure?

DAVID KING
Mountainside, N.J.

A. Although you do not mention where your speakers are located, if they are either in corners or on the floor, try mounting the speakers on a stool or shelf away from the corner. This will decrease the bass response. If you have assembled the system yourself, using speaker components from different manufacturers, your problem probably results from the relative inefficiency of the mid-range speaker, and possibly of the tweeter. If so, then one solution would be to install a T-pad between the woofer and the crossover network. This will enable you to reduce the level of the woofer, but it may also cause a slightly boomy effect because of a lowering of the amplifier's damping factor. The only other alternative is to replace the woofer with a less efficient one.

Cartridge Load Impedance

Q. How critical is the matching between a magnetic cartridge and its load impedance? My cartridge requires a load impedance of 50,000 ohms, and my preamplifier has a 68,000-ohm input resistor. Do you think I should change the resistor?

CHARLES GRAF
Pittsfield, Mass.

A. In general, a resistor of a value higher than that recommended will tend to produce high-frequency peaks in the pickup's response. On the other hand, too low a value will roll off the high-frequency response. A number of cartridges, usually very low impedance types, are relatively insensitive to the load impedance they work into as long as the resistance is above a certain value. Ceramic and crystal cartridges have entirely different requirements and are sensitive to cable capacity in addition to load impedance. If in doubt about the setup for a particular cartridge, check with its manufacturer.

Speaker Oscillation

Q. I have a record changer, an inexpensive transistorized amplifier, and two bookshelf speakers. When the amplifier volume control is set for

(Continued on page 14)

8" mid-range with 5½ lb. magnet structure, 1½" voice coil

First 'soft' dome hemispherical tweeter; 2" cotton diaphragm and 5½ lb. magnet structure

15" woofer with 6 lb. magnet structure and 2" eddy current-damped voice coil wound on pure electrolytic copper

AcoustiGlas-packed non-resonant sealed enclosure

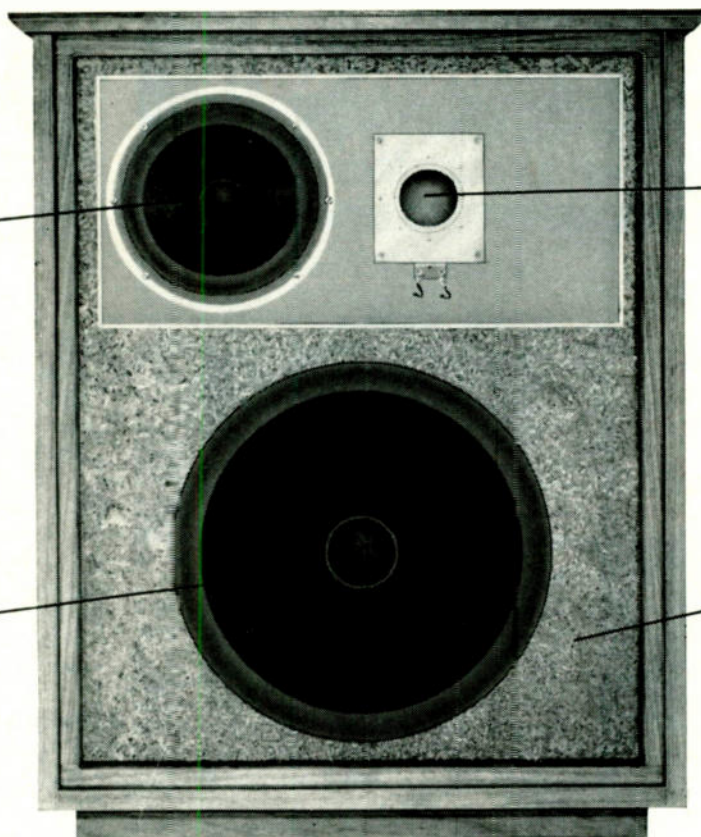

Introducing the XP-10...an extraordinary new speaker system.

THE XP-10 CONSOLETTA is a new 3-way loudspeaker system utilizing hand-made, high-compliance transducers with massive, high flux density magnet assemblies. It is relatively compact in size but has the ability — due to the increased cone dimensions of the drivers used — to produce the "big" sound usually found only in the largest, most expensive systems available today.

The woofer, for example, is a large 15" transducer utilizing a pure electrolytic copper 2" voice coil to generate eddy currents which achieve frequency-linear damping of cone motion. The cone itself has a butyl-impregnated half-roll surround and is extremely stiff and straight-sided so as to operate as a true, rigid piston throughout its assigned range. The heavy magnet structure (6 pounds) achieves a very high flux density for precise control of the rigid, compliantly-suspended moving mass. Open-air resonance of this superb bass unit is below 19 cps.

The midrange speaker is a full 8" with a 5½ lb. magnet structure. Due to its relatively large size and special design, an unusually low cross-over point of 200 cps is facilitated, resulting in negligible phase distortion (since the same speaker reproduces the major part of musical intelligence produced by orchestra and voice). It is housed in its own AcoustiGlas-packed sub-enclosure for optimum loading and to prevent distortion-causing interaction with woofer and tweeter.

High frequencies are more 'transparent' than ever as the result of major breakthrough in speaker design — the "soft" dome tweeter. This tweeter, which handles frequencies above 2,000 cps, consists of a soft cotton hemispherical dome bonded to a light copper 2" voice coil. The use of a soft

cone instead of a rigid diaphragm virtually eliminates high frequency resonances. Transient response is unsurpassed due to the unit's remarkably high flux density (14,000 gauss) and low moving mass (1¼ grams). Cone break-up is virtually eliminated by applying the driving force to the soft cone on its periphery rather than at its center.

The system utilizes a low-loss 6 db/octave quarter-section inductance-capacitance network crossing over at 200 and 2,000 cps. All inductors are of the low-loss, air-core type. Continuously variable level controls for mid-range and treble speakers provide wide flexibility in compensating for differences in room acoustics. Overall system response extends from 28 cycles to

beyond audibility. Each system is matched within ± 1 db of a laboratory standard to insure balanced stereo response when used in pairs.

The infinite baffle enclosure is made of ¾" reinforced, non-resonant, compressed particle board with bonded genuine wood veneers. It measures 24¾" wide x 30½" high x 14¾" deep and weighs 80 lbs. It is luxuriously crafted in Scandinavian Walnut.

In the area of such objective criteria as frequency response, distortion and instrumentation measurements, the XP-10 meets the challenge of much larger, more expensive loudspeaker systems. Its true capabilities invite direct comparison with only the finest transducers available. Once seen and heard, you will find it difficult to believe it is priced at only \$249.50*.

Foreign residents write to: Fisher Radio International, Inc., Long Island City 1, N. Y. Canadian residents write to Tri-Tel Associates, Ltd., Canada.

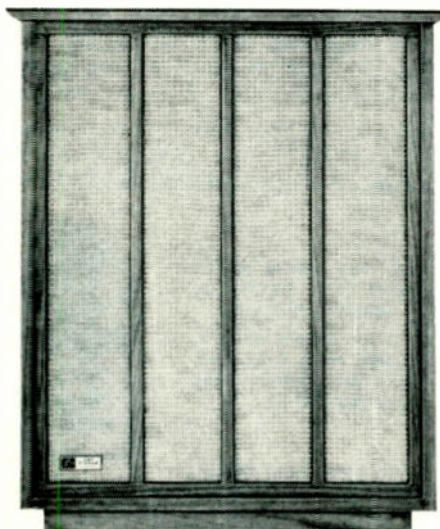

\$1.00 VALUE! ONLY 25¢!
Please send me the new 1964 edition of The Fisher Handbook, a 52-page reference guide, idea book and component catalogue for custom stereo. I enclose 25¢, double-wrapped, to cover cost of handling and mailing.



FISHER RADIO CORPORATION
21-37 44th Drive, Long Island City 1, N. Y.

Name _____
Address _____
City _____ Zone _____
State _____

021210

The XP-10 Console by Fisher

Sensational FUJICA Offer

If you don't like the pictures you take, you get your money back on both camera and film* . . .

You get a full 10 days to take pictures like these with your very first roll or get your money back!

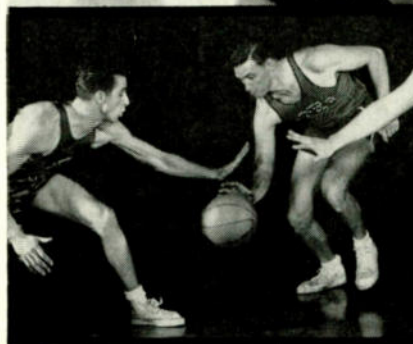

Why do we dare make this offer?

The new Fujica is the first camera with a built-in computer electric eye. Patented. It makes all settings for you . . . both speeds and lens openings. You can't make an exposure mistake even if you try. If the light is too bright or too dim, the computer speeds up or slows down the shutter speed . . . instantly! Automatically! You just press the button. Perfect exposure every time.

Professional effects also automatic.

A simple dial turn does it. Soft backgrounds. Sharp backgrounds. Catch incredibly fast action . . . and to top it all, you can switch from fully automatic operation to manual control and make any combination of settings you wish. Speeds are up to 1/500th second.

Takes perfect pictures indoors.

The superb f/2.8 lens gets pictures in light so low, other cameras require flash . . . and if the light is too dim to give you a perfect picture, the Fujica locks . . . won't fire. No more blurs, blanks or wasted shots.

Preview your finished picture.

The viewfinder-rangefinder shows you big, bright and beautifully clear, what your finished picture will look like. You get exactly what you see.

How much does this FUJICA cost?

Less than \$100, and with the money back guarantee . . . you risk nothing.

Like to see how easy it is to operate? . . . just ask your favorite camera dealer or write for FREE booklet today.

ASK YOUR CAMERA DEALER ABOUT EXTRA SAVINGS ON COMPLETE FUJICA KIT

Includes Auto-M camera, camera case, hand grip, flash unit, battery, lens shade and case.



*35mm Anscochrome Holiday Pak

FUJI PHOTO OPTICAL PRODUCTS INC. 111 Fifth Ave., Dept. A-83, New York 3, N. Y.
A subsidiary of Ehrenreich Photo-Optical Industries Inc.

(Continued from page 12)

loud listening, any bass note will cause the speakers to go into low-frequency oscillation. This can be stopped either by turning down the amplifier's volume control or by touching the cone of the woofer. What could be wrong with the speakers?

J. L. KEPLINGER
Lafayette, La.

A. From the symptoms described, it would appear that it is your amplifier, not your speakers, that is at fault. Your amplifier is probably marginally unstable, and the back voltage generated by your speakers during a large excursion tends to trigger the low-frequency oscillation. Since the oscillation continues to drive the speaker, a positive feedback situation (the cause of most oscillation) is present. The solution is to have your amplifier serviced by a qualified technician.

Parallel Wattage

Q. What is the wattage rating of a speaker system consisting of two identical 8-ohm speakers connected in parallel, each rated at 30 watts?

B. T. STRICKLAND
Deerfield Beach, Fla.

A. Assuming that the speakers have similar impedance characteristics, the applied power will be divided across them equally. Therefore, if a total of sixty watts is applied, each speaker will receive its normal maximum of thirty watts. The above would also apply if the speakers were connected in series.

Hot, Grounded, and Common

Q. I have seen the terms "hot," "grounded," and "common" used in connection with audio cables and speaker leads. Exactly what do the terms signify?

ROBERT GRAYSON
Toronto, Ontario

A. In audio, the term "hot" is usually used to indicate a wire that carries a signal voltage. For example, the center conductor of a shielded audio cable would be "hot," and the braided metallic shield would be the "grounded" conductor. "Ground" refers to the unit's chassis, which serves as the "common" return path for the signal.

Because the number of queries we receive each month is greater than we can reply to individually, only those questions selected for this column can be answered. Sorry!

“Well worthy of the Fisher name, both in performance and in ease of construction... Beautifully packaged and ‘instructed’... Excellent specifications, and the performance equals or exceeds the specs.”

—AUDIO MAGAZINE

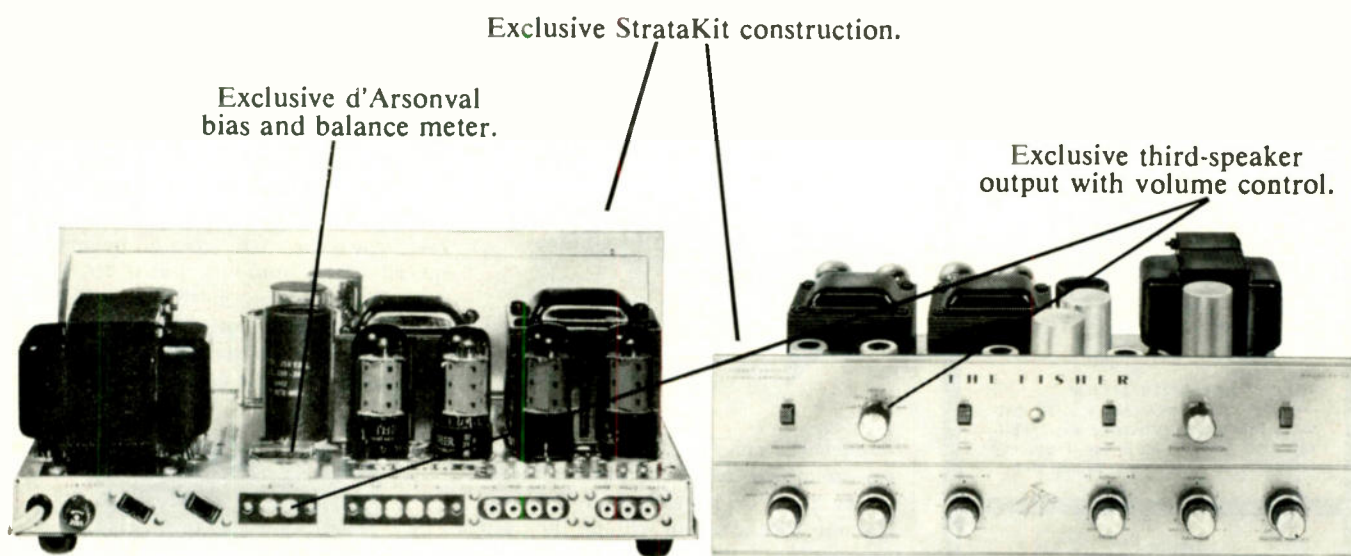

The Fisher KX-200 StrataKit, the 80-watt stereo control-amplifier kit, \$169.50*

This is the most powerful and in every way the most advanced single-chassis stereo control-amplifier kit you can buy — and by far the easiest you can build.

The 80-watt music power output (IHFM Standard, both channels) assures peak performance with even the most inefficient speakers. Engineering features never before offered in an integrated control-amplifier kit result in unequalled versatility. And the exclusive Fisher StrataKit method of kit construction makes the technical skill or previous experience of the builder completely unimportant and immaterial.

But the most exclusive thing about the KX-200 is the Fisher name -- your guarantee of a head start in kit building before you even pick up your screwdriver!

FREE! \$1.00 VALUE! The Kit Builder's Manual: a new, illustrated guide to high-fidelity kit construction.

**The
Kit Builder's
Manual**

FISHER RADIO CORPORATION
21-37 44th Drive
Long Island City 1, N. Y.

Please send me without charge The Kit Builder's Manual, complete with detailed information on all Fisher StrataKits.

Name _____

Address _____

City _____ Zone _____ State _____

021211

*WALNUT OR MAHOGANY CABINET, \$24.75. METAL CABINET, \$15.95. PRICES SLIGHTLY HIGHER IN THE FAR WEST. EXPORT: FISHER RADIO INTERNATIONAL, INC., LONG ISLAND CITY 1, N. Y., CANADA: TRI-TEL ASSOCIATES, LTD., WILLOWDALE, ONT.

2000 REASONS WHY YOU SHOULD INSTALL UNIVERSITY COMPONENT SPEAKERS

To get right into them...there are the Brandenburg Concertos, the Prague Symphony, Eroica, Petrouchka, La Boheme, the Benny Goodman '38 concert, Jazz at the Philharmonic, Ella singing Gershwin, West Side Story, the soundtrack from Breakfast at Tiffany's, T. S. Eliot reading Prufrock, Waiting for Godot, Lester Lanin's music for dancing—but why not complete the list yourself according to your own tastes and needs? You may even come up with more than 2,000 reasons why University component speakers are the finest you can buy today. They are recognized as the prestige speakers in the popular price range. Anything on record or tape shows you why!

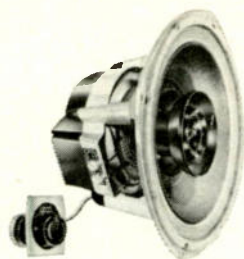

THE 312 INTEGRATED SYSTEM
—a high compliance 12" woofer, patented Diffusicone mid-range and Sphericon super tweeter, all in one. Frequency response: 28-40,000 cps. \$73.00 net.

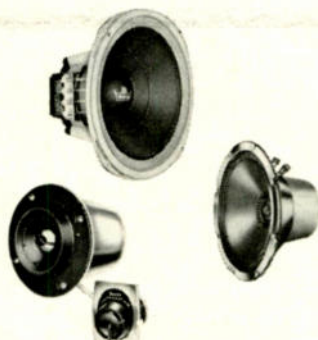

SPECIALIZED INDIVIDUAL 3-WAY SYSTEM
—consisting of the C-12HC 12" high compliance woofer, C-8M mid-range and Sphericon super tweeter. Frequency response: 20-40,000 cps. \$91.40 net.

Write for free catalog, Desk D-12

**UNIVERSITY
LOUDSPEAKERS**

Division of Ling-Temco-Vought,
Oklahoma City, Oklahoma

CIRCLE NO. 76 ON READER SERVICE CARD

JUST LOOKING ...at the best in new hi-fi components



● **ABC's of Hi-Fi & Stereo** is the title of a new book by Hans H. Fantel, who is known to our readers through his regular column "Beginners Only." Written for the novice, the book explains the elements of audio in terms the reader can follow without prior knowledge of electronics. Throughout the book, engineering matters are related to music, which the author regards as the "raw material of audio," and several chapters are devoted to the practical problems of budgeting an audio purchase, choosing components, and setting them up in the home. The book may be ordered directly from its publisher, Howard W. Sams & Co., 4300 West 62nd Street, Indianapolis 6, Indiana. Price: \$1.95.

● **Dynaco** introduces the SCA-35, its first integrated stereo amplifier. Available either as a kit or factory-assembled, the amplifier provides 17½ watts per channel from 20 to 20,000 cps, and the music-power rating is 45 watts with both



channels driven. The use of several factory-assembled etched circuits reduces assembly time to an estimated 8 hours. The unit can be set up without the need for instrument adjustment. Provision is made for stereo headphones or a third-speaker output, and a special bandpass filter eliminates rumble and scratch with negligible effect on the music. Price: \$99.95 kit, \$139.95 factory-assembled.

circle 183 on reader service card

● **Electronic Recorder's** Wayfarer stereo tape player is designed for operation in an automobile. The four-track tape system accommodates continuous-

play cartridges of three different sizes. No rewinding is required. The player mounts under the dashboard and is powered by the car's 12-volt storage battery. Four speakers are included, two for installation in the front doors of the car, and two

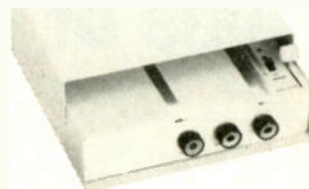

for the rear. Frequency response extends to 10,000 cycles, wow and flutter are inaudible, and the two transistor amplifiers are each capable of three watts output. Price: \$129.95.

circle 184 on reader service card

● **Jensen's** new five-speaker, four-way TF-4 Slender Shelf speaker system is a bookshelf unit measuring 16 x 25½ x 8½ inches. A high-compliance long-travel Flexair woofer with ceramic magnet, a special 8-inch mid-range, two 3½-inch tweeters, and an E-10 Sono-Dome tweeter are used in the system to achieve a frequency range from 25 cycles to beyond audibility. The crossover points are

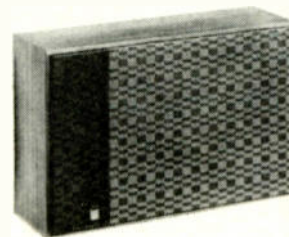

600, 4,000, and 9,000 cps. System power rating is 25 watts, and impedance is 8 ohms. Price: \$114.50 (oiled walnut), \$97.50 (unfinished gum hardwood).

circle 185 on reader service card

● **Miranda** enters the high-fidelity market with the Sorrento stereo tape recorder. The two-speed (3¾ and 7½ ips) Sorrento features solid-state circuitry with 21 transistors and 19 diodes in an output-transformerless circuit, and all-electronic push-button switching. Tape movement is controlled by three separate motors. A separate servo motor is also incorporated for use with the Sorrento's remote-control unit. This optional

(Continued on page 20)

The Institute of High Fidelity has prepared an informative 64-page *Introduction to Hi-Fi & Stereo*. Written for the nontechnical music listener, the booklet is available for 25¢ from the Institute of High Fidelity, 516 Fifth Avenue, New York, N.Y. 10036.

The sound from this new Shure cartridge is awesome in its vitality & clarity

A NIGHT-AND-DAY DIFFERENCE

From the very first prototype, the sound from the new Shure Series M44 Stereo 15° Dynetic Cartridge was incredible. Even skeptical high fidelity critics have expressed unconcealed surprise at the audible increase in brilliance, clarity, transparency, presence, fullness and smoothness of this amazing new Shure development. A close analysis of its performance reveals startling differences in this cartridge—although not extraordinarily improved in the “usual” areas of frequency response (still a virtually flat 20-20,000 cps) or in compliance (25×10^{-6} cm/dyne)—rather it is in the distortion measurements where Shure engineers have achieved a highly significant and dramatic reduction of 75% to 90% in IM and harmonic distortion from even such admirably distortion-free cartridges as earlier versions of the Shure Stereo Dynetic. Further, cross-talk between channels has been effectively negated in the critical low frequency and mid ranges . . . providing superior channel separation throughout the audible spectrum.

SCRATCH-PROOF RETRACTILE STYLUS

And, as if that were not enough, the new 15° cartridge incorporates a totally efficient retractile stylus that momentarily retracts whenever excessive forces are applied to the tone arm. It cannot scratch records—even if bounced onto the record or dragged across the grooves.

PERFECTION IS A MATTER OF DEGREE

It has been known for some years that a difference between the angle used to cut stereo records and the angle of the stylus of the cartridge used to play them would result in an increase in IM and harmonic distortion audible on certain records. With widely different cutting angles employed by the record companies, the effective angle of the playback cartridge stylus had of necessity to be a compromise so as to provide the best possible results from records of all makes.

Recently, industry attention was focused on this problem by a series of technical articles ascribing the difference in effective vertical angles between the cutter stylus and the playback cartridge stylus as a cause of distortion and urging the adoption of a standard effective angle to which records would be cut.

Major record companies have now begun to use an effective cutting angle of 15°, which is the proposed standard of the RIAA (Record Industry Association of America) and EIA (Electronic Industries Association.)

With the emergence of the single standard effective vertical tracking angle for cutting records, Shure engineers immediately began what seemed on the surface the seemingly simple but in actuality the arduous and exacting task of converting their formidable Stereo Dynetic cartridge to the 15° effective tracking angle. It couldn't be done. So Shure designed this radically new moving-magnet cartridge that will track at an effective angle of 15°. Graphically, this is the kind of cartridge geometry involved in the new Shure Series M44 15° Stereo Dynetic Cartridge:

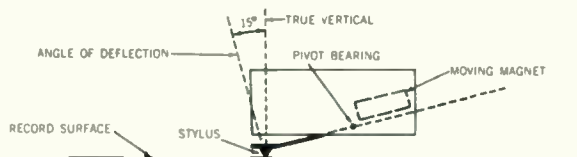

THE ULTIMATE TEST

You must hear this cartridge to appreciate the totality of the sound improvement. It will be instantly recognizable to the ear without the necessity for elaborate test instruments or A-B listening tests—although we assure you, instruments and A-B tests will more than substantiate our claims.

M44 SERIES SPECIFICATIONS

	M44-5	M44-7
Frequency Response:	20-20,000 cps	20-20,000 cps
Output Voltage at 1000 cps (Per Channel, at 5 cm/sec peak velocity):	6 millivolts	9 millivolts
Channel Separation (at 1000 cps):	Greater than 25 db	Greater than 25 db
Recommended Load Impedance:	47,000 Ohms	47,000 Ohms
Compliance:	25×10^{-6} cm/dyne	20×10^{-6} cm/dyne
Tracking Range:	$\frac{3}{4}$ to $1\frac{1}{2}$ Grams	$1\frac{1}{2}$ to 3 Grams
Inductance (Per Channel):	680 millihenries	680 millihenries
D.C. Resistance (Per Channel):	650 Ohms	650 Ohms
Stylus:	.0005" diamond	.0007" diamond
Stylus Replacement:	N44-5	N44-7
Cartridge Price, Net (including stylus):	\$49.50	\$44.50
Replacement Stylus Price, Net:	\$21.75	\$16.75

Monophonic Styli:

Model N44-1—For monophonic LP records, with .001" diamond \$16.75 net
Model N44-3—For 78 rpm records, with .0025" diamond \$14.25 net

SHURE

Stereo **15°** *Dynetic®*

**SERIES M44 SCRATCH-PROOF CARTRIDGE
WITH RETRACTILE STYLUS**

the new standard
in distortion-free
hi-fi cartridges



LITERATURE: Shure Brothers, Inc. 222 Hartrey Avenue, Evanston, Illinois

Manufactured under U.S. Patents 3,055,988; 3,077,521 and 3,077,522. Other Patents Pending

...for the Christmas Season
GIVE RECORDS OF SUPREME QUALITY



For the person who cares about quality. Each DGG record is the result of inspired music-making in the great tradition, coupled with the most meticulous standards of record manufacturing in the world.



"The most mellifluous 'Cosi'!"
—I. Kolodin, Saturday Review

MOZART: COSI FAN TUTTE—Irgard Seefried, Nan Merriman, Erika Koeth, Dietrich Fischer-Dieskau, Ernst Haefliger, Herman Prey, Berlin Philharmonic cond. Eugen Jochum. (Boxed, w/libretto). LPM 18 861-2-3 Stereo, SLPM 138 861-2-3



TCHAIKOVSKY: PIANO CONCERTO No. 1 in B Flat Minor—Sviatoslav Richter; Vienna Symphony, cond. H. von Karajan LPM 18 822 Stereo, SLPM 138 822



EUROPEAN CHRISTMAS SONGS—Maria Stader. From England, France, Germany, Italy, Portugal, Russia, etc. Munich Boys' Choir. LPEM 19 266 Stereo, SLPEM 136 266

for those who seek the unusual...

CARL ORFF: ANTIGONAE (Opera) — I. Borkh, C. Hellmann, E. Haefliger, K. Borg, etc., cond. F. Leitner. (Boxed, w/libretto) LPM 18 717-18-19 Stereo, SLPM 138 717-18-19

TEN CHRISTMAS SONGS by Praetorius & contemporaries. M. Guillaume, H. Krebs, Chorus, Boys' Choir with inst. ensemble. ARCHIVE 3216 Stereo 73216



and...the unforgettable gift!

"A set that will go down in history"

BEEHOVEN:

THE NINE SYMPHONIES

Berlin Philharmonic Orchestra, cond. Herbert von Karajan, with soloists & chorus. 8 LP's in presentation box with 24 pg. book. KL 1-8 Stereo, SKL 101-108

THE PRICE? Less than you think...

Ask your record dealer.

DIRECT IMPORT • FACTORY SEALED

FREE! ON REQUEST: the new 1964 DGG/ARCHIVE Illustrated Color Catalog.

Write MGM Records, Classical Div. 1540 B'way, N.Y., N.Y. 10036

(Continued from page 16)

accessory includes individual channel volume controls as well as the full complement of tape-transport controls. Other features include automatic shutoff at end of reel, push-button mode controls, individual volume and tone controls for



each channel, illuminated VU meters, and two built-in 4 x 6-inch speakers. Power output of the Sorrento is 3½ watts per channel, and playback can be either through the two built-in speakers or through external speaker systems. Price: \$399.95. Remote control: \$34.95.

circle 186 on reader service card

● Pilot's new solid-state portable stereo phonograph provides for the addition of an optional AM-FM stereo tuner. Housed in a luggage-type case, the phonograph includes a transistorized amplifier with an output of 15 watts of music power, two dual speakers, and a Garrard record changer with magnetic cartridge. An additional compartment accommodates the



matching AM-FM stereo tuner. The unit's lid is formed by two speaker enclosures that can be separated for a broad source of stereo sound. The controls include a stereo-mono selector, input selector, bass, treble, balance, and volume controls. Price: \$199.

circle 187 on reader service card

New York City readers will be interested to learn of two new hi-fi clubs in the metropolitan area. One is the New York Audio Society, 106 Fulton St., New York, N.Y. 10038; and the other is the Audio Exchange Hi-Fi Club, Audio Exchange, Inc., 153-21 Hillside Ave., Jamaica, N.Y. 11432.

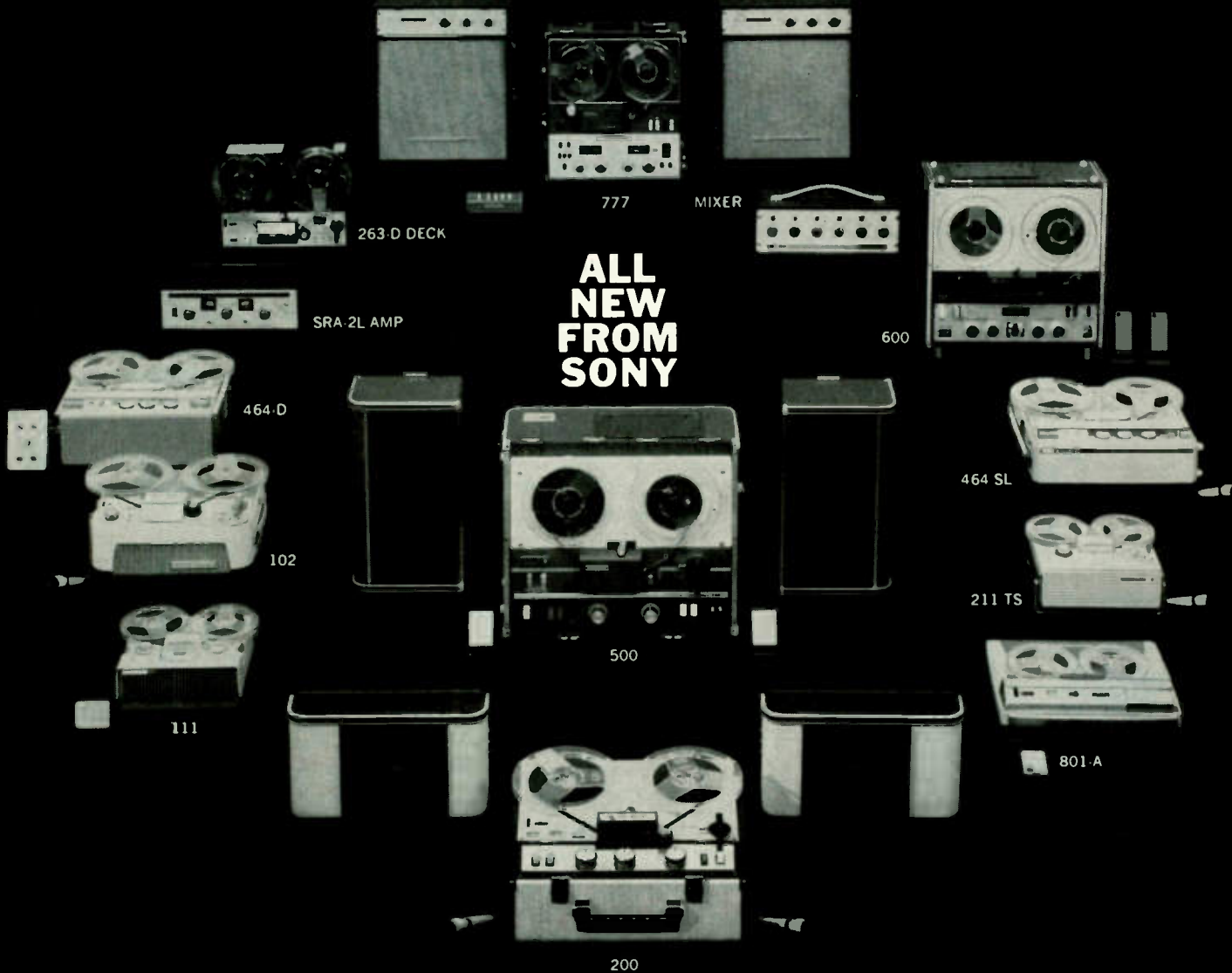

THE MOST COMPLETE LINE OF QUALITY TAPE RECORDING EQUIPMENT IN THE WORLD

■ **Sony Sterecorder 777 S**—Professional, all transistorized 2 or 4 track stereo/mono tape recording system featuring remote control and the exclusive Sony Electro BiLateral head system. World's finest tape recorder. Less than \$695. ■ **Sony Amplifier/ Speaker System SSA 777**—All transistorized, 10 watt, extended range 8" infinite baffle hi fidelity speakers created to produce perfect, full-sound reproduction with the 777 S. Less than \$175. ■ **Sony Stereo Mixer MX 777**—For advanced recording techniques, this all-transistorized, battery-powered 6 channel stereo/mono mixer is the perfect accessory to complete the 777 professional system. Less than \$175. ■ **Sony Stereo Tape Deck 263-D**—Add tape to any sound system with this 4 track stereo playback tape transport. 3 heads, 2 speeds, vertical or horizontal operation. Less than \$119.50. ■ **Sony Stereo Recording Amplifier SRA-2L**—All the facilities for adding stereo recording to the 263-D unit. Less than \$99.50. ■ **Sony Sterecorder 464-D Deck**—2 speed, 4 track, stereo/mono, record/playback compact tape deck with built-in pre-amps. Ideal for custom installation. Less than \$199.50. ■ **Sony Portable Tape Recorder 102**—Rugged 2 speed, dual track, hi fidelity recorder with deluxe features and 7" reel capacity satisfies the most exacting recording requirements. Less than \$129.50. ■ **Sony Tape Recorder 111**—A popularly priced, high quality bantam recorder for everyday family fun. Less than \$79.50. ■ **Sony Sterecorder 200**—The most compact and lightweight quality 4 track tape recording system on the market today. Carrying case lid separates into

NOW ON DISPLAY

AT YOUR FRANCHISED
SONY / SUPERSCOPE
AUDIO/TAPE DEALER

2 full range speaker systems. Unequaled for performance and price. Less than \$239.50. ■ **Sony Sterecorder 500**—A complete 4 track stereo/mono tape system with unsurpassed studio quality. The full range, infinite baffle detachable speaker systems integrate into the recorder lid, and separate 15 feet for optimum stereo effect. Less than \$399.50. ■ **Sony Battery-Operated Executive Portable 801-A**

—A distinctively styled, transistorized, 2 speed all purpose recorder of utmost precision and quality. For the executive desk or portable use. The self-storing mike features a remote stop and go switch. Tape it with you for less than \$250. ■ **Sony 'Slide-Sync' Tape Recorder 211-TS**—Incredibly versatile, serves the photo enthusiast with an exclusive, automatic built-in 'programmer' to activate a slide projector in 'sync' with your own recorded narration. Also the most compact tape teaching recorder available. Less than \$129.50. ■ **Sony Tape Teaching Recorder 464-SL**—A deluxe language and music teaching aid, 2 speed, 4 track, stereo and mono. Less than \$219.50. ■ **Sony Sterecorder 600**—3 heads, tape and source monitoring, sound on sound, vertical or horizontal operating, this 4 track stereo recording and playback unit is perfect for professional quality home installation. Less than \$450. ■ Also available, an extensive line of professional studio quality microphones and accessories. All Sony Sterecorders are Multiplex Ready! For detailed literature and name of nearest franchised tape dealer write Superscope, Inc., Dept. 8, Sun Valley, Calif.

IN NEW YORK, VISIT THE SONY SALON, 585 FIFTH AVENUE.

SONY

SUPERSCOPE®

The Tapeway to Stereo

CIRCLE NO. 72 ON READER SERVICE CARD

What's new from Ampex?

Collector's Library

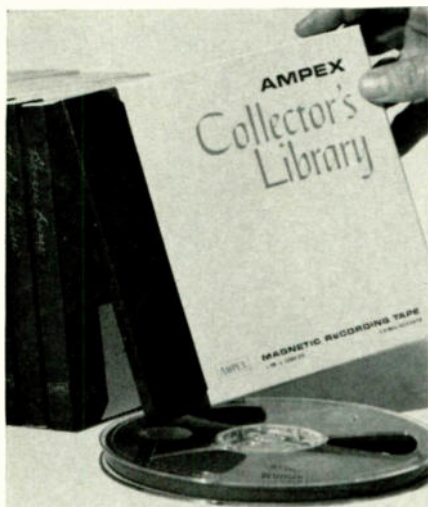

Here's good news for people who care how their sounds sound—and how their tape collection looks. It's Collector's Library—a new tape from Ampex. It's ideal for all general recording needs and for building an attractive tape library. Here's why: 1) An exclusive Ferro-Sheen* oxide surface gives maximum frequency response, clean operation and low head wear. 2) The new book-like design on the box gives your tapes a matched set appearance. Just five or six boxes look like a collector's library. In addition to this each box comes with famous "Signature Binding"—the simulated leather binding and gold foil strip for custom labeling of your tapes. 3) Collector's Library is economically priced. You'll save money on every box of tape you buy. Available on Mylar** and acetate bases in all popular sizes. Collector's Library is the latest addition to the fine line of Ampex precision tape. Ampex Corp., Redwood City, California.

*TM Ampex Corp.

**TM for Dupont Polyester Film



CIRCLE NO. 5 ON READER SERVICE CARD



FM TUNERS—PART I: SENSITIVITY

IN CHOOSING an FM tuner, sensitivity is one of the important specifications to be checked, for it provides an excellent clue to how well the tuner will perform in your particular location. The sensitivity rating of a tuner is a measure of its ability to provide satisfactory reception of weak or distant stations. It is stated as the smallest number of microvolts (abbreviated μv) of incoming signal required to yield an output signal of a certain quality. The smaller the number of microvolts required to accomplish this, the more sensitive the tuner.

Sensitivity is always defined in relation to "quieting," which is a term that refers to the ability of the tuner to eliminate noise and static from the FM signal so that a noise-free audio signal appears at the tuner's output. To provide effective quieting, the tuner must pick up a signal of sufficient strength for it to work with. Sensitivity and quieting are therefore interdependent, and you may expect to find a typical tuner specification reading as follows: "Sensitivity is 3 μv for 30 db quieting," meaning that an incoming signal must be 3 microvolts strong (and modulated 100 per cent) for the audio output signal of the tuner to be 30 db above the background noise.

If the sensitivity rating of one tuner is to be compared with that of another, both must of course be measured under identical conditions. For this reason, the Institute of High Fidelity (IHF) recommends that all sensitivity ratings be stated for 30 db quieting. This means that the total noise and distortion will be a maximum of 3 per cent of the tuner's audio output signal. The less stringent 20-db standard adopted by some manufacturers is not, therefore, directly comparable. In addition, sensitivity measurements should be made with the equivalent of a 300-ohm antenna input (the impedance of the usual home antenna). If the equivalent of a 72-ohm antenna is used in the test, there is an *apparent* increase in sensitivity, but this, of course, does not make the tuner genuinely more sensitive. For example, one manufacturer's specification of 1 μv , obtained at a 20-db quieting level using a 72-ohm input, would, under the IHF test conditions, probably test out at about 2.5 μv . When comparing sensitivity ratings, therefore, it is a good idea to make sure that the specifications state under what conditions the measurements were made. If you see a reference to the IHF standard, you will know that the most stringent test standards have been applied.

It is difficult, however, to make specific recommendations as to the tuner sensitivity required for good FM reception in a given location. This depends on the terrain, the type of antenna you are using, and the distance of the stations you want to pull in. As a general rule, a tuner with a 4-to-6 μv sensitivity (IHF) should suffice if you live close to your principal stations. But beyond a distance of 25 miles or so, you will probably get better results—especially in stereo—with a 2-to-4 μv sensitivity. In fringe areas, extreme-sensitivity tuners (in the 1.5-to-2 μv range) may bring in a clean signal where less sensitive tuners would yield noisy reception or none at all. Of course, a roof antenna is virtually a must for fringe-area reception.



What new recorder is virtually custom-built?

AMPEX F-44

The F-44 is a brand new 4-track stereo recorder from Ampex. It's Ampex through and through. And there's this, too: at every stage of manufacture Ampex tunes, adjusts and aligns each F-44 to obtain its maximum performance — far beyond minimum specifications. Thus, no two F-44s are quite alike. Each is virtually a custom-built recorder. Each performs to the utmost of its capabilities. And each gives you the best possible sounds today—and for many years to come. As an F-44 owner, you'll receive from Ampex a record of the individual performance specifications of your own F-44. This record shows the frequency

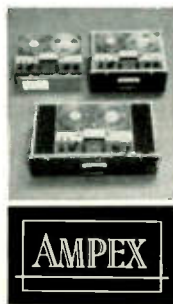

response curve, the signal-to-noise ratio, the flutter and wow, and the crosstalk rejection measurement. And it is signed by the Ampex engineers who tuned and adjusted your recorder. The new Ampex Fine Line F-44 also features a new special design hysteresis motor for smooth, quiet, accurate operation; an easy-to-read point-to-point record level meter for each channel; multiple sound-on-sound capability; new simplified controls; and the Ampex one year warranty. See and hear the new F-44 at your local Ampex dealer. Brochure? Write: Ampex Corporation, Redwood City, California. Sales and service throughout the world.

should Sherwood increase its prices by 20%



the superlative new S-8000 III FM stereo receiver priced at \$319.50



Years ago, Sherwood high-fidelity tuners and amplifiers were evaluated by highly-respected, totally-impartial research companies as either the finest designed or the best valued on the market. ■ Although we were pleased by such endorsements of pure quality in design and performance, the really significant fact was that *other leading components carried higher price tags.* ■ *Subsequent Sherwood components have received ratings indicating features and performance equal or superior to brands carrying price tags at least 20% higher.* ■ A current example of Sherwood design superiority is our new S-8000 III receiver. Sensitivity is rated at 1.8 microvolts. Capture effect is an *outstanding 2.4 db.* ■ No other FM receiver can claim the 80-watt music-power rating of the S-8000 III, and only one other (priced \$50 higher) offers the professional D'Arsonval zero-center tuning meter that's standard with Sherwood. ■ We still believe that our old-fashioned policy of superior engineering and realistic prices is best for both you and Sherwood.

SOME OF THE S-8000 III FEATURES THAT MAKE THE DIFFERENCE

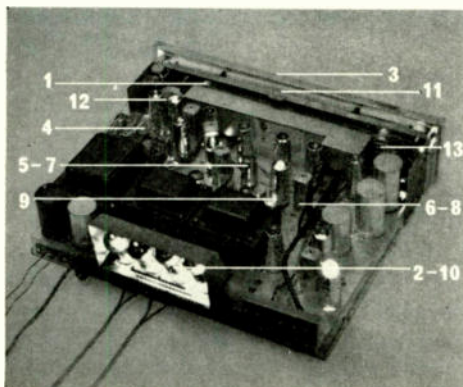

1. Zero-center tuning
2. 80-watt music power
3. Complete stereo control center
4. 1.8 μ v. (IHF) sensitivity
5. Wide-band 3-mc. gated beam limiter
6. 1-mc. band pass balanced ratio detector
7. 2.4db. capture effect
8. 1/3% distortion at 100% modulation
9. Interchannel hush
10. Long-life Novar output tubes
11. 8-inch professional-type tuning scale
12. Silk-smooth flywheel tuning
13. Positive stereo broadcast identification

For your free copy of our complete catalog, write Dept. R-12
SHERWOOD ELECTRONIC LABORATORIES, INC.
4300 North California Ave. Chicago 18, Illinois

Sherwood
HIGH FIDELITY

STEREO RECEIVERS ■ TUNERS ■ AMPLIFIERS ■ STEREO INDICATOR LIGHTS ■ SPEAKER SYSTEMS ■ CONTEMPORARY CABINETRY

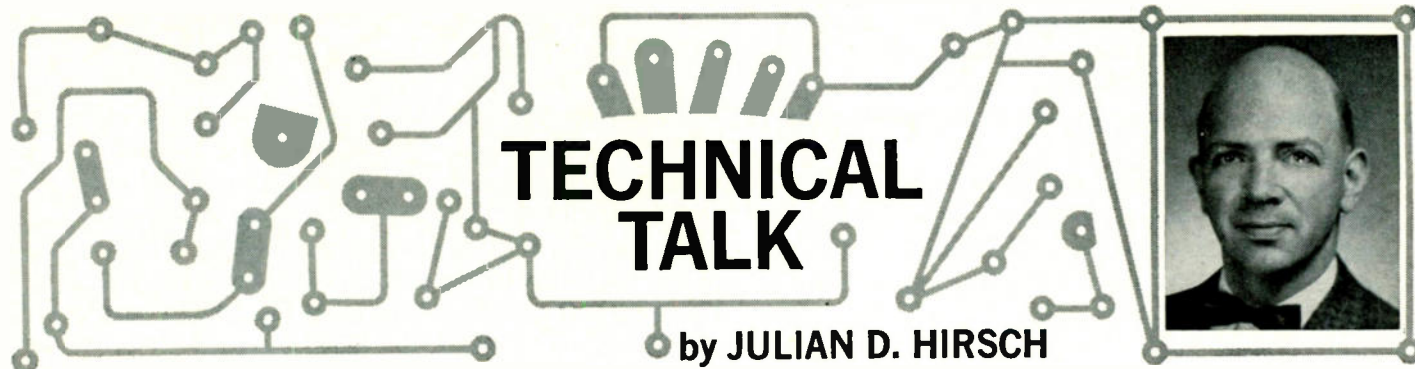

● **TAPE-RECORDER TESTING:** At first glance, it might seem that measuring the performance of a tape recorder should be a rather straightforward matter. However, there are several factors peculiar to tape recorders that can make the testing process—in certain respects—somewhat trickier than one would expect.

After familiarizing myself with the operation of a tape recorder, I connect its output to an audio vacuum-tube voltmeter and oscilloscope. There are several test tapes available, and I usually use the RCA 12-5-61 or the NCB to measure playback frequency response. Both are 7½-ips half-track tapes, covering the range from 30 to 15,000 cps, and are designed to be played with the NAB Standard Reproducing Characteristic. (Incidentally, the NAB Standard [Primary] Response limits established for semiprofessional and professional machines are ± 1 db from 100 to 7,500 cps, and down not more than 4 db at 50 cps and 15,000 cps.)

For measurement of the over-all record-playback frequency response, I usually use a 1-mil tape, such as Scotch 190A, LR Audiotape, or the tape recommended by the manufacturer. Although output level and frequency response can be affected by the type of tape used, few tape machines have instructions or facilities for setting the recording bias for optimum results with a particular tape. As a result, I usually do not attempt to optimize the bias, unless it is recommended.

I record a sequence of test frequencies from an audio generator, from 20 to 20,000 cps, at a level 20 db below the maximum recording level, as indicated by the recorder's eye tube or meter. Although most recorder manufacturers specify performance relative to a maximum level that gives a certain amount of harmonic distortion, such as 3 per cent, I prefer to use the machine's own level indicator as a criterion, since this is the only indication available to the user. The low input level of -20 db is more or less standard for response measurements, since higher levels will result in loss of high-frequency response due to tape saturation.

The played-back output of the tape is measured at each speed the machine provides and in the same man-

ner as with one of the standard playback test tapes.

Signal-to-noise ratio is also measured relative to maximum recording level. I record a maximum-level (as per the recorder's indicator) 1,000-cps signal on a reel of bulk-erased tape, set the playback level for a 1-volt output, and then measure the output from the *unrecorded* portion of the tape. The oscilloscope connected to the output jacks shows what portion of the recorder's residual noise signal is hum and how much is hiss. Stereo crosstalk is measured by recording a maximum-level 1,000-cps signal on one channel and measuring the output of the other channel.

In the measurement of wow and flutter, I depart somewhat from the ideal practice. It would be preferable to use a test tape with a constant-frequency tone that is recorded without flutter, or with very low flutter. Not having such a tape, I record a 3,000-cps tone on the machine being tested and play it back on the same machine. Obviously some flutter will be introduced during recording and some during playback. It is possible that some cancellation of one by the other will result in a flutter reading that is slightly lower than the true flutter of the machine. The difference is minor—at least from the standpoint of the user of a home tape recorder—and in any case it is a reasonably valid indication of the performance of the machine used as a recorder-reproducer, rather than as a reproducer of prerecorded material only.

I use a Donner Model 2800 wow-and-flutter meter, which measures instantaneous frequency variations of a 3,000-cps tone, in accordance with IRE (IEEE) standards. Frequency variations of 0.5 to 10 cps are measured separately as wow, while those of 10 to 300 cps are termed flutter.

One measurement I do not make is distortion. Low-level harmonic distortion of a recorder is difficult to measure because of low-frequency noise and flutter that, even in small amounts, can cause large fluctuations of the meter of a distortion analyzer. For the same reason, conventional intermodulation-distortion measurements produce shockingly large figures, even on the

REVIEWED THIS MONTH

Scott LK-30 Stereo Amplifier Kit



KLH Model 14 Speaker System

best recorders. I find that critical listening tests are remarkably sensitive indicators of the distortion and frequency-response aberrations of a recorder, and I value them above distortion measurements whose validity may be questionable.

If you are considering the purchase of a tape recorder, try recording a good record and compare the original to the recorded program. This is my ultimate test, and it is one that few recorders can pass with flying colors.

**SCOTT LK-30
STEREO
AMPLIFIER
KIT**

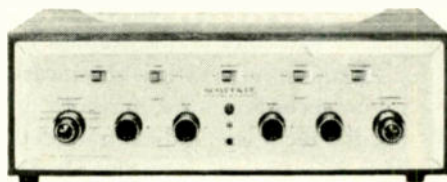

● THIS latest Scott stereo amplifier brings the high quality and ease of construction of the other Scott kits to the low-price, low-power market. The LK-30 is rated at 15 watts per channel (IHF music power), or 12 watts per channel (continuous). Despite the current emphasis on high power, good low-power amplifiers, such as this one, fill a definite need for the music listener on a modest budget.

The LK-30 uses only three and one-half multi-section tubes in each channel. A pair of ECL86 amplifier-triode, output-pentode tubes serve as the push-pull power amplifier, voltage amplifier, and phase inverter for each channel. A slow-heating rectifier tube (5AR4) enables all tubes to warm up before high voltage is applied, thus preventing voltage overload on circuit components.

The LK-30 has a full complement of operating controls, with most of the flexibility of higher-price units. There are inputs for magnetic or ceramic phono cartridges, tuner, and tape recorder (including tape-monitoring provisions). Each channel has separate feedback-type bass and treble tone controls that do not affect mid-frequency gain and that give a true flat response when the controls are centered. There is a front-panel headphone jack, which also reduces the speaker volume when phones are plugged in (only when 8-ohm speakers are used, however). Switchable loudness compensation boosts both lows and highs at low listening levels. The scratch filter is usable with all program sources.

The mode selector is unusually flexible, with positions for mono, stereo, reversed-channel stereo, left or right inputs through both channels, and two additional positions labeled BAL R and BAL L. These are used with the concentric volume controls, which have a slip-clutch knob arrangement to permit independent adjustment of the gain of each channel. The concentric volume controls are adjusted while switching between the two BAL positions until equal volume is obtained

from both speakers. This is one of the simplest and most effective balancing techniques I have used.

The LK-30 also has a very clever and effective circuit for adjusting output-tube bias without the use of a meter. A switch on the chassis compares a fixed reference voltage to another at the cathode resistors of the output tubes. The difference voltage charges a capacitor, which is connected to the amplifier inputs. When the switch is turned back and forth, clicks are produced in the speakers if the bias is not set correctly. When the bias is proper, the clicks disappear.

Scott kits are designed so that they can be built by those with no previous electronic or kit experience. The construction process is broken down into a number of stages. All parts—and pre-cut, tinned wires for each stage—are packed in assembly groups. The manual has separate full-color illustrations for each assembly group, leaving no doubt as to the color of wires, lead dress, and resistor color codes. Construction time was about 25 hours. It is hard to imagine a more fool-proof kit design.

I measured the continuous power output of the Scott LK-30, with both channels driven, to be 11 watts per channel at 1 per cent harmonic distortion between 50 and 10,000 cps. With only one channel driven, the output was 13 watts. These figures are consistent with the 15-watt music-power rating, which I did not check. Available power at the low and high frequencies fell off somewhat, as is normal in any but the most expensive amplifiers. The power at 1 per cent distortion fell to about 8.5 watts at 30 and 12,000 cps. However, at the 3-per-cent distortion level, 10 watts were available from about 25 to 20,000 cps.

Intermodulation distortion, which is largely indicative of low-frequency (60-cps) nonlinearity, on my tests ranged between 1 and 2 per cent over most of the amplifier's useful output range. Scott's rated IM distortion is 1 per cent, at an unspecified power output; the discrepancy is probably because of a difference in test techniques. The 1,000-cps harmonic distortion, which I believe in this case is a more meaningful indication of the over-all linearity of the amplifier, was very good,

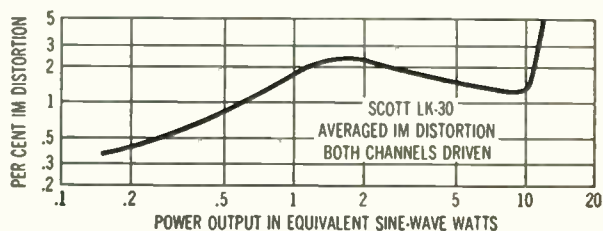
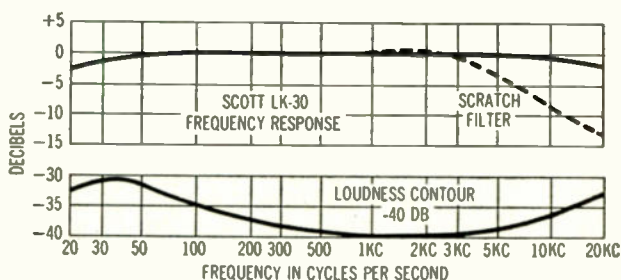

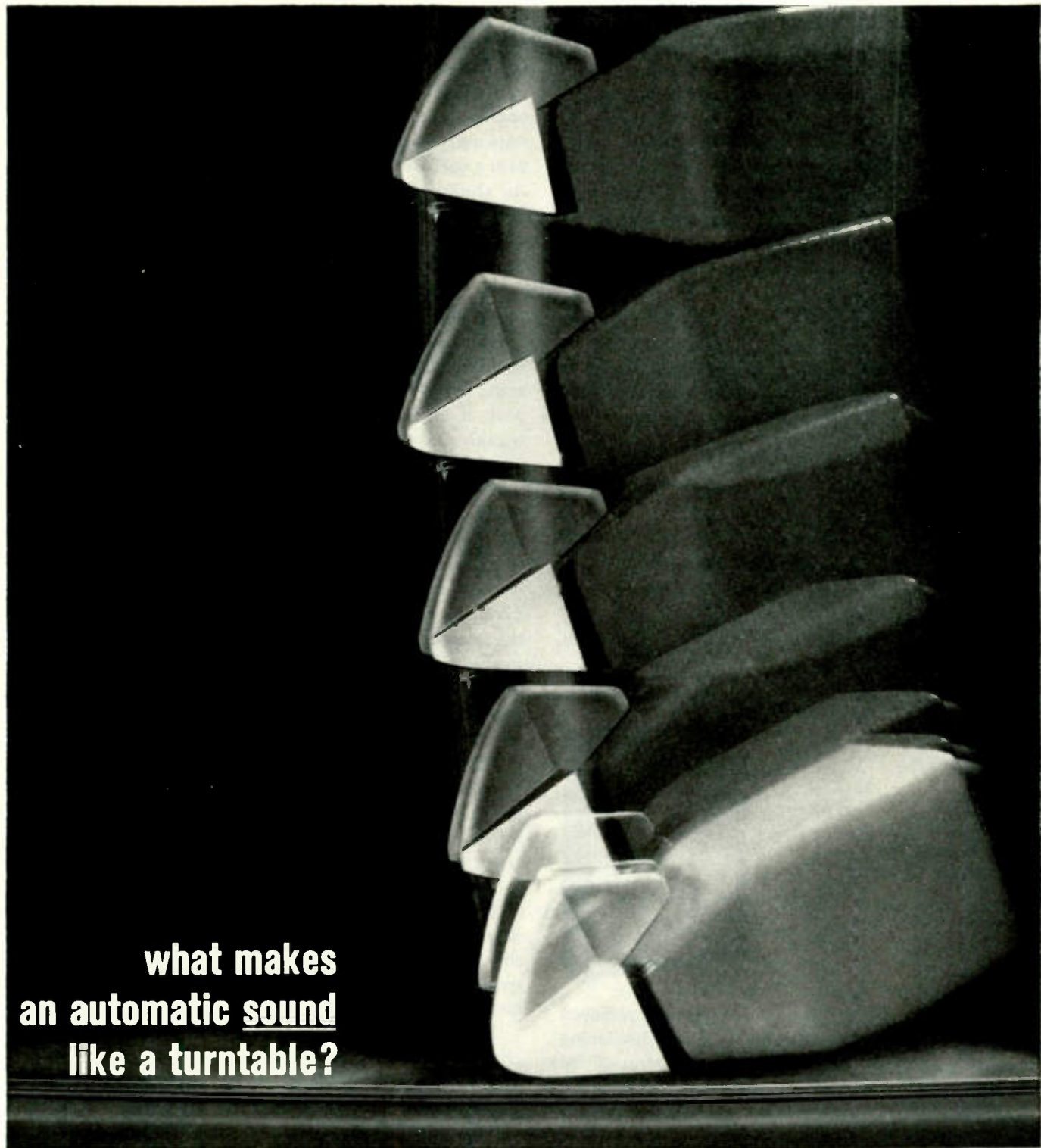

what makes
an automatic sound
like a turntable?

The U38!
expressly designed
for automatic
turntables

The new generation of automatic turntables tracking and tripping at lower and lower forces demands this new kind of cartridge. Demands a "floating stylus" that protects your diamond and record as it plays...demands complementary electrical characteristics which maximize the use of forward-looking circuitry whether vacuum tube or solid state. The U-38 meets these demands and makes your automatic **sound like** a turntable. With Pickering's famous plug-in replaceable stylus assembly you get a cartridge with a life-time of trouble free performance. Pickering and Company, Inc., Plainview, New York.

Pickering



U38 cartridge with
AT Stylus...2.5 grams tracking force
ATG...1-3 grams



Plug-in head assembly for
Garrard Type A and Model AT6

actually being under 0.25 per cent at the 5-watt level.

The LK-30's frequency response was within ± 1 db from 20 to 20,000 cps with the tone controls mechanically centered. The scratch filter was effective above 4,000 cps. The loudness-compensation contours are well chosen, and had a pleasing effect, with no trace of boom or tubbiness. The tone controls had slightly more than their rated ranges, and hum (-56 db on phono and -75 db on tuner input, referred to 10 watts) was inaudible in normal operation.

I have one minor criticism of the LK-30's volume-control arrangement. In tests, I found that the concentric volume controls track very well when they are set for the same gain in both channels. However, if they are displaced slightly to compensate for differences in speaker efficiency, their tracking becomes very poor, and they must be balanced after every change of setting. This is a common fault in amplifiers employing dual gain controls rather than a single master gain plus balance control, and is a good reason to use two speakers of the same make and model.

In operation, I found the LK-30 to be an excellent performer. It was clean and stable, and its sound could not be distinguished from that of much more expensive amplifiers. The Scott LK-30 kit sells for \$99.95. The same amplifier is available factory-wired as the Model 200B for \$139.95.

KLH MODEL 14 SPEAKER SYSTEM

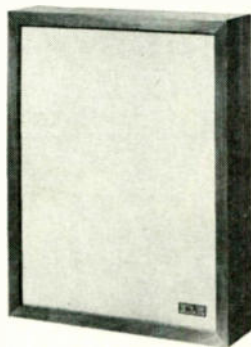

● NOW THAT bookshelf speaker systems have achieved wide acceptance, there seem to be trends developing toward both larger and smaller systems. Most of the midget systems make serious compromises with quality, and are really only suitable for use as kitchen or bedroom extension speakers. A notable exception is the new \$49.50 KLH Model 14, which incorporates two special 3-inch speakers in a ported walnut enclosure measuring only 14 x 18 x 3 $\frac{3}{4}$ inches.

The speakers of the Model 14, despite their small size, are capable of a $\frac{3}{8}$ -inch peak-to-peak cone excursion—which exceeds the capabilities of many 12- and 15-inch speakers. The ceramic magnets are considerably larger than the rest of the speaker structure, and, according to KLH, these units have the most powerful magnets in relation to their cone mass of any speakers being made.

This combination of two small, long-throw speakers in an enclosure of one-third cubic foot volume is capa-

ble of a surprising bass output. However, the light, stiff cones would normally also tend to be more efficient at middle and high frequencies. This is taken care of in the KLH Model 8 FM receiver and Model 11 phonograph by "contouring" the amplifier's frequency response to be the inverse of the speaker's response, with a flat acoustic frequency response as the objective. An equivalent correction circuit has been built into the Model 14, in the form of an equalizing network that depresses the mid-frequency response (by about 8 db), and to a lesser extent the high-frequency response, to produce a better over-all balance. The input impedance at the compensated input is 8 ohms.

My acoustic frequency-response measurements revealed a slightly sway-backed curve, very smooth, and rising somewhat at high frequencies. There was a broad peak of approximately 5 db around 300 cps, with a smooth roll-off below 200 cps. The over-all response was ± 4 db from 100 to 10,000 cps.

A jack on the enclosure permits bypassing the contouring network, so that the Model 14 can be substituted for the Model 11 portable phonograph's regular speakers. In this situation, the amplifier of the Model 11 provides the required equalization. I remeasured the frequency response with my signal source connected to the uncompensated input and found the speaker's response to be an exceptional ± 1 db from 350 to 15,000 cps, falling off at low frequencies. Over the stated range, this is the flattest response I have ever measured on a loudspeaker.

The harmonic distortion at low frequencies was quite high, even with only 0.5 watt of drive. Although this speaker can, without difficulty, produce enough sound for most living rooms, it cannot equal the volume of larger systems.

The extremely smooth and flat frequency response of the Model 14 suggested that its transient response would also be excellent; and tone-burst measurements showed that it was as good in this respect as any cone speaker I have ever tested. At no frequency was there any sign of spurious output or sustained ringing.

The sound of the KLH Model 14 is quite similar in character to that of the larger KLH systems. It is clean and airy, without stridency or any other unpleasant characteristics. The bass response varies considerably with speaker placement, from adequate at a floor-wall junction to rather thin at a mid-wall position. At any reasonable listening level, the system's very smooth bass rolloff permits a fair amount of amplifier bass boost to be used without introducing boom. Efficiency of the KLH 14 is rather low, but it can produce excellent results when driven by any good 10-watt amplifier.

All things considered, I would say the Model 14 is the best fifty-dollar speaker I have ever heard.

For additional product information, use the reader service card. Circle number 188 for the Scott LK-30 stereo amplifier, number 189 for the KLH Model 14 speaker system.

the one outstanding feature is that it has them all

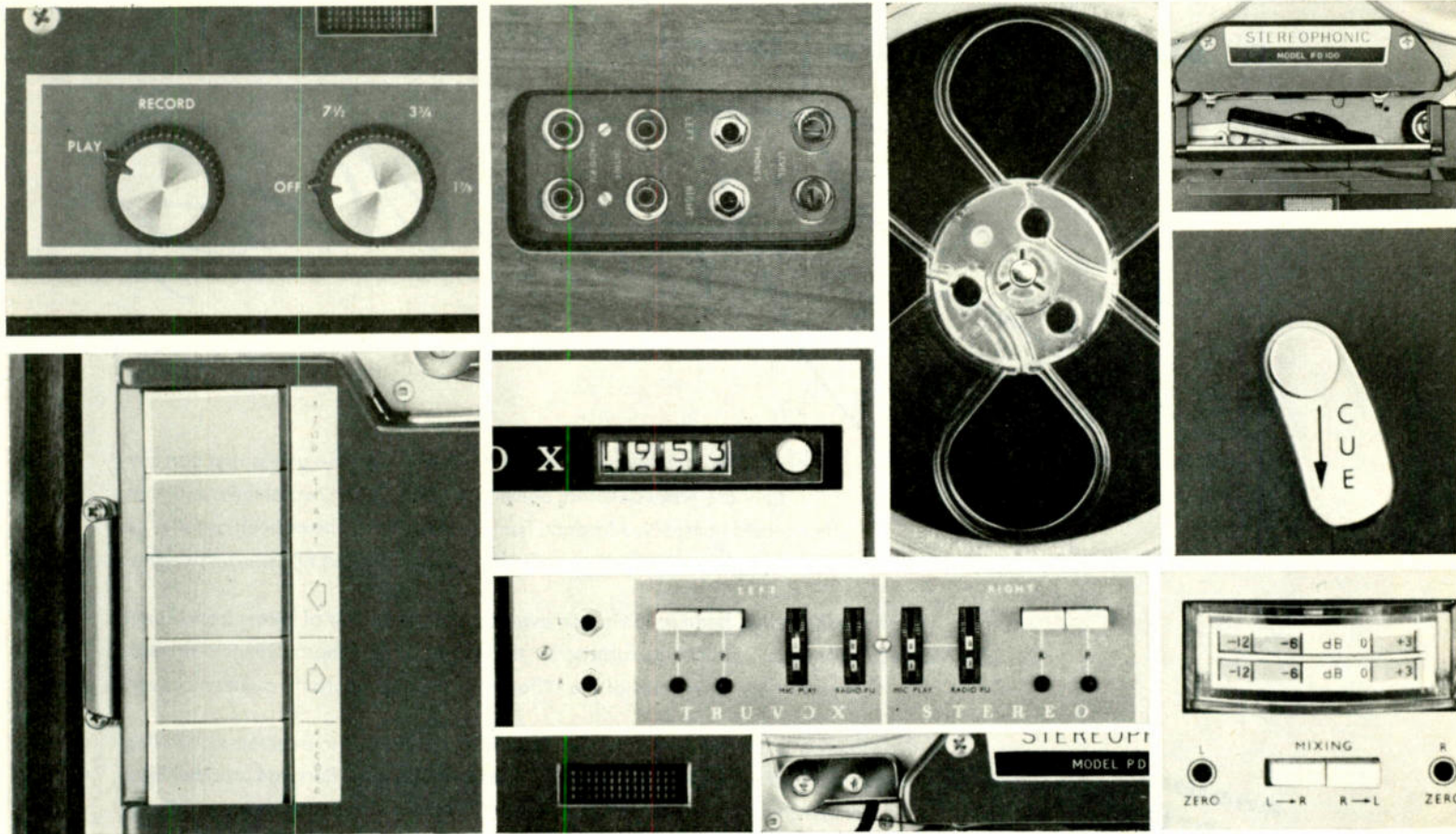

New Benjamin-Truvox PD-100

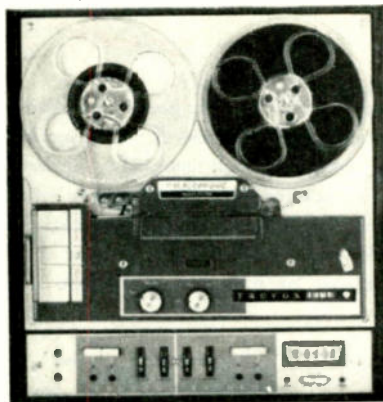

The Truvox PD-100 is a new 4-track, stereo tape deck with built-in 'record', 'playback' and 'monitor' preamplifiers. It is so complete in every detail, no one feature or facility can be said to dominate. It has them all. A remarkable example of British thoroughness in audio equipment design!

Whether you judge this unit by these features or by the quality of its performance, there is only one conclusion you will reach: *the PD-100 stands squarely with the finest professional tape units available today.*

features: □ operates vertically or horizontally □ 3 speeds: 7 1/2, 3 3/4 and 1 7/8 ips □ 3 heads: 'erase', 'record', and 'playback' □ 3 motors: including Papst 'squirrel-cage' motor for capstan drive □ 6 1/2-inch capstan flywheel □ 'record-playback' preamps with

cathode-follower outputs □ transistor preamps for monitoring 'record' quality with low-impedance headphones directly from tape. □ 2 VU db-calibrated meters □ 4-digit counter with automatic zero-reset button □ 'stop-start' cueing button □ self-adjusting instantaneous stop' brakes □ hinged-cover giving access to tape heads with convenient splicing guide-plate built in □ automatic-end-of-play and tape-break 'shut-off' □ patented 'nubloc' spindles hold reels securely when operated vertically □ function signal lights.

recording versatility: □ off-the-air tapes of FM-multiplex, mono radio or TV programs □ stereo and mono tapes from your favorite records for unlimited playback without wear to your records and stylus □ sound-on-sound □ echo, fade and mixed input effects.

and here are some hints of the quality you can expect: □ frequency response: 30 to 20,000 cycles at 7 1/2 ips; 30 to 12,000 at 3 3/4; and 50 to 8,000 at 1 7/8; ±3 db □ wow and flutter: less than 0.1% at 7 1/2 ips; 0.15% at 3 3/4; and 0.25% at 1 7/8. □ signal/noise ratio: better than 50 db □ channel separation: better than 55 db

Dimensions of the PD-100: 14 1/4" wide x 15 7/8" deep x 7" high. Price is \$399.50 (less base). At your high fidelity dealer, or write: Benjamin Electronic Sound Corp., 80 Swalm Street, Westbury, New York.

Sole U.S. Distributor for Truvox tape recorders, Mirocord turntables and Elac cartridges.

**BENJAMIN
TRUVOX**

CIRCLE NO. 14 ON READER SERVICE CARD

a **marantz** owner

Forever

There is no such thing as a typical Marantz owner—unless one can say they are firmly devoted. Some may have determined at the outset that they would have only Marantz. For still others it may have been a matter of budgeting, with planned growth to a full Marantz system.

We have, however, been receiving an ever increasing number of letters from recent Marantz "converts", indicating surprise at the extent of the improvement obtained. They are now convinced of the difference, and are Marantz owners forever.

Whether one is buying soap or automobiles, it is difficult to evaluate conflicting claims and counterclaims of superiority. Yet, when it comes to stereo amplifiers and preamplifiers, almost anyone will acknowledge that Marantz is outstanding from any point—whether performance, precision, quality of construction, reliability, or sound quality.

Hear for yourself what the finest music reproduction sounds like—and you too will be a confirmed Marantz owner—forever!

another
important
message



Quality does not come easy. It takes hard work, know-how, craftsmanship and time. The introduction of the classic Model 7 Stereo console, if you remember, took time. Now, our Model 10 Stereo FM tuner again requires time. Those of you who have already received your Model 10 tuner can see that they are individually custom crafted with traditional Marantz quality. So, you who have ordered and are waiting delivery . . . please be patient. I assure you it is well worth waiting for.

Marantz President



Superb American Craftsmanship **marantz**

25-14 BROADWAY, LONG ISLAND CITY 6, NEW YORK

Model 7 Stereo Console • 1M distortion @ 10V eq. pk. RMS, within 0.15%, 0.1% typical • Hum and noise, 80 db below 10 mv phono input • Sensitivity, 400 microvolts (0.4 millivolts) for 1 volt output • Equalizer and tone curves matched to better than 0.5 db • Beautiful precision construction • Price \$264 (Cabinet extra)

Model 8B Stereo Amplifier • 35 watts per channel (70 watts peak) • Harmonic distortion, less than 0.1% in most of range, less than 0.5% at 20 cps and 20 kc • Hum and noise, better than 90 db below 35 watts • Exceptional stability assures superb clarity with all types of loudspeakers • Price \$264.

Model 9 Amplifier—70 watt basic amplifier • Response at 70W, ± 0.1 db, 20 cps to 20 kc • Harmonic distortion, less than 0.1% in most of range, 0.3% at 20 cps and 20 kc. • Hum & noise, better than -90 db • Completely stable for smooth response • Built-in metered tests and adjustments • Price \$384 each. (higher in West)



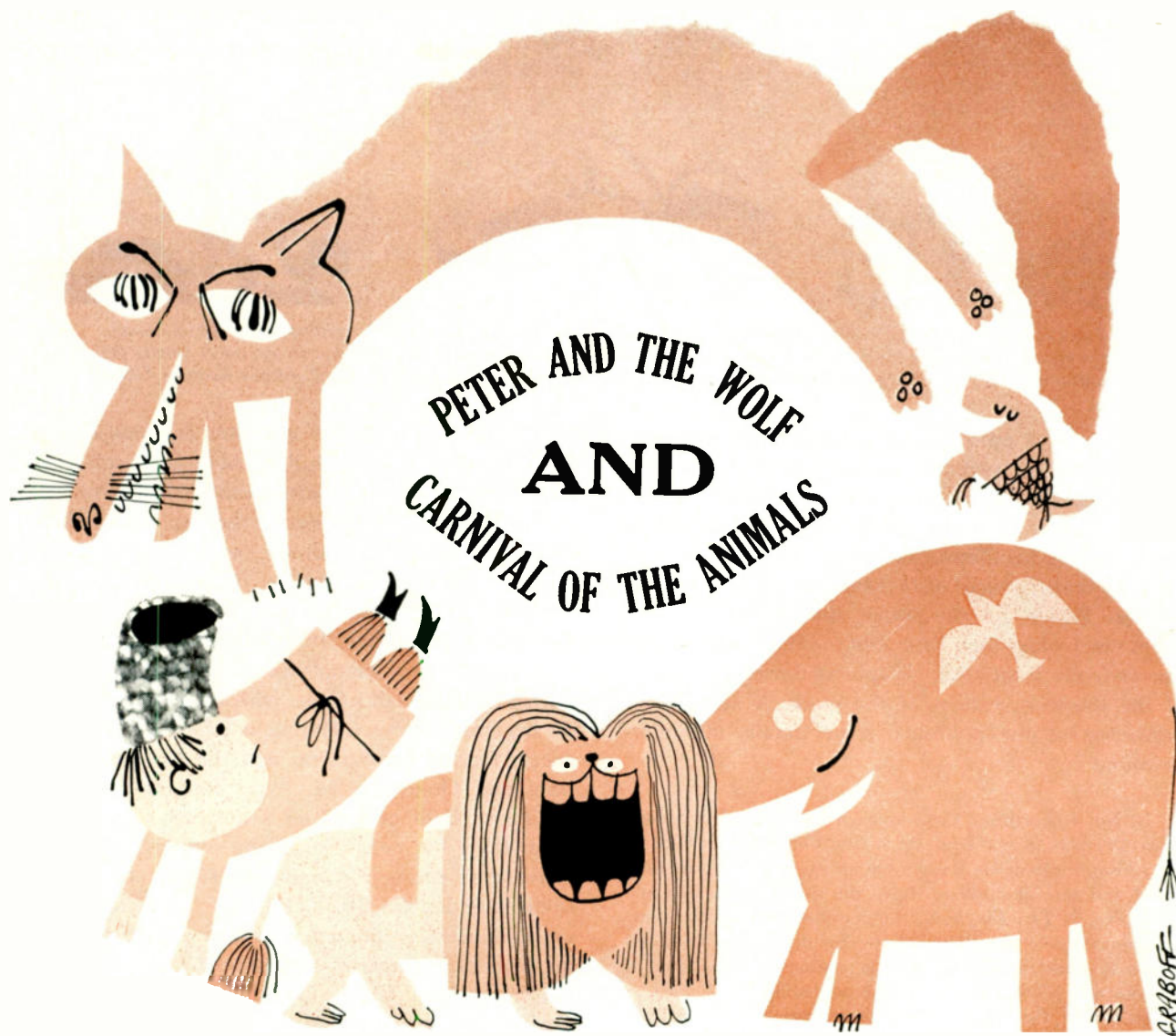

BEFORE HE CAME to Boston in 1924, Serge Koussevitzky was instrumental in introducing much of the music of his compatriot Serge Prokofiev to the musical capitals of Europe. During Koussevitzky's quarter-century as music director of the Boston Symphony Orchestra, he made the Massachusetts capital a Prokofiev stronghold: many of the composer's scores were given their first American performances in Boston. During those years, too, Prokofiev himself appeared fairly frequently as a guest conductor and piano soloist in Boston. In March of 1938, he made what was destined to be his last Boston Symphony Orchestra appearance, conducting a program of his own music in which he also was the soloist in his First Piano Concerto. The second half of the concert consisted of music entirely new to this country: the second suite from his recently completed ballet, *Romeo and Juliet*, and the first performance outside Russia of something brand new and special — an orchestral fairy tale, with narrator, called *Peter and the Wolf*.

I was not quite twelve at the time, but I distinctly

recall my absorption in the story spun by that best of *Peter and the Wolf* narrators, Richard Hale, and the thunderous applause that erupted in Symphony Hall when the performance was over. About a year later RCA Victor released a performance of the work with Koussevitzky and the Boston Symphony Orchestra, and with Hale repeating his superb narration.

A quarter-century has passed since *Peter and the Wolf* was first performed in this country. In that period of time, the work has become one of the best-loved of all pieces of musical fun. The reasons are easy to find: Prokofiev created some unforgettable melodies to accompany the animals' adventures, and young people quickly become captivated by both the music and the story. Even more important, however, are the recognizable human characteristics of Peter and the menagerie — the duck, the bird, the cat — that make people of all ages smile.

While Prokofiev wrote *Peter and the Wolf* hoping to reach the broadest possible audience, fifty years earlier, in 1886, Saint-Saëns had composed his Grand Zoological Fantasy, *Carnival of the Animals*, as a pri-

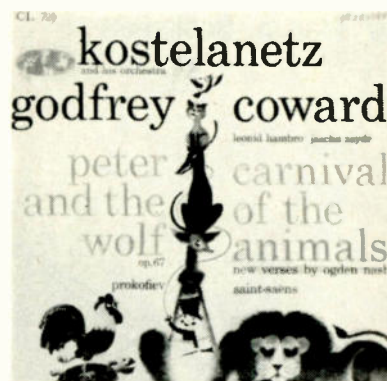
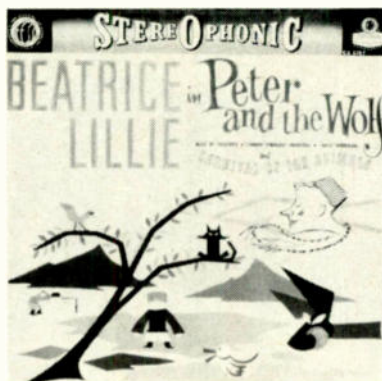
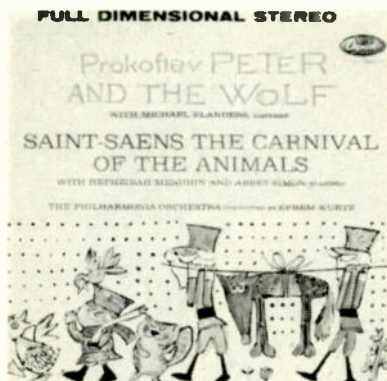

The Capitol coupling of *Peter and the Wolf* and *Carnival of the Animals*. Efrem Kurtz conducting the Philharmonia Orchestra, is musically the best. Both Henderson for London and Kostelanetz for Columbia (mono only) handle the music capably, but, in Ogden Nash's verses for *Carnival*, Columbia's Noel Coward tops London's Beatrice Lillie.

vate joke for a group of his colleagues. It was originally scored for two pianos and chamber ensemble, and though he later orchestrated it, Saint-Saëns refused to allow it to be published or performed in public during his lifetime. It was not until 1922, after he died, that *Carnival of the Animals* finally saw publication. Hence, for the public, this superlative farce is not much older than *Peter and the Wolf*. Saint-Saëns quotes freely from other composers during the course of the fourteen sections of the score. A note at the beginning of the published score details the interpolations:

"In No. 4, *Tortoises*, the composer has utilized two tunes from *Orpheus in the Underworld* by Offenbach, which he has re-harmonized. He has chosen an excerpt from the final ballet and several measures from the finale of the first act.

"In No. 5, *The Elephant*, the composer interpolates several measures of the Ballet of the Sylphs from *The Damnation of Faust* by Berlioz with a passing souvenir from *A Midsummer Night's Dream* by Mendelssohn.

"In No. 12, *Fossils*, there are introductions of motifs from *J'ai du bon Tabac*, *Ah! Vous dirai-je-Maman*, *Danse Macabre*, *The Departure for Syria*, and the Air of Rosina from *The Barber of Seville*."

Both *Peter and the Wolf* and *Carnival of the Animals* are among the most-recorded works in the catalog. There are no fewer than seven different recordings available that couple the two scores back-to-back. Columbia started it all ten years ago with a disc still listed in the current catalog (CL 720). The musical direction is in the capable hands of André Kostelanetz; Arthur Godfrey is the *Peter* narrator, and the two pianists in the *Carnival* are the irrefragable Leonid Hambro and Jascha Zayde. The Saint-Saëns performance is further fitted out with verses written by Ogden Nash and spoken marvelously by Noel Coward. There is a decided air of disingenuous cleverness about the *Carnival* performance, and yet I continue to find it disarmingly amusing. I am a good deal less happy about Godfrey's part in the *Peter and the Wolf* performance—he is coy and condescending.

Of the stereo/mono couplings of the two scores, the most straightforward is that of Efrem Kurtz conducting the Philharmonia Orchestra (Capitol SG/G

7211). Michael Flanders is a fine narrator-actor in the Prokofiev, and Hephzibah Menuhin and Abbey Simon are the expert pianists in the Saint-Saëns.

The Westminster version of the two works (WST 14040, XWN 18525) is almost lost in gimmickry. This *Carnival* has verses written by John Burt and spoken by Garry Moore, who also serves as the narrator in the *Peter* performance. In addition, there is a host of "natural sounds of animals recorded at the Bronx Zoo" throughout the Saint-Saëns performance, and also at the beginning of *Peter*. Hermann Scherchen is the conductor for the Saint-Saëns, and the two pianists are Josef and Grete Dichler. Artur Rodzinski conducts the *Peter*. Both performances are rather pedestrian.

Anything but pedestrian is the coupling of the two scores that enlists the narrative talents of Beatrice Lillie (London CS 6187, CM 9248). Skitch Henderson conducts the London Symphony Orchestra, and the pianists in *Carnival* are Julius Katchen and Gary Graffman. Miss Lillie, too, declaims the verses of Ogden Nash, but unlike Mr. Coward, she is thoroughly self-conscious in her readings: the listener is almost painfully conscious that Miss Lillie is trying to amuse. In addition, there are here, too, all manner of animal noises at the beginning, and throughout the reading trick microphone techniques, echo chambers, and other accoutrements add to the feeling of overproduction. The *Peter* presentation is much more successful; the narrative is specially adapted for Miss Lillie by someone called Bidrum Vabish, and some of the Lillie-isms are actually quite charming. Henderson conducts meticulous performances of both scores, and some of his effects—the slow, lumbering gait for the first appearance of the cat in *Peter*, for example—are marvelously appropriate.

The three remaining couplings of the work, on the Harmony, Rondo-lette, and Monitor labels, are considerably inferior in both artistic and recording values to those I have discussed. Of the four respectable coupled performances of *Peter and the Wolf* and *Carnival of the Animals*, the Capitol version is unquestionably best in musical qualities. As for the other three, it is a matter of how much extramusical frolicking you can tolerate.

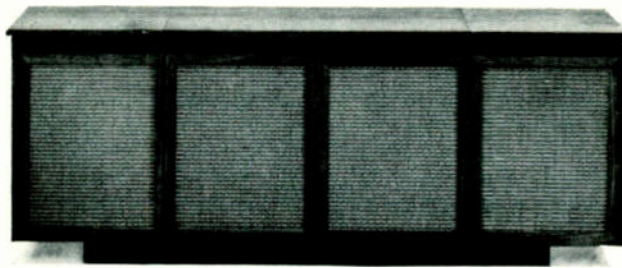

No Larger Than A Record Changer . . . Every Inch A Troubador

The New Empire 488 . . . tailor made for console or equipment cabinets. It is well known that acoustic feedback has been harassing playback equipment in console cabinets for years. This is due in large measure to the close proximity of turntable to speaker. Not too long ago, Audio Magazine tested the Empire Troubador . . . they reported: "We tried to induce acoustic feedback by placing the turntable on top of our large speaker system and turning up the gain—we were unsuccessful." Other factors important to cabinet owners are stability and level surfaces, the jars and jolts of heavy footsteps or accidental bumps can jump some arms even in the most stable cabinets. Stability under virtually

any conceivable situation is now assured by Empire's sensational "Dyna-Mount" (vibration-absorbing multiple floating suspension system) found only in the new Empire 488. The Famous Empire 398 . . . professionals' turntable—too perfectly engineered for even a whisper of distortion . . . too handsome to hide behind cabinet doors. Hi Fidelity reports: "The Troubador represents a precision-engineered product of the highest quality . . . wow, flutter and rumble completely negligible . . . speed accuracy very good . . . maximum tracking error of the arm judged to be negligibly small . . . very low needle talk, minimum hum pick-up . . . clean response . . . one of the finest, handsomest record players available."

EMPIRE

"World's Most Perfect Record Playback System."

Empire 3-speed "silent" turntable, only 2 moving parts.

Empire 98C dynamically balanced playback arm with the sensational Dyna-Lift*

Empire 880p mono-stereo cartridge featuring the virtually indestructible Dyna-Life* stylus

13 1/4"

15 7/8"

*Patent Pending

Dimensions: Minimum space requirements 15 7/8" wide x 13 1/4" deep . . . height required above mounting board 2 3/4"; depth required below turntable base plate 3 1/2".

Prices: 488 complete with walnut mounting board: \$192. Walnut base optional (\$15). 398 complete with handsome walnut base: \$210.

Empire Scientific Corp. • 845 Stewart Ave., Garden City, L. I., N. Y. / Export: EMEC, Plainview, L. I., N. Y. • Canada, Empire Scientific Corp., Ltd., 1476 Eglinton West, Toronto

TUNER SECTION: In the kit, the two most critical sections—the front end and the IF strip—are supplied pre-wired and pre-aligned; and a high quality circuit board and pre-aligned coils are provided for the stereo demodulator circuit. The IF strip has 4 amplifier-limiter stages and a wideband ratio detector for perfect limiting and flat frequency response. Sensitive bar-type electron-ray tuning indicator pinpoints the center of each broadcast channel for lowest distortion, and also serves as the stereo program indicator

Antenna input: 300 ohms balanced □ IHFM usable sensitivity: 3 μ v (30 db quieting), 1.5 μ v for 20 db quieting □ Sensitivity for phase locking (synchronization) in stereo 3 μ v □ Full limiting sensitivity: 10 μ v □ IF bandwidth: 280 kc at 6 db points □ Ratio detector bandwidth: 1 mc peak-to-peak separation □ Audio bandwidth at FM detector: flat to 53 kc □ IHFM signal-to-noise ratio: 55 db □ IHFM harmonic distortion: 0.6% □ Stereo harmonic distortion less than 1.5% □ IHFM capture ratio: 3 db □ Channel separation: 30 db.

AMPLIFIER SECTION: High quality Eaxandall bass and treble controls do not interact or affect loudness, permit boost or cut at extremes of range without affecting mid-range. Balance control is infinitely variable, permitting complete fade of either channel. Blend control is variable from switch-out, for maximum separation, to full blend. Tape Monitor switch permits off-the-tape monitoring with the Eico RP100 Stereo Tape Recorder.

Power: 36 watts IHFM music, 28 watts continuous (total) □ THM distortion (each channel): 2% at 14 watts, 0.7% at 5 watts, 0.2% at 1 watt □ Harmonic distortion (each channel): 0.6% at 10 watts, 40 cps to 10 kc; 0.2% at 1 watt, 30 cps to 20 kc □ IHFM power bandwidth at rated continuous power, 1% harmonic distortion: 30 cps to 20 kc □ Frequency response \pm 1 db, 15 cps to 40 kc □ Speaker output: 8, 16 ohms □ Inputs: Magnetic phono or adapted ceramic phono, tuner, tape auxiliary □ Sensitivity: 2.3 mv phono, 250 mv others □ Noise: -65 db at 10 mv, mag phono; -80 db others.

New Eico Classic 2536 Stereo FM Receiver

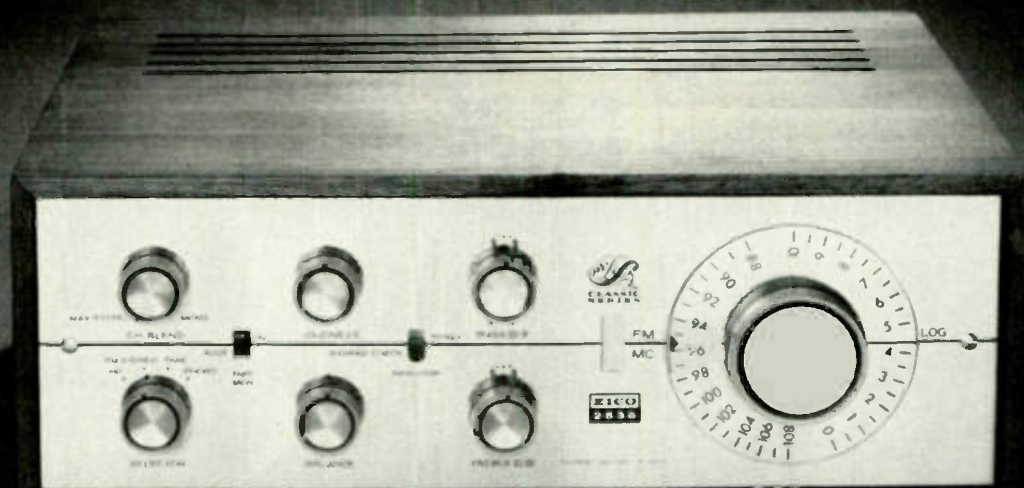

Now... every other stereo receiver seems overpriced

Take a superb stereo tuner, guaranteed stable under all conditions, and sensitive enough to give full stereo separation even on weak, fringe-area signals...

Add a virtually distortion-free 36-watt stereo amplifier with remarkable overload and transient characteristics...

Mount them on one chassis—effectively separated for the performance benefits of components plus the convenience of a single compact unit... Price this combination at \$209.95 factory-wired, and at \$154.95 in a new kit pack that makes building a delightful experience—and what do you have? The Classic 2536 Stereo Receiver, star of the new Eico Classic Series, and a component that matches or surpasses the performance of components selling at substantially higher prices. How? Simple. It's pure performance. Stripped of everything but the finest basic circuitry. Examine the specifications yourself. Compare them with those of more expensive units. Listen to the 2536—then to higher priced units. Can you see or hear a difference worth paying for?

If you're interested in building a fine stereo receiver, take a long look at our new kit pack, too. Note the logical, orderly arrangement of parts. How easily it sets up for work. How easily it closes down between work sessions—with no loose parts to go astray. Thumb through the 2-color Construction Manual. Ever see such graphic diagrams? Every step is clear and unmistakable—and no diagram shows more than 20 steps. Another thing the diagrams show you: how simple the wiring is. No tricky frills; no clutter; no confusion, even around switches and controls. Plenty of space to work in. And Eico has eliminated the most tedious part by pre-mounting jacks, sockets, terminal boards, and transformers.

Does any other kit give you more building ease, or assurance of success than the Eico Classic? See it at your hi-fi dealer. Optional Walnut Cabinet WE-73, \$19.95, Metal Cover E-12, \$7.50. Write for catalog. Eico Electronic Instrument Co., Inc., 131-01 39th Avenue, Flushing, N. Y. 11352. Export: Roburn Agencies, Inc., 431 Greenwich Street, New York 13, New York.



CIRCLE NO. 25 ON READER SERVICE CARD



WAGNERDÄMMERUNG

AS THE TWILIGHT DEEPENS, THE ICONOCLASTS GATHER
TO SUNDER THE IMAGE OF A FALLEN DEITY

By FREDERIC GRUNFELD

PEOPLE still flock to the Bayreuth festival and they still get married to the wedding march from *Lohengrin*, but Wagnerism—genuine gold-plated Wagner worship of the old school—is deader than Fafner after the second round of *Siegfried*. We think of Wagnerism nowadays as being one of the quaintest aspects of music history: a faded *edelweiss* and a peacock's feather pressed between old sepia photographs of large ladies in dowdy armor. We tend to forget that Wagnerism in its heyday was an incredible cult of personality bordering on religious hysteria. Its basic assumption was that Wagner would “redeem”—the word was *erlösen*—mankind, especially the Germans, through a new kind of super-art. As the first great all-around genius he moved, naturally, on a much more exalted level than ordinary opera composers such as Rossini, Berlioz, or (Heaven forbid!) Meyerbeer, with whom he refused even to be compared. Friedrich Nietzsche, who should have known a real philosopher when he saw one, hailed Richard Wagner

in the 1870's as “the restorer of primitive drama, the discoverer of the place of art in all true human society and poetic interpreter of ancient philosophies, the thinker, the historian, the critic and aesthete, the master of language, the mythologist and myth-maker,” and so on.

It was poor King Ludwig II of Bavaria who set the style for Wagner worship. He never addressed Wagner except in terms of the most passionate adoration: “How I love you! How deeply I love you! You are the star that illumines my life! From the depths of my soul I call down blessings and good fortune upon you. Praise to the God-sent messenger who brings us the counsel of the Eternal Being; all praise to his unforgettable works!” etc., etc.

Wagner's biographer Ernest Newman urges us not to misinterpret these effusions in the light of Ludwig's known homosexuality. They were directed, he thinks, not at Wagner the man but at Wagner the philosopher and symbolist. As the composer of *Lohengrin*, Wagner

WAGNER

André Gill's 1869 caricature shows Wagner reworking the human ear to fit it to his music.



CULVER

had provided Ludwig with his favorite symbol, the swan. Ludwig fell in love with *Lohengrin* as a boy, and for the rest of his life he had swans embroidered on his cushions, painted on his china, carved on his bedsteads. Newman, who distrusted psychoanalysis, says that they appealed to Ludwig as "symbols of purity." But if you have ever seen the swan doorknobs, the swan faucets, and the swan tapestries in the king's dream castle, Neuschwanstein, you need not be an advanced student of psychology to realize that Ludwig's swan, virtually all neck and beak, is the most explicit symbol since the maypole.

This particular fixation played a crucial part in the development of Wagnerism, for without Ludwig there would have been no Bayreuth festival, and without a sanctuary the cult would never have grown into another Eleusinian mystery. As luck would have it, Ludwig became king at the impressionable age of eighteen, after his father's sudden death early in 1864. Bavaria was then a poor but independent country with seven million inhabitants and the largest per capita beer consumption in the world. Soon after ascending the throne, Ludwig sent his cabinet secretary scurrying after Wagner, who was just then engaged in the ignoble activity of running away from his Viennese creditors. It may be recalled that Wagner was the champion borrower in the annals of music. Like Dumas' Count of Monte Cristo, he knew the meaning of "unlimited credit," and had been known to charm aging actresses out of their life savings.

The king's emissary reached him in the very nick of time and escorted him back to the palace. His first meeting with Ludwig, he wrote the next day, "was one great never-wanting-to-end love scene. He has the deepest understanding of my nature and my requirements. He offers me everything I need to live, to create, to perform my works. I am only expected to be his friend; there is no job to hold, no services to perform." An immediate transfusion of funds from the Bavarian privy purse into his own convinced Wagner that his lean years were over at last, and that at fifty-one he had found "the complete ideal of my dreams."

They wrote letters to each other: over six hundred of them, which take up the better part of five thick volumes published half a century after their deaths. The tone is mystical, rapturous, very much on the

summit level. Their styles are so much alike that one wonders who was copying from whom:

Wagner to Ludwig:

My dearest beloved, my only, most magnificent friend! With tears in my eyes I ask: How are you? Are you sad? Are you Happy? How does my most gracious King feel? . . . Highest glory of my life, sun that shall light up my nights, redeemer, savior of my existence!

It is—wonderful—because it is more marvelous than a poet could imagine it!—

Yes! He found me!

My adored friend! Could I ever part from him again!

Loyally yours forever, Richard Wagner

Now "Tristan" is being born; he grows, he flourishes; every day now brings us a feast—a feast of thanksgiving for you, King "Parzifal"!

Ludwig to Wagner:

My dearly beloved and only friend!

. . . Soon I hope to see the beloved again!—I want to be joyful and glad, for I have heard that you are happy; when I know that you are, then so am I!

With deepest joy I have learned that the rehearsals of "Tristan" are going well!—O how blessed will be the day of the first performance! . . .

The most beautiful hopes, the strongest yearnings of my soul have been fulfilled!—O! I am yours in life, yours in death! . . .

Eternally, your Ludwig

Both of these letters—to furnish a point of historical reference—happen to be dated April 14, 1865, which

Ludwig II, at the beginning of his friendship with Wagner.

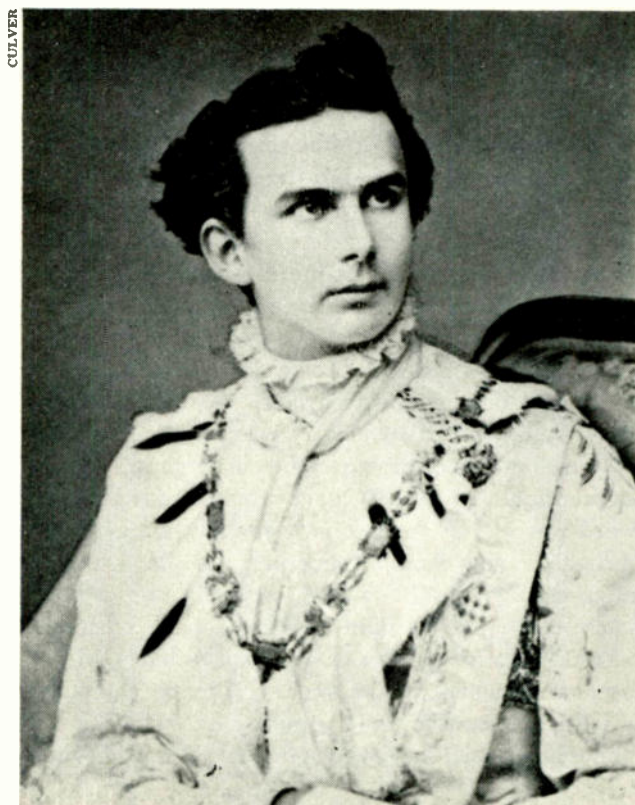

CULVER

was the day Lincoln was shot by John Wilkes Booth.

Ludwig was not the first devout Wagnerite, but he was the first to possess the really massive resources needed to keep Wagner personally solvent and to put his cause on a businesslike footing. In larger and smaller amounts, Wagner extracted about a million dollars, in today's terms, from the royal coffers, despite the finance minister's frantic efforts to keep them locked. At one point, faced with yet another draft for 40,000 thalers, the treasury officials claimed to have run out of bills and made Wagner's errand-lady, Frau Cosima von Bülow, accept payment in coins. Undismayed, she had them count out the money in sacks, which she carted off to Wagner in a hansom cab.

Cosima was Wagnerism's other great asset. She epitomized Wordsworth's "perfect woman nobly planned; to warn, to comfort, and command." She was one of Franz Liszt's love-children by the Countess d'Agout, and at nineteen she had married Hans von Bülow, Germany's best young conductor and Wagner's most ardent disciple. Soon she herself discovered the greatness of Wagner, and in a few years "with tears and sobs we sealed our confession to belong to each other alone." The girl Isolde born to Cosima in 1865 was Wagner's, but Bülow loyally acquiesced to a *ménage à trois*. "Our great man," he said, speaking like an exemplary Wagnerite, "is in need of a little friendship and consolation." Afterwards, when divorce became inevitable,

his main concern was for Wagner's reputation. "The fact that I shall emerge stainless is but poor consolation for the outcry that will inevitably be raised against the great master."

WITH Cosima at his side and Ludwig furnishing logistical support, Wagner embarked upon the literary campaign that was to form the ideological basis of Bayreuth. Bismarck was at the point of uniting the chequered German kingdoms and duchies into a single *Reich*. Wagner proclaimed Germany's redemption through the unified work of art, the *Gesamtkunstwerk* (of which he was the sole practitioner). He wrote on culture and politics, on religion and the state, on science, drama, audiences, Christianity, philology, mythology; he railed against vivisection and against the French, the Jesuits, and the Jews, whom he hated with "a hatred that is as necessary to my nature as gall is to the blood."

The most consistent theme in these murky writings is his reiterated Germanism. "I am the most German of beings," he announced. "I am the German spirit. Consult the incomparable magic of my works; hold them side by side with everything else: you have no choice but to say—this is German."

By 1876, when he inaugurated his Festspielhaus at Bayreuth on a tract of land donated by the farsighted town fathers, he had persuaded even the intellectuals

An early photograph of Wagner, made in the middle 1850's.

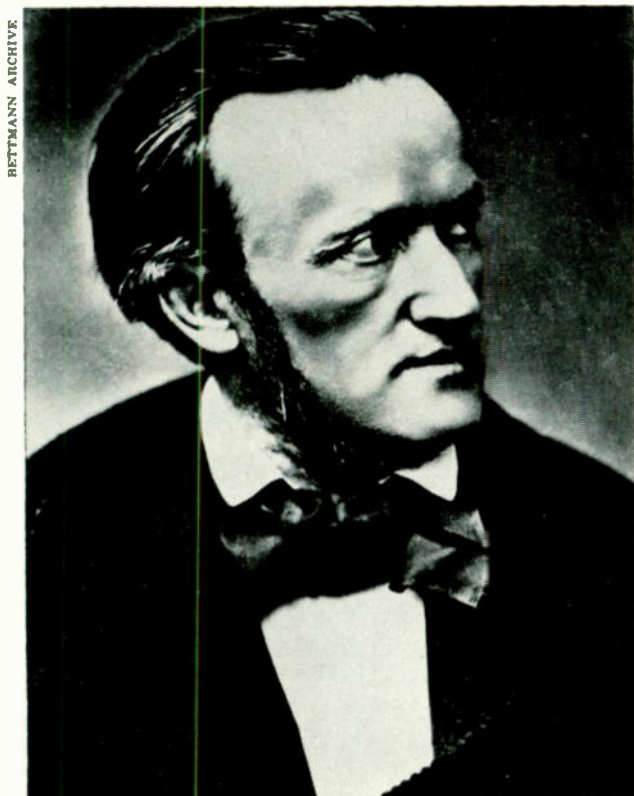

BETTMANN ARCHIVE

Cosima Liszt, who left husband Hans von Bülow for Wagner.



CULVER

WAGNER

According to this caricature of the 1880's, Wagner's auditors were literally bowled over by his music.

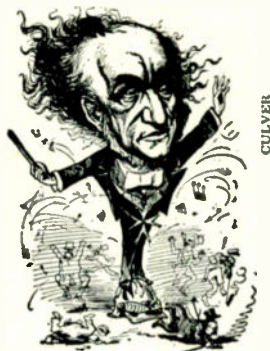

to take him seriously. Nietzsche accorded him "the glory of having given us the supreme models for the large-scale execution of lofty conceptions." Once he had consecrated his temple as a showcase for these conceptions, Wagner really came into his own as prophet, priest, and potentate of the greatest one-man art movement the world had ever seen.

DESPITE its severely Teutonic premises, Wagnerism had an almost universal appeal. The dollars that built the "big barn" flowed in via a network of Richard Wagner Societies, from Chicago and Kronstadt, Berlin and Bordeaux, from the Khedive of Egypt and the Sultan of Turkey. The French, the Jews, and the vivisectionists contributed liberally to bring the art of the future a little closer to fulfillment. Crowned heads arrived in droves for the opening ceremonies, and Emperor Wilhelm I personally tendered his congratulations: "By George, Wagner, I never thought you'd bring it off!" But it was Ludwig the Bavarian who had to cover the first festival's \$150,000 deficit.

Much of Wagner's strongest support came, ironically, from Paris, where the memory of his published attacks during the Franco-Prussian war still rankled. "Wagner has written a rotten and ridiculous satire against Paris," said Catulle Mendès, "and good Lord at what a time!—Just as we were being pursued by hunger and misery, this elephant had to trample on us. I was his friend; I am his friend no longer!" But like a true Wagnerite he added, "I still remain his ardent apostle; I confine myself to not offering him the hands with which I applaud him."

The first great French Wagnerite, Charles Baudelaire, confessed on initially hearing parts of *Tannhäuser* and *Lohengrin* that he felt "destined to love" this music as though it were his own. He responded to the utterances of a great soul inciting men to grandeur; he had the sensation of "letting myself be penetrated and invaded—a really sensual delight that resembles rising in the air or tossing upon the sea. . . ." Two generations of French poets, from Baudelaire and Nerval to Mallarmé, Valéry, and Claudel, worshipped Wagner as the symbolist *par excellence*. As for the musicians, Berlioz had refused to embrace Wagnerism even when it was urged on him by the Abbé Liszt, but after him most of the French em-

braced the new faith without a struggle. Everyone made at least one pilgrimage to Bayreuth. Emmanuel Chabrier, that most vivacious of composers, burst into tears at the thrill of hearing, at long last, the prelude to *Tristan*. "Ten years," he sobbed into the ear of his neighbor, Vincent d'Indy, "ten years I've been waiting for that A on the cellos!"

Even such a skeptic as Gabriel Fauré couldn't resist the magic of Bayreuth. "All we can speak about are the performances," he reported to his wife, "and there is not one of us who can really put into words what he feels. . . . You must really forget the daily routine of life and become here one of the faithful to do justice to the drama of the *Ring*." Bernard Shaw came away convinced that England should launch a Wagner festival of her own, and that the world would recognize that Wagner was "greater than Beethoven by as much as Mozart was greater than Haydn."

What Wagner had originally envisioned for his festival was an audience of initiates, spiritually prepared for redemption-by-music-drama. At one point, Catholic newspapers warned that he was trying to usurp the functions of the Church by substituting his theater for the Mass. But Bayreuth, against all expectations, became a sound business proposition, and as Shaw ruefully noted, "the only qualification required from the visitor is money."

The carriage trade came to see and be seen; Americans began booking Bayreuth into their grand tour

The "redeemer," lavishly, theatrically (and typically) attired.



as a standard side trip, like the Matterhorn. The master's disciples were deeply affronted by this invasion of rich globe-trotters and "plutocratic art-faddists," patently unworthy of being "guardians of the grail temple." Receptions at Wagner's Villa Wahnfried ("Folly's End") brought together a curious mixture of pilgrims, some of them distinguished intellectuals and others, in Fauré's phrase, "as stupid as can be." As Thomas Mann delicately explains this phenomenon, Wagner had been all too successful in winning over both the finest and the coarsest people, "and the result is a certain sense of discomfort felt

there were 60-pfennig *Volks*-booklets (the word means "people" but is as untranslatable in this context as it is in *Volkswagen*). "Wagner," concludes one of these booklets, vintage 1900, "was one of the greatest poets, and the greatest dramatic composer produced by the German *Volk*. He was the first herald of Germany's glory and grandeur; he awakened the saga and history of the German *Volk* to a new life; he gave this *Volk* an artistic entity and a national *Heldendrama* just as Bismarck gave it political unity. Hail to us that he was a German! Hail to us that we are Germans, of his blood, his spirit, his people!" That



In Munich, for the 1865 premiere of "Tristan." Standing behind Wagner is Hans von Bülow; third from right is Leopold Damrosch.

by one section of his admirers in the presence of the other."

At Wagner's funeral in 1883, the Munich Wagner Society's wreath bore the quintessential tribute, "Redemption to the Redeemer." From then on Cosima ruled Bayreuth shrewdly and autocratically until her death in 1930, at the age of ninety-two. She kept Wagnerism on the march with the aid of a high-powered propaganda mill and a world-wide network of some four hundred clubs and societies. Leftover Wagneriana from that period can still be found on the back shelves of any second-hand bookstore—twelve-volume, six-volume, two-volume sets, expurgated letters, denatured memoirs, heroic biographies, paeans to the poet, kudos to the composer, surveys of the vowel sounds he used, guides to the ninety *leitmotifs* of the *Ring*, speculations on the future of the music-of-the-future, Wagner encyclopedias, iconographies, catalogs, twice-told Nibelungen sagas, essays on the cosmic significance of the Rheingold, and, from Shaw, an interpretation of the *Ring* as a socialist parable. To indoctrinate the working man and the school boy,

remained Bayreuth's prevailing tone for close to sixty years; obviously it owed a good deal to Wagner's own hail-to-me epistolary style.

"I don't bother about the Wagner-swindle," snapped his sometime patroness Princess Metternich, "but the Germany-swindle connected with it is repugnant to me." Nietzsche attacked on the same grounds when he parted company with the cult and published *Der Fall Wagner* in 1888. "Wagner's stage," he says, "has only one requirement—Teutons! Definition of a Teuton: obedience and long legs. . . . It is significant that Wagner's emergence coincides with the rise of the *Reich*: both point to one and the same thing—obedience and long legs." And in sixty pages of impassioned arguments he assaults "the lie of the overblown style" and Wagner's claim to being a Germanic redeemer. "If Wagner was a Christ," asks Nietzsche, "then perhaps Liszt was a Church Father?"

Most of the other dissenters, though numerous and noisy, were merely members of the old rear guard fighting a bourgeois holding action against the triumphal advance of a sensual new music. Their criticisms were

WAGNER

The Sage of Bayreuth is not only the beater, but is himself the drum in this 1882 caricature.



BETTMANN ARCHIVE

apt to be merely malicious. The trouble with the whole Wagner controversy, decided Jean Cocteau fifty years ago, lies in the fact that "it is an idiot who flings it in your face. There are truths which can only be said after one has acquired the right to say them."

The one critic in the enemy camp who combined a genuine respect for Wagner's greatness with a healthy distrust of his pretensions was Eduard Hanslick of Vienna's *Neue Freie Presse*. He concentrated his fire on Wagner's weakest point—the plots and language of the music-dramas. "Only the maddest Wagnerites can regard the *Ring* as a self-sufficient drama capable of standing on its two feet without musical assistance," he wrote after the world premiere. "If they were spoken rather than sung, these stammering and stuttering alliterations would merely irritate and amuse." This is precisely what German literary critics are saying today about Wagner's so-called poetry. And Hanslick correctly predicted that "in fifty years the writings of the Wagnerites will be looked upon in amazement as the relics of an intellectual plague."

The best antidote to Bayreuth was silence. Brahms, supposedly the chief antagonist, always maintained a polite distance between himself and Cosima. He liked to tell his pupils, "I am a much older Wagnerian than all of you." Tchaikovsky, who was bored to tears by *Tristan* and *Parsifal*, confided only to his intimates that "Wagner has killed his colossal genius with theories." Saint-Saëns tried speaking out publicly against Wagner and found himself suddenly ostracized; in matters touching the Faith, discretion was the better part of criticism.

Just when the tide began to turn is hard to say; it would be about the time people stopped naming their children Senta, Sieglinde, Siegmund (as in Freud) or Siegfried (as in Sassoon). The twilight of Wagnerism set in with Debussy, who tried to fight clear of its influence as desperately as the sailor who descends into Poe's maelstrom. In the case of *Pelléas et Mélisande* his love-hate for Wagner produced a sort of mirror-image *Tristan*, but with this grudging act of tribute Klingsor's magic spell was finally broken.

Busoni, the founder of neoclassicism, campaigned against Wagner on a reform ticket whose banner read, "Throw the Colossals Out!" He was the first to sug-

gest that the nineteenth century had also produced an anti-Wagner whose work held greater promise for the future; he taught the heresy that "it was Berlioz who pointed the way for unknown generations."

The young composers of Diaghilev's circle and *Les Six* had even less use for Wagnerism. Stravinsky went to Bayreuth for *Parsifal* and hated it. "What I find revolting in the whole affair," he said, "is the underlying conception which dictated it—the principle of putting a work of art on the same level as the sacred and symbolic ritual which constitutes a religious service. And, indeed, is not all this comedy of Bayreuth, with its ridiculous formalities, simply an unconscious aping of a religious rite?"

That Schoenberg and the twelve-tone school still hewed close to the Wagner tradition was cold comfort to the orthodox Wagnerites. Though Schoenberg's method owed much to the harmonies of *Tristan*, it sounded merely blasphemous to their ears. Now it was their turn to cry in horror, "You call this music?"

To such a critic as Carl Van Vechten, Wagner's works sounded "shopworn" and "old-fashioned" by 1916. Four years later Paul Rosenfeld of the *Dial* could announce that Wagner had definitely been displaced. "We who were born and grew under the sign of Wagner have witnessed the twilight of the god. He has receded from us."

He might have receded in Germany as well if events had not conspired to harness the music of the future to the politics of the moment. Adolf Hitler was welcomed to Bayreuth as early as 1923, when he paraded his Brownshirts for the benefit of Houston Stewart Chamberlain, the bogus English "philosopher" and racist who had married Wagner's daughter Eva. With

A Wahnfried tea scene, and the last photograph of Wagner.



NEW YORK PUBLIC LIBRARY

Cosima's connivance, Chamberlain used Bayreuth as a platform from which to preach "hate, hate, hate" against Jews, Negroes, and "the non-Germanic races of Europe." The festival became a rallying point for the ultra-nationalists. After Hitler had seized power, he appeared every year as guest of honor in the swastika-bedecked Festspielhaus (where his favorite work was not *Götterdämmerung* but *Meistersinger*). He became an intimate friend of Frau Winifred Wagner, the widow of Richard's only son Siegfried, who had died in 1930.

Arturo Toscanini, who for a few years had restored the musical luster of the festivals, saw the Nazis coming and indignantly resigned in the summer of 1933. Some of Wagner's grandchildren went into exile to

remembered that Richard Strauss and Hans Pfitzner were the most prominent signers of the denunciation. "It was this very speech which determined my emigration," Mann said later.

In Zurich, in 1937, he tried to make the Swiss understand that "*Volk* and sword and myth and Nordic heroics—in a certain mouth those words are only a despicable theft from the vocabulary of Wagner's art. . . . For him the German spirit was everything, the German state nothing."

In America, in 1940, Mann was again counsel for the defense when Wagner's reputation was put on trial. Yes, he admitted that Wagner was a charlatan, "a sensuous sorcerer, drunk with his own wisdom," but nevertheless, "something overwhelming remains." Only

CULVER



The Festspielhaus at Bayreuth, designed by Wagner himself, has been the Mecca for devout Wagnerites for almost ninety years.

protest the use of Bayreuth as a party propaganda center. But the festival continued right through the war until 1944, with audiences composed mainly of soldiers on special leave. Erich Kuby, a leading post-war German author, recently wrote that "the educated Germans would not have fallen into Hitler's arms so unresistingly if they had not been prepared for it by Wagner, by Bayreuth and the Wagnerians."

These were difficult years for those who hated Nazism and loved Wagner—especially for Thomas Mann, who had written some of his finest essays on the man he considered "perhaps the greatest talent in the entire history of art." His famous 1933 speech on "The Sorrows and Greatness of Richard Wagner" failed to satisfy the Nazis, who expected unalloyed enthusiasm for their *Kultur*-hero. Mann was publicly reprimanded for having insulted the master's memory; it should be

the defeat of Nazism, Mann said, might "restore political innocence to the works of Germany."

Bayreuth, at any rate, was officially "de-Nazified" after the war, though Franz Beidel, a Wagner grandson-in-exile, complained bitterly that "it was just as though nothing had happened," and that the venerable pose of piety and infallibility had hardly changed. Winifred was retired, and her two sons, Wieland and Wolfgang, took over the family enterprise. Their first mission, obviously, was to restore Bayreuth's bruised prestige and create a new image of the Festspielhaus as something other than a theater for paranoiac illusions. At the outset Wieland announced that "we are no longer interested in Germanic gods; only Man concerns us. We want to get away from the Wagner cult. . . ." They succeeded brilliantly in diverting Bayreuth discussions away from ideologies and over to

WAGNER

This concept of Alberich, the "Rheingold" dwarf, is by Aubrey Beardsley.



NEW YORK PUBLIC LIBRARY

purely aesthetic questions. Starting in 1951 they applied a series of shock treatments to their grandfather's moribund music-dramas: they stripped the stage, threw out the moth-eaten bearskins, dimmed the lighting to a murky, mystical gloom, and directed Wagner as psychological drama.

Postwar German critics refuse to take Wagner seriously as poet, essayist, or philosopher, but the grandsons have tried to salvage what they can of his reputation as a myth-maker. "Wagner's ideas are always current," says Wieland, "because they are eternally human." The new doctrine at Bayreuth suggests that Wagner was a kind of primitive, unconscious psychologist, and that Lohengrin, Tristan, Siegfried, and Parsifal are essentially projections of unresolved Oedipal situations.

In other words, Bayreuth has weathered its crises as well as most other old established German concerns. It is once more fixed in the tourist and social circuit; visitors come away pleasantly impressed by the brothers' modernism and occasional surprise packaging—such as this year's debunking of *Meistersinger*. Now that the "redemption" has been let out of it, you can take your Wagner without having "to forget the daily routine of life and becoming here one of the faithful." Today's Bayreuth controversies are mainly technical: how to produce a music-drama without offending an intelligent audience; how to put together a cast now that *Helden-singers* are scarcer than swan's teeth.

By leading the discussion away from ideologies and into purely aesthetic channels, the grandsons have, in effect, brought Bayreuth into line with the rest of the musical world, where Wagner's work has to stand or fall by its ability to entertain opera-goers in opera houses. This is precisely the status that Wagner always wanted to avoid—he hated the idea of having to compete with ordinary opera composers. The critics, I have noticed, hardly know how to deal with him at this level: if you are not willing to become a latter-day Beckmesser, what can you make of the sobered-up, morning-after image of Richard Wagner?

There is a tendency now to draw a line between Wagner's character and his work—the one arrogant and disagreeable, the other mystical and sincere. Deems Taylor, whose essay on Wagner as "The Monster" has become a minor classic, recites the composer's most glaring faults—greed, vulgarity, egotism, dishonesty,

ingratitude—and then proceeds to exonerate him on the grounds that the value of his work outweighs his villainies. "When you listen to what he wrote," Taylor concludes, "the debts and heartaches that people had to endure from him don't seem much of a price." I am more inclined to believe that Wagner's art could not have been bought at any other price. He was not a "bad" character who produced "good" works but a neurotic at war with society, the model of the artist-as-outlaw, the poet-nihilist. To a great many listeners, the vulgarity and crudeness of his ambition remain indissoluble components of the music itself, all the more audible now that common sense has swept away the *Gesamtobfuscations*.

SEEN through an opera glass, Wagner emerges as a kind of primitive, one who deceived not only his admirers but also himself about the real nature of what he was creating. Infatuated with his pose as thinker and theorist, he claimed to have rediscovered "the sensually perfected speech-expression with which the *Volk* created poetry when it was still creating myths." He criticized older operas because their poetry served musical ends and their librettos were so much weaker than their music. Yet few librettos in the annals of opera are drearier than those of the music-dramas. His real innovations—which, like a primitive, he took for granted—are in the music: the continual ebb and flow of his chromatic harmonies, moving through carefully plotted progressions of keys; the massive, glittering sound of his orchestra, with its surrealist identity tags; and the brilliant use of sonic analogies from nature—the sort of thing that Shaw, writing on the *Ring*, once cataloged as "music of river and rainbow, fire and forest . . . the love music, the hammer and anvil music, the clumping of the giants, the tune of the young woodsman's horn. . . . the dragon music and nightmare music and thunder and lightning music."

In these passages we can search for Mann's "something overwhelming" that remains after all the huffing and puffing. Some of these fragments have lost little of their old power to seduce the sedulous ear—notably the "rides," "journeys," "entries," and other kinetic moving-pictorial music that sounds better in the concert hall than booming up from an orchestra pit. They are what Debussy foresaw when he prophesied Wagner's decay: "Yet noble ruins must remain, in the shadow of which our grandchildren will brood over the past splendor of this man who, had he been a little more human, would have been altogether great."

Frederic Grunfeld, whose by-line appears with some frequency in HIFI/STEREO REVIEW, lives in the Balearic Islands, from where he does free-lance writing and recording assignments.



A CHRISTMAS GUIDE TO CHILDREN'S RECORDS

By HERBERT MITGANG

CARTOONIST Walt Kelly, whose comic strip *Pogo* is peopled (is that the right word?) with a swamp full of little folk behaving suspiciously like grownups, has said: "Children can be exposed without much danger to many things—they're pretty vital characters." If these instructions still leave you, as a parent, slightly uneasy, you will find that the same notion has been developed at greater length by a more reassuring authority—Doctor Spock.

You may need such reassurance when you set out to build a record library for your youngsters. Many parents wonder how our children manage to survive much of the unwholesome corn served up for them in record jackets. The fact is that they do— but we should, if possible, make survival a little easier for them in this area, as we do in others. The purpose of this essay,

then, is to offer suggestions from the wide range of better music, stories, and educational material being put on records for children these days.

Anyone who, over a period of time, has seen—or, more exasperatingly, heard—children in the process of listening to records will understand that they can not be forced to listen to what their parents want them to. A child sometimes plays the same record over and over again until everyone in the household knows it backwards. Then, on another day, the child will play the discs in his collection for only thirty seconds each, strewing them meanwhile under the bed, between the radiator pipes, and into the far corners of the room. But the time will nevertheless come when parental propaganda, if it has been subtly administered, must triumph. Perhaps the child has heard good music in

CHILDREN'S RECORDS



an older child's room or over the radio. He may then reach into his own record pile for a long-neglected introduction to classical music, and the door to a real understanding and appreciation of good music stands wide open.

Once this happens, parents should start to erase the line that has divided the family's record collection into adult and children's sectors. As replacement copies of old adult favorites are purchased, the child might receive the hand-me-downs. And an older child who can operate the equipment properly should be allowed to borrow the household's best records for his private listening.

But, on the most basic level, some parents still find it difficult to obtain records that provide what they want their children to hear. The display in the average supermarket or drugstore is usually a cross-section of the available worst. The canny parent is therefore advised to track down the store in his community that

not only stocks the widest range of record labels, but also has an efficient ordering service. If no satisfactory store can be found, you still have recourse to the children's section in the Schwann catalog to facilitate doing your own shopping by mail.

One thing seldom taken into consideration in discussions of children's records is the equipment the child plays his records on. A youngster should have his own record player. Part of the fun is in turning it on and off and changing the records himself. But giving the child only a toy machine will defeat this purpose. When parents decide to buy their child his first record player, they often reason that, since the pre-school child breaks everything anyway, it is unwise to buy a player of good quality. But a well-made record player will last far longer than a cheap one, and it also can be repaired when something goes wrong—a cheap one usually can not. Also, it is foolish to subject good children's records costing between two and five dollars apiece to the damaging needle of a cheap player, for it quickly wears out the records.

One of the first things a parent runs into when shopping for children's records is the practice of classifying records by age brackets. Unless the age brackets are considered as arbitrary, they will mislead most parents. Obviously, the difference between one six-year-old and another can be great. It is up to the parent to assume the responsibility of deciding what record his child will be able to comprehend next.

The foundation of any child's record library should be good music—not the gimmicky records with television stars as narrators or with coloring sets enclosed. For the time will come when the child passes out of what the record producers cutely call the "kiddie pops" stage. Then he will no longer sit still for the coy performances, the television theme songs, the overblown

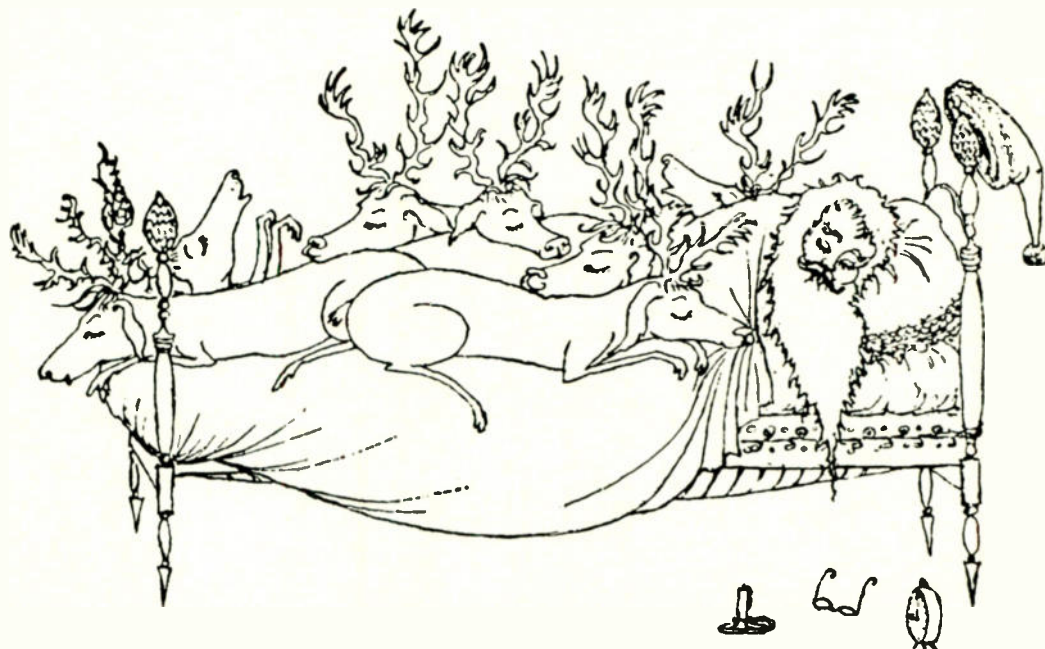

productions. The last are to be particularly avoided, since they often overwhelm the child. A child prefers simplicity in musical performance and in story line. Simple presentation—a single, affirmative, clearly enunciated voice at center stage—appeals most to children of all ages.

It is wise to exercise a good deal of caution in certain general subject areas—foreign-language discs, for instance. Be leery of buying full sets that purport to teach children a language or supplement the language they study in school. Learning a language from records (have you tried it lately?) takes hours of patient listening. And even though your child may be a paragon of stick-to-it-iveness, teaching styles in schools vary, so that it is still best to buy language records only under a teacher's supervision. It is a perfectly safe bet, however, to take a plunge on children's records containing folk songs of other lands.

Poetry, with its rhyme and rhythm, is seldom a problem, but prose is another story. There are many ways of telling a story, from a straightforward reading by an actor or narrator right from the book, through a reading with sound effects, to a full dramatization, and on to the musical version. (All these approaches have been tried in children's records of *Alice in Wonderland*, for instance.) In general, the younger the child, the more he will respond to the sound effects and the music; the older the child, the better the chance he will hold still for a straight reading.

Game discs are best avoided entirely. Those that ask the youngster to do something may work well as a supervised activity in a nursery school, but at home, boys and girls generally do not expect to work for a record—they want the record to work for them.

BEFORE going into particular recommendations for various age groups, there should be singled out a few of the introductions to music and musical instruments that can help train a child's ear to appreciate the best. An unusually fine example of these is "Instruments of the Orchestra" (Capitol Educational Series HBZ 21002), with a commentary by Yehudi Menuhin. This two-record album includes examples of the sound of each of the instruments of the orchestra played by leading European soloists, and an excellent illustrated descriptive booklet about the instruments. Menuhin demonstrates methods of bowing, explains such things as harmonics and muted strings, and follows with a demonstration of the sound of a full violin section (the Berlin Philharmonic Orchestra conducted by Rudolf Kempe) in the finale of Brahms' Symphony No. 1.

Then there is the perennial threesome of Britten's *Young Person's Guide to the Orchestra*, Prokofiev's



Peter and the Wolf, and Saint-Saëns' *Carnival of the Animals*. These can be had in various renderings and couplings. My own choices are, for the Britten piece, Angel 35135—the Philharmonia Orchestra conducted by Igor Markevitch (coupled with *Carnival*)—and for the other two, Capitol SG 7211, G 7211, with Michael Flanders as narrator and Efreim Kurtz leading the Philharmonia Orchestra. [Also see this month's "Basic Repertoire" article by Martin Bookspan.]

For the child who is already familiar with some music, "Symphonic Movements from the Masters" (Capitol HAK 21001) includes William Steinberg and the Pittsburgh Symphony playing the "Surprise" movement from Haydn's Symphony No. 91, Herbert von Karajan and the Philharmonia Orchestra in the third movement from Schubert's Symphony No. 2, and Sir Thomas Beecham and the Royal Philharmonic Orchestra in the third movement from Tchaikovsky's Symphony No. 4. The recording "Great Composers" (Disneyland S 3915, 3915) includes a simplified treatment of the music of Bach, Haydn, Mozart, Beethoven, Chopin, Brahms, Tchaikovsky, and Mendelssohn, with an explanatory booklet and biographical data. A little more advanced is the *Wonderland* series, on the Riverside label, entitled "Young People's Introduction to _____," and including Beethoven, Brahms,

CHILDREN'S RECORDS



Chopin, and the like. Norman Rose comments between examples of the music.

I have deliberately not attached age specifications to these introductory records. Try out the best and most advanced even on nursery-school children—the results may surprise you.

The paragraphs that follow will suggest a number of outstanding recordings—songs, readings, dramatizations—for three broad age groups: nursery school, elementary school, and junior high. It is well to keep in mind that some things can be appreciated by any school-age child—strongly rhythmic music is a good example.

For the nursery-school group: "Music Time," with Charity Bailey (Folkways FC 7307); "Tom Glazer Concerts for and with Children" (Riverside-Wonderland RLP 1452 and RLP 1467); "The Three Little Pigs and Other Fairy Tales," read by Boris Karloff (Caedmon TC 1129); "The Tale of Benjamin Bunny," narrated by Vivien Leigh (Riverside-Wonderland RLP 2457); "Grimm's Fairy Tales," told by Danny Kaye (Golden LP 92); "Dr. Seuss Presents the Sneetches and Horton Hatches the Egg," a musical dramatization and a bit more advanced (RCA Victor LPS/LPM 2454); and excerpts from "The Wind in the Willows" (London OSA 1216, A 4244).

For the elementary-school group, I recommend introductions to the orchestra and good music, and to folk songs—especially those with a narrative. George Kleinsinger's *Tubby the Tuba* and *Pan the Piper*, coupled with *Peter and the Wolf*, are well done by Basil Rathbone on Columbia CL 671. Fantasies and imaginative stories in general appeal to the sense and nonsense of grade-schoolers. Jim Copp and Ed Brown have produced several, including the excellent "Fable Forest" (on Playhouse 202, obtainable from Playhouse Records, Los Angeles 5). "Come and See the Peppermint Tree" (Washington WC 302), a more realistic story, is also good.

Before going on to serious subjects, there should be mentioned such delightful records as "Whoever Shall Have Some Good Peanuts" (Folkways 7530), this being a group of folk songs sung by Sam Hinton; Carl Sandburg's "Poetry for Children" (Caedmon 1124), with comments and happy chuckles by the poet himself; and "The Story of Jazz" (Folkways 7312). It is also a happy fact that many folk-song records for grown-ups are suitable for children. Most children, incidentally, take to Pete Seeger and Tom Glazer like ducks to water.

For the junior-high-school group, current events, history, and literature regularly provide provocative educational material on records. Among the best are "Wilson's Fourteen Points," backed by the "Preamble to the U.N. Charter" (Enrichment EAD 6); "Franklin D. Roosevelt's Four Freedoms," backed by the "Monroe Doctrine" (Enrichment EAD 4); "The American Revolution" (Heirloom Records HL 502); "American History in Sound" (Harcourt Brace LO 8P); and "Treasury of Famous Speeches," edited by Joseph Wershba (Golden Records 80).

RECORDS, of course, are no substitute for books, but there are special circumstances—perhaps in the middle of a case of measles—when one of the excellent Caedmon story readings (Basil Rathbone's "Edgar Allan Poe," for example, on TC 1028) would be welcome. For special interests, there are such things as "A Child's Introduction to Atomic Energy and Outer Space" (Riverside RLP 3402) and the like. On the musical side, publishers Simon and Schuster have a fine Christmas gift in the combined reading and listening package "Leonard Bernstein's Young People's Concerts." On five seven-inch Columbia LP's a number of classics—from Moussorgsky's *Pictures at an Exhibition* to Brahms' Symphony No. 2—are played. In a handsomely illustrated booklet, Mr. Bernstein translates himself effortlessly from the TV screen to the printed page.

Finally, it is to be remembered that, by the time any child displays voluntary interest in the records listed on the junior-high-school level, he is really ready to graduate from children's records as such. He is now prepared for the wider horizons and richer rewards of the light-hearted and fanciful masterworks in which children and adults may meet on common ground. In the scores of Haydn, Mozart, Ravel, Saint-Saëns, Prokofiev, and Britten, he will meet kindred and ageless spirits who, like himself (to apply a phrase of Nietzsche) are "seriously at play."

Herbert Mitgang of the New York Times staff, was formerly its children's-records reviewer. Among his books, the latest is The Man Who Rode the Tiger, a biography of Judge Samuel Seabury.

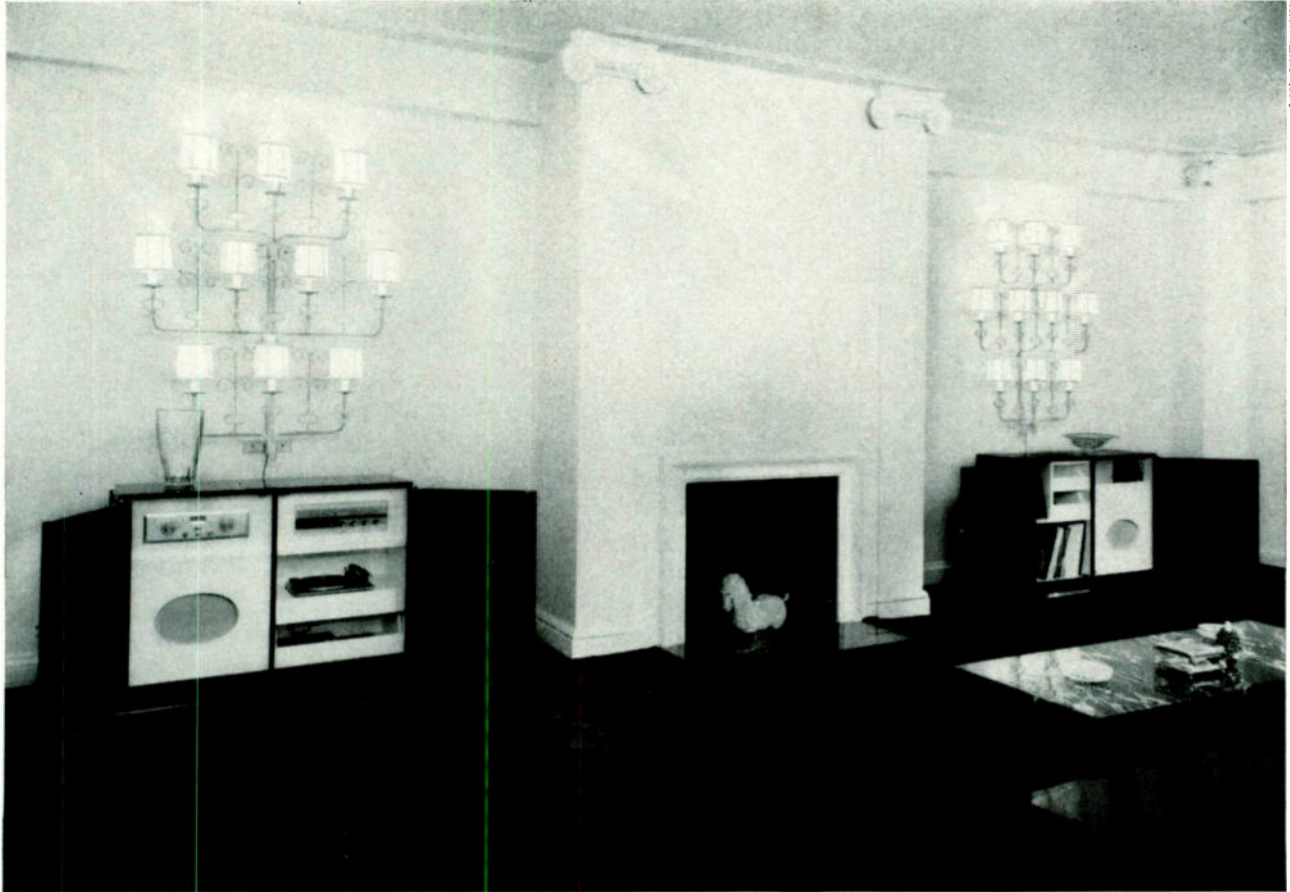

INSTALLATION OF THE MONTH

Solving a DECORATOR'S DILEMMA

WHEN Harry Streim originally decided to fit a stereo system into his wife's plans for redecorating their New York apartment, he called on Fred Kamiel of Hi-Fi Headquarters to supply both equipment and advice. Fred, a specialist in custom sound systems for home and industrial uses, had no qualms about tackling a stereo installation under the watchful eye of an interior decorator, but he did have to supply more than the usual amount of ingenuity to bring good stereo sound unobtrusively into the Streim living room.

The accompanying photograph of Mr. Streim's system doesn't tell the whole story. Although the handsome cabinets can be seen, with features providing for both present and future convenience, Fred Kamiel's answer for Mr. Streim's particular problem is well hidden.

The problem itself sprang from the decorator's insistence that the two cabinets housing equipment and speakers must be located some sixteen feet from each

other, flanking the living-room fireplace. When the equipment was set up to conform to the decorator's mandate, the resulting stereo separation was too wide for a proper blend of sound in the listening areas across the room.

To cope with the all-too-audible hole in the middle, a pair of downward-pointing auxiliary speakers were installed in the flue of the Streim's fireplace—one which, needless to say, is never used for the purpose for which it was built. Although completely hidden from the eye, the two speakers make their presence known and supply the center support necessary for a solid spread of stereo sound.

The visible components of Mr. Streim's system include a Sargent-Rayment 30-watt stereo amplifier, a Scott 330-C tuner, and a Miracord changer with Miratwin stereo cartridge. The speakers, both main and auxiliary, are Princeps units from France. The cabinets provide ample room for record storage and future addition of a tape deck.

BRUNO WALTER'S LAST RECORDING SESSIONS

By THOMAS FROST

DURING the years 1960 and 1961, I had the great privilege of supervising a series of recording sessions by Bruno Walter, a man who had been my idol for more years than I can remember. I suppose that I first became conscious of the name Bruno Walter in our house in Vienna at whatever tender age I was first able to comprehend the word music, and I can still remember the excitement conveyed by my mother whenever she announced that she would be going to hear Dr. Walter conduct Bruckner or Mahler. It was therefore with great anticipation that I looked forward to meeting him in Hollywood during January of 1960. Coming face to face with an idol can be a very disappointing experience. I am glad to say that Bruno Walter did not disappoint me. Quite the contrary!

We met at the American Legion Hall, where Dr. Walter had been making his recordings since 1957. I was scheduled to observe some sessions being supervised by my colleague John McClure before embarking on a series of sessions of my own. I was greeted most cordially by the eighty-three-year-old conductor. He had heard of my Viennese background and was very interested in knowing which district I had lived in and which schools I had attended, and he was quite impressed by my having been a member of the Vienna Boys' Choir. Our reminiscing came to an end when the orchestra contractor informed him that the session would begin in five minutes. He excused himself and was joined by his faithful companion, Mrs. Delia Reinhardt, a dignified, soft-spoken German woman. Slowly, they walked arm-in-arm to the ballroom, where the orchestra was assembled and tuning up. As he was seen to approach the podium, silence gradually fell over the musicians, and as he stepped up, they applauded and greeted him. With a friendly "Good afternoon, gentlemen," the session began.

In the weeks to come, I was privileged to take a long and close look at this great man. My assignment

included an exciting repertoire list: Brahms' Third Symphony, Schubert's Fifth Symphony, and three Mozart symphonies — the "Jupiter," the "Linz," and No. 39. We started with Brahms' Third on January 27, 1960, and finished with Schubert's Fifth on March 3. Because of Dr. Walter's age, we recorded a maximum of nine hours a week—three alternate days of three hours each. About an hour before each session, I would pick up Dr. Walter and Mrs. Reinhardt at his house in Beverly Hills and drive them to the American Legion Hall in Hollywood, a ride of about twenty minutes. Dr. Walter would talk about the music he was going to perform, singing the themes quietly. I always had the feeling that he talked during those trips only to be polite, that he was already deeply involved with the music he was about to conduct, and that the responsibility of it weighed heavily on him. On one occasion I forgot myself, and, having been listening to a beautiful piano concerto on the car radio, neglected to turn it off when Dr. Walter entered the car. He quickly told me in his gentle but firm way that he could not possibly listen to any music on the way to the session since his head was full of the music he was about to conduct.

Arriving at the hall, Dr. Walter and Mrs. Reinhardt would head for the artist room, where he would don his familiar black rehearsal jacket. He would then look over his scores and perhaps ask to see certain musicians to point out important problems. In the meantime, I would go out into the hall to check the positioning of all the microphones, while our orchestra contractor, Phil Kahgan, walked around nervously, counting heads to make sure everyone had arrived. The sessions always started with rehearsing, since separate rehearsals are not permitted by the musicians' union; the rehearsing had to be done during the actual session. This gave me plenty of time to determine the proper balance of orchestral sections and capture the true sound of the orchestra. After perhaps an hour

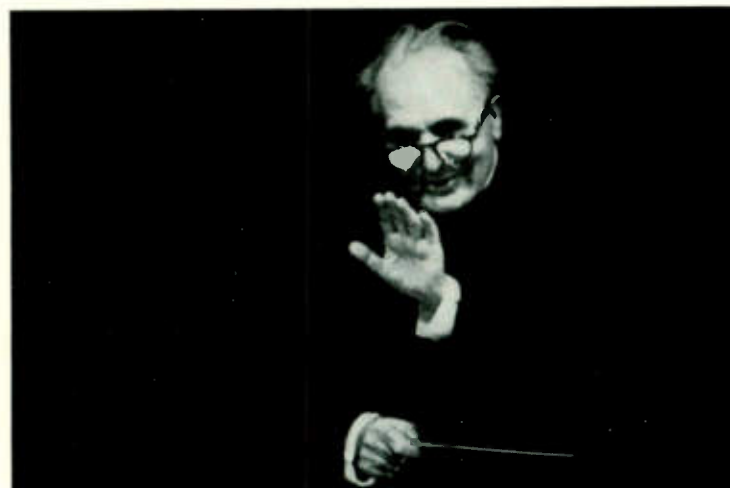

COLUMBIA RECORDS

AN INTIMATE MEMOIR BY THE SUPERVISOR OF THE CONDUCTOR'S FINAL RECORDINGS

of rehearsing, Dr. Walter would tell me that he was ready for a take, and we would then record — a movement of a symphony, for example. During the recording, I made notations in my score, marking pluses and minuses and indicating questionable balances. Afterward, Dr. Walter would come into the control room and we would listen to each take together. During these playbacks, the control room would be filled with musicians interested in improving their performance and awaiting Dr. Walter's comments. He often listened with closed eyes, conducting with his right hand, breathing and moving with the music. Occasionally, he would praise or gently admonish a musician, and often his humorous remarks would relieve the tension. With the gentle invitation, "Come, my friends, we do it again," all of us would go back to work.

Sometime during each session, Dr. Walter would call an intermission, and Mrs. Reinhardt and he would retire to the artist room where she served him cheese and crackers, orange juice, and an apple or pear carefully quartered and peeled. On many of these occasions, I joined them, and it was here that Dr. Walter used to talk a great deal about the music and the composers. Mozart was like a god to him. When he talked of Mozart, a rapt expression would come over his face, his eyebrows would be raised, and he would gently shake his head in wonder and incredulity at the beauty of the music. On one such occasion in the artist room, I confessed to him that, perhaps even more than his musicianship, I admired his human qualities. Pointing in the direction of the ballroom, I said: "The men not only respect you, they love you." There was silence, and Walter's eyes filled with tears. At that moment I remembered something he had said some years earlier in an interview. He was asked what the essential difference between Bruckner and Mahler was, and he answered that it was of a religious nature, that "Mahler . . . his whole life

BRUNO WALTER

through was seeking God; Bruckner had found God." I realized then that most of us, all through our lives, seek love; Bruno Walter had found it.

I returned to California at the end of February, 1961. Bruno Walter was now in his eighty-fourth year. He was quite cheerful and seemed even firmer on his feet than he had been the previous year. Some weeks earlier he had completed a truly great recording of Mahler's Ninth Symphony, which was supervised by my colleague John McClure. Now it was my turn again, and on the agenda was the following program: Bruckner's Seventh Symphony, Wagner's *Tannhäuser* Overture and Venusberg Music, Haydn's Symphonies No. 88 and No. 100, four Mozart overtures and the *Masonic Funeral Music*. Looking forward to at least five weeks of recording, I brought along my wife and eight-month-old boy. We stayed at a quiet motel in Westwood.

THE sessions began with Haydn's Symphony No. 100 on March 2, 1961. The one-month period from this session to the last one, on March 31, represents an enormous achievement for Bruno Walter. The *Tannhäuser* Venusburg Music, for example, comes through with incredible power and drive. The extended climaxes never let up. The performance is completely mature, but youthful in its strength and vigor. That an eighty-four-year-old man, somewhat shaky on his feet, directed it is quite astonishing.

This month was also beset with problems. The Venusberg Music, for example, almost lost its sensual theater ending, the off-stage chorus of the sirens. The women's chorus, a collegiate group, had been trained extremely well by its director, and since the music is not complicated or difficult, Dr. Walter did not feel

the need to rehearse the women until the regular session with the orchestra. At the beginning of this session, he started to rehearse them without orchestra. They had been placed on a stage far behind the orchestra, to give their voices a distant off-stage effect. For some strange reason, the choir was unable to follow Dr. Walter. He tried again and again, and finally, refusing to believe that he had suddenly forgotten how to conduct, he walked back to the stage and asked one of the young ladies to hand down her part to him. What was on the page made him stare in disbelief. Then he told me what had happened and asked that the session be called off. The women had been rehearsing from an edition in which the editor had inexplicably changed the original meter of 3/4 to 4/4. Dr. Walter was completely stunned and shaken. I begged him to give me just ten minutes to figure something out. The problem was that the choir would not be available again for some weeks. I had to think quickly, or we might lose this beautiful ending, with the "real" sirens. The solution was obvious—new chorus parts had to be made very quickly—but was it practical? Our orchestra contractor, Mr. Kahgan, made several telephone calls and was able to arrange for three copyists to be at the hall within fifteen minutes. I thereupon persuaded Dr. Walter to continue the session by assuring him that he could rehearse and record the Venusberg Music up to the point at which the sirens enter, and that the new choir parts would be ready by that time. He agreed, and so we started to rehearse and record, while the three copyists feverishly wrote out enough parts for the choir. We had lost time because of the confusion, however, and now I had a problem from an unexpected quarter. The director of the choir told me that he had promised to return the women to the campus in time for them to have dinner at the dining hall, and it was so late now that he could spare only half an hour

Thomas Frost checks the score while Bruno Walter, eyes closed, "conducts" the playback in the control room.



COLUMBIA RECORDS

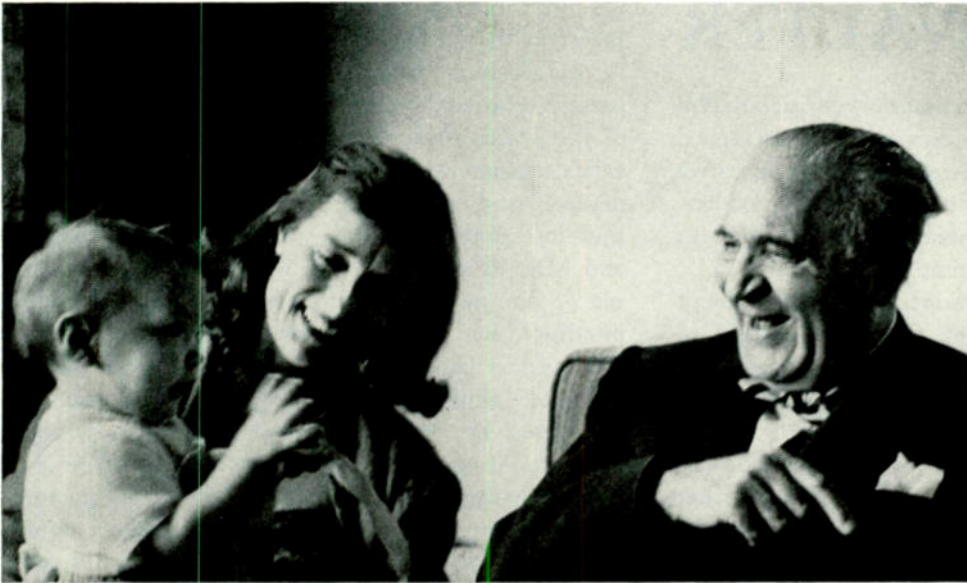

Young David Frost, in the arms of his mother, charms his distinguished visitor.

more. At this time, we had not even started to rehearse the choir with the new parts. I told him we would do our best, knowing full well that it would be impossible to finish in half an hour. The choir director seemed to be completely insensitive to the importance of the occasion and could not see beyond his own problem, and when the half hour was up, he was ready to take his choir home, finished or not. I pleaded with him, making certain that Dr. Walter heard nothing of this. He finally weakened when I agreed to have Columbia Records buy dinner for the entire choir. Luckily, Dr. Walter did not get wind of any of this, and he finished the session in a tranquil spirit. We could not have known at the time that Bruno Walter was destined to do only one more week of recording in his lifetime.

I NEVER ceased to marvel at Bruno Walter's conducting. He did practically nothing with his baton and his left hand, and everything with his eyes and face. The way he communicated was sheer magic. Most important, the musicians were motivated to give their absolute best. No one could resist his gentle invitation: "Come, my friends." They indeed came with him, wherever he wanted to lead them. His was leadership in its highest form, and I think his example explodes the myth that a great conductor must be feared or hated by the men who follow him.

But let there be no misconception about Dr. Walter's gentle kindness. It did not serve to cover up the least bit of compromise or appeasement. He always got his way, but without the need for force. He was never overbearing in his relations with people, never sarcastic. He seemed to surmount the common problem of fitting the means to the end: it appeared as if the means and the end were inseparable as far as

he was concerned. He would most certainly have been a great statesman.

Being a deeply religious man, he always attempted to look into the soul of a person, and formed his opinion accordingly. Some were perhaps unjustly condemned by his rigorous spiritual standards. For example, he told me that he would never collaborate with a certain young singer who sang popular songs and jazz in public. He doubted that any singer who would do that could possess the right spiritual qualities for making music with him. An instance of the opposite effect these judgments could have concerns a young conductor about whom Dr. Walter had heard good reports from some of the musicians who played both in our recording orchestra and in the Los Angeles Philharmonic. The young man visited Dr. Walter, who was much impressed by his human and spiritual qualities. As a result, Dr. Walter was ready to endorse the young man fully, despite the fact that he had never heard him conduct!

On March 11, 1961, we started to work on Bruckner's Seventh Symphony. It was thrilling to listen to the first rehearsal because everything fell into place so quickly, even though the men had never played the work before. One of the visitors at this session was an executive of an important European company that records the finest orchestras in Europe. After hearing a few minutes of the very first reading of the first movement, he asked me how many hours this movement had been rehearsed the day before. When I told him that this was the very first reading, he stared at me in disbelief. I added that Bruno Walter had often called this orchestra the finest ensemble in the world. These men had played for his recordings since 1957. The change in personnel over these four years was as little as perhaps five per cent, thanks to

BRUNO WALTER

the untiring efforts of the orchestra's contractor, Phil Kahgan, who coaxed, cajoled, and even threatened the men, so that they often gave up more lucrative television or film jobs in order to play for Dr. Walter. Bruno Walter and the Columbia Symphony Orchestra were at their zenith at this time.

Ironically, a leading magazine chose this moment to attack Dr. Walter's "The Orchestral Music of Brahms" album for an alleged lack of noble orchestral sound. The reviewer stated—on what grounds it is impossible to imagine—that this was probably due to the so-called "pickup" orchestra foisted upon Dr. Walter by Columbia Records, and also conjectured that "too much of the balance and tone quality seems to have emanated from the control room rather than from the conductor's musical consciousness." Since any critic is entitled to his opinion, Dr. Walter, although disturbed, did not object until the same magazine a month later printed a similarly derogatory letter, couched in suspiciously similar terms, from a nonmusician. As it happened, in a letter to Walter the same writer had glowingly described the recording sessions in question as the greatest experience of his life, and had requested, and received, an invitation to the conductor's home. Dr. Walter correctly denounced the use of technical evidence from an unqualified observer, and pointed out also that it is completely wrong to say categorically that only orchestras that have existed for many years and have a tradition and a history are on the highest level. He said to me: "There are no orchestras—only conductors," explaining that there is no such thing as the sound of an orchestra, only the sound of a conductor. An orchestra is a neutral entity which takes on quality and color from each individual conductor.

THE last two recording sessions, which took place on March 29 and March 31, 1961, produced four Mozart overtures and the *Masonic Funeral Music* (Bruno Walter preferred to have it translated as *Masonic Dirge*). He considered the latter one of Mozart's finest works, incredibly different from anything else he wrote," and unfortunately very rarely performed. He rerecorded the entire *Magic Flute* Overture at the last session because he was not happy with the first four bars. Between the two sessions, Dr. Walter had called me to tell me that he had not been able to sleep because of the opening of the overture. The up-beat sixteenth notes had not been short enough. (Whenever he was dissatisfied with some aspect of his performance, he would describe the problem as a burden weighing him down.) On March 31, then,

we rerecorded the entire *Magic Flute* Overture, and recorded the *Impresario* Overture and the *Così fan tutte* Overture. After the session, Dr. Walter was greatly relieved by the improvement in the opening of the *Magic Flute* Overture, and also glad that the year's sessions were over. He felt somewhat tired and depleted and was looking forward to some rest. I was therefore quite astonished to hear him say that he and Mrs. Reinhardt would like to visit my wife and me at our motel so that he could meet our eight-month-old son, whom he knew only from photographs.

Two days later, my wife and I awaited our visitors in silence, while our little boy played in his crib. We knew that Dr. Walter had given up his daily walk at Santa Monica in order to visit us. He followed a rigid daily routine imposed by himself and his doctors. Every morning he read his mail and dictated letters to his secretary. Letters came to him from all over the world, from strangers as well as friends, and no letter ever went unanswered. This would occupy most of his morning. After lunch, he would sleep and then study scores. In late afternoon, weather permitting, he would walk along the ocean with Mrs. Reinhardt. As I was sitting quietly thinking about Dr. Walter, my wife motioned me to the window. It overlooked a swimming pool, and there was a ramp at the side of the pool leading up to our level. What I saw touched me deeply. Dr. Walter and Mrs. Reinhardt were walking very slowly up the ramp arm-in-arm. He was carrying a large bouquet of flowers and Mrs. Reinhardt a white package. His face was calm and serene. When they reached our door, Dr. Walter handed my wife the bouquet and Mrs. Reinhardt opened her package, which contained a beautiful light-blue toy rabbit. After that, all attention was focused on my boy, David. Unfortunately, he could not realize who the visitor was. Dr. Walter had a wonderful time playing with the baby, and it was touching to see two human beings eighty-three years apart in age communicating with each other. After about an hour, Dr. Walter and Delia Reinhardt took their leave. We walked them to the corner where Mrs. Reinhardt's car was parked, and we said good-bye. That was the last time I saw him.

He will be remembered by many people for many things, but perhaps primarily for the love and respect for humanity that manifested itself in everything he said and did. He left a great legacy of musical performances, and to those who knew him, he left also a vivid image of a great human being.

Thomas Frost studied the violin in his native Vienna, conducting in Chattanooga, and composition at Yale. After stints at Decca and Urania, he moved to Columbia, where he produces the recordings of the Philadelphia Orchestra, Horowitz, Stern, and others.

THE PRICE COMES DOWN

AN EXAMINATION OF THE EXPANDING FIELD OF
MODERATELY PRICED STEREO EQUIPMENT

By JOHN MILDER

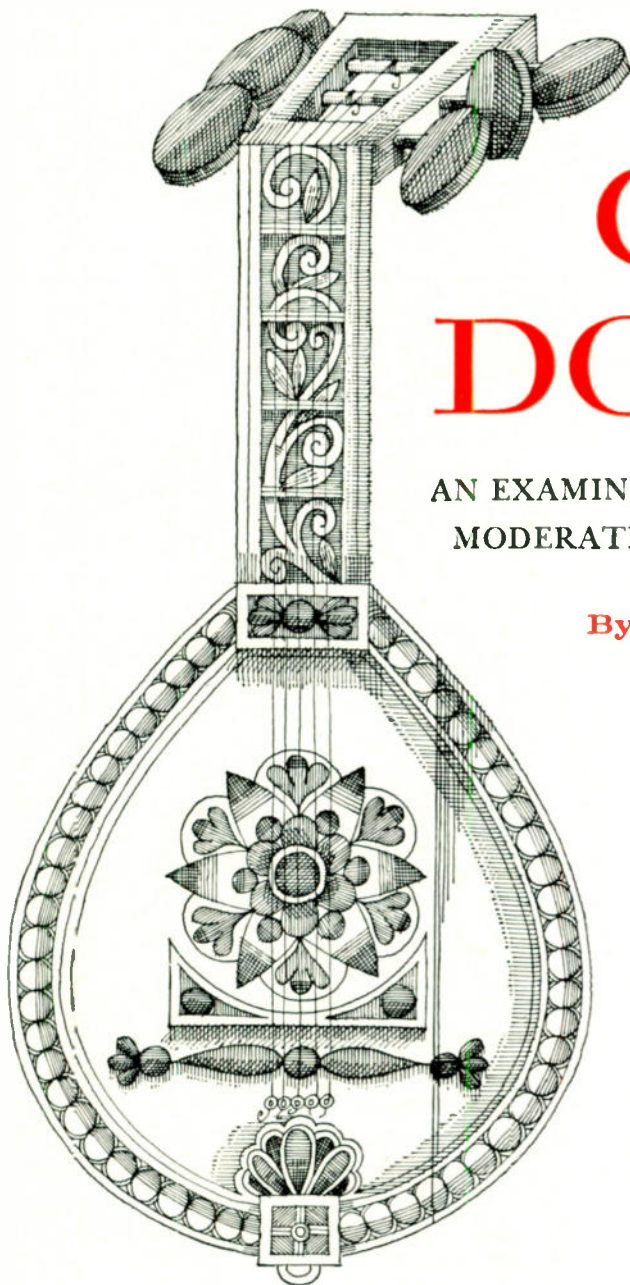

THE CURRENT hubbub over \$350 preamplifiers, \$400 basic amplifiers, and \$500 tuners has tended to obscure a significant development taking place at the other end of the price scale. It may come as a surprise to many, but the price of stereo high fidelity actually has diminished considerably over the past several years. The reasons for this are diverse, but if you are planning any hi-fi purchases, it is worthwhile to be aware of why and in what areas cost has come down.

Although the increasing popularity of hi-fi has led to a higher volume of sales, mass-production techniques are not the key to the lower cost of today's medium-price audio equipment. In comparison with the home-appliance industry, high fidelity remains a fairly small business, and audio plant managers can not calculate costs on the basis of hundreds of thousands of units rolling off a production line. It is true, however, that hi-fi manufacturers have been able to adopt the production methods used in other areas of modern industrial electronics. Printed circuits, for example, have not only made for lower prices, but—more importantly—for greater dependability and uniformity. And many manufacturers are convinced that transistors, currently used mostly in expensive, ultra-high-per-

PRICE COMES DOWN

formance equipment, eventually will lead to the development of special designs and construction techniques that will make possible large improvements in the very lowest price categories.

Equally important in the price picture is a slow but definite trend toward integration of components. There is a growing opinion among audio manufacturers that the designer can do a better—and less expensive—job if he has design control over the associated components in a system. For the moment, there is no agreement on how far the combining of equipment should go, since price, performance, and sales potential are at issue. Some combination units, for instance, are definite compromises in favor of a lower price and greater convenience for the nontechnical buyer. Others, however, offer improvement in performance as well as a lower price. For example, the transistorized amplifier-speaker is a marriage of necessity and convenience. However, as long as some manufacturers feel that the listener's desire to be selective is paramount, it is likely that everything down to cartridge styli will continue to be available separately (and to be interchangeable to some degree). But the trend toward integration is gaining momentum.

TO SEE what improved design, production techniques, and integration have so far accomplished in lowering the cost of good performance, we must look at some of today's hi-fi components category by category. Since it is not possible to cover all of the improvements in design-for-price over the past few years, attention will be focused on some of the ideas that seem to have played the greatest role in bringing down the price of good sound.

Much of the quality of today's moderately priced amplifiers can be traced to the appearance, in 1957, of some new output tubes from Europe. Such tubes as the EL34 and EL84, which are still popular in their power classes, offered an irresistible performance combination: more undistorted output for less drive voltage fed into them. The immediate result was higher-power amplifiers with one or two fewer driver stages than had previously been necessary. The prime example was the original Dynakit mono power amplifier, which used only three tubes (plus rectifier) to achieve a fifty-watt output.

The prices of the first stereo amplifiers reflected not only the cost of adding a second channel, but also the money spent on solving the problems of stereo design. Within a year, however, the price of stereo amplification began to drop. Both Dynaco and Eico introduced kit-built amplifiers that offered seventy watts of stereo power for less than \$100. Inexpensive integrated amplifiers were offered by such manufacturers as Scott, Fisher, Harman-Kardon, and Sherwood.

The output sections of most of today's amplifiers use stereo versions of the same circuits made possible by the new output tubes of 1957. Tubes have continued to improve, and U.S.-designed tubes (such as the 6550, 7591, and 7189) are fast replacing the European types. What has been accomplished in power amplifiers is illustrated by Harman-Kardon's Citation V, a luxury amplifier that costs less in kit form (\$119.95) for eighty watts of stereo power than most pre-1957 units demanded for forty watts of monophonic output. A roll call of stereo power-amplifier kits that provide top performance for a cost of approximately a dollar a watt includes the Dynaco Stereo 70 (70 watts for \$99.95), the Eico HF-87K (70 watts for \$74.95) and HF-89K (100 watts for \$99.50), the Heathkit AA-121 (80 watts for \$79.95), the Knight-Kit KB-85

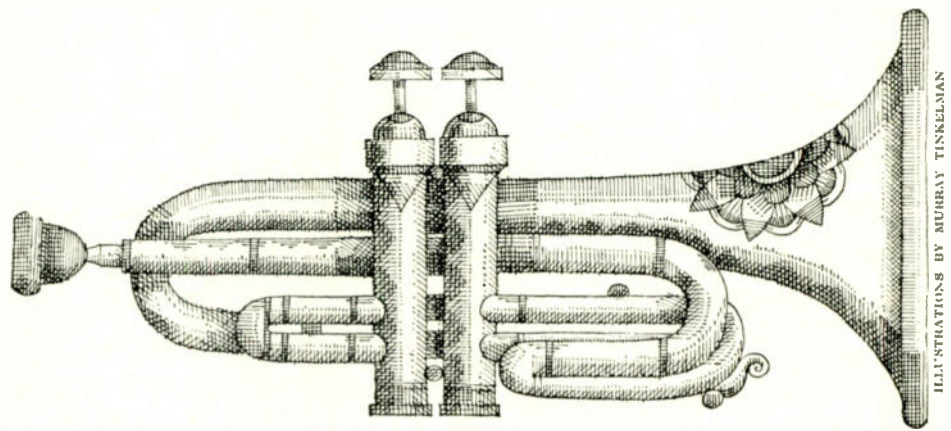

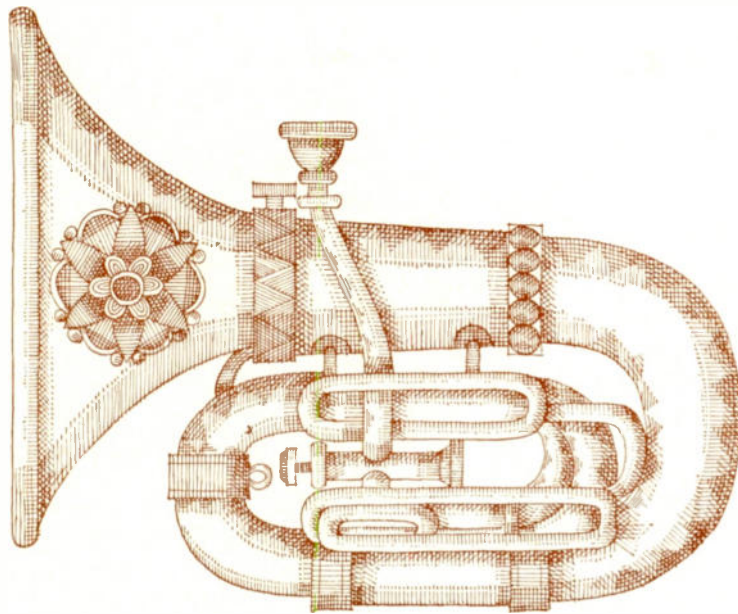

(70 watts for \$69.95), and the Lafayette KT-550 (100 watts for \$134.50). Any of these units can help bring the cost of a luxury stereo system down almost to the medium-price category, and although their cost is relatively modest, there is no compromise in performance.

Despite the excellent values in high-power basic amplifiers (and such low-cost kit preamplifiers as those made by Dynaco, Eico, and Heath), integrated amplifiers still account for the majority of sales. And here the interest is not only in price, but in performance. In many respects, the new integrated amplifier-pre-amplifier combinations from Dynaco, Eico, Fisher, Harman-Kardon, Knight, and Scott are very close in performance to the more expensive combinations of the same companies' separate basic amplifiers and pre-amplifiers—and with little or no sacrifice of control features. As for price, it is now possible to find a number of excellent amplifiers (with outputs of 30 to 70 watts) for less than \$100 in kit form or under \$150 wired. This is roughly the price range of 20-watt monophonic amplifiers of several years ago, and the price is due to dip still more with the introduction of units (such as Eico's Classic series) that drop marginally useful control features.

ALL of this, of course, is happening to vacuum-tube amplifiers. For the moment, the lower-cost integrated transistor amplifiers in the 30-watt class pose an interesting problem. Most of them are slightly more expensive than comparable tube models, and have less impressive specifications. However, a number of authorities have stated that they sound better than their specifications indicate they should—probably, some have remarked, because they operate without output transformers.

Part of the transistor's long-range potential is its usefulness when employed in the integration of equipment. In many respects, transistor amplifiers challenge the advantages traditionally claimed to result from the separation of the preamplifier from the power amplifier: the transistor almost completely solves the old problems of hum, heat, and size-vs-output. A trend in the use of transistors is exemplified by J. B. Lansing's transistor amplifiers, designed specifically for integration with Lansing's speakers. The idea here is to have the amplifier complement a particular speaker as regards power, damping, and frequency response, particularly at low frequencies. This type of integration will make for economy as well as improved performance of both speakers and amplifiers.

As for today's speaker systems, the focus of most manufacturers' attention is the slightly-under-\$100 price range. With the quality performance of compact speakers now taken for granted, the emphasis is both on further savings in space (as in slim-line systems) and the least scaling-down of performance necessary to arrive at a reasonable price. For the latter objective, such systems as the EMI 319, Electro-Voice One, Fisher XP-2a and KS-1 kit, Grado Lab "Jr.," Jensen TF-3, KLH-10, University Companion II, and Wharfedale W-40 are designed to differ in performance from the same companies' more expensive speakers essentially only at the extreme high and low frequencies.

At the moment, however, even less expensive (and smaller) speakers are in planning or production, some of which embody radical departures in design. KLH's Model 14, for instance, aims at a low price (\$50) through the use of two miniature full-range speakers. To get the full low-frequency potential of the small speakers, the Model 14 incorporates a network that

PRICE COMES DOWN

gradually rolls off an amplifier's signal above 250 cps. [Also see "Technical Talk" this month.] Whether or not KLH's frequency-contouring principle is widely adopted, other low-price, quality speaker systems will be emphasized in coming months. Among these are ADC's Brentwood, Electro-Voice's Coronet kits, Jensen's X-20, and University's Miniflex.

In record-playing equipment, the trend toward integration has been given impetus by the success of the Acoustic Research turntable-and-arm combination. The company contends that both the turntable's low price (\$68) and its insensitivity to feedback are the result of integrated design. The new Rek-O-Kut R-34 turntable makes similar use of integration as a design approach, including the isolation of the arm and the platter from the motor board, and its price (\$89.85) is considerably lower than earlier Rek-O-Kut models with similar specifications.

Since integration is obviously inevitable in record changers, credit for the performance of current models must go to a combination of good design and efficient production methods. Though it is true that the prices of such units as the Garrard A, the Miracord 10, and the Dual 1009 are higher than those of earlier record changers, few people question that the performance improvements far outweigh the increases in price.

Now, only two years after the beginning of stereo FM broadcasts, the price of stereo FM equipment has also dropped—more than was at first expected. Two special factors, in addition to circuit and component improvements, are responsible. The designers have come to realize that most tuners are used in urban locations where supersensitivity is not worth—to most listeners, at least—what it costs. The other factor is that the reception problems emphasized by stereo broadcasting—such as multipath distortion—can be combatted more successfully by a good antenna than by the tuner itself. While neither of these premises has perceptibly slowed the production of elaborate and expensive tuners, both have encouraged the appearance of moderate-price units. In this category are such tuners as Dynaco's FM-3 (\$109.95 in kit form), Eico's ST-97 and 2200 kits (\$99.95 and \$92.50), the Fisher KM-60 kit (\$169.50), Harman-Kardon's F50XK kit (\$129.95), the Pilot 280B (\$99.95), and several units from H. H. Scott, including the LT-111 kit (\$119.95), the FM 370B (\$159.95), and the LT-110 kit (\$164.95). A number of units within fifty dollars of this range (from Fisher, Pilot, Scott, Sherwood, and others) are also excellent bargains.

In considering what has happened to tape recorders, it is impossible not to mention Japan. Thanks to a specialized electronics industry (in which labor is *not* particularly cheap, incidentally), and close cooperation with American designers and sales agencies, the Japanese now produce many, if not yet the majority, of the tape machines in all price ranges, and the made-in-Japan label has long since lost any flavor of the pejorative. The well-designed recorders in the low- and medium-price classes (Japanese, American, and European) have become too numerous to note by model, but a list of companies that offer excellent recorders would include Concord, Eico, Heath, Knight, Lafayette, Norelco, Roberts, Sony, and Viking. All of these manufacturers offer reasonably priced recorders with much of the performance and flexibility once found only in far more expensive machines. And thanks to transistors, the built-in amplifiers of many recorders now offer surprisingly good playback quality through their own speakers—an important consideration for anyone who intends to use a recorder both in and out of a hi-fi system. Higher-price recorders still offer the utmost in performance and in features, but the bargains in low- and medium-price tape machines are numerous.

THE one category in which the price of performance has not dropped sharply is the integrated stereo receiver, or tuner-amplifier combination. Units from Bogen, Fisher, Harman-Kardon, Pilot, Scott, and Sherwood are excellent values (with prices justified both by high amplifier power and excellent FM reception), but until recently there were few models in the low-price category. This situation is on the way to being rectified; recent entries include such kits as the Eico Classic 2536K (\$154.95), the Harman-Kardon FA 30XK (\$169.95), the Heathkit AR-13 (\$195), and the Knight-Kit KU 45A (\$139.95). There are also a number of under-\$200 wired units from such companies as Grommes, Kenwood, Lafayette, Pilot, and Realistic.

If you have been waiting to buy your first audio system, or to convert to stereo, the foregoing survey may convince you that you have waited long enough. Innovations and improvements in equipment will of course continue, and the price of each watt of amplifier power or microvolt of tuner sensitivity probably will continue to creep downward. But the real breakthroughs in design-for-price have already occurred, and the present is probably the best time ever to invest in quality sound-reproducing equipment.

John Milder, a free-lance writer who is also occasionally a retail salesman of hi-fi gear, has been describing various aspects of audio to HiFi/STEREO REVIEW readers for five years.

BEST OF THE MONTH



A GREAT ENSEMBLE PERFORMANCE OF *COSI FAN TUTTE*

Mozart's comic masterpiece receives a superb recording by Deutsche Grammophon

HARD ON THE HEELS of Angel's excellent *Così fan tutte* (reviewed in the June issue) comes Deutsche Grammophon's magnificent new production, with Eugen Jochum conducting the Berlin Philharmonic, and an all-German cast of top-ranking Mozartians in the opera's six challenging roles. Like Angel, DGG offers a nearly complete account of *Così*—considerably more than is included in most staged versions—but where Angel required four discs, DGG manages comfortably with three, thanks to Jochum's livelier pacing.



DEUTSCHE GRAMMOPHON

EUGEN JOCHUM

Firm control, sensitive balance

Ensemble is everything in *Così*, and this is a remarkable ensemble performance: spirited, precise, and enriched by vividly individual contributions that are yet oriented toward the whole. Credit for this accomplishment should go primarily to conductor Jochum, whose meticulous reading reveals the score's delights with utter clarity, produces shimmering and sensitively balanced orchestral sonorities, and guides the singers firmly but without rigidity. Jochum's tempos seem unerringly right: unlike Karl Böhm, whose Angel reading is equally imposing in control and sensitivity, Jochum, in this recording, never allows fastidiousness to

inhibit the forward motion of Mozart's scintillating music.

The singers form a superlative ensemble even against the considerable handicap posed by the absence of a strong Fiordiligi. One questions the wisdom of assigning this bravura role to Irmgard Seefried, whose voice is weak at both extremes of the range, and who, therefore, must adopt a cautious approach to arias that were meant to be taken at a daredevil pace. But she manages somehow, and because

(Continued overleaf)



she is still an outstanding Mozartian stylist, and because she holds up her end in the ensembles remarkably well, the performance suffers relatively little from this bit of imperfect casting.

Both Seefried and Nan Merriman (Dorabella) project vivid personalities into their roles. Merriman molds her dark, essentially non-Mozartian timbre with intelligence and sensitive control to exquisite Mozartian ends. In their duets, the two produce a captivating blend despite the pronounced contrast in timbre. Equally effective are the two suitors, and although Ernst Hæfliger is somewhat overshadowed by the more dynamic Hermann Prey, it is again the contrast that makes for more meaningful delineation. Prey's impulsive and temperamental Guglielmo is near ideal. Hæfliger is somewhat ill at ease in the florid passages, but elsewhere his singing is a model of polished tone and artistic phrasing. As Don Alfonso, the cynical mastermind behind the whole implausible plot, Dietrich Fischer-Dieskau exhibits not only his customary polish and gifts of expressiveness, but also a ripe comic sense and an obvious delight in what he is doing. Erika Köth brings ample vocal resources and a delightful temperament to her piquant portrayal of Despina, and her Notary is hilarious.

DGG's sound is rich and transparent, and the packaging includes the lavish features usually offered by this source, including multilingual essays and librettos. A truly outstanding production.

George Jellinek

Ⓢ Ⓜ **MOZART: *Così fan tutte*.** Irmgard Seefried (soprano), Fiordiligi; Nan Merriman (mezzo-soprano), Dorabella; Ernst Hæfliger (tenor), Ferrando; Hermann Prey (baritone), Guglielmo; Dietrich Fischer-Dieskau (baritone), Don Alfonso; Erika Köth (soprano), Despina. RIAS Chamber Choir and Berlin Philharmonic, Eugene Jochem cond. DEUTSCHE GRAMMOPHON SLPM 138861/2/3 three 12-inch discs \$20.94, LPM 18861/2/3* \$17.94.

APOTHEOSIS OF THE MADRIGAL ART

*The Deller Consort excels in intonation,
balance, and range of expression*

IT IS AN unhappy fact that the second volume in any series is seldom as good as the first. In the case of Vanguard's "Madrigal Masterpieces," however, Volume Two—running the gamut from French chanson, the Italian school, the Flemish Cyprien de Rore, the

Dutch Jacob Arcadelt, to a light-hearted English madrigal—is not only as well planned as the excellent Volume One (BGS 5031/BG 604, released in 1960), but is even better performed. Volume Two, in fact, is very possibly the best madrigal recording I have ever heard. It is also an amazing display of Alfred Deller's continuing growth as an interpreter. What formerly was extremely fine madrigal singing on his part (and that of his vocal consort) has now become not only much more refined stylistically, but also far more emotional in content, more subtle in expression, and much more effectively welded to the texts.

Most people are apt to think of madrigals as mere vocal pleasantries, full of those "fa-la-la's" brilliantly typified in Anna Russell's hilarious parodies. And, of course, she pokes fun not only at the music, but at the style of singing as well. Madrigal singing meant pure, white vocal execution with no emotion whatsoever. A great number of the many madrigal collections available on records illustrate precisely this approach, but as more and more information about the Renaissance and Mannerist styles has been brought to light, it has become increasingly apparent that emotion and passion (not soupy romanticism) are just what this vocal chamber music requires.

Alfred Deller and the members of his consort have accomplished this brilliantly. The makeup of his group is not quite the same as in the previous volume, and the new singers, to my mind, are a considerable improvement. The enormous difficulties of such a capella singing as this are not apparent here: the intonation is superlative, the balancing of the voices exquisite. Above all, however, is the wide range of expression, which places most previous madrigal collections in the shade. The recording is excellent, and the stereo pressing makes the most of the placement of the six vocalists. Now, Vanguard, what about some more Gesualdo for Volume Three? *Igor Kipnis*

Ⓢ Ⓜ **MADRIGAL MASTERPIECES, Vol. Two.** Costeley: *Allons, gay Bergères; Mignonne, allons voir si la rose.* Passereau: *Il est bel et bon.* Monteverdi: *Lagrime d'Amante al Sepolcro dell' Amata; Zefiro torna e'l bel tempo rimena.* Marenzio: *Solo e pensoso; Leggiadre Ninfe.* Rore: *Ancor che c'ol partire.* Gesualdo: *Morro lasso al mio duolo.* Arcadelt: *Il bianco e dolce cigno.* **R. Jones:** *Fair Oriana seeming to wink at folly.* The Deller Consort (Mary Thomas and Honor Sheppard, sopranos; Alfred Deller, countertenor; Robert Tear and Max Worthley, tenors; Maurice Bevan, baritone). VANGUARD BACH GUILD BGS 5051 \$5.95, BG 639 \$4.98.

A BRILLIANT RECITAL OF *SCHWANENGESANG*

*Fischer-Dieskau and Moore collaborate
in the best-yet performance of
Schubert's last song cycle*

IT WAS doubtless only sound commercial instinct, mixed perhaps with a dash of sentiment, that prompted publisher Tobias Haslinger to take the fifteen songs left unpublished after Schubert's death (including the last one he ever wrote) and group them in a posthumous collection called *Schwanengesang*. But Haslinger's impulse turned out to be a stroke of genius: the songs making up this unplanned and artificial cycle form nonetheless a compelling sequence.

And now *Schwanengesang* can be heard in the greatest performance ever recorded of this collection—Angel's new release with Dietrich Fischer-Dieskau. In this disc, the artist is in superlative form: vibrant tone, uncommon range of expression, intelligence and imagination, perfect diction—all these qualities of a superb recitalist are coupled with meticulous attention to musical nuance. His over-all treatment is expansively Romantic, occasionally skirting the overdramatic, but never falling into sentimentality. It is hard to imagine the wistful lyricism of *In der Ferne* and *Ihr Bild* captured more persuasively,

or the rippling measures of *Liebesbotschaft* or *Die Taubenpost* delivered with more infectious cheer. These are, of course, the songs best suited to the range and expressive qualities of Fischer-Dieskau's lyric baritone. But his meeting of the challenges of heroic utterance is no less remarkable. The artist sings so skillfully, with such a sensitive control of dynamics, that his rather modest-size voice creates the illusion of thundering strength in the powerful climaxes. Thus two of the most demanding Heine songs in the group—*Der Atlas* and *Der Doppelgänger*—emerge in all their gripping majesty. And the effects are not achieved by declamatory stresses: even the monotonous line of *Die Stadt*, set against an eerie, evocative accompaniment, is projected with a firm singing tone.

I have some reservations about *Aufenthalt*, which Fischer-Dieskau has imaginatively recreated in his own lyrical image, but which nevertheless calls, I feel, for brisker pacing and a fiercer, more menacing mood. Here and in *Kriegers Ahnung* the dark tone colors of Hans Hotter (whose earlier version is now deleted) seem more appropriate. Surprisingly, too, *Ständchen* suffers from intonation uncertainties. But a few lapses must be permitted an accomplishment of this degree of excellence.

In his autobiography, *Am I Too Loud?* Gerald Moore says of Fischer-Dieskau: "He had only to sing one phrase before I knew I was in the presence of a master." For the accompanist's collaboration here, Fischer-Dieskau can only return the compliment. The recorded sound is clear and ideally balanced.

George Jellinek

© ● **SCHUBERT:** *Schwanengesang, D. 957*. Dietrich Fischer-Dieskau (baritone); Gerald Moore (piano). Angel S 36127 \$5.98, 36127* \$1.98.

SOEUR SOURIRE: A SONG PROGRAM, DELIGHTFUL AND IMPROBABLE

*A singing nun reveals a world
of simple faith with wit and charm*

BEARING IN MIND the example of the *Missa Luba*, the Congo folk Mass reviewed in these pages in October, it would appear that Philips has quite a talent for finding treasure in unlikely places. One would scarcely expect, for instance, to discover a professionally accomplished, guitar-

ANGEL RECORDS



DIETRICH FISCHER-DIESKAU AND GERALD MOORE
An unbeatable combination?

playing folk-style composer-singer in a Dominican convent at Ficherfont, near Brussels in Belgium. Although the Church is the veritable wellspring of the musical art, it is still somewhat surprising to come suddenly upon a Dominican nun named Soeur Sourire ("Sister Smile") singing in a voice of purity, clarity, sweetness, and charm, and with the perfect simplicity that conceals great art, her own little strophic songs.

"Sourire" is, of course, a pseudonym for anonymity's sake, a *nom de disque*, one which cannot help pulling along in its train its verbal meanings—to be agreeable, to delight, to please—and this is precisely what these songs do. Perhaps because of the echoes of French folk and nursery tunes, they may at first hearing seem childlike, but this is only because they share two qualities we customarily associate with children: innocence and candor. These can nonetheless be used to express great intellectual and spiritual sophistication.

It is often a characteristic of the best in the arts that they are *aware of themselves*, that they describe themselves far better than any other words possibly could. Soeur Sourire says, for example, in a song about her guitar (called Adele):

*Et sa parole chaude et discrète
Était bien douce à écouter.*

And it was indeed sweet to listen
To [her] tale, warm and shy.

It would be difficult to invent two other lines that could better sum up the total effect of this album. Nor could we find a better description of simple faith than Soeur Sourire's own words in *Je Voudrais*, a moving prayer in song:

*Je voudrais être comme une guitare
Au coeur chantant.
Je voudrais être comme une guitare
Au coeur vibrant,
Comme une guitare que tu puisses
Remplir de ta chanson.*

I would like to be like a guitar
With a singing heart.
I would like to be like a guitar
With a throbbing heart.
Like a guitar that thou mayest
Fill [me] with thy song.

Sister Smile's subject is the love of God, which is universal and not denominational. And although a knowledge of French will certainly give you an increased appreciation of these songs, it is not necessary, since the English versions are both sensitive and accurate. At least one track, a hilarious gem called *Resurrection*, even gains briefly in the translation: "Eskimo pies" (par-

ticularly those sold by "les p'tits scouts de l'Alaska") are better than "chocolats glacés."

It is an unhappy task to criticize a record that has given me so much pleasure, but I must in conscience remark that the tastelessly coy and fulsome once-upon-a-time album notes seem to be almost deliberately vague and uncommunicative where they should be most explicit: who and what is Sister Smile, and under what circumstances were these songs written and the recordings made? In addition, only a profound degree of insensitivity to the songs themselves could have produced the offensive tone of saccharine sentimentalism that pervades the notes. They would appear to have been written in that never-never sugarplum parish just south of Hollywood and Vine where a cute little nun (Ingrid Bergman) teaches boxing while your friend in the confessional (Bing Crosby) sings lullabies to sleepy moppets. All this has less than nothing to do with the real joy, perfect sincerity, and moving faith of Sister Smile's songs. Philips has obviously spent a good deal of money on the physical production of this album in its Connoisseur Collection series—but in the wrong places. It is further unfortunate that whoever decides these matters in the recording studio had so little confidence in the excellence of the material that he chose to "improve" it with such gimmickry as overdubbing, heavy reverberation, fade-outs, and tricked-up stereo reprocessing (the mono version has a more honest sound, and is to be preferred).

But no matter. This album is a must for anyone who even pretends to like music.

William Anderson

© © SOEUR SOURIRE, THE SINGING NUN. Soeur Sourire (vocals, guitar). *Dominique; Fleur de Cactus; Complainte pour Marie-Jacques; Tous les Chemins; Plume de Radis; Mets Ton Joli Jupon; Alleluia; J'ai Trouvé le Seigneur; Entre les Étoiles;* and three others. PHILIPS PCC 603 \$5.98, PCC 203 \$4.98.

AN IMPORTANT DOCUMENT IN THE HISTORY OF JAZZ

*"The Ellington Era" traces
the development of a great band*

THE LATEST ENTRY in Columbia's distinguished series of jazz reissues is "The Ellington Era (1927-1940), Volume



ASSOCIATED BOOKING CORP.

DUKE ELLINGTON

Builds on intimate, creative interplay of forces

One." The forty-eight performances on the three discs in this album comprise the first of two sets that Columbia has prepared to illustrate this period of Ellington's career. The numbers have been assembled from Okeh, Brunswick, and Columbia masters; and although the original 78's had somewhat more brilliance and body, the LP transfers are competent and admirably document the durability of Ellington's compositions and of his band.

As Leonard Feather points out in the album notes, although the Ellington band grew in size during these years, there were only three permanent withdrawals from mid-1929 to mid-1939. With so stable a unit to write for, Ellington was able to compose, as he prefers, with specific instrumentalists in mind. Accordingly, the pieces are unmistakably extensions of Ellington's own musical ideas heightened in performance by the powerfully individual filling out of those ideas by the sidemen. No orchestra in jazz history has been built on such an intimate, creative interplay between a composer-leader and his sidemen as has Ellington's.

The first volume contains several refinements of the "jungle" style that Ellington had begun to work on in the mid-1930's. Among them are *East St. Louis Toodle-oo*, *The Mooch*, and *Black and Tan Fantasy*. (Interestingly, the trumpet solo on the version of *Fantasy* here is not Bubber

Miley's, but is instead a spare, ardently lyrical interpretation by Jabbo Smith.) Ellington's musical language gradually became much broader in scope and color, and his book grew to include a wide variety of blues, from the soaring *Old Man Blues* to the gently introspective *Subtle Lament*. Also present during these years were luminously evocative ballads (*Solitude*, *I Let a Song Go Out of My Heart*, *Prelude to a Kiss*), and concise, impressionistic portraits and vignettes (*Saddest Tale*, *Mood Indigo*, *Portrait of the Lion*, *Sophisticated Lady*).

The collection also demonstrates Ellington's precedent-setting ability to write carefully structured compositions for a single jazz soloist (*Echoes of Harlem* for Cootie Williams, *Boy Meets Horn* for Rex Stewart, and *Clarinet Lament* for Barney Bigard). Further diversity in conception is indicated by *Battle of Swing* (Ellington's first attempt at a jazz "concerto grosso") and the two-part *Diminuendo and Crescendo in Blue*, which, with its fascinating play of reed textures and its gathering intensity, is one of the most dramatic of all Ellington recordings.

Among the brilliant soloists are Bubber Miley, the nearly forgotten Arthur Whetsol, Cootie Williams, "Tricky Sam" Nanton, Harry Carney, Barney Bigard, Johnny Hodges, Lawrence Brown, and Ellington himself. Hodges and Brown, now heard usually in romantic performances, were also surgingly hot players, as these recordings indicate. If any one soloist especially colors these numbers, it is the late "Tricky Sam" Nanton, whose peer as a witty and sometimes melancholy trombonist Ellington was never to find again. There are also wordless vocals by Baby Cox and several superb performances by the wry, bittersweet, and wholly unique Ivie Anderson—easily the best vocalist Ellington ever had.

As is Columbia's custom in its reissue packages, an illustrated booklet contains full discographical details. Leonard Feather's essay is a useful introduction to the Ellington "mystique" and also, in a brief section, to the structure of his music. In a concluding piece, Stanley Dance provides information about each number. "The Ellington Era" is certainly one of the indispensable sets for a jazz library, as, I expect, the second volume in the series will be.

Nat Hentoff

© DUKE ELLINGTON: *The Ellington Era (1927-1940), Volume One. Jubilee Stomp; Saddest Tale; Caravan; Grievin';* and forty-four others. COLUMBIA C3L 27 \$11.98.

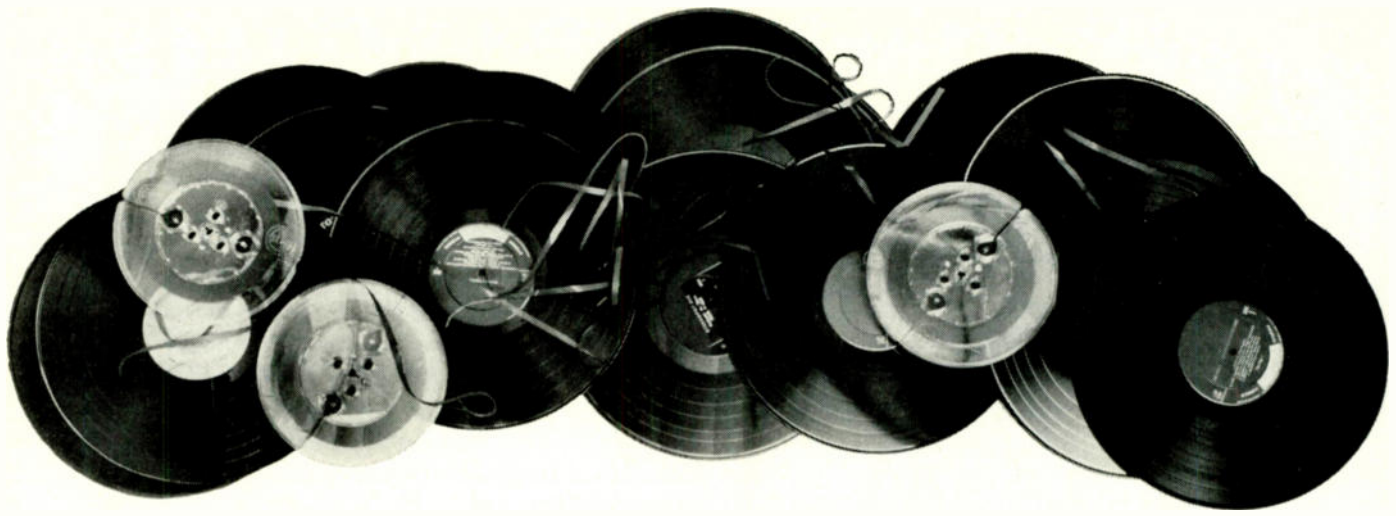

**NOW...DIRECT TO YOU FROM HiFi/STEREO REVIEW—
THE RECORDINGS YOU WANT!**

As a special service to our readers—you can purchase any of the recordings reviewed in this issue directly from HiFi/STEREO REVIEW RECORD SERVICE...and...*At No Increase In Prices* (we pay all charges for packing, handling and postage).

Here is a new service designed especially for you...a quick, easy way to obtain “New Release” and hard-to-get recordings. You don’t have to wait weeks or months ever again for your favorite recordings...they can be yours as fast as the mails can carry them.

Here’s all you have to do. Read the reviews in this issue by the expert music critics. Then decide which recordings you want to buy. Fill out the form below and mail it today. It’s that easy. For quick delivery, order your recordings now!

HiFi/STEREO REVIEW RECORD SERVICE • DEPT. SC
ONE PARK AVE. • NEW YORK 16, N.Y.

Please send the following records and/or tapes reviewed in this issue.

- Check or Money Order for \$.....is enclosed.
- C.O.D.

(ALL RECORDINGS FULLY GUARANTEED)

PAGE NO. OF REVIEW	TITLE	RECORD (TAPE) NUMBER (SEE REVIEW)	MANUFACTURER	PRICE (SEE REVIEW)

(N.Y.C. residents add 4% sales tax)

Total

Name (please print).....

Address

CityZone.....State.....

Orders must be received no later than January 2, 1964

1263



HIFI/STEREO REVIEW'S CHOICE OF THE LATEST RECORDINGS

CLASSICAL

Reviewed by WILLIAM FLANAGAN • DAVID HALL • GEORGE JELLINEK • IGOR KIPNIS

Ⓢ Ⓜ BACH: *Chorale Preludes. Komm, Gott Schöpfer, heiliger Geist* (S. 667); *Fantasy on Komm, heiliger Geist, Herre Gott* (S. 651); *Triptych on the Holy Trinity: Kyrie, Gott Vater in Ewigkeit; Christe, aller Welt Trost; Kyrie, Gott heiliger Geist* (S. 669-71); *Nun freut euch, lieben Christen g'mein* (S. 734); *Nun komm' der Heiden Heiland* (S. 661); *Vater unser im Himmelreich* (S. 737); *Von Gott will ich nicht lassen* (S. 658); *Wir glauben all' an einen Gott* (S. 680); *Wo soll ich fliehen hin* (S. 646). Eduard Commette (organ of the Cathedral of St. Jean, Lyon, France). ANGEL S 36119* \$5.98, 36119 \$4.98.

Interest: Renowned French organist
Performance: Vigorous
Recording: Excellent

The eleven chorale preludes in this recording derive mainly from the collection of eighteen published in Leipzig about 1747, and from the third part of the *Clavierübung*, published in the same city in 1739. Also included is one of the

Explanation of symbols:

- Ⓜ = monophonic recording
- Ⓢ = stereophonic recording
- * = mono or stereo version not received for review

Schübler chorales (S. 646) and two other pieces: "Nun freut euch" and "Vater unser im Himmelreich." This recital is well thought out, not only for variety and mood, but also in that it does not rely exclusively on the most familiar chorale preludes. Eighty-year-old Eduard Commette plays with a rock-steady technique that many a younger organist might envy. Furthermore, he has always performed Bach in a most attractively vigorous manner, without most of the exaggerations that typify the interpretations of the older school of French organists. In this respect, he is much like Albert Schweitzer, though far more brilliant a virtuoso. The instrument on which he plays, that of St. Jean Cathedral in Lyon, where he has been organist for nearly sixty years, is of nineteenth-century French construction—it was built in 1841. Though it apparently does not have a swell stop and is a small organ, it has most of the characteristics of the Cavaillé-Coll school: many orchestral reed stops, heavy bass, and enclosed pipes, with the resulting mushy sound. Consequently, in spite of Commette's superior interpretations and sensible registration, much of the transparency of Bach's writing is lost. The reproduction is extremely good for an organ of this type (I did not hear the stereo version), and the bass response is very full.

I. K.

Ⓜ BACH: *Organ Music. Toccata and Fugue in D Minor* (S. 565); *Fantasia and Fugue in G Minor* ("The Great," S. 542); *Fugue in G Minor* ("The Little," S. 578); *Preludes and Fugues: in F Minor* (S. 534), *C Major* (S. 545), *G Major* (S. 541). Albert Schweitzer (organ of All Hallows Church, Barking, London). ANGEL COLH 89 \$5.98.

Interest: Early Schweitzer
Performance: Trail-blazing in 1935
Recording: Respectable for its time

In 1935, when the contents of this record were released as the first in a three-volume anthology of Bach organ music, only a relative handful of Bach organ recordings were available. A good half of these were transcriptions for piano or orchestra, and such organ discs as did exist were for the large part performed on instruments whose tonal characteristics were more suited to the music of the nineteenth century. Albert Schweitzer's splendid work during the early part of this century in propagating the wisdom of using a Baroque-type organ for Baroque music was incalculable in its impact, as was also the effect of these pieces played by him in a—for that time—startlingly straightforward manner, without Romantic flourish or exaggeration in either rhythm or registration. Schweitzer was never a great

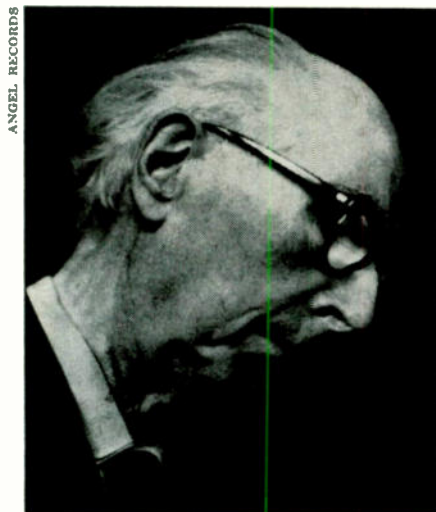

EDUARD COMMETTE

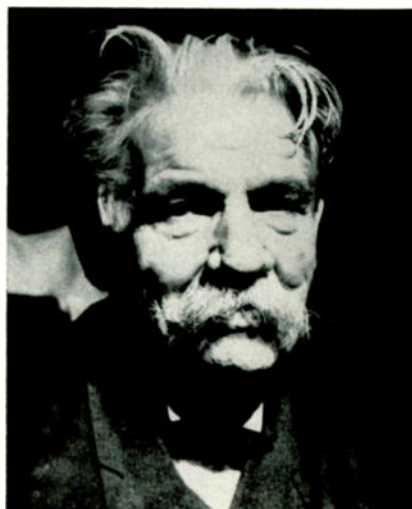

ALBERT SCHWEITZER

Two elder statesmen of the organ: stylistic and technical contributions to a demanding art

technician, and it is a bit of a shock now to hear the organist's many "blue notes," unevenness of fingerwork, and tempo fluctuations, especially in contrast to the perfection tape-editing has brought to present-day organ recording, including Schweitzer's own more recent discs on Columbia. Interpretively, there is much to admire here, though what Schweitzer was trying to do in 1935 has been excelled by Walcha, Heintze, Weinrich, and Biggs, to mention only a few of today's outstanding players. The present disc is an important one historically, but the fact that the pieces contained on it have been performed better, at least in the technical aspects, makes one wonder whether this collection really merits rerelease in the Great Recordings of the Century series.

I. K.

RECORDING OF SPECIAL MERIT

© BACH: *The Six Partitas*. Glenn Gould (piano). COLUMBIA M2S 693 two 12-inch discs \$11.98, M2L 293 \$9.98.

© BACH: *Partita No. 3, in A Minor; Partita No. 1, in D Major; Toccata No. 7, in E Minor*. Glenn Gould (piano). COLUMBIA MS 6498 \$5.98, ML 5898 \$4.98.

Interest: Bach as clavier virtuoso
Performance: Masterly
Recording: Excellent
Stereo Quality: Appropriate

Glenn Gould has now completed his version of the six Bach partitas—the so-called "German Suites" that in Bach's

lifetime (as Forkel tells us) made "a great noise in the musical world," delighting both clavier virtuosos and audiences with their brilliance, expressiveness, and novelty. The reasons for their enthusiastic initial reception are more vividly apparent in Mr. Gould's performance than in any other I have heard, and I think this is due largely to his unambiguous assertion of their exuberant secular nature and their public function. The astonishing diversity of these fifty-five pieces is celebrated; certain historians seemingly would have preferred them more weighty (Parry went so far as to call them "miniatures"—which in comparison to the B Minor Mass I suppose they are), and certain performers devoted to respectful underplaying miss the point entirely by giving them a false cosmetic unity that amounts to a suppression of their radically contrasted characters.

Not so Mr. Gould, who treats them explicitly as concert Bach of the most variegated and energetic sort; listeners will search here in vain for the discreetly grey approach that so often passes for musicological reverence. It would be hard to imagine a more convincing demonstration of Mr. Gould's virile concept of the *galant* spirit—the surface posture of formality and the erupting subterranean turbulence that constitute the special historic paradox of the style. Beneath the ornate proliferation of the Baroque melodic line, Mr. Gould never for a moment lets us forget the surging energies that alone justify and support its extravagant expansion. And we understand why High Baroque art had little love or need for

(Continued on page 68)

"BACH'S GREATEST HITS"

IF ONE survives the initial shock of this perfectly mad record, he will hear thirty minutes or so of purely abstract musical sound that, taken without an a priori axe to grind, can be described as unendingly delightful.

A musician by the whimsically metaphorical name of Ward Swingle has, it seems, got his fingers into a number of Sebastian Bach's short instrumental pieces and has set them, replete with dooby-do and papa-dah vocalized scat syllables, for small chorus and an underlying rhythm section. Swung Bach, in other words.

The remarkable thing is the arranger's claim—which I thoroughly believe—that the Bach musical texts have been essentially unaltered. There are some alterations of key, done in order to make certain of the numbers singable, and some switches to 4/4 time. And some of them are performed in tempos—fast or slow, that is—different from those in which they

are traditionally heard. But otherwise they rattle along quite as they were composed, making pretty, animated sounds. The effect is charming.

Bach purists will howl with rage, I suspect, and there are no reasonable arguments to be made against the reaction. But those music-lovers who favor Bach in the sort of ponderous orchestral dress that has been intermittently fashionable in our concert life would do well to temper their outrage with the realization that these clean, light arrangements are far closer in spirit to Bach than Mr. Stokowski's apocalyptic transcriptions.

W. F.

© BACH'S GREATEST HITS. *Fugue in D Minor (from The Art of the Fugue); Prelude for Organ Chorale No. 1; Aria (from the Suite in D Major); and ten others*. The Creative Swingle Singers. PHILIPS PHS 600097 \$5.98, PIIM 200097 \$4.98.

STEREO
FIRST PERFORMANCE
LINCOLN CENTER
FOR THE PERFORMING ARTS
PHILHARMONIC HALL
SEPTEMBER 21, 1962
A COMPLETE DOCUMENTARY IN WORDS, MUSIC AND PICTURES OF THE OPENING OF LINCOLN CENTER WITH
LEONARD BERNSTEIN
NEW YORK PHILHARMONIC

L2L 1007/L2S 1008° (a 2-Record Set)

STEREO
THE SOUND OF HOROWITZ
SCARLATTI • SCHUBERT • SCHUMANN • S Scriabin

ML 5811/MS 6411°

STEREO
BETTY BARRETT ROBERT ELSTON JOYCE VAN PATTEN CHARLES AYDAM
KINGAR LEW HASTENS
Spoon River Anthology

OL 6010/OS 2410°

STEREO
THE ACTORS STUDIO THEATRE
EUGENE O'NEILL'S
Pulitzer Prize Play
STRANGE INTERLUDE

BETTY FIELD
JANE FONDA
BEN GAZZARA
PAT HINGLE
GEOFFREY HORNE
GERALDINE PAGE
WILLIAM PRINCE
FRANCOIS TONE
JOSE QUINTERO

DOL 288/DOS 688° (a 5-Record Set)

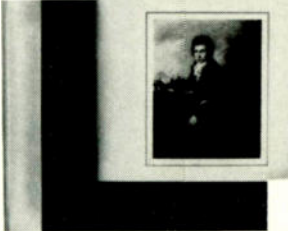
A Beethoven Reader

D7L 265/D7S610° (a 7-Record Set)

Beethoven: The Nine Symphonies; Columbia Symphony Orchestra; Bruno Walter, Conductor. A 7-record set including a 46-page illustrated book.



ML 5911/MS 6511°



ML 5899/MS 6499°



ML 5769/MS 6369°



M2L 263/M2S 607 (a 2-Record Set)



ML 5908/MS 6508°

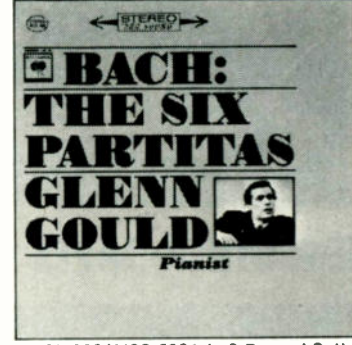

M2L 293/M2S 693° (a 2-Record Set)



M3L 292/M3S 692° (a 3-Record Set)



DOL 287/DOS 687° (a 4-Record Set)



L2L 1011/L2S 1012° (a 2-Record Set)

Gathered here are some of the world's greatest artists to help make your Christmas giving more thoughtful, meaningful and memorable.

The Sound of Genius on Columbia Masterworks  ...to give, to have, to share.

SEE YOUR RECORD DEALER FOR THE COLUMBIA RECORDS FULL-COLOR GIFT CATALOG.

*Stereo/All Stereo albums are also available in Guaranteed High Fidelity (Mono).

*STEREO ●COLUMBIA ●MARCAS REG. PRINTED IN U.S.A.



WHEN OTHER TAPES HAVE RUN OUT...



**AMERICAN'S "PROFESSIONAL LENGTH"
STILL HAS 25% MORE ON THE REEL**



Only American's Revolutionary New "Professional Length" Tapes offer up to 25% more tape and 25% more playing time on the standard 7" reel. Available in 1500', 2000', 3000' and 3600' reels at little or no more than you would pay for other leading brands in standard lengths.

See your dealer or write to:

GREENTREE



ELECTRONICS

291 S. LA CIENEGA BOULEVARD
BEVERLY HILLS, CALIFORNIA

formal repose. In its place we are given sheer adventure—active symmetries of whirling movement that balance only in the intoxicating splendors of flight. When the audacious energies and the psychological intoxication are stylistically negated in performance, we have already left Bach and the Baroque for the less strenuous elegancies of the Rococo spirit, and Mr. Gould is to be thanked for insisting here on the profound difference.

The complete partitas are also of great interest as a revealing paradigm of Mr. Gould's preferences in instrumental tone as they have developed from 1959, the recording date of the fifth and sixth partitas (which, it should be noted, have been rechanneled for stereo), to 1963, the recording date of the third and fourth partitas. He has moved steadily in the direction of a fairly stark and often somber bass sound and a plangent, harpsichord-like treble; since his instinct, as I have noted before, is rather more sculptural than painterly, it is no accident that he obtains a maximum of graphic delineation with this minimum of coloristic means.

The single disc of the third and fourth partitas includes the early and romantically moody Toccata in E Minor—a key that seems to bring Bach as near as he ever gets to confessional discursiveness. This piece lasts more than eight minutes, and the Toccata of the sixth partita, also in E Minor, lasts almost ten (as compared to an average of two to three minutes for all the others). It should be added that both these recordings capture Mr. Gould's highly personal tonal tastes and balances with complete fidelity.

Robert Offergeld

Ⓢ Ⓜ BEETHOVEN: *Quartet, in E-flat Major, for Piano and Strings, Op. 16.* SCHUBERT: *Quintet, in A Major, for Piano and Strings, Op. 111 ("Trout").* Mieczyslaw Horszowski (piano); Julius Levine (double bass); the Budapest String Quartet. COLUMBIA MS 6473 \$5.98, ML 5873 \$4.98.

Interest: "Trout" and early Beethoven
Performance: Good
Recording: Well balanced and clear
Stereo Quality: Very fine

The earlier version by the Budapest Quartet and Horszowski of the ever-popular "Trout" Quintet was released as long ago as 1950, and like most recordings of this score, it was the only work contained on the disc. Columbia's new recording, lasting a total of sixty-one minutes, adds a lengthy bonus—Beethoven's Op. 16 in the version for piano and three strings (the same music is a quintet for piano and winds). It is a fine piece, although, of course, not in the same league with the "Trout." Columbia
(Continued on page 70)



JBL FOR

CHRISTMAS

Approach select **the** tion of your family's Christmas gift in the spirit **gift of** of high fidelity—no compromise.

Does it pay **EVERLASTING** to get the best there is? Ask any JBL owner. **SATISFACTION** He likely thinks his JBL speakers became part of the family only yesterday. That's how young and vital they sound. Every listen a fresh experience. Yet, looking back, they've been around for, lo, many a holiday season. Does he ever want to trade them for something else? Mmm, maybe for a more advanced JBL system. Probably, though, he'll stick with what he's got and refine it still further . . . by adding a dividing network and high frequency unit . . . by installing his transducers in a bigger acoustical enclosure . . . or by duplicating his original JBL loudspeaker system to form an ideal stereophonic set-up. This Christmas he can add the new JBL two channel, solid state Energizer, an advanced power source precisely matched to his specific loudspeaker system to provide virtually perfect reproduction. JBL ownership generates a special kind of loyalty, a loyalty that flourishes on a diet of everlasting satisfaction. Newcomer or devotee, there's a gift of everlasting satisfaction waiting to be moved to your house by your JBL Franchised Audio Specialist. When you visit him, be sure to ask for a complete audition of the new JBL Energizer / Transducers; it's almost a paternal obligation.

Write for new literature
on the subject.



JAMES B. LANSING SOUND, INC., LOS ANGELES 39, CALIFORNIA

Records at Cost!

through our Special Membership Plan

BUILD YOUR RECORD LIBRARY INEXPENSIVELY, QUICKLY, CONVENIENTLY NO "AGREE TO PURCHASE" OBLIGATION CHOOSE THE RECORDS YOU WANT

Citadel Record Club members purchase hi-fi and stereo albums at cost; classical, popular, jazz, show hits, folk, etc. There are never any "list price" purchases through Citadel.

CITADEL Membership —

The Proven Method Of Record Buying Used By Thousands Because . . .

- * **YOU DECIDE ON YOUR PURCHASES** — You are not obligated to purchase any particular quantity of records. Buy as few or as many records as you want . . . the choice is yours.
- * **YOU HAVE COMPLETE FREEDOM OF SELECTION** — Virtually any record or album, by any artist on any label is available including all major labels plus hundreds of smaller labels as well as most imports. Again, the choice is completely up to you.
- * **PROMPT SERVICE** — Many orders are shipped the day received, rarely later than the next several days. In the event of a delay, partial shipments are made and your order completed when available.
- * **PERIODIC SPECIALS** — Periodically you receive a list of hit albums from all categories of music at prices up to 55% off list. Again, you are under no obligation to purchase any of these specials.
- * **FREE! SCHWANN RECORD CATALOG** — With your membership you receive this quick reference to over 25,000 albums. This easy-to-use catalog contains separate sections for classical, popular, ballet, opera, musical shows, folk music, jazz, etc., and for all new releases.
- * **100% GUARANTEE** — If a damaged or defective record does get through our inspection, we shall immediately replace with a perfect copy.

Membership dues is \$3.00 a year . . . a nominal amount if you think of the prices you have paid within the past year. AS A CITADEL MEMBER BUYING RECORDS AT COST, YOUR DUES WILL BE PAID FOR WITH VIRTUALLY THE FIRST PURCHASE YOU MAKE THROUGH THE CLUB. Additional savings quickly mount up, permitting you to buy many more albums on your record budget.

May we suggest that you give Citadel an opportunity of proving its value to you. You enter no obligations, take no risks . . . simply complete the coupon below, include your \$3.00 yearly dues and upon receipt we shall immediately forward all membership material to you.

SATISFACTION GUARANTEED. Try membership for 30 days. If you are not completely satisfied, dues will be refunded immediately.

FREE! Act now. Fill out coupon, enclose your dues; we will include a free record cleaning cloth as a gift.

CITADEL RECORD CLUB

545 Fifth Avenue, New York 17, N. Y. S-123
Enroll me in Citadel for one year. I am under no obligation to purchase any particular quantity of records, but those that I do purchase will be at cost price . . . NEVER more. Send the current Schwann catalog and free record cloth immediately. I understand that if, after 30 days, I am not completely satisfied I can get my full membership dues back immediately. \$3.00 dues enclosed.

FULL NAME _____
STREET _____
CITY _____ ZONE _____ STATE _____

CIRCLE NO. 18 ON READER SERVICE CARD
70

bia's package therefore is distinctly a bargain, especially since the performances are good and the recording is exceedingly well-balanced and clear (the mono version has slightly better bass response). The interpretations, however, are not superlative: there is a certain feeling of routine handling and a lack of the tragic gravity that pervades late Schubert, like late Mozart, beneath the surface of even the sunniest works. The Schnabel-Pro Arte Quartet collaboration on Angel COLH 40 has these missing elements and, in addition, a piano performance of considerably more feeling and personality. *I. K.*

© © **BEETHOVEN: *Symphony No. 3, in E-flat, Op. 55 ("Eroica"); Coriolan Overture, Op. 62.*** Philharmonic Promenade Orchestra of London, Sir Adrian Boult cond. VANGUARD SRV 127 SD \$2.98, SRV 127 \$1.98.

Interest: Bargain Beethoven
Performance: Neat and swift
Recording: Passable 1959 vintage
Stereo Quality: Adequate

For bargain-minded stereophiles, this Adrian Boult Beethoven package represents generally good value, though some may find the Englishman's approach a bit too neat and gentlemanly when measured against that of a Klemperer, a Toscanini, or a Bruno Walter. *Coriolan*, wherein Beethoven is in his most ferocious C-Minor humor, moves at rather too fast a clip to carry the weight it should.

Vanguard issued this same coupling in mono only some four years ago in its regular series, as well as the "Eroica" by itself in stereo. The sound is not quite up to contemporary standards, but it remains listenable. *D. H.*

© © **BEETHOVEN: *Symphony No. 4, in B-flat, Op. 60; Leonore Overture No. 3, Op. 72.*** Cleveland Orchestra, George Szell cond. EPIC BC 1264 \$5.98, LC 3864* \$4.98.

Interest: Beethoven's most lyrical symphony
Performance: Taut
Recording: Too close
Stereo Quality: Good enough

Cleveland maestro George Szell has only the first two Beethoven symphonies to go, plus a stereo version of the Fifth, to complete the Beethoven symphony cycle with the orchestra that he has made into one of the world's finest.

In this reading of the marvelously poetic Fourth Symphony, Dr. Szell runs true to the form displayed in his earlier Beethoven issues from Cleveland. Which is to say that the fiercely dramatic odd-numbered symphonies are his dish of tea,

and not the more relaxed "Pastoral" or No. 8—let alone No. 4. I complained about the rather dry quality of the Szell-Cleveland version of the "Pastoral" when it was issued some months ago, a quality underlined by the close-up microphoning that seems to have become a habit in Cleveland's Severance Hall, and I do likewise now. The notes and rhythms of this music emerge with flawless clarity, but the poetry is lost. For that one must turn to the recordings of Walter, Klemperer, or Ansermet.

In conclusion, let it be said in Szell's favor that he and his players turn out a topnotch *Leonore Overture No. 3*—musically flawless and stunning in dramatic effect. *D. H.*



BEETHOVEN AS A YOUNG MAN
(A romanticized wood engraving)

RECORDING OF SPECIAL MERIT

© © **BEETHOVEN: *Symphony No. 8, in F Major, Op. 93.*** SCHUMANN: *Symphony No. 4, in D Minor, Op. 120.* Cleveland Orchestra, George Szell cond. EPIC BC 1254 \$5.98, LC 3854* \$4.98.

Interest: Fine reissue pairing
Performance: Vital
Recording: A-1
Stereo Quality: Fine

That neither of these topnotch Szell-Cleveland Orchestra recorded performances has been available heretofore except as parts of larger album sets is a circumstance that has resulted in a fascinating coupling of two effectively contrasted essays in symphonic terseness. Beethoven's "little giant" of an Eighth and Schumann's romantically virile yet tautly woven D Minor Symphony make for an oddly satisfying musical experience when played one after the other.

Szell and his orchestra are in superb form throughout both works. The Beethoven is full of sparkle and vigor (despite a somewhat sedately paced minuet),

(Continued on page 76)

CIRCLE NO. 27 ON READER SERVICE CARD →

plays your precious records with a light, gentle touch

Whether you use your Miracord as a manual turntable, an automatic turntable or an automatic changer, whether you play stereo or mono, you enjoy the same gentle quality, the same flawless performance that has made Miracord first choice in the finest consoles and component systems.

It is the only unit of its type obtainable with self-regulated, constant-speed hysteresis motor, the only one with a one-piece, 12-inch turntable and mass-balanced tone arm employing no springs, and the only one with feather-touch pushbutton controls.

Incredibly quiet, smooth and gentle, the Miracord brings out the best in your records with every play, and preserves that quality for long-lasting enjoyment.

Before you choose a record player for your system, be sure to see and hear the Miracord at your high fidelity dealer. Model 10H with hysteresis motor, \$99.50; model 10 with 4-pole induction motor, \$89.50 (less cartridge and base). For complete details, write to:

**BENJAMIN
MIRACORD**



A FINAL LEGACY FROM BRUNO WALTER

By David Hall

TOGETHER with the late Sir Thomas Beecham and the still very much alive and kicking Leopold Stokowski, Bruno Walter boasted one of the longest and most fruitful of all recording careers as a conductor. If one reviews Walter's basic concert repertoire, with its foundation in Schubert, Mozart, Haydn, Wagner, Brahms, Beethoven, Mahler, Bruckner, and Johann Strauss, he will discover that Walter recorded a good percentage of this music at least three times in the thirty-year development of recording technology from 78-rpm shellacs to LP, and from monophonic LP to stereophonic. Although we may regret not having a Mahler Fourth Symphony in stereo from Walter's baton, not to speak of a Bruckner Eighth Symphony or a Strauss *Death and Transfiguration*, there is much from Walter's last years in which we can take profound joy.

In these years his musical activities became almost wholly confined to recording under the ideal conditions that Columbia arranged for him on the West Coast, complete to an acoustically superb auditorium and an orchestra made up of the finest musicians in the area. The Mahler Ninth Symphony, the even-numbered Beethovens, the Bruckner Fourth, and the Overture and Venusberg Music from Wagner's *Tannhäuser* are all among the great recordings of the century.

In the eight discs listed here, we have the final harvest of Bruno Walter's interpretive testament as a recording artist. Twelve out of the sixteen sides are newly issued performances, with the Mozart "Haffner" and "Jupiter" Symphonies, the Mahler *Wayfarer* songs, the Brahms *Academic Festival Overture*, and the Wagner *Meistersinger* Prelude being recouplings of previously issued material.

Confining immediate attention to the newly issued recordings, the Beethoven and the Bruckner are the peaks of interest. The Beethoven *Leonore* No. 2 is a first recording for Walter, and his treatment of this first essay for what was to become the far more terse and telling *Leonore* No. 3 is expansive and compellingly dramatic. Even more so, however, is Walter's way with the mighty *Coriolan Overture*, cut from the same cloth as the Fifth Symphony's first movement. Not since Willem Mengelberg's pre-war 78-rpm recording of this work have I heard a reading so powerful and so magnificently played. Like Walter's readings of the Wagner *Tannhäuser* Overture and Venusberg Music and the *Flying Dutchman* Overture, it gives the lie to those who would pigeonhole the conductor as merely a genial lyricist. Indeed, I have come to the conclusion, after

listening to the Mozart and Haydn readings in this release, that what seems on the surface an easy-flowing, lyrical approach is actually supersophisticated power and underlying tension—this being particularly noticeable in the aforementioned Beethoven and Wagner scores, as well as in the Bruckner Fourth and Mahler Ninth Symphonies.

One's reaction to Walter in Mozart and Haydn will be determined in large measure by personal taste, for Walter's fast movements are far removed in spirit from the virile insistence of Beecham in top form or Klemperer, let alone the hectic, even febrile quality of Toscanini. On the other hand, his treatment of the

The Brahms-Mahler disc finds the gifted mezzo-soprano Mildred Miller a little out of her vocal depth for the now bleak, now serenely Olympian *Alto Rhapsody* of Brahms. Not even Walter's impassioned urgency can efface the strong impressions of the memorable recorded performances of Christa Ludwig, Marian Anderson, Kathleen Ferrier, and Aafje Heynis. The *Song of Destiny* fares better: the Occidental College Concert Choir gives a fine account of itself, singing the Hölderlin text in the original German.

Miss Miller is much more comfortable in the Mahler *Songs of a Wayfarer*, issued originally as part of the two-disc Columbia album of Mahler's *Das Lied*



BRUNO WALTER

Sophisticated power, moving from strength to strength

slow movements and the dance movements is sheer joy. Such curiosities here as the hesitation at bar 47 following the recapitulation in the first movement of Mozart's G Minor are, over-all, fully compensated for.

We have had all too little Haydn on LP from Bruno Walter, and his interpretation of the lovely Symphony No. 88 is a special treat. It has become the custom over the past generation to drive the first and last movements of this work altogether too hard in an effort to display orchestral virtuosity. My first acquaintance with it goes back to 1933, when I bought a set of three 10-inch 78's with Clemens Krauss conducting the Vienna Philharmonic. It is enough to say that the new Walter performance brings back to life all of the lyrical and rhythmic felicities of that old Krauss reading, but with the addition of breathtakingly beautiful sound and exquisite details of phrasing and texture that were not to be heard on the discs of thirty years ago.

von der Erde; and Columbia was well advised to issue this performance separately, following the single-disc reissue of *Das Lied*. Here Miss Miller's vocal timbre is just right for the projection of Mahler's adolescent wanderer, sick of heart amid the beauty of the Bohemian countryside. The poignancy she brings to her performance, in company with Walter's loving hand with the orchestra, plus stunning recorded sound, is something that beggars description. For comparison, one can only mention the late Kathleen Ferrier with Dr. Walter in Mahler's *Das Lied von der Erde* (London) and *Kinder-totlieder* (Columbia).

The continuing absence of a first-class stereo recording of Anton Bruckner's Seventh Symphony understandably turns the attention of all admirers of the Austrian master to this long-awaited Bruno Walter reading. And unless they insist on a shatteringly monumental treatment, they will not be disappointed. Walter conceives the music as a gorgeous lyrical poem,

equally removed from the bucolic rusticity of the "Romantic" Symphony No. 4 and from the apocalyptic visions of Nos. 8 and 9. Quite correctly, he eschews the climactic cymbal crash interpolated into the slow movement over Bruckner's protest, with the result that the movement stands in its proper relationship to the finale.

The new Wagner performances—of the *Lohengrin* Act I Prelude (Walter's first and only recording of the piece) and of the *Siegfried Idyll* (the fourth by Walter)—neither add to nor detract from the conductor's stature.

Unlike a number of veteran recording artists, whose finest work on discs was done during the middle 1930's and early 1940's, and who attempted in vain to equal or surpass for LP or stereo their great achievements of the 78-rpm era, Bruno Walter seemed to go from strength to strength in his last recordings. Not all were superior to earlier versions—as witness the Schubert "Great" C Major of 1961 as against the thrilling 1947 reading with the New York Philharmonic (once available on Columbia ML 4093). But with few exceptions, these recordings will stand through the years as a final legacy.

© ④ BRUCKNER: *Symphony No. 7, in E Major*. WAGNER: *Lohengrin: Prelude; Siegfried Idyll*. Columbia Symphony Orchestra, Bruno Walter cond. COLUMBIA M2S 690 two 12-inch discs \$11.96, M2L 290* \$9.96.

© ④ MOZART: *Symphonies: No. 35, in D Major (K. 385, "Haffner"); No. 36, in C Major (K. 425, "Linz"); No. 38, in D Major (K. 504, "Prague"); No. 39, in E-flat (K. 543); No. 40, in G Minor (K. 550); No. 41, in C Major (K. 551, "Jupiter")*. Columbia Symphony Orchestra, Bruno Walter cond. COLUMBIA M3S 691 three 12-inch discs \$17.94, M3L 291* \$14.94.

© ④ BRAHMS: *Alto Rhapsody, Op. 53; Song of Destiny, Op. 54*. MAHLER: *Songs of a Wayfarer*. Mildred Miller (mezzo-soprano); Occidental College Concert Choir; Columbia Symphony Orchestra, Bruno Walter cond. COLUMBIA MS 6488 \$5.98, ML 5888* \$4.98.

© ④ BEETHOVEN: *Leonore Overture No. 2; Coriolan Overture, Op. 63*. BRAHMS: *Academic Festival Overture, Op. 80*. WAGNER: *Die Meistersinger: Prelude*. Columbia Symphony Orchestra, Bruno Walter cond. COLUMBIA MS 6487 \$5.98, ML 5887* \$4.98.

© ④ HAYDN: *Symphonies: No. 88, in G Major; No. 100, in G Major ("Military")*. Columbia Symphony Orchestra, Bruno Walter cond. COLUMBIA MS 6486 \$5.98, ML 5886* \$4.98.

NEW!

GRADO TRACER BEAM

STEREO CARTRIDGES

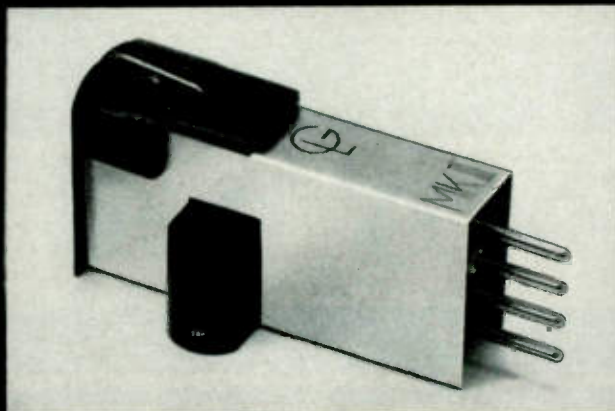

THE GRADO TRACER BEAM STEREO CARTRIDGES MEET ALL OF THESE REQUIREMENTS!

Eliminate inner groove distortion.

Eliminate completely "Shattering," and buzzing during playback.

Play both stereo and monaural records.

Be completely non-critical to installation problem and still perform superbly.

Track in a good tone arm at 1 gram or less (not just make sound but trace with low distortion!)

Work in all record changers and automatic turntables at up to 6 grams.

Have IM distortion of no more than 2% at the highest recorded levels and maintain 1% or less IM distortion for normal recorded levels.

Have a high frequency response to at least 24,000 CPS or better.

Have a FLAT frequency response down to 10 CPS.

STYLUS ASSEMBLY REPLACEABLE BY CONSUMER!

TRACER BEAM MK I STEREO CARTRIDGE \$75.00
 TRACER BEAM MK II STEREO CARTRIDGE \$49.50
 TRACER BEAM MK III STEREO CARTRIDGE \$37.50
 TRACER BEAM MK IV STEREO CARTRIDGE \$27.50

For further information please write:

GRADO LABORATORIES, INC. 4614 Seventh Ave., B'klyn 20, N.Y.

ANOTHER REASON WHY HEATHKIT

SOLID-STATE* STEREO

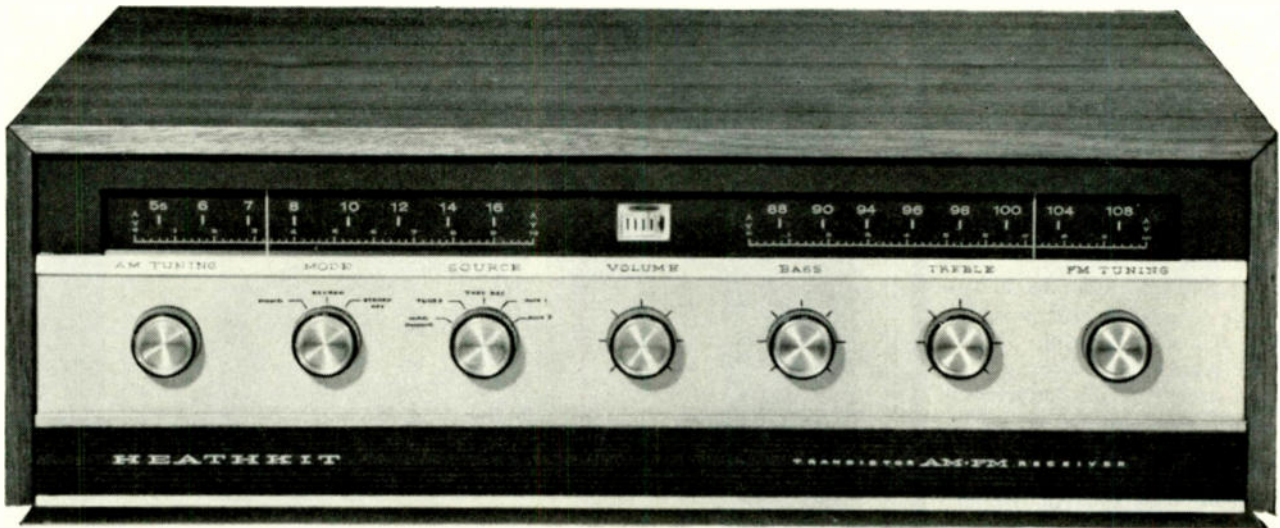

NEW! AR-13 STEREO RECEIVER...only \$195⁰⁰

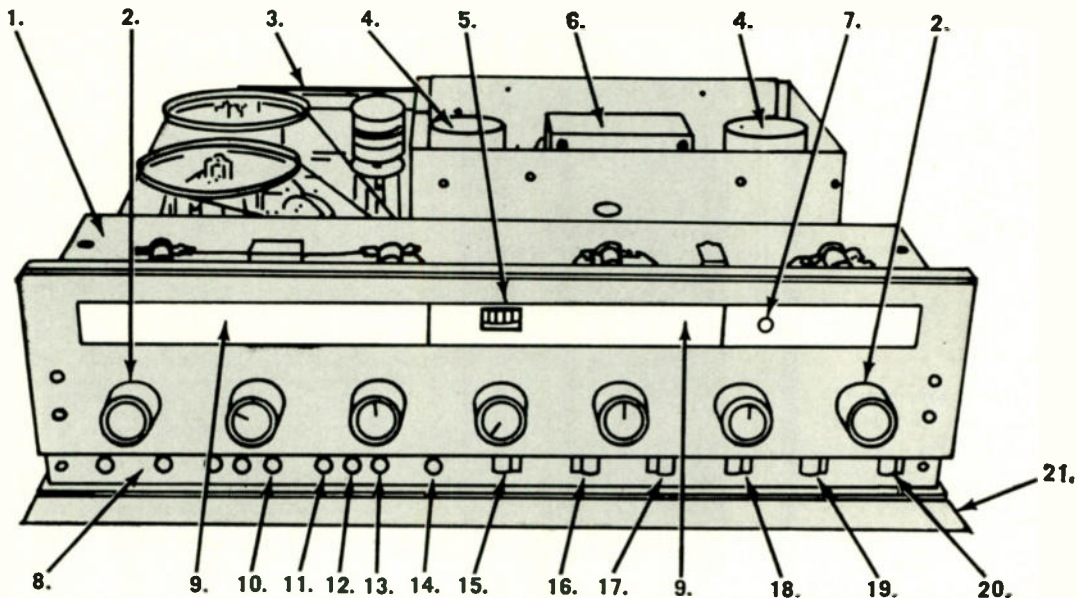

- | | |
|---|---|
| 1. Preassembled FM Front End | 12. Stereo Separation Control |
| 2. Individual AM and FM Tuning | 13. FM Squelch Control |
| 3. AM Rod Antenna | 14. Level Balance Control |
| 4. Regulated & Electronic Filtered Power Supply | 15. Phase Adjust Switch |
| 5. Tuning Meter | 16. AFC Switch |
| 6. Transformer Operated Power Supply | 17. Local-Distance Switch |
| 7. Stereo Indicator Light | 18. SCA Filter Switch |
| 8. Input Level Controls | 19. Noise Filter Switch |
| 9. Illuminated Slide Rule Dials | 20. Speaker Phase Switch |
| 10. Phase Adjust Control | 21. Hinged Lower Front Panel
(conceals secondary controls) |
| 11. Converter Balance Control | |

* 43 Transistor, 16 Diode Circuitry

LEADS IN TRANSISTOR STEREO

TUNER-AMPLIFIER

by Heathkit

FIRST IN KIT FORM!

ALL-TRANSISTOR AM-FM & FM STEREO TUNER PLUS ALL-TRANSISTOR 40-WATT STEREO AMPLIFIER—ALL IN ONE SMART WALNUT CABINET FOR JUST \$195.00

Now in time for Christmas giving, Christmas listening! Two 20-watt power amplifiers...two separate preamplifiers...plus wide-band AM, FM, and FM Stereo...all beautifully housed in this one, compact Heathkit All-Transistor Stereo Receiver. For Heathkit this means another first! For you it means experiencing the uncompromising realism of "transistor sound" in a handsomely styled receiver that won't overheat...just the coolest, fastest, most "hum-free" operation possible! Just the purest, most "solid sound" possible! This is the why of transistor stereo. This is why you should move up to the new AR-13 Receiver. And the traditional Heathkit economy makes this advanced performer easy to own...just \$195.00

All the electronics you need for a complete music system are "Heath-Engineered" into this handsome unit...just add two speakers and a phonograph or tape recorder! And there's plenty of advanced features to match the advanced performance of the AR-13. You'll like the way this unit automatically switches to stereo, thus eliminating any manual operation. In addition the automatic stereo indicator light silently signals when stereo is being received. For versatility there's three stereo inputs (mag. phono and two auxiliary) plus two filtered tape recorder outputs for direct "off-the-air" beat-

free stereo recording. Dual-tandem controls provide simultaneous adjustment of volume, bass, and treble of both channels. Balancing of both channels is accomplished by a separate control. The AM tuner features a high-gain RF stage and high-Q rod antenna.

Other quality features include a local-distance switch to prevent overloading in strong signal areas; a squelch control to eliminate between-station noise; AFC for drift-free reception; heavy die-cast flywheel for accurate, effortless tuning; pin-point tuning meter; and external antenna terminals for long-distance reception. For added convenience the secondary controls are "out-of-the-way" under the hinged lower front panel to prevent accidental system changes.

Building the AR-13 is quick and easy with the pre-assembled FM "front-end" and 3-stage AM-FM I.F. strip, plus circuit board construction. Styled in Heathkit's new low-silhouette design, the beautiful walnut cabinet accented with the extruded gold-anodized aluminum front panel makes the AR-13 a handsome addition to any home decor. This Christmas, move up to the better listening of "transistor sound" with the new AR-13 Stereo Receiver...another example of superb Heathkit quality at unmatched savings.

Kit AR-13, 30 lbs., no money dn., \$19 mo. . . . \$195.00

SPECIFICATIONS—Amplifier: Power output per channel (Heath Rating): 20 watts/8 ohm load, 13.5 watts/16 ohm load, 9 watts/4 ohm load. (IHF Music Power Output): 33 watts/8 ohm load, 18 watts/16 ohm load, 16 watts/4 ohm load @ 0.7% THD, 1 KC. **Power response:** ±1 db from 15 cps to 30 KC @ rated output; ±3 db from 10 cps to 60 KC @ rated output. **Harmonic distortion (at rated output):** Less than 1% @ 20 cps; less than 0.3% @ 1 KC; less than 1% @ 20 KC. **Intermodulation distortion (at rated output):** Less than 1%, 60 & 6,000 cps signal mixed 4:1. **Hum & noise:** Mag. phono, 50 db below rated output; Aux. inputs, 65 db below rated output. **Channel separation:** 40 db @ 20 KC, 60 db @ 1 KC, 40 db @ 20 cps. **Input sensitivity (for 20 watts output per channel, 8 ohm load):** Mag. phono, 6 MV; Aux. 1, .25 v; Aux. 2, .25 v. **Input Impedance:** Mag phono, 35 K ohm; Aux. 1, 100 K ohm; Aux. 2, 100 K ohm. **Outputs:** 4, 8, & 16 ohm and low impedance tape recorder outputs. **Controls:** 5-position Selector; 3-position Mode: Dual Tandem Volume; Bass & Treble Controls; Balance

Control: Phase Switch; Input Level Controls (all inputs except Aux. 2); Push-Pull ON/OFF Switch. **FM: Tuning range:** 88 mc to 108 mc. **IF frequency:** 10.7 mc. **Antenna:** 300 ohm balanced (internal for local reception). **Quieting sensitivity:** 2½ uv for 20 db of quieting, 3½ uv for 30 db of quieting. **Bandwidth:** 250 KC @ 6 db down (full quieting). **Image rejection:** 30 db. **IF rejection:** 70 db. **AM suppression:** 33 db. **Harmonic distortion:** Less than 1%. **Multiplex:** bandpass: ±½ db, 50 to 53,000 cps. **Channel separation:** 30 db, 50 to 2,000 cps; 25 db @ 10 KC. **IF KC suppression:** 50 db down, from output @ 1 KC. **30 KC suppression:** 45 db down, from output @ 1 KC. **SCA rejection:** 30 db. **AM: tuning range:** 535 to 1620 KC. **IF frequency:** 455 kc. **Sensitivity:** 1400 KC, 3.5 uv; 1000 KC, 5 uv; 500 KC, 10 uv—standard IRE dummy antenna. **Bandwidth:** 8 KC @ 6 db down. **Image rejection:** 30 db @ 800 KC. **IF rejection:** 45 db @ 800 KC. **Harmonic distortion:** Less than 1%. **Overall dimensions:** 17" L x 5½" H x 14¾" D.



HEATHKIT-1964

NEW! FREE 1964 HEATHKIT CATALOG. See the latest new products in Heathkit's wide, wonderful line. Over 250 do-it-yourself kits for stereo/hi-fi, marine, TV, electronic organs, amateur radio, test instruments, educational, and home and hobby items that will save you up to 50%. Send for your free copy today!



HEATH COMPANY Benton Harbor 40 Michigan 49023

- Enclosed is \$195.00, plus postage. Please send Model No. AR-13.
- Please send Free Copy of New 1964 Catalog.

Name _____

Address _____

City _____ State _____

and the Schumann—long a Szell specialty—was the most satisfactory performance in the four-disc Epic package containing all four of the composer's symphonies.

The recorded sound has just the right proportion of body, detail, and depth. All told, this is one of the finest of Szell's substantial number of fine discs from Cleveland. *D. H.*

RECORDING OF SPECIAL MERIT

© ① **BEETHOVEN: *Violin Concerto, in D Major, Op. 61.*** Jascha Heifetz (violin); Boston Symphony Orchestra,

Charles Munch cond. RCA Victor LSC 1992 \$5.98, LM 1992* \$4.98.

Interest: Violin touchstone
Performance: Flawless
Recording: Still very good
Stereo Quality: Good

Reissued in de luxe format with a special biographical brochure by Samuel Chotzinoff and a complete discography of the Heifetz recordings currently available, this 1956 recording of the Beethoven Concerto shows that the old master need defer to no one—not to Oistrakh in technique nor to Menuhin in musicianship

—in the interpretation of this, the most beautiful of all violin concertos.

Heifetz is more than usually selfless and communicative in this reading, and this may stem in part from the fact that Charles Munch was himself a first-rate violinist before embarking on a conductorial career in the 1930's. Whether or not this is the reason, the effect of the performance is that of an exquisite chamber-music collaboration, comparable in caliber to that of the acclaimed Cortot-Thibaud-Casals Beethoven trio now to be heard on Angel's Great Recordings of the Century series. It makes for great Beethoven and wonderfully satisfying listening, an experience enhanced to a considerable extent by clear, clean, and unexaggerated sonics. *D. H.*

© ① **BRAHMS: *Violin Concerto, in D Major, Op. 77.*** Zino Francescatti (violin); New York Philharmonic, Leonard Bernstein cond. COLUMBIA MS 6471 \$5.98, ML 5871 \$4.98.

RECORDING OF SPECIAL MERIT

© ① **BRAHMS: *Violin Concerto, in D Major, Op. 77.*** Jascha Heifetz (violin); Chicago Symphony Orchestra, Fritz Reiner cond. RCA VICTOR LSC 1903 \$5.98, LM 1903* \$4.98.

Interest: Violin staple
Performance: Studies in integration
Recording: Both good
Stereo Quality: Okay

In a work such as the Brahms Violin Concerto, in which soloist and orchestra function as symphonic partners rather than as virtuoso and accompanist, the matter of tonal matching assumes an added degree of importance. On this point the Francescatti-Bernstein collaboration founders. Both take a big, ultradynamic view of this concerto, but the tonal expressions of their individual views mesh poorly if at all: Francescatti's quicksilver agility and white-hot intensity against Bernstein's weighty lushness and rhythmic dynamism. I found the aural result discomfiting in the extreme, and wonder why Columbia did not tap Szell and the Cleveland Orchestra as more apt foils for Francescatti. The 1955 Heifetz-Reiner-Chicago Symphony recording, now reissued by RCA Victor in the same de luxe format as the artist's Beethoven concerto disc, comes along as if for corroboration. For this performance stands as a flawless dovetailing of soloist and orchestra, in tonal quality and musical conception alike. Though Heifetz does not strive for the epic heights of Oistrakh (Angel) or Szigeti (Mercury), he and Reiner bring off a superb lyrical realization. The decade-old recording still stands up well, too. *D. H.*

(Continued on page 78)



GIVE THE GIFT OF GREAT MUSIC

The new phenomenal Russian artist.

YAKOV FLIERE
playing:

KABALEVSKY — Twenty-four Preludes — **MK 1530**

CHOPIN—Piano Recital—"Funeral March" Sonata/Mazurkas—**MK 1549**

exclusively on the MK Label

ORFF: Carmina Burana—Czech Singers Choir; Czech Philharmonic Orchestra, Vaclav Smetacek, Conductor. **PLP 161/PLPS 161**

SHOSTAKOVICH: Symphony #5 — Czech Philharmonic Orchestra, Karl Ančerl, Conductor. **PLP 168/PLPS 168**

SCHUBERT: Symphony #9 "The Great"—Czech Philharmonic Orchestra, Konwitschny, Conductor. **PLP 173/PLPS 173**

VERDI: Requiem—Vishnevskaya, Isakova, Ivanovsky, Petrov, The State Academic Chorus; Moscow Philharmonic Orchestra, Igor Markevitch, Conductor. **PLP 154/PLPS 154**

SZYMANOWSKI: Violin Concerto #1; **MOZART:** Violin Concerto #3. David Oistrakh. **ALP 156**

BACH: Violin Concerto #1; **MOZART:** Sinfonia Concertante, K.364. Oistrakh and Barshai. **ALP 165**

BARTOK: Piano Concerto #3; Concerto for Viola & Orchestra; Eva Bernathova, Karlovsky, Czech Philharmonic Orchestra, Ančerl, Conductor. **ALP 199/ALS 7199**

DVORAK: The Wood Dove; The Golden Spinning Wheel, Czech Philharmonic Orchestra, Chalabala, Conductor. **ALP 200/ALS 7200**

DVORAK: The Water Sprite; The Midday Witch, Czech Philharmonic Orchestra, Chalabala, Conductor. **ALP 201/ALS 7201**

PROKOFIEV: Alexander Nevsky, Vera Soukupova, Czech Singers Choir, Czech Philharmonic Orchestra, Ančerl, Conductor. **ALP 202/ALS 7202**

MARTINU: Field Mass; **JANACEK:** Amarus, **SUA 10387**

JOSEF FIDELMAN PLAYS: Beethoven-Sonata Appassionata; Chopin—Etudes & Ballade in F Minor. **UR 8031/US 58031***



CONNOISSEUR RECORD CORP.

*URANIA SALES CORPORATION

160 PASSAIC AVENUE, KEARNY, NEW JERSEY
CIRCLE NO. 21 ON READER SERVICE CARD

SOLID-STATE STEREO

BY HEATHKIT



NEW! Low-Cost All-Transistor, All Mode Stereo Tuner and Matching 40-Watt Stereo Amplifier

Cooler, faster operation . . . lower power consumption . . . longer life . . . and the clean, quick realism of "transistor sound." You'll enjoy all this and more with Heathkit's newest All-Transistor Stereo "Twins." Compact, low-silhouette styling magnificently fashioned in rich walnut cabinets neatly fits this handsome pair into a "proud place" in any hi-fi stereo system. Add to this extruded brushed gold-anodized aluminum front panels that serve practically to conceal secondary controls and decoratively to enhance over-all beauty. The AA-22 Amplifier provides 40 watts of continuous power at ± 1 db from 15 to 30,000 cps with no fading, no faltering . . . just pure solid sound! The AJ-33 Tuner offers selection of AM, FM, or FM Stereo to please any listening preference. Check both unit's features and discover why Heathkit leads in Transistor Stereo. The price? A great value, you'll agree . . . \$99.95 each!

AA-22 40-watt Transistor Stereo Amplifier, 14 lbs. \$10 mo. \$99.95

AJ-33 Transistor AM-FM-FM Stereo Tuner, 14 lbs. \$10 mo. \$99.95

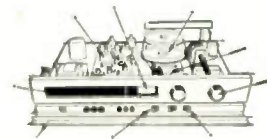
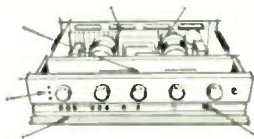

- 40 watts of power (20 per channel)
- 5 stereo inputs
- Speaker phase switch
- Miniature Indicator light for each position on mode switch
- Transformerless output circuits
- Brushed gold-anodized aluminum front panel conceals secondary controls
- Walnut cabinetry

- Stereo phase control
- Automatic stereo indicator
- AFC and AGC
- Filtered stereo tape recorder outputs
- Built-in stereo demodulator
- Tuning meter
- Flywheel tuning
- Slide-rule dial
- Prealigned FM tuner and circuit board construction
- Brushed gold-anodized aluminum front panel conceals secondary controls
- Walnut cabinet



HEATHKIT-1964



NEW! FREE 1964 HEATHKIT CATALOG

See the latest new products in Heathkit's wide, wonderful line. Over 250 do-it-yourself kits for stereo/hi-fi, marine, TV, electronic organs, amateur radio, test instruments, educational, and home and hobby items that will save you up to 50%. Send for your free copy today!

HEATH COMPANY Benton Harbor 40 Michigan 49023

Enclosed is \$ _____, plus postage. Please send model No. _____

Please send Free Copy of New 1964 Catalog.

Name _____

Address _____

City _____ State _____

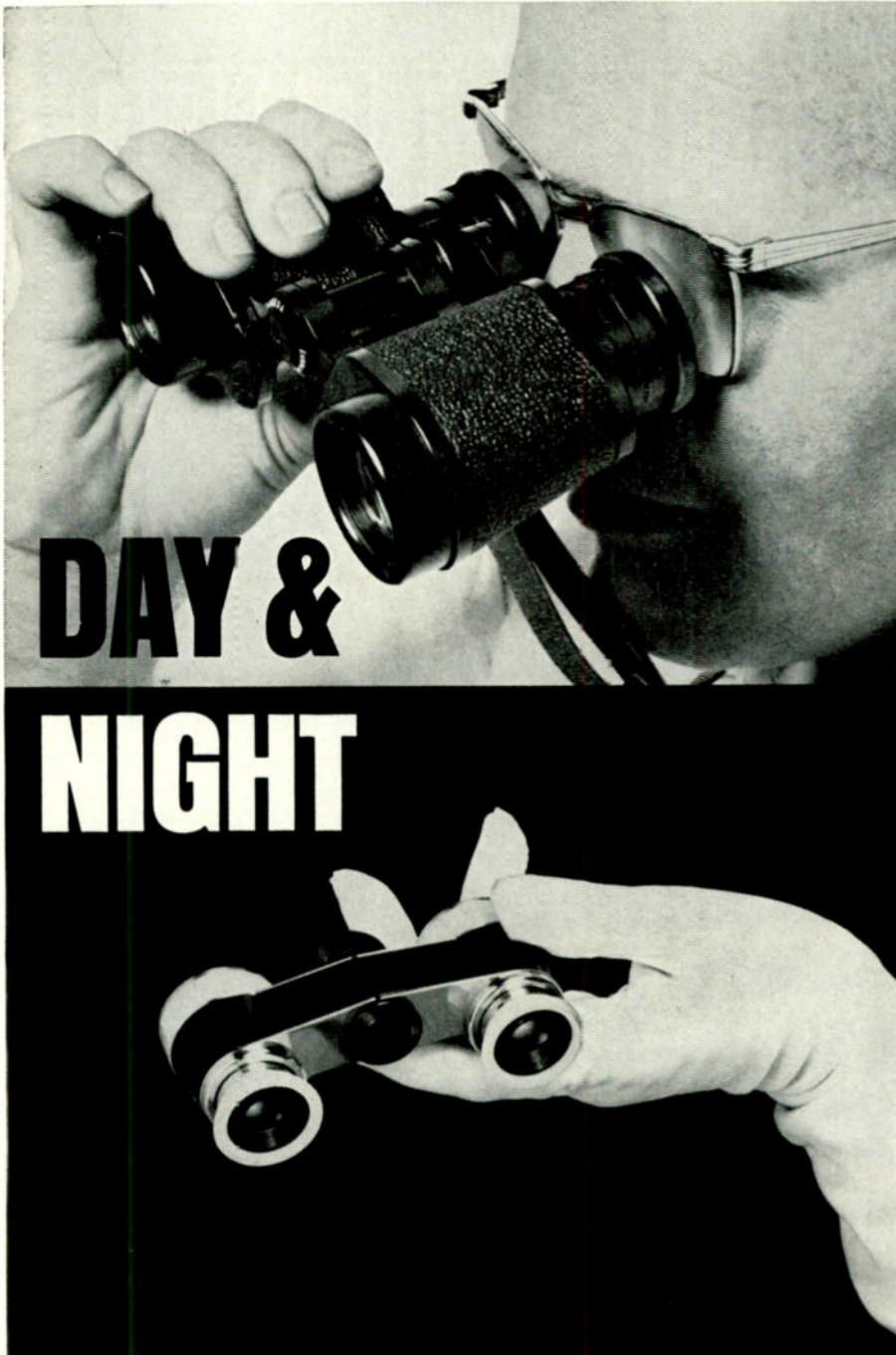

Zeiss binoculars love the active life

Daypeople . . . Daytime's more dynamic with a new Zeiss "B" type binocular, especially designed for use *with or without* eyeglasses or sunglasses. At rallies, regattas and races, only these remarkable binoculars give you the same wide field of vision—with your glasses on or off—bright, sharp focus right to the edges. A light-weight binocular superbly engineered for action. **Nightpeople** . . . Night-time's more glamorous with an elegant Hensoldt Diadem theatre glass. Bright lights or dim, it enhances the evening's performance by giving you a close, clear and crisply-detailed view of what's happening on stage. Choose from luxury combinations of mother-of-pearl, silver, gold, or other colorful tones to dramatically complement the most alluring ensemble. **Give the gift of a lifetime** . . . These are just 2 out of 27 high quality Zeiss and Hensoldt binoculars available at leading photo and sports dealers. We invite you to write Dept. 26 for a free copy of our booklet: "How to Select the Right Binocular."

CARL ZEISS, INC.

444 Fifth Avenue, New York 18, New York
 IN CANADA: CARL ZEISS CANADA LTD., 80 OVERLEA BLVD., TORONTO 12, ONTARIO



The Great Name in Optics

CIRCLE NO. 80 ON READER SERVICE CARD

© ① BRUCKNER: *Mass No. 3, in F Minor*. Maria Stader (soprano), Claudia Hellman (alto), Ernst Haefliger (tenor), Kim Borg (bass); Anton Nowakowski (organ), Kurt Prestel (choirmaster); Chorus and Orchestra of the Bavarian Radio, Eugen Jochum cond. DEUTSCHE GRAMMOPHON SLPM 138829 \$6.98, LPM 18829* \$5.98.

Interest: Late Romantic mysticism
 Performance: A la mode
 Recording: Spacious
 Stereo Quality: Helpful

Anton Bruckner's Mass in F Minor—the so-called "Great" Mass—is the last of three such works in the composer's catalog. This admirable recording of the work should constitute a large boon to the perfect Brucknerite, while those who can take the composer or leave him would do well to proceed with caution.

For this mass is, in many ways, archetypical Bruckner: unyieldingly solemn, almost grotesquely Germanic in its heavily cosmic expressive intent. For all of Bruckner's celebrated personal humility and piety, he was not one to balk at the most metaphysical of musical intentions. Frankly, at its worst, this makes me squirm, for the composer seems to me far more eager to impress us, through his music, with his own religiousness than he is to invoke such feelings in his listeners. I do not like to hear a man proclaim his own piety—and at length.

The performance is admirable, although there is some sogginess of rhythm dogging the more animated contrapuntal passages. There is also some smudging of polyphonic vocal parts. But this could very well be a shortcoming of DGG's otherwise estimable recorded sound. The soloists, by the way—Maria Stader in particular—do some uncommonly impressive work in their finer moments.

W. F.

RECORDING OF SPECIAL MERIT

© ① CARTER: *Eight Etudes and a Fantasy for Woodwind Quartet (1950)*. SCHULLER: *Woodwind Quintet (1958)*. FINE: *Partita for Wind Quintet*. New York Woodwind Quintet. CONCERT-DISC CS 229 \$5.98, 1229 \$5.98.

Interest: American music, grade A
 Performance: A joy
 Recording: Clean and bright
 Stereo Quality: Helpful

I state my enthusiasm for this record of American chamber music without reservation. The pieces are elegant and sophisticated, and the playing is dedicated, crisply intelligent, effortlessly expressive.

Although Gunther Schuller's work is consistently absorbing in both continuity

(Continued on page 80)

HIFI/STEREO REVIEW

SOLID-STATE STEREO

BY HEATHKIT®



New! Deluxe All-Transistor, All-Mode Stereo Tuner & Matching 70-Watt Amplifier

Instantaneous bursts of power as the music demands...clean, uncompromising "solid" sound...cooler, faster, "hum-free" operation...this is the exciting performance of Heathkit's new deluxe all-transistor twosome. Add luxurious deluxe styling, plenty of deluxe features, plus "Heath-Engineered" quality, and you have the neatest, most advanced tuner and amplifier in the industry today! You'll enjoy deluxe extras like the unique "push-to-turn-off/on" switch, the concealed secondary controls to prevent accidental system changes, the automatic switch-to-stereo feature of the tuner, and the prebuilt, prewired encapsulated component modules in the amplifier for quick, easy assembly. You'll enjoy high fidelity AM-FM-FM Stereo reception, plus a full 70 watts of continuous power, 100 watts music power at all frequencies from 13 to 25,000 cps. You'll enjoy handsome matched tan, vinyl-clad steel cabinet styling with polished aluminum trim and soft refracted lighting...complements any decor! Both units are easy to build...easy to own! These are reasons you should move up to this all-transistor twosome from Heathkit now!

Kit AJ-43, Tuner, 18 lbs., no money dn., \$11 mo.....\$119.95
 Kit AA-21, Amplifier, 29 lbs., no money dn., \$13 mo.....\$139.95

AJ-43 All-Mode All-Transistor Stereo Tuner, 18 lbs., \$11 mo.....\$119.95

AA-21 70-Watt All-Transistor Stereo Amplifier, 29 lbs., \$13 mo.....\$139.95

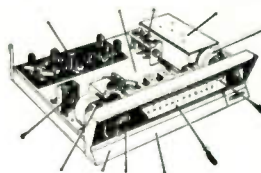

THE LATEST IN FEATURES

- 25 transistors, 9 diodes • Built-in circuitry • Automatic Stereo Indicator • Automatic Stereo switching to eliminate manual switching to receive stereo • Built-in Automatic Frequency Control and Automatic Gain Control • Adjustable FM squelch • Stereo phase control • Filtered stereo tape recorder • Built-in AM & FM antennas • Separate AM & FM tuning meters • Lighted slide-rule dial • Flywheel tuning • Regulated power supply • Factory assembled FM tuning unit and 4-stage IF circuit board • Concealed controls behind hinged lower front panel.

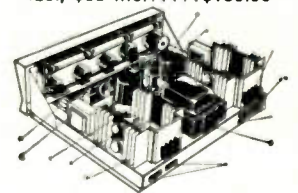

THE LATEST IN FEATURES

- Eight Germanium Power Output Transistors mounted on four finned heat sinks • Output circuit breakers • Power amplifier circuit boards containing four transistors and six diodes • Two driver transformers • Two preamplifier circuit boards contain six epoxy-sealed component modules and ten transistors • Two Germanium driver transistors plus two electronic filter transistors • Filter condensers and four power supply diodes • Output terminal boards • Input jacks • Tape recorder output • Power transformer • AC outlets.



HEATH COMPANY, Benton Harbor 40, Michigan 49023

Enclosed is \$ _____, plus postage. Please send Model No. _____

Please send FREE copy of New 1964 Catalog.

Name _____

Address _____

City _____ State _____ Zip No. _____



NEW! FREE 1964 HEATHKIT CATALOG
 See the newest products in Heathkit's wide exciting line. Over 250 do-it-yourself kits for stereo/hi-fi, marine, TV, electronic organ, amateur radio, test instruments, educational and home & hobby items that will save you up to 50%. Send for your free copy today!

Never before,
such a portable
as this!



The KLH Model Eleven
Stereophonic Phonograph



\$199.00

The world's first *re-pectable* portable — a system of fine components designed into a sophisticated 28 pound package of breathtaking performance, featuring a pair of KLH's revolutionary new full-range, long-excursion speakers. See and hear it (and ask about the unique 5 year guarantee) at your franchised KLH dealer's. Or write us for literature.



KLH RESEARCH AND DEVELOPMENT CORPORATION
30 CROSS STREET, CAMBRIDGE 38, MASSACHUSETTS

CIRCLE NO. 48 ON READER SERVICE CARD

The collector's pipe... Heritage

What makes a pipe outstanding? Aged, imported briar? Painstaking hand work — or its mild, cool, smoking qualities? No matter the measure — you'll find Heritage distinguished by all of these. Only \$10.50 in rugged Antique finish; \$13.50 in smooth Heirloom finish. Our new illustrated brochure is yours for the asking.

Swan Pipes & Co.

TOBACCONISTS SINCE 1857
133 SOUTH WABASH AVENUE, CHICAGO 3, ILLINOIS

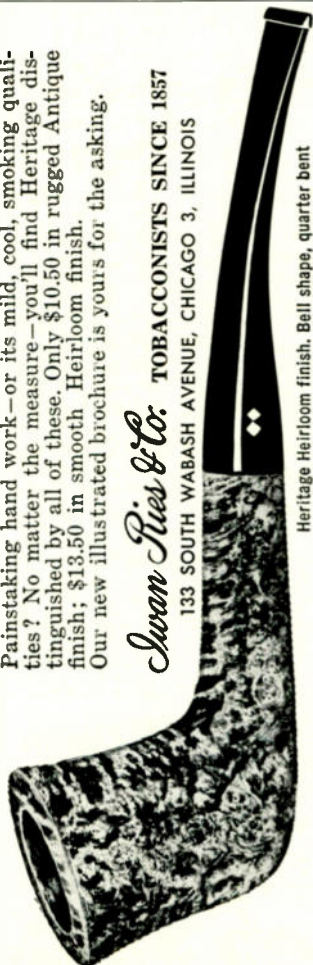

Heritage Heirloom finish. Bell shape, quarter bent

CIRCLE NO. 62 ON READER SERVICE CARD

and musical detail, the Carter and Fine pieces—in quite entirely different ways—steal the show. Elliott Carter is that rare composer of avowedly “intellectual” or “cerebral” music who does not bore us to death with his preoccupations. Musical device, compositional technique, and the posing of a problem are the drama of music for Carter; and in posing and solving and challenging, Carter projects a cool, intellectual passion that is just as tangible as the more subjective emotionalizing in the music of a Tchaikovsky or a Wagner. Experience the play of detail and the constant intellectual animation of this woodwind work, and you will share my enthusiasm for this man's music.

Irving Fine, who died recently and tragically while still in his forties, was a composer of great skill, unusual poise, and high sensitivity. His enthusiasms are apparent enough in his partita: Stravinsky's neoclassicism has made its mark on the work, and one can also see that Copland's music meant a great deal to Fine. But the special tenderness, the gentleness of Fine's expression is unique to him. This partita is touching, songful, and awfully good.

The performances of the New York Woodwind Quintet are definitions, by themselves, of the best instrumental professionalism and musicianship to be found today. The recording is excellently adapted to the material at hand. *W. F.*

Malcuzyński copes with this particular problem in Chopin's sonatas as effectively as I have ever heard it done. He imposes contrast on the musical shapes by (for example) minimizing technical brilliance where another pianist might be tempted to make the most of it. Even more cogently, at no point does he allow momentary possibilities for lyrical flight to obscure the formal function of the given thematic member.

The result is musical discourse that is remarkably convincing as extended statement. True, there is a loss of the sort

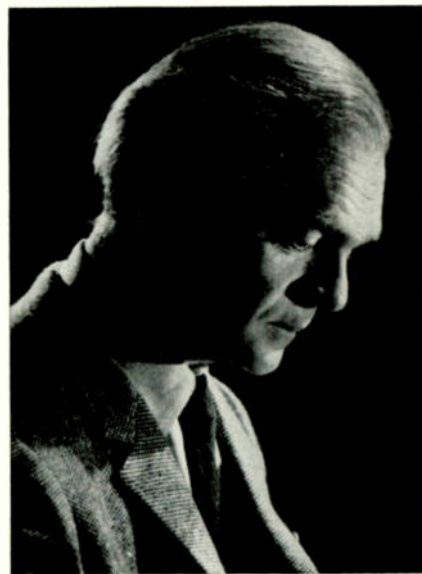

ANGEL RECORDS

WITOLD MALCUZYŃSKI

Rewarding and original Chopin playing

RECORDING OF SPECIAL MERIT

© ● CHOPIN: *Sonata No. 2, in B-flat Minor; Sonata No. 3, in B Minor, Op. 58.* Witold Malcuzyński (piano). ANGEL S 36122 \$5.98, 36122* \$4.98.

Interest: Thoughtful Chopin
Performance: Adroit
Recording: Subdued
Stereo Quality: Okay

of high excitement that a Rubinstein can bring to the moment. But the results are on the whole rewarding and—not the least of it—original.

The recorded sound is good but perhaps more consistently muted than might have been ideal. *W. F.*

RECORDING OF SPECIAL MERIT

© ● DVOŘÁK: *Quintet, in A, Op. 81.* SCHUBERT: *Quartettsatz, in C Minor, D. 703.* Vienna Philharmonic Quartet; Clifford Curzon (piano). LONDON CS 6357 \$5.98, CM 9357* \$4.98.

Interest: Dvořák lyricism
Performance: Warm and lucid
Recording: First-rate
Stereo Quality: Good

Malcuzyński's achievement here is a thoroughly impressive one and, in certain aspects, a brilliant one. For Chopin's sonatas present real problems in performance, problems that cannot be solved simply by “beautiful” playing. The problems are, of course, structural. One hears it said that the “inspiration” in these works is “uneven” or that Chopin, being a Romantic and all that, just wasn't very good at what the theory teachers call “form.”

The first of these charges is the exact opposite of the truth, of course. And the second one is nonsense: Chopin had all the required skills of manipulation and metamorphosis. What he lacked was either the will or the ability to be canily ordinary. Each bar, each musical event is conceived for maximum expressive effect and musical interest. Ultimately, contrast is difficult, and the music begins to cancel itself out.

There have been signs in the American music world of a revival—or more accurately, perhaps, a rediscovery—of the chamber music of Antonin Dvořák. Just listen to this wondrously affectionate reading of the Quintet in A, and you will see the justice of this renewed interest. For this work is purely and simply a masterpiece.

Curzon and his colleagues have lav-
(Continued on page 82)

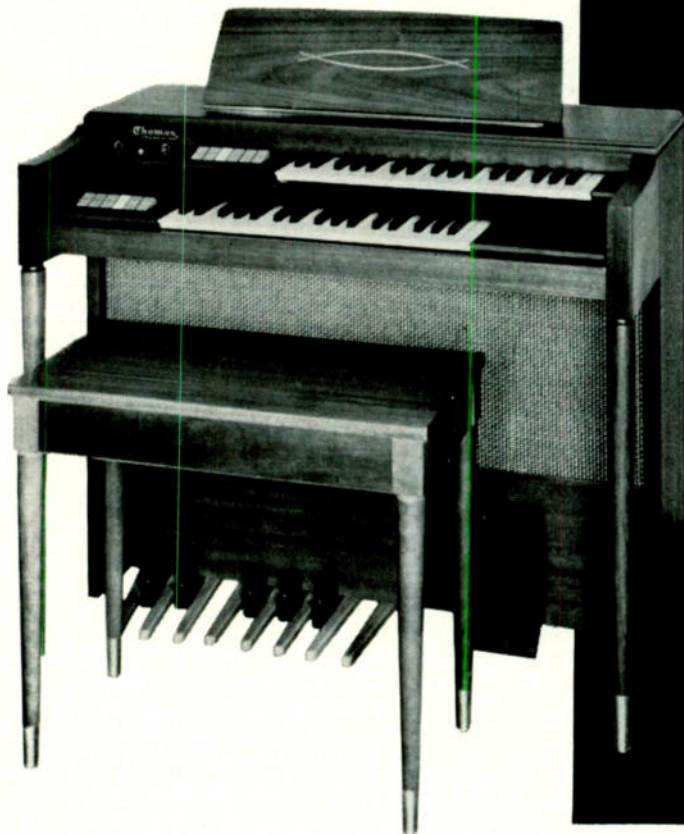

Who says you can't afford an organ this Christmas?

**This New Feature-Packed 1964 Model Of The HEATHKIT
2 Keyboard "Transistor" Organ Costs Just \$349.95 ...
AND YOU CAN BUILD IT!**



What a delightful surprise on Christmas morning! And there's endless hours of fun, relaxation, education and achievement ahead for the whole family with Heathkit's 1964 version of the famous Thomas Organ. You'll be saving big money too, by easily building it yourself! No experience necessary! And you're assured long, faithful performance with the full 5-year warranty on tone generators. Can't play a note? Learn quickly and easily with a complete 48-lesson self-teacher course on 4 LP records (GDA-232-2) that's valued at \$50 . . . it's yours for only \$19.95! Like to hear it perform? Send 50c to the address below, and ask for demonstration record GDA-232-5. Plan now to give your family the exciting dimension of live music with the 1964 Heathkit Electronic Organ this Christmas!

Kit GD-232R, Organ, 160 lbs., no money dn., \$23 mo. \$349.95
GDA-232-1, Matching walnut bench, 16 lbs., no money dn., \$5 mo. \$24.95

Attention Heathkit Organ Owners! Add Variable Repeat Percussion to your Heathkit Organ with the easy-to-install kit.

GDA-232-4, 1 lb. only \$9.95

**COMPARE THESE FEATURES
WITH UNITS COSTING
TWICE AS MUCH!**

* **10 True Organ Voices;** Trombone, Reed, Flute, Oboe, Cornet, Violin, Saxophone, Horn, Viola, Diapason * **New! Variable Repeat Percussion;** produces effects of banjo, marimba, mandolin, balalaika, etc. * **Variable Bass Pedal Volume Control** * **Manual Balance Control;** adjusts volume of keyboards in any degree for solo work * **Variable Vibrato** * **Standard Expression Pedal;** adjusts volume from soft to full * **13-Note Heel & Toe Bass Pedals** * **Two Over-Hanging Keyboards;** each with 37 notes, range C thru C * **Beautiful Walnut Cabinet;** modern styling, hand-rubbed, hand-crafted * **20-Watt Peak-Power Amplifier & Speaker** * **Compact Size;** 34½" H x 39¼" W x 21½" D * **Transistorized;** for longer life, better tone, trouble-free operation.



HEATH COMPANY, Benton Harbor 40, Michigan 49023

Name _____ (please print)

Address _____

City _____ Zone _____ State _____

Enclosed is \$349.95, plus postage, please send my Heathkit Electronic Organ, model no. GD-232R.

Enclosed is \$24.95, plus postage, please send matching walnut bench, model no. GDA-232-1.

Please send my free copy of the new 1964 catalog.

HEATHKIT-1964

NEW! FREE 1964 HEATHKIT CATALOG
 See all the latest products in Heathkit's exciting line. Over 250 do-it-yourself electronic kits in all . . . by far the world's largest line! There's something for every interest . . . stereo/hi-fi . . . marine . . . amateur radio . . . test and lab . . . television . . . home . . . and hobby. Send for your free copy today, and learn how you can save up to 50%.



the
deep
deep
feeling
you
get
from
Christmas
music

... yours
from Mercury

Look for this
Mercury
Christmas
display at
your dealer!



SOUNDS OF CHRISTMAS—Johnny Mathis; MG20837†, SR60837*
 CHRISTMAS WITH THE PLATTERS—MG20841†, SR60841*
 THE NUTCRACKER BALLET (Tchaikovsky)—London Symphony,
 Antal Dorati; OL2-113†, SR29013*
 THE MAGIC OF THE BELLS—Kamiel Lefèvre, carillonneur;
 MG50189†, SR90189*
 THE WONDERFUL SONGS OF CHRISTMAS—Harry Simeone
 Chorale; MG20820†, SR60820*



*SR—stereo †MG & OL—monaural

ished the care and affection on this work that it so clearly merits, just as they have on Schubert's far more celebrated *Quartetsatz*—the one-movement remnant of an unfinished work. It is no denigration of the Schubert piece to observe that the Dvořák work matches it all the way for sheer enchantment of melodic invention.

The performances are ideal, and the recording could not be improved. *W. F.*

RECORDING OF SPECIAL MERIT

Ⓢ Ⓜ ELGAR: *Enigma Variations; Cockaigne Overture*. Philharmonia Orchestra, Sir John Barbirolli cond. ANGEL S 35120 \$5.98, 35120* \$4.98.

Interest: Elgor's integrity
 Performance: Loving
 Recording: Mellow
 Stereo Quality: Appropriate

Sir John Barbirolli brings something very special to his performances of both Ralph Vaughan Williams and Edward Elgar. Scrupulous observation of the composer's indicated intention is, of course, an important facet of Barbirolli's characteristic success; and he is nothing if not a careful, painstaking technician.

But these qualities cannot alone account for the warmth and dignity that pervade his recent recording of Vaughan Williams' Fifth Symphony and, now, his glowing account of Elgar's *Enigma Variations*. For one senses that, in the most uncommon way, Barbirolli's success with this music springs from the validity of his assessment of its value. It is hard to come by a British conductor who does not, for example, confuse Elgar with Brahms, in both manner and worth. Barbirolli not only acknowledges the distinction but, in this performance of the *Variations*, proceeds to demonstrate it. Barbirolli's Elgar is a composer of sensibility, integrity, and utter candor; a winning modesty dwells just beneath the showy, even pompous façade of certain aspects of his work. In short, Barbirolli's Elgar is a pleasure to meet.

Angel's recording of the *Variations*, along with the boisterously entertaining *Cockaigne Overture*, is absolutely first-class—spacious and mellow yet clean in detail. *W. F.*

FINE: *Partita for Wind Quintet* (see CARTER).

Ⓢ Ⓜ FRANÇAIX: *Quintet for Winds*. TAFFANEL: *Quintet for Winds*. New York Woodwind Quintet. EVEREST SDBR 3080 \$5.98, LPBR 6080* \$4.98.

Interest: Breezy winds
 Performance: Elegant
 Recording: Okay
 Stereo Quality: Good

(Continued on page 84)

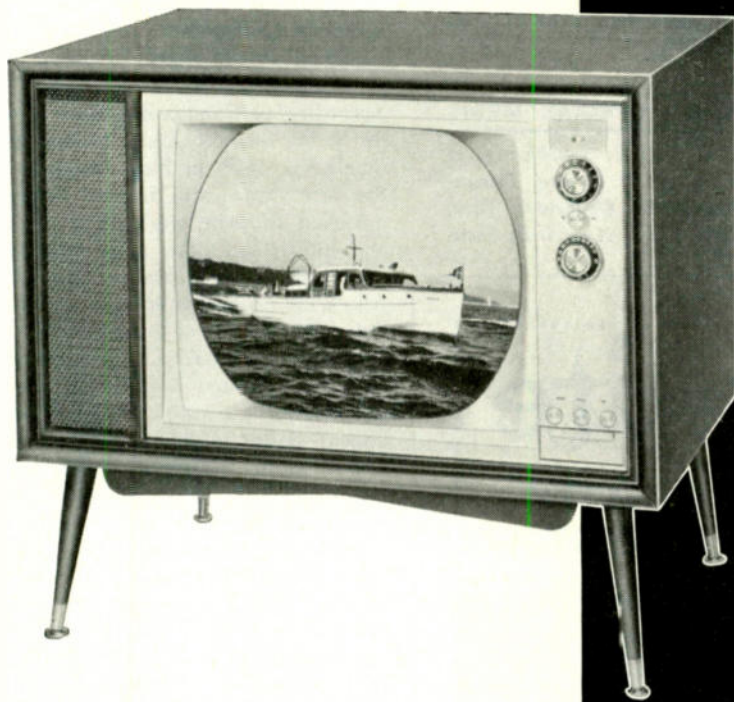

**Who says
you can't
afford
Color TV?**

**You Can With This New Heathkit
High Fidelity 21" Color TV Kit For As Little As \$349⁰⁰**

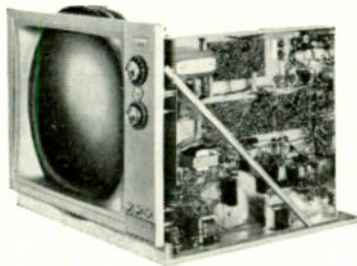

- 27 tube, 8 diode circuit with optional UHF • High definition RCA 70° 21" color tube with anti-glare, bonded face safety glass
- Built-in dot generator for initial set-up adjustments
- All critical circuits factory-built and tested • Au-

tomatic Color Control • Gated Automatic Gain Control for peak performance • Hi-Fi sound with outputs for speaker and hi-fi amp • 24,000 volt regulated picture power • Deluxe Nuvistor tuner with "push-to-tune" fine tuning for individual channels • 3-stage high gain video I.F. • Line thermistor for longer tube life and thermal circuit breaker for component protection • Can be custom mounted or installed in handsome walnut cabinet • Degaussing coil for demagnetising picture tube

The sharpest, clearest high fidelity picture and sound, plus the latest advanced Color TV circuitry possible in the industry today! Unmatched savings . . . compare it with sets costing \$600! Easy to build . . . from parts to picture in just 25 hours and no experience needed! These are the reasons why you'll be wise to choose the new Heathkit 21" Color TV.

- Kit GR-53, Chassis & all tubes, 118 lbs., \$23 mo. \$349.00**
- GRA-53-1, Walnut-finish cabinet, 70 lbs., \$5 mo. \$49.00**
- UHF Tuner, GRA-53-2, 3 lbs. . . \$20.00**



HEATHKIT-1964

SEND FOR FREE 1964 HEATHKIT CATALOG
Gives full description and specifications of units above, plus 245 others in Test, Amateur Radio, Hi-Fi, Marine, Educational and General Hobby fields of interest. Send for your free copy today and get the complete story on money-saving Heathkits.

HEATH COMPANY, Benton Harbor 40, Mich. 49023

- Please enter my order for a Heathkit Color TV Kit subject to conditions below*
- Please send FREE copy of 1964 Heathkit Catalog.

Name _____
Address _____
City _____ State _____

*Delivery Limited by tube availability send no money until we confirm shipping date. Orders processed in sequence of receipt. CL-164

You will search long and far for wind-ensemble playing to surpass the work on this disc. True, the music is not absolutely first-class: Françaix, in his studied avoidance of profundity, plays his usual game of musical brinkmanship, time and again approaching but just drawing back from banality. Taffanel, similarly, is no great master; he was famed during his lifetime (1844-1908) as a great flutist and conductor, and his music is rather more remarkable for its instrumental style than for its quality.

Still, it's all very listenable, and it gives the New York Woodwind Quintet an occasion for some extraordinarily

beautiful playing. Samuel Baron's flute work in the Taffanel is, as a matter of fact, worth the price of the record by itself.

The recording is good. I could imagine a more brilliant and vivid sonic quality for this particularly brilliant disc, but what has been achieved is more than merely satisfactory. *W. F.*

RECORDING OF SPECIAL MERIT

© ® GOTTSCHALK: *Symphony: A Night in the Tropics; Grand Tarantelle for Piano and Orchestra (arr. Kay)*. GOULD: *Latin American Sym-*

phonette. Reid Nibley (piano); Utah Symphony Orchestra, Maurice Abravanel cond. VANGUARD VSD 2141 \$5.95, VRS 1103* \$4.98.

Interest: The Gottschalk charm
Performance: Vivacious
Recording: Excellent
Stereo Quality: Good

According to Vanguard's sleeve annotator S. W. Bennett, Louis Moreau Gottschalk (b. 1829 in New Orleans) was the first "classically trained American musician to write works that are alive and interesting today quite apart from their historical significance." As a Gottschalk fan of long standing, I see no reason whatever to take issue with this opinion. At the same time, however, it should be pointed out that it is as impossible for the initiate to explain the appeal of this music to the nonbeliever as it is for the theatergoer to explain the magic of Miss Ethel Merman to the spectator who finds in her style only corn, brass, and vulgarity.

For Gottschalk's music is, heaven only knows, corny. The unswerving sentimentality of the long melody that dominates the Andante of *A Night in the Tropics* is mitigated only by its candor, its curious objectivity, and its utter musicality. But when the composer sails into one of his more characteristic dance sections—and there is no more lively a demonstration than the second movement of this same work—I am personally disarmed of all criticism. Perhaps this music casts its spell only in the context of the tortured, anxious musical practice of our own era. For there is joy in Gottschalk's work—a joy that seems born of the sheer pleasure to be had from the very act of writing music.

Abravanel's reading of the work seems just right. He does not patronize the music by taking special note of its innocence. At the same time, he recognizes that the successful performance of this material rests in directness and understatement. The *Grand Tarantelle* for piano and orchestra—a sly, tricky bit of keyboard virtuosity—is a welcome Gottschalk encore, smoothly played by pianist Reid Nibley. Morton Gould's *Latin American Symphonette*, a contemporary effort at musical entertainment, seems glib and mechanical in the company of Gottschalk's breezy spontaneity.

The recorded sound is fine, the release—taken in sum—another handsome addition to the Utah Symphony's growing list of distinguished recordings. *W. F.*

GOULD: *Latin American Symphonette* (see GOTTSCHALK).

® HAYDN: *Trio, in E Major, for Violin, Cello, and Piano*. KHACHATUR-
(Continued on page 86)

reproduction so good
... from an enclosure so small
... it's almost unbelievable

Petite

HIGH FIDELITY SPEAKER SYSTEM



USE ANYWHERE



Performance of the Petite is unmatched by any enclosure close to its 18" x 12" x 3¾" size. Bass notes come through rich and resonant . . . highs clean and brilliant. The secret? Argos system-engineered techniques . . . techniques which precisely coordinate the enclosure with the moving system of two Jensen speakers custom-made to Argos specifications. Trim design and beautiful hand-rubbed ¾" oiled American walnut veneer cabinetry make the Petite a distinctive addition to any room setting. Graceful solid brass legs, plus wall hangers, make your Petite useable anywhere . . . shelf, table, wall or floor. See it at your hi-fi store, or write direct for descriptive catalog.

Price \$24.95

ADDITIONAL FEATURES

- Speakers include: custom-designed Jensen high-compliance woofer with 200% more cone travel, and Jensen tweeter with matching network
- Frequency range, 50 to 17,000 cps.
- 8-ohm input
- Screw terminals polarized for stereo
- Volume control recessed into side of cabinet.

Argos

PRODUCTS COMPANY

Dept. F, Genoa, Illinois

MORE CLASSICAL REVIEWS IN BRIEF

DATA

⑤ ⑥ **DUBOIS:** *Seven Last Words of Christ*. Winifred Dettore (soprano), Wayne Connor (tenor), Marshall Heinbaugh (baritone); Philadelphia Oratorio Choir, Earl Ness cond. RITTENHOUSE RS 1002 \$5.98, 1001* \$4.98.

⑤ **GERSHWIN:** *Rhapsody in Blue; Piano Concerto in F; An American in Paris*. Oscar Levant (piano); Philadelphia Orchestra, Eugene Ormandy cond. New York Philharmonic, André Kostelanetz, Artur Rodzinski cond. COLUMBIA CS 8641 \$5.98.

⑥ **GOEB:** *Symphony No. 1*. Japan Philharmonic, Akeo Watanabe cond. **DRUCKMAN:** *Dark upon the Harp*. Jan de Gaetani (mezzo-soprano), New York Brass Quintet. COMPOSERS RECORDINGS INC. CRI 167 \$5.95.

⑥ **HINDEMITH:** *Concerto for Violin and Orchestra*. Ivry Gitlis (violin); Westfälisches Symphonieorchester, Hubert Reichert cond. *Concerto for Viola and Orchestra*. Gunther Breitenbach (viola); Wiener Symphoniker, Herbert Hafner cond. Vox PL 11980 \$4.98.

⑤ ⑥ **MONTEVERDI:** *Madrigali Guerrieri*. Charles Bressler and Herbert Handt (tenors), Chester Watson (bass); Aeterna Chamber Orchestra and Chorus, Frederic Waldman cond. DECCA DL 79417 \$5.98, DL 9417 \$4.98.

⑤ ⑥ **RIMSKY-KORSAKOV:** *Scheherazade, Op. 35*. Philadelphia Orchestra, Eugene Ormandy cond. COLUMBIA MS 6365 \$5.98, ML 5765 \$4.98.

⑤ ⑥ **SCHUBERT:** *Sonata No. 15, in C Major (Unfinished); 17 Deutsche Tänze: Nos. 1, 3, 4, 5; Moments musicaux, Op. 91: No. 3, in F Minor; Allegretto in C Minor*. Sviatoslav Richter (piano). MONITOR MCS 2057* \$4.98, MC 2057 \$4.98.

COMMENTARY

This is French Romantic religiosity in a Gounod-Massenet vein by the Paris Conservatoire director who was important in the 1905 Ravel scandal. The chorus is competent, the soloists sometimes wobbly, the sonics spacious. *D. H.*

The concerto recording dates from 1942, the other two from 1945, and all have done yeoman's work as CL 700 (mono). Levant's piano styling is crackling, but the sound is faded, and I could discern no so-called "stereo effect." Caveat emptor! *D. H.*

Goeb's symphony is surprisingly diatonic, yet no phraseturm is predictable, no chords make a progression that summons an outside stylistic influence. The work of Druckman, another American, is a bit pretentious, perhaps, but very effective. *W. F.*

Hindemith's Viola Concerto is one of his more inspired long instrumental compositions, and it was a good idea to back it with the infrequently heard Violin Concerto. But the performances are a mite snappish and graceless, and the recording is somewhat hard and severe in sound. *W. F.*

This performance uses a chorus and small orchestra, with a resulting lack of clarity in the part-writing. Noticeable, too, are a rigidity of rhythm and a generally mild and undramatic treatment. The solo singing is very agile. Good recorded sound. *I. K.*

The Philadelphia's *Scheherazade* is about what one would expect: a paragon of polished virtuosity and with it a certain heavy-handedness. The sound is very clean but dry. *D. H.*

Several hands tried completing the fragmentary final two movements of the C Major Sonata ("Reliquie"). Whose Richter plays is not specified. None of the interpretations displays the Schubertian command one might expect from this artist. *I. K.*

NEW!



16-WATT HEATHKIT STEREO AMPLIFIER . . . OPERATES WITH MAGNETIC PHONO-CARTRIDGES; DELIVERS FULL POWER WITHIN ± 1 DB FROM 30 TO 30,000 CPS; HAS FULL-RANGE CONTROLS, 4 STEREO INPUTS, 2 FOUR-STAGE PREAMPLIFIERS, 2 PUSH-PULL POWER OUTPUT STAGES; PLUS NEW MOCHA BROWN, BLACK & SILVER STYLING; AND IT COSTS JUST \$39.95! COMPARE AND ORDER NOW!

SPECIFICATIONS—Simultaneous power output per channel: 8 watts (16 watts total); IHFM music power output per channel; 10 watts (20 watts total). Frequency response: ±1 db from 30 cps to 30,000 cps at rated output. Harmonic distortion: (at rated output) 2% @ 20 cps, 0.7% @ 1000 cps, 2% @ 15,000 cps. Intermodulation distortion: (at rated output) Less than 3% using 60 and 6000 cps, mixed 4:1. Hum & noise: Mag. phono input 48 db below rated output. Aux input, 65 db below rated output. Channel separation: 42 db @ 30 cps, 45 db @ 1000 cps, 30 db @ 15,000 cps. Input sensitivity: Mag. phono, 6 mv; Ceramic phono, 250 mv; Tuner, .25 V; Aux, .25 V. Input impedance: Mag. phono, 47 K ohm; Ceramic phono, 2.2 meg.; Tuner, 470 K ohm; Aux, 470 K ohm. Outputs: 4, 8, and 16 ohm. Damping factor: 9. Feedback: 18 db. Tube complement: 3-6EU7 and 4-ECL-86 (6GW8). Power requirements: 105-125 V. 50-60 cps AC. 85 watts at 120 volts. Dimensions: 13½" W x 4-11/16" H x 9½" D.



HEATH COMPANY
Benton Harbor 40 Michigan 49023

- Enclosed is \$39.95 plus postage. Please send model AA-32 16-Watt Stereo Amplifier (15 lbs.).
- Please send my Free copy of the 1964 Heathkit catalog.

FREE 1964 HEATHKIT CATALOG
See the entire exciting array of the latest in do-it-yourself electronic kits from the world's largest manufacturer . . . Heathkit. Over 250 in all!

Name _____
Address _____
City _____ State _____ Zip No. _____

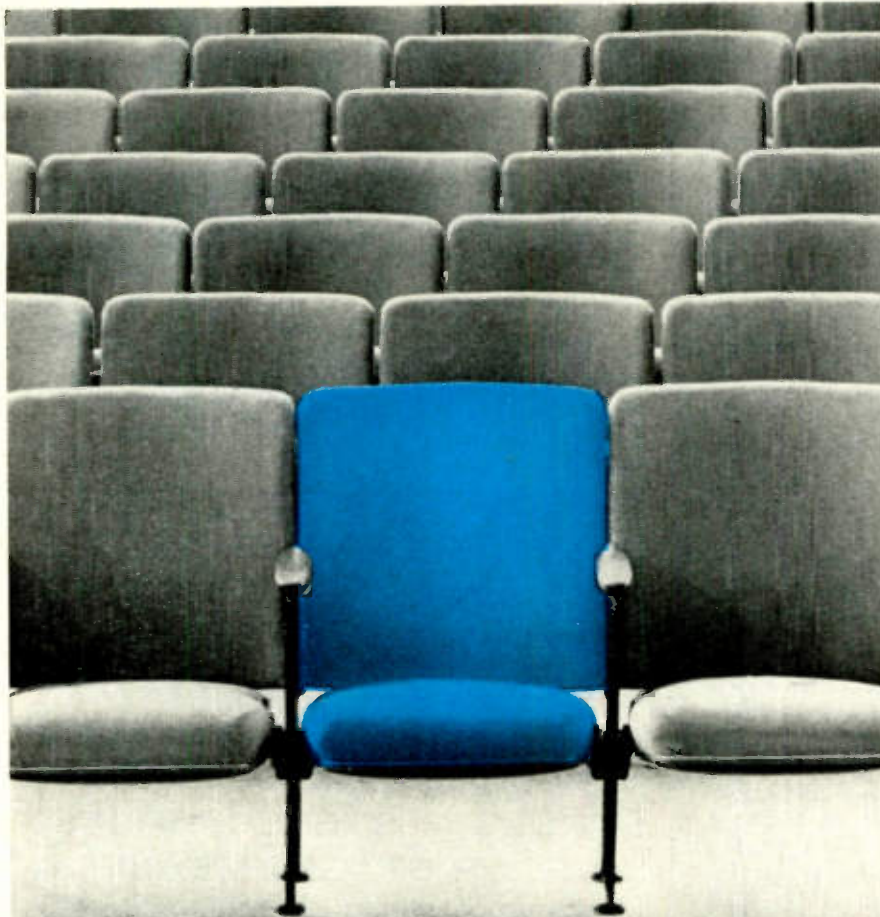

the best seat in the house...

... and it's right in your living room if your FM
is equipped with a

FINCO® AWARD WINNING FM ANTENNA

Broadcasting authorities agree that an outdoor antenna is absolutely essential for the reception of full quality monaural and multiplex FM sound.

A *FINCO* FM antenna will deliver a clean undistorted signal and bring in more stations, regardless of location.

Guarantee yourself the best seat in the house for tonight's FM concert... install a fidelity-phased *FINCO* FM antenna.

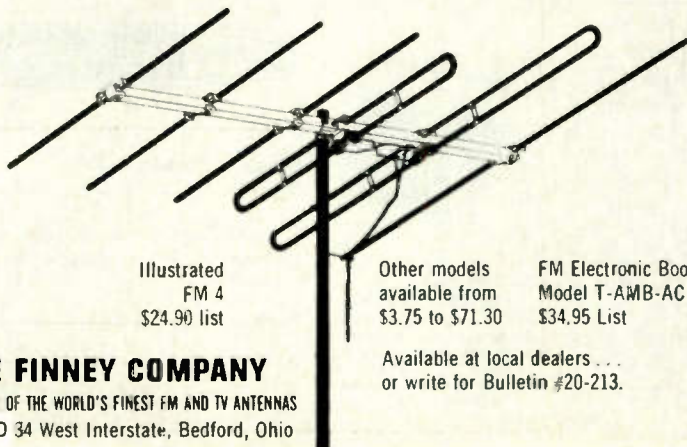

Illustrated
FM 4
\$24.90 list

Other models
available from
\$3.75 to \$71.30

FM Electronic Booster
Model T-AMB-AC
\$34.95 List

Available at local dealers...
or write for Bulletin #20-213.

THE FINNEY COMPANY

PRODUCERS OF THE WORLD'S FINEST FM AND TV ANTENNAS
Dept. HD 34 West Interstate, Bedford, Ohio

IAN: *Trio for Clarinet, Violin, and Piano.* **TANEYEV:** *Trio, in D Major, for Two Violins and Viola.* David Oistrakh (violin), Peter Bondarenko (violin), Michael Terian (viola), Vladimir Sorokin (clarinet), Eduard Grach (violin), Arnold Kaplan (piano), Sviatoslav Knushevitzky (cello), Lev Oborin (piano). **MONITOR MC 2059 \$4.98.**

Interest: Oistrakh in chamber music
Performance: Fine
Recording: Good
Stereo Quality: Good

What the Russians achieve in chamber-music forms is a sort of salon-music lyricism. Shut your eyes, dive into a fruit cocktail, and, while listening to the Khachaturian and Taneyev trios on this disc, you might well imagine that you are in the presence of the classiest sort of prandial music that used to accompany the dinner hour at the Cafe Rouge of Detroit's Hotel Statler when I was a boy.

There are far worse musical atmospheres to be encountered in this day and age, and if you happen to fancy the Russian manner, this disc is done to perfection. David Oistrakh seems to have inspired his fellow musicians to really first-class performing, and the recorded sound is everywhere lucid and wholly appropriate. *W. F.*

KHACHATURIAN: *Trio for Clarinet, Violin, and Piano* (see HAYDN).

Ⓢ Ⓜ **MENDELSSOHN:** *A Midsummer Night's Dream—Incidental Music, Opp. 21 & 61.* Arlene Saunders (soprano); Helen Vanni (mezzo-soprano); Inga Swenson (narrator); Boston Symphony Orchestra and Chorus, Erich Leinsdorf cond. **RCA VICTOR** limited edition LSC/D 2673 \$7.98, LM/D 2673 \$6.98; LSC 2673 \$5.98, LM 2673* \$4.98.

Interest: Mendelssohnian magic
Performance: Crystal-clear
Recording: Excellent
Stereo Quality: Good

All of the Mendelssohn *Midsummer Night's Dream* score that can stand on its own, with the minor exception of the Pyramus Funeral March (which is included on Klemperer's Angel disc), has been fashioned by Erich Leinsdorf into a concert suite with connecting narration from Shakespeare's text. Leinsdorf has given us the Overture, Scherzo, Fairies' March, "You spotted snakes," Intermezzo, Nocturne, Wedding March, Clown's Dance, and Finale.

Sparkle, elegance, precision, but also a touch of rigidity, mark Leinsdorf's readings. The vocal solo and choral episodes are done with great verve and imagination, but unhappily, Inga Swenson
(Continued on page 90)

CHOSEN BY **Popular Science** **AS THE BEST THAT MONEY CAN BUY**
(WITHOUT FRILLS)

This photo and caption (the price is an approximation) appeared in the September 1963 *POPULAR SCIENCE* as part of an article entitled "The Low-Down on Hi-Fi Stereo." It is a picture of those high fidelity components which, according to a panel of experts, provide the best sound possible today.



The panel carefully considered return-for-the-money, but "where there was a more expensive component that produced a detectable improvement in sound, it was chosen."

These components are recognizable to hi-fi enthusiasts as the AR two-speed turntable, the Dynakit PAS-2 preamplifier, the Dynakit Stereo 70 dual power amplifier, and the AR-3 loudspeakers.*

*They have been on demonstration as a system for several years at the AR Music Rooms, on the west balcony of Grand Central Terminal in New York City, and at 52 Brattle St., Cambridge, Mass. No sales are made there; you may ask questions if you like, but most people just come and listen.

More detailed information, including a list of dealers in your area, is available from:

ACOUSTIC RESEARCH, INC., 24 Thorndike Street, Cambridge, Massachusetts 02141

DYNACO, INC., 3912 Powelton Avenue, Philadelphia, Pennsylvania 19104

TODAY... A GREAT NEW A GREAT NEW BREED OF THE INCOMPARABLE 1000



THE A-1000T PROFESSIONAL SOLID STATE INTEGRATED 70-WATT STEREO AMPLIFIER

In much of today's advertising the word great is stretched and strained beyond belief. In the new 1000 Series Harman-Kardon recaptures its full meaning.

The A-1000T and F-1000T provide the cleanest, most transparent sound ever achieved in an integrated stereo amplifier and FM stereo tuner.

Both reflect Harman-Kardon's years of research in the application of semi-conductors to high fidelity design. This new technology breaks through the performance limitations imposed by vacuum tubes and audio transformers in conventional components. It permits the engineer to design to the theoretical limits of perfection.

Consider the A-1000T, 70-Watt Stereophonic

Amplifier. It is the first integrated amplifier to extend the range of reproduced sound well beyond the normal range of hearing — an **unprecedented** 10 to 100,000 cps, $\pm 1/2$ db! But equally important — the A-1000T delivers solid usable power across the entire bandwidth.

Through the use of specially designed high power, industrial-grade silicon semi-conductors, its 70 watts is **pure** power. Distortion is actually **unmeasurable!**

The results (a visit to your dealer will verify them): tone quality that is totally transparent and true to the original; unsurpassed instrument separation and perfect speaker control (damping) over the entire audio spectrum! Use any speaker system

TECHNOLOGY PRODUCES STEREO INSTRUMENTS— SERIES BY **harman kardon**

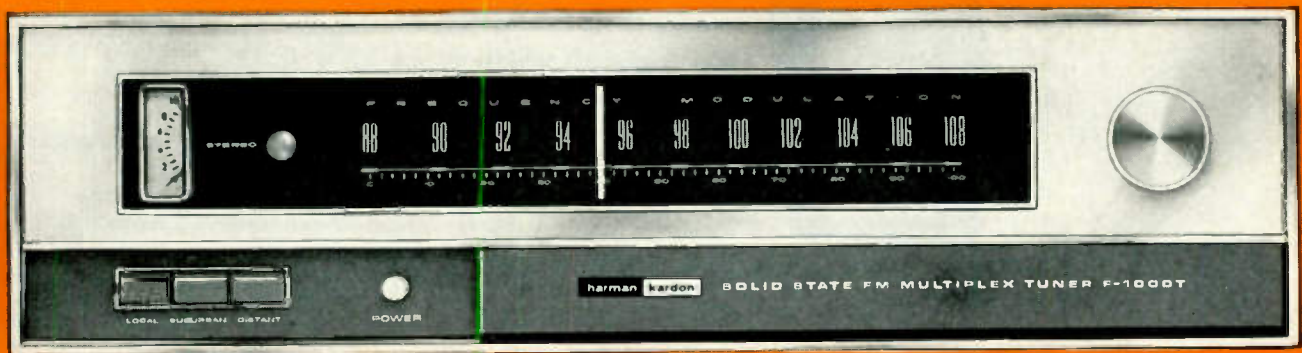

THE F-1000T PROFESSIONAL SOLID STATE AUTOMATIC FM STEREO TUNER

you wish — high or low efficiency — the A-1000T will make it sound better. **Demonstrably better.**

The F-1000T is the perfect mate for the A-1000T. It is the first FM stereo (multiplex) tuner free of drift, distortion, hum, heat and microphonics. With its exclusive STEREO-LOGIC circuit, it even thinks for you. This new device **automatically** switches the tuner to stereo the instant a station broadcasts stereo!

With its high gain, low noise RF stage, and ultra-wideband IF and limiter stages, the F-1000T's reception is free of noise and interference even in fringe areas. To assure "radar" selectivity and error-proof tuning, the F-1000T offers a new Quadra-tuned front-end with special mesa-alloy

diffused junction transistors, plus a professional D'Arsonval signal strength tuning meter. In short, the F-1000T meets the highest professional broadcast standards.

In their striking good looks, both instruments embody the true elegance of totally functional design. (The lower right-hand panel on each unit is a hideaway door for all infrequently used controls!)

For a completely documented brochure on these remarkable new instruments, write Dept. R-12, Harman-Kardon, Inc., Plainview, N. Y. The price of the A-1000T is \$369.95; the F-1000T, \$299.95. All prices are slightly higher in the West.

harman kardon

A subsidiary of THE JERROLD CORPORATION



Do you want good movies of your family's hobbies, travels, and activities? Do you want a movie camera that looks good, is easy to use, and provides dependable, trouble-free operation? Then see the new line of 8mm movie cameras from Honeywell Elmo!

There are three of these superb instruments from which to choose—the Zoom 82 (shown here with the accessory Battery Operated Zoom Grip which allows you to zoom in and out without running film through the camera) at \$189.50; the Zoom 81 at \$169.50, and the compact Pocketauto 80 at just \$99.50.

Built by the Elmo Company, Japan's most respected maker of movie products, these fine new cameras are constructed to extremely high standards and are backed by Honeywell's guarantee and full factory service facilities. Ask your Authorized Dealer for a demonstration soon!

For detailed literature, write to John Thornton (209), Honeywell, Denver 10, Colorado.

Honeywell
PHOTOGRAPHIC PRODUCTS

son's narration is rather obtrusive, particularly throughout the first side, where she seems unduly coy and the volume level of her voice sits rather high in relation to the music.

Save for the balance of narrator and music, RCA's recording is of amazing clarity and presence. Had I been a musician on the taping session, I would have been afraid to breathe too loudly. Those who prefer to do without narration should try the London disc with Peter Maag (for stylish interpretation), or Otto Klemperer on the Angel recording (for completeness). RCA Victor's limited-edition version listed in the heading involves some knockout luxury packaging—an oversize "elephant" folio that contains two Boydell engravings from Fuseli's eighteenth-century surrealist paintings illustrating the play. *D. H.*

© ® MOZART: *Clarinet Concerto, in A Major (K. 622); Concerto in C Major, for Flute and Harp (K. 299)*. Alfred Prinz (clarinet); Werner Tripp (flute); Hubert Jellinek (harp); Vienna Philharmonic Orchestra, Karl Münchinger cond. LONDON CS 6351 \$5.98, CM 9351* \$4.98.

Interest: Often-recorded classics
Performance: Enjoyable
Recording: Somewhat harsh
Stereo Quality: First-rate

The mellow Clarinet Concerto in this, its thirteenth recording in the current catalog, is given an exceptionally lyrical performance, and a very sensitive and gentle account of the solo part is contributed by Alfred Prinz of the Vienna Philharmonic. It is among the best of the available versions. The same lyrical ensemble smoothness can be heard in the Flute and Harp Concerto, which, at least through the frequency of its recorded appearances—this is the eighth—must soon move from the category of a minor Mozart novelty to a warhorse. The soloists' playing is not as spectacular as in the most recent version by Grandjany and Baron (on Decca DL 710075/10075), but this is nonetheless a well-integrated and thoroughly engaging interpretation, particularly because of the carefully gauged and light accompaniments of Karl Münchinger. The sound is well-balanced and round, but the loud passages have a wiry quality. *I. K.*

© ® MOZART: *Piano Concerto No. 6, in B-flat Major (K. 238); Piano Concerto No. 22, in E-flat Major (K. 482)*. Géza Anda (piano); Camerata Academica of the Salzburg Mozarteum, Géza Anda cond. DEUTSCHE GRAMMOPHON SLPM 138824 \$6.98, LPM 18824* \$5.98. (Continued on page 92)

NEW ROBERTS CROSS FIELD "770"



*15
high fidelity
stereo albums
for the price of one*



Records automatically—imagine! Eight hours of full-range high fidelity stereophonic music, or 16 monaural hours, are now yours on one 7" reel with the new Roberts Cross Field "770" Tape Recorder. The average tape cost per album: only 33¢. The "770" has an exclusive patented third head, the Cross Field Head, which separates recording and biasing functions. It records 40-22,000 cps . . . produces true fidelity at 1 7/8 ips, and preserves the high frequency harmonics that breathe life into a music playback. The "770" playback head has a gap width of only 40 micro inches, and is made of a new alloy, NC-88, that is practically wear-proof. Other features: 2-speed, electrically switched, heavy duty hysteresis synchronous motor; miniscule wow and flutter at low speeds; special ventilation keeps "770" cool even after 8 hours; 5"x7" self-contained, extended range, heavy duty Alnico V magnet speakers; automatic total shut-off, vertical or horizontal operation. Only \$499.95.

Specifications: 7 1/2, 3 3/4, 1 7/8 ips. Power Amplifier Output: 12 watts • Frequency response: at 7 1/2 ips, 40 to 22,000 cps ± 2 db; at 3 3/4 ips, 40 to 18,000 cps ± 2 db; at 1 7/8 ips, 40 to 13,000 cps ± 3 db • Signal to noise ratio: — 55 below 0 recorded level • Wow and flutter: at 7 1/2 ips, less than 0.12% rms; at 3 3/4 ips, less than 0.20%; at 1 7/8 ips, less than 0.30% • 5"x7" elliptical, extended range, heavy duty Alnico V magnet speakers • Hysteresis synchronous electrically controlled 2 speed motor • Automatic total shutoff • Operates Horizontally or Vertically.

THE ROBERTS CROSS FIELD "770" AND OTHER ROBERTS RECORDERS FROM \$269.95 TO \$699.95 AT BETTER SOUND AND PHOTO CENTERS



New #330 lets you listen as you record. Three heads for separate record, playback and erase. Sound on sound multiple recording. Two 7" full range speakers. Special biasing for FM multiplex recording systems. 7 1/2, 3 3/4 ips. \$349.95



New! 3-motor professional model #455. Three electrically switched dual-speed motors. Separate bass/treble controls. 4 simultaneous mixing inputs. Playback loudness controls. Two full range 5"x7" speakers. 7 1/2, 3 3/4 ips. \$599.95. Remote control: \$49.95

SEND FOR
FREE BOOKLET!
"40 AND MORE WAYS TO USE
A ROBERTS TAPE RECORDER"



IN CANADA: J. M. Nelson Electronics Ltd., 7725 Adera St.,
Vancouver 14, B. C. (Prices slightly higher in Canada)
CIRCLE NO. 85 ON READER SERVICE CARD

Roberts Electronics, Inc.
5978 Bowcroft, Dept. HFS-12,
Los Angeles 16, Calif.

Please send free booklet
Please send me complete information
about Roberts Tape Recorders

Name _____
Address _____
City _____ State _____

All the music-



in the most compact instrument yet

The KLH Model Fifteen Compact Phonograph System

Nothing with such sound quality was ever so compact and convenient before. Performance never before possible in an instrument of this size derives from 4 revolutionary full-range KLH speakers and the use of frequency contouring in the KLH-designed solid state amplifier. A complete stereophonic music center in 3 oiled walnut cabinets, with inputs and outputs for tuner, tape recorder, earphones, etc. Includes: Garrard changer, magnetic pickup with diamond stylus, solid state stereo amplifier (15 watts music power), two speaker systems, and control center.....\$259



KLH RESEARCH AND DEVELOPMENT CORPORATION
30 CROSS STREET, CAMBRIDGE 39, MASSACHUSETTS

CIRCLE NO. 48 ON READER SERVICE CARD

Jean Philippe Rameau's **M**asterpieces for the harpsichord. The complete works on 3 records. Albert Fuller, harpsichord.

Old North Singers perform **E**arlychoral music of Bach and Schütz, Monteverdi and Gibbons, in Paul Revere's Church. (2)

Yankee Charles Ives: some **R**emarkable Chamber Pieces and Songs by America's most original composer.

Eight Songs by Hopkinson, **R**evolutionary patriot; and 12 Songs by Robert Burns, Thomas Hayward, tenor, with harpsichord.

Under the Greenwood Tree: the **I**nimitable Hugues Cuenod. "Songs from Shakespeare, A.-M. Bach, La Fontaine". (Harpsichord)

Xmas Carols in Cambridge: **E**xciting Harvard Glee Club-Radcliffe Choral Society concerts with G. Wallace Woodworth.

New Choral Compositions: **e**Xhibiting works of Flanagan, Kay, Rorem, Wuorinen. Pinkham conducting King's Chapel Choir.

Opera soprano Lucine Amara — **M**arvelous in English, French, German, Spanish, Italian, Armenian songs. (Piano)

Early French Organ Music on **A**ndreas Silbermann's Marmoutier organ, Melville Smith plays de Grigny, J. & P. Dandrieu, L. & F. Couperin, Daquin, others. 3 vol.

Luise Vosgerchian-Ralph Votapek, **S**onata for 2 Pianos & Percussion; and Divertimento for String Orchestra — Bartók.

CAMBRIDGE RECORDS INC.
471 Washington Street, Wellesley 81, Mass.

CIRCLE NO. 17 ON READER SERVICE CARD

Where Spivakovsky seems simply to encounter new thematic events, Schneiderhan all but bumps into them. Stravinsky's classical stylistic allusions are as such barely noticeable in the Spivakovsky version; in the new one, they seem sometimes grotesque and parodistic in an approach distinctly big, romantic, even virtuosic. In sum, Schneiderhan has done a remarkably convincing job of relating the work to a nineteenth-century stylistic and performing manner, whereas Spivakovsky placed it more locally in the eighteenth century—no doubt where Stravinsky intended it to be.

If the Spivakovsky version (which I prefer, incidentally) is more authentic than the new one, this does not invalidate the Schneiderhan-Ancel reading for the listener of compatible tastes. And, although both releases have excellent recorded sound, the DGG disc is a little more robust.

Schneiderhan's reading of the Prokofiev violin sonata is big of gesture and appropriately romantic. Whatever one may say of either recording of the concerto, the new release's second-side inclusion of the Prokofiev is clearly a better idea than the Leroy Robertson Violin Concerto, which fills out and mars the Vanguard disc. *W. F.*

TAFFANEL: *Quintet for Winds* (see **FRANÇAIX**).

TANEYEV: *Trio, in D Major* (see **HAYDN**).

© **T**CHAIKOVSKY: *Symphony No. 6, in B Minor, Op. 74 ("Pathétique")*. Boston Symphony Orchestra, Charles Munch cond. RCA Victor LSC 2683 \$5.98, LM 2683* \$4.98.

Interest: Staple
Performance: Coarse-grained
Recording: Rather harsh
Stereo Quality: Okay

In this performance Munch and the Boston Symphony add nothing of distinction to the best contributed in the dozen or more available stereo recordings of the "Pathétique." Munch's reading is surprisingly matter-of-fact, even coarse-grained, and only in the great lyrical buildup midway in the final movement does he achieve a measure of genuine communicative power. The Dynagroove recording is no help either: the trumpets are distressingly overprominent throughout the first movement and the famous march-scherzo third movement, and though there is ample presence at the extremes of the frequency range, there is no solid and natural mid-range sonority in the violin register—very much like the recording of Ravel's *Boléro* from RCA's initial Dynagroove releases.

(Continued on page 96)

YES, WE HAVE THE "CONCORD 880"

three speed, three heads, 4 track complete stereo record/playback tape recorder



Write for full specifications and our free mail order **DISCOUNT CATALOGUE**. See our other ad in the **HIFI/STEREO MARKET PLACE** for special low prices on **QUALITY RECORDING TAPE** **SAXITONE TAPE SALES**

div. of **Commission Electronics, Inc.**
1776 Columbia Rd., Wash., D.C.

CIRCLE NO. 86 ON READER SERVICE CARD

ROCK BOTTOM PRICES

GET OUR QUOTE

STEREO • HIGH FIDELITY

PLUS THESE RABSONS EXTRAS

- Established 1905 58 Years of Reliability
- Franchised Protection Plus
- Rabsons Special Two Year Guarantee
- Easy Payment Plan Up to 24 Months to Pay
- Each Component Double Packed to Insure Safe Arrival... At no extra charge
- Rabsons Sells ONLY Factory Fresh Merchandise in Original Factory Sealed Cartons

SO WRITE RABSONS

Whatever your HI-FI requirements and receive

FREE A \$1.00 genuine Miracle Record Cleaning Cloth with EVERY Quotation from Rabsons on a component or system of your choice.

RABSONS -57 ST. INC.

119 West 57th St., New York 19, N.Y.

Area Code 212 Circle 7-0070

Diagonally opposite Carnegie Hall

CIRCLE NO. 60 ON READER SERVICE CARD
HIFI/STEREO REVIEW

OVER 2000 COMPONENTS...

Amplifiers

Phono Equipment

Tuners

Tape Machines

Speakers & Cabinets

Accessories

...are covered
in the 1964
edition of the

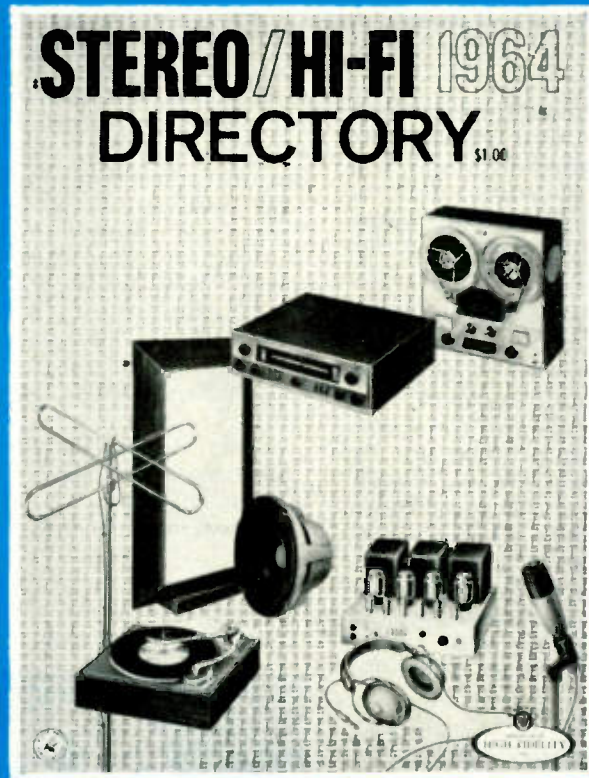

STEREO/HI-FI DIRECTORY

It's the world's most comprehensive **BUYERS' GUIDE** to the hi-fi market. Everything you need in sound is featured in the 180 product-packed pages of the 1964 **STEREO/HI-FI DIRECTORY**. It gives you the vital statistics — photos, prices, and performance data — on over 2000 components from 177 different manufacturers. It's the best way to see and compare speakers, enclosures, cartridges, changers, amplifiers, tone arms, FM tuners, tape recorders and FM antennas *before* you buy.

Plus you get these special features:

- How to select an FM tuner
- Tips on buying Tape Recorders
- Complete listing of all FM Stereo Multiplex Stations broadcasting in the U.S. and Canada (as of September 1963).

- Complete listing of all Hi-Fi dealers throughout the United States.

The 1964 **STEREO/HI-FI DIRECTORY** is your indispensable guide to the total-sound market. It goes on sale October 1st at your favorite newsstand or hi-fi dealer's. Or fill in this coupon and we'll send you a copy.

Price only \$1.00

Ziff-Davis Service Division Dept. SD
589 Broadway, New York 12, New York

Please send me a copy of the 1964 **STEREO/HI-FI DIRECTORY**. I enclose \$1.00, the cost of the **DIRECTORY**, plus 10¢ to cover mailing and handling charges. (Canada & Overseas: \$1.25 plus 20¢ postage.)

NAME _____

ADDRESS _____

CITY _____ ZONE _____ STATE _____

(Add 4% sales tax if N.Y.C. resident)

HF-123

For the most satisfactory stereo "Pathétique," one that combines drama and a decent measure of refinement in first-rate sound, the choice is Ormandy and the Philadelphia Orchestra on Columbia.

D. H.

Ⓢ Ⓜ **TELEMANN: *Der Getreue Musikmeister. Four Sonatas for Alto Recorder and Continuo.*** Ferdinand Conrad (alto recorder), Johannes Koch (viola da gamba), Hugo Ruf (harpsichord). BÄRENREITER BM 25 R 907 \$4.98.

Ⓢ Ⓜ **TELEMANN: *Trio Sonatas: in F Major, for Recorder, Diskant Viola, and Continuo; in B-flat Major, for Recorder, Cembalo Concertante, and Continuo; in G Major, for Two Violins and Continuo; in A Minor, for Recorder, Violin, and Continuo; "Polish" Sonata No. 2, in A Minor, for Violin, Viola, and Continuo.*** Vienna Baroque Trio: Karl Trötzmüller (recorder, viola, violin), Paul Angerer (diskant viola, violin, harpsichord), Gertraude Kubacek (harpsichord), Werner Adler (cello). AMADEO AVRS 6181 \$6.98, AVR 6181* \$5.98.

Interest: German Hausmusik
Performance: Entertaining
Recording: Mostly satisfactory
Stereo Quality: Wide separation

Of Telemann's six hundred or so instrumental works, the present two discs offer a tantalizing and well-selected sampling. *Der Getreue Musikmeister* (*The Faithful Music Master*), the first German music periodical, was founded by Telemann in Hamburg in 1724 and contained, among other *Hausmusik*, four sonatas for recorder and continuo. In these charming, lightweight pieces, Ferdinand Conrad shows not only his customary performing skill but also his thorough knowledge of Baroque style. The movements, particularly the slow ones, are tastefully embellished, and the articulation of all the instruments is praiseworthy.

Telemann, according to his autobiographical notes, felt that he had done some of his best work in trio-sonata settings. Hearing the rather unprofound but completely diverting examples in this Amadeo collection, one can only agree. The Vienna Baroque Trio plays these gems with great *joie de vivre* and splendid stylistic insight. What is more, the performers sound as though they are having a wonderful time.

Both discs are adequately recorded, but are marred by the placing of the recorder too close to the microphone. The quite reverberant Amadeo pressing features extremely wide though effective stereo separation and considerable stridency toward the side-ends, and the Bärenreiter (mono only) reproduces the

music more cleanly. The former has program notes in German only, the later in both German and French.

I. K.

RECORDING OF SPECIAL MERIT

Ⓢ Ⓜ **VERDI: *Il Trovatore.*** Antonietta Stella (soprano), Leonora; Fiorenza Cossotto (mezzo-soprano), Azucena; Carlo Bergonzi (tenor), Manrico; Ettore Bastianini (baritone), Conte di Luna; Ivo Vinco (bass), Ferrando; Armanda Bonato (soprano), Ines; Franco Ricciardi (tenor), Ruiz. Orchestra and Chorus of La Scala Milan, Tullio Serafin cond. DEUTSCHE GRAMMOPHON SLP 138835/6/7 three 12-inch discs \$20.94, LPM 18835/6/7 \$17.94.

Interest: Stand-out cast
Performance: Very good
Recording: Lavish
Stereo Quality: Not emphasized

With this very fine performance, the number of near-superlative *Il Trovatore*s rises to four; and to assert a clear-cut



GEORG PHILIPP TELEMANN
Diverting if unprofound

preference for one is more difficult than ever. The new set offers brilliant contributions. No Count di Luna on records matches the menacing figure richly portrayed here by Ettore Bastianini in dark-tinted, vibrant, and sonorous tones. Nor is there an Azucena in whom flaming passion is blended with the control and musical accuracy of Fiorenza Cossotto. To say that Carlo Bergonzi's Manrico eclipses the achievement of either Jussi Bjoerling or Richard Tucker would overstate the case, but it is most certainly on the same high level. In the lyrical passages, especially "*Ai nostri monti*," Bergonzi's phrasing and control are wholly admirable. His voice is essentially light, but very expressive, colored with passion, and capable of ringing climaxes. There is a sense of strain in the "*Di quella pira*"

—sung as written, incidentally—and the high C in the final "*all'armi*" is unduly exhibitionistic, but there are no other lapses in his performance. The same goes for Ivo Vinco, whose powerful voice succeeds in creating the almost visible image of a tall bearded warrior.

But Antonietta Stella's acceptable Leonora seems rather less than that in such company. She is an intelligent artist and a good Verdi stylist, but her laudable intentions are at the mercy of an inconsistent tone quality. The mounting burdens of Act Four, in particular, cause moments of distress, although she does deliver the difficult and often-omitted cabaletta "*Tu vedrai*" quite creditably.

There is no flamboyance, but ample conviction, in Tullio Serafin's direction. This grand old man was a veteran of many *Trovatore*s long before this cast of principals was born. He brings to every measure the right sense of passion, tenderness, and theatricality, and lets the music speak—or rage, rather—for itself. DGG's sound is opulent and well-detailed, but has occasional recording-level inconsistencies. This opera offers many opportunities for imaginative employment of stereo that are not fully realized here, but the artistic rewards outweigh such quibbles.

This admirable set is a contender for honors with RCA Victor LSC 6150—in which Leontyne Price's Leonora may be the deciding factor. But don't disregard the enduring glories of Bjoerling, Milonov, and Warren on RCA Victor LM 6008 and the Callas-Karajan combination on Angel 3554.

G. J.

COLLECTIONS

Ⓢ Ⓜ **JULIAN BREAM CONSORT: *An Evening of Elizabethan Music.*** Byrd: *Mounsiers Almain, Pavin; My Lord of Oxenford's Maske.* Johnson: *The Flatt Pavin.* Allison: *The Batchelars Delight; De la Tromba Pavin.* Anon.: *Kemps Jig; The Nightingale.* Morley: *O Mistress Mine; Fantasia, The Swallow; Joyne Hands; The Frog Galliard.* Dowland: *Lachrimae Pavin; Fantasia; Dowlands Adew; Tarletons Resurrection; Galliard, Can She Excuse.* Campian: *It fell on a Summers Day.* Julian Bream Consort (Julian Bream, lute; Desmond Dupré, cittern, lute; Joy Hall, bass viol; David Sandeman, flute; Robert Spencer, baritone, pandora, lute; Olive Zorian, violin). RCA VICTOR LDS 2656 \$6.98, LD 2656 \$5.98.

Interest: Elizabethan ensemble
Performance: Slick
Recording: Rich and brilliant
Stereo Quality: Satisfactory

Julian Bream, the superb British guitarist and lutenist, is soon to tour this country
(Continued on page 98)

NEW Σ SIGMA™ SERIES By JENSEN

7 SUPERB HIGH FIDELITY LOUDSPEAKERS

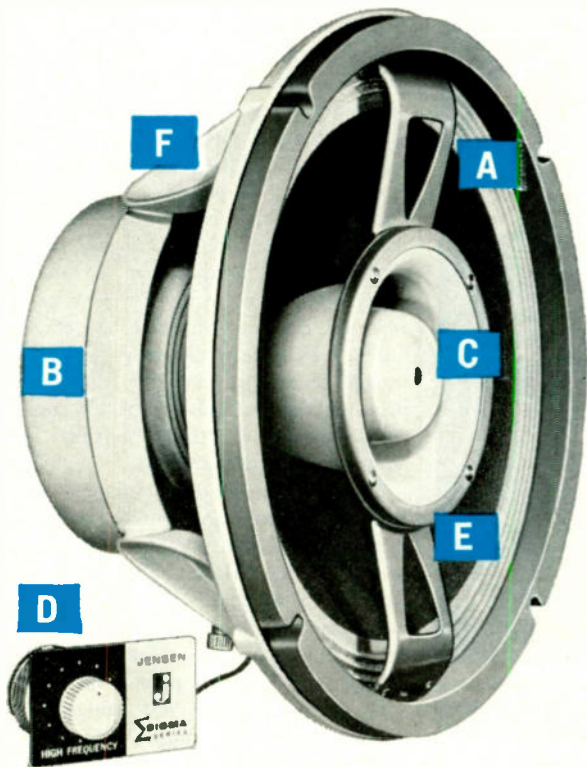

SG-223 REFLEX HORN COAXIAL 12" SPEAKER. Jensen's finest unitary. A true 2-way speaker with our unique horn-loaded reflex tweeter and high-compliance low-resonance FLEXAIR® woofer. Net\$69.50

The brilliant new Jensen SIGMA Series incorporates the newest advances in electro-acoustic design, plus performance and reliability that set new standards for high fidelity unitary loudspeakers. Note these outstanding features:

- A** FLEXAIR® suspensions permit improved bass response even in compact enclosures.
- B** High-energy SYNTAX-6® magnetic structures for high power capacity and low distortion.
- C** Exclusive design low-crossover tweeters (2,000-cycle) provide excellent m-f and h-f response.
- D** Separate HF control with all coaxials permits custom-balancing of frequency response.
- E** Carefully formulated cones retain strength and shape even after long service.
- F** Heavy-duty die-cast frames give rigidity, permanently accurate alignment of moving system.

Jensen's full-time research and development program has consistently produced significant advances in loudspeaker design. Recent developments have dictated numerous changes in the construction of loudspeakers to take advantage of new performance possibilities. The 7 speakers in the new SIGMA Series incorporate all of those refinements and changes which have been proven effective. The SIGMA Series represents the first completely new loudspeaker group redesign in the industry in a number of years. It makes available a comprehensive range of types most often requested for unitary requirements at reasonable prices.



For complete information on SIGMA Series speakers write for Catalog B-165.

JENSEN MANUFACTURING COMPANY / DIVISION OF THE MUTER COMPANY / 6601 SOUTH LARAMIE AVENUE, CHICAGO 38, ILLINOIS
 Canada: Radio Speakers of Canada, Ltd., Toronto • Argentina: Ucoa Radio, S. A., Buenos Aires • Mexico: Fapartel, S. A., Naucalpan, Mex.



BIRGIT NILSSON
AIDA—Excerpts



REGINE CRESPIN
ITALIAN OPERATIC RECITAL



JOAN SUTHERLAND
LA TRAVIATA



HERMANN PREY
LIEDER RECITAL



REGINA RESNIK
CARMEN



NICOLAI GHIAUROV
RUSSIAN & ITALIAN ARIAS



DIETRICH FISCHER-DIESKAU
BRITTEN: WAR REQUIEM

**NEW RELEASES BY
THE WORLD'S GREATEST
SINGERS ARE ON**

Trademarks Reg. U.S. Pat. Off.



FULL FREQUENCY RANGE RECORDING

with his newly formed consort, a group of six whose repertoire consists primarily of Elizabethan court music. His first record with the consort, issued in RCA's lavish Soria series, complete with full-color plates and an extensive essay, presents a wonderfully varied selection of pieces, most of which are drawn from Morley's 1599 collection, *The First Book of Consort Lessons*.

Bream has gathered about him a fine group of instrumentalists, but I must question what might be called his twentieth-century interpretations. The fast pieces are almost all too fast, well beyond the most rapid pace possible for music that is intended for dancing. Take the opening Byrd piece, *Mounsiers Almain*, a slow, heavy dance not unlike the pavan whose place it took in the late Renaissance. Bream's tempo is so fast as to be ridiculous—likewise in *My Lord of Oxenford's Maske* (a march) and the galliards. Compare these with the sensible, far less slick, and musically more appropriate interpretations of Beck's consort, whose manner in this repertoire is as charming as one can find.

Bream seems to have taken a rather Madison Avenue-ish approach to his consort: he has tried to make "An Evening of Elizabethan Music" as flashy as possible for audiences who, in most cases, are unfamiliar with English late-Renaissance music and instruments. His own solos, along with the pavans of the consort, are by far the best things in the collection. This is because they are mostly slow pieces, and are treated with fitting gravity. But the Dowland lute *Fantasic*, once recorded by Bream on Westminster XWN 18429—possibly the greatest lute record ever made—sounds here as though the performer had played it once too often and wanted only to get the most out of its very considerable virtuosic aspects. For the sake of comparison, the earlier performance times four minutes and fifty-five seconds, the new one three minutes and forty-five seconds. Aside from the difference in speed, there is more simplicity, more musicality, and cleaner execution of ornaments in the Westminster version. Also, there is less striving for coloristic effects and a continuous vibrato. The two vocal items, too, are disappointing because of the amateurish quality of the baritone.

Lest this be thought an entirely negative report, I must state that there are many lovely things in the album (such as the touching lute solo, *Tarletons Resurrection*) that help somewhat to redeem its defects. The recording is very rich and clean, but the overprominent and totally unrealistic solo miking of Bream's lute in the consort numbers gives one the same impression as listening to the latest pop hit. Perhaps this is what Bream wants, but I fear he is doing Elizabethan music a disservice. *I. K.*

See the **ROCKFORD** Newest in Acoustical Cabinetry

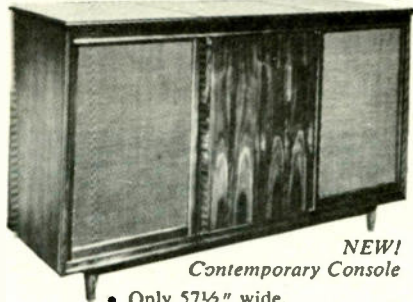

• Only 57½" wide.

- Houses complete system, including tape deck, changer or turntable, amplifier, tuner and speakers.
- Record storage for over 100 12" LP's.
- Speaker compartments are vented port type with 1" acoustical fibre glass lining. Each compartment houses up to 12" speaker.

FREE illustrated brochure describing equipment cabinets, speaker enclosures in a wide variety of styles and finishes. Write to...



FURNITURE-CRAFTED BY
ROCKFORD
SPECIAL FURNITURE CO.
2024 TWENTY-THIRD AVE • ROCKFORD, ILL.

Dealer Inquiries Invited

CIRCLE NO. 63 ON READER SERVICE CARD
98

PURCHASING A HI-FI SYSTEM?

TRADE-INS O.K. TIME PAYMENTS

Up to 2 years to pay!

**Send Us
Your List Of
Components
For A
Package
Quotation**

**AIREX
WON'T BE
UNDERSOLD**

All merchandise is brand new, factory fresh & guaranteed.

Visit our showroom
Free cabinet brochure

AIREX RADIO

CORPORATION

85-MR Cortlandt St., N.Y. 7, WO 4-1820

CIRCLE NO. 2 ON READER SERVICE CARD

Jim Lansing*
Altec Lansing
Electrovoice
Jensen • Leak*
Hartley*
University
Acoustic Research
Janszen
Wharfedale
USL Citizen Band
International Crystals
Ganset • Hallcraft
Texas Crystals
Concertone • Viking
Bell • G.E.
Weathers
Harman—Kardon
Eico • Pilot
Sherwood*
ESL • Frazier
Superscope
Dual Changer
Bogen • RCA
Dynakit • Fisher
H. H. Scott
KSC Speaker Systems*
Finco • ECI
DeWald
Sony • Roberts
Challenger
Browning • National
Garrard • Norelco
Miracord
General Radio
Rek-O-Kut
Polytronics
Tandberg*
Fairchild
Pickering • Sonar
Audio Tape
Magnecord*
Rockford Cabinets
*Fair Traded

© **MUSIC FOR FLUTE.** Evangelisti: *Proporzioni*. Castiglioni: *Gymel*. Berio: *Sequenza*. Messiaen: *Merles Noir*. Matsudaira: *Somaskah*. Maderna: *Honeyrêves*. Severino Gazzelloni (flute), Aloys Kontarsky (piano). TIME S 8008 \$5.98.

Interest: Modern Pied Piper
Performance: Excellent
Recording: Lucid
Stereo Quality: Good

Most of the music here is a manifestation of the European post-Webern avant-garde, with Olivier Messiaen's *Merles Noir*, for flute and piano, being the only clear exception. Add to this the fact that about half the disc is devoted to compositions for unaccompanied flute, and you will readily perceive that this record is aimed at something less than mass consumption.

Still, for the sophisticated listener and the professional musician—particularly the composer—the disc has its interest. The very limitations of the flute have driven some of these composers to a relative—and I do mean relative—simplicity of expression. At the same time, the flute has been combed clean of its technical possibilities. *W. F.*

© **MUSIC FOR STRINGS.** Couperin-Bazélaire: *Pièces en concert*. Mozart: *Divertimento No. 1, in D Major (K. 136)*. Corelli: *Concerto Grosso No. 4, in D Major, Op. 6*. Britten: *Simple Symphony for Strings, Op. 4*. Antonio Janigro (cello, in Couperin); Solisti di Zagreb, Antonio Janigro cond. RCA VICTOR LSC 2653 \$5.98, LM 2653* \$4.98.

Interest: Virtuoso string ensemble
Performance: Polished
Recording: Good
Stereo Quality: Good

Here is a typical example of the tonal characteristics, the technical polish, and the repertoire of the Solisti di Zagreb. The Couperin, arranged by Paul Bazélaire from five movements originally for treble instruments and continuo in *Les Gouts Reunis*, is heard frequently in this adaptation but has relatively little to do with Couperin, although the romantic performance by Janigro effectively reveals his superior abilities as a cellist. The often-recorded Mozart is played with precision, as is that barely modern charmer, Britten's *Simple Symphony* of 1934, with its delectable pizzicato movement. The most stylish performance of the older works is the Corelli, which owes its success mainly to Anton Heiler's prominent and imaginative harpsichord continuo. The chamber orchestra has been recorded with warmth and presence, and the stereo version is very satisfactory. *I. K.*

DECEMBER 1963



PRO-4 STEREOPHONES
Fluid-filled earpads for tight, comfortable seal. A durable phone designed for professionals. 30-20,000 c. p. s. response 4-16 ohms impedance. \$45.00.

The perfect Christmas Gift for People Who Own One of these Fine Amplifiers

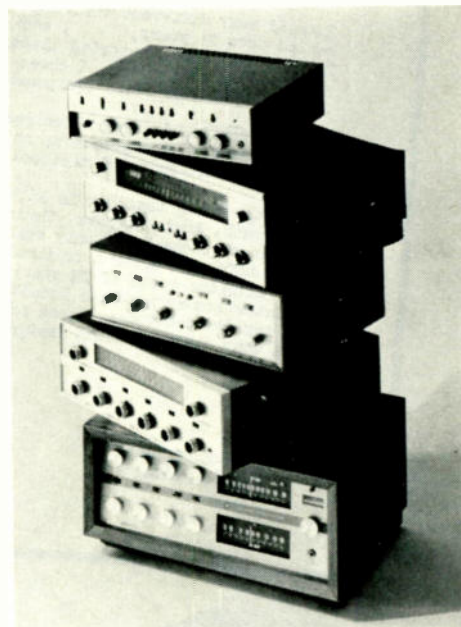

From top: Knight, Fisher, Scott, Bogen, Harman-Kardon

What would they like? Why, Koss Stereophones are the perfect thought. Just plug Koss Stereophones into the jack on the front panel of one of these Knight, Fisher, Scott, Bogen, or Harman-Kardon amplifiers and a whole new world of breathtaking stereo surrounds you.

And despite the fact that hundreds of thousands of pairs of Koss Stereophones have been sold, so many people still don't have them. This will be a memorable Christmas with Koss Stereophones under the tree . . . and you won't be forgotten for giving them.

SP-3X STEREOPHONES — Wide range 10-15,000 c.p.s. response obtainable only through earphone listening. Sensitive 3½" sound reproducers mounted in each earpiece. Soft sponge foam ear and head cushions. Impedance 4-16 ohms. \$24.95.



KOSS electronics 2227 NORTH 31st STREET
MILWAUKEE, WIS. 53208

CIRCLE NO. 82 ON READER SERVICE CARD

99

NEED WE SAY MORE?

May 4, 1965

DYNA COMPANY
5916 Powelton Ave.
Philadelphia 4, Pa.

Re: FM-1 tuner

Dear Sirs:

In our wonderful 20th-century American life of TV sets that fail fast, cars that are no longer utilitarian, washing machines that don't wash, and a general failure of good engineering and workmanship to wind up in most consumer products, it is a pleasure to report that:

1. the FM-1 kit works beautifully.
2. components are high quality.
3. mechanical assembly is elegant and precise.
4. my wife can operate it.

Since in this instance the mechanical and electronic design are parts of the same design problem, please pass my praise to the engineer that stayed with the project until he had it licked, and to whoever kept on diddling with the manufacturing end so that all corners, holes, and fittings really fit.

I tried many different tuners in this fringe area, and the choice boiled down to yours, and . . . Since the local shop, Bakersfield Audio, reported almost complete freedom from service problems with your gear, I chose yours, to say nothing of the bargain it is compared to other equipment in the same price range.

Very comforting to find a designer-manufacturer willing to design thoroughly from the ground up rather than to stick together a bunch of stock front-ends and handbook circuitry and call it a day.

I put the thing together in 12 hours and settled down to enjoying Long Beach, Santa Barbara, Thousand Oaks, and a whole raft of Los Angeles stations I had only read about. These are all about 150 miles away, and offer a cultural variety undreamed-of by our rock-and-religious quota of FM stations here in Bakersfield. Final praise: no interference problems locally on the FM-1, which is more than I can say for the tuners whose manufacturers spend more for advertising than they did on product design.

Many thanks,

John H. Gardner
John H. Gardner

cc: Consumers Union
Mount Vernon, N.Y.

This letter pleases us because it recognizes some of the less obvious virtues which have established the Dyna reputation: improved performance through unique engineering concepts; simplest and fastest construction since Dynakits are designed for ease of assembly; operating simplicity in a thoroughly distilled, non-critical design which has full flexibility for the enthusiast's subtle adjustments.

Visit your High Fidelity Specialist for a Dyna Demonstration.



SCA-35—Combined stereo preamp-amplifier with low noise, lower distortion, and 35 watts continuous power output from 20 to 20,000 cycles below 1% distortion. Exclusive Dyna feedback circuitry and output transformers for distinctly superior sound.

SCA-35 kit \$99.95; assembled \$139.95



FM-3—STEREO Matic FM tuner featuring automatic stereo/mono switching with the visual Stereocator. Super-sensitive, drift-free design with less than 0.5% distortion. Four IF-limiters, wide-band balanced bridge discriminator, and time switching multiplex system.

FM-3 kit \$109.95; assembled \$169.95



PAS-3—The famous "no distortion" PAS-2 stereo preamplifier with Dyna's new look. Wide band, lowest distortion, lowest noise, with every necessary feature for superb reproduction. Less than 0.1% distortion at any frequency. The accepted standard of the industry.

PAS-3 kit \$69.95; assembled \$109.95

Complete descriptive literature available on request

DYNACO INC. 3912 POWELTON AVENUE, PHILADELPHIA 4, PA.

HIFI/STEREO REVIEW'S
CHOICE
OF THE LATEST
RECORDINGS



JAZZ

Reviewed by JOE GOLDBERG • NAT HENTOFF

RECORDING OF SPECIAL MERIT

⑤ ● **COUNT BASIE: *L'il Ol' Groovemaker*** . . . Basie! Count Basie (piano), Snooky Young, Fip Ricard, Al Aarons, George Cohn and Don Rider (trumpets), Henry Coker, Grover C. Mitchell, Benny Powell, and Urbie Green (trombones), Eric Dixon, Marshall Royal, Charlie Fowlkes, Frank Wess, and Frank Foster (saxophones), Freddie Green (guitar), Buddy Catlett (bass), Sonny Payne (drums). *Pleasingly Plump; Boody Rumble; Belly Roll; Count 'Em*; and five others. VERVE V6 8549* \$5.98, V 8549 \$4.98.

Interest: Basie piano
Performance: Best in a while
Recording: Good

This new Count Basie album, featuring music composed and arranged by Quincy Jones, is by far the best big-band disc Basie has released in a long time. But the credit does not rest entirely with Jones, whose knowing arrangements are masterpieces of competence: inspiration must be given its due. The driving force is, of course, Basie himself, whose sparse piano technique propels, nudges, defines, and occasionally mocks his band with short stabs of notes placed as accurately as *banderillas*.

On two numbers, *L'il Ol' Groovemaker* and *Kansas City Wrinkles*, Basie plays superbly an old-time prepared tack piano (thumbtacks in the faces of the hammer felts). The latter piece, a slow blues, is the finest track on the record because of its solos. Snooky Young has an excellent cup-mute trumpet solo, and Marshall Royal, in a rare clarinet exercise, reminds me of Barney Bigard. The general mood of the number is Ellingtonian. Royal also has a notable alto solo on *Jolie*. And others show that Basie is again beginning to draw together important soloists. Bassist Buddy Catlett

Explanation of symbols:

- = monophonic recording
- ⑤ = stereophonic recording
- * = mono or stereo version not received for review

and trumpeter Al Aarons are impressive, and Frank Foster grows more powerful.

On occasion the use of flutes diminishes the power that is the band's main stock-in-trade. But as long as there is that piano, and soloists of such potential, the Basie band, despite long periods in the doldrums, will continue to be a force to be reckoned with. J. G.

⑤ ● **CLIFFORD BROWN: *Remember Clifford***. Clifford Brown (trumpet), Harold Land and Sonny Rollins (tenor saxophones), Richie Powell (piano), George Morrow (bass), Max Roach

of his work as we are likely to have. Half of the ten tracks (the jacket lists twelve) are taken from a with-strings ballad set arranged by Neal Hefti. The remainder were recorded by the pioneering hard-bop quintet of which Brown was co-leader with Max Roach in the middle Fifties. One of these latter tracks has Sonny Rollins on tenor, but he does not solo.

Brown, the leader of the trumpet school stemming from Fats Navarro, was more lyrical than Dizzy Gillespie and had a full, burnished brass tone in contrast to the muted introspection delivered by Miles Davis. Brown was a good, fluent melodist, but his ideas are not startling, and it will probably be that magnificent trumpet tone that will continue to be his hallmark.

Although the string tracks are lovely, the quintet tracks are, of course, more characteristic. They are marred by a self-conscious attempt at program music (train sounds on *A Train*, "Indian" modes on *Cherokee*), but are otherwise a good indication of what was taking place in one of the most important groups of the middle Fifties. The electronically processed stereo recording is quite realistic. J. G.

⑤ ● **BILL DOGGETT: *Fingertips***. Bill Doggett (organ); unidentified rhythm section and tenor saxophonist. *Soul Zone; Memphis; Monkey; Hot Fudge*; and eight others. COLUMBIA CS 8882 \$4.98, CL 2082* \$3.98.

Interest: Ordinary rhythm-and-blues
Performance: Predictable
Recording: Good
Stereo Quality: Very good

Although he has displayed possibilities as a jazzman on some of his previous recordings, Bill Doggett's work here is run-of-the-beat rhythm-and-blues. Most of the tunes are based on simple, familiar riffs. The rhythm section is held down to dull, repetitious patterns that chug along rather than swing. None of the soloists is outstanding. The album can be recommended only for a teen-age dancing party. N. H.

(Continued on page 102)



CHUCK STEWART

COUNT BASIE
Propelling, nudging, mocking

(drums). *Yesterdays; Laura; Stardust; Sandu; Cherokee*; and five others. MERCURY SR 60827 \$4.98, MG 20827* \$3.98.

Interest: Brown in retrospect
Performance: Variable
Recording: Good
Stereo Quality: Reprocessed

There will probably always be speculation on how great the late Clifford Brown would have been had he not died in a car crash at the age of twenty-five. This disc presents as good a cross-section

● **FRANK FOSTER:** *Basie Is Our Boss*. Frank Foster (tenor saxophone), Eric Dixon (flute, tenor saxophone), Al Aarons (trumpet), John Young (piano), Buddy Catlett (bass), Phil Thomas (drums). *Vested Interest; Samba Blues; May We; Kelly Blue*; and two others. ARGO LP 717 \$4.98.

Interest: Foster's tenor
Performance: Varies
Recording: Good

The title of this sextet disc, "Basie Is Our Boss," is somewhat misleading. True enough, tenor saxophonist Frank Foster and all the others but the pianist and drummer work for Basie, but the effect of the music is not Basie-like. As with some of the Swingville releases, an obvious commercialism (e.g., the heavy back-beat on *Vested Interest*) destroys the essence of the style supposedly being represented.

There are, however, some very good moments. Pianist John Young uses some Monk tricks interestingly on *May We*, and trumpeter Al Aarons has fashioned a simple, direct style from a Miles Davis base. But Foster is the main attraction. Bluff and forceful, with occasional hints of Rollins and Coltrane, his is a powerful presence here. J. G.

RECORDING OF SPECIAL MERIT

⑤ ● **DON FRIEDMAN:** *Flashback*. Don Friedman (piano), Dick Kniss (bass), Dick Berk (drums). *Alone Together; News Blues; Ochre; Flashback*; and three others. RIVERSIDE RS 9463* \$5.98, RM 463 \$4.98.

Interest: Important modernist
Performance: Expert and individual
Recording: Good

Don Friedman's two previous Riverside albums, "A Day in the City" (9384, 384) and "Circle Waltz" (9431, 431), established him as one of the few distinctive jazz pianists to have emerged since the advent of Bill Evans. This third set does not dilute that impression. Friedman, first of all, is a thoroughly accomplished pianist. He can improvise complex patterns fluently with *both* hands. Second, he gets an unusually attractive sound from his instrument—bright but never brittle. On the standards he interprets here, Friedman is consistently able to reshape the basic material into absorbingly personal statements without obliterating the original design of the tune.

Of the three numbers written by him, *Ballade in C-sharp Minor* illustrates Friedman's capacity to construct and heighten a lovely, supple ballad line. With *Ochre* and *Flashback*, he buttresses his prominent standing among the most resourceful of the jazz avant-garde. The

theme of *Ochre*, for instance, is in several meters, but the improvisations on that theme are without meter. In *Flashback*, there is no predetermined harmonic structure. Instead, the harmonies of the solos are freely improvised. Both of these compositions are developed with uncommon originality.

Friedman's associates are the regular members of his trio—when he finds work as a leader. Relatively unknown so far in jazz, both bassist Kniss and drummer Berk are acutely sensitive musicians who, with Friedman, form a thoroughly integrated trio. This is not just another album by a piano soloist with conventional



DON FRIEDMAN
An unmistakably major talent

rhythm backing. The individual abilities of Kniss and Berk are especially well demonstrated in their *Ochre* duet.

Don Friedman is not yet a poll-winner, nor is he a sure-fire night-club draw, but his talent is so unmistakably major that he should have a long and rewarding jazz career. And this, along with his other two albums, can withstand many playings. Riverside is to be commended for showing continuing faith in his work. N. H.

⑤ ● **JOHNNY GRIFFIN:** *Do Nothing 'Til You Hear from Me*. Johnny Griffin (tenor saxophone), Buddy Montgomery (vibraphone, piano), Monk Montgomery (bass), Arthur Taylor (drums). *The Midnight Sun Will Never Set; Slow Burn; Heads Up*; and three others. RIVERSIDE RS 9462* \$5.98, RM 462 \$4.98.

Interest: Big-tone lyricism
Performance: Maturing
Recording: Warm and clear

Johnny Griffin once had the dubious distinction of being billed as "the fastest

tenor in jazz." This album, recorded at a California coffeehouse, indicates that Griffin has finally learned that speed alone does not insure eloquence. In these performances his solos are much more economical than they have been on previous recordings. The result is an unexpected display of skill with ballads, particularly on *Wonder Why*. On medium- and up-tempos, moreover, Griffin's selectivity in the notes he plays results in much more flowing rhythmic lines and also makes it possible for him to show how deep and full a tone he can draw from his instrument. Griffin is still not an especially original improviser, but now that he has stopped sprinting in every number, he is a consistently solid soloist. The rhythm support is accurate, with Buddy Montgomery contributing lucid solos on piano and vibes. N. H.

● **ILLINOIS JACQUET:** *The Message*. Illinois Jacquet (tenor saxophone and bassoon), Kenny Burrell and Wallace Richardson (guitars), Ralph Smith (organ), William Rodriguez (percussion), Ben Tucker (bass), Ray Lucas (drums). *The Message; Wild Man; Bassoon Blues; Turnpike; Bonita*; and two others. ARGO LP 722 \$4.98.

Interest: Slight
Performance: Emotional
Recording: Good

It has become clear that tenor-saxophonist Illinois Jacquet is capable of far more than his grandstand plays with Jazz at the Philharmonic, and it should also be clear that he is capable of far more than is revealed on this latest disc. Jacquet's Epic record of several months back showed that he is very close in spirit to Lester Young, and the kinship is evident here on *Like Young*, the André Previn tune—the title, in this performance, thus has an amusing double meaning.

Elsewhere on this disc Jacquet is bogged down with two guitars, organ, maracas, conga, and all the electronic trappings of the show lounge. The result is perilously close to rock-and-roll, and Jacquet does not rise above his surroundings. On one track, he plays blues on the bassoon—pleasant enough, but no revelation. Kenny Burrell has some fine guitar solos, and bassist Ben Tucker contributes *The Message*, a piece that employs the bass figure from Tucker's recently popular *Comin' Home Baby*. But it is very far between high spots. J. G.

⑤ ● **JUAREZ:** *Bossa Nova Brasil*. Juarez (tenor saxophone), Nelsinho (trombone), Bituca (drums), others. *Samba Toff; Tema Para Dede; Bim Bom; Labo Bobo*; and twelve others. ABC-PARAMOUNT ABCS 449 \$4.98, ABC 449* \$3.98.

(Continued on page 101)

YOU COULD SPEND \$100 MORE AND NOT GET BETTER PERFORMANCE

(or better features, or better quality.)

INTRODUCING the new Rek-O-Kut R-34 playback system—a complete 2-speed turntable, tonearm, and base unit, WITH A 5 YEAR WARRANTY ... unheard of in the audio industry! When we say our turntables are built to take it—we mean it.

INSTANT SPEED SELECTOR.

A mere flick of your finger changes its speed from 33 $\frac{1}{3}$ to 45 rpm. An exclusive Rek-O-Kut feature.

HYSTERESIS SYNCHRONOUS MOTOR. Pabst is its name. Pioneered by Rek-O-Kut. For constant speed no matter what the variation in line voltage. It's the first time *this* motor (used in our higher-priced units) has been used in a system at *this* price.

ISOLATION SUSPENSION: Totally eliminates acoustic feedback. Makes vertical rumble a negative factor. No need for complicated spring devices to shock-mount your playback system. Ever.

S-340 TONEARM. A modified version of the S-320 professional tonearm. Tracks at less than one gram! Resonance factor is *below* 12 cycles. Ruggedly constructed, its removable cartridge shell handles *any* standard cartridge. Available separately at \$24.95.



SOLID OILED-WALNUT BASE. Fine furniture crafted.

SPECIFICATIONS. Noise and rumble: —60 db below average recorded level (@ 7 cm/sec. @ 1000 cps). Flutter & wow: .08% RMS. Dimensions: 15" x 14 $\frac{3}{8}$ " x 5 $\frac{1}{2}$ " (overall height, including tonearm).

ONE-PIECE CAST ALUMINUM TABLE. Full-size, 12 inch, professional quality. Dynamically balanced. Its weighted rim provides all the necessary flywheel motion for perfect rotation at constant speed.

EXCLUSIVE REKOTHANE BELT. Polyurethane. Individually ground to precision tolerances, this belt reduces noise and rumble *minus 6 db lower than any other belt*. And unless you actually cut or tear a Rekothane belt it should work for the life of the unit.

SIGNIFICANT PRICE. ONLY \$89.95!

A most modest price for such quality. See your dealer for a comparison demonstration. Only then will you know why you could spend \$100 more and not get better performance (or better features, or better quality).

REK-O-KUT, the world's largest manufacturer of turntables. 38-19 108 Street, Corona 68, New York

Export: Morhan Exporting Corp., 458 B'way, N.Y.C. Canada: Atlas Radio, 50 Wingold Ave., Toronto 19

THE RAMSEY LEWIS TRIO

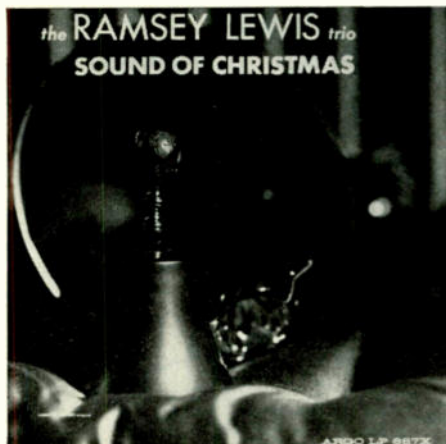

THE SOUND OF CHRISTMAS ARGO 687

MERRY CHRISTMAS BABY
WINTER WONDERLAND
SANTA CLAUS IS COMING TO TOWN
CHRISTMAS BLUES
HERE COMES SANTA CLAUS
THE SOUND OF CHRISTMAS
THE CHRISTMAS SONG
GOD REST YE MERRY GENTLEMEN
SLEIGH RIDE
WHAT ARE YOU DOING NEW YEARS EVE

THE PERFECT CHRISTMAS GIFT FOR
JAZZ FANS — FOR ALL MUSIC LOVERS

MONO AND STEREO LIST PRICE \$4.95

ARGO RECORDS

CIRCLE NO. 39 ON READER SERVICE CARD

HI-FI BUYERS!

Want to
Save yourself
a sack of
money?



SEND US YOUR LIST OF
COMPONENTS FOR AN
UNBELIEVABLE QUOTATION
THAT CAN NOT & WILL NOT
BE BEAT. WRITE TODAY!

Send for our discount catalog, too.

KEY ELECTRONICS CO., INC.
518 E. 95 St., B'klyn 12, N.Y.
Phone: Dickens 6-4191

CIRCLE NO. 49 ON READER SERVICE CARD

Interest: Brazilian bossa
Performance: Pleasant
Recording: Fair
Stereo Quality: Okay

On the cover of this record, in rubber-stamp-stenciled lettering that means business, is the word **AUTENTICO**. And the album probably is authentic. A group of apparently Brazilian musicians with one name each (Juarez, Neco, Nelsinho, Tenorio Jr.) play bossa nova, and in the process prove something about so-called national music and cross-influence. The leader and tenor saxophonist, Juarez, is strongly influenced by Stan Getz; the trombonist, Nelsinho, is a carbon Kai Winding. A Getz bossa nova may sound like a jazzman skirting the outer reaches of hotel music, but the present offering sounds like a few would-be jazzmen imprisoned in a hotel band. If these men are Brazilians, then, with Gilberto and Jobim excepted, I prefer Americans. If, on the other hand, this is a group of pseudonymous Americans, theories fly out the window. Either way, this is a pleasant but forgettable album, burdened by too much echo and an aggressively bad two-named pianist called Fats Elpidio.

J. G.

© ● STAN KENTON: *Artistry in Bossa Nova*. Stan Kenton (piano) and his orchestra. *Artistry in Rhythm; Eager Beaver; Opus in Pastels; Jump for Joe*; and twelve others. CAPITOL ST 1931 \$4.98, T 1931* \$3.98.

Interest: Kenton versus bossa nova
Performance: Overweight
Recording: Excellent
Stereo Quality: First-rate

The essence of bossa nova is tenderness and subtlety of execution. Predictably, Stan Kenton's heaviness of sound and conception are not at all appropriate. Moreover, Kenton had the unfortunate idea of trying to rearrange a number of his most venerable pieces in the bossa nova idiom instead of utilizing authentic Brazilian material. There are three new Kenton compositions, but they are all undistinguished.

The twenty-four-piece band is not only too large in itself to allow for the intimacy the bossa nova requires, but all of the arrangements are greatly overwritten. Kenton's failure to become a major influence in jazz lies in his compulsive grandiosity. Here, for example, the scores are laden with gratuitous rhetoric. Kenton's own piano playing, though simpler than his scores, is equally ponderous and dull. The recording, as is usual when Capitol's engineers are given a big band, is superb.

N. H.

© ● SAM LAZAR: *Soul Merchant*. Sam Lazar (organ), Miller Brisker

(tenor saxophone), George Eskridge (guitar), Phil Thomas (drums). *High Noon; Happy Bossa Nova; Sam's Jams; C. C. Rider; Smooth Coasting; Soul Merchant*. ARGO S 714* \$4.98, LP 714 \$3.98.

Interest: Unpretentious swinging
Performance: Good-humored
Recording: Competent

Sam Lazar gets from the organ a warmer, less strangled sound than most jazz performers on the instrument, but he is deficient in improvisational freshness, and his solos are sometimes wearying. A more satisfying soloist, Miller Brisker, plays a big-toned, hot, but spare tenor saxophone. Also superior to the leader is George Eskridge, a crisp, blues-rich guitarist who might well be ready for an album of his own.

Drummer Phil Thomas is not especially resourceful, and his work constricts the unit generally. Lazar's originals are slight, but they are suited to the straightforward conception of the organist and his colleagues.

N. H.

© ● JOHNNY LYTLE: *Got That Feeling!* Johnny Lytle (vibes), Milt Harris (organ), Peppy Hinnant (drums), Milt Hinton (bass). *Pow-Wow; Big John Grady; Lela; The Soulful One*; and five others. RIVERSIDE RS 9456* \$5.98, RM 456 \$4.98.

Interest: Fluent vibes
Performance: Organ-heavy
Recording: Crisp and warm

Johnny Lytle is a buoyant improviser with an unforced beat, a graceful melodic sense, and a nimble wit. In this set, however, he does not indicate much emotional depth. It may be that a more imaginative rhythm section could have stimulated him into fuller exploration of his feelings. As it is, he generally glides along in a pleasant but undistinctive manner. A basic flaw in the accompaniment is the presence of the Hammond organ, which thickens the over-all texture, particularly on ballads. When the organ is silent during part of *Lela*, the resultant airiness is most welcome. Lytle does have the capacity to become a more singular soloist, as he shows in his subtle personalization of *Love Is Here to Stay*. It is Riverside's responsibility to record him with musicians who will stimulate him to reach beyond his present level of amiable competence. And next time, omit the Hammond organ, please.

N. H.

© ● SHELLEY MANNE: *My Son the Jazz Drummer!* Shelley Manne (drums), Shorty Rogers (flugelhorn, trumpet), Teddy Edwards (tenor saxophone), Victor Feldman (piano, vibes).
(Continued on page 106)



SONY®

RESEARCH MAKES THE DIFFERENCE

stars on every gift list

This year let SONY star on every gift list. There is a quality SONY transistorized set for everyone—fine FM for Dad, truly portable TV for Mother, sensitive pocketable for Sis, and powerful multiband for Brother. (1) TR-817, 8-transistor pocketable with tone control. With battery, earphone, case.

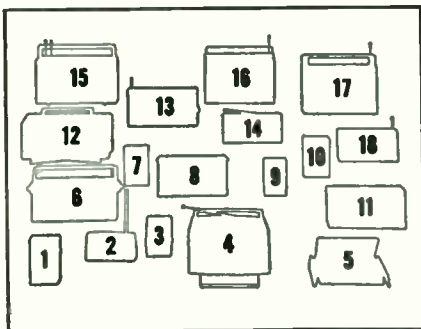

\$39.95. (2) TR-725, 7-transistor pocketable for broadcast, shortwave. With battery, earphone, case. \$39.95. (3) TR-650, 6-transistor pocketable with big sound quality. With battery, earphone, case. \$19.95. (4) Micro-TV, 8-lbs., 25 transistors, 3-way operation. \$189.95. UHF converter, \$49.95. (5) TR-624, 6-transistor desk set pops open and plays. With batteries. \$34.95. (6) EFM-117, 11-transistor FM/AM portable with all top features. With batteries, earphone, case. \$49.95. (7) TR-826, sensitive 8-transistor pocketable with quality tone. With battery, earphone, case. \$24.95. (8) TR-751, 7-transistor portable with tone control. With batteries, earphone, case. \$29.95. (9) TR-621, 6-transistor pocketable with built-in watch to turn set on, off. With battery, earphone, case. \$49.95. (10) TFM-825, pocketable 8-transistor FM/AM set weighs 10 ozs. With battery, earphone, case. \$39.95 (11) TR-818,

8-transistor portable with extra selectivity. With batteries, earphone, case. \$49.95. (12) TR-6120, 6-transistor cordless table set weighs 4 lbs. With batteries. \$29.95. (13) TR-910T, 9-transistor 3-band portable for standard, shortwave. With batteries, earphone, case. \$59.95. (14) TFM-96, FM/AM portable with 9-transistors and superb sound quality. With batteries, earphone, case. \$49.95. (15) TFM-116A, super sensitive 11-transistor FM/AM portable has marine band, too. With batteries, earphone. \$99.95. Case extra. (16) TFM-951, 9-transistor FM/AM portable doubles as car set, with optional bracket. With batteries, earphone. \$79.95. (17) TR-911, 9-transistor portable for broadcast, shortwave. With batteries. \$99.95. Case optional. (18) TR-820A, 8-transistor broadcast and marine portable. Complete with batteries, earphone, case. \$39.95.

Famous LAFAYETTE HI-FI COMPONENTS

LAFAYETTE KT-900 CRITERION® 120-WATT ALL TRANSISTOR AMPLIFIER KIT

KT-900WX

129.50

\$7 monthly

MADE IN U.S.A.

- 60-Watts Output Per Channel
 - Separate Concentric Bass, Treble and Volume Controls
 - Wide Selections of Stereo Inputs
 - Easy-to-Wire Printed Circuit Boards
- Available wired and Tested LA-900 only 189.50



LAFAYETTE PROFESSIONAL 4-TRACK RECORD/PLAYBACK STEREO TAPE DECK

99.50

\$5 Monthly

Mikes and Case
Optional



RK-140 Imported

- Plays 2-Track, 4-Track Stereo; 2-Track, 4-Track, Full-Track Mono
- Records 4-Track Stereo or Mono from FM, AM, FM MPX, Radio or Phono; Live from Mikes
- Complete with 4 Connecting Cables, 7" Take-up Reel

LAFAYETTE 4-TRACK STEREO TAPE RECORDER

129.50

\$7 Monthly

RK-600WX Imported

- Plays 2-Track, 4-Track Stereo; 2-Track, Full-Track Mono
- Records 4-Track Stereo and Mono
- Complete with 2 Mikes, Patch Cords, 7" Take-up Reel, Built-in Record and Playback Preamps



Mail the Coupon for Your
1964 Lafayette Catalog
FREE

LAFAYETTE RADIO ELECTRONICS

Dept. HML-3 P.O. Box 10
Syosset, L. I., N. Y. 11791

- Rush my FREE 1964 Lafayette Catalog 640
- Send me Stock No., shipping charges collect. \$..... enclosed.
- I would like to order Stock No. on the Easy-Pay Credit Plan.

Name.....

Address.....

City..... Zone..... State.....

CIRCLE NO. 50 ON READER SERVICE CARD

Al Viola (guitar), Monty Budwig (bass). *Hava Nagila*; Yussel! Yussel!; *Exodus*; *My Yiddish Momme*; and five others. CONTEMPORARY S7609 \$5.98, 3609* \$4.98.

Interest: Fusion of idioms
Performance: Sensitive
Recording: Superior
Stereo Quality: Excellent

The notion of making jazz adaptations of Jewish and Israeli songs is a viable one. There is a "cry" in Jewish music similar in intensity and exclamatory directness to that of jazz, and the ebullient rhythms of many Israeli tunes also parallel those of jazz. Shelley Manne's particular blending here, however, does not work out. There are some sections in the writing and the solos in which an affecting poignancy is achieved, but the performances as a whole are thin in effect.

For one thing, there are some strange anomalies—as in the decision to put two of the tracks into a bossa nova framework. Furthermore, the choice of tunes is not altogether judicious: there is such a heterogeneous mixture of the folk, the commercial, and (occasionally) the over-familiar that the album inevitably becomes fragmented in mood and concept. Finally, not all the players feel Jewish-style jazz the same way, and their diversity of approach compounds the dilution of the material.

On the credit side, there is the distinctive work of Shorty Rogers, who appears temperamentally well suited to this experiment. Another asset is the expert rhythm section. Bassist Monty Budwig is especially memorable because of the inventiveness and taste with which he handles a wide range of rhythmic assignments. In sum, the idea is a challenging one, but the album is only intermittently persuasive. N. H.

Ⓢ Ⓜ BILL MARX: *Jazz Kaleidoscope*. Bill Marx (piano), Paul Horn (flute, alto and tenor saxophones), Ray Linn and Jack Shelton (trumpets), Larry Bunker (vibraphone), Dick Nash (trombone), Roger Benioff (clarinet, bass clarinet, alto saxophone, flute), James Bond (bass), Lawrence Marable (drums). *Somewhere*; *Blue Hue*; *Angel Eyes*; *I Believe in You*; and four others. VEE JAY 3032 \$4.98.

Interest: The West goes Coltrane
Performance: Perfunctory
Recording: Good

The musicians of the West Coast, having learned as much as they can from Miles Davis, are now apparently switching to John Coltrane's school. This nonet, headed by pianist-arranger Bill Marx, who, the notes hint, is Harpo's son, borrows from such Coltrane performances

as *Greensleeves* and *My Favorite Things* for *It Ain't Necessarily So*. The Coltrane influence is elsewhere apparent in the work of saxophonist Paul Horn.

As a whole, the album tries for, and achieves, cute effects, but never touches the core of the music. Marx should be commended for including Frank Loesser's seldom-done *More I Cannot Wish You*. He has also jazzed up *Frère Jacques* and called it *Brother Jack*. On both jacket and label, *Jack* and *I Believe in You* are in the reverse of their order on the disc. Few listeners, however, will get far enough to discover this. J. G.

Ⓢ Ⓜ MEMPHIS SLIM AND WILLIE DIXON: *Baby Please Come Home*. Memphis Slim (vocals and piano), Willie Dixon (vocals and bass), Phillippe Combelle (drums). *New Way to Love*; *Pigalle Love*; *All by Myself*; *Shame Pretty Girls*; *Do De Do*; and eight others. BATTLE BS 96122* \$4.98, BM 6122 \$3.98.

Interest: Natural blues
Performance: Generic
Recording: Poor

If you liked those old records on which Joe Turner sang the blues while Pete Johnson and Albert Ammons played the piano, you'll love Memphis Slim. Slim is all three rolled into one, singing like the former and playing like the latter two. With him, usually, is Willie Dixon, a rumbling, primitive vocalist and superb slap-style bass player. Their newest record was made in November, 1962, during an engagement at the *Trois Maillets* in Paris. Since French intellectuals have the same love for our blues singers as they do for our Monogram thrillers, Slim and Willie were probably a success.

The effect is diminished somewhat here by the poor quality of the recording, and by the corny crowd-pleasing that mars Slim's best work. But crowd-pleasing is his job, and he and Willie do it artlessly and well. The numbers grow too much alike over an entire disc, and the music never reaches the depths of the great bluesmen, but the album is worthwhile, particularly for one poignant gem of a performance, *How Come You Do Me Like You Do?* J. G.

Ⓢ Ⓜ CHARLES MINGUS: *The Charles Mingus Quintet Plus Max Roach*. Charles Mingus (bass), Willie Jones and Max Roach (drums), George Barrow (tenor saxophone), Eddie Bert (trombone), Mal Waldron (piano). *A Foggy Day*; *Drums*; *Haitian Fight Song*; *I'll Remember April*; and two others. FANTASY 86009* \$4.98, 6009 \$4.98.

Interest: Sketches for masterpieces
Performance: Intense
Recording: Fair

This latest Mingus release features the same personnel as the earlier "Chazz!," recorded at New York's Bohemia in 1955, and is probably derived from tapes of the same engagement. Three of the selections, *A Foggy Day*, *Love Chant*, and *Haitian Fight Song*, were given brilliant and extended treatment by Mingus on Atlantic, the first two on "Pithecanthropus Erectus" (1237) and the last on "The Clown" (1260). The present versions sound like sketches for the Atlantic masterpieces.

Even when working with hornmen not of the top rank (such as trombonist Eddie Bert and tenor saxophonist George Barrow here), Mingus' instantly identifiable musical vision imposes itself. Even the bop standard *Ladybird*, through voicing and phrasing, becomes a Mingus



THELONIOUS MONK

Unpredictable but invariably logical

piece. One track, *Drums*, is a showcase for guest drummer Max Roach's boilerworks approach.

This is far from the best record Mingus has made, but it is fascinating to see how close to his best this music is in intention. Mingus himself is superb, as is pianist Mal Waldron. J. G.

© ● THELONIOUS MONK: *Two Hours with Thelonious*. Thelonious Monk (piano), Charlie Rouse (tenor saxophone), John Ore (bass), Frankie Dunlop (drums). *I Mean You; Off Minor; Just a Gigolo; Well You Needn't*; and fourteen others. RIVERSIDE RS 9460/1* two 12-inch discs \$12, RM 460/1 \$10.

Interest: Monk abroad
Performance: Easeful
Recording: Good

Recorded in Paris and Milan in the spring of 1961, these two Thelonious

Monk records contain no new compositions. But as Orrin Keepnews observes in the liner notes, Monk's reworkings of his own pieces and of favorite standards are usually sufficiently different from his previous tries to warrant close listening. Moreover, it takes a considerable number of playings of any Monk recording to absorb all the intricacies of his fertile, unpredictable, and invariably logical imagination. As always, his playing is alive with—to borrow a term from the art of poetry—sprung rhythms. Monk's beat is remarkably pliable and resourceful. He is also capable of a broad range of mood, conveyed by both slashing dissonance and precise delicacy.

Over the length of two discs, however, the deficiencies of Monk's colleagues become more and more evident. Tenor saxophonist Charlie Rouse is diligent, forceful, but ultimately quite dull: he lacks inventiveness. Bassist John Ore lays down a comparatively simple rhythmic line, probably at the instruction of Monk, but his solos could be more daring than they are. Drummer Frankie Dunlop is a more interesting soloist, yet he too does not often hold the attention. But because of the originality and consistency of Monk himself, the set is an important one, and it demonstrates again how viable and carefully wrought Monk's originals are. He is one of the relatively few jazzmen to develop not only a brilliantly personal style, but also a distinctive body of compositional work. N. H.

© ● OSCAR PETERSON TRIO: *Affinity*. Oscar Peterson (piano), Ray Brown (bass), Ed Thigpen (drums). *Waltz for Debbie; Gravy Waltz; Six and Four; I'm a Fool to Want You*; and four others. VERVE V6 8516 \$5.98, V 8516* \$4.98.

Interest: Technical expertise
Performance: Lacks emotion
Recording: Very good
Stereo Quality: First-rate

Oscar Peterson is a pianist of formidable technique. No matter how swift the tempo, each note is crisply articulated, and the logic of his often complex patterns is unerringly clear. Nonetheless, Peterson remains a disappointing jazz pianist. He tends to substitute dazzling prolixity for taste, and ignores the expressive value of economy. It is as if he derives most of his musical satisfaction from demonstrating his thorough mastery of the keyboard rather than from distilling his feelings about different tunes.

When Peterson plays the blues, for example, his work is perfectly idiomatic, but it has little originality or emotional conviction. Even on Ray Brown's engagingly casual *Gravy Waltz*, Peterson seems unable to relax sufficiently to settle into his colleagues' gamboling mood. Here,

flick it!
bend it!
maul it!

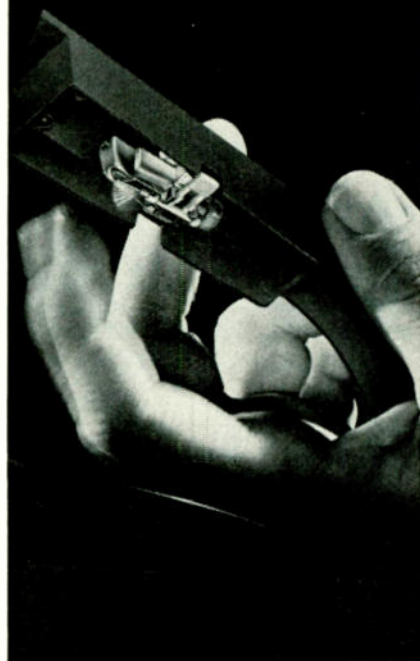

it still provides superb performance

The new Sono-Flex® needle incorporated in the Velocitone Mark III and other Sonotone cartridges brings new pleasure to music lovers. Not only does it overcome the problem of broken needle shanks, but it increases music listening pleasure by providing higher compliance, wider and flatter frequency response, lower distortion, less needle and record wear.

Make sure the next cartridge you buy is the Sonotone Velocitone Mark III with Sono-Flex needle. And, if you're one of 14 million phonograph owners with a phonograph equipped with a Sonotone cartridge, replace your current needle with a Sono-Flex. You'll notice a marked improvement in performance. Available at all leading hi-fi dealers.

NEW SONOTONE
SONO-FLEX® NEEDLE

SONOTONE CORPORATION, ELMSFORD, N. Y.
CIRCLE NO. 69 ON READER SERVICE CARD

BRAND NEW

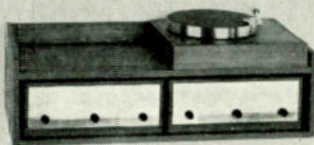
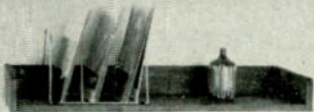

101 Puts your components on the wall where they may be enjoyed so conveniently. A refreshing new approach to express your individuality. Offers a thousand and one decorative possibilities. Complete with equipment enclosure, record shelf, custom panel and concealed wall supports. Finished in Oiled Walnut. **\$69.50**

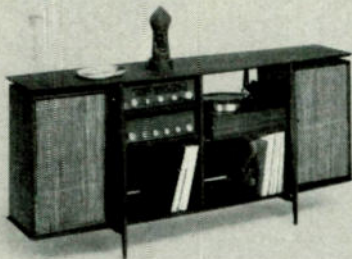

303 Award winning design created for "Shelf Speakers." Place your shelf speakers at each end and instantly a beautiful Stereo Music Center is created. Has adjustable component shelves, sliding changer/turntable pull-out shelf and place for hundreds of records and tape deck, too. Over six feet long. **\$109.50**

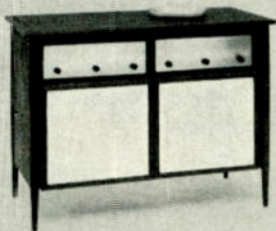

404 Stunning equipment cabinet that features two big pull-out drawers, one for changer/turntable, the other for hundreds of records or tape deck at your fingertips. Beautifully accented fronts in cane or matching veneers. **\$99.50**

All are carefully crafted from genuine hardwoods and superbly finished to match every decor. See the complete line at leading Hi Fi dealers or write for free brochure.

Audio Originals Dept. A0-1

474 S. MERIDIAN ST. INDIANAPOLIS 25, INDIANA

CIRCLE NO. 12 ON READER SERVICE CARD

too, his playing is heavy with excessive display. His associates, Ray Brown and Ed Thigpen, are also expert technicians, and they are superior to their leader in subtlety, humor, and the capacity to employ technique to move toward more fundamental musical goals. *N. H.*

© **MAX ROACH: *Speak, Brother, Speak***. Max Roach (drums), Cliff Jordan (tenor saxophone), Mal Waldron (piano), Eddie Khan (bass). *Speak, Brother, Speak; A Variation*. FANTASY 86007* \$4.98, 6007 \$4.98.

Interest: Powerful solos
Performance: Intense
Recording: Good for in-person

This new Max Roach record is a departure for the drummer. It consists of two pieces, one a little over twenty-two minutes long and the other twenty-five, on which each member of Roach's quartet solos at length. For about one-fourth of the disc, recorded during a performance at San Francisco's Jazz Workshop, the music is completely absorbing. This one-fourth is a portion of *Speak, Brother, Speak*, a blues with a gospel-rhythm figure, on which Jordan and Waldron solo. Waldron's spare, precise manner of building a solo is one of the minor glories of contemporary jazz, but Jordan has never recorded anything that approaches his power here. Even Roach, in accompaniment, abandons the mechanical coldness that has marred much of his work, and adds emotional force to his technical wizardry.

Unfortunately, the remainder of the disc demonstrates that few solos of the length here attempted can sustain interest. But that half of *Speak* on which Waldron, Jordan, and Roach cooperate in reaching beyond themselves is worth many entire albums. *J. G.*

© **SHORTY ROGERS: *Gospel Mission***. Orchestra, Shorty Rogers cond. *Wake Up and Shout; Freedom's Coming; Great Days Ahead; Joshua's Saxes*; eight others. BATTLE BS 96122* \$4.98, T 1960* \$3.98.

Interest: Instrumental gospel
Performance: Coarse
Recording: Live and clear
Stereo Quality: First-rate

In an apparent attempt to attract big-band partisans to gospel music, Capitol commissioned Shorty Rogers to write and arrange a set of quasi-gospel tunes. Without exception, the scores are insensitive to the essence of the Negro gospel tradition. Synthetic excitement is substituted for spontaneous ardor. The section writing is obvious and thin in imagination. The rhythm patterns are egregiously limited—gospel music can be

fascinatingly polyrhythmic. There are intermittent attempts to add tinges of "authentic" color—an archaic-sounding guitar, a harmonica, and a growling trumpet. These devices, however, are artificially grafted onto the scores and are not part of a cohesive musical design. In short, this album has all the marks of a pot-boiler, assigned and executed for a quick ride on the pop gospel train. *N. H.*

© **HORACE SILVER: *Silver's Serenade***. Horace Silver (piano), Blue Mitchell (trumpet), Junior Cook (tenor saxophone), Gene Taylor (bass), Roy Brooks (drums). *Silver's Serenade; Let's Get to*

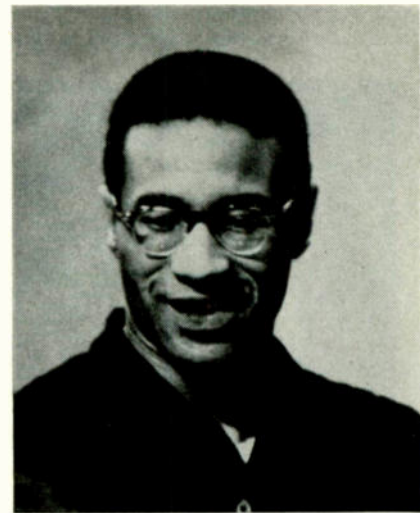

MERCURY RECORDS

MAX ROACH

Emotional force, technical wizardry

the Nitty Gritty; Sweet Sweetie Dee; The Dragon Lady; Nineteen Bars. BLUE NOTE ST 84131 \$5.98, 4131 \$4.98.

Interest: Tarnished Silver
Performance: Mostly perfunctory
Recording: Flat
Stereo Quality: Good

Over the years, something has happened to the fire that once characterized the playing and writing of Horace Silver. He has tried to expand the rather limited hard-bop basis of his work, experimenting with unusual bar combinations as well as with Latin and oriental thematic material. But as he grows more complex, he becomes less effective, as is sharply revealed on this new quintet record. The title track has no propulsiveness or tension at all. Silver's passion has been replaced by mere competence, and the quotes that have always heavily studded his piano playing are now less palatable. Trumpeter Blue Mitchell has played much better before, but this may be tenor saxophonist Junior Cook's best recording: he shows signs of beginning to come out of his involvement with Coltrane into something powerful of his own. The recorded sound is rather flat.

It may be that Silver is skimming his talents as leader and pianist in order to concentrate on composition. If so, I feel that this record indicates the emphasis is misplaced. J. G.

● SONNY STITT: *Rearin' Back*. Sonny Stitt (alto and tenor saxophones), Ronald Mathews (piano), Arthur Harper, Jr. (bass), Lex Humphries (drums). *Rearin' Back*; *Little Girl Blue*; *Cut Plug*; *Queen*; *Bunny R.*; and two others. ARGO 709 \$4.98.

Interest: Standard Stitt
Performance: Perfunctory
Recording: Good

Unfortunately, Sonny Stitt rarely plays as well as he can. On his recent Atlantic disc "Sonny Stitt and the Top Brass," arrangements by Tadd Dameron and Jimmy Mundy challenged him to do his best. On this record, backed by a fashionably funky rhythm section, the emotion he has on occasion shown is replaced by the placid attitude of the practice room, and he seems merely to be repeating runs he learned a long time ago. His own boppish lines are little more than excuses for beginning a solo. Stitt could make an album like this every day of the week. Not many other saxophonists could, but that is not the point. It is that his albums could be very good if he chose better material and did more than just come in at the appointed time and blow. J. G.

● CLARK TERRY AND COLEMAN HAWKINS: *Eddie Costa Memorial Concert*. Clark Terry (trumpet, flugelhorn), Art Davis (bass), Dick Hyman (piano), Osie Johnson (drums), Willie Dennis (trombone), Coleman Hawkins (tenor saxophone), Urbie Green (trombone), Markie Markowitz (trumpet), Sonny Clark (piano), Roy Haynes (drums), Chuck Israels (bass). *The Simple Waltz*; *Things Ain't What They Used to Be*; *I'm Confessin'*; *Just You, Just Me*. COLPIX SCP 450 \$4.98, CP 450* \$3.98.

Interest: Uneven tribute
Performance: Clark Terry best
Recording: Good
Stereo Quality: Competent

Recorded at the Village Gate in New York in 1962, this is part of a memorial concert for the late Eddie Costa, a boldly personal musician and a modest, thoroughly likable man off the stand. The better jazz is on the first side. Clark Terry, as is his custom, plays with warmth, wit, and unforced individuality. He is particularly well accompanied by bassist Art Davis. On *Things Ain't What They Used to Be*, the Terry quartet is joined by trombonist Willie Dennis, who is far too seldom heard on records. The second side begins persuasively with a passionate

but disciplined Coleman Hawkins performance of *Confessin'*. The fifteen-minute *Just You, Just Me* by a Hawkins-led sextet, however, is diffuse and uneven.

At least one other Eddie Costa memorial is needed—a compilation of some of Costa's best recordings. Many are out of print, but an energetic artist-and-repertoire man should be able to compile enough for an album that would demonstrate the level of Costa's own exacting jazz standards. N. H.

● RANDY WESTON: *Music from the New African Nations*. Randy Weston (piano); Budd Johnson (soprano saxophone); Booker Ervin (tenor saxophone); Ray Copeland (trumpet); Jimmy Cleveland and Quentin Jackson (trombones); Julius Watkins (French horn); Aaron Bell (tuba); Peck Morrison (bass); Charlie Persip and Frankie Dulong (drums); Archie Lee and George Young (percussion). *Niger Mambo*; *Zulu*; *Congolese Children*; *Mystery of Love*; and three others. COLPIX SCP 456 \$4.98, CP 456* \$3.98.

Interest: New Afro-American fusion
Performance: Skillful
Recording: Lacks spaciousness
Stereo Quality: Very good

This album is a product of Randy Weston's long-time study of African music, and reflects as well a trip he made to Nigeria in 1961. It is only a beginning in Weston's attempts to adapt African melodies and rhythms to jazz, and I expect that subsequent efforts will be considerably more rewarding. The quality of this material varies considerably. The "high-life" numbers are slight and, although attractive on first hearing, do not sustain interest. Much more durable is *In Memory Of*, a funeral song in which Weston freely juxtaposes his feelings about his African heritage and his impressions of several deceased jazz musicians. Particularly effective in the opening section is a haunting, speech-like drum that sounds like an African form of timpani. Also memorable is *Mystery of Love*, a fragile, intimate ballad by Guy Warren, a Ghanaian composer.

The most joyful track is *Congolese Children*, a delightfully unpretentious adaptation by Weston of a traditional song of the Bashai tribe in the Congo. In all the performances, Weston's own piano playing is characteristically thoughtful and incisive. Of the other musicians' work, a particular surprise is the maturing of trumpeter Ray Copeland. And Melba Liston's freshly voiced, closely twined arrangements are among her most intriguing of the past couple of years. The execution of the scores, however, suggests that a few more rehearsals might have led to greater ensemble ease.

N. H.

All new from Sony



a stereo deck with 3 heads!



and stereo recording amplifier

Now you can add famous Sony 4 track stereo tape playback to your present hi fi system. Handsomely styled in gold and grey, with 3 heads, 2 speeds, vertical or horizontal mounting, automatic shut-off, tape counter and pause control, the new Sony 263-D is a remarkable value.

Less than \$119.50

For stereo recording, add the new Sony SRA-2L recording amplifier that instantly connects to the 263-D. Its matching gold and grey decor makes a handsome companion for your 263-D. All new from Sony!

Less than \$99.50

■ All Sony Stereorecorders are Multiplex Ready! ■ In New York visit the Sony Salon, 585 Fifth Avenue ■ For literature or name of nearest dealer write Superscope, Inc., Dept 8, Sun Valley, California.

SONY SUPERSCOPE

The Tapeway to Stereo

CIRCLE NO. 81 ON READER SERVICE CARD

Now you know why you waited

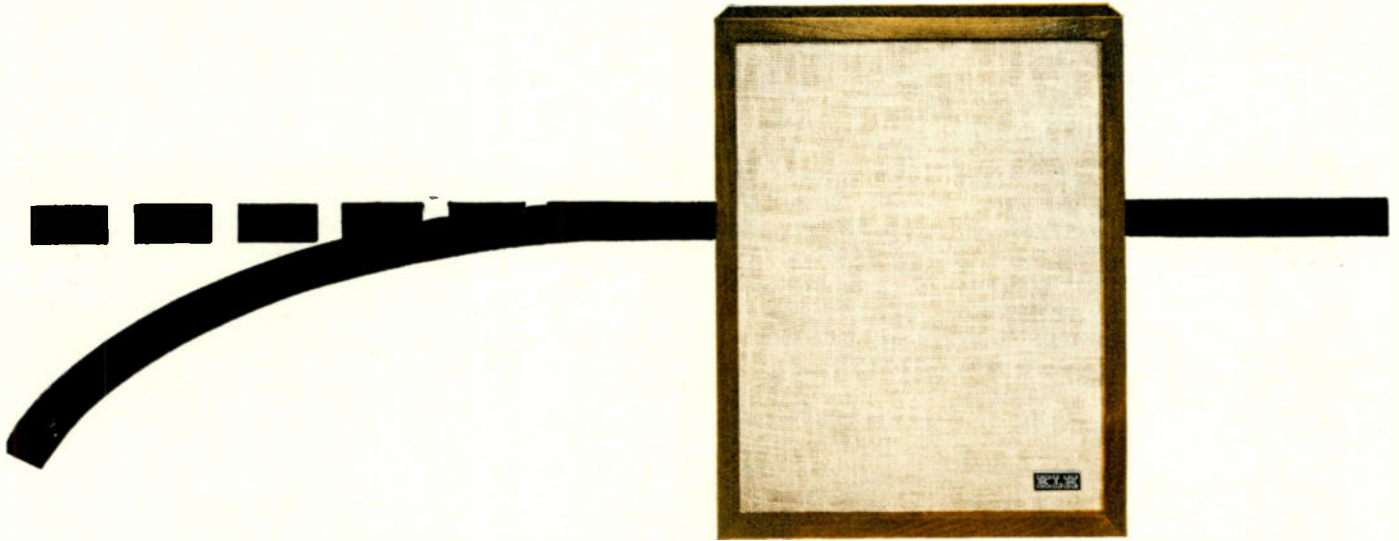

KLH has just introduced a new speaker system — the Model Fourteen — designed to accomplish two objectives: — to reproduce music (1) with less distortion and (2) with more bass than has heretofore been possible for a small speaker system. Inside the compact enclosure of this new speaker are a number of vital departures from any speaker system ever produced before.

The Model Fourteen employs two extremely compliant *full-range* speakers. The diameter of their cones is only 3". Their maximum excursion is $\frac{3}{8}$ ". This excursion is controlled by the highest ratio of magnet power to cone lightness ever engineered into a loudspeaker.

There are a series of problems involved in achieving good bass response in a small speaker system. First, all speakers roll off in the bass region. Small speakers have higher resonant frequencies and roll off at higher frequencies than large speakers. But a large speaker is not effective in a compact enclosure. The conventional small speaker is no better, since it cannot move enough air to produce respectable bass.

In the Model Fourteen, part of the answer is a small speaker with a very powerful magnet and long excursion. This provides two great advantages — the ability to move large volumes of air, and the precise control over cone movement necessary for freedom from distortion. It also provides a problem, however, since the damping effect of the heavy magnet increases at the lower frequencies. This reduces the bass output of the speaker.

The rest of the answer is the first use, in a small

multi-speaker system, of a revolutionary technique which we call *frequency contouring*. This technique was pioneered by KLH in the now famous Model Eight FM Receiving System and Model Eleven Portable Stereophonic Phonograph — each generally conceded to be the finest example of its class yet produced. Incorporated in the Model Fourteen is a passive electronic network which reshapes the power output of any conventional amplifier to match exactly the low frequency power requirements of the speakers, so that their response curve remains flat far below its normal roll-off point.

This technique can only be applied successfully with speakers whose low frequency response is held precisely to a profile of certain specific characteristics. Only because the speakers used in the Model Fourteen — including their impregnated paper cones — are designed and manufactured in our own plant can they be held to the rigid uniformity required for the use of frequency contouring. No commercially supplied cones have the necessary uniformity. No other manufacturer of small full-range speakers produces its own cones.

The result is a range and quality of reproduction you have never heard before in a compact speaker. The Model Fourteen, at any given level of overall loudness, will deliver more bass power, at lower frequencies, with less distortion than any other speaker system in the same range of cost or size.

The Model Fourteen's dimensions are 18" x 14" x 3 $\frac{3}{4}$ ". The price is about \$50. Wait no longer.

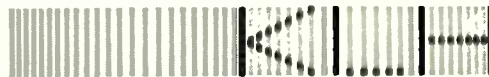

KLH RESEARCH AND DEVELOPMENT CORPORATION
30 CROSS STREET, CAMBRIDGE 39, MASSACHUSETTS

CIRCLE NO. 65 ON READER SERVICE CARD



HIFI/STEREO REVIEW'S CHOICE OF THE LATEST RECORDINGS

ENTERTAINMENT

POPS • HUMOR • FILMS • THEATER • FOLK • SPOKEN WORD

Reviewed by JOE GOLDBERG • STANLEY GREEN • NAT HENTOFF • PAUL KRESH

⑤ ④ **KAYE BALLARD:** *Boo-Hoo, Ha-Ha*. Kaye Ballard (vocals); orchestra. *All Alone; Purple; Rags*; and nine others. UNITED ARTISTS UAS 6165 \$4.98, UAL 3165* \$3.98.

Interest: Sad songs
Performance: Uninhibited
Recording: Clear
Stereo Quality: Acceptable

The torchy and the comic sides of Kaye Ballard's musical personality are both displayed on this recording, neatly wrapping up six of one and half a dozen of the other. The ballads consist mostly of standard fare (*All Alone, Mad about the Boy*), and most of the humorous items are products of latter-day minstrels such as Fred Ebb, Paul Klein, Jay Thompson, and Arthur Siegel. The only trouble is that the sentimental old-timers still pack a wallop, but the funny stuff has little point or genuine wit. Miss Ballard, however, treats everything as if it were written by Larry Hart and Cole Porter. S. G.

⑤ ④ **THE BROTHERS FOUR:** *Cross-Country Concert*. The Brothers Four (vocals). *Brandy Wine Blues; Winken, Blinken and Nod; The Beast*; and ten others. COLUMBIA CS 8746 \$4.98, CL 1946* \$3.98.

Interest: Pleasant program
Performance: Easy to take
Recording: A bit close
Stereo Quality: Effective

The well-scrubbed, friendly, youthful, and rather bland quartet known as the Brothers Four has apparently been doing a lot of traveling. Each selection on this disc was taken from a concert at a different college campus where the group appeared during the past year, though this fact would be impossible to tell from the recording alone. There is no denying that the boys are engaging performers,

Explanation of symbols:

- ④ = monophonic recording
- ⑤ = stereophonic recording
- * = mono or stereo version not received for review

but they seem to be incapable of whipping up any real rhythmic excitement. Almost everything is given a light, comic touch, and what comes across stronger than anything else is their seemingly unquenchable desire to be liked. S. G.

⑤ ④ **LES BROWN:** *The Explosive Sounds of Les Brown and his Band of Renown*. Les Brown Orchestra. *Bizet Had His Day; Borodin's Bounce; Three Oranges*; and nine others. COLUMBIA CS 8830 \$4.98, CL 2030* \$3.98.

Interest: Exploding the classics
Performance: Crisply swinging group
Recording: Fine
Stereo Quality: Obvious but effective

This new Les Brown release returns to that old stand-by of swing bands, swinging the classics. What's more, it still



LES BROWN
Stand-by classics loud and lively

works. The Brown group emphasizes crisp, bright arrangements, mostly by one J. Hill, with the reeds on the left and the brasses on the right. Occasionally there is an effective solo—an oboe on Khachaturian's *Sabre Dance*, a flute on *Swan Lake*—but Brown's forte is unquestionably ensemble work. The tempos are generally lively, the single exception be-

ing the moody treatment of *Debussy's Dream*, another pop version of *Reverie*. S. G.

RECORDING OF SPECIAL MERIT

④ **CARLO BUTI:** *Carlo Buti's Best*. Carlo Buti (vocals); orchestra. *Firenze; Firenze Sogna; Porta un Bacione a Firenze*; and nine others. CAPITOL T 10347 \$3.98.

Interest: Emotional Italian fare
Performance: One of the best
Recording: Good

Blessed with vocal equipment of impressive range and persuasiveness, Carlo Buti sails through this varied collection like a master. Few pop singers can match his variety, subtlety, and projection, and this program gives him ample opportunity to display these talents. In one piece, *L'Ultimo Amante*, for example, he begins with a wonderfully deep, rich tone, and then, almost without the listener's being aware of it, glides gracefully into an almost falsetto quality. Though no translations are furnished, the three titles listed above indicate a passionate preoccupation with the city of Florence. S. G.

⑤ ④ **VIC DAMONE:** *My Baby Loves to Swing*. Vic Damone (vocals); orchestra, Jack Marshall cond. *My Melancholy Baby; My Baby Loves to Swing; Baby, Baby, All the Time*; and nine others. CAPITOL ST 1811 \$4.98, T 1811* \$3.98.

Interest: Primarily the backing
Performance: Pleasant singer
Recording: Splendid
Stereo Quality: Vic on the right

Vic Damone may never make an outstanding album, but his sure musical sense and the attractiveness of his singing have, so far, kept him from ever making an inferior one. What gives this current package its distinction, however, are Jack Marshall's uncommonly inventive and striking arrangements. They are both sympathetic to the singer's style and individual enough to be appreciated on their own. These qualities are made espe-

cially apparent by the wise placement of the singer on the right, the orchestra on the left and center.

No planning genius was wasted on the repertoire, however. The tenuous thread that holds these twelve numbers together is the use of the word "baby" either in the song titles, the lyrics, or, in the case of *Make It a Slow Goodbye*, the addition of a spoken "coda" consisting of a fondly whispered "Bye bye, baby." S. G.

⑤ ● BESSIE GRIFFIN: *The Fabulous Bessie Griffin and the Gospel Pearls*. Bessie Griffin and the Gospel Pearls (vocals). *Didn't It Rain*; *Same Train*; *By the River*; *Wade in the Water*; and eight others. Epic BN 26025 \$4.98, LN 24065* \$3.98.

Interest: Driving gospel music
Performance: Fervent
Recording: Good in-concert
Stereo Quality: Well balanced

Recorded during a performance at The Bear in Chicago, this is yet another exclamatory program of Negro gospel music, an idiom the major labels have been pushing in recent months. Soloist Bessie Griffin occasionally sounds like Sister Rosetta Tharpe in her slicing, almost recitative-like phrasing. At other times, however, she becomes rougher in texture and more abandoned in spirit.

The background voices are able, but they seldom surprise. The program, moreover, has insufficient variety. Nor do the performers display much dynamic skill within each song. The rhythm section is often overpowering, and the engineer ought to have made some compensation for the drummer's excessive vigor. Miss Griffin's singing is the album's major merit, but her solos do not lift the recital above the average of gospel recordings. After listening to this gospel shouting, I found the sensitivity and originality of the Staple Singers on *Riverside* all the more evident. N. H.

⑤ ● BOBBY HACKETT: *Plays the Great Music of Henry Mancini*. Bobby Hackett (cornet); orchestra, Dick Hyman cond. *A Profound Gass*; *Soft Touch*; *Joanna*; and nine others. Epic BN 26061 \$4.98, LN 24061* \$3.98.

Interest: Horn beauties
Performance: Appealing
Recording: Beautiful
Stereo Quality: Well spread

It has been a long time since anyone compared Bobby Hackett with Bix Beiderbecke, but the veteran cornetist can still play a profoundly moving horn of undimmed tonal beauty. He is well suited to interpreting the film and television themes by Henry Mancini that

have been assembled for this collection, though they do not seem to possess sufficient variety or musical interest to sustain the two sides. In fact, you will find disturbing similarities from track to track, particularly in the introductions to the *Peter Gunn Theme* and *Baby Elephant Walk*, and in the melodies of



BOBBY HACKETT

Tonal beauty for Mancini's melodies

Joanna and *Days of Wine and Roses*. Of the more unfamiliar entries, I was impressed most by *Don't You Forget It* and *Song about Love* (which was apparently once called *Siesta*). Dick Hyman's arrangements are a bit on the solemn side. S. G.

⑤ ● IVY LEAGUE TRIO: *Folk Ballads from the World of Edgar Allan Poe*. Ivy League Trio (vocals). REPRIS R 96087 \$4.98, R 6087* \$3.98.

Interest: Poe-inspired ballads
Performance: Monotonous
Recording: Superior
Stereo Quality: Souped up

The Gothic tales of Poe have inspired such serious musical works as Caplet's *Masque of the Red Death*, for harp and orchestra, and Rachmaninoff's symphony, *The Bells*. Now these three pretentious youngsters named Ronn Langford, Bob Hider, and Morris O'Neill come along to feed on his reputation with a dozen tasteless and interminable ballads based vaguely on the tales and their titles. *The Tell-tale Heart* now begins, "Cheatin' Pete was the meanest cuss/That ever rode the West." *The Raven* is tailored for twisting at the local juke joint. The bells tintinnabulate for a hillbilly barn dance. The next sound you hear will be that of Poe turning over in his grave. P. K.

⑤ ● THE LIMELITERS: *Our Men in San Francisco*. Lou Gottlieb (vocals and bass), Glenn Yarbrough (vocals and

guitar), Alex Hassilev (vocals and guitar). *The Wabash Cannonball*; *Corn Whiskey*; *The Lute Player*; *Sleep Soft*; and eleven others. RCA Victor LSP 2609 \$4.98, LPM 2609* \$3.98.

Interest: Folk pastiche
Performance: Slick
Recording: Very live
Stereo Quality: Excellent

Recorded at the hungry in San Francisco, this is a characteristic Limelitters program. The numbers are balanced between parodies and arch fantasies on the one hand and more serious interpretations of traditional folk tunes on the other. Of the former, there are *Max Goolis* (the tale of the John Henry of street sweepers) and *The Lute Player* (a sketch of a Frenchman who combined love and business). Among the straight performances are *By the Risin' of the Moon* and *The Jam on Jerry's Rock*.

The Limelitters are somewhat hampered in doing their nonhumorous numbers because Glenn Yarbrough is the only accomplished folk singer among them. The passages of whimsy, while moderately amusing on first hearing, pall quickly. Yet there is a pervasive exuberance in the Limelitters' work, and they have an attractive disinclination to take themselves too seriously. On its own terms—entertainment for a broad audience—the trio fulfills its function. By the criteria of meaningful and durable folk music, however, the Limelitters are of only peripheral interest. N. H.

⑤ ● DEAN MARTIN: *Rides Again*. Dean Martin (vocals); orchestra, Marty Paich cond. *I Can't Help It*; *My Sugar's Gone*; *Rockin' Alone*; and nine others. REPRIS R 96085 \$4.98, R 6085* \$3.98.

Interest: Back-country tear-jerkers
Performance: Relaxed
Recording: Splendid
Stereo Quality: Satisfactory

Hardly a bit saddle-sore from his last outing down the country-music trail, Dean Martin here tries another dozen maudlin tunes in that idiom. Since Mr. Martin has never been one to take a melody or a lyric seriously, we should not be surprised at his rather bemused handling of a repertoire rich in such situations as these: the fellow whose girl prefers candy kisses to real ones, the character who brings his girl a bouquet of roses ("one for every time you broke my heart"), or the sight of an old mother "rockin' alone in an old rockin' chair." S. G.

⑤ ● JERRY ORBACH: *Off Broadway*. Jerry Orbach (vocals); orchestra, Norman Paris cond. *There's a Small Ho-*
(Continued on page 114)

Long play never had it so long!



New! Triple the length on a 7" reel!

Longest non-stop tape time ever! That's what you get with a 7" reel of new SCOTCH® BRAND Recording Tape No. 290—any way you play it! At 3¾ ips, for example, it provides 3 hours of uninterrupted stereo or monaural—6 hours of recording in both directions.

This exclusive triple length tape offers 3600' lengths on 7" reels. That's three times the footage possible with standard length tape on a 7" reel. And compared with regular double length tape, you get 50% more recording time, pay less per foot.

What's 290's secret? A superior new coating technique, developed by 3M, makes possible thinner high potency oxide coatings to reduce tape thickness, allow bonus tape footage per reel. Backing for No. 290 is the same extra-strong, half-mil tensilized polyester used on regular "SCOTCH" Double Length

Tape. No. 290 is made to demanding stereo quality standards to ensure brilliant sound characteristics. And exclusive Silicone lubrication, which lasts the life of the tape, protects against recorder head wear, actually extends tape life.

Full hour on a miniature reel! No. 290 is also offered in 600' lengths on 3¾" reels that fit most miniature recorders, play a full hour at 3¾ ips, 2 track. Ask your dealer about both sizes of new No. 290.

"SCOTCH" AND THE PLAID DESIGN ARE REGISTERED TRADEMARKS OF MINNESOTA MINING & MANUFACTURING CO., ST. PAUL 19, MINNESOTA. EXPORT: 99 PARK AVENUE, NEW YORK, CANADA: LONDON, ONTARIO. ©1963, 3M CO.

Magnetic Products Division **3M** COMPANY

REVOLUTION in STEREO PHONES

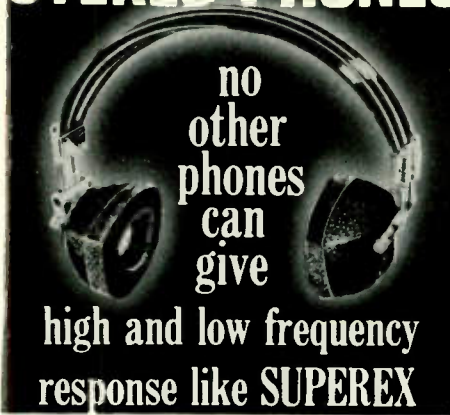

the only stereo phones with built-in woofer and tweeter in each phone

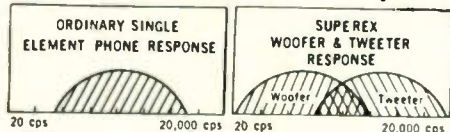

Obviously single element phones must compromise on high or low frequency
 Superex delivers the full range because of separate woofer and tweeter in each phone

You deserve the most advanced phones... adjustable treble control in each phone... miniaturized cross-over network in each phone... single lead with stereo plug! For true stereo or monaural listening (full 20-20,000 cps range; 8-16 ohms impedance) get the most remarkably engineered stereo-phones ever built. Write for Free Valuable Handbook ST-M \$29.95

SUPEREX stereo/phones
 SUPEREX ELECTRONICS, 1 RADFORD PLACE YONKERS, N.Y.
 CIRCLE NO. 71 ON READER SERVICE CARD

SAVE OVER 40% ON HI-FI
 USE OUR EASY-PAY-PLAN Up to 24 months to pay

DON'T BUY HI-FI-COMPONENTS

Tape Recorders or Electronic Equipment until you get return mail quotation from "your friend in the business."

- Trade-Ins—Highest Allowance—Send us your list.
- 15 day money-back guarantee.
- Full 2-year warranty—parts & labor.
- We are factory franchised all lines. We ship from stock.
- 18th year of dependable & reliable service throughout the world.
- We guarantee "We Will Not Be Undersold."
- Call us at (212) EN 9-3700 from any part of U.S.A. You may deduct 3-minute toll charge if your order is in excess of \$100.00.

BEST BUY HI-FI LIST FREE. Send 10¢ for stereo tape catalog—All labels save 33 1/3%.

ELECTRONIC WORLD HI-FI RECORDING TAPE

7" Spools - Splice Free - Freq. Resp. 30-15KC

60M	3 1/4"	600' Mylar	3.11	12+
12A	7"	1200' Acetate	\$1.09	\$.99
18M	7"	1800' Mylar	1.89	1.79
24M	7"	2400' Mylar	2.59	2.39
24MT	7"	2400' Mylar-Ten.	2.89	2.79

Any assortment permitted for 12+ price. Add 15¢ per reel postage & handling, continental U.S.A. Write for complete listing & 100+ price.



1797-H First Ave., New York 28, N.Y.

CIRCLE NO. 43 ON READER SERVICE CARD

tel; *Portofino*; *Lazy Afternoon*; and nine others. MGM SE 4056 \$4.98, E 4056* \$3.98.

Interest: Attractive program
 Performance: Bland
 Recording: Very good
 Stereo Quality: Good

The idea was intriguing: a program of songs first heard in off-Broadway musicals sung by an actor who first won notice off Broadway. The only trouble is that Jerry Orbach has a dry and uninteresting voice that, save for a well-done *Mack the Knife*, seems incapable of projecting a vocal characterization.

Though the program includes such worthwhile, though little-known, items as *What Can It Be?*, *King of the World*, and *Laddie*, I was surprised to find two ringers, *There's a Small Hotel* and *I Could Be Happy with You*, being passed off as off-Broadway numbers. Arranger Norman Paris again proves that he is easily one of the most imaginative and tasteful men in the business. S. G.

THEATER — FILMS

Ⓢ Ⓜ **LEONARD BERNSTEIN: *The Popular Music of Leonard Bernstein.*** Alfred Drake (baritone) and Roberta Peters (soprano); Ray Charles Singers; Enoch Light and his Orchestra. *Tonight; Maria; It's Love*; and seven others. COMMAND RS 855 SD \$5.98, 33855* \$4.98.

Interest: Bernstein's Broadway
 Performance: Concert atmosphere
 Recording: Brilliant
 Stereo Quality: Tasteful and effective

It's been six long years since Leonard Bernstein was represented on Broadway by a score. This record of selections from his four musicals reminds us how much we have missed. All of the pieces have a musicianship and craftsmanship that make them not only durable but continually exciting. They are presented here in a manner that suggests an original-cast album, with its *New York, New York* opening, solo and choral numbers, and finale of reprises. The resulting theatrical flavor, although vivid, is not the same as in-the-theater realism, partly because of the extraordinarily taut control of conductor Light, who has unified the attack of his varied performers to the point that they suggest a virtuoso on a single astonishing instrument. The highly stylized singing of Alfred Drake and the impressive soprano range and spectacular coloratura of Roberta Peters—outstanding in *Glitter and Be Gay*—further intensify the production's concert-hall atmosphere.

Sonically, the record is a joy. Each instrumental and vocal solo comes across with remarkable clarity. Probably for the first time in its history, every word of

Gee, *Officer Krupke* can be heard perfectly, and neither tempo nor characterization is sacrificed. S. G.

Ⓢ Ⓜ **PORGY AND BESS** (George Gershwin - Ira Gershwin - DuBose Heyward). Leontyne Price, William Warfield, McHenry Boatwright, John W. Bubbles; chorus, Leonard DePaur cond.; orchestra, Skitch Henderson cond. RCA VICTOR LSC 2679 \$5.98, LM 2679* \$4.98.

Interest: Eternal
 Performance: Impressive
 Recording: Very clear
 Stereo Quality: Balance occasionally off

If RCA Victor can lavish the complete-opera treatment on Verdi and Puccini and Wagner, why not on Gershwin? By universal consent, *Porgy and Bess*, if not technically an opera, is nonetheless the



ENOCH LIGHT

Virtuoso on an astonishing instrument

most highly regarded American musical drama. Yet this new release, impressively sung and conducted, is a collection of arias and scenes that merely whets the appetite for the entire work. Columbia produced a complete *Porgy and Bess* over ten years ago, and with the advantages of stereo and Dynagroove, it is unfortunate that RCA has, at this late date, been content to offer excerpts.

The remarkably vibrant and rich voice of Leontyne Price and the sonorous baritone of William Warfield were first heard in the leading roles when the two appeared in the Robert Breen production of *Porgy and Bess* some eleven years ago. In addition to Bess' songs, Miss Price sings Clara's deeply affecting *Summertime*, and Serena's heart-rending *My Man's Gone Now*. McHenry Boatwright as Crown is properly forceful and robust in the duet, *What You Want wid Bess?*, though neither he nor Miss Price is easy to understand in the dialogue. By far the weakest of the principals is John Bubbles (Continued on page 116)



What went on in room 433 at the New York Hi-Fi Show?

The first solid state receiver...Bogen's RT1000 a superb instrument accorded the most enthusiastic response

The response was twofold. People responded to the Bogen technology which produced the FM-Stereo and FM/AM RT1000. And they responded to the understated elegance of design, to the hushed gold front panel. The RT1000 responded with pure performance. In high fidelity, transistors have just one reason for being . . . to make a component perform better. We knew the RT1000 was a milestone. Now all who saw and heard it in room 433 know it, too.

Here are but a few reasons why: 100 watts of exceptionally clean power (50 per channel). Distortion is practically extinct since transistors replace a major source, *output transformers*. The RT1000 is actually hum-free.

Cool. That's a good word for the RT1000. Transistors reduce heat markedly. That does away with enclosure vents ordinarily needed to cool the chassis.

Let's talk tuner, FM-Stereo and FM/AM that is. Separation, selectivity and sensitivity approach professional perfection. Flywheel tuning that sweeps the dial as effortlessly as moving your fingers. An FM-Stereo switch position automatically lights the Stereo Minder Indicator when mono transmission changes to stereo.

Summing up the responses, "there has never been a sound quite like it . . . clean, cool, pure performance." Check your own responses. Let us send you free, detailed literature on the RT1000 all-transistor receiver. Just mail the coupon below.



LEAR SIEGLER, INC.  BOGEN COMMUNICATIONS DIVISION
PARAMUS, NEW JERSEY

Please send me literature on the RT1000 and a catalog of all the 1963 Bogen Components.

Name

Address

City.....State.....

R-12

BOGEN

Mated to Perfection!

THORENS

NEW STEREO TURNTABLE
WITH INTEGRATED ARM



THORENS TD-135

COMPLETE WITH INTEGRATED ARM

For the first time, Thorens — in the new TD-135 — offers a *component-quality* arm and turntable mated with a precision that insures you perfect sound . . . always . . . with a minimum of installation effort on your part.

There's no compromise whatever with quality such as you usually find in integrated turntable and arm units. THORENS TD-135 is Swiss-precision crafted throughout . . . true component high fidelity all the way. You get: A precision turntable featuring 4 speeds, all adjustable, with an 8-pound non-magnetic table . . . plus a completely new, advanced tone arm that's so good we also sell it separately (see below) for use with *any* turntable of your choice. Exceeds NAB specs for wow, rumble and flutter. Has same belt-plus-idler drive as famous TD-124. Shuts off automatically at end of record. Many, many more features than we can detail.

\$125 net



THORENS BTD-12S

12" PROFESSIONAL TONE ARM

Identical arm included with TD-135, but sold as separate unit. Less than 0.5" inch tracking error. Built-in cueing device. All adjustments: vertical height; calibrated gram-force; stylus positioning slide; balancing counter-weight. Unique vertical pivot keeps stylus vertical for any height adjustment. Resonance well below audible frequencies. Interchangeable 4-pin cartridge shells. Mounted on board for THORENS TD-124, TD-121 turntables.

\$50.00 net

See and hear the THORENS TD-135 and ALL the members of the "TD" family of fine turntables at your franchised dealer's today; there's one for every budget! For additional information, write us direct.



THORENS DIVISION

ELPA MARKETING INDUSTRIES, Inc.

New Hyde Park, N. Y.

In Canada: Tri-Tel Associates Ltd., Willowdale, Ont.

CIRCLE NO. 28 ON READER SERVICE CARD

116

as Sportin' Life. Bubbles, who played the role in the original 1935 Broadway production, strains mightily, but his voice sounds the worse for wear.

The balance between orchestra and singers is not always satisfactory. Occasionally, as in *Bess, You Is My Woman Now*, the soloists are engulfed by the orchestra. The packaging is quite handsome, though it does not state who sings what. S. G.

© © 1963—THE YEAR'S MOST POPULAR THEMES. Orchestra, Enoch Light cond. COMMAND RS 854SD \$5.98, RS 854* \$4.98.

Interest: Movie music
Performance: Spectacular
Recording: Superduper
Stereo Quality: Spectacular

Close your eyes and you would swear you were in the nearest Loew's theater as Mr. Light whips his forces into the heady stretches of spectacular arrangements based on the year's Hollywood themes, and a couple of foreign items as well. The driving, pounding energy of the music from *Hud* should be played only in solidly built houses, or the walls might come tumbling down, and the opening stuff from *Mutiny on the Bounty* will put your equipment to the severest test. Listeners preoccupied with technical achievements are likely to get more of a thrill from some of the weaker stretches—sticky passages from *Days of Wine and Roses*, *Spencer's Mountain*, and atmosphere laid on with twenty trowels from such epics as *Lawrence of Arabia* and *Cleopatra*—than those whose first love is music. But Command is to be commended for capturing, particularly in stereo, the essence of that luxurious wide-screen feeling of anticipation you get as the picture starts in a big movie house. P. K.

© © THEY STOPPED THE SHOW! Broadway-cast performances. Mary Martin; Alfred Drake and Joan Roberts; Betty Garrett; John Raitt; Rosalind Russell; Danny Scholl; Ray Bolger; Gertrude Lawrence; Walter Huston; Gertrude Nielsen; Dolores Gray; Dooley Wilson. DECCA DL 79111 \$4.98, DL 9111* \$3.98.

Interest: Theatrical highlights
Performance: Memorable
Recording: Poor-to-acceptable
Stereo Quality: Nil

That © for stereo at the upper left-hand corner of this review is there only because Decca has brazenly put "Stereo" across the top of the record jacket. Let no one be deceived: what Decca has done is merely to reprocess old mono recordings, many of them 78's, and some dating back over twenty years! If you can over-

come your feelings about such deception, you should enjoy listening to this catch-all. Half the numbers included are also part of currently available original-cast albums on LP. The other half, however, consists of such currently unavailable show-stoppers as Gertrude Nielsen trumpeting *I Wanna Get Married*, and Ray Bolger gaily inviting the audience to join him in singing *Once in Love with Amy*. S. G.

FOLK

© © THE BADMEN. Pete Seeger, Ed McCurdy, Harry Jackson, Carolyn Hester, Jacques Menahem (vocals); Sandy Bull, Charlie Byrd (guitars); George Bolds, Zoe Tilghman, Homer Croy, Sophie Poe (spoken reminiscences). *Billy the Kid; Sam Bass; Jesse James; Belle Star*; and fourteen others. COLUMBIA L2S 1012* two 12-inch discs \$11, L2L 1101 \$10.

Interest: For Western buffs
Performance: Adequate to excellent
Recording: First-rate

This handsomely produced two-volume set is part of Columbia Records' Legacy Collection series. Accordingly, the recording comes with an imposing book, containing essays about "The Badmen" along with photographs of them, some alive and some, by the time the camera caught them, riddled to death. As for the music, the first two sides contain performances—both solo and in rather ragged ensembles—by Pete Seeger, Harry Jackson, Ed McCurdy, Jack Elliott, Carolyn Hester, and Jacques Menahem.

Jackson and Elliott are by far the most convincing interpreters of these tales of Western rogues and mythical heroes—Jackson is in particularly solid command of the idiom. Pete Seeger is often affecting, especially in *The Cowboy's Lament*, but Ed McCurdy is stiff, and Miss Hester's ingenuous approach is simply out of place. A welcome inclusion from Mexican balladry is Jacques Menahem's story of Gregorio Cortez, whose fascinating history is detailed in the book. The performance is marred, however, by the presence of Miss Hester.

The second disc is devoted to reminiscences of the old West by George Bolds, Zoe Tilghman, Homer Croy, and Sophie Poe. These additions to the oral history of the West are valuable, but hardly warrant replaying by the nonspecialist.

The enclosed booklet is a deromanticizing of the Western badman. There are essays by B. A. Botkin, Harold Preece, and James Horan, biographies of the desperadoes who are sung about on the record, background information, and complete texts of the songs. In addition to the photographs of the badmen, there are fascinating drawings and reports from

contemporary newspapers and magazines. Having absorbed all this material, no listener will ever again be taken in by the fanciful rewriting of history that takes place nightly on television westerns.

The set is recommended more for the booklet than for the music, although the work of Harry Jackson and Jack Elliott is first-rate. *N. H.*

RECORDING OF SPECIAL MERIT

© **DUKES OF DIXIELAND/CLARA WARD AND HER GOSPEL SINGERS: *We Gotta Shout!*** Frank Assunto (trumpet), Fred Assunto (trombone), Jac Assunto (trombone, banjo), Kenny Davern (clarinet), Gene Schroeder (piano), Jack Six (bass), Buzzy Drootin (drums), Alton Williams (organ); Clara Ward, Mildred Means, Voyla Crowley, Malvilyn Simpson, Geraldine Jones, Vermettya Royster, Thelma Bumpess (vocals). *Move Along; In the Morning; Marching In; Michael Row the Boat Ashore*; and seven others. COLUMBIA CS 8842 \$4.98, CL 2042* \$3.98.

Interest: Gospel plus Dixie
Performance: Exciting
Recording: Good
Stereo Quality: Good

On the face of it, the decision to pair the Dukes of Dixieland with Clara Ward and her Gospel Singers would seem to be motivated more by commercial than musical considerations. But however conceived, it has turned out well. The Ward Singers have never sounded better, and except for one clinker by Frank Assunto on *Travelin' Shoes*, the Dukes acquit themselves admirably. The Ward ensemble adds an organist and tambourines to the Dukes' instrumentation, and the group sound is instantly thrilling. For the most part, the Dukes play a decidedly subsidiary role, confining themselves mainly to accompaniment and obbligatos. The piece in which they participate most fully, *Just a Closer Walk*, is also the most successful. Mention should be made of Thelma Bumpess, not a regular member of the Wards, whose vocal on *I'm Too Close to Heaven* is one of the high moments of the set, and of Kenny Davern, a fine little-known clarinetist who is now a member of the Dukes.

All in all, the Dukes' freewheeling exuberance and the Ward Singers' exciting redemption singing combine, however unlikely, to result in a resounding success. *J. G.*

© **JOHN HAMMOND: *John Hammond*.** John Hammond (vocals, guitar, mouth-harp). *Two Trains Running; This Train; Mean Old Frisco; Crossroads Blues*; and nine others. VANGUARD VRS 9132 \$5.95, VSD 2148 \$4.98.

(Continued on page 118)

A FAX 2-RECORD SET
FAXLP-5201 (monaural)
FAXLP-5201S (stereo)
High Fidelity Sound
33 1/3 RPM



the Ballad of Fanny Hill

AN ORIGINAL MUSICAL MONODRAMA
based upon the book
memoirs of a woman of pleasure

by **JOHN CLELAND**
Produced and Directed by **BILL DOOR**
Text written by **VINCENT PURCELL**
Lyrics by **CHARLES SYDNEY**
Music by **GERALD COATES**
And featuring **JULIE HAMILTON**
as Fanny Hill

The most famous erotic novel ever published in the English language now comes to life in a brilliant musical monodrama — *The Ballad of Fanny Hill*. This delightful heroine has survived the gross indignities of oppression, condemnation and censorship associated with the book's turbulent 200-year history, and now frolics through her ribald misadventures to a new musical tune. The lyrics transport the flavor of Cleland's prose into a humor and form to delight the modern ear. The music sparkles with 18th century verve.

This Fax 2-record album brings you the very first performance of this new musical that is most certainly destined for on-stage production in the near future. Miss Julie Hamilton, the gifted young lady in the role of Fanny Hill, handles both the dramatic and musical sections with inspired virtuosity. The album is a collector's edition you'll not want to miss.

SONGS • TRUTH, NAKED TRUTH • ALIVE, ALIVE, OH • LADEN WITH MAIDEN • LEWD, LASCIVIOUS PHOEBE • CHARLES • REVENGE • EMILY'S TALE • HARRIET'S TALE • LOUISA'S TALE • TWICE A VIRGIN • GENTLEMEN OF NOBILITY • THRASH ME, LADDIE • AT THE MASKED BALL • PARAMOUR OF PLEASURE • REPRISÉ . . . CHARLES • ONE LOVE IS ALL LOVE



THE BALLAD OF FANNY HILL (2-record Set)
FAXLP-5201 (monaural) \$ 9.95
FAXLP-5201S (stereo) \$11.95

Special pre-release offer! For immediate delivery send your order direct to:

FAX RECORD COMPANY
DEPT. E-7
6 3 1 1 Y U C C A S T R E E T
H O L L Y W O O D 2 8 , C A L I F O R N I A
Soon available at your record dealer!

© COPYRIGHT 1963. FAX RECORD CO. ALL RIGHTS RESERVED



**some rather special
stereo tape
Christmas offerings:**

NUTCRACKER

Tchaikovsky. Ansermet & Orchestre Suisse Romande. Complete—Twin-Pak. London #80027—\$11.95

MESSIAH

Handel. Joan Sutherland, Kenneth McKellar, Sir Adrian Boult, London Symphony & Chorus. Complete—2 reels. London #80077—\$21.95

18th CENTURY CONCERT

Solisti di Zagreb. Vanguard #1617—\$7.95

**MAGNIFICAT IN D
CANTATA No. 50**

Bach. Prohaska and the Vienna State Opera Choir & Orchestra. Vanguard #1629—\$7.95

**MISSA HERCULES DUX FERRARIAE
& MOTETS**

Josquin Des Pres. Vienna Kammerchor & Antique Society, Hana Gillesberger, cond. Vanguard #1644—\$7.95

NOTRE DAME MASS

Guillaume de Machaut. Perotin: Viderunt Omnes; Sederunt Principes; the Deller Consort; Renaissance Chamber Ensemble. Vanguard #1644—\$7.95

MADRIGAL MASTERPIECES

Alfred Deller Consort. Vanguard #1652—\$7.95

REQUIEM

Mozart. Herman Scherchen, Vienna State Opera Orchestra; Vienna Academy Chorus. Westminster #122—\$11.95 (Twin-Pak)

MASS IN B MINOR

Bach. Scherchen. Westminster #119—\$19.95

MESSIAH

Handel. Vienna Academy Chorus & Soloists; Vienna State Opera Orchestra, H. Scherchen, cond. Westminster #134—\$23.95

GLORIA

Vivaldi. Mimi Coertse, Ina Dressel, Sonja Draxler; Vienna Academy Chorus; Vienna State Opera Orch. H. Scherchen, cond. Westminster #153—\$7.95

CHRIST ON THE MOUNT OF OLIVES

Beethoven. Jan Peerce, Maria Stader, Otto Wiener; Vienna Academy Chorus; Vienna State Opera Orch., H. Scherchen, cond. Westminster #160—\$7.95

A FESTIVAL OF LESSONS IN CAROLS

Choir of Kings College Chapel, Cambridge University. London #90071—\$7.95

Look for these unusual Christmas releases at your music or electronics dealer. Write for free catalog of other albums. Ampex United Stereo Tapes, 401 Broadway, Redwood City, Calif.



CIRCLE NO. 7 ON READER SERVICE CARD
118

Interest: Blues revivalist
Performance: Honest
Recording: Excellent
Stereo Quality: First-rate

John Hammond is one of the growing number of city folk singers who are trying to express themselves through immersion in the Negro blues tradition. Nearly all these acolytes, the twenty-year-old Hammond included, have the same basic problem: their own backgrounds are completely unlike the environment of oppression that produced the authentic Negro blues singers. The best of the young city bluesmen have studied their Negro models faithfully, and they feel a sympathy for the Negro's experience in America, but they are outsiders in the Negro blues idiom. For all their eagerness and honesty, they are not completely convincing.

Hammond, son of jazz expert and Columbia Records executive John Hammond, comes close to being genuinely affecting as *himself*. On the more lyrical blues, Hammond communicates a directness of emotion and sings with a resilience of line that are quite impressive. When he adopts a guttural swagger, however, and sings such defiant blues as Muddy Waters' *The Hoochie Coochie* and Big Bill Broonzy's *This Train*, he begins to sound self-conscious and alien. Even, for that matter, on the more introspective blues, the effect is blurred by the realization that Hammond is speaking through other people's experiences and with other people's imagery.

Maynard Solomon, who contributes an excellent, concise analysis of country blues in the notes, has suggested elsewhere that city singers such as Hammond must be measured as themselves, apart from the Negro tradition. This objectivity is impossible, however, as long as the city singers continue to shape themselves so directly from older Negro prototypes and as long as they continue to base their repertoire on songs out of another time and another culture. Alongside every one of Hammond's numbers here, for example, is listed the recorded source for his performance—from Blind Lemon Jefferson to Chuck Berry.

The answer—if there is an answer—is that these young blues aspirants should try to develop their own repertoire out of their own needs and experiences. Eventually, they must transcend their influences and find their own singing styles if they are to make the blues contemporary for themselves as performers. Otherwise, they will remain (like Hammond) skillful imitators. N. H.

© **BURL IVES:** *Burl*. Burl Ives (vocals); orchestra and chorus, Owen Bradley cond. *Curry Road*; *The Same Old Hurt*; *I'm the Boss*; *Busted*; and seven others. DECCA DL 4361 \$3.98.

Interest: Ives in Nashville
Performance: As usual
Recording: Good

This album should have been called "Burl Ives Goes to Nashville." Ives, whose voice has a pure, remote quality that tends to make any song sound at least fifty years old, essays here the work of the contemporary Nashville tunesmiths. Chief among them is Harlan Howard, a young man who has said that "boy, a good, well-written sad song just tears me up." His *Mary Ann Regrets*, which sounds like a condensation of Henry James' *Washington Square*, is the best thing on the album. *Busted*, a more realistic situation, fails because Ives does not bring to it the involvement that (for example) characterizes Johnny Cash's recording. Cash, who works with much of the same material, uses stark backgrounds and a near-monotone to counteract the



TESTAMENT RECORDS

BILL JACKSON

Subtle and inventive East Coast bluesman

sentimentality of many of the lyrics, but Ives surrenders to bathos and makes the songs ludicrous. He is much better on *The Moon is High*, a song whose raucous humor depends on its off-kilter construction. Elsewhere, Ives fans are likely to feel he has tried to work with the wrong material—and followers of country-and-western music will probably feel that some good songs have been given the wrong interpreter. J. G.

RECORDING OF SPECIAL MERIT

© **BILL JACKSON:** *Long Steel Rail*. Bill Jackson (vocals and guitar). *Last Go-Round*; *Titanic Blues*; *Blues in the Morning*; *Blood Red River*; and nine others. TESTAMENT T 201 \$4.98.

Interest: Maryland blues
Performance: Subtle and unique
Recording: Good

SANBORN'S
DALLAS, TEXAS

"HI!

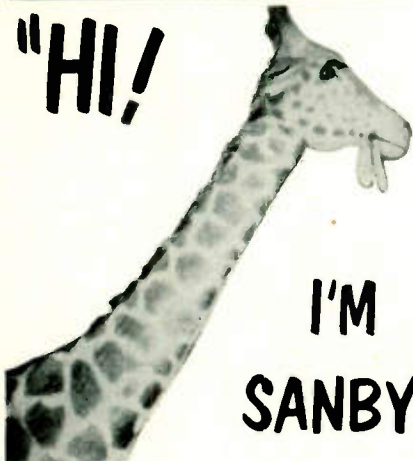

I'M
SANBY"

WITH SOME FABULOUS NEWS
Buy components direct
from wholesale distributor
3 YEARS TO PAY
LOW INTEREST RATES

Let Us Send You
A Quote For Lowest Prices



OVER 50 BRANDS

FREE! Send for low, low,
low quotes on the
following equipment...

- KITS
 - CHANGERS
 - AMPLIFIERS
 - SANBORN'S SPECIALTY EQUIPMENT CABINETS
 - MICROPHONES
 - TUNERS
 - SPEAKERS
- Write Us for Your Special System Prices

SANBORN'S STEREO CITY
5551 W. LOVERS LANE
DALLAS 9, TEXAS

Name _____
Address _____
City _____ Zone _____
State _____

CIRCLE NO. 88 ON READER SERVICE CARD
DECEMBER 1963

Peter Welding, a former critic for HiFi/STEREO REVIEW and now an associate editor of *Down Beat*, has launched his own record label by focusing on a relatively unexplored area of the blues tradition. Bill Jackson, fifty-seven, originally from Maryland and later based in Philadelphia, represents what Welding terms the East Coast blues style. By contrast with the more immediately visceral, raw blues of the Mississippi Delta and other parts of the South and Southwest, the East Coast approach, Welding notes, "is characterized by a carefully controlled emotionality; a deliberate, more sedate handling of vocal and instrumental techniques; a very conscious awareness of and adherence to formal elements; and an extremely high caliber of musicianship, especially as regards the complexity of instrumental accompaniment."

Jackson is a subtle guitarist, complementing his vocals with more inventive and flexible instrumental patterns than is common in most blues singers. His voice is soft-edged and his phrasing seems casual, so he does not make a strong first impression. Closer listening, however, reveals a clarity and consistency of style that are insinuating and appealing. Although Jackson does not shout or moan, he communicates deep involvement with his material: his passion is disciplined and distilled.

Another element in these Eastern blues, as sung and played by Jackson, is their considerable use of white Anglo-American as well as Negro sources. Included with the album is a transcript of Jackson's absorbing reminiscences of the music made by workmen and other neighbors in the Maryland of his youth. Since this new label has limited distribution, the Jackson record can most easily be ordered by mail (Testament Records, 5851 Blackstone Avenue, Chicago 37, Illinois; the \$4.98 price is postpaid). N. H.

RECORDING OF SPECIAL MERIT

• T-BONE WALKER: *His Original 1915-50 Performances*. T-Bone Walker (guitar and vocals), Bumps Myers (tenor saxophone), Karl George (trumpet); others unidentified. *I'm Still in Love with You; I Want a Little Girl; Wise Man Blues; Born to Be No Good*; and eight others. CAPITOL. T 1958 \$3.98.

Interest: Sensual blues
Performance: Expert and relaxed
Recording: Good

Texas-born T-Bone Walker moved to California in the mid-1930's, and by 1943 he was a very popular recording artist. Capitol has reissued twelve sides from the period of his widest renown. Made between 1945 and 1950 on the now-defunct Black and White label, these are craftsmanlike performances by a man

STANLEY KRAMER
PRESENTS

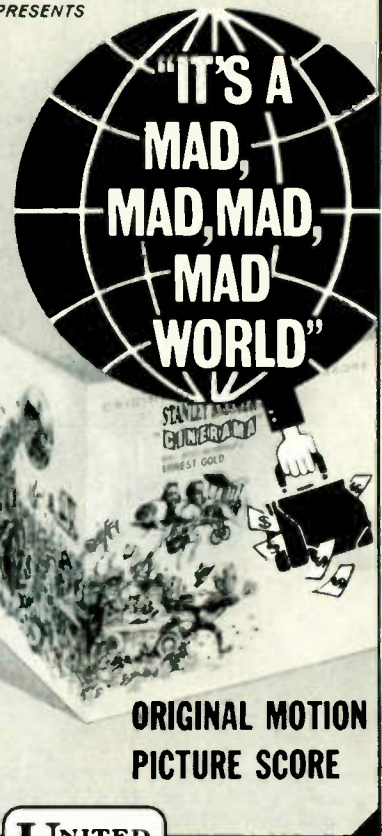

ORIGINAL MOTION
PICTURE SCORE

UNITED
ARTISTS
RECORDS

TRULY the Prudent
Name in Entertainment

CIRCLE NO. 87 ON READER SERVICE CARD

MOVING?



If you've recently changed your address or plan to in the near future, be sure to notify us at once. Place magazine address label here and print your new address below.

NEW ADDRESS:

NAME _____ PLEASE PRINT
ADDRESS _____
CITY _____ ZONE _____ STATE _____

Please fill in moving date below:

If you have any other questions about your subscription be sure to include your magazine address label when writing us.

Mail to: HiFi/STEREO REVIEW, 434 So. Wabash Avenue, Chicago 5, Illinois

LESA

DIRECT FROM ITALY... OVER 30 YEARS OF QUALITY



The LesaMatic CD3/31 is a superb unit. It plays manually or automatically and has a jam-proof arm, aside from many other features. See and hear it for yourself. Write for free brochures to Lesa of America Corp., 32-17 61 Street, Woodside 77, New York, Dept. C

NOTE: LESA ANNOUNCES A ONE-YEAR GUARANTEE ON ALL PRODUCTS!

CIRCLE NO. 52 ON READER SERVICE CARD

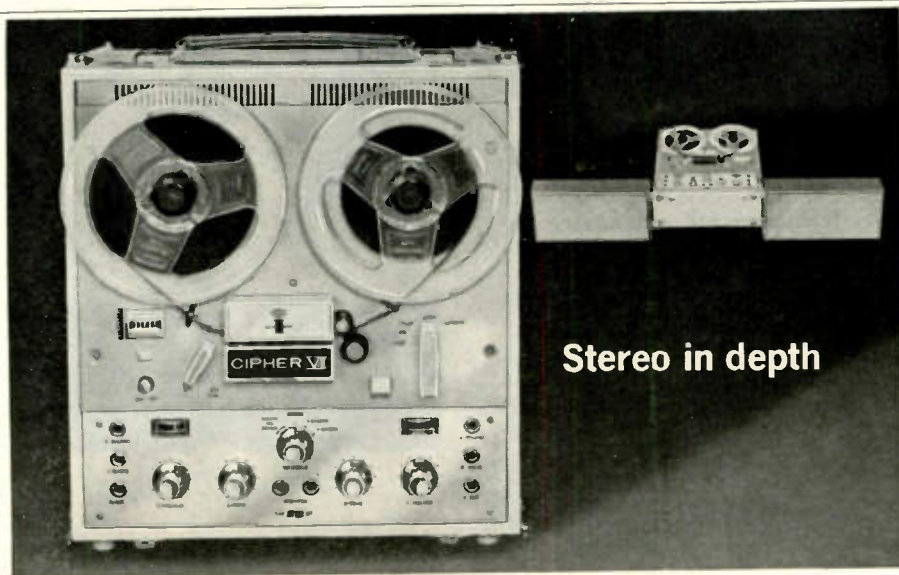

Stereo in depth

CIPHER VII STEREO

In so many ways, the new Cipher VII stereo tape recorder is heads above the crowd: records and plays back in 4-track, 3-speed stereo or monaural, records sound-on-sound, and its two full-range speakers are detachable for best positioning. Cipher VII can be played horizontally or vertically, or it can be installed into your present hi-fi system.

Other professional features of the Cipher VII include: separate volume and tone controls for each channel • 2 dynamic microphones • 2 VU meters • editing facilities • tape index counter • auto, reel-end shut-off • 10 watt output • two-tone cabinet with brushed aluminum control panel. **\$274.95**

For brochure and name of nearest Cipher dealer, write to:
INTER-MARK CORP., Dept. SR, 29 West 36th Street, New York 18, N. Y.



CIRCLE NO. 42 ON READER SERVICE CARD

who relies for effect on subtlety of phrasing and intimacy of mood. His voice is soft and inviting, provocatively complemented by his virile guitar-playing. Not all the material is of top quality. T-Bone, however, rescues most of it, and when he has a superior tune—such as *I Want a Little Girl*—he shows how singularly affecting a storyteller he could be. Unlike some of the more prestigious blues singers, T-Bone wears very well throughout a long-playing disc, and Capitol is to be commended for issuing this one.

N. H.

SPOKEN WORD

© M BERTOLT BRECHT: *Bentley on Brecht*. Eric Bentley (adapter and performer). RIVERSIDE RS 97017* \$4.98, RM 7017 \$4.98.

Interest: Brecht
 Performance: Amateurish
 Recording: Indifferent

Eric Bentley is an outstanding authority on the theater, a brilliant teacher, and an exceptionally astute, if at times pedantic, translator. Here Mr. Bentley sings many of his own translations of Brecht's songs, some to the accompaniment of a prepared piano or a wheezing harmonium, and he annihilates every one of them. He calls himself an untrained singer, but that is begging the question. Aside from the issue of vocal quality, he has missed the mark in projecting the humor, irony, and earthiness of this material—you can measure how far by comparing the performances with identical selections in Columbia's admirable original-cast recording of "Brecht on Brecht." Mr. Bentley's straight readings, too, are distressingly nasal and professorial, and his choice of material for the program is heavily weighted on the side of the sordid, the sullen, and the scatological. Even so, much brilliant writing passes in review, and it is interesting to compare the seldom-heard (at least on this side of the Berlin wall) settings of Brecht lyrics by Hans Eisler and Stefan Wolpe with the more familiar Kurt Weill efforts. The Eisler songs seem curiously sophisticated musically for their subject matter, but are rarely infectious, and the Wolpe attempts scarcely register at all.

And let's face it—Mr. Bentley is just no substitute for Lotte Lenya. P. K.

RECORDING OF SPECIAL MERIT

© RUDYARD KIPLING: *From the Jungle Books—How Fear Came*. Boris Karloff (reader). CAEDMON TC 1100 \$5.95.

© RUDYARD KIPLING: *From the Jungle Books—Toomai of the Elephants*. Boris Karloff (reader). CAEDMON TC 1176 \$5.95.

HIFI/STEREO REVIEW

Interest: Entrancing children's tales
 Performance: Soft-spoken
 Recording: Fine

Rudyard Kipling's accounts of the adventures of Mowgli, the Indian boy brought up by wolves in the jungle, generally demand more attention and imagination from youngsters than is expected by today's story-tellers. Children who give themselves to the spell of these stories, however, are as likely to become devoted *Jungle Book* addicts as were their forbears. As Boris Karloff, in that hypnotic purr he adopts for readings of this kind, leads the listener into the jungle for the eerie tale of how fear came to the animal world, it is hard to conceive an audience of any age being anything but spellbound. The same is true for the tale of Toomai, the son of an elephant herdsman, who manages to track the pachyderms to their secret hiding place and witness their lurid ritual dance. These are wonderful additions to the growing anthology of Kipling tales Caedmon has recorded with this actor, including, to date, two volumes of the *Just So Stories* and *Mowgli's Brother*. P. K.

© © **LET FREEDOM RING.** Fredric March and Burgess Meredith (readers).
 COLPIX SCP 515 \$5.98, CP 515* \$4.98.

Interest: Bells and bills-of-rights
 Performance: Good
 Recording: Excellent
 Stereo Quality: Three-dimensional

This is probably the most tinkling and ringing album ever made. It includes the sounds of bells from no fewer than eighteen schools, churches, military academies, and ships, all tolling away for freedom with a force that eventually makes you feel as if you're being struck right in the sinuses. The bells mostly play patriotic numbers—*Three Cheers for the Red, White, and Blue*, *My Country 'Tis of Thee*, and the like—and their timbres and sonorities are so varied and well recorded that the total effect is quite overwhelming. Most spectacular of all is the sound of the carillon in New York's Riverside Church. The second side offers a lucid, but insufficiently grand, reading of that resounding document the Declaration of Independence, by a somewhat tired-sounding Fredric March, and a more vigorous rendition of the Bill of Rights by Burgess Meredith. A playing of this disc—the idea for which originated in the editorial offices of *This Week* magazine—might make a Fourth of July at home more meaningful than does the usual cacophony of fireworks. P. K.

© © **SHAKESPEARE AT STRATFORD.** Royal Shakespeare Company: Max Adrian, Peggy Ashcroft, Ian Ban-

NEW DECOR AND SIZE NEW PERFORMANCE

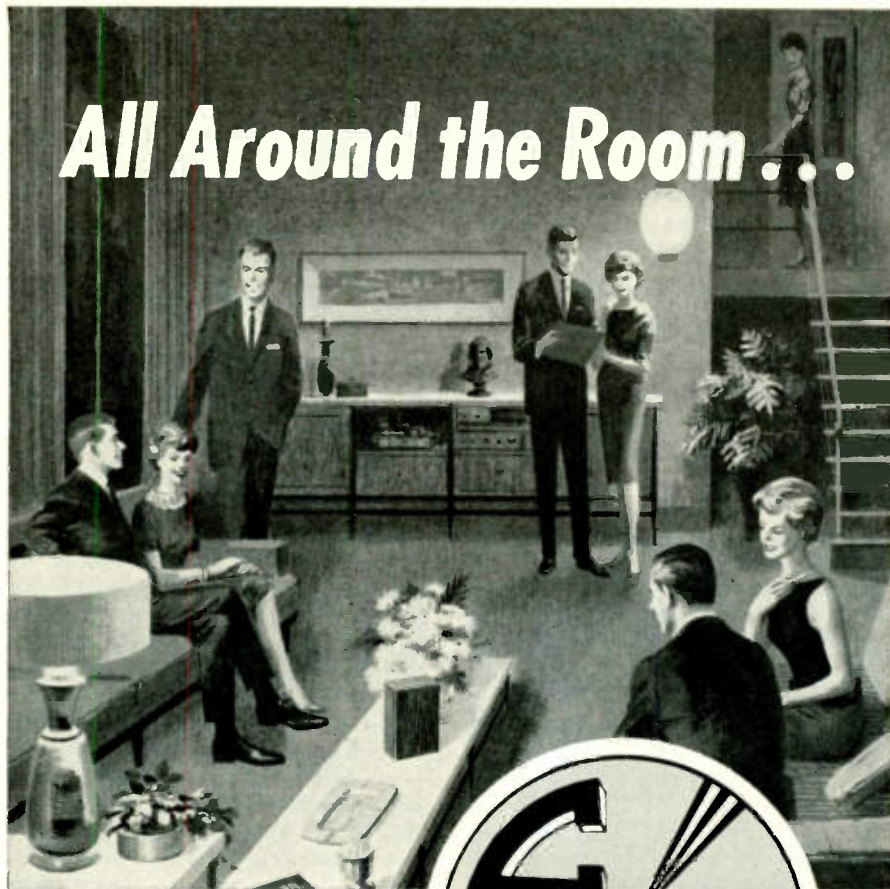

CAVITY
 GENERATED
 SPHERICAL



SOUND is *Everywhere!*

These people are enjoying an exciting new principle in sound reproduction. Everyone is receiving a uniform intensity of program material from this single Murray-Tone Cavity Generator Spherical Sound System regardless of his relative position or distance from the instrument!

True 360° spherical propagation is but one of the unique principles built into this quality instrument and offered to the listener for the first time from a single sound source.

"CG's" spherical principle and compact design encourage complete flexibility of placement — even under or behind furnishings — without distortion of performance in either monaural or stereo application.

The use of a single driver in Murray-Tone "CG" systems produces balanced, full-range sound with a new dimension of timbre, presence and response.



Introducing the
CAMILLE SERIES

Size: 11"x8"x4 1/4"—Full Frequency Range (without boom).
 Power: 8 Watts (measured).
 Propagation: 360 Spherical Degrees.
 OPTIONAL FINISHES:
 OILED WALNUT, HARVEST MAPLE OR LIMED OAK
 Moderately Priced at \$39.95

Murray-Carson Corporation

2424 E. 55th STREET DEPT. A, INDIANAPOLIS 20, INDIANA

SEND FOR LITERATURE AND
 DEALER INFORMATION

NEW LISTENING PLEASURE NEW PRINCIPLE

What is ZIP Code?

ZIP Code is a five digit distribution code designed to speed mail deliveries by cutting down on the steps now required to move a letter from sender to addressee. The code will also aid materially in the manual distribution of mail and will pave the way for mechanized distribution in post offices.

Ask your letter carrier or your post office for your ZIP Code—remember, it will speed your mail to you!

BUYER'S GUIDE TO COMPONENTS TRADING

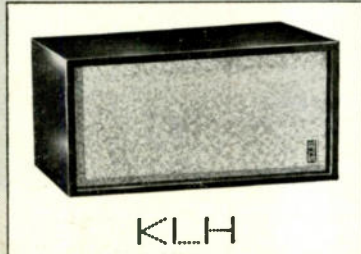

1 TUNERS, RECEIVERS & AMPLIFIERS . . . all leading makes and models. WHY BUY? When you can TRADE . . . and receive the highest trade-in allowance from the country's original and largest audio trading organization, Audio Exchange.

2 RECORD PLAYBACK SYSTEMS, AND TAPE RECORD/PLAYBACK . . . all leading makes and models. . . . The Hi Fi/Stereo components your ear is yearning for will not only cost you less when you trade by mail with Audio Exchange (or in person at our New York area showrooms), it's SAFER. Unmatched guarantees: free parts and labor within 90 days. . . 75% allowance in trade-back within 6 months . . . plus a 10-day money-back guarantee on USED components.

3 SPEAKER SYSTEMS, Wall, Large Enclosure and Bookshelf . . . all leading makes and models . . .

■ FREE—"TRADERS HANDBOOK"—a colorful 12-page booklet that explains everything about trading by mail. New components from over a hundred manufacturers, and guaranteed used equipment by the carload. All at lower cost because of higher trade-in allowances. Write for free copy.

audio exchange WORLD'S FIRST AND FOREMOST HI FI/STEREO TRADING ORGANIZATION

PLEASE MAIL ALL ORDERS AND INQUIRIES TO JAMAICA 153-21 Hillside Ave., Jamaica 32, N. Y. Dept. RG AXtel: 7-7577
WHITE PLAINS, N. Y. BROOKLYN, N. Y. MANHASSET, N. Y.
203 Mamaroneck Ave. 1065 Flatbush Ave. 451 Plandome Rd.

PLEASE SEND ME FREE BOOKLET

NAME _____
ADDRESS _____
CITY _____ STATE _____

nen, Esmé Church, Edith Evans, John Gielgud, Derek Godfrey, Paul Hardwick, Richard Johnson, Geraldine McEwan, Christopher Plummer, Eric Porter, Vanessa Redgrave, Elizabeth Sellars, Dorothy Tutin, and Patrick Wymark. LONDON OS 25770 \$5.98, 5770* \$4.98.

Interest: All-star sampler
Performance: Varying
Recording: Splendid
Stereo Quality: Excellent

If you are fond of what we have come to know as "coming attractions," the high points of the movie all happening at once and over in minutes, you may cotton to this assortment of scenes and speeches from the Royal Shakespeare Company's 1960 and 1961 productions of the plays. This aside, it must be admitted that there is a lot of great acting packed onto this disc. Elizabeth Sellars is particularly thrilling as Hermione in the trial scene from *The Winter's Tale*, and she scores again along with Edith Evans as the old Queen Margaret, in a scene from the fourth act of *Richard III*—the high point of the album. Other big moments are the scene from *Much Ado About Nothing*, in which Christopher Plummer as Benedict confesses his love to Beatrice, and she, devastatingly portrayed here by Geraldine McEwan, asks him to prove it by killing Claudio; Max Adrian's grand delivery of "All the world's a stage" from *As You Like It*; Othello's speech to the Senate, because of the intelligent reading by John Gielgud; and Vanessa Redgrave's winsome performance of the epilogue from *As You Like It*. There are some disappointments, but there are also more great stars, scenes, and speeches. Nonetheless, Shakespeare should not be served as *hors d'oeuvres*. P. K.

RECORDING OF SPECIAL MERIT

⑤ ⑥ SHAKESPEARE: *The Rape of Lucrece*. Tony Church, Peggy Ashcroft, Peter Holmes (readers). George Rylands, director. LONDON OSA 1251 two 12-inch discs \$11.96, A 1251* \$9.96.

Interest: Great dramatic poem
Performance: Intense
Recording: Superior
Stereo Quality: Heightens interest

Having presented his patron, the Earl of Southampton, with the rapturous pastoral *Venus and Adonis*, Shakespeare then astonished the man with the longer and far more serious *Rape of Lucrece*, his second published work and one of his greatest. The narrative concerns the betrayal of the Roman nobleman Collatinus (who boasts of the chastity of his wife Lucretia) by Sextus Tarquinius, whose father has recently taken over the king-

dom. Sextus, while a guest at the home of Collatinus, invades Lucretia's bedchamber and ravishes her. The Romans are so outraged that they banish Tarquin and his whole hated family. The poem's characterizations, its suspense, and its passages of philosophical digression make the work a Shakespearean history play in embryo. Not long ago the Shakespeare Recording Society released on the Caedmon label a magnificent reading of the whole text by Richard Burton. The present version is, if anything, even more magnificent, since the poem is approached as though it were indeed a play. The trio of actors (Sextus, Lucretia, and a narrator) enunciate Shakespeare's language with enormous feeling and comprehension, and at the same time bring to the drama the tension and excitement it needs to keep the persistent iambs from becoming monotonous. Shakespeare's dedication to his patron, a fulsome little paragraph, is read as a curtain-raiser. P. K.



SIR JOHN GIELGUD
Full justice for Shakespeare's sonnets

RECORDING OF SPECIAL MERIT

⑥ SHAKESPEARE: *Sonnets*. John Gielgud (reader). CAEDMON SRS M 241 two 12-inch discs \$11.90.

Interest: Poetic masterpieces
Performance: Unsurpassed
Recording: Excellent

Intimate, lyrical, and profound, the sonnets of Shakespeare stand, in relation to the body of English poetry, somewhat as the quartets of Beethoven do to all other music. Their commitment to discs by as distinguished a Shakespearean interpreter as Gielgud is a recording event, and I regret only that he did not choose to perform all 152 of them. Even though all but thirty-two are present, a few of my own favorites—and perhaps of yours—are missing. It is to be hoped that Caedmon will someday issue a supple-

ment to complete the collection. There are on LP records two complete versions of the sonnets—one on London discs, anonymously read, in the Marlowe Society tradition, and another on Spoken Word, read by Anew McMaster—but the intellect and feeling with which Gielgud informs his readings leave the competition far behind. Perhaps because he recorded them over a period of six months, a few at a session, he brings to each of the poems a fresh mood, a tempo that suits its theme, a tone, and even a timbre in keeping with its character. And what poems they are! The early verses are transparent and direct, as the poet implores the nameless addressee to perpetuate his beauty by marrying and having children. Starting with Sonnet 15, the poet resolves to assure the youth's immortality through his verses—a bold, and, as it turned out, a valid enough prediction. Sometimes whole groups of sonnets are variations on a theme—absence, jealousy, the ravages of age, or the mysterious dark lady to whom the poet speaks in so many. Gielgud reads them all with a full understanding of their richness, including such perfect examples as “When to the sessions of sweet silent thought,” “Not mine own fears, nor the prophetic soul,” and “Full many a glorious morning I have seen.” A beautiful album, with the bonus of a text containing all the sonnets read. *P. K.*

RECORDING OF SPECIAL MERIT

● **ROARK BRADFORD: *Of Man Adam.*** Mantan Moreland (reader). CAEDMON TC 1174 \$5.95.

Interest: Bible stories in dialect
Performance: Expert
Recording: Good

Roark Bradford's stories of “the time when the Lord walked the Earth like a natural man” would be justly celebrated if only because they inspired Marc Connelly's enchanting play *The Green Pastures*. As it happens, the tales also hold up beautifully alone: Sheba tells King Solomon “You got too many brains for a lil ole country gal like me”; Noah bargains with the Lord to let him bring just one more “kaig of likker” aboard the Ark; King David calls out “Good mornin’, sister” to the wily Bathsheba. Mantan Moreland, a distinguished Negro actor, reads the stories charmingly in a rich full dialect, yet skirts the pitfall of slurring or obscuring the words. *P. K.*

● **HARRY MORTON: *Look out for Harry Morton.*** UNITED ARTISTS UAL 4104 \$4.98.

Interest: New comic
Performance: Raconteur-type
Recording: Night-club atmosphere
(Continued on page 124)

DECEMBER 1963

Command Performance

at your fingertips ...



... every time you capture the magnificent world of full fidelity sound on tape.

Taped sound retains full fidelity even after hundreds of playbacks ... yours to enjoy always ... on VIKING tape components, naturally.

A VIKING invests you with unlimited versatility to record live programs or off the air including F.M. multiplex, duplicate, put sound on sound and edit with perfect ease.

Retro-matic 220 — ultimate performance with tomorrow's features for discriminating audiophiles and professionals only.

Two-directional playback, quarter track stereo at two speeds. "Feather-touch" push buttons, remote control, 12 watt amplifier, simultaneous record/playback with 20-25,000 cps frequency response. Independent channel controls, "luma-touch" record buttons and illuminated VU meters. Photo electric run-out sensor, four heads, hysteresis capstan motor plus two reel drive motors and digital counter. Superbly styled with stainless steel face plate this compact operates vertically or horizontally.



88 Stereo Compact—for connoisseurs of the fine things in high fidelity stereo sound.

Two speed tape recorder with choice of half or quarter track stereo. Three new type hyperbolic heads—no more old fashioned pressure pads. New design amplifier with excellent 30-18,000 cps frequency response, lets you monitor off the tape with "A-B" comparison switch. Independent channel controls and VU meters, two motors, record indicator light, counter, automatic tape shut-off. With its attractive, brushed aluminum face panel, the 88 Compact fits any installation for vertical or horizontal operation.

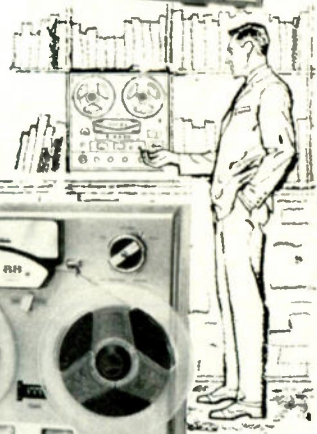
Put Command Performance at your finger tips with VIKING tape components — made by skilled American craftsmen.

Tape recorders, transports, cartridge players—even for your car or boat—at reputable high fidelity dealers most everywhere.



Viking OF MINNEAPOLIS, INC.
9600 Aldrich Avenue South, Minneapolis, Minnesota, 55420

Your assurance of Quality in Tape Components

CIRCLE NO. 78 ON READER SERVICE CARD

123

Newest from Telex
INTEGRAL CHANNEL CONTROL
 with HEADPHONE STEREO



The famous Stereo-Twin® performance is now linked with the most advanced engineering development in the headset field—INTEGRAL CHANNEL CONTROL.

This newest wonder of miniaturization from Telex Stereo Laboratories has moved the stereo controls into the headset itself. No longer is a separate control center required.

With Telex INTEGRAL CHANNEL CONTROL, each channel is controlled individually by convenient, smoothly styled volume control knobs on each earpiece. Nothing to build, solder or hook up. Just plug into your stereo set and adjust each channel separately to the ideal listening

level. It's better, more convenient and costs less because no separate stereo control center is required.

Audiophiles look to Telex for the best in high fidelity performance. Now Stereo-Twin with INTEGRAL CHANNEL CONTROL adds to the list of Telex "firsts" in listening pleasure. \$29.15

A Product of Sound Research

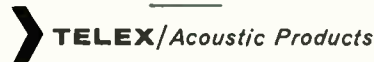

TELEX/Acoustic Products

COMMUNICATIONS ACCESSORIES

3054 Excelsior Blvd. • Minneapolis 16, Minn.

CIRCLE NO. 73 ON READER SERVICE CARD

**Send HiFi/Stereo Review
 Every Month**

HiFi/Stereo Review



Check one: 3 years for \$12
 2 years for \$9 1 year for \$5
IN THE U. S. and POSSESSIONS
 Payment Enclosed Bill Me

Foreign rates: Canada and Pan American Union countries, add \$ 30 per year; all other foreign countries, add \$1.00 per year.

name _____
 address _____
 city _____ zone _____
 state _____

Mail to:

HIFI/STEREO REVIEW
 Dept. 1-1030

434 S. Wabash Ave. Chicago 5, Ill.

Well, I'll tell you. This Harry Morton, he recites stories. You know, he stands up there, with a microphone, and he spins them out. Some of them are long—one is twelve minutes and thirty seconds (it says on the record jacket), another one is only a minute fifty-five, but, mostly, they're good and long. He's got one number there about a Volkswagen—how he put more and more gas in this car that his neighbor buys, the neighbor hasn't been so nice to him, you understand, and he starts to think he's getting 500 miles on a gallon—I thought I'd die laughing. This story is already a "show business classic." It says so right on the jacket. And wait—that's not all. Harry Morton, he knows all the interesting people. Jan Murray, Hal March, Buddy Hackett—everybody. So, about each one he's got a story. And it's usually about a car. Somewhere in it there's a car. And what an imagination! I tell you, on the record he has this night-club audience in *stitches*, how he used to take his shoes all the way to Washington Heights from Brooklyn to get them shined, and this narcotics detective he doesn't believe him, you understand, and beats him up something terrible? And another one about a traffic cop that wanted to get a job as a singer, so it's this freezing cold night on the West Side highway, and Jan Murray. . . . What's the matter, you don't want to hear about Jan Murray? What do you think a comedian who must have practiced already on the borscht circuit who knows how many years would sound like? Exactly. Listen, can't I tell you the one about that Volkswagen? No? You don't know what you're missing. It's a *scream*. P. K.

Ⓜ **TERRY-THOMAS: Strictly T-T.**
 LONDON 5764 \$4.98.

Interest: English comedy
 Performance: Bewildering
 Recording: Exemplary

It is hard to know what to make of this curious record debut by Terry-Thomas, one of Britain's funniest film actors. On this record, he mainly mutters to himself. His aimless anecdotes about cats, ladies in lakes, and randy farm animals make possible the display of an ingenious variety of regional accents, but they are defeated by a dogged pointlessness that is just not mirth-provoking. Except for an inspired spoof of a Noel Coward scene and a rather too realistic take-off on a boring guide at the Tower of London, the skits are dismal and the jolly songs self-consciously witless. Even the program notes, written (like too much of his material) by Thomas himself, have a floundering quality more likely to bewilder than regale. P. K.

GUARANTEED!



FEATURES AND SPECIFICATIONS

24" wide, 10" high, 9" deep; 8" high compliance woofer; 3" hardened tweeter cone; coaxial wound 1" voice coil; silicone treated edge allows for 3/4" cone displacement; Alcomax III 1-lb. 5-oz. magnet; 10,000 gauss flux density; 8 ohm impedance; zero external magnetic field; 40-18,000 rps; up to 30 watts power capacity; 1450 cubic inch volume; Fibreglass acoustic dampening; matched for stereo. Solid wood—not a composite. **ORDER NOW** to insure prompt delivery! This remarkable speaker is probably the best investment you'll ever make in hi-fi equipment! Price—\$19.95 F.O.B. factory. Shipping weight 18 pounds.

- Outperforms speakers costing five times more
- Three year warranty against manufacturing defects
- Complete satisfaction or your money back

the **KENT** \$19⁹⁵
 all new...all wood
 1964 model only

Anglo American Acoustics Ltd. HI 12-63
 129 Maryland Ave., Freeport, New York
 Gentlemen: Enclosed is my check for \$ _____
 Please ship me _____ "Kent" natural wood cabinet speaker(s) at \$19.95 each.

I UNDERSTAND THAT THESE SPEAKER SYSTEMS ARE GUARANTEED AND IF I AM NOT COMPLETELY SATISFIED I MAY RETURN FOR A FULL REFUND WITHIN TEN DAYS AFTER RECEIPT.

NAME _____
 ADDRESS _____
 CITY _____ ZONE _____ STATE _____



Why We Make the Model 211 Available Now

Although there are many stereo test records on the market today, most critical checks on existing test records have to be made with expensive test equipment.

Realizing this, HiFi/STEREO REVIEW decided to produce a record that allows you to check your stereo rig, accurately and completely, just by listening! A record that would be precise enough for technicians to use in the laboratory—and versatile enough for you to use in your home.

The result: the HiFi/STEREO REVIEW Model 211 Stereo Test Record!

Stereo Checks That Can Be Made With the Model 211

- ✓ Frequency response—a direct check of eighteen sections of the frequency spectrum, from 20 to 20,000 cps.
- ✓ Pickup tracking—the most sensitive tests ever available to the amateur for checking cartridge, stylus, and tone arm.
- ✓ Hum and rumble—foolproof tests that help you evaluate the actual audible levels of rumble and hum in your system.
- ✓ Flutter—a test to check whether your turntable's flutter is low, moderate, or high.
- ✓ Channel balance—two white-noise signals that allow you to match your system's stereo channels for level and tonal characteristics.
- ✓ Separation—an ingenious means of checking the stereo separation at seven different parts of the musical spectrum—from mid-bass to high treble.

ALSO:



Stereo Spread
Speaker Phasing
Channel Identification

PLUS SUPER FIDELITY MUSIC!

The non-test side of this record consists of music recorded directly on the master disc, without going through the usual tape process. It's a superb demonstration of flawless recording technique. A demonstration that will amaze and entertain you and your friends.

NOW...GET THE FINEST STEREO TEST RECORD ever produced

for just...**\$4.98**

Featuring The Most Spectacular Music Demonstration On Disc Today

UNIQUE FEATURES OF HiFi/STEREO REVIEW'S MODEL 211 STEREO TEST RECORD

- Warble tones to minimize the distorting effects of room acoustics when making frequency-response checks.
- White-noise signals to allow the stereo channels to be matched in level and in tonal characteristics.
- Four specially designed tests to check distortion in stereo cartridges.
- Open-air recording of moving snare drums to minimize reverberation when checking stereo spread.

All Tests Can Be Made By Ear

HiFi/STEREO REVIEW's Model 211 Stereo Test Record will give you immediate answers to all of the questions you have about your stereo system. It's the most complete test record of its kind—contains the widest range of check-points ever included on one test disc! And you need no expensive test equipment. All checks can be made by ear!

Note to professionals: The Model 211 can be used as a highly efficient design and measurement tool. Recorded levels, frequencies, etc. have been controlled to very close tolerances—affording accurate numerical evaluation when used with test instruments.

DON'T MISS OUT—SUPPLY LIMITED

The Model 211 Stereo Test Record is a disc that has set the new standard for stereo test recording. Due to the overwhelming demand for this record, only a limited number are available thru this magazine. They will be sold by HiFi/STEREO REVIEW on a first come, first serve basis. At the low price of \$4.98, this is a value you won't want to miss. Make sure you fill in and mail the coupon together with your check (\$4.98 per record) today.

FILL IN AND MAIL TODAY!

Stereo Test Record
HiFi/STEREO REVIEW—Dept. SD
One Park Ave., New York 16, N.Y.

Please send me _____ test records at \$4.98 each. My check (or money order) for \$_____ is enclosed. I understand that you will pay the postage and that each record is fully guaranteed. (Add 50¢ to partially defray postage costs outside U.S.A.)

Name _____
(Please Print)

Address _____

City _____ Zone _____ State _____

SORRY—No charges or C.O.D. orders!

HF123



BE A PRO!

Record with the tape used to capture the world's greatest artists!

Perry Como, Van Cliburn, Peter Nero, Harry Belafonte, Artur Rubinstein, Arthur Fiedler — to capture the ultimate in quality of performances by these great artists, RCA Victor engineers must be sure they can depend on every inch of master recording tape! That's why they developed RCA



Red Seal Magnetic Tape for their own use. Now this professional studio tape is available for your use on home equipment.

Try Red Seal Magnetic Tape. If your dealer doesn't have it, he'll be glad to order it for you. But be a pro: stubbornly refuse any substitutes!

RED SEAL SOUND TAPE  **The Most Trusted Name in Sound**



HIFI/STEREO REVIEW'S CHOICE OF THE LATEST RECORDINGS

STEREO TAPE

Reviewed by CHRISTIE BARTER • DAVID HALL

Ⓢ **BEETHOVEN:** *Christ on the Mount of Olives, Op. 85.* Jan Peerce (tenor); Maria Stader (soprano); Otto Wiener (bass); Vienna Academy Chorus; Vienna State Opera Orchestra, Hermann Scherchen cond. WESTMINSTER WTC 160 \$7.95.

Interest: Second-drawer Beethoven
Performance: Creditable
Recording: Respectable
Stereo Quality: Good enough

The musical language of this setting of the New Testament episode of Christ's agony in the garden seems to bear out the contention that it was written about the same time Beethoven was working on his only completed opera, *Fidelio*. The embarrassingly bad text elicited from him something like the dramatic manner of the opera, and just occasionally the soaring intensity of idealism of *Fidelio*'s own agony scene, Florestan in the dungeon. *Christ on the Mount of Olives* is for Beethoven specialists or for Christian sentimentalists only, its artistic stature being to Bach's Passions as Bernini to Michelangelo.

The recorded performance is highly creditable. Peerce turns in a dramatically intense interpretation of Jesus, and Maria Stader contributes operatic brilliance and tonal purity to the Seraph. Scherchen's handling of the choral and orchestral forces is firm and effective, and Westminster's close-miked sound is full. D. H.

BEETHOVEN: *Symphony No. 8* (see SCHUMANN).

RECORDING OF SPECIAL MERIT

Ⓢ **BEETHOVEN:** *Violin Concerto, in D Major, Op. 61.* Jascha Heifetz (violin); Boston Symphony, Charles Munch cond. RCA VICTOR FTC 2152 \$8.95.

RECORDING OF SPECIAL MERIT

Ⓢ **BRAHMS:** *Violin Concerto, in D Major, Op. 77.* Jascha Heifetz (violin);

Explanation of symbols:

- Ⓢ = monophonic recording
- Ⓢ = stereophonic recording

Chicago Symphony, Fritz Reiner cond. RCA VICTOR FTC 2151 \$8.95.

Interest: Bulwarks of the repertoire
Performance: Dazzling
Recording: Very good
Stereo Quality: Satisfying

Admirers of either or both of these recordings should rejoice that they have finally been released on tape. Originally issued on monophonic discs in the mid-Fifties and later made available in stereo,



JASCHA HEIFETZ
Unequaled elegance and poise

they have long held an honored place in collections and catalogs the world over. Whatever the competition—and there is very little so far on four-track reels—they are unique. Jascha Heifetz's playing in both works, if fairly neutral in sentiment when compared to other versions, nevertheless possesses an elegance and poise no other violinist has yet equalled. His Beethoven, perhaps the fastest on record, is of compelling virtuosity and impeccable musicianship. The remastering Victor has evidently done serves to make one think the recording sessions were held within the year, yet these were two of the company's earliest stereo efforts. But the sound is cleaner than ever, and the violinist's tone has been

rendered, if anything, more silken. It is a pity that, while they were at it, RCA did not issue a third twin-pack reel offering the two in tandem. C. B.

RECORDING OF SPECIAL MERIT

Ⓢ **BERLIOZ:** *Beatrice and Benedict.* Josephine Veasey (mezzo-soprano), Beatrice; John Mitchinson (tenor), Benedict; April Cantelo (soprano), Hero; Helen Watts (contralto), Ursula; others. St. Anthony Singers and London Symphony, Colin Davis cond. LONDON-OISEAU-LYRE EOH 96001 \$12.95.

Interest: Opéra comique
Performance: Stylish
Recording: Good
Stereo Quality: Okay

This opera-with-dialogue, based on Shakespeare's *Much Ado about Nothing*, is Berlioz's last major work, and although the twin-pack recording omits the dialogue, it introduces the complete score, and some of the composer's loveliest music, to tape. In addition to the overture, which is well enough known, three sections stand out: a gorgeous duet evoking the night's "harmonies infinies," sung by Hero and her attendant Ursula; Beatrice's forceful "Dieu! que viens-je d'entendre?"; and the closing duet between the nominal lovers—reminiscent of the *Queen Mab* Scherzo, but spiced with irony. These and other perhaps less inspired passages (including a spirited drinking song accompanied by guitar, trumpets, and tambourine) combine to make *Beatrice and Benedict* unusually interesting. The performance under Colin Davis' direction could hardly be improved upon. His wife, April Cantelo, is a vocally disarming Hero. Josephine Veasey imparts a properly vixenish quality to the role of Beatrice, and is ably matched by John Mitchinson's Benedict. Though the recording tends to tubbiness on the bass end, the sound is otherwise satisfactory. Stereo action is slight, but the placement of the principals in relation to the chorus and orchestra is just and well defined. Notes and libretto are provided. C. B.

(Continued on page 128)

WORLD PREMIERE SHOWING . . .
 . . . so simple to operate, professional results are automatic!



FREEMAN
 "660 SENIOR"
 Audiophile Net
 \$199.50

FREEMAN
 The Official
 Portable
 Tape Recorder
 of more than 600
 radio stations
 from
 coast to coast.

A Freeman is the most wanted (and practical) gift in America. This Christmas, record your priceless sounds of Christmas for your loved ones to cherish . . . with a Freeman "660 Senior" Portable Tape Recorder. Only 7" x 9", revolutionary all-new 3 speed "660 Senior" weighs just 8 lbs. in leather carrying case. Operates on self-contained battery and AC power. Operates with one knob simplicity, yet has every feature of a \$1,000 studio instrument. Comes complete with dynamic microphone, earphone and telephone pickup. It's the national scholastic champion . . . It's the national professional champion. See it today!

LAST MINUTE LISTING OF SOME OF THE SENSATIONAL FEATURES OF THE NEW FREEMAN "660 SENIOR" . . .

- Super fast forward and rewind
 - Digital index counter
 - Cue (pause-edit) lever
 - Speed switch on top deck panel
 - Three speeds: 7 1/2, 3 3/4, 1 7/8
 - Precision speed adjustment on top deck panel
 - Built-in stroboscope for 7 1/2 I.P.S. on capstan
 - Battery condition indicator in play mode
 - Operates in carrying position and accepts Freeman 600 reels
- ... plus many, many other professional features!

MAIL COUPON TODAY FOR MORE INFORMATION ON THE GREAT, ALL-NEW FREEMAN "660 SENIOR"

Please send me:

Booklet containing ingenious suggestions on how to get the most from a tape recorder at work or play. I enclose 25¢ (coin, stamps) for postage and handling.

Name of nearest dealer.

Name _____

Address _____

City _____ Zone _____ State _____

BRAHMS: Violin Concerto, in D Major (see **BEETHOVEN**).

RECORDING OF SPECIAL MERIT

© **BRITTEN: War Requiem, Op. 66.** Galina Vishnevskaya (soprano), Peter Pears (tenor), Dietrich Fischer-Dieskau (baritone); Bach Choir, Highgate School Choir, Melos Ensemble, London Symphony Orchestra and Chorus, Benjamin Britten cond. LONDON LOH 90067 \$12.95.

Interest: Major contemporary score
 Performance: Devoted
 Recording: Superior
 Stereo Quality: Meaningful

That Benjamin Britten's *War Requiem* will be a twentieth-century musical masterpiece, as some have already hailed it, is open to doubt. I am aware that anyone who takes the time to listen closely to this deeply moving score will unquestionably be tempted to retort "Why not?" Its power, and its relation to the majority of new works one hears, would seem to qualify it for that appellation. Yet what might its appeal be to a future generation that, God willing, may not be living under the threat of a nuclear holocaust, or even a so-called limited conflict? If such a fortunate generation is born, if it hears this music, and if it decides that it is less than a Great Work of Art, then we may perhaps say that the *War Requiem's* message has been heard and acted upon. For, as the composer notes at the head of the score, "My subject is War, and the pity of War. The Poetry is in the pity. All a poet can do today is warn."

The words are those of Wilfred Owen, now recognized as the leading poet of protest against World War I and, although revered in British literary circles, known only to a small extent in this country. These words best describe why the *War Requiem* was written, since by alternating the traditional stanzas of the Mass for the Dead with nine of Owen's war poems, each reflecting the actuality and horror of the battlefield, Britten is warning us all. This mammoth score, one of his very finest to date, is as eloquent a plea for brotherhood as any yet produced in music.

The composer himself conducts this performance. His control over the formidable vocal and orchestral elements involved is astonishing, and the devotion to the work by all concerned, supreme. Of the soloists, Pears and Fischer-Dieskau sing with compassion, and Galina Vishnevskaya's soprano is forceful but at times hard and unduly weighted.

The stereo engineering is especially effective, vividly defining the work's three levels of musical expression—the

(Continued on page 130)



© Eastman Kodak Company MCLX1

NOW THERE ARE TWO GREAT TAPES TO CAPTURE SOUND BRILLIANTLY

Two new magnetic tapes from Kodak—both with high-performance oxide layer that gives a new richness and brilliance to your recorded sound

With new bases and oxide layer, KODAK Sound Recording Tape becomes a new standard of tape quality: **Two new bases.** DUROL Base for Kodak tape is a new triacetate that is 40% stronger, yet breaks clean in case of accident. It permits splicing a break without loss of recorded sound. Kodak tape on 1½-mil DUROL Base can be your standard of tape excellence. For 50% longer play choose the 1-mil thickness. To double the recording time, get KODAK Sound Recording Tape on ½-mil Polyester Base.

New oxide layer. Kodak emulsion scientists have found a better way to disperse the recording oxide in a new, tougher resin binder. Result: a smoother oxide surface which reduces residual noise and recorder head wear, increases high-frequency response.

Exclusive backprinting. Kodak tapes are printed on the base side with our company name and manufacturing control number as your assurance of high quality.

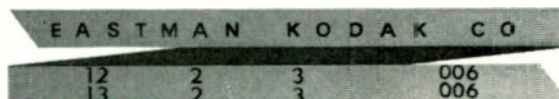

KODAK Thread-Easy Reel. Simply pull tape through the slot—it's loaded! Timesaving splicing jigs and index scales are on both sides of reel. Try all-new KODAK Sound Recording Tape soon. At your Kodak dealer's now!

Remember: You get each 7-inch roll of Kodak tape on the popular KODAK Thread-Easy Reel.

Kodak
TRADEMARK

EASTMAN KODAK COMPANY, ROCHESTER, N. Y.

DECEMBER 1963

CIRCLE NO. 24 ON READER SERVICE CARD

129

What are five ways to tell good recording tape from bad?

This question, and many others about tape and tape recorder use for fun, education, and profit, are answered in Tarzian Tape's new 32-page illustrated booklet, "Lower the Cost of Fun With Tape Recording." Send for your copy today...use Tarzian Tape for your next recording session.

FREE!



Sarkes Tarzian, Inc.
Department SR-6
Magnetic Tape Division
East Hillside Drive
Bloomington, Indiana

Please send a free copy of "Lower the Cost of Fun With Tape Recording" to:

Name _____

Address _____

City _____ State _____

I have have not used Tarzian Tape
My dealer does does not stock
Tarzian Tape.



CIRCLE NO. 64 ON READER SERVICE CARD

worldly, represented by the two male soloists and chamber orchestra; the ritual, by the soprano, mixed chorus, and full orchestra; and the celestial, by a semi-distant chorus of boys' voices and organ. The recorded sound is realistic and utterly transparent, but the tape transfer is fairly hissy, sufficiently so in the quieter passages to be annoying. Notes and text, essential to a complete appreciation of Britten's achievement, are not supplied. They are available, however, on request and free of charge.

C. B.

RECORDING OF SPECIAL MERIT

⑤ **COPLAND: *A Lincoln Portrait; Quiet City; Our Town—Music from the Film; An Outdoor Overture.*** Charlton Heston (speaker); Utah Symphony Orchestra, Maurice Abravanel cond. VANGUARD VTC 1668 \$7.95.

Interest: The popular Copland
Performance: Affectionate
Recording: Good
Stereo Quality: Good

These well-chosen selections, some of Copland's most immediately communicative scores, are firsts on stereo tape, and the lovely nocturne for trumpet and orchestra, *Quiet City*, as well as the *Our Town* film music, have their only stereodisc renderings on the original release of this recording. Unmannered warmth and affection are the hallmarks of Abravanel's leadership, and his Utah players respond to the music with a full measure of vitality and warmth. Vanguard provides sound to match.

Charlton Heston's eloquent and unforced reading of Abraham Lincoln's moving words in the *Lincoln Portrait* is the best I have heard since singer-actor Kenneth Spencer's performance in the disc premiere during the war years. Add to this the extroverted exuberance of the *Outdoor Overture*, written for a student orchestra in 1938, and the poignancy of *Quiet City*, which accompanied a 1939 Irwin Shaw play, and you have, all told, a singularly attractive tape. D. H.

RECORDING OF SPECIAL MERIT

⑤ **MOZART: *Eine Kleine Nachtmusik; Masonic Funeral Music; Overtures: The Impresario, Così fan tutte, The Marriage of Figaro, The Magic Flute.*** Columbia Symphony, Bruno Walter cond. COLUMBIA MQ 543 \$7.95.

Interest: Walter's last
Performance: Affectionate
Recording: Very good
Stereo Quality: Just right

With the exception of the *Nachtmusik*, these readings derive from sessions on

the West Coast in March of 1961, and are presumably the last recordings Bruno Walter made. His eloquent performance of the *Masonic Funeral Music*, available on tape for the first time, is surely a fitting valedictory statement. Similarly marked by his sensitivity and insight is his reading of the overture to *The Magic Flute*, and the others move brightly and crisply. The *Nachtmusik* employs a larger string ensemble than many conductors and listeners today deem desirable, yet the sound is well defined and transparent. The engineering is absolutely first-rate on all counts. C. B.

RECORDING OF SPECIAL MERIT

⑤ **PURCELL: *Dido and Aeneas.*** Janet Baker (soprano), Dido; Raimund Herincx (baritone), Aeneas; Patricia Clark (soprano), Belinda; Monica Sinclair (contralto), Sorceress; Dorothy Dorow



LONDON RECORDS

JANET BAKER
Dido sensitively portrayed

(soprano), Spirit; John Mitchinson (tenor), Sailor. St. Anthony Singers, English Chamber Orchestra; Thurston Dart (harpsichord continuo); Anthony Lewis cond. LONDON-OISEAU-LYRE EOL 96002 \$7.95.

Interest: Early operatic gem
Performance: Conscientious
Recording: Excellent
Stereo Quality: Ditto

When this recording was issued on discs a year or so ago, it was logically compared with the classic *Dido and Aeneas* performed by the Mermaid Theatre Company, with Kirsten Flagstad and Elisabeth Schwarzkopf. Whatever its stylistic shortcomings, that HMV-RCA Victor release is cherished for its vocal splendor, and can stand as one of the century's great recordings. The new *Dido*, which

will probably be the only one available on tape for a good while to come, is in many ways superior, but it lacks something of the warmth and humanity of the earlier version. It is, all told, a good, accurate re-creation of a minor masterpiece. Janet Baker, a light, supple-voiced soprano and a sensitive artist, contributes a moving portrait of the queen, and the others in the cast handle their roles effectively. The chorus is outstanding under Anthony Lewis' direction. Though discreet in terms of action, the stereo engineering is excellent, and the sound is remarkably transparent. Notes and libretto are included. *C. B.*

© **RACHMANINOFF:** *Piano Concerto No. 3, in D Minor, Op. 30.* **TCHAIKOVSKY:** *Piano Concerto No. 1, in B-flat Minor, Op. 23.* Vladimir Ashkenazy (piano); London Symphony, Anatole Fistoulari and Lorin Maazel cond. LONDON LCK 80125 \$11.95.

Interest: Challenger of Cliburn
Performance: Sympathetic
Recording: Excellent
Stereo Quality: Ditto

The third recording of the Tchaikovsky Piano Concerto on tape and, strangely enough, only the second of the Rachmaninoff D Minor are performed on this twin-pack by the co-winner of the 1962 Tchaikovsky Competition in Moscow. Vladimir Ashkenazy is undoubtedly a talent to be reckoned with, no less than his celebrated American prize-winning predecessor, Van Cliburn, who is also represented on tape by the same two works. To choose between them in the case of the Tchaikovsky concerto is a difficult and perhaps unnecessary task, especially since London's twin-pack format is so economical a way to own both works. Cliburn's Tchaikovsky, occupying a single reel (RCA Victor FTC 2043), evidences a greater personal involvement, a more vivid projection than Ashkenazy's. The Russian pianist is almost too reticent and introspective at the outset, but he builds to a whirlwind finish. It is a stunning technical performance, once under way, and at all points sympathetic. The Rachmaninoff likewise gets off to a rather inhibited start and ends with a flourish, though here the tempos are more justly proportioned. Certainly the Ashkenazy Tchaikovsky recording surpasses Cliburn's in sound, the latter having been taped in concert at Carnegie Hall. London's engineers favor fairly dry acoustics in both sequences, but the sound is balanced and robust. *C. B.*

RECORDING OF SPECIAL MERIT

© **SCHUMANN:** *Symphony No. 1, in D Minor, Op. 120.* **BEETHOVEN:**



If you're willing to pay anything for professional quality.....but would rather not

The Concertone 605 is for the one man in several who can't stand less than perfection...but can't see why professional quality should cost so much. Never before have so many features and so much professional quality been available at this price. Read ahead carefully and see: Precision plug-in head assembly...includes four precision heads; Separate microphone and line controls (input can be mixed); Delay memory control circuit (never spill or break tape); Automatic glass tape lifters, including electric cue feature; Sound on sound and add sound; Solenoid operated brakes; Three motors, including 2-speed hysteresis synchronous drive; Automatic rewind; Exclusive Reverse-O-Matic®. Learn all about the 605 in complete detail. Ask your dealer for a demonstration or send for free literature today.



CONCERTONE 607

Broadcast version

The Concertone 607 with higher impedance is for the true professional or broadcaster. Remote control optional. This superb tape recorder is constructed to 19" x 14" dimensions, permitting it to be used as an exact replacement for old or outdated tape recorders.

CONCERTONE 400 COSMOPOLITAN

For people on the go...it's the Cosmopolitan - Combination Tape Recorder with AM Radio. A versatile companion and co-worker for business or pleasure travels. 5" reel capacity. Push-button operation. Amazing fidelity. Remote mike. Foot-pedal control. This all-transistorized recorder has big recorder features in miniature form.

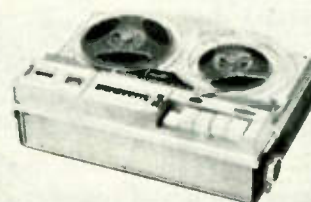

for further information write:



AMERICAN CONCERTONE, INC.
A DIVISION OF ASTRO-SCIENCE CORP.
9449 W. JEFFERSON BLVD. • CULVER CITY • CALIF.

Export: J. D. Marshall International, 170 W. Washington, Chicago, Illinois

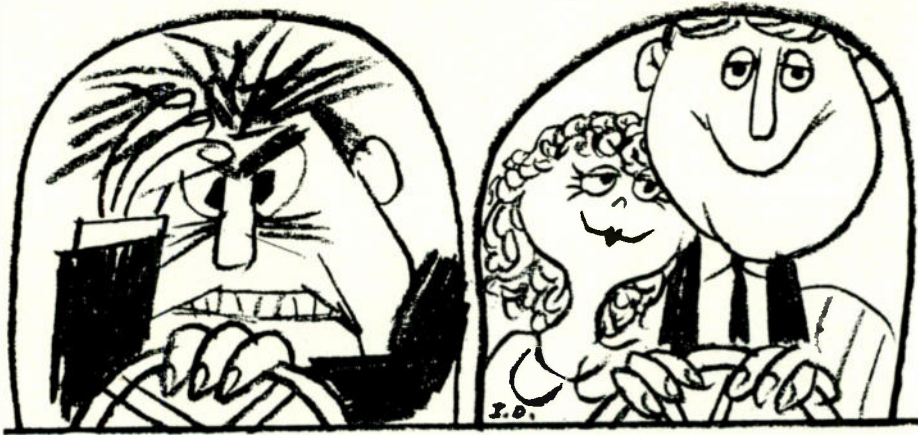

WHICH DRIVER HAS CAR-STEREO?

Music hath charm to soothe the savage breast. However, it's pretty hard to hear the music you like on radio these days. Commercials (yes, Virginia even on FM) run rampant during rush hours. Cars run rampant, too, and that causes problems, traffic jams, crinkled fenders, frayed nerves, etc. Put it all together and it doesn't spell Mother—it spells bugged driver. ■ So... we've prepared a special bugged drivers kit for you. It's guaranteed to help you relax when traffic is rotten. It contains six proven nostrums to ease your day. It's free, write. ■ We'd also like to tell you about our product—the Wayfarer Car-Stereo. The Wayfarer is a cartridge stereo tape player that fits easily in every make of car. It plays self-wind stereo tape albums and produces fantastic sounds in traffic—or anywhere! You'll want car-stereo! ■ To get your free "Bugged Drivers Kit" direct your cards to Curtis Howard. He's our Prez. and keeps us unsnarled. Don't write to D. J. Reiner. He's only a V.P. and thinks we should charge more for our four track, four speaker car-stereo. By the way, the guy on the left doesn't have a Wayfarer Car-Stereo. But that's kind of obvious.



WAYFARER CAR-STEREO

6505 Wilshire Blvd., Suite 302, L. A. 48, Calif.

CIRCLE NO. 79 ON READER SERVICE CARD

SPECIAL 3.95

This 7.95 stereo tape for only 3.95 or... Burgess recording tape for only 2.95 PLUS...

one year's FREE membership listings of tapes at discount prices... savings up to 50%!



MUA-S 3515—TALENT ON PARADE; Steve Lawrence, Eydie Gorme, Ferrante & Teicher & Others - Begin The Beguine, Everything's Coming Up Roses, Would It Be Lovely, April In Paris, Green Dolphin Street, Jeepers Creepers, Skyliner, Never On Sunday, The Continental - \$7.95



141—BURGESS MAGNETIC BLANK RECORDING TAPE; 1.5 mil, 1/4" Standard Play Plastic—All-purpose standard play tape with maximum frequency response. Available in 1200' (7" reel). - \$2.95

Send check or money order (No COD's please) to:

TOPSELCO

230 N. MICHIGAN AVE. • CHICAGO 1, ILL.

CIRCLE NO. 74 ON READER SERVICE CARD

132

Why?

DO THOUSANDS OF HI-FI ENTHUSIASTS BUY FROM AUDIO UNLIMITED

It's Obvious!

- LOWEST PRICES
- FAST SERVICE
- FACTORY SEALED UNITS
- FULLY INSURED SHIPMENTS
- UP TO 2 YEAR MANUFACTURERS' WARRANTY
- TIME PAYMENT PLAN
 - only 10% down
 - up to 36 months to pay
- FRANCHISED DISTRIBUTORS

Write for FREE Catalog Today

SEND US YOUR LIST FOR OUR AIR MAIL QUOTE TODAY

Visit Our Showroom and Warehouse

AUDIO unlimited, inc.

715-S Second Ave., (Nr. 38) New York 16, N.Y.
3 blocks from the U.N.

CIRCLE NO. 13 ON READER SERVICE CARD

Symphony No. 8, in F Major, Op. 93.
Cleveland Orchestra, George Szell cond.
EPIC EC 831 \$7.95.

Interest: Felicitous coupling
Performance: Sympathetic
Recording: Very good
Stereo Quality: Distinct

Rivalled only by the Bernstein and Klemperer recordings on discs, George Szell's lucid reading of the Schumann Fourth Symphony has the tape field to itself. There now remains to record only the "Rhenish" in order to complete the cycle in which the Clevelanders are so brilliantly represented. The Beethoven Eighth, originally released to fill out a two-record album containing the Ninth, is one of the very best. And it is the only version available in a single-reel coupling at a single-reel price. Along with the Schumann symphony, it was recorded a couple of years ago when the practice in taping sessions at Severance Hall was to emphasize stereo separation. The result is that, in both, the antiphony between the upper strings on the left, the cellos on the right, and the winds at the rear is clearly projected. The sound, although a little dry, is vividly realistic. C. B.

TCHAIKOVSKY: Piano Concerto No. 1, in B-flat Minor (see RACHMANINOFF).

COLLECTIONS

© TERESA BERGANZA: *Spanish and Italian Songs*. Guridi: *Come quieres que a divine; Mañanita de San Juan*. Lavilla: *Four Basque Songs*. Turina: *Saeta; Farruca*. Granados: *El tra la la y el punteado; El majo tímido; El maja dolorosa*. Cherubini: *Ah! che forse ai miei di. Cesti: Intorno all'idol mio*. Pergolesi: *Confusa, smarrita*. A. Scarlatti: *Se delitto è l'adorarvi; Chi vuol innamorarsi; La rosaura; Elitropio d'amor*. Teresa Berganza (mezzo-soprano); Felix Lavilla (piano). LONDON LOL 90066 \$7.95.

Interest: Engaging recital
Performance: Persuasive
Recording: Good
Stereo Quality: Incidental

In this recital, the treasure is in the first sequence, in which Teresa Berganza sings songs of her native Spain, including four Basque songs by her husband-accompanist, Felix Lavilla. One of these, a lullaby entitled simply *Loa-Loa (Sleep, Sleep)*, is outstanding for its serenity, and Miss Berganza sings it beautifully. She nicely captures the earthy vigor of the Granados songs, leading to his passionate *El maja dolorosa*, and the eloquent solemnity of Turina's *Saeta*. The early Italian arias oversee, (Continued on page 135)

HIFI/STEREO REVIEW

HIFI/STEREO REVIEW EDITORIAL INDEX FOR 1962

BASIC REPERTOIRE (Bookspan)

- Brahms, *Double Concerto*, Nov. 25
Dvorak, *Symphony No. 4*, Jun. 23
Franck, *Sonata in A Major for Violin and Piano*, Mar. 29
Gershwin, *Piano Concerto in F*, Aug. 23
Mahler, *Symphony No. 4*, Sep. 25
Mozart, *Quintet in A Major*, Jan. 31
Mozart, *Symphony No. 41*, Oct. 11
Prokofiev, *Peter and the Wolf*, Dec. 31
Saint-Saens, *Carnival of the Animals*, Dec. 31
Schubert, *Quintet in C Major*, Jul. 22
Schumann, *Symphony No. 1*, Feb. 37
Updatings and Second Thoughts, Apr. 25, May 21

BEGINNERS ONLY (Fantel)

- Speaker Enclosures, Jan. 22
Speaker Frequency Response, Feb. 22
Speaker Transient Response, Mar. 26
Phono Cartridges—Part 1, Apr. 16
Phono Cartridges—Part 2, May 16
Tone-Arm Design, Part 1, Jun. 20
Tone-Arm Design, Part 2, Jul. 16
Turntable Noise, Aug. 20
Distortion—Part 1, Sep. 22
Distortion—Part 2, Oct. 15
Distortion—Part 3, Nov. 22
FM Tuner Specifications—Part 1, Dec. 22

EQUIPMENT REVIEWS

Amplifiers

- Acoustech I, Feb. 42
Harnman-Kardon Citation A (kit), Jul. 25
Heath AAW-21, May 28
Lafayette KT-900 (kit), Aug. 27
Scott LK-30 (kit), Dec. 26

Cartridges

- ADC-1 Mark II, Jul. 36
ADC-3, Jun. 44
Dynaco Stereodyne II, Jun. 43
Elac 322, Jul. 35
Fairchild F-7, Jul. 38
Ortofon SPU, Jul. 37
Pickering Stanton 400AA, Jul. 35
Pickering Stanton 481AA, Jul. 36
Shure M77, Jun. 43
Shure M222, Jan. 35
Sonotone Velocitone Mark III, Jun. 42
Weathers LDM, Jun. 44

Record Players

- Acoustic Research, Mar. 33
Lesca CD3/31, Jul. 26

Speakers

- ADC-18, Oct. 9
Bozak B-4000, Jun. 27
Electro-Voice Esquire 200A, Apr. 32
IMF Styrene Pressure, May 27
Jensen CC-1 (stereo-headphone control center), Feb. 41
KLH Model 14, Dec. 28
University Senior II, Sep. 34
Wharfedale W60, Mar. 34

Tape Recorders

- Bell RT360, Nov. 30
Concord 880, Jan. 36
Dual TG12SK, Aug. 28
Norelco Continental 401, Apr. 31
Tandberg 64, Oct. 7
Vernon 47/26, Sep. 33

Tuners

- Dynaco FM-3A, Feb. 62
Eico ST-97, Jan. 49
Fisher FM-100-B, Feb. 65
Fisher Model 400, Nov. 31
Grommes 101 BM, Jan. 49
Heath AJW-41, Feb. 63
Knight KN-250A, Jan. 47
Lafayette LT-700, Jan. 48
Pilot 780, Feb. 64
Scott Model 340, June 28
Scott 350B, Feb. 64
Sherwood S-3000-IV, Jan. 50

FEATURE ARTICLES

- Acoustics (*see* Critical View of Modern Concert Halls)
Acoustics (*see* Music, Acoustics, and Architecture)
Alley Cat Saga (Gilmore), Aug. 40
Art of the Album, Jan. 56
Antennas, Recommended FM (Friedman), Oct. 54
Arkansas Panpipe: 100 A.D. (Offergeld), May 42
Baez, A Talk with Joan (Hentoff), Nov. 39
Bartok's Full Trunk (Jablonski), Oct. 35
Beethoven, Nine Symphonies with Karajan (Hall), Oct. 106
Bluegrass, Ballads, Banjos and (Hentoff), May 48
Bossa Nova Bust (Lees), Sep. 46
Buddha of the Keyboard (Schonberg), Feb. 58
Captive Composer (Panufnik), Feb. 26
Cartridges, Laboratory Report on Stereo (Hirsch and Houck), Pt. 1 Jun. 41, Pt. 2 Jul. 34
Chamber Music Library, Essentials of (Haggin), Jun. 37
Children's Records, A Christmas Guide (Mitgang), Dec. 43
Chopin: The Dissident Romantic (Schonberg), Pt. 1 Apr. 35, Pt. 2 May 31
Contemporary Music in England and France (Searle cartoons), Feb. 55
Contemporary Music, Essentials of a Library (Flanagan), May 36
CRI Comes of Age (Flanagan), Nov. 84
Critical View of Modern Concert Halls (Kuttner), Jul. 29
Criticism, Music: Where Words Fail (Grunfeld), Aug. 49
"D" is for Deleted (Goodfriend), Sep. 50
Decca's "Chronicle of Music" Series (Hall), Feb. 86
Decibel Gap, Can We Close? (Lasson), Jul. 43
Distortion and What You Can Do About It (Burststein), Nov. 43
Dynagroove Makes its Bow (Hall), May 60
EMI Imports (*see* Transatlantic Treasure)
Evans, Bill, and the New Jazz Piano (Lees) Jul. 39
Fiddler with a Fountain Pen (Offergeld), Oct. 52
Fourth Dimension (Grunfeld), Jan. 26
Gift of Sound (Offergeld), Dec. 48
Godowsky (*see* Buddha of the Keyboard)
Golden Voices in Your Attic (Ellsworth), Apr. 40
Gould, Glenn: As Among Bach, Botticelli, and Bruegel (Offergeld), Jun. 31

- Guitarra! (Lees), Oct. 42
Have Mike, Will Travel (Milder), Jul. 45
How to Start a Record Company (Goodfriend), Jun. 46
Installation of the Month:
Between Two Poles, Jan. 45
Kits for Keeps, Mar. 43
New Angle for Stereo, Apr. 52
End-Table Stereo, Jun. 51
Surrounded by Sound, Aug. 39
Custom Look in Standard Cabinets, Sep. 59
Dream System Come True, Oct. 40
Decorator's Dilemma, Dec. 47
Jazz and Race (Feather), Feb. 45
Madama Butterfly, Roman Summer of (Mohr), Feb. 50
Music, Acoustics, and Architecture (Villchur), Jan. 58
Music-Making in Lilliput (Alper photos), Sep. 44
Music Minus One (*see* Sing Along with Wustman)
Opera, Essentials of a Library (Jellinek), Nov. 45
Persistence of Pan (Offergeld), May 41
Pitch in music (*see* Sound of "A")
Polish Music (*see* Captive Composer)
Prerecorded Tape Prospects (Angus), Mar. 51
Prerecorded Tape Today, A Critical Look (Barter), Mar. 46
Price Comes Down (Milder), Dec. 55
Readers' Choice: 1962, Jan. 51
Record Wear and Care (Milder), Nov. 50
Richmond, Vocal Riches on (Jellinek), Feb. 78
Romeo at the Windowsill (Grunfeld), Apr. 20
Service ... With a Smile? (Berger), May 44
Sing Along with Wustman (Anderson), Sep. 79
Sound of "A" (Roy), Jan. 39
Speaker Buying (Milder), Aug. 31
Speaker Design, Directions in (Gilmore), Apr. 47
Speakers, Eighteen Ways to Get the Most (Milder), Aug. 36
Speaker Enclosures, Three (Klein), Aug. 45
Speakers, How to Add Extension (Friedman), Aug. 42
Spoken Word, Basic Library (Kresh), Oct. 47
Tape, "Bargain": Is it Reliable? (Angus), Sep. 55
Tape Recorders: 1963 (DeMotte—table), Mar. 44
Tape Recorder, Guideposts for Selecting (Burststein), Mar. 37
Tapesters, Twenty-one Practical Tips for (Holt), Mar. 54
Tauber, Richard, and Vienna (Fantel), Nov. 33
Time in music (*see* Fourth Dimension)
Toscanini, Schubert, and the Philadelphia (Hall), Nov. 72
Transatlantic Treasure (Hall and Jellinek), Oct. 84
Tuners, Laboratory Test of Stereo FM (Hirsch and Houck), Pt. 1 Jan. 46, Pt. 2 Feb. 62
Victrola Series (Hall), Oct. 88
Wagnerdämmerung (Grunfeld), Dec. 35
Walter, Bruno, A Final Legacy (Hall), Dec. 72: Last Recording Sessions (Frost), Dec. 50

HiFi / STEREO MARKET PLACE

WHOLESALE RADIO AND CAMERA CO.

P.D. BDX 3085 PHILA. 50, PENNA.

SAVE \$\$—BUY Direct From Distributor
HUNDREDS OF NAME BRAND PRODUCTS

- HI-FI COMPONENTS
- CAMERAS
- TAPE DECKS
- STEREO COMPONENTS
- TAPE RECORDERS
- PHOTO EQUIPMENT

FREE CATALOG
NOW AVAILABLE

Distributor price lists sent upon request.
Special bargain offers included.

LOW WAREHOUSE PRICES WAREHOUSE DIRECT SHIPMENTS

SPECIAL WAREHOUSE PACKAGE DEALS
ALL BRAND NEW COMPONENTS
FRESH FROM WAREHOUSE

GET OUR
WAREHOUSE
PRICE LIST

STEREO WAREHOUSE

228-S Greenway Terrace, River Edge, N.J.

BRITISH HI-FI COSTS LESS WHEN YOU BUY DIRECT

FROM

C. C. GOODWIN (Sales) Ltd.
The U.K. Hi-Fi Mail Order Specialists

All equipment carefully packed, insured and shipped promptly at minimum cost.
Send \$1 bill for illustrated catalogue (refundable on first purchase) and details of HiFi equipment required to:

DEPT. HS, 7, BROADWAY, WOOD GREEN,
LONDON, N. 22, ENGLAND

PROMPT
DELIVERY

LOW
PRICES

AMPLIFIERS — MULTIPLEX —
TAPE RECORDERS, TUNERS
SPEAKER SYSTEMS, ETC.
AIR MAIL QUOTES — COMPARE
WRITE FOR CATALOG

AUDIO DIVISION

L. M. BROWN SALES CORP

Dept. S—242 West 10th Street • New York 14, N. Y.

WRITE FOR QUOTATION
ON ANY HI-FI COMPONENTS

SOUND
REPRODUCTION, INC.

34 New Street, Newark 2, N. J.

Mitchell 2-6816



SAVE

... WHEN YOU BUY
FROM HI-FIDELITY SUPPLY

Write for quotation
on any components.
All factory new and
shipped immediately.

HI-FIDELITY SUPPLY
2817-K THIRD AVE., NEW YORK 55, N. Y.

SAXITONE RECORDING TAPE

*Oxide guaranteed not to rub off or squeak—or money back. Compare ours with other "Bargain" tape. You'll find it's more than just "price" when you deal with us. We are original pioneers in the tape recorder business and our reputation means everything to us.



225' MYLAR, 3" (in mailable box)	.39
600' acetate (plastic), 5 inch	.75
600' MYLAR 5 inch reel	.85
900' MYLAR (Polyester), 5 inch	.89
1200' MYLAR, 1/2 mil, 5 inch reel	1.18
1200' MYLAR, tensilized, 5 inch	1.59
1200' acetate (plastic), 7 inch	1.15
1200' MYLAR, 1 1/2 mil, (strong)	1.29
1800' acetate (plastic), 7 inch	1.39
1800' MYLAR 1 mil thick, 7 inch	1.89
2400' MYLAR, untensilized, 7 inch	2.39
2400' MYLAR, tensilized, 7 inch	2.89

(Large Users Even Lower)

SAVE 30%
4-track stereo music on tape
(Complete stock)

PLUS
POSTAGE

NORELCO SPEAKERS

Famous AD-800M, twin cone 8" (75-19,000) cycles comparable net \$9.99 now \$4.95, 2 for \$9.00, plus postage. OTHER Norelco models at BIG DISCOUNTS. Specifications on entire Norelco line sent on request.

SAXITONE TAPE SALES

div. Commission Electronics, Inc.
1776 Columbia Rd. N.W., Wash. 9, D.C.

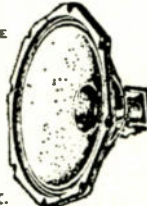

FAST SHIPMENTS

COMPONENTS • KITS

RECORDERS • TAPES

- BEST-BY-COMPARISON PRICES
- FACTORY SEALED CARTONS
- SEND FOR "QUOTES" ON PACKAGE DEALS AND SAVE MORE



WRITE FOR MONTHLY SPECIALS
VISIT OUR STORE

CARSTON Studios

125-H East 88 St., New York 28, N. Y.



TAPEMATES

Makes available to you:

- ALL 4-Track Tapes
- ALL labels
- POSTPAID to Your Door

At **40%** Savings

FREE BROCHURE | 5280-B West Pico Blvd., Los Angeles 19, Calif.

SAVE MONEY ON HI-FI COMPONENTS

TAPE RECORDERS
TAPES, ACCESSORIES
SLEEP LEARN KITS
MERITAPE

Low cost, high quality recording
tape, in boxes or cans.

SEND FOR FREE CATALOG



1523 JERICHO TPKE,
NEW HYDE PARK 21, N.Y.

DIXIE

HIGH FIDELITY WHOLESALERS

Largest discount High Fidelity component distributors in the South. Wholesale prices on package or individual components. Latest models in factory sealed cartons. Special attention given to Audio Clubs, Churches and Schools.

Are prices too high?—Write

DIXIE HI-FI

703 Horton Drive, Silver Spring, Md.

LEARN WHILE YOU SLEEP



Headquarters

Experiment in this fascinating, educational new field. Use your phonograph, recorder or amazing new *Electronic Educator* endless tape recorder. We carry a full line of endless repeating tape cartridges for all makes of standard recorders plus automatic timers, pillow speakers and complete outfits. Also over 200 unusual educational and self-help courses on tape and record for sleep-learning and hypnosis experimenters. Write for free 300 items catalog and full astonishing details.



Sleep-Learning Research Association
P. O. Box 24-Y, Olympia, Washington

**HiFi/Stereo
Market Place (Cont.)**

**NATIONWIDE
DELIVERY...** 

on all your Stereo needs.
Recorders, Tuners, Amplifiers
Turntables, etc.
LET US PROVE that we can sup-
ply your requirements
PROMPTLY AT LOWEST COST.
FREE CATALOG.

STEREO COMPONENT Supply Co., Dept. S
150 NINTH AVE., NEW YORK 11, N. Y.

RENT 

STEREO TAPES

- Over 2500 different, 4-track
- No deposit on tapes rented
- Postpaid 2 to 5 day delivery (48 States)

FREE
BROCHURE

stereo-parti

1616-B Terrace Wy, Santa Rosa, Calif.

End Tape Selection Search. New method enables you to proceed directly to the selection of your choice without needless time consuming search.

Each Kit processes ten 7" reels of pre-recorded stereo tape.

Works only with tape units having tape footage counters.

Each Kit complete with instructions, \$1.00 post paid. No C.O.D., send cash check or money order:

Illes Brothers
811 South Western Avenue
Los Angeles 47, California

**How to edit your
mother-in-law — instantly!**

Treat yourself to a precision EdiTall Tape Editing and Splicing Block and do things with tape you've never done before. EdiTall's patented curved groove lets you splice, edit, reassemble without clips or gadgets. You cut and splice where you want to—quickly, undetectably. Used professionally all over the world, EdiTall is the standard editing block—so simple, so accurate, you'll become an expert tape editor in no time. And think how proud your mother-in-law will be! S-2 (Adhesive-Mount) \$6.50 • KS-2 (Complete Kit) — \$7.45 — S-3 (Mounting Holes) \$8.00 • KS-3 (Complete Kit) — \$8.95. At your dealers or write:

THE TALL COMPANY
27 East 37th Street • New York, N. Y. 10016

none of them familiar but all characteristic of the eighteenth-century style, provide an agreeable balance, in the stylistic directness of Cesti's *Intorno all'idol mio*, the dramatically forceful *Confusa, smarrita* by Pergolesi, and the mercurial enchantment of the four Scarlatti selections. Miss Berganza sings with an unerring sense of style and impeccable musicianship, imparting to each song the appropriate vocal weight and color. The recorded sound is intimate, and the notes are adequate, although texts and translations are not supplied here, as they were with the disc. C. B.

© **JOAN SUTHERLAND: Command Performance.** Weber: *Oberon: Ocean! Thou mighty monster.* Massenet: *Le Cid: Pleurez, mes yeux.* Meyerbeer: *Dinorah: Ombre légère.* Leoncavallo: *Pagliacci: Stridono lassù: Mattinata.* Verdi: *I Masnadieri: O tu del mio Carlo; Luisa Miller: Tu puniscimi, o Signore.* Rossini: *La Cambiale di matrimonio: Vorrei spiegarvi.* Bellini: *Beatrice di Tenda: Deh! Se un'urna.* Benedict: *The Gipsy and the bird.* Arditì: *Parla!; Il bacio.* Ricci: *Crispino e la Comare: Io non sono più l'Annetta.* Tosti: *Ideale; La Serenata.* Bishop: *Lo, here the gentle lark: Home sweet home.* Flotow: *Martha: The last rose of summer.* Wallace: *Maritana: Scenes that are brightest.* Balfe: *The Bohemian Girl: I dreamt I dwelt in marble halls.* Joan Sutherland (soprano); London Symphony and Chorus, Richard Bonynge cond. LONDON LOH 90063 \$12.95.

Interest: Showcase for Sutherland
Performance: Compelling
Recording: Balanced
Stereo Quality: Adequate

The idea was a clever one, to assemble a program of songs and arias that might have been sung in recital for Her Gracious Majesty Queen Victoria, and to interest one of our more celebrated sopranos in recording it. But I question the value of its incarnation on tape. For one thing, beautiful as much of Joan Sutherland's singing is, it is hard to believe that anyone will devote undivided attention to the contents of this reel more than the first time in a single sitting—its two sequences together run over an hour and a half. For another, its contents are variable in interest. The first half of the program, made up of operatic arias for which Miss Sutherland may or may not have some qualifying vocal or temperamental affinity, is certainly the more substantial. The rest is a collection of simple songs that today have a kind of anachronistic charm but not much else. Finally, most selections in both sequences are no more than four or five minutes in length, meaning that none is easy to single out. With tape this practical in-

convenience is just the price one pays, but choosing a single aria or song in such an extended program, and excluding the ones nearest it, is a damned nuisance.

Miss Sutherland is generally in fine voice, even though occasional dips into her lower register are plainly uncomfortable, particularly in the opening Weber aria, for which she does not really have the vocal weight. Virtually throughout, her diction is very poor, as it has often been recently, and her tendency to droop is marked. But come the cabalettas—in the aria from Verdi's *I Masnadieri*, the "Vorrei spiegarvi" from *La Cambiale di matrimonio*, and the *Beatrice di Tenda* aria "Deh! Se un'urna"—and her singing is as dazzling as ever. She has a whale of a good time with the little ballads by Benedict, Tosti, Arditì, and the others, which she obviously likes and has been known to include in her own infrequent recital programs—without being "commanded" to do so. Over-all, Miss Sutherland's artful approach to the material at hand, and the great pleasure



JOAN SUTHERLAND
Beatrice di Tenda as dazzling as ever

she takes in singing it, are completely disarming. The support she receives from her conductor husband is sympathetic, and appropriately quaint in Tosti's *Ideale* and *Serenade*, when he accompanies her on what sounds like a vintage pianoforte.

The sound is good and sharply focused on the soloist throughout. The tape transfer is marred only by occasional pre-echo in the Meyerbeer excerpt and elsewhere. An informative booklet with complete texts is available on request. (The list price of this twin-pack reel exceeds that of the two-record album by a dollar.)

C. B.

ENTERTAINMENT

© **CLEOPATRA** (Alex North). Sound-track recording. Orchestra, Alex North cond. TWENTIETH-CENTURY FOX SXT 5008 \$7.95.

Interest: North on the Nile
Performance: Colorful

(Continued on page 137)

Hi Fi/STEREO SHOPPING CENTER

RATE: 40¢ per word. Minimum 10 words. February issue closes December 5th. Send order and remittance to: Martin Lincoln, HiFi/STEREO REVIEW, One Park Ave., N.Y.C. 16

EQUIPMENT AND ACCESSORIES

COMPONENTS at lowest prices anywhere. Write for catalog. The Macalester Corporation 355 Macalester Street, St. Paul 5, Minnesota.

COMPONENTS, Recorders! Free wholesale catalogue. Carston, 125-L East 88, N.Y.C. 28.

KIT Experts—Dynaco Specialists—Kits at reasonable prices are our specialty. Also custom wired kits guaranteed to exceed factory standards at substantial savings. Beautiful handcrafted Walnut cases for complete Dynaco line starting \$15.00 each. Plus everything in audio. Kitcraft, 738 Washington Avenue, Brooklyn, New York 11238, MA 2-6946.

LDW, Low quotes: all components and recorders. HiFi, Roslyn 9, Penna.

WRITE for quotation on any Hi Fi components: Sound Reproduction Inc., 34 New St., Newark, N.J. Mitchell 2-6816.

DISGUSTED with "Hi" Hi-Fi Prices? Unusual Discounts On Your High Fidelity Requirements. Write: Key Electronics, 120 Liberty St., New York 6, N.Y. Dickens 6-4191.

SALE items—tapes—recorders—component quotations. Bayla—Box 131R—Wantagh, N.Y.

MILITARY Discount—Name brands free recording tape and stereo handbook. Include rank and serial number. Electronics International, Box 3066, Charlottesville, Virginia.

BEFORE You Buy Receiving Tubes, Test Equipment, HiFi Components, Kits, Parts, etc. . . . send for your Giant Free Zalytron Current Catalog, featuring Standard Brand Tubes: RCA, GE, Etc.—all Brand New Premium Quality Individually Boxed, One Year Guarantee—all at Biggest Discounts in America! We serve professional servicemen, hobbyists, experimenters, engineers, technicians. Why Pay More? Zalytron Tube Corp., 461 Jericho Turnpike, Mineola, N.Y.

TRANSISTORIZED Products importers catalog, \$1.00 Intercontinental, CPO 1717, Tokyo, Japan.

CANADIANS—Giant Surplus Bargain Packed Catalogs. Electronics, HiFi, Shortwave, Amateur, Citizens Radio. Rush \$1.00 (refunded). ETCO, Dept. Z, Box 741, Montreal, CANADA.

SAVE dollars on radio, TV-tubes, parts at less than manufacturer's cost. 100% guaranteed. No rebrands, pulls. Request Bargain Bulletin. United Radio, 1000-H, Newark, N.J.

HARPISCHORDS — Clavichords fine European instruments at reasonable prices. Write 3101 Summit Road, San Bruno, California.

Hi-Fi Components, Tape Recorders at guaranteed "We Will Not Be Undersold" prices. All brands in stock. 15-day money back guarantee. 2 year warranty. Write your requirements for quotation. No Catalog. Hi-Fidelity Center 1797-R, 1st Ave., New York 28, N.Y.

WRITE for lowest quotations, components, recorders. No Catalogs. Hi-Fidelity Supply, 2817-TC Third, New York City 55.

TAPE recorders, Hi-Fi components, Sleep Learning Equipment, tapes. Unusual values. Free catalog. Dressner, 1523HF Jericho Turnpike, New Hyde Park 9, N.Y.

THE Price is Right! Hi-Fi Components. J. Wright Co., 65-B Jensen St., East Brunswick, N.J.

MAY we give you our quote on your Hi-Fi requirements? You'll be pleasantly surprised that what you had in mind won't cost as much as you thought. We carry all brands in stock. Components are new and fully guaranteed. Ask to be put on our mailing list for special bargains. Crown Electronics Corp., 64 Cortlandt St., New York 7, N. Y. (212) WO 4-0790.

"BUY British — Buy Best! For the finest in all High Fidelity Equipment write for our quotation first. The Hi-Fi Export Specialists! Send \$1 for catalogue. When in England call and see us. Telesonic Ltd. 92 Tottenham Court Road, London, W.1. England."

"FM/Q" Metropolitan Broadband Antenna, the finest compact yagi made, completely rustproof, only \$14.95 prepaid. FM Book with station directory 30¢. FM/Q, Wethersfield, Connecticut.

DHM'S law never forgotten with copyrighted tool. \$2.00 Postpaid. Beck Radio, 6323 South Dale Mabry, Tampa, Florida 33611.

IMPORTANT Announcement. The Hermann Scherchen Sterophoner (Patent device for producing stereophonic sound effect from all ordinary mono, radio, gram & tape equipment) now available direct from Sole Manufacturers for only \$16.00 (U.S. or Canadian) including insured post. Send cash, M.D. or cheque or request details, Symphony Amplifiers Ltd., 16 Kings College Rd., London, N.W. 3. England.

SAVE Money—Free catalog: Photography, Tape Recorders, Hi Fidelity, Electronics, Tools. Wholesale Radio & Camera Company, Box 3085, Philadelphia 50, Pennsylvania.

SUPERSENSITIVE Listening-In-Device picks up any telephone conversation in vicinity. No connection to telephone necessary. Easily concealed. \$2.98 complete. Consolidated Acoustics, M1302 Washington St., Hoboken, New Jersey.

\$30.00 value—7" TV test picture tube, perfect for 70° and 90° sets, built-in ion trap—your cost \$6.99. Tubes—new, jobber-boxed RCA, G.E. etc.—65% off list prices. Special: Tube #6146—\$2.95 each. Send your order. We pay postage (you save 4%). Immediate delivery. Write for Free Catalog listing thousands of parts, phono needles, tubes, etc. Arcturus Electronics Corp., Dept. ZD, 502 22nd St., Union City, New Jersey.

SPEAKERS lonesome for solid, acoustically matched "homes"? Identify speakers; Audio Room of St. Louis builds beauties! 8", unfinished enclosure, \$25.50. Other quotes. 1325 Gregan, St. Louis 33, Missouri.

WRITE For quotation on any Hi Fi Components and Tape Recorders. Lowest prices, fast delivery, factory sealed cartons. Olde Chelsea, Inc., 150 Ninth Avenue, New York 11, New York.

RECORDS

RARE 78's. State Category. Write Record-Lists, P.O. Box 2122, Riverside, California.

"HARD To Get" records—all speeds. Record Exchange, 812 Seventh Avenue, New York, N.Y.

THE Record Collector Journal—comprehensive, valuable data, varied record mart. Introductory six issues—\$1.50. Record Research, 131 Hart, Brooklyn 6, N.Y.

CASH For Your Unwanted LPs. Reder, Forshay Rd., Monsey, N.Y.

LP's Like new. Send 25¢ for List. Records, Hillburn, P.O., Hillburn, N.Y.

SUPRAPHON L.P. records at only \$2.45 each. Send for complete list of 500 titles, including many new issues just released. All 12" new at \$2.45, 10", \$2.10. Postage extra. The Gramophone Shop, 901 Dumbarton Rd. Glasgow, W.I. Great Britain.

COLLABORATE with Rudolf Friml. Write the lyrics to one or two themes in Friml's Golden Jubilee L. P. Share equal royalty. High fidelity album only \$3.00, cheque or money order—Historical Records, Box 2181, Los Angeles 53, California.

SPECIAL Offer of Everest popular, classical records (Stokowski, Steinberg, Krips, etc.) \$2.48—3 for \$6.95. Also special prices on Concert-Disc, Counterpoint & Esoteric. Write for catalog. Everest (HS1) 1313 N. Vine St., Hollywood, Calif.

NINE Beethoven Symphonies by Everest Records featuring London Symphony, Josef Krips conducting. Eight long play records, with 24 page booklet, in leatherette box. Monaural or stereo, regularly \$48.00, special \$14.95. Everest (HS1), 1313 N. Vine St., Hollywood, Calif.

TAPE AND TAPE RECORDERS

RENT Stereo Tapes—over 2,500 different—all major labels—free brochure. Stereo Parti, 1616-G Terrace Way, Santa Rosa, California.

RECORDING Tapes. Free sample. Mail 25¢ (handling). Towers, Lafayette Hill, Penna.

SAVE 30% Stereo music on tape. Free bargain catalog/blank tape/recorders/norelec speakers. Saxitone, 1776 Columbia Road, Washington, D.C.

SELF-Hypnosis. New concept teaches you quickly by tape or LP-record. Free literature. McKinley Publishers, Dept. T4, Box 3038, San Bernardino, Calif.

TAPE Recorder Sale. Latest models, \$10.00 above cost. Arkay Sales, 22-11 Riverside Ave., Medford 55, Massachusetts.

TAPE sale 1800' Mylar 10+ \$1.70 Postpaid Single \$1.95 Bayla, Box 131-TR, Wantagh, N.Y.

BEFRE renting Stereo Tapes try us. Postpaid both ways—no deposit—immediate delivery. Quality—Dependability—Service—Satisfaction prevail here. If you've been dissatisfied in the past, your initial order will prove that this is no idle boast. Free Catalog. Gold Coast Tape Library, Box 2262, Palm Village Station, Hialeah, Florida.

SPECIAL offer of Everest and Concertape popular and classical 4-Track stereo tapes \$4.95 (Stokowski, Steinberg, Krips, Fine Arts Quartet, etc.). Write for catalog. Everest (HS1), 1313 N. Vine St., Hollywood, Calif.

REPAIRS AND SERVICING

ALL Makes of Hi-Fi Speakers Repaired. Amprite, 168 W. 23 St., N.Y.C. 7, CH 3-4812.

TV Tuners rebuilt and aligned per manufacturers specification. Only \$9.50. Any make UHF or VHF. We ship COD. Ninety day written guarantee. Ship complete with tubes or write for free mailing kit and dealer brochure. JW Electronics, Box 51F, Bloomington, Ind.

TAPE Recorder and HiFi repairs. Amplifiers, tuners, turntables. All American and foreign makes serviced. Estimates in 48 hrs. after receiving equipment from any part of U.S. Macken Electronics, 5 West Post Road, White Plains, N.Y., WH9-9777.

TV Tuners Rebuilt and Aligned to Specifications. Guaranteed All Makes, One Price. \$9.50 Complete. Plus Shipping. Valley Tuners, 5641-E Cahuenga, North Hollywood, California.

Hi-Fi Problems solved by "The Hi-Fi Doctor" on the spot. Audio, Acoustic, Radio Engineer, Professional visits, day, evening. New York area. William Bohn, Plaza 7-8569.

METERS—Multimeters repaired and calibrated. Free estimates—Catalog. Bigelow Electronics, Box 71-G, Bluffton, Ohio.

PATENTS

INVENTIONS; Ideas developed for Cash/Royalty sales. Raymond Lee, 2104G Bush Building, New York City 36.

BOOKS

AUTHORS' Learn how to have your book published, promoted, distributed. Free booklet "ZD," Vantage, 120 West 31 St., New York 1.

VERY Unusual! The Booklover's Answer, bi-monthly magazine for book connoisseurs. One year \$2.00, sample 40¢. The Booklover's Answer, Webster 7, New York.

WANTED: Short stories, books, articles, plays of all descriptions for sale to publishers, producers. Free Literature! Literary Agent Mead, Dept. 39A, 915 Broadway, N. Y. C. 10.

BOOKHUNTING? All subjects searched free! Cambridge Book Service, Box 18K, Cambridge 40, Mass.

SHOPPING GUIDE CLASSIFIED

A HANDY GUIDE TO PRODUCTS AND SERVICES, NOT NECESSARILY IN THE HIGH FIDELITY FIELD, BUT OF WIDE GENERAL INTEREST.

EDUCATIONAL OPPORTUNITIES

LEARN While Asleep, hypnotize with your recorder, phonograph. Astonishing details, sensational catalog free! Sleep-Learning Association, Box 24-ZD, Olympia, Washington.

HIGHLY-effective home study review for FCC commercial phone exams. Free literature! Wallace Cook, Box 10634, Jackson 9, Miss.

PHOTOGRAPHY — FILM, EQUIPMENT, SERVICES

SCIENCE Bargains—Request Free Giant Catalog "CJ"—144 pages—Astronomical Telescopes, Microscopes, Lenses, Binoculars, Kits, Parts. War surplus bargains. Edmund Scientific Co., Barrington, New Jersey.

PHOTOGRAPHERS Earn Part Time, Write: PCI Dept. 470, Arlington 10, Virginia.

WORLD'S Most Complete Photographic Buying Guide. 700 Illustrations. Impossible Low Prices. Send 50¢ (deductible with order). Olden Camera, 1265 Broadway, New York City.

GOVERNMENT SURPLUS

GOVERNMENT Surplus Receivers, Transmitters, Snopescopes, Parabolic Reflectors, Picture Catalog 10¢. Meshna, Nahant, Mass.

JEEPS \$111.68, Boats \$6.18, Airplanes, Electronics Equipment, Typewriters, thousands more, typically at up to 98% savings. Complete information \$1.00. Surplus Service, Box 820, Holland 12, Michigan.

JEEPS—\$89.64, Typewriters—\$4.15, Receivers—\$5.65, Televisions, Oscilloscopes, Multimeters, Typical Government Surplus Prices. Exciting Details Free. Enterprises, Box 402-86, Jamaica 30, New York.

JEEPS \$178, Airplanes \$159, Boats \$7.88, generators \$2.68, typewriters \$8.79, are typical government surplus sale prices. Buy 10,001 items wholesale direct. Full details, 607 locations, procedure only \$1.00. Surplus, Box 177-C1, Abbottstown, Penna.

STAMPS AND COINS

SURPRISE Collection! Exotic mint British Colonials, absolutely Free with approvals. Viking, Great Neck 50, New York.

EMPLOYMENT INFORMATION

FOREIGN Employment. Construction, other work projects. Good paying overseas jobs with extras, travel expenses. Write only: Foreign Service Bureau, Dept. D, Bradenton Beach, Fla.

EMPLOYMENT Resumes. Earn more by presenting yourself to prospective employers more effectively. Send only \$2.00 (cash or money order) for complete Resume Writing Instructions, including sample and instructions for letter of transmittal. J. Ross, 63-61 Yellowstone Blvd. Forest Hills 75, New York, Dept. 6J-HF.

BUSINESS OPPORTUNITIES

I MADE \$40,000.00 Year by Mailorder! Helped others make money! Start with \$10.00 Free Proof. Torrey, Box 3566-N, Oklahoma City 6, Oklahoma.

SONGS into \$\$\$\$\$ — New, unknown Songwriters, Song-poets. Composers share \$33 millions yearly. Any subject, we collaborate, publish, promote. Largest firm, information, appraisals Free. Send Nordyke Publishers, 6000 Sunset, Hollywood, California 3-90028.

PLEASANT Way To Earn At Home. Free Details. Hamilton Studios, Seaford 2, New York.

DETECTIVE Opportunities. Experience unnecessary. Write, Wagner, 125 W. 86th, New York 10024.

MISCELLANEOUS

HYPNOTIZE Unnoticed, quickly, effortlessly, or refund! Thousands delighted! \$2.00. Minter Box 244-D, Cedarburg, Wisconsin.

WILD Labels, bumper strips! Strange, startling, unconventional! Crazy Labels, Box 15-H, Olympia, Washington.

EVERYONE wants to progress... but how do we go about it? Send 20¢ for Issue 163—The Driving Urge To Be Somebody. Write to: Lemurian Viewpoint, Ramona 6, California.

WANTED

QUICKSILVER. Platinum, Silver, Gold. Ores Analyzed. Free Circular. Mercury Terminal, Norwood, Mass.

KINSMAN One Keyboard Electronic Organ. Baldwin, 703 George, New Haven, Connecticut.

Recording: Glorious
Stereo Quality: Spectacular

Whatever the fate of the film or its stars, this sound-track recording is bound to become a model of its kind. It has just about everything commonly associated with the Hollywood supercolossal—music for a cast of thousands, you might say, although the personal drama of the protagonists is not overlooked. As might be expected, the score is at its grandest and most exotic in the sections accompanying Cleopatra's procession into Rome and in the scene aboard that famous barge. The sound will test the finest stereo systems. C. B.

⑤ GIANTS OF JAZZ. Dave Brubeck Quartet; Quincy Jones and the All Stars; Dukes of Dixieland; Lambert, Hendricks and Ross; others. *Waltz Limp; Grasshopper; By and By; This Here*; and eleven others. COLUMBIA CQ 548 \$7.95.

Interest: Jazz sampler
Performance: High average
Recording: Fine
Stereo Quality: Acceptable

Since it is culled from Columbia's rich jazz roster, this reel has more to offer than the usual mixed bag. It also runs about an hour, and so is a bargain purchase as well. Most of the artists are indeed giants in the jazz world today, and most are heard here in various states of musical exhilaration: Miles Davis' busy *Devil May Care*; J. J. Johnson's solid treatment of *Fatback*; Lambert, Hendricks, and Ross' lusty *This Here*; Eddie Condon's engaging *Tiger Rag*, and so on. In somewhat less inflated spirits is Thelonious Monk for his somber *Coming on the Hudson*, and the Bud Powell Trio in a rather heavy-handed reading of *Ruby My Dear*. Jimmy Giuffre is the only real iconoclast among them—his *Motion Suspended* is highly abstract. With few exceptions, the recordings are of recent vintage, and the sound is good. C. B.

⑤ JIMMY SMITH: *Hobo Flats*. Jimmy Smith (organ); orchestra, Oliver Nelson cond. *Hobo Flats; Blueberry Hill; Walk Right In; Trouble in Mind*; and four others. VERVE VSTC 290 \$7.95.

Interest: Smith's sequel
Performance: Rough-riding
Recording: Hefty
Stereo Quality: Pronounced

Jimmy Smith, the jazz organist who established himself on tape and discs with a collection featuring a best-selling rendition of *A Walk on the Wild Side* (Verve VSTC 279), returns with another ingratiating reel. *Hobo Flats* is a blues by conductor-arranger Oliver Nelson

in which the King of Instruments is felicitously mated with the lowly harmonica. Another engaging down-and-outer is *Trouble in Mind*, which concludes the first sequence. Horace Silver's *The Preacher*, on the second side, has a certain gospel appeal, but its six minutes of sermonizing wear thin. Casual nods toward the bossa nova idiom, in *Blueberry Hill* and *Meditation*, and an easy-going arrangement of Don Gibson's *I Can't Stop Loving You* just about complete the set. Good, juicy sound. C. B.

⑤ CAL TJADER: *Soña Libre*. Cal Tjader (vibraphone), Clare Fischer (organ, piano), Fred Schreiber (bass), Johnny Rae (drums), Bill Fitch (conga drums). *Hip Walk; Sally's Tomato; O Barquinho; El Muchacho*; and six others. VERVE VSTC 295 \$7.95.

Interest: Latino jazz
Performance: Assertive
Recording: Clean
Stereo Quality: Distinct

With an even thirty discs to his credit, it is surprising that this is Cal Tjader's tape debut as leader of his own group. Predictably, the mood is latin, ranging from the blues in 6/4 time—his own *Hip Walk* and the quasi-Debussian *My Reverie*—to "hard" readings of two bossa nova classics, *O Barquinho* and *Manha de Carnival*, the theme from the film *Black Orpheus* (written by Luiz Bonfã, not Luis Confã as the notes have it). The surprise, and a welcome one, is *Sally's Tomato*, a sultry samba Henry Mancini composed for his *Breakfast at Tiffany's* sound track. This is generally an attractive, rhythmically hearty, and well-recorded session, particularly enlivened by Clare Fischer's dry organ riffs placed on Tjader's left and a lively percussion trio on his right. C. B.

⑤ ANDY WILLIAMS: *Days of Wine and Roses*. Andy Williams (vocals); orchestra. *Falling in Love with Love; It's a Most Unusual Day; When You're Smiling; I Left My Heart in San Francisco*; and eight others. COLUMBIA CQ 555 \$7.95.

Interest: Sundry pops
Performance: Assured
Recording: High-level
Stereo Quality: Well defined

As a recording artist, Andy Williams has immediate appeal, and he knows how to pick a song. The ballads he sings here, standards such as *You Are My Sunshine* and the classic *Falling in Love with Love*, as well as a smattering of current pops, are good showcases for his rugged outgoing style. The orchestrations are big, wide, and mostly wonderful, the voice a little larger than life. C. B.

Printed in the U.S.A.

HIFI/STEREO REVIEW ADVERTISERS' INDEX

READER SERVICE NO.	ADVERTISER	PAGE NO.	READER SERVICE NO.	ADVERTISER	PAGE NO.
1	Acoustic Research, Inc.	87	42	Inter-Mark Corp.	120
2	Airex Radio Corporation	98	47	Jensen Manufacturing Company	97
3	Altec Lansing Corporation	93	48	KLH Research and Development Corporation	80, 94
4	American Concertone, Inc.	131	65	KLH Research and Development Corporation	110
5	Ampex Corporation	22	49	Key Electronics Co., Inc.	104
6	Ampex Corporation	23	82	Koss Electronics	99
7	Ampex United Stereo Tapes	118	50	Lafayette Radio Electronics	106
38	Anglo American Acoustics Ltd.	124	83	Lansing Sound, Inc., James B.	69
39	Argo Records	104	15	Lear Siegler, Inc.	115
55	Argos Products Company	84	52	Lesla of America Corp.	120
9	Audio Devices, Inc.	3rd COVER		London Records	98
10	Audio Dynamics Corporation	8	53	Marantz	30
11	Audio Exchange	122	84	Mercury Records	82
12	Audio Originals	108	44	Minneapolis-Honeywell (See Honeywell)	10
13	Audio Unlimited, Inc.	132	51	Minneapolis-Honeywell (See Honeywell)	90
14	Benjamin Electronic Sound Corp.	29	56	Minnesota Mining & Manufacturing Co.	113
27	Benjamin Electronic Sound Corp.	71	57	Murray-Carson Corporation	121
15	Bogen Communications	115	58	Pickering and Company, Inc.	27
16	British Industries—Garrard	2	59	RCA Red Seal Magnetic Tape	126
	Brown Sales Corp., L. M.	134	60	Rabsons—57th Street, Inc.	94
17	Cambridge Records, Inc.	94	61	Rek-O-Kut	103
	Carston Studios	134	62	Reis & Co., Iwan	80
18	Citadel Record Club	70	85	Roberts Electronics, Inc.	91
19	Columbia Records	66, 67	63	Rockford Special Furniture, Co.	98
20	Command Records	7	88	Sanborn's Stereo City	119
86	Commission Electronics, Inc.	94	64	Sarkes Tarzian, Inc.	130
	Commission Electronics, Inc.	134	86	Saxitone Tape Sales	94
21	Connoisseur Record Corp.	76		Saxitone Tape Sales	134
22	Crown International	6	66	Scott, Inc., H.H.	2nd COVER, 1
45	Deutsche Grammophon	20	67	Sherwood Electronic Laboratories, Inc.	24
	Dixie Hi-Fi	134	68	Shure Brothers, Inc.	19
23	Douwe Egberts Royal Factories	12		Sleep-Learning Research Association	134
	Dressner	134	69	Sonotone Corporation	107
40	Dynaco, Inc.	100	70	SONY Corporation of America	105
24	Eastman Kodak Company	129		Sound Reproduction, Inc.	134
25	EICO Electronic Instr. Co., Inc.	34		Stereo Component Supply Co.	135
26	Electro-Voice, Inc.	4th COVER		Stereo-Parti	135
28	Elpa Marketing Industries, Thorens Division	116		Stereo Warehouse	134
29	Empire Scientific Corp.	33	71	Superex Electronics	114
30	Fax Record Company	117	72	Superscope, Inc.	21
31	Finney Company, The	86	81	Superscope, Inc.	109
32	Fisher Radio Corporation	9, 11, 13, 15		Tall Company, The	135
33	Freeman Electronics Corp.	128		Tapemates Club	134
34	Fuji Photo Optical Products, Inc.	14	73	Telex/Acoustic Products	124
	Goodwin (Sales) Ltd., C.C.	134	74	Topselco	132
35	Grado Laboratories, Inc.	73	87	United Artist Records	119
36	Greentree Electronics	68	75	Universal Record Club	5
41	Harman-Kardon, Inc.	88, 89	76	University Loudspeakers	16
37	Heath Company	74, 75, 77, 79, 81, 83, 85	77	Vanguard Records	92
43	Hi-Fidelity Center	114	78	Viking of Minneapolis, Inc.	123
	Hi-Fidelity Supply	134	79	Wayfarer Car-Stereo	132
44	Honeywell Photographic Products	10		Wholesale Radio and Camera Co.	134
51	Honeywell Photographic Products	90	80	Zeiss, Inc., Carl	78
	Illes Brothers	135			

HIFI/STEREO REVIEW PRODUCT INDEX

As an additional reader service, we list below, by classifications, the products advertised in this issue. If there is a specific product you are shopping for, look for its listing and turn to the pages indicated for the advertisements of manufacturers supplying that equipment.

CLASSIFICATION	PAGE NUMBERS
Amplification Systems	15, 34, 77, 79, 85, 93, 100, 106
Antennas, FM	86
Binoculars	78
Cabinets	98, 108
Cameras	10, 14, 90
Cartridges, Phonograph	8, 19, 27, 73, 107
Headphones	99, 114, 124
Organ Kits	81
Pipes, Smoking	80
Portable Phonographs	132
Portable Radios	105
Records	5, 7, 20, 66, 67, 70, 76, 82, 92, 94, 98, 104, 117, 119

CLASSIFICATION	PAGE NUMBERS
Speakers and Speaker Systems	13, 16, 69, 80, 84, 87, 94, 97, 110, 121, 122, 124, 4th Cover
Tapes, Prerecorded	118, 132
Tape, Recording	22, 68, 113, 126, 129, 130, 3rd Cover
Tape Recorders and Decks	6, 21, 23, 29, 91, 106, 109, 120, 123, 128, 131, 132
Tobacco	12
Tuners and Tuner-Amplifiers	2nd Cover, 1, 9, 11, 24, 30, 34, 74, 75, 77, 79, 88, 89, 100, 115, 122
Turntables and Changers	2, 33, 71, 87, 103, 116, 120
TV	83, 105

audiotape

PRESENTS

*The
Melody
Lingers
on*

IMMORTAL SONGS BY:

**COLE PORTER
HAROLD ARLEN
IRVING BERLIN
GEORGE GERSHWIN
FREDERICK LOEWE
RICHARD RODGERS**

AND OTHERS

IN RICH ARRANGEMENTS BY: **RAOUL POLIAKIN** HIS 55 PIECE ORCHESTRA AND 20-VOICE CHORALE
FROM THE MAGNIFICENT EVEREST STEREO LIBRARY

\$1.00

Christmas is early this year! We're offering a superb recorded tape for a fraction of its actual cost for trying a 7" reel of Double Recording Audiotape on Tempered "Mylar." (A great tape in itself: double length plus double strength.) ■ Just buy a reel of Double Recording Audiotape (Type 2431T) at the regular price, and for only \$1.00 additional come away with *The Melody Lingers On*—a magnificent 55-minute program of great popular standards. These unforgettable melodies are performed in luxurious arrangements from the Everest stereo library, long noted for the superb quality of its

recordings. ■ The \$1.00 price tag is even more remarkable when you consider that the entire program is recorded on a reel of standard Audiotape which actually sells for more than twice that price! So even if you erased the tape (heaven forbid!) you'd still be ahead of the game. ■ Go to any store that carries Audiotape products and buy a reel of Double Recording Audiotape, Type 2431T. Then add one dollar for *The Melody Lingers On*, a great tape that you and the women in your life will treasure. Available only in 4-track stereo. And Merry Christmas!

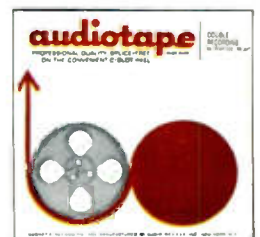

AUDIO DEVICES, INC.
444 MADISON AVENUE,
NEW YORK 22, NEW YORK

Introducing...



THE PATRICIAN® 800 SERIES

... a complete new collection of high fidelity loudspeaker systems and matching equipment consoles

The Patrician 800, like its famous predecessors, is devoted to the reproduction of sound with absolute honesty. It speaks only when spoken to . . . with a voice that is no more spectacular—and no less so—than the music it is asked to duplicate.

As a result, the Patrician 800 is somewhat larger than most other speaker systems—even to its extraordinary 30-inch

woofer—simply because a system of this magnitude is required to reproduce the deepest musical sounds accurately and without compromise.

In appearance, the Patrician 800 achieves a new standard of elegance in both Traditional and Contemporary designs . . . for this system was conceived as the ultimate reflection of your good taste in

fine music and superb home furnishings.

We invite your critical appraisal of the entire new Patrician loudspeaker collection at your nearby Electro-Voice high fidelity demonstration center. Or we will be happy to send a catalog on request.

ELECTRO-VOICE, INC., Consumer Products Division, Dept. 1234-F, Buchanan, Michigan

Electro-Voice®
SETTING NEW STANDARDS IN SOUND