



serving: recording, broadcast and sound contracting fields

sound \ˈsaund\ n [ME *soin*, fr. OF *son*, fr. L *sonus*]
1. An auditory impression, i.e.: a) Breaking Into Concert Sound, Part II, b) The 30-Second Drum Sound Set-up, c) Re-creating the Sousa Sound.

Also this month:
Lab Report - Aphex Expressor
Hands On - E-mu Proteus I and II



A New Loews Sound System

A few important words about the new A-T 40 Series:



AT4049
Omnidirectional
Capacitor

Tony Bongiovi
Power Station

"The 4051 is a great mike, especially for rock. It sounds fat and you can bang away at it with a lot of level without a pad...for a rock studio like the Power Station that's important. When you put it on horns it has a nice clean sound and it holds the dynamics well...it's just an excellent sounding mike."



AT4051
Cardioid
Capacitor

David Cook
Dreamland Studios

"...real nice top end and a warm bottom end...very versatile. I didn't have to pile on a lot of EQ to capture the air in the studio...very present, very natural sounding mikes."



AT4053
Hypercardioid
Capacitor

Milan Bogdon
Masterphonics

"The S/N ratio is superior to some of the other mikes we used. They're bright and clean so we don't have to push the EQ. Superb mike...great for vocals, overheads, snare, toms, electric and acoustic guitar...it seems to work well wherever we put it."

Jeff Baxter
Producer/Artist

"If I'm not getting what I want from another microphone...I've been putting up the 4051 and it nearly always does the job."

Mack Emerman
Criteria Studio

"The response is very flat...it holds the natural tonal qualities even at high sound pressure levels."

Now it's your turn!

Compare the new Audio-Technica 40 Series against the very best in your studio. Contact your A-T pro sound dealer today.

Circle 10 on Reader Service Card

www.americanradiohistory.com



audio-technica

1221 Commerce Drive, Stow, OH 44224
(216) 686-2600 • FAX (216) 688-3752

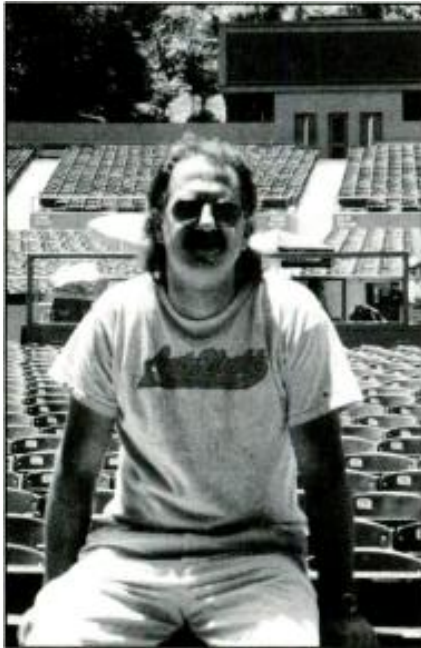

page 24



page 14

About the Cover

• The new SurroundStar XII and TheatreStar XIII loudspeakers from Community Light and Sound have a new home in the Loews 19th Street Theatre in New York City. The speakers are specially designed for high suspension above the audience and give an excellent surround effect. The drawing on our cover shows the theater's ultra-modern design, which complements the new sound system. See page 30 for the full story.

serving: recording, broadcast and sound contracting fields

The recording engineer

RE-CREATING THE SOUSA SOUND <i>Larry Zide</i>	8
HANDS ON: E-MU PROTEUS I AND II <i>John Barilla</i>	14
THE 30-SECOND DRUM SOUND SETUP <i>Malcolm Chisholm</i>	21
LAB REPORT: APHEX EXPRESSOR 651 COMPRESSOR/LIMITER <i>Len Feldman</i>	38
AES ROUNDUP <i>Jim Paul</i>	52

The sound contracting engineer

BREAKING INTO CONCERT SOUND, PART II <i>Jim Paul</i>	24
A NEW LOEWS CINEMA SOUND SYSTEM <i>Greg DeTogne</i>	30
TEK TEXT: SPEAKER ANGLES II: CALCULATING SPEAKER LOCATION <i>Dan Rogers</i>	32
AUDIO FOR THE CHURCH <i>Brent Harshbarger</i>	48

The broadcast engineer

BROADCAST AUDIO: DIGITAL AUDIO BIT-RATE REDUCTION <i>Randy Hoffner</i>	55
---	----



THE ELECTRONIC COTTAGE

MUSICIAN'S NOTEBOOK: THE BASICS <i>Mark Maulucci</i>	42
RECORDING TECHNIQUES: CLEANER MIXES WITH MIDI TAPE SYNC <i>Bruce Bartlett</i>	44

CALENDAR	2
LETTERS	4
EDITORIAL	6
NEW PRODUCTS	59
BUYER'S GUIDE: COMPRESSORS/LIMITERS, NOISE GATES, NOISE REDUCTION EQUIPMENT, SPECTRUM ANALYZERS	63
CLASSIFIED	73
PEOPLE, PLACES, HAPPENINGS	74

Calendar

• Electro-Voice and Mark IV Audio will conduct seminars Nov. 12-13 in Montreal and Nov. 15-16 in Toronto for E-V professional sound reinforcement contractors and consultants. The day-and-a-half seminars will cover a wide range of in-depth product presentations, including comparative demonstrations and application tips; a demonstration of the AcoustaCADD computer-aided sound system design program and; an overview of E-V's engineering research and development facilities. For more information and registration, contact Rockwell or Murray at 800/827-6701 or Doug MacCallum, general manager of Mark IV Audio Canada at 613/382-2141.

• Nominations for the broadcast industry's highest engineering honors, the National Association of Broadcasters' Engineering Achievement Awards, are now being accepted. For the first time, two awards will be given, one to a radio engineer and one

to a television engineer. To qualify for consideration, candidates must have made a single contribution or contributions over a period of time which have considerably advanced the state of the art of broadcast engineering. Examples of contributions may include an invention, the development of new techniques, leadership or the dissemination of technical knowledge and literature. Awards will be presented at the Engineering Luncheon during the NAB 1991 Convention in Las Vegas, NV, April 15-18. Nominations must be received by Dec. 1.

• The 26th Annual Management Development Seminars for Broadcast Engineers, sponsored by the NAB, will be held Feb. 10-15, 1991, at the University of Notre Dame in South Bend, IN. Fundamentals of Leadership, Toward Leadership Effectiveness and Leadership and Teamwork are the three seminars being offered. Registration deadline is Feb. 1. To register for the seminars, or to request a nomination form for the NAB Engineering Achievement Awards, contact the NAB's Science & Technology Department at (202) 429-5346.



Editor/Publisher
Larry Zide

Associate Publisher
Elaine Zide

Senior Editor
John Barilla

Editorial Assistant
Caryn Shinske

Contributing Editors

Bruce Bartlett

Brian Battles

Drew Daniels

Len Feldman

Brent Harshbarger

Randy Hoffner

Jim Paul

Robyn Gately

Graphics & Layout

Karen Cohn

BPA Audit applied for May 1989

db, The Sound Engineering Magazine (ISSN 0011-7145) is published bi-monthly by Sagamore Publishing Company Inc. Entire contents copyright 1990 by Sagamore Publishing Company Inc., 203 Commack Road, Suite 1010, Commack, NY 11725. Telephone: (516) 586-6530. db Magazine is published for individuals and firms in professional audio recording, broadcast audio-visual, sound reinforcement-contracting, consultants, video recording, film sound, etc. Application for subscription should be made on the subscription form in the rear of each issue. Subscriptions are \$15.00 per year (\$28.00 per year outside U.S. Possessions, \$16.00 per year in Canada) and payable in U.S. funds. Single copies are \$3.50 each. Editorial, Publishing, and Sales offices are at 203 Commack Road, Suite 1010, Commack, NY 11725. Second Class postage paid at Commack, NY 11725 and an additional mailing office. **Postmaster: Form 3579 should be sent to db Magazine, 203 Commack Road, Suite 1010, Commack, NY 11725.** Trademarked names are editorially used throughout this issue. Rather than place a trademark symbol next to each occurrence, we state that these names are used only in an editorial fashion and to the benefit of the trademark owner, and that there is no intention of trademark infringement.

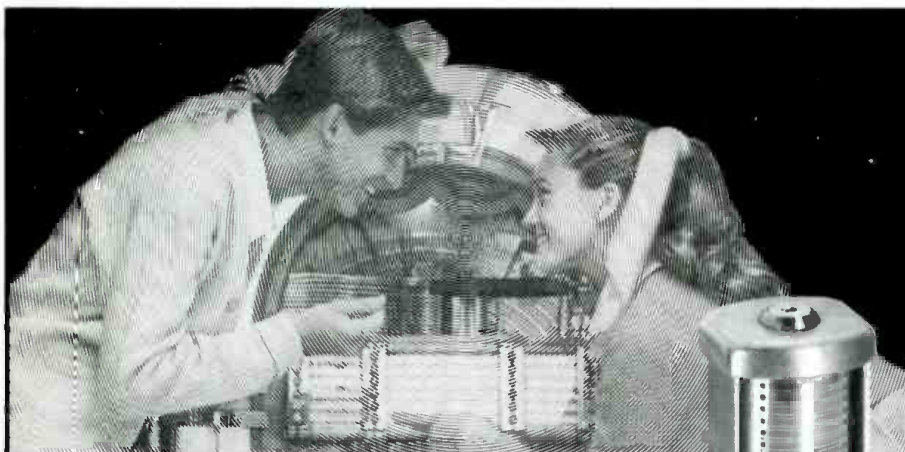

SOUND ADVICE

From The Magnetic Head Specialists

Timely Maintenance is Essential. Reconditioned and Aligned Heads will:

- RESTORE signal amplitude stability
- ENHANCE top end response
- ELIMINATE tape/head generated distortion
- REMOVE causes of oxide shedding & build-up
- STABILIZE tape-path tracking



For the best sound, always rely on the best service.

Head Replacements — Reconditioning — Optical Alignment — Time Code Kits — Alignment Tapes.

249 Kennedy Road • P.O. Box 121 • Greendell, NJ 07839
Tel.: (201) 579-5773 • Telex: 325-449 • Fax: (201) 579-6021

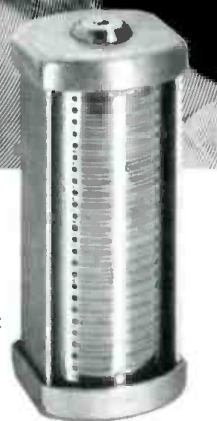

MACRO REFERENCE. FOR INCOMPARABLE SOUND.

The sound is incredibly transparent, unbelievably true. It's as if you were experiencing a live performance. Yet, the sound is a result of Crown's newest technological achievement. Macro Reference. A 20 bit amplification system with the essence of 20 bit digital sound.

Reference is the ultimately damped, high excursion amplifier. A dual velocity feedback system enables Reference to take its low frequency damping range to in excess of 20,000. This makes low-end response tight, well-defined and

incredibly natural. Crown has also enhanced ODEP™ (Output Device Emulator Protection) circuitry for Reference, creating precise transfer function (monitored by IOC®) and thereby accurate control of the music signal within the amplifier.

To assure that Reference can function under exacting requirements, its power supply was designed around an advanced toroid which nearly eliminates electromagnetic interference. And its revolutionary convection cooling system with computerized, proportional fan assist prevents thermal overload in high-demand situations. This makes Reference quiet enough to use in even the most discriminating environment.

Digitally ready with a dynamic range that approaches the environment in which we live, Macro Reference will be the industry Reference for years to come. But you must experience Macro Reference to truly appreciate it. Visit your Crown dealer today. Comparing apples to apples, there is no comparison.

Crown. Guaranteed Excellence.

Crown® International, Inc.
P.O. Box 1000
Elkhart, Indiana 46515-1000 U.S.A.
Telephone: 219/294-8000
Toll-Free: 800/535-6289



MACRO
REFERENCE

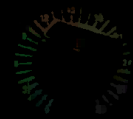
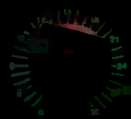

CROWN

Circle 16 on Reader Service Card

www.americanradiohistory.com

Letters

Dear Editor:

I would like to compliment John Barilla on his excellent article "Understanding Timecode Synchronization." However, it seems that I have become self-appointed Guardian of Timecode Facts, and as such, I feel a couple of problems should be pointed out for the benefit of readers new to this arena.

First, to clarify the most misunderstood aspect of timecode usage: drop-frame. SMPTE timecode comes in rates of 24, 29.97 and 30 frames per second: 29.97 fps code is always used in video production today, and can be either drop or non-drop frame. However, because the timecode runs at 29.97 fps but counts to an even "30", at the end of one real-time hour the

code has not yet reached the one-hour count. When the timecode finally reaches 1:00:00:00, the program is actually 108 frames (0.1%) too long. The drop-frame system was developed to correct this inequity between the timecode count and the true elapsed time when using 29.97 fps code. This is done by eliminating the first two frames in every minute, except the tens minutes (0, 10, 20, 30, 40, 50), thus reducing the final count by the necessary 108 frames. Contrary to the implication of the article, however, 29.97 fps non-drop frame code is commonly used by video houses, because it is simpler to deal with, except when exact timing is required (such as in broadcast).

Secondly, I would be less casual about the importance of frame rates.

While it's true that things will generally work themselves out if all dubs are done properly, synchronizers do not simply "act a little strange" when dealing with mixed frame rates. Serious out-of-sync nastiness can result if attention is not given to this matter, particularly when interchanging with a video house. Remember, in a simple synchronizing system, all transports will be resolved to the rate of the master code. Even if they have different rate code, this can effectively change the actual "speed" of the audio. I recommend using 29.97 fps code if dealing with video.

Lastly, the terminology used by a given timecode reader/generator should be examined carefully when jam-syncing code. I interpret continuous jam to mean "follow the incoming code exactly at all times," which would not do for restriping a missing segment of code. In this case I would use momentary jam, which says "look at the incoming code initially, but then keep counting on your own" (locked to an internal crystal or external video sync, not tach pulses!).

Eric Wenocur
KLM Video, Inc.
Bethesda, Md.

John Barilla responds:

I am grateful to Eric Wenocur for both his kudos on my article and his criticism. There is no doubt that Mr. Wenocur is, in fact, a bona fide "Guardian of Time-Code Facts"—something that I do not claim to be. The purpose of my article was simply to point out the everyday practice of time-code usage on the level of *The Electronic Cottage* (the smaller, personal production studio).

On this level, commercials and industrial presentations are often done on a "quick and dirty" level; fact is, for short programs, this works sufficiently well. I didn't feel my article required going into the (admittedly important) distinction between the various time-code formats, however, Mr. Wenocur did an excellent job of doing so, and his letter serves as an informative postscript to my article.

Finally, I thank Mr. Wenocur for pointing out my inadvertent use of the term "continuous jam sync"—for the process known as "one-time" or "momentary" jam-sync. I am always happy to receive input from db's readership.

Free Catalog of

Professional SOUND recording & duplicating SUPPLIES

C2

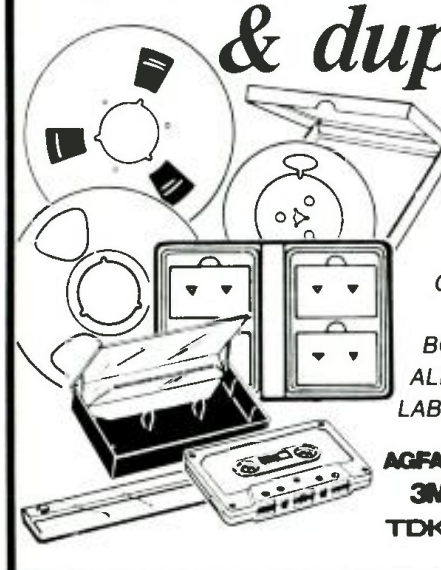

POLYLINE™ EMPTY
REELS & BOXES

BLANKLOADED
CASSETTES

BOXES
ALBUMS
LABELS

AGFA AMPEX
3M Scotch
TDK maxell
tapes

now from
STOCK
in
CHICAGO
and
L.A.

Call Polyline

708/298-5300

8:30 am-5 pm Central Time

Polyline
Corp.

1233 Rand Road
Des Plaines, IL 60016

Circle 15 on Reader Service Card

HOW TO FIT A SYMPHONY ORCHESTRA INTO A SMALL STUDIO.

It's simple. Buy a Proteus/2. The latest member of E-mu's acclaimed family of 16-bit digital multi-timbral sound modules.

Proteus/2 is the first—and only—instrument to offer the complete resources of a world class symphony orchestra. All in a single rack space.

Specifically, you get 8 megabytes of new sounds including solo and ensemble violins, violas, cellos, and basses. Arco and pizzicato. Winds. Brass. Orchestral percussion. All of which are instantly accessible in ROM.

And every sound takes full advantage of our amazing G chip. Providing the unparalleled audio quality that led Proteus/1 to be selected *Keyboard Magazine's* "Technological Innovation of the Year."

Besides a complete orchestra, the new Proteus/2 gives you dazzling new synth sounds. Made possible by the

instrument's extensive user editing functions and new complement of digital waveforms.

Like every Proteus sound module, Proteus/2 features 32-voice polyphony and 16-channel multi-timbral capability.



Six programmable polyphonic outputs with integral effect send/returns for on-board mixdown. And E-mu's MIDIPatch™ modulation system for real-time access to over 40 performance parameters.

Built in the U.S., Proteus/2 is remarkably easy to use. And even easier to get your hands on. Just visit your E-mu dealer.

And discover a true classic.



E-mu Systems, Inc.
applied magic for the arts

Circle 17 on Reader Service Card

© 1990 E-mu Systems, Inc. 1600 Green Hills Road,
Scotts Valley, CA 95066. All trademarks are
property of their respective companies.

Editorial

• The best laid plans, even in publishing, don't always happen the way we expect. So when we were putting together our AES Show issue, (September/October) we assembled a number of articles for that issue that space requirements and priorities, prevented publishing. So, in one way at least as applies to the first three stories described, here is the Show issue, part II.

Jim Paul returns to our pages with *Breaking into Concert Sound in Los Angeles, part 2*. This time he only travels as far as Griffiths Park for a major article on engineer Jeff Cox who plies his trade at the famous Greek Theatre. Just what he does there and the hows and whys of it are explored by the author.

Dan Rogers also returns to our pages with *Speaker Angles II, Calculating the Ideal Speaker Location*. And Dan includes a *Basic* computer program that will do just that in a most elegant way.

How do you mic the drums? You think you know? Read Malcolm Chisholm's *Thirty Second Drum Sound Setup*, and you will know just that!

In July, I travelled into Manhattan to witness a full day's classical-style recording of a brass band. RCA/BMG Studio A was the venue. John Eargle was the engineer. The session was by *Delos International* and they were there to do a new collection of Sousa marches.

Rounding out this issue: a blow-by-blow by Jim Paul of what was seen and heard at the just concluded Los Angeles AES Convention, and there was plenty! LZ

Precision Tools for the Professional.



Professionals rely on their tools to bring out the best of their abilities. At Apogee, we make precision tools for audio professionals who are committed to achieving the optimum solutions in sound design. Each electronically integrated speaker system is designed in a laboratory setting and thoroughly tested in real-world environments to ensure smooth, predictable response for voice and music. In musical theatre, touring systems, churches, stadiums, clubs, and sound reinforcement for world class events, Apogee has established itself as the quality leader.

For product information, a CAD data disk, or a product demonstration, call (707) 778-8887, or FAX (707) 778-6923.

APOGEE
SOUND INC.

1150 Industrial Drive
Petaluma, CA 94952

Circle 18 on Reader Service Card
www.americanradiohistory.com

Re-creating the Sousa Sound

Capturing the sound of a large brass band requires some of the technological aids available for rock recording, but others used primarily for classical recording. Here's a recording session where both have occurred.

There is fame resident in Studio A at New York's BMG studios. Many of the greats of both classical and rock were and still are recorded in this room. It was built as part of a still-active RCA recording complex on Sixth Avenue and 44th Street. The Studio, and the RCA name and complex are now BMG Studios.

Studio A is a huge room with an adjustable ceiling and side valences that can be moved to change the actual ambiance of the room. The room also has a large stage, with a thickly-

padded curtain across it, so it can be added to or taken from the overall room characteristics. (See the box at the end of this article for further information about the room's features.)

I was there, on a balmy July day, for a new Delos recording, with John Eargle, Director of Recording for Delos International and Producer Adam Stern in the control room. The recording, which is now in release, was of the *New Sousa Band* under Maestro Keith Brion.

According to Eargle, "Studio A, at 100 by 60 by 40 feet, is quite large as studios go, however; it is not large enough to function as a "Concert Hall" for an ensemble the size of the New Sousa Band. When we made our first tests, we had the room adjusted for its largest and most reverberant parameters. What immediately became apparent was the relatively low direct-to-reverberant sound balance. In short, the room was too live for its size! While this may work well for small chamber orchestra and solo instruments where

Figure 1. The band layout and the microphone placements used for the recordings.

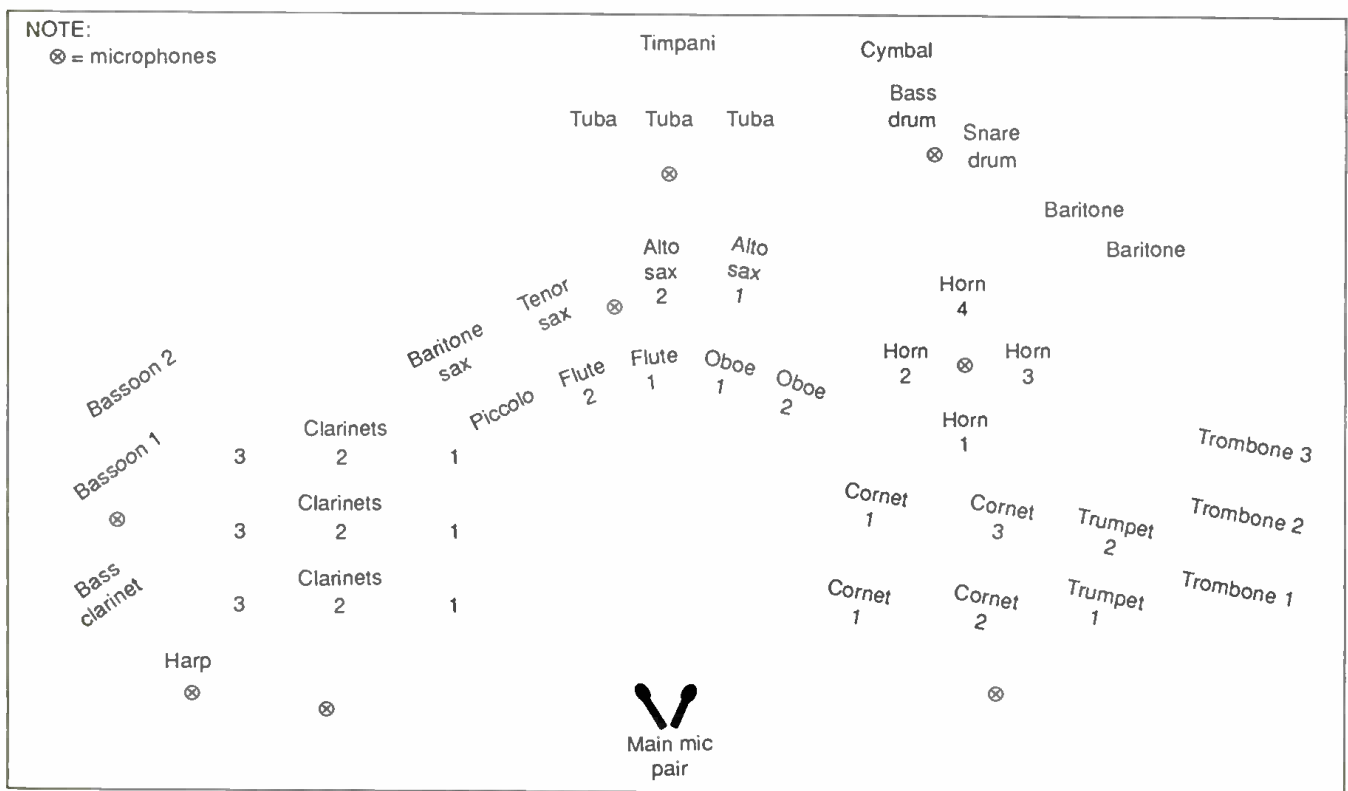

Confused About "Exciters"?

Read the Facts.

Seems like a good thing always leads to imitators. Which is why there seems to be a rash of so-called "brightness enhancers," "phase correctors" and "exciters."

The Aphex Aural Exciter® is a *patented* audio process that will recreate and restore missing harmonics. When added, they restore *natural* brightness, clarity and presence, and actually extend audio bandwidth. All without adding any appreciable power to the signal.

As a result, the Aural Exciter has become a standard tool in the recording, film, broadcast and sound reinforcement industries around the world. It has been licensed for use in prod-

ucts sold by Yamaha, Numark, AKG, Proton, Gentner Engineering, MacKenzie Labs, and Vestax.

Other "brightness enhancers" only boost existing high frequencies, pumping as much as an additional 12dB, which can distort the amp or even blow your speakers... in addition to sounding unnatural. In fact, you could probably achieve the same effect more flexibly and economically by using any equalizer.

Don't be confused by hype. Listen to any device claiming to do what only an Aphex Aural Exciter does, then listen to the real thing. Your ears will hear the difference.



APHEX
SYSTEMS

All Aphex products are designed and manufactured in the U.S.A.
© 1989 Aphex Systems Ltd.
Aphex and Aural Exciter are registered trademarks of Aphex Systems Ltd.

11068 Randall Street
Sun Valley, CA 91352
(818) 767-2929

Circle 19 on Reader Service Card

www.americanradiohistory.com



Figure 2. Studio A control. John EArgle has his hand on the Neve, Adam Stern studies the score of the number being recorded, and Sandy Palmer minds the Sony DAT machines.

the microphones can be placed at fairly close quarters, the basic pickup scheme for the New Sousa Band (four microphones overhead across the front) resulted in too much reverberant sound pickup.

"The only solution was to damp the room and, through the flexibility of the moveable ceiling, to decrease its volume. As a result, we had to rely basically on a qujite realistic Concert Hall reverberation program using the Lexicon 224X reverberation gen-

erator to produce the desired balance between direct and reverberant sound textures. A second consideration in damping the room was to reduce the high reverberant level in the studio itself and allow the players to hear each other comfortably. With forty-three wind and percussion players on hand, it is easy to see how acoustical levels could be quite significant."

Figure 1 details the seating arrangement for the band showing Eargle's microphone locations. According to him, "The seating of the group emphasizes the reeds at the left and center and brass at right and center. Percussion is at the back, and the harp (!) is at the front far left. This is Sousa's own seating arrangement, with the sole exception of the harp. Sousa placed that instrument right in the front arc of the main seating."

The console also had the Lexicon 224X. Signal was fed through this, with its Concert Hall program turned on and set for a reverberation time of 2.4 seconds in the midrange and 2 seconds at low frequencies.

Eargle continued, "The main microphone array consists of a pair of Neumann U89s in an ORTF configuration (cardioids 17 cm apart and angled at 110 degrees). Flanking these at a distance of about ten feet on each side were Sennheiser MKH 20 omni microphones. These four mics provided the main pickup of the group, and they were about eight-foot high and slightly behind the conductor.

"In order to get added detail," Eargle added, "the following accent microphones were also used:

- Lower pitched woodwinds at left, Neumann U89 panned left.
- Harp, Neumann U89 panned left.
- Saxophones, Sennheiser MKH20, panned slightly right of center.
- Tubas, Sennheiser MKH 20, panned slightly left of center.
- Snare drum and cymbals, Neumann U89, panned half right.

STAR CASE

*The Intelligent Alternative
To The Cardboard Box !!*



SOONER or LATER

- ✓ Shipping expensive and hard-to-replace equipment in cardboard boxes will cause damage to its' contents.
- ✓ Shipping expensive equipment in "crow bar-opening" wooden crates will cause loss of precious time.
- ✓ Shipping expensive equipment in soft-sided suitcases will breed nothing but disaster.
- ✓ Shipping expensive equipment with towels or blankets as padding will cause major vibration damage.

STAR CASE MANUFACTURING CO., INC.

648 SUPERIOR AVENUE - MUNSTER, INDIANA 46321
(219)922-4440, FAX (219)922-4442

800-822-STAR OUTSIDE IN
OR

800-782-CASE INSIDE IN

Circle 26 on Reader Service Card

www.americanradiohistory.com

World-Class Sound Reinforcement!



"...extensive listening to the Soundcraftsmen 900X2 revealed this amplifier would be as at home in the most discriminating audiophile's listening room as it would be in a demanding sound reinforcement environment." —db Magazine

SPECIFICATION	MFR'S CLAIM	db MEASURED
Power Output/ch.at 1 kHz		
4 ohms	675 watts	700 watts
8 ohms	375 watts	400 watts
2 ohms	900 watts	Not Measured
8 ohms mono (bridged)	1350 watts	Confirmed
Rated THD	0.05%	0.03% (see text)
Frequency Response	20 Hz to 20 kHz +/-0.1 dB	(See text)
S/N (re: 1 Watt)	N/A	-78 dB
S/N (re: rated output)	-105 dB	-106 dB
Slew Rate	50 V/usec	Confirmed
Input Sensitivity, Rated Output	1.22 V	1.20 V
Weight	59 lbs.	Confirmed
Dimensions (WxHxD, inches)	19x5.25x16.5	

The 900X2 includes the following features: • Built-in power-line conditioning. • Zero delay/zero phase shift negative feedback loop • 7-stage turn-on delay • Switchable signal compressor • Drives a 70 Volt line without a step-up transformer. For a copy of the complete review of the 900X2 or any of the other Soundcraftsmen products, use the Reader Service Card, Call, Write or Fax us.

International distributorship inquiries welcomed.

Soundcraftsmen

MADE IN THE U.S.A.

2200 S. RITCHIEY, SANTA ANA, CA 92705 PHONE 714-556-6191 FAX 714-662-0750

Circle 20 on Reader Service Card



• French horns, Neumann U89, panned half right.”

In the control room, this modest array (by rock standards) was fed to a fully-automated Neve. The automation was turned off as not needed for this application. The console also had the Lexicon 224X. Signal was fed through this, with its *Concert Hall* program turned on and set for a

reverberation time of 2.4 seconds in the midrange and 2 seconds at low frequencies.

(The resultant sound, heard in the control room on near-field B & W 801 monitors, had an excellent feeling of both depth and breath, with fine instrumental detailing and natural-sounding ambiance. Ed.)

Eargle mixed the program directly to stereo and it was recorded on a Sony PCM-2500 DAT recorder, with a simultaneous clone running on a PCM-2000. BMG's Sandy Palmer, who was the assistant engineer, ran the tape machines, and served as liaison with the studio management.

As each selection, there were thirteen-such recorded this one day, came through the speakers, Stern sat with a conductor's score, marking sections for re-takes or completion as required. Accordingly, he would call for repeats of sections, or even a complete work, or go to the next number. Stern is well equipped for this, with a 1977 Masters Degree in music from the California Institute of the Arts.

That evening, with the DAT tapes in his hand luggage, Stern headed back to California and the editing of the tapes that were to become the master for the CD and cassette release that Delos now has out.

After graduation and several stints as a conductor, he drifted toward record producing and now has the title of Senior Producer for Delos and produces many of their releases. I wanted to know why this Los Angeles-based company had to come to New York and to BMG's Studio A. Stern replied, "Most of the musicians are New York based, so that dictated that. As for Studio A, we've done recordings in there before, and we like the room. There are really few subway-rumble-free large rooms in New York. It's as simple as that."

That evening, with the DAT tapes in his hand luggage, Stern headed back to California and the editing of the tapes that were to become the master for the CD and cassette release that Delos now has out. Because R-DAT still has no sophisticated editing systems, the tapes were transferred, in digital domain,

WIRELESS THAT'S AT HOME, ANYWHERE.

Sony VHF wireless systems give you 168 channels to choose from, so no matter where your next gig is and no matter how congested the airwaves get, you'll always be able to have a channel to call your own. To find out more call 1-800-635-SONY.

Sony ad WRT-420

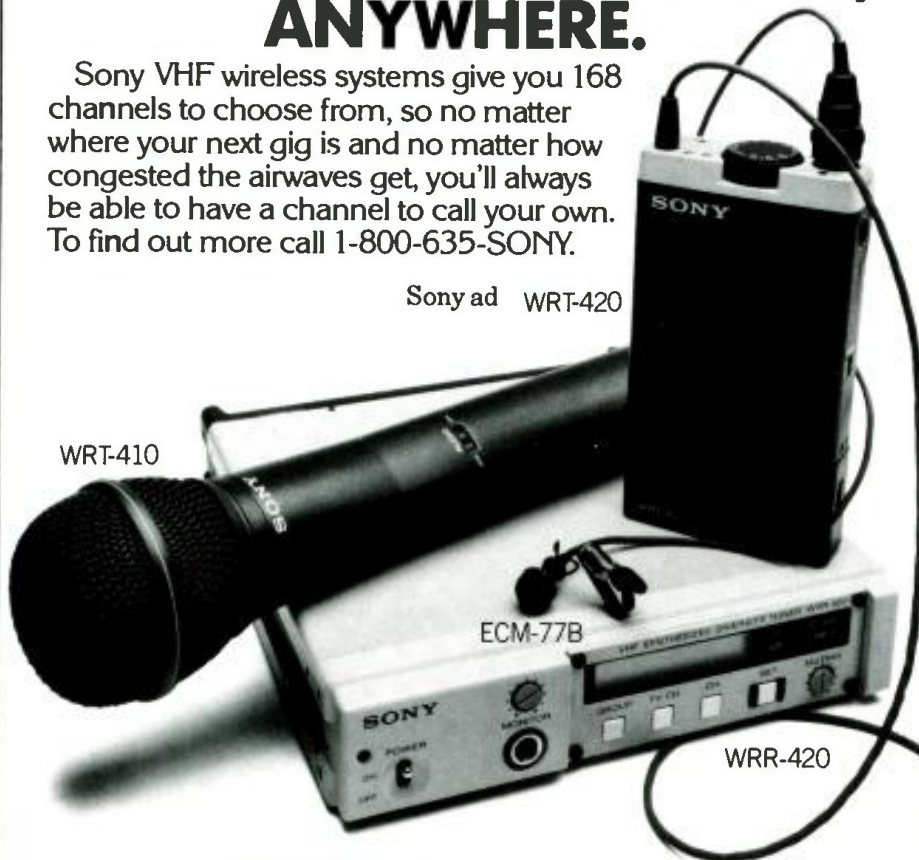

VHF WIRELESS SYSTEM

- **WRT TRANSMITTERS** • PLL (Phase Locked Loop) synthesized frequencies • Rotary selection of channels • AA battery operation • Battery LED indicator • Greater than 96dB S/N ratio • Optional guitar adaptor cable • **WRR RECEIVERS** • PLL synthesized tuning • Adjustable muting
- Microprocessor group selection • RF and audio indicators • LCD display
- 7 to 12 volt DC operation • WRR-410 is non-diversity • WRR-420 is diversity • Carrying case and other accessories available

SONY

Sony Communications Products Company
1600 Queen Anne Rd Teaneck, NJ 07666
© 1989 Sony Corporation of America Sony is a registered trademark of Sony

PROFESSIONAL AUDIO

to a Sony 1630 machine. Editing was done with a Sony DAE3000 Editor.

Once the final versions of each Sousa selection were determined, it

was also decided to add five re-mastered selections of John Philip Sousa conducting the U.S. Field Artillery Band, and bring the final release timings to over 60 minutes.

Delos has packaged the CD into a collectors' album since it also commemorates the 100th anniversary of Sousa's glorious decade.

In July/August 1988, db Magazine featured an article on the reconstruction of the aging RCA complex into the new BMG complex. As a part of that, Don Frey of BMG, who was instrumental in the re-building, talked about Studio A and its special features.

"All of this curvilinear design work was conceptualized by Dr. Harry Olsen, an acoustician who taught at Princeton," Frey said. "He called those curved shapes *polys*. You will probably notice that the polys are a recurring concept in this complex. Mr. John Volkmann was responsible for the implementation of Dr. Olsen's concepts.

It was John Volkmann who determined the number and size of the polys that were to be used at the original RCA complex. The polys are still the fundamental elements that give these studios such acoustic integrity. Even some of the control rooms utilize the poly as an acoustic-design building block. The studio ceiling moves. Those huge ceiling panels in the studio, lights and all, can move up and down, changing the characteristics of the room to suit any given project and taste.

That part of the ceiling back there (he points to the far end of the room) not only moves down, but tilts so that the back edge comes to the top of the partitions and the front edge stays where it is. The wall panels (polys) are on special casters so that they can come out from the walls to form gobo-like enclosures. Behind each of these wall panels are drapes that can be used to acoustically balance the ambiances and isolation as needed.

This (studio A) is three floors in height from the floor to ceiling. The three studios, A, B and C, are right on top of one another. Each studio is three floors in height, on the fourth, seventh and tenth floor. This studio (A) can comfortably seat two hundred to two hundred and fifty musicians," he said. □

CHECK YOUR BALANCE.

Before you invest in a professional DAT recorder, check to see if it stacks up against the Sony PCM-2500:

- ✓ Records at 44.1kHz as well as 48kHz
- ✓ Has professional SDIF-2, AES/EBU and S/P DIF interfaces
- ✓ Has built-in error indicator
- ✓ Operates on 100/120/220/240V, 50/60Hz
- ✓ Is supplied with both wired and wireless remote control
- ✓ Can individually trim L/R analog input and output



If it's a Sony, you can check all of the above — which is what you'd expect from The Leader in Digital Audio™. For more information call 1-800-635-SONY.

PCM-2500

- Recording and erasure of Start ID, Skip ID and Program Number subcodes
- Two-hour recording time (with DT-120 Sony DAT cassette) •Less than 0.005% Total Harmonic Distortion at +4dB •Greater than 90dB dynamic range
- High-speed locate capability at 60 times normal playback speed

SONY®

PROFESSIONAL AUDIO

Sony Communications Products Company,
1600 Queen Anne Rd., Teaneck, N.J. 07666
© 1989 Sony Corporation of America,
Sony and The Leader in Digital Audio are
trademarks of Sony

Hands On

Proteus II-XR: A Hot New Addition To The Proteus Family

• When Proteus I first hit the market about a year ago, the buzz in the street said this unit was going to sell

like hotcakes. E-mu Systems, Inc. had apparently packaged a bunch of the most useful sounds from the

famed Emulator III into a sample playback unit, put it in a no-frills plastic box and sold it for a \$995 list price. The consumer response was overwhelming. It reminded one of the joyful panic inspired by the release of the original Yamaha DX-7 several years ago. Everyone just had to have one. Musical instrument dealers were back-ordered for weeks. The Proteus I, with its wide variety of both sampled and synthesized sounds, immediately became a studio classic.

SO WHAT ABOUT THE PROTEUS II?

Well, if your penchant is for an intriguing electronic assortment of sampled orchestral instruments, then Proteus II is for you.

Proteus II goes beyond the world of generic strings and horns to capture orchestral instruments in highly expressive postures (tremolo, arco, pizzicato strings); various ambiances (instruments in a small chamber, large concert hall, or close-up); and several combinations (solo, duet, quartet, ensemble, etc.).

Additionally, Proteus II has a modest, but extremely usable collection of textures and sound effects which should endear it to those who do scores for video or film. The preset sounds are extremely clean and nicely configured, frequently using multiple layers of sound and graphic panning arrangements. So, if you are looking for great out-of-the-box sounds, you will undoubtedly be satisfied by what you get from Proteus II—but there is much more lurking below the surface for those interested in exploring the possibilities.

Figure 1. The harmonic waveforms have been designed so that almost any harmonic combination can be realized.

HARMONIC WAVEFORMS

- 70. Oct 1 (Sine)
- 71. Oct 2 All
- 72. Oct 3 All
- 73. Oct 4 All
- 74. Oct 5 All
- 75. Oct 6 All
- 76. Oct 7 All
- 77. Oct 2 Odd
- 78. Oct 3 Odd
- 79. Oct 4 Odd
- 80. Oct 5 Odd
- 81. Oct 6 Odd
- 82. Oct 7 Odd
- 83. Oct 2 Even
- 84. Oct 3 Even
- 85. Oct 4 Even
- 86. Oct 5 Even
- 87. Oct 6 Even
- 88. Oct 7 Even
- 89. Low Odds
- 90. Low Evens
- 91. Four Octaves

Starting from the first octave (fundamental), the harmonic waveforms contain the harmonics (odd, even, or all) present in each octave. In each successive octave the number of harmonics doubles. By combining (pri/sec or link) the harmonic waveforms in various amounts (volume), and transposing them (coarse/fine tuning), a vast range of timbres may be produced.

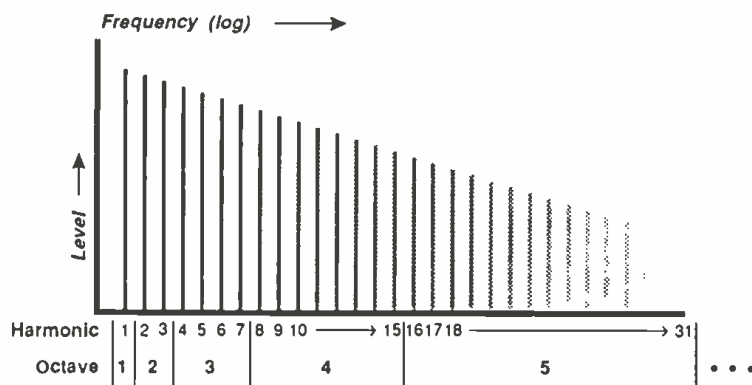

MIDI Spoken Here

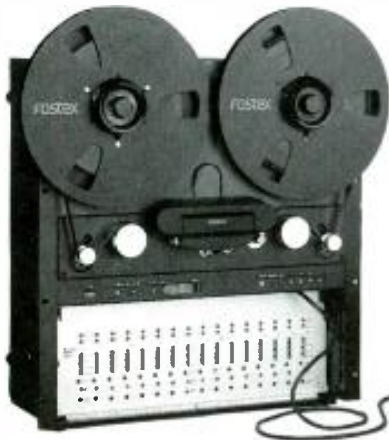

and here...



and here...



here, too.

Fostex offers you by far the most sophisticated MIDI control in all of the most popular recording formats.

Choose either 16 - or 8 - track open reel or 4 - track cassette and Fostex lets you use MIDI commands to control the recorder via the MTC-1.

It simply plugs into the R8 or 280 and provides a bridge between SMPTE time code and MIDI time code. For the G-16, the MTC-1 is on the optional Model 8330 plug-in synchronizer card.

Dip switches allow you to set a MIDI System Exclusive address (0-16), an address-free mode and MIDI note information.

Thus truly sophisticated MIDI control* with full system integration is now possible.

If you own an Atari™ or Macintosh™ computer, you'll make the most of MIDI control with Midi-Remote™ – a Fostex Desk Accessory. In addition to standard tape transport and monitoring control, the software will let you select tracks, locate and loop among ten cue points, automatically punch-in/out, set zone limits, display MIDI time code and generate SMPTE code (all 4 formats).



* The 280/MTC-1 interface does not offer all of the functions available with the open reel interface. • Atari and Macintosh are registered trademarks.

© 1990 Fostex Corporation of America

The Macintosh software works with Performer and Master Tracks Pro. The Atari software works with Master Tracks Pro and Dr. T's KCS.

Steinberg's Cuebase sequencer has a device driver for the MTC-1 and 8330 built-in, so you don't need MidiRemote software with it.

As with all computer interfacing certain restrictions apply. So check the details at your local Fostex Dealer or call Fostex.

No other tape recorder company offers a better combination of hardware and software.

Fostex

15431 Blackburn Avenue
Norwalk, CA 90650
(213) 921-1112.

Circle 21 on Reader Service Card

www.americanradiohistory.com

Modulation Sources:
Key Number and Key Velocity

Destinations: Off, Pitch, Primary Pitch, Secondary Pitch, Volume, Primary Volume, Secondary Volume, Attack, Primary Attack, Secondary Attack, Decay, Primary Decay, Secondary Decay, Release, Primary Release, Secondary Release, Crossfade, LFO 1 Amount, LFO 1 Rate, LFO 2 Amount, LFO 2 Rate, Auxiliary Envelope Amount, Auxiliary Envelope Attack, Auxiliary Envelope Decay, Auxiliary Envelope Release, Sample Start, Primary Sample Start, Secondary Sample Start, Pan, Primary Pan, Secondary Pan, Tone, Primary Tone, Secondary Tone

When Modulating Envelope Attack, Decay, or Release Times:

Positive amounts of modulation increase the time.

Negative amounts of modulation decrease the time.

KEYBOARD and VELOCITY MODULATION CONTROL

These functions allow you to route keyboard and velocity information to any of the modulation destinations on the Proteus. Up to 6 simultaneous paths or "patches" may be programmed. For each modulation patch, there is a source (keyboard or velocity), and a corresponding amount parameter which is variable from -128 to +127. Place the cursor under the appropriate parameter and change the patch number, modulation source, modulation destination, or the amount using the data entry control. If a parameter is not labeled either primary or secondary, it affects both.

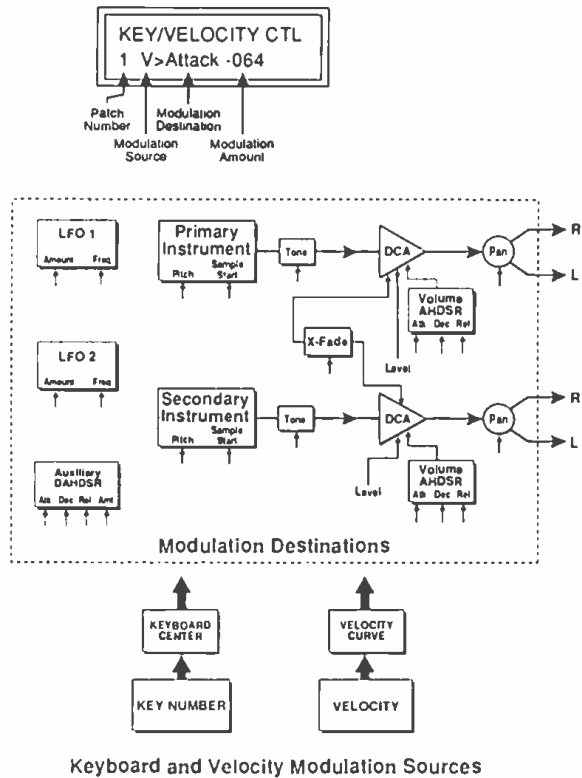

Keyboard and Velocity Modulation Sources

Figure 2. The Edit Menu.

PROTEAN CHARACTERISTICS

In ancient Greek mythology lived a god named Proteus—a wise old God of the sea whose distinguishing characteristic was his ability to change shape quickly. It was said that he would yield his knowledge only to those bold enough to hold onto him while transforming himself into a variety of imaginative creatures. The Proteus family of synthesizers is true to its namesake.

They do much more than play back samples. In fact, you can very rapidly transform samples into exotic sounds that bear no resemblance to the originals by utilizing the processing and modulation sections of Proteus I and II.

With the exception of a minor change in the chorus function, the architecture of Proteus I and II are identical. Let's take a closer look at the Proteus' programmability.

PROTEAN ARCHITECTURE

For each preset memory location, the user is allowed to select and combine two sounds—the primary and secondary sounds. These can be selected from the various samples stored in ROM (71 of them on the Proteus II), or from the 22 additional harmonic waveforms or the 50 additional digital waveforms.

The harmonic waveforms (see Figure 1) are various extractions of the overtone series specified as far out as the seventh octave. As Figure 1 indicates, one can very quickly access each octave with all its inherent harmonics or perhaps just odd or even numbered harmonics.

What we are given is, essentially, a "quick and dirty" approach to additive synthesis by which some very useful timbres can be achieved without a lot of tedium. Note that any of these harmonic relationships can be transposed up or down to a totally

unnatural octave, yielding some very rich effects.

The digital waveforms appear to be something like you might see on a wave-table synthesizer: digital representations of some classic analog waveforms like pulse wave, sawtooth and ramp, plus an assortment of either highly abbreviated samples (rendering a distinct pluck or buzz for attack characteristics) or synthesized sounds (which render that contemporary digital "glassiness" or "shimmer" usually characteristic of FM synthesizers).

From the above selection of sounds, the user gets to pick two for each preset, adjust their relative level and panning, process and modulate them individually, switch or crossfade one into the other, send them out (through an effects loop) for external processing and layer them with three other preset sounds in a variety of ways. It would be impossible to discuss all of these functions in the context of a review, so instead, I will just focus on those which I found outstanding.

The screens on the front panel are intuitively laid out, making it easy to program Proteus even if you don't remember the instructions.

WHAT I LIKE ABOUT PROTEUS II

This is a simple, but important item: the manual. As far as synthesizer manuals go, this is one of the best I've seen to date. It is clearly written, and easy to understand. Please don't misinterpret this as some sort of xenophobic attitude on my part, but frankly, most manuals sound like they were written in Japanese, geared towards the Japanese mind, and only as an afterthought translated into English (by a Japanese translator)! On the contrary, the Proteus manual is all-American in its concept: nice charts, diagrams and western-style logic.

The screens on the front panel are intuitively laid out, making it easy to program Proteus even if you don't remember the instructions. As with all rack mount units, it is a relatively small screen, and to get the most from the unit, it should be either mounted close to eye level or in a

slanted (45 degree) rack. To E-Mu's credit, the screen "viewing angle" is somewhat adjustable, giving a greater focus of view from whatever position you choose to place it; but if you're planning to do some serious programming, you will have to put the unit where you can comfortably see it.

Another small, but nice touch is the use of a data entry knob rather than the more commonly implemented switch. Twisting a knob is much more efficient than laboriously stepping through parameters. It is a simple elegance that encourages creativity and experimentation.

IT'S USER FRIENDLY

Proteus is replete with thoughtful, user-friendly equipment, but what really knocked me out was the modulation section. I haven't had so much fun designing sounds since the salad days of the patchable analog synthesizer. Those were gleeful times for me: getting a handful of patchcords, plugging almost anything into anything, and playing "let's see what happens." Some of the most serendipitous sounds emerged by this kind of childlike curiosity. MIDI quickly quenched that kind of naivete; if you chain enough synthesizers together you get an awesome sound anyway, so why bother programming! But the Proteus logic seems to restore some of that primal urge to experimentation.

Perhaps you belong to the club that says, "Alternate tunings are a nice academic exercise, but not very useful on a pop record."

The modulation section is extremely easy to use. Proteus breaks the whole operation down to two important screens. One screen (see *Figure 2*) allows you to electronically patch key number or velocity information (as a control source) to around thirty different destinations including various envelopes, LFOs, pitch, panning and so on. Up to six patches may be programmed for these two control sources. If the effect of the patch is not intense enough, two or more identical patches may be programmed, allow-

ing sort of a "piggy back" effect. These six patches are just for one-time events: key number and velocity.

Another screen deals with real-time events, allowing continuous sources like pitch-wheel, LFO or some external MIDI device (such as a wind controller) to modulate

twenty-three different destinations. Eight simultaneous patches can be programmed here. Combine the aforementioned modulation control screen with this one, and some truly bizarre (and possibly beautiful) combinations can result. For example, suppose (from the first screen) we could program key velocity to modu-

The shape of pure sound



Community's philosophy has always been a little unconventional, achieving transparently high levels of pure sound economically and efficiently.

For those prepared to listen the shape of Community sound can influence their design approach, and for those brave enough to invest in what they hear, the rewards are clear.

Now expanding their market Community has developed the definitive compact enclosure.

The new RS220 Supreme projection from a 3 way system that has precise time alignment.

Trapezoidal, the RS220 can be flown easily and unobtrusively.

The horn loaded wavefront coherent design utilises two double spider, ferrofluid cooled, eight inch woofers. The midrange is Community's exclusive two inch exit driver and the high frequency is provided by a smooth sounding efficient one inch exit compression driver.

Complementary products are the VBS210 subwoofer enclosure enabling powerful micro cluster arrays to be built, and the 220 System Controller providing electronic crossover at 1000Hz and dynamic equalization using the unique *IntelliSense*SM circuitry.

Community's RS220
The shape of pure sound

Community

PROFESSIONAL SOUND SYSTEMS
COMMUNITY LIGHT & SOUND, INC.

333 East Fifth Street
Chester, PA 19013
Tel. (215) 876-3400
FAX (215) 874-0190



late the amount of LFO 1. From the second screen we program LFO1 to modulate the rate of LFO 2; and LFO2 to modulate the auxiliary envelope; and the auxiliary envelope to loop back and modulate the rate of LFO 1; and so on. This type of patch would probably result in something more appropriate for a space movie than a pop record, but the fact that all this kind of tweaking is possible indicates that Proteus is an open instrument, capable of a wide range of sonic possibilities that go far beyond sample playback.

PROTEAN ENVELOPES

There is no lack of envelopes in the Proteus. Each sample or waveform comes with its own inherent envelope which may be switched out in favor of an alternate user-programmable envelope. What's nice about this feature is that it enables you to

A/B your own creation with the factory setting without having to reprogram either one of them. Additionally, there is an auxiliary envelope which can be used as a modulation source or destination.

I tried layering some instruments—strings, for example—leaving some in normal equal tempered tuning and others in the Valotti system. It did not sound weird.

Another useful feature is found on the alternate tuning screen. Perhaps you belong to the club that says, "Alternate tunings are a nice academic exercise, but not very useful on a pop record." Well, I think I have found an exception to that complaint in

Proteus' Valotti tuning. Valotti, who lived in the 18th century, pioneered this system of unequal temperament in which all keys were playable, but had different characteristics because the temperament was apportioned differently for each key.

Unlike Just Intonation which sounds fine in the central key but truly hideous elsewhere,

Valotti tuning can handle the harmonic changes of modern music and still sound quite good. I tried layering some instruments—strings, for example—leaving some in normal equal tempered tuning and others in the Valotti system.

It did not sound weird. In fact, it sounded excellent, adding breadth to the entire sound. It seemed to replicate some of the nuances of intonation that occur when a stringed instrument is performed by a real player, rather than a sequencer.

IF YOU'RE THINKING OF BUYING AN 8-TRACK, MAYBE YOU SHOULD THINK TWICE.

Think 16 tracks. Think MSR-16. Because for around \$7500,* you get a full 16 tracks for just a little more than your average 8-track. Which doubles your capabilities. All in a cost effective 1/2-inch format.

What's more, the MSR-16 is loaded with features usually found on units selling for twice the price.

Like a rehearse mode that allows

you to listen to an insert without committing it to tape. When it's right, you record it.

Plus, our exclusive circuitry assures gapless, punch-in/out, and spot erase capabilities.

The MSR-16 is now playing at your local Tascam dealer. So grab your checkbook, and head on down. It's a deal you won't have to think twice about.



TASCAM®

© 1989 TEAC America Inc., 7733 Telegraph Road, Montebello, CA 90640, 213/726-0303 *Manufacturers suggested retail price

Circle 23 on Reader Service Card
www.americanradiohistory.com

TASCAM MSR-16



The "link" feature is a convenient way to join other presets to the one you are using for the purposes of layering or splitting the keyboard. Splits are conveniently programmed by using the "key range set" function, which allows you to touch the desired keys thereby assigning the lower and upper limits for that preset sound. (It beats the heck out of punching in note and octave numbers.) A similar approach can be used to name a preset before or after storing it. Each alpha-numeric symbol is mapped onto a corresponding note on your keyboard. From there, it's simply a matter of playing a chromatic scale to the appropriate symbol.

There is just one simple convenience I wish were present in the design of Proteus. It would have been fitting, I think, to include separate volume parameters for the various links. When layering, the user needs to exit the preset he is working with

(making sure he has stored the latest changes), and enter the preset of each link, reset the relative volume, store that change, perhaps, in another location, return to the initial preset and audition the volume difference.

The process is time-consuming and does not permit you to A/B changes quickly. Overall, E-Mu has created another gem. While it may not reach as wide an audience as Proteus I, studios specializing in audio-for-video or film scoring will undoubtedly make great use of Proteus II. Those who do big-sounding pop-productions, commercials and ambient music will also find Proteus II a worthy addition to their rack of sound modules.

FOR YOUR INFORMATION

There are four members of the Proteus family with one still in the

oven. Here's how it goes: Proteus I is a 4 Meg unit listing for \$995.

Proteus IXR has some memory expansion both in ROM and RAM—giving you more preset sounds and enabling you to store more sounds, as well. It lists for \$1,295.

Proteus II is an 8 Meg unit, the extra memory being required to maintain the number and quality of the orchestral samples. This unit lists for \$1,495.

Proteus IIXR is simply a memory expanded Proteus II, listing for \$1,795.

Now here's what's in the oven. Shortly to be released is a circuit board that will please Proteus I owners to no end. Featuring both RAM and ROM, this board will allow Proteus I owners to access some (but not all) of the most popular Proteus II samples. This 4 Meg expansion card will list for \$495.

What a deal!

db

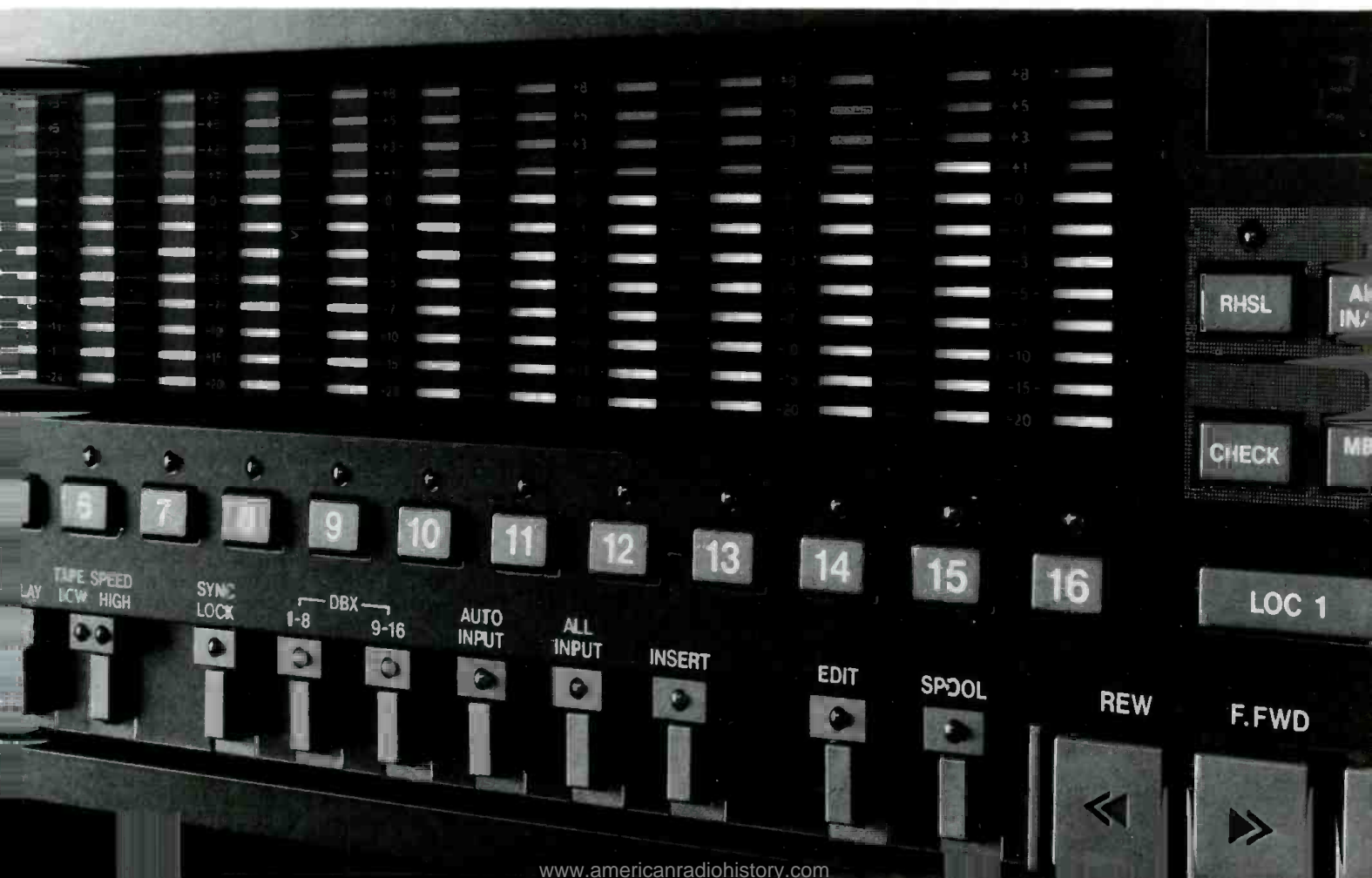

Advanced Microphone Evaluation Technique at Electro-Voice

db

NOV 1984 VOLUME 18 NO 4

Sound With Images

Handling Beta and VHS Audio

ACTUAL AUDIO TAPE SPEED IN BETA AND VHS VCRs

The original Betamax video format of recording and playing tapes and sound on a magnetic tape... 11 hours when tape lengths... Beta machines... format which involved an... speed of 1.5 ips. That is... 1.8 ips speed used on home... tape machines. Yes, it is... possible to achieve greater... quency response for the... reasonably good signal-to-... (loud), however, the Beta... come all but obsolete... available can play both... record at that speed any... The new popular Beta... used that day with home... Beta II's, and they con... linear tape speed of 0... per second respectively... that audio frequency... and that signal-to-noise... than what... ratio, one would expect... above 10 dB even... given industry high... tones. But such a... mistake of VCR's... As anyone involved... audio recording... us to see... during recording... any playback...

db

NOV 1984 VOLUME 18 NO 4

PETER HAMMAR and DON OSOSKE

The Birth of the German Magnetophon Tape Recorder 1928-1945

The following article is based on research done in the... in Germany. Author Hammar... BA... AEG-Telefunken, the... the Deutsches Museum and to various...

db - the most

magazine in the audio industry works for you over and over again

Broadcast Application For Activated Phones

Studio 42

Here, we... a behind-the-scenes look at one of New York's most successful and up-to-date audio/video recording studios.

db

NOV 1984 VOLUME 18 NO 4

Designing Audio For Video

Editel is one company that has decided to do something about changing the image of sound mixing for video.

db

NOV 1984 VOLUME 18 NO 4

SHORTCOMINGS

One shortcoming of the multi-track video field... and a major source of confusion to the average... in the lack of... accepted format. When professional tracks... film, separate 30 mm (or occasionally 16 mm)... are mixed and lined up in picture, then mixed down to a... multi-track full track from which composite stereo copies are... made for release or transfer. A reviewer can walk into any... film facility in the country with these elements and feel... reasonably confident that they will be played here at the... current level and with correct equalization. Numerous... support facilities are capable of making transfers to and... from mag, and film editors and mixers are generally quite... skilled in managing the operation and setting of most... tracks. There is a similar standardization within the... recording industry, but here the tapes are 1/2 or 3/8 ips multi... tracks, or two tracks on quarter- or half-inch tape. Most... studios can play quarter-inch recordings without... much difficulty, but the above work, however, there is little... standardization of audio elements. While a number of... facilities use 24 track or more on a digital standard, many... broadcasters run 16-track, analog video facilities. How... fully capable of the above-mentioned projects. It would... be the most appropriate to make provisions, it seems... likely to be frequent.

db

NOV 1984 VOLUME 18 NO 4

SHORTCOMINGS

One shortcoming of the multi-track video field... and a major source of confusion to the average... in the lack of... accepted format. When professional tracks... film, separate 30 mm (or occasionally 16 mm)... are mixed and lined up in picture, then mixed down to a... multi-track full track from which composite stereo copies are... made for release or transfer. A reviewer can walk into any... film facility in the country with these elements and feel... reasonably confident that they will be played here at the... current level and with correct equalization. Numerous... support facilities are capable of making transfers to and... from mag, and film editors and mixers are generally quite... skilled in managing the operation and setting of most... tracks. There is a similar standardization within the... recording industry, but here the tapes are 1/2 or 3/8 ips multi... tracks, or two tracks on quarter- or half-inch tape. Most... studios can play quarter-inch recordings without... much difficulty, but the above work, however, there is little... standardization of audio elements. While a number of... facilities use 24 track or more on a digital standard, many... broadcasters run 16-track, analog video facilities. How... fully capable of the above-mentioned projects. It would... be the most appropriate to make provisions, it seems... likely to be frequent.

db

NOV 1984 VOLUME 18 NO 4

SHORTCOMINGS

One shortcoming of the multi-track video field... and a major source of confusion to the average... in the lack of... accepted format. When professional tracks... film, separate 30 mm (or occasionally 16 mm)... are mixed and lined up in picture, then mixed down to a... multi-track full track from which composite stereo copies are... made for release or transfer. A reviewer can walk into any... film facility in the country with these elements and feel... reasonably confident that they will be played here at the... current level and with correct equalization. Numerous... support facilities are capable of making transfers to and... from mag, and film editors and mixers are generally quite... skilled in managing the operation and setting of most... tracks. There is a similar standardization within the... recording industry, but here the tapes are 1/2 or 3/8 ips multi... tracks, or two tracks on quarter- or half-inch tape. Most... studios can play quarter-inch recordings without... much difficulty, but the above work, however, there is little... standardization of audio elements. While a number of... facilities use 24 track or more on a digital standard, many... broadcasters run 16-track, analog video facilities. How... fully capable of the above-mentioned projects. It would... be the most appropriate to make provisions, it seems... likely to be frequent.

db

NOV 1984 VOLUME 18 NO 4

SHORTCOMINGS

One shortcoming of the multi-track video field... and a major source of confusion to the average... in the lack of... accepted format. When professional tracks... film, separate 30 mm (or occasionally 16 mm)...

The 30-second Drum Sound Set-up

Studio work is changing. An apparently accelerating trend to live sessions, combined with the breakdown of an apprenticing system which taught live recording techniques until the late 70s, has put a number of thoroughly competent recording engineers in the awkward position of knowing how to do good work, but not knowing how to do it fast enough to meet the demands of live sessions. Those demands are that the work be done well, and done immediately-if-not-sooner, as time, energy and patience are in short supply when working live. Four sides in three hours allows very little time for corrections, let alone experimentation.

The techniques passed on by the late and sometimes lamented apprenticeship programs were developed over a course of some 50 years by the live broadcast and recording engineers of the time, who not only had to get good sound, but couldn't fix it in the mix. They did it by inventing and refining a very large bag of tricks which allowed them to achieve otherwise impossible results.

This article is about tricks for drums.

A FEW WORDS ABOUT DRUMMERS

While there's an old line about hiring six musicians and a drummer for a gig, the line is a basic fraud. After working with drummers for quite some time, I have come to the conclusion that drummers are probably the most competent of ordinary studio musicians. Whether or not they play better than other musicians is arguable, but drummers generally know far more about their instruments and the sounds they can produce than other members of a band.

The majority of musicians play one note at a time on one instrument, with only small variations in sound from one job to another, and they generally leave the maintenance of their instruments to professionals in

Malcolm Chisolm is an audio design and recording engineer based in Chicago, IL.

that field. Very few pianists, for example, can so much as tune the beast, let alone voice it or adjust the action.

In contrast, jobbing drummers carry and play eight instruments, most of which they have rebuilt and modified several times, and six of which change their sound every time the drummer changes rooms. This makes it necessary to re-tune about half of the kit and play the other half differently for each gig. Because of this recurring need to produce a different sound in each room in order to project the same sound to the audience, drummers become genuinely expert in generating nearly any sound they want from the kit. And they use that ability in studios. The good drummers routinely listen to the first playback, do a little light re-tuning, make some small changes in playing and get what they want to hear when it comes back the next time. They do that so well that they can get a pretty good sound from a poor mic setup, and have been known to cancel out an engineer's unwanted equalization.

Since any given drummer was almost certainly hired because of his particular playing style and drum sound, unrequested help from the mixer is usually something between counterproductive and a source of conflict, and is best done subtly or avoided altogether. All the mixer really needs to do is give the drummer a setup that turns out a fair picture of what the kit produces, sit back and let the expert do the work.

Eight of anything except drums would be called a section, and a form of section mic'ing is appropriate on a drum kit. While single or stereo mic'ing is not acceptable for contemporary work, the other extreme of over-mic'ing a drum kit to the extent of removing all perspective and compound section sound is equally bad, as it takes control of the sound away from the drummer, aggravates phasing problems and can easily end up sounding like a drum machine instead of a live musician. A little fall through on a drum set is a good thing.

A LITTLE, THAT IS, NOT A LOT

If two mics pick up the same drum at anything approaching the same level, they will produce a comb filter which will ruin the mono sound and drive the cutter head, light valve, or CD channel nuts. The two mics sometimes seen a couple of feet above a drum kit in drum booths and overdub situations not only pick up everything else in the studio on a live session, but are about as dangerous as a pair of spitting cobras in terms of phase cancellation. They can be adjusted to prevent cancellation using a phase monitor in the form of a handy monitor paralleling switch, but it takes time and still leaves the stray pickup problem. Not recommended for live work.

What's recommended for live work is the fewest mics that will get the job done. This follows a cutesy version of Occam's razor known as the KISS rule; Keep It Simple, Stupid. The object of the exercise is to reproduce the sound of a drum kit as quickly, simply and faithfully as possible. If the sound is to be modified by gates and/or other signal processors, all is well and good, but it's wise to keep in mind that the best way to make a silk purse from a sow's ear is to begin with a silk sow. Tricking up a good sound to make a producer happy is one thing, but using toys in an attempt to save a bad sound is incredibly time consuming, and since it doesn't always work, it sometimes results in egg on face.

No two drummers set up a kit quite alike, and there are variations in the number and size of the instruments. Therefore, a basic setup can't be engraved in stone. With judicious adjustments in mic positions and the addition of a mic here and there for a drummer who brings in the whole store, the following will yield a very fair representation of what the drummer plays, allow balancing in about 30 seconds and encourage the drummer to make performance changes in order to get exactly what he wants on the playback.

It also invites him to break out a lot of little tricks he normally only uses

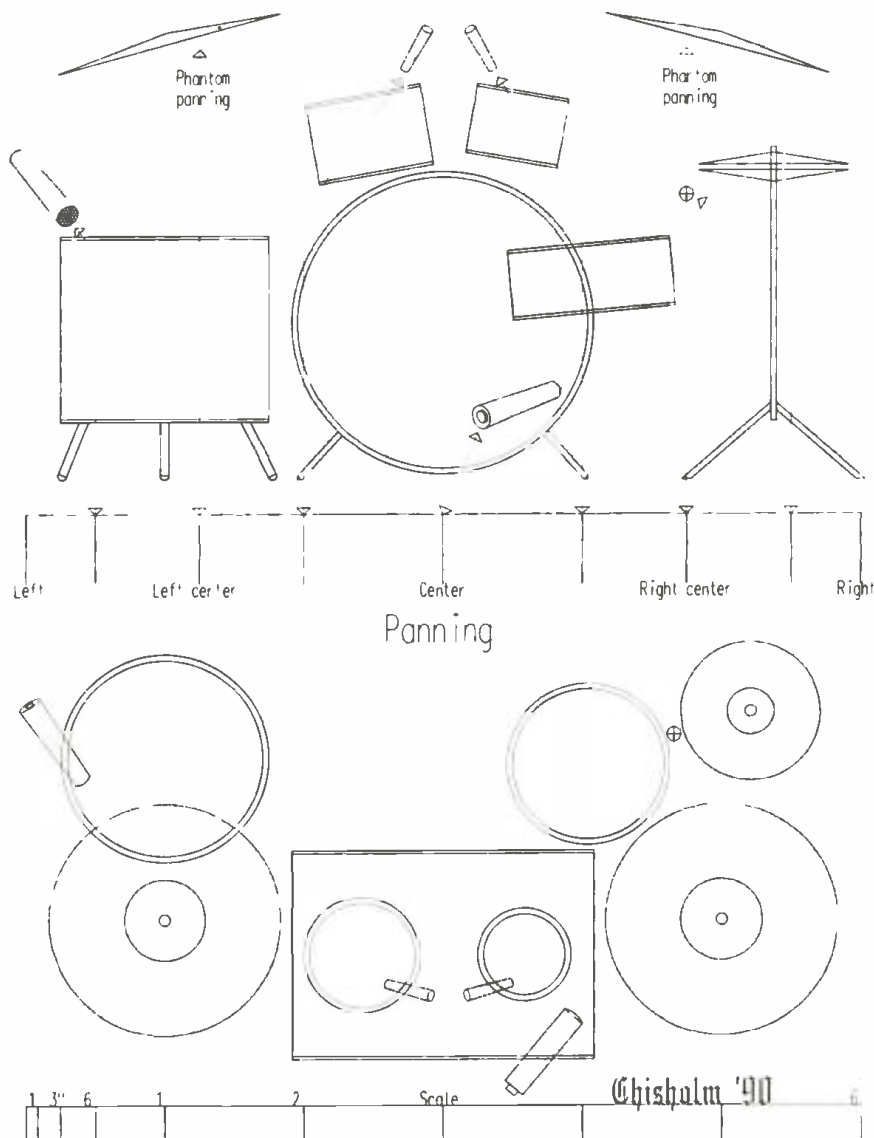

Figure 1. A typical drum setup showing both a front and top view. Microphone positions are shown.

in practice sessions as they can't be heard on stand, but work very well in recording. It is a genuine delight to listen to a bandstand drummer tailor his playing and sound to studio conditions during a session, and that alone is probably worth the effort involved in making a good live mic setup.

STARTING LOW AND WORKING UP; BASS DRUM

Because normal mic'ing distance for a 26-inch instrument would be about six feet, bass drum is usually mic'd inside the drum case by an end-fire full-range dynamic placed an inch or two off one side of the case and pointed more at the case than the drum head. Used in this manner, the mic acts like a PZM, picking up

the boundary layer sound traveling along the case edge and exhibiting little to no proximity effect, despite being less than two feet from a source bigger than that.

Dynamics are generally used because they will stand up under the extreme levels inside the drum, their patterns are tight enough to sidestep the phase schmaze inside the case, and their slow transient response discriminates against the snapping attack sound generated by some bass drum heads.

Ribbons actually work better in this application, but short of cutting a ribbon out of Belfoil and hanging it in an old Altec Lansing 639, they don't last long. RE-20s are nearly traditional on bass drum. They work

as well as any dynamic, and better than most.

FLOOR TOM

Close dynamic again, and the RE-20 really shines on a tub. The RE-20 has a small pickup element resonance at about 700 Hz that makes it peculiarly suited to percussion work in general and drum heads in particular. The mic is placed an inch off the tub's head at its outside and pointed toward the middle of the drum kit.

This setup works nicely unless the tub has a bottom head. If it does, very close mic'ing will pick up both heads, and since the bottom head cannot possibly be matched to the top (it has no damper, and has never been played), the two will produce a dog fight and sound terrible. The options are to back off the mic, or spend a great deal of time trying to get the two heads to work together, or remove the bottom head and the problem with it. The latter is best, and most drummers will cooperate. Studio drummers almost invariably carry one head on each tom, so the problem doesn't come up.

SNARE/HI HAT

This pair has always been a problem. Normal mics do a poor job of picking up the hi hat, and using two mics puts them so close to each other as to make phase cancellation inevitable. There is a solution available in the form of electret condenser mics made as announcer's lavalieres. One of these, Electro-Voice's CO-94, works astonishingly well for both instruments, partly because it is a true omnidirectional and partly because the very small pickup element has a much higher mechanical slew rate than normal mics. In fact, it moves so fast that it picks up the real sound of the hi hat, which makes it something of a jaw dropper. The 94 sounds a little thin at first earball, but since it feeds back through the control room glass at about 5 Hz under extreme gain, that's probably due to the extended top end. On the down side, the thing is only about an inch long, and has no mount. Mine's attached to a replacement portable radio whip antenna, which is handy for snaking it through the chromium jungle.

TOM TOMS

Almost any end fire condenser small enough to fit over a tom will

work, and there doesn't seem to be a lot of difference between one and another. Dealer's choice.

Placement is two or three inches off the center side of the tom head pointed down at about 30 degrees and toward the ride or sock cymbal. This placement allows a trick solution to mic'ing those two instruments, which otherwise would have to be picked up at three or four feet to avoid proximity, which wouldn't work anyway, because at those distances you lose too much top end. A reasonably quick mic looking at the tom sees the big cymbals reflected off the head and, again, acts like a PZM.

No proximity problems, and it eliminates a couple of channels as well. The cymbals come through a trifle weak, but the drummer can correct that by hitting them a little harder, just as he does when he's working a big room. Cymbals tend to drop dead in big rooms and drummers normally overplay them to compensate.

So much for mics and positions; Upward and awkward to panning, as shown in *Figure 1*.

At one time, I spent a good many years doing sessions one day and cutting lacquer masters on them the next, and in common with other engineers with the same responsibilities, developed a number of recording stratagems to make the transfers quick, easy and faithful to the original.

It is commonly known that keeping things in phase helps with the end product. A rather more obscure, but equally helpful technique is panning the instruments so what the mixer hears is close to what he sees. I have no clear ideas as to how or why panning impacts on transfers, let alone on the mono sound, but in both cases the influence exists, and the transfer effects are not limited to lacquers. They are equally clear in film work and appear, although to a lesser extent, on CDs.

Both the microphone position and panning parameters of this setup are arranged with the above factors in mind. Most of the panning is obvious, but since there are no dedicated mics on the big cymbals, a small trick used on them merits a little explanation.

The main pickup for each big cymbal is a bounce off the head of its nearby tom tom, but there is also a degree of fall through on the floor tom and snare/hi hat mics. This fall through on mics panned to the outside of the kit pulls the big cymbals toward them, and with a little 10 kHz boost on the tub mic, results in their appearance about halfway between the tom toms and the outside mics on tub and snare. For lack of a better term I have called it phantom panning, and despite the fall-through, it generates no transfer problems because the frequencies involved are very high, the signal rise times quite long and the amount of fall through fairly small.

In summation, by recognizing and encouraging the utilization of the unique skills of drummers, a mixer can use a very simple mic setup for drums which will save considerable time both in setting up the studio and in balancing a drum kit, to say nothing of currying favor with the drummers.

Try it.

□□

KEEP UP IN A CHANGING WORLD

Take advantage of the wealth of knowledge available from your Government. The U.S. Government Printing Office has produced a new catalog. It tells about the most popular books sold by the Government—nearly 1,000 in all. Books on agriculture, business, children, diet, energy, health, history, space, and much more. For a free copy of this new catalog, write—

New Catalog

Post Office Box 37000
Washington, D.C. 20013

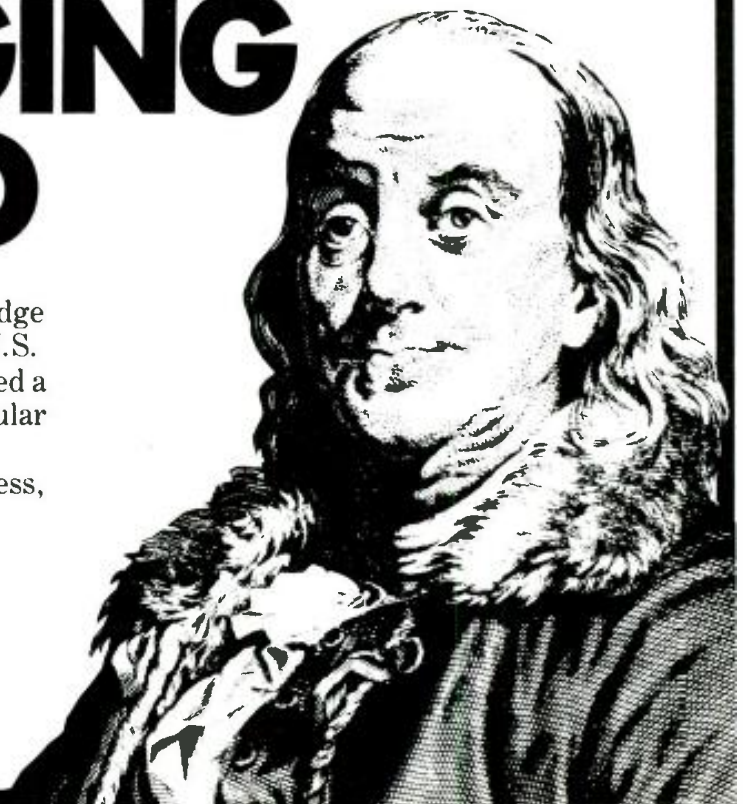

Breaking Into Concert Sound, Part II

High-powered live concerts are the lifeblood of the music industry in Los Angeles. Brightly lit scenes where top recording artists storm the stage and perform their special magic to an adoring multitude. Instantly recognizable are the names of these "concert cathedrals" where lively throngs come to venerate their musical idols. But there is one place and one name which stands both figuratively and literally far above the others: The Greek Theatre.

Sitting high above the city of Los Angeles in the hills of Griffith Park, The Greek Theatre is built within a natural amphitheatre and is one of the city's oldest and dearest concert venues.

On September 24th, 1990, The Greek Theatre will celebrate its 60th anniversary in Los Angeles. If only the hallowed halls there could talk, what tales they could tell, like a who's-who of the music business stretching from the 1930s into the present day and still going strong! What stories could be told of artists like Neil Diamond, Crosby Stills and Nash, Henry Mancini, Judy Garland, Victor Borge, Frank Sinatra, Bob Dylan and Richard Marx.

And these are only a minute fraction of the superstars who have graced the Greek Theatre's stage. Oh, to be the lucky few charged with the awesome responsibility of the sound system at this venue of venues!

In this, the second of a three-part series on breaking into live sound in Los Angeles, we will spend the better part of a warm July morning with Jeff Cox, the sound system coordinator at the Greek Theatre.

front, punctuated by large posters of currently appearing superstars.

The air is charged with a feeling of expectation, as there are several semi-trucks with ALABAMA painted on their sides parked in front of the theater. This is load-in day for the band *Alabama* who will perform tonight!

The most striking feature from the entrance is a vast sea of bright, orange seats (about 6,200) which stretch hundreds of feet away from the stage and high up into the upper reaches of the amphitheatre. At the very front of all the seats, the stage looms larger than life and is a beehive of activity as the crew sets up for the show at a steady, but unhurried pace.

One cannot help but notice the large

speaker arrays flanking each side of the stage, poised in readiness for tonight's coming onslaught of country/rock music. The look and feel of the stage area and its speakers, lights and risers state clearly that this place means music (see sidebar for a partial equipment list).

An island in the sea of seats is the house mixing position, sitting dead center, about 100 feet in front of the stage, and just above stage level. A small group of people are gathered around this island and as I approach, I am greeted with a warm hello from a smiling face with dark, mirrored sunglasses on.

This friendly greeting is followed by a self introduction which confirms that this is the man we came to see, Jeff Cox.



Figure 1. The front view of the Greek Theatre.

GRIFFITH PARK

Our trip begins on Los Feliz Boulevard in one of Los Angeles' high rent districts. On the right are million dollar homes backed by the mountainous hills of Griffith Park and from the moment we make a right turn and start up the hill, it is evident we are headed toward a very special place. The narrow, winding road is divided by a belt of greenery, and huge old trees reach with outstretched arms to form a living tunnel as up and up into the hills we go.

Finally, we pass a large gate which announces our entry into Griffith Park, and just beyond the gate on the left stands the front facade of The Greek Theatre, looking like a Hollywood version of a modern day Acropolis with white columns adorning its

HE WASTES NO TIME IN STARTING OUR INTERVIEW.

"I want to start by stressing what I think is the most important point; here at the Greek, we have employees from Maryland Sound (the company which employs Cox and is contracted to provide sound to the Greek Theatre), employees from the union (International Alliance of Theatrical and Stage Employees), and employees from the theater itself, not to mention the band's road crew, and the thing is, we are all a team!" Cox says. "It's not just me or any single person, but each person doing their job and working with the others toward a common goal. That's what makes it work," he says.

With that statement as a preface, Cox began to dig into some biographical material. He is 39, has been in the business for over 20 years and is happily married to a woman who has played a very important part in his career. Like many successful people in the music industry, Cox' interest began at a very young age.

"As a child, I had the opportunity of being given music lessons," he said. "I tried drums. I tried saxophone. I tried guitar. I tried EVERYTHING, but I just didn't have the brain-to-finger dexterity that musicians have. But you know, I had something inside of me that wanted to get out. So finally in 1968, my first year of college, I happened to room with a couple of guys who had a band. We started out with a Bogen amplifier and two Cobraflex horns, two Shure Unidyne microphones and a station wagon. We played college fraternities and dance halls," Cox said.

He laughed as he recalled the excitement he and the bandmembers felt at the prospect of upgrading their sound system to two Vox columns and a Shure Vocalmaster head. "When we got the Vocalmaster, it was like, 'WOW! Real reverb! Six channels! Colored buttons and knobs!' and in the process at this time, it was absolutely nothing," Cox said. "No monitors, no EQ, no nothing! Just a couple of mics plugged into an amplifier and that was it," he said.

Cox continued to work with his roommates' band, 'Paste', for about a year, and at the same time, there were many growing opportunities in the sound-reinforcement field. He was able to see major touring acts like 3 Dog Night and Steppenwolf in

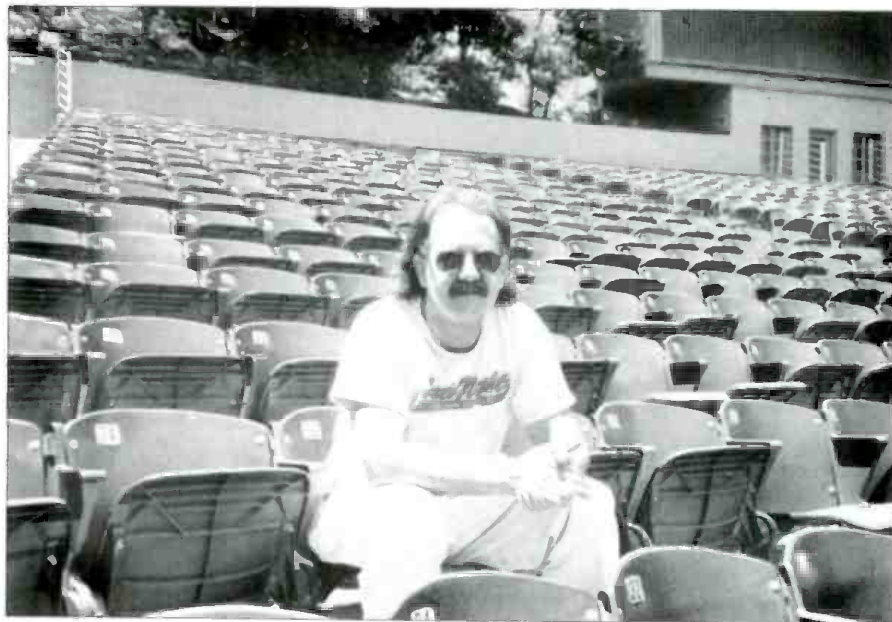

Figure 2. Jeff Cox at the top of the house.

concert. However, after the band broke up, Cox did not do much in music for nearly two years. But true to form, when an opportunity presented itself, he jumped at the chance.

RADIO

"The next thing that I did musically was to get into radio," Cox said. "Myself and a couple of other people developed the campus radio station at Western Washington State College. Because of my penchant for music, the people developing the sta-

tion invited me to get involved, so I got my FCC license and I came to work with them," he said.

At this time, Cox made a major change that would be a big step in a long journey toward his current tenure as an integral part of the Southern California music scene.

He was then majoring in education, and was destined to become a teacher, a far cry from the live concert scene. But, involvement in the radio station convinced him to change his major to communications.

Figure 3. The Greek Theatre stage with its speaker arrays.





Figure 4. Power amps, equalizers, limiters, etc., used for the Alabama show.

“The funny thing is that up until that time, I was not doing that well in college,” he said. “It was more of a place to hang out and have a good time with my friends. But all of a sudden, I was back in touch and dealing with music again, and it was like another set of rockets kicked in,” Cox said.

Soon after, he was offered a position in commercial radio in Seattle. He had his own morning radio show on KIL0-AM Radio called ‘Eggs and A Side Of...’ where he was given the freedom to be as eclectic as he wanted, and he thrived in this environment. Unfortunately, the station itself did not fare as well, and Cox eventually found himself out of a job.

“One day I showed up at work at six o’clock in the morning, and my key wouldn’t work in the door,” Cox said. “I called the station manager and he said something like, ‘Oh, we’re closed babe. Sorry I forgot to call you,’ and with that, the station was closed.”

Coincidental with the closing of the radio station, it was around this time, 1973, that an event occurred that would have life-transforming consequences for Cox, and during which he would make connections with people that, even to this day, still remain a part of his circle of friends. Little did he know what a profound effect hearing a radio announcement would have upon the rest of his adult life.

“I heard an advertisement on the radio for a recording studio seminar held at Sea West Studios in Seattle. Rick Keifer, who owns Sea West, was conducting a six-week seminar on recording,” Cox said. “There was something in hearing that on the radio...I can place exactly where I was,” he said. “I was in the living room—it’s etched in my mind—I heard this announcement on the radio and said ‘That’s what I’ve got to do! I can get that much closer to the music...’” Cox felt that this would get him as close to the music as he could be without actually being a musician. He also knew that Keiffer was the owner of the studio where several early *Heart* albums had been recorded, and this was the chance to meet the man himself, so Cox somehow scraped together the tuition for the six-week seminar (\$150.00).

GETTING TO SCHOOL

“I remember I was driving this old beat-up Falcon, so bad that the driver’s side had no floorboard, just a piece of plywood,” Cox said. “But there I was with this seminar to attend for six weeks. In the course of this seminar, and I will always God bless Rick Kiefer for this, he brought in a guy named Charley Morgan from Seattle, Washington. Charley was Gordon Lightfoot’s engineer and owns Morgan Sound, perhaps the largest audio company in the northwest. He came in and gave a couple of night classes on live sound.

Whoa! My ears perked up and I thought, ‘Wow, what a great thing’, and so I cornered Charley both nights after class and talked and talked, and I kept in touch with him,” he said.

With his head full of new ideas but his wallet empty, Cox found it necessary to get a *real* job and naturally, he fit right in at Budget Tapes and Records in Seattle where again, he would be working around music. But little did he suspect that this job at the record store would be the very thing which would open up the door into his first professional gig as a concert sound engineer. A local cover band called *Skyboys* at the time was making a name for itself around the northwest. They were doing tunes by *Graham Parsons*, *Emmy Lou Harris* and the like, which happened to be the very kind of music that Cox loved to listen to. He first became a fan of the band, catching them in concert, and then a fateful meeting occurred at the record store.

“One day at Budget Tapes and Records, the lead singer came in with the pedal steel player looking for music,” Cox said. “I had ordered some European pressings of several hard-to-get record albums and when these guys came in I said, ‘Hey you guys, I’ve got this great stuff...’ etc. and we just hit it off,” he said. “So I started going to more of their concerts and one day I approached them and said, ‘I don’t know anything about doing live sound, but I’ve had some experience doing it on a very small level. If you are interested in having someone purchase some equipment as a beginning neophyte, I am really interested in becoming an audio engineer, and I’d like to work for you,’” Cox said.

The *Skyboys* expressed interest in Cox’ offer, and by this time, he had built up the ability to secure a loan. He immediately borrowed \$7,500.00 to purchase sound equipment. Prevailing upon his former acquaintance with Morgan, Cox went straight to Morgan and asked him what to do.

“Charley said first I had to build my own snake, so I sat in my living room with 150 feet of 19 pair-cable, a box of cannon connectors, a solder gun and heat shrink which I had to shrink in my oven because I had no heat gun!” Cox said. “So I built my first snake, and Charley helped me get together some gear. I bought a

Yamaha PM-700 board, a UREI third-octave EQ, some Shure SM-57 and 58s, and some Northwest bin with JBL 15s and two-inch JBL hi-end drivers, etc., and we got started," he said.

Cox ended up with a biamped, balanced, and very usable sound system with Crown power and JBL components. The system's capabilities far exceeded the abilities of this fledging young audio mixer, and it gave Cox the opportunity to grow along with the system. By 1981, it had grown into an active four-way system which he sold for over \$10,000 shortly before the band broke up.

"The *Skyboys* gig is what really got me going," Cox said. "We opened for bands of the caliber of the *Charlie Daniels Band* in front of thousands of people, and this brings me to a very important point," he said. "I have been blessed with situations where the engineers I have worked with have been forthcoming with knowledge and helpful and understanding. I have been fortunate enough that the people I worked around have not been closed-mouthed and egocentric about the knowledge and experience they have garnered. They have been open and sharing, and are what I consider to be truly professional engineers," he said. "The nature of this business is circular, and we need to cooperate with each other the way that the musicians do."

Laughing heartily as he relayed some of the nightmarish experiences of his early apprenticeship with the *Skyboys*, Cox spoke of their tours around the Pacific Northwest and Canada. He expressed a genuine feeling that this time was truly the pivotal point in his career, and that every up-and-coming engineer should develop a relationship with a working band. This gives an engineer the valuable opportunity to learn, grow and practice their art.

MOVING ON

Cox' experience up to this time had been limited to the Pacific Northwest, but just around the corner was his best opportunity yet—a chance at a national tour with a major touring group. The opportunity to do this tour came as a result of a bit of luck, some contacts, but mostly by the sheer strength of his determination to do what he had to do in order to get

the job, as his telling of the story demonstrates.

"I was in a club in Portland, Oregon, and a friend of mine who was the engineer for *Quarterflash* came in and mentioned that there was a position open for a monitor engineer with *Quarterflash*'s opening band, *Prism*, out of Vancouver, British Columbia," Cox said. "It was Saturday night, and we were finished with the gig, and I drove from Portland, Oregon to Seattle, Washington, took a shower, changed clothes and drove straight to Vancouver, British Columbia. I got there the next morning and interviewed with the engineer for the gig, drove back to Seattle, went to sleep and woke up later that night with a phone call from him, and he said, 'OK, great, meet us in Chicago'. Two days later, I was in Chicago and out on tour with *Prism*," he said.

After a year with *Prism*, which included concerts with *Marshall Tucker*, *Quarterflash*, *Loverboy* and even the *Beach Boys*, Cox finally made the decision to give it a try in the big city and moved to Los Angeles. He believed that to really make it big, he had to be in one of the places where music was really happening. He felt rather strongly, however, that it was important to develop the drive, the respect for music and many of the skills necessary to make it. Then a person can bring all that with them into the big arenas.

IT'S DIFFERENT IN THE BIG CITY

Cox was a little surprised to discover just how competitive Los Angeles can be, and how many qualified engineers there are in this city. "I was finding work opportunities fewer and further between than I did in Seattle," he said. "Here, you might be at the store or in the bathroom and miss that all-important phone call. Even if you have a phone machine, by the time you get back to the person, they may have called five other people and someone else got the job. So I found the key was to make a network," Cox said. "A person can't be everywhere at once, and occasionally, a friend would get two calls and could pass a job on to me," he said. At this point, Cox went on to stress the importance of networking. He said this includes making friends in management, record labels, engineers and anyone else that

might be responsible for recommending or hiring and firing for an act.

Los Angeles was good to Cox, and after several tours and shows, another large tour, this time with a headline act, came his way.

He signed on with the *Ventures* as house mixer and road manager. This relationship continued off and on for about four years. There were other bands too, and it wasn't all roses during this time. There were incredible highs and lows.

"I mixed at places ranging from the smallest, slimiest and most pathetic little clubs to major, major concerts," Cox said. "I can remember mixing for a club in the hills of West Virginia with less than seven people in the house which was able to seat 300, and I also remember mixing for huge concerts for 50,000 people and above," he said. "We even did a show at Taos, New Mexico in the snow, where all the equipment had to be brought in on toboggans!"

Despite being so busy during this period, Cox somehow found time to go back to the recording studio in Seattle for a year, and engineer and produce several albums, including two with the *Skyboy's* lead vocalist using Glenn Frey's band and JD Souther on vocals.

BURNOUT?

Cox said he began to reach a sort of burnout during his years with the *Ventures*. After mixing 200 to 250 nights per year for several years, plus the rigors of the road, he began to feel his passion for music ebbing. Cox decided to take some time off and do a little soul searching. Going back to Seattle, Cox actually got a job doing something completely unrelated to the music business.

It was during this break that Cox began dating a woman he had met several years before. It soon became apparent they would marry. With a new wife and new energy, Cox felt ready to go out and mix again. At just about that time, Mel Taylor of the *Ventures* called and asked Cox to come back on the road. Without hesitation, he said, "You bet!" and two days later, he was back on the road with the *Ventures*.

After a three-month tour with the *Ventures*, Cox was hired at McCune Audio in Los Angeles as a sound-reinforcement engineer, and he had the opportunity to do public-address

audio as well as music. Finally, in March 1989, another large national tour was in the cards for Cox, but this time with a difference. This was the Julie Andrews national tour with a fully-equipped 40-piece orchestra, and Cox was chosen as the front-of-house mixer.

"Some might scoff at this, but for all my time in the studio, I always wanted to mix a full orchestra," Cox said. "I had the time of my life and it was a gas. Julie Andrews is a really good vocalist, and we had a great time!" he said. "I got to mix a full-on 40-piece orchestra!"

This tour lasted another four months and as before, another offer was just around the corner; and it turned out to be the best and most incredible opportunity yet to come. A large East Coast sound company, Maryland Sound, was gearing up its West Coast Division, and was looking for someone to handle a very important and prestigious position—a real dream come true!

MARYLAND SOUND WEST

"In May of 1989, just before the Julie tour, the phone rang right at McCune Audio and it was for me," Cox said. "It was Michael Stahl from Maryland Sound. He said, 'Look, I know that you can't talk right now, but I would like you to come to work for me and run the sound system at the Greek Theatre.' Just like that, and I was absolutely dumbfounded! So I met with Michael the next day and told him I would love to, but I was committed to the Julie Andrews tour. The funny thing was that this tour ended with two nights right here at the Greek! So Michael said no problem, to go do the tour and to stay in touch with him on the road," Cox said. "I did, and when we finally came here to do the last show, Michael came out and said, 'Walk around and get comfortable. This is your new home!'"

There was one more little hurdle to get over; and Stahl told Cox that the time was not quite right just yet, but if Cox could hang on a little while, he had the job. Needless to say, Cox was dismayed and excited all at the same time, but with almost infinite patience, he waited. When Stahl finally called to say the job was a go, he also said that Cox' new job would be coordinating the sound systems at the Greek Theatre AND at the Universal Amphitheatre!

"It took a lot of patience, but I kept hanging on and I can tell you it was worth the wait," Cox said. "Finally, on the first of November, 1989, I came on board full-time with Maryland Sound, and was put in charge of both venues, the Greek and the Universal, and here I am today telling you the story!" he said.

One of the high points of the morning came when Cox talked about how his marriage fit in with his career. As he spoke about his wife, Cox' face lit up, and another of his warm smiles which come so naturally appeared. "I have an amazing wife. Her name is Debra and she has been incredibly supportive. I love my marriage and I love my home. The decision for me to not travel definitely stems from the fact that I have a wonderful marriage and a great wife and I am really happy to stay home," he said. "I love going home each night to my own bed."

Cox says there are definitely ways to balance a career and a family, and told of another example, pointing down to someone standing way down at the mix position. "Chief Parker, who is going to mix the actual show tonight, was Jackson Browne's engineer at the very beginning, and is Neil Young's monitor engineer. He has a wonderful wife and home, and he doesn't travel anymore either; except to go out and do monitors for Neil when Neil needs him to go," he said.

Cox had nothing but high praise for Maryland Sound, which has developed their West Coast Division only within the last year, and has taken on the sound responsibilities for the Greek Theatre even more recently.

"Michael Stahl, our boss at Maryland Sound, handpicked the people that are on the staff out here," Cox said. "He found some people that wanted to tour and put them into that situation, and those that did not want to tour were given the opportunity to have a home life and not feel the pressure of having to go out constantly on the road," he said.

COMPANY LOYALTY

Cox commented that companies like Maryland Sound breed real loyalty in their personnel, and that in his experience, it is difficult to find that kind of company and that kind of loyalty in this industry. Cox says the industry itself tends to weed out

those who are not committed or those without the drive to really hang in there. He believes if a person doesn't have that kind of drive or commitment, they should look for another kind of work.

With the advent of so many recording schools and institutions where a person can go to accelerate their learning curve, it is interesting to note Cox' reaction to a question about education in the live sound field. When the subject of schools came up, he flashed a big smile and carefully stated his position. "I am under the impression that there are a number of good college classes," he said, "and I believe that even UCLA has some classes that you can take. I know that George Massenburg has hosted some classes there, and he is a recording engineer. There are a lot of similarities between live sound and recording. Perhaps the most important thing that is not as involved in recording engineering and is at the center of live engineering is acoustics and dealing with rooms and speaker arrays and the cabling, etc." Cox said. "Education, however, is not necessarily a requirement to get a job in this field."

By now, the sun was directly overhead, the shade was gone and things were heating up on the stage as well as off. It was almost time to bring this meeting to a close, but it was difficult to just let go. Cox is a warm, intelligent and pleasant person to be around. It is obvious that his success has been no accident, and when asked if he had any concrete pointers for those at an earlier stage of their career, he was more than happy to oblige.

"First, ask questions," he said. "My feeling is that no matter how stupid the question may seem to you, I mean you may be embarrassed to ask it, but it doesn't make any difference because you need to ask that question when you don't know. And it's better that you know or try to know, than to walk around with unanswered questions and not understanding.

"Abandon your ego and remember that the most important thing is the music that you're mixing," he added. "Keep in mind that you are being handed the 'muse' of someone's music, and develop the thought that it's a golden opportunity any time a musician hands you their music to manipulate and to work with and to

become creative with. That attitude is the thing that I have seen work for myself and for those around me who have experienced success," he said. "The reward is incredible!"

READ AND LEARN

Cox added that it's important to buy or become familiar with state-of-the-art equipment, as well as reading up on the latest technologies.

"Read, read, read. Read **db Magazine**, read **Mix**, read everything you can get your hands on," he said. "Read specs of equipment. Fill out reader service cards at the back of the magazines and have the manufacturer send you literature on this new stuff. Be aware of what is coming out because the companies that manufacture the equipment that we work with dictate the growth of your abilities. Unless you understand the color of the paints and the quality of the brushes that you have to work with, you're tied by your lack of knowledge," he said.

"Go see bands! Hang out and listen to engineers mix. Talk with engineers. Approach engineers. Tell

them that you are interested. Tell them what kind of experience you have," Cox said. "Develop a resume'. And if at all possible, get it on floppy disk so that you can always update it and then it can be printed out at any given moment and mailed to someone. To me, those are the most important points," he explained. "Communication, working on your skills, and keeping abreast of the industry, and go see shows."

As a final examination at what it takes to go out and get work in the sound mixing field, Cox listed the important qualities that he would look for in hiring a person to work as an engineer for him. "First, personality, then experience, then maybe education," he said. "But in actuality, I'd say that the whole person is the most important thing. It is the sum and total of the person that generates to you who they are, what their desire is, how committed they are to becoming an integral part of the team," he said. "If it was down to two candidates, and the first had the experience and/or the education, and the other met more of the holistic cri-

teria, I would probably go with the holistic applicant."

Down at the mixing position, the show mixer was setting up *Alabama's* large Soundcraft custom console along with their outboard rack, and the stage hands were getting close to having the lights rigged. It seemed Cox was feeling the call of the stage, and the time to close was at hand. After a brief tour of the backstage area, we said our goodbyes and the trip back down the mountain began.

The vision of that sea of seats would not fade easily as the Greek Theatre was left behind, and I could picture Cox joking and talking with the light crew, the sound crew, the band, and his voice seemed to ring out like a quarterback on a championship ballclub, telling his partners, "We are all a team! It's not just me or any single person, but each person doing their job and working with the others toward a common goal. That's what makes it work."

Words to live by!

A Closer Look at the Greek Theatre Sound System

The sound quality at the Greek Theatre has long been questioned by many Southern Californian concert goers. But Jeff Cox, sound system coordinator at the Greek Theatre, was pleased to explain that Maryland Sound has installed a state-of-the-art system which he feels is the best the Greek Theatre has ever seen. Cox explained that much of the equipment used at the Greek Theatre was also used by the group Chicago on their recent World Tour. When he talked about the Greek Theatre's sound system, Cox sounded like a proud father telling of the exploits of a favored son.

The speaker arrays consist of 40 boxes, 20 per side. Eight are high-mid cabinets, six are low and six are sub-woofers. The high side of the high-mid cabinets are loaded with two JBL 2404 H Transducers which are powered by one side of a Urei 6300 power amp. The mid sides are driven by two-inch JBL 2445 compression drivers loaded on JBL 2385 60 degree by 40 degree horns, and

are also powered by one side of a Urei 6300 amp.

The low boxes are loaded with two JBL 2202 H 12-inch cones per box, and are powered by one side of a Crest 4001 power amp. The Sub-woofers contain two 18-inch JBL 2245 speakers and are driven by Crest 7001 power.

There is a center cluster of boxes serving the orchestra section which are almost inside of the sound wings and would not otherwise receive much high-end from the mains.

A pair of long throw clusters positioned high above the stage serve the very back of the house which is several hundred feet away from the stage, and are also elevated about 50 feet from stage level. Each side of the long throws are comprised of three JBL 4866 long throw boxes, each loaded with two JBL 2386 lenses with two JBL 2445 two-inch compression drivers.

The left-right configuration is also served by the following components:

- 2 Yamaha 1027 third-octave EQ's to tune the house
- 1 dbx 162 Comp/Limiter
- 2 Brooke/Siren FDS 360 crossovers
- 2 Yamaha 1027 third-octave EQ's for the visiting engineer to 'fine tune'
- 1 Teac C 3RX cassette deck
- 1 Tascam CD 501 CD player

● The center cluster has its own Brooke/Siren FDS 360 crossover, Yamaha 1027 third-octave EQ and a dbx 160 comp/limiter.

● The subwoofers also have their own comp/limiter, a dbx 160, and their own crossover which serves as an 80 Hz low pass filter.

The sound of the system is incredibly rich with all the frequencies properly represented, and the coverage is quite even, with a minimum of peak and nulls throughout the house. Maryland Sound and Cox deserve a lot of praise for a job well done.

db

A New Loews Cinema Sound System



Figure 1. The interior of one of the Loews-19th Street theaters. Note the SurroundStar XII speakers along the junctures of ceiling and wall.

The 19th Street Theatre in New York City has officially unveiled two of the latest Community cinema loudspeakers. In addition to becoming a showcase for the manufacturer, the theater, which is part of the Loews chain, was also recently selected as one of New York City's best by one of the city's leading newspapers.

From an audio standpoint, the 19th Street Theatre's sound system represents a first of its kind in design.

A NEW IDEA

Built around the company's SurroundStar XII and TheatreStar III loudspeakers, the initial idea for

the triangularly-shaped SurroundStar XII loudspeaker was conceived by John Kedzierski, architectural and acoustic designer for Loews. Based upon what Kedzierski envisioned, Community President Bruce Howze put pen to paper and drew up plans for the enclosures, which unlike other loudspeakers of this type, are specially built to be suspended well above theater audiences at the intersection of the wall and ceiling.

"Traditionally, loudspeakers used to produce a surround effect in theaters are mounted 10-12 feet above the audience," Howze explained. "By relocating them between the wall and ceiling, a number of advantages are gained. By constructing a surround system using our SurroundStar XII loudspeakers, Loews has ensured that there will be even coverage across the entire seating area," he said. "Because the loudspeakers are raised higher in the air, you also have a more uniform dis-

tance between the audio source and the audience, therefore making it virtually impossible to pinpoint an actual loudspeaker location,"

Howze added. "That, in essence, is what a surround system should do—create an aural sensation in which the sound seems to be coming from all around the listener, just like in a natural environment."

Outfitted with a black grille cloth and a black exterior finish, each SurroundStar XII loudspeaker easily blends into its theater surroundings to the point of being almost invisible, even when the lights are up. Measuring 24 inches from front to back, and 16 inches across its face, the SurroundStar XII houses a 12-inch loudspeaker which handles the bass and midrange frequencies, and a specially built, proprietary high-frequency horn.

Asymmetrical in configuration, the latter component was custom-built for this application to provide

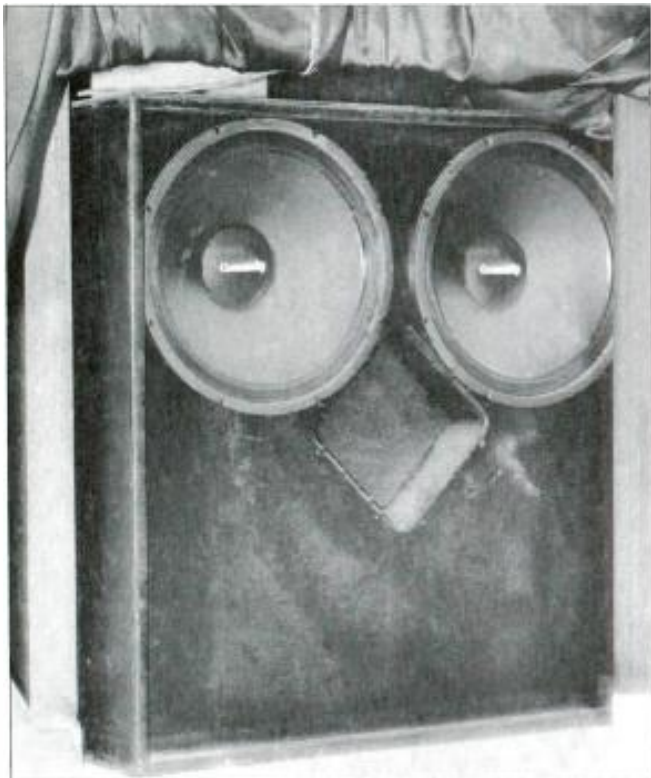

Figure 2. The sub-woofer system is behind the screen as are the TheatreStar III systems (see Figure 3 below).

long-throw uniform coverage across the entire rectangular area which comprises the theater floor.

It additionally performs on two different planes or axes, a fact which allows theater patrons to hear the full range of the frequency spectrum, regardless of whether they are seated directly under a loudspeaker or many feet away.

HIGH SENSITIVITY HELPS

"Complementing the above features is the SurroundStar XII's high sensitivity, which adds to the excellent projection qualities inherent in each unit," Howze said. "Other surround speakers are oftentimes adaptations of hi-fi loudspeakers, which can project adequate sound in your living room, but will fall short in a large theater," he said.

"The SurroundStar XII, like the TheatreStar III, is manufactured exclusively for theater use, and is equipped to project sound evenly within its area of coverage."

Each speaker diaphragm within the enclosure is also phase-aligned to provide correct transient response without the use of additional electronic processing equipment.

Utilized in conjunction with the SurroundStar XII loudspeakers at the 19th Street Theatre, the TheatreStar III loudspeaker is a completely horn-loaded device. Four-feet square in size, and a mere 20-inches deep to facilitate behind-the-screen mounting, twin 15-inch woofers coupled to custom-fabricated low-frequency horns provide strong bass response, while directivity in the midrange frequencies (where the all-important vocal ranges are found) is enhanced by a Community M200 compression driver coupled to a pattern control horn.

HIGH FREQUENCIES

For the high frequencies, a beryllium-diaphragmed compression driver is attached to an asymmetrical horn which works on the same principle as that used in the SurroundStar XII.

Each speaker diaphragm within the enclosure is also phase-aligned to provide correct transient response without the use of additional electronic processing equipment. This alignment also insures that the sound emitted from each individual driver arrives at the listener's ear at the same time.

Housed in a black cabinet and incorporating a one-piece molded fiber-glass low-frequency and mid-range section, the TheatreStar III, as well as the SurroundStar XII, will see use in other Loews theaters throughout the country.

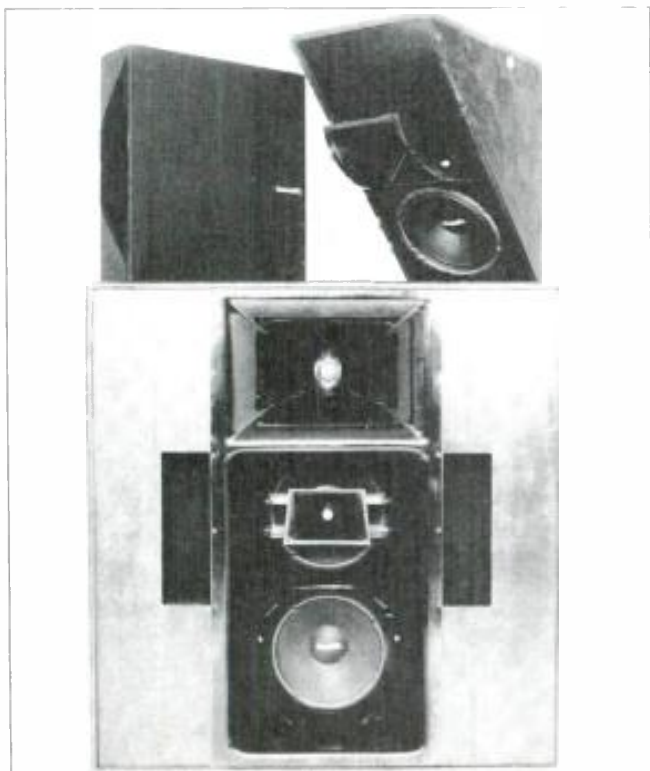

Figure 3. Community's wedge-shaped SurroundStar XII (top right) and TheatreStar III (bottom) are the new sound system tenants at Loews' 19th Street Theater. The two enclosures are part of the company's new line of cinema loudspeakers, which also include the SurroundStar II (top left in photo).



Speaker Angles II Calculating The Ideal Speaker Location

REVIEW

• Did you save July/August's issue like I asked? Good. Well, here is the second program. Let's review the four programs briefly.

There are usually a limited number of places to mount the speaker. The first program will tell the ideal required coverage angles for an actual mounting location.

After the ideal angles are calculated, a speaker should be selected to closely match the ideal. The second program now calculates the ideal location for the actual coverage angles.

Enter practical compromise. Adjust between the two previous locations for a usable location, and the third program will calculate the actual loss for an actual coverage angle and an actual location. This allows for testing the variation of the SPL

coverage without climbing a scaffold or buying the wrong speaker.

If an existing system is being analyzed, the third program will tell the variation of coverage. If it is not uniform enough, the second program will indicate the proper mounting location. If the proper mounting location is ten feet above the ceiling (or any other unsuitable location), then the process of selecting a new speaker starts with the first program as described above.

The fourth program calculates the direct path from the speaker to the microphone, and the primary reflection path off the back wall, to aid in locating the acoustic padding.

PROGRAM

The "P.A. Position" program is very similar to the "P.A. Angle" program. They operate the same way,

and have nearly identical screens. Most of the program code is the same. The primary difference is that the speaker coverage angle and the distance from the first to last listener is entered instead of the speaker location. The calculations are more complicated also. The core of the program (lines 100 through 9020) is identical, and can be copied from the first program to save time typing. *Figure 1* is a sample screen to test your program.

ANGLE LIMITS

This program more clearly reveals a severe limitation on allowable coverage angles as indicated in the last issue. You will also find that only one -12dB angle is correct for a given -6dB angle. I can hear you now, "But they don't make speakers like that!" Tell me about it! On the other hand, tell the people who make the speakers. As I said before, this is not a new concept or science.

OOPS!

If you look at *Figure 3* in *db's* July/August issue, you will notice "-6 dB BACK WALL:" was followed by 25 feet 12 inches, which should have calculated as 26 feet. This rounding error is easily corrected by changing the last routine of the first program (lines 51500 through 51530) to match the second program (replace with lines 51500 through 51560).

In the first program, line 50500 should be: "50500 REM VERT DIST FROM FLOOR TO AVERAGE LISTENING HEIGHT".

We had a couple of minor typos (probably because I was pushing deadline) last time. The equation on

Figure 1. A sample screen.

P.A. SPEAKER POSITION CALCULATIONS

H. 1ST TO LAST LIST: 100 ft 0 in.
H. LAST LIST TO WALL: 10 ft 0 in.

V. FLOOR TO AV LIST: 4 ft 6 in.
SPKR -6 dB COVR ANGL: 20 ft
ON AXIS SPKR TO REF: 4 ft 0 in.

SPEAKER TO:	Vertical height Feet In.	Horizontal distance Feet In.	Throw distance Feet In.	dB loss Decibels	Vertical to throw Degrees
LAST LISTENER:	21 1	123 1	124 10	-29.89	80.29
-6 dB LISTENER:	21 1	56 9	62 5	-29.86	70.29
-12 dB LISTENER:	21 1	23 1	31 2	-29.84	47.59
-6 dB BACK WALL:	26 3	133 1	133 1	-36.44	90.29
-12 dB BACK WALL:	82 0	133 1	144 6	-43.16	112.99

-6 dB COVERAGE ANGLE: 20.00°
-12 dB COVERAGE ANGLE: 65.40°
SPEAKER TILT FROM VERT: 9.71°

VERT FLR TO CENT OF SPKR: 25 ft 7 in.
AVG LIST TO CENT OF SPKR: 21 ft 1 in.

/CR/TO START AGAIN:

page 15 is really an equation and an example.

The "-12dB=20Log(4ft./16ft.)" is the example. Page 16, *Figure 2*, should be "D=Distance" (as if you couldn't guess) and D6 goes from L3 to L1.

TRICKY TYPING

In this marvelous age of technology, computers and typesetting machines still do not agree well with each other. If you are not much of a programmer, you probably had some difficulty typing the first program in.

Here are a couple of tips. Many of the program lines were longer than the column width, so they were split on two or three lines.

A new line is indented one space and always begins with a line number. If the line has been split, you need to put it all back on one line or the computer will get nasty. You may also have some difficulty knowing how many blank spaces to use in some places. My best advice is trial and error. If the screen doesn't look right, check lines 11000 though 11125 for the background text and

the prompts. Check 50000 through 50390 for the display of the results. P\$=" is as important as a PRINT line.

STAY TUNED

As I said last time, save this issue and make sure your subscription is up to date. Next program, next issue.

If you have any questions or comments, please contact me through **db Magazine**.

The Basic Program

```

10 REM SPEAKER POSITION
CALCULATIONS FOR P.A. SYSTEM
20 REM "PAPOSITN.BAS",A
30 REM V1.1
40 REM 07-12-90
50 REM DCR

100 REM ***** INITIALIZE
110 REM **** SYSTEM FUNCTIONS
120 ON ERROR GOTO 8000
130 CLEAR
140 KEY OFF

800 REM **** SET SYSTEM
VARIABLES
810 P3$=STRING$(80," ")
820 P4$=STRING$(80,"-")
830 P5$=STRING$(80,"=")
840 P6$=CHR$(254)

900 REM **** SET PROGRAM
VARIABLES
910 GOSUB 10000

1000 REM ***** DISPLAY SCREEN

1010 REM **** INITIALIZE
1020 CLS
1030 COLOR C0,C1,C
1040 FOR Y=1 TO 25
1050 LOCATE Y,1:PRINT P3$;
1060 NEXT Y
1100 REM **** HEADING
1110 REM *** FRAME
1120 LOCATE 3,1:PRINT P5$;
1130 LOCATE 22,1:PRINT P5$;

1140 IF G0>0 THEN LOCATE
G1,G0:PRINT LEFT$(P4$,G2);
1150 IF G3>0 THEN LOCATE
G4,G3:PRINT LEFT$(P4$,G5);
1200 REM *** SYSTEM FUNCTIONS
1210 GOSUB 6000
1220 REM *** TITLE
1230 COLOR C0,C1,C
1240 LOCATE 2,1:PRINT G$;

1300 REM **** LINES
1310 REM *** INITIALIZE
1320 RESTORE
1330 J1=0
1340 ON ERROR GOTO 1900
1350 REM *** GET DATA
1360 READ
F$,F0$,F1$,F2$,F,F0,F1,F2,F3,F4,F3$
1370 J1=J1+1
1400 REM *** SET NUMBER
1410 P1$=""
1420 IF F0$="N" THEN GOTO 1500
1430 P1$=STR$(J1)
1440 FOR J3=1 TO LEN(P1$):IF
LEFT$(P1$,1)=" " THEN LET
P1$=RIGHT$(P1$,2):NEXT J3
1450 IF F0$="0" THEN GOTO 1490
1460 IF LEN(P1$)=1 THEN LET
P1$="0"+P1$
1470 IF F0$="2" THEN IF LEN(P1$)=2
THEN LET P1$="0"+P1$
1490 P1$=P1$+" "
1500 REM *** DISPLAY
1510 LOCATE F0,F:PRINT P1$+F$;
1600 REM *** REPEAT
1610 GOTO 1350

1900 REM **** END OF DISPLAY
1910 RESUME 1920

1920 ON ERROR GOTO 8000

2000 REM ***** INPUT DATA

2010 REM **** INITIALIZE
2020 RESTORE

2050 REM **** START LOOP
2060 FOR J=1 TO J1

2070 REM **** GET PARAMETERS
2080 READ
F$,F0$,F1$,F2$,F,F0,F1,F2,F3,F4,F3$

2100 REM **** PROMPTS
2110 COLOR C0,C1,C
2120 LOCATE 23,1:PRINT P3$;
2130 LOCATE 24,1:PRINT P3$;
2140 COLOR C2,C3,C
2150 LOCATE 23,1:PRINT F3$;

2200 REM **** GET INPUT
2210 GOSUB 7000

2300 REM **** VALIDATE
2310 IF LEN(D$)><1 THEN GOTO
2350
2320 IF J=1 THEN IF
INSTR("QqEeXtT",D$)>0 THEN GOTO
9000
2330 IF ASC(D$)=27 THEN GOTO
8100
2340 IF D$="!" THEN GOTO 6100
2345 IF D$="*" THEN GOTO 100
2350 FLAG$=""
2360 GOSUB 20000

```



```

30090 IF J=9 THEN LET A9$=D$
39999 RETURN

40000 REM ***** CALCULATIONS -
USER SUBROUTINE

40010 REM ***** CONVERT TO
NUMBERS AND INCHES
40020 REM *** FIRST TO LAST
LISTENER
40030 D6#=(12*VAL(A1$))+VAL(A2$)
40050 REM *** LAST LISTENER TO
WALL
40060 D4#=(12*VAL(A3$))+VAL(A4$)
40070 REM *** FLOOR TO AVERAGE
LISTENING HEIGHT
40080 H6#=(12*VAL(A5$))+VAL(A6$)
40090 REM *** DISTANCE FROM
SPEAKER FOR db SPL REFERENCE
MEASUREMENT
40100 R#=(12*VAL(A8$))+VAL(A9$)

40110 REM *** SPEAKER'S RATED
-6dB COVERAGE ANGLE
40120 A4#=VAL(A7$)

40130 REM *** CONVERSION
FACTORS
40140 REM ** RADIANS TO DEGREES
40150 RD#=180/3.1415927
40160 REM ** DEGREES TO RADIANS
40170 DR#=3.1415927/180

40200 REM ***** SOLVE FOR ANGLES
FROM HORIZONTAL TO THROW
40210 REM *** A1 - VERTICAL TO ON
AXIS THROW ANGLE
40220
A1#=(RD#*ATN((2-COS((A4#/2)*DR#)
)/(SIN((A4#/2)*DR#))))
40230 REM *** A2 - VERTICAL TO
-6dB AXIS ANGLE
40240 A2#=A1#-(A4#/2)

40250 REM *** A3 - VERTICAL TO
-12dB AXIS ANGLE
40260 REM
A3#=ARCCOSINE(4*COS(A1#*DR#))

40262
GOAL#=INT(4*COS(A1#*DR#)*10000
00)
40264 IF GOAL#>=1000000 THEN
LET A3#=A3#/0
40266 TOPANGLE#=90
40268 BOTTOMANGLE#=.01
40270
TESTANGLE#=((TOPANGLE#-BOTTO
MANGLE#)/2)+BOTTOMANGLE#
40272
TEST#=INT(COS(TESTANGLE#*DR#)
*1000000)

40274 IF TEST#=GOAL# THEN
GOTO 40282
40276 IF TEST#<GOAL# THEN LET
TOPANGLE#=TESTANGLE#
40278 IF TEST#>GOAL# THEN LET
BOTTOMANGLE#=TESTANGLE#
40280 GOTO 40270
40282 A3#=TESTANGLE#

40300 REM ***** D1 - HORIZONTAL
SPEAKER TO LAST LISTENER
40310
D1#=D6#/(1-(TAN(A3#*DR#)/TAN(A1#
*DR#)))

40320 REM ***** H1,H2,H3 - SPEAKER
HEIGHT ABOVE AUDIENCE
40330 REM *** H1
40340 H1#=D1#/TAN(A1#*DR#)
40350 H2#=H1#
40360 H3#=H1#
40370 H7#=H1#+H6#

40400 REM ***** REMAINING
HORIZONTAL DISTANCES
40410 REM *** D2 - HORIZONTAL
SPEAKER TO -6dB AXIS
40420 D2#=H1#*TAN(A2#*DR#)
40430 REM *** D3 - HORIZONTAL
SPEAKER TO -12dB AXIS
40440 D3#=H1#*TAN(A3#*DR#)
40450 REM *** SPEAKER TO BACK
WALL
40460 D5#=D1#+D4#

40500 REM ***** CALCULATE
SPEAKER AXIS THROW DISTANCES
40510 REM *** 0 db ON AXIS THROW
DISTANCE
40520 T1#=(H1#/COS(A1#*DR#)
40530 REM *** -6 db AXIS THROW
DISTANCE
40540 T2#=(H1#/COS(A2#*DR#)
40550 REM *** -12 db AXIS THROW
DISTANCE
40560 T3#=(H1#/COS(A3#*DR#)

40670 REM ***** SPEAKER TILT FROM
VERTICAL
40680 A6#=90-A1#

40700 REM ***** CALCULATE
SPEAKER COVERAGE ANGLES
40730 REM *** -12 db ANGLE
40740 A5#=(A1#-A3#)*2

40800 REM ***** CALCULATE BACK
WALL REFLECTION

40810 REM *** -6 db
40820 REM ** ANGLE FROM
HORIZONTAL IN DEGREES
40830 A9#=A4#+A2#-90
40840 REM ** THROW DISTANCE
40850
T4#=D5#/COS(ABS(A9#*DR#))
40860 REM ** BACK WALL HEIGHT
40870
H4#=H7#+((ABS(A9#)/A9#)*((TAN(A
BS(A9#*DR#)))*D5#))
40880 REM ** ANGLE FROM
VERTICAL
40890 A7#=A1#+A1#-A2#

40900 REM *** -12 db
40910 REM ** ANGLE FROM
HORIZONTAL IN DEGREES
40920 A9#=A5#+A3#-90
40930 REM ** THROW DISTANCE
40940
T5#=D5#/COS(ABS(A9#*DR#))
40950 REM ** BACK WALL HEIGHT
40960
H5#=H7#+((ABS(A9#)/A9#)*((TAN(A
BS(A9#*DR#)))*D5#))
40970 REM ** ANGLE FROM
VERTICAL
40980 A8#=A1#+A1#-A3#

41000 REM ***** CALCULATE
DISTANCE SPL LOSS FOR AXIS
41010 REM *** 0 db ON AXIS TO
AUDIENCE
41020
L1#=20*(LOG(R#/T1#)/LOG(10))
41030 REM *** -6 db AXIS TO
AUDIENCE
41040
L2#=20*(LOG(R#/T2#)/LOG(10))-6
41050 REM *** -12 db AXIS TO
AUDIENCE
41060
L3#=20*(LOG(R#/T3#)/LOG(10))-12
41100 REM *** -6 db AXIS TO BACK
WALL
41110
L4#=20*(LOG(R#/T4#)/LOG(10))-6
41120 REM *** -12 db AXIS TO BACK
WALL
41130
L5#=20*(LOG(R#/T5#)/LOG(10))-12

49999 RETURN

50000 REM ***** DISPLAY RESULTS -
USER SUBROUTINE
50010 REM ***** TEXT FORMAT
50020 REM *** DISPLAY FRAME
50030 LOCATE 8,1:PRINT "
VERTICAL HORIZONTAL THROW
VERTICAL"

```

```

7970 LOCATE F2,F1+LEN(D$):PRINT
P2$;
7980 RETURN

8000 REM ***** ERRORS
8010 RESUME 8020
8020 COLOR C14,C15,C
8030 LOCATE 23,1:PRINT P3$;
8040 LOCATE 24,1:PRINT P3$;
8050 COLOR C14,C15,C
8040 LOCATE 23,1:PRINT "ERROR AT
LINE";ERL;
8050 LOCATE 24,1:PRINT E$;
8060 INPUT "",X$
8070 GOTO 1000

8100 REM ***** STOP
8110 ON ERROR GOTO 0
8120 COLOR 15,0,0
8130 STOP

9000 REM ***** EXIT
9010 CLS
9020 SYSTEM

10000 REM ***** PROGRAM
VARIABLES

10010 REM **** PROGRAM TITLE
10020 LET G$="P.A. SPEAKER
POSITION CALCULATIONS"

10030 REM **** ERROR MESSAGE
10040 LET E$="CONFIGURATION IS
NOT POSSIBLE. ANY KEY TO
RESTART: "

10050 REM **** BELL AT AFTER
MASK DISPLAY
10060 LET BELL1$="N"

10070 REM **** BELL AT FIELD FULL
PROMPT
10080 LET BELL2$="N"

10100 REM **** DIVIDING LINES
X,Y,LEN
10110 LET G0=1:LET G1=7:LET
G2=80
10120 LET G3=0:LET G4=0:LET
G5=80
10200 REM **** COLORS
10210 REM *** BORDER
10220 C = 0

10230 REM - ALL OTHERS TEXT &
BACKGROUND
10240 REM *** INITIALIZE AND
BACKGROUND TEXT
10250 C0 = 7 : C1 = 0
10260 REM *** PROMPTS
10270 C2 = 15 : C3 = 0
10280 REM *** MASK
10290 C4 = 15 : C5 = 0
10300 REM *** CURRENT CURSOR
10310 C6 = 31 : C7 = 0
10320 REM *** CURRENT INPUT
10330 C8 = 15 : C9 = 0
10340 REM *** FOREGROUND TEXT
(ACCEPTED INPUT)
10350 C10 = 15 : C11 = 0
10360 REM *** FOREGROUND TEXT
(OUTPUT DISPLAY)
10370 C12 = 15 : C13 = 0
10380 REM *** ERROR TEXT
10390 C14 = 15 : C15 = 0

10999 RETURN

11000 REM ***** DATA
11005 REM FIELD DESC,AUTO
NO.,DEFAULT,MASK CHR,X,Y,IN
X,Y,MIN,MAX,PROMPT
11006 REM
F$,F0$,F1$,F2$,F,F0,F1,F2,F3,F4,F3$
11007 REM AUTO NO.: N= OMIT
NUMBER, 0= OMIT LEADING ZERO,
1= 2 DIGIT NO., 2= 3 DIGIT NO.
11008 REM MASK CHARACTER (F2$)
= TO "&" WILL DISPLAY A BOX -
CHR$(254)

11010 DATA "H 1ST TO LAST LISTN:
ft"
11011 DATA "N","0","&",1,4,22,4,0,4
11012 DATA "HORIZ. DISTANCE
FROM THE FIRST TO LAST LISTENER
(FEET + INCHES OR INCHES ONLY)"

11020 DATA "in"
11021 DATA "N","0","&",37,4,30,4,0,6
11022 DATA "HORIZ. DISTANCE
FROM THE FIRST TO LAST LISTENER
(INCHES ADDED TO FEET)"

11030 DATA "H LAST LIST TO WALL:
ft"
11031 DATA "N","0","&",1,5,22,5,0,4
11032 DATA "HORIZ. DISTANCE
FROM LAST LISTENER TO BACK
WALL"
11040 DATA "in"
11041 DATA "N","0","&",37,5,30,5,0,6

11043 DATA "HORIZ. DISTANCE
FROM LAST LISTENER TO BACK
WALL"

11050 DATA "V FLOOR TO AV LIST :
ft"
11051 DATA "N","0","&",42,4,63,4,0,4
11052 DATA "VERT. DISTANCE FROM
FLOOR TO AVG. LISTENING HEIGHT"

11060 DATA "in"
11061 DATA "N","0","&",76,4,71,4,0,4
11062 DATA "VERT. DISTANCE FROM
FLOOR TO AVG. LISTENING HEIGHT"

11070 DATA "SPKR -6dB COVR
ANGL:"
11071 DATA "N","0","&",42,5,63,5,0,6
11072 DATA "ENTER THE SPEAKER'S
RATED -6 dB COVERAGE ANGLE
(LESS THAN 31.05 DEG.)"

11080 DATA "ON AXIS SPKR TO REF:
ft"
11081 DATA "N","0","&",42,6,63,6,0,4
11082 DATA "DISTANCE FROM
SPEAKER TO ON AXIS db SPL REF.
MEASUREMENT"

11090 DATA "in"
11091 DATA "N","0","&",76,6,71,6,0,4
11092 DATA "DISTANCE FROM
SPEAKER TO ON AXIS db SPL REF.
MEASUREMENT"

20000 REM ***** VALIDATIONS -
USER SUBROUTINE
20010 IF D$="" THEN LET D$=F1$
20020 FOR J3=1 TO LEN(D$)
20030 IF
INSTR("0123456789.-+ ",MID$(D$,J3,1))=
0 THEN LET FLAG$="REENTER"
20040 NEXT J3
29999 RETURN

30000 REM ***** SLOT DATA - USER
SUBROUTINE
30010 IF J=1 THEN LET A1$=D$
30020 IF J=2 THEN LET A2$=D$
30030 IF J=3 THEN LET A3$=D$
30040 IF J=4 THEN LET A4$=D$
30050 IF J=5 THEN LET A5$=D$
30060 IF J=6 THEN LET A6$=D$
30070 IF J=7 THEN LET A7$=D$
30080 IF J=8 THEN LET A8$=D$

```

```

2370 IF FLAG$="REENTER" THEN
GOTO 2100
2380 IF FLAG$="START OVER" THEN
GOTO 100
2390 IF FLAG$="ERROR" THEN
GOTO 8000

2400 REM **** REDISPLAY
2410 COLOR C10,C11,C
2420 LOCATE F2,F1:PRINT D$;
2430 COLOR C0,C1,C
2440 PRINT
LEFT$(P3$,F4-LEN(D$)+1);

2500 REM **** SLOT DATA
2510 GOSUB 30000

2600 REM **** END OF LOOP
2610 NEXT J

2700 REM ***** CALCULATIONS
2710 GOSUB 40000

2800 REM ***** DISPLAY RESULTS
2810 COLOR C12,C13,C
2820 GOSUB 50000

3000 REM ***** END OF SCREEN

3010 REM **** PROMPT
3020 F$="/CR/ TO START AGAIN:"
3030 LET F0$="0":F2$="&"
3040
F=1:F0=23:F1=22:F2=23:F3=0:F4=1
3050 COLOR C0,C1,C
3060 LOCATE 23,1:PRINT P3$;
3070 LOCATE 24,1:PRINT P3$;
3080 COLOR C2,C3,C
3090 LOCATE F0,F:PRINT F$;
3100 GOSUB 7000
3110 GOTO 1000

6000 REM ***** DATE & TIME
SUBROUTINE
6010 COLOR C0,C1,C
6020 LOCATE 1,70:PRINT DATES$;
6030 LOCATE 2,70:PRINT TIME$;
6040 LET PREVT$=TIME$
6050 RETURN

6100 REM ***** BACK-UP ONE FIELD
ROUTINE
6110 REM *** CLEAR CURRENT
FIELD
6120 COLOR C0,C1,C

6130 LOCATE F2,F1:PRINT
LEFT$(P3$,F4);
6140 IF J=1 THEN GOTO 100
6200 REM *** RESET FIELD
6210 RESTORE
6220 J2=J-1
6230 FOR J3=1 TO J2
6240 READ
F$,F0$,F1$,F2$,F,F0,F1,F2,F3,F4,F3$
6250 NEXT J3
6260 J=J3-1
6270 GOTO 2100

7000 REM ***** STANDARD
KEYBOARD INPUT SUBROUTINE

7010 REM **** MASK
7020 IF F2$="&" THEN LET F2$=P6$
7030 IF LEN(F2$)>1 THEN LET
P$=F2$:GOTO 7060
7040 IF F2$="" THEN LET
P$="":GOTO 7060
7050 LET P$=STRING$(F4,F2$)
7060 P$=P$+" "
7070 COLOR C4,C5,C
7080 LOCATE F2,F1:PRINT P$;
7090 IF BELL1$="Y" THEN PRINT
CHR$(7);
7095 REM --- SET BELL PARAMS &
GOSUB

7100 REM **** CLEAR INPUT
VARIABLE
7110 D$=""

7200 REM **** CHECK FOR FIELD
FULL
7210 IF LEN(D$)><F4 THEN GOTO
7300
7220 COLOR C2,C3,C
7230 LOCATE 24,1:PRINT "THIS FIELD
IS FULL. /CR/ OR BACKSPACE.";
7240 IF BELL2$="Y" THEN PRINT
CHR$(7);
7245 REM - SET BELL PARAMS &
GOSUB

7300 REM **** INPUT
7310 LOCATE F2,F1
7320 GOSUB 7900
7330 D1$=INKEY$
7340 IF TIME$><PREVT$ THEN
GOSUB 6000
7350 IF D1$="" THEN GOTO 7330
7360 GOSUB 7900

7400 REM **** /CR/ CHECK
7410 IF ASC(D1$)<>13 THEN GOTO
7600
7420 IF F3=0 THEN GOTO 7800

7430 IF LEN(D$)>=F3 THEN GOTO
7800
7440 GOTO 7200

7600 REM **** BACKSPACE
7610 IF ASC(D1$)<>8 THEN GOTO
7700
7620 COLOR C0,C1,C
7630 IF LEN(D$)=F4 THEN LOCATE
24,1:PRINT P3$;
7640 IF LEN(D$)=0 THEN GOTO 7200
7650 COLOR C4,C5,C
7655 REM --- NEXT LINE, F2$ WON'T
WORK WITH LONG MASK, NEED
MASK VARIABLE
7660 LOCATE
F2,F1+LEN(D$)-1:PRINT F2$;
7670 D$=LEFT$(D$,LEN(D$)-1)
7680 LOCATE F2,F1+LEN(D$)-1
7690 GOTO 7200

7700 REM **** ADD CHR TO STR &
DISPLAY
7710 IF LEN(D$)=F4 THEN GOTO
7200
7720 COLOR C8,C9,C
7730 LOCATE F2,F1+LEN(D$):PRINT
D1$;
7740 D$=D$+D1$

7750 REM **** LENGTH CHECK
7760 IF LEN(D$)<F4+1 THEN GOTO
7200

7800 REM **** RETURN
7810 COLOR C10,C11,C
7820 LOCATE F2,F1:PRINT D$;
7830 COLOR C0,C1,C
7840 PRINT
LEFT$(P3$,F4-LEN(D$)+1);
7850 IF LEN(D$)=F4 THEN LOCATE
24,1:PRINT P3$;
7860 RETURN

7900 REM **** SET CURRENT
CURSOR COLOR SUBROUTINE
(TOGGLE - BLINK)
7910
P2$=CHR$(SCREEN(F2,F1+LEN(D$),0
))
7920
P0=SCREEN(F2,F1+LEN(D$),1):REM
- READ CURRENT COLOR
7930 P1=P0 MOD 16:REM - GET
FOREGROUND VALUE
7940 IF P0>127 THEN LET
P1=P1+16:REM - ADJUST IF
BLINKING
7950 IF P1 = C6 THEN COLOR
C4,C5,C
7960 IF P1 = C4 THEN COLOR
C6,C7,C

```



```

50040 LOCATE 9,1:PRINT "
HEIGHT DISTANCE DISTANCE
dB LOSS TO THROW"
50050 LOCATE 10,1:PRINT "SPEAKER
TO: Feet In. Feet In. Feet In.
decibels degrees"
50060 LOCATE 11,1:PRINT "-----
-----"
50070 LOCATE 18,1:PRINT "-----
-----"

50100 REM *** DISPLAY DATA
50110 REM ** LONG LINES
50120 REM * SET MASK
50130 P1$=":##### ## #####"
## ##### ## #####
###.##"
50140 X=1

50200 REM * DATA
50210 Y=12:P$="LAST LISTENER
":P0#=H1#:P1#=D1#:P2#=T1#:P3#
=L1#:P4#=A1#:GOSUB 51000
50220 Y=13:P$="-6dB LISTENER
":P0#=H2#:P1#=D2#:P2#=T2#:P3#
=L2#:P4#=A2#:GOSUB 51000
50230 Y=14:P$="-12dB
LISTENER":P0#=H3#:P1#=D3#:P2#=
T3#:P3#=L3#:P4#=A3#:GOSUB
51000
50240 Y=16:P$="-6dB BACK
WALL":P0#=H4#:P1#=D5#:P2#=T4#
:P3#=L4#:P4#=A7#:GOSUB 51000
50250 Y=17:P$="-12dB BK WALL
":P0#=H5#:P1#=D5#:P2#=T5#:P3#
=L5#:P4#=A8#:GOSUB 51000

50300 REM ** SINGLE DATA LINES
50310 REM * BOTTOM OF SCREEN
50310 X=1:Y=19:P$="-6dB
COVERAGE ANGLE : #####.##
deg.":P0#=A4#:GOSUB 51200
50320 X=1:Y=20:P$="-12dB
COVERAGE ANGLE : #####.##
deg.":P0#=A5#:GOSUB 51200

50330 X=1:Y=21:P$="SPEAKER TILT
FROM VERT: #####.##
deg.":P0#=A6#:GOSUB 51200
50340 D#=H7#:GOSUB 51500
50350 X=38:Y=19:P$="VERT FLR TO
CENT OF SPKR: #####
ft.":P0#=DF#:GOSUB 51200
50360 X=75:Y=19:P$="##
in.":P0#=DI#:GOSUB 51200
50370 D#=H1#:GOSUB 51500
50380 X=38:Y=20:P$="AVG LIST TO
CENT OF SPKR: #####
ft.":P0#=DF#:GOSUB 51200
50390 X=75:Y=20:P$="##
in.":P0#=DI#:GOSUB 51200

50400 REM * REFRESH TOP OF
SCREEN (INPUTS)
50410 REM HORIZ DIST FROM FIRST
TO LAST LISTENER
50420 D#=D6#:GOSUB 51500
50430
X=22:Y=4:P$="#####":P0#=DF#:GO
SUB 51200
50440 X=30:Y=4:P$="
##":P0#=DI#:GOSUB 51200
50450 REM HORIZ DIST FROM LAST
LIST TO BACK WALL
50460 D#=D4#:GOSUB 51500
50470
X=22:Y=5:P$="#####":P0#=DF#:GO
SUB 51200
50480 X=30:Y=5:P$="
##":P0#=DI#:GOSUB 51200
50500 REM VERT DIST FROM FLOOR
TO AVG LISTENING HEIGHT
50510 D#=H6#:GOSUB 51500
50520
X=63:Y=4:P$="#####":P0#=DF#:GO
SUB 51200
50530 X=71:Y=4:P$="
##":P0#=DI#:GOSUB 51200
50540 REM SPEAKER'S RATED -6dB
COVERAGE ANGLE

50550
X=63:Y=5:P$="#####":P0#=A4#:G
OSUB 51200
50600 REM REFERENCE DISTANCE
50600 D#=R#:GOSUB 51500
50610
X=63:Y=6:P$="#####":P0#=DF#:GO
SUB 51200
50620 X=71:Y=6:P$="
##":P0#=DI#:GOSUB 51200

50999 RETURN

51000 REM **** PRINT LONG LINE
SUBROUTINE
51010 REM *** SET VARIABLES
51020 D#=P0#:GOSUB
51500:PF0#=DF#:PI0#=DI#
51030 D#=P1#:GOSUB
51500:PF1#=DF#:PI1#=DI#
51040 D#=P2#:GOSUB
51500:PF2#=DF#:PI2#=DI#
51110 REM *** PRINT
51110 LOCATE Y,X:PRINT USING
P$+P1$;PF0#,PI0#,PF1#,PI1#,PF2#,P
I2#,P3#,P4#
51120 RETURN

51200 REM **** PRINT A SINGLE LINE
51210 LOCATE Y,X:PRINT USING
P$;P0#
51220 RETURN

51500 REM **** CONVERT TO FEET
AND INCHES
51510 DF#=INT(D#/12)
51520 DI#=INT(D#-(DF#*12)+0.5)
51530 IF DI# < 12 THEN RETURN
51540 DF#=DF#+1
51550 DI#=0
51560 RETURN

65535 END

```

Lab Report

Aphex Expressor™ Model 651 Compressor/Limiter

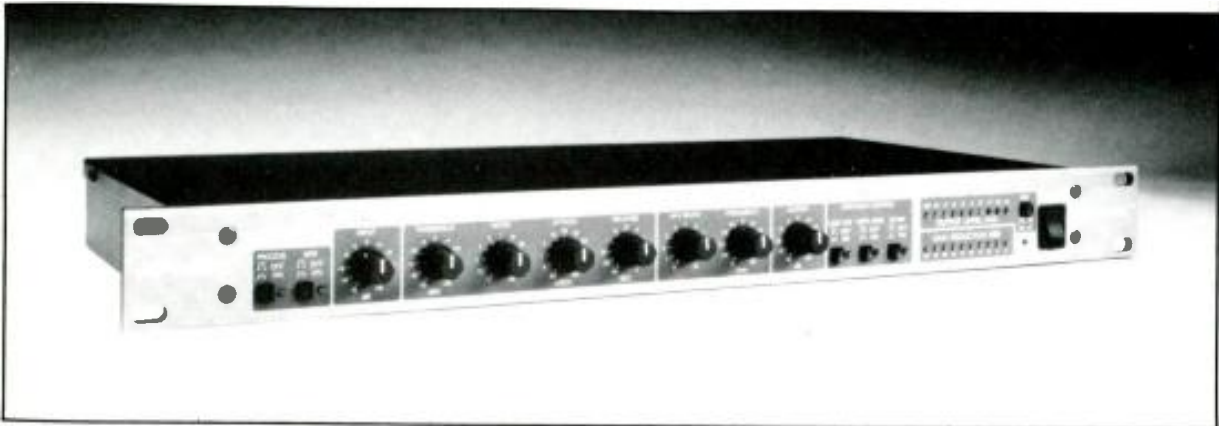

GENERAL INFORMATION

• This compressor/limiter from Aphex Systems goes far beyond the ordinary compressor or compressor/limiter in its flexibility and versatility. In addition to the usual standard compressor controls that you would expect to find on this type of component (such as *Input, Threshold, Ratio, Attack, Release* and *Output*), there are several unique features and additional controls that enable you to adjust compression and limiting over a far greater range without worrying about introducing artifacts such as “dullness” that are typically found in other wide-band compressor/limiters.

For example, Aphex’s High Frequency Expander (for which a patent is pending) lets you use higher compression ratios, even up to 50 to 1 without worrying about such artifacts. A feature that Aphex calls a Spectral

Phase Refractor helps to restore bass clarity and punch without any increase in amplitude. Sidechain controls let you choose whether you want to cut low-frequencies, employ a soft-knee threshold, or link two Expressors for stereo or master/slave operation. Servo-balanced XLR input and output connections allow you to use your expressor in such diverse environments and applications as tracking, mixing or mastering, in fixed installations, for tape duplication, in P.A. system applications, voice processing or in post-production work.

ABOUT GAIN REDUCTION

In order to understand the many controls associated with the Model 651, certain gain reduction parameters need to be defined. The Threshold setting is the level at which gain reduction starts. Above the threshold setting,

Figure 1. Frequency response with the controls set for minimum compression and fastest attack and decay times.

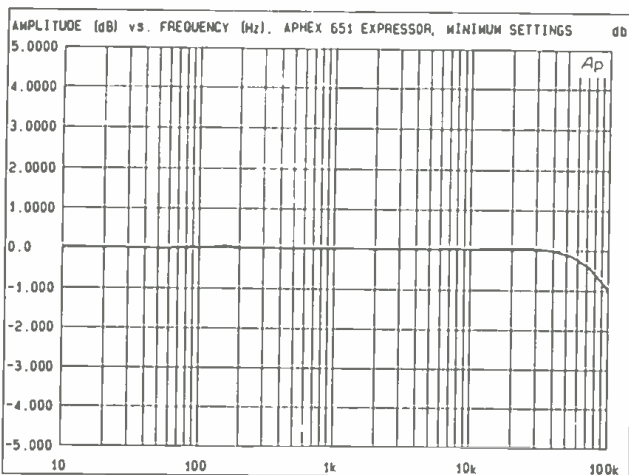
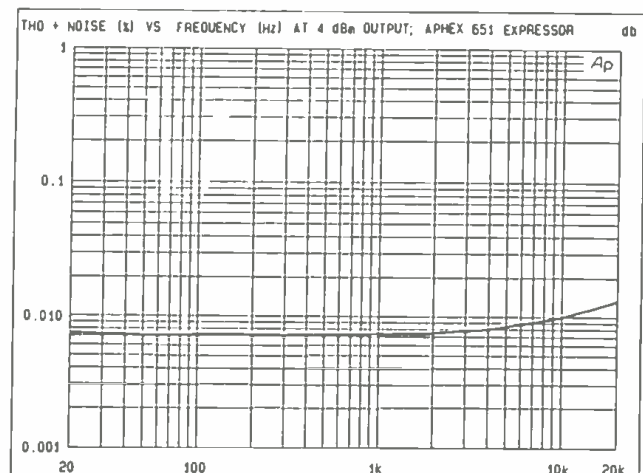

Figure 2. Harmonic distortion plus noise versus frequency at +4 dBm output, controls again set for minimum compression and fastest attack and decay.



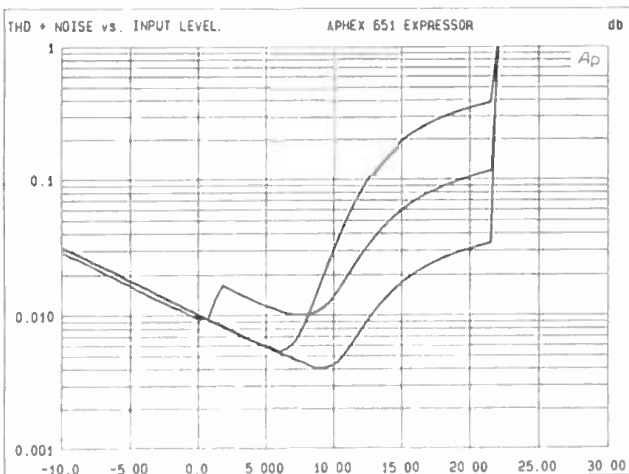
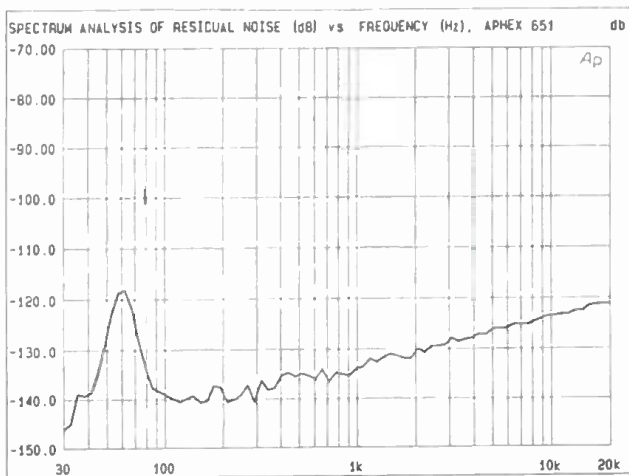

Figure 3. Harmonic distortion plus noise versus input level, 0 dB gain setting. Best curve is 1 kHz, next best power is 20 kHz, lowest output before clipping is for 100 Hz.

gain reduction takes place as audio level rises. Ratio is the mathematical relationship that tells how much an increase in input level will be reduced. A ratio of 10:1, for example, means that any increase in input will be ten times as great as the signal level change at the output. Attack time is the time it takes to attenuate by 10 dB an increase in input signal above threshold level. Release time, conversely, is the time it takes the gain reduction circuit, set at its highest ratio, to un-attenuate by 10 dB a decrease in the input signal above threshold. Finally, make-up gain is the amount of additional gain needed to bring the gain-reduced signal up to a desired output level.

As Aphex clearly explains in their well-written operating guide supplied with the Model 651, in its simplest form, gain reduction is the level difference between input and output audio signals. As input level increases above a set threshold, the amount of gain reduction increases. As input level decreases, the amount of gain reduction decreases. There are five different kinds of gain reduction defined by Aphex: leveling, compression, program limiting, peak limiting and clipping. Leveling maintains a consistent output level over the long term, without affecting short-term dynamics. Compression is typically used to bring up the level of low-level signals. Program limiting employs fast attack and release times to set a maximum level for an "average" output. Peak limiting, on the other hand, is used to set a maximum

Figure 4. Spectral analysis of residual noise, referenced to =4 dBm input, with input control set for maximum and minimum compression settings.



level for peak output. Clipping is an infinite ratio setting with nearly instantaneous attack and release times. It provides an absolute zero overshoot at which peak levels will be capped. A simplified block diagram showing the signal path in the Expressor Model 651 is shown in Figure 6.

CONTROL LAYOUT

The first two controls at the left of the front panel are the Process On/Off switch and a switch labeled *SPR Off/On*. In the *off* position, the *Process On/Off* switch provides a hardwire audio bypass. *SPR* stands for Spectral Phase Refractor and when this switch is *on*, the main audio signal is processed so that bass frequencies lead in phase in relation to the rest of the spectrum. This feature was first introduced in Aphex's Aural Exciter Type III and is said to correct a bass delay anomaly to restore clarity and openness without adding any actual EQ or bass boost.

The Input level control can be adjusted from -15 to +15 dB, with 0 dB representing unity gain. Next comes the threshold control that lets you set the level where gain reduction begins, regardless of the setting of the input level control. This control is adjustable from -20 to +20 dBm. The *ratio* control alongside the threshold control can be varied from a ratio of 1.1:1 to 50:1. The *attack* control nearby can be varied from 0.05 milliseconds to 100 milliseconds, while the *release* control can be varied from 0.04 to 4 seconds.

This compressor/limiter provides a feature that adds equalization when necessary. The HFX control allows you to set the amount of equalization (6 dB per octave shelving) for the amount of gain reduction. At its minimum setting, there is no EQ. At 1.0:1, there is 1 dB of high frequency boost for every 1 dB of gain reduction. An adjacent *frequency* control varies the corner frequency of the HFX expander and can be adjusted from 2 kHz to 20 kHz. The last rotary control is an output control and is adjustable from -12 to +18 dB, with 0 dB representing unity gain at your system's operating level.

Three small switches near the right end of the front panel are labeled *low cut off/on* (a 6 dB per octave low-cut filter below 80 Hz), *soft knee/on-off* (to produce a less perceived sound change at the threshold point) and *slave off/on* that, when punched in, allows an audio control signal from another Expressor to control your Expressor through rear panel link jacks. Two horizontally oriented

Figure 5. Output versus input for various compression and threshold ratios. Input level ranged from -10 dBm to 10 dBm.

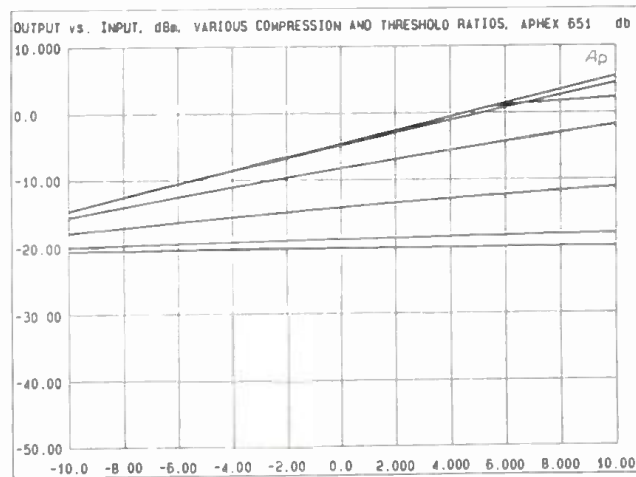

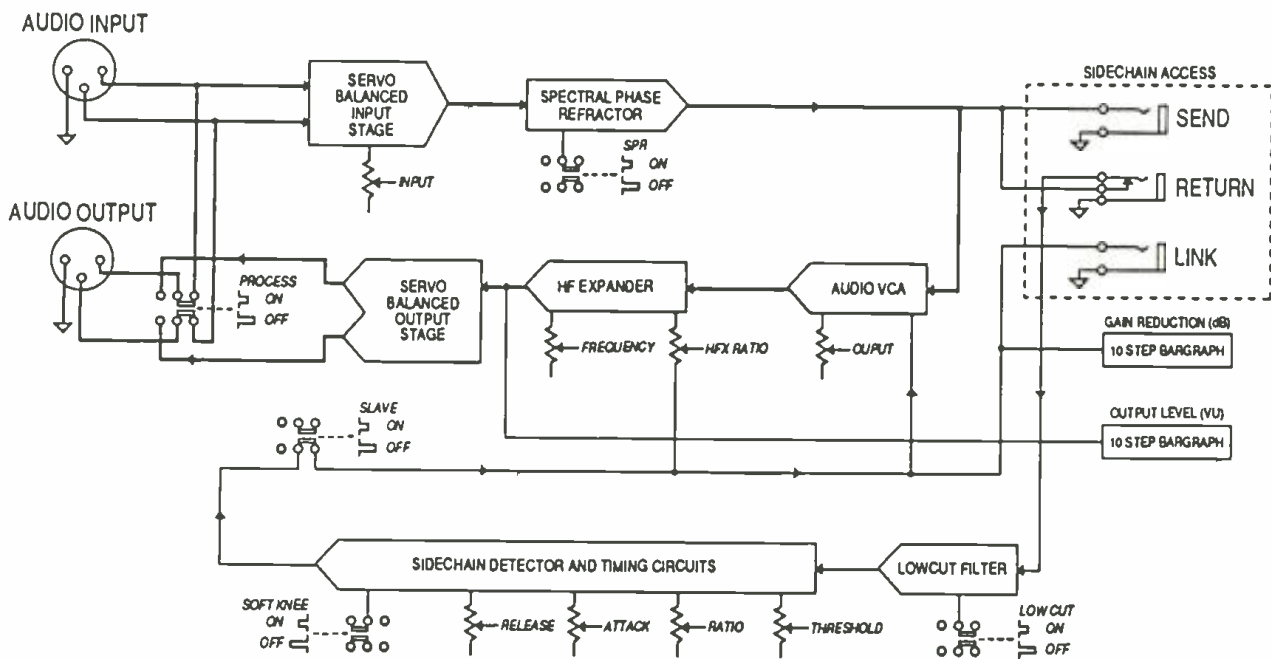

NAMES IN ITALICS ARE USER CONTROLS

- = AUDIO SIGNAL PATH
- - - → = CONTROL SIGNAL PATH
- ▽ = AUDIO GROUND

Figure 6. The block diagram showing signal flow.

LED level meters (one showing output level, the other showing gain reduction in dB) and a power on/off switch complete the front panel layout.

LABORATORY MEASUREMENTS

Static bench measurements can't begin to tell the story about how effectively this compressor/limiter works when actual music or voice signals are applied to it. Nevertheless, we wanted to check out at least some of the more common measurable parameters of this unit to make certain that installing it in the signal path of a high quality audio system will not degrade the basic quality of that system. We were more than satisfied that the unit is capable of low-distortion, wide-band operation under a variety of conditions and control settings.

Figure 1 shows the basic frequency response of the Aphex 651 with controls set for minimal compression and fast attack and delay times. Response was flat down to 10 Hz and was down a mere 1 dB at 100 kHz. Next, we measured total harmonic distortion plus noise as a function of input signal frequency. Level was adjusted for unity gain with an input of +4 dBm and results are plotted in Figure 2. At these input and output settings, THD plus noise amounted to no more than 0.007 percent at low and mid-frequencies, increasing to a still insignificant 0.012 percent at 20 kHz. We also made a spot (single) measurement of SMPTE-IM distortion at the same relative input and output levels and observed a reading of only 0.008 percent.

In Figure 3 we measured distortion plus noise as a function of input levels, with the gain controls set for unity gain. Measurements were made for test frequencies of 100 Hz, 1 kHz and 20 kHz. Good correlation was obtained between the measurements for 1 kHz at the +4 dBm point in this test and the test depicted in the graph of Figure 2.

A-weighted signal-to-noise ratio, referred to +4 dBm, measured 106.3 dB as against only 85 dB claimed by

Aphex. Possibly Aphex did not use an A-weighting curve when measuring their unit, whereas we did, in accordance with standard practice when measuring signal-to-noise ratios for audio amplifiers, preamplifiers, etc. Figure 4 is a spectrum analysis study of noise versus frequency, using a 1/3-octave band pass filter to make the measurement plot. The higher readings seen here are the result of referencing the graph to a +25 dBm output. Under those conditions, even the slight influence of the power supply (the peak seen at 60 Hz) is nearly 120 dB down relative to the +25 dBm reference level.

In the tests represented by Figure 5, we attempted to depict some of the compression characteristics of the Model 651. The upper curves represent fairly moderate compression ratios, while those that appear to be almost horizontal represent extreme compression (output remains fairly constant in level regardless of input). Of course, no graph derived from static slow-moving test frequencies can actually depict the effect of varying attack and release times in a unit such as this. At the most extreme ratio setting of the controls, it appears as though even the most extreme change in input level results in no change of output level. In actual practice, under musical signal conditions, this would not be the case.

A summary of the manufacturer's published specifications and, where applicable, our measurements appear in the *Vital Statistics* table at the end of this report.

CONCLUSIONS

Anyone using the Model 651 Expressor would do well to experiment with it for a considerable length of time before using it in an actual audio project, whether that be in the broadcast, recording studio or PA environment. There are just so many permutations and combinations of control settings that with a bit of care, you should be able to come up with just the amount and type of compression that's needed for your application. To aid you in

getting started with the 651, Aphex has wisely elected to include a complete and comprehensive section of the operating manual that illustrates exact control settings for no fewer than 22 different applications.

Examples include kick and snare drums, tympani, percussive sound effects, eight types of guitars, vocals and an example of using the 651 as a peak limiter. As if those examples aren't enough, the manual even provides a page full of blank control templates onto which you can draw the control setting that you work out for applications not covered by the other examples shown.

We could not possibly try out all of the examples given by Aphex in the owner's manual. For one thing, we did not have access to the program sources (instruments, vocalists, etc.) that would be needed to experiment with each set of control settings. Using a variety of program material (everything from selected portion of CDs to FM radio broadcasts), we can attest to the fact that when properly used, the Aphex "Expresor" Model 651 can probably provide you with the kind of sound you'd like to have while at the same time allowing you to use higher compression ratios than you might otherwise be able to employ. 

VITAL STATISTICS

SPECIFICATION	MFR'S CLAIM	db MEASURED
Maximum Input Level	+27 dBm	+25 dBm
Input Impedance	22 Kohms	Confirmed
Output Impedance	65 Ohms	Confirmed
Maximum Output Level	+25 dBm	Confirmed
Dynamic Range	112 dB	115 dB
Bandwidth, 5 Hz to 100 kHz	±0.2 dB	+0 , -0.8 dB
Noise and Hum, Unity Gain	85 dB	N/A
Noise & Hum, re: max. output	N/A	106.3 dB
THD @ +4 dBm	0.006%	0.007%
SMPTE-IM	0.006%	0.008%
Input Control Range	-15 to +15 dB	Confirmed
Threshold	-20 to +20 dBm	Confirmed
Attack Time	0.5 to 100 msec	N/A
Release	0.4 to 4 sec.	N/A
Ratio Range	1.1:1 to 50:1	Confirmed
HF Expander Ratio	0:1 to 1:1	Confirmed
HF Frequency Range	2 kHz to 20 kHz	Confirmed
Power Requirements	97 to 132 VAC, 12W	Confirmed
Dimensions (HxWxD, inches)	1.75x19x8.6	Confirmed
Price: \$495.00		

Musician's Notebook

The Basics

• Hi there. I've been making music for years, spending thousands of dollars and hours plying my craft, hoping to make "the big time." It's my intention to share some of my experiences and ideas with you in the hope that you might be able to apply them to your experiences.

For the past seven years, I've had the opportunity to represent a major manufacturer of electronic musical instruments. When I got the job, I'd been a professional musician for ten years. I was a published songwriter and recording artist and was beginning to explore the worlds of producing and engineering. I had always dreamed of having a home recording studio. Back in 1983, professional quality multi-track recorders and signal processors were still not affordable for many, and this blues guitarist thought MIDI was the length of a skirt and an envelope was something you mailed a letter in.

My job forced me to learn about a technology I would have found too intimidating otherwise. Over the years I've bought various multi-tracks, drum machines, synthesizers, samplers, sequencers, signal processors and by gum, I learned how to use 'em. Imagine, a roots oriented guitarist who's sequencing his compositions and making hot demos. If I can do it, anyone can.

To quote an old Freddie King song, "You gotta use what you got." Each step of the way, I poured my heart and soul into whatever piece of gear I had and went for the maximum results possible. It doesn't matter whether your equipment is the latest

Introducing Mark Maulucci. Mark is a salesrep for a major manufacturer, plays with the Mark Nomad Band and owns and operates Blue Star Productions—all in Hartford CT.

technology or not; if your music is good and your heart is true, it'll fly.

I was in a publisher's office recently and played three songs for him. The first two songs were done in my studio which had been upgraded to the tune of several thousand dollars. The third song was done in a state-of-the-art 24-track studio. He responded with the usual "Nice songs, nice production, but they don't kill me. I'm looking for something different, something risky." I dove into my briefcase and handed him another cassette which he played and really liked. It was a song I'd done on my old 8-track before the acquisition of my 12-track and several 16 bit toys and accessories.

BETTER CASSETTE SOUND

Next are two areas which, when used effectively, can greatly enhance the impact of your demos: aural exciting and stereo imaging. Do the cassette copies of your demos sound tired? That's often the case when you copy a stereo master tape in the home studio. Remember, the cassette is a third generation recording and that's what others will hear when you send it out. To add zest and put life back into it, try using an exciter on the mix.

There are at least a few exciters on the market. Aphex, Rocktron and BBE (by Barcus-Berry) come immediately to mind. I have the Rocktron RX2H. Its phase notching helps immensely in zeroing in on the overall tonality of the mix and it's been invaluable in breathing life into old demos. In addition, it has the Hush II built in, so it's a triple processor.

I favor "exciting" the mix as it goes from multi-track to two-track. That way, every time I make a cassette copy, it's already excited and ready to go. You could put the exciter between

your two-track and cassette player if you'd like. I've brought older pre-excited tapes back from the dead that way. Either way you do it, a little excitement goes a long way. Too much, and the sound gets harsh, saturated and really brittle. Exciters add harmonic distortion to do their thing. I seldom record individual tracks with them because I can't take the effect out once it's printed. Also, since I almost always excite the entire mix, it won't do to have some tracks excited twice; that would sound too harsh. Just enough spice can mean the difference between something ho-hum and something hot!

Now, on to stereo imaging. You might be wondering why I would devote space to something so basic, something everybody already knows about. It's my opinion that it's the simple things that really make a difference. You'd be surprised at how many tapes I've heard that haven't utilized this very basic tool for creating an interesting soundscape. Imaginative use of the stereo field can weave textures into a mix and create big, spacious and ear-catching results. We're living in an era where much of pop music is of the "in your face" variety. Usually, kick and snare drums, vocals, bass, lead guitar and so on, all share the same middle position in the stereo field.

STEREO DRUMS?

Stereo drums have long been an insisted standard in contemporary music. It can still be very exciting to hear a tom fill start on one side and move across the field to end up on the other side. Crash or ride cymbals or percussion emanating from one speaker or the other can be very effective. For years though, when I had an eight-track machine and mixer and no sub-mixer, I forwent the stereo drums. I felt other uses of that

valuable track would have more dramatic effect on my mixes than an occasionally nifty drum fill.

It's neat to hear a snare drum whack or guitar chop and hear the resultant reverb on the other side.

I'm a big fan of stereo rhythm guitars. I like a nice, gritty electric rhythm on one side and an acoustic guitar on the other, or a dirty guitar on one side and a real clean one on the other, or one guitar in stereo, where a panning, chorused delay follows the original guitar across the field. All these things can create an interestingly textured mix, and the listener often may not even realize why it sounds so good.

A good friend of mine is crazy about stereo background vocals and I admit that I use them whenever possible. He likes to record background vocal parts three or four times and bounce them all down to one side. Then he does it all over again and bounces it to the other side. The result is a big lush background vocal that has plenty of "chorus" due to the natural detuning of many voices singing the same parts. If he's in a situation where he can't afford so many tracks in the initial recording process, he can induce stereo electronically. Since you're hearing the same vocals both left and right, he alters one or both sides with different types of delay or chorus so that you're getting a different stereo treatment.

Digital stereo reverb is now an industry standard even in inexpensive units. Many of these reverbs are not true stereo in that they often have only one input with two outputs, but they do the job nicely. It's neat to hear a snare drum whack or guitar chop and hear the resultant reverb on the other side. All of you guys and gals with your hoards of MIDI gear can usually get interesting chorused and delayed sounds just by running out of your modules in stereo. The internal effects processors on many of today's sound modules save you

money on external processing and provide for real stereo effects. This, however, can certainly eat up channels and is responsible for the burgeoning line mixer market.

Perhaps a more effective avenue for your MIDI symphonies would be to arrange sounds left or right for the

horn blast, percussive or interjective variety use "center," or both sides in stereo for the more meat and potato parts. Remember—while a great mix can make a good song sound stronger, the opposite is also true.

Next time: *Practical Guitar Synthesis*. □

Fried Any Speakers Lately?

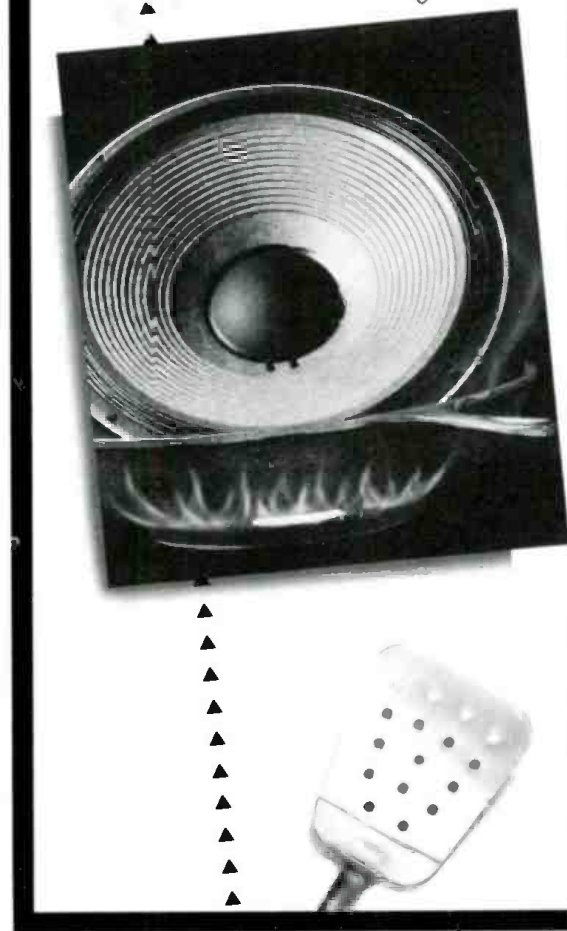

If your livelihood depends on loudspeakers, odds are you've had a few die on you. Sure, a speaker can be repaired, but if it couldn't handle the job the first time, it'll blow again.

By the time you've tried it and reconed it, you could have started with a Gauss, saved money and your reputation. Gauss speakers are engineered to be bullet proof. They have the largest voice coil in the industry, 4.125 inches, directly wound on an aluminum former for maximum heat dissipation. Our innovative dual spider design insures that the voice coil stays centered in high power applications. Even our cast aluminum frames are more robust!

Your Gauss dealer can tell you all about the other design features that make our speakers the most reliable you can buy. And, contrary to popular myth, they are competitively priced, but what's your reputation worth anyway?

gauss ◀ ◀ ◀ ◀ ◀

a MARK IV company
9130 Glen Oaks Blvd.
Sun Valley, CA 91352
(213) 875-1900
Fax: (818) 767-4479

© 1990 Gauss

Recording Techniques

Make Cleaner Mixes With Midi Tape Sync

● In the songs you record, chances are you don't want to be limited to the sounds of a synthesizer, sampler and drum machine. You might want to use acoustic instruments and vocals as well. If you want to add a vocal or other microphone signal, you must record it on a multi-track tape recorder or in other words, you want to record part of your song in a sequencer and another part on a tape recorder. You need a way to make them both start together and run at the same tempo. This is done with a special sync tone that is recorded on one track of the multi-track tape recorder.

Start by recording synth and drum-machine parts with a sequencer. Next, record the sync tone on tape. After rewinding the tape to the beginning of the tone, start recording on tape. The sync tone makes the sequencer play. While listening to the sequencer playback, record vocals or acoustic instruments on tape. During mixdown, the tape plays back the audio signal of the vocals, while the sequencer plays back MIDI data that drives the synth and drum machine. The sync tone keeps the recorder and sequencer running together in synchronization. Usually, the sync tone comes from a tape-

sync connector in your sequencer or MIDI interface. Run a special cable from the tape sync connector to the input and output connectors of one tape track.

Here's how it works: The MIDI clocks (timing pulses) from the sequencer are converted to a tape-sync tone which you record on tape. The tone shifts rapidly between two frequencies to convey the timing pulses. This signal is called FSK (Frequency Shift Keying). For more on the MIDI clock, please see the sidebar.

When you play the tape, the sync tone is converted back into clocks that the sequencer can lock to. The sync tone forces the virtual tracks to play in sync with the tape tracks. That is, the tone starts the sequencer playing at the beginning of the sequence, at whatever tempo is set in the sequencer. The sequencer then drives all the MIDI instruments at the same tempo.

If your sequencer lacks a tape-sync connector, you need a tape-sync box or tape synchronization adapter. Connect it between the sequencer's MIDI ports and one track of the tape recorder. This tape-sync unit is built into some recorder-mixers, such as the Tascam 644 and 688 Midistudios.

TAPE-SYNC PROCEDURE

Let's say you want to record synth parts with a sequencer, then add a vocal on tape. Follow this procedure:

1. Record your sequencer tracks and set their tempo;
2. Record (stripe) a sync tone on one track of the recorder for the entire length of the song. This track is usually track 4 of a recorder-mixer with a sync input;
3. Rewind to the beginning of the tape tone, and set up the musician and microphone to record on another tape track;
4. While the tape is rolling to record the vocal, the sync track will start the synthesizer sequence at the proper time;
5. The vocalist listens to the synth playing and sings along while being recorded on an open track;
6. During mixdown, the sync track keeps the recorded voice track and live synth signals in synchronization. There's no need to record the synth signals onto multi-track tape — these signals just play "live" in real time along with the recorded vocal track. The result is a cleaner sound.

If you need more parts in your composition, you can record the synth parts onto tape, then overdub more synth parts in your sequencer. The sync track will keep them all synchronized. If your sequencer tracks have tempo changes, they will be followed if they were present when you recorded the sync tone.

SONG POSITION POINTER

What if you start the tape in the middle of a song — say, for overdubbing a solo? The sequencer will start from the beginning, instead of at the same point in the sequence, so you always have to rewind to the top of the song to keep the tape and sequencer running together. There is a

Figure 1. The recording setup.

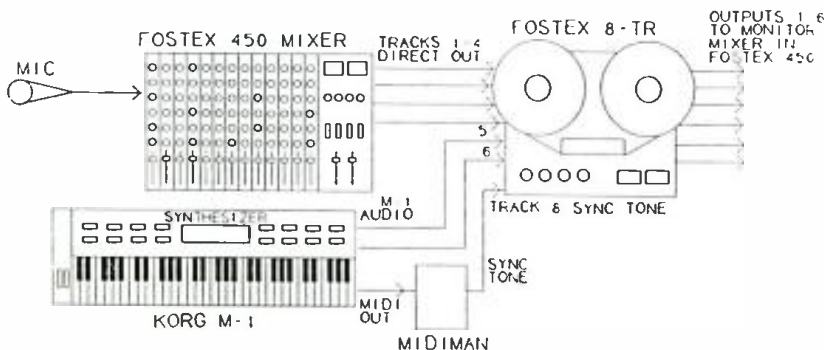

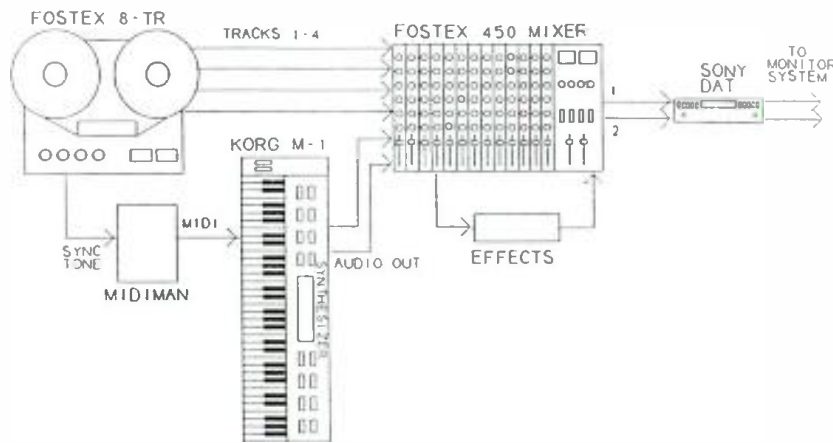

Figure 2. The setup for mixdown.

solution, however: Song Position Pointer (SPP).

The SPP tells the sequencer where to start playing. It specifies the bar and beat (to the nearest sixteenth note) from the beginning of the song. That is, it keeps track of how many sixteenth-note pulses elapsed from the start of a sequence. With the SPP feature, you don't have to keep going back to the top. You can start a tape anywhere in a song, and the sequencer will start at the corresponding point in the sequence (after a short delay).

To use SPP, you need a sync-to-tape converter with Song Position Pointer (also called smart tape sync). Some examples are the JL Cooper PPSI, Harmony Systems MTSI and Tascam MTS-30. With one of these units, tape tracks and virtual tracks can be synced anywhere in the song. This works only if your sequencer and synth implement the SPP — check your manuals.

A MIDI/TAPE SESSION

To illustrate how tape sync is used, I'll describe an actual home-recording session in which I used tape sync and DAT mastering. The sound quality you can achieve with these methods is outstanding. I hope you can learn from my mistakes as well as my successes!

The purpose of this session was to develop and record songs as entries for a songwriting contest. My friend Steve Mills assisted in the project. Tom Stewart, a local musician, composed each song in the form of a vocal with acoustic-guitar accompaniment.

Mills and I had to create a "backup band" with a synthesizer, record

these parts with a sequencer, record vocals and guitars on tape and sync it all together. We used not only an analog tape recorder, but a MIDI sequencer and a DAT recorder (for mastering) as well. The recording required the following equipment:

- Musical workstation: Korg M-1 sample-playing synthesizer keyboard with a built-in 8-track sequencer;
- 8-track tape recorder: Fostex Model 80 with Dolby C;
- Mixer: Fostex 450;
- Microphones: Crown GLM-100 (guitars) and CM-200 (vocals).

We used the Korg M-1 to create the sounds of bass, drums and piano, and then recorded them with the Korg's internal sequencer. We recorded vocals, acoustic guitar and electric guitar on tape. The Korg's sequencer was synced to the tape tracks with a Musicsoft Midiman Midi-to-Tape Converter.

The Midiman is a smart tape-sync box that converts MIDI clocks with SPP to a tone you record on tape. But unlike other tape-sync boxes, it also lets you record sequences (MIDI performance data) on tape. This system costs less than a disk drive and allows more data storage than a RAM card.

Figure 1 shows the equipment setup for recording. From the Fostex mixer, direct outputs from input channels 1-4 went to the Fostex multi-track on tracks 1-4. The Korg M-1 audio outputs were recorded on tracks 5 and 6. Normally, the Korg audio outputs would not be recorded on tape until mixdown, but I wanted a tape backup in case the tape sync failed.

For monitoring, tape-track outputs 1-6 returned to the board's monitor mixer, which is the aux 2 bus. The Korg's MIDI OUT went to the Midiman's MIDI IN. The Midiman converted Korg sequencer data (including MIDI clocks) to a sync tone recorded on tape track 8. Track 7 was left blank and served as a guard track to prevent crosstalk to and from the sync-tone track.

PUTTING A SONG TOGETHER.

Let's describe a typical composing/recording process for this session.

Now we were ready to add acoustic guitar. I stuck a GLM-100 mini omni condenser mic in a GLM-SM surface mount, and attached it with double-sided tape to the sound board of the guitar.

As Stewart sang and played guitar, I wrote down the chord changes and the tempo. We then set up the Korg to record bass on track 1 of its sequencer. While listening to the Korg's metronome, I recorded a 2-bar count-off of bass notes (1, 2, 3, 4, 1, 2, rest rest). Then, reading the chord changes, I played the root note of each chord as a reference by which to record other tracks.

I fluffed some notes and had to go back and punch in the correct ones, using the Korg's automatic punch in/out feature. I noted which measures needed correction, set the punch points to those measure numbers and re-recorded the bass part for those measures.

When the bass track was done, I set the Korg's patch to drums and labeled the Korg keyboard with tape to indicate which keys played which drums. Next I recorded a 2-bar drum pattern. Then, on sequencer track 2, I made the pattern repeat for the length of the song. Now we had two basic tracks of bass and drums. I set the Korg to record on track 3, and switched to a bass patch. While listening to bass and drums, I added bass fills on track 3.

I recorded drum fills (such as a cymbal crash at the beginning of each chorus) on sequencer track 4.

The synthesized parts of the song were done.

ACOUSTIC OVERDUBS

Now we were ready to add acoustic guitar. I stuck a GLM-100 mini omni condenser mic in a GLM-SM surface mount and attached it with double-sided tape to the sound board of the guitar. A natural-sounding mic placement was halfway between the sound hole and the bridge, near the low-E string.

Wearing headphones, Stewart listened to a monitor mix consisting of his acoustic guitar and the Korg tracks. He played along with the Korg tracks to practice his part. When we were ready to record his overdub on tape, I hit "record", pressed the *write* button on the Midiman to start the sync tone and pressed the *play* button on the Korg to start its sequence.

Normally you record the sync track first, then go back and record other tape tracks. This is because you might lose sync if you record the sync track and other tracks at the same time. In this case, we were able to record them simultaneously without losing sync.

A sync tone must be recorded non-stop for the entire length of the song. Even though Stewart made some mistakes playing his guitar part, we kept going to the end. We later punched-in to correct errors.

Finally we added the lead vocal. A Crown CM-200 cardioid condenser mic with a foam windscreen was placed about eight inches from the singer, at eye height aiming at the mouth to prevent breath pops. Harmony vocals were recorded after several practices.

Mills overdubbed electric lead guitar on one song. His guitar amp was mic'd with a Crown GLM-100 mini omni microphone taped to the amp's grillecloth. On another song, Stewart wanted to add a bass track with the Korg, which contained only a drum track in its sequencer. I couldn't record a bass track in the Korg's sequencer in sync with the tape track. That is, while the Korg sequencer was recording a bass part on an open track, it did not sync properly with the prerecorded tape tracks. Normally I could listen to the Korg drum track by itself and overdub bass, but I needed the tape tracks for musical cueing. It's best to start with a simple bass line in the se-

quencer so you have something to cue to later.

Another thing I found useful was to note the measure numbers for the main sections of each song: verse 1, chorus 1, verse 2, chorus 2, etc. Knowing these numbers made it easy to go directly to the part needing work.

One song ended in a ritard. Stewart had difficulty following the ritard originally programmed into the Korg, so we decided to stop the Korg tracks when the ritard started, and have it played by the acoustic guitar. To stop the Korg, I simply erased the sync tone from where the ritard began. The Korg sequencer stopped playing at that point.

Most of the songs synched properly: the beat of the tape tracks matched that of the sequencer tracks, but one song did not sync.

After we finished recording one song on tape, we discovered that it was too long, and we wanted to edit out 8 bars. Using a splicing block and a razor blade, I removed the appropriate section from the multi-track tape. I then realized I had also edited the sync track. Would the Korg stay in sync? Sure enough, it did. However, I don't recommend this procedure for an FSK sync track. Normally you would perform such an edit on the 2-track mix tape, but we planned to master to DAT, which doesn't permit such editing.

Several times throughout the session we were treated to a MIDI surprise: a drum-track performance was played by a bass patch instead, or a piano-track performance was played by drums. It was an interesting effect, but not what we wanted. To solve it, Mills suggested I pull the MIDI cable from the Korg's MIDI in port. That worked. The sync track had been driving the Korg set to whatever patch I was working with. I also made sure the correct patches were assigned.

MIXDOWN

With all the songs in final form, we were ready for mixdown. The mixdown setup is shown in *Figure 2*. Tape track 8 containing the sync tone fed the Midiman, which converted the sync tone into MIDI to

drive the Korg's sequencer. The Korg's stereo audio outputs were fed into the Fostex 450 mixer, along with tape tracks 1-4 (the acoustic overdubs).

So we had a 6-track mix: four tape tracks and two Korg audio signals. Those two Korg signals were a mix of up to four sequencer tracks. The output of the mixer fed a Sony DAT recorder.

I set the multi-track tape in *play* mode. The sync tone started the Korg and activated its sound generators. I had set the Korg's sequencer to external clock, thinking that was the correct way to activate it from the sync track. But I heard a double performance — two versions of the same song playing on top of each other, slightly delayed. Each time I stopped and restarted the tape, the delay changed. The Korg was trying to play both the external sequence (recorded in the tape-sync tone) and its internal sequence (recorded in its built-in sequencer). Setting the Korg to internal clock solved the problem.

Normally you would set a sequencer to external clock to drive it from an external MIDI clock from an FSK sync track, but the Midiman's tape-sync signal already had sequence data in it. I set the Korg to internal clock, and it played only the sequence recorded on tape.

Most of the songs synched properly: the beat of the tape tracks matched that of the sequencer tracks, but one song did not sync. The cause might have been dropouts in the sync track (I saw dropouts of up to 4 dB on the level meters), or I may have started the sync tone before the recorder was up to speed. I was glad we had recorded the Korg performance on tape; these tracks were used in the mix of this song.

In the rest of the songs, however, the Korg tracks played live-to-DAT during the mixdown. The multi-track parts were heard virtually first generation, since the DAT did not degrade their signals. The resulting mix was super clean. For slap echo and reverberation, we used an Alesis Midiverb II and a Microverb. They really added a professional finish to the production.

After recording a mix on the DAT, I hit stop on the DAT machine. Next, I set up the mix for the next song. Then I set the DAT in record and pause mode, played the multi-track

tape and started the DAT just after the count-off. The entire group of five songs was assemble-edited this way. The DAT put slight noises between cuts, but they were hardly au-

dible. From the DAT master tape we made cassette copies.

It was fun learning the new technology and getting the bugs out. The end result was the cleanest mix we

have made to date, and you can expect the same results with similar equipment. Now we just hope that Mills wins the songwriting contest!

SIDEBAR: THE MIDI CLOCK

• Think of your MIDI instruments as a band of musicians; you want them to start playing at the same time and at the same tempo. To do this, they need to see a signal that is like a conductor's baton movements. This signal is the MIDI clock.

The MIDI clock is a series of timing pulses in the MIDI signal. A clock is a single-byte message that occurs 24 times for each quarter note. That is, the standard clock rate is 24 pulses

per quarter note (24 ppq). Each MIDI note or event is time-stamped with a pulse timing reference.

The clock generates pulses at a high rate (24 ppq) to provide good resolution of the time value of each note or event. The 24 ppq standard can resolve sixty-fourth-note triplets, which occur every pulse.

When a MIDI instrument receives a series of clock bytes, it knows the desired tempo. For example, if a se-

quencer drives several MIDI instruments at a certain tempo, its clock forces all the MIDI instruments to play at the same rate.

If you want to synchronize MIDI equipment with a tape recorder, you need to record a form of MIDI clock pulses on tape. As the article mentioned, this is done with a special sync tone that you record on one track of your multi-track tape recorder. 



serving: recording, broadcast and sound contracting fields

Index

Looking for a certain article? Are you missing information to complete your research? db Magazine indices are available for the years 1967-1975 and 1976-1985. **The search is over!**

Yes! Please send ___1967-1975 index, ___1976-1985 index.

Each index is \$7.50 plus \$1.00 for postage and handling. Make checks payable to Sagamore Publishing Co. in US funds only.

Name _____

Address _____

City _____ State _____ Zip _____

Credit card#

expiry date _____



Signature _____

Sagamore Publishing Co. Inc., 203 Commack Road, Suite 1010, Commack, NY 11725

Audio for the Church

• Let's look at the audio needs of smaller churches. So far we have discussed many topics and all of the principles apply, but not the space, time or budget. Therefore, the proper devices and uses for small churches, 200 seats or less, will be discussed.

In my travels to various churches, the smaller churches usually have poor sound systems as a result of their budget. The first step in purchasing equipment is buying quality microphones. Prices vary depending on quality. A good quality microphone costs approximately \$150 or more, while a great mic starts at \$500, and an excellent mic starts around \$850. Any mic costing less than a \$150 won't sound very well, or be sensitive enough to do you any good. The key to getting good quality sound is to have good quality transducers (microphones and speakers). Microphones in the good range usually have healthy warranties to back them up, and this is important when shopping for a mic. Other items to shop for, in order of importance, are: buy to fit the job; look at the value, *i.e.* warranty, and; price.

The sound business parallels the entertainment business, and is equally full of hype and buyer beware. The "coolest" looking, best-advertised product is not necessarily the best for the job, and many common myths about audio are always circulating. For example, most small churches only need one choir mic, not four, or one for each section of the choir. If your church has a choir loft and a pulpit, only two mics are needed, which will cost a minimum of \$300 and will last for 10 to 15 years or more, providing you purchased a mic with a warranty on its acoustics. The question then arises on whether to use high or low impedance, and balanced or unbalanced lines.

By using both low impedance and a balanced line, you gain a wider frequency response with less noise and problems with outside interference. A balanced line has two conductors

and a shield. The audio runs on its own conductor (180 degrees out of polarity with the other conductor) so that any noise entering into the lines will be cancelled at the input. If you want to plug in an electronic instrument, such as a synthesizer, you will need a direct box to match the line level output to a mic level in order to keep the instrument on a balanced low impedance line.

BALANCED LINES

Balanced lines usually use XLR connectors, with pins numbered one through three. Pin one is always the shield and pin two is the + (or hi) lead which can be any color conductor, other than black. Black is the - (or low) lead. XLR connectors are the standard balanced mic line in the audio industry. A quarter-inch connector may come into play when connecting up electronic devices in the system. Please proceed with caution, because many believe that quarter-inch jacks are all high impedance.

There are two conductor (single conductor with shield—referred to as TS conductor) quarter-inch jacks and three-conductor (two-conductor with shield) quarter-inch jacks commonly referred to as stereo jacks, because they are the type of jack used on stereo headphones. This is misleading because when you used the quarter-inch jack to interconnect devices, the tip is the + lead, the ring (or middle) is the - lead and the shield is connected to the sleeve, making it act just like the XLR type connector. The three-conductor quarter-inch connector is more correctly referred to as a quarter-inch TRS (tip, ring, sleeve) jack.

THE MIXER

The next selection in the audio systems chain is a mixer, but a small church usually can't afford a stand alone mixer, so what's left? Let's look at what we need to do first. If the service requires music playback, is a separate feed for performing talent needed? If your services are primarily speech and don't need music

played back to the talent, then a line mixer with a built-in amplifier, better known as a package amp, can be used. If you need the talent to monitor the tape or CD playback, then additional mixing facilities and an amplifier are needed. A powered mixer that has two amplifiers and is capable of internal or external patching, preferably both, would be the best choice.

But for some, the typical powered mixer may be out of the budget, and the need for playback monitoring is a must. You can get a smaller mic/line mixer, some terminal blocks, spades, a crimp tool and a smaller utility amplifier similar to the one used in the package amplifier. At this point, the assumption is we are not using condenser microphones. We will put the terminal block into an equipment rack, then pull the mic lines and output of the tape deck, or CD player, to the terminal block and attach each conductor and its respective shield to its own slot. Remember to always mark the cable with numbers at both ends before pulling the cable so you will always know, without a doubt, what is connected to what. Next, hook to the adjacent slot of the terminal block two cables with two red conductors, two black conductors, and two shields to the single red and black conductors and shield (respectively). Now one of the cables will go to your mic/line mixer for your monitor, and the other will go to your mixer/amplifier for the house system. You now have independent control over your monitor and the house. If the singer wanted to hear the pre-recorded tape at a comfortable level in his monitor, you could then turn the mic he used all the way down, while still maintaining perfect balance between music and singer to the house system's mixer/amplifier.

EQUALIZATION

If you are using a powered mixer, you will more than likely have an equalizer built into it. In the case of the mixer/amplifier however, it will, at most, have tone controls, so you

will need to add an equalizer. Most of the better mixer/amplifiers have a loop circuit so that you can add an equalizer in the circuit after the mixer section and before the amplifier section. A single octave equalizer, in my opinion, is not worth the investment for a house equalizer, particularly in this situation. Some will say that a single octave is better than none, but for a little more money, you may be better off using a 1/3-octave equalizer.

The next device in the audio chain would be an amplifier, but at this time, you only need to know that it needs to be large enough to handle the speaker load required.

We have come again to the electro-acoustic component of the system, the speaker. I have discussed system design from an electro-acoustic standpoint in the past few issues, covering the five parameters of sound system design, which are *level, bandwidth, coverage, gain before feedback, and intelligibility*. These principles still apply, even though I will not go into detail at this time. You should, however, be keeping them in mind as you plan on what you are going to do.

THE SPEAKER SYSTEM

If you have a fairly high ceiling in your church, you should consider a

central speaker cluster. All seating locations in the church should be in the line of sight of the speaker location. One or two high quality full-range speaker cabinets should work fairly well, as long as you follow the five parameters. If you have a low ceiling, then your next logical choice would be to use distributed ceiling speakers.

The type of speaker to be used depends on the type of worship service. If your service is mainly voice then you only need the quality of an inexpensive eight-inch ceiling speaker. If you have a fairly active music program, then high quality twelve-inch coaxial ceiling speakers with the appropriately tuned back box should be used to maintain the widest bandwidth possible for this type of installation. When using distributed ceiling speakers, you need to use a "constant voltage" line that is typically 25 volt, or a 70.7 V system. Most "package" amplifiers come with 8 ohm, 25 V and/or 70 V terminals for easy hookup. Powered mixers, on the other hand, only have 8 ohm terminations, usually with a quarter-inch jack.

CONSTANT-VOLTAGE SYSTEMS

Therefore, to use a constant-voltage system, you would need an auto

transformer on the output of the power mixer which will match the 8 ohm output with the transformer on the speaker. The transformer on the speaker transforms the 25 V or 70 V line to an 8 ohm load for the speaker. The wattage for the 8 ohm load can be selected (or tapped).

Most transformers will allow you to select between 1/4 W, 1/2 W, 1 W, 5 W, or 10 W. Every speaker can be tapped at a different wattage as long as the total wattage used does not exceed the wattage of the amplifier. For example, let's say you have a 100 W amplifier. You can tap the speaker at 10 W. Therefore, you can only use 10 speakers, but if you use two speakers tapped 5 W, you could only have the nine remaining speakers tapped at 10 W, or you could tap 100 speakers at 1 W.

Although the central cluster would be the most cost-effective and technically a better thing to do, most small churches do not have the ceiling height for it. Therefore, although it's less cost-effective, the distributed ceiling speakers will easily provide better control of the five parameters.

Digital in the Church will be the subject of next issue's column. ☐

NOT FOR SALE

Because It's Free!

Every year the Government publishes thousands of books. And every year the Government Printing Office sells millions of these books to people in the know. Now there's a book that tells you about the Government's "bestsellers"—but it's not for sale . . . it's free!

It's our new catalog of almost 1,000 of GPO's most popular books. Books like *Infant Care*, *Merchandising Your Job Talents*, *The Statistical Abstract*, *Starting a Business*, *The Space Shuttle at Work*, *How to Select a Nursing Home*, *Voyager at Saturn*, and *Cutting Energy Costs*.

This catalog includes books from virtually every Government agency. So the subjects range

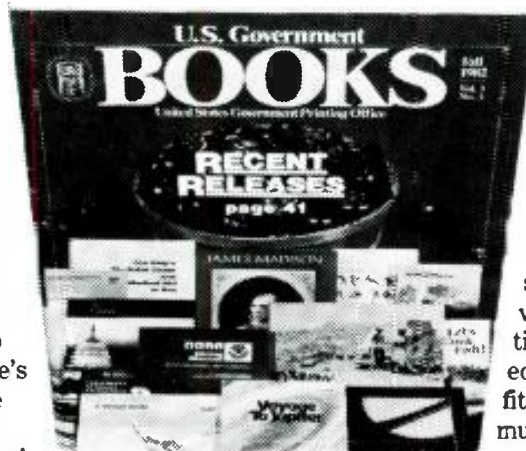

from agriculture, business, children, and diet to science, space, transportation, and vacations. And there are titles on military history, education, hobbies, physical fitness, gardening, and much, much more. There's even a special section for recently

published books.

Find out about the Government's bestsellers. Send today for a copy of the book we don't sell.

Write—

New Catalog

Post Office Box 37000
Washington, D.C. 20013

BETTER THAN EVER!

The Best Book In The Recording Industry Is Now Even Better!

Completely revised and up to the minute; this is the book you must have.

Rewritten by Alan P. Kefauver, director of recording at the world famous Peabody Conservatory of Music, this book is for everyone who is involved in recording.

This book has information on:

- DIGITAL
- MIDI
- AUTOMATED CONSOLES
- SMPTE TIME CODE
- AND SO MUCH MORE!

ELAR PUBLISHING CO. INC. 9011B
203 Commack Road, Suite 1010, Commack, NY 11725

Yes! Please send me _____ copies of the New Recording Studio Handbook @\$45.95 per copy. Add \$2.00 for shipping. (New York State residents please add appropriate sales tax.)

- Payment Enclosed or charge my
 Charge Card (Visa/Master Charge only)

Acct # _____ Expiry Date _____

Name _____

Address _____

City _____

State _____ Zip _____

Signature (required for charge cards) _____

Outside the U.S.A. add \$3.00 for postage. Checks must be in US funds drawn on a US bank.

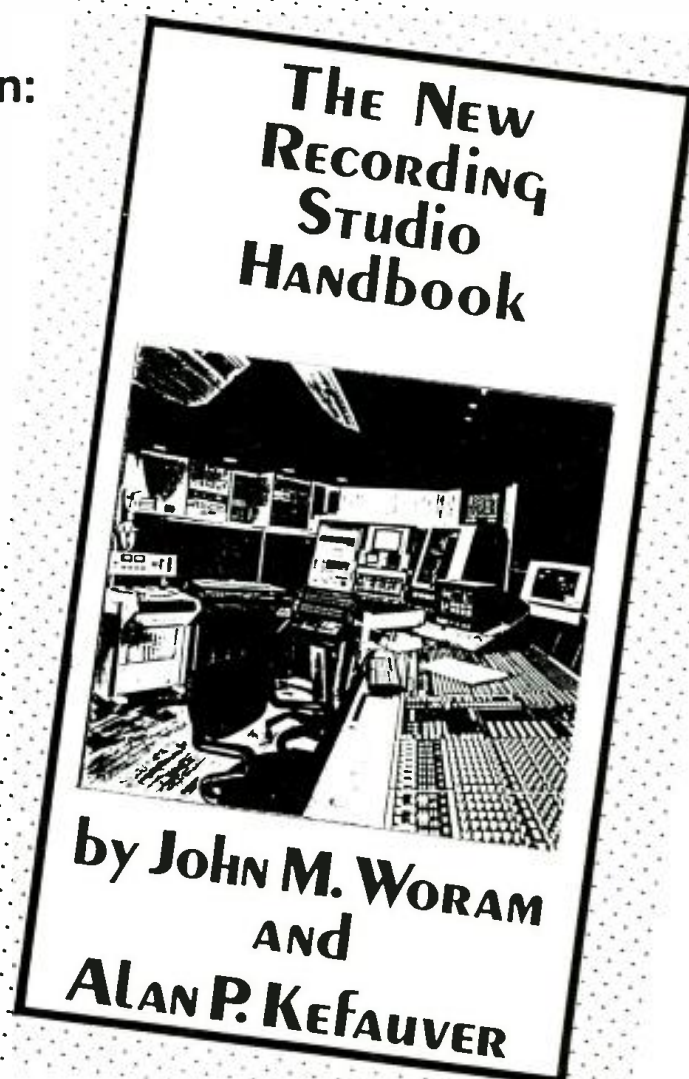

Handbook of Sound System Design

by John Eargle

AVAILABLE NOW!

• If you are in sound reinforcement, John Eargle's **Handbook of Sound System Design** has the answers to those needs you have for accurate technical information. It is the technical bible on everything from a small church to Madison Square Garden, from live sound for 60,000 to canned sound for 600.

There are chapters on:

- High-Frequency Speaker Systems
- Mid-Frequency Speaker Systems
- Low-Frequency Speaker Systems
- Dividing Networks
- Central Loudspeaker Arrays
- Distributed Systems
- Paging Systems
- Microphones
- Ambiance Systems
- *All this and so much more.*

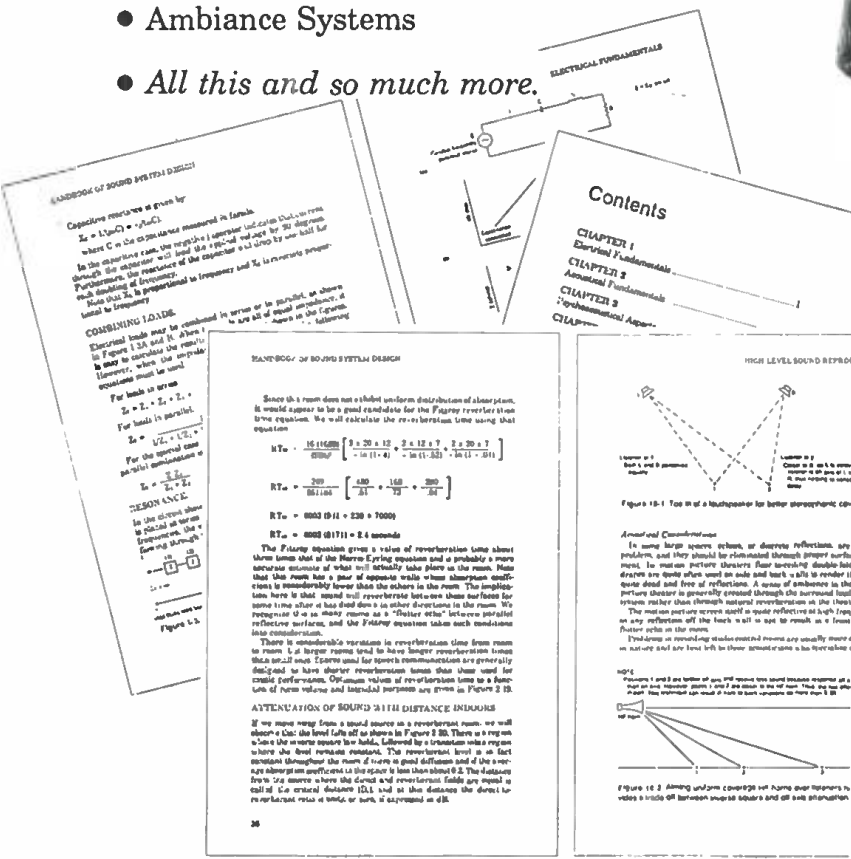
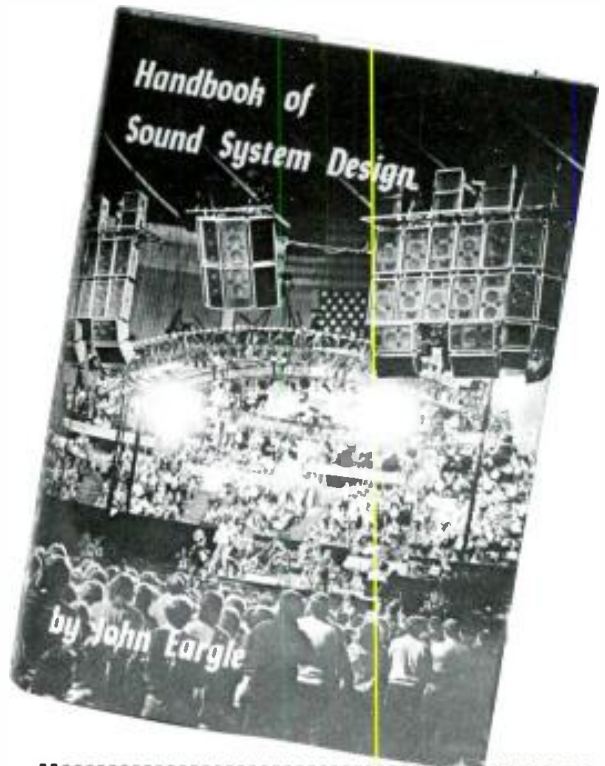

ELAR PUBLISHING CO. INC.
 203 Commack Road, Suite 1010, Commack, NY 11725

Yes! Please send me _____ copies of the Handbook of Sound System Design @\$37.50 per copy. Add \$2.00 for shipping. (New York State residents please add appropriate sales tax.)

Payment Enclosed or charge my
 Charge Card (Visa/Master Charge only)

Acct # _____ Expiry Date _____

Name _____

Address _____

City _____

State _____ Zip _____

Signature (required for charge cards) _____

Outside the U.S.A. add \$3.00 for postage. Checks must be in US funds drawn on a US bank.

AES Roundup

Cruising the AES Convention

As always happens at the AES convention, it was impossible to be everywhere I wanted to be and to see everything I wanted to see. Perhaps the show should be stretched to ten or twelve days instead of four (five, if you count Friday—no exhibits, only technical papers). That way, I can get around to all the incredible exhibits, workshops and papers and be able to write about *everything!*

While I didn't get to see it all, I did manage to see a great deal of exciting products, and presented here is a quick look at some of the highlights of the show which I managed to catch. If something earth-shaking got left out, it's probably because I was somewhere else when it was shaking, or perhaps I didn't hear about it—else it would be in this article.

EVENTS

DIGITAL WORKSTATION SHOOTOUT

It seems like everyone is coming out with a digital workstation these days. On Friday, Sept. 23rd, all of the companies with actual products (as opposed to vaporware) got together in an incredible "shootout" of sorts. There were 15 systems represented, including systems from Studer ReVox, New England Digital, Digidesigns, Waveframe and Solid State Logic.

Each system was set up in usable form with a demo person running each system, and the audience was able to move from one to the other, directly comparing the usability and features of each system. It was amazing how much alike, yet different, they were. I don't know for sure, but it seems there are only so many ways to cut, paste, chop, slice and dice sampled waveforms.

Despite the fact that the audio from one station would bleed heavily into the next station, all those present appeared to have a great time, and the audio quality was consistently high. No clear winner, but no clear loser, either.

NARAS RECORDING TECHNICS WORKSHOP

On Saturday, Sept. 24, AES recording engineer-types were able to partake of a very rare treat. Four of the most famous and talented recording engineers/producers in the business got together in one of the large meeting halls for a three-hour free-for-all discussion about their techniques and experiences. What a thrill to see Bruce Swedien, George Massenburg, Al Schmitt and Bob Clearmountain all in the same place sharing their knowledge with the world! The room was packed to standing-room-only and stayed that way through the entire three hours.

During a discussion period afterwards, many probing questions were answered by each engineer. Each panelist then presented the audience with an example of their work, commenting on how they got the sound, and on the

overall process of making the recordings. The audience received the benefit of over 100 years of combined recording experience from these great legends and I say **bravo!** Let's do it again next year!

A WORKSHOP ON DAT AS A FORMAT

No one seems to get tired of talking about DAT machines and this AES convention was no exception. This three-hour workshop (or was it four?) started off and remained slow, as two movie sound men spoke at length regarding their concerns about trusting DAT for location work.

A more lively moment came when a sound recordist from *National Geographic* stood at the microphone and challenged the nay sayers by relating his experience with DAT on world-wide locations. He had taken his machine into sub-zero weather, the dust and heat of the Serengeti Plain and even crashed it in a fender-bender—all without the loss of a single bit of data.

Next, several important engineers/producers took the stage and shared how they used DAT in their work. Roger Nichols in particular, was outspoken and sounded very much like a real fan of the DAT format. He personally owns about six or seven machines and uses them every day in his work with mostly positive results.

Finally came the moment all had been waiting for. The manufacturers of the DAT machines came up and opened the discussion to all questions and comments. Represented were Sony, Panasonic, Fostex, Stellavox and JVC. All but Panasonic now produce a DAT machine incorporating SMPTE time code for synchronous work in the film and music industries.

It was particularly invigorating for the thinning crowd to have the opportunity to speak directly to the DAT manufacturers about their products. Unfortunately, this most important of segments was allotted the smallest margin of time, while the largest slice was given to the slow segment at the beginning. Oh well, maybe next year.

DIGITAL 8-TRACK PORTABLE STUDIOS

Yamaha, Korg, Waveframe and Roland all unveiled their 8-track digital recorders. These machines range from self-contained complete studios to recorder-only packages which require a separate mixing console. Each unit appeared to have features that the others didn't, some with digital mixing and built-in signal processing, and others with built-in sequencers, etc. The packages were certainly well put together. The audio quality was excellent on each, but the most amazing thing was the price disparity—from about \$13,000 to over \$39,000! These products are all 8-track digital recorders, either direct-to-disk or to an 8 mm tape cassette. The basic features are similar and without sitting down and beta testing each one, a question comes to mind. Is there really a \$26,000 difference between them? HMMMMM...



3M's new 996 tape

DIGITAL FIBER OPTIC AUDIO SNAKE

Monster Cable Inc. introduced a remarkable fiber optic product. This is a 12-input A/D converter box which sends 12 channels of digital audio on an optical cable not subject to hum, buzz, RF interference, or other signal degradation, even with cable runs of over two miles! A complete 12 channel system is about \$6,000, and you can add a 96 kHz sampling option for ultra high fidelity. The 12 channels of audio may be archived with a consumer VCR and retrieved by simple playback. Swedien announced that he's installing this system in his home studio. (For more information circle 60 on the Reader Service Card.)

TASCAM PRODUCES AUTOMATED CONSOLE

Continuing their long-standing tradition of producing high quality, innovative products at reasonable prices, Tascam introduced its new M-3700 automated production console. Based on the successful M-3500, the M-3700 automates levels, mutes, and EQ on or off, all at a modest price. The system stores 30,000 real time events per mix referenced to SMPTE time code, and you can store six mixes on the built-in disk drive. Choose 24, 32, or 24 mono + 8 stereo inputs! And it starts at less than \$12,000 to come to the party! (For more information circle 61 on the Reader Service Card.)

NEW DAT MACHINES

Sony, Panasonic, Kenwood, JVC, Tascam and Otari all have new DAT machines with all the bells and whistles a pro could want, including SMPTE time code, serial sync ports, jog wheels, 64 times oversampling and 1 bit A/D converters. Sony even has a new DAT editing system that works just like a video editing system with two machines and an edit controller. It looks like DAT is here to stay and it probably won't be long until the cassette goes the way of the vinyl record! Hurray!

A BRAND NEW EXCITING TAPE?

Some people might say "ho-hum" to a new tape formulation, but when no less than 14 major recording engineers of the caliber of Swedien and Alan Sides are jumping out with strong endorsements, it's important to take notice. The 3M company introduced its 996 tape format

and according to the literature and the users, it can be printed as hot as +9 dB steadily without breaking up, and is reported to have an extremely low noise floor. It even comes with a brand new moisture and dust resistant TAPE BOX! Could we be witnessing the birth of a new standard? (For more information circle 62 on the Reader Service Card.)

ROLAND STUNS LISTENERS WITH 3-D SOUND

We've all heard the hype about 3-D sound with two speakers, so when I visited the Roland Sound Space System demo, I was prepared to be underwhelmed. Suddenly the room was filled with sound swirling around me, with absolute perfect localization behind me, to my right, left, and moving in a circle around my head. Gasp-ing in disbelief, I was told there were only two speakers in front of me. Then to convince me further, my ears were stuck between the speakers of an inexpensive consumer "boom box" cassette player and again the music was swirling around my head! The technician told me this is a single-ended system, requiring no decoder box of any kind, and that Massenburg expressed interest in doing the first commercial mix with it! Wow, lucky guy. (For more information circle 63 on the Reader Service Card.)

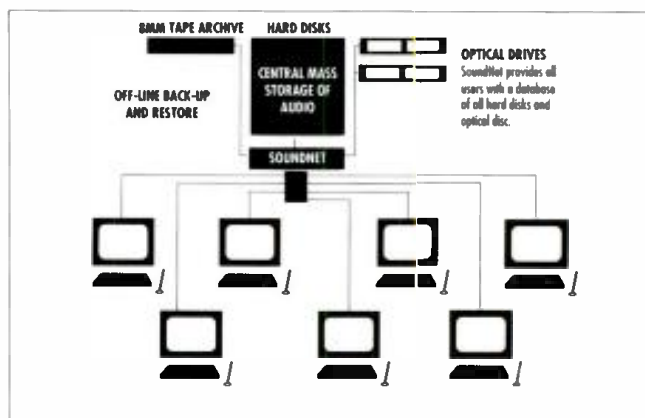

A diagram of SSL's Soundnet System.

DAN: THE DIGITAL AUDIO NETWORK

Two major players in the digital audio field, New England Digital and Solid State Logic, premiered multi-user digital audio networks. These are systems where a number of people can be on line with the New England Digital PostPro or the Solid State Logic Screen Sound systems and all share the same files and sound database resources. This is just like the mainframe computer world with its multi-user remote terminal environment! I wonder how long it will be until IBM introduces its first music computer! (For more information on NED circle 64 on the Reader Service Card. For more information on SSL circle 65 on the Reader Service Card.)

A WIRELESS MIXER!

Leave it to Sennheiser to come up with an innovative twist on the wireless mic arena—a RF Microphone mixer which receives and transmits five mic inputs, has a two-band EQ, high-pass filter, PFL and full metering! Says John Kenyon, vice president of Sennheiser of California, "I expect this product to forever change the expectations

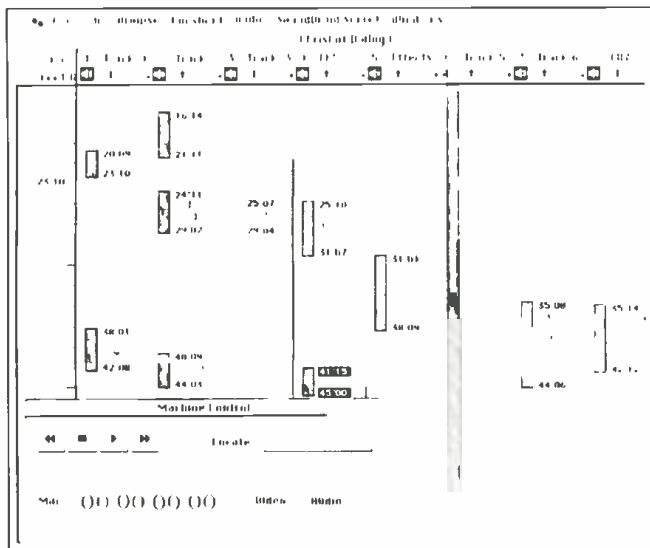

A screen shot of NED's Sounddroid™ editing system.

of production mixers!" (For more information circle 66 on the Reader Service Card.)

QSC "MONSTER" AMP!

QSC was showing off its brute EX 4000 amp at their booth, with 2200 watts (1100 per side @ 4 Ohms). The big guy is now in full production and its list price was reduced from \$2,800.00 to \$1,998.00! That works out to about 91 cents per watt! At that price, I could get one for my car—that should take care of those sub-woofers! (For more information circle 67 on the Reader Service Card.)

SONY REINVENTS THE ANALOG 24 TRACK

With the dramatic inroads that digital multi-tracks have made recently, some people tend to forget the analog market. Not so Sony! They just released new firmware for their APR-24 which will allow it to talk directly to a VTR through the Sony nine-pin dialect. This allows the APR-24 to directly control or be controlled by a VTR in an audio sweetening environment. Sony has also made the technical specs available to synchronizer manufacturers so they can utilize its capabilities. (For more information circle 68 on the Reader Service Card.)

The QSC EX-4000 power brute.

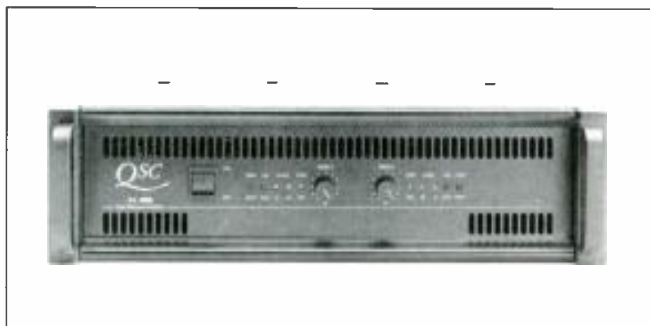

ALL-IN-ONE M-S MICROPHONE

Shure Brothers was happily showing off its new self-contained M-S stereo mic at the AES show. This mic contains two high-quality condenser mic cartridges, with one facing forward in a cardioid pattern and the other perpendicular in a bi-directional mode. The user can choose to use the on-board MS processor which will output a mono-compatible stereo signal, or can take separate, discrete Mid and Side outputs to be processed externally. Listing at \$995, this looks like a good value for stereo recording applications. (For more information circle 69 on the Reader Service Card.)

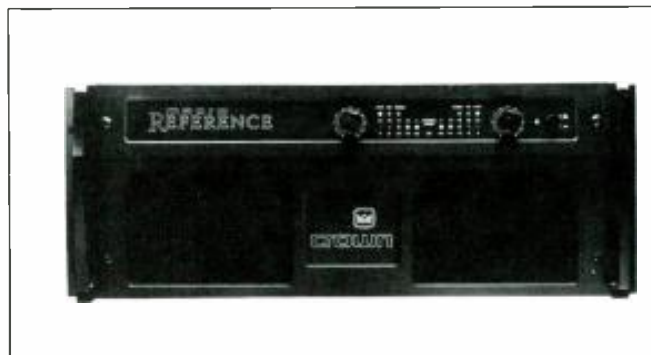

750 watts per channel at 8Ω per channel from Crown, their new Macro-Reference Series.

CROWN DEBUTS AN "AMP FOR THE 21ST CENTURY"

With ultra high-end specs and enough power to drive a herd of buffalo, the Crown Macro-Reference Amplifier was introduced to the world. The amplifier promises 120 dB dynamic range, comparable to a 20 bit digital system, an ultra clean 750 watts per side into 8 ohms and a bandwidth of 3 Hz to 100,000 Hz with damping capabilities in excess of 20,000. Crown is even developing plug-in modules which will allow digital consoles to plug directly into the front end of the amplifier. Looks and sounds like a winner! (For more information circle 70 on the Reader Service Card.)

ENTER THE SOUND DROID

Sounding like something right out of Star Wars, the long-awaited Sounddroid™ Audio Editing System software was debuted by New England Digital. This software, developed by New England Digital and Lucasfilm Ltd., integrates the complete post-production process from initial sound spotting through a completed final mix, including ADR and Foley capabilities. Integrating and automating the process seems a logical step, especially when you consider that it was developed along with the same people who gave us R2-D2 and C3-PO. (Remember them?) May the Force be with you! (For more information circle 71 on the Reader Service Card.)

There were many more things to be seen, heard, experienced and written about than this space will permit, but I hope this little tour through some of the highlights will at least give some of the flavor of the convention. There is however, only one way to really get the whole picture of this mega-showcase for the audio industry. I hope to see you there next time, because hearing is believing!

Broadcast Audio

Digital Audio Bit-Rate Reduction

• Digital technology will without a doubt become an increasingly important factor in the future of television. It offers many attractive alternatives to the analog technologies that it is in some cases augmenting, and in some cases replacing.

Advanced television systems particularly are developing along digital lines. Many of the high definition direct broadcast satellite transmission systems in various parts of the world, as well as the terrestrial advanced television broadcast systems proposed for the United States, are at least partially digital. All incorporate some form of digital audio.

The penalty exacted for digital audio's and video's advantages is that in their linearly-encoded form they require transmission channels of uneconomical bandwidth. Compact disc digital audio with its 44.1 kHz sample rate and 16-bit linear quantization has a data rate of around 1.4 megabits per second, which would require a transmission channel well over one megahertz wide. When compared with the 200 kHz bandwidth of an FM broadcast channel, this definitely could not be called parsimonious use of available spectrum.

The answer to the problems presented by the bandwidth requirements of digital audio and digital video transmission is bit-rate reduction by digital compression. The objective of such compression is to reduce the data rate in a way not subjectively perceptible to the viewer/listener. A cornerstone of such compression techniques is the elimination of redundancy. Research and development work on digital audio compression techniques has been going on for some time, and the present results of these efforts are remarkable, with the future promising even better things.

A relatively early digital audio bit rate compression system is the NICAM system developed by the BBC. NICAM is the television stereo transmission standard in England and several other places in the world including New Zealand, and is the first digital stereo transmission system for broadcast television. NICAM is an acronym for Near Instantaneous Companding and Multiplexing. It begins with 14-bit digital audio, and reduces the number of bits transmitted per sample to 10. It does this by coding groups of 32 samples into one of five level ranges, depending on the original maximum amplitude of the signal in a given sample group. Low-level signals that use less than 10 bits do not lose any resolution in the NICAM compression process.

If the methods of bit-rate reduction used by developers of the various sophisticated systems are scrutinized carefully, it may be seen that they contain elements of the simpler approaches.

Higher-level signals using more than 10 bits lose sufficient less-significant bits to reduce their word length to 10 bits. This increases their quantization error, and thereby increases quantization noise for higher-level signals, but the higher quantization noise is masked by the high signal level. Thus NICAM, like other perceptually-based digital audio data reduction systems (and most audio noise reduction systems) relies on psychoacoustic masking to work. NICAM reduces the bit-rate requirement for two channels of dig-

ital audio by about half, requiring about 700 kHz of bandwidth to transmit two channels of 15 kHz audio plus housekeeping overhead and a small amount of additional data capacity.

The data rate may be further reduced using adaptive delta modulation (ADM). Delta modulation is a technique in which the audio signal is sampled at a very high rate using a single bit per sample, with this bit representing the change in the audio signal's amplitude since the last sample. To accurately represent very fast transients and changes in the audio signal, delta modulation in its pure form requires a very high sampling frequency, and the bit rate produced by such fast sampling is too high for transmission over limited bandwidth channels. Adaptive delta modulation reduces the bit rate by changing or adapting the step size of each sample bit to fit the nature of the audio program material. In order to properly decode the ADM signal and reproduce the original audio waveform, the audio data words must be accompanied by data that tells the decoder the step sizes of the audio data bits. The step size must be optimized for best results. Too small a step size will generate distortion because the slope of the audio waveform is not accurately represented, and too large a step size will generate excessive quantization noise. The Dolby ADM system also uses sliding-band pre-emphasis to further mask the effects of the ADM process. ADM reduces the bandwidth requirements for two channels of stereo audio to around 500 kHz.

The most recently developed data rate reduction schemes reduce the bit rate even further. Systems that successfully reduce the bit rate requirement of two channels of 15 kHz audio to 256 kilobits per second are

available, reducing the linearly-encoded bit-rate requirement by a factor of four. It is believed by the developers of some of these systems that a target bit rate as low as 96 or even 64 kilobits for a single audio channel may be realized without perceptual degradation, although this cannot now be demonstrated.

Some of these systems use techniques known as *transform coding* and *sub-band coding*. Transform coding involves the conversion of a block of consecutive samples into the frequency domain, by use of a Fourier transform or cosine transform, for example. This enables a reduction in the redundancy of the audio signal by matching quantization size to the thresholds of perception of quantizing errors. Only those values of amplitude and phase that are relevant with respect to the masking effects of the ear are quantized.

Sub-band coding is a process that divides the audio spectrum into a number of sub-bands and then applies different, adaptive quantizing levels to each band. Once in each digital frame, the maximum amplitude attained by each sub-band or scale factor is quantized and sent. In this way, increased noise or distortion in any one band will be confined to a small range of frequencies and will be masked by program signals in that band. The number of sub-bands varies from four to over 20.

If the methods of bit-rate reduction used by developers of the various sophisticated systems are scrutinized carefully, it may be seen that they contain elements of the simpler approaches.

The apt-X system, for example, uses sub-band coding and adaptive differential pulse code modulation (ADPCM), which is actually a cross

between linear PCM, as used in compact discs, on one hand, and adaptive delta modulation on the other. Rather than the sixteen-bit word length of linear PCM or the one-bit word length of ADM, ADPCM codes the audio sample to a lower number of bits (but more than one bit) that represent the difference in audio signal level between sample periods, rather than the absolute audio signal level.

The work that is ongoing in digital audio bit rate reduction has many applications. In addition to digital audio for advanced television broadcast and satellite transmission systems, another emerging application is digital audio broadcasting (DAB).

In fact, any system that requires transmission of digital audio over a restricted bandwidth channel may effectively use such a data rate reduction system. □□

Copies of articles from this publication are now available from the UMI Article Clearinghouse.

For more information about the Clearinghouse, please fill out and mail back the coupon below.

UMI Article Clearinghouse

Yes! I would like to know more about UMI Article Clearinghouse. I am interested in electronic ordering through the following system(s):

- DIALOG/Dialorder ITT Dialcom
 OnTyme OCLC ILL Subsystem
 Other (please specify) _____
 I am interested in sending my order by mail.
 Please send me your current catalog and user instructions for the system(s) I checked above

Name _____
Title _____
Institution/Company _____
Department _____
Address _____
City _____ State _____ Zip _____
Phone (_____) _____

Mail to: University Microfilms International
300 North Zeeb Road, Box 91 Ann Arbor, MI 48106

New Products

WIRELESS SYSTEM

• As part of their new Series 600 line, the new Pro Plus UHF wireless microphone system includes the R-662 receiver and T-677 transmitter. UHF operation provides relief from VHF frequency congestion problems and allows the addition of literally dozens of systems without affecting existing VHF equipment. The new system features DYNEX™ III audio processing, with lower distortion and up to 35dB increased signal-to-ratio as compared to other available UHF systems. The T-677 bodypack transmitter delivers 150 mW of RF output power and provides up to 1,700 feet of range. The selectable four-frequency R-622 receiver is extremely sensitive and offers true dual-receiver diversity operation. The receiver can use 115/220 VAC, external DC power or optional battery packs.



It also offers an optional rack mount adapter and several types of high performance remote antennas, providing installation versatility.

Manufacturer: Vega

Price: Transmitter T-677 is \$1,199.00

Receiver R-662 is \$3,599.00

Circle 31 on Reader Service Card

STEREO MIXING CONSOLE

• The BK-1642 stereo mixing console is for the professional music market, and many new features. The BK-1642 utilizes a hum-bucking ground design which makes it virtually immune to hum and interference from external sources. Modern electronic design, including high-speed operational amplifiers (op-amps) usually found in only higher priced units, provides increased definition and sound quality. The BK-1642 also offers active, servo-balanced outputs that eliminate noise pickup from cables attached to the mixer, power amplifiers and/or signal-processing equipment. Even if the mixer is incorrectly grounded, the servo-balanced outputs guarantee that output will be reduced no more than 6 dB. It also has other features including mechanical VU meters with integral peak LEDs, which

provide a clear warning of the onset of clipping. It also has 100-mm faders and a PFL monitoring system.

Manufacturer: Electro-Voice

Price: \$1,750.00

Circle 32 on Reader Service Card



detented potentiometers; freedom from pumping; freedom from spec-

JBL Professional

Model 950-Ambient Noise Controlled Amplifier (ANCA)

Expander precisely tracks increases in room noise up to 20 dB past a preset minimum; controlled response time catches major noise changes, yet avoids "pumping" or "breathing"; transformer isolated input and output.

Dimensions: 3.5" x 19" x 7.5"

Weight: 9 lbs.

Price: \$1,390.00

Rane Corporation

This includes 27 1/3 octave filters from 40 Hz to 16 kHz, with red/green/yellow display on each indicating 0 dB response and either 1 dB or 3dB via the Window selector switch. Also included are a flat-response condenser microphone, 40 ft. cable, built-in pink noise generator, input sensitivity control and extra mic and line inputs.

Dimensions: 1.75" x 19" x 8.5"

Weight: 8 lbs.

Price: \$499.00

ADDRESSES

Alesis Studio Electronics
3630 Holdrege Avenue
Los Angeles, CA 90016

Amber Electro Design
6969 Trans-Canada Highway
St. Laurent, PQ, Can. H4T 1V8

Aphex Systems
11068 Randall Street
Sun Valley, CA 91352

ARX Systems
P.O. Box 842
Silverado, CA 92676-0842

Audio Control Industrial
22313 70th Avenue West
Mountlake Terrace, WA 98043

B & B Systems
28111 North Avenue Stanford
Valencia, CA 91355

dbx, (AKG Acoustics, Inc.)
71 Chapel Street
Newton, MA 02195

DOD Electronics Corporation
5639 South Riley Lane
Salt Lake City, UT 84107

Dolby Laboratories Inc.
100 Potrero Avenue
San Francisco, CA 94103-4813

Furman Sound, Inc.
30 Rich Street
Greenbrae, CA 94904

Goldline
Box 500
West Redding, CT 06896

Hewlett-Packard Company
1212 Valley House Drive
Rohnert Park, CA 94928

IVIE Technologies
1366 West Center Street
Orem, UT 84057

JBL Professional
8500 Balboa Boulevard
Northridge, CA 91329

Klark-Teknik Electronics, Inc.
200 Sea Lane
Farmingdale, NY 11735

LT Sound
7980 LT Parkway
Lithonia, GA 30058

Peavey Electronics Corporation
711 A Street
Meridian, MS 39301

Rane Corporation
10802 47th Avenue West
Everett, WA 98204-3400

Rocktron/RSP Technologies
2870 Technology Drive
Rochester Hills, MI 48309

Symetrix
4211 24th Avenue West
Seattle, WA 98199

Tektronix Inc.
P.O. Box 500
Beaverton, OR 97077

White Instruments
1514 Ed Bluestein Boulevard
Austin, TX 78767

Yamaha Pro Audio
P.O. Box 6600
Buena Park, CA 90622

Classified

FOR SALE

AUDIO CASSETTE LABELS

Label Size: 3-1/2" x 1-5/8" Sheet Size: 7-1/4" x 11-1/4"
 12 Labels Per Sheet 1200 Labels Per Package

Colors Available:
 Matte White, Semi-Gloss White, Glossy White,
 Sand Parchment, Pewter Parchment, Blue,
 Red, Yellow, Gold, Lime, Green, Orange



audico chicago, inc.
 7206 W. Grand Ave.
 Elmwood Park, IL 60635
 708/456-0003

Planning an Audio Career? Get **NEW EARS!** Guide to Recording Engineering Programs. 84 schools profiled, 324 listed. Comprehensive 208 page reference. \$11.95. NEP, 1033 Euclid, Syracuse, NY 13210, ph: 800-666-5355.

Custom Cases Acoustic Foam Custom Stands Studio Furniture



Request Catalogue 800-343-1433, 516-563-0633
 Island Cases • 1120 J Lincoln Ave. • Holbrook, NY 11741

MAGNETIC RECORDING HEADS
 RELAP/REPLACEMENT for Audio, Video, Time Code, Duplication. Thirty years of head design experience. IEM, 350 N. Eric Drive, Palatine, IL 60007. (708) 358-4622

WANTED

RADIO TRANSCRIPTION DISCS:
 Any size, speed. Drama, comedy, music, variety, adventure, soaps, children's, AFRS, big band remotes, library services. **KINER-db, Box 724, Redmond, WA. 98073-0724.**

WE BUY USED DOLBY CAT. #22 CARDS! If you have replaced your cards with Cat. #280 SR cards, we will buy them. Please let us know how many you have and the asking price. **SMART THEATRE SYSTEMS, P.O. Box 80361, Atlanta, GA 30341. (800) 45-SMART.**

SERVICES

DAVIDSON
ELECTRONICS
 516-753-0197
SERVICING:
 MUSICAL INSTRUMENTS
 REINFORCEMENT
 PRO-AUDIO
 RECORDING
 BY APPOINTMENT ONLY

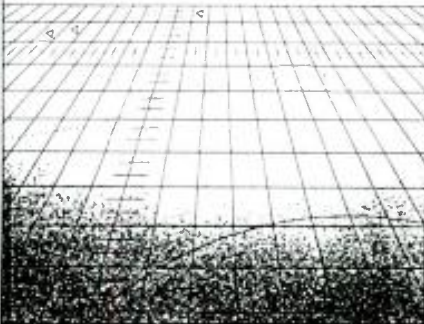

Closing date is the first of the second month preceding the date of issue.

Rates are \$1.00 per word with a \$25.00 minimum. Boxed ads are \$40.00 per column inch. db Box Numbers are \$8.50 additional for wording "Department XX" plus \$1.50 additional for postage and handling.

Quantity discounts are:
 3X - 15%; 6X - 30%.

ALL CLASSIFIEDS
MUST BE PREPAID

Send copy to:
 db, The Sound
 Engineering Magazine,
 203 Comrnack Road,
 Suite 1010, Commack,
 NY 11725.

People, Places... & Happenings

• **Renkus-Heinz** recently announced the signing of an agreement that gives the company exclusive worldwide distribution rights of the English version of the **EASE** acoustic design software program. **EASE** (Electro-Acoustic Simulator for Engineers) is designed for use on any IBM or compatible PC/AT computer. The program, which features simple data input, extreme accuracy, superior color graphics and AutoCAD file exchange, was initially developed for acousticians and scientists. Several loudspeaker manufacturers have contacted Renkus-Heinz President **Harro Heinz** about submitting their data for inclusion in the program's data base.

• **Cliff Electronic Components Ltd.** of London, England recently announced the availability of their audio product line to the United States through their newly established North American sales office in Houston, Texas. A complete line of jack sockets, connectors, cabinet hardware and other audio products suitable for the needs of domestic audio product manufacturers, studio contractors and suppliers is available.

• **QMI**, a new company formed to market and distribute Professional Audio Products in the United States, has been appointed exclusive United States distributor for **Drawmer Distribution**, England; **FM Acoustics**, Switzerland; **Genelec OY**, Finland; and **SCV Audio**, France. QMI will continue to support the existing dealer networks for both Drawmer and Genelec. QMI will focus its marketing and distribution efforts on performance-oriented quality products. The majority of the Representative network for each line will remain unchanged.

• **New England Digital Corp.** has moved from Vermont to a signif-

icantly larger headquarters in Lebanon, New Hampshire. The new center, which houses all of New England Digital's Manufacturing, R&D, Product Development, Sales, Marketing, Finance and Administration operations, provides the company with up to 100,000 sq. feet of space to grow into. The move, which started in early August, is expected to be completed by year's end. In addition to the move, **Ted Pine** has been promoted to director of Marketing.

• Other company moves include **Northeastern Digital Recording, Inc.** to Southboro, MA. The new facility features two mastering rooms and a "Composing Suite" with hard disc editing and MIDI...**TimeLine**, the manufacturer of **Lynx** synchronizer systems, has moved its corporate headquarters from New York to California in an effort to expand their facilities and activities...**Audio Animation** has moved its headquarters to Knoxville, TN, where their new 12,000 sq. foot building houses Audio Animation's Engineering, R&D, Manufacturing, Sales, Marketing and Administrative departments. The company has also added **James M. Ruse** as its Product manager, and **David L. Ball** as Applications engineer...**Gauss Loudspeakers** has expanded its speaker production capability with a move to a specialized manufacturing plant in Newport, TN. The move enables Gauss Loudspeakers to be manufactured in a facility dedicated to only producing professional loudspeakers, according to **Jim Williams**, president of Gauss. Williams also announced that **Electro Sound, Inc.**, high-speed audio cassette tape duplicating manufacturer, has relocated its manufacturing operations to Sun Valley, CA, and is moving from its present plant in Sunnyvale, CA, to two facilities in the Los Angeles area...The first European office for **Narada Productions, Inc.** has opened in Hilversum, Netherlands.

Jaap Hoitingh has been named director of European Marketing and Sales.

• **Ronald Graham** has been named a vice president of **Mark IV Audio, Inc.** He will be responsible for overseeing management of human resources for all companies in the Mark IV Audio Group, including **Electro-Voice**, **Altec Lansing**, **Gauss**, **Vega**, **Electro-Sound**, **University Sound** and **Dynacord**. Promotions and appointments have occurred at several other companies including **AKG Acoustics, Inc.**, where **Scott Heineman** has been named product manager for **dbx Professional Products** and **Orban Broadcast and Professional Products**...**Steve Cunningham** has been appointed vice president of Sales and Marketing for **JL Cooper Electronics**...**EFX Systems**, a leading digital audio post production facility in Hollywood, CA, has named **Paul Rodriguez** to its vice president and general manager post...**James Walsh** has been made general manager of **Metro Studios** in Minneapolis, MN...**Soundwave** has named **Chris Paul** as their new director of marketing...**Jeff Van Ryswyk** has been promoted to sales manager at **White Instruments** where he will be responsible for national and international sales...**Christopher Lyons** has been promoted by **Shure Brothers Inc.** to product line manager, wired microphones. Lyons has been with the company since 1985, and formerly worked as technical markets specialist...**Beth Simon** has moved from sales manager to director of sales and marketing at **Audio Plus Video International** and its new post-production division, **International Post**...**George Meals** has been appointed East Coast Regional sales manager at **Numark PPD**. Prior to joining the company, Meals held sales management positions with **Emilar**, **Renkus-Heinz** and **OAP**.



Get the Low Down



THE PEAVEY PVM™ 520TN

The PVM™ 520TN gets down to where the bottom is . . . it also maintains superior off-axis rejection of other sounds. When you mike the kick drum with the 520, that's what you get . . . the low frequency fundamental and the snap.

The pick-up pattern is cardioid while the polar response control is maintained to below 100 Hz, which makes it ideal for recording where isolation and separation are required.



The extremely high output plus accurate response produces exceptionally "natural" performance with the brass and woodwind families.

It can even do vocals! If you want studio-accurate vocal reproduction for live situations with all the crisp edge on top and warmth on

the low end . . . then get the low down on the PVM 520TN.

Musicians' Edge 

Peavey Electronics Corporation • © 1990 • 711 A Street • Meridian, MS 39302-2898 U.S.A. • (601) 483-5365 / Telex: 504115 • Fax: 484-4278

Circle 13 on Reader Service Card

www.americanradiohistory.com

"I've been sold on Beta's superiority since I first tried them. I use them on vocals, drums, amps, and brass because their sensitivity and resistance to feedback make them the perfect fit for the groups I work with. And the Beta 58 Wireless is the first system I've found that gives my artists the freedom of a radio mic without sacrificing sound quality."

Paul Dalen, Sound Engineer for David Sanborn and Lisa Stansfield.



Shure Beta Microphones. Buy Them On Word Of Mouth Alone.

Before you select a microphone, listen to the leading pros who use the Shure Beta Series on stage. They'll tell you about the benefits of Shure Beta's advanced transducer design, extraordinary gain-before-feedback, and true supercardioid polar pattern, as well as its outstanding sensitivity and low handling noise. But most important, they'll tell you that nothing beats a Beta for live performance. And that's not just talk. Try Shure Beta today and get the final word for yourself. Or call us for more information at 1-800-25-SHURE. The Sound Of The Professionals®...Worldwide.

SHURE BETA

Circle 12 on Reader Service Card

www.americanradiohistory.com