

JUNE 1984
\$2.50

db

THE SOUND ENGINEERING MAGAZINE

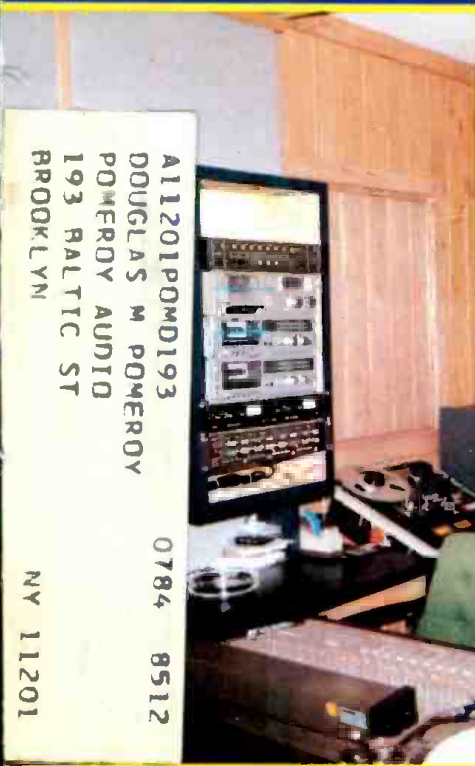

11201POMD193
DOUGLAS M POMEROY
POMEROY AUDIO
193 RALTYC ST
BROOKLYN
0784 8512
NY 11201



On designing a cassette transport to meet 2" mastering standards.

As an audio professional, you probably work with several tape formats. But your demands for reliability and performance are always the same.

In designing a transport for the Studer A710 and the Revox B710 MKII cassette decks, our engineers worked with the same principles established for our professional open reel decks. No cost-cutting compromises were permitted. For example, the Studer Revox cassette transport is built on a die-cast aluminum alloy chassis, not on stamped metal. This is the only way to assure precision machining and long term stability.

Four direct drive motors handle your cassettes smoothly and gently. Two quartz-locked, Hall effect capstan motors keep wow-and-flutter down to a conservatively rated 0.05% (DIN weighted). Two additional DC reel motors, both servo regulated and microprocessor controlled, provide constant speed fast winding, automatic start-of-oxide cueing, and motion sensing for positive tape protection.

No sleds allowed. Most other cassette decks use a sled mechanism to insert the heads into the cassette shell. The free play inherent in this design often contributes to azimuth misalignment.

In the Studer Revox design, a die-cast headblock pivots upward on two precision (0.001 mm tolerance) conical bearings and

locks into a solid 3-point mount. Because the headblock always locks into exactly the same position, absolute azimuth stability is assured.

One transport, two decks. This remarkable transport can be found in only two tape decks, the Revox B710 MKII and the Studer A710. Features shared by both units include 3 head design, internal 24 hour clock for programmable operation, tape type sensor, Dolby™ B and C noise reduction, plug-in modular PC boards, optional remote control, and adjustable headphone output with ample amplification.

A710: The Studer Version. This deck offers professional line level inputs and outputs, with output levels adjustable from -3 to +14 dBu. It also has calibrated input and output levels, XLR connectors, and a rack mount flange standard.

B710 MKII: The Revox Version. The lower priced B710 MKII has front panel mike inputs, mike/line mixing, and an optional infrared remote control.

For the long run. The Studer A710 and Revox B710 MKII are built for consistent, dependable performance. Hour after hour. Year after year. The kind of performance you expect from the world's most respected name in audio recording.

For more information on Studer Revox cassette decks, contact: Studer Revox America, 1425 Elm Hill Pike, Nashville, TN 37210, (615) 254-5651.

STUDER REVOX



Revox B710 MKII

Studer A710

Circle 10 on Reader Service Card

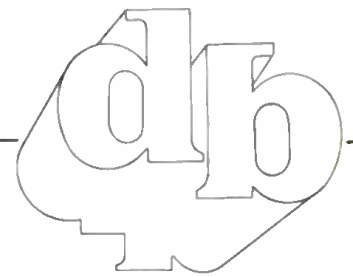

Editor/Publisher
Larry Zide

Associate Publisher
Elaine Zide

Managing Editor
Mark B. Waldstein

Associate Editor
Ricki Zide

Technical Editor
Linda Cortese

European Editor
John Borwick

Technical Advisor
John Eargle

Layout & Design
Kathi Lippe

Advertising Coordinator
Karen Cohn

Book Sales
Lydia Calogrides

Circulation Manager
Eloise Beach

Graphics
K & S Graphics

Typography
Spartan Phototype Co.

FEATURES

PROBLEMS WITH CDs—REAL OR IMAGINED? 24	<i>Len Feldman</i>
A SOUNDMIXER'S GUIDE TO VIDEODISC 28	<i>Charles P. Repka</i>
DEVELOPMENT OF A NEW STUDIO ARTIFICIAL HEAD 34	<i>Stephen Peus</i>
NAB 1984—AN IMPRESSION 38	<i>H. Burrell Hadden</i>
THE GOLDEN AGE OF RADIO RETURNS 42	<i>Skip Pizzi</i>

COLUMNS

THEORY AND PRACTICE 6	<i>Ken Pohlmann</i>
COMPUTER AUDIO 14	<i>Jesse Klapholz</i>
DIGITAL AUDIO 18	<i>Barry Blesser</i>
SOUND REINFORCEMENT 21	<i>John Eargle</i>

DEPARTMENTS

LETTERS 2
EDITORIAL 23
NEW PRODUCTS AND SERVICES 48
PEOPLE, PLACES, HAPPENINGS 52
CLASSIFIED 55

db, the Sound Engineering Magazine (ISSN 0011-7145) is published monthly by Sagamore Publishing Company, Inc. Entire contents copyright © 1984 by Sagamore Publishing Co., 1120 Old Country Road, Plainview, L.I., N.Y. 11803. Telephone (516) 433-6530. db is published for those individuals and firms in professional audio-recording, broadcast audio-visual, sound reinforcement, consultants, video recording, film sound, etc. Application should be made on the subscription form in the rear of each issue. Subscriptions are \$15.00 per year (\$28.00 per year outside U.S. Possessions \$16.00 per year Canada) in U.S. funds. Single copies are \$1.95 each. Editorial, Publishing, and Sales Offices: 1120 Old Country Road, Plainview, New York 11803. Controlled circulation postage paid at Plainview, N.Y. 11803 and an additional mailing office.

Q: The Department of Defense picked what sound effects library as the one to use in all their radio stations around the world?

The Production EFX Library. 5 stereo albums arranged by categories. Shouldn't you give a listen?

A:



PRODUCTION EFX LIBRARY
 2325 Girard Ave. S.
 Minneapolis, MN 55405

Circle 13 on Reader Service Card

POLYSET
 Audio Cassettes

PROFESSIONAL QUALITY
in 46 Stock Lengths
 C-02 thru C-92
 In One Minute Per Side
 Increments

POLYSET DIV.
 of
Polyline Corp.
 1233 Rand Road
 Des Plaines, IL 60016
 (312) 298-3073

Circle 14 on Reader Service Card

Letters

IN A BIND

TO THE EDITOR:

Ever since Barry Blesser's series on Digital Audio began appearing, I have wanted to write you about it.

As a tutorial it is sorely needed, and in my view Blesser is an excellent teacher. Since I've been working and writing in this area for many years, my point of view may be atypical, but it seems to me that his stuff is first class.

Recognition of that by your readership may not be evidence in itself to you. I would like to make a suggestion: Bind the set separately, offer it as a new (or renewal) premium, celebrate its value—I do—and see what happens.

The challenge to follow Blesser's teaching need not be frightening to the more timid reader; he needs to have it all in one piece, tho.

EMORY COOK
 Cook Laboratories, Inc.

What is your opinion, dear reader? Let us know. Younger readers might not know that Emory Cook is one of the true pioneers of both pro and consumer hi-fi as we know it now. His Cook Laboratories audiophile records of the '50s are collector's items today, particularly the stereo recordings using outer grooves for one channel and inner grooves on the disc for the other, which predated the present stereo discs.

But Mr. Cook does know, and you may not, that we sell, at modest price, binders to hold those copies of db. See the ad in this issue.

THE FUTURE'S IN...ILLINOIS?

TO THE EDITOR:

We read with great interest and enthusiasm your article on Modular Sound in the March issue. Many of the comments made regarding the logic of compact PA were exactly in line with our thinking. However, we felt that we must comment on the article. At Pyramid Audio, we have been designing and using tiny PA for the past decade, and no less than six years ago we were using the "innovative approach" spoken of in the Modular article.

Index of Advertisers

Amber.....	6
Carvin.....	10
Compusonics.....	8
Crown.....	Cover III
Garner.....	10
JBL.....	Cover IV
Brooke-Siren.....	7
Orban.....	4
Polyline.....	2
Production EFX.....	2
Shure.....	3
Studer Revox.....	Cover II
3M.....	12

About The Cover

• This month's cover features Control Rooms A and B of Audiovisions Recording Complex in Louisville, Kentucky. Control Room A features a Neotek Series III 36 x 24 console, one Studer A80 24-track recorder with dbx, Studer A80 and B67 2-track mixdown machines, and a full complement of outboard gear. Control Room B features a Tascam M-50 12 x 8 console, one Tascam 80-8 8-track recorder with dbx, three Ampex ATR-700 2-track recorders, and Tascam and dbx outboard processors.



Shure's new FP31 Mixer takes a big weight off your shoulders.

Introducing the most innovative field production mixer of its kind. Shure's FP31. You won't find another mixer this small with these features, dependability and ease of operation.

The FP31 measures only 6⁵/₁₆" x 5⁵/₁₆" x 1⁷/₈", and weighs just 2.2 pounds! Incredibly, it offers the same important features as much larger mixers. Plus, a few of its own.

Every channel has a mic/line level and a low-cut filter switch. And to prevent overload distortion, there's a built-in limiter with adjustable threshold.

The FP31 can be powered by two internal 9-volt batteries, or from an external 12-volt source. A green LED flashes to remind you that the mixer is on. Phantom and A-B power are also provided to operate lavalier and shotgun microphones.

A slate tone can be laid

down on the tape for locating specific takes, and there's also a built-in mic for voice slating.

The mixer also has two separate mic/line outputs for 2-camera shoots and a tape output to feed a cassette. For monitoring, there are two stereo headphone jacks—one 1/4-inch and one for miniplugs. The FP31's rugged nylon carrying case allows you easy access to every mixer function and lets you piggyback the mixer on your VCR or other equipment.

For ENG, EFP and film use, Shure's FP31 has everything you need to make your mix a perfect success. Coming from a mixer this small, that's quite an accomplishment.

For more information on Shure's FP31 Mixer, call or write Shure Brothers Inc., 222 Hartrey Ave., Evanston, IL 60204, (312) 866-2553.



SHURE

THE SOUND OF THE PROFESSIONALS®...WORLDWIDE

Circle 15 on Reader Service Card

Our newest system is approximately one-fourth the size of Modular's, and will deliver more SPL than systems 10 times its size. We can take a cube van and deliver sound to over 10,000 seats, including eight bi-amped monitor mixes, with only two guys! In fact, the stage cabinetry for our 28,000 watt system to cover a 20,000 seat venue totals only 226 gross cubic feet (that's only the first 60 inches of truck space)!

We're not about to give away any "proprietary secrets," but a combination of the latest technology, including utilization of the new Intersonics servo-drive subwoofer system, innovative cabinet design, and a unique philosophy towards crossovers and power has allowed us to build what we believe to be the most compact, yet efficient PA in the world. We will gladly challenge all comers.

Our future plans include a computer-controlled signal processor that will automatically tune the system to its ideal crossover settings

continuously as it monitors the incoming signal. We plan to debut the product later this year.

Mr. Gately refers in your article to "what the future holds." We would like you to know that the future is right here in little old South Holland, Illinois. Our hats are off to the people at Joe's and everyone else who is battling to allow high tech and miniaturization to enter the sound reinforcement industry.

TY VON JENEF
Pyramid Audio Inc.

XEROX BLUES

TO THE EDITOR:

I just wanted to drop you a line to let you know just how much I appreciated the articles by John Eargle on Sound Reinforcement over the past two years.

What I would like to know is whether Mr. Eargle is going to publish those articles in a manual or book form. They, along with appropriate references to the mate-

rial at the end of each chapter, would provide a valuable reference handbook for contractor/engineers in the design of various types of sound systems. If some handy 'black boxes' and useful 'hints and kinks' were also added, this would be a very valuable work.

I would like to know what you or Mr. Eargle think of this idea. If the material was going to be in manual or book form, it would save xeroxing all the various articles contained in the series.

Thank you for your kind attention.

WILLIAM POLLARD

Stop your Xeroxing, Mr. Pollard! Just such a book is well along in production. What will emerge toward the end of this year, is a wholly new major book on sound reinforcement, not a recasting of the monthly columns. As of this writing, John Eargle has nearly completed the manuscript. So, as the saying goes, watch these pages for further announcements.

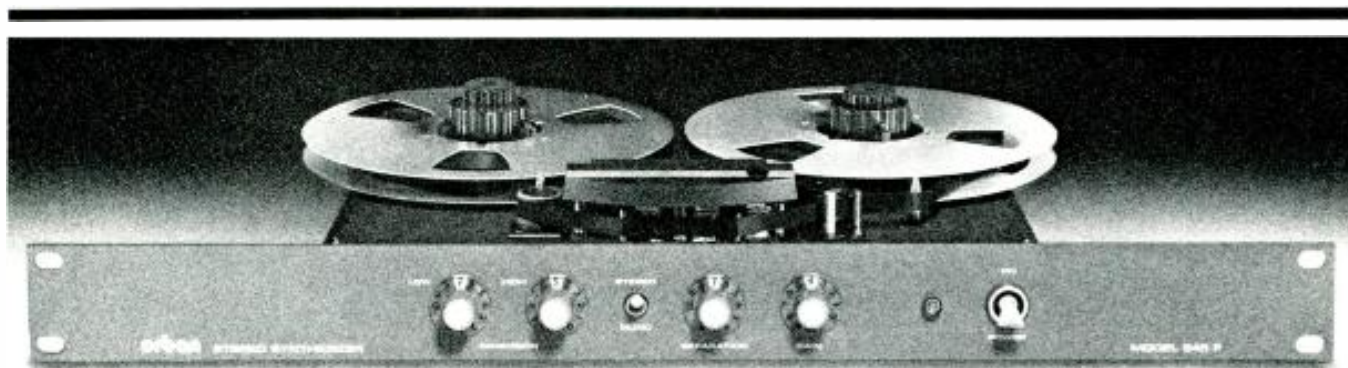

Introducing the 5th (9th, 17th, or 25th) track.

Orban makes an amazing little device that greatly expands your multitrack capabilities. Our new 245F Stereo Synthesizer uses a patented technique for processing mono tracks into pseudo-stereo during mixdown. So you can save tracks by recording instruments like drums, strings, synthesizer, organ, horns, or electric guitar in mono, and then expanding them into convincing pseudo-stereo during the mix rather than taking two tracks.

The 245F is particularly useful in processing *intrinsically* mono sources—like many electric and electronic instruments. And unlike many other ambience-generating techniques, our stereo synthesis is completely mono-compatible: There's no phase cancellation or comb-filtering when the stereo channels are summed.

For \$399, you won't find a better, more cost-effective way to save tracks and get more on your master. Call or write for details.

orban Orban Associates Inc. 645 Bryant St.
San Francisco, CA 94107 (415) 957-1067
Telex: 17-1480

Circle 16 on Reader Service Card

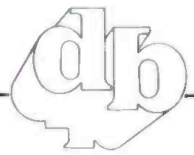

CD's: How To Make Them Yourself

• I've been perplexed for the past several months. Consumer acceptance of the Compact Disc system is very strong; it is expected that a quarter of a million players will be in the hands of American consumers by the year's end, with as many as 25 discs purchased per player. Yet some audio professionals still persist in badmouthing the system, claiming everything from excess of clarity to absence of emotion. (I'm *very* perplexed about such claims.)

I couldn't figure out why consumers love the sound of CDs while some professionals, whose careers stand to flourish from the new medium, are still reticent. Then, at last, I found the answer. The reason is that audio professionals aren't paid very well, and some of them can't afford to buy Compact Discs. They are thus very jealous of the consumers who can afford to luxuriate in this higher fidelity digital sound, while they are still taping nickels to their tonearms

in an attempt to keep them tracking. They can't afford the discs, and they are bitter.

This is understandable. The only people paid less than audio practitioners are audio journalists. I can't afford to support my own disc habit, and when engineer Roger Nichols told me his collection includes 200 discs, I fainted. Thus I set about to solve the dilemma. When I visited the CBS/Sony CD pressing plant south of Tokyo I carefully observed their

Looking for a Distortion Measurement System?

The Amber model 3501 is quite simply the highest performance, most featured, yet lowest cost audio distortion and noise measurement system available.

It offers state-of-the-art performance with THD measurements to below 0.0008% (-102dB), maximum output level to +30dBm and noise measurements to below -120dBm.

It has features like automatic operation, optional balanced input/output and powerful IMD measurement capability. It includes comprehensive noise weighting with four user changeable filters. Unique features like manual spectrum analysis and selectable bandwidth signal-to-noise measurements.

The 3501 is fast, easy to use and its light weight and small size make it very portable. It can even be battery powered.

And the best part is that it is 20% to 50% below what you would pay elsewhere for less performance. The Amber 3501 starts at \$2100. Send for full technical details.



Amber Electro Design Inc.
4810 Jean Talon West
Montreal Canada H4P 2N5
Telephone (514) 735 4105

amber

Circle 18 on Reader Service Card

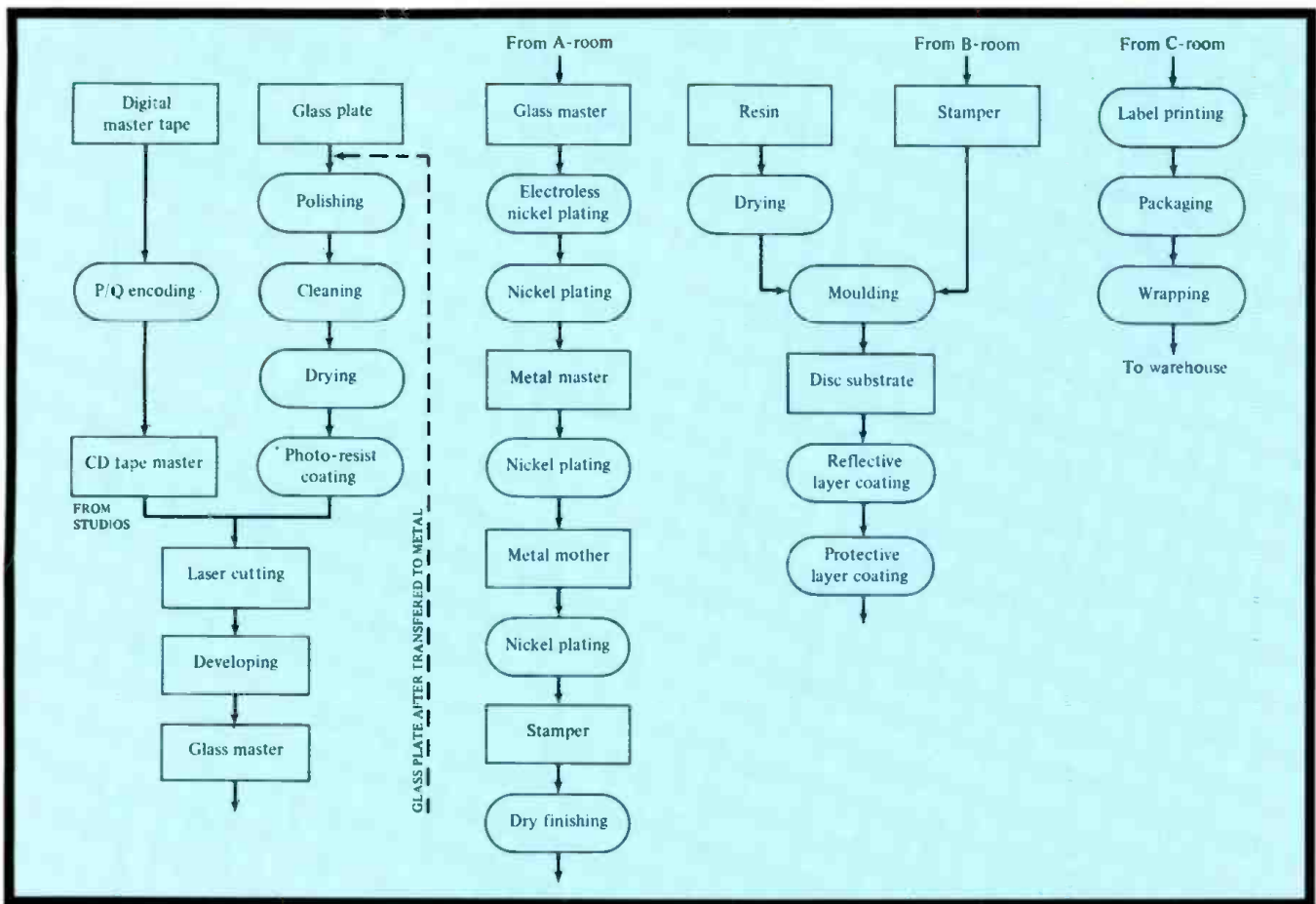

Figure 1. CD mastering process.

Brooke Siren Systems

For years our MCS200 series crossovers have been used by major touring companies worldwide. The same high technology is available in our FDS300 series crossovers. Our products include some very unique features, highlighted below, but perhaps our best feature is the way we'll sound with you. Available now through professional audio distributors and music stores nationwide.

- 24dB/Octave Slope
- Subsonic/Ultrasonic Filters
- Section Mute Control
- Limiters on Each Section
- ± 6 dB Level Control
- Sealed Potentiometers



Brooke Siren Systems, 262A Eastern Parkway, Farmingdale, New York 11735 (516) 249-3660
 Gerraudio Inc., 363 Adelaide Street East, Toronto, Ontario M5A 1N3 (416) 361-1667



Frequency Dividing Systems

FDS 340

- FDS320 2-Way Stereo
- FDS340 3 or 4-Way Mono
- AR116 Active Direct Box
- AR125 Cable Tester
- MCS200 Modular Series
- 3, 4, or 5-Way Stereo

Circle 19 on Reader Service Card

YOUR WORLD

For you, it's the sixth session of the day. For them, it's the biggest session of the year. So you push yourself and your board one more time. To find the perfect mix between four singers and 14 musicians. Between 24 tracks and at least as many opinions. To get all the music you heard—from the deepest drums to the highest horns—on to the one thing they'll keep. The tape.

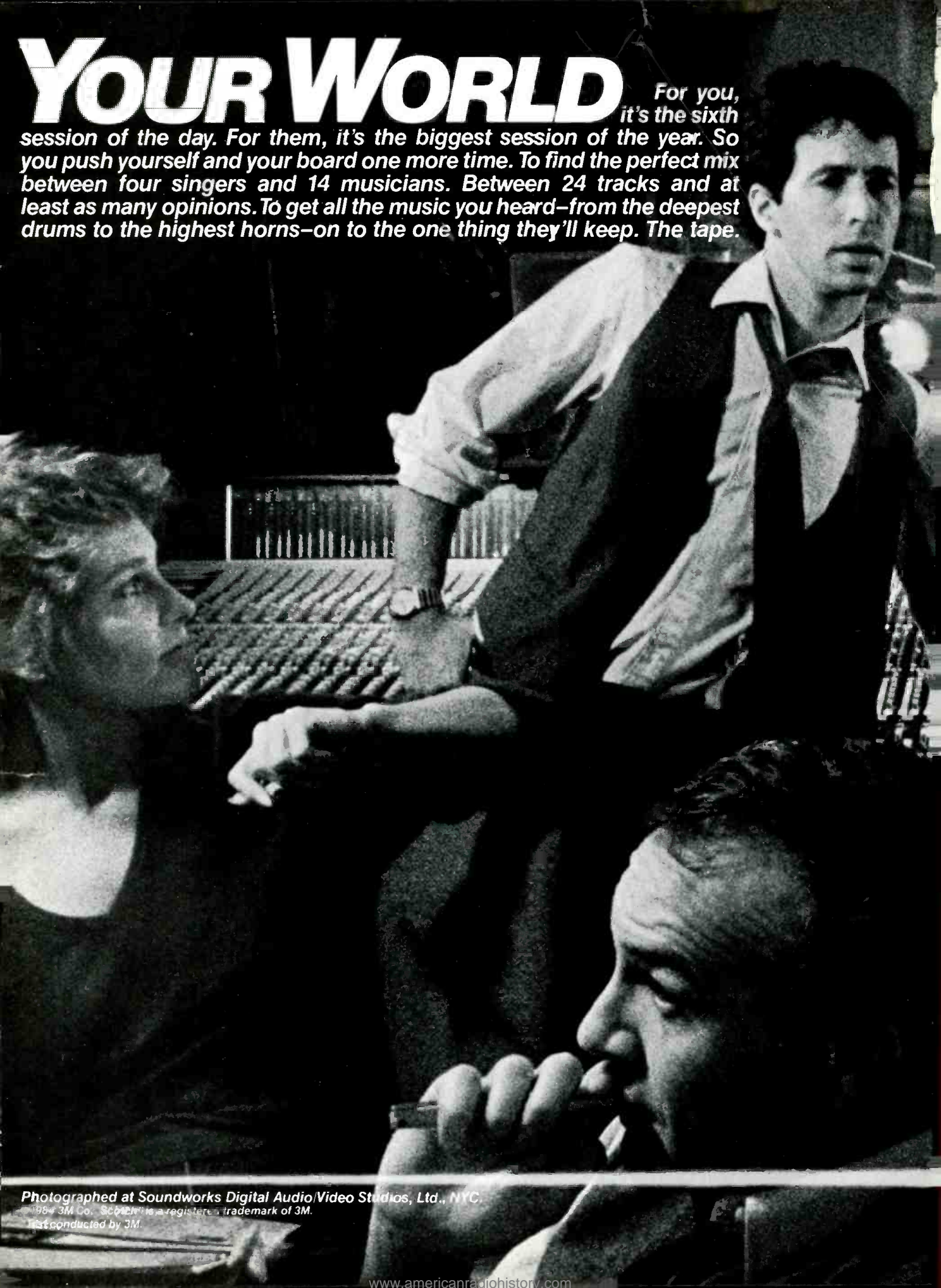

Photographed at Soundworks Digital Audio/Video Studios, Ltd., NYC.

© 1987 3M Co. Scotch is a registered trademark of 3M.

Test conducted by 3M.



OUR TAPE

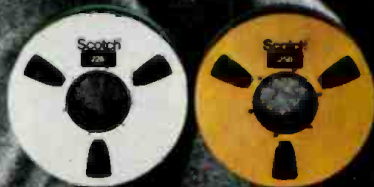

We know that our tape is the

one constant you have to be able to count on. So we make mastering tapes of truly world-class quality. Like Scotch[®] 226, a mix of Scotch virtuosity and the versatility to meet your many mastering needs—music, voices, effects. And Scotch 250—with the greatest dynamic range and lowest noise of any tape, it is simply the best music mastering tape in the world. Both tapes were preferred by Ampex and Agfa users at a listening test* conducted at the 1983 Audio Engineering Society

convention in New York. They are both backed by our own engineers a call away. They are just two of the tapes that make us...number one in the world of the pro.

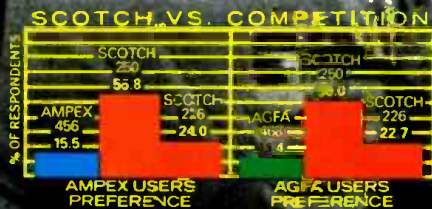

Scotch[®]

AUDIO & VIDEO TAPES

NUMBER ONE IN THE WORLD OF THE PRO



Circle 41 on Reader Service Card

ONE PASS

The Only Four-Second Tape Erasers

That's Garner... The Quality Eraser

You're recording on a machine that costs hundreds or thousands of dollars, and you're recording on recycled tape. Can you guarantee that tape is absolutely clean? You can if you're using a Garner Audio Tape Degausser.

Garner is the standard of the industry...designed to the specifications of leading tape manufacturers. Garner is a conveyor-belt tape eraser. It can erase in less than five seconds what most degaussers take up to a minute to erase, and Garner erasers do a better job.

Time savings, ease of operation, quality of erasure, and rugged construction make Garner the most cost-effective eraser available.

Garner has established a reputation as the "Eraser People" because we manufacture a complete line of both audio and video erasers. Call and let us show you what a Garner eraser can do for you.



Dependability...Guaranteed

garner industries

4200 N. 48th Street Lincoln, NE 68504
Phone: (402) 464-5911 Telex: 438068

manufacturing techniques. I was intent on stealing their secrets, and thus beat the high cost of CDs by making them myself! Sure, a CD has 10 billion pits on its surface; if a CD was enlarged to the size of the Roman Colosseum, a pit would be the size of a grain of rice, but the height of this technology didn't deter me. Now, for the first time, I am prepared to divulge the complete CD manufacturing process to db readers. By following these few simple steps, you too can turn *your* recordings into CDs!

TAPE MASTERING

The CD manufacturing process involves three general steps: tape mastering, CD disc mastering, and duplication. The tape mastering process is the culmination of the recording process, in which the master tape (hopefully digital) has been edited using Sony's DAE-1100 editor and recorded on a BVU-800 via a PCM 1610 processor. At this time, every CD must be manufactured

from the 1610 format, and to my knowledge no direct transfer between formats exists. Thus a digital 3M recording must undergo D/A and A/D conversions in the transfer to the 1610 format. While no analog tape recording is involved, this needless pair of conversions is to be frowned upon. I hope that some manufacturer designs a black box to accomplish the transfer: I have heard persistent rumors that a box exists in Germany which permits PCM F1 tapes to be directly mastered to CD, avoiding even the 1610 format—yes, with left/right correction.

During tape mastering, the PQ subcode, which contains music number and absolute address time code, is created for the master using a subcode editor such as the DAQ 1000. The subcode is entered on an audio channel at the beginning of the U-matic tape and is later modulated along with the music data into the CD format during disc cutting. The subcode is thus present in every CD frame. Each frame contains six of the original audio samples; clocking determines the 1.41×10^6 audio bits/second rate. In addition, the table of contents data is entered into the disc lead-in area. The encoding process also entails multiplexing, creation of the cross interleave Read-Solomon code (CIRC) to encode parity into each data block, and eight-to-fourteen (EFM) modulation to form channel bits. In EFM code, blocks of eight bits are translated into blocks of 14 bits. The blocks of 14 bits are connected by three merging bits; the ratio of the number of bits before and after modulation is thus 8:17. For bit stream synchronization, a pattern of 27 channel bits is added to each frame, resulting in a total bit rate of 4.32×10^6 channel bits/second.

CD MASTERING

CD mastering is the next step; a glass plate 220mm in diameter (no center hole) and 6mm thick comprised of simple float glass is washed in alkali and Freon, lapped, and polished with a CeO₂ optical polisher. The plate is prepared for cutting in a clean room with a dust filtering class of 10,000. After inspection and cleaning, the plate is tested for optical dropouts with a helium-neon laser; any burst drop-outs in reflected intensity over a 20 micrometer length will be cause for rejection of the disc. An adhesive is applied, followed by a coat of photoresist applied by a spinning coater. The

FREE!



1984 Pro-Line Guide

- ★ If you're a pro sound user or contractor, get the FREE 84 page CARVIN catalog. See top groups like *Missing Persons*, *Alabama*, *Roy Clark*, and *Jefferson Starship* play CARVIN.
- ★ Choose from hi-end recording consoles with parametric EQ, 800 watt amps, 1/3 octave equalizers, bi & tri amp crossovers, pro monitor & concert speaker systems with Electro-Voice, Renkus Heinz, & MagnaLab drivers. Over 25 sound systems with further reduced prices. Also, a complete line of guitars and amps.
- ★ Compare Carvin's exceptional values and service. Buy DIRECT at Pro-Net prices — saving you hundreds of dollars.

Write: CARVIN, Dept. DM84, 1155 Industrial Ave.
Escondido, CA 92025. PH 619-747-1710

FREE CARVIN CATALOG

Free Catalog \$2 for Rush 1st Class Mail

Name _____
Address _____
City _____
State _____ Zip _____ DM84

plate is cured in an oven, and stored (having a shelf life of several weeks); it is now ready for cutting.

CUTTING THE CD

The cutting machine uses a 15 mW HeCd laser beam, intensity-modulated by an acousto-optic modulator, to create a signal that corresponds to the data on the audio master tape. It exposes the photoresist on the glass master disc with the familiar pit track, cutting the entire spiral continuously in real-time with the tape. The serial encoder high frequency output signal is connected to the acousto-optical modulator in the light path of the CD laser recorder. The quality of basic signal characteristics such as high frequency signal modulation amplitude, eye pattern symmetry, and track following signal are all determined during the master cutting. To insure cleanliness, a very stringent filtering system of class 100 is used inside the cutting machine. Optics similar to those found in CD players (polarized beam splitters, objective lens, semiconductor laser) are used; the more sophisticated stylus block is supported and moved by an air-float linear slider. A HeNe laser which does not affect the photoresist is used for focus and tracking error correction. The entire sequence of operations is controlled by microcomputer; the operator places the glass plate on the turntable, keys in the start command, reads db magazine while the disc is cut (Theory and Practice column first), and then removes the disc.

After exposure, the glass master is developed by an automatic developing machine in which developer is sprayed on the disc. While developing takes place, a HeNe laser monitors the depth of the photoresist layer and halts development when proper engraving depth has been reached; that is, when the etching reaches the glass substrate. The pit depth thus depends on the thickness of the photoresist layer. In theory, the optimum signal from the finished CD occurs when the pit depth equals one-quarter the wavelength of the 790nm reading laser in CD players and the pit width dictates that the intensity of the light reflected from the pit bottom equals the intensity of the light reflected from the surface; destructive interference causes an absence in reflected light wherever there is a pit. In practice, a compro-

mise must be utilized to balance the need for zero reflected intensity against that for radial signal tracking, which requires a one-eighth wavelength pit depth. The pit length varies according to the signal in the optical modulator. At a recording speed of 1.25 meters/second (speed of rotation of the disc varies from 3.5 to 8 revolutions/second), a pit length can vary incrementally by 0.278 micrometers from 0.833 to 3.054 micrometers total length. Accuracy of pit length is $\pm 30\text{nm}$. The minimum and maximum lengths, and tolerance, of the land between pits is identical.

The master electroplating process imparts a silver coating, accomplished by sputtering on the glass master. By the same process, this "father" can be used to generate a number of positive "mothers." Each mother can then generate a number of negative stampers. Stamper life has been tested to over 8,000 discs per stamper; maximum useful life has not been determined. At each step, these nickel plates are inspected by means of photopolymerization. The photopolymerized test disc is used as a reference to evaluate the quality of the final production discs. The glass master may be polished and recycled as many as 20 times.

THE FINAL STEP

Injection moulding is used to produce the final discs. A polycarbonate material is used because of its low vapor absorption coefficient, about 70 percent less than that of a PMMA material. Polycarbonate material has an inferior birefringence specification, especially when produced by injection moulding; however, injection moulding is a more efficient production method (cycle time of 15 seconds). After experimentation with different kinds of mold shapes and moulding conditions, techniques for producing a single-piece polycarbonate disc were achieved. After injection, but before the disc is removed from the mold, the center hole is punched out such that no trimming is needed.

After moulding, a layer of aluminum approximately 100nm thick is evaporated onto the disc surface to provide reflectivity. The reflection coefficient of this layer, including the substrate (the CD player laser looks through the 1.2mm transparent plastic disc up to the aluminum layer) is specified to be between 70

and 90 percent. While a thickness of 20 to 30nm is sufficient, 100nm is chosen to prevent deterioration. The layer is applied in an evacuated chamber, in a process which takes about 15 minutes. Large racks of discs are treated with the evaporation process simultaneously to improve productivity. The aluminum is covered with an ultra-violet cured acrylic layer which is about 20 micrometers thick, by using a spin-coating machine. It protects the aluminum layer from scratches and oxidation. A label is printed directly upon this layer.

The finished discs are inspected for continuous and random defects. Birefringence, high frequency signal, frame error rate, frame tracking, noise, number of interpolations, and skew are measured on selected discs. Visual inspection is currently being employed. In newer facilities such as the Terre Haute plant, scheduled to go on-line in August, inspection will be 100 percent automated. In the CBS/Sony plant in Japan, the AQL (Acceptable Quality Rate) is claimed to be 2.5 percent. Yield is claimed to be over 90 percent. Current maximum production capacity is 750,000 Compact Discs per month. Total CD production from this plant in the first three months of 1984 was 1.2 million discs, including over 600 titles.

There you have it. As you can see, there is nothing very tricky about manufacturing Compact Discs. Although some of the equipment is expensive (for example, the master laser cutter sells for \$1.5 million), costs should come down. And frankly, I think much of this could be kluged from items commonly found in most households or recording studios. Did researchers test the birefringence of Tupperware, the coherent light properties of Porsche sunglasses, or the reflectivity of satin baseball jackets? Probably not. I'll bet some enterprising inventor could perfect a do-it-yourself CD pressing plant. For you diehard analog audiophiles, this might be your last chance to stop digital madness: Build a cheap pressing plant and flood the world with bad-sounding pirate CDs (from analog masters, of course). ■

REFERENCES

- Verkaik, Willem. "Compact Disc Mastering—An Industrial Process." *Digital Audio* (Collected Papers from the AES Premiere Conference).
Miyaoka, Senri. "Manufacturing Technology of the Compact Disc." *ibid*.

Finally, somebody took digital recording from here



COMPUSONICS INTRODUCES “TRUE” DIGITAL SOUND. FROM MIKE TO MASTER. IT’S WHAT DIGITAL SHOULD HAVE BEEN ALL ALONG.

Digital sound. Until now, most of what you heard about it was distorted.

Because the majority of digital masters were, in fact, produced on analog tape equipment and then merely converted into a digital format.

But a new company called CompuSonics has developed a multitrack digital audio mixer/recorder that allows you to produce digital recordings from mike to master. Without a single analog step in-between.

Introducing the CompuSonics DSP-2000. With it, an engineer records from start to finish with digital sound.



to here.

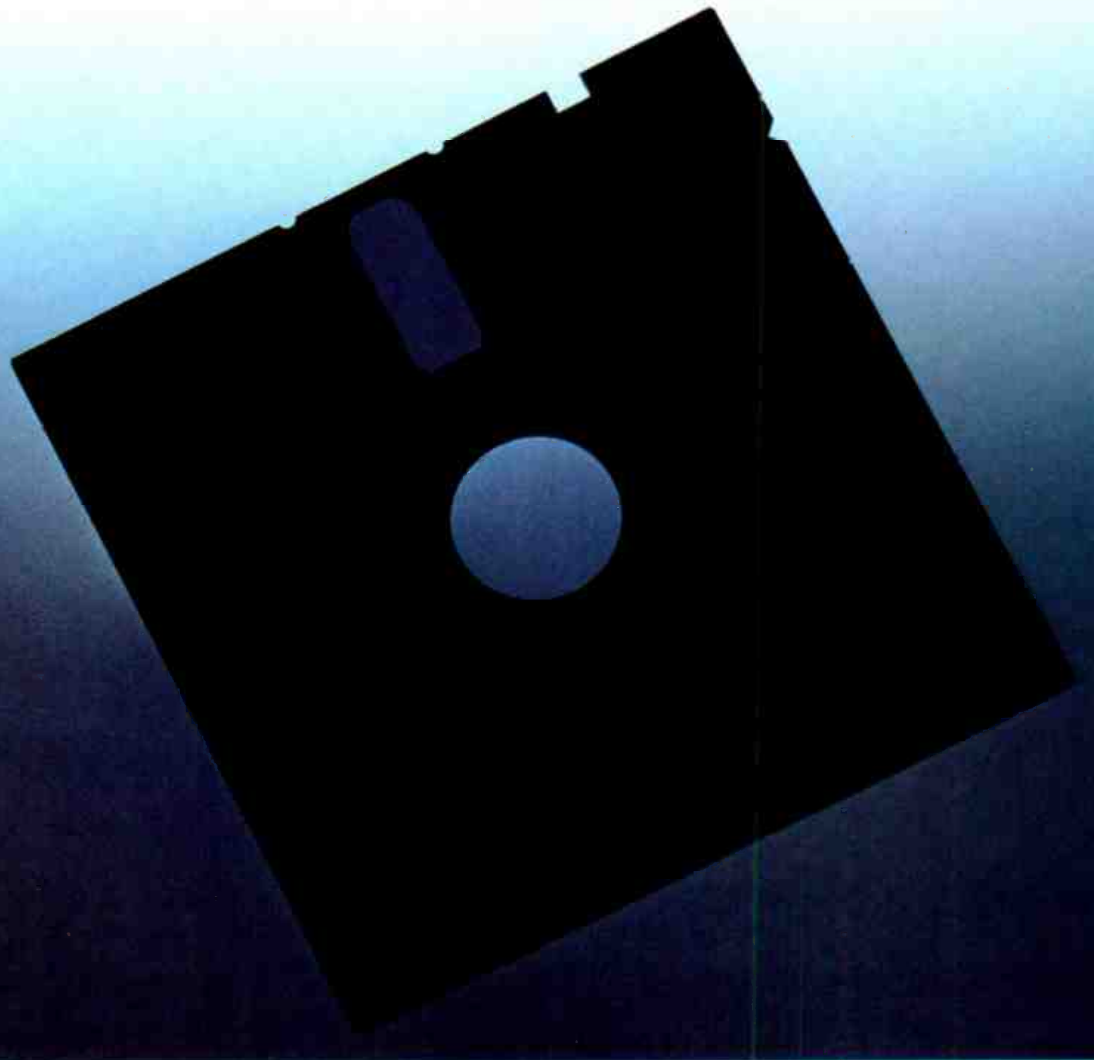

True digital sound.

Without analog compromise. Which means the elimination of signal loss on dubbings and re-mixes. High end loss. Tape hiss. Degradation. And background noise.

So from now on, the only sound you'll hear is the one you intended to put down.

And because the DSP-2000 is a multi-processor computer it offers benefits conventional equipment can't. For instance, with the computer you have instant access to file positions without rewinding miles of tape. Plus the advantage of digital signal processing. Allowing you to control your sound.

To shape it. Play with it. Store it. Recall it. Edit it. In your choice of formats.

But all of this is just the beginning of what the DSP-2000 can do. Now that you've heard about it, hear it. Call your CompuSonics sales representative at 1-800-223-1821 for more information. He'll take you into the digital sound of the future. And that's true.



© 1984 CompuSonics Corporation



Circle 20 on Reader Service Card
www.americanradiohistory.com



The General Purpose Digital Computer

• This column will introduce the reader to the general purpose digital computer through its basic functional blocks. You may ask, "Why should I bother learning this digital circuit theory?" The answer is (fortunately for all of us) that thanks to the history of the computer industry, the new user doesn't need to know the inner workings of a computer. The only thing that is required is a general knowledge of the structure of a computer.

In FIGURE 1, we see the three main units of a digital computer system: the CPU (central processing unit), memory, and I/O (input/output) units. The central processing unit, or processor, is the "brains" of the system. It performs the central control functions. All the computational, logical, and operational decisions are made here.

The memory unit is used to store instructions and data. Instructions in the form of digital codes are stored in a step-by-step sequence so

the computer system knows what to do; it needs data in order to perform an operation. This data is usually brought in through an input unit and stored in memory. After the computer system has completed an operation, it stores the results of the operation in memory. These results are data. Data may be words, letters, characters, numbers, symbols, etc.

The input units, as the name implies, pass input information to the computer. The input information may be entire programs or program-related, or it may be data.

Output units send the information from inside the computer out to us so we can use it. The output from a computer most commonly appears as a video display, or it may be printed out on a printer. It also may appear on an LED display, be sent to another digital system over a transmission line, or stored in auxiliary storage such as magnetic tape or magnetic disk.

The CPU controls what happens. It tells the input when to bring information into the system, and the output when to write information. It sends signals to the output to turn on a disk-drive motor, or form a letter or number on a display. It also controls when and at what time each operation is to be accomplished. The CPU does this by following instructions stored in memory in a step-by-step sequence called the program. The information inside the computer is not recognizable as written letters or numbers because it is converted to

electrical signals of digital codes so that it may be handled easily by the computer.

The digital coded information inside the computer system must be coupled from one unit to another via buses. There are three principal buses in a computer system, as shown in FIGURE 2. Each I/O unit of the computer system is given an address, as is each information location in memory. To locate specific information in memory, a digital code—the address of the information—is sent on the address bus to the memory by the CPU. At the same time, other digital codes representing control signals are sent to the control bus to tell the memory what to do, i.e., either to read or to write information. The information coming to the CPU from the memory when the memory is read, or going to the memory from the CPU to be written into the memory, is also in digital codes and travels along the data bus; this description also applies to any I/O unit.

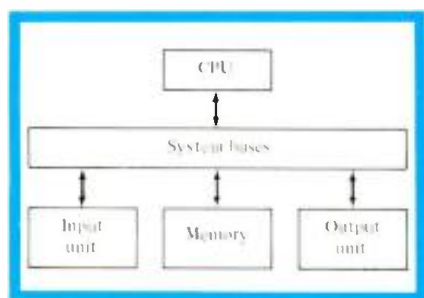

Figure 1. Basic blocks of a computer.

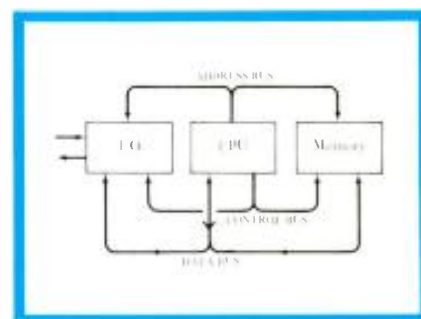

Figure 2. Three principal buses.

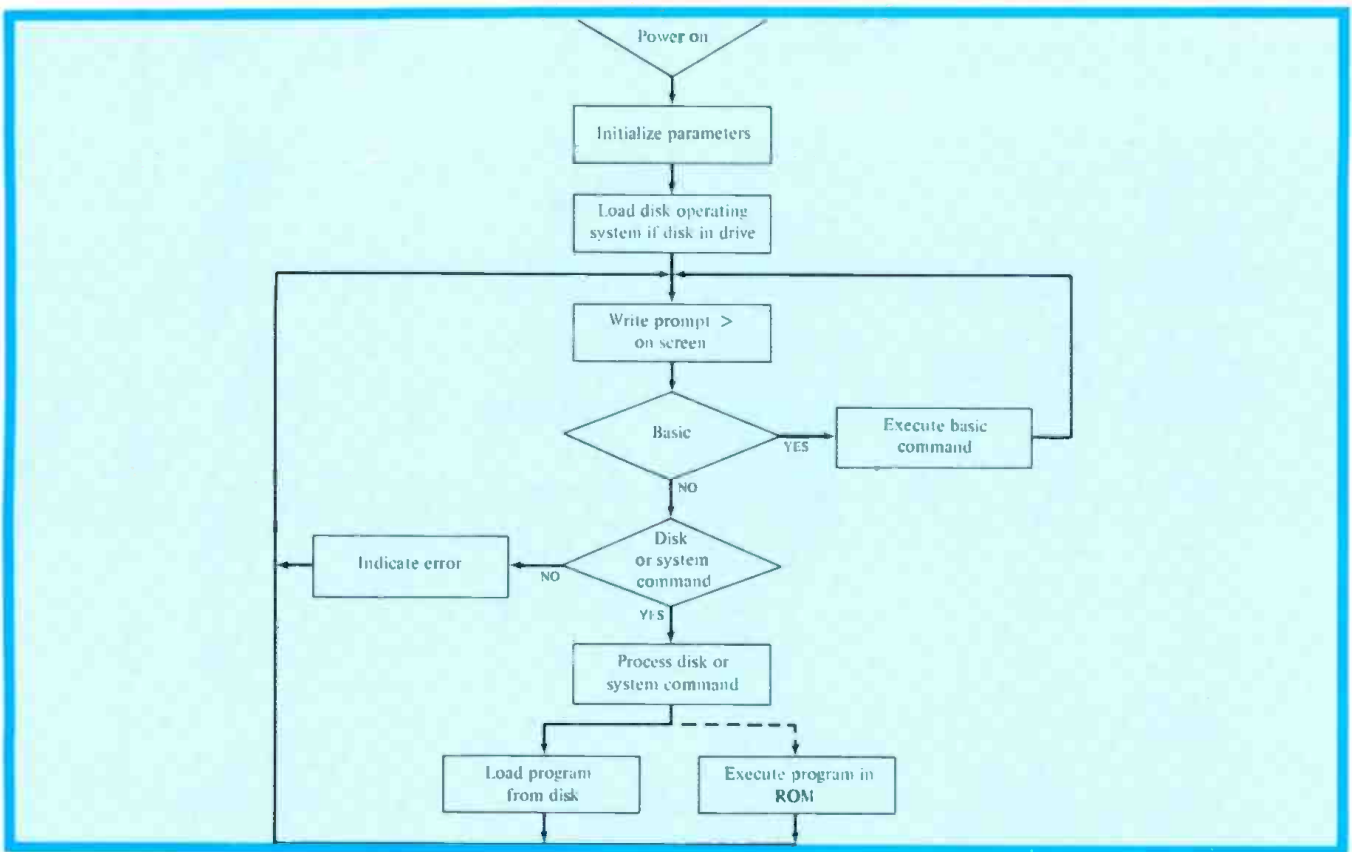

Figure 3. Functions of the operating system.

This is, of course, a simplified description of the signals on the buses; many functions are involved, each requiring a separate signal that is synchronized to occur at a specified time. Basically, the address signals, the control signals, and the data signals (which may be either data or instructions in the program), flowing at set times, control all the operations of the computer system.

THE OPERATING SYSTEM

What is an operating system? Have you ever had someone constantly looking over your shoulder while you were working? That's what this special program does to your program as your program goes through the execution process. This special program, which is actually a collection of many different types of programs, is called an operating system.

The operating system monitors and controls the execution of your program when you feed it into the computer via an input unit such as a disk drive. In order to get a good handle on just what an operating system should provide, let's examine a small computer and the way we execute a BASIC program on it.

First, let's take a look at our small

personal computer system. It has two mini-floppy disks, a keyboard, a CRT, and 64K of read-only and read-write memory. To execute a BASIC program, we first turn the power on, and a prompt character appears on the CRT indicating that the system is ready for BASIC. We may now type: >PRINT 2*3 <RETURN or ENTER> The computer immediately performs the multiplication and prints 6 on the CRT.

How did this happen? First of all, where did the prompt character come from? Well, a set of instructions had to write it on the screen. And, how did the computer translate BASIC to machine language?

Let's go back to when we turned on the power. When power is applied to the computer, the CPU immediately begins executing a set of instructions at a pre-specified memory location. These instructions must direct the computer to begin its initialization process. Where did these instructions come from? You guessed it, they have been permanently "burned in ROM" (Read-Only Memory). Remember, ROM is not volatile. The instructions in ROM are part of the system's Monitor or Operating System.

FIGURE 3 illustrates the functions of the operating system. Notice that first some necessary "housekeeping" functions, such as zeroing accumulators, are done in the initializing process. Next, an attempt is made to read the disk, if one is connected. The disk operating system that has the instructions for the disk-drive controller is kept at a specified location on disk. This location is stored in ROM and the disk-operating system (DOS) routines are loaded in a special area of RAM (Random Access Memory), which is reserved for system use only, under control of instructions in ROM.

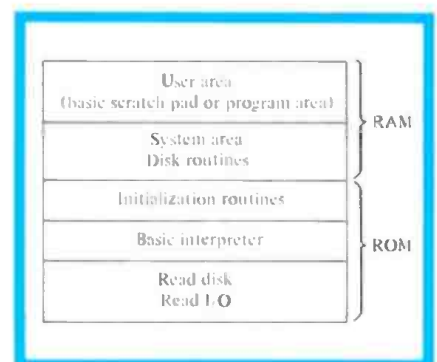

Figure 4. Memory map.

The sequence is as follows if a disk is attached: An instruction is sent to ROM to find the location of the DOS routine. After the routine is located, it is read into the special area of RAM reserved for system use. Thereafter, other information can be written to, or read from, the disk. The prompt character is next displayed on the screen and a wait for the keyboard begins.

After a set of characters is entered at the keyboard and the RETURN or ENTER key depressed, the characters are scanned. If they indicate a BASIC command without a line number, such as PRINT 2*3, the command is immediately executed and control returned to the keyboard. If the BASIC command is a deferred one (that is, a line number is specified), the command is stored in a scratch pad area of memory as illustrated in the memory map of FIGURE 4. Now I'm sure you're all asking yourselves, "Why is the BASIC interpreter in ROM?" The BASIC interpreter could have resided on disk and been read in. However, with it in ROM, the system may be used for BASIC programs without a disk.

If the command specifies loading and running a program, the program is first loaded into the system's memory and then control is passed to the program for execution of the program. In addition to the file name given to the program, the type of file is also kept. Files such as a BASIC program file, binary or machine language program file, or a data file are examples. Then, if the loaded file is a BASIC program file, the BASIC interpreter is used. If a Binary file is indicated, the instructions are already in machine language; therefore, the CPU executes each instruction directly.

Without the operating system, you couldn't use a computer system very easily or effectively. You certainly would have to write much more involved programs and enter them in machine language. Thus, an operating system is required for any computer system. Before the use of floppy disks for microcomputers, the operating system could handle the simple I/O and language support. With use of disks, everything changed.

The operating system controls the allocation of the system resources. It operates the disk system, keeping track of the storage and retrieval of programs and data. It also creates, opens, and closes files. The DOS contains all of the system utilities used

to format diskettes, to copy files and entire disks, lock and unlock files on disk, delete files on disk, etc. In addition, it provides the input/output connection for all of the languages running on the computer.

VARIOUS DOS

A DOS is indeed a complete language, full of commands that must be used in correct syntax to direct the operation of the system. Since the DOS is not one program, but a software system, learning it requires study and experience.

The language and application programs that you choose all depend upon the operating system that runs on the computer. Since the DOS also controls the input/output methods, it indirectly determines the type of peripherals you can use.

Often we read about some great new language we would like to use, or an application program that is just what we need. Upon reading a little more, we find that it runs on a different operating system, or uses a different disk format. Sorry, but you are just not going to run that software. However, with some computers, it is possible to change your operating system.

The Radio Shack TRS-80 Mod I, II, and III have TRSDOS in several versions, to say nothing of NEWDOS, VDOS, and LDOS. And they can also use CP/M. Zenith/Heath has its own system called HDOS, and you can also, choose CP/M or UCSD P-system. The Apple II family offers a choice of Apple DOS and the UCSD P-system, but you can also plug in a Z-80 and run CP/M; Apple III uses a new system called SOS; Commodore machines can only use the version of PET DOS that they were made to use.

If you begin to get the idea that CP/M is almost a *de facto* standard for microcomputers, you are correct. That's why IBM and Xerox made sure that their new micros could use it (with a special version called CP/M-86). CP/M offers the widest choice of languages and application software. It's interesting to point out that there are more Apples running CP/M than any other computer.

IBM has created a new standard, MSDOS, written by the people that brought us BASIC on microcomputers in 1975, Microsoft Inc. This new standard has spawned a new generation of MSDOS computers (or more commonly referred to as IBM clones).

The most popular operating systems in musical and audio applications to date are PET DOS and APPLE DOS, with MSDOS only having a limited library. Electrical engineering and CAD (Computer Aided Design) applications programs are mainly available in both APPLE DOS and MSDOS. The most widely used data base, word processing, and spreadsheet programs are written in CP/M.

With the advent of 16-bit chips and multi-user systems, new DOS's are being introduced. We do not know what the "CP/M" of the future will be, but there are already indications that today's CP/M software will be able to run under the new improvements.

LANGUAGE AND ENVIRONMENT

It would be nice if people and computers shared a common language. However, since human languages are so complex, it has been necessary to invent computer languages. Last month we discussed the more popular higher-level languages. This month we'll put that into the perspective of the computer environment.

The method of directly programming the microcomputer in binary form (or its equivalent) is called machine language. Everything else must be translated into machine language before it can be used by the microprocessor.

Programming in machine language consists of supplying the microprocessor with machine instructions, memory locations, and data in certain forms and sequences. The microprocessor can only distinguish between instructions and data through the form of the program. The instructions are unique to each microprocessor and are built into the chip, with the "power" of the microprocessor defined by the number and complexity of the instructions it can perform.

Programs written in machine language using binary numbers are almost impossible to read, so symbols were invented to stand for the instructions. These symbols are called mnemonics (memory aids). Assembly language uses mnemonics and a special syntax to write a program.

What we have learned so far is that higher level languages, such as BASIC, FORTRAN, and COBOL are a

human programmer's method of conveniently communicating with the digital computer. Thus, whatever language you use, the computer still demands that the program be read as a sequence of binary numbers. A program called an assembler translates the programs that you input in Assembly language into instructions that the computer can understand and execute. A program called a compiler executes the same conversion process for higher-level language programs.

A program written in a programming language is referred to as a source program. Once the program has been converted to the sequence of numbers that the computer can understand, it is then called an object program. Thus, assemblers and compilers read in data (your source program) and convert it to another form of data (an object program). There are two types of compilers. One type converts your program into a form the computer can directly execute and save in converted form. The second type of compiler never translates your source program in its entirety to an object program; this type of compiler is called an interpreter. When you use an inter-

preter, your entire source program resides in memory, along with the interpreter, throughout the entire execution time of the program. The interpreter converts your source program into object code as it is needed.

Higher level languages are easier to use than Assembly language because they represent the problem rather than the computer. Another advantage of higher-level languages is that they are not designed with any computer in mind. If you write a program in a higher-level language, you can convert that source program to an object program that will run on any computer, provided the computer has a compiler (or interpreter) for your higher-level language.

On the other side of the fence, Assembly languages have their advantages. Assembly language generates shorter object programs than do higher-level languages. Because these programs are shorter, they run faster by a factor of two or more. Assembly language doesn't "eat up" memory with longer programs, compilers, or interpreters; this makes them more effective in writing advanced applications software.

Confused about these languages?

Not to worry. Now we have program generators—software that produces other programs. If you want the computer to do something new, you no longer have to write a program; you just run a program generator, which asks you questions about what you want your new program to do. A program that used to take many weeks to write can be produced by a program generator in less than an hour! Within a few years, only a small fraction of all computer professionals will need to be fluent in a complex computer language.

All of the microcomputer systems of this fourth generation that we are currently using are akin to the Model T Fords; the Model T's had hand crank starting, manual chokes, manual transmissions, and top speeds of around 30 mph. We are now on the verge of the fifth generation of microcomputers, in which we will see machines that are more powerful, economical, and will interface with human beings. The Apple MacIntosh is the beginning of this next generation; one of its many revolutionary features is that it has been designed to operate in a real world environment—the machine adapts to the human, not vice versa. ■

Do You Know Where?

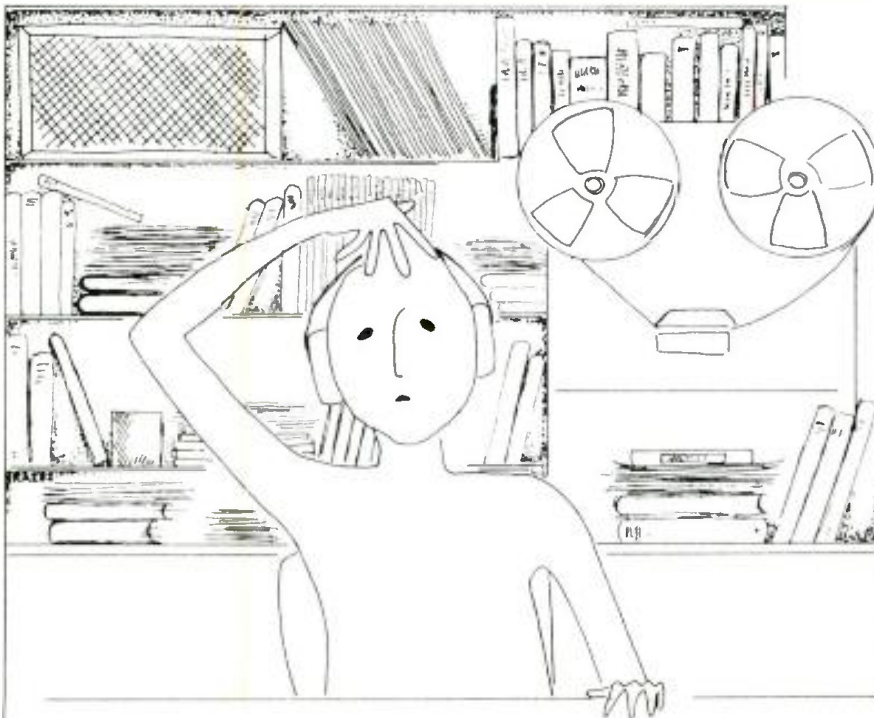

Have you misplaced your db again? Our high quality, royal blue vinyl binders keep 12 copies of db neat and handy for ready reference.

Just \$9.95, available in North America only. (Payable in U.S. currency drawn on U.S. banks.) ORDER YOURS NOW!!

Sagamore Publishing Co., Inc.

1120 Old Country Road
Plainview, NY 11803

YES! Please send _____ db binders @ \$9.95 each, plus applicable sales tax. Total amount enclosed \$ _____

Name _____

Company _____

Address _____

City _____

State/Zip _____

The FFT, Part II

• The FFT is an abbreviation for the term Fast Fourier Transform, which is nothing more than a computer algorithm for implementation of the old-fashioned Fourier transform. In the computer business it seems that we always need a fancy word with initials to describe old ideas. What we are often not told is that the essence of the FFT is really nothing more than that of the DFT, which stands for Digital Fourier Transform. And this is nothing more than the computer version of the analog Fourier transform.

Although we have now connected the jargon to an old idea, you may not be familiar with the Fourier transform itself. Even if you know that it means spectrum, you may not be familiar with its origins. The complex definitions found in textbooks usually require a sophisticated understanding of an idea which should require almost no mathematics; the transform is really based on the concept of averaging.

FOURIER TRANSFORM

The transform is a fancy way of saying that a signal can be described in two different languages. The transform is the operation that converts from one language to another. One language is the time description: We define a signal for each instant of time. The other language is a spectrum description: We define the signal for all possible frequencies.

In FIGURE 1, there is a time description on the top which shows a voltage value for every possible time (the figure is limited, but assume that it goes on forever). On the bottom, there is a frequency description which shows a voltage value for every possible frequency. In this example, the values are zero, except for 1 kHz and 3 kHz.

FIGURE 2 shows the same kind of picture except that the signal is an exponential time pulse. Now the spectrum shows energy at many frequencies. This is the spectrum we would get if the signal was passed into an ideal set of bandpass filters.

The intuitive approach, demon-

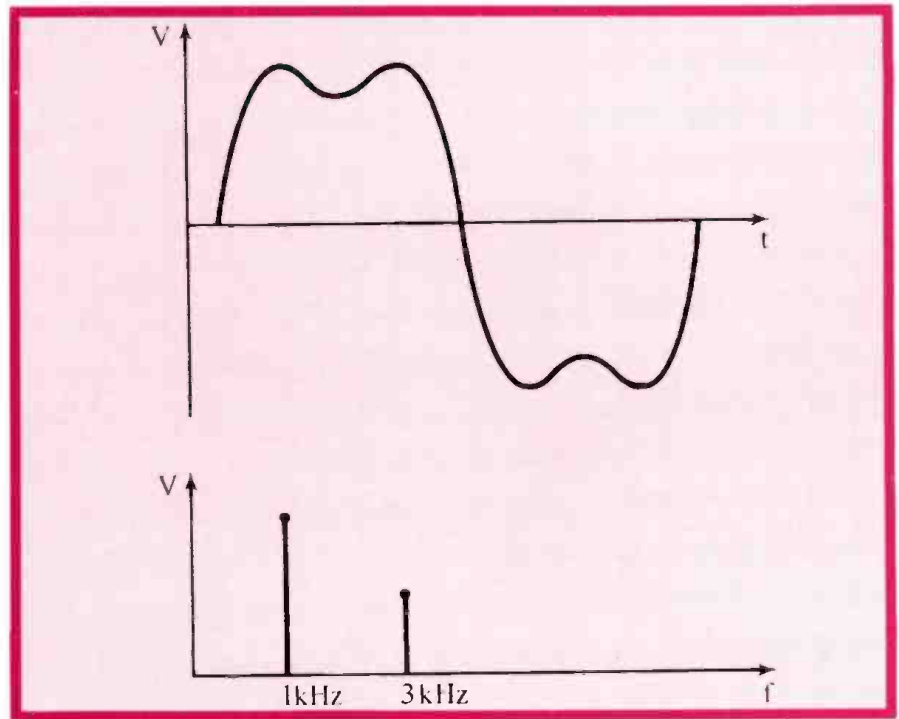

Figure 1. A time signal (top) with a value for each time and a frequency signal (bottom) with a value for each frequency. Both contain the same information and describe the same signal.

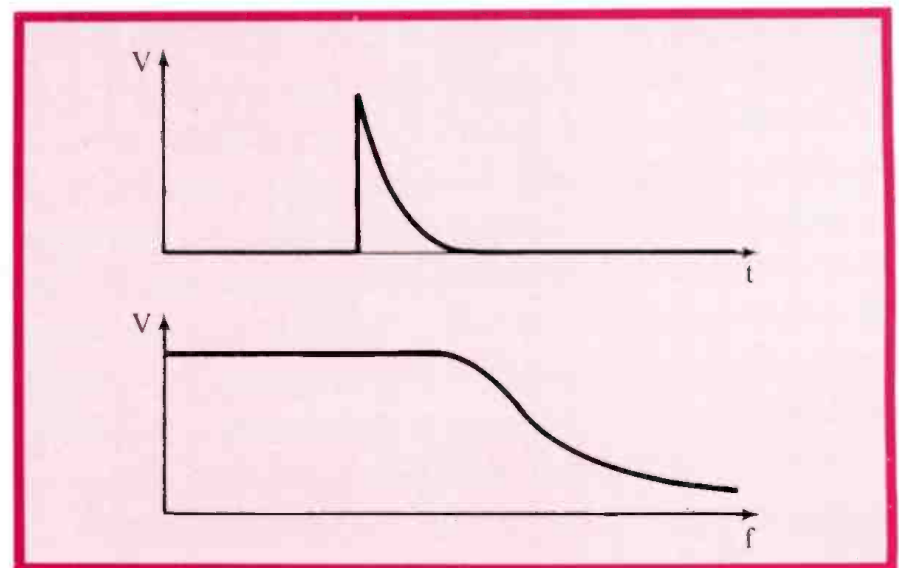

Figure 2. This is the same as FIGURE 1 except that the signal is a pulse in time. Notice that it has energy at many frequencies.

strating a transformation between time and frequency, can be formulated with mathematics. The concept of a spectrum can be defined as how much of a given frequency is present in a signal. To create a mathematical way of measuring a frequency, we need to observe the fact that the

This is a very elegant result. If we wish to know whether there is any 1 kHz energy in an unknown signal, we simply multiply that unknown signal by a 1 kHz sine wave from our generator and average the result. If the result is 0, then we know that there was no 1 kHz sine wave energy in

number of time values in any interval. The same holds true with frequency. All possible frequencies do not exist in the digital domain. With a 50 kHz sampling rate, a 1 kHz sine wave has only 50 discrete values, each spaced 7.2 degrees apart.

Suppose we only consider 50 discrete time points at a 50 kHz sampling rate. This covers a time span of 1 msec. We thus see that 1 kHz is the lowest frequency that can still have a single full cycle of a sine wave. We could have two cycles of a 2 kHz sine

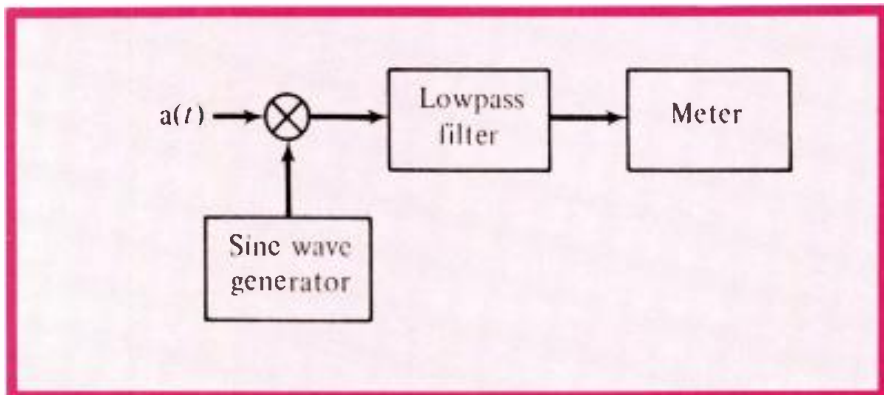

Figure 3. A spectrum analyzer based on the Fourier transform.

average value of a sine wave is zero. The average value of a sine wave multiplied by another sine wave is also zero if the two sine waves are different in frequency. The exception is what makes for a transform. The average value of a sine wave multiplied by another sine wave of the same phase and frequency is 0.5!

For convenience, we will represent the process of averaging by placing a bar over the expression. Thus, the average of a sine wave is written as:

$$A = \sin(\omega t) = 0 \quad (1)$$

Similarly, with a product of two sine waves of frequencies ω_1 and ω_2 we would get the following:

$$A = \sin(\omega_1 t) \times \sin(\omega_2 t) = 0.5 \cos((\omega_1 - \omega_2)t) - 0.5 \cos((\omega_1 + \omega_2)t) \quad (2)$$

This, of course, is also 0 since the two terms on the right are themselves sine waves, each of which has an average value of 0. But, if $\omega_1 = \omega_2$, then equation (2) reduces to

$$A = 0.5 \cos(0)t - 0.5 \cos 2(\omega t) = 0.5 \quad (3)$$

The averaging of a product of a sine wave with an unknown signal becomes a way of extracting the magnitude of the sine wave at the frequency of the sine wave.

the signal. If the average is not 0, then the average tells us how much of that sine wave was in the signal.

What we have presented is not really a simplification; many commercial spectrum analyzers are built using nothing more than the averaging process we have described. FIGURE 3 shows a block diagram of such a system. The unknown signal $a(t)$ is applied to one port of a multiplier while the other port is driven by a sine wave generator having a selectable frequency. The multiplier's output is averaged and used to drive a meter or display. By changing the generator frequency, we can change that component of the incoming signal which we wish to measure.

To get the full spectrum one would have to repeat the process for all frequencies. There are ways to avoid doing this, but they will not be considered here.

DFT

We are now in a position to consider the application of the Fourier transform to the digital world. As you may remember, the digital world is made up of a discrete series of time samples; we only need to consider those discrete time values. Unlike the analog world, which has continuous time, the digital world only has a countable

When everyday problems pile up, don't take it out on your kid. Try any or all of these alternatives:

1. Stop in your tracks. Step back. Sit down.
2. Take five deep breaths. Inhale. Exhale. Slowly, slowly.
3. Count to 10. Better yet, 20. Or say the alphabet out loud.
4. Phone a friend. A relative. Even the weather.
5. Still mad? Punch a pillow. Or munch an apple.
6. Thumb through a magazine, newspaper, photo album.
7. Do some sit-ups.
8. Pick up a pencil and write down your thoughts.
9. Take a hot bath. Or a cold shower.
10. Lie down on the floor, or just put your feet up.
11. Put on your favorite record.
12. Water your plants.

For more parenting information, write:
National Committee for Prevention of Child Abuse
 Box 2866, Chicago, IL 60690

Take time out. Don't take it out on your kid.

wave or three cycles of a 3 kHz sine wave, etc. In other words, we can only represent 25 sine waves when we have 50 sample points. But, sine waves come in two flavors: sine and cosine. We actually have 50 spectral components made up of 25 sine waves and 25 cosine waves. Notice that 50 time samples match the 50 spectral components.

The transformation of 50 time values to 50 spectral values is not cumbersome; we could just as easily transform 50 spectral values to 50 time values. The averaging process described previously can easily be implemented in the digital domain. Our spectrum analyzer of FIGURE 3 becomes the equation:

$$A = \frac{1}{50} \sum_{n=0}^{49} \sin(\omega nT) \times a(nT) \quad (4)$$

where:

T is the sampling period and n is the pseudo time index.

Remember, time values only exist for the sampling points. With 50 kHz, there is a time sample at $t = 0$ [$n = 0$], $t = 20 \mu\text{sec}$ [$n = 1$], $t = 40 \mu\text{sec}$ [$n = 2$], etc. It is easier to keep track of time with n rather than with t.

The value of A in equation (4) is the amount of spectral energy at the frequency ω . To get the full spectrum this equation has to be repeated 50 times. In each equation there is a sum of 50 products. To get the full spectrum thus requires us to do $(50)^2$ multiplication. Because the multiplication rate of most computers is slow, the DFT is a time-consuming algorithm when the number of points becomes large. With our example of 50 points, there are 2,500 multiplications. For a more interesting time span of 1024 or 4096 time points, the number of multiplications becomes 1 or 4 million.

A typical microprocessor might require 500 μsec to do a floating point multiplication. The total DFT for 1024 points becomes 500 seconds or 10 minutes. The duration of this signal was only 20 msec!! This problem resulted in less extensive use of the DFT. The solution was invented in the mid 1960s: the Fast Fourier Transform. By re-ordering the terms, the number of multiplications could be reduced dramatically. This reduction made the Fourier transform a more interesting tool. Instead of 1 million multiplications for 1024 data points, there were only 10,000. This is a 100:1 reduction in computational time. The result is the same as with the DFT, only the speed is faster.

THE FFT ALGORITHM

The first thing we need to observe is that the ω in equation (4) cannot take on all values. Our examples limited the ω to 1 kHz, 2 kHz, etc. We could thus consider any ω as being defined as

$$\omega = \omega_0 k \quad (5)$$

where:

ω_0 is 1 kHz for our example, and k is any integer from 1 to 25.

Now, when we look at equation (4) for two sets of computation such as 1 kHz and 2 kHz, we find the following:

$$A_1 = \frac{1}{50} \sum \sin(\omega_0 nT) \times a(nT) \quad (6a)$$

$$A_2 = \frac{1}{50} \sum \sin(\omega_0 2nT) \times a(nT) \quad (6b)$$

Note that many of the terms in these equations appear to be similar, yet not the same. What we will now do is find another way to represent the various sine wave terms as a set of products and then factor out common terms. This will be a way to extract the similarities to avoid doing all of the computations. The FFT algorithm is a particular way of constructing the sine wave terms such that they can be factored into a set of expressions with less multiplies. The bookkeeping saves us from doing multiplication that could have been avoided. When we do a multiply we make sure that it multiplies more than just one term.

Since we are now concerned with finding a "bookkeeping" method to keep track of all the product terms which are the same in the 50 sets of equations like (6), we must do a little mind stretch. If we look at a particular time sample $a(nT)$ in all of the equations, we will notice that the product terms are of the form $\sin(\omega_0 nT)$, $\sin(\omega_0 2nT)$, $\sin(\omega_0 3nT)$, $\sin(\omega_0 4nT)$, etc. Each of these is of the form $\sin(\theta)$ where (θ) is defined as:

$$\theta = nk \omega_0 T \quad (7)$$

where:

$$\omega_0 T = \frac{1}{50} (2\pi)$$

In other words, we have an incremental angle, in our case 7.2 degrees, and all the multiples of it. There are 50 of these possible angles. Therefore, our problem reduces to find a simple way of generating the 50 $\sin(\theta)$ terms.

This last step is a bit complex. If you will remember from last month, we demonstrated that complex numbers are able to do a phase shift when we keep track of the sine part as the real number and the cosine part as the complex number. Our 50 equations are made up of 25 sine parts and 25

cosine parts. Therefore, we can use complex numbers at this point.

The complex number (.992-0.125j) is able to create a 7.2 degree phase shift. The number (.969-0.2453j) is able to create a 14.4 degree phase shift; the number (.929-0.368j) is able to create a 21.6 degree shift. We can continue to find a set of complex numbers which produce 43.2 degrees, 86.4 degrees, etc. Since multiplication of these complex numbers is equivalent to an addition of the phase, combinations of these can create any multiple of the 7.2 degrees. The product of the first two terms gives the third. Just as in an A/D converter where each bit has twice the value of the previous one, we only create the complex numbers for 7.2 degrees, 14.4 degrees; 28.8 degrees, 57.6 degrees, etc.

This means that a given phase shift is a product of six terms, any of which could be a 1. The expression for 7.2 degrees would thus be (.992-0.125j) (1) (1) (1) (1) (1); the expression for 21.6 degrees would be (.992-0.125j) (.969-0.2453j) (1) (1) (1) (1). It now looks like we have taken a step backwards because we have to create six additional multiplications for each $\sin(\theta)$. The key is that the terms are all common in these 50 expressions and a large amount of factoring can be done. When the task is finished, we find that the number of multiplications has actually been greatly reduced. The elegance requires a few additional constraints, the most important of which is that we can only work with a set of samples which is a power of 2. Our example of 50 points would not work, but 64 would. The set of base complex numbers would then correspond to the following list: 5.625 degrees, 11.25 degrees, 22.5 degrees, 45 degrees, 90 degrees, 180 degrees. It is easy to show that binary sums can create any multiple of 5.625 degrees. For example, 73,125 degrees is 6.625 degrees plus 22.5 degrees plus 45 degrees which is 13×5.625 degrees.

If you think this is complicated, you are right. Moreover, it took several mathematicians at IBM until the 1960s to discover that this kind of complex bookkeeping results in a reduction in the multiplications from n^2 to $n \log_2(n)$. The bigger n is, the bigger the savings. For $n = 4096$, we are comparing 49,152 multiplies with 16,777,216. This is a savings of a factor of 341!

Next month we will do something simple, so stay with us. ■



The Role of Time Delay in Distributed Systems

• Where utmost naturalness is a necessity, time delay can be used with certain distributed systems to create the psychoacoustical impression that a sound source appears in the direction of the talker rather than at an overhead or local loudspeaker, which may be operating at a much higher level.

Only in the last twelve or so years has reliable electronic time delay been available for these purposes. In earlier days, acoustical delays using pipes to couple microphones and loudspeakers were occasionally specified for delay. Tape loops were never a satisfactory solution for a permanent installation, due to inevitable wear on the tape loop itself.

THE HAAS EFFECT

The Haas, or precedence, effect is the important factor in specifying time delay in a system. The basic effect is shown in FIGURE 1. If two loudspeakers are fed the same signal, as shown in 1A, there will be a phantom image between them. This effect is well known to anybody who has ever listened to a stereophonic playback system.

If a five-millisecond delay is introduced into the right loudspeaker, as shown in 1B, the listener will clearly localize the source of sound at the left loudspeaker, even though the two loudspeakers are putting out the same level as before.

Now, if the leading (left) loudspeaker is reduced some 10 dB in level, as shown in 1C, the image will tend to move back to the middle. It may not be as clearly centered as in the case shown in 1A, but it will be perceived as coming from somewhere between the two loudspeakers.

If the delay is increased, a constant 10 dB level imbalance will maintain

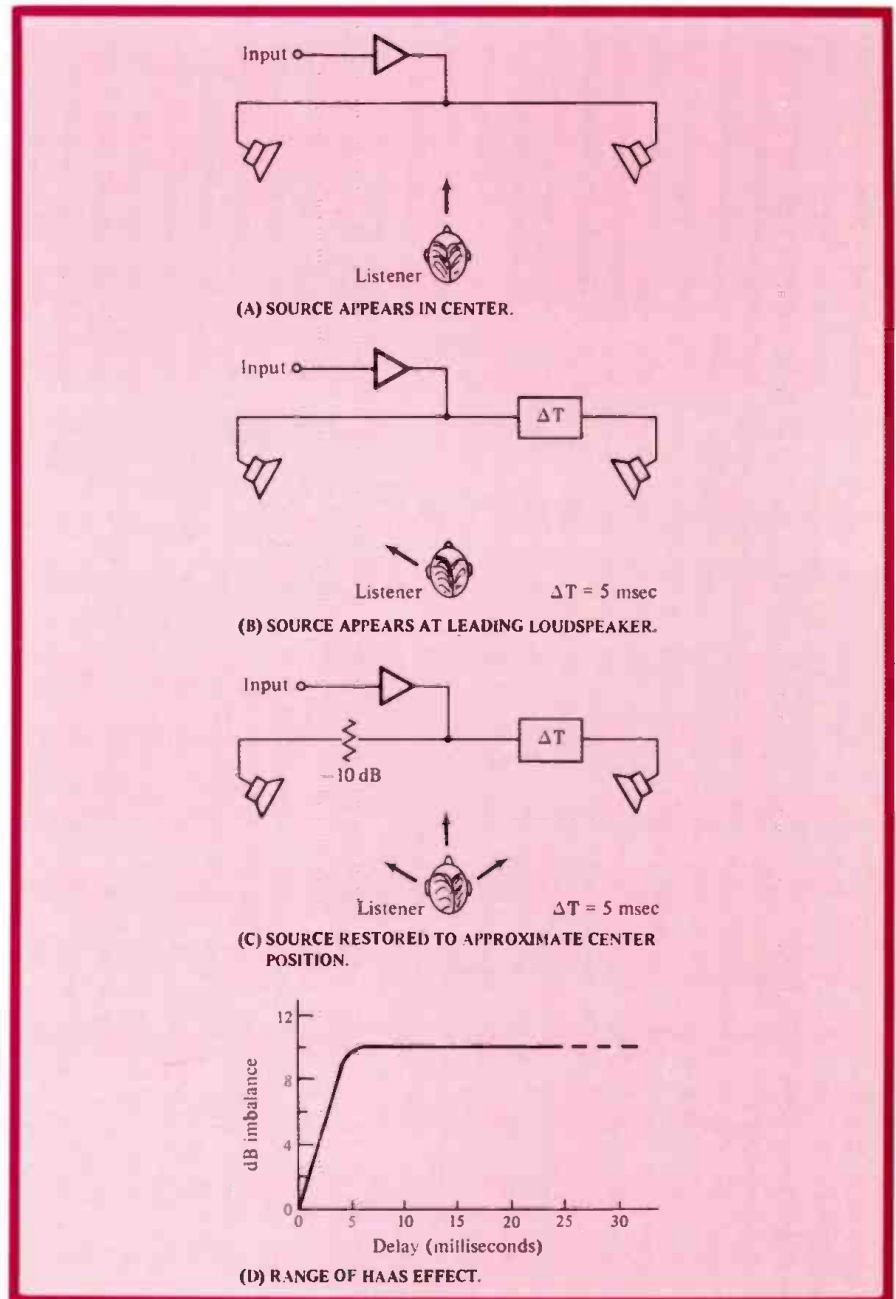

Figure 1. The Haas Effect. A) source appears in center, B) source appears at leading loudspeaker, C) source restored to approximate center position, and D) range of Haas Effect.

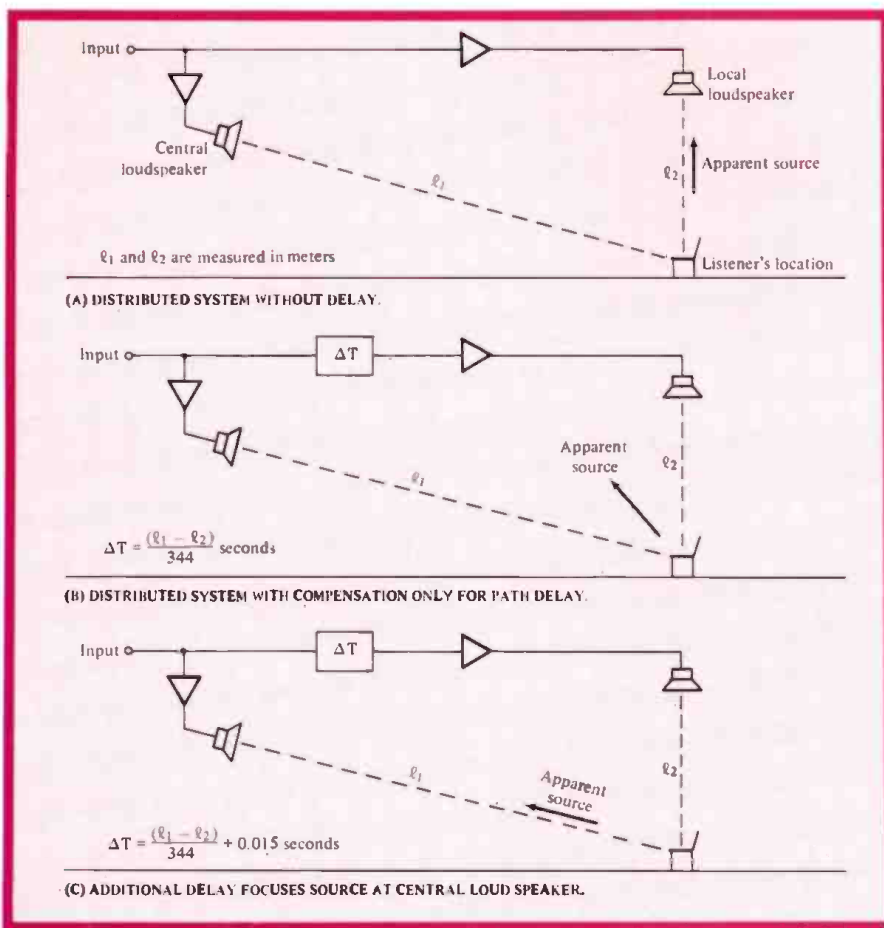

Figure 2. The Haas Effect in sound reinforcement.

approximate center localization. This effect will continue up to some point, in the 25-to-30-millisecond range, where the listener will begin to hear two distinct sources. The range of the effect is shown in 1D.

In sound reinforcement, we use the Haas effect, as shown in FIGURE 2. In a large reverberant room, for example, listeners in the rear of the room may have difficulty hearing a central loudspeaker clearly. If a local loudspeaker is placed close to the listener, as shown in 2A, the sound from that loudspeaker will arrive much earlier than that from the front loudspeaker, and the listener will localize the source at the local loudspeaker. Although he/she will understand speech better, the effect is an unnatural one.

Our first step to correct this problem is shown in 2B. Here, we simply delay the local loudspeaker by an amount equal to the delay path from the front loudspeaker to the local one.

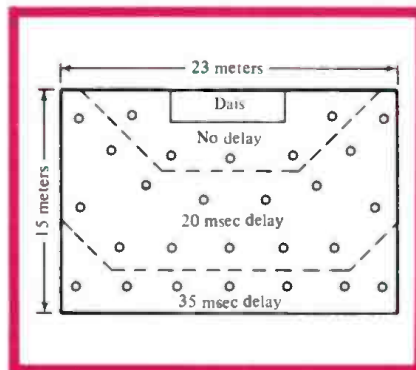

Figure 3. Zoning distributed systems; a ceiling system in a ballroom.

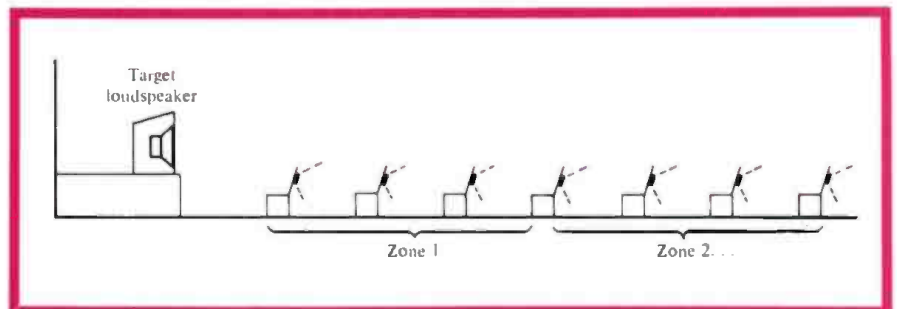

Figure 4. A pewback system.

When we do this, both loudspeakers may be operated so that the listener hears them at the same level. Under this condition, the source of sound may appear to be somewhere between the two.

Now, as shown in C, we delay the local loudspeaker an additional 10 to 15 milliseconds. In doing this, we make it possible to increase the level of the local loudspeaker up to 10 dB relative to the central loudspeaker. Even under this condition, the listener will perceive the source of sound at the central loudspeaker, and speech reinforcement will be quite natural.

ZONING OF TIME DELAY

In large distributed systems, time delay zones are useful. Intervals of every 15 or 20 milliseconds are common (see FIGURE 3).

Perhaps the most elegant application of time delay in distributed systems is embodied in a pewback system in a house of worship. FIGURE 4 illustrates this.

In a pewback system, small loudspeakers are placed every two meters or so on the backs of the pews. The delay zoning may be every five or six rows, with an appropriate additional delay, as suggested in FIGURE 2C.

There is usually a target loudspeaker located at the pulpit. This is operated at a fairly low level; its only role is to provide focus to the perceived source of sound at the front of the room. Obviously, the local loudspeakers provide the bulk of the sound heard by the listeners, while the target loudspeaker becomes the effective source of the sound.

Such systems are extremely effective in large reverberant spaces, inasmuch as the local loudspeakers do not generate a significant reverberant field. The drawback of such a system is the high labor cost of installing it. ■

A Question of Shows

WE'RE BACK FROM the AES Anaheim. It was a success as a conference, with a rich, varied, and well attended lecture series. However, there were some 60-plus exhibitors in attendance, and each agrees, with apparently no dissention, that the attendance at the booths was a total failure. Perhaps it wasn't really so bad; some manufacturers told us that attendance, while way down, was high quality. But, be that as it may, attendance, by all previous standards, was way down, leaving most manufacturers wondering why they were there. It also left those manufacturers that boycotted the conference, but attended personally, convinced that they had done the correct thing.

It must be understood that the question of one U.S. show versus two U.S. shows is controversial. Many manufacturers must attend a number of shows per year—AES, CES, NAB, SMPTE, as well as sound contracting and other broadcast and recording regional shows—each year!

This, in part, answers the question of one or two AES shows. The simple fact is that the two shows, when they were existing, were almost universally well attended for both the papers and the exhibits. So, the argument that there are too many AES shows does not hold water.

The professional audio market needs trade shows. The manufacturer needs *good* trade shows, where he can reach his customers. But is AES that kind of show? Probably not. There is the need for an independent, well run

selling show, on the style of the NAB or NAMM. These kinds of shows will generate sales, and that, after all, is what the manufacturers want, and need. Can the AES run them? Probably, but only if they will separate the shows from their other non-profit concerns and run them as true selling shows.

This, then, brings up another question. Why do we, when we buy a booth from non-profit AES, pay \$12.00 sq./ft. plus dock-to-booth drayage costs, and our sister publication, *Modern Recording & Music*, pays for-profit NAMM only \$7.00 sq./ft. including drayage? (A typical single booth is 10×10 ft.) Multiply our single booth requirements with major manufacturers' multi-booth needs, and cost differences escalate.

Finally, when there were two U.S. shows, it seemed to us that at times the AES was searching for papers needed to fill the time, while at the same time, the exhibitions were well attended. So, what makes sense to us is the following: There should be two U.S. selling exhibitions per year. Papers should either precede or follow the exhibition, though there could be a day or two of overlap. One show should generally be on the east coast and the other should generally be on the west coast. We say generally, because these trade shows should go, sometimes, to other places besides NYC and LA/Anaheim. Why not mount an exhibition in Chicago, Las Vegas, San Francisco, Miami, Nashville? We hope we've given you some things to think about. Write to us about your thoughts. We do want to know. L.Z.

Problems With CDs— Real Or Imagined?

Much has been written about the problems with CD software. Well, what about the hardware?

IF NOTHING ELSE, the introduction and apparent proliferation of Compact Discs and CD Players has provided the professional and consumer audio press with ample subject matter for an ongoing debate. Enough has now been written about the pros and cons of the laser-read digital Compact Disc to fill several volumes of text. Having read a good deal of this material (and written some, too, I confess), I have been struck by the fact that most of the criticism—and for that matter the plaudits—have been based purely upon intuitive conjecture and, in some cases, subjective judgment that makes no distinction between the CD system itself and samples of the software produced for that system.

Indeed, it is difficult to separate the audible effects of inferior software from the deficiencies (if there are any) inherent in the CD system as standardized by Philips and Sony. One valiant attempt to do so has been made by Robert Carver who, working with a psychoacoustician in the Seattle area, spent more than a year analyzing the differences between the “sound” of certain CDs and the “sound” of their LP equivalents. Carver has been noted for his so-called Sonic Holography products which, through manipulation of stereo difference (L-R) signals and phase relationships, manage to present listeners with an illusion of increased stereo spread and depth.

Since one of the criticisms aimed at certain CDs has been their “loss of stereo depth or spaciousness,” Carver analyzed the L-R content of such discs and compared this signal with that of the corresponding LP discs. Much to his amazement, he discovered that, invariably, the CD version contained less L-R information than did the LP. The difference, moreover, was not trivial; it often amounted to as much as 3 dB. That’s another way of saying that the stereo difference signal obtained from the CD disc was *half as powerful* as the difference information contained in the LP version of the same recording. A simulation of these experiments was repeated in my own lab, and the results are shown in FIGURES 1A and 1B.

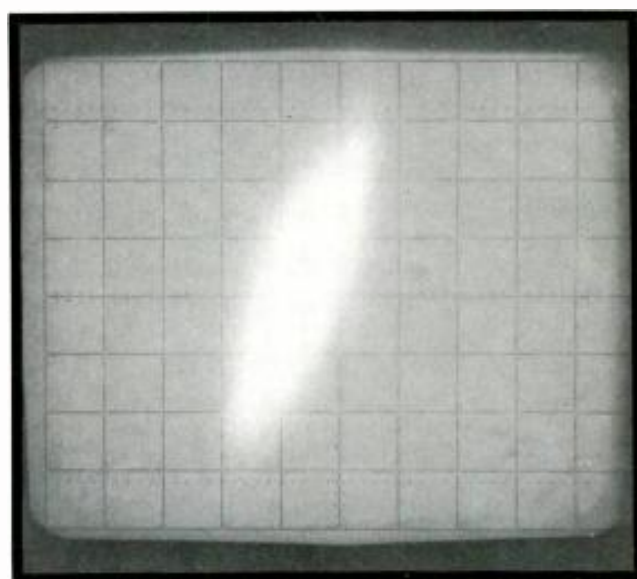

(A)

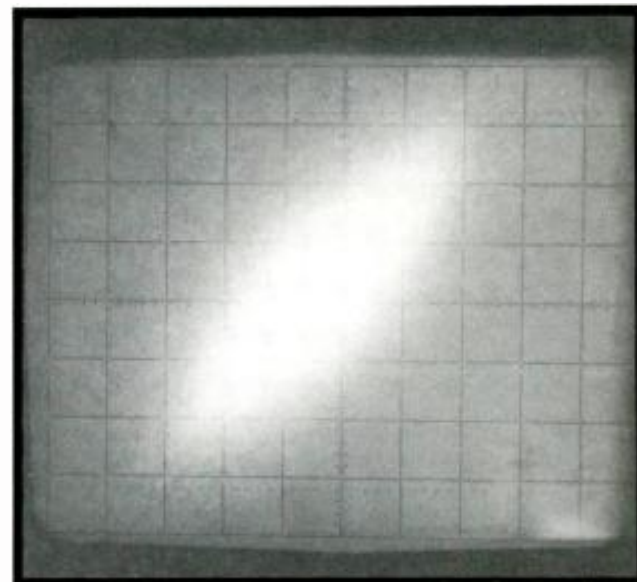

(B)

Figure 1. “Thickness” of ellipse depicts amount of stereo difference (L-R) signal. Note how much less L-R signal is present in first 5 seconds of play of a particular CD (A), compared with first 5 seconds of play of the equivalent LP disc (B).

Carver went further. He next compared the energy versus frequency content of CDs and LPs of identical moments of musical material. Arbitrarily assuming that the LP version of the recording was nominally “flat” in response, he discovered that the CD version of the same musical moment exhibited a definite rising characteristic in the 3 to 5 kHz region of the audio spectrum, as illustrated in the curves of FIGURE 2. According to Carver, that would explain the so-called “harshness” or “brittle high end” that has been noted by some critics when listening to certain early CDs. Carver makes no attempt to explain *why* these measurable differences occur, suggesting that somewhere along the line, during the re-mix of the original master tapes for CD, recording engineers are “doing something wrong”—deliberately or inadvertently.

Rather than pursue the matter further, Bob Carver, in his typical fashion, has come up with a “solution” to these problems in the form of another one of his “magic black boxes”—this one dubbed a Digital Time Lens. The new product simply reverses the processes discussed, increasing the amount of L-R through judicious matrixing and rematrixing, and altering the overall frequency response of signals fed into it to compensate for that 3-5 kHz rising characteristic. To add a little spice to the mix, Carver’s product also introduces a bit of low-level random noise, or “dither,” so as to mask any coherent quantization noise which might otherwise be detected when listening to low-level signals at high volume settings.

It is to Carver’s credit that he publicly announced that this product is to be considered an “interim” product with a life of no more than two years or so. His contention is that by that time, the recording industry will have learned how to deal with the new CD medium, and the sonic defects attributable to the software will have disappeared. Indeed, the product may not even last that long, judging by some of the recently released CDs I have acquired.

WHAT ABOUT THE BASIC CD SYSTEM ITSELF?

If we can assume that problems with CD software are or will be solved, that still leaves us with whatever problems are inherent in the CD system itself, or in the hardware used to play CDs. It is in this area that I decided to do some exploring of my own. Since I wanted to eliminate software from the “mix,” I decided to do some experimenting with a couple of special, digitally generated test CDs that I normally use to evaluate the performance of CD players. The test discs used were Philips #410 055-2 and Sony YEDS-7.

DISTORTION VS. LEVEL

It is well known that the harmonic distortion specifications quoted for CD players are those obtained when reproducing a signal recorded at maximum recording level. Unlike audio amplifiers, whose distortion tends to increase with increasing power output, the distortion produced when playing a CD varies inversely with the level of the recorded signal. This is a very logical result of the way in which digital sound is

recorded. Lower level signals have fewer and fewer “number values” with which to describe their exact amplitude. In a 16-bit digital encoding system, at maximum recording levels (0 dB reference), there are 65,536 available “numbers” or levels with which to describe the instantaneous amplitude of a given sample of any waveform. At a level that is roughly 72 dB lower than maximum, there are only 16 discrete “numbers” available to describe any instantaneous sample. At that level, linearity errors as great as 0.5/16 may arise, which amount to an equivalent THD of more than 3 percent!

If you listen to a single test tone, as reproduced on the Philips test disc mentioned earlier, there is a test available in which this mid-frequency tone is reduced in amplitude, in discrete steps, from 0 dB recording level all the way down to -90 dB. To hear the lowest level tones in this test sequence, it is, of course, necessary to keep turning up the volume control on your monitor amplifier as the signal gets lower and lower. When you get down to about -70 or -80 dB, the tone begins to sound distorted—rich in new harmonics—almost approaching the sound of a triangular waveshape or even a square wave.

Does that mean that reproduction of low-level musical signals in CDs is necessarily distorted? Yes. Does it also mean that these distortion components are audible? Emphatically, *no!* There are at least two reasons for this seeming contradiction. First, there is the matter of noise floor. Consider the scope photos in FIGURE 3. These were taken from the CRT of a spectrum analyzer, sweeping logarithmically from 20 Hz to 20 kHz, while reproducing a 1 kHz test signal from the Philips test disc. In FIGURE 3A we see the reproduced 1 kHz tone in the form of a spike near the center of the screen. The level of 1 kHz during this test was maximum recording level, or 0 dB reference, and there is no evidence of noise or distortion at the bottom of the screen. Vertical sensitivity of the display is 10 dB per division, so we are looking at a signal level that is approximately 74 dB above the bottom of the screen.

In FIGURE 3B the reproduced signal is 60 dB lower than

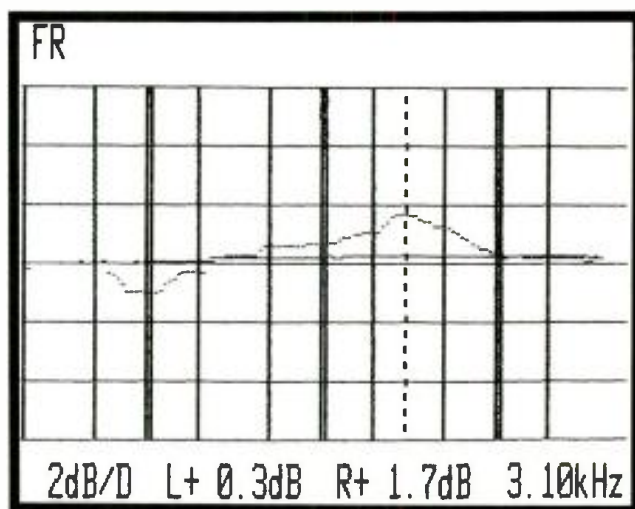
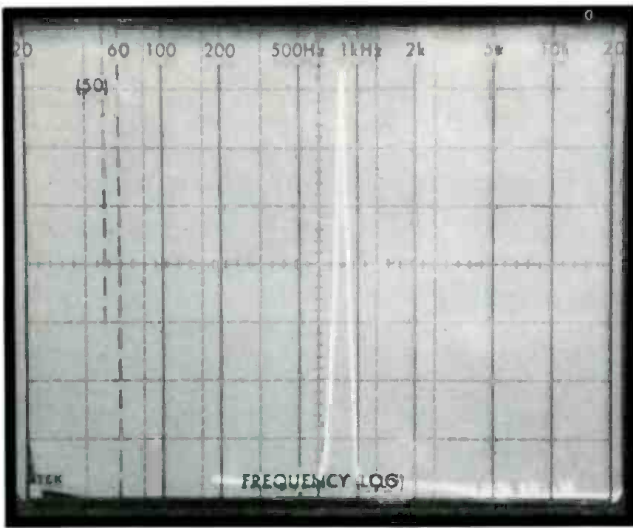
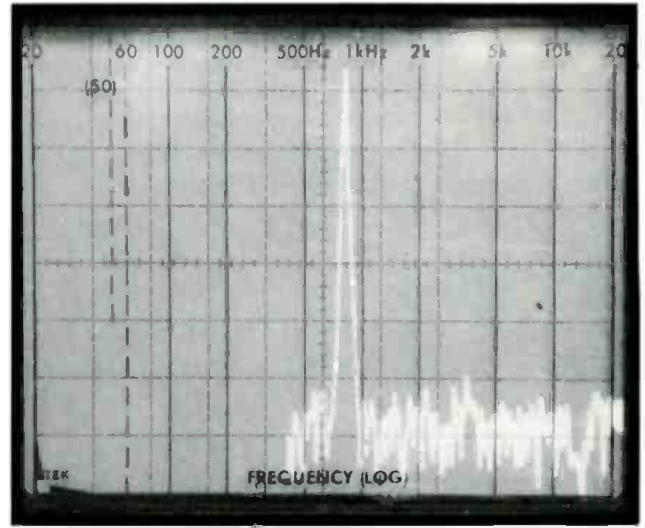

Figure 2. Response of overly bright sounding CDs is generally peaked in 3-5 kHz region compared with output from equivalent LPs. In this plot, scale is 2 dB/division, and differences as great as 1.4 dB are observed between “L” reference plot and “R” CD comparison plot.



(A)



(B)

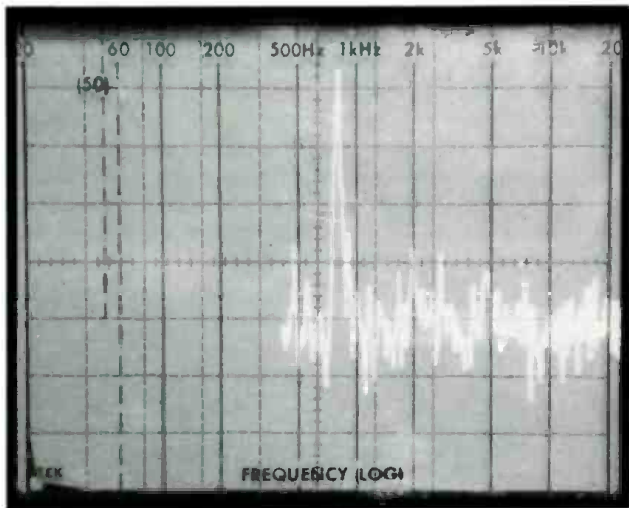

(C) Figure 3. Referenced to maximum record level, noise and THD are not visible in spectrum analysis photo (A). At -60 dB level (B), noise and THD are more than 50 dB below signal level, while at -80 dB, noise and THD are only 30 dB below signal level (C).

realistic listening conditions, the softest tones of music are likely to be some 70 dB or so lower than the loudest tones. Assuming we are listening in a room that is reasonably quiet, we should be able to hear those soft -70 dB passages of music. Now, consider their distortion components. We have said previously that they may be approaching 3 percent at such low levels. But 3 percent distortion means that the sum of all the unwanted harmonics of the soft tones are still 30 dB lower than the tones themselves! That would put them at -100 dB relative to the loudest tones, making the distortion components themselves inaudible in virtually any real-world listening environments!

SQUARE WAVES, FILTERS, AND SAMPLING

Much has been written about the fact that CD players can't accurately reproduce square wave signals. While most of us don't listen to square waves as a rule, let's explore this problem anyway. First, I would suggest that before you jump to any conclusions, you get yourself a good LP test record that contains square wave test signals (CBS Records' STR-112 might be a good one to start

before, but we have increased the gain of the spectrum analyzer so that the desired signal appears on-screen at the same level as before. Now, however, random noise has come up and is masking or obscuring any higher order harmonic distortion components that must surely exist at such a low level. In FIGURE 3C the effect is even more pronounced, as the signal level is now 80 dB below 0 dB reference level (we have again increased analyzer vertical gain to keep the desired signal spike at the same level on the 'scope face) and, as you might expect, noise floor (and whatever distortion is hidden behind the noise) has risen by another 20 dB relative to the signal level.

While it is true that we are unable to detect distortion components in the 'scope photos of FIGURES 3B and 3C, we were able to hear the distortion when we listened to these tones as we turned up the volume control for *each successively lower level tone*.

Now let's return to the real world of musical reproduction. We are not going to turn up the volume control in order to be able to hear those low-level tones reproduced loudly. We're going to set the volume control so that the loudest tones of music don't shatter our eardrums, and let the soft tones "fall where they may." Under these more

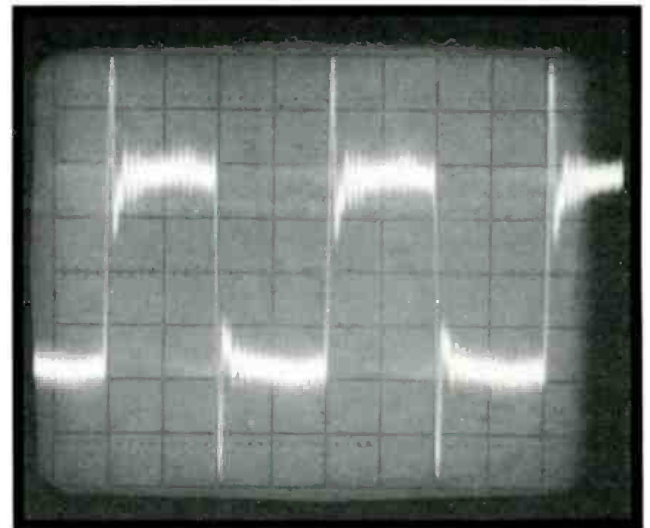
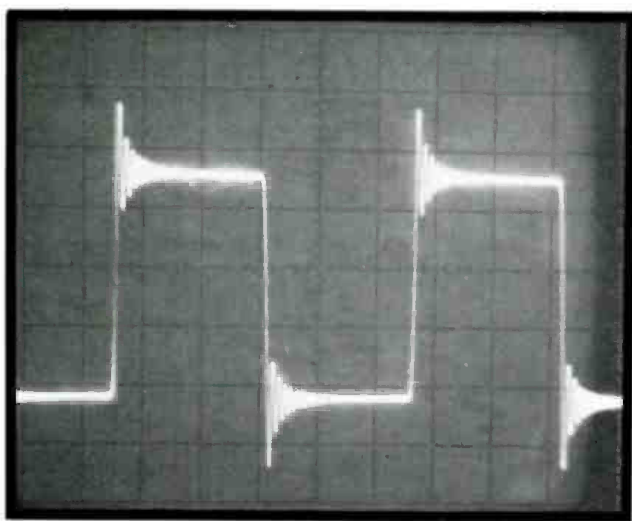
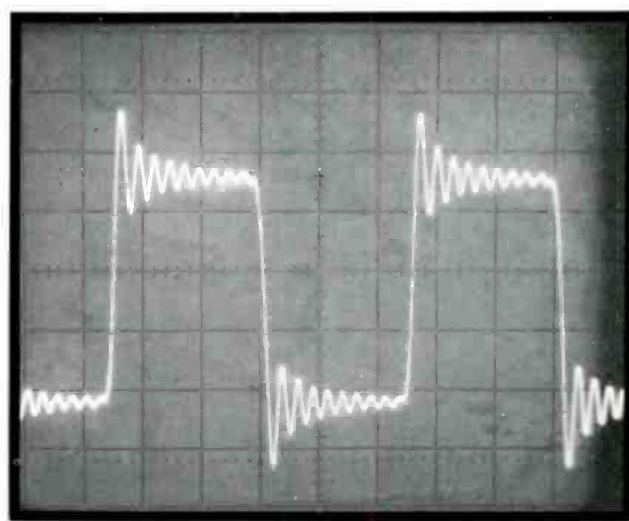

Figure 4. Square wave as reproduced by top quality phono cartridge using CBS test record STR-112.



(A)



(B)

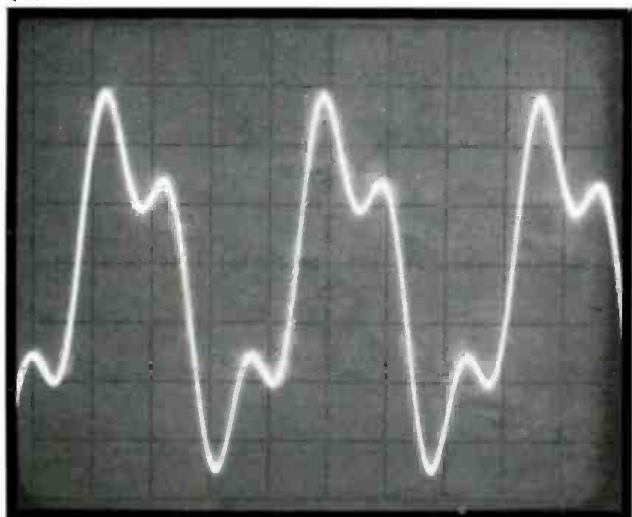

(C)

Figure 5. Square wave signals as reproduced by CD player that employs multiple analog filters with cut-off at 20 kHz. (A), 100 Hz; (B), 1 kHz; (C), 5 kHz.

with). Then equip your conventional turntable with the best phono pickup you can get your hands on. Next, play the square wave test band. Don't be too surprised if you see something resembling what's shown in the 'scope photo of FIGURE 4! Now you are ready to look at square waves as reproduced by a CD player. In this case, it's a CD player that employs those much maligned steep multi-pole analog filters. FIGURE 5A shows a reproduced 100 Hz square wave. (Remember, these square waves are digitally reproduced in the CD test disc, so don't blame the software for what looks like "ringing" or overshoot.) FIGURE 5B shows what a 1 kHz square wave looks like when reproduced by the same CD player. Finally, in FIGURE 5C we see what a 5 kHz square wave looks like when reproduced by this player. As might be expected, since everything above 20 kHz is (and must be) cut off by the steep analog multi-pole filters, all we see when attempting to reproduce the 5 kHz square wave from the test disc are the fundamental 5 kHz tone and the third-harmonic contribution to the square waveshape, at 15 kHz. The next odd-order harmonic contribution to a 5 kHz square wave would, of course, be at 25 kHz (the fifth harmonic) and it is therefore not present, thanks to the steep filters that eliminate everything above 20 kHz.

But it is exactly this characteristic which can be used to counter the argument that we don't have a high enough sampling rate in the now-standard CD system. Many have argued that, since the sampling rate is only 44.1 kHz, if you try to digitize a 20 kHz tone, you'll only have two samples to describe that sine wave. When you try to reconstruct the waveform during digital-to-analog conversion in playback with only 2 samples per cycle, all you get is a very distorted looking waveform ranging from a square wave to a lopsided triangular waveshape (depending upon when those two samples were taken during the occurrence of each cycle of the 20 kHz tone). Well, of course, that's not the case at all. It *would* be if there were no cut-off filters above 20 kHz. But with those required filters in place, what starts out as a 20 kHz square wave turns out to be the pure 20 kHz sine wave we started out with. The third harmonic of the square wave, and all the other higher order odd harmonics which would have resulted in a square wave, are lopped off by the filters and we are left with only the fundamental frequency—or pure 20 kHz!

Now, it can be argued that digital filters are superior in this case to analog multi-pole filters in that they don't introduce as much phase shift in the reproduced signals. I don't want to get into that one, except to say that I now hear a subtle difference between players that employ digital filters plus oversampling and those that utilize steep multi-pole analog filters. In terms of musical accuracy, however, I would be hard pressed to make a judgment as to which type of player produces more "realistic" sound.

Of course, all of this falls apart if you are of the school that believes that audio frequency response of music must extend from DC to Channel 5. If you are such a believer, then clearly, the chosen sampling rate of 44.1 kHz is too low and you are being deprived of those RF components which you think you can sense. I wonder, however, what phono pickup you were using with your LP collection that did as well or better in high frequency response than even the lowliest of CD players? As for myself, I am content with a high-end cut-off of 20 kHz and am willing to reserve higher-frequency listening to my dogs, the bats in the belfry, and others who require their daily fix of ultrasonics. ■

A Soundmixer's Guide To Videodiscs

Soundmixing for videodiscs is a relatively new concern; here's what the audio engineer should know.

THE RECENT INTRODUCTION of the stereo videodisc as a home entertainment medium has added the dimension of high fidelity sound for the average television viewer. This new audio dimension does, however, add an additional burden for the soundmixer who must learn how to produce an optimum audio mix that will fit within the conflicting requirements of his own experience, the listening conditions at the time of the mix, and the requirements of the producer and/or artists. With all these demands, it is not surprising that the soundmixer does not concern himself with the requirements of others who may use his mix in another medium.

It is, however, in the best interest of all concerned—artists, producers, and engineers—to learn the limitations of each medium in which their handiwork is to appear. Accomplishing this will enable them to know (and make) the compromises necessary to ensure that their work appears in the best possible light.

BASIC PRINCIPLES

A good understanding of basic principles is essential before we can discuss specific audio mix problems. Although the author has had extensive experience with only the CED system, the many design features in common with the LaserDisc will allow discussion of a more general nature. The fact that one system recovers the recorded signal by means of a reflected light beam and the other by means of a metal electrode that senses minute changes in capacitance has no direct effect on audio performance.

FM MODULATION

Both the laser and CED videodiscs use separate FM carriers to incorporate the audio channel(s) with the video. Both systems use two FM carriers for stereo signals but CED also uses an L+R, L-R matrix before modulation to ensure compatibility with mono players. Mono CED discs have only 1 FM carrier. LaserDisc uses two independent FM carriers and modulates both carriers with the identical signal for mono programs. For

bilingual programs, both CED and LaserDisc modulate the two carriers independently.

Maximum allowable deviation for the FM carriers (which relates directly to the maximum allowable audio amplitude) is specified as ± 100 kHz for mono LaserDiscs and ± 50 kHz for mono and stereo CED discs. For both of these systems, the 0 dB reference is specified as 50 percent modulation. Therefore, in spite of different deviation limits, mono LaserDiscs and CED discs, as shown in FIGURES 1 to 3, have the identical 6 dB headroom at mid frequencies.

For stereo LaserDisc programs using CX¹ noise reduction, maximum deviation is specified as ± 150 kHz and 0 dB is specified as ± 40 kHz. The net effect of these changes is to increase headroom to 12 dB and reduce S/N at reference by 2 dB.

Both LaserDisc and CED systems use some form of

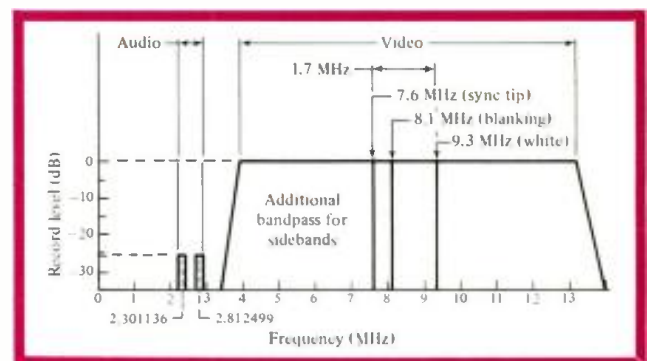

Figure 1. LaserDisc FM modulation spectrum

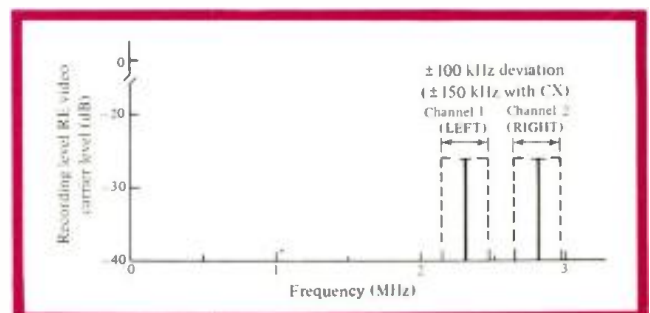

Figure 2. LaserDisc FM audio subcarrier spectrum.

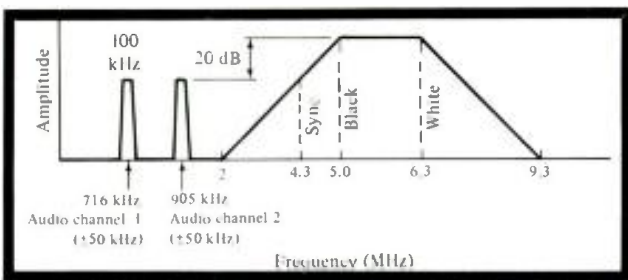

Figure 3. Spectrum assignments for the CED stereo videodisc system. Channel 1 is the Sum channel, Channel 2 is the Difference channel.

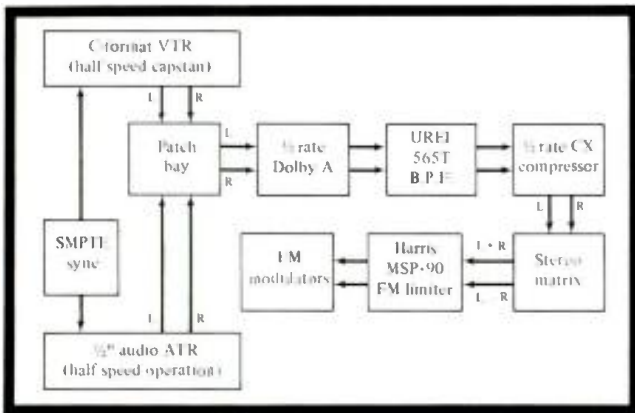

Figure 4. Audio signal path in the CED stereo mastering system.

limiting in their respective mastering chains to keep audio carrier deviation within the player audio FM filter bandpass (see FIGURE 4).

PRE-EMPHASIS

To improve S/N performance, all audio signals for mono CED discs and all LaserDiscs are pre-emphasized using a 75 μ s characteristic; i.e., all signals above 2.1 kHz are boosted at a 6 dB-per-octave rate. While this improves S/N by over 13 dB, it does so at the sacrifice of high frequency headroom which decreases at a 6 dB-per-octave rate above 2.1 kHz and increases the burden placed on the FM limiter used in the mastering chain.

Stereo CED discs use a double pre-emphasis with break points at 75 μ s (2.1 kHz) and 25 μ s (6 kHz). The second pre-emphasis reduces high frequency headroom for frequencies above 6 kHz while improving S/N performance by an additional 3 dB.

CX NOISE REDUCTION

To further improve S/N performance, both videodisc systems have incorporated CX noise reduction circuits. CX was originally developed by CBS for noise reduction on phonograph discs, but the versions used by LaserDisc and CED are quite different from the phonograph disc version as well as from each other.

As implemented in the CED system, the CX process provides up to 20 dB of noise reduction by means of a complementary compansion process. Audio signals are compressed by a 2:1 factor (on a dB scale) during the disc mastering process. During playback, the demodulated audio signals are expanded by a 1:2 factor. Unlike other compansion systems (i.e., Dolby² or dbx), compression takes place with no spectral alteration. This characteristic permits compatible playback without an expander.

Compression occurs only for signals greater than -40 dB relative to 0 dB. All signals below -40 dB retain a 1:1 characteristic, as shown in FIGURE 5.

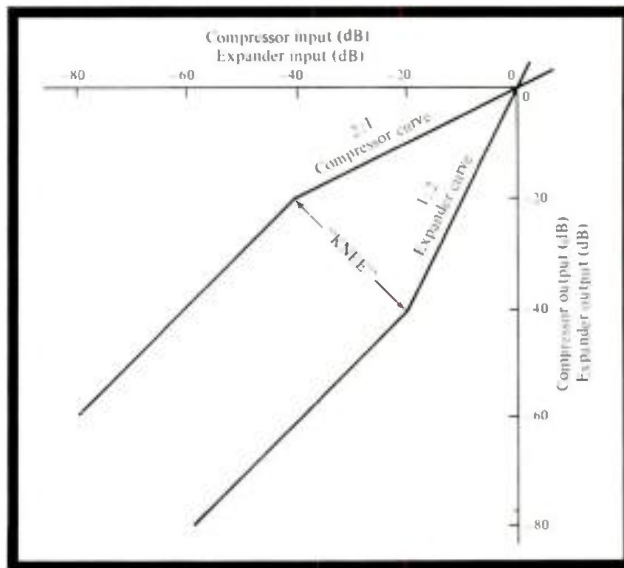

Figure 5. CED system CX Compressor and Expander Input/Output curve.

Audio signals below 100 Hz are attenuated by 6 dB per octave before being applied to the gain control element in the CX compressor. This prevents gain pumping that can be caused by strong subsonic signals. System pre-emphasis is also added to the audio signal before being applied to the gain control element. This improves headroom and noise reduction characteristics at high frequencies. For the CED system, headroom *decreases* at a 3 dB-per-octave rate (for steady state signals) and at a 6 dB-per-octave rate above 6 kHz.

The CX process, as implemented in the LaserDisc, differs from the CED system in several significant ways. First, only 14 dB of noise reduction is used, with the compressor "knee-point" occurring at 28 dB below 0 dB (see FIGURES 6 and 7). Audio signals are compressed before pre-emphasis during disc mastering and all signals below 500 Hz are attenuated by 6 dB-per-octave before being applied to the gain control element.

The CX decoder on the current LaserDisc player is manually switchable by the user. On the CED system, the player can sense the presence of CX encoding by means of a digital "flag" recorded on the disc, which automatically activates the CX decoder.

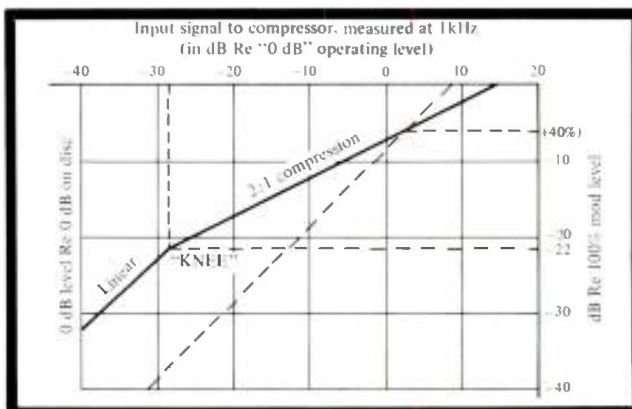

Figure 6. LaserDisc CX static encoding characteristics.

db June 1984 29

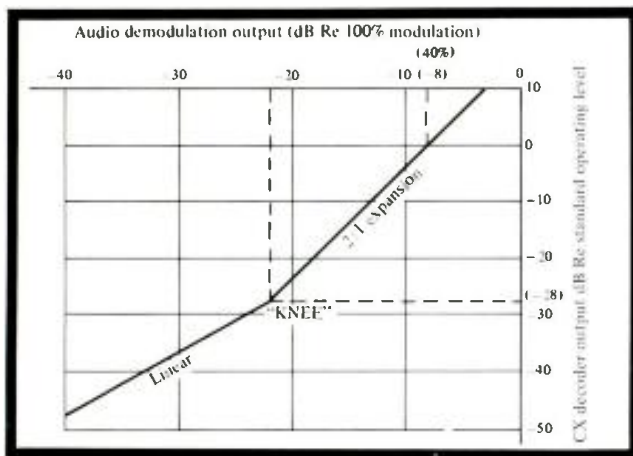

Figure 7. CX decoding gain characteristic.

STEREO SEPARATION

Since the LaserDisc uses separate carriers for the left and right audio channels, separation typically exceeds 60 dB. In the CED system, the use of the L+R, L-R matrix limits separation to 35-40 dB; this is still far in excess of the amount of separation required to produce a typical stereo program. In the bilingual mode, both systems have greater than 60 dB separation between channels.

FREQUENCY RESPONSE

Both the LaserDisc and CED systems are capable of reproducing stereo programs with a 30 Hz to 15 kHz bandwidth. For monaural programs, the CED player rolls off high frequency response above 6 kHz at 6 dB per octave to improve compatibility with typical home TV audio performance.

DISTORTION AND NOISE

Both disc formats have harmonic distortion levels less than 1 percent at 1 kHz for modulation levels of 50 percent or less. Distortion levels above 50 percent modulation are primarily a function of the limiter used in the mastering chain. The overall system distortion for both formats is less than the levels found in typical program sources such as optical sound tracks and C format video tape.

Audio signal to noise for both disc formats exceeds 70 dB with the CX circuitry active.

AUDIO MIXDOWN FOR VIDEO DISC—GENERAL GUIDELINES

Because of the large number of complex variables that can affect the characteristics of an audio program, only broad general guidelines can be presented to help the soundmixer prepare a program that will fit within the constraints imposed by the videodisc's audio channels.

Feature Film Soundtracks. When transferring film soundtracks to the videodisc format, the soundmixer must keep firmly in mind that the program will be heard in a typical living room/family room environment rather than a large theatre environment. The typical living room cannot support the dynamic range and peak volume levels found in the average movie theatre. In addition, the home environment, in conjunction with loudspeakers found in the average high fidelity playback system, produces an audible spectrum significantly different from the Academy Curve used as a standard in the film industry. To optimize results, the soundmixer should

work in an environment similar in size and acoustics to that of an average living room and utilize loudspeakers that are more representative of those found in the average home.

Music Concert Programs. Although the majority of videodisc titles to date have been transfers of feature films, an increasing number of programs are of music concerts that have been recorded primarily for the home video market. For the most part, these music programs have been recorded by producers and engineers who are experienced in mixing programs for the home environment and only minor modifications are needed to make these recordings suitable for videodisc use.

Dynamic Range. As indicated in earlier paragraphs, peak headroom in a videodisc audio channel is limited to 6 dB above the 0 dB reference for signals below 2 kHz and decreases with increasing frequency because of system pre-emphasis. If the soundmixer were to simply transfer the typical "theatrical mix" film soundtrack so that the loudest portions were within the videodisc audio channel upper limits, the result would be a disc with inaudible or unintelligible dialogue, when played back in the home at a volume level that can comfortably support the loudest program sections.

In general, music and effects occur at a higher level than dialogue, especially in musicals, where the music portions can often be 20 dB louder than dialogue-only portions. When transferring a "theatrical mix" for videodisc use, the soundmixer must raise low level dialogue sections so they can be heard more easily in the home. Of course, common sense must be applied at all times; a whisper should not be as loud as a shout, nor should levels be raised or lowered in an obvious manner. The overall artistic effect should be maintained but within a narrower dynamic range.

Some form of peak program meters should be used during mixdown to ensure that maximum levels do not exceed allowable limits. The typical VU meter cannot respond fast enough to control level on a peak basis.

Music concert programs have dynamic range problems of a somewhat different nature. Most rock music has a very narrow dynamic range, 5 dB or less. However, the peak to average ratio of the signal can be 10-15 dB even with a constant loudness level. Here the soundmixer has two choices: He can either lower the average program level so that peaks are within the +6 dB upper limit (at the possible sacrifice of some overall S/N), or maintain the average level and limit the peaks by electronic means. The choice of which method to use depends on the nature of program material and must be made on a program by program basis.

Classical music programs can have a far wider dynamic range, often in excess of 60 dB. This range must be reduced to a more reasonable level by careful gain riding in conjunction with the musical score. The BBC has developed guidelines (with which the author concurs) that recommend modulation levels be maintained between 5 percent and 100 percent. This corresponds to a dynamic range of 26 dB.

When dealing with dynamic range problems of either feature film or music programs, there is the temptation to achieve the reduction in dynamic range by means of some form of automatic gain control device. While these devices can produce acceptable results (especially on programs played back on the narrow bandwidth audio channel found on a typical TV), their noticeable side effects, i.e., gain breathing and noise pumping, preclude

their exclusive use for programs that will be played back on a wide bandwidth, low noise audio system.

PROGRAM SPECTRAL CONTENT

The problem of dynamic range is further complicated by the use of pre-emphasis in the videodisc audio channels. As mentioned earlier, the use of pre-emphasis reduces available headroom with increasing frequency; thus, headroom is dependent on overall program level and program spectral content.

Fortunately, the predominant energy of most music and speech lies below 2 kHz with a rapid rolloff above that point. However, there are two situations which can cause problems in the videodisc audio channel: the use of "Dialogue EQ" and the use of close microphone techniques.

Dialogue equalization is often used in film sound tracks to improve dialogue articulation and intelligibility as well as compensate for high frequency losses found in the typical movie theatre. Although the optical-acoustic response has been standardized for some time by the Academy Curve, Dialogue EQ is very non-standard and varies from studio to studio and producer to producer. In general, Dialogue EQ produces a peak in the response in the 5-8 kHz region with energy peaks as much as 8 to 10 dB above the average program level. If such an equalized program is used for videodisc purposes, the end result can be either severe splatter distortion or sibilants and high frequency transients, or a noticeable reduction in overall program level as the videodisc mastering system limiters try to maintain the pre-emphasized modulation levels below 100 percent.

These side effects can be avoided by either applying compensating equalization during the film to tape transfer or by using the original dialogue, music, and effects tracks. The use of a high frequency limiter or de-esser may also be effective if used on the dialogue track alone.

Close microphone techniques can also produce distortion or gain pumping in the videodisc audio. This mic technique is used almost exclusively in the production of pop and rock music programs. Microphones placed a fraction of an inch away from the player's instruments or the vocalist's lips can produce a *flat energy spectrum in excess of 15 kHz*. After pre-emphasis, such a signal exceeds the headroom limitations of the videodisc audio channels.

To control this problem, some form of electronic limiting must be used on the individual vocal and/or instrumental tracks during the original recording or during mixdown from the multitrack master tape. Short high frequency transients or percussive sounds can normally be handled by the videodisc system limiters with no audible side effects.

Other than headroom considerations, there is no need to restrict the audio bandwidth on programs to be transferred to videodisc. It has been the practice of some software suppliers to deliberately filter all frequencies below 150 Hz and above 6 kHz. This practice had its origins in the days when TV network audio was transmitted via narrow bandwidth telephone lines.

However, current network programs are distributed via satellite with audio channels that have a full 50 Hz to 15 kHz bandwidth. The wide audio bandwidth capability of the videodisc and current TV satellite distribution systems eliminates the need to restrict program audio bandwidth. Filtering should be used only to correct

specific problems such as low frequency projector rumble or horizontal sync spurs.

STEREO/MONO COMPATIBILITY

When transferring a stereo program for videodisc use, the soundmixer cannot know in advance under what conditions the finished disc will be played back. The disc could be viewed on an expensive video monitor and stereo audio system or on a simple tabletop TV with its built-in loudspeaker. Since the audio performance of the tabletop TV is, obviously, vastly inferior to that of the stereo audio system, the soundmixer is faced with the seemingly impossible task of creating a compromise mix that will satisfy both playback situations.

Fortunately, the design of the videodisc playback systems alleviates this potentially serious problem. On the CED player, the compatible L+R mono signal is incorporated into the RF TV signal in CX encoded form. Thus, the signal played back by the TV has its dynamic range compressed by a 2:1 ratio, making it more compatible with the TV's limited audio capability. On the current laser player, the L+R mono signal is derived after the CX decoder; however, the user is given the option of manually deactivating the decoder.

There is no need to limit frequency response. The TV loudspeaker will act as a filter and not reproduce the wide bandwidth audio preferred for playback on the high fidelity audio system.

The only precaution that must be observed is to be certain that no dialogue or critical sound effect is recorded 180 degrees out of phase. When played back in mono, an out-of-phase signal will either cancel completely or suffer a significant loss in level. Programs recorded with wide separation will have a moderate reduction in level when played back in mono. This reduction can be easily corrected by increasing the level control on the TV.

STEREO IMAGERY AND SEPARATION

Feature Films. Stereo soundtracks on current feature films are reproduced on three channels—left, center, and right—in the theatre. Three channels are required because of the width of the viewing area and the possibility of extreme viewing angles. Without a firm center channel, viewers at the extreme left or extreme right of the theatre would observe no stereo effect and hear only the speaker closest to them.

As a general rule, dialogue is placed primarily on the center channel with music and effects distributed across the left, center, and right channels. Dialogue is occasionally placed on the left or right channel for off-screen effect or when one of the principle characters is located at the extreme edge of the screen.

Playback conditions in the home greatly reduce the effective viewing area. A typical home viewing situation would utilize a 19-inch or 25-inch TV screen with stereo speakers located two to three feet on either side of the screen. There is no center audio channel (although this could be approximated by the L+R TV audio signal) and the viewer must rely on the "Phantom Center" effect to create the illusion that sound is coming from between the loudspeakers.

The soundmixer must take the left, center, and right signals and recombine them into composite left and right signals that will create an effective stereo image when played on two loudspeakers placed approximately six feet apart. This relatively straightforward task is complicated by the fact that anamorphic films (Cinemascope, Todd-

AO, etc.) are visually panned and scanned during the transfer for home use. As a result, a principle character or major plot action located to one side in the theatrical release will be repositioned to center screen on the home video version. The appropriate corrections should be implemented to ensure that the stereo audio image agrees with visual image. Dialogue and effects should be re-panned to their new locations and their overall separation be reduced slightly for a better fit to the smaller screen size. No reduction in separation is required, however, for the music tracks, off-screen dialogue, and off-screen effects.

Music Concert Programs. In many music concert programs, the practice of using a rapid sequence of images from a variety of locations and angles and the use of montage effects often makes a consistent relationship between the video image and the stereo audio image impossible. In this situation, the soundmixer should make a fixed stereo image that acts as an anchor point for the kaleidoscopic video images. The fixed audio image can be based on a long shot of the entire stage that is used repeatedly during the course of the concert.

When mixing rock music for *conventional* audio discs, practice places all low frequencies (i.e., bass guitar, kick drum synthesizer, etc.) in the center because of groove geometry and amplitude considerations. Since the videodisc audio channels are FM modulated, these restrictions are unnecessary and one can place these instruments anywhere on the sound stage.

When mixing classical orchestral music, the conventional orchestral layout should be observed with violins on the left, cellos and basses on the right, and woodwinds and brasses more or less in the center.

DOLBY SURROUND PROCESSING

Many current stereo feature film soundtracks have been encoded using the Dolby Surround process. This process utilizes a 4:2 matrix encoding technique that is very similar to the quadraphonic encoding used in the music recording industry in the late 1970s. The encoding process shifts the phase of each of the four audio signals, then adds and subtracts components of the phase-shifted signals to produce two encoded signals. A similar complementary process decodes the two encoded signals back into four separate signals; however, the basic decoded signals have a significant loss in separation. The Dolby 150B Cinema Decoder incorporates gain riding and logic "steering" circuits to enhance the separation between the decoded left, center, right, and surround channels.

Both videodisc audio systems are transparent transmission mediums to the encoded signals. A Dolby Surround encoded soundtrack can be decoded properly from a videodisc player (two home-type decoders are currently commercially available). However, since the majority of home viewers will be listening to programs in stereo or mono, some precautions are in order.

The Dolby Cinema Decoder can change the gain of the left and right channels up to 14 dB with respect to the center channel to improve the center image. The soundmixer should carefully review the encoded two-channel mix to ensure that there is a proper center-to-left/right balance.

Since the encoding process involves phase shifted signals, there can be a loss of low frequency information in the encoded signal. Therefore, the encoded mix should be reviewed for proper bass/treble balance. Dolby has

recognized this potential problem and provides a bass combine circuit which prevents encoding losses.

Surround channel information is encoded out of phase in the Dolby process. This signal will be reproduced with no attenuation when played back in stereo but will virtually cancel when played back in mono. The soundmixer should ensure that no audio essential to the plot is lost because of surround encoding.

VIDEO NOISE REDUCTION, SCAN CONVERSION, AND LIP SYNC

Digital noise reduction devices and scan conversion equipment (NTSC-to-PAL, PAL-to-NTSC, etc.) introduce significant delays into the video signal. If digital noise reduction is used in conjunction with scan conversion or used repeatedly during each subsequent copying process, the accumulated video delay can easily exceed six frames. To prevent lip sync errors, the audio signals must be delayed an amount equal to that of the video signal. This delay can be achieved by means of any of the large number of commercially available audio delay devices, but the selection of the proper device must be made with some care. All audio delay devices use some form of analog-to-digital conversion and subsequent digital processing to achieve the desired time delay. In order to produce a device within a given price range, the various manufacturers must make design trade-offs with respect to frequency response, dynamic range, distortion, and signal-to-noise ratio. The audio delay device selected for use in the production of videodisc master tapes should produce no audible degradation of the audio signal.

TIME COMPRESSION

Time compression is sometimes used to shorten programs that exceed the 60-minutes-per-side maximum permitted by the videodisc format. Since time compression is achieved by increasing the linear speed of the playback VTR, there is a corresponding shift in the musical pitch of the audio signal. To prevent unnatural sounding pitch effects, the audio signal should be processed with an electronic pitch-shifting device. These devices utilize digital processing techniques similar to those used in audio delay devices; similar criteria should be used in the selection of a device for use in preparing videodisc master tapes. The device selected should produce no audible degradation of the audio signal.

PROGRAM SOURCES

TABLE 1 shows a listing of the possible audio sources that could be used to prepare a master tape for videodisc use. Whichever format is used, one should always try to use the cleanest possible source material. Any distortion or noise problems in the source material will be faithfully reproduced by the videodisc. For example, noisy stereo optical soundtracks can cause noise pumping effects if the CX encoded disc is played back in mono. If a stereo master has had too many intervening generations of copies, the resulting accumulated azimuth errors can result in poor stereo image. If necessity requires the use of substandard source material, every effort should be made to improve the program material (by the use of filters, equalizers, noise gates, limiters, etc.) before preparing the videodisc master tape.

PREPARATION OF VIDEODISC MASTER TAPES

The 1-inch C-type video tape is the required video

format for both LaserDisc and CED videodisc. Since many film-to-tape transfers are made using B-type or 2-inch helical scan machines (IVC-9000), an additional dub is often necessary to create a videodisc master tape in the required format. The audio performance of a well maintained C-format machine is more than adequate for most monaural programs and many stereo programs. There are, however, some serious performance shortcomings that can restrict the transfer of high quality audio programs:

- The use of thin oxide coatings on C-format videotape results in high harmonic distortion at low frequencies—distortion levels of 10 percent at 50 Hz @ +10 VU are quite typical.
- Head azimuth is not adjustable on many machines. Multiple copies on a variety of machines can introduce significant phase shifts on stereo programs due to accumulated azimuth errors.
- Perturbations in the control track signal can induce audible wow and flutter while producing no significant video side effects.
- C-format audio tracks located near the edge of the tape are susceptible to tape damage and dropouts.
- Audio alignment controls are often not readily accessible for routine maintenance adjustments.
- Some manufacturers use pre-distortion circuitry in their audio electronics. While these circuits can be effective at moderate signal levels, the distortion levels can increase rapidly above a given threshold point.

To achieve the best possible transfer of a high quality audio program, ½-inch four channel audio tape running at 15 ips should be used during the initial transfer of the original program source, and during all subsequent transfers. While this does increase complexity with the use of two tape machines and synchronizer, there is a significant improvement in overall audio quality.

Whichever tape format is used, the use of Dolby A noise reduction is highly recommended to reduce accumulated tape hiss. After the initial transfer, there can be as many as four additional copies made in the production of the videotape master.

Whichever tape format is used, both playback and record machines should be properly aligned before the transfer is made. Alignment tones (1 kHz, 10 kHz, 100 kHz, Dolby Tone) should be recorded at a reference flux level *at the time of the transfer*. The average program level should relate directly to the reference flux level and should not change significantly throughout the length of the program. The alignment tones should be carefully transferred or regenerated during each subsequent copy. The use of Dolby A makes the presence of alignment tones imperative. The Dolby A circuitry will not track properly unless the playback machine frequency response is identical to that of the record machine.

All other associated audio equipment used during the transfer process should have a 20 Hz to 20 kHz bandwidth, distortion levels less than 0.5 percent and headroom capability of at least 20 dB.

CONCLUSION

It is readily apparent that audio can no longer be the stepchild of the video industry. The audio performance levels of the current generation of videodisc players and home audio equipment have increased the demand for

video software with high quality audio. The electronics industry is now producing television associated electronics with high quality audio electronics and loudspeakers. The Cable TV industry is transmitting programs in stereo on a regular basis. The Broadcast TV industry now has the capability to transmit (via satellite) wide bandwidth stereo programs on a world-wide basis. Commercial stereo TV broadcasting is currently being made in Japan and West Germany and is under investigation here in the United States. The motion picture and video industries must keep pace with these developments and begin producing programs with greatly improved audio fidelity. ■

TABLE I
Audio Program Sources

Mono	Stereo
35mm Optical	35mm Optical
35mm Composite Mag	35mm Dolby Optical
35mm Dialog, Music, Effect Mag	35mm Composite Mag
1 inch C-format	1-inch C-format
	½-inch 4-Channel Audio Tape
	Multi-track (8, 16, 24) Audio Tape

CED Update

On April 4, 1984 (some time after this article was written), RCA announced that they would cease manufacturing and marketing CED Videodisc players, citing stiff price competition from VCRs and pre-recorded videotapes, along with the slow Videodisc market growth as the principal causes of the phase out.

Does this mean the demise of the CED Videodisc system? Not necessarily. CED players are still manufactured in Japan (notably by Hitachi). In a subsequent press release, RCA stated that "disc pressing operations are planned to continue at RCA's plant in Indianapolis for three years or as long as reasonable demand continues." In addition, CBS Records announced that it would continue pressing CED discs at its Carrollton, Georgia, plant, placing the potential market at well over 10 million discs annually on the basis of players in use and in inventory. After some initial confusion, all major program suppliers have decided to continue to release new titles in the CED format. So it would appear that both CED players and discs will be available for the foreseeable future.

C.R.

References

- E. J. Freeman, G. N. Mehrotra, C. P. Repka. "Stereo Audio on CED Videodiscs." *IEEE Transactions on Consumer Electronics*, Aug. 1983, Vol. CE-29, Number 3.
- G. Badger, R. Allen. "The Audio Side of the Laser Videodisc." Paper presented at the 72nd AES Convention, Oct. 1982, Preprint #1935.
- Sommerwerck, William. "The Dolby Labs Surround-Sound System for Motion Pictures." *MCS Review*, Summer 1982.

Development Of A New Studio Artificial Head

Natural listening with an Artificial Head.

RECENT RESEARCH SHOWS that diffuse field equalized artificial head recordings provide better results than free (direct) field equalized ones. Neumann has recently built such a head.

Following many years of applications, the KU 80 artificial head by Neumann, first introduced at the IFA in 1973, has shown several insufficiencies which have become the subject of considerable research, both by the manufacturer as well as by users in diverse institutions.¹ It finally came to a revision of the artificial head with funds provided by the Institute for Broadcast Technology (IRT) in Munich. By using electronic filtering (as had been the case in previous work), an attempt was made to "correct" the 0 degree axis frequency response of the head (which was considered to be the principal problem).

While in the old KU 80 artificial head one tried to simulate the free field frequency response of the human ear at a particular point in the ear canal, there were subsequent suggestions to equalize the head for a linear *free* field frequency response, for instance for a sound impinging direction from in front. That was supposed to make the artificial head signal sound compatible for loudspeaker listening, since a "normal" studio microphone also has a linear frequency response at the zero axis.

Because of the very complicated shape of the outer ear, its directional characteristic is highly frequency-dependent. Free field equalization can only be made for one sound impinging direction at a time (FIGURE 1), but it influences the transmission characteristic for all sound impinging directions and falsifies the artificial head signal for them.²

If one makes the assumption that in most cases the artificial head will be set up at a considerable distance from the sound source in very differentiated acoustical surroundings, then one has to examine the proper relationships in the diffuse sound field. (The diffuse sound

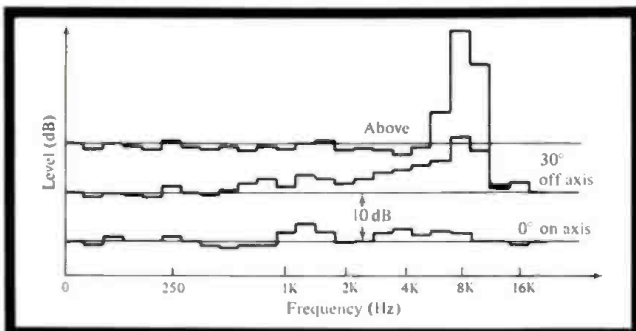

Figure 1. Third octave spectra of the free field transmission factors: The free field equalization can only be valid for a single sound impinging direction.

field is one in which equal sound partials reach the microphone from all directions, by contrast to the free sound field used for acoustical measurements, in which only a single sound source direction is present.) While one can simulate a free sound field by means of an anechoic chamber, one uses an *echoic* chamber for measurements in the diffuse sound field.

If the artificial head is now equalized in such a way that its diffuse field frequency response is linear, as is also the case for stereo microphones used in studio work, then there is no longer a preferential direction. This avoids the accentuation of specific, frequency-dependent properties of the outer ear for a particular selected direction.

DIFFUSE FIELD EQUALIZATION REPLACES FREE FIELD EQUALIZATION

Diffuse field equalization, which is the deciding new property of the KU 81 artificial head (FIGURE 2), makes sound integrity possible both for earphones and for loudspeaker reproduction.

Prior investigations have shown that in designing the artificial head, one may neglect the simulation of the entire ear canal and the eardrum impedance because the



Figure 2. The diffuse field equalized artificial head: Recordings made with this head are also suitable for reproduction through loudspeakers.

Stephen Peus is an engineer at Georg Neumann GmbH, Berlin.

outer sound field only has a directional dependent influence on the ear canal to a depth of about 4mm.³ Further inside the ear canal there is only a direction independent (linear) frequency response change, which can be practically corrected in any desired way.

In the prototype of the IRT artificial head, the desired diffuse field equalization of the head was achieved principally using electrical, passive filters which were inserted into the audio modulation line. In the head itself there was a coupler as a transition from the ear canal diameter (5mm) to the microphone capsule diameter (21mm).⁴

This conically shaped transition piece (seen in FIGURE 3A) was equipped with a short soldered-in tube (B) as the ear canal, an inside cone (C) to reduce the enclosed air volume, as well as two coupled Helmholtz resonators. The resonator attached at the side (D) was tunable by means of a screw (E) for the purpose of damping the coupler resonance. The cushion effect of the air in the perforated disk (F) which had the inside cone mounted upon it, was

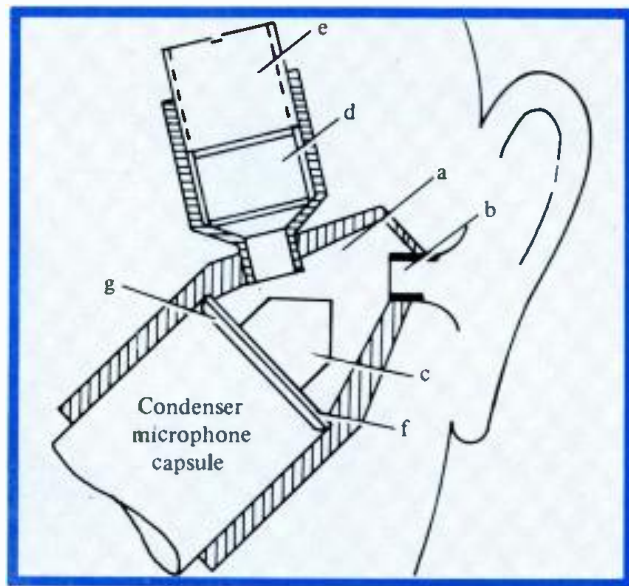

Figure 3. The IRT prototype: A passive filter was required in order to achieve diffuse field equalization.

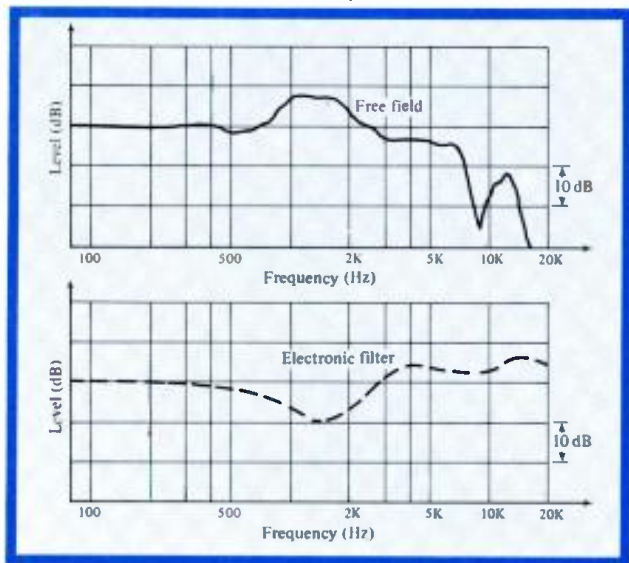

Figure 4. Artificial head frequency response curves: A comparison between the original frequency response (top, free field equalization) and frequency response electronically corrected to the "diffuse" field (bottom).

tuned, in connection with the air mass (G) remaining in front of the microphone membrane, to the roll-off of the transmission factor which otherwise would occur too early.

This arrangement provided the free field frequency response for frontal sound impingement shown in FIGURE 4 (top). A comparison with the frequency response of the electronic filter (FIGURE 4-bottom) shows that direction-dependent anomalies, such as the sharp dip at 8 kHz for frontal sound, were not equalized out and therefore were also not lost.

MAKING OVER THE OLD HEAD

The concept which was set up for this project included the desire to incorporate the microphone parts which had been built into the earlier KU 80 artificial head into its successor, the KU 81, and to upgrade the existing heads to the newer version, which uses the latest technology. This proved to be unworkable because of demands made by users of the KU 80 concerning the new head: 1) that it deliver the properly equalized signal without the necessity of any additional piece of equipment, 2) that it have a higher SPL tolerance than the KU 80 head, and 3) that it have better mounting and suspension possibilities than its predecessor.

While the last item only concerned the outer construction and was solvable by inserting a mic stand female threaded part and suspension eyes, both of the other requirements made it clear that the desired diffuse field equalization had to be realized mostly in the coupler, and required a new amplifier type which made the frequency response correction possible: i.e., the raising of the upper three octaves.

The acoustic equalization was achieved by rebuilding the coupler as shown in FIGURE 5. First of all, the microphone capsule, the coupler, and the ear canal were axially arranged. That not only makes the insertion of the ear canal tube easier, but removes the "dead space" in the upper conical protrusion which, in the prototype version, was used principally to damp the frequency partials above 10 kHz (see FIGURE 3).

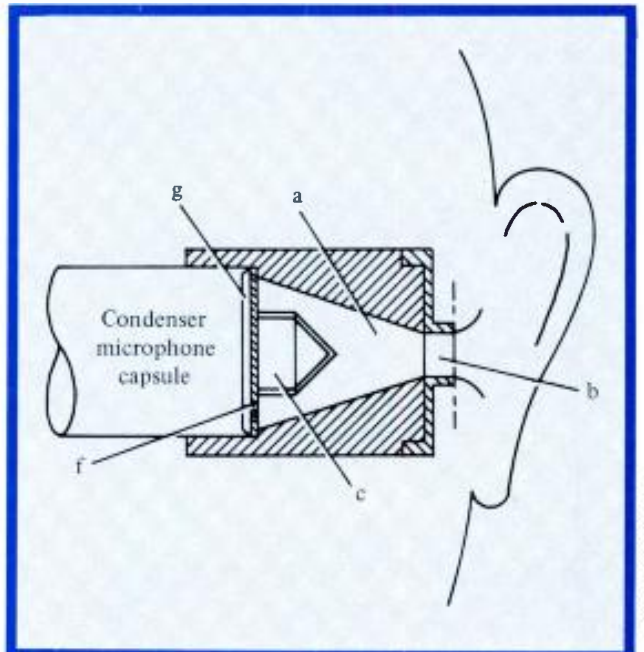

Figure 5. The new microphone arrangement: The KU 81 is "mechanically" diffuse field equalized by virtue of the arrangement of the sound receiving components.

db June 1984

IMITATING THE EAR

In the second step the inside cone, which is mounted on the perforated disk, was equipped with a cavity and a drilled hole such that a Helmholtz resonator was created for $F=1.5$ kHz. This replaces the resonator (D from FIGURE 3) mounted at the side and does away with part of the frequency response boosts created by the air mass in the coupler (A), which oscillates through the ear canal (B).

Since the oscillating air particles in the opening of the resonator cavity have the highest velocity, resulting from the smallest opening, it is easy to inhibit them by the use of friction at that point. This is done by means of a fine meshed gauze over the opening of the resonators (A and C), which are then damped by it.

The acoustic resonant circuit (G, F) which is in series with the resonator (A, B) remains, but is also damped, since the frequency range around 7.5 kHz would otherwise be excessively boosted by it. The measures described together replace the rather complex filter of the old model and give the new KU 81 artificial head the diffuse field frequency response shown in FIGURE 6.

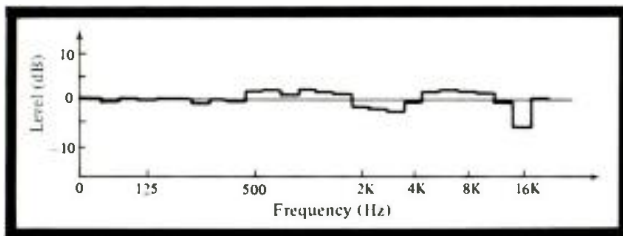

Figure 6. Nearly ideal: The third octave spectrum of the diffuse field transmission factor of the KU 81 comes very close to the ideal (zero line).

The artificial head obtains its directional information through the complex shaping of the outer ear (frequency dependent directional characteristic) and through the delay times and diffraction of the sound around the head itself.

New outer ear forms were produced after investigations at Ruhr University Bochum. In fact this is a casting of the ears of a "typical" test person ascertained through intensive investigations. The form is elastic and uses a new casting material which allows the ears to be reproduced with all their folds, creases, and crevices, thus conforming completely to real ears.

Many recordings made with the newly developed artificial head have meanwhile confirmed that the measures taken in this new head not only produce impressive aural improvements when listening to the head signal with earphones, but that reproduction through loudspeakers produced a natural sound picture that gives good directional resolution within the listening horizon, with precise recreation of both the sensation of the depth of the room as well as its spaciousness.

DUMMY HEAD NOW ALSO USEABLE FOR LOUDSPEAKER REPRODUCTION

The possibility of high quality loudspeaker reproduction is, as indicated previously, one of the most significant differences between the KU 81 head and its predecessor, the KU 80. Pressure microphones (omni-directional), as they're used in the artificial head, can only provide a linear frequency response either in the diffuse or free

sound field, since the sounds impinging at right angles onto the membrane (0 degree) provide a pressure build-up in front of the membrane for high frequencies with a wavelength on the order of magnitude of the membrane diameter. As a result, the 0 degree transmission factor for this frequency band rises if the transducer has been developed for a linear frequency response in the diffuse sound field, since this pressure build-up is not created for sounds from all of the other directions. Conversely, the diffuse field transmission factor rolls off at the higher frequencies, if we are talking about a pressure transducer with a linear free field frequency response.

The KU 80 artificial head that was free-field equalized for a point at the eardrum, therefore had to sound dull when listened to via loudspeakers. A rise in the range of 1.5 kHz, which was recreated in the KU 80 and exists at the eardrum, provided a loudspeaker sound that additionally sounded too "barrelly." By contrast to pressure transducers, good pressure gradient transducers, for example, with cardioid or figure-8 directional characteristic, have a linear frequency transmission factor, both in the free and the diffuse sound fields. Most users are unaware of this property in spite of the fact that these microphone types are the most widely used. Nevertheless, it was obviously this diffuse field property which one had to clearly build into the pressure transducer artificial head, in order that it obtain a sound for loudspeaker reproduction equal to the one that we are used to in intensity stereo recording.

The valid standards (DIN 45 500/45 619) recommend a linear free field frequency response for earphones and provide a rather broad tolerance field into which the response curve of such earphones has to fall. Recent measurements have shown that many high quality headphone models, by fully utilizing this tolerance field, provide a linear frequency response in the diffuse field rather than the one that is required in the standard. This equalization was selected consciously on the basis of listener tests which showed that a more natural and a more agreeable sound picture was created as a result.⁵

Headphones with a linear diffuse field frequency response are not only the proper reproducing device for the diffuse field equalized artificial head, but also appear better suited for the reproduction of traditional intensity stereo programs than the free field equalized headphones.

Considering the diffuse field frequency response of the new artificial head does not necessarily make it an "exotic" item in acoustics merely because the usual reference is the free sound field, but rather integrates it well into the newest knowledge about the compatibility of different recording techniques and reproducing possibilities. ■

Footnotes

1. Huddle, M. and Schroeter, J. "Improvements Made in the Neumann Dummy Head System." *RTM* 25 (1981), p. 1-6.
2. Thiele, G. "About the Compatibility of Dummy Head Signals with Intensity Stereos When Reproduced via Loudspeakers: The Sound Coloration." *RTM* 25 (1981).
3. Huddle, M. "Equalization of Artificial Heads Without Exact Replication of the Eardrum Impedance." *Acustica* 44 (1980).
4. Wollherr, H. "Coupling a Microphone to the Outer Ear of a New Dummy Head." *RTM* 25 (1981).
5. Rhenius, V. "Earphones: Entirely Dynamic." *Funkschau* (1982), issue 17, pgs. 52 and 53.

Updated Recording Studio Handbook

A must for every working professional... student... audio enthusiast

Features latest state-of-the art technology of creative sound recording.

21 Fact-Filled Chapters

I. The Basics

1. The Decibel
2. Sound

II. Transducers: Microphones and Loudspeakers

3. Microphone Design
4. Microphone Technique
5. Loudspeakers

III. Signal Processing Devices

6. Echo and Reverberation
7. Equalizers
8. Compressors, Limiters and Expanders
9. Flanging and Phasing

IV. Magnetic Recording

10. Tape and Tape Recorder Fundamentals
11. Magnetic Recording Tape
12. The Tape Recorder

V. Noise and Noise Reduction

13. Tape Recorder Alignment
14. Noise and Noise Reduction Principles

15. Studio Noise Reduction Systems

VI. Recording Consoles

16. The Modern Recording Studio Console

VII. Recording Techniques

17. The Recording Session
18. The Mixdown Session

Three all-new Chapters

19. The In-Line Recording Studio Console
(The I/O Module, The Basic In-line Recording Console, Signal flow details)
20. An Introduction to Digital Audio
(Digital Design Basics, Digital Recording and Playback, Error Detection and Correction, Editing Digital Tapes)
21. Time Code Implementation
(The SMPTE Time Code, Time-Code Structure, Time-Code Hardware.)



\$39.50

Easy to Order

You can enclose a check with your order or charge it to Master Charge or BankAmericard/Visa. Use the coupon below to order your copies of the new updated *Recording Studio Handbook* (\$39.50).

ELAR PUBLISHING COMPANY, INC.

1120 Old Country Road, Plainview, N.Y. 11803

Yes! Please send _____ copies of THE RECORDING STUDIO HANDBOOK. \$39.50. On 15-day approval.

Name _____

Address _____

City/State/Zip _____

Total payment enclosed \$ _____
(In N.Y.S. add appropriate sales tax)

Please charge my Master Charge
 BankAmericard/Visa

Account # _____ Exp. date _____

Signature _____
(changes not valid unless signed)

Outside U.S.A. add \$2.00 for postage.
Checks must be in U.S. funds drawn on a U.S. bank.

The *Recording Studio Handbook* is an indispensable guide with something in it for everybody. It covers the basics beautifully. It provides in-depth insight into common situations and problems encountered by the professional engineer. It offers clear, practical explanations on a proliferation of new devices. **And now it has been expanded with three all-new chapters . . . chapters on the in-line recording studio console, digital audio and time code implementation.**

Sixth printing of industry's "first" complete handbook

The *Recording Studio Handbook* has been so widely read that we've had to go into a sixth printing to keep up with demand (over 30,000 copies now in print). Because it contains a wealth of data on every major facet of recording technology, it is invaluable for anyone interested in the current state of the recording art. (It has been selected as a textbook by several universities for their audio training program.)

Highly Acclaimed

Naturally, we love our book. But don't take our word for it. Here's what others have to say:

"John Woram has filled a gaping hole in the audio literature. This is a very fine book . . . I recommend it highly." *High Fidelity*

"A very useful guide for anyone seriously concerned with the magnetic recording of sound" *Journal of the Audio Engineering Society*

15-Day Money-Back Guarantee

When you order *The Recording Studio Handbook* there's absolutely no risk involved. Check it out for 15 days. If you decide it doesn't measure up to your expectations, simply send it back and we'll gladly refund your money.

NAB 1984—An Impression

IN THE WORDS of the poet:
*"The tumult and the shouting dies,
 The captains and the kings depart—"*

And the NAB Convention is over for another year. Held this year in the vast Convention Center in Las Vegas, it, as usual, attracted thousands of delegates and exhibitors from all over the world. Convention papers for both managerial and engineering personnel ran concurrently, while the technical exhibit covered a great number of acres. All who attended came away with aching feet, information overload, and a feeling that their company's budget would never be big enough to satisfy what "just had to be done."

Commonly, magazine articles reporting on major conventions (particularly those with extensive equipment exhibits) concentrate on the new equipment available. However, because most of us get bombarded with literature on the new equipment from the local manufacturers'

representatives, we feel that such an article in *db* would merely be repetitive. Instead, it seems appropriate to regard the convention as a means of trying to foresee which developments in progress might affect the audio side of the broadcasting industry in the future.

DIGITAL AUDIO & COMPUTER TECHNOLOGY

Digital audio technology is well established in the field of commercial recording; indeed, all the major record manufacturers are mastering with the digital process. Digital has not, however, reached the broadcasting field in any significant way. True, many stations are now playing Compact Discs, but few have used digital technology for their own production or transmission. In the April issue of *db*, Peter Swanson reported on his use of the dbx Delta Modulation System as a link from Symphony Hall in Boston to his station, WGBH, and then to their transmitter. John Borwick, in his "Scenes from Europe" in the same issue, talked about the BBC's all-digital audio console. As of now, these are relatively isolated incidents. But judging by some trends seen at NAB, they may soon be commonplace.

Many of us have long felt that computer technology and digital audio should be combined into an audio storage system that would have capabilities paralleling those of a word processor, but with application in the audio domain. Gotham Audio displayed a system at NAB that comes very close to this ideal.

Up till now, automation systems in broadcasting have been built from large numbers of cartridge machines and reel-to-reel tape recorders linked together by mechanical and electrical means to provide the required information retrieval system. This is not a very satisfactory system. It needs a great deal of maintenance to continue to work well and to give consistently good audio quality.

SYSTEX

The Gotham "Systex" computerized audio information retrieval system totally eliminates the need for these mechanical horrors. It records high quality audio on high density computer hard disks. A random access system allows almost instant retrieval of any recorded item, in

H. Burrell Hadden has been working in broadcasting, mostly in radio, for almost 40 years. After a stint designing communication equipment for the British army during World War II he spent 20 years with the BBC. During that time he acquired experience in the field of high quality broadcast audio, both in radio and TV. Starting as a studio engineer doing technical production of live and recorded broadcasts of all forms of classical music, he became an audio quality consultant, and finally was engaged in the technical training of studio staff.

Since coming to North America in 1969, he has been chief engineer at two major market rock radio stations in Toronto, Canada, each with both AM and FM outlets. He has been responsible for a number of studio designs for broadcasting and recording.

Burrell Hadden has been writing about professional and consumer audio on both sides of the Atlantic for over 30 years. He is now a Canadian citizen, residing in Toronto.

With this issue, we introduce H. Burrell Hadden, who will be a regular columnist on Broadcast Audio in future issues.

any order. Systex uses a standard 330 Megabyte Winchester-type SMD compatible hard disk drive, manufactured by a number of computer hardware suppliers; each disk pack contains five 14-inch magnetic discs, for a total storage capacity of 330 Megabytes. This gives a recording time of 60 minutes mono or 30 minutes stereo.

The Systex system uses state-of-the-art digital audio technology, with a 48 kHz sampling rate. The heart of the system is the advanced Motorola 68000 16/32-bit processor. Error correction is provided to insure against dropouts, and A/D and D/A conversion is extremely accurate. The basic system is sold with one disk drive, but can be expanded to as many as 60, storing over two days of music in mono, or over one day in stereo. The system may be controlled from its own integral control panel, or by means of any personal or business computer with an EIA RS 232-C interface.

The remote computer controls up to four sequencers within the system, each sequencer containing up to 15 disc drives. The sequencers can be independently controlled by the host computer, or one of them can be controlled by the system control panel. A typical address for a track might be "Sequencer A, Unit 3, Time 15.50." This would mean the track would be found on the first sequencer, disk drive 3, 15 minutes and 50 seconds into the disk.

The average access time to any spot on the disk is 50 milliseconds after the 'GOTO' command is entered. Sequential commands are buffered and joined together by an automatic crossfade giving a 37-millisecond splice between any two items, anywhere on the disk. The effect to the listener is of instant random access without any interruption in the audio.

As would be expected, the audio quality is truly state-of-the-art. S/N is greater than 88 dB; Frequency response is flat 20 Hz to 20 kHz; THD is less than 0.1 percent, and there is maximum headroom of 21 dB.

Of course, Systex is expensive. The basic price is \$125,000 with one disk drive. Extra drives are \$10,000 each. But the present electro-mechanical automation systems are not cheap either, and Systex gives so much more.

As always, one could wish for more. Continuing the analogy of the word processor, would it not be possible to use this machine for audio editing as well? It would then be perfect for the station newsroom. Incoming audio newsclips from the news agency could be recorded, edited using the computer keyboard, and assembled on the disk for the next newscast. After use, any 'morgue' clips could be retained on an 'archive' disk, and the rest deleted, freeing the main disk for the next newscast.

DON'T FORGET RADIO

Radio transmission systems are also going digital. In addition to the dbx system described in Peter Swanson's article, Dolby Labs was exhibiting a digital system using a development of Delta Modulation, and Sansui was showing a PCM system with reduced bit rate.

Digital audio transmission by radio has thus far been restricted to satellites. There is good reason for this. The conventional PCM digital system requires a very high-speed bit stream to transmit high quality audio. The Scientific Atlanta system presently in use by the major US networks (to transmit programming via satellite to their affiliates) requires a bit rate in excess of 400 kBit/sec for each audio channel. To transmit such a signal



One tree can make
3,000,000 matches.



One match can burn
3,000,000 trees.



A Public Service of This Magazine & The Advertising Council

requires a radio frequency bandwidth of about 1.25 MHz. This is not a problem at the very high carrier frequencies employed in satellite transmission, but obviously a very serious problem, say, on the FM band where the carrier spacing is only 300 kHz. It might be possible to use such a system on a television subcarrier, but possible cross-modulation between the video and the digital carriers could mar the reception of both. If digital radio transmission is to be possible, some reduction in the bit rate is essential. But this must be done without compromising the audio quality.

Sansui demonstrated a novel way of reducing the bit rate in conventional PCM, and from what could be heard on headphones, with the ambient noise of the exhibition leaking in, it seemed to be very successful. They have combined two techniques of bit reduction, Differential PCM (DPCM), and near instantaneous companded PCM (NIPCM). Differential PCM, instead of representing the instantaneous amplitude of the signal as sampled, represents the change that has occurred in the value since the last sample. The audio is quantized into a 14-bit word in the usual way, which represents the starting point. The second sample is similarly quantized, and the difference between the first and second sample is itself quantized into a 15-bit word. The process is repeated, and a series of 15-bit words is thus obtained. A block diagram is shown in FIGURE 1.

These words are not, however, the transmitted word. The differential 15-bit words are then compressed by a NIPCM system to an 8-bit word, and this is transmitted. In most NIPCM systems, the truncated bits removed in the compression are lost, but in the Sansui system they are carried in an "accumulator." The accumulator generates a "carry" signal from the truncated bits, which is added to the transmitted 8-bit word. This carrying of a

signal representing the missing bits does two things: it ensures that the decoded signals do not contain errors that would cause a fluctuation in DC level, and that low frequency signals are properly reproduced, even when their differential data is removed. FIGURE 2 shows the operation of the accumulator.

FIGURE 3 shows the signal-to-noise ratio variation with frequency, compared with a NIPCM system. The S/N in the near instantaneous system is reduced over the whole frequency spectrum, the amount of the reduction depending on the amount of bit compression. With DC-PCM, the signal-to-noise ratio at low frequencies reaches the full limit of the original quantizing rate before compression, but rises with frequency. In practice, this is not too serious. The effects of low-frequency noise modulation are not heard, and the noise modulation at higher frequencies is masked by those very frequencies, and so is seldom observed.

Using this system, with a transmitted bit rate of just over 250 kBit/sec per audio channel, the required RF

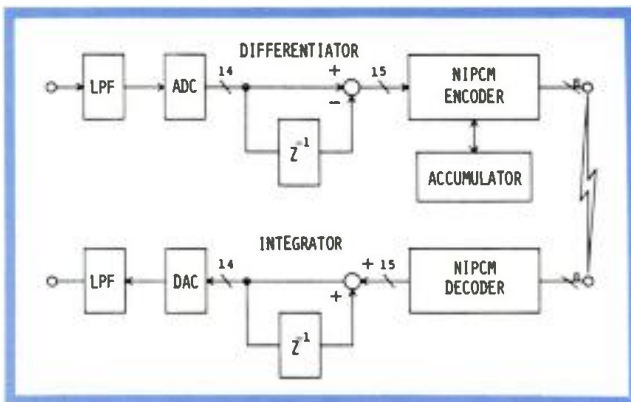

Figure 1. Block diagram of the 8-bit DC-PCM system.

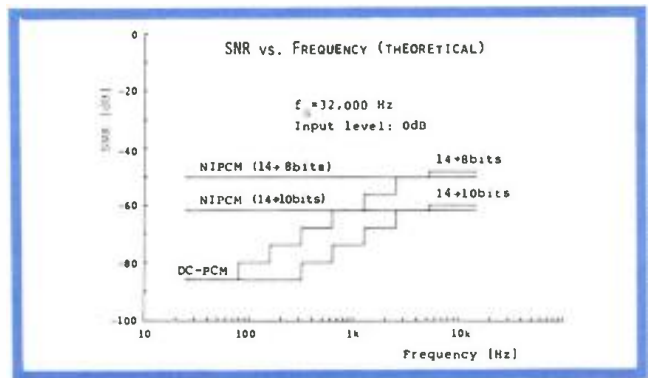

Figure 3. Signal-to-noise ratio with frequency vs. a NIPCM system.

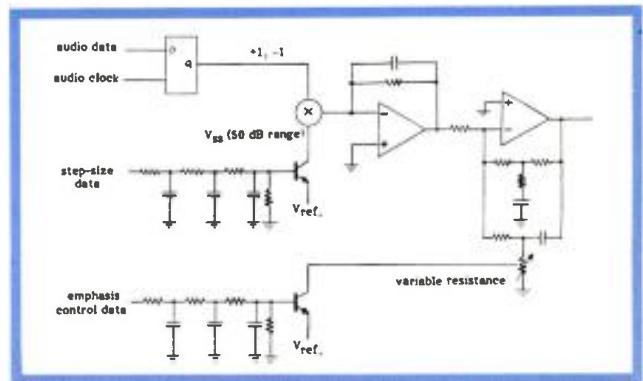

Figure 4. Consumer decoder.

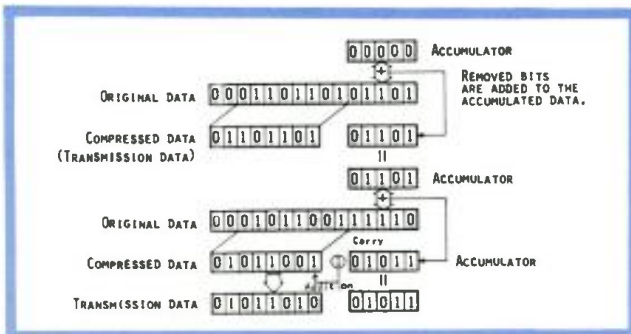

Figure 2. Operation of the accumulator.

bandwidth is greatly reduced over the conventional PCM methods. It becomes much more practical, say, to transmit this on a subcarrier in the TV signal.

Dolby Laboratories has offered yet another approach, this time without using PCM at all. They have chosen to investigate ways of improving the system of audio digitization known as delta modulation. This system is used by telephone companies for the transmission of speech, and is an economical medium for this purpose, but until recently it has not been considered a high

quality medium suitable for the transmission of music.

Like Differential PCM (DPCM), delta modulation measures the difference in level between samples, not the instantaneous level of the whole sample. Unlike DPCM, Delta modulation does not transmit this difference in levels, but rather the rate of change of the level. The sampling rate is high, but the system only transmits a pulse when the rate of change of level changes, so the actual number of pulses transmitted is greatly reduced. Delta modulation has some advantages over PCM. The circuitry does not require expensive high precision

this happens, the de-emphasis curve actually increases the low frequency noise, an undesirable stage of affairs. Dolby has solved this problem by using a sliding pre- and de-emphasis characteristic similar to those used in their noise reduction systems, controlled by a third digital bit stream derived from the spectral content of the audio. FIGURE 4 shows a block diagram of the decoder. FIGURE 5 the encoder.

The net result of all this is a digital transmission system which undoubtedly works, again as demonstrated on headphones at NAB. (I only wish I could have heard it

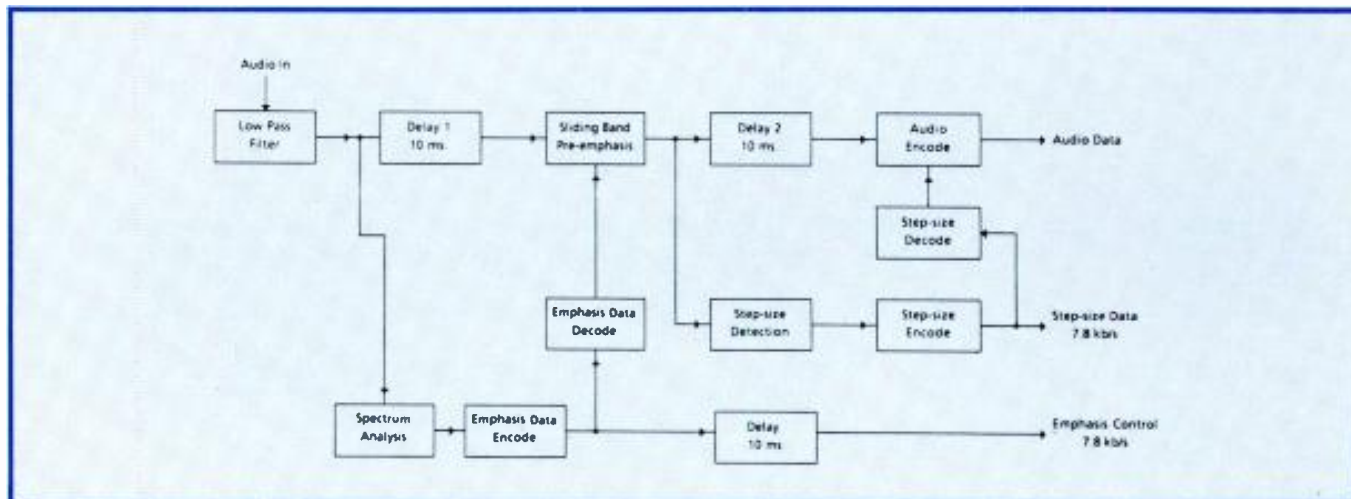

Figure 5. Block diagram of a professional audio encoder.

components, and allows inexpensive decoding equipment. Since all bits have equal significance, single bit errors have only a minor audible effect. An error correction system may therefore not be necessary, again a considerable cost saving. Against this, simple linear delta modulation doesn't have enough dynamic range, at suitable bit rates, for high quality audio. Dolby therefore uses Adaptive delta modulation.

Adaptive Delta Modulation (ADM), being a companded system, suffers from noise modulation as do all companded systems, analog or digital. However, unlike PCM, where the noise modulation is caused by high amplitude signals, in delta modulation it is caused by high slope signals, and therefore occurs mostly at high frequencies. Noise is predominantly of high frequency content, and so it is masked by the wanted high frequencies that it is associated with, and so not audible.

Adaptive delta modulation usually encodes the audio information and the step size or scaling information in the same bit stream. This can cause sudden gain changes on some bit errors. Dolby has reduced this effect by separating the audio information bits from the step size bits, and allowing the control signal to move more slowly. This would cause poor transient response, except for the fact the Dolby delays the audio information so that the step signal can rise in advance of the transients in the audio bit stream.

Problems of noise modulation can be reduced by the use of pre- and de-emphasis, but this is not satisfactory if the audio contains a great deal of high frequency energy. If

under conditions of less ambient noise. It is extremely difficult to hear the effects of noise modulation if the ambient noise is high.) One great advantage of the system, as well as the low bit rate, around 200 kBit/sec per channel, is that the circuitry for the decoder is cheap and easy to make. Dolby suggests it may cost less than \$10. The circuitry for the encoder, however, is relatively expensive, but since the decoder, in any case, is not owned by the consumer but by the transmitting company, and very few will be needed, this is of little consequence.

One last comment: Techniques such as those just described for reducing the transmitted bit rate for a high quality digital system make digital audio with television possible.

WRAP-UP

In North America, we are all but committed to a multi-channel audio with television system (which was also described at NAB), which uses technology originally developed for FM radio almost 40 years ago. As good as the proposed system is, should we not be looking at technology that is more in keeping with the audio state of the art in the 1980s, and not locking ourselves into a system which is already 40 years old, and once adopted, cannot ever be easily changed? Successful TV transmissions with digital audio have been carried out in Europe.

So, for this writer, NAB '84 prefaced the arrival of digital audio in the broadcasting arena. It remains to be seen how soon the techniques will be implemented. ■

The Golden Age of Radio Returns

Return with us to those exciting days of yesteryear when live radio ruled the airwaves.

TO MOST PEOPLE, live radio drama is something that went out in the Pleistocene epoch, or shortly thereafter. Recently, however, it had a bit of a revival in a coast-to-coast broadcast from the John F. Kennedy Center for the Performing Arts in Washington, D.C. The event, entitled “The Henny Penny Playwriting Contest,” was produced by Children’s Radio Theater (CRT) in association with National Public Radio. CRT is a vastly talented little group of adults (chronologically, at least) that produces radio drama programs for kids, aired on about 100 stations around the country.

For the past six years, CRT has solicited radio drama scripts from its young listeners and produced a recorded program from the best of them. This year, after receiving over 1,000 scripts, they felt for the first time that they were ready to do the show as a live, nationwide broadcast. CRT would produce the show from the best four scripts, and NPR would provide technical support: mixing, providing house PA feed, technical direction, and live distribution in stereo via the NPR satellite network. Aileen Quinn, of the film *Annie*, would host the broadcast.

As the event approached, both organizations began to realize the immensity of the project (and perhaps some of the reasons why it’s not done much anymore), but everyone involved proved up to the challenge.

JUS’ LIKE THE GOOD OL’ DAYS

This was to be live radio drama in the classic sense: live music, live actors, and *live sound effects* (plus some pre-recorded ones), all performed on-stage before a live audience of about 300, in the Theater Lab of the Kennedy Center, and simultaneously broadcast around the U.S., at 10 o’clock on a Saturday morning, no less (kiddie prime-time!).

Our initial site survey proved easy enough: nice large stage, adequate PA, decent acoustics, well-kept house piano (6-foot Baldwin), and an extremely helpful and gracious staff. The only unsolvable problem was occasional airplane noise from nearby Washington National Airport.

Rather than our preferred mixing location of a backstage, acoustically isolated room in which monitor

speakers could be used, the mix would take place out in the audience area, for several reasons: 1) The engineers needed to hear the PA mix; 2) Full visual contact with the stage was required—there was no “booth,” and a video link would not have been adequate; 3) CRT wanted the mixing position and broadcast engineers to be visible to the audience. This, of course, meant resorting to the dreaded headphone monitoring.

THE SETUP

The layout of the stage was decided upon mainly for reasons of acoustics and isolation between microphones, but sight lines had to be considered as well (see FIGURE 1). The four-member band consisted of keyboards (piano, electric piano, synth, backup vocals), percussion (snare, kick, cymbals, roto-tom, vibes, assorted percussion), sax/clarinet, and flute/piccolo. No bass and only a small amp on the electric keys helped in terms of leakage, but isolating the band without goboes looked like it might be a problem, so they were placed in the far upstage left area.

The actors were downstage center, around a stereo microphone (Neumann SM69 in X-Y cardioid patterns) with two solo microphones (Sennheiser MKH416P48, “short shotguns”) for the host, special solo voice effects, and “voice-over-a-crowd” effects. An API compressor/limiter was patched into the mixing channel of one of these solo mics to facilitate the voice-overs, especially when the actors sang. In those cases, the solo mic with compression was used for lead vocals, and the actors’ backup vocals were on the SM69. All other mics were run without gain-reduction, but the (Studer 169 and 269) mixers’ built-in stereo limiters were used for light limiting and protection of the phone lines, which were measured to have only 11 dB of headroom. (Frequency Response, Phase Response, and S/N on the lines were all very good. The linear distance between the Kennedy Center and NPR Master Control is only about 12 city blocks, so there were probably no Telco amplifiers in the lines.)

The sound effects table used another stereo X-Y pair (SM 69) for its main pickup, with two spots (416s) on adjustable stands to be placed as needed for off-the-table and floor effects. The latter SFX included a barn door being knocked down (a stack of wooden crates and tin cans being kicked over), falling into a puddle (a plunger dropped into a bucket of water), or a bank vault door opening (two old Datsun wheel rims rubbed together, with reverb added). The SFX person (and sound designer

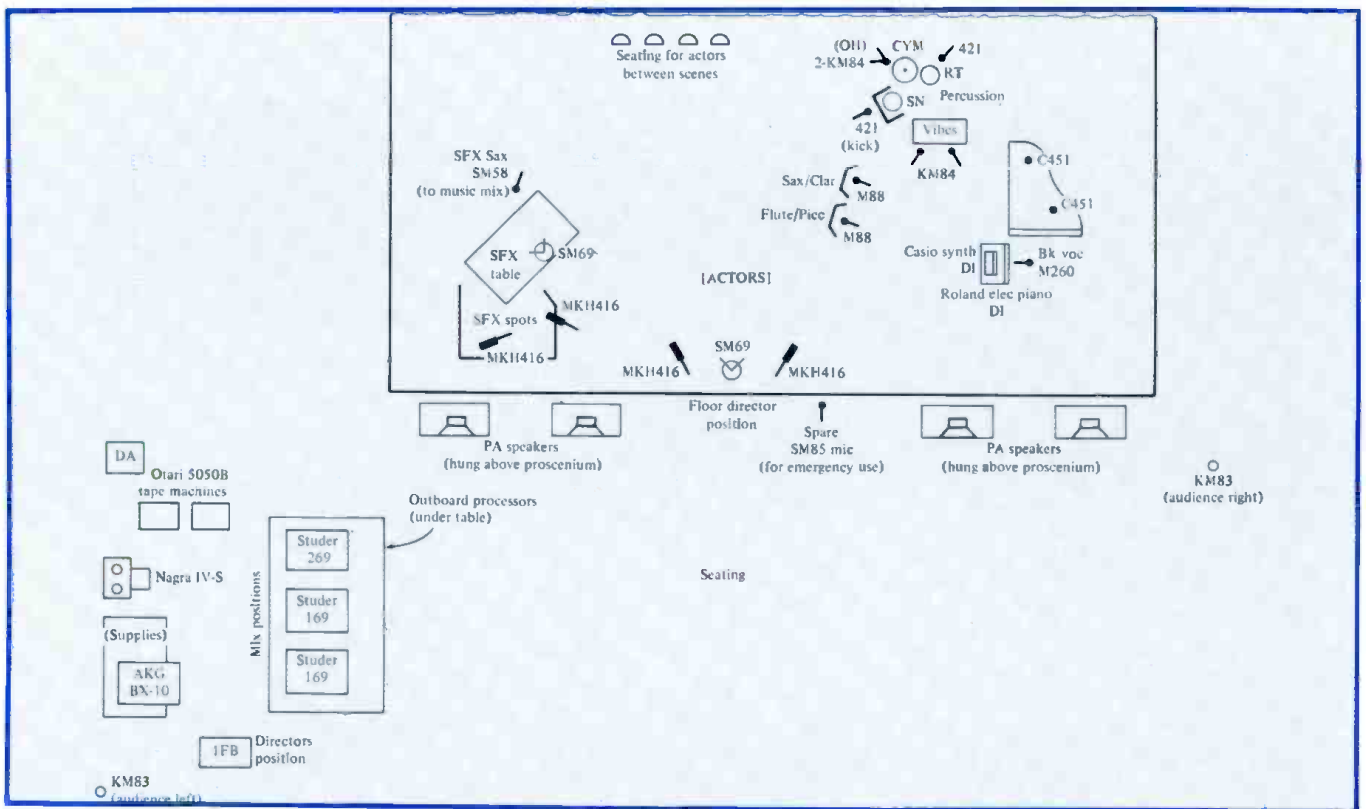

Figure 1. Layout plan.

for the show), Dave Taylor, Director of Program Services at the National Federation of Community Broadcasters (NFCB) in real life, also played a few tenor sax licks with the band.

During this production, Taylor found that squishing around a pile of loose 1/4-inch audio tape that's been dumped off a reel makes a very convincing "walking through the forest" sound. Of course, there were also coconut-shell halves pounded in a kitty-box full of packed soil for "hoofbeats," a key ring shaken against the head for "dog scratching fleas," a "whistle-tube" and the popping of paper and plastic bags for "spells being cast," and lots of clinking plates, rustling paper, typing sounds, and birdcalls, to name but a few. (This show *really* had all the bells and whistles.)

THE MIX

For versatility and simplicity in the heat of battle, it was decided that a "Hollywood" style of mixing, i.e., dialogue, music, and effects as separate submixes, would be used, but with a twist: PA feeding. The best portable consoles available to NPR for this event were two Studer 169 mixers (10 x 2 each), and one Studer 269 mixer (16 x 2). Each had one pre-fader and one post-fader send, a pair of aux returns, and flexible monitoring. The 269 was used for the music mix. One 169 was used for all effects mics and the outputs of two reel-to-reel playback machines (Otari MX5050-B, used for the CRT standard open theme and recorded SFX). Two decks were needed because of several scene changes requiring crossfading between two stereo ambience tracks. The other 169 was used for the actors' mics, the audience mics, and for master-mixing the stereo outputs of the other two consoles (see FIGURE 2). Although all three consoles could have been bused

together, this would not have allowed changing the music or SFX submix levels without using the masters of their respective consoles. For purposes of optimum gain structure, those masters had to remain at the "design center," and could only be moved in emergencies or for overall fades to and from black. Hence the decision to operate the music and SFX mixers as slaves to the dialogue mixer (no multi-channel-output consoles were available). The dialogue master mixer fed a distribution amplifier (NPR design), which fed a Nagra IV-S recorder and Telco lines back to NPR master control. From there the signal took the usual microwave route to the NPR uplink in suburban Virginia.

THE THICK PLOTTENS

The procedures involving aux sends were a little more complex. Ideally, two individually *switchable* pre- or post-fader sends on each output would have been helpful, but this was not possible without console modification, for which time did not allow. (The newer Studer 900 series consoles provides such a function, but on our consoles, the aux sends are normally dedicated as one pre-, one post-.) Consequently, the following arrangement was devised (call it "Byzantine but workable"):

Since the dialogue and effects mixes called for several different and quick-changing reverb sounds, the music mix would have to have its own separate reverb device. An AKG BX10 was fed from the post-fader send of the music mixer, and its returns brought back on the same mixer (see FIGURE 2). Its pre-fader send was used for a PA mix. Since the Studer's aux returns do not access its aux sends, in order for reverb to get into the PA, the BX-10 outputs had to come in on two faders, switched to line input mode.

For effects and dialogue reverb, a Lexicon 224 was used:

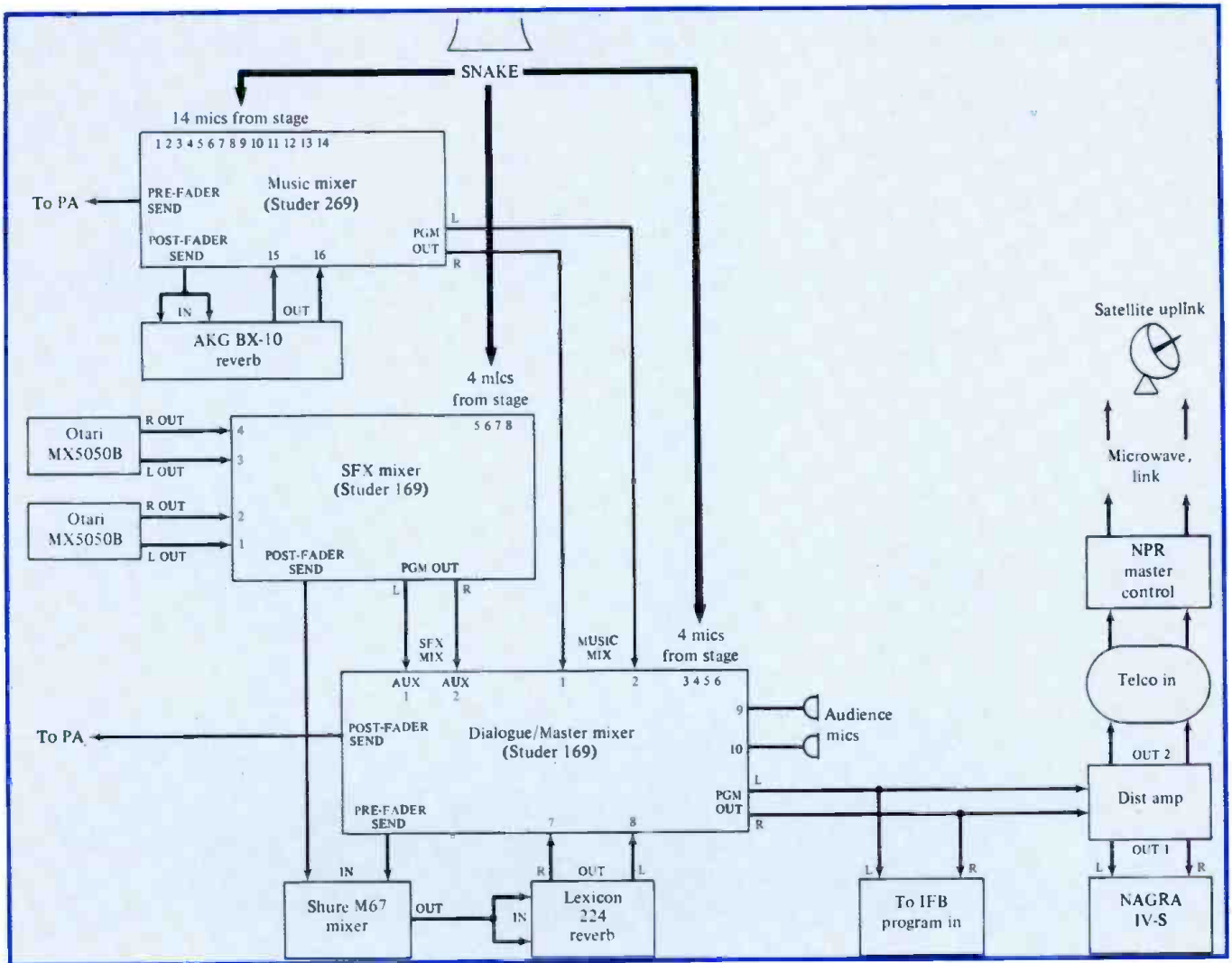

Figure 2. Mix signal flow.

its ability to make quick reverb program changes and to store customized effects was quite helpful.

Because we realized that practically all the effects (live and tape) would be mixed for the PA the same way they were for the broadcast (as opposed to the music and dialogue mixes, where the significant acoustic outputs of some sound sources into the theater would require a different PA mix), a simple stereo output *split* of the effects mix was given to the PA. The post-fader send of the effects mixer fed the Lexicon 224.

The dialogue master mixer used its *post-fader* send to feed the PA, since dialogue mics were always coming up and down in the mix. They were also the most downstage, and therefore closest to the PA speakers (which were suspended above the proscenium), so potential for feedback was high. Moreover, they could easily pick up leakage from the band; and it was most important to have them at the proper level in the PA. For all of these reasons, it was necessary to have the dialogue mics follow the faders, rather than be open and at a more or less fixed level, as the *pre-fader* approach would have dictated.

Of course, the audience mics were not sent to the *post-fader* bus, since the PA did not need them (or want feedback); the music and SFX submixes were also not fed to this bus, since the PA was already getting separate feeds directly from the two other mixers. This left the *pre-fader* send on the dialogue master mixer for use as a

reverb send to the Lexicon 224. As it happened, this turned out to be an advantage, since it allowed "fade to wet" effects (where the signal is faded completely out, but the *pre-fader* send is left up so that the reverb return is the only thing heard from that mic), which the script called for on a couple of occasions (e.g., a character losing consciousness).

The *post-fader* send from the SFX mixer and the *pre-fader* send from the dialogue mixer were combined on a Shure M67 mixer, and its output sent to both left and right inputs of the Lexicon 224. The Lexicon's outputs returned in stereo to the dialogue master mixer through two fader line inputs and, via that mixer's *post-fader* send, accessed the PA. (If you think *you're* lost, you should have seen the rat's nest we were in the middle of. We almost convinced the theater staff that NPR stood for National Public Rodent. FIGURE 2 may or may not help.)

KEEPING IT ALL TOGETHER

As if that wasn't enough, we had to add communications to this mess. Luckily, NPR has several in-house designed and built portable IFB (Interruptable Foldback) units, each with six stereo output sends. These units allow either the stereo program mix or an auxiliary stereo mix to be individually delegated to each of the six sends, a director's mic interrupts the *left channel only* of any individual send, or of all the sends, by the use of

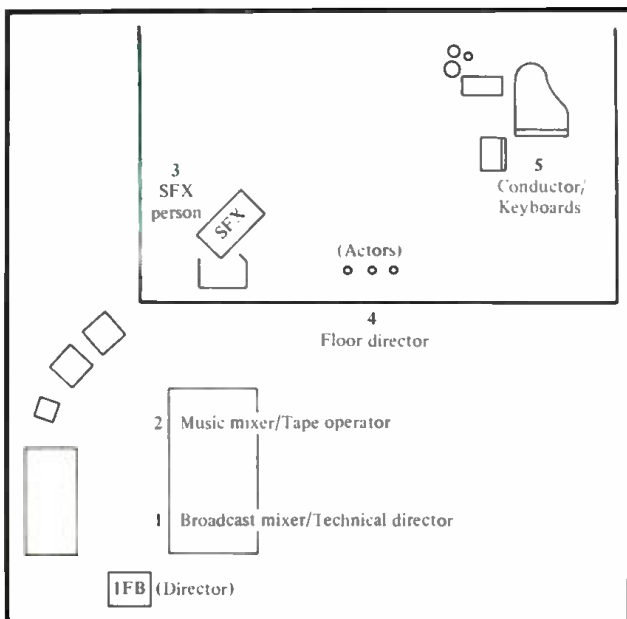

Figure 3. Communications layout, showing IFB panel and the five headset (send) locations.



Figure 4. Broadcast mix position.



Figure 5. Director's position and mix area with IFB control panel in foreground.

momentary switches. (The left channel only function allows the listener—who is usually wearing stereo headphones—to easily distinguish between what is on the air and what is coming from the director; i.e., both ears vs. one ear.)

One of these units was employed at this remote, with the sends assigned as shown in FIGURE 3. Routing these sends to some of those locations was accomplished by using a few pairs “in reverse” of the same 27-pair snake system (NPR-built to a Record Plant design) that the mic lines were using. No crosstalk was observed.

Jim Gleeson, also of NFCB, acted as director, and as such, cued the engineers (NPR's Terry Knight and myself), the SFX person, the floor director (Joan Bellsey of CRT), and conductor/composer/keyboardist Terry Tucker. The engineers' IFB sends were routed through one of the auxiliary monitoring positions on each of the Studer boards to allow for additional headphone volume, and to permit mono sum-checking. Most tech cues went only to the engineers, but many went to the floor director, who stood in front of the stage and visually cued and directed the actors (who were *not* on headphones, by choice—since this was not a studio, but a theater stage, the actors needed to “work to the house,” but stand at the microphones. Their positioning at the mics was carefully rehearsed, and adjusted by visual cueing from the FD as necessary.)

Robin Lyttle operated the PA with help from lighting operator Michael Morris. Robin's feed from the NPR mix consisted of four separate sends, as discussed above: music, SFX left, SFX right, and dialogue. She was then able to adjust relative levels (and stereo placement) between the submixes, since the NPR engineers could not continuously monitor the PA, but had to be under the cans listening to the broadcast mix and IFB. During the show, one of the NPR engineers would occasionally shed the cans to check individual mic balances *within* the submixes of the PA feed. These levels were all initially set during tech rehearsals with more specific attention paid to the PA sound, but that was without the large and

somewhat boisterous audience that attended the broadcast.

PROBLEMS

Needless to say, Edsel Murphy saw us coming on this one, and put the gig on his calendar well in advance. Due to the theater's and NPR's schedules, our load-in, set-up, and tech rehearsals were all lumped into one day, and a Friday the 13th at that! To say that day was rough is like saying the Grand Canyon is a hole in the ground.

After loading in, the set-up required no less than the



Live radio drama as performed by Doris Indyke and David Thompson



Vincent Brown and David Ingram performing a section of "The Yankee And The Georgian Witch" for Children's Radio Theatre

construction of an ad-hoc studio and "control room," and of course, "unexpected" technical problems (with RFI, Telco, rental equipment, IFB, and other glitches) slowed this work down considerably. (Note: Divestiture seems to have indeed made the broadcaster's work a little harder—"I'm sorry, sir, we don't do that sort of thing anymore..." "Oh, that's no longer our responsibility, sir, you'll have to call..." I wouldn't be surprised if they now have a vice president in charge of buck-passing.)

Worst of all, we had less than half a day to rehearse with the CRT folks, who had been rehearsing themselves steadily for about *six weeks*. Much of their work could have been for naught if the technical execution wasn't up to their speed, so a heavy game of catch-up was in order for us. The obliging theater staff gave us some extra time that night, but by the end of that very long day, no one was too confident that the next morning's broadcast would be successful.

Nevertheless, Murphy must have slept in that morning, because the show was pure magic. It went off without a hitch, to a packed house, and it even ran on time. The trials of the preceding day made the relief we all felt at the end of the program even sweeter.

One member of the audience who had attended network radio drama broadcasts in the old days told us that this production "ran circles around" anything he had seen back then. Of course, advances in technology render any such comparison unfair, but we basked eagerly in such high praise.

ON SECOND THOUGHT...

Some things that I'd do differently in a situation like this in the future (and we hope that this will now be an annual event) include:

1) Isolate or move the main SFX pair further upstage, away from the PA speakers, since the high gain required for some of the quieter SFX (plus the large stereo pickup pattern) caused some PA ringing on occasion.

2) Put an IFB station at the PA console, with either an assistant to the PA mixer always on cans, or some sort of call-light/headset arrangement.

3) Give the conductor's IFB send the *music submix* instead of the complete program mix.

4) At least *consider* doing the broadcast mix in a separate, offstage room with monitor speakers, and use mic splits to a console out in the hall for the PA mix. Director and IFB control panel would also be in this backstage room, and communications between director and broadcast mix engineer(s) would not be through IFB,

but simply spoken, since they are all in the same room. (A problem in doing the mix for this show—beyond simply having to *do* it on headphones—was that the director's cues for timing out a crossfade, for example, were coming into one ear of the cans *while* you were trying to do the crossfade. This was quite distracting, not just because the voice was over the sound being mixed, but also because the stereo image was screwed up, and any isolation from your cans was lost whenever the director pushed the talk button. This is because PA and room ambience were coming in through his mic along with his voice, since he was sitting out in the audience area as well. Using a noise-cancelling lip-mic helps, but still doesn't solve the problem when you really need to listen closely to the mix as the cue is coming in.)

5) Have one day for load-in and set-up, and at least one full day for tech rehearsals with complete cast. A small, invited audience at the rehearsals is helpful, since audience-mic boosts and fades are an important part of the mix.

6) Or just arrange to be on vacation in the Pyrenees when the gig is scheduled. (Avoid letting Murphy or any of his franchisees know where you'll be.)

'ROLL END TITLES!'

Other folks not yet mentioned for their contributions to this event are Tracy Wilson, Eileen Kelly, Kim Kovac, and Carole Huggins of the Kennedy Center; Jane Holmes, Dennis Herndon, Alan Corbeth, Dave Harris, Mary Lou Finnegan, and Joe Gwathmey of NPR; and Dave Thompson and Dottie Indyke of CRT, along with the rest of the wonderful cast (Erika Bogren, Vincent Brown, David Ingram, and Brian Mendoza) and band (Pete Chauvette, Carrie Moore, and Tom Allen). The playwrights were Cindy Buchanan, age 13; Tom Dickson, 16; Chris Freitag, 11; and Jason Freitag, 14.

Now I'm sure you'll all want to run right out and do one of these, so have fun and *good luck!* But seriously, folks, this is truly a vanishing and nearly extinct medium. Seek it out—it's a thrilling experience for everyone involved. They didn't call it the Golden Age of Radio for nothing.

About the only other regular event of this kind that I know of is the Midwest Radio Theater Workshop, a multi-day function with some big names, held every year in Columbia, MO, sponsored by KOPN-FM there, which always concludes with a live broadcast.

And for those sufficiently intrigued with *this* show, cassette copies of "The Sixth Annual Henny Penny Playwriting Contest" are available for \$7.00 from Children's Radio Theater, P.O. Box 53057, Washington, DC 20009. ■

MULTI-PAIR AUDIO CABLE SYSTEM

• Pro Co Sound's new Helix D-System Professional Multi-pair Audio Cable System is intended for demanding professional applications in concert sound, multitrack remote recording, and sound reinforcement installations. Utilizing a modular building-block approach to complex cabling requirements, the D-System includes floor- and rack-mounting junction boxes for 8 to 32 channels of input or output, with corresponding trunks and connector fan-outs available in virtually any lengths required. These components are interconnected via Elco multi-pin connectors for convenient system storage, transportation, modification, and expansion. D-System boxes are constructed of heavy-gauge steel with recessed connector panels and integral handles; bold silk-screened numbers provide high visibility channel identification. Boxes are equipped with Neutrik XLR-type connectors and phone jacks as required for microphone and line send input/output. Up to four multi-pin connectors can be fitted, providing complete signal-splitting and loop-through capabilities. Elco 8016-120 multi-pin connectors are standard and feature die-cast aluminum covers, impact-resistant polycarbonate pin blocks, gold-flashed hermetically sealed contacts, and reliable jackscrew mating for dependable performance. Parallel splits, isolated splits with Prem or Jensen transformers, and ground-lift switches can all be provided as necessary. Other multi-pin connectors such as MIL-38999 and AMP "Quicklatch" types may be accommodated by special order. D-System trunks are stocked in standard lengths of 25 to 250 feet with 6, 9, 12, 16, 20, and 32 channels. Each channel consists of a twisted pair with drain wire and 100 percent foil shielding. Stock trunk configurations have a male Elco connector at one end and a female at the other, allowing the stacking of trunks to meet varying length requirements. Versatility is further enhanced by the use of Elco 8016-120 connectors for all trunks, with a compatible pin



arrangement allowing any trunk to be joined to any other trunk, box, or fan, regardless of the number of channels. All shields are carried through on separate pins to minimize noise and crosstalk, including a "box ground" drain wire. D-System fans for termination of trunks are available in stock 6- through 32-channel models. Standard length of tails is three feet; other lengths are also available. Standard connectors are Neutrik XLR-type, with die-cast shells, chuck-style nylon strain

reliefs, and flexible rubber boots. Phone plug connectors are metal-barrelled three-conductor types by Switchcraft. Elco 8016-120 male multi-pin connectors are standard. Fans can plug directly into boxes for signal-splitting applications when trunks are not required. Other D-System components include box/trunk/multi-pin and fan/trunk/multi-pin hybrids for situations when complete system modularity is not required.

*Mfr: Pro Co Sound Inc.
Circle 31 on Reader Service Card*

NEW SYNCHRONIZER

• The Sony Sync Master is a new time-code-based synchronizer designed for synchronization of audio tape machines, videotape recorders, and film systems. The Sync Master provides a totally new synchronizer system based on the evolving SMPTE/EBU studio control protocols. The Sync Master consists of a multi-purpose keyboard/display unit, the AVS-500, and a processor rack, the AVP-500. Up to four machines can be locked together and controlled from the central keyboard/display unit. The display can be removed from the keyboard and mounted in a remote location for optimum visibility. This device incorporates the technology of video editing systems, providing an audio edit decision list with management capability, with the added ability to accept edit lists from CMX-compatible video editors. The Sync Master is designed for



interface with leading brands of professional analog audio recorders, 3/4-inch video recorders, and Sony BVH-1100 and BVH-2000 one-inch C-format VTRs as well as the full line

of Sony digital audio equipment.
Mfr: Sony Corporation of America
Price: \$12,000 to \$15,000,
depending on size of systems
to be controlled.
Circle 32 on Reader Service Card

DIGITAL AUDIO PERIPHERAL

• Micro Technology Unlimited's new DigiSound-16 is a professional quality digital audio peripheral for small computers. With DigiSound-16 and any small (or large) computer, it becomes possible to digitize and reconstruct high-fidelity sound. Applications include music and speech analysis, psychoacoustic research, and very high quality computer music synthesis. The unit requires only 8-bit parallel ports for interfacing. It is capable of full 16-bit audio digitizing and reconstruction with 12- and 8-bit companded formats also programmable for less stringent requirements. The sampling rate may be as high as 100 kHz in mono or 50 kHz in stereo. The needed low-pass filters are plug-in modules which allow any mix of sample rates to be used in an installation. A built-in FIFO buffer of 32K samples eliminates the need for double-buffering in the host and even allows continuous-with-disk operation in systems without DMA disk controllers. While a hard disk is desirable, continuous 25 kHz 12-bit



operation has been documented using the NTU-140 personal computer, which has only dual floppy drives. The buffer status is shown on a front-panel bar graph display. The

free-standing unit measures 3.5 × 12 × 8.25 inches and is self-powered.
Mfr: Micro Technology Unlimited
Price: \$2995 introductory
Circle 33 on Reader Service Card

STEREO AUDIO-VIDEO DELAY COMPENSATOR

• Lexicon's Model 1300 Stereo Digital Audio Delay Synchronizer optimizes audio synchronization with video signals in any professional broadcast environment. It precisely compensates for video delay, holding lip sync regardless of what digital video processors are in use, and compensates for satellite transmission delays. It decodes the hysteresis frame offset information from any video synchronizer for frame-accurate synchronization, and gives the user complete compatibility in any broadcast setup. Model 1300's advanced engineering provides transparent audio processing and conforms to the 16-bit standard. Its microprocessor-controlled, removable delay configuration control module can be software- or hardware-configured to conform to any delay/sync decoding scheme. Three initial standard decoding options include a pulse-width, wild feed genlock and a serial data. Digit switches on the

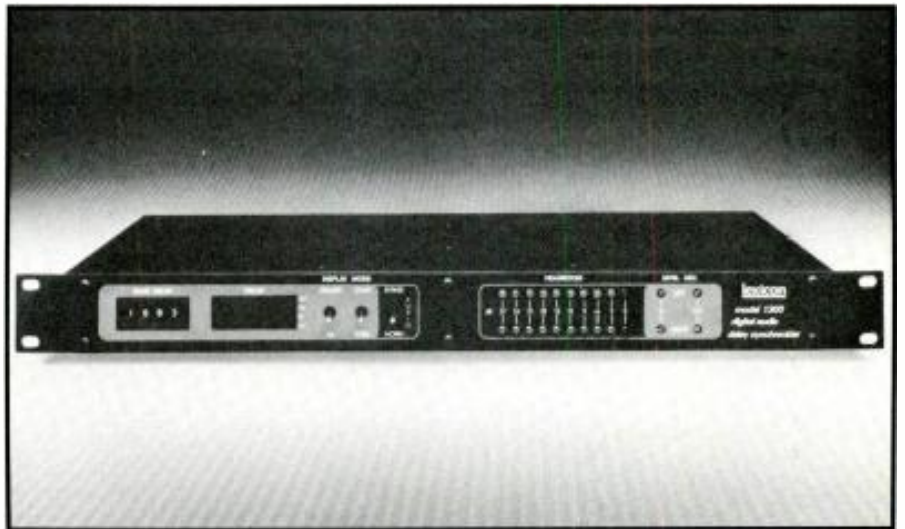

front panel can set a delay offset value displayed in either milliseconds or frame units. System specifications include 20 kHz bandwidth and .025 harmonic distortion. Stereo delay is from 0 to 340, 680, 1365, or 2048 ms.

Mono delay is from 0 to 680, 1365, 2731, or 4096 ms. Input/output levels are +24 dBm maximum.

Mfr: Lexicon, Inc.

Circle 34 on Reader Service Card

MIXING CONSOLE

• The ACE mixing console is the high end of the Audiotec product line, designed for the most demanding customers. The unit is fully modular with a maximum of 32 inputs and 12 stereo outputs (for 24-track recorders). The unit offers the following features per channel: 48-volt phase mic/line, Tape Return, Hi-cut, Low-cut, EQ-off, 4-band EQ, Mid 1 and Mid 2 parameter with switchable Q factor, 4 cues pre/post, mute, solo, peak LED, -20 dB LED, 100mm fader.

Dist: Audiotec

Price: 16/8/2, \$9,980

24/8/2, \$11,980

32/12, \$16,495

Circle 35 on Reader Service Card

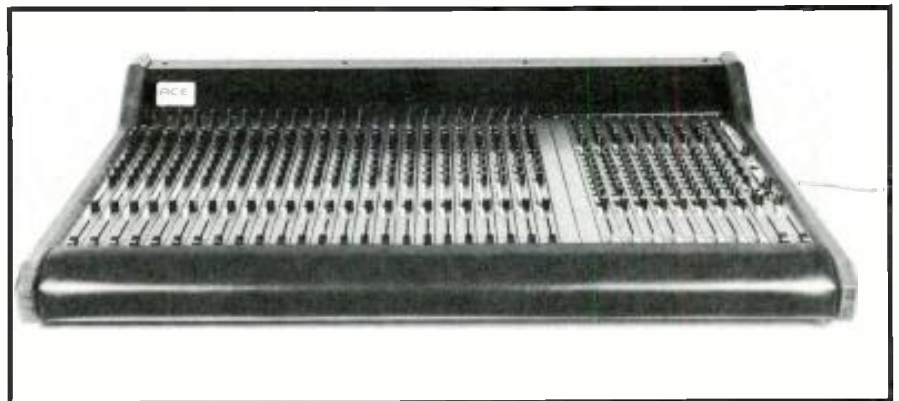

"SMART" CROSSOVERS"

• Renkus Heinz' new generation of "Smart" crossovers has an 18 dB/octave variable frequency crossover and a "Smart" SWG II electronic processor which provides complete amplitude and phase correction at both ends of the frequency band, fail-safe woofer and driver protection, variable intelligibility enhancement, and time coherent acoustic output. Wedge-shaped enclosures

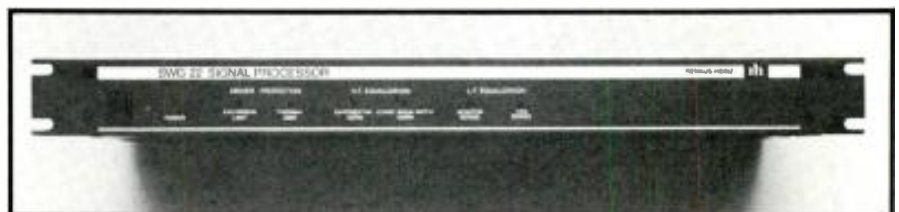

allow coupled array design for uniform coverage of any size venue. The "Smart" SWG II mounted with the low- and high-frequency power

amplifiers forms a simple module allowing fast and accurate setups.

Mfr: Renkus Heinz, Inc.

Circle 36 on Reader Service Card

AUDIO NOISE AND LEVEL METER

- Valley People's Advantage Model 310 Audio Noise and Level Meter was created to provide recording studios and broadcast facilities with a low cost, high quality measuring device capable of delivering greater accuracy than that achievable with more expensive general purpose instruments. Careful attention has been paid to ensure that the features of the Model 310 are specifically needed for analyzing noise performance in modern audio equipment. The unit offers: isolated, balanced, Trans-Amp™ differential inputs to eliminate unwanted noise, RF, and hum pickup while allowing measurement of extremely low level signal; 10 Hz to 100 kHz wide-band filter, which allows insertion of an external weighting network as required by the user's measurement application; 20 Hz to 20 kHz multiple pole filter to achieve accurate measurement of noise in an actual 19,980-cycle bandwidth through incorporation of 18 dB/octave filters with appropriate -3 dB points; 400 Hz to 20 kHz multiple pole filter to remove the lower four octaves of the audio spectrum in order to eliminate measurement errors caused by ground loops and other low frequency noise sources; "A" weighting filter, which correlates noise measurement to loudness as perceived by the human ear; CCIR weighting filter, which allows noise measure-



ment to be equated to current European standards; Average detector response, which indicates VU readings; RMS detector response; Peak detector response; Easy-to-read, dual scale analog meter, which accurately displays a wide 70 dB range in 1 dB increments; Full-scale range select, which allows measurement from -100 dB to +30 dB, thereby encompassing the entire spectrum of anticipated noise and signal levels

common in audio equipment; Detector output, which provides for indication of input signal level by an oscilloscope or other outboard recording devices; and a Preamplifier output/return, which allows connection of monitor amplifier and speakers without interfering with the measurement process.

Mfr: Valley People, Inc.

Circle 37 on Reader Service Card

ELECTRONIC FILTERS

- Precision Filters' new line of electronic filters are said to have excellent performance characteristics. The elliptic (Cauer) filters—the basis of the company's filter systems—is said to offer transfer characteristics superior to the traditional Butterworth or Chebyshev types. Instead of rolloffs that eventually reach 36 or 48 dB-per-octave, the company's LPI filters have rolloffs that reach 80 dB of stopband rejection less than one octave above the cutoff. Even more notable is the performance of the company's TD1 linear phase filters.

Time delay characteristics are said to be significantly better than those of the traditional Bessel filter, yet the TD1 has a much steeper rolloff. (The related diagram shows the performance characteristics of the LPI filter. Despite the lobes in the stopband, rapid attenuation to 80 dB re full scale is desirable for the ultra-high performance signal conditioning.)

Mfr: Precision Filters, Inc.

Circle 38 on Reader Service Card

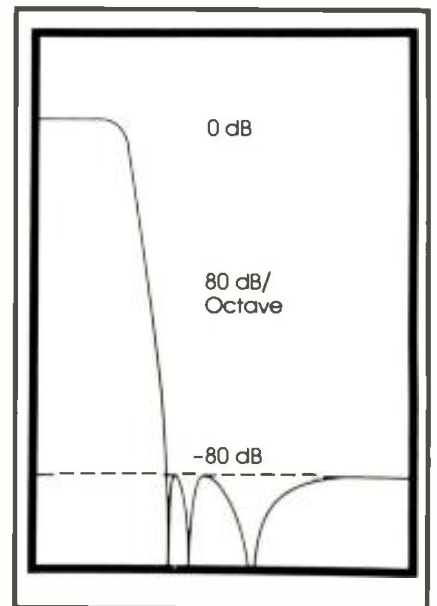

ELECTRONIC CROSSOVER

• Ace Audio Co's new model 6000-SF is designed for bi-amping and features a 12 dB/octave slope with low-distortion, active filter circuitry. Crossover points are available at any frequency from 200 to 18,000 Hz. The crossover frequency is controlled by precision metal film resistors and polyesterene capacitors, and may be easily changed via a plug-in frequency module. Distortion is in the .002 percent region at a 2-volt output level. The 6000-SF incorporates a newly-designed infrasonic filter circuit which removes infrasonic "garbage" below 15 Hz at 18 dB/octave. This effectively removes subsonic disturbances due to record warps, etc., which can interfere with good sound reproduction. Because of the Bessel filter circuitry, there is no ringing on pulse-type signals typically found in music programs. Options available include a mono woofer output, and level controls on either the woofer or tweeter outputs. 240 V models are also available.

Mfr: Ace Audio Company

Price: 6000-SF, \$181.00

*Extra frequency modules,
\$36.00*

Circle 39 on Reader Service Card

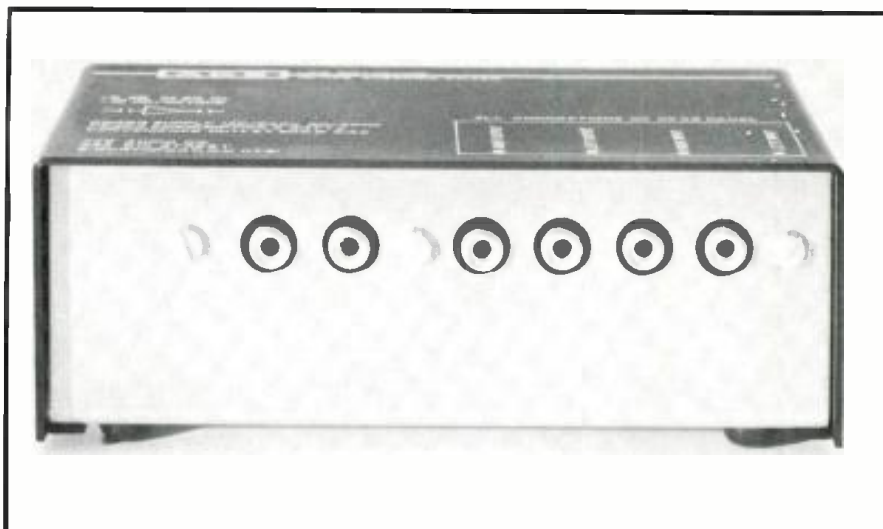

SOUND/SLIDE SYNC PROGRAMMER

• Audiotronics' new Model 154S sound/slide sync programmer allows the operator to tape programs on standard audio cassettes and then add the pulse signals that automatically and silently advance the visuals through the use of a professional dissolve technique on a single 35mm slide projector. The inaudible sync signals are recorded on a separate track, allowing the addition or deletion of pulses without changing the audio portion of the program. Additional convenience features allow complete remote control of the 154S console, changing the slides in forward or reverse without touching the projector. A Pause control allows the operator to stop the program for discussion or a longer look, and a variety of LEDs show recording levels and give visual indication of operational status of the programmer. A Reverse button allows manual return to a previous slide when the programmer is in the Pause mode,



and a Cut switch gives standard manual fast cuts to quickly review the slides. In addition, the 154S features ALC/ALC On/Off, a Public Address system, Bi-directional Sound, Cue, and Review for rapid retrieval of tape segments, Autostop,

Tape Counter, Pause, three-wire permanently attached AC cord, and In/Out jacks for duplicating separate track tapes and generating tapes using an external sync source.

Mfr: Audiotronics Corporation
Circle 40 on Reader Service Card



• **Rod Bell** has left his position as president of **Soundcraftsmen, Inc.** in Santa Ana, California. He will be joining his brother, David, as a manufacturer's representative in the Northwest, representing **Yamaha, Klipsch,** and **Soundcraftsmen,** among other audio lines. **Roger Hagemeyer** has been appointed vice president of sales at **Soundcraftsmen.** Hagemeyer had served as national sales manager at **Soundcraftsmen** since 1978. **Ralph Yeomans** resumes the title of president. For the immediate future, Bell's responsibilities will be shared by Hagemeyer and Yeomans.

• **Burbank Studios,** home of **Warner Brothers** and **Columbia Pictures,** recently purchased a **Mitsubishi X-800** 32-track digital recorder for their **Scoring Stage #1.** The **Mitsubishi** machine will be used primarily to record the musical portions of soundtracks for the studio's motion-picture product. "We want our recordings to sound as close to reality as possible," says post-production sound director **Tom McCormack.** "The **Mitsubishi X-800** provides better frequency response by operating at a higher digital sampling rate of 48 kHz. When we play back the **Mitsubishi** digital, we get almost an exact replica of the original performance."

• **Bill Jasper,** president of **Dolby Laboratories Inc.,** has announced that **Michael J. Stone** has joined **Dolby Laboratories** as vice president of **Finance and Administration.** Stone comes to **Dolby Laboratories** from **McKesson Corporation** of San Francisco, where he was assistant controller.

• **Donald F. Bogue** has been promoted to general manager of **Ampex Corporation's** **Magnetic Tape Division.** Since 1982, Bogue has served as director of business management for the tape division with overall responsibility for audio, video and instrumentation tape marketing and product line strategy for the company's magnetic tape business worldwide. Bogue joined **Ampex** in 1976 and has held various planning and financial management positions within the division and at the corporate level of **Ampex.** He was appointed business manager for audio tape products in 1980.

• Design work for a new two studio complex called **Sounds Unreel** in Memphis, TN, was recently com-

pleted by **Phase Audio, Inc.,** a Memphis-based sound contracting firm. **Sounds Unreel,** owned by Memphians **Don Smith** and **Jon Hornyak,** opened its doors April 1. According to **Murphy Odom,** owner of **Phase Audio,** the design incorporates economy and flexibility for various recording projects. **Studio A** offers 24-track capability and will be used primarily for record projects, while **Studio B** has eight tracks, with the capability for expansion, and will be used for voiceover work.

• The sound recording technology program and the **Sound Services Club** at **Fredonia State University** College in **Fredonia, NY,** have recently received gifts from several major corporations in the audio industry as a result of a fund-raising campaign created and implemented by **Ellen Fitton,** a senior in the sound recording technology program (**Tonmeister**) and chairperson of **Fredonia State's** **Sound Services Club.** **Fitton** approached approximately 50 corporations through a mail and telephone campaign which began in the fall of 1983 and is still continuing. **Electro-Voice, Inc.,** donated two pairs of studio monitor loudspeakers to replace the aging units currently in service. **Hitachi Sales Corporation of America** has made an unrestricted

cash donation that will be used for the purchase of equipment. Sony Corporation of America has donated a series of microphones and headphones. The Workshoppe Recording Studios, of New York City, has donated several Ampex tape recorders.

- **George Oppenheimer** has been named vice president of operations for **Sony Tape Sales Company** in Park Ridge, NJ, it was recently announced. In this newly created position, Oppenheimer will be responsible for the management of all financial and administrative activities for Sony Tape Sales Company. He succeeds **Eiji Tanaka**, who is returning to Sony Corporation in Tokyo to assume a new assignment with the International Operations Group. Oppenheimer joined Sony Corporation of America in 1980 as a financial analyst and was named controller for Sony Tape Sales Company in the same year.

- The **SMPTE 1/4" Working Group**, comprised of technical experts concerned with the use and manufacture of cassette-based ENG recording equipment, has tentatively agreed on a compromise draft standard format. This format provides 20-minute recordings on a single cassette. It utilizes oxide tapes currently being sampled. The agreement requires that members of the working group be satisfied that the format-related requirements of the User's Report have been met. It is expected that an additional period of time will be necessary to finalize the format. In the interim, the working group continues to be receptive to alternate format considerations.

- Construction is nearing completion on the new 15,000 square foot home of **Leo Diner Film & Video**, at 620 Third Street, San Francisco. The new Diner complex will incorporate film developing, Rank Cintel film-to-tape transfer capabilities and the recently introduced video-cassette duplication plant into a

single unit. Since its acquisition last year by **William H. Smith**, president and owner of **Allied Film & Video**, the Diner firm has grown steadily toward the amalgamation of film and video services typified by other Allied operations. Allied also operates facilities in Detroit, Chicago and Dallas. According to **Roy Diner**, vice president and general manager, "The firm's objective is to offer a complementary range of film and video products and services from which customers can choose those which are most appropriate and cost effective for their purpose. Film and tape no longer compete—they complement each other." The move is expected to be completed by June 1, 1984.

- **VPS Studios of Los Angeles** has put the final touches on its 12,000 square-foot independent studio facilities. The studio is designed for use by production companies for such activities as taping music videos and filming television commercials. The 6,000 square-foot air-conditioned sound stage features 25-foot ceilings, an extensive grid system, and 3,600 amps of AC power. The production control room overlooks the stage floor and features the **Grass Valley 1600** switcher, hi-resolution **Ikegami 20-inch** program and preview monitors, **JBL** audio monitoring, a separate producer/client console with its own RTS and telephone and the latest in RTS communications. A 16-channel audio board in VPS Studio's audio mixing room, a record/playback machine and a studio floor patch panel with 15 microphone inputs, 15 line inputs and 8 RTS outputs, round out the audio system. The engineering master control is capable of handling six cameras, four one-inch "C" format VTRs, four 3/4-inch VCRs and consists of a VTR bay and an engineering bay.

- For the second year, **Craig Sound and Recording Studios of Jenkintown, PA**, is providing sound reinforcement at the Academy of Music in Philadelphia for the **Philly Pops Orchestra**. Craig continues its nine years of service to advertising agencies, industrial clients and radio

stations with its studio recording and distributor products line. Recently, they have expanded their location sound work, adding the **Lankenau Hospital** and the **Abington Memorial Hospital** fund-raising fairs to their list of location projects. **Craig Recording** supplies unique multiple reinforcement systems for these fairs, incorporating paging, background music and full-stage systems. The equipment is arranged so that any audio source can be delivered to any specific area of the fair grounds. By pre-wiring coverage areas, Craig can operate out of a fully-equipped truck which can be driven away, then reconnected to the system in minutes.

The Advertising Council is the biggest advertiser in the world. Last year, with the cooperation of all media, the Council placed almost six hundred million dollars of public service advertising. Yet its total operating expense budget was only \$1,147,000 which makes its advertising programs one of America's greatest bargains... for every \$1 cash outlay the Council is generating over \$600 of advertising.

U.S. business and associated groups contributed the dollars the Ad Council needs to create and manage this remarkable program. Advertisers, advertising agencies, and the media contributed the space and time.

Your company can play a role. If you believe in supporting public service efforts to help meet the challenges which face our nation today, then your company can do as many hundreds of others—large and small—have done. You can make a tax-deductible contribution to the Advertising Council.

At the very least you can, quite easily, find out more about how the Council works and what it does. Simply write to: **Robert P. Keim, President, The Advertising Council, Inc., 825 Third Avenue, New York, New York 10022.**



A Public Service of This Magazine & The Advertising Council.

The cost of preparation of this advertisement was paid for by the American Business Press, the association of specialized business publications. This space was donated by this magazine.

A Golden Guy

• Grammy Award Nominee Jeffrey Osborne won his first Ampex Golden Reel Award for his gold album, *Stay With Me Tonight*. Pictured left to right are Tommy Vicari (chief engineer); Jeffrey Osborne; George Duke (producer), and Nick Spigel (assistant engineer). The album was recorded at Le Gonks West on 456 Grand Master Professional Mastering Tape.



You think we have to give these back after the photo session?

More Awards

• Wayne Freeman, Sales and Marketing manager of Soundcraft Electronics, Inc., the UK-based manufacturer of professional audio equipment, recently presented Westlake Audio, of Hollywood, CA, their Number One Dealer Award for 1983. Westlake Audio doubled their sales volume of Soundcraft products from 1982. Seen in the photo are Glenn Phoenix, owner/president of Westlake Audio (left), and Wayne Freeman.

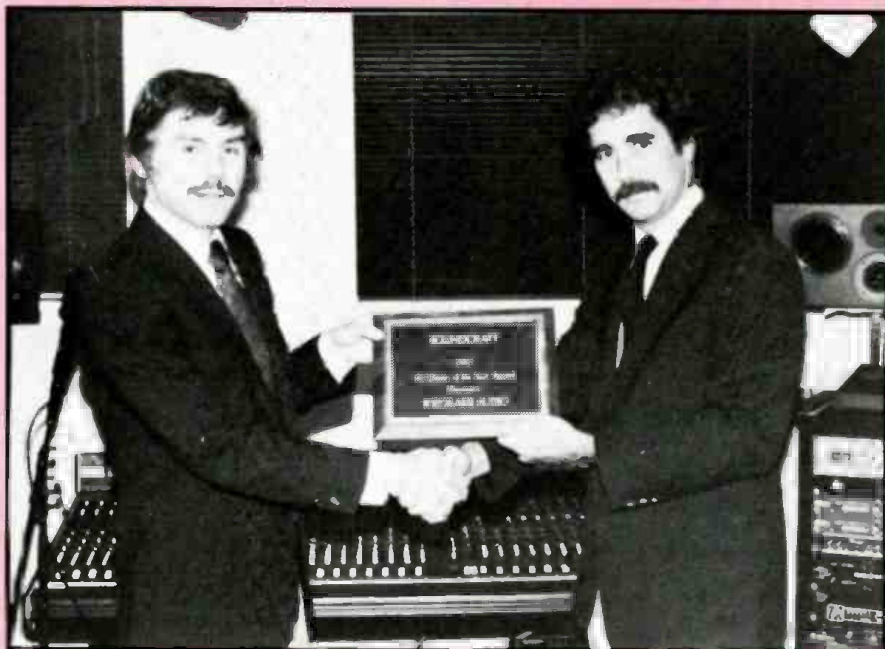

Hands across the ocean.

Classified

Closing date is the fifteenth of the second month preceding the date of issue.

Send copies to: Classified Ad Dept.
db THE SOUND ENGINEERING MAGAZINE
1120 Old Country Road, Plainview, New York 11803

Minimum order accepted: \$25.00

Rates: \$1.00 a word

Boxed Ads: \$40.00 per column inch

db Box Number: \$8.50 for wording "Dept. XX," etc.

Plus \$1.50 to cover postage

Frequency Discounts: 6 times, 15%; 12 times, 30%

ALL CLASSIFIED ADS MUST BE PREPAID.

FOR SALE

Nagra IV audio reel tape recorder; full track; monaural; three speeds; NAB standard; non-sync; includes two low impedance mic pre-amps; condition mint, used less than fifty hours—best offer. **Thomas Schreiner, 464 Delta Rd., Amherst, NY 14226. (716) 837-1753 evenings.**

FOR SALE: Telex 300 reel to cassette duplicator—four channel—six slaves. \$2000. Telex Copier 4 & 5, \$1000 each. All excellent. **Quik Cassette, 250 W. 57th St., New York, NY 10019. (212) 977-4411.**

WANTED: Used recording equipment. All ages and varieties. **Dan Alexander, 965 Hillside, Berkeley, CA 94708. (415) 527-4789.**

Quality audio equipment, supplies, low prices, any quantity, custom records, on-location recordings, cassette duplicating, printed labels, blank cassettes any length, recording tape. Our twentieth year. **FREE CATALOG: Stith Recording Services, 8 Redwood Lane, Ithaca, NY 14850 (607) 273-2309.**

FOR SALE

THE MOST COMPLETE
SELECTION OF

AUDIO TEST TAPES

All formats including cassettes

Write or phone for free catalog

STL

STANDARD TAPE LABORATORY, INC.
26120 Eden Landing Road #5, Hayward, CA 94545
(415) 786-3546

ANDOL AUDIO PRODUCTS, INC. is celebrating their 20th anniversary in the business. Andol Audio will institute a cumulative program—the biggest yet! We will have the cheapest prices in the country on all custom length cassettes:

- AUDIO CASSETTES
- VIDEO CASSETTES
- MASTERING TAPE
- 8-TRACK TAPE

DON'T DELAY—CALL TODAY! For more info: **Andol Audio Products, Inc., Dept. db, 42-12 14th Ave., Brooklyn, NY 11219, Toll free 1-800-221-6578, ext. 1, NY residents (212) 435-7322.**

Pair Shure SM-81 microphones with both omni and cardioid capsules. Mint. \$215 each, \$420 both. AKG N62E dual AC phantom supply. Excellent. \$55. **(414) 634-5422.**

FREE 32pg Catalog & 50 Audio/Video Applic.



PHONO, MIC, TRANS, ACN, TAPE, VIDEO, LINE, OSC

Stereo Mono Prev Ampl. Video & Audio Dist Ampl. TV Audio & Recd Prof Consoles

8-in 2-out, 12-in 4-out, 18-in 4-out

OPAMP LABS INC (213) 934-3566
1033 N Sycamore Av LOS ANGELES CA, 90038

PORTABLE NOISE MEASUREMENTS. **B&K 2306** Level Recorder, log/linear; **B&K 1616** One-third Octave Filter set for SLM's 2203, 2209; OSHA Noise Dosimeters, **Quest M-7B**, 80/90 thresholds, self-timing calibrator, set of four. \$950.00 each. **T.H. Rockwell, P.E., 13 Highgate Circle, Ithaca, NY 14850 or (607) 277-3550.**



Have you misplaced your **db** again? Our high quality, royal blue vinyl binders keep 12 copies of **db** neat and handy for ready reference. Just \$9.95, available in North America only. (Payable in U.S. currency drawn on U.S. banks.) **ORDER YOURS NOW!!**

Sagamore Publishing Co., Inc.
1120 Old Country Road
Plainview, NY 11803

YES! Please send _____ **db** binders @ \$9.95 each, plus applicable sales tax. Total amount enclosed \$ _____

Name _____
Company _____
Address _____
City _____
State/Zip _____

FOR SALE: AKG and NEUMANN tube type mics, all types. Other miscellaneous equipment. **Dan Alexander, 965 Hillsdale, Berkeley, CA 94708. (415) 527-4789.**

SENSURROUND LOW FREQUENCY ENCLOSURES with 18" CER-VEG 300 watt die-cast 96 oz. magnet driver. \$195.00. **Empirical Sound, 1234 East 26th Street, Cleveland, OH 44114. (216) 241-0668.**

EMPLOYMENT

INSTRUCTORS—AUDIO TECHNOLOGY, VIDEO TECHNOLOGY, ELECTRONICS. Full-time and part-time faculty openings to teach basic and advanced technology at leading proprietary technical institute. Industry experience and/or teaching experience required. Professional, satisfying atmosphere. Dynamic Greenwich Village location. Send resume and salary history to **Philip Stein, Director, INSTITUTE OF AUDIO RESEARCH, 64 University Place, New York, NY 10003.**

SERVICES

SONGWRITERS RESOURCES and SERVICES is a non-profit organization dedicated to the education and protection of songwriters. For free information, write or call **SRS, 6772 Hollywood Blvd., Dept. DB, Hollywood, CA 90028; (213) 463-7178.**

New York Technical Support, Ltd

IS SERVICE

"We provide the support necessary for today's recording technology. Our work is guaranteed."

CALL GREG HANKS 914-776-2112

1440 MIDLAND AVE., SUITE-1D
BRONXVILLE, NY 10708

MOVING?

Keep **db** coming without interruption!

Send in your new address *promptly*.

Enclose your old **db** mailing label, too.

Write to:

Eloise Beach, *Circ. Mgr.*
db Magazine
1120 Old Country Rd.
Plainview, N.Y. 11803

you write it

Many readers do not realize that they can also be writers for **db**. We are always seeking meaningful articles of any length. The subject matter can cover almost anything of interest and value to audio professionals.

You don't have to be an experienced writer to be published. But you do need the ability to express your idea fully, with adequate detail and information. Our editors will polish the story for you. We suggest you first submit an outline so that we can work with you in the development of the article.

You also don't have to be an artist, we'll re-do all drawings. This means we do need sufficient detail in your rough drawing or schematic so that our artists will understand what you want.

It can be prestigious to be published and it can be profitable too. All articles accepted for publication are purchased. You won't retire on our scale, but it can make a nice extra sum for that special occasion.

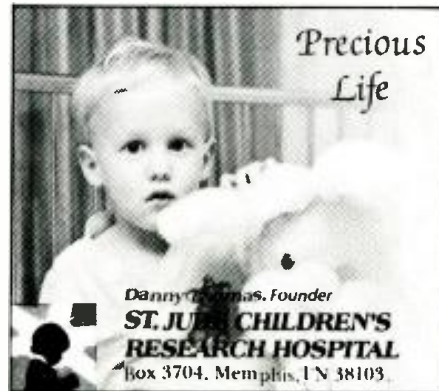

From Hendrix to Hall and Oates.



A history as glorious as the tracks they produce — Electric Ladyland has recorded the stellar names in the business for over 15 years.

Led Zeppelin, David Bowie, Foreigner, the Clash and the Cars are just a sample of the Electric Lady product.

We're proud to announce that Electric Lady gets her power from Crown — exclusively.



1718 West Mishawaka Road
Elkhart, IN 46517 U.S.A.
(219) 294-5571

Circle 11 on Reader Service Card

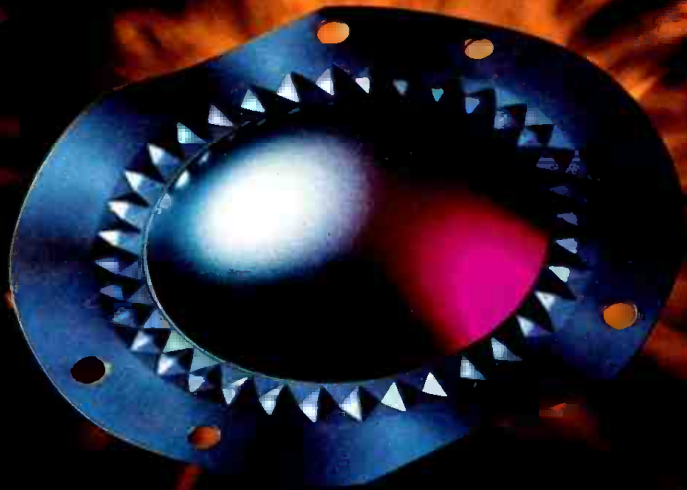

JBL's unique titanium diaphragm and "Diamond Surround" bring new purity and consistency to high frequency response.

IT TOOK JBL SCIENCE, A NITROGEN EXPLOSION, AND PURE TITANIUM TO GIVE YOU PERFECTED HIGH FREQUENCY SOUND.

High frequency sound has always fought with the technology that brings it to the ear. The driver diaphragm has been most vulnerable, pushed to the breaking point, unable to hold uniform frequency response.

JBL scientists decided to fight back. They exploded nitrogen into a remarkable metal, pure titanium, encircling their unique diaphragm with a vibration-absorbing "Diamond Surround," so revolutionary it warranted its own patent.

The result? A diaphragm that delivers and sustains a power and purity to high frequency response never before approached in the industry.

Perfecting titanium technology is just one of innumerable ways in which JBL science is re-shaping the quality of sound. From ultimate accuracy in laying down your initial tracks, to capturing the full power and subtlety of your final mix, JBL audio systems are focused on the most exacting demands of the recording studio professional. To find out which system is designed to meet your specific requirements, contact your authorized JBL professional products dealer today.

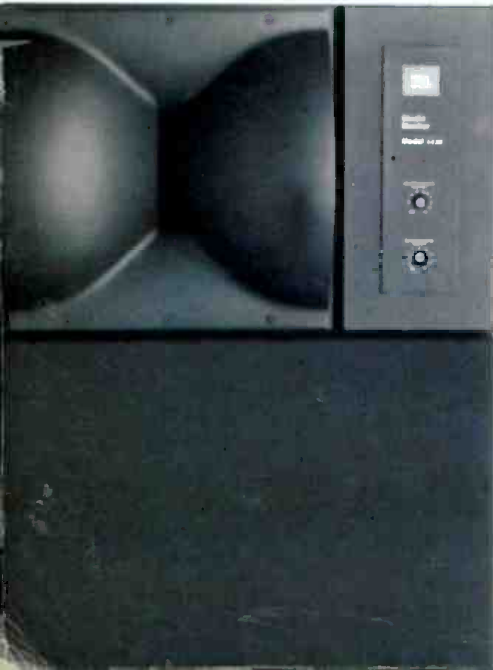

JBL Incorporated,
8500 Balboa Boulevard
P.O. Box 2200,
Northridge, CA 91329
U.S.A.



JBL/harman international ©JBL INCORPORATED 1984

Circle 12 on Reader Service Card