

# db

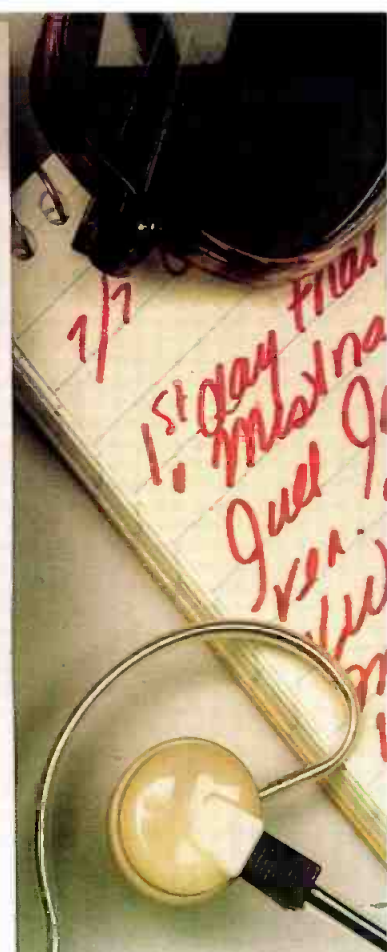



**Amid the hostility, the confusion, the competition,  
one microphone stands above the crowd.**

## **The SM63.**

No matter how rough things get in the field, the Shure SM63 Omnidirectional Dynamic Microphone gives your crew the whole story with a lot less handling noise than any microphone in its class. When Shure's engineers developed the SM63 and SM63L (with longer handle), their objective was to create a high-output, lightweight microphone perfect for the needs of electronic news journalists.

With the SM63's patented internal mechanical isolation system reducing undesirable handling noise, its high output and smooth extended frequency response lets your story come through crisp and clear. Its omnidirectional polar pattern prevents boominess that is often encountered during close miking situations. And its overall lightness makes continuous hand-held ENG/EFP assignments less fatiguing, without sacrificing ruggedness. Even its profile is small and elegant so it won't obscure faces on camera.

The output of the SM63 is a full 6 dB higher than comparable hand-held interview microphones.

And there are even more precision-engineered refinements. A highly effective internal humbucking coil rejects strong magnetic fields encountered around lights and other broadcast situations. And when things get really tough, the Shure-developed *VERAFLEX*<sup>®</sup> grille is virtually impervious to rust, moisture and dents. This system includes a highly effective internal anti-wind and -pop filter; and for more adverse conditions, a dual-density two-layer windscreen also is supplied.

The Shure SM63. The hard-working microphone for the working press.

For more information on the complete line of professional broadcast products, call or write Shure Brothers Inc., 222 Hartrey Ave., Evanston, IL 60204, (312) 866-2553.

# **SHURE**<sup>®</sup>

**THE SOUND OF THE PROFESSIONALS<sup>®</sup>...WORLDWIDE**

Circle 10 on Reader Service Card  
[www.americanradiohistory.com](http://www.americanradiohistory.com)

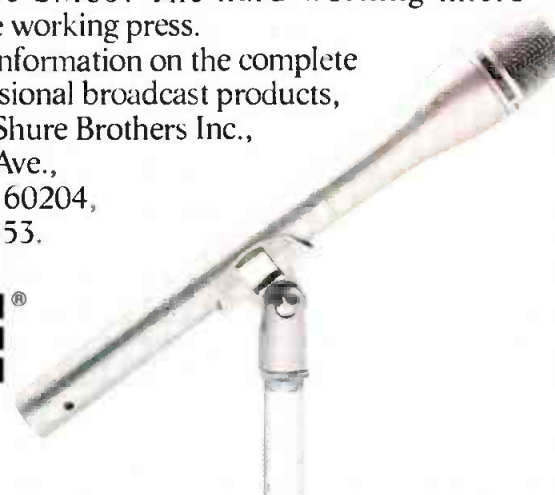



JULY-AUGUST 1983 VOLUME 17, NO. 7

Publisher  
**Larry Zide**

Associate Publisher  
**Elaine Zide**

Editor  
**John M. Woram**

Managing Editor  
**Mark B. Waldstein**

Associate Editor  
**Ricki Zide**

Technical Editor  
**Linda Cortese**

European Editor  
**John Borwick**

Layout & Design  
**Kathi Lippe**

Advertising Coordinator  
**Karen Cohn**

Book Sales  
**Lydia Calogrides**

Circulation Manager  
**Eloise Beach**

Graphics  
**K & S Graphics**

Typography  
**Spartan Phototype Co.**

### FEATURES

<b>AUDIO INSTALLATION AT THE FORT WORTH MUSEUM OF SCIENCE AND HISTORY</b> 29	<b>Bo Carr</b>
<b>A db TEST REPORT: THE ORBAN 422A/424A GATED COMPRESSOR/LIMITER/DE-ESSER</b> 38	<b>John Monforte</b>
<b>JBL's CENTRAL ARRAY DESIGN PROGRAM (CADP)</b> 41	<b>John Eargle</b>
<b>COMPRESSION DRIVERS OLD AND NEW</b> 46	<b>William J. Gelow</b>

### DEPARTMENTS

<b>LETTERS</b> 6	<b>EDITORIAL</b> 28	<b>CLASSIFIED</b> 55
<b>SOUND WITH IMAGES</b> 12		<b>Len Feldman</b>
<b>DIGITAL AUDIO</b> 18		<b>Barry Blesser</b>
<b>SOUND REINFORCEMENT</b> 22		<b>John Eargle</b>
<b>THEORY AND PRACTICE</b> 24		<b>Ken Pohlmann</b>
<b>NEW PRODUCTS AND SERVICES</b> 50		
<b>PEOPLE, PLACES, HAPPENINGS</b> 58		

#### **ABOUT THE COVER**

• This month's cover features the Automatt's Studio A. The room features a Trident board, Studer deck, and Meyer monitors. The board is set for sessions with Narada Michael Walden's band, the Warriors. Thanks to Kaz Tsuruta for the photo.

db - the Sound Engineering Magazine (ISSN 0011-7145) is published monthly by Sagamore Publishing Company, Inc. Entire contents copyright © 1983 by Sagamore Publishing Co., 1120 Old Country Road, Plainview, L. I., N. Y. 11803. Telephone (516) 433-6530. db is published for those individuals and firms in professional audio-recording, broadcast, audio-visual, sound reinforcement, consultants, video-recording, film sound, etc. Application should be made on the subscription form in the rear of each issue. Subscriptions are \$12.00 per year (\$28.00 per year outside U.S. Possessions, \$16.00 per year Canada) in U.S. funds. Single copies are \$1.95 each. Editorial, Publishing and Sales Offices: 1120 Old Country Road, Plainview, New York 11803. Controlled circulation postage paid at Plainview, NY 11803 and an additional mailing office.

# ONE PASS

**The Only Four-Second  
Tape Erasers**

**That's Garner...  
The Quality Eraser**

You're recording on a machine that costs hundreds or thousands of dollars, and you're recording on recycled tape. Can you guarantee that tape is absolutely clean? You can if you're using a Garner Audio Tape Degausser.

Garner is the standard of the industry...designed to the specifications of leading tape manufacturers. Garner is a conveyor-belt tape eraser. It can erase in less than five seconds what most degaussers take up to a minute to erase, and Garner erasers do a better job.

**Time savings, ease of operation, quality of erasure, and rugged construction make Garner the most cost-effective eraser available.**

Garner has established a reputation as the "Eraser People" because we manufacture a complete line of both audio and video erasers. Call and let us show you what a Garner eraser can do for you.



**Dependability...Guaranteed**

**garner industries**

4200 N. 48th Street Lincoln, NE 68504  
Phone: (402) 464-5911 Telex: 438068

## Letters

### CLARIFICATION AND ACKNOWLEDGEMENT

TO THE EDITOR:

I'd like to clarify something that appeared in my article on "Tips on Recording from the Telephone" (March 1983). In discussing digital PBX phone systems, I mentioned "ITT/ROLM" as an example, whereas what should have been said was "Rolm, ITT, and others." At NPR, we use a Rolm system main-frame with mostly ITT telephone instruments; hence our combined in-house designation. The two companies are in fact *not* associated, as I implied, and they both make their own, separate PBX systems, as do Western Electric and many other telecommunications companies.

Also, I'd like to acknowledge the contribution of Joel Tall, founder of Editall, Inc., and a radio engineer at CBS for many years, who inspired the article and laid much of the groundwork for it. I'm happy to say that after a lifetime of achievement that includes the invention of the splicing block for audio tape, his innovative activity continues: currently he's working on improvements in the technology of aids for the hearing impaired. Thanks, Joe, from all of us at NPR, and keep up the good work.

SKIP PIZZI  
Audio Engineer/  
Training Coordinator

### WHY?

TO THE EDITOR:

I found Ken Pohlmann's two recent columns on compatibility very insightful. I have just one question: Why?

In a recent issue of *Keyboard* magazine, Robert Moog explained some of the reasons why music synthesizers currently have incompatible designs. The problems stem from a lack of technological knowledge in a totally new field, inability to predict the popularity of an untried product, and acute competitiveness among designers.

Since entering the audio field I have encountered compatibility problems—such as "pro" vs. "semi-pro"—and their solutions everywhere. However, the majority of these problems, like those in synthesizers, have existed for a long time and are deeply entrenched (and accepted) in the way the industry operates. It is too late to change them.

But *why*, given our ability to study past mistakes, would today's manufacturers willingly design incompati-

## Index of Advertisers

Alpha Audio .....	19
Amber.....	20
Ampex .....	Cover IV
AXE .....	14
Bruel & Kjaer .....	9
Communications Co.....	10
Crown .....	12, 26
DeltaLab .....	21
Dolby .....	17
Eastern Acoustic Works .....	23
Electro-Voice .....	15
Emilar .....	50
Garner .....	6, 22
ITT Cannon.....	13
JBL .....	7
Klark-Teknik .....	34
Knowles .....	32-33
Modular Audio.....	39
PAIA.....	54
Polyline.....	52
Pro-Tech Audio .....	16
Quad-Eight .....	31
Shure Bros.....	Cover II
Sound Ideas.....	51
Standard Tape Labs.....	37
Studer Revox .....	27
UREI .....	Cover III
White.....	8

### COMING NEXT MONTH

• Next month, *db* goes to the AES Convention. Among the featured articles will be a piece on CDs by Michael Tapes of Sound Workshop a look at the history of the LP by John T. Mullin and a *db* Test Report on the Bruel & Kjaer studio microphones. In addition, Bob Anthony brings us a look at the sound reinforcement system used at the US Festival while Gregory Hanks brings us the first installment of a feature on recording consoles in film production. Of course, all our regular departments and columnists will be on hand. All this—and more—coming in the special AES issue of *db*—The Sound Engineering Magazine.

# High Technology. JBL.



Until now, buying advanced technology high frequency components could be both a pleasure and a problem. A pleasure because of the improved performance these devices can provide. A problem because exotic designs can often be less than reliable. Or easy to use. Or cost effective.

At JBL, we don't think you should have to give up practicality to get the performance you need. And to prove it we're introducing a new generation of high frequency components that combine unsurpassed frequency response, high reliability, and surprisingly affordable prices.

The secret behind this rare blend of features lies in the use of new engineering technologies that not only improve performance, but actually reduce manufacturing costs.

Our latest 1- and 2-inch throat diameter compression drivers, for example, utilize a pure titanium diaphragm with JBL's patented diamond-pattern

surround. The exceptionally high stress limit of titanium together with the stronger surround allows this design to match the reliability of phenolic and composite type diaphragms. At the same time, the design's improved

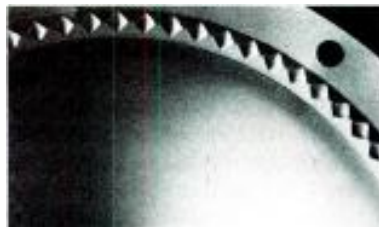

**JBL's titanium-diamond diaphragm combines performance with reliability.**

flexibility and light weight provide the extended frequency response of more expensive, fragile, exotic metal diaphragms. Finally, the drivers feature a newly developed, high-flux ferrite magnetic structure for maximum efficiency and extended response.

And the drivers are only part of the story. Because JBL engineers have also developed a complete new line of compact,

Bi-Radial™ constant coverage horns. Designed for flush cabinet mounting or compact cluster applications, the horns provide precise pattern control. The horn's highly consistent horizontal dispersion eliminates the problems of midrange narrowing and high frequency beaming associated with conventional horn designs.

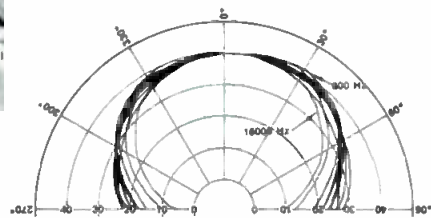

**Composite 1/2-octave polar responses of a 2380 horn from 800 Hz-16 kHz in the horizontal plane.**

So if you're looking for advanced high frequency components that combine real world practicality with unmatched performance, ask your local dealer about the new generation of high technology. From JBL.



**Professional  
Products  
Division**

JBL/harman international

JBL Incorporated,  
8500 Balboa Boulevard, P.O. Box 2200,  
Northridge, California 91329 U.S.A.

db July-August 1983

7

Circle 13 on Reader Service Card

www.americanradiohistory.com

bility into a device? The fact that Mr. Pohlmann is able to write about incompatible digital sampling rates, while the equipment is being created, means that the problem can be corrected. Nevertheless, there are now three different standards.

I find this foolishness infuriating. Surely we are not still suffering from the same shortcomings as designers working twenty years ago. Even if the future of digital is not completely clear, why not at least make whatever is offered as "state-of-the-art" as useful and sensible as possible. Designing digital devices for optimum performance/cost, with compatible operation, can only help their acceptance!

Incidentally, the difficulty that Mr. Pohlmann described with modems sounded a little funny to me. From my experience, if the modems transpond in ASCII, the connected computers can communicate. The modem or terminal software will compensate for word format differences, etc.

ERIC WENOCUR  
Lab Tech Systems  
Roar Productions

**Ken Pohlmann replies:**

*I agree with Mr. Wenocur's comments and share in the frustration of incom-*

*patibility. As he points out, it seems to stem from manufacturer competitiveness—perhaps it's an inevitable result of the free enterprise system. Maybe in a totalitarian society all pictures fit all picture frames.*

*Of course, even in a totalitarian society technological evolution would have a tough time squeezing itself into the old formats. Perhaps in that respect compatibility is a self-defeating goal. Still, as Mr. Wenocur writes, we are able to identify the problem and design solutions to it, so the next logical step is to apply a little foresight and cooperation. Surely everyone would benefit, and technology's acceptance would be enhanced. How about brave ventures such as the DIN system? Is this a step in the right direction?*

*As for modems, you caught me red-handed! The modem is indeed one of the greatest compatibility inventions of the 20th century. On the other hand, how much would you be willing to bet that your word-processed letter would appear correctly on my screen on the first try?...on the second try?*

*No, I'd rather go all the way and buy a special compatibility plug-in. The fact that the editor and I could then trade otherwise incompatible software—why that never crossed my mind.*

**...and db replies:**

*When it comes to incompatibility, don't forget the Justice Department and the anti-trust laws which often discourage manufacturers from "collaborating" on standards. The idea is to keep everyone honest and prevent price-fixing, restraint of trade, and such. All things considered, it's probably not such a bad idea that manufacturers wind up "slugging it out" in the marketplace, rather than agreeing up front on a standard way to build something. That way, the customer gets half-a-chance to pick the best system, rather than the one that would be most profitable to build. Of course, it's difficult to copy with those early incompatibility problems, but it would probably be even more difficult to copy with the alternative.*

**PIZZI REPRISE**

TO THE EDITOR:

With the break-up of A.T.&T., the guerilla warfare between broadcasters and Ma Bell will soon escalate into open warfare. For the radio engineer, a thorough understanding of telephone interfaces will be crucial...yet Mr. Pizzi's article in the March issue of db tends to mystify and complicate the area without spreading much light. Besides, it is the classic example of "our tax dollars at work." The photo on page 54 says it all: over a thousand dollars in equipment to sweeten phone calls!

Here at WSPD we have seven reporters in the news department, three sportscasters, plus air personalities who all rely on the telephone. And we are an AM music station successfully competing with five FM stations.

In news we simply run straight off a QKT. We don't have time to equalize, and frequency response is limited by the carbon mics in most office phones. We've also found it best not to equalize program material too much with modern multi-band processing. Com-panding or compression would simply add noise—besides, the gated AGC in the Optimod does a much better job.

Where we can control the sending end, we have had considerable success equalizing dial-up telephone lines on our same telephone exchange. We maintain a news bureau in City Hall, near most of the city and county offices, and base two reporters there. Instead of fighting traffic and deadlines, they file reports over a standard dial-up line we have equalized from 100 to 8 kHz ( $\pm 2$  dB) using an inexpensive Shure Audio Master (M-63). We have a small box with a mic preamp and limiter feeding a QKT at -10 at the bureau end; once the line is set, the equalization stays constant since in the local exchange the path length remains constant. We feed the equalizer



**2 Channel Octave Band Graphic Equalizer  
L-C ACTIVE 4100A**

The model 4100A features Active, Inductor-Capacitor (L-C) Tuned Filters. The resonant frequency of each filter is derived PASSIVELY by a Tuned L-C Pair. This drastically reduces the number of active devices necessary to build a Ten Band Graphic Equalizer. Only seven operational amplifiers are in each channel's signal path: THREE in the differential amplifier input; TWO for filter summation; ONE for input level control; ONE for the output buffer. The result . . . the LOWEST "Worst Case" NOISE of any graphic equalizer in the industry . . . -90dBv, or better.

White	<b>instruments, inc.</b>
	P.O. Box 698 Austin, Texas 78767
	512/892-0752
	TELEX 776 409 WHITE INST AUS

Circle 14 on Reader Service Card

# Brüel & Kjær Studio Microphones

The Next Logical Step



	Low Intensity Studio Microphone	High Intensity Studio Microphone
Balanced or single ended output. Line Level. No-compromise design. Powering via Type 2812. Two Channel Microphone Power Supply	Type 4003	Type 4004
Standard P 48 Phantom Power	Type 4006	Type 4007

Ask for our 16-page colour brochure for a thorough description of these new Brüel & Kjær studio products.



**Brüel & Kjær Instruments, Inc.**

185 Forest Street, Marlborough, Massachusetts, 01752 (617) 481-7000 TWX: 498 0421

World Headquarters: Nærum, Denmark. Offices in 55 countries

Circle 15 on Reader Service Card

# You do better with sound system components and accessories from Communications Company!

## Room Audio Director

**RAD-30** / Provides expandable (movable-wall) meeting room facilities with the ultimate control for combining audio areas. You get touch-button audio status control in each area.

## Programmable Intercom

**IC-28** / This economical, reliable, versatile dual channel amplifier is perfect for fast food service systems, ticket window, teller cages, etc.

## Projector Patch

**PP-2255** / For quick, effective interfacing into sound systems from projectors or any audio input device in a sound system.

## Record Patch

**RP-3030** / For connection to speaker level line 25v-70v or voice coil impedance. Transformer and resistor isolation against interference between source and up to four recorders.

## News Media Audio Distribution Amplifier

**MADA-1** / Amplifier-mixer-distribution press patch eliminates mic congestion on lecterns. Serves up to 10 mic or line level outputs and can be cascaded to serve more.

SEND FOR OUR FULL-LINE CATALOG AND LEARN MORE ABOUT THESE AND OTHER SOUND SYSTEM COMPONENTS AND TEST EQUIPMENT . . . DESIGNED BY A SOUND CONTRACTOR FOR SOUND CONTRACTORS.

**COMMUNICATIONS  
COMPANY**  
inc.  
3490 Noell Street  
San Diego, CA 92110  
(619) 297-3261



directly from a QKT on our news line; we also have a two-relay circuit that allows us to send air audio, or mic back down the line from our news booth for cues when the circuit is used for live reports. The remote amp has a switched cueing circuit for this purpose.

For out-of-town news reports (as in the 1982 state elections when we reported from Columbus) we use the Comrex equipment. Although, with care, the Comrex works well by itself, we have an old Gates AGC driving the receiver ("hot" telephone lines sometimes cause the decoder to unlock) and another Shure M-63 following. With the Shure equalizer, we consistently get 80 to 3500 Hz response ( $\pm 2$  dB) from anywhere in the country. We've found the optional 8 kHz whistle filter invaluable to clean up carrier problems. Again, two 4-pole relays give us air feed, or control mic back down the phone line for cues.

The Comrex equipment is especially valuable for sports; we cover Division I University football and basketball as well as minor league baseball (the famous Toledo Mud Hens). We are able to carry local games with a 7.5 kHz remote pickup transmitter, the away games must sound as good as possible. On the typical portable radio, most listeners notice no objectionable differences and we've received a number of calls wondering whether we are carrying a road game or a home game.

A word about QKTs: we buy our own (PCI) and cut the diodes out. Then we carefully control the level fed into the QKT to -10 (measured on the active telephone line). Some of Ma Bell's illegitimate offspring have come up with a new version of the QKT (labelled the POP, we think) which cuts off anything below 500 and above 2700 (and even has a 1/10 amp fuse in the audio for aggravation).

We've developed a number of other tricks to improve quality without a lot of expense. However, the point is that the radio engineer can get respectable quality audio off dial-up lines without a great deal of expense or much complication.

TOM TAGGART  
assistant chief engineer  
WSPD AM Stereo, Toledo, OH

### Skip Pizzi replies:

Tom Taggart makes a point that every broadcasting engineer should have laser-etched in their brains: "Keep it simple." Although I believe Mr. Taggart thinks my article advocates excessive complexity, he lists a fairly extensive and smart arrangement of his own for

phone processing, using similar techniques—albeit with somewhat less expensive equipment. Of course, what's most important is not what it costs, or even how you do it, as long as it works for you.

Moreover, my article was meant to share some specialized (and at times exotic) techniques to get the absolute maximum out of telephone audio; that's no mean feat, and takes some work to achieve, but I certainly don't endorse the use of such heroic efforts for every crosstown dial-up news spot. For longer feeds, such as WSPD's away games (hail to the Mud Hens!) or NPR's reporters' pieces (3 minutes or longer, fed from anywhere in the world), we both use some fancier procedures. Mr. Taggart leaves the compression to the Optimod. Since we don't broadcast, and most of our stations don't process their air signal much, we compress what needs it in the production studio (with much less expensive compressors).

What it comes down to really, is a question of scale. We're both in basic agreement on the need for processing, which is the important thing. The best techniques and hardware used are often those which you have the means to provide. Mr. Taggart seems to have "his sponsors' dollars at work" to an extent I would guess is roughly equivalent (if not higher) than ours on a per-listener basis (NPR's weekly cum is currently around 8 million). There's also a bit of apples and oranges here, comparing what's appropriate at a busy full-time local AM station to a national radio network producing a couple of meticulously prepared daily news programs for mostly FM stations.

I will pick one specific bone with Mr. Taggart, however. Referring to his third paragraph, on not equalizing phone reports for news, I can't argue with equalization taking time to perform, but he's missed my point a bit when he states, "...frequency response is limited by the carbon mics..." True enough, but the equalization procedures in my article are less designed to extend frequency response than to flatten it. A typical dial-up can be greatly enhanced in terms of intelligibility by cutting out the big hump in its response between about 400 and 800 Hz, and that's the primary use of the equalizer in this application. A little post-equalizer compression on the phoner voice helps restore lost loudness, and provides a level match to other full-bandwidth program material, the latter being something his overall Optimod compression may not do as well.

Nevertheless, we're more in agreement than not, I think. However, I'm sorry that he found the article "mystifying." I heartily echo his warning on "POP" couplers—avoid at all costs! And regarding the AT&T divestiture, well—see you in the trenches, Tom!



1

Acoustic foam "pop" and moisture filter.

2

Three-layer mesh grille resists denting for better element protection and appearance.

3

High-output moving-coil dynamic cardioid capsule.

4

Felt dust cover protects entire element.

5

All grille screens soldered (not glued) to brass retaining rings for maximum strength.

6

Two integral shock mounts to reduce cable and handling noise.

7

Precision-machined body of materials selected for perfect balance, shaped for comfort.

Aluminum  
Zinc Alloy

8

Rear acoustic phasing chambers for shaped low-end frequency response.

9

Armorized finish\* resists chipping.

10

Professional 3-pin balanced output connector connects directly to element with no heavy transformer.

# 10 reasons why you can't buy a better vocal microphone!

\* We have six more very colorful reasons to choose an ATM41: Red, White, Blue, Green, Black, and Gold! Each custom-color ATM41 comes with matching-color 25-foot cable, complete with connectors. Lock as great as you sound!

There's one other reason why you'll put the ATM41 first in vocal microphones. Listen. Our sound blows them all away! Try it today at your Audio-Technica sound specialist.

audio-technica

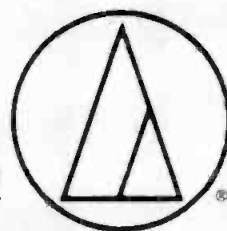

AUDIO-TECHNICA U.S., INC., 1221 Commerce Dr., Stow, OH 44224 216/686-2600

Going wireless? Write to Nady Systems, 1145 65th St., Oakland, CA 94608 for details on the ATM41/Nady combination.

Circle 17 on Reader Service Card

# Sound With Images

## Betamovie Cuts the Umbilical Cord

• The sight of a video cameraperson lugging a shoulder-mounted camera plus a portable video recorder slung over the other shoulder and a battery pack strapped around the waist has become quite common as more and more ENG (Electronic News Gathering) teams take to the field for on-the-spot coverage of local news events. In the case of professional equipment of this sort, it usually takes at least two people to lug all the equipment around, especially when you include all the



Figure 1. Betamovie Model BMC-100.

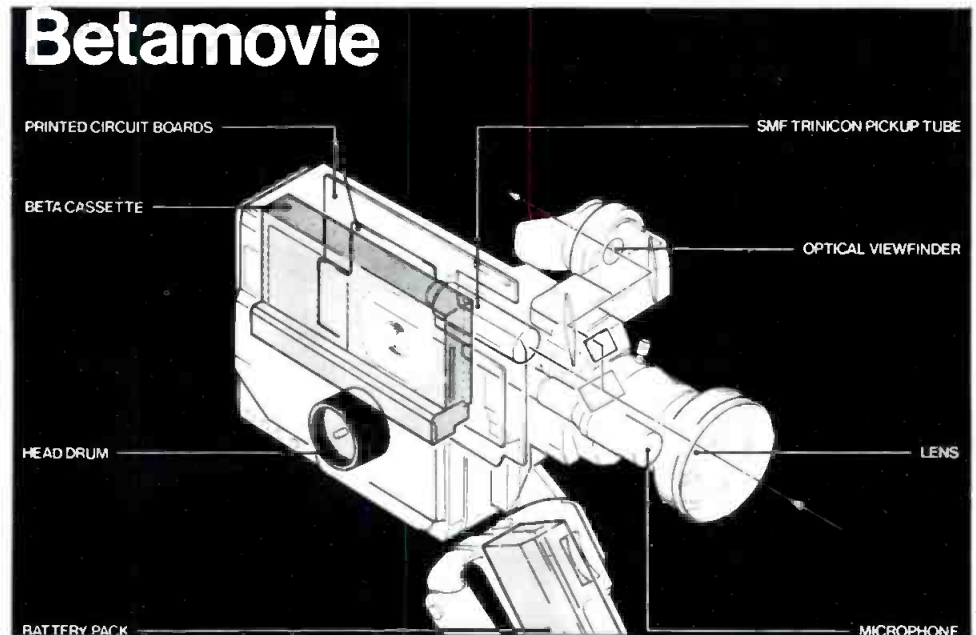
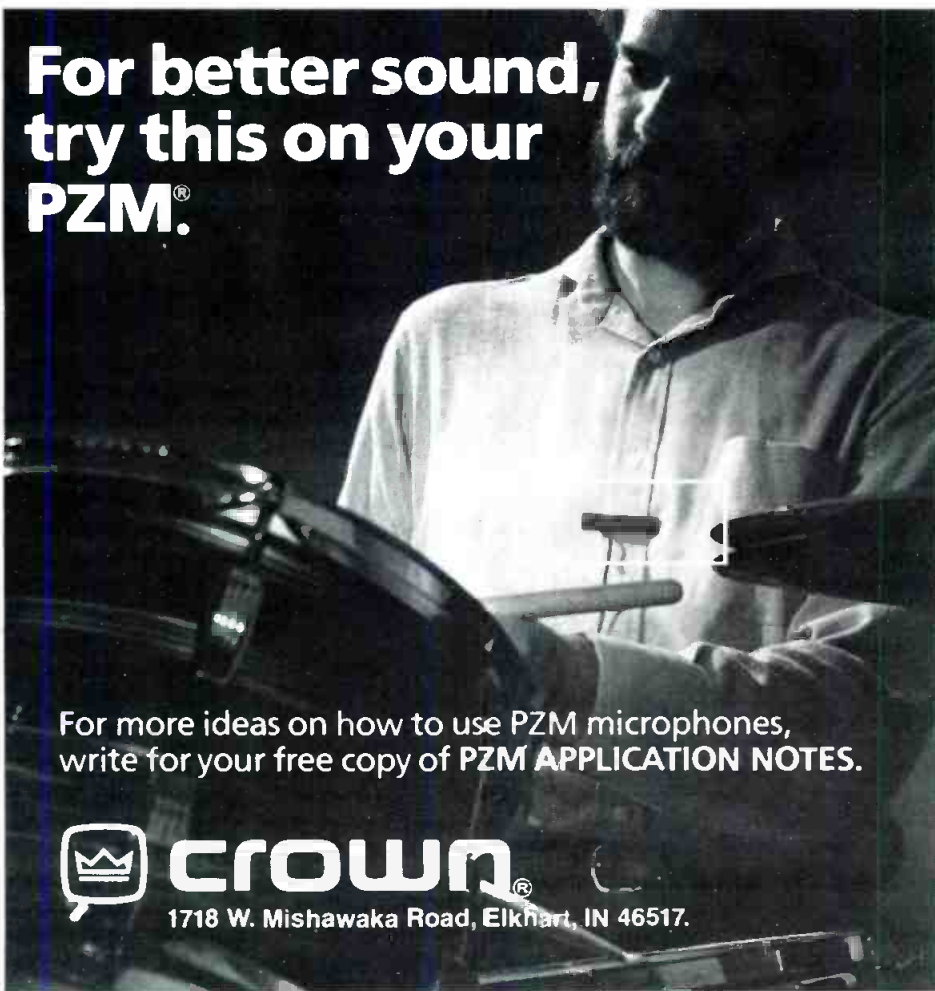

Figure 2. See-through sketch of the Betamovie.

**For better sound,  
try this on your  
PZM.<sup>®</sup>**



For more ideas on how to use PZM microphones,  
write for your free copy of **PZM APPLICATION NOTES.**



**CROWN<sup>®</sup>**

1718 W. Mishawaka Road, Elkhart, IN 46517.

peripherals such as microphones, spare battery pack, extension cables and the like (not to mention auxiliary lighting equipment which is often necessary when ambient lighting isn't bright enough for the job).

For some time now, both professional and amateur videographers have been tantalized by the idea of having a single, lightweight video camera that would contain the tape transport as well as the optical and electronic components related to the camera itself. Many felt that the age of the all-in-one-camera would dawn with the coming of 8 millimeter video tape formats. (See last month's "Sound With Images," in which I discussed the new standards for 8mm video/audio taping.) Indeed, when the first 8mm cameras finally do make their appearance (they aren't expected to appear much before late 1984), they will probably incorporate the tape transport in an all-in-one package. Meanwhile, Sony Corporation has decided to go ahead with their much-discussed Betamovie camera, an all-in-one, lightweight package that houses the camera elements, microphone, audio recording electronics and the tape transport mechanism needed to produce a ready-to-play videotape. The new, one-piece camera is pictured in FIGURE 1, and the most amazing thing about it is the fact that it is able to accommodate standard Beta video cassettes.

# Protect your investment with a cannon.

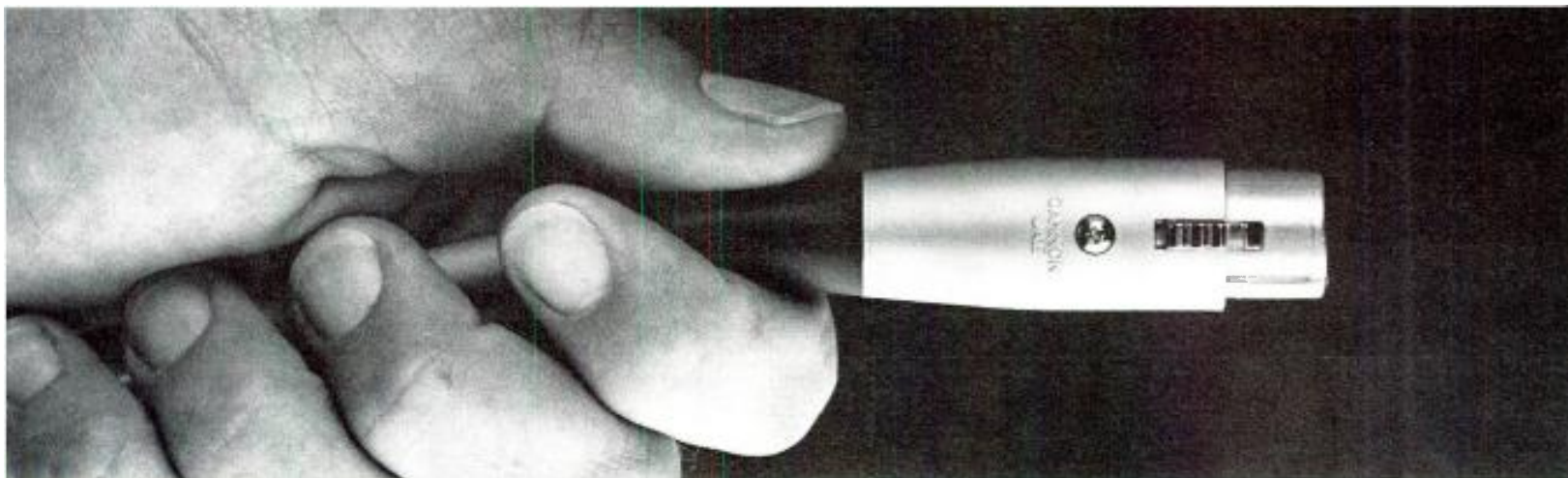

An audio connector by any other name is simply not an ITT Cannon audio connector. Which is precisely why so many audio engineers continue to specify Cannon® connectors for use with their audio equipment.

The XLR, the new XLB and XLA series are small, rugged, quick-disconnect connectors designed for use in audio/video and other low level circuit applications where reliability, quiet operation, elimination of mechanical interference and ease of use are necessary. Four different plug styles are available.

The EP connector is ideally suited to applications where extreme ruggedness and versatility are required. The new AP connector is a

## Audio Connectors from Cannon



popular choice for heavy duty audio applications and is interchangeable and intermateable with the EP series. Both the EP and AP series may be used where as few as 3, or as many as 18, contacts are required.

The APLNE and AXLNE are specifically designed to handle the special needs of mains and other power supply applications.

For more information, please contact International Products Marketing Manager, ITT Cannon, a division of International Telephone and Telegraph Corporation, 10550 Talbert Avenue, Fountain Valley, CA 92708, (714) 964-7400.

**CANNON ITT**  
The Global Connection

Circle 19 on Reader Service Card

# Betamovie

## LOADING SYSTEM

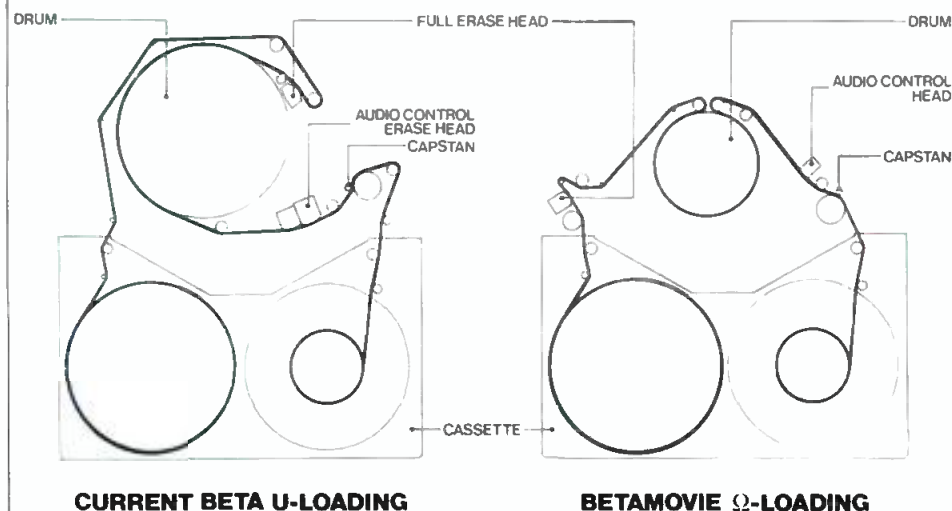

Figure 3. Comparison of Betamovie loading system and standard Beta loading system.

### THE BMC-110

Designated Model BMC-110, the first Betamovie unit to be released is designed as a record-only home movie device. It records video and audio tracks onto standard-sized Beta-format

videocassettes that can then be inserted directly into any Beta VCR for playback. Although the new camera's recordings are totally incompatible with Beta format VCRs, examination of the see-through sketch of the camera

(FIGURE 2) discloses that several new and innovative design concepts had to be incorporated in the camera to reduce its size and weight. The unit's compact size is primarily the result of Sony's decision to exclude playback and TV recording functions and the development of a unique ultra-compact drum. Referring to FIGURE 3, note that the drum currently used in Beta machines is much greater in diameter than the drum that has been developed for the Betamovie camera. Specifically, standard Beta VCRs use a drum having a diameter of 74.5 millimeters while the diameter of the drum used in the new Betamovie is only 44.7mm in diameter. That being the case, how is it possible to maintain compatibility between standard Beta machines and the Betamovie camera? The two diagrams in FIGURE 4 show how this is accomplished.

The current Beta head drum is equipped with two or more video tape heads and the tape itself is wrapped about the drum over an angle of only 180 degrees, the familiar "U-wrap." In contrast to this arrangement, in the Betamovie camera a single, double-azimuth head is used and the tape is wrapped around the smaller drum for a total of 300 degrees. As is shown in FIGURE 4, this arrangement results in a track length (the distance that the head travels relative to the tape for "laying down" one field of a video picture) and a track angle that are identical to the track length and angle employed in a standard Beta format VCR arrangement.

The Betamovie camera weighs 5 pounds, 8 ounces. With its battery pack and a Beta cassette installed, the unit weighs less than 7 pounds. It measures 5 inches x 8 $\frac{3}{4}$  inches x 14 inches, including lens, grip and viewfinder. The system records at the Beta-II speed. Uninterrupted recording time is up to 60 minutes using a single rechargeable battery pack, with a maximum recording capacity of three hours and 20 minutes on a single L-830 cassette.

### OTHER BETAMOVIE CAMERA FEATURES

The camera section of the BMC-110 uses a newly developed  $\frac{1}{2}$ -inch Saticon Mixed Field Tricon pickup tube. Minimum illumination is specified at 28 lux, which is equivalent to about 2.6 foot-candles. The  $f/1.2$  lens supplied with the camera features macro (close-up) focus and a 6:1 power zoom.

The camera section offers automatic white-balance adjustment. A side-mounted, through-the-lens optical viewfinder includes four LEDs that indicate low-light condition, white balance set, tape run, and record head cleaning required.

The recorder section of the BMC-110 employs a single button on the hand-

## Into Audio? Then you need the SP-100!

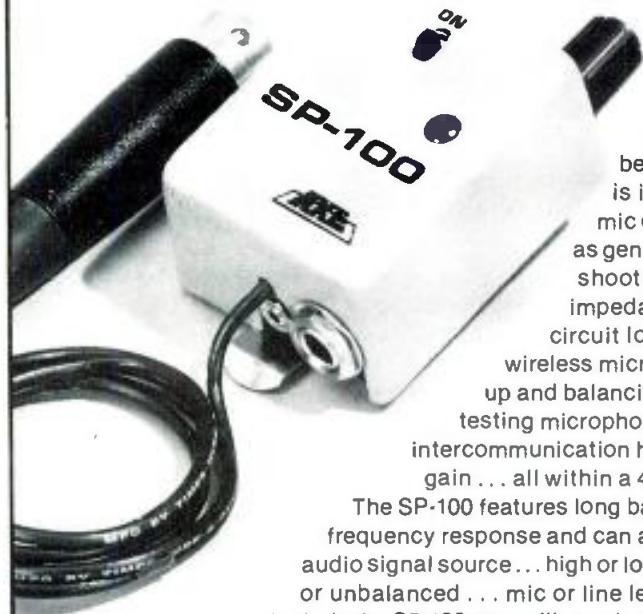

The perfect tool for the audio professional, the SP-100 is a super rugged belt pack headphone amp. It is invaluable for monitoring mic or line level signals as well as general audio system troubleshooting. The unit's high input impedance allows for minimum circuit loading, is ideal for tuning wireless microphone receivers, setting up and balancing piano pick-ups, quality testing microphones and as a "listen only" intercommunication headset amp with variable gain... all within a 4 oz. micro-size belt pack. The SP-100 features long battery life, low noise, wide frequency response and can accommodate almost any audio signal source... high or low impedance... balanced or unbalanced... mic or line level. Your toolbox should include the SP-100. You will wonder how you got by without it!



**ARTISTS X-PONENT ENGINEERING**

BDX 2331 DB • MENLO PARK, CA 94025 • [415] 365-5243

© 1983 AXE

## The EV SH15-2 Speaker System

The all-new EV SH15-2 horn-loaded, two-way speaker system is America's answer to the Yamaha 4115. It's loaded for full-range, high-output action. And we mean action. The SH15-2 is capable of filling the air with a solid, audience-rousing 120 dB. And with an efficiency that is unmatched by most comparably-sized systems.

The high frequency section of the SH15-2 uses an EV DH1202 driver coupled to an HR-Series Constant Directivity™ horn to give you a full 90 x 40 degree coverage pattern. This means that virtually every seat in the house is the best seat in the house. (When every seat's the best seat, it helps all the seats get filled.)

The low frequency section of the SH15-2 features a 15-inch speaker mounted in a vented horn enclosure. This offers the double advantage of wide frequency response and low distortion, plus the "blow-them-away" sound pressure levels that make your audience want to stay for all your music, for all your action.

And if the excitement and the action get tough, the EV SH15-2 is built to take it. Like all EV speaker systems, the SH15-2 comes packaged in a rugged ¾-inch cabinet, covered in spill-proof, scratch-proof, stain-proof black vinyl trimmed with an edge-protecting aluminum frame.

Whatever your sound, whatever your music, whatever your action, catch the EV SH15-2 in action at your nearest Electro-Voice dealer. Hear for yourself how it outperforms the Yamaha 4115 and the rest of the competition as well. And while

**IT FILLS  
THE AIR WITH MUSIC,  
THE SEATS WITH PEOPLE,  
AND THE HOUSE WITH  
APPLAUSE.**

you're there, be sure to check out EV's full family of "Sound in Action" systems and equipment, from mikes to monitors and every-

thing in between. Or write to us directly for a free copy of our brochure, "Instruments and

Sound Reinforcement Systems." Electro-Voice, Inc., 600 Cecil Street, Buchanan, MI 49107.

**EV** **Electro-Voice**<sup>®</sup>  
**SOUND IN ACTION**<sup>™</sup>



Circle 21 on Reader Service Card

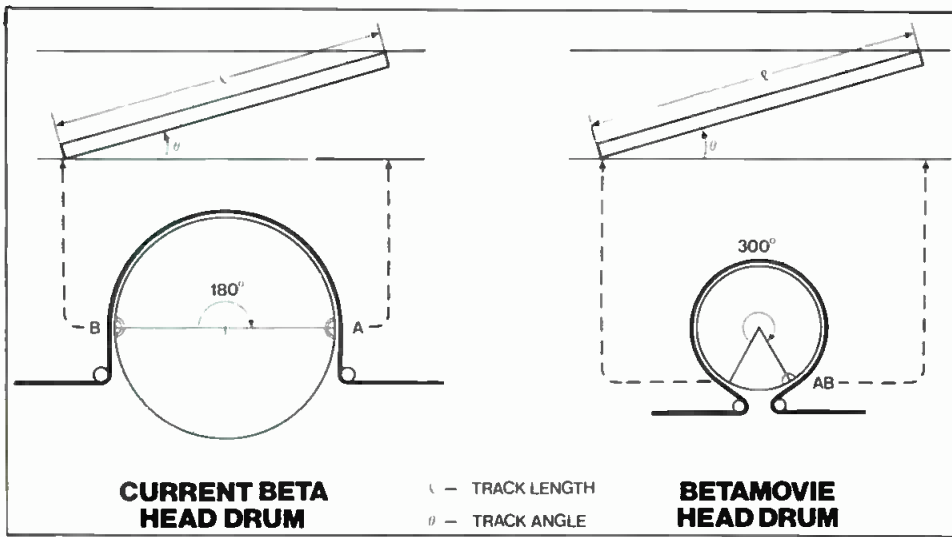

Figure 4. Betamovie recording format shows how compatibility between standard Beta machines and Betamovie is maintained.

grip for starting and stopping the record function. The entire unit is powered by a rechargeable battery pack that slides into the handgrip. An AC adaptor is also provided, and it is capable of recharging the battery pack in one hour.

A boom-type microphone is supplied with the camera for recording the monaural audio track, but there is also provision for connection of a low impedance external microphone via a mini-jack located on the side of the body

of the camera. Nominal microphone input level is specified at -65 dB. Another mini-jack is provided as a headphone output jack, with audio signals at a level of -26 dB. Eight-ohm monitoring phones may be connected at this jack. The Betamovie consumes a total of only 9.5 watts during recording, and the battery supplies a DC voltage of 9.6 volts.

During a demonstration of the Betamovie camera conducted by Sony a few weeks ago, I was impressed by the

picture quality delivered by this new unit. I could not, however, see any professional applications for the device as it is presently configured. For one thing, there is no way to audition the quality of video or audio in scenes that have been recorded in the field unless you cart along a separate portable VCR and a small, battery-operated color monitor. Interestingly, the provided headphone jack actually helps you to judge the audio that's being recorded better than the optical viewfinder helps you to judge video quality. Nevertheless, even this headphone facility is only judging the audio input signal and not the audio quality that will be available during playback.

I asked about the possibility of applying the Beta HiFi principle to Betamovie. That's the new audio technology discussed in this column a few months ago; the system which yields up to 80 dB of dynamic range, negligible wow-and-flutter, flat frequency response over the full audio range and low distortion by recording stereo FM audio tracks via the fast-writing video heads. I was told that, for the moment at least, Sony had no plans to incorporate that better form of audio into the Betamovie products. Still, if Betamovie is to have any application in the professional or semi-professional field, someone will ultimately have to offer it with better audio quality and flexibility than is now available in this first Betamovie product. It will be interesting to see what happens to this new concept when the first of the 8 millimeter format VCR/Camera combinations arrive. Sony sees the Betamovie primarily as a device that will be bought by present owners of Beta-type VCRs. They are therefore concentrating on making the first units as simple and unencumbered with extra features as possible.

I suspect, however, that in time, as competition from 8mm VCR appears, the possible applications for Betamovie may be broadened in ways that will make the product more attractive for those of us involved in more professional audio/video applications.

In the meanwhile, as one colleague suggested to me, having gotten rid of the shoulder strap that's connected to that heavy "portable" VCR, the professional user could always substitute a good ol' Nagra recorder and put the soundtrack on it (after first disconnecting the mic supplied with Betamovie, of course). The standard "dubbing" feature found on all full-sized VCRs could then be used to incorporate an edited soundtrack onto the video tape as a post-production technique. As for synchronization, I guess it would be back to the old "sticks" technique that's worked for films for so many years and is still in use today. ■

**think ambicon™**  
for a sound PA paging system



**in factories,  
shopping malls, airports, lounges,  
mass transit systems, racetracks,  
you name it, you profit.**

The Ambicon listens to ambient noise and automatically adjusts PA levels to compensate for variations. Ambicon, preferred in sound reinforcement by leading professionals. Increase profits and reliability. Call or write today for the complete story.

**ProTech™ (516) 584-5855**  
**Audio** Flowerfield Bldg #1  
St. James, N.Y. 11780

# DOLBY® NOISE REDUCTION FOR THE 1980'S

SP multi-track unit

360 single-track units

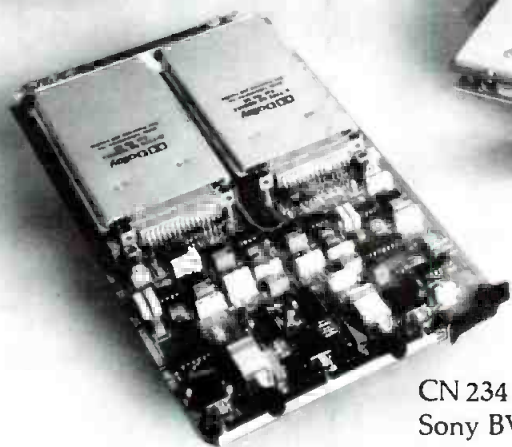

CN 221B for  
Sony BVH  
1000/1100

CN 234 for  
Sony BVH 2000

CN 226 for  
Ampex  
VPR-2

Dolby noise reduction is keeping pace with today's demand for high-quality sound — everywhere. With the introduction of such products as plug-in modules for VTRs and the SP multi-track unit, it is easier than ever before to protect *all* your irreplaceable audio tracks from hiss, hum, and print-through. From broadcasting to music recording, from video sweetening to motion picture dubbing, Dolby A-type NR reliably continues to fulfill its original promise: effective noise reduction combined with complete signal integrity.

Dolby Laboratories Inc., 731 Sansome St., San Francisco, CA 94111.  
Telephone 415-392-0300. Telex 34409. 346 Clapham Road, London SW9.  
Telephone 01-720-1111. Telex 919109. "Dolby" and the double-D symbol  
are trademarks of Dolby Laboratories Licensing Corp. S83/5050

 **Dolby®**

Circle 23 on Reader Service Card

# Digital Audio

## Re-sampling

• Last June, the Audio Engineering Society held a special conference on digital audio in Rye, New York. Unlike the usual AES convention, this conference featured technical papers only—all in the area of digital audio. There were no exhibits or other commercial activities. The intent was to present a concentrated forum for the technical leaders to present the state-of-the-art. There will probably never again be such a “dense” meeting in this field. Many of the papers were very technical and difficult for the beginner. For this reason, we will begin discussing some of these topics in *db* on a more elementary basis. The Rye papers will actually be published by the AES as a Proceedings within the next few months. Thus, the discussion here will allow *db* readers to gain a basis for understanding the full reprints.

Re-sampling was one of the interesting topics which appeared in three of the technical papers, presented by R. Lagadec, L. R. Rabiner, and R. J. Van de Plassche. Re-sampling deals with converting one sampling frequency to another. The need to do so comes from the dual sampling frequency standards now being proposed. The professional part of the audio industry intends to use 48 kHz as its standard sampling frequency; the consumer part of the industry will be using 44.1 kHz. This difference has a long and complicated political history. Much of this history can be found in the discussions of standards which have appeared in the *Journal of the AES* and the convention preprints. Basically, there was a perceived need to have a

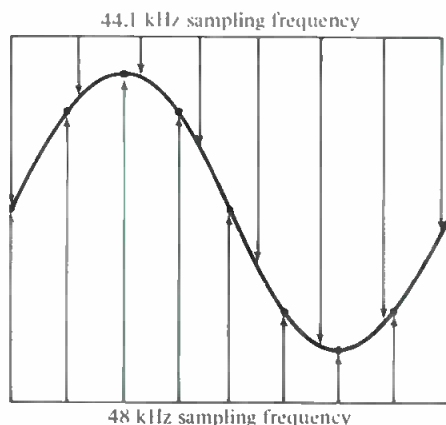

Figure 1. Time samples of a sinewave at two different sampling frequencies showing that the sample numbers appear at different times.

sampling frequency related to several other frequencies in the TV industry in order to allow compatibility with video recorder technology. While this argument may no longer be relevant, it did lead to the dual standard.

The industry will thus be faced with digital recordings at 48 kHz which need to be transformed to 44.1 kHz for consumer production. How does one change the sampling frequency? To begin our discussion, we can observe that with one second of data, the professional recording will create 48,000 digitized samples of audio. This set of numbers needs to be mapped to 44,100 samples. What sort of algorithm will do this mapping?

One re-sampling technique would be

an algorithm which just discarded certain samples. However, this would not sound good because the signal would be noisy or choppy, or sound like local phase modulation.

Remember, there are two ways of bookkeeping the sequence of samples. There is the count method (sample 1, sample 2, sample 3, etc.) and there is the time method (sample at  $t = 0.2083 \mu\text{sec}$ ,  $41.66 \mu\text{sec}$ ,  $62.50 \mu\text{sec}$ , etc.) We normally think of these as being equivalent, since the count index multiplied by the period of the sampling frequency gives the time index. However, when we consider two different sampling rates, we have a more complex mapping.

FIGURE 1 shows the original audio signal and two sampling frequencies. If we start with the analog audio, we can clearly sample it at either 48 kHz or 44.1 kHz. However, if we have already sampled it at 48 kHz, then we do not have the original audio any more, but only the resulting samples. Our data is thus a sequence of numbers. The task is to convert the sequence taken at 48 kHz into the sequence that would have been taken at 44.1 kHz. It is not clear how this mapping is to be done.

The most obvious way would be to recreate the original audio signal from the given samples and then to re-sample the signal at the new sampling rate. We know that the samples can be used to reconstruct the original signal since this corresponds to the standard D/A operation. The samples would be passed to a D/A converter and an anti-image lowpass filter. The resulting analog signal has values for all instants of time, not just those instants corre-



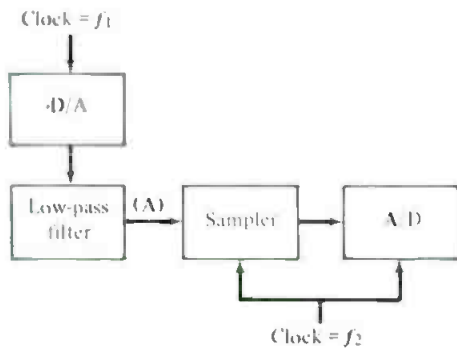

Figure 2. Block diagram of re-sampling using the analog domain. Samples (digital) at rate  $f_1$  are used to create the analog signal at (A); this analog is then digitized at rate  $f_2$ .

sponding to the samples. FIGURE 2 shows the block diagram of a re-sampling system using the analog domain as the intermediate representation.

Notice that this technique will allow us to go between any set of sampling frequencies without regard to their ratio. The only constraint is that the lowpass filter must have a cut-off which is at the Nyquist frequency of the lower sampling rate.

Let us consider some examples. If the source sampling frequency is 32 kHz, then the usable spectrum is from 0 to 16 kHz (above 16 kHz there would be the image frequency). With a re-sampling at 48 kHz, the A/D could tolerate frequencies up to 24 kHz. However, the region from 16 to 24 kHz would not contain any audio because the original sampling rate limited the signal bandwidth to 16 kHz. The low-pass filter must therefore be fully cutoff at 16 kHz.

The reverse of this example shows the same result. If the source sampling frequency is 48 kHz, the lowpass might cutoff at 24 kHz, since there could be audio information up to this frequency. However, if the re-sampler were at 32 kHz, the spectrum above 16 kHz would have to be removed to prevent aliasing. Regardless of which frequency is source and which is re-sampling, the lowpass is actually the combination of an anti-image filter for the source and an anti-alias filter for the re-sampler. The composite filter is the combination and it does not matter which comes first.

#### DIGITAL RE-SAMPLING

The above system does not have any theoretical restrictions and it will work just fine. However, it requires extremely good components in order to do the D/A, filtering, sampling, and A/D without introducing additional degradation. Because real-world circuitry will produce extensive degradation, the analog re-sampler is not an ideal method. We may ask, why not use

the same algorithm, but in the digital domain?

This reduces to the computation of values in-between existing values. Another way of stating the problem is the following. Given a set of numbers corresponding to the time  $t = nT_1$ , can we compute a new set of numbers corresponding to the time  $t = nT_2$ ? Suppose the set of numbers in the original corresponds to  $t = 0, 20, 40, 60, 80, \text{ etc. } \mu\text{sec}$ . How do we compute a set of numbers corresponding to 0, 10, 20, 30, 40, 50, 60, etc.? This example corresponds to changing the sampling rate from 50 kHz to 100 kHz. It is a simplified example, since half of the

new time samples are the same as the original. The value of the signal at  $t = 20 \mu\text{sec}$  in the re-sampled result is the same as the original signal at  $t = 20 \mu\text{sec}$ . However, there is no sample of the original at  $t = 10 \mu\text{sec}$ .

A first trivial method might be to consider the intermediate value to be the average of the neighboring values. Hence we would say that the value at  $t = 10 \mu\text{sec}$  is

$$x_{10} = \frac{y_0 + y_{20}}{2}$$

where  $x$  is the re-sampled output and  $y$  is the original signal. Notice that this is a first-order interpolation. A zero-

**SONEX is the art of shaping sound.**  
**Anywhere.**  
**Alpha Audio**  
 2049 West Broad Street  
 Richmond, Virginia 23220 (804) 358-3852  
 Acoustic Products for the Audio Industry  
 Sonex is manufactured by Illbruck/USA.

Circle 24 on Reader Service Card

# GIVE YOUR EMPLOYEES AN EXTRA CHECK THIS MONTH.

Help your employees fight the Silent Killer—High Blood Pressure. Start a blood pressure checkup program at your workplace.

Please send me a copy of "HIGH BLOOD PRESSURE: DETECTION AND CONTROL AT THE WORKPLACE."

Name \_\_\_\_\_  
 Title \_\_\_\_\_  
 Company \_\_\_\_\_  
 Address \_\_\_\_\_  
 City \_\_\_\_\_ State \_\_\_\_\_ Zip \_\_\_\_\_

Mail to: Gerald J. Wilson, Director,  
 Field Office, Citizens For The Treatment Of High Blood Pressure, Inc.,  
 1440 Connecticut Avenue, N.W.,  
 Suite 604, Washington, D.C. 20036

**HIGH BLOOD PRESSURE**  
 WHAT YOU DON'T KNOW ABOUT IT CAN KILL YOU



A Public Service of Citizens For The Treatment Of High Blood Pressure, Inc., National Hypertension Association and this magazine.

order interpolation would simply be  $x_{10} = y_0$ . The zero-order interpolation is a very bad approximation to the true value. The first-order interpolation is much better. If we look at the first-order interpolation carefully, we would notice that it is actually a filter. Specifically, it is an FIR filter of the type discussed several months ago.

Let us dwell on this filter because it does give some interesting results. The filter is represented in FIGURE 3 with the delay equal to 20  $\mu$ sec. To see the frequency response of this filter, just assume that the input is a sinewave of frequency  $\omega$ . This gives us the following:

$$y = \sin \omega t$$

$$x = \frac{\sin \omega t + \sin \omega(t + T)}{2}$$

After a little trigonometry we can rewrite this expression as

$$x = H_{\omega} \sin \omega(t + T/2)$$

$$H_{\omega} = \cos \omega T/2.$$

The term  $H_{\omega}$ , we will call the frequency response. For low frequencies, this term is unity and the net effect of the filter is to provide a delay of 0.5 sampling units. This point needs to be repeated: In a digital system it is possible to create a filter which has a delay which is *not* an integer number of sampling intervals. Except

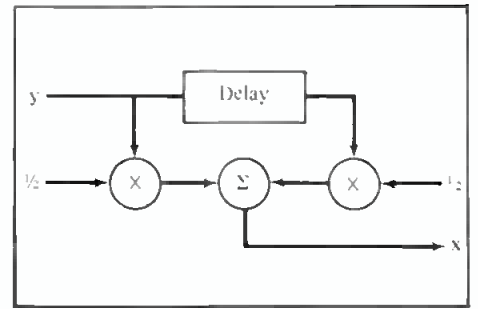

Figure 3. A simple digital filter to create a delay of half a sampling interval.

for the slight non-flatness of the filter, this example provides a delay of 0.5 sampling units. The non-idealness of the filter only comes at higher frequencies where the term  $H_{\omega}$  is not equal to unity. With a more complex filter, having more taps, the value of  $H_{\omega}$  becomes almost unity. We now see that the creation of the intermediate values at  $t = 10, 30, 50, 70$  etc. is directly related to the equality of a digital filter having a delay of 10  $\mu$ sec.

When we speak of a digital filter having a delay other than an integer number of samples, we are saying that the original signal which gave rise to the initial samples is delayed. The actual samples are still coming at the same rate. To further emphasize the point, had we used a D/A on the input and output of the filter of FIGURE 3, we would have gotten the same sinewave with a delay equal

## Looking for a Distortion Analyser?

### Check the little guy on the right...



... the highest performance, most featured and easiest to use audio distortion and noise measurement system in the industry. (and at the lowest price)

Amber Electro Design Ltd.  
 4810 Jean Talon West  
 Montreal Canada H4P 2N5  
 Telephone (514) 735 4105

# amber

	Sound Technology 1710A	Hewlett Packard 339A	Amber 3501
Balanced Input & Output	YES	NO	YES*
Termination Switches	NO	NO	YES
IMD: SMPTE/DIN	YES*	NO	YES*
CCIF/IHF	NO	NO	YES*
Frequency Range	7kHz fixed	—	2kHz-100kHz
Automatic Set Level	YES	YES	YES
Automatic Null	YES	YES	YES
Quantity of Filters	3	3	4
Filters user changeable	NO	NO	YES
Continuous frequency tuning	NO	NO	YES
Calibrated output attenuator	YES	YES	YES
Selective voltmeter mode	NO	NO	YES
Battery operation	NO	NO	Option
Options field installable	NO	NO	YES
Residual distortion 1kHz	<0.002%	<0.0018%	<0.0008%
100kHz	<0.35%	<0.032%	<0.006%
Residual noise (80kHz BW)	<8 $\mu$ V	<8 $\mu$ V	<2 $\mu$ V
Maximum output (600 ohm load)	+26dBm	+12dBm	+28dBm
Minimum input THD mode	-18dBm	-28dBm	-28dBm
Auto-null time	<6 secs	not spec	<2 secs
Voltmeter sensitivity (F.S.)	-80dBm	-80dBm*	-120dBm
Size (cubic feet)	1.6	1.0	0.4
Weight (pounds)	25	18	12.5
Price (unbalanced)	—	\$2700*	\$2100
balanced	\$4195	—	\$2850*
balanced + IMD	\$5195*	—	\$3550*

\*certain features are options and are included in price stated.

Circle 25 on Reader Service Card

to 10  $\mu\text{sec}$ . By extension, we could have created other filters with other delays. Had the coefficients in this figure been 0.75 and 0.25, the delay would have been 5  $\mu\text{sec}$  instead of 10  $\mu\text{sec}$ . We can see that the issue of interpolation really is an issue of designing FIR filters with flat frequency response and a selectable delay.

The above example is trivial because we assumed a set of sampling and re-sampling frequencies which were a factor of 2:1. We can make the example more complex by assuming sampling frequencies of 50 kHz and 47.619 kHz. These two frequencies produce samples at  $t = 20, 40, 60, 80, \text{etc.}$  and at  $t = 21, 42, 63, 84, \text{etc.}$  To convert from one system to the other, we must look at the computation on a sample-to-sample basis. The data at  $t = 21$  can be created from the original samples by using a filter with a delay of 1  $\mu\text{sec}$ . The data at  $t = 42$  can be created from the data by using a delay of 2  $\mu\text{sec}$ . If you continue the sequence, you will see that we need delays of 1, 2, 3, 4, etc., all the way up to 20  $\mu\text{sec}$ . At 20  $\mu\text{sec}$  delay, this is only skipping a sample so that no filter is required. At 21  $\mu\text{sec}$  delay, this corresponds to skipping a sample and using a delay of 1  $\mu\text{sec}$ .

The complexity of the task appears to be determined by the ratio of the two sampling frequencies. When we play and the task of digital re-sampling is difficult.

use frequencies of 48 and 32 kHz, we only need one kind of interpolation filter. When we use frequencies with a ratio of 20/21, we need 20 filters. This is why the set of standard frequencies determines the complexity of the re-sampling if done digitally.

At the time of discussion on sampling frequencies, 48 and 32 kHz were natural choices, with the former being the professional standard and the latter the European broadcast standard. However, as time went on, the European community agreed to use 48 kHz. Now, only the 44.1 and 48 remains as an interesting example. These frequencies are not easy multi-

To appreciate how difficult it is requires us to use a different way of looking at the problem. The concept of an interpolation filter is very nice but it does not give us a way of determining the required accuracy of the filter. The previous discussion showed that  $H_{\omega_c}$  was only flat at low frequencies. A better  $H_{\omega_c}$  would have given us a better result but we would not know how good this  $H_{\omega_c}$  had to be.

In the next article we will examine this issue from a more classical point of view rather than from an interpolation point of view. The interpolator idea is necessary to understand the concept of non-integer delays. ■

## HAVE A RECORDING STUDIO PROBLEM?

Call DataLine®

A service provided by

**SPARS**

A Non-profit Organization  
Dedicated To Excellence Through  
Innovation · Education · Communication

\* The Society of Professional Audio Recording Studios offers SPARS members, and non-members referred by a SPARS member, a national telephone 'hot-line.'

Questions regarding any area of recording studio operations including business, audio engineering, and technical maintenance will be answered by SPARS-approved sources at no charge.

Want a problem solved?  
Call SPARS –  
(305) 443-0686



### SPARS Board of Directors and Consultants

Murray R. Allen  
Universal Recording  
Corporation, Chicago

Jerry Barnes  
United Western Studios  
Los Angeles

Charles Bennett  
Soundwork's Digital  
Audio/Video Studios  
New York

Nick Culleram  
Alpha Audio  
Richmond

Guy Costa  
Motown/Hitsville USA  
Los Angeles

Mark Emerman  
Orsteria Recording  
Miami

Leroy Friedman  
Columbia Recording  
Studios, New York

John Rosen  
Fante Professional  
Services, Nashville

Malcolm Pierce Rosenberg  
Wolov & Rosenberg  
Philadelphia

Christopher Stode  
Record Plans, Inc  
Los Angeles

Joseph D. Tasma  
Sigma Sound Studios  
Philadelphia

David Teng  
New York  
John Woram  
Woram Audio Associates  
New York



# “Now You Can Afford to Delay . . .”

by Deltalab

The ADM 310 unit offers 310ms in 10ms increments at *full power bandwidth* (20Hz to 20KHz) with greater than 90dB dynamic range.

A true digital delay product with exceptionally natural sound quality, for applications where one or even a dozen delays, via serial and parallel coupling, are needed. Unobtrusive sound reinforcement in churches, theatres, and function rooms; pre-reverb delay in studios, and special effects such as simple doubling and echo. **SUGGESTED RETAIL \$599**

For more information, contact:



DeltaLab Research, Inc.  
27 Industrial Ave.  
Chelmsford, MA 01824

**The Audible Difference!**

# Sound Reinforcement

## Equalization in Sound Reinforcement Systems: Motion Picture Theater Systems

• The move to upgrade theater systems through equalization came about largely through the efforts of Dolby Laboratories. During the early seventies, when Dolby noise reduction was being introduced into the post-production phases of filmmaking, it was found necessary to equalize both the systems used in dubbing theaters and in theaters across the country if the benefits of noise reduction were to be fully appreciated. What was found in the field typically looked like FIGURE 1. In many cases, the theater systems were underpowered, and attempts to even-out their response called for larger power amplifiers.

Dolby Laboratories adopted the

same equalization contour that had earlier been suggested by Boner, and

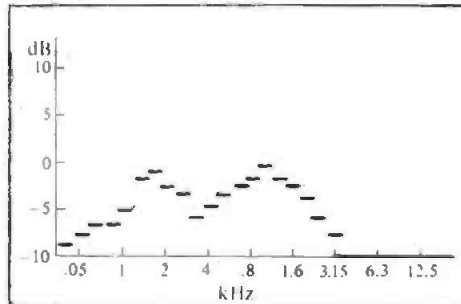

Figure 1. Typical two-way system's acoustical response, before equalization.

one-third octave equalizers were incorporated into Dolby processors to

facilitate the process. The playback contour was formalized through ISO Bulletin 2969 and specifies a curve flat to 2 kHz, rolling off at the rate of 3 dB/octave above that point. Usually, equalization is carried out only to about 9 kHz, but some systems are capable of being equalized to beyond 15 kHz.

As constant coverage high- and low-frequency elements have found their way into theaters, the disparity between axial and power response of the systems has been minimized. Subjectively, the ISO curve is still preferred, despite its origin in the days before constant-coverage systems.

In many ways, constant coverage devices simplify the process of equal-

In times like these  
it's good to know

**The first  
duplicator  
Garner sold  
is still at  
work...20  
years later.**

**garner industries**

4200 N. 48th Street Lincoln, NE 68504  
Phone: (402) 464-5911 Telex: 438068

**And It Looks Like It's Going to Work Another 20**

Twenty years ago, Garner Industries manufactured their first high-speed professional dubbing machine. Twenty years later, that machine is still at work making hundreds of dubs a day. In times like these when every dollar counts, it's nice to know that Garner is still building duplicators to last, and we've made some improvements along the way. The Garner 3056 and Garner 4056 cost much less, take up less space, use less power and require far less maintenance than other duplicating machines on the market today. And the new Garner duplicators offer advantages that our first duplicator didn't have:

- Fast 60 ips speed
- No wow/flutter added because of a common capstan drive
- Simplified tape loading
- Long-life modular electronics
- Solid-state modular electronics
- Smooth, quiet operation
- Three-year mechanical warranty.

When you consider the cost of a duplicator, consider what you'll be getting for your dollar. If you want all of the state-of-the-art features in a product that's practically indestructible, then Garner has your machine. The only problem is, if you buy one of our duplicators, you may never need another duplicator.

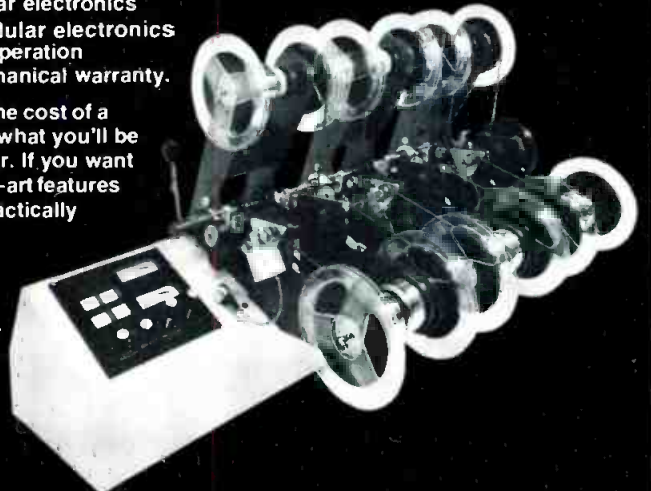

**Dependability... Guaranteed**

Circle 26 on Reader Service Card

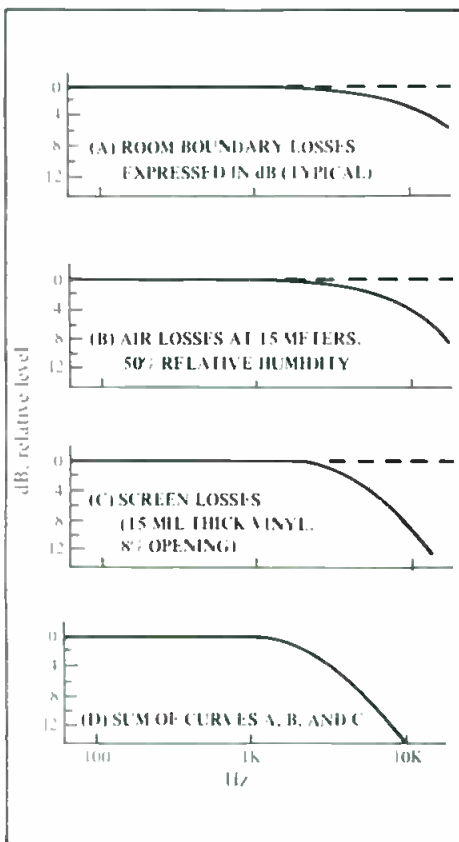

Figure 2. Typical acoustical losses in a motion picture theater (JBL data).

ization. FIGURE 2 shows the acoustical losses in a typical theater. In 2A we have shown typical boundary losses, due to an increase in absorption at high frequencies. Atmospheric losses at 50 percent relative humidity are shown in 2B, and typical screen losses are shown in 2C. The sum of these curves is shown in 2D; this sum is shown in FIGURE 3 superimposed on the ISO curve.

What this tells us is that a constant-coverage system, with broad-band power response correction above 3 kHz, fits nicely within the tolerance of the ISO curve and would require little, if any additional equalization.

Systems such as these were first demonstrated in mid-1981 (1), and they have provided the basis for the new Lucasfilm TH-X theater system (2). ■

#### REFERENCES

1. M. Engebretsen and J. Eargle, "Cinema Sound Reproduction systems: Technical Advances and System Design Considerations," *Journal of the SMPTE*, Volume 91, Number 11 (November 1982).
2. M. Kane, "Lucasfilm's TH-X Theatre Speaker System," *Film Journal* (November 1982).

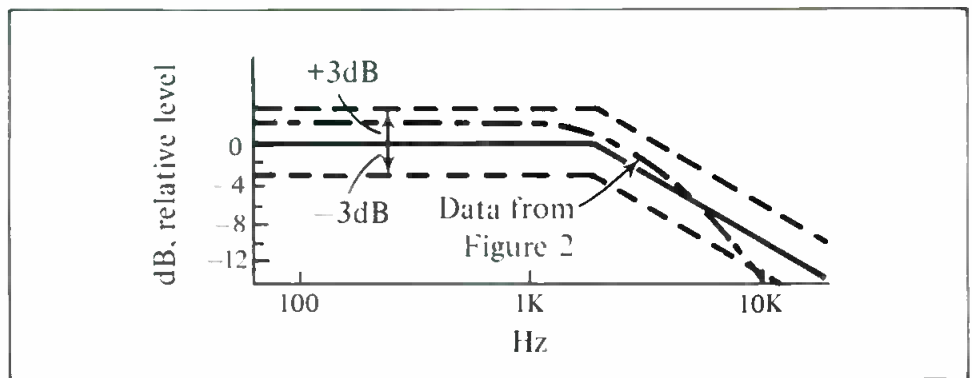

Figure 3. ISO standard response curve (shaded area), compared to typical acoustical losses in a motion picture theater (JBL data).



## MORE FOR LESS

The RCF N-480 High Technology Compression Driver gives you more power handling, more extended response, less distortion, and it will cost you at least 50% less than any comparable driver on the market today.

**More Power Handling for 50% less . . . .** 150 watts continuous program, 75w rms long term sine wave @ 1,200 Hz and up, 100w program and 50w rms long term @ 800 Hz and up.

**More Extended Response for 50% less . . . .** equal to the finest aluminum and titanium compression drivers in high frequency response.

**More Fidelity for 50% less . . . .** with low inherent distortion thanks to a high dampening composite material diaphragm.

For more information, contact us today.

**EASTERN ACOUSTIC WORKS**

P.O. Box 111  
Framingham, Mass. 01701  
(617) 620-1478



# Theory & Practice

## Waiting for Godot

• Acoustical design is both an art and science filled with danger. The complexity of the endeavor should be obvious to anyone who has ever set pencil to paper with the purpose of devising a set of drawings, such that when realized in masonry and wood, the variables—room size, geometry, isolation and absorption, reflections and focus, dispersion, functionality and utility, and

cost—all are miraculously melded into a satisfactory permutation. Of course, the experienced designer relies on his experience to predict the results; he knows that the lines flowing from his pencil will yield the intended results. Using his working knowledge, he chooses from a trusted selection of acoustic tools to help determine his acoustic results. In this way he is able

to sort out the possible permutations and find the one best suited to his client's needs. It is a design process, rather than a ouija board sort of thing. Unfortunately, just as most electrical engineers eventually experience the trauma of a carefully designed circuit bursting into flames, most acousticians eventually suffer the embarrassment of a room that sounds bad. Relatively

db July-August 1983

24

# TELEX<sup>®</sup>

# AUDIOCOM

## For Communications Behind The Scene

AUDIOCOM. The closed circuit intercom for small, large, portable or fixed installations at concerts, stage productions, film or TV studios, stadiums or race tracks, industrial or public safety applications. AUDIOCOM belt packs or wall mount stations can be "daisy-chained" by the dozens over five miles without degradation in signal quality or strength. AUDIOCOM interfaces with other sound systems and telephone circuits. AUDIOCOM includes headsets, mics, cables, switchboards, signalling kits, even battery packs for remote locations; the complete intercom system for communications behind the scene.

Quality products for the audio professional.



# TELEX

TELEX COMMUNICATIONS, INC

9600 Aldrich Ave. So., Minneapolis, MN 55420 U.S.A.

Europe: Le Bonaparte—Office 711, Centre Affaires Paris-Nord, 93153 Le Blanc-Mesnil, France

Circle 28 on Reader Service Card

speaking, the latter is a more severe misfortune. Whereas a burned bread-board circuit represents loss of a small investment, a new concert hall with bad acoustics is a big loss. Imagine designing a 10-million dollar hall, then having your friends say it sounds like a barn—boy, I'll bet that's embarrassing. The point is that other designers enjoy the luxury of prototyping, whereas the acoustical designer does not—when he lays down the pencil, he is committed.

It is a business filled with danger. How many concert halls can you name which were opened, sounded bad, and were later acoustically renovated (and sometimes got even worse)? How many recording studios are remodeled every five years? (Is this because the term "acoustically perfect" is redefined twice each decade, or because people's concepts of "acoustically perfect" changes twice each decade, or because the competition remodels twice each decade?) And how many studios are ashamed to show visitors their reverberation plates, because they are stored in someone's catastrophic attempt at a live echo chamber? Gee, I'll bet that's *really* embarrassing.

The contemplation of acoustic peril

is especially poignant to me right now, since I have recently returned to the drawing board for a little design work. Middlebury College has honored me with a request to design their new electronic music studio. During my first of three visits to Vermont, we ironed out some preliminary problems:

1. Size—the room must be acoustically intimate for precise realization of electronic scores, yet large enough for lecture demonstrations; this utility to be augmented with video monitors.
2. Sound intrusion—a basement was chosen for its ideal acoustic isolation from the external world.
3. Internal noise—the audio computer is a relatively noisy device; thus it and the tape machines will be isolated behind glass to achieve a very low sound pressure level in the composing studio.
4. Recording facility—multiple microphone inputs will be available for live recording to the sophisticated Synclavier II sample-to-disk computer; this is an important compositional provision.
5. Environment—temperature and humidity must be carefully controlled, especially in the enclosed computer area.
6. Ergonomics—the layout of the equipment has been chosen for utility

both from a user and maintenance standpoint; the computer is designed with wheels for mobility to performance spaces.

7. Accessibility—a small electrical lift, isolated from the studio electrical equipment, is to be used to move equipment upstairs to a loading dock.
8. Acoustics—the room will be treated to provide an accurate acoustic environment; selection and placement of absorbers such as Sonex and acoustic tile, and reflectors such as slate and wood will provide an even acoustic balance.
9. Aesthetics—we anticipate a handsome studio that is pleasing to the eye as well as the ear. This facility will be a showcase for the College.

#### THE ACOUSTICS DILEMMA

Perhaps not curiously, it is only criterion number eight which causes this designer to sharpen and resharpen his pencils. The other criteria can be adequately planned for: I can draw a room which feels and sounds intimate yet has good sight lines for observation; I can calculate the transmission loss of the ceiling to the room upstairs, and the glass enclosures. I can choose the right Belden cable for a microphone harness. An air conditioner can be specified and

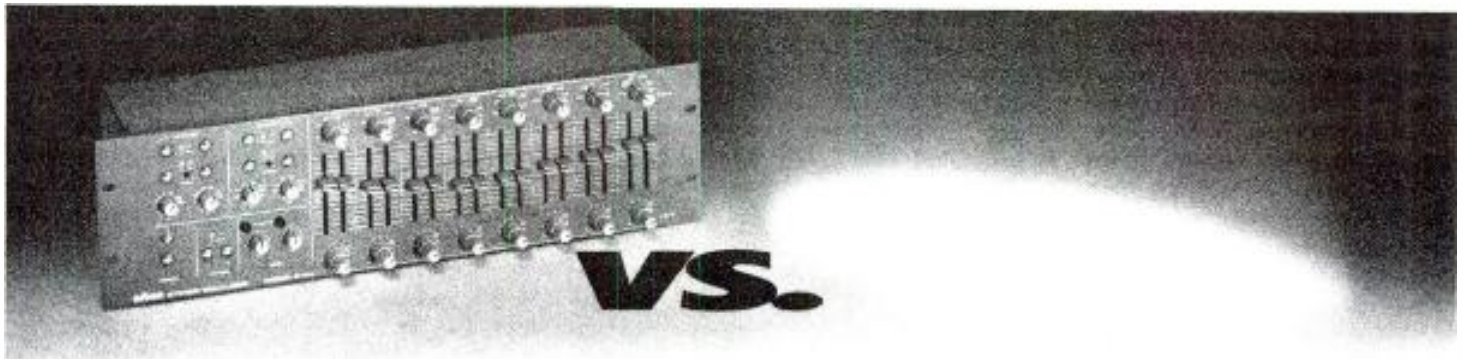

## The unequalled equalizer.

Not all equalizers are created equal. You know that from experience. So do we. Our years of parametric design experience let us build so much performance and versatility into our 672A (mono) and 674A (stereo) graphic/parametric equalizers that *Modern Recording & Music* (October, 1981) described the 674A as "... the most powerful equalizing tool for pro audio work that I have yet to come across".

They clearly appreciated the versatility and functionality of eight bands of EQ with fully adjustable center frequency and bandwidth, plus the availability of 12dB/octave highpass and lowpass filters to limit signal bandwidth or to serve as a full electronic crossover.

No matter what your application—production, program shaping, room tuning, reinforcement work, or clean-up chores—you can count on Orban's heavy-duty professional construction and equally professional documentation and service. Find out why the Orban 672A/674A's are truly the "un-equalled equalizers."

**orban** Orban Associates Inc. 645 Bryant Street  
San Francisco, CA 94107 (415) 957-1067  
TLX: 17-1480

Circle 29 on Reader Service Card

## you write it

Many readers do not realize that they can also be writers for **db**. We are always seeking meaningful articles of any length. The subject matter can cover almost anything of interest and value to audio professionals.

You don't have to be an experienced writer to be published. But you do need the ability to express your idea fully, with adequate detail and information. Our editors will polish the story for you. We suggest you first submit an outline so that we can work with you in the development of the article.

You also don't have to be an artist, we'll re-do all drawings. This means we do need sufficient detail in your rough drawing or schematic so that our artists will understand what you want.

It can be prestigious to be published and it can be profitable too. All articles accepted for publication are purchased. You won't retire on our scale, but it can make a nice extra sum for that special occasion.

installed; layout and accessibility can be evaluated. I know what color Sonex will look good. We've already tested for RF interference and checked the room's electrical wiring. But when it comes to acoustics, how can I be certain? I know how surface areas and combinations of various treatments perform, but I've never tried *this* permutation. Furthermore, I have a good idea of what an electronic composition studio should sound like, and I am confident that this design, if properly executed, will yield this sound. But what if composer George Todd has a different idea of what an electronic composing studio should sound like? He's the one paying the bills, or more specifically, the Middlebury College Board of Regents is—and who knows what they think sounds good? The point is that acoustical design is necessarily an inexact process because the intended outcome, for even the best designer, cannot be communicated to the client until the room itself is listened to. That is, until it's too late.

### GODOT TO THE RESCUE— EVENTUALLY

John Walsh and Marcel Rivard of Barron and Associates Acoustical Consultants in Vancouver, British Columbia, electrified me with the presentation of their paper at the 72nd AES convention. (Signal-Processing Aspects

of Godot. AES Preprint 1910. See Pohlmann's Convention Report in the November 1982 *db* for a brief summary—Ed.) Their description of the Godot system brought the idea of CAAD (computer-aided architectural design) into sharp focus for me. Godot is a software and hardware system designed to run on a minicomputer, and it provides both modeling and audible simulation of room acoustics. Thus acousticians and their clients can hear a room design prior to its realization; the conundrum of design now, evaluate later has been solved. For the first time, the client's conception of the project's acoustics can be communicated, and the acoustician's designs can be auditioned, modified, and finalized long before the first spade is turned. And isn't that how rooms should be acoustically designed—with a system that enables the designer to hear his design? Designing with pencil and paper doesn't make any sense—how good a mix could a recording engineer achieve if he had to use calculations instead of listening to his monitors?

The miracle of a modeling and simulation CAAD system lies in the ubiquitous power of its programming. Godot software uses a "beam-tracing" program in which beams originate at a source to strike across an edge between two planar faces of the polyhedral room model. A geometric theory of edge diffraction is used to generate diffracted beams from the original source beams. A beam is thus split between two faces and the directivity of each new beam is determined from its relation to the original beam. The series of reflections is stored as a list to represent the beam structure within the room.

Path characteristics such as arrival direction and path length, and boundary conditions detailing acoustical properties of the reflecting surfaces are used to determine the transfer function of each path at each of eight one-octave bands. An autocorrelation linear least-squares prediction method is used to calculate the coefficients of the all-pole digital filters which will emulate the path's frequency response. Transfer functions for the listener's ears are realized through an array of filter parameters and group delays. A digital reverberator is based on a design by Schroeder and consists of four comb-filter loops in parallel, followed by two all-pass filters, and an output filter. This path-parameter generating program determines values for all coefficients used by the simulation subsystem. These values may be used to calculate time delay, arrival direction, broadband attenuation, and frequency response of every reflected segment of every beam path.

The simulation program draws upon the previously determined values of filter parameters, gain terms, and

**For better sound,  
try this on your  
PZM.®**

For more ideas on how to use PZM microphones,  
write for your free copy of PZM APPLICATION NOTES.

**crown**®  
1718 W. Mishawaka Road, Elkhart, IN 46517.



delays for each path to control the sound generation program conceptually designed to contain parallel, multiple channels of delays, filters, gain stages, pan pots, and reverberators. The path parameter values when processed through the simulation subsystem produce an audible simulation of the modeled environment. Modifications are accomplished by altering the nature of the acoustical materials and their placements in the environment, assembling a new beam list, and recalculating the values for a new simulation

#### HARDWARE

The hardware currently used to implement the program consists of a Three Rivers PERQ super minicomputer with user micro-programmable 16-bit CPU with 170 nanosecond cycle time, and 32-bit virtual memory mapping. I/O devices are micro-programmed, and other software is written in PASCAL. A Burr-Brown PCM 75 is used alternately as a 16-bit A/D converter with a single channel conversion rate of 55 kiloHertz, or a 16-bit D/A with stereo output conversion rate of 55 kiloHertz. A disk/buffer arrangement is used to facilitate data transfer for both input and output conversion. The maximum length of the audio sample is limited only by the

amount of disk space available. Measured frequency response of the system's current implementation is 20 Hz to 20 kHz plus-or-minus 1 dB. Distortion is less than 0.05 percent, 20 Hz to 20 kHz. Dynamic range is approximately 80 dB.

As the researchers have noted, with the introduction of CAAD systems the process of room construction suddenly shifts from a large-scale experiment to a matter of matching the acoustical properties which are known beforehand to be the properties of the blueprints. Similarly, sound system design may be computer-aided within the software context of their future home and audibly evaluated before construction begins. Extending these ideas further, we quickly perceive that any acoustic transfer function may be evaluated via computer audible simulation, rather than literal prototyping. Given appropriate hardware and software, we could audition any imaginary concert hall, recording studio, microphone, monitor, console, etc. Audio design engineers could get it right—before you buy it and discover it's all wrong.

I can envision an entire new business enterprise emerging in which acousticians have sold their drafting tables and opened simulation studios instead. Clients come in to audition some new acoustic phenomenon they have in

mind. Perhaps a multimillionaire wants to listen to a concert hall before his name is carved upon a 2,000 seat turkey. The acoustician plays with his controls for awhile, then the multimillionaire says "that sounds good, but can you put a little more fizz in the high end?" The acoustician responds by entering a fizz command. That's better, but now the multimillionaire wants more punch in the low end. Again, the acoustician responds. At last, happy with the result, a print command is entered and soon the multimillionaire is out the door, blueprints under his arm.

#### BACK AT THE RANCH...

Meanwhile, here I am at the drawing board instead of a computer terminal. Unfortunately, I don't have any computer-aided expertise to fall back on. Thus I must be content with mere experience, calculation, and intuition, and trust my design to those assets. I'm pretty certain that Middlebury will have a nice room when we're finished. To help insure that, I'm making liberal use of my own modeling and simulation system consisting of a lot of pencils and a very large (and progressively much smaller) eraser. It does the job, but Mr. Walsh and Mr. Rivard, I want you to know that I'm waiting for Godot. ■

## The Standard-Setting Telephone Interface (Modestly Improved)

It's no secret. Studer has become the acknowledged leader in high quality telephone interfacing equipment. The Studer Telephone Hybrid – already selected by hundreds of U.S. broadcasters, including all three major networks – has been praised for its straightforward design, long-term reliability, and consistently outstanding performance.

At the heart of the Studer Telephone Hybrid is an auto-balancing hybrid circuit which automatically matches phone line impedance while isolating send and receive signals for maximum sidetone attenuation. A built-in limiter prevents sudden overloads, and bandpass filters shape the voice signals for optimum clarity and system protection. The new updated Studer Hybrid includes additional noise suppression circuitry

to eliminate unwanted noise and crosstalk while still preserving true 2-way hybrid operation.

Now the Studer Telephone Hybrid is also available as part of a complete Telephone System. Designed to operate independent of the studio console, the self-contained Telephone System includes a microphone input plus a palm-sized remote module (on a 30' cable) with VU meter for line level, headphone output, and level controls for microphone, headphone, and telephone receive.

The time-tested Studer interfaces. Improved for even better performance. Expanded for more flexible operation. And built to set the quality standard for years to come. Call your Studer representative today for complete details.

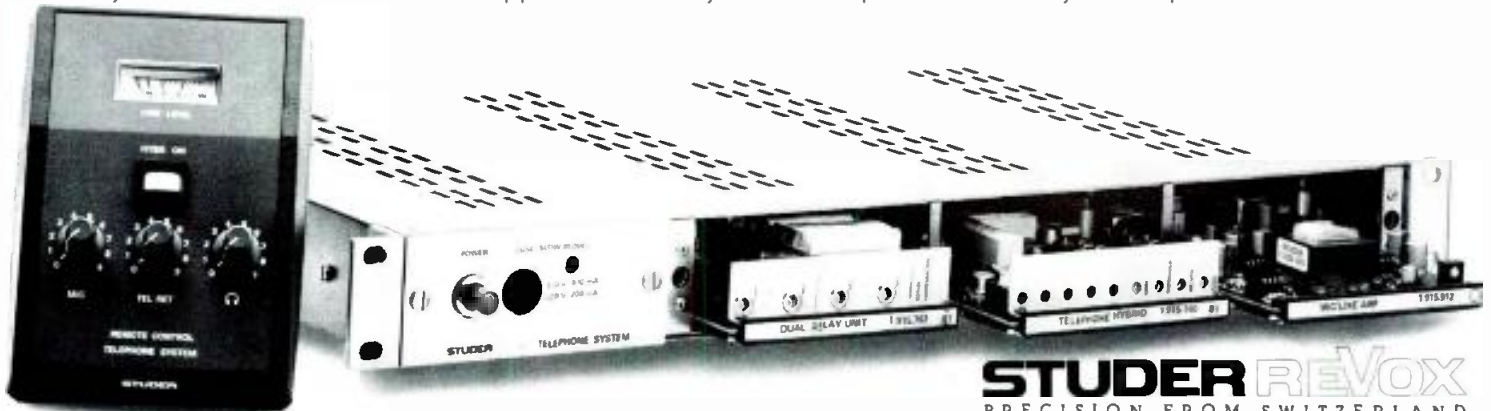

**STUDER REVOX**  
PRECISION FROM SWITZERLAND

1425 Elm Hill Pike, Nashville, TN 37210 (615) 254-5651 • Los Angeles (213) 780-4234 • New York (212) 255-4462 • Dallas (214) 760-8647

Circle 31 on Reader Service Card

## Quizzes and Exams

**I**T'S QUIZ TIME. If you had a need for one or more of the following services, how would you go about selecting a doctor?—a lawyer?—an accountant?—a psychiatrist?—or any other professional service?

Chances are, you'd want to know a little something about the person's qualifications, and you might even check with a trusted friend for some recommendations. But what would you do if your friend suggested a guy who didn't really have any formal education, but did have a great personality?

Possibly, you'd find another friend. Everybody knows that doctors, lawyers, and such are supposed to have lots of education. Personality is nice too, but it's the other stuff that counts.

Question Two. You need another body for the studio. Who will you hire? What about the kid down the block with the great personality? He's not very good with electronics, but everybody likes him. Besides, he's very sharp, and even plays a little guitar on the side.

Not too long ago, lots of us would have picked such a person. In fact, folks with degrees were often regarded with suspicion (sometimes, well deserved). Many of these types thought that because of the sheepskin, they had "graduated" from menial tasks, such as wrapping mic cables, going for coffee, and doing all the other really important things that need doing around the studio.

Well the last thing most studios needed was more chiefs, and so the applicant with the degree was often passed over, in favor of someone with less book-learning and more street-smarts.

But lately, the climate in the studio manager's office has been changing. Formal education is being seriously reconsidered and, in some cases, demanded, as a prerequisite for hiring.

What happened? Well the hardware has gotten a lot scarier lately, and although there's still a need for personality-plus, there's a double need for people who can keep the studio running smoothly when things get hairy. Yes, that means maintenance engineers, but it also means an engineering staff that can cope with the technology, as well as the artistry.

SPARS—the Society of Professional Audio Recording Studios—has recently tackled the problem by forming an Education Committee. And Larry Boden, who is chief engineer at the JVC Cutting Center in Hollywood, has come up with what should be—as he understates it—a "...great opportunity to help our industry." This will be SCE, the Spars Certification Exam.

But first, a little digression. The "glamour" side of the recording industry has not gone unnoticed by many audio entrepreneurs. Hardly a day goes by without another "school" opening up somewhere, promising to teach the hopeful student everything that needs to be known about the industry. Universities have also been getting more involved in education in audio.

Both the entry-level student and the prospective employer are now faced with the dilemma of distinguishing the worthwhile schools from the rip-off joints. Some studios have been badly burned by hiring graduates from the fly-by-night school of recording science who know just enough to be dangerous. On the other hand, some universities are a little out-of-touch with

the real world, and have put together curricula that are—to put it kindly—irrelevant.

So, how does the prospective student and/or the studio evaluate the merits of this or that school? At the moment, it's almost impossible, except on a word-of-mouth basis, or—for the studio—by judging the eventual track record of recently hired graduates. There must be a better way.

Back to you, Larry. The SCE will consist of several hundred questions, starting with the basics (what's a dB?), then going on to more technical matters (describe the difference between Dolby and dbx), and possibly concluding with a little something on error detection and correction schemes. Anyone who is interested may take the test (although editors are, of course, exempt), and a test-taker may include the score as a part of his/her resume.

Naturally, SPARS will also keep a record of the scores, so that suspiciously inflated values may be verified by prospective employers. Periodically, a list of cumulative scores will be published. The scores will be listed not by student, but by the institution from which the student graduated. It is hoped that in time, such listings will become a self-screening tool. Schools whose graduates consistently do well on the test will eventually be recognized, although not endorsed by SPARS or anyone else.

Schools that want to better serve the industry will be encouraged to communicate with SPARS, and collaborate on the continual updating of the SCE. And, since education is a two-way street, SPARS will be able to offer schools whatever help they need in staying in touch with this industry.

Who decides on the questions? This will become a joint venture between educators and SPARS member studios, and the information exchange at this level should be mutually rewarding. Presumably, the schools will submit questions that should be answerable by their graduates. The studios will submit questions that they feel need to be correctly answered by job applicants. Some students from some schools will be able to answer all the questions. Others will only be able to handle some of them. Students who don't do well will be able to discover the areas in which they need further study. Schools that don't do well will be able to do likewise. And the industry at large will be the winner.

Of course, the SCE won't be infallible. As Larry Boden cautions, traits such as willingness to work, good rapport with clients, and others won't show up on the test. However, the industry will be able to get its hands on entry-level personnel who at least know the difference between bias and azimuth. (We always knew there was a difference.)

Although most db readers are not potential SCE test-takers, many are potential beneficiaries of the SCE concept. And so, we'll keep a close watch on how the SCE project progresses, and keep you informed. And, if anyone has any thoughts on the subject, please let us know, and we'll pass on the information to SPARS.

With a little luck, we may even discover what the difference is between bias and azimuth. (Larry wouldn't tell us.) JMW

# Audio Installation at the Fort Worth Museum of Science and History

*Sound systems for theatre installations take a quantum leap forward deep in the heart of Texas.*

**W**HEN THE CONVERSATION swings around to state-of-the-art sound systems, theater installations do not usually come to mind. However, the newly completed audio-visual system in the theater of the Fort Worth Museum of Science and History in Texas may change all that.

Upon entering the theater, one immediately notices a difference: the traditional flat movie screen is nowhere in sight. Instead, the first impression is that of being in a planetarium, listing 30 degrees to the front of the room—a type of film presentation concept better known as a hemispherical-screened Omnimax theater (audience capacity 380).

The domed projection surface measures 80 feet in diameter. Near the center of the room amid the plush, tiered seating sits the motion picture projector, which features a 12-kilowatt lamp and a fish-eye lens, similar to the kind used to shoot the film. (The dome shape compensates for the normal dispersion properties of the fish-eye lens.) The mammoth film-frame size (2.7-in. wide x 2-in. high) and the stability of the projected image provide a picture of high acuity. Essentially, the audience sees nothing but the in-perspective picture to the left, right, above and in front.

The complexity of the projector dictates that it be housed in the basement, where the four-foot-diameter film reels are loaded and threaded. At show time, the projector rises up to the top of a 25-foot track to take its position within the sound-attenuation enclosure located near the center of the theater. The reels remain at basement level, while the film path stretches up to the projector and back down to the take-up reel.

The Omnimax concept debuted in San Diego around 1973. Others have since been built throughout North America, including St. Paul, Minnesota (the hometown of the architect and theater consultant); Monterrey, Mexico; Huntsville, Alabama, and most recently, here in Ft. Worth.

Purcell + Noppe + Assoc. Inc., an acoustical consulting firm from Chatsworth, California, was commissioned, as they have been in the past, to design the \$300,000 sound system that would augment this unique style of film show. According to senior consultant Richard Negus, the firm was responsible for the envelope design and the theater's acoustics to ensure that outside noise and air conditioning would not be audible within the room.

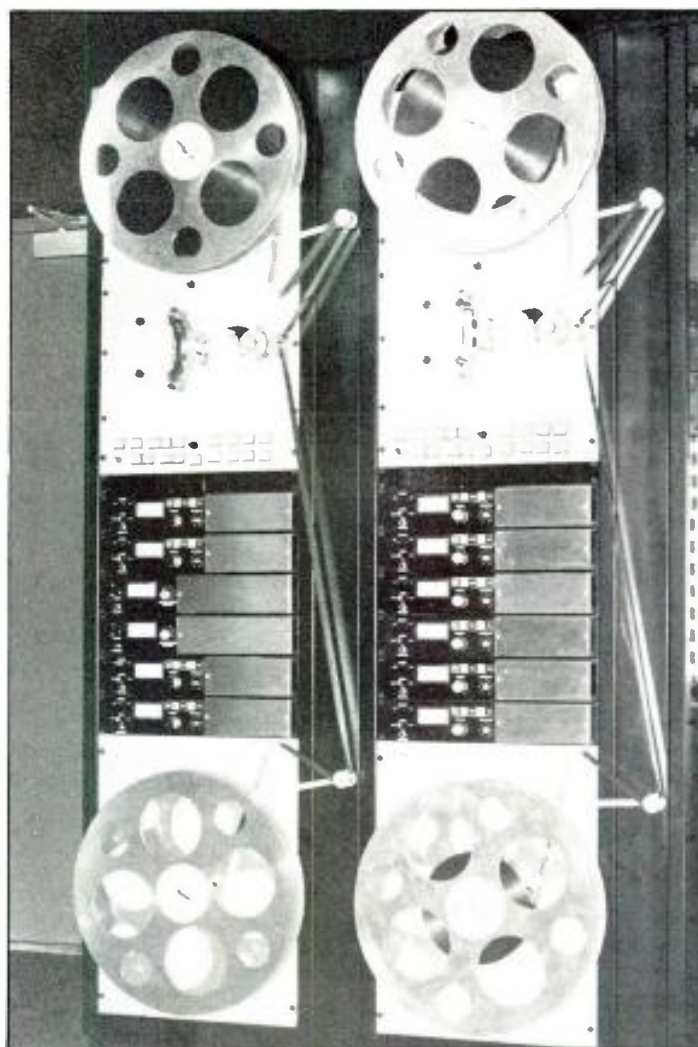

Figure 1. Part of the \$250,000 sound system. These reels house the 6 track 35mm sound tape that runs in sync with the Omni Theatre productions.

## ACOUSTICAL TREATMENT

The general layout consists of the dome, arced over and tilted toward the front of the audience. Speakers are suspended from the walls and ceiling of the building shell, which is located outside the circumference of the hemispherical screen. Purcell + Noppe recommended an acoustical ceiling.

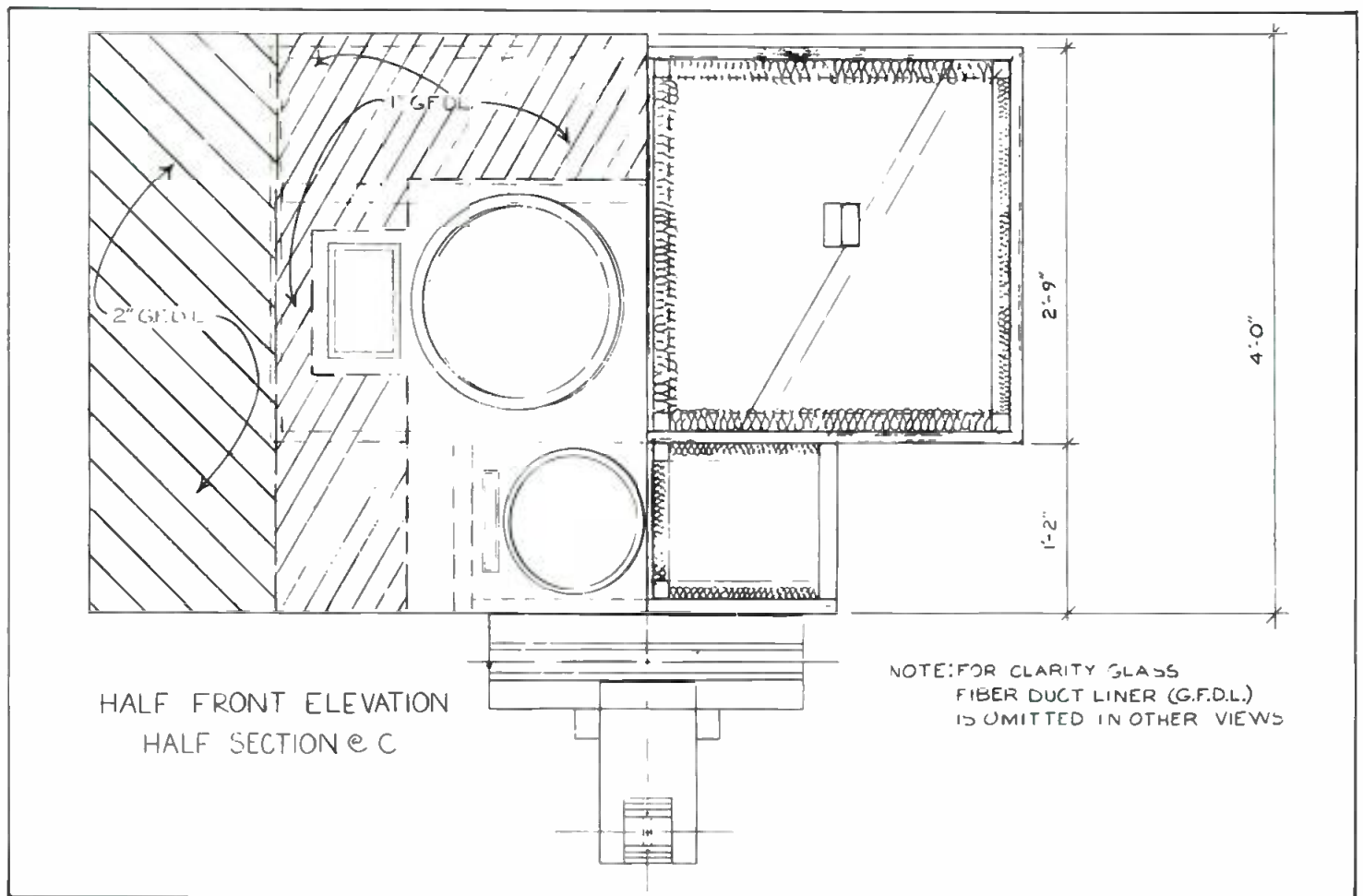

Figure 2. Construction drawing detail.

and treated all the walls with commercially available fiberglass material of two-inch thickness. To enhance low-frequency absorption, the insulation is not attached directly to any of the surfaces, but hung at a variety of distances to extend the low-frequency absorption efficiency.

Highly absorptive seating in the theater and a heavily carpeted floor deaden the acoustics even more. "Essentially, the room is anechoic," Negus points out. "The design criteria was NC-25, the universal code that specifies the spectrum of allowable noise in the main room."

Acoustic insulation also covers the exterior of the speaker enclosures. In an anechoic-like environment, such as the interior of the theater, any large surface within the dome acts as a reflector. A cough in the audience, for instance, creates distracting reflections. To reduce those unwanted

echoes, all the loudspeaker enclosures are covered with fiberglass of varying thickness. Only the minimum area required for the radiation of the speakers is not treated.

The dome remains the only acoustically-reflective surface in the building. Although 22 percent of the projection screen is open area (due to tiny, round perforations) and transmits practically all the low-frequency sound, sound attenuation through the screen increases with increasing frequency. "At around 15 kHz, approximately 6 dB of the energy is reflected off the outer side of the dome and back into the building, where it's absorbed by the acoustical treatment on the walls and ceiling," says Richard Negus.

Unfortunately, this attenuation at high frequencies places a great demand on the power-handling capacity of the high-treble transducers, and requires that the units be fed close

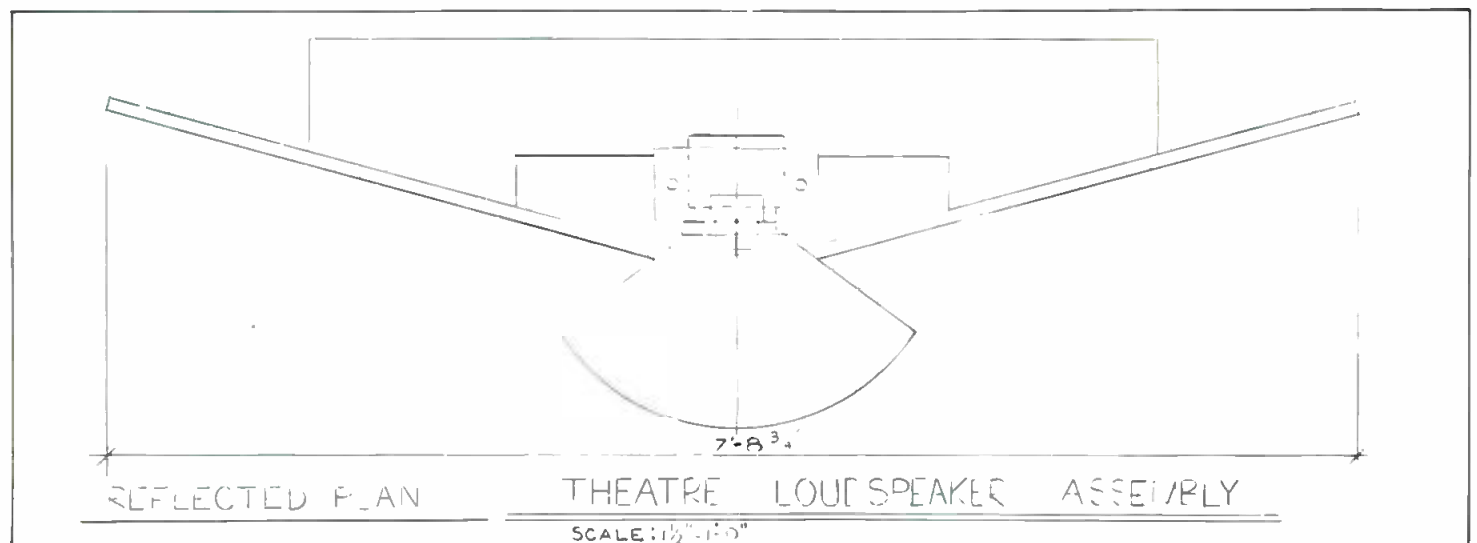

Figure 3. Construction drawing detail.

to their maximum operating level. In fact, to reproduce the larger-than-life sonic aspects of the Omnimax presentations, all the system transducers are operated close to their specified rating limits.

Given the possible consequences (occasionally a speaker may blow due to system mismanagement), Negus specified JBL components incorporating high-temperature adhesives for the voice coils, and mechanical restraints to control cone motion.

### SPEAKERS

The audio system comprises two different types of speaker assemblies—a low-bass system, and a series of ten, four-way speaker units. The bass speakers operate from 20 Hz to 80 Hz, while the four-way configuration takes care of all sounds from 80 Hz upwards. The cone-type transducer enclosures are computer-designed and custom-built for optimum loading and flat-frequency response. "Correct design of these enclosures ensures that the displacement-limited power-handling capacity is not exceeded," says Negus.

### LOW-BASS SYSTEM

The entire low-bass system (six cabinets—three high and two abreast, each housing two transducers) weighs around 5000 pounds. The Ft. Worth design called for the speakers to be suspended center front and approximately 30 feet above the floor with concrete baffle extensions on both sides. The walls allow the sound to radiate in only the forward direction, thereby increasing the radiation efficiency.

Three factors determined the final layout of the low-bass assembly: mutual coupling between transducers; the system's desired polar response, and practical enclosure configurations. Taking into account only the mutual coupling and polar response parameters would have suggested an assembly of four transducers high and three wide. But practical enclosure considerations prohibited that arrangement. The alternative design groups the active low-bass components in an array two speakers wide by six high. Although the twelve 18-inch speakers in the baffles actually measures about 38 inches across (two 18-inch transducers side-by-side) and 9-ft. 11-in. high (6 x 18-in. ft. plus the space in-between), the effective radiation dimensions are 2-ft. 6-in. w x 9-ft. h.

Acoustical laws dictate that maximum mutual coupling may be attained when all speakers within an array are essentially coplanar and operate within an area that measures less than approximately  $\frac{1}{4}$  wavelength between the most widely separated transducers. By examining the degree of mutual coupling attained by the low-bass system within the intended frequency

range, the total mutual coupling averages 60 percent at 80 Hz, increasing to 80 percent or greater below 40 Hz in the vertical direction.

The polar response is relative only to the size of the baffle dimension in the horizontal direction, the length of the vertical speaker column, and the height of the baffle in the vertical direction. To restrict the polar response of the low bass to a hemisphere, the baffle is extended some six feet on each side of the array with concrete walls that measure two inches in thickness, bringing the overall baffle width to 28 feet. The reasoning is that any baffle dimension measuring larger than  $\frac{1}{2}$  wavelength

may be considered to be approaching an infinite size, which constrains the sound to radiate in only the forward direction. For a dimension of 28 feet, this phenomenon occurs above a frequency of approximately 25 Hz.

Although the baffle is extended in the vertical direction of the walls of the building envelope above the low-bass assembly, similar baffle extension in the downward direction is not possible due to interference with other elements of the building. The nine-foot height of the transducer assembly tends to produce a vertical polar response which narrows significantly as the 80-Hz, upper-operating frequency is



Quad-Eight Automated Custom Console, Alfred Hitchcock Theatre, Universal Studios.

# Thoroughbred

The lineage of the **248 Component Series** includes the largest and most sophisticated audio consoles in the world. **248**—a manufactured console with custom capabilities and an uncompromised heritage — **Quad-Eight** quality and experience!



**quad/eight electronics**

11929 Vose Street, North Hollywood, California 91605

Telephone: 213-764-1516

Telex: 662-446 QUADFATHER LSA

Circle 32 on Reader Service Card

Around the world,  
the choice of  
professionals is the

# AUDIO SIGNAL DELAY.

From Westminster Abbey to performing arts centers such as Wolf Trap Park and Ravinia Festival, the Superdome and Three Rivers Stadium, the digital AUDIO SIGNAL DELAY from Industrial Research Products has meant *PERFORMANCE* in these demanding facilities and many more!

## ANNOUNCING . . . DF-4015

The NEW DF-4015 Digital Delay has the performance, reliability and flexibility that made the Audio Signal Delay, the standard since the early 1970's, and is the most versatile model yet with even lower noise and distortion.

Check these outstanding features:

- 1, 2, 3 or 4 outputs
- 192 ms in 3 ms increments
- Thumbwheel delay setting
- Greater than 90 db dynamic range
- Compact 1 3/4" x 19" rack mount chassis
- Security panel
- Transformer isolated in and out

For more information,  
CALL OR WRITE TODAY

**INDUSTRIAL  
RESEARCH  
PRODUCTS, INC.**

A *Knowles* COMPANY

321 Bond Street  
Elk Grove Village, IL 60007  
312-439-3600

Circle 68 on Reader Service Card



Three Rivers Stadium



Westminster Abbey



Ravinia Festival

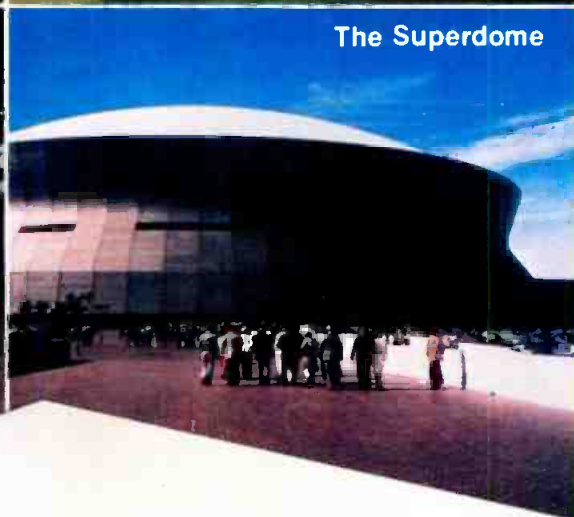

The Superdome



Model DF-4015



Wolf Trap Park

# The VOICE-MATIC™ Automatic Microphone Mixer

**JUST GOT  
EVEN  
BETTER**

**WORKS WITH ALL  
MICROPHONES**

## Introducing the LEVEL-MATIC™ module option

The Voice-Matic Model DE-4013 has received wide acceptance in sound reinforcement, broadcasting and teleconferencing applications by eliminating feedback and fading sound levels. With the NEW LEVEL-MATIC master module option, the Voice-Matic is totally automatic.

- Soft talkers receive added gain.
- Loud talkers and background sounds are attenuated.
- A smooth, uniform output level is the result.
- Retrofits all existing DE-4013 mixers.

Once you hear it, you won't want your sound system without one.

Call or write today for more information on how the Voice-Matic mixer with the Level-Matic option can improve your sound installation...automatically!

Videotape demonstration of LEVEL-MATIC available upon request



LEVEL-MATIC OR OPTIONAL BY-PASS

VARIABLE THRESHOLD

10dB AUTOMATIC GAIN RANGE

VOICE-MATIC MODE OR STANDARD MIXER

MASTER SYSTEM GAIN

**VOICE-MATIC™**  
automatic microphone mixer

INDUSTRIAL  
RESEARCH  
PRODUCTS,  
INC.  
A Knowles COMPANY

321 Bond Street • Elk Grove Village, IL 60007  
(312) 439-3600

Circle 33 on Reader Service Card

approached. The resulting polar-response lobe would, for a vertical array, diminish significantly the sound intensity at the front audience seating rows.

To encompass all of the seats within the vertical, polar-response lobe, the complete assembly could have been tilted forward approximately 15 degrees. However, such an action would have tended to bias the transducer cones from their natural position within the drivers, and possibly caused them to perform less accurately. As an effective alternative, the enclosures were stepped backwards in one-foot increments with decreasing elevation such that the steps are less than  $\frac{1}{10}$  wavelength at 80 Hz. This scheme successfully simulates the desired forward tilt with minimal response aberrations.

#### FOUR-WAY SPEAKER SYSTEM

All the four-way speaker units are identical (see sidebar) and suspended by rods from the ceiling outside the projection dome surface. The 500-pound units are uniformly phased, physically time-aligned, and spaced equidistant from the centroid of the dome. Loudspeaker locations were chosen in accordance with predetermined standards for positions designated as QLR (quad left rear), QLF (quad left front), CF (center front), QRF (quad right front), QRR (quad right rear), and FA (front apex). Other loudspeaker assemblies are placed at potential source locations.

Six channels of stereo (the soundtrack is not on the film, but on a separate six-track, 35mm film-base reproducer that runs in sync with the picture) enhance every presentation. Each channel is patchable to any position as required. Although Omnimax theaters may have as many as fifteen speaker assemblies, most program material is assigned to three front and two rear locations (all in a single plane parallel to the tilted-dome base) and one speaker overhead toward the front, which provides elevation to the sound.

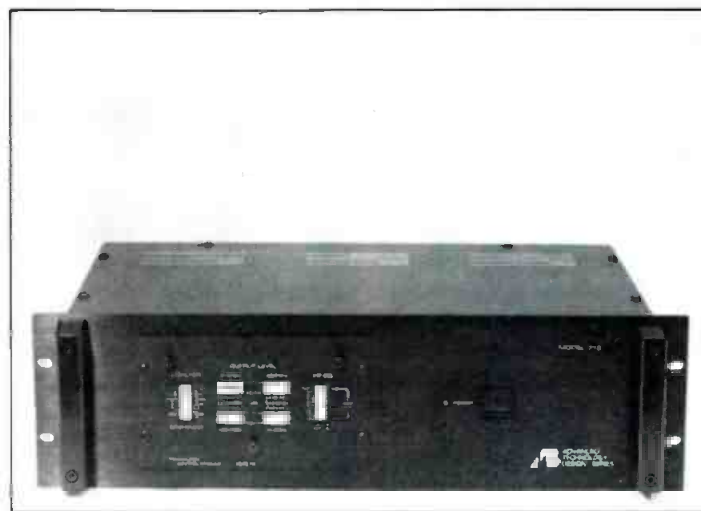

Figure 4. Advanced Technology's model 713 power amp.

If the soundtrack was recorded in fully coherent stereo, the imaging would be perceived only at the very center of the dome. "Because the system works primarily on the theory of discrete sources," explains Richard Negus, "there are very few fused images between loudspeakers. Everyone perceives the sound as coming from the intended visual location on the screen."

#### POWER AMPS

Driving these speakers are amplifiers manufactured by Folsom, California-based Advanced Technology Design Corporation. The amps are mostly custom-designed to Purcell + Noppe specs for this application. (See sidebar.)

All audio amplification equipment resides in eight racks situated in the basement projection room, while the system

# The unequaliser - from Klark-Teknik Research.

When you're engineering the sound system for a major auditorium, you need something special in fit-and-forget technology ... the Klark-Teknik Research DN301. This Attenuating Graphic Equaliser has an unfair advantage over the competition: the micro-electronic reliability of active-circuit filters and thick-film technology earn it a 5-year parts warranty.

Designed for theatres, conference centres and multi-media installations, 30 precision faders give up to 15dB of cut at  $\frac{1}{2}$

octave ISO frequencies matching our DN60 Spectrum Analyser. The state-of-the-art DN301 has sweepable high and low pass filters and selectable low pass slope, 20dB overall gain restores signal gain to unity, and a built-in failsafe bypass ensures uninterrupted performances.

Specification includes:

Frequency response  $\pm 0.5$ dB  
20Hz-20kHz  
Distortion < 0.01% @ 1kHz  
Equivalent input noise < -90dBm  
Output gain 0 to +20dB

#### The Klark-Teknik promise — a bigger investment in the future with:

1. Greater R&D investment, with 12% of all company personnel directly involved in new product development.
2. Consistent attention to production economies for professional performance at 'breakthrough' prices.
3. Effective 'Reliability Control' during manufacture.



## KLARK TEKNIK



British designed, British made

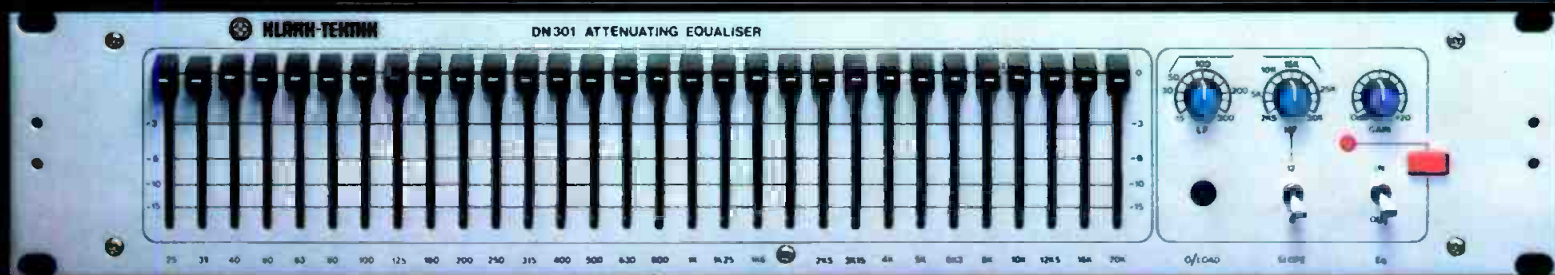

Manufactured by Klark-Teknik Research Limited  
Coppice Trading Estate, Kidderminster DY11 7HJ,  
England. Telephone: (0562) 741515 Telex: 339821

Klark-Teknik Electronics Inc.  
262a Eastern Parkway, Farmingdale,  
NY 11735, USA. Telephone: (516) 249-3660

Omnimedia Corporation Limited  
9653 Côte de Liesse/Dorval, Quebec H9P 1A3,  
Canada. Telephone: (514) 636 9971

Circle 34 on Reader Service Card



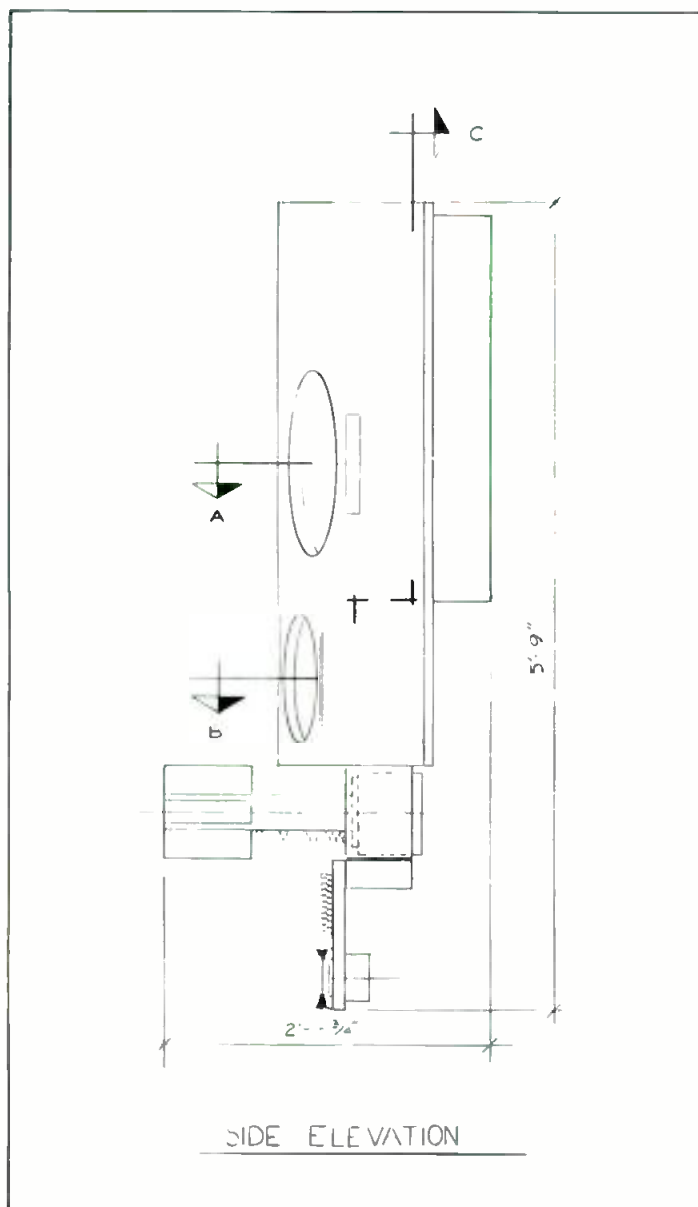

Figure 5. Construction drawing detail.

control takes place at a custom-designed and-built control panel located near the center of the auditorium, in front of the projector. The console panel incorporates a level and mute control for each speaker, a group control for each of two groups of six individual level controls, a master control,

and a separate level control for the low-bass system. Every switch and fader is connected to DC-controlled VCA's, which are also in the racks. The only audio circuits that run to the console are equalizer in and out, and tie lines for ancillary reproducers.

#### COMPUTER CONTROL

Ft. Worth's entire audio/visual operation is computer-controlled. The Model MC-10 computer system was designed and manufactured by Richard A. Gray in San Diego, California, with functional specifications by Purcell + Noppe + Assoc. especially for this application. To understand the versatility that such an addition affords, a brief examination of conventional theater installations is in order.

A normal film soundtrack generally emphasizes the high-frequency range to overcome screen attenuation, and rolls off the bass so as not to overload the speaker system. However, the Ft. Worth Omnimax theater is not normal. The acoustic power capability of the low-frequency system is 1200 watts, with the frequency response being essentially flat above 20 Hz. To compensate for the "standard" sound-system response characteristics, the low frequencies must be boosted extensively and the high end rolled off. For example: to accommodate high-level sound effects such as rocket take-offs, the system level may be increased by up to 30 dB to reproduce the required level. "A rocket take-off can exceed 125 dB with the major energy concentration being below 200 Hz," Negus points out. "This obviously shakes the whole theater. But most people don't object, because the ear is relatively insensitive to low-frequency sound."

The dynamic range, too, is usually restricted due to the limited sound level capability of most theater systems. The Ft. Worth dubbers are high-quality devices that essentially play back flat from 20 Hz to 20 kHz, with a signal-to-noise ratio approaching 80 dB. In contrast, conventional film machines spec out around 70 dB signal-to-noise within a 50 Hz to 12 kHz frequency range. To further enhance the wider dynamic range that is possible with their dubbers, the in-house engineers are able to program the computer to automatically control the volume level as well as the signal routing at any time. Richard Negus explains: "The operator may essentially remix many aspects of the film soundtrack in the theater. The computer can be programmed both by scripted entry and by reading the positions of conventional level controls. All of the desired remixing takes place in real time, and is synchronized by SMPTE time code recorded on tracks adjacent to the film's edge."

To the 35mm audio film, Purcell + Noppe added two SMPTE control tracks outside the perforations along the



Figure 6. The Fort Worth Museum of Science and History.

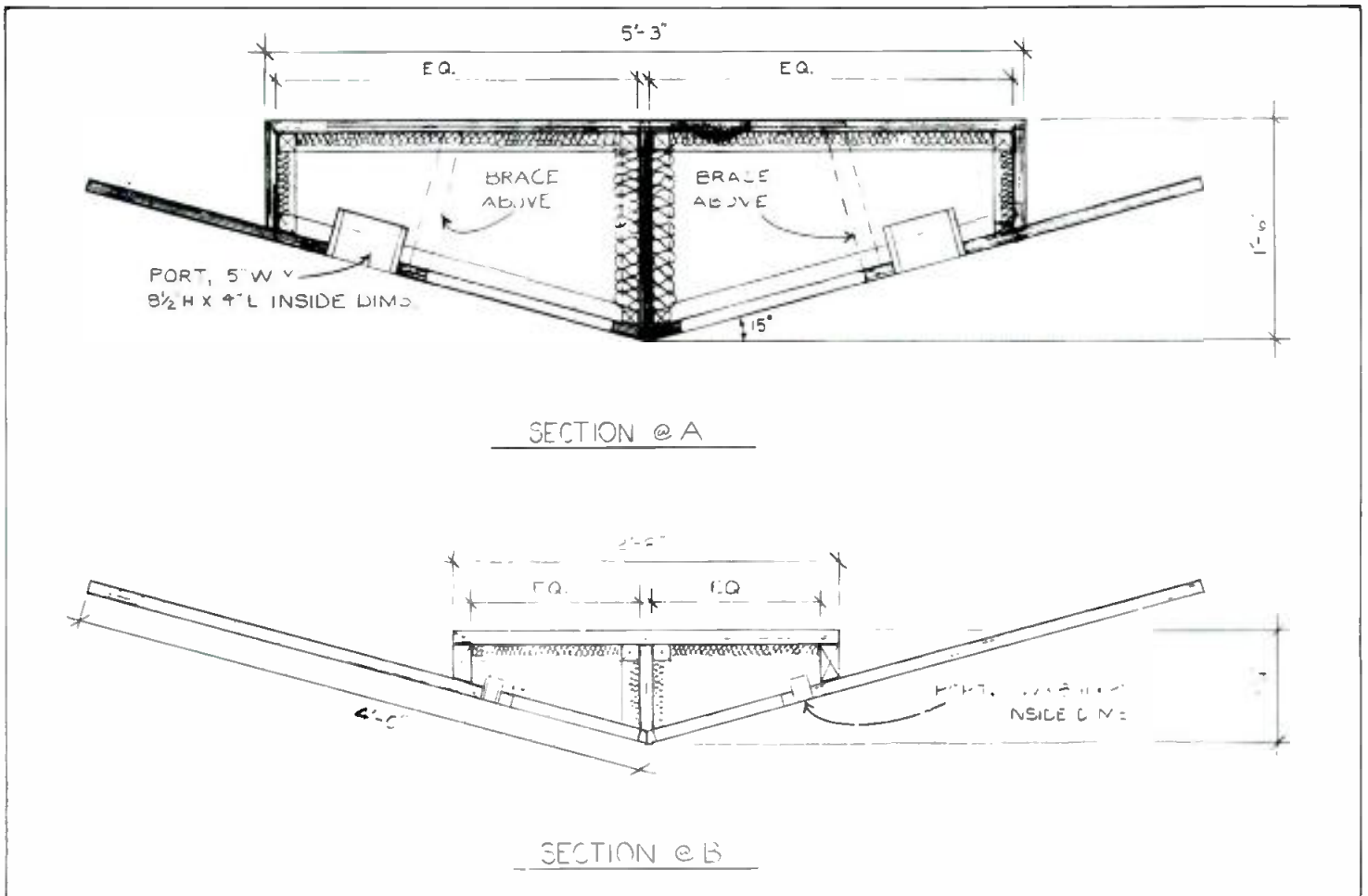

Figure 7. Construction drawing detail.

edge of the film, while the six audio tracks lie in the middle. Those two time code tracks control the progress of a real-time computer that in turn adjusts the level of every loudspeaker more or less instantaneously. In addition, computer software manipulates the group level of the speakers; the muting of any input source or output to loudspeaker; input selection to the system; switching between any of the three inputs; instantaneous patching of any loudspeaker to any channel, and all visual projection equipment and house lighting. "If we want, we can even make sound move by manipulation of the level and signal routing function to pan the sound from speaker to speaker," mentions Negus. "Essentially, all the starting and stopping of every device is computer controlled. An engineer needs only to hit a button and the whole presentation sequence takes place perfectly."

This theater currently has two film-format audio reproducers, with one capable of recording. The museum personnel can run two film recordings in synchronism with very reasonable phase coherency for twelve-channel stereo, or make their own presentations if they want. A stage platform, located at the base of the screen, houses microphone pockets in the floor to inconspicuously accommodate any type of voice presentation. (Instrumental productions are unlikely, because acoustically dead environments are not known to be the best choice for concerts.) A phonograph and cassette recorder/player provide added versatility for alternative sound sources. And in case the museum wishes to upgrade to digital technology, the conversion can be accomplished simply by changing the sound reproducer.

Considering the stage of most audio installations, that's really not too bad a system for a movie theater...or any place else. ■

## CREDITS

### Architects:

Hammel, Green and Abrahamson  
St. Paul, Minnesota

### Theater Systems Consultant:

Michael Sullivan  
St. Paul, Minnesota

### Acoustical Consultants:

Purcell + Noppe + Assoc., Inc.  
Chatsworth, California

### Audio Systems Contractor:

Sonics Associates  
Birmingham, Alabama

Film projector, film transport and associated equipment designed, manufactured and installed by Imax Corporation, Toronto, Canada.

Projection dome and computer-control interface manufactured by Spitz Space Systems, Chaddsford, Pennsylvania.

# Tech Specs— The system at a glance

**Transducers**—JBL Incorporated; Northridge, California.

**Amplifiers**—Advanced Technology Design Corp.; Folsom, California.

**Equalization units**—dbx, Inc.; Newton, Massachusetts.

All crossovers are active and located before and within the power amplifiers.

## Four-way Speaker System: (ten four-way arrays)

**Components:**

2 18" JBL 2240s, 80 Hz to 250 Hz.

**High pass:**

12 dB/octave at 80 Hz.

**Low-pass:**

6 dB/octave at 250 Hz increasing to 18 dB/octave at 500 Hz. (The double-slope crossover maintains the optimum slope condition in the immediate crossover region.)

**Powered by:**

Model 421, 400 watts per channel into 8 ohms. One amp/speaker.

**Components:**

2 12" JBL 2202s, 250 Hz to 800 Hz.

**High-pass:**

6 dB/octave at 250 Hz increasing to 18 dB/octave at 125 Hz.

**Low-pass:**

6 dB/octave at 800 Hz increasing to 18 dB/octave at 1600 Hz.

**Powered by:**

One channel of model 713, a tri-amp unit; 450 watts into 4 ohms.

**Component:**

A custom horn (manufactured by Electro Acoustic Devices, Inc. in Westlake, California) is attached to a JBL 2441, 800 Hz to 7 kHz.

**High-pass:**

12 dB/octave at 800 Hz with high-frequency boost up to 8 kHz maintaining flat power response.

**No low-pass**—natural transducer roll-off.

**Powered by:**

One channel of model 713, a tri-amp unit; 100 watts into 12 ohms.

**Component:**

1 JBL 2405 or 2403 (depending upon the location), above 7 kHz.

**High-pass:**

12 dB/octave at 7 kHz.

**Powered by:**

One channel of model 713, a tri-amp unit; 75 watts into 16 ohms.

## Low-Bass System:

**Components:**

12 18" JBL 2245s in six cabinets.

**High-pass:**

12 dB/octave at 20 Hz.

**Low-pass:**

12 dB/octave at 80, 63, or 50 Hz; selectable bass boost (2, 4, or 6 dB at 30 Hz.)

**Powered by:**

Model 421, 400 watts into 8 ohms. One amp/transducer. Total power for low-bass is approximately 4.8 kwatts.

**Amplification:**

The front panel has banks of dip-switches which control various parameters of the amplifier, such as attenuation and boost across sections of the frequency spectrum. Level switches, for example, provide ½, 1, 2, 4, 8, and 16 dB, in an additive series.

**Equalization:**

12 model 905s. The 905 is a three-band, variable frequency, parametric device featuring shelving- and parametric-response equalization. One equalization unit is assigned per channel; six channels per sound reproducer; and two sound reproducers in the play-back system. The 12 equalizers allow 2 six-channel film presentations to be equalized independently and shown alternately without readjusting any settings.

**Wiring:**

All wiring is 12 gauge, stranded, twisted pair. Because of the great distances between components, a minimal amount of power loss occurs, which amounts to less than 0.5 dB, or approximately 1/20 of the total power of the amplifiers being absorbed in the wire.

**AC Power:**

The audio system, assigned approximately 50 kilowatts of AC power, is fed via a separate transformer installed in the basement, which maintains a constant voltage and removes irregularities from the AC waveform.

## STL Offers The Most Complete Selection Of Test Tapes

Available Anywhere

STL can serve all your needs with precision test tapes for frequency alignment, level set, azimuth set, flutter & speed tests, sweep frequency tests and pink noise analysis. Also available is the Standard Tape Manual & the Magnetic Tape Reproducer Calibrator.

*Phone for fast delivery or free catalog*

**STL**

**STANDARD TAPE LABORATORY, INC.**

26120 EDEN LANDING ROAD • 5, HAYWARD CALIFORNIA 94545 • (415) 786-3546

# db Test Report

JOHN MONFORTE

## The Orban 422A/424A Gated Compressor/Limiter/ De-Esser

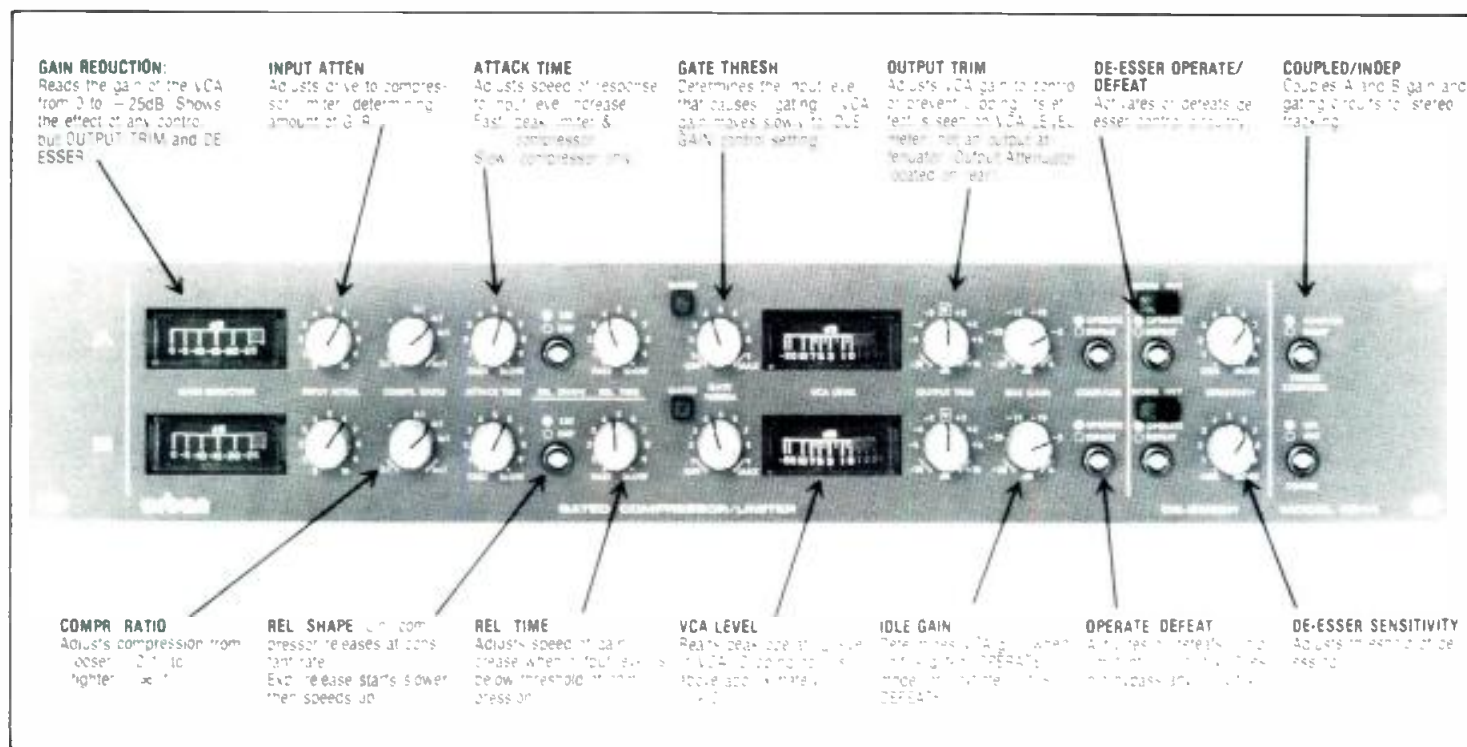

**T**HE ORBAN 422A/424A is an all-purpose level-control device, intended for recording, mastering and broadcast applications. Our test sample was the 424A two-channel version, which includes a control-signal voltage coupling switch for stereo tracking of the channels. As its name indicates, Orban has designed the unit to be a multi-function gain-control processor, capable of controlling any signal with a minimum of audible side-effects.

For the most part they have succeeded, and, as far as I can tell, this unit allows the user to control more side-chain parameters than any other unit available. This flexibility, however, comes at a price. In order to achieve this high degree of versatility, the user must attend to a lot of knobs, some of which are interactive, and time must be spent to fine-tune for the desired sound.

After some practice and experimentation, it is possible to achieve almost any amount of limiting with virtually no residual pumping or breathing for almost any input signal. Conversely, in the hands of someone who doesn't understand

the principles behind deriving a good control-loop signal, it is very easy to make strange sounds that are very offensive to the ear.

### THE REAR PANEL

The 424A comes in a 19-inch rack mountable chassis that uses  $3\frac{1}{2}$  inches of rack space. It can be powered by 115- or 230-volt mains and the voltage is easily selected by a recessed rear-panel switch. The inputs and outputs are accessible on rear-panel terminal strips, as is common with all Orban devices. Distinction is made here between chassis ground and signal ground, so the 424A can be installed obeying the grounding requirements of the user's system. The input is a direct-coupled differential amplifier with an input impedance of 20 kohms.

Because of its differential nature, the input level control is located after the amplifier. This leaves a possibility that with a large input signal (over 15 volts peak), the input amplifier could overload, causing unintended dynamic range reduction. If for some reason the signal feed comes from a point after a power amplifier (such as in a musical instrument or a distributed sound system), an input attenuator must be used to avoid this distortion.

*John Monforte is on the faculty of the University of Miami's Music Engineering Program.*

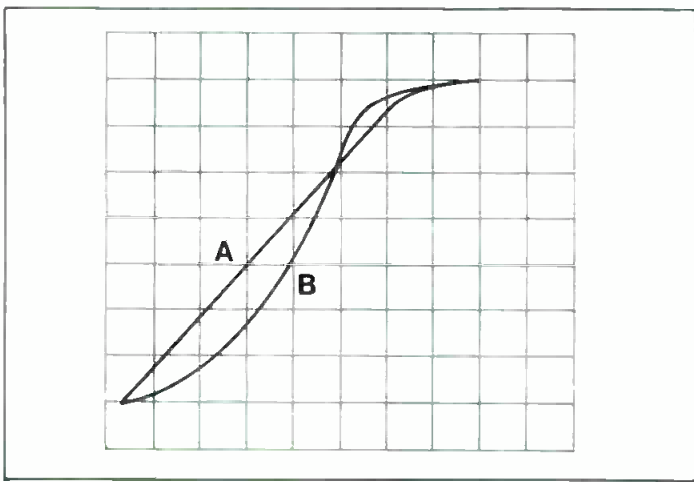

Figure 1. A plot of linear (A) and exponential (B) release settings.

The output is also both active and differential, with a source impedance of about 100 ohms, capable of driving a 600-ohm load to over 24 dBm without changing the frequency response with a change in termination. It is also possible to use one side of the output for a single-ended system, with a corresponding loss of headroom. The output is also capable of surviving a short circuit either to ground or to the other leg of the line.

For those who wish to equip their unit with XLR-type connectors, Orban has thoughtfully provided pre-punched holes behind a small rear-panel access cover that allows the user to install his own connectors on the chassis.

Also appearing on the rear-panel terminal strips are the

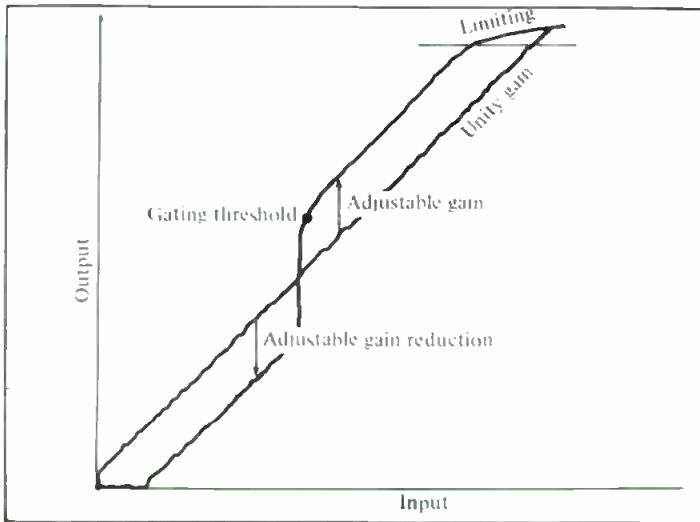

Figure 2. Input versus output level.

gating and gain-reduction signals. These can be used to couple other 422A or 424A systems, or—with a little ingenuity and some buffer circuits—a remote gain reduction meter could be rigged for broadcasters requiring this information at the transmitter site. Output level controls are also found on the rear panel. At first glance it may seem strange to find this control here—where it is out-of-reach for routine on-session use. On other limiters it is usually necessary to adjust the output level to make up the differences caused by the limiting action. Orban, however, uses the VCA gain trim on the front panel to perform this function. This optimizes the signal level at the VCA, which is inherently the device with the least dynamic range capability. This in turn optimizes the gain structure of the limiter for the best noise and distortion characteristics.

#### THE FRONT PANEL

The front panel is the familiar powder-blue color common to all Orban products, with white silk-screened lettering that—if past experience with Orban devices is any indica-

tion—is very durable. White collet knobs are used throughout, and each is clearly marked with a black line that extends to the front of the knob, so it is very easy to see the settings at a distance. Winkey pushbuttons are used to clearly indicate the status of a switch, without using indicator lamps. In fact, the only lamps used are on the meters. Orban states that these lamps are operated well below rated conditions, insuring a long life span. This is particularly beneficial, since replacing a lamp is a fairly complicated task, requiring extensive disassembly.

The front panel layout is quite logical, and tends to follow the signal flow from left-to-right. On the extreme left is the gain-reduction meter, which displays the control voltage used by the VCA. Next is the input attenuator that, besides controlling the level to the VCA, adjusts the level to the level-sensing circuitry that develops the control voltage. This means that, by default, the knob also controls the limiting threshold. This is followed by a compression ratio control that smoothly adjusts between 2:1 and infinity. Two more knobs adjust the attack and release times, with a switch added to choose between linear and exponential release rates, as shown in FIGURE 1.

#### CONTROLS

The right half of the front panel contains the controls that make the 424A unique and versatile. First is the gate threshold control. This is not a noise gate as normally encountered in studio effects racks. This control prevents the limiter from raising the residual noise of a quiet channel to 0 VU while trying to gain-ride the signal. The threshold level is adjusted such that the gating indicator LED comes on in the absence of signal. The attack and release of this gate is not controllable. The recovering time is set by the release time control, and may not be the rate desired by the user for this function. Careful adjustment is necessary to avoid pumping.

## MAP AUDIO IMPAC™ SERIES



Model 4900  
3 1/2" Card Frame

**For IMPAC Series Plug-in Cards. Frame will accommodate wide range of modules:**

- MIC Preamps
- Line Amplifiers
- Phono & Tape Preamps
- VCA Modules
- Monitor Amplifiers
- Power Supplies
- Switcher Cards
- Distribution Amps

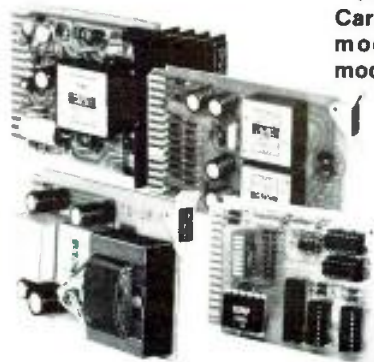

**MODULAR  
AUDIO PRODUCTS**

• A UNIT OF MODULAR DEVICES, INC.  
50 Drville Drive • Airport International Plaza  
Bohemia, New York 11716 • 516-567-9620

Since this action of the gate is affected by input level, release time and VCA idle gain. I found it preferable to set this control last. Until then, it is easily defeated by setting the knob fully counterclockwise. Next to this control is the peak-reading VCA level meter, which will indicate how much headroom is left in the VCA. It is paired with an output trim control which sets the VCA signal level without disturbing the gain reduction parameters selected by the other controls.

This is followed by an idle gain control which determines the VCA gain when the limiter is defeated or gated. This allows for a smooth transition when the unit is activated and deactivated. Next to this is the defeat switch that deactivates the control voltage signal to the VCA. Because of the idle gain requirements, this switch does not bypass any circuitry.

The last section is a de-esser that operates independently of the compressor/limiter section. It is activated by a switch and adjusted with a sensitivity control. Unlike Orban's dedicated de-essers, the amount of de-essing is dependent on the absolute signal level. To ameliorate this problem, the de-esser is located after the compressor/limiter functions. Orban recommends using this on vocals that have already been mixed into the program. The de-esser tends to be very tricky to use, and it may leave audible discontinuities in the program level, with attack and decay times that are unrelated to the limiter settings. It is conceivable that its use would be beneficial on certain types of program material, and I will be the first to admit that my tests with program material may not have included a selection broad enough to include examples that demonstrate the effectiveness of the device.

A very complete manual is included. Along with the standard installation and operation instructions, a thorough maintenance section describes disassembly procedures, gives trouble-shooting tips, and explains the procedures necessary to calibrate the unit and verify its specifications. Included with the schematic is a complete parts list, giving Orban part numbers as well as suggesting alternate sources. The documentation carefully notes which components are selected and which will require system realignment when replaced.

In addition to all this, Orban unabashedly explains the circuitry used, giving detailed description of the concepts included and the techniques used to realize them. The more proprietary elements are epoxy-encapsulated modules that are treated as components. These include the timing module used for the attack and release functions, and the de-esser module which generates the control voltage required for that function. All things considered, it is rare to find documentation so complete. One can only suspect that a carefully written manual is a consequence of an equally meticulous design effort.

### DESIGN CONSIDERATIONS

Anyone who uses limiters, and I assume all readers of *db* are included in this group, can appreciate the difficulty of designing such a device. Obviously, it is necessary to design a signal path that is low in noise and distortion, while allowing some sort of gain control—perhaps 20 to 30 dB. Orban has done this using operational transconductance amplifiers in a very clever two-quadrant multiplier/divider arrangement. That, however, is the trivial part. A limiter also includes a side chain, or level-sensing circuit, that takes the signal and attempts to map out its envelope. If such a circuit is designed to follow the brisk transient wavefronts of percussion instruments, it will also tend to follow individual cycles of a low-frequency instrument such as a bass guitar. The limiting in the latter application actually alters the waveshape, causing distortion. A circuit that tries to ride gain on the crescendos and decrescendos of program material will tend to make an inhaling vocalist sound like a hurricane. If designed to follow the sharp asymmetrical leading edge of a piano note, it will also add tremolo to a

legato stringed instrument. In answer to these varying requirements, Orban has made as many parameters as possible available to the user, to customize the limiter to the signal at hand. Of course, as I have mentioned before, this means that it takes much more than a patch cord to get good results. To me, this flexibility is welcome, and, in my opinion, Orban could also have added a variable threshold control for the limiting function and adjustable attack and release times for the gating circuits. I imagine such an idea may have been considered, but a device bristling with knobs that each require careful attention will tend to consume expensive studio time.

Another difficult design aspect of a limiter is the need to predict the signal's crossing of the limiting threshold in time to adjust the VCA gain to insure the output does not exceed the selected level. This seemingly impossible task has been accomplished by Orban in a very elegant fashion. The level-sensing circuit predicts the future of a signal by examining its recent past history, and subsequently tweaks the attack and release time settings to anticipate the oncoming burst and its duration. For this reason, the attack and release controls are not calibrated in units of time. Instead, a 1-to-10 scale reflects the fact that some control has been left to internal circuitry.

By now, I imagine that there is a certain percentage of readers out there who are saying, "I don't care if the front panel is international orange with lavender knobs and lithium-incapsulated setscrews. What does the damned thing sound like?"

For this part of the review, I use my most elaborate piece of test gear. Our university recording studio has about forty first engineers, and almost as many second engineers. I only need to tell them that under no circumstances must they use this device, and by 8:00 am the next day I'll have enough comments to complete this report.

### THE VERDICT

First up was some mixed program material. With or without wide dynamic contrasts, selection of satisfactory settings for a variety of sounds was easy, and they depended a great deal on the characteristics of the lead instrument. Individual tracks were more difficult. A floor tom needed careful selections for release time and gate threshold. If these were wrong, it would seem to ring excessively. Piano, bass guitar, brass, synthesizer, and organ were all effectively controlled with substantially different settings on all controls. High-hat seemed to cause the de-esser some difficulty. When the sensitivity control was turned down enough to prevent a fluttering sound, it was almost completely dormant. Surprisingly enough, vocals were not that well tamed by the de-esser. It seems the action was much more exaggerated at high levels, leaving a choppy, modulated sound to the signal. However, Orban is careful to note that this is not the same circuit used in their highly acclaimed dedicated de-essers, and the user needs to listen critically. Nevertheless, the addition of the de-esser option adds no complexity to the main signal path when defeated, and is conceivably useful on some material.

FIGURE 2 is a plot of input versus output level, using the swept amplitude mode on an Amber 4400a Test Set. At very low levels, the gating function reduced the level while keeping the below-threshold compression ratio at 1:1. System gain was increased for input signals above threshold level while maintaining the 1:1 compression ratio. Beyond the limiting threshold, the output level increases very slowly.

Overall, the Orban 422A/424A should prove to be a system of diverse capabilities, able to tackle the widest variety of material—once the user masters its operation. In addition, its solid construction and excellent service documentation should insure years of reliable operation. Such qualities are typical of timeless designs that tend to retain their value long after the accountants have depreciated them away.

Now that I've gotten the attention of your accountant, I should mention the price. It's \$989.00. ■

# JBL's Central Array Design Program (CADP)

*CADP is a computer-graphics program that plots sound pressure levels produced by an array of acoustical elements.*

**B**EGINNING ABOUT THE middle of 1982, JBL embarked on an ambitious project of developing a computer-graphics program for plotting the sound pressure levels produced by an array of acoustical elements. Earlier, several other companies and individuals had developed mapping systems, most of them making use of "horn contours," which were superimposed upon a mapping of the seating area as seen from the horn or the array. Most of these systems had built-in errors, due to the problems of mapping a three-dimensional space into two dimensions. It was our intention to avoid these distortions completely by calculating directly each "ray" from the loudspeaker onto the floor, using inverse-square relationships as seen through the loudspeaker's directional pattern.

Another of our goals was to provide for direct viewing of the array (top, front, and side views) as an aid in drafting and constructing the array.

In the sections to follow, we will detail the operation of the program, listing the display options available to the user.

## FORM OF THE PROGRAM

CADP is written in compiled BASIC for the IBM Personal Computer. Necessary options are a color monitor, 64 kilobytes of memory, two disk drives, and a 120-character dot matrix printer.

*John Eargle is vice president, Product Development, at JBL, Northridge, CA.*

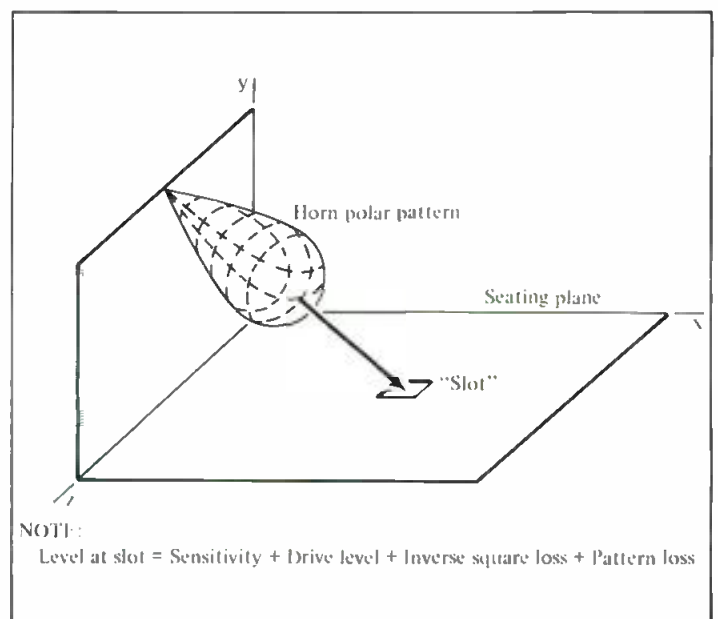

Figure 1. Horn aiming, direct field calculations.

The program diskette is copy-protected, and there are a number of data diskettes containing directional information on all JBL high- and low-frequency components normally used in sound reinforcement. Directional data is available

on several octave centers, and there are drawing files on each item for the mechanical display.

The program is broadly divided into two sections: acoustical and mechanical. We will describe these.

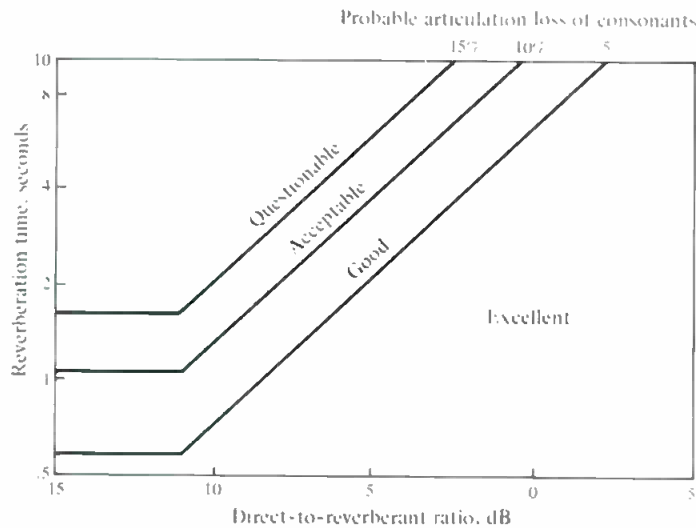

Figure 2. Calculation of estimated intelligibility.

### ACOUSTICAL PROGRAM

In this part of the program, the user enters the Cartesian coordinates which define a seating space, simple or complex. Acoustical information, such as the room's volume, surface area, and reverberation time or average absorption coefficient, are entered as well.

Coordinates are chosen for the loudspeaker location, and the user may specify an array of any number of components, the angular orientation of each component, and the relative drive levels. The user can then examine the following displays:

1. Normalized direct field response.
2. Direct/reverberant ratio, R.
3. Direct/reverberant ratio, R'.
4. Estimated intelligibility, and
5. Maximum direct field.

Commenting on the above displays, the normalized direct field is calculated as shown in FIGURE 1. Levels are adjusted so that the maximum sound-pressure level is zero, with all other values negative with respect to it.

The direct/reverberant ratio, R, compares the direct field level with a fixed-power input to the reverberant field level (constant throughout the room), as given by:

$$\text{Reverberant Level} = 126 + 10 \log(W/R) \text{ dB}$$

where W = total acoustical power output of the array.

$$R = S\bar{\alpha}/(1 - \bar{\alpha}), = \text{room constant,}$$

S = surface area of the room,  
 $\bar{\alpha}$  = average absorption coefficient.

The direct/reverberant ratio can also be calculated using a variant of R, known as R'. As we define it here, R' assumes that two-thirds of the sound from the array is incident on the fully occupied seating area, with its absorption coefficient of 0.9 in the 2 kHz band. It is given by:

$$R' = S\bar{\alpha}/(0.4 - \bar{\alpha}/3).$$

The estimated system intelligibility is based on the work of V.M. A. Peutz (see reference), and it compares the direct/reverberant ratio with the reverberation time, as shown in FIGURE 2. This display may be done with either R or R', giving the user a best case (room fully occupied) and worst case (room empty) picture of system estimated intelligibility.

The maximum direct field is simply the SPL produced at each display point on the floor when the system is powered to its normal limit.

### MECHANICAL PROGRAM

The mechanical portion of the program provides for orthogonal views of the individual components or the entire array as seen from front, top, and side. The center of gravity of the array is indicated as an aid in determining rigging requirements.

### PRINT-OUT CAPABILITY

At any point in the program, the screen display can be printed directly on the dot matrix printer. There is also provision for printing out all internal data, including room coordinates, loudspeaker mounting and drive data, and the like.

Some sample screen print-outs are given for the following system:

The seating plane is 12 meters across the front and 16 meters long. The loudspeaker array is located approximately 8 meters above the floor at front center. The array consists of one JBL 2360 bi-radial horn and two JBL 2380 horns, each with a 2445 high-frequency driver, and one 4508 low-frequency enclosure. The room volume is 1530 cubic meters, the surface area is 832 square meters, and the reverberation time is 2.4 seconds. All views of the seating area are as seen from directly above.

FIGURE 3 shows the maximum direct field levels that the high-frequency system can produce throughout the room, when each of the three 2445 drivers is powered with 100 watts.

112	114	114	116	115	115	113
112	114	115	116	116	115	113
114	115	116	116	116	114	114
114	117	117	117	117	115	114
116	117	117	117	117	115	112
116	117	117	117	116	115	112
116	117	117	118	116	115	113
116	117	118	117	116	114	113
117	117	120	118	117	114	113
118	119	120	118	116	115	114
119	119	119	118	116	116	113
119	119	119	118	116	115	113
118	118	120	118	116	115	113
118	118	118	118	116	114	113
117	118	118	118	116	114	113
117	118	117	117	116	115	113
118	118	117	117	116	115	112
116	118	117	117	117	114	113
115	116	117	116	116	114	113
115	115	116	116	116	115	113
113	115	115	116	116	115	113

Figure 3. Maximum direct field levels.

FIGURE 4 shows the direct/reverberant ratio for R' for this system, and FIGURE 5 shows the corresponding estimated intelligibility provided by the system.

FIGURES 6, 7, and 8 show, respectively, the top front, and side views of the array. The little circle appearing inside the low-frequency enclosure is the center of gravity of the system. Its exact coordinates are part of the system print-out.





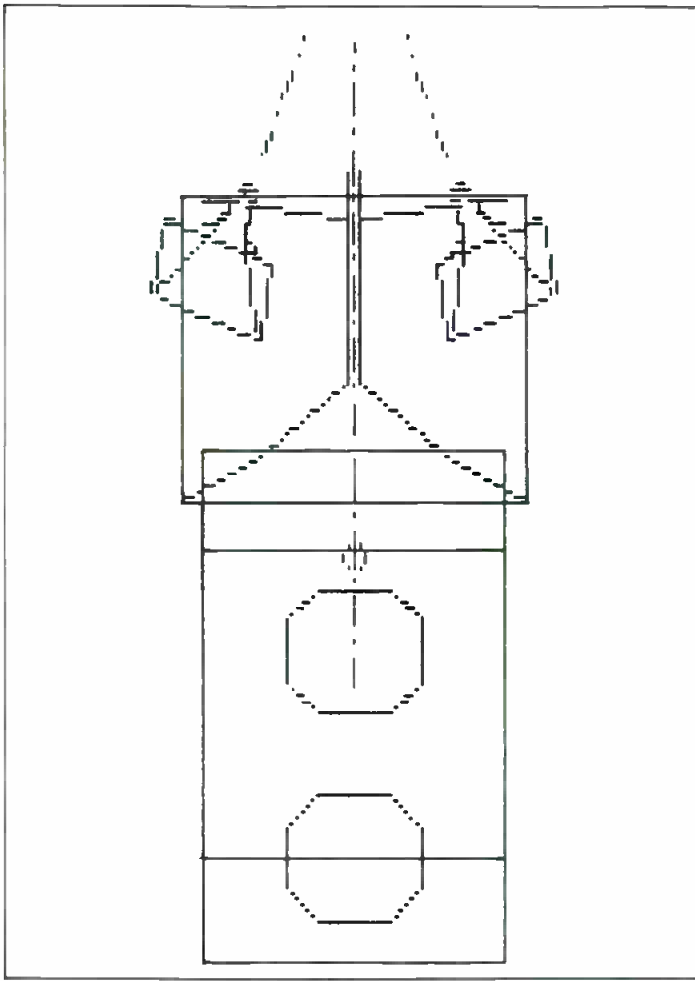

Figure 7. Front view of array.

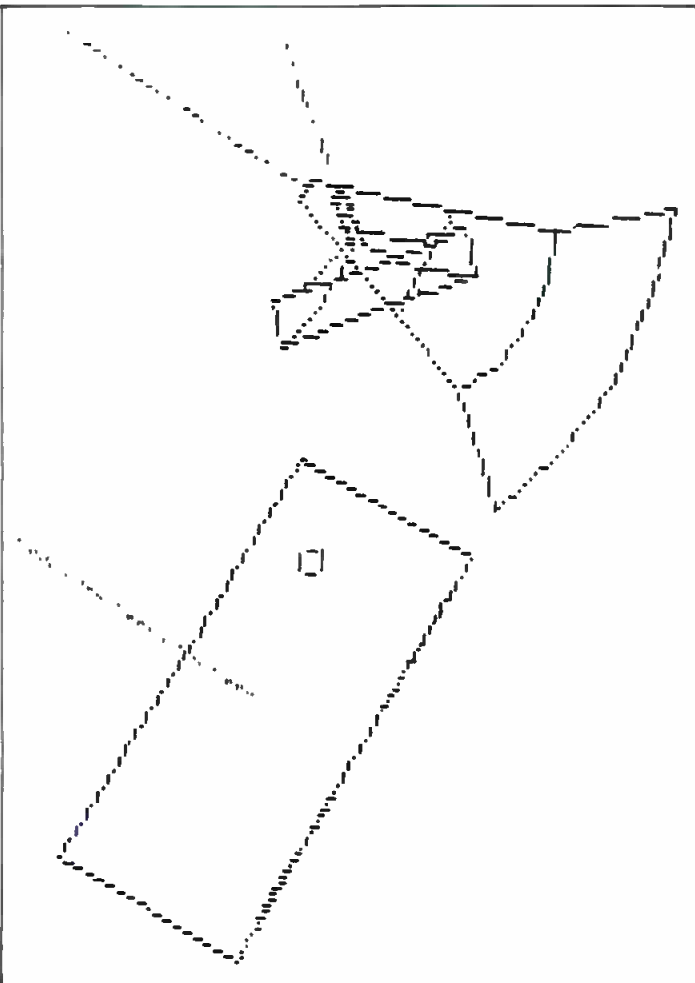

Figure 8. Side view of array.

-11	-12	-12	-22	-25	-27	-25
-13	-11	-16	-34	-25	-23	-22
-15	-14	-25	-27	-20	-19	-21
-19	-22	-28	-19	-17	-16	-20
-32	-19	-15	-14	-15	-15	-19
-19	-12	-10	-10	-13	-15	-18
-13	-7	-8	-8	-12	-14	-17
-7	-4	-4	-7	-12	-13	-14
-4	-2	-3	-6	-11	-12	-13
-3	-1	-3	-6	-11	-12	-13
-3	0	-3	-6	-10	-12	-13
-3	-1	-3	-6	-11	-12	-13
-3	-2	-4	-7	-11	-12	-13
-5	-3	-4	-7	-12	-12	-13
-10	-6	-7	-8	-12	-13	-15
-15	-15	-9	-10	-14	-14	-18
-30	-17	-13	-13	-15	-15	-19
-18	-30	-19	-18	-16	-17	-20
-16	-16	-35	-23	-19	-19	-21
-13	-11	-20	-43	-24	-23	-23
-11	-10	-15	-25	-32	-27	-25

Figure 9. The normalized direct field.

The second, more complex strategy takes into account the phase relationships existing at each display point on the floor as produced by the entire ensemble of radiators. In the examples we have given so far, we used the simpler of these two strategies. As a sample of how the other strategy works, we present the data of FIGURE 9. Here, two radiators are placed 0.2 meter apart, side-by-side, and their response at 2 kHz is seen. Note the formation of a large major lobe, two null angles, and finally the beginnings of minor lobes outside the null lines. The dotted lines in the figure indicate the null directions.

#### PROVISION FOR ADDITIONAL DIRECTIONAL AND DRAWING FILES

Realizing that many consultants and sound contractors will want to enter other high- and low-frequency devices into the program, we have made available on the program diskette the necessary programs for doing so, and the Users Manual which comes with the program will detail how to do this. ■

#### REFERENCE

V. M. A. Peutz, "Articulation Loss of Consonants as a Criterion for Speech Transmission in a Room," *J. Audio Eng. Soc.* Vol. 19, No. 11 (1971).

PEAK  
WATTS/8Ω

● CLIP

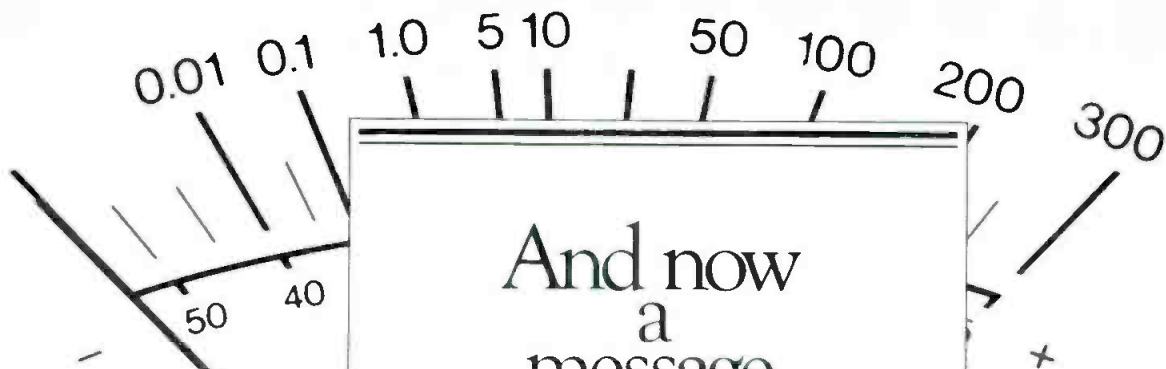

And now  
a  
message  
on  
Yamaha's new  
PC2002M  
power amp.

CHANNEL A

CHANNEL B



-dB





# PC2002M

## SPECIFICATIONS

		PC2002/PC2002M
POWER OUTPUT LEVEL	Continuous average sine wave power with less than 0.05% THD. 20 Hz to 20 kHz	Stereo, 8 ohms 240W + 240W Stereo, 4 ohms 350W + 350W Mono, 16 ohms 480W Mono, 8 ohms 700W
FREQUENCY RESPONSE	10 Hz to 50 kHz, 8 ohms, 1W	+0dB -0.5dB
TOTAL HARMONIC DISTORTION	Stereo 8 ohms 120W Mono 16 ohms 240W Mono 8 ohms 350W	1 kHz 20 to 20 kHz 20 to 20 kHz Less than 0.003% Less than 0.007% Less than 0.01%
INTERMODULATION DISTORTION	70 Hz and 7 kHz mixed 4:1	Stereo 8 ohms, 120W Mono 16 ohms, 240W Less than 0.01% Less than 0.01%
INPUT SENSITIVITY	Input level which produces 100W output into 8 ohms.	0 dB (0.775 V rms)
INPUT IMPEDANCE	Balanced and unbalanced inputs, maximum attenuator setting.	25 k ohms
8 OHM DAMPING FACTOR		1 kHz 20 to 20 kHz Greater than 350 Greater than 200
S/N RATIO	Input shorted at 12.47 kHz Input shorted at IHFA	110dB 115dB
SLEW RATE		Stereo 8 ohms 60V/μsec Mono 16 ohms 90 V/μsec
CHANNEL SEPARATION	8 ohms 120W 8 ohms 120W	1 kHz 20 to 20 kHz 95dB 80dB
DIMENSIONS (W×D×H)		18-7/8×16-1/4×7-1/4" (480×413×183 mm)
WEIGHT		PC2002 44 pounds (20 kg) PC2002M 45 pounds (20.5 kg)

All specifications subject to change without notice.

The performance of the PC2002M speaks for itself. So does its sound, with exceptional low end response. And you can count on its superior performance over the long haul. We use massive side-mounted heat sinks, extensive convective cooling paths and heavy gauge steel, box-type chassis reinforced by heavy gauge aluminum braces and thick aluminum front panels. Yamaha's reliability is legendary, and with the PC2002M and PC2002 (same amp without meters), the legend lives on. For more complete information write: Yamaha International Corporation, P.O. Box 6600, Buena Park, CA 90622. In Canada, Yamaha Canada Music Ltd., 135 Milner Ave., Scarborough, Ont. M1S 3R1.



Circle 61 on Reader Service Card

# Compression Drivers Old and New

*It started with simple devices coupled to phonograph horns... then the movie industry provided the reasons and the money to push the development of compression drivers close to perfection...the advent of electronically amplified musical instruments introduced new challenges...*

**A**S EARLY AS 1915, a driver designed by Pridham<sup>1</sup> was coupled to a phonograph horn to produce sound from electrical signals generated by microphones. No electronic amplification was available, but this driver was electro-magnetic in its construction and therefore was begging for an amplifier. The relatively simple device consisted of a straight piece of wire placed between the poles of an electromagnet. A short connecting link of wood was glued from the center of the wire to a flat diaphragm. Thousands of people heard this early driver in San Francisco during the Christmas celebration of 1915.

The first speakers driven by an amplifier were used in 1919 to assist in the sale of "Victory Bonds" in New York City. With the introduction of amplifiers, larger public address systems became a possibility and on November 11, 1921, a sound system designed and built by Western Electric reproduced President Harding's inaugural address for a crowd of 125,000 in Arlington, Virginia. This huge system was powered by just 40 watts. Back then, watts were expensive and bulky—the amplifiers occupied two six-foot rack spaces.

Relatively high efficiency was achieved through the use of an improved version of Pridham's first driver coupled to a large ten-foot horn. The new transducer designed by Egerton<sup>2</sup> had a balanced armature with four air gaps linked to a flat diaphragm of impregnated cloth. Essentially, the new design allowed greater diaphragm motion for improved low-frequency performance. Egerton's system was state of the art in 1921. During the next years, there was no compelling need to improve speaker systems further and the pace of development slowed.

## MOVIES PROVIDE A BOOST

In the late 1920s, the invention of "talking pictures" brought with them the need for economical and efficient reproduction of speech and music for fairly large audiences. The movie industry had more than enough money to hire the best scientific and engineering talent available. Most of the basic theory of sound and the basic principles for the design and construction of audio transducers and exponential horns were developed then.

*William J. Gelow is the chief engineer at Renkus-Heinz, Irvine, CA.*

FIGURE 1 shows a Western Electric model 555 compression driver mounted on a Western Electric KS 6368 exponential horn. The inventors of the device, Wente and Thuras<sup>3</sup>, did an amazing amount of original research and



*Figure 1. A Western Electric model 555 compression driver mounted on a Western Electric KS6368 exponential horn.*

engineering. Their solutions to the design of magnetic circuits, studies of the relations of mass and rigidity in diaphragms, work on compliances and on minimizing phase cancellations at high frequencies laid the basis for all modern compression driver design.

The construction of the 555 featured a domed diaphragm (no longer a flat piece of impregnated cloth) constructed of light weight aluminum only 0.002-in. thick. The compliance (the flexible ring surrounding the diaphragm enabling it to move up and down in response to electronic signals) allowed the relatively large excursions needed for extended low-frequency response. The design provided a large but rigid radiating diaphragm surface, while maintaining low mass by the use of thin, light material formed into a section of a sphere. An aluminum edgewound ribbon voice-coil further contributed to reduced mass and much improved efficiency. The Western Electric 555 was also the first driver to use a "phasing plug." The introduction of this new com-

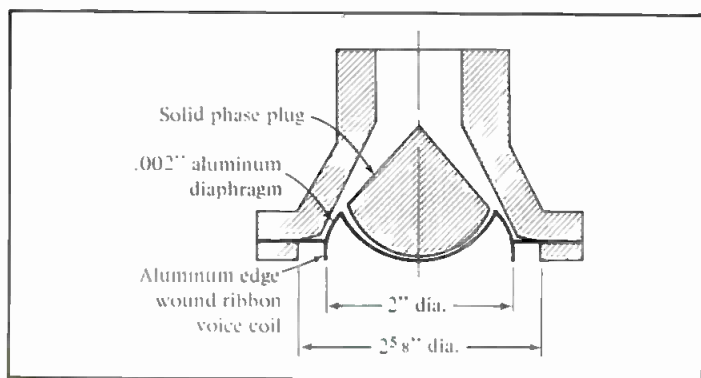

Figure 2. Construction details of the Western Electric model 555.

ponent represented another significant breakthrough. A phasing plug increases radiation resistance, which in turn increases efficiency and flattens the resonance-induced peak in the frequency response. The specific design of this device allows the sound pressure generated by the motion of the diaphragm to be summed in phase at the throat of the horn. FIGURE 2 illustrates the important elements of the internal construction of the Western Electric 555.

Frequency response of the 555 mounted on a six foot plane-wave tube is shown in FIGURE 3. In a plane-wave, all of the driver's output is passed down a tube terminated by an acoustic absorber. The absorber is designed to insure that no sound is reflected. As a consequence, the sound waves travel in one direction only, and when the sound-pressure in the tube is sampled by a precision microphone, a very accurate measurement of the driver's acoustic output power can be made.

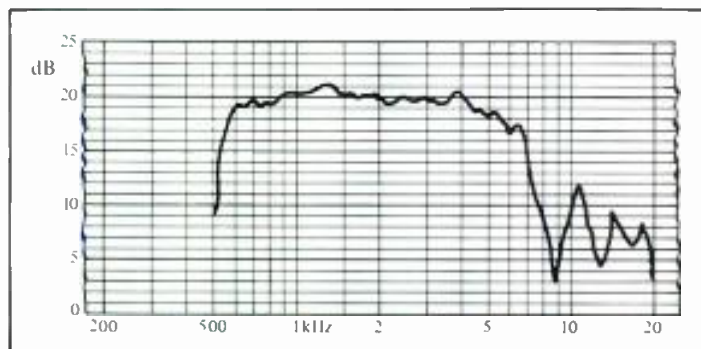

Figure 3. The frequency response of the model 555, mounted on a six-foot plane wave tube.

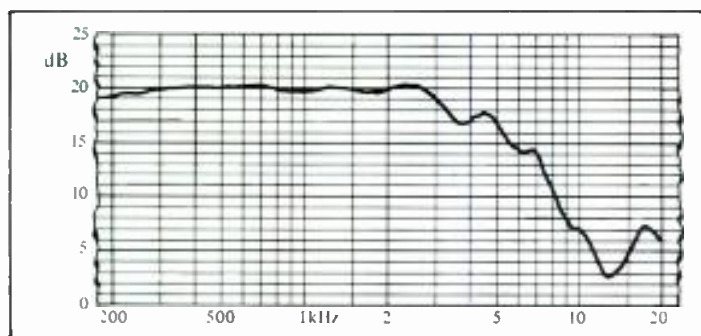

Figure 4. The free-air response of the model 555 when mounted on the KS6368 exponential horn.

FIGURE 4 shows the frequency response of the 555 driver in free air when mounted to the KS 6368 horn. The combination of horn and driver with its maximum input of 10 watts was capable of three watts of acoustic outputs from 50 Hz (with a large horn) to 7 kHz. Its upper bandwidth was primarily limited by the solid phasing plug.

About 1934, the high-frequency response was improved to about 10,000 Hz with a phasing plug that featured concentric annular slits. The resulting new driver was known as the Western Electric 594. This design, with only minor changes, provided the basis for the Altec 288 and JBL 375 compression drivers manufactured until recently.

After the quantum improvements made in response to the needs of the motion picture industry, the evolution of the compression driver slowed again. Alnico, and later ceramic, magnets replaced the original electromagnets and minor refinements were made for specialized applications, but no basic changes were introduced or required for a long time.

## THE ROCK 'N' ROLL CONNECTION

The next major stimulus for improvements came along in the 1950s with heavily amplified live Rock 'n' Roll music. With concert sound levels increasing by orders of magnitude, the power output had to be improved; it was also desirable to extend the high end of the frequency response beyond the then current state of the art.

To the design engineer, the new requirements of increasing power output and at the same time extending the high frequency response presented formidable challenges. Good high frequency performance requires the use of light, low-mass coils and diaphragms. On the other hand, high power is better served by the utilization of substantial coils and diaphragms. However, because of their very mass, these are inherently inefficient at higher frequencies.

Because of this dilemma, the mid- to high-frequency range is usually divided into two bands and covered by physically different driver units. The lower end (mid-range) is serviced by drivers with relatively heavy diaphragm assemblies; the high end is covered by drivers equipped with light diaphragms and small-diameter coils. Several of the smaller drivers are then required to match the output of each of the larger mid-range units. This solution is reliable, but not altogether satisfactory because of the obvious penalties in cost, size and weight.

Renkus-Heinz, as a relative newcomer, has found a niche in the compression driver market, by offering drivers that in a single unit combine reliable power handling, high-frequency response, and low distortion to a degree not previously offered. Some of the important design considerations for the new generation of compression drivers in general and the R-H Model SSD 1801 in particular are described below.

## DESIGN CONSIDERATIONS

Opportunities for improvements can be found in a redesign of the fragile diaphragm assemblies. Of particular importance here is the choice of the diaphragm material, the construction of the compliance, and the efficient removal of heat. Other than in the area of heat removal, there is not much that can be done to the magnetic structure to improve either the high-frequency performance or the power output of the device.

All R-H drivers use aluminum diaphragms because, for relatively low distortion at high power levels, general sound quality and high-frequency capability, aluminum is probably still the best compromise material. It combines comparatively low weight with stiffness and good internal damping. The latter property assures that much of the unavoidable diaphragm distortion is converted into heat, and therefore is not available to produce distorted sound. The fatigue strength of the aluminum is improved substantially through the utilization of special heat-treatable aluminum of the type used in aircraft wing construction.

By comparison, the widely used phenolic diaphragms have still higher fatigue strength, but are much too heavy for high frequency performance. Beryllium, another material now in use for diaphragms, is excellent for the reproduction of high frequencies but has very low internal damping and

is extremely brittle. These properties cause not only higher distortion at high input levels but also allow the diaphragm to shatter and self-destruct on even momentary overloads. Titanium, first introduced as diaphragm material by a Japanese company, is not brittle, but it has low internal damping and is relatively heavy.

By far the weakest element in compression drivers is compliance. Although many solutions have been tried, most concentrate bending stress to a series of single points, causing material fatigue and breakage. This notorious weakness may be eliminated through the use of silicon elastomer. This material, for all practical purposes, does not fatigue at all. Additionally, careful consideration must be given toward improved heatsinking. For example, the back cover of the driver may be designed to be in intimate contact with an aluminum diaphragm ring. This particular arrangement will turn the back cover into an effective heatsink, further contributing to reliability under high power operation.

The combination of special aluminum, elastomer surround and the additional heatsinking makes for excellent long-term power handling coupled with respectable performance. The SSD 1800 1-inch throat driver (forerunner to the SSD 1801) performs well up to 16 kHz. FIGURE 5 shows plane-wave tube measurements of the SSD 1800. The extended high-frequency performance is achieved through deliberate use and placement of the first resonance frequency of the aluminum dome (FIGURE 6).

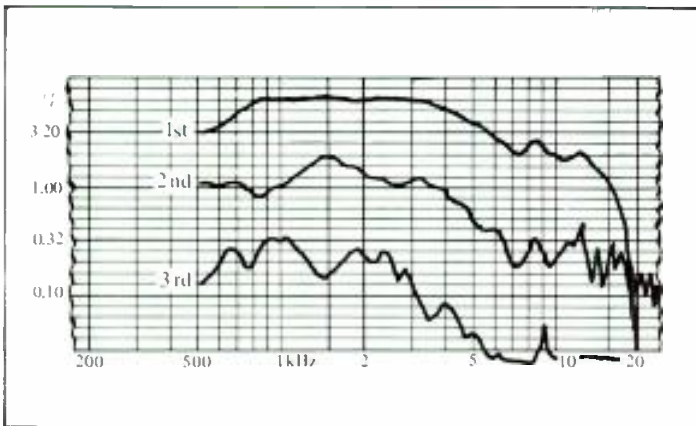

Figure 5. Harmonic distortion of the Renkus-Heinz model SSD 1800 mounted on a one-inch plane wave tube.

For the design of the newer SSD 1801 driver, the challenge was to extend the frequency response to beyond 20 kHz without loss of power handling, while simultaneously lowering distortion at extreme output levels. The final design is the subject of pending patents and cannot be disclosed here. However, the frequency response, distortion characteristics (FIGURE 7) and power rating curves (FIGURE 8) attest to the success in meeting all of the design objectives.

For reasons of efficiency and sound pattern control, all compression drivers are connected to horns which should be designed with a relatively short path length. The short path length is important for several reasons: it minimizes distortion in the horn, it makes it easier to design time-coherent speaker systems and, finally, it makes for a very compact and easy to mount device.

The horizontal and vertical off-axis frequency response of a CBH 800 horn is shown in FIGURE 6; the on-axis frequency response and distortion characteristics are indicated in FIGURE 7. For these latter measurements, the horn is coupled to an equalized Renkus-Heinz SSD 1801 driver. This combination, when mounted to a baffle with a 12- or 15-inch woofer, exhibits time coherent performance well below the Blauert and Law<sup>4</sup> Criteria for audible time delay discrepancies.

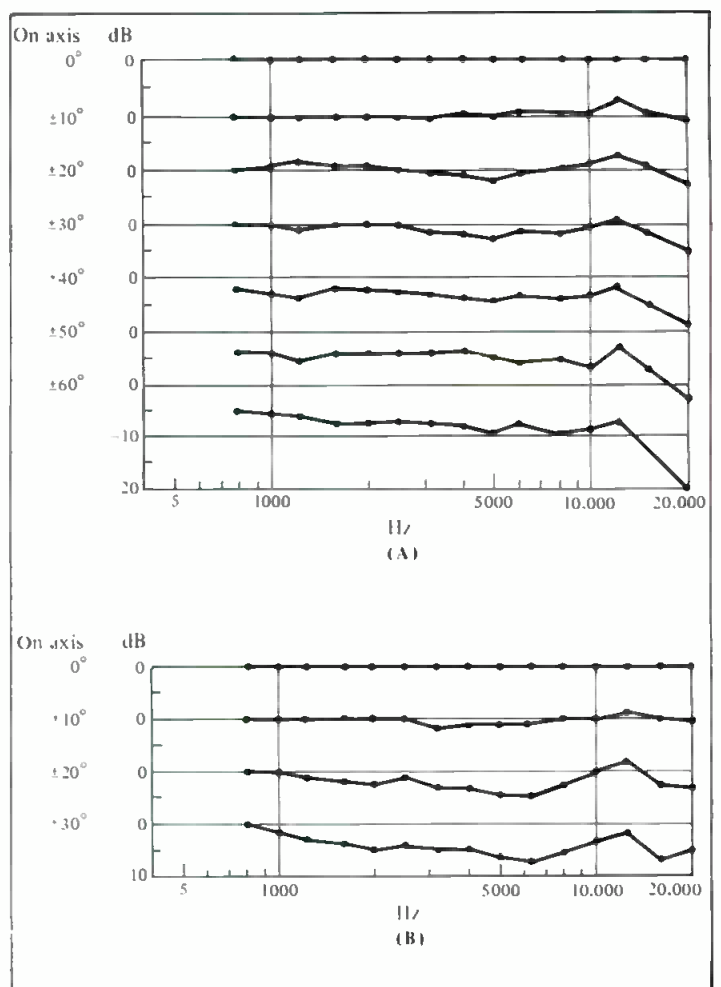

Figure 6. The horizontal (A) and vertical (B) off-axis frequency response of the CBH 800 horn.

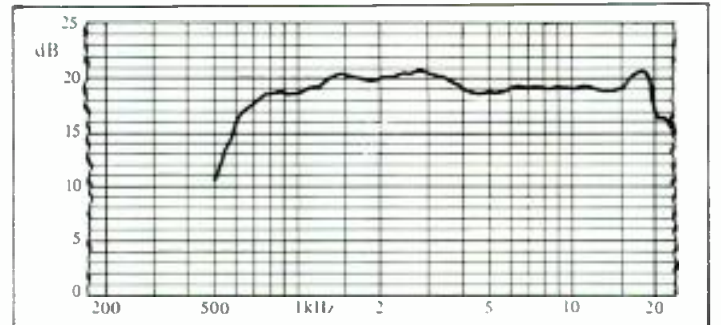

Figure 7. Frequency response of a horn and driver, and signal processor.

## SUMMING UP

In summation, we believe the design of the SSD 1801 driver to be new and useful. It pushes the quest for reliable high power output, extended frequency response and lower distortion one step closer to the ideal. Especially in combination with the short CBH horns, a new generation of compact speaker systems (Studio Monitors, Playback Systems and Sound Reinforcement Speakers), improved in power handling, linearity and frequency response, is now possible. ■

## REFERENCES

1. Beranek, Leo L., "Loudspeakers & Microphones." *The Journal of the Acoustical Society of America* Vol. 26, No. 5 (1954).
2. Same as above.
3. Wentz, E. C. & Thuras, A. L., "A High-Efficiency Receiver for a Horn Type Loudspeaker of Large Power Capacity." *Sound Reinforcement, An Anthology, Audio Engineering Society* D81.
4. "Group Delay Distortions in Electroacoustical Systems." *Journal of the Acoustical Society of America* Vol. 63 (1978).

# New Products

## PRECISION ALIGNMENT ASSEMBLY

• JRF's new precision alignment assembly, the Promix II, is designed to adjust azimuth, zenith, wrap, and track placement (height). It is specifically designed to reduce tape machine alignment time as well as to simplify magnetic head maintenance. The complete package includes a special assembly cover with hinged top for easy access. The Promix II is currently available to fit most MCI JH series multitrack tape machines.

*Mfr: JRF Magnetic Sciences Co.*

**Circle 41 on Reader Service Card**



## NEW MICROPHONES

• Audio Technica's two new microphones, a one-point stereo electret and a miniature electret lavalier/lapel model, bring their array of microphones to four. The AT9400 one-point electret offers the convenience of stereo pickup in a single microphone with two unidirectional elements. Its response range of 60 Hz to 17 kHz makes it suitable for a variety of recording and live reinforcement applications. Its 9 ft. 10-in. cable is terminated with twin miniplugs, designed so that its 1/4-in. adapters (included) can be screwed on. The microphone comes with a slip-on stand and AA battery. The AT9500, which measures 1 1/4-in. long by 3/8-in. in diameter, is powered by a single self-contained mercury cell (included). Despite its small size, the lavalier/lapel microphone provides balanced response over a range of 50 Hz to 16 kHz, making it well-suited for a variety of sound reinforcement, lecture, and on-camera video uses. The microphone comes with a tie clip, foam wind-screen, and a screw-on plug adapter that converts the mini-phone jack to a 1/4-in. plug, when there is a need to do so. The cable provided is also 9 ft. 10-in. long.

*Mfr: Audio Technica*

*Price: AT9400 \$39.95*

*AT9500 \$24.95*

**Circle 42 on Reader Service Card**



## EL-15 Woofer

- 25-5000 Hz
- 200 Watts
- 100 dB M/W
- 4" Voice Coil

# EMILAR

**For complete information:**

(714) 632-8500

(800) 854-7181

**EMILAR CORPORATION**

1365 N. McCan St.,  
Anaheim, CA 92806

**Circle 37 on Reader Service Card**



## SPEAKER LINE

• Electro-Voice's new EVM Pro-Line Series speakers are designed for professional, extra-high-level, high-performance sound reinforcement systems. Pro-Line drivers double the power-handling capacity of the EVM Series II drivers while maintaining efficiency. The speakers' improved performance is accounted for by several design factors including heat-resistant materials, low-mass edge-wound flat-wire voice coil construction, and proprietary manufacturing techniques. The Pro-Line assemblies are driven by EV's largest 16-pound magnetic structure. Both the voice coil and the magnetic structure are vented to maximize heat dissipation in the voice coil area. The new EVM's are available in three sizes and five models to fit any design application. The 15- and 18-inch models can handle 400



watts of continuous power (per EIA Standard RS-426A) and short duration program peaks of up to 1600 watts. The 12-inch EVM Pro-Line speakers are

rated at 300 watts of continuous power with 1200-watt program peaks under the same test conditions. The Pro-Line characteristics are appropriate for both vented (bass reflex) and horn enclosures. Six specific enclosures have been designed for EVM speakers. They span low-frequency limits (3 dB down) from 38 to 83 Hz and internal volumes from 1.3 to 13 cubic feet; they may be stepped down for more extended bass response, with low frequency limits ranging from 27 to 58 Hz. Four of the enclosures house single speakers, and two utilize a four-speaker array for increased efficiency and maximum output ability.

Mfr: Electro-Voice

Price: EVM-12S, EVM-12L \$240.00  
EVM-15B, EVM-15L \$264.00  
EVM-18B \$395.00

Circle 43 on Reader Service Card

## AUDIO DELAY

• Lexicon's Model 1300 audio delay synchronizer allows broadcasters to solve lip-sync problems resulting from the increasing use of digital video processors and synchronizers. The system decodes the hysteresis and frame offset information from any video synchronizer to provide frame accurate audio synchronization in any broadcast or production set-up. Three standard decoding options are supplied: pulse-width decoding, "wild-feed"/genlock decoding, or serial data decoding—each with its own interface panel and software. The removable Delay Configuration Control Module can be configured to conform to any delay/sync decoding scheme presently in use and provides software/hardware flexibility for future configurations. The system has an optional Remote Video Sensing Module which allows audio synchronization information from the

video section of the facility to be communicated via RS-422 to the Model 1300 mainframe located in the audio section. The Model 1300 is available in a mono or stereo configuration. It allows synchronous operation of multiple units in master/slave configurations. The digital audio delay section of the 1300 has distortion less than .025 percent, dynamic range greater than 90 dB, channel separation greater than 70 dB, and balanced studio inputs and outputs. Front panel controls allow operators to display either the compensating or total delay in milliseconds or frames. Digital switches provide the means of entry for any base delay to which the compensating delay is then automatically added. Other displays and indicators have been included for ease for operation.

Mfr: Lexicon

Circle 44 on Reader Service Card

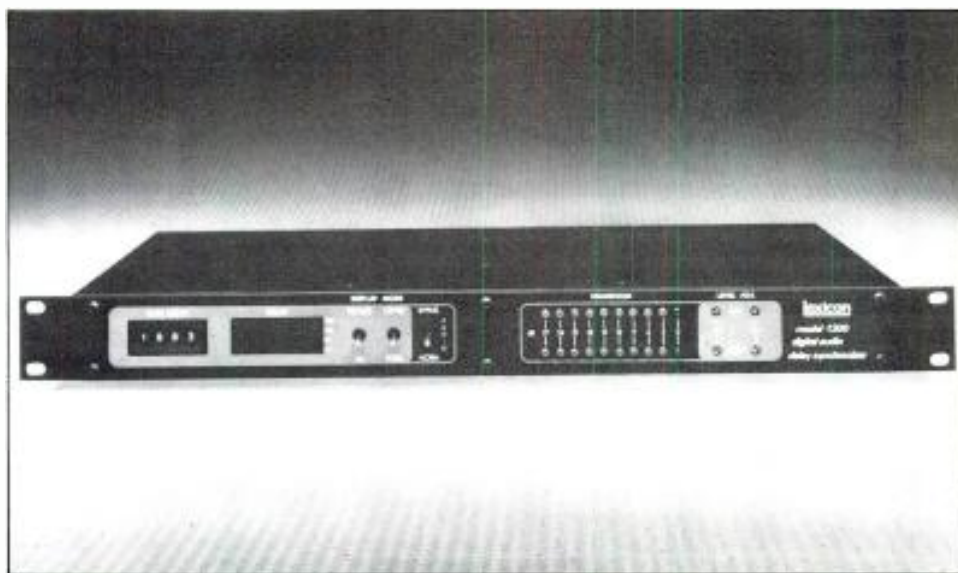

## Introducing THE SOUND EFFECTS LIBRARY FOR PROFESSIONALS

- 3000 STEREO EFFECTS
- 30 HOURS OF SOUNDS
- 125 TAPES at 7½ or 15ips
- PRICED FROM \$1500.00
- NO ROYALTY PAYMENTS EVER

"Some of our Clients."

- \* ABC
- \* NBC
- \* CBS
- \* Walt Disney



86 McGill Street,  
Toronto, Ontario,  
Canada. M5B 1H2  
(416) 977-0512

Circle 40 on Reader Service Card

### THREE-WAY COMPACT LOUDSPEAKER SYSTEM

• Community's RS320 is a three-way loudspeaker system designed from the ground up (not a two-way system with added super tweeters). It includes a high-performance midrange compression driver loaded by a Constant-Directivity type midrange horn. The low-frequency section consists of a high-power, 12-inch woofer in a vented enclosure that's terminated by an exponential coupler; the high frequency section is a pair of piezo-electric supertweeters loaded by their own Constant-Directivity type horn. This combination gives the RS320 a wide dynamic range and smooth frequency response (both on-and-off-axis). All of the components are loaded on a unified fiberglass faceplate which helps reduce unwanted resonances and reduces overall enclosure size. Options include the model RS320-EQ equalizer, which improves the low- and high-frequency response of the RS320 and helps protect it against excessive low-frequency power; the VB990 15-inch high-power auxiliary woofer, which is designed to improve the RS320's low-

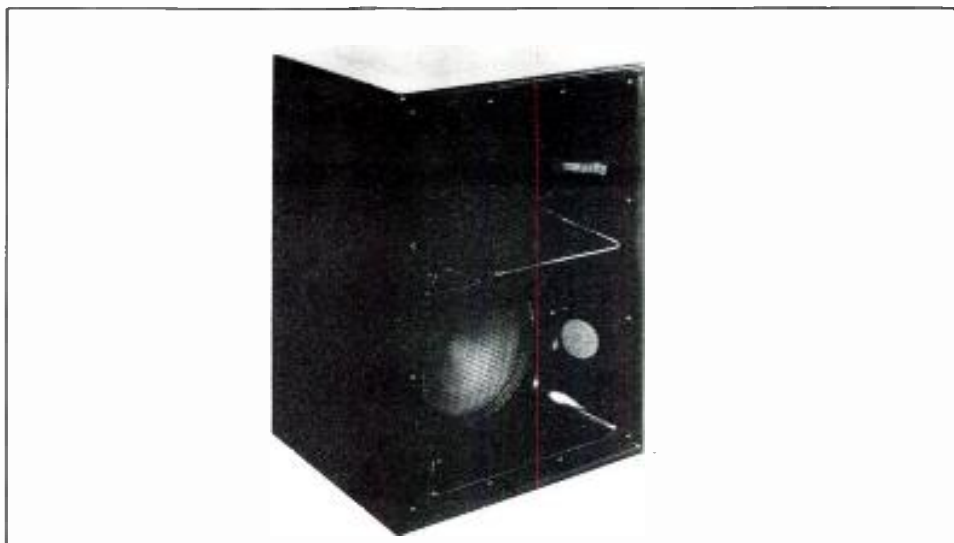

frequency output capabilities in an enclosure of the same size, and the model Grille-30, which hides the RS320's components for appearance-sensitive installations. The RS320 is

also available without the enclosure (model RS320 KIT-1).  
Mfr: Community Light and Sound, Inc.  
Price: \$538.00

Circle 45 on Reader Service Card

### MICROPHONE PREAMP CARD

• Hardy's new MPC-500C microphone preamp card directly replaces the stock preamp card in the MCI series 500 consoles. Features contributing to improved performance include 1) the 990 discrete op-amp, which offers faster slew rate, higher output current, and lower distortion than the stock op-amp; 2) the Jensen JE16-B microphone input transformer, which provides 1/3 the distortion, the ability to handle signal levels 10 to 15 dB higher without saturation, flatter responses,

less overshoot, and more linear input impedance than the stock transformer; 3) on-card power supply regulation, which provides reduced crosstalk, increased stability, and elimination of the "swinging transistors" used on the stock card, and 4) a special servo circuit, which eliminates all coupling and gain-pot capacitors to provide a significant improvement in sound quality.

Mfr: John Hardy Co.  
Price: \$195.00

Circle 46 on Reader Service Card

## Audio Tape for professionals



**REEL TO REEL TAPE**  
Ampex, 3M. All grades.  
On reels or hubs.

**CASSETTES, C-10—C-90**  
With Agfa, TDK tape.

**LEADER & SPLICING TAPE**

**EMPTY REELS & BOXES**  
All widths, sizes.

**Competitive!**  
**Shipped from Stock!**

Ask for our recording supplies catalog.

**Polyline Corp.** 312/298-5300  
1233 Rand Rd. • Des Plaines, IL 60016

15

Circle 38 on Reader Service Card

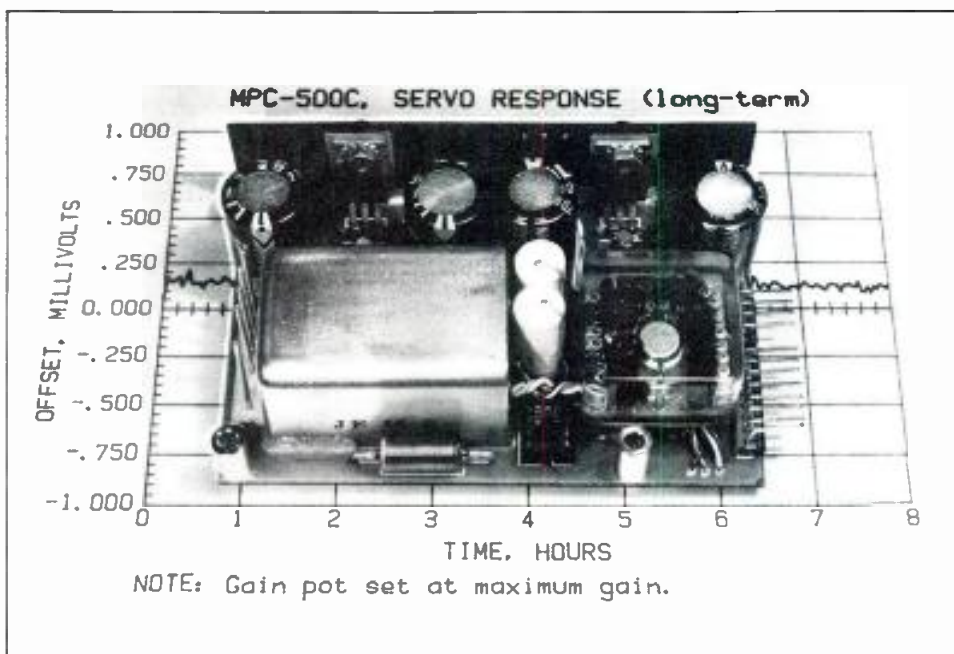

# Updated Recording Studio Handbook

A must for every working professional... student... audio enthusiast

Features latest state-of-the-art technology of creative sound recording.

## 21 Fact-Filled Chapters

- |  |  |
|--|--|
| <p><b>I. The Basics</b></p> <ol style="list-style-type: none"> <li>1. The Decibel</li> <li>2. Sound</li> </ol> <p><b>II. Transducers: Microphones and Loudspeakers</b></p> <ol style="list-style-type: none"> <li>3. Microphone Design</li> <li>4. Microphone Technique</li> <li>5. Loudspeakers</li> </ol> <p><b>III. Signal Processing Devices</b></p> <ol style="list-style-type: none"> <li>6. Echo and Reverberation</li> <li>7. Equalizers</li> <li>8. Compressors, Limiters and Expanders</li> <li>9. Flanging and Phasing</li> </ol> <p><b>IV. Magnetic Recording</b></p> <ol style="list-style-type: none"> <li>10. Tape and Tape Recorder Fundamentals</li> <li>11. Magnetic Recording Tape</li> <li>12. The Tape Recorder</li> </ol> <p><b>V. Noise and Noise Reduction</b></p> <ol style="list-style-type: none"> <li>13. Tape Recorder Alignment</li> <li>14. Noise and Noise Reduction Principles</li> </ol> | <ol style="list-style-type: none"> <li>15. Studio Noise Reduction Systems</li> </ol> <p><b>VI. Recording Consoles</b></p> <ol style="list-style-type: none"> <li>16. The Modern Recording Studio Console</li> </ol> <p><b>VII. Recording Techniques</b></p> <ol style="list-style-type: none"> <li>17. The Recording Session</li> <li>18. The Mixdown Session</li> </ol> <p><b>Three all-new Chapters</b></p> <ol style="list-style-type: none"> <li>19. The In-Line Recording Studio Console<br/>(The I/O Module The Basic In-line Recording Console. Signal flow details.)</li> <li>20. An Introduction to Digital Audio<br/>(Digital Design Basics Digital Recording and Playback Error Detection and Correction Editing Digital Tapes)</li> <li>21. Time Code Implementation<br/>(The SMPTE Time Code Time-Code Structure Time-Code Hardware)</li> </ol> |
|--|--|



**\$39.50**

### Easy to Order

You can enclose a check with your order or charge it to Master Charge or BankAmericard/Visa. Use the coupon below to order your copies of the new updated *Recording Studio Handbook* (\$39.50)

#### ELAR PUBLISHING COMPANY, INC.

1120 Old Country Road, Plainview, N.Y. 11803

Yes! Please send \_\_\_\_\_ copies of THE RECORDING STUDIO HANDBOOK. \$39.50. On 15-day approval.

Name \_\_\_\_\_

Address \_\_\_\_\_

City/State/Zip \_\_\_\_\_

Total payment enclosed \$ \_\_\_\_\_  
(In N.Y.S. add appropriate sales tax)

Please charge my  Master Charge  
 BankAmericard/Visa

Account # \_\_\_\_\_ Exp. date \_\_\_\_\_

Signature \_\_\_\_\_

(charges not valid unless signed)

Outside U.S.A. add \$2.00 for postage.  
Checks must be in U.S. funds drawn on a U.S. bank.

The *Recording Studio Handbook* is an indispensable guide with something in it for everybody. It covers the basics beautifully. It provides in-depth insight into common situations and problems encountered by the professional engineer. It offers clear, practical explanations on a proliferation of new devices. **And now it has been expanded with three all-new chapters . . . chapters on the in-line recording studio console, digital audio and time code implementation.**

### Sixth printing of industry's "first" complete handbook

The *Recording Studio Handbook* has been so widely read that we've had to go into a sixth printing to keep up with demand (over 30,000 copies now in print). Because it contains a wealth of data on every major facet of recording technology, it is invaluable for anyone interested in the current state of the recording art. (It has been selected as a textbook by several universities for their audio training program.)

### Highly Acclaimed

Naturally, we love our book. But don't take our word for it. Here's what others have to say:

"John Woram has filled a gaping hole in the audio literature. This is a very fine book. . . I recommend it highly." *High Fidelity*  
"A very useful guide for anyone seriously concerned with the magnetic recording of sound." *Journal of the Audio Engineering Society*

### 5-Day Money-Back Guarantee

When you order *The Recording Studio Handbook* there's absolutely no risk involved. Check it out for 15 days. If you decide it doesn't measure up to your expectations, simply send it back and we'll gladly refund our money.

**ACOUSTIC FEEDBACK SUPPRESSOR**

• Altec Lansing's Model 1620A Automatic Feedback Suppressor detects oscillations due to acoustic feedback, automatically lowers gain, and operates the system optimally below the threshold of feedback. Audio sound produced by oscillation due to feedback is distinguished in character from that produced by the system audio program. Presence of any persistent feedback frequency is sensed by the 1620A's phase-lock-loops and timing circuitry. Feedback sensing also occurs at critical thresholds of time and amplitude. Threshold sensitivity of the feedback

detector circuit is manually adjustable from approximately -25 to +4 dBm. Detected signals are sent to the attenuation computer where system gain is automatically adjusted upon detection of acoustic feedback. When feedback occurs, the attenuation computer cycles to determine how much attenuation is required to stop it. Attenuation is then introduced and indicated on an LED display. Attenuation range is in 3 dB increments to 18 dB, and a final 10 dB increment for a total range of 28 dB. Unity gain may be restored with a manually operated reset switch on the front panel. Provision is also made for remote resetting. If power is turned off

or disconnected, the signal path is automatically bypassed through a bypass relay. When power is restored, the relay energizes to return the signal path through the 1620A. Noise suppression circuitry assures quiet operation of the bypass relay and guards against turn-on and turn-off transients. The 1620A is housed in a 19-in. chassis that occupies a 1½-in. vertical rack space in a standard 19-in. equipment rack. XLR type receptacles and barrier type terminal strips are provided for input and output connections.

*Mfr: Altec Lansing*

**Circle 47 on Reader Service Card**



**DYNAMIC MICROPHONE**

• Milab's P-14 is a low priced PA-dynamic microphone designed for handheld use and vocals. It is available in two standard versions: with a fixed cable either terminated by a 6.3mm phone plug with switch, or a 3-pin male XLR-type connector without switch. The P-14 may also be tailored to have either a slide or push switch, be balanced or unbalanced, and have one or more pilot wires.

*Mfr: Milab*

**Circle 48 on Reader Service Card**



In general, spring reverbs don't have the best reputation in the world. Their bassy "twang" is only a rough approximation of natural room acoustics. That's a pity because it means that many people will dismiss this exceptional product as "just another spring reverb." And it's not. In this extraordinary design Craig Anderton uses double springs, but much more importantly "hot rods" the transducers so that the muddy sound typical of most springs is replaced with the bright clarity associated with expensive studio plate systems.

Kit consists of circuit board, instructions, all electronic parts and two reverb spring units. User must provide power (±9 to 15v) and mounting. (Reverb units are typically mounted away from the console).

**COMPACT CLOSE-UP STEREO MONITOR**

• UAP's 250-Series amplifiers, claimed to be the world's smallest stereo audio monitors, require a 1¼-in. space, and accept one balanced and one unbalanced bridging input per channel, having high-frequency tone control with "flat" preset. The Model 255 includes an extra four-source pushbutton input

selection per channel as well as on/off switches for a pair of remote loudspeakers. The 250 series offers models with input VU metering, and others with front-panel input patchjacks and speaker auto-disconnect headphone jacks.

*Mfr: Ultra Audio Pistec*

*Price: \$345.00*

**Circle 49 on Reader Service Card**



db July-August 1983

54

**CHARGE TO VISA OR MC TOLL-FREE**  
**1-800-654-8657 9AM to 5PM CST MON-FRI**  
 DIRECT INQUIRIES TO:  
**RAA Electronics, Inc.**  
 Dept. 3d, 1020 W. Wilshire Bv., Oklahoma City, OK 73116 (405) 843-9626

Send the 6740 REVERB KIT \$59.95 plus shipping (\$3) enclosed or charged.  
 Send Free Catalog

name \_\_\_\_\_  
 address \_\_\_\_\_  
 city \_\_\_\_\_ state \_\_\_\_\_ zip \_\_\_\_\_

**Circle 39 on Reader Service Card**

## HIGH-SPEED CASSETTE TAPE DUPLICATOR

• Cetec Gauss' Model 2400 system is a high-speed cassette tape duplicator featuring adjustable dual capstan servo system, front access modular electronics, an efficient tape loading system, unique hub locks, precision tape packer arms, replaceable tape cleaner cartridge, and advanced circuit technology and automatic componentry.

*Mfr: Cetec Gauss*

**Circle 50 on Reader Service Card**



## CABLED INTERCOM LINE

• HM Electronics' new line of cabled intercom systems, the 700 Series, offers two multi-station power supplies, a two-channel power station, a belt-pac remote station, plus several accessory items. The power supplies and power station incorporate fully-regulated 24 VDC power supplies that provide current-foldback protection for shorted audio cables and automatic reset when the fault is cleared. The system components are fully plug-compatible with existing three-wire cabled intercom systems as well as the HME 150E series wireless intercom. A unique soft-limiter allows undistorted audio performance during high-level operation, and a special presence peak in the audio frequencies provides clear voice transmission without the ear fatigue usually associated with this feature.

*Mfr: HM Electronics*

**Circle 51 on Reader Service Card**



## STEREO CONSOLE

• The ESA-10 stereo console, recently added to the Audio Metrics line of studio equipment, features ten channels, linear faders, total DC control, and quality audio specifications. Other standard features include: 30 inputs; two outputs, each with mono mixdown; three muting circuits; remote starts; internal test oscillator; cue amp; set-up meter; two auxiliary switches, and programmable cue logic. Audio specifications include: .03 percent total IM and THD and mic noise 80 dB below -50 dBV. The low profile styling is highlighted by multi-segment LED meters and a bright clock and timer.

*Mfr: Radio Systems, Inc.*

*Price: Under \$9000.00*

**Circle 52 on Reader Service Card**



# Classified

**Closing date is the fifteenth of the second month preceding the date of issue.**

**Send copies to: Classified Ad Dept.  
db THE SOUND ENGINEERING MAGAZINE  
1120 Old Country Road, Plainview, New York 11803**

**Minimum order accepted: \$25.00**

**Rates: \$1.00 a word**

**Boxed Ads: \$40.00 per column inch**

**db Box Number: \$8.50 for wording "Dept. XX," etc.**

**Plus \$1.50 to cover postage**

**Frequency Discounts: 6 times, 15%; 12 times, 30%**

**ALL CLASSIFIED ADS MUST BE PREPAID.**

**FOR SALE:** Complete audio restoration laboratory. Specialized equipment for playing and copying cylinders, discs, tape and wire. Equipment has been used in various significant projects during the last several years. Only **SERIOUS INQUIRIES** from qualified institutions or individuals will be answered. All inquiries should be sent to **db Magazine, Dept. 12, 1120 Old Country Road, Plainview, NY 11803.**

**NEUMANN VMS-70 SAL/SX-74/Technics SP-02** motor cutting system. New condition, 5 yrs. old. **KAWAI 9'** concert grand. Ivory keys, 5 yrs. old. Excellent condition, \$10,500 obo (213) 204-2854.

**PRO AUDIO IN STOCK**—ready to ship Top lines, top dollar trade-ins, clearance specials. Call or write for our prices. **Professional Audio Video Corporation, 384 Grand Street, Paterson, NJ 07575 (201) 523-3333.**

**MICROPHONES** Immediate delivery via UPS. All popular models in stock. Best prices you'll see in '83. **PLUS** we pay freight. **UAR Professional Systems, 8535 Fairhaven, San Antonio, TX 78229. (512) 690-8888.**

**AGFA CHROME** and normal bias **BLANK CASSETTES.** CUSTOM LOADING to the length you need. Your music deserves the best—your budget deserves a bargain. **GRD P.O. Box 13054, Phoenix, AZ 85002. (602) 252-0077.**

**MCI 24/16** track recorder with auto locator and large spares inventory... Sale or Trade... \$18,500.00 and Ampex MM1100 16 track fully modified, mint condition. Sale or Trade... \$13,000.00. **Call Dan at (415) 441-8934.**

**TECHNICS TURNTABLES IN STOCK!** AKG, Neumann, UREI, Orban Eventide, dbx, Lexicon. Best pro-audio equipment. Lowest prices. **IMMEDIATE DELIVERY** **UAR Professional Systems. (512) 690-8888.**

**USED RECORDING** equipment for sale. **Dan (415) 441-8934.**

**CASSETTE DUPLICATION** IN real time from 10-10,000. Nakamichi cassette decks used for optimum quality. Best rates, labels, inserts and shrink wrap available. Fast turn around. **Audiohouse (303) 751-2268.**

## FOR SALE

**STEPHENS 821B**—Multi-track recorder. Auto-locator with 10 position locate. 16, 24 and 32 track 2" head stacks. Pre-wired for 40 channels, with 32 channels of electronics. \$28,000. Also for sale, 32 channels of dbx 2161. **Contact Bee Jay Studios, 5000 Eggleston, Orlando, FL 32810. (305) 293-1781.**

**FREE 32pg Catalog & 50 Audio/Video Applic.**



Stereo Mono Pwr Ampl.      PWR SUPP. EQ.  
 PHONO, MIC  
 TRANS. ACN  
 TAPE, VIDEO  
 LINE, OSC

Video & Audio Dist Amplic      8-in/2-out, 12-in/4-out, 18-in/4-out  
 TV Audio & Recd Prod Consoles

**OPAMP LABS INC (213) 934-3566**  
1033 N Sycamore Av LOS ANGELES CA, 90038

## FOR SALE: USED EQUIPMENT

**AKG:** C-61; C-60; C-451; D-20; D-25; D-19; D-24  
**NEUMANN:** KM-54; U-67; SM-2; U-64  
**SCHOEPS:** CMT-36; CMH-32; M-221  
**RCA:** BK5B; 77DX; 44BX  
**SENNHEISER:** MKH-805; MKH-405; MD-413; MD-421  
**BEYER:** M-160  
**ELECTRO-VOICE:** 668; 667; CS-15  
**ALTEC:** GRAPHIC (\$90); COMPRESSOR (\$100)  
**LANG:** PEQ-2; LQX-1; LMX-3 (MIXER)  
**PULTEC:** MEQ-5; EQH-2; HLF-3; MH-4; SP-3 (STEREO PANNER)  
**UNIVERSAL AUDIO:** 175 LIMITERS; 500 EQ; 550 FILTERS  
**WHITE:** 3400 1/3 QCT EQ; 4300 1/3 OCT EQ; 4301 1/6 OCT EQ  
**ITI PARAMETRICS;** MELCOR EQS (\$100)  
**LANGEVIN EQS (\$150)**  
**TEAC:** NAKAMICHI; SONY CASSETTE DECKS  
**COOPER TIME CUBE (\$500)**  
**EVENTIDE:** 1745M DDL; PHASOR  
**BI-AMP; REVERB**  
**ORBAN:** 105 PARASOUND REVERB  
**CROWN:** DC-300; D60  
**MARANTZ:** 240  
**CITATION 12 AMP**  
**ALLISON GAIN BRAINS (\$160); ELECTRODYNE LIMITERS**  
**MARTIN AUDIO VSO (\$300); DOLBY A301 (\$500)**  
**DBX 157 (8 CHANNELS); SCAMP RACK (4 MODULES)**  
**3M 64 TWO TRACK/FOUR TRACK**  
**CALL DAN (415) 441-8934.**

**FOR SALE**—AKG C-24 and other tube type condenser mics (415) 441-8934 or 527-6167.

**NEOTEK Series III** 16 x 16 transformerless console, \$10,500. (512) 472-8975, 451-3630.

**DIRECT FROM BROADWAY**

**USED SOUND EQUIPMENT SALE**

**PETER PAN • FIDDLER • CAMELOT  
 KING & I • CHDRUS LINE • DOLLY**  
 Wireless Microphones  
 Used By The Stars  
**AMPS • MIXERS • RECORDERS**  
*all guaranteed*

**SOUND ASSOCIATES, INC.**  
 424 WEST 45 ST. • N.Y. N.Y. 10036  
 TELEPHONE 212-757-5679

BLANK AUDIO AND VIDEO CASSETTES direct from manufacturer, below wholesale. any length cassettes 4 different qualities to choose from Ampex and Agfa mastertape—from 1/2-inch to 2-inch. Cassette duplication also available. Brochure **Andol Audio Products, Inc., Dept. db, 42-12 14th Ave., Brooklyn, NY 11219. Toll free 1-800-221-6578, ext. 1. NY residents (212) 435-7322.**

MCI 500—56 input frame, 32 out; 40 active inputs. Best offer. HARRISON 4032C—36 active inputs—transformerless. Best offer. **PARAMOUNT RECORDING (213) 461-3717.**

AMPEX MM1000 16 track recorder, good condition \$9000.00; OPAMP LABS 2008 console w/dual 16 track mixdown 20 x 8 \$7000.00. PACKAGE: \$14,000.00. (919) 821-5614.

NEUMANN U-87, U-47, four each. Used once. In warranty. \$849, \$829. Call John (512) 690-8187.

(2) Ampex 350 mono with Inovonics 375 electronics, rack mounted, well maintained, excellent condition; asking \$850 each or \$1500 for both. Call (416) 977-0512.

MCI JH-500 Console. Allison automation. JH-16 multitrack recorder with 24 track heads. Very reasonable price: Contact: **Gregory King (305) 425-1001 (Florida).**

THE LIBRARY Sound effects recorded in STEREO using Dolby throughout. Over 350 effects on ten discs. \$100.00. Write **The Library, P.O. Box 18145, Denver, CO 80218.**

### SERVICES

MAGNETIC HEAD relapping—24 hour service. Replacement heads for professional recorders. IEM, 350 N. Eric Drive, Palatine, IL 60067. (312) 358-4622.

ACOUSTIC CONSULTATION—Specializing in studios, control rooms, discos. Qualified personnel, reasonable rates. Acoustilog, Bruel & Kjaer, HP, Tektronix, Ivie equipment calibrated on premises. Reverberation timer and RTA rentals. **Acoustilog, 19 Mercer Street, New York, NY 10013. (212) 925-1365.**

Records Pressed, Jackets Printed—Your Custom, Our Stock, Promotion materials. No minimum quantity. **Rocky Mountain Recording, 8305 Christensen Rd., Cheyenne, Wyo. 82009. (307) 638-8733.**

VIF INTERNATIONAL will remanufacture your Ampex or Scully (Ashland/Bodine) direct drive capstan motor for \$200. Average turn around time 2-3 weeks. For details write: **P.O. Box 1555, Mountain View, CA 94042, or phone (408) 739-9740.**

### WANTED

WANTED: TRANSCRIPTION discs, any size, speed. Radio shows, music. **P.O. Box 724-db, Redmond, WA 98052.**

WANTED: MCI, Neve console; MCI, Ampex tape machine; Neumann, E-V mics; McIntosh amps. (204) 885-2922 or 837-8970.

### EMPLOYMENT

Employment Wanted: Management/Supervisory position with reputable Pro Audio manufacturing firm. Will relocate, travel. Self motivated, hard working. Send responses to: **Dept. 21, db Magazine, 1120 Old Country Rd., Plainview, NY 11803.**

### MOVING?

Keep **db** coming without interruption!

Send in your new address *promptly*.

Enclose your old **db** mailing label, too.

Write to:

Eloise Beach, *Circ. Mgr.*  
**db Magazine**  
1120 Old Country Rd.  
Plainview, N.Y. 11803



Have you misplaced your **db** again? Our high quality, royal blue vinyl binders keep 12 copies of **db** neat and handy for ready reference. Just \$9.95, available in North America only. (Payable in U.S. currency drawn on U.S. banks.) **ORDER YOURS NOW!!**

**Sagamore Publishing Co., Inc.**  
1120 Old Country Road  
Plainview, NY 11803

**YES!** Please send  **db** binders @ \$9.95 each, plus applicable sales tax. Total amount enclosed \$

Name

Company

Address

City

State Zip

# People, Places

• **Dolby Laboratories of San Francisco** has announced the appointment of **Bill Jasper**, formerly executive vice president, as president and chief operating officer. In his new position, Jasper will be reporting to company founder **Ray Dolby**, who now assumes the title of chairman and chief executive officer. Jasper, 35, joined Dolby Laboratories in February, 1979, as vice president, Finance and Administration. Ray Dolby, the inventor of Dolby noise reduction, stated that he will retain the final responsibility for setting long-range objectives and overall direction of the company, which he founded in 1965. Jasper will have the responsibility for managing the company on a day-to-day basis to ensure effective and profitable operation and growth. Dolby also reported that the company's structure will remain essentially unchanged in other respects. **David Robinson**, senior vice president, Advanced Development, will continue to oversee the conceptualization of new products and areas of activity. **Ioan Allen**, senior vice president, Marketing, will continue to head up marketing and sales to the U.S. and Canada. **Ian Hardcastle**, senior vice president, Licensing, will continue in charge of the licensing program. **Gary Holt** will continue as managing director of Dolby Laboratories' London operation, with **Elmar Stetter** as International Marketing manager and **Bob Tallon** as Production director.

• **Restoration**, located in Van Nuys, California, has added the complete reconditioning of Ampex Series 350, AG350, and AG440 to their existing line of head refurbishment and new head sales. **Rick Olsen**, formerly of Ampex and United Western Studios, Hollywood, has been appointed chief of maintenance. Free pick up and delivery in the company's local area and scheduled pick up and delivery in the San Francisco and San Diego area is offered. Restoration will also be offering the Inovonics line of replacement electronics for updating the machines.

• The Board of Governors of the Audio Engineering Society has fixed September 30, 1983, as the date of the annual election of officers. Candidates are the following: President-elect—**Albert Grundy**, **Han Tendeloo**; Vice President-Eastern Region—**Daniel Gravereaux**, **Nancy Timmerman**; Vice President-Central Region—**David Clark**, **Richard Greiner**; Vice President-Western Region—**Robert Trabue Davis**, **Wesley Dooley**; Vice President-Europe Region—**John Borwick**, **Jacob Menger**, and Vice President-International Region—**Kunimaro Tanaka**, **Derek Tilsley**. Voting ballots will be issued August 15, 1983.

• **AEG-Telefunken Nachrichtentechnik GmbH**, which is jointly owned by **Allianz Versicherungs-AG Munich**, **Robert Bosch GmbH, Stuttgart**, and **Mannesmann AG, Duesseldorf**, has changed its name to **A N T Nachrichtentechnik GmbH**. Under the new name, the company will continue in its structure and activities. These consist mainly of multiplex, space-communication, telecommunication cable, and radiolink systems for audio communications and special communications systems.

• **Thomas E. Mintner** has been promoted to director, **Studer Products** effective August 1, 1983, according to an announcement by **Hans D. Batschelet**, president of **Studer Revox America, Inc.** In his new position, Mintner will assume responsibility for administration of the Studer Division throughout the U.S., including sales, marketing and technical areas. From 1980 to the present, Mintner has served as Broadcast Products manager. Prior to joining Studer Revox, he was with **Rupert Neve Inc.**, where he specialized in consoles and automation. Mintner is a member of the **Audio Engineering Society** and the **National Academy of Recording Arts and Sciences**.

• **Norman Kasow**, specialist in music and sound effects for the motion picture, TV, commercial and corporate industries over the past 30 years, has brought his extensive libraries to **National Video Center/Recording Studios**. Kasow's cornucopia of sounds has been heard in the classic TV sit-com *Car 54, Where Are You?*, **Woody Allen's *Sleeper***, the soon-to-be released **Mike Nichols film *Silkwood***, and in commercials for such major advertising agencies as **Doyle Dane Bernbach, Leber-Katz** and **J. Walter Thompson**. Kasow's collection boasts 45,000 sound effects in categories ranging from aircraft and animals to sports and trains. His extensive inventory of every imaginable type of stock music rounds out the library.

• **Tore Nordahl** has recently announced the formation of **Digital Entertainment Corporation**, a company formed for the purposes of exploring the opportunities available in providing equipment, systems and services for the entertainment industries within the areas of digital audio. One specific purpose of the company is to develop, assemble and market interactive digital audio storage and processing systems for professional applications within broadcasting and recording. In making the announcement, Nordahl (chairman and president of Digital Entertainment Corp.) also stated: "Currently available digital audio and computer technologies make it possible to drastically reduce the cost of a complete digital audio studio facility compared with the total cost of purchasing separate storage and processing systems from different manufacturers in today's market. Digital Entertainment Corporation's purpose is to bring the various technologies together in a comprehensive system at half of today's price. I believe we can accomplish this by mid 1984. To that end, we are presently discussing joint venture opportunities with several prominent companies." Nordahl recently resigned from his post as president and deputy chairman of **Neve**.



## Stadium Sound Fit for a Queen

• **Electro-Voice** loudspeaker clusters and microphones are featured in the sound installation in the new stadium at British Columbia Place in Vancouver, Canada, which opened June 19th. One half of the permanent system, augmented by equipment on loan from EV, was in place and played an important role in the gala ceremonies honoring Her Majesty Queen Elizabeth on March 9th.

The festivities, witnessed by 8000 school children and 30,000 invited guests, featured performances by the **Vancouver Symphony Orchestra**, the **Beefeaters Band**, two bagpipe bands, a 1000-voice high school choir, and 7000 grade school choristers, as well as addresses by the Queen and other dignitaries. The sound system also enabled the audience to hear the special messages from the Queen, carried by phone to Canadian embassies around the globe, inviting the people of other nations to visit Vancouver for Expo '86, the 1986 World's Fair.

The sound installation for the 60,000-seat stadium was specified by **Bob Coffeen of Coffeen Anderson Fricke & Associates** in Mission, KS, and installed by **C. C. Multicom** of Vancouver.

To solve the problems of the stadium's reverberant air-supported fabric roof and wide audience and stage areas, Coffeen used a version of the semi-distributed cluster system and complex network of separate mixing assemblies and audio delays. The system features 26 small EV clusters, each comprised of four HR6040A constant directivity horns and one TL606D bass loudspeaker assembly, hung at heights of 135 feet around the perimeter of the playing field. A larger central cluster, which covers the field and close-in

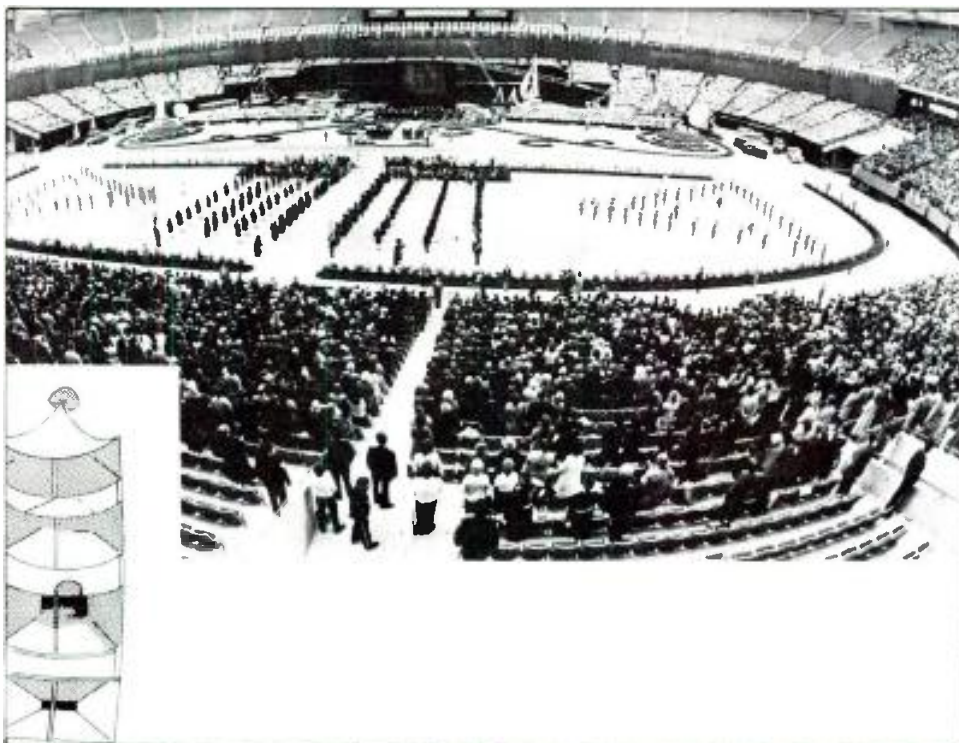

*Vancouver's 60,000-seat stadium at British Columbia Place, site of ceremonies honoring Her Majesty Queen Elizabeth in March.*

seating, can be moved up or down to a height of 45 feet (for shows) or 160 feet (for sports events). It includes 20 high-frequency horns, both HR6040A's and HR4020A's, with DH1012A drivers and 8 TL606D bass assemblies. Final plans also call for 96 100S two-way speaker systems serving the seats beneath the upper balcony which are shielded from the two other sources. Six FM12-3A stage monitors and six 315-3A stage speaker systems will be

used on stage for monitoring and front-row presence.

For the March 9th event, there were 11 different sound-distribution systems and 10 microphone mixing and sub-mixing assemblies, making for quite complicated mixing. Seventy-nine EV microphones, mostly RE11's and RE18's, were used, 43 of them on the orchestra alone, 32 on the choruses, and four on the rostrum for speakers and soloists.

## CDs On the Road...

• For those of you studio owners/engineers/producers who are not quite convinced that the day of the CD is upon us—this should be the clincher. Mitsubishi Car Audio has introduced a prototype compact disc player designed for one of America's favorite adult toys—the automobile. The unit, installed in a Mitsubishi Motors Cordia, was displayed at the 1983 Summer CES. The CD player, according to car audio division general manager Mike Hyde, will probably have a suggested retail price of \$800, and will be mounted underdash in a console configuration. He expects to have a production model ready by December, 1984.

And you thought it was tough keeping cassette decks from getting ripped out of cars! Wonder what the CD player will do to car insurance prices?

### ...Cigarettes and CDs?

• The Radiation Control for Health and Safety Act and regulations implementing it require all dealers selling products subject to the Act to maintain certain records of the sale or other disposition of each such product.

Interesting, you say, but so what? Well, the audiodisc player incorporates a semi-conductor laser and, as such, is governed by the performance standards for laser products. Therefore, companies selling or leasing CDs must keep careful records detailing information on the name and address of the customer, the product's brand name and serial number, and the date of the sale or other disposition of the product.

Can a warning from the Surgeon General be far behind?



*The prototype Mitsubishi Compact Disc player, installed in a Mitsubishi Motors Cordia.*

## That Olympic Sound

• Incorporating an extensive, all-Altec Lansing sound system, the recently opened Athens Olympic Stadium is the largest, most versatile sports facility in Greece. The 85,000-seat stadium is designed primarily for Olympic-calibre athletic games and events, and will also be used for national celebrations and similar gatherings.

The Altec Lansing sound system installed in the stadium makes extensive use of Altec Mantaray® Constant Directivity Horns arranged around the circumferences of the upper and lower seating rings. The 64 Mantarays in the distributed system are powered by Altec Incremental Power® Amplifier Systems and generate an operating SPL of 97 dB (+0, -6 dB), with a maximum SPL of 103 dB.

Altec International sound contractor for the Olympic Stadium installation is Omikron, S.A., of Athens.



# The New UREI Power Amplifiers

The UREI power amplifiers are designed to extend UREI quality from our low level signal processing all the way through to our exclusive Time Align™ studio monitors.

Careful evaluation of competitive power amplifiers indicates that while in some cases adequate reliability has been

achieved, audible performance is often marginal.

The UREI 6000 Series amplifiers offer the knowledgeable professional the reliability he demands *and* the sound quality he deserves.

Exceptionally large power supplies and exceedingly high speed, high current circuitry combine to produce low-end punch and high-end sparkle which is unexcelled in professional power amps. Moderate use of negative feedback results in fast recovery from transient overloads and avoids excessive high order harmonic distortion when the amplifier is driven into clipping.

## The Model 6500 Listening Amplifier

Two totally independent plug-in channels, removable from the front panel,

each with its own power supply and continuously variable cooling fan. Exclusive Conductor Compensation™ corrects for wire loss and transducer related load anomalies, resulting in absolutely accurate waveforms at the speaker terminals. 275 Watts per channel into 8 ohms, 600 Watts per channel into 2 ohms. Standard rack mount, 7" high.

## The Model 6300 Dual Channel Power Amplifier

225 Watts per channel into 8 ohms, 380 Watts per channel into 4 ohms. 5¼" rack space!

## The Model 6250 Dual Channel Power Amplifier

150 Watts per channel into 8 ohms, 200 Watts per channel into 4 ohms. 3½" rack space!

## The Model 6150 Dual Channel Power Amplifier

80 Watts per channel into 8 ohms, 80 Watts per channel into 4 ohms. 1¾" rack space!!

Addition the UREI Power Amplifiers at your professional sound dealer and discover how good a reliable amplifier can sound.

From One Pro to Another—trust all your toughest signal processing needs to UREI.

\*Time-Align is a Trademark of E. M. Long Assoc., Oakland, CA. All referenced Trademarks are property of, or licensed by, United Recording Electronics Industries, a URC Company.



**UREI** From One Pro To Another

United Recording Electronics Industries  
8460 San Fernando Road, Sun Valley, California 91352 (818) 767-1000 Telex: 65-1389 UREI SNVY  
Worldwide: Gotham Export Corporation, New York, Canada: Gould Marketing, Montreal H4T 1E5

See your professional audio products dealer for full technical information

IFEJ 198

# HALL & OATES CONTRIBUTE TO A MOVING EXPERIENCE.

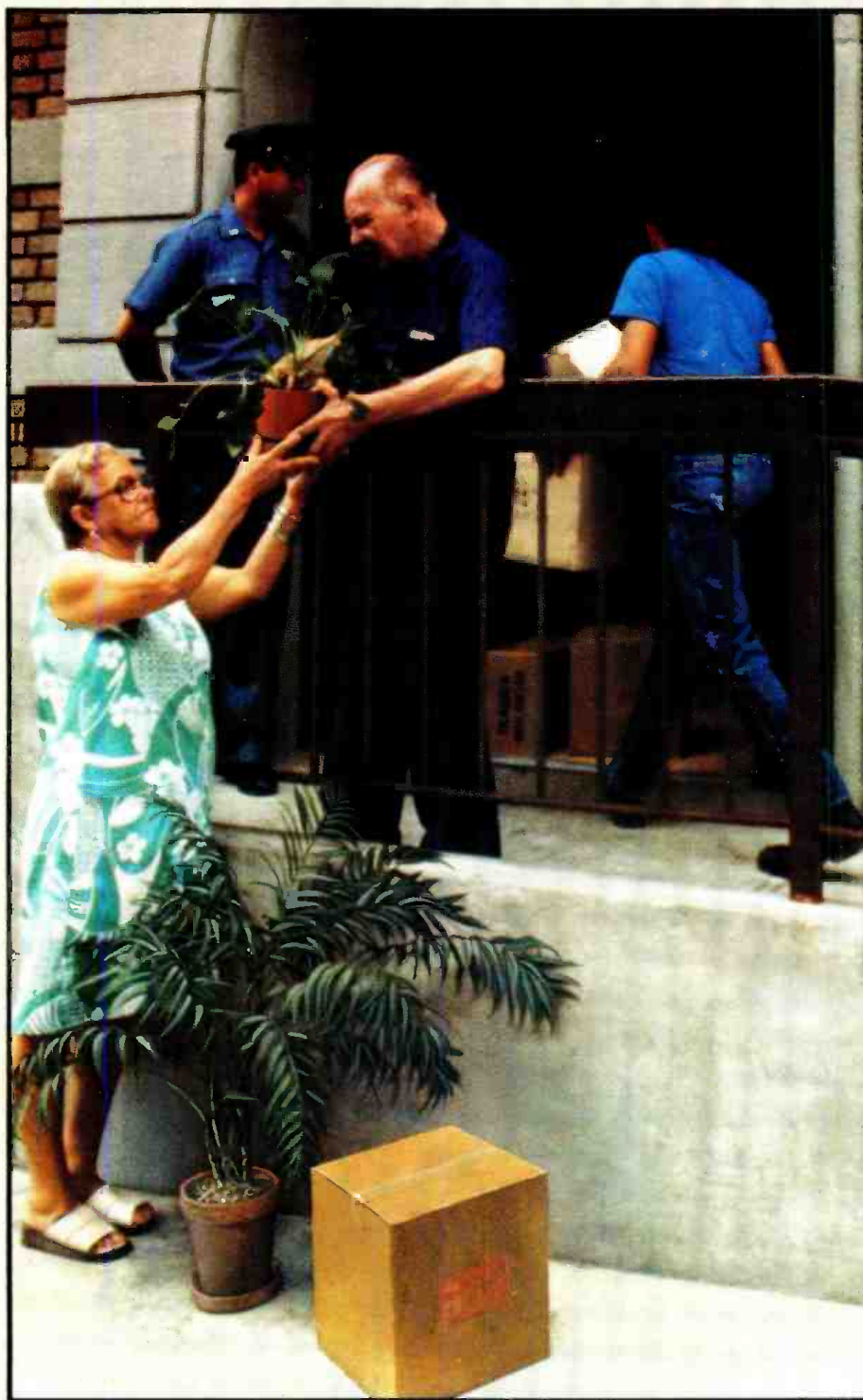

Rescuing deserted housing in the South Bronx is part of what the Erma Cava Fund is all about. Then it's turned into comfortable, affordable housing for the area's seniors.

Daryl Hall & John Oates found this ongoing project a worthy one indeed. In fact, they contributed two one thousand dollar awards to the Erma Cava Fund. And the Ampex Golden Reel Award made it possible. It's more than just another award. It's a thousand dollars to a charity named by artists receiving the honor.

For Hall & Oates, *Voices* and *Private Eyes*, were the albums, *Electric Lady* and *Hit Factory* were the recording studios, and the seniors were the winners.

So far, over a quarter of a million dollars in Golden Reel contributions have gone to designated charities. For children's diseases. The arts. Environmental associations. The needy.

Our warmest congratulations to Hall & Oates, *Electric Lady*, *Hit Factory*, and to all of the other fine recording professionals who've earned the Golden Reel Award.

## AMPEX

Ampex Corporation • One of The Signal Companies



Circle 11 on Reader Service Card