

**db**



# "Obsolete" will never apply to Mitsubishi Digital Audio Equipment.

## Mitsubishi means flexibility.

We've designed our systems with you, your budgets, and the future of the entire recording industry in mind. Mitsubishi Digital Audio Systems let you start out with basic mastering equipment and build your system as the need develops. The equipment you buy today is state-of-the-art and is designed to accommodate any improvements the future may bring. For instance, we've already greatly improved the abilities of our 2-channel recorders capabilities.

## Why choose Mitsubishi?

### Selection.

We are one of the few companies that can offer uncompromised quality and flexibility in such a wide range of PCM equipment. From 2-channel mastering to 32-channel recorders to advanced electronic editors, Mitsubishi makes them all with the quality that you demand at very realistic prices.

THE CONSOLE TYPE X80A



## Fixed Head Design.

All Mitsubishi Recorders use a fixed head design. We believe this is the link between analog and digital recording. The fixed head design makes engineering as simple as analog, allows simultaneous sound monitoring, and is much more reliable than the cassette rotary head format. The fixed head design even allows for razor blade editing, as well as sophisticated electronic editing.

Also, the fixed head design allows for a flat frequency response of up to 23 kHz (optionally) and has a more practical design than other systems. And, of course it's highly compatible with the CD digital audio disks that will be available in audio stores in the United States next year.

## System Design.

We will come to you anywhere in North America, allow you to test and evaluate this recording equipment in your own studio, and custom design



THE TRANSPORTABLE X80

a Mitsubishi PCM system for your specific needs. Immediate delivery is available on most models. Leasing programs are available and we even rent systems directly for short term projects.

## Come See and Hear the Mitsubishi Digital Audio Systems.

Stop by our booth at the AES Show and talk to our designers and system analysts. We'll be in room 699 at the Waldorf Astoria Hotel in New York, from October 30th to November 2nd.

If you can't make it to the AES show call Lou Dollenger or Sonny Kawakami, at 800-323-4216 or 312-982-9282 (within Illinois), for more detailed information about Mitsubishi Digital Audio Systems.

Mitsubishi can't be beat for sound, price, versatility, or service.

Don't even consider another PCM system 'til you've seen and heard Mitsubishi.

 **MITSUBISHI**  
**DIGITAL AUDIO SYSTEMS**

EXPERIENCE the 3rd dimension in sound.

7045 North Ridgeway Avenue, Lincolnwood, IL 60664

Circle 10 on Reader Service Card



THE SOUND ENGINEERING MAGAZINE  
NOVEMBER 1981 VOLUME 15, NO. 11

Publisher  
**Larry Zide**

Editor  
**John M. Woram**

Associate Editor  
**Mark B. Waldstein**

Advertising Production & Layout  
**Kathy Lee**

Classified Advertising  
**Carol Vitelli**

Book Sales  
**Lydia Calogrides**

Circulation Manager  
**Eloise Beach**

Art Director  
**Bob Laurie**

Graphics  
**K&S Graphics**

Typography  
**Spartan Phototype Co.**

sales offices

**Roy McDonald Associates, Inc.**  
Dallas, Texas 75237

First Continental Bank Bldg.  
5801 Marvin D. Love Freeway  
Suite 303  
(214) 941-4461

**Denver, Colorado Area**  
**Englewood, Colorado 80112**

14 Inverness Dr. East  
Bldg. 1—Penthouse  
(303) 771-8181

**Houston, Texas 77036**

6901 Corporate Drive  
Suite 210  
(713) 988-5005

**Los Angeles Area**  
**Glendale, California 91204**

424 West Colorado Street  
Suite 201  
(213) 244-8176

**Portland Area**  
**Hillsboro, Oregon 97123**

510 South First  
P.O. Box 696  
(503) 640-2011

**San Francisco Area**  
**Emeryville, California 94608**

265 Baybridge Office Plaza  
5801 Christie Avenue  
(415) 653-2122

**Sagamore Publishing Co., Inc.**  
New York

**Plainview, NY 11803**  
1120 Old Country Rd.  
(516) 433-6530

## DEPARTMENTS

LETTERS	CALENDAR	EDITORIAL	CLASSIFIED
6	10	32	78

THEORY AND PRACTICE	Norman H. Crowhurst
12	

DIGITAL AUDIO	Barry Blesser
18	

SOUND WITH IMAGES	Len Feldman
28	

NEW PRODUCTS AND SERVICES
72

NEW LITERATURE
75

PEOPLE PLACES, HAPPENINGS
80

## FEATURES

BUILDING TRES VIRGOS	Jerry Jacob and Richard Millward
36	

THE ATLANTIC STUDIOS PROJECT: A PRELIMINARY REPORT	Alan Fierstein
45	

ARCHITECTURAL DESIGN FOR STUDIO ONE SIGMA SOUND STUDIOS	Maurice Wasserman
50	

CONTEMPORARY MIXDOWN ROOM DESIGN	G. L. Augspurger
54	

RESONATORS AND REVERBERATION	Barry Hufker and John M. Woram
62	

THE MITSUBISHI XE-1 AUTOMATIC ELECTRONIC EDITOR	Lou Dollenger
67	

## ABOUT THE COVER

• This month's cover features the new control room at Sigma Studios. Thanks to Spencer Zahn for his imaginative rendering.

db, the Sound Engineering Magazine (ISSN 0011-7145) is published monthly by Sagamore Publishing Company, Inc. Entire contents copyright © 1981 by Sagamore Publishing Co., 1120 Old Country Road, Plainview, L. I., N. Y. 11803. Telephone (516) 433-6530. db is published for those individuals and firms in professional audio-recording, broadcast, audio-visual, sound reinforcement, consultants, video recording, film sound, etc. Application should be made on the subscription form in the rear of each issue. Subscriptions are \$15.00 per year (\$28.00 per year outside U.S. Possessions, \$16.00 per year Canada) in U.S. funds. Single copies are \$1.95 each. Editorial, Publishing, and Sales Offices: 1120 Old Country Road, Plainview, New York 11803. Controlled circulation postage paid at Plainview, NY 11803 and an additional mailing office.

# FitzCo SOUND, INC.

AAE "Concept One"  
Automation

AKG

AUDIOARTS ENGINEERING

BGW TANNOY

HANNAY  
(Cable Reels)

EVENTIDE

IVIE

LEXICON

SENNHEISER

TECHNICS

VEGA

WIREWORKS

*If It Sounds Good*  
It's From FITZCO

204 N. Midkiff  
Midland, Texas 79701  
(915) 684-0861

## db Letters

### TO THE EDITOR:

Re your editorial in the July issue concerning the Los Angeles AES, I can relate to your lamenting mounting travel costs; I don't attend AES conventions that aren't in L.A. The editorial recalled to me Ray Dolby's article upon assuming the AES presidency, in which he suggested reducing the number of conventions per year. Accordingly, the L.A. Section recently polled its members on this topic, and being a student member, naturally I voted for more, not less conventions.

Yes, I was one of the "tire-kickers" at the 69th; I went three days on my own and one day with my how-to-become-a-big-time-recording-engineer class (identified in the schedule of classes as "Advanced Recording Techniques," however) and was generally well-treated by the exhibitors. I remember, and no doubt will remember when I can afford to do more than kick tires at an AES, being impressed by Mitsubishi's digital equipment, the opportunity to work with several outboard devices at the dbx exhibit, the opportunity to do some mixing at the Audioarts exhibit, the many features and great specs on Allen & Heath's smaller boards, and meeting and talking with Jeff Cooper and Bob Moog.

So, to answer the questions posed at the end of your editorial, I would like *two* conventions *a year* in LA and I have no plans to attend future New York or European conventions because of, in this order, money, geography and time. Certainly not interest; I'd go to all of them if I could.

Thanks again for the opportunity to share my thoughts with you, and for the thoughtful editorial.

FARREL SVESLOSKY

## Index of Advertisers

AKG	26
Alpha Audio	23
Ampex	59, Cover III
Audio & Design	39
Audio-Technica	7
Cetec Gauss	16
Cetec Vega	18
Crown	47, 49
dbx	20
Eastern Acoustic Works	13
Electro-Voice	19
Fitzco	6
Garner	8
JBL	41-44
Kimball	14
Klark-Teknik	9
Microtran	30
Mitsubishi	Cover II
Orban	11, 22
Otari	60, 61, 63
Panasonic	34, 35
Penny & Giles	69
Pioneer	31
Polyline	28
Pro Audio Systems	30
PSI	12
RCL	72
R-Columbia Products	75
Sescom	28
Shure	15
Sound Technology	52, 53
Soundcraftsmen	57
Standard Tape Lab	58
Studer Revox	21
Swintek	17
Teac	27
Telex	29
Telex Furner	10
Tentel	68
TOA	24, 25
UREI	Cover IV
White	14
Wireworks	20
Yamaha	33

## Coming Next Month

• In December, we'll close out 1981 with a review of some of the various components that go into the studio system. We'll start with meters and work our way through sync systems and consoles to control rooms. In addition, we'll have our yearly index of authors, titles and subjects.



# 10 to 1 you'll like ours!

Every studio needs a \$1,000 microphone. It tells everyone you're serious about good sound, and it impresses the talent.

But when the session gets under way, all that counts is results. Not price tags. And judged *only* by what you hear, the new AT813 Unidirectional Electret Condenser from Audio-Technica is going to truly impress you...at about 1/10 the cost you might expect.

Recently a recording engineering class at a major university made simultaneous multi-track tapes comparing our AT813 side-by-side with some of the best microphones money can buy. The informed and critical students did the judging.

Surprisingly, in many cases they couldn't find a nickel's worth of difference. And some preferred the AT813 sound to the expensive competition.

You may agree with these student engineers when you hear the AT813. Or you may not. But at these odds, you can't afford to overlook us. And for new studios just getting underway, who can't afford a roomful of top-dollar microphones, the AT813 is an effective way to achieve full multi-mike capability. Write today for the AT813 spec sheet and A-T microphone dealer list. Then see your Audio-Technica sound specialist for great sound...right from the start.

Circle 33 on Reader Service Card



**audio-technica**  
® INNOVATION □ PRECISION □ INTEGRITY

AUDIO-TECHNICA U.S., INC., 1221 Commerce Drive, Stow, Ohio 44224 • In Canada: Audio Specialists, Inc., Montreal P.Q.

[www.americanradiohistory.com](http://www.americanradiohistory.com)

**Now you hear it...**

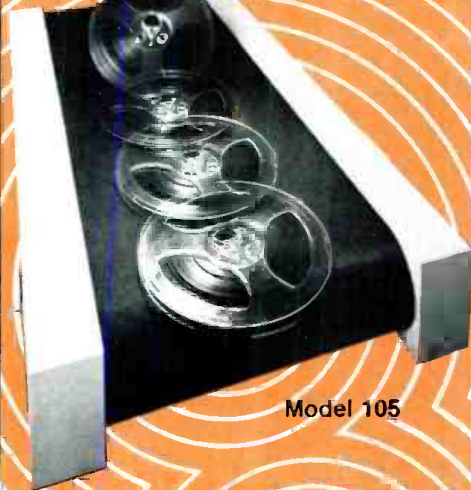

Model 105

**Now you don't.**

The Garner Audio Tape De-gaussers are truly the most flexible and thorough audio tape erasers available. With them, you can erase cassettes, reels, and cartridges in just four seconds. And, we guarantee that your erasure will meet the most stringent recording standards. It really is a case of "Now you hear it... Now you don't."

**garner**

**GARNER INDUSTRIES, INC.**  
4200 No. 48th St., Lincoln, Nebraska 68504  
Phone (402) 464-5911

**There's more to hear...**

Just write Garner Industries for more information:

NAME \_\_\_\_\_  
TITLE/POSITION \_\_\_\_\_  
COMPANY \_\_\_\_\_  
ADDRESS \_\_\_\_\_  
CITY \_\_\_\_\_ STATE \_\_\_\_\_ ZIP \_\_\_\_\_

Circle 32 on Reader Service Card

TO THE EDITOR:

I was reading your article, "The Mathematics of the Microphone," not because I enjoy math and theory but rather work was slow and the only thing I had to do was rearrange my files. Mic theory has always eluded me and I tend to be a "move it around until it sounds good" type. I was enjoying the article until I came to the computer calculus section. I disliked my calculus courses and passed it off as organized black magic, but your article used a computer program to solve the integral calculating REE. I dislike messing around with computers even more.

Grabbing up my trusty (and rusty) table of integrals, I dived in and came up with a fairly simple result. The listed equation for a first order microphone is:

$$REE = 0.5 \int_0^{\pi} (A + B \cos \theta)^2 \sin \theta \partial \theta$$

algebra yields:

$$REE = 0.5 \int_0^{\pi} [A^2 \sin \theta + 2AB \cos \theta \sin \theta + B^2 \cos^2 \theta \sin \theta] \partial \theta$$

and when the smoke clears:

$$REE = \int_0^{\pi} [-1/2 A^2 \cos \theta + 1/2 AB \sin^2 \theta - 1/3 B^2 \cos^3 \theta]$$

where one evaluates the bracketed equation at  $\pi(180^\circ)$ , then at 0, and subtracts the 0 value from the  $\pi(180^\circ)$  value. Plugging in your values for A and B listed under the Polar Equation Summary, I got identical values for REE (except for supercardioid where REE = 0.271). Eureka! It works.

Feeling intrepid, I decided to tackle second order.

For second order:

$$REE = 0.5 \int_0^{\pi} [(A + B \cos \theta) \cos \theta]^2 \sin \theta \partial \theta$$

after integrating:

$$REE = \int_0^{\pi} [-1/6 A^2 \cos^3 \theta - 1/4 AB \cos^4 \theta - 1/10 B^2 \cos^5 \theta]$$

Not having any proven numbers to plug in, I'm not as certain that it is correct. But it should be.

Perhaps you could pass these equations on to the readers for those who do not have, or do not want, access to a computer.

All of this quasi-mathematics and qualified conjecture brings back to mind a battle cry once raised in one of my classes, "Damn the theory—just give me the plug!"

GEORGE ERNEST

**This publication is available in microform.**

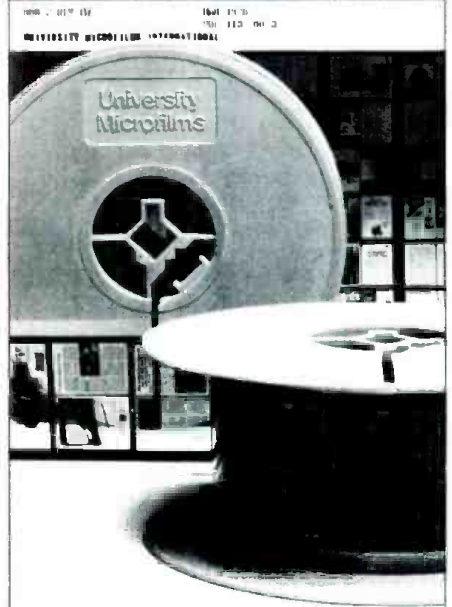

**University Microfilms International**

Please send additional information for \_\_\_\_\_  
Name \_\_\_\_\_  
Institution \_\_\_\_\_  
Street \_\_\_\_\_  
City \_\_\_\_\_  
State \_\_\_\_\_ Zip \_\_\_\_\_

300 North Zeeb Road Dept. P.R.  
Ann Arbor, Mi. 48106 U.S.A.  
30-32 Mortimer Street Dept. P.R.  
London W1N 7RA England

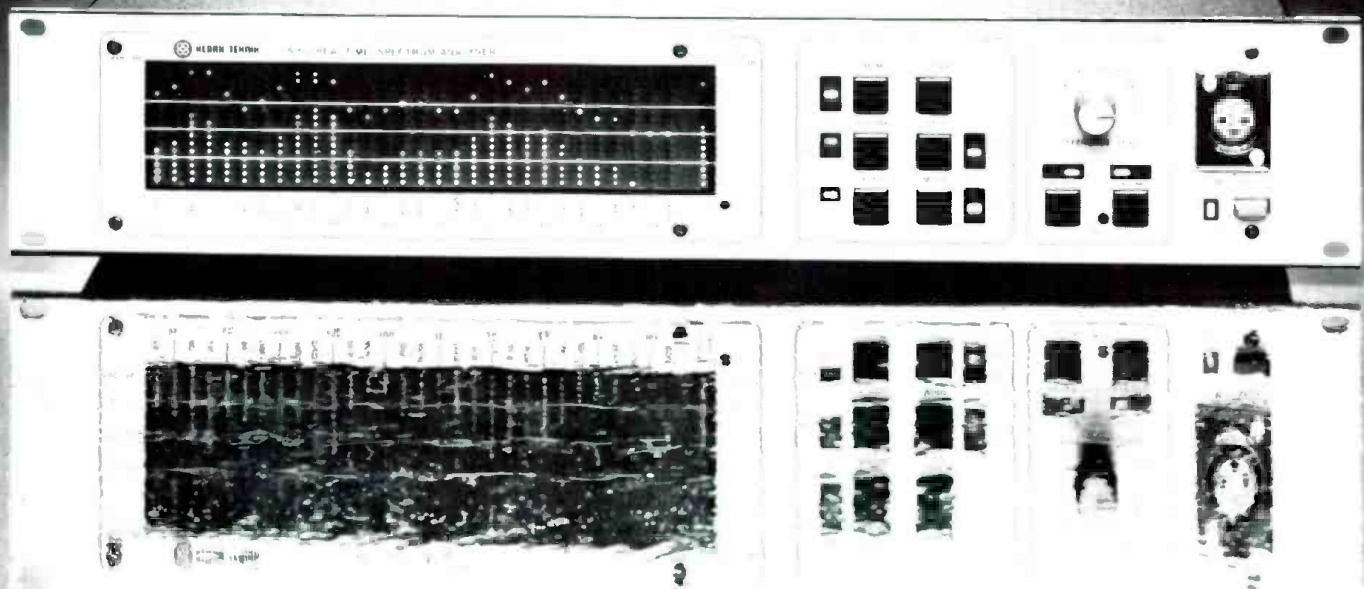

# "REFLECTIONS OF YOUR SOUND JUDGEMENT"

The "DN60 REAL TIME ANALYSER" is the heart of a new audio measurement system from the engineers at KLARK-TEKNIK and is the perfect compliment to the new DN27A Equaliser shown below. Using Micro-Processor based circuitry, the DN60 is capable of performance checks on virtually any audio equipment, and is especially well suited for aligning audio tape recorders. On-site performance verification, whether of a 10,000 seat arena, or a studio control room, is easily facilitated with the DN60; and is an excellent method of building your customer's confidence.

If you're a recording or broadcast studio, include the RT60 Option and provide quick and accurate alignment for your reverberation systems (plates, springs, digital). The DN60 incorporates a pink noise source internally, and occupies only 3 1/2" (2U) in a standard 19" rack.

If you take your sound on the road, the DN60 can help make that 5 p.m. sound check go easy, leaving enough time for a quick dinner before showtime. With the inclusion of Three Memories, and a Peak-Hold function, you can expand the scope of your sound check, and provide that extra edge of excellence.

The DN60 is Micro-Processor technology at a price you will like.

Other useful features include:- "A" Weighting, Average or Peak Reading and Selectable Response Time.

DN60 Options:- • Calibrated microphone  
• RT60 (Reverberation time) package • X/Y Plotter and oscilloscope interface • Dot matrix printer interface.

Now complete your system with the new DN27A 1/3rd OCTAVE EQUALISER and quickly adjust your sound to perfection.

The new DN27A is the successor to the DN27, acclaimed world-wide as the industry standard in graphic equalisation. New features include improved headroom, earth lift facility and fail-safe system bypass plus the legendary reliability and performance of it's predecessor.

Please contact us and get our DN60 and DN27A data sheets and related literature.

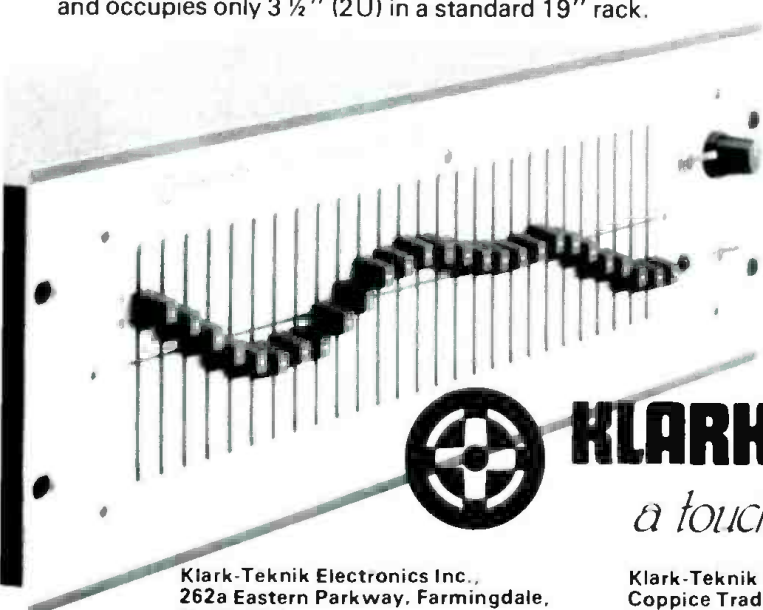

**KLARK-TEKNIK**  
*a touch of class*

Klark-Teknik Electronics Inc.,  
262a Eastern Parkway, Farmingdale,  
N.Y. 11735.  
☎ (516) 249-3660.

Klark-Teknik Research Ltd.  
Coppice Trading Estate, Kidderminster,  
Worcs. DY11 7HJ England.  
☎ (0562) 741515 Telex: 339821

✂

Name .....

Company .....

Address .....

Phone ( ) .....

I'd like more information on:

EQ's  Delays  Analysers  Effects

I'd like to contact my nearest distributor

# Desk Paging?



# Turner has More!

Turner desk paging microphones allow the audio professional more flexibility in choosing the right microphone for each installation. A minimum amount of electronic modification is required because Turner has engineered its products to meet virtually all applications. Twelve distinctly different microphones in two desk-top case styles. There is a quality Turner desk paging microphone with features to meet the following applications requirements:

- Omnidirectional • Low Impedance • Normally Open Switching
- Normally Closed Switching • High Impedance • Zone Paging
- Cardioid • Noise Cancelling • Press-To-Talk • Lift-To-Talk
- Amplified.

And, that's only the beginning. Turner has 13 other paging microphones in gooseneck, handheld and wall mount versions, as well as a full line of sound reinforcement microphones. Turner does have more, and now, with the additional product development strength of Telex Communications, Inc. there will be even more to come.

## Quality Products for The Audio Professional



**TELEX** **TURNER**

TELEX COMMUNICATIONS, INC.

9600 ALDRICH AVE. SO. MINNEAPOLIS, MN 55420 U.S.A.  
EUROPE: 22 rue de la Legion-d'Honneur 93200 St. Denis France

Circle 40 on Reader Service Card

### NOVEMBER

- 12-15 **Billboard Magazine's 3rd Annual Video Entertainment/Music Conference.** Beverly Hilton Hotel, Los Angeles. For more information contact: Ms. Chris Soffley, Billboard Conference Bureau, 9000 Sunset Blvd., Los Angeles, CA 90060. Tel: (213) 273-7040.
- 17-19 **Syn-Aud-Con Classes.** Orlando, Florida. For more information contact: Don Davis, Synergetic Audio Concepts, P.O. Box 669, San Juan Capistrano, CA 92639. Tel: (800) 854-6201.
- 25-27 **Prosound '81 Professional Sound Equipment Exhibition.** West Centre Hotel, London. For more information contact: Batiste Exhibitions & Promotions, Pembroke House, Campsbourne Road, London N8. Tel: 01-340-3291.

### DECEMBER

- 1-3 **Syn-Aud-Con Classes.** Dallas, Texas. For more information contact: Don Davis, Syn-Aud-Con, Box 669, San Juan Capistrano, CA 92693. Tel: (800) 854-6201.

### FEBRUARY

- 24-26 **Electro-optics, fiber optics and lasers for non-electrical engineers.** Given by George Washington University, Washington, D.C. For more information contact: Director, Continuing Engineering Education, George Washington University, Washington, D.C. 20052. Tel: (800) 424-9773.

### MOVING?

Send in your new address promptly. Enclose your old db mailing label, too.

Write to:

Eloise Beach, *Circ. Mgr.*  
db Magazine  
1120 Old Country Rd.  
Plainview, N.Y. 11803





# The First Family Of Audio Processing

## 111B Dual Spring Reverb

The most cost-effective spring reverb on the market

## 245E Stereo Synthesizer

Convincing pseudo-stereo from any mono source

## 418A Stereo Compressor/Limiter

Smooth, undetectable level and high frequency control in recording and broadcast

## 526A Dynamic Sibilance Controller

Clean, inaudible de-essing of vocals with consistent action regardless of levels

## 622B Parametric Equalizer

An exceptionally versatile EQ which has become the standard in studios, broadcast, and road shows

## 672A/674 Equalizers

A Parametric EQ with graphic controls, including variable high and low-pass filters usable as an electronic crossover (mono or stereo)

Orban Pro Audio Products are sold through a worldwide dealer network. Call or write for the name of the dealer nearest you.

**orban**

Orban Associates Inc.  
645 Bryant Street  
San Francisco, Ca. 94107  
(415) 957-1067



Circle 44 on Reader Service Card

**humanized**

**AUDIO LEVEL DISPLAYS . . .**

- Selectable PPM or VU mode.
  - 3 LED colors with brightness tailored to level to provide excellent peripheral vision monitoring.
  - Calibration and brightness unaffected by supply voltage from 10-35 VDC (single or bipolar supply).
  - CLIP indicator (supplied option), flashes whenever any peak exceeds threshold you have set (PPM or VU mode).
  - PPM mode captures all positive or negative peaks up to 22KHz half sinusoid.
  - Permanent  $\pm 0.3$ dB midband accuracy,  $\pm 0.5$ dB, 18Hz - 22KHz, 47K ohm balanced or unbalanced input.
  - Mountable in standard card cage or your own panel.
- Custom OEM versions available.



- 2-, 8- and 16- channel versions available in enclosures with power supplies.

**... AT A PRICE YOU CAN AFFORD**

- **MODEL ALD-12 (shown)**
- **\$97.00 each; discounts for quantities above 9.**
- **Prices good thru Dec. 81**

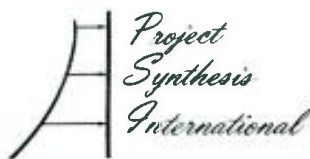

500 Hidden Valley Road  
Grants Pass, Oregon 97526  
(503) 474-2192

**Biological Inter-relationships**

● Recently we commented on an established fact that should be of interest to the audio pro: a noise signal, piped to a patient's ears while he is undergoing dentistry, can serve as an almost unbelievably effective anesthetic. If you've ever had a tooth drilled without benefit of anesthetic, or where the anesthetic "wasn't working," you know how severe the pain can be. It seems incredible that a simple noise signal in a pair of headphones should render you incapable of feeling such intense pain. Yet this, we are assured, has been proved.

If you've ever been involved in an accident where you had multiple injuries, you have probably experienced a situation where, for example, you were unaware your elbow was hurt, because of the much worse hurt to your knee. The pain from the injury to your knee "masked"—to use an audio term—the pain signal from your elbow. And we all know about masking in audio, even though we are seldom directly conscious that it occurs.

But for an innocuous noise, received in a pair of headphones, to completely mask the sensation of pain from a dentist working on your teeth seems extra incredible. Loud rock might do it, you'd think, but just a simple, not-too-loud noise signal? That doesn't seem to fit the principle that the brain pays attention to the "stronger" signal, does it?

Perhaps a line from a widely-acclaimed beer commercial here in the Northwest can be adapted here. The line is, "Well now, where are you going with all that beer?" We think of both pain and loudness in terms of physical intensity. It's a very bad hurt, or a sound that is unpleasantly loud (unless you happen to like it that way). But now, talk to a neurologist. Where is that intense pain perceived? Where do you hear that overload sound? Or, where are you going

with all that pain (or sound)?

Your subjective impression is that the pain is in (for example) your knee. The message is conveyed to your brain that the intense pain you "feel" is located in your knee. When the doctor does something to your knee, that seems to affect the pain you feel, confirming that belief. But, a person whose leg has actually been amputated may still think he feels pain *in* the leg, even though it's missing! Do you see what all this means?

What you really "feel" is an illusion, perceived in your brain as being wherever you think it is, but conveyed there by the vast network of nerves in your body. Neurologists have documented how these nerves transmit their "signals." It's really quite simple; nothing like an electrical circuit containing different voltages, currents and frequencies. A nerve just conveys simple impulses of rather simple waveform, and with not very much variation in amplitude, because the impulses are triggered along the fiber like a succession of relays.

So what makes feeling differ, from something you are not quite sure you can feel, up to something that causes pain you would describe as anguish? What makes the intensity of sound, or the impression it conveys, vary over a range representing a physical intensity ratio of  $10^{12}$ , or 120 dB? Why is the illusion conveyed almost precisely logarithmic? We can see why it has to be, to accommodate such a range, but why is it? what makes it that way?

Hearing nerves don't convey sound waves, or even audio frequency currents, and optic nerves don't convey light waves, or the frequencies associated with them. All nerves convey the same kind of impulses. What those impulses are perceived as depends on the receiving centers at the brain. So what influences the apparent severity perceived? If you think about this you realize that, while

26"   
 10 3/8"



**This domed midrange**



**makes MS 300 the monitor choice for the '80s**

EAW's exclusive MR 52 direct radiator delivers polar response far superior to any horn. The MS 300 offers flatter amplitude response than any other world-class monitor system, and its high bandwidth, and low distortion at high SPLs set new precedents that leave horn-based systems out of the competition. Check these specs:

- Midband polar response at -3 dB points, horizontal and vertical. .... 140°
- Frequency passband -3 dB ... 35-19,000 Hz   
 ± 1 dB ... 50-15,000 Hz
- THD at 100 dB SPL ..... < 1%
- Efficiency (output at 1 meter with 1 watt input) ..... 94 dB SPL
- Maximum operating level ..... 117 dB SPL

Compare the MS 300 to the monitors you now use; then, tell us when you'd like us to deliver your MS 300 monitors for the '80s. If you'd like to read performance before you hear it, circle reader service number or call us for complete information.



**Eastern Acoustic Works, Inc.**

59 Fountain Street,

Framingham, MA 01701 USA (617) 620-1478

**Available in Florida from Harris Audio Systems—Miami (305) 944-4448**

Circle 21 on Reader Service Card

# SPECIFY EXCELLENCE!

from the company who pioneered equalization

- **ACTIVE AND PASSIVE EQUALIZERS**

18 different Models to choose from

- **REAL TIME ANALYZERS**

Octave Band, one-third and one-sixth octave

- **BI-AMP AND TRI-AMP CROSSOVERS**

Low-level at any frequency and slope

- **NARROW BANDWIDTH NOTCH FILTERS**

Control of room feedback and ring modes

- **CUSTOM FILTERS FOR AUDIO APPLICATIONS**

High-pass low-pass band-pass notch

**SEND FOR OUR COMPLETE PRODUCT CATALOG**



INSTRUMENTS, INCORPORATED  
P.O. BOX 698  
AUSTIN, TX 78767  
(512) 892-0752

Circle 34 on Reader Service Card

## More and more recording studios are discovering the great sound of the Kimball Professional Grand.

### Here's why:

The Kimball 6'7" Professional Grand derives its heritage of greatness from the world's finest piano—the Bösendorfer. The scale and plate design are derived from the Bösendorfer Model 200, and the plate is extra thick to assure maximum sustain and to avoid plate noise from hammer strikes. The Bösendorfer-derived scale and non-duplexed trebles enhance tonal depth, clarity, and pitch perception. The Kimball Professional Grand is specifically designed for clear, pure tonality, free of spurious noise and false harmonics. It also offers superior durability and tuning stability. Its entire structure, including the soundboard, is of precision-laminated woods, greatly reducing differential expansion in changes of temperature and humidity.



For more information about the Kimball Professional Grand, contact Wade Gray at (812) 482-1600. See us at AES in New York, Booth 117 (Bösendorfer in Room 622).



Circle 13 on Reader Service Card

sensory nerves are responsible for conveying information to the brain, they do not act alone; the motor nerves are involved as well. When pain telegraphs its message to the brain, motor nerves are involuntarily activated to activate muscles, whose purpose is to protect the body or to alleviate the problem causing the pain.

In the auditory system, a loud sound decreases the sensitivity of the analog part of the ear to enable the same sensory system to still handle it. In the optical system, a change of lighting intensity, such as when you drive from bright sunlight into a dark tunnel, activates the mechanism of the eye, to increase its "aperture."

The sensory capacity of the eye and the ear may have a range exceeding that of the best camera film or audio equipment, as can be seen by comparing the contrast that can be recorded on film with what the normal eye can see. Or, consider the instantaneous dynamic range of the ear when listening to a large orchestra where all the instruments are playing at once. But impression of either light or sound intensity must also be affected by the motor-nerve "commands" that serve to operate our physical AGC control.

Modern communications are moving from electrical circuitry and multiplexing, to the use of optical fibers and transmission, with infinitely more channel capacity over what amounts to a single "conductor" (optical fiber). They achieve this by the equivalent of multiplexing. Digital, as used in scientific equipment, including audio, uses a similar device: the digital code is time-sequenced (the equivalent of multiplex) over a single conductor or channel.

The human nervous system (as well as that of other animals) is digital. It may to an extent use time sequencing, in that repetitive impulses along the same nerve fiber mean something different from a single pulse, and also the rate at which pulses are repeated is part of the significance conveyed. But this is not sequencing, or multiplexing in the same sense that we use in scientific equipment, where timing or frequency are precise and decoding of information along a single channel is a vital element of the system. The relatively slow transmission speed along human or other animal nerves would preclude anything like our scientific process in the animal equivalent.

So the brain receives digital impulses along an infinitely greater number of "channels"—individual nerve fibers. While timing and repetition rate of impulses along different fibers is undoubtedly an important element in the "intelligence" conveyed, the timing is a correlation between arrival times along a great many different fibers, rather than critical relative timing of pulses along the same single fiber, or channel. There lies a fundamental difference.

# Twice again: Shure sets the standard for the industry!



## Introducing two new microphone mixers

Ten years ago—with the introduction of the M67 and M68—Shure set the standards of the industry for compact, portable micro-

phone mixers. Shure is now introducing two new mixers with features and improvements that will make them the *new* industry standards.

**NEW**

### M267

**For Professional Broadcasting**  
Both TV and Radio—in the studio and for remote broadcast applications.

**For Professional Recording**

**For Professional Sound Reinforcement**

For more complex public address systems.

**With all these new features:**

- Switchable, fast-attack limiter
- LED peak indicator
- All inputs switchable for mic or line
- Simplex power
- Greater headphone power
- Built-in battery supply
- Lower noise
- Reduced distortion

...and all of the famous M67 original features.

**NEW**

### M268

**For Public Address and Paging**  
In hotels, schools, churches, community centers, hospitals, etc.

**For the Serious Tape Recording Enthusiast**

**As an Add-On Mixer for Expanding Current Equipment**

**With all these new features:**

- Lower noise
- Dramatic reduction in distortion
- Mix bus
- Automatic muting circuit
- Simplex power

...and all of the famous M68 original features.

Both new models include the same ruggedness and reliability that have made the M67 and M68 the top-selling mixers in the industry.

For complete information on the M267 and M268 send in for a detailed product brochure (ask for AL669).

The Sound of the Professionals®



Shure Brothers, Inc., 222 Hartrey Avenue, Evanston, IL 60204

In Canada: A. C. Simmonds & Sons Limited

Manufacturers of high fidelity components, microphones, sound systems and related circuitry.

Circle 36 on Reader Service Card

# Know the difference between 1 and 2 spiders?



Sound like the latest joke? If you get caught with a one spider loudspeaker in a professional performance, the joke may be on you.

Single spider loudspeakers are what those other manufacturers make. Gauss makes only double spiders.

We direct wind voice coil wire onto a center former to prevent separation from the tube. Then we attach the tube to the frame with two spiders and route the voice coil leads from the terminal to the tube between the two spiders. This provides continual "active centering" of the voice coil and prevents "hang up" and lead break off. Even when driven out of the voice coil gap by some sonic accident, the double spider assembly maintains voice coil alignment. This process costs more but provides greater cost effectiveness.

With two spiders, you can drive a Gauss to its limit—with your sound, at any level, all night long—and still be in the music business.

## gauss

Your reputation's worth it.

**Cetec Gauss** 9130 Glenoaks Blvd. Sun Valley, CA 91352

And although the information is conveyed in this rather different digital manner, perception appears to be essentially analog. What we feel, hear or see, is the cumulative effect of a great many digital impulses received along a very large number of nerve fibers. We have no perception of the individual impulses.

The fact that noise, which uses up a wide portion of the auditory nerve, albeit in a manner which does not convey the impression of pain, can "blank out," or mask a pain signal from the mouth region, combined with observations about being able to exercise selectivity in our hearing, suggests that the anesthetic effect could be due to the amount of information being "processed" by the brain under that combination of circumstances.

Our ability to consciously pay attention to certain sounds, while ignoring others of apparently equal intensity, shows that the processing center in the brain must achieve this. The aural transducer we call the ear is essentially analog. It has no way of rejecting certain sounds and selecting others. Such selection must take place at the other end of the auditory nerve.

The sounds concerning which we can be selective often contains the same, or at least overlapping, frequencies. So the selection must take place by using a far more analytical process than a simple wave analyzer uses. For instance, if you are listening to one person's voice in a crowded room where many people are talking, your hearing faculty in some way "latches onto" the characteristics of that person's voice, eliminating, or at least reducing to a point of relative non-interference, all the composite spectra from other voices, received at the same time.

Has anyone produced electronic or other scientific equipment with such a capability? If any reader knows of such a device or development, we would be pleased to learn about it.

For the future of audio, we need to think what all this means to us. The mechanism in the ear is not essential to hearing, as evidenced by the fact that bone conduction can be used when the ear is defective. But bone conduction must use the transducer part of the "inner ear," including the cochlea. Bone conduction does not transmit directly to the auditory nerve. And the fact that the sound perceived by bone conduction is different from that perceived by a good ear, shows that the mechanical coupling to the transducer makes a difference.

But so far, anything recognizable as sound must send its message to the brain via the transducer at the other end of the auditory nerve that we call the cochlea. Is it possible to make an artificial cochlea? Some of its characteristics have been duplicated experimentally, but a biological cochlea is one organ that, to the best of our knowledge, man has thus far been unable to duplicate.

However, it may be profitable to think about how it functions. For any specific frequency, a certain fiber or fibers (according to intensity) of the basilar membrane is/are excited. Transmission of nerve impulses is initiated by the hair cells, which means that impulses will be transmitted to correspond with a certain phase of the fiber's cyclic movement, commencing with the first time that phase is reached in the movement.

Now, if you regard each fiber as equivalent to a band-pass circuit, or transformer, the precise tuning point for that fiber will produce a response in phase with the driving force. A lower frequency will produce movement that is somewhat less than that due to the precise frequency, and also that leads in phase, while a higher frequency will also produce less movement, but in a lagging phase.

Now consider the action due to a single frequency whose intensity is sufficient to excite movement in a whole band of fibers of the basilar membrane. Those for higher frequencies (nearer the windows) will lag the stimulus, while those for lower frequencies (nearer the end of the helix) will lead the stimulus. Transmission time in the fluid will be fast enough so that difference in timing will be due to difference from precise resonance, rather than to the time taken for the vibration to travel up the helix. So the interpretive faculty will be able to judge the phasing and the intensity of any single frequency signal reaching each ear very precisely. It will also be able to make comparisons between signals received by both ears.

And, just as the interpretive faculty coordinates impulses received from a band of fibers near the same frequency, it will include information from fibers located at frequencies corresponding with overtones or harmonics of that frequency, and between signals received by each ear at all of these frequencies. Thus it receives an enormous amount of digital, or impulse information, very precisely timed, from which to "put sounds together," either as to direction, or simply as being part of the "same sound."

## Copies of db

Copies of all issues of **db—The Sound Engineering Magazine** starting with the November 1967 issue are now available on 35 mm. microfilm. For further information or to place your order please write directly to:

**University Microfilm, Inc.**  
300 North Zeeb Road  
Ann Arbor, Michigan 48106

# Swintek®

## has it. NOW!

### Mark 200 Full Duplex Communicators Systems

Specifically designed to provide Continuous Closed-Circuit Wireless headset intercommunication for industrial or reinforcement sound market. This can be a telephone-type network between a football coach and his spotter or behind-the-scenes voice link between a show director and his sound, lighting and stage crews. In industrial plants, such a system keeps continuous contact between production control and a worker in a hazardous or high noise environment.

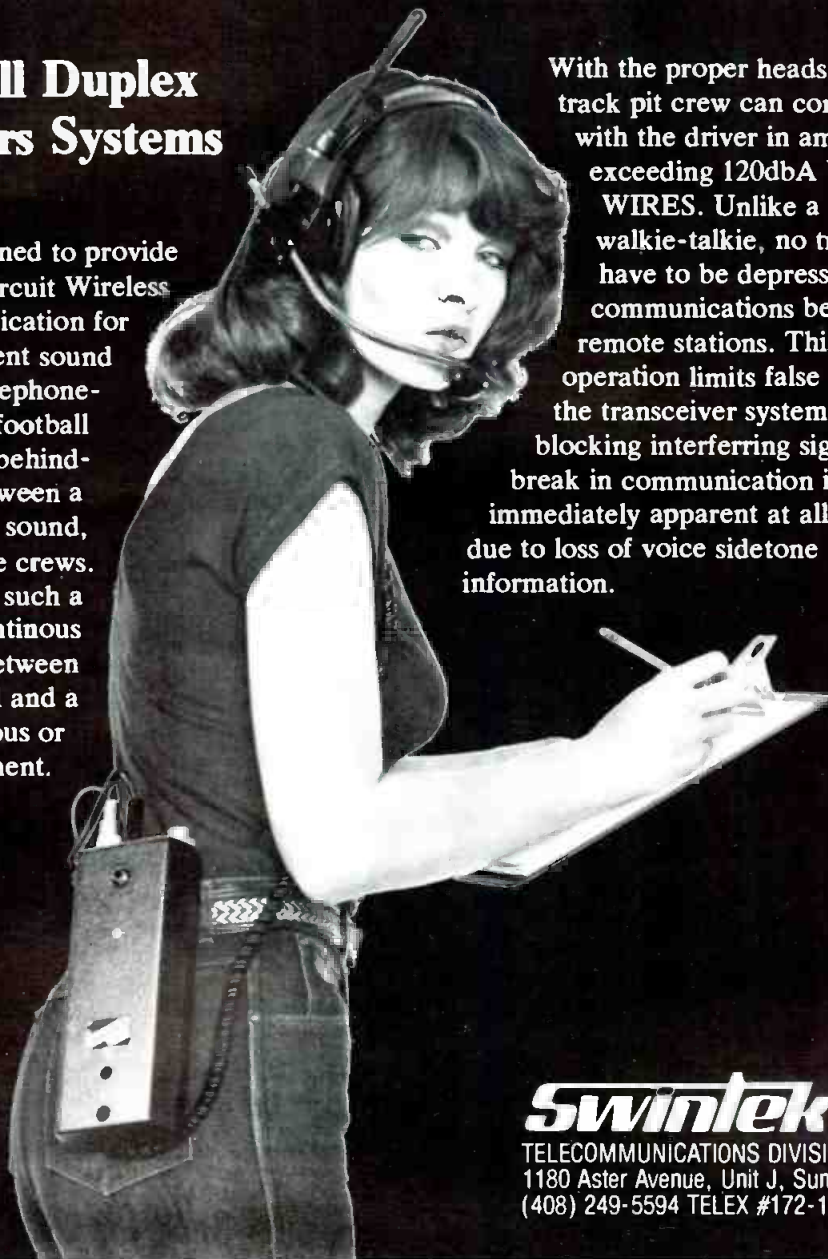

With the proper headsets a race track pit crew can communicate with the driver in ambient noise exceeding 120dbA **WITHOUT WIRES**. Unlike a conventional walkie-talkie, no transmit buttons have to be depressed to establish communications between two remote stations. This mode of operation limits false triggering of the transceiver system, thus blocking interfering signals. Any break in communication is immediately apparent at all stations due to loss of voice sidetone information.

**Swintek®**

TELECOMMUNICATIONS DIVISION  
1180 Aster Avenue, Unit J, Sunnyvale, CA 94086  
(408) 249-5594 TELEX #172-150 SUVL SWINTEK

Circle 29 on Reader Service Card



### The Professional's Choice in Wireless Microphones

- Wide frequency response
- Low noise and distortion
- Latest companded technology
- Built-in level indicator
- VHF high band for less interference
- Attractive, non reflective finish

 **Cetec Vega**

Division of Cetec Corporation

P.O. Box 5348 • El Monte, CA 91731  
(213) 442-0782 • TWX: 910-587-3539

## Correcting Bit Errors

### ORIGIN OF ERRORS

• In ordinary digital circuits, bit errors are assumed to come from hardware defects and so the appropriate action is to fix the defective components. Since digital logic always produces the same output for the same inputs, errors must come from dead components. Noise and bandwidth errors are minimal since the connections are just a few inches of wire. If there is excessive noise it is usually traceable to poor printed circuit layout, bad grounds, inadequate power supply bypass, etc.

With digital storage and transmission, however, the medium is often limited in its performance because the design engineer pushes that medium to its limit. With the digital audio disk, for example, the more bits that can be placed on the record, the more music can be recorded. This leads to packing as many bits as possible. Similarly with transmission, the more bits, the more efficient the use of the medium. Hence, the limitations of the medium play a role. Small physical defects are extremely large when compared to the size of a bit.

A digital tape recorder would not be interesting if the recording process had only 100 bits/inch along the tape. Stereo audio generates on the order of  $10^6$  bits/second or on the order of  $10^8$  bits/hour. At 100 bits/inch, we would need 20 miles of tape to record an hour-long stereo program on a single digital track. For this reason, one must push the packing density to the limits; currently on the order of 40 to 100k bits/inch. At such densities, the bit errors become excessive.

Thus the survival of digital audio requires some way to correct the errors. Our robust digital signal is actually quite fragile and relatively easy to destroy. The very attraction of digital audio is some-

what more problematic when we consider these aspects of the real world. However, there is a solution based on redundancy.

### REDUNDANCY

If the concept of redundancy seems difficult, think of it as "excess" information. Consider the following examples using the head and tail side of a coin. Take one coin (i.e., one bit of information); if we drop the coin, the information is lost. Now suppose we start with three coins and make all three coins carry the same single bit of information. This means that all three are heads or all three are tails. Now suppose we drop one coin. The other two are still left to carry the information. If the receiver of the three coins saw them as HHT, he would know that the information was H (heads) and that one of the three was dropped. This redundancy can correct for 1 coin (bit) error in three coins. If two coins had been dropped and both changed state, the algorithm would break down and the correction would no longer work. When the receiver gets HTT, he assumes the original pattern was TTT and that the first coin was dropped. A two-coin error is not correctable.

We can try to extend our error-correction ability by using four coins. However, if the receiver now gets HHTT, we would know that at least two coins were in error but not which two. The original pattern might have been HHHH with the last two being in error, or it could have been TTTT with the first two in error. So, although we've detected a two-bit error, we can't correct it. We say that this code has one-bit correctibility and two bits of detectability. The more bits of transmission capacity that are used to represent a single bit of information, the more redundancy. The first example had



# EVM™ by Electro-Voice

## The low-frequency loudspeaker

Electro-Voice EVM™ Series II loudspeakers represent the ultimate in maximum efficiency, low-frequency speaker design. Years of experience, testing and refinement have resulted in a series of loudspeakers that are ideally suited for professional high-level, high-quality musical instrument and sound reinforcement systems.

Series II speakers incorporate many unique and innovative refinements that result in a loudspeaker that combines incredibly high power handling capability, efficiency and mechanical durability. All EVM's are conservatively rated at 200 continuous watts per EIA Standard RS-426A. This procedure is substantially more stringent than the more common continuous or "RMS" sine wave test, because it provides not only a 200-watt long-term stress (heat) but also duplicates mechanically demanding short duration program peaks of up to 800 watts which can destroy speaker cones and suspension parts.

EVM's are the ideal speaker for vented and horn-type enclosures. They are also featured in Electro-Voice's TL line of optimally-vented low-frequency systems. TL enclosure builder's plans are also available for custom construction, and each EVM data sheet contains the Thiele/Small parameters which allow you to predict the large and small signal performance in vented boxes.

For these and other reasons, not the least of which is an unmatched record of reliability, EVM's have been universally accepted by sound consultants, contractors and touring sound companies. When specifying a low-frequency loudspeaker, there really is no other choice. EVM - by Electro-Voice.



600 Cecil Street, Buchanan, Michigan 49107

In Canada:  
Electro-Voice, Div. of Gulton Industries (Canada) Ltd.,  
345 Herbert St., Gananoque, Ontario K7G 2V1.

Circle 45 on Reader Service Card

**ALL NEW,** We took an industry work-horse—the dbx Model 160 **WITH**—and made it even more versatile. We gave it Over Easy® so you can choose **OVER EASY** soft knee or hard knee compression **TOO.** at the touch of a button. We've also made it strappable for dual channel compression. **\$420.\*** Added dual LED meters, Infinity +™ compression, and the provision for a Jensen output transformer. And, we've put it all into a new slim-line rack mount package with phone jack and barrier strip connectors. Voila! The new Model 160X. See your dbx Pro dealer, or write for information.

\*Manufacturer's suggested retail price.



Model 160X Compressor/Limiter

dbx, Incorporated, Professional Products Division,  
71 Chapel St., Newton, Mass. 02195 U.S.A.  
Tel. (617) 964-3210, Telex: 92-2522. Distributed in  
Canada by BSR (Canada) Ltd., Rexdale, Ontario.



Circle 22 on Reader Service Card

# wireworks

the source for  
all your cabling needs

- microphone multicable components group ● coaxial cables ● audio/video multicables ● microphone cables ● microphone multicables ● microphone splitting systems ● te-2 cable tester ● computer interface cables ●



## WIREWORKS CORPORATION

Professional Audio Products/Broadcast Cabling Division  
380 Hillside Avenue/P.O. Box 3600, Hillside, New Jersey 07205-0380  
Telephone: (201) 686-7400 TWX: 710-985-4675

Circle 19 on Reader Service Card

a redundancy factor of 3, the second example 4. Notice that this approach is very inefficient since the information rate is one-third or one-quarter of the transmission rate. If the system handles 100,000 bits/second, then the information rate would only be 33,333 or 25,000 bits/second. This gives us the most important rule of error correction: the redundancy that allows correctability also reduces the information rate.

### ERROR DETECTION

The above illustration was not very efficient since the number of extra bits was very large. We will now explore a more efficient system, but this will require some mathematics (or at least patience) on the reader's part. To begin, let us consider a system which has no correctability but does have 1 bit of error detection. This is called parity. The algorithm is as follows: We take  $n$  bits of data where  $n$  can be any number, e.g. 10 bits; we determine if the number of 1s in these 10 bits is odd or even. If the number is even, we add a "parity bit" of 0; if the number is odd, we add a parity bit of 1. Notice that now the resulting 11 bits will always have an even number of 1s in the word. The table below shows the kind of patterns which can happen.

```
00000 00000 0 (last digit is parity bit)
00000 00001 1
00000 00010 1
00000 00011 0
00000 00100 1
etc.
```

The first two groups of 5 bits are called data bits, and the last bit is called the parity bit. Consider what happens if one bit is received in error. Regardless of which bit is wrong, the number of 1s will now be odd. For example, the word 0000 00101 1 is not a legal transmission word because there is an odd number of 1s. Hence, one of the received 0s must have been a 1, or, one of the received 1s must have been a 0. There is no knowledge of which bit is in error. This is a 1-bit detector with no correction: the most degenerate of redundancy. Notice however that we only had a 10 percent reduction of information rate. If the parity had been applied to a 20-bit data word, then the redundancy rate would have been even smaller. On a 100-bit word, the loss of information rate would have been only 1 percent.

What is the appropriate number of bits for the parity word? Sometimes there are practical limitations, but mostly this is a free choice. The issue comes from the expected error rate in the transmission channel. Consider a 9-bit data word with 1 bit of parity and consider a channel that, on average, makes 1 error in 1000. We say that there is a 0.1 percent probability of each bit being in error or a 99.9 percent probability of each bit being correct. The probability of all ten bits being correct is the probability of bit 1

# New transformerless output Studer A80VU multi-tracks and 1/2-inch mastering decks.

## The analog alternative.

With the introduction of these two newest versions of the legendary A80, Studer has expanded the dimensions of analog recording technology. Now, within a sensible budget, you can stay one step ahead in today's competitive studio market by offering your clients a finished product of significantly higher audio quality. And with Studer's unsurpassed record of reliability, you can count on staying one step ahead for years to come.

### THE A80VU MKIII 24-Track

- Transformerless output amplifiers now standard on all multi-tracks, and with *no price increase!* • Four power transistors in output stage. • Low source impedance (22 ohms) means no signal degradation regardless of loading from long cable runs. • Frequency response from 14 Hz to 50 kHz (+0, -1 dB). • THD of less than 0.01% at 1 kHz with +24 dBm output. • New low distortion transformer line amp card also available as option.
- New headblock design with erase head immediately adjacent to record head. Tape travel time between heads of less than 40 milliseconds at 30 ips assures extremely accurate punch-in and punch-out.
- Full-function channel remote and microprocessor controlled autolocator with 20 address memory.

### The Studer A80 1/2-inch 2-Track Mastering Decks

- Available in either A80RC or A80VU versions. New transformerless line amps are standard on the VU version (shown).
- Exceptionally low signal-to-noise ratio of -75 dB, without noise reduction!
- Exclusive Studer head design for excellent low end response.

Call or write today for more information on "the analog alternative"; and be sure to inquire about our special package pricing. Your clients—and potential clients—are waiting to hear the difference.

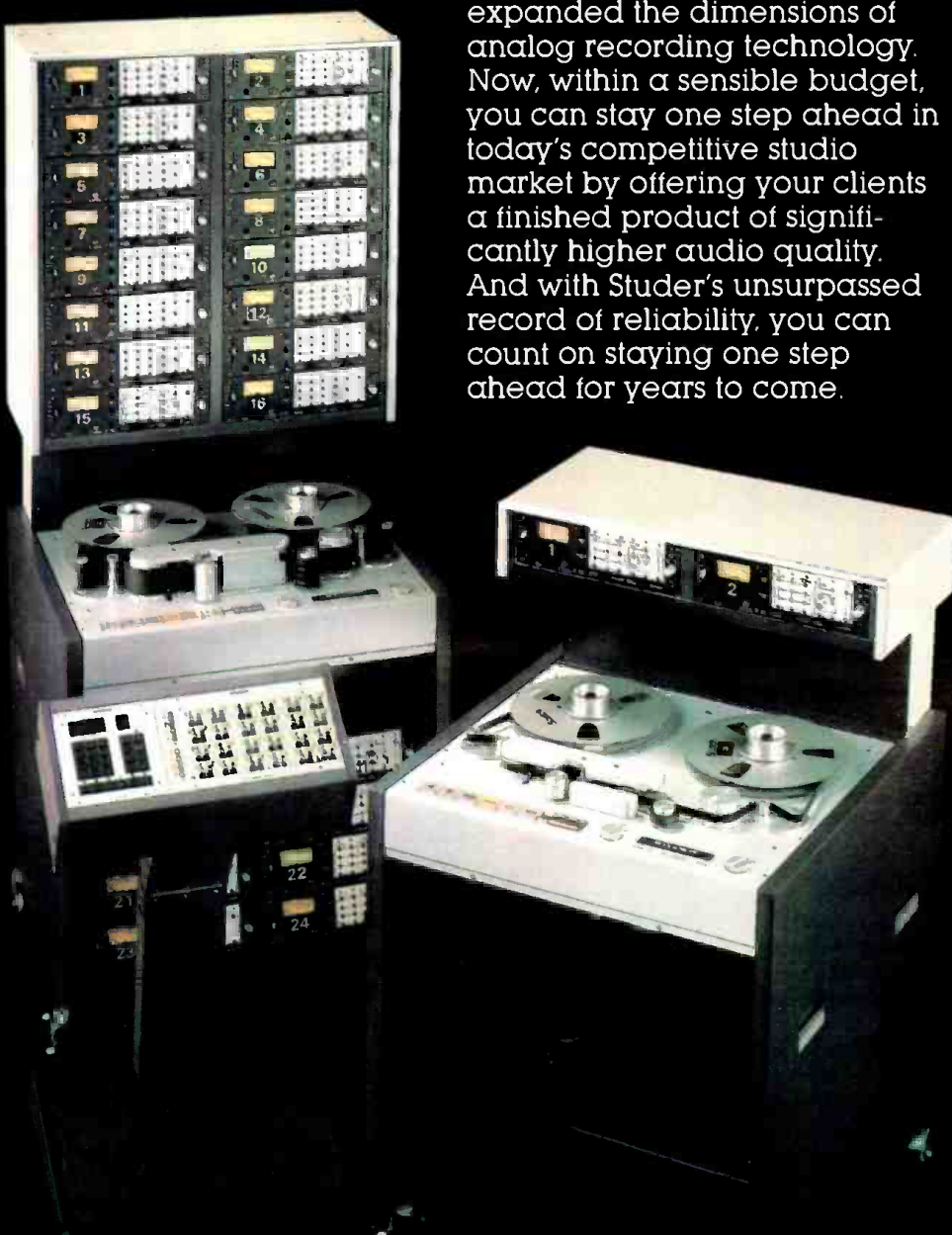

## STUDER

Studer Revox America, Inc.  
1425 Elm Hill Pike, Nashville, TN 37210 (615) 254-5651  
Offices: Los Angeles (213) 780-4234 / New York (212) 255-4462  
Canada: Studer Revox Canada, Ltd.

Circle 24 on Reader Service Card

This publication  
is available  
in microform.



## University Microfilms International

300 North Zeeb Road  
Dept. P.R.  
Ann Arbor, Mi. 48106  
U.S.A.

30-32 Mortimer Street  
Dept. P.R.  
London WIN 7RA  
England

being correct, times the probability of bit 2 being correct, times the probability of bit 3 being correct, etc. With a calculator we find that the probability of all bits being correct is  $(.999)^{10}$  or 0.99. This case is uninteresting because the parity did not have to do any work.

We now must calculate the probability of 1 bit being received incorrectly. Since this calculation is more complex, let's do it slowly. This probability includes 10 cases which are: bit 1 is in error and bits 2 through 10 are correct; bit 2 is in error and bits 1 and bits 3 through 10 are correct; etc. A little math shows that this probability is  $10 \times (0.001) \times (0.999)^9$ . The product of  $(0.001) \times (0.999)^9$  is the probability of bit 1 in error and bits 2 through 10 being correct. The factor of 10 comes from the fact that there are 10 other cases, e.g. bit 2 being in error and the other correct, etc. The result is 0.0099 or 0.01. There is a 1 percent chance that the system will detect an error. If the mathematics had been carried out exactly then we would see that the probability of no errors and one error is slightly less than 1 since there is a probability of more than one error. This turns out to be 0.0045 percent. In other words, of 20,000 groups of these 10 bits, one group will have more than 1 error.

If we repeat the above computation for a 20-bit word, then we find that the probability for a group of words to have more than one error is 0.02 percent. In

other words, there will be more groups which have more than one error and these errors may not be detected. Even though the words have twice the number of bits, the probability of not detecting the error increased by a factor of 4.

Thus, the size of the word determines the undetectable rate and this rate is a function of the channel transmission rate. A 20-bit word might have been okay if the channel error rate was 1 bit in 10,000 instead of 1 bit in 1000. In this case, the parity would have missed an error in only one group out of every 500,000 or 0.0002 percent. The redundancy factor is determined by the expected error rate. A larger percentage of transmitted bits must be parity for a high channel error rate.

### ERROR CORRECTION

Parity can be extended to error correction by adding more parity bits. Remember the parity definition is: the sum of all the 1 bits must be even. Suppose we create another type of parity in which the sum of all bits in positions which are odd must itself be even. This is as follows: we look at the value of bit 1, 3, 5, 7, etc., and if the number of 1s is odd we make an auxiliary parity bit a 1. This is like the previous use of parity except we apply it to only some of the data bits rather than to all. This is abstract and we first need to take an example.

*Continued on page 26.*

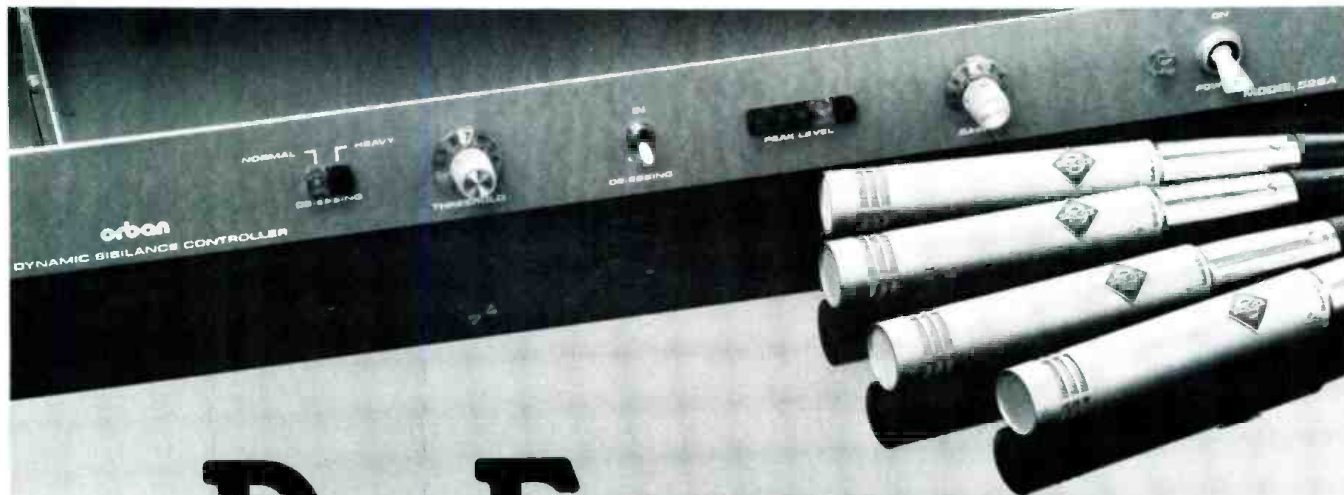

# De-Esssss

The Orban 526A single-channel Dynamic Sibalance Controller is a *simple*, economical dedicated de-esser—without the complexity and compromises of multi-function processors. It sets up *fast* to produce sibalance levels that sound natural and right. Features include mic/line input, fully balanced input and output, LED level meter, GAIN control, compact size and more. Special level-tracking circuitry assures consistent results with varying input levels. And our control technique doesn't emphasize residual IM when de-essing occurs.

De-essing doesn't have to be complex, expensive, and time consuming. The 526A does it fast and *right* in recording studios, cinema, broadcast and cassette duplication.

The 526A De-Esser is available at your Orban pro-audio dealer.

**orban**

Orban Associates Inc.  
645 Bryant Street  
San Francisco, CA 94107  
(415) 957-1067

Circle 14 on Reader Service Card



# SONEX

## FOR CLEAN SOUND

After WLEE installed SONEX, people called about the "clean, new sound!" Was it new equipment?

No. The answer is simple and inexpensive:

SONEX kills all the stray reflections, so the mike processes a clean signal of the announcer's voice. The announcer hears himself in a warm environment, and there's

less clutter to waste watts. The result is a noiseless, clear signal and greater market penetration.

Get the facts today. SONEX is available in five colors, in three thicknesses, and in standard four-ft. square panels. Use it in broadcasting, recording, videotaping or performing areas for really pure, clean sound.



COLOR  
OPTIONS  
AVAILABLE

**Alpha  
Audio**

2049 West Broad Street  
Richmond, Virginia 23220 (804) 358-3852  
Acoustic Products for the Audio Industry

Circle 35 on Reader Service Card

**SUPERB HANDLING.  
PERFORMANCE  
TO SPARE.**



# THE NEW TOA RX-7 SERIES MIXING CONSOLES.

## THE NEVER-ENDING CONSOLE RACE.

Year-in, year-out, it seems like there's never any clearcut winner. With dozens to choose from, it's been easy for the sound pro to make the wrong choice.

Until now.

Introducing the new TOA RX-7 Series machines: from 16 to 32 inputs (and anywhere in-between) to 4 or 8 program outputs. The RX-7's are completely modular consoles built to take the bumps along any road they travel. Whether you need an RX-7 for reinforcement or recording, or both—we designed them to be small and agile enough to move-out easily and big enough to handle just about any conceivable fixed or remote sound requirement. They give you incredible flexibility,



Every picture tells a story—like these fully professional, and easily accessible back panel interconnections.

copious features and the kind of performance you might expect from a board that can cost up to twice as much. Or more.

## SIT BEHIND SOME REAL PERFORMANCE.

Before we engineered the RX-7's we looked at 'em all: Yamaha, Ramsa,



*If you need a more humble mixer, but don't want to eat the pie, we make a few lower horsepower, two channel economy models patterned on the RX-7 Series.*

Tascam—all the rest. We stripped down the look-alikes that think they're in the fast lane. We saw that a sound pro has a slim chance of seeing the winner's circle by spinning-out on yesterday's technology. So at TOA, we started from scratch. And here's why we're so confident: **DRIVER'S EDUCATION.**

Because an RX-7 is fully modular, you create the board you need. Start with input modules that feature three band E.Q., two echo and foldback sends, long travel faders, peak indicators, stereo panning—and more. A lot more. Going in, you're transformer isolated via XLR from -60 to +10 dBm; insert any signal processing devices you want in the signal path; and, take a direct out for recording.

Add two foldback and echo return Buss Master modules. For your outputs, add either 2 or 4 modules that feature +4 dBm on XLR's. To complete your board, just plug-in a Phones module, a Talkback module and of course, a Power Supply module. A multipin plug connects the remote power supply unit which also

gives you switchable phantom power for your condensers.

## GREAT VISIBILITY.

14 large, illuminated V.U.'s (Model 328) are easily seen as well as accessible on a hinged, low-profile meter pod. Easy to see, easy to use, easy to service.

## EVEN A PADDED ARMREST.

And a lot more convenience and useful features make the TOA RX-7 Series the professional mixers that they are; for any critical and demanding sound environment.

## THE FASTEST WAY TO SHIFT INTO FIRST GEAR.

Give us a call at (415) 588-2538. We'll rush out all the spec's and the name of your nearest qualified TOA dealer. We're confident you'll want to sit behind the superb handling of an RX-7. The one that has performance to spare—and the serious machines that won't drive you to the poorhouse



*Crafted in Japan,  
Proven in the States.*



TOA Electronics, Inc.  
1023 Grandview Drive  
S. San Francisco, CA 94080  
(415) 588-2538  
Telex: 331-332

Circle 28 on Reader Service Card

Consider 4 data bits called  $D_4, D_3, D_2, D_1$  and 3 parity bits called  $P_3, P_2, P_1$  which are added to the data word to form a 7-bit result. Since there are 4 data bits, there are 16 possible data words, but since there are a total of 7 bits, there are a total of 128 possible words. Of these, 112 are "illegal" in that they arise only from errors. Now to the illustration. The table shows the 16 possible transmitted words

W	$D_4$	$D_3$	$D_2$	$D_1$	$P_3$	$P_2$	$P_1$
0	0	0	0	0	0	0	0
1	0	0	0	1	0	1	1
2	0	0	1	0	1	0	1
3	0	0	1	1	1	1	0
4	0	1	0	0	1	1	0
5	0	1	0	1	1	0	1
6	0	1	1	0	0	1	1
7	0	1	1	1	0	0	0
8	1	0	0	0	1	1	1
9	1	0	0	1	1	0	0
10	1	0	1	0	0	1	0
11	1	0	1	1	0	0	1
12	1	1	0	0	0	0	1
13	1	1	0	1	0	1	0
14	1	1	1	0	1	0	0
15	1	1	1	1	1	1	1

There is one very interesting property of this table: how many bits must change value for a given word to become another word in this table? Let's pick one at random—such as  $W_5$ —and ask how many bits must change for it to become  $W_4$ . Bit  $D_1$  must change from a 1 to 0, bit  $P_2$  must change from a 0 to 1, and bit  $P_1$  must change from 1 to 0. If you look through the table you will not find any word which can be made from  $W_5$  without changing at least three bit values. This is interesting since if we receive a word which differs from a legal word by a 1-bit change, then the transmitted word can be determined. For example, the received word 0 1 0 1 1 1 0 differs from  $W_4$  by 1 bit,  $D_1$ , but differs from  $W_5$  by 2 bits. In other words, the assumption that there was no more than one error means that the transmitted word must have been  $W_4$ . If there had been two errors, this statement would be wrong but then this code is not intended to handle more than one error in the word.

The number of bits which must be changed to transform one legal word into another legal word is called the Hamming Distance. The above example

had a Hamming distance of 3, whereas the simple parity had a Hamming distance of 2. A Hamming distance of 4 is able to give 1 bit of error correction and 2 bits of error detection. We notice that the more power in the corrector, the more extra bits must be added. A 1-bit parity could have been added to a 4-bit data word to give 5 total bits, or 80 percent efficiency. In contrast, 1 bit of error correction requires 3 extra bits to give only 57 percent efficiency.

Just like the parity, however, the 1 bit of correction could have been applied to a larger word. To give an example, 11 data bits requires 4 correction bits for an efficiency of 73 percent; 26 bits requires 5 correction bits for an efficiency of 84 percent. The equation is  $N_D = 2^{N_p} - 1 - N_p$ , where  $N_p$  is the number of parity bits in the correction segment and  $N_D$  is the number of data bits. There is another way to understand this equation.  $2^{N_p}$  is the number of cases which can be represented in the parity bits: 3 bits gives 8 cases, 4 gives 16. One of the cases is for no errors, and the remaining cases tell where the error is. The extra bits must be able to point to an error in any of the 7 bits with our example. ■

# AKG

## The best digital recordings start here.

The advantages of digital recording can now be realized as never before with the new AKG C414 EB/P48 microphone.

The famous gold plated dual-large diaphragm CK-12 capsule shown here is in use in AKG's total line of professional quad stereo and mono condenser microphones. And these microphones have been used to produce some of today's very best recordings.

The C414 EB/P48 maintains all the features of our highly acclaimed standard model C414 EB—but incorporates new electronics designed to open the door to truly outstanding digital recordings.

Now you can work with an AKG microphone with allowable sound pressure levels of 142 dB (162 dB with selectable attenuation) and the lowest self-noise figure of any microphone we know.

To learn more about this vital link to the best digital recordings, we recommend a visit to your AKG dealer.

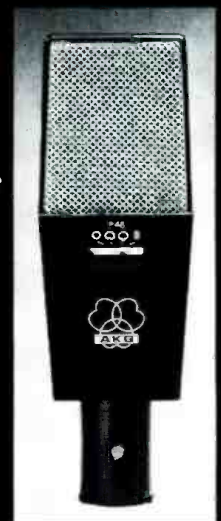

**AKG ACOUSTICS INC.**  
A NORTH AMERICAN PHILIPS COMPANY  
77 Selleck Street, Stamford, CT 06902



# WHEN YOUR WORK BEGINS AT 8.



## AND GOES TO 16.

### The New Model 15SL.

Today it's 8-tracks. Tomorrow 16. And unless you have a pile of money stashed somewhere, you'll need hardware that can grow to fit your future.

Enter the Model 15SL. An 8-in/8-out configuration with a double 8-track monitoring system and 6-position EQ on all inputs. Expandable to 24 inputs with full 16-track monitoring. It's the "short load" version of our renowned Model 15.

The Model 15SL gives your ears an almost unlimited mixing and monitoring repertoire. For example, you can punch up a 8 x 2 or 8 x 4 output monitor mix without affecting what goes onto

tape. Or solo one or several monitor channels. You can listen to a performer's headphone cue, hear the echo buss, add external signal processing to the monitor or tape. You'll easily satisfy your musicians, your producer and yourself, with an amazing amount of flexibility and control.



The model 15SL is the perfect studio mate for the world's most popular 8-track recorder: the Tascam 80-8. Put both to the test at your Tascam dealer today.

And the Model 15SL does all this very quietly. The mic preamps are all discrete FETs (not chips) for lower noise and distortion. The power supply is housed separately for remote mounting to keep heat and hum away from the amplifiers. Mic input S/N is greater than 76dB (1 channel, WTD). And overall distortion (Mic In to Line Out) is 0.03% THD @ 1,000Hz.

So listen to the Model 15SL. Examine its extraordinary flexibility. You'll find everything you need to start work at 8. And go to 16. At your Tascam dealer right now.

**TASCAM** STUDIO SERIES  
TEAC Production Products

# Audio Tape

for professionals



## REEL TO REEL TAPE

Ampex, 3M. All grades.  
On reels or hubs.

## CASSETTES, C-10—C-90

With Agfa, TDK tape.

## LEADER & SPLICING TAPE

## EMPTY REELS & BOXES

All widths, sizes.

**Competitive!**  
**Shipped from Stock!**

Ask for our recording supplies catalog.

**Polyline Corp.** 312/298-5300  
1233 Rand Rd. • Des Plaines, IL 60016  
15

Circle 23 on Reader Service Card

LEN FELDMAN

# db Sound With Images

## Now We're Number Three (Four?, Five?, Six?...)

• September 1981, Berlin, Germany. One of the largest audio/video expositions in the world is held here annually: The *Internationale Funkausstellung Berlin* (or, if you like—International Audio and Video Fair—Berlin). Its twenty-three huge buildings are linked in a vast oval, with lovely gardens and endless varieties of foods to be sampled in the center area inside the oval. With so much space available, it's no wonder that some of the larger exhibiting companies, such as Philips, Telefunken, Grundig and Siemens, have taken over an entire pavillion for their exhibits, which may well cost MILLIONS of dollars. Even the very largest of industry shows back in the states seems miniscule by comparison—but don't get the idea from the few names listed above that this show is limited to European manufacturers—or that it is strictly a "radio" or "audio" show. This exhibition includes companies, or at least local representatives of companies, from all the major industrial countries of the world including, of course, Japan and the U.S. And, while there is plenty of audio product to be seen in most displays, there's no doubt in anyone's mind that video has become as important as, if not more important than, audio.

But the big surprise for me (and for other foreign visitors who had not had a preview of what was about to happen) is stereo audio on TV, as broadcast by *Zweites Deutsches Fernsehen* (ZDF) Second German Television System. You will recall that I discussed stereo or multi-channel audio TV last month, as it related to TV broadcasting in this country and in Japan. Little did I suspect, then, that West Germany was about to play a major role in the development of this new audio/TV entertainment format. As you may have guessed by now, German TV has "gone stereo" in a big way. Not only did they begin broadcasting in many parts of the country on September 1, to be on the air by the time the Berlin exposition opened on September 4, but they chose a system that differs substantially from *any* of the three systems currently being proposed to the FCC in this country (including the system in use in Japan). Needless to say, this makes it even less likely that the industrialized nations of the world can

come to an agreement regarding a single system of stereo audio for TV. And, of course, if we had any idea that the U.S. would be the second country to initiate stereo audio on TV, that possibility no longer exists. At the rate things are going there is some question in my mind as to whether we will even be *third*. With distances in Europe from one country to the next being as small as they are, and with major German TV set makers having a large share of the market for TV sets in neighboring countries, I wouldn't be the least bit surprised if countries close to Germany would soon initiate stereo audio in conjunction with their TV transmissions. I should hasten to add that although I have been referring to this German TV audio system as a "stereo" system, it is also being used for other two-channel audio applications, notably for transmitting German-dubbed dialogue and original language dialogue when foreign motion pictures are shown.

### ANTI-TRUST LAWS DIDN'T HINDER PRODUCTION

An interesting sidelight of this whole development is the fact that literally *every* German manufacturer of TV sets exhibiting here in Berlin have not one prototype, but many production models of TV sets that can receive the new stereo audio TV transmissions and properly decode them. What's more, I've seen displays of stereo-capable TV receivers in audio/video shops in Central Berlin as well. In other words, all of the manufacturers *knew* that multi-channel audio on TV was about to start, and they had full knowledge of what the system would be and how it would work. Can you imagine what would happen in the U.S. if, on the day the FCC announced a stereo, multi-channel TV audio system, all U.S. TV set manufacturers (or importers) were ready and waiting with appropriate sets that could receive and decode the new transmissions.

### HOW THE NEW SYSTEM WORKS

Unlike all of the multi-channel audio systems currently under consideration for use with TV broadcasting, the system selected by the German broadcasters does not use any form of multiplexing. As some readers may already know,

**★ FOR LIVE PERFORMANCE**

**★ FOR RECORDING**

**★ FOR PA**

**Adjustable Active Crossover**

**Send For Your Free Copy Of Our Catalog**

**SESCOM, INC.**  
Professional Sound Division  
11111 Las Vegas Blvd. North  
Las Vegas, NV 89101 U.S.A.

(702)384-0993  
(800) 634-3457  
TWX 910-397-6996

Circle 20 on Reader Service Card

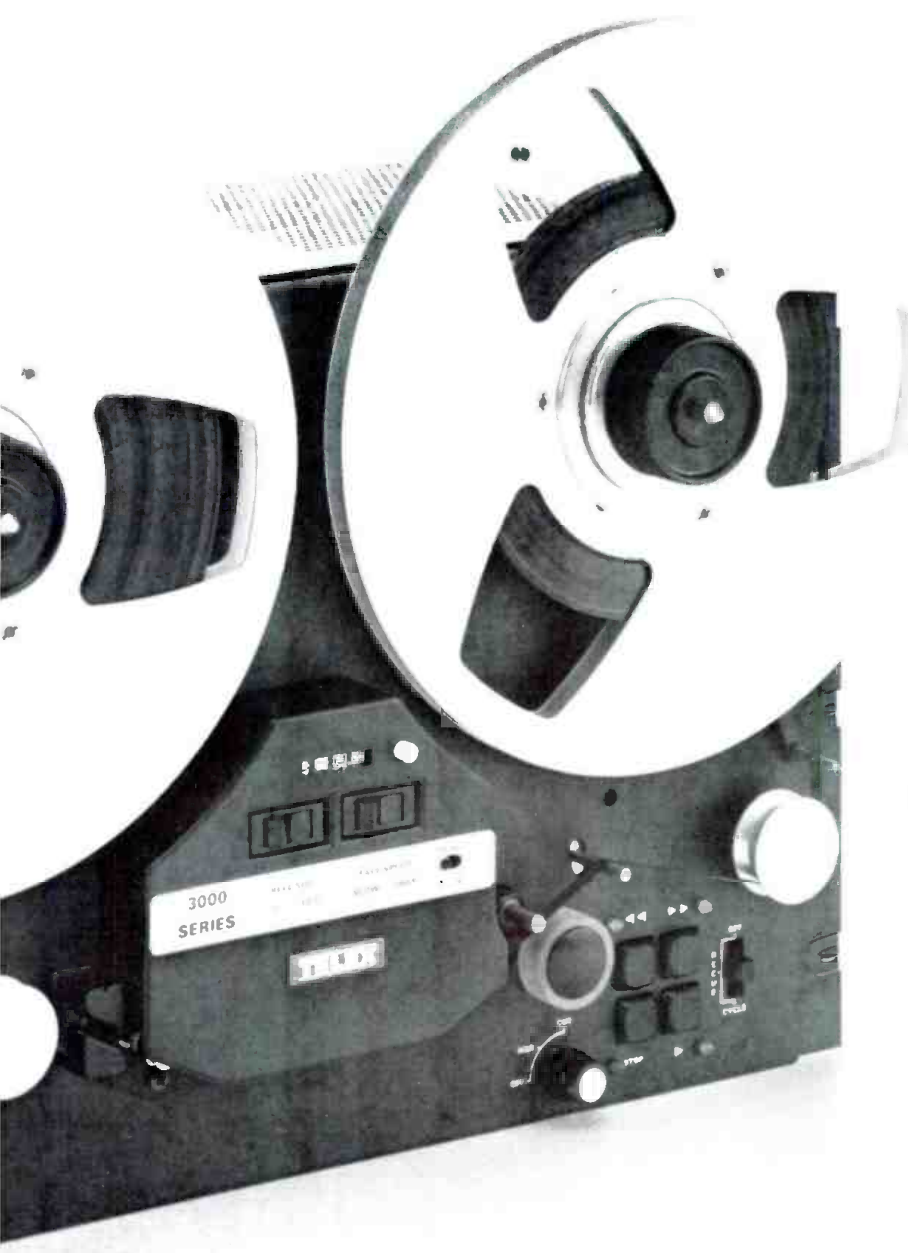

# Take a close look at what Tape Transports are going to be like in the '80s

The all new Telex 3000 is here NOW!

No industry has witnessed more technological improvements over the past few decades than our own. So, if you're looking for a tape transport for broadcast, studio or industry, it's important to choose a product with all the latest industry innovations in one unit, the NEW Telex 3000. Write for exciting details about these features.

- Interchangeable head blocks
  - A.Q.R. (Auto Cue Release)
- Differential electro-mechanical braking
  - Spill-proof logic
  - Motion sensing
  - Tape counter
  - 4 head capability
  - Hyperbolic tape path
  - Remote control capability
- Play only or record/play combinations
  - Auto cue/rewind/cycle
  - Dual speed
  - Hysteresis drive motor
- Two torque spooling motors
  - Quiet operation
  - 120/240 volt operation
- Urethane pressure roller

Quality products for the audio professional



## **TELEX**

TELEX COMMUNICATIONS, INC.

9600 Aldrich Ave. So. Minneapolis, MN 55420 U.S.A.  
Europe: 22, rue de la Légion d'Honneur, 93200 St. Denis, France.

Circle 25 on Reader Service Card

## LOW LEVEL INPUT TRANSFORMERS

### For Microphones/ Transducers



Control and Instrument  
Amplifier Applications  
Excellent magnetic  
ESS shielding  
Response 30-20 KHz +1db  
Turns Ratio 1:1 thru 1:20

Single Threaded  
Stud Mounting

Equivalent to  
Imported European  
Studio Grade  
Transformers



7-Pin  
PC  
Mounted

COMPLETE SPECIFICATIONS  
AND PRICE SHEET AVAILABLE

Complete Catalog line of

### AUDIO-POWER COMMERCIAL-MIL TRANSFORMERS

IMMEDIATE DELIVERY  
FROM DISTRIBUTORS



**MICROTRAN**  
COMPANY, INC.

145 E. Mineola Ave., Box 236, Valley Stream, N.Y. 11582

Circle 37 on Reader Service Card

# 1982 studio supplies

- Cut the high cost of studio supplies in 1982.
- Our "Special Order" flyers offer the same great supplies you'd find in our 5,000 sq. ft. store.
- Ampex tape, Tascam Equipment, XEDIT & ANNIS, RAMSA Mixers, MC1 Recorders & Consoles, Mics by Audio Technica, Neumann, PZM, Master Room Reverbs, Lexicon, Orban.
- Write or phone to get your **FREE** flyer.

**PROAUDIO  
SYSTEMS**

FEATURING FINE STUDIO EQUIPMENT

**(206) 367-6800**

11057 8th N.E., Seattle, WA 98125

Circle 15 on Reader Service Card

Germany (and most of Europe) uses the so-called PAL system of color TV. As employed in Germany, that system has its video and audio RF carriers separated by 5.5 MHz. TV channels are, in turn, separated by 7.0 MHz, which means that there is plenty of room *above* the present mono audio carrier to insert a second, totally independent audio carrier. The frequency chosen for this second audio carrier is such that it is positioned 5.742 MHz above the video carrier, or 242.0 kHz above the first audio carrier. Line repetition rate in the European PAL system is 15,625 Hz which, at a 50 field/25 frame per second picture rate, means that each frame contains 625 lines as opposed to our 525 line system. All of which places the first audio carrier at a frequency which is 352 times the line repetition rate, while the newly added, second audio carrier is at 367.5 times the line repetition rate.

When the system is to carry a stereo program, in which L and R signals are related, the main (previously existing) audio carrier is frequency modulated with a sum-signal having a relative amplitude of  $(L + R)/2$ . The new, second audio carrier is an FM modulated right-channel signal, R. Why such a strange matrix arrangement? Well, the need for the sum signal is obvious. Older TV sets, not responsive to the second audio carrier, simply pick up and demodulate the  $(L + R)/2$  signal, which is a totally-compatible monophonic equivalent of the stereo program being transmitted. Furthermore, the factor of 2 in this new signal insures that loudness levels will remain about the same as they had been during a mono broadcast (since, if L and R had been equal, adding them together would have resulted in a 3 dB increase in volume level for the mono listener).

The algebraic signal manipulation required for the new stereo TV sets is fairly obvious. Subtracting from the original carrier, one-half of the right-channel signal from the second channel gives us  $(L + R)/2 - R/2 = L/2$ . Now to keep right channel amplitude correct, we simply divide the signal recovered from the second audio carrier by 2, to obtain R/2.

But why not the familiar  $(L + R)$  and  $(L - R)$  arrangement common to stereo FM in the U.S. and elsewhere? Simply because the power of the second audio carrier is kept 7 dB lower than that of the original first audio carrier, which is itself 13 dB lower than the video carrier. The 7 dB decrease in power of the second audio carrier is necessary to prevent interference to an adjacent video channel of another station. By increasing the amplitude of what goes on that second audio carrier (compared with what goes on the first audio carrier), signal-to-noise ratio in stereo is virtually the same as it is in mono. And, it goes without saying that stereo separation is *far* superior to what it can be with a multiplex system where

slight differences in phase or amplitude as a function of frequency play such havoc with high frequency separation.

If the system seems a bit "brute force" up to this point, let me assure you that it is more sophisticated than at first appears. Specifically, the system also includes a pilot signal which modulates the second audio carrier and has a frequency of 54.7 kHz (or 3.5 times the line repetition rate in the PAL TV system). During mono transmission the pilot signal itself is unmodulated. When a stereo program is to be broadcast, this pilot signal is amplitude modulated by 50 percent, using a frequency of 117 Hz. During bilingual audio transmissions, the pilot signal is again 50 percent modulated (AM), but this time with a 274 Hz tone. These different types of modulation incorporated in the signal applied to the second audio carrier enable TV set manufacturers to build sets that can automatically switch from mono, to stereo, to bilingual without the user having to touch any controls.

Of course, system flexibility is such that if a manufacturer wants to build a lower-cost set, switching from mono to stereo or to two separate programs (one at a time, of course) would be done by pushbuttons or any other suitable low-cost mechanical switching arrangement on the front of the TV receiver.

At the start of the stereo, bilingual service in Germany, some twenty nine ZDF network transmitters went on the air with the new service, covering approximately 60 percent of West Germany. Obviously, this took a great deal of planning and coordination. Yet, to most of the industry, the whole thing came as something of a surprise. Some say the choice of a system was meant to deliberately exclude foreign manufacturers of TV sets (at least at the outset) who were caught quite unexpectedly by the new development. Perhaps that's true, and is indicative of a form of protectionism for which countries in Europe have been well known. But aside from political motives, I can tell you that the audio quality of this new German two-channel TV system is superb. My own feeling would be that—if it's not too late, and if we can work out a way of adopting the system to our NTSC standards—perhaps we ought not to exclude this "fourth" two-channel TV audio system from our own current deliberations on the subject. Walking through the exhibits in Berlin and seeing the many alternative ways of adding stereo to TV (adaptors, new TV sets, extra speakers with decoders, etc., etc.) convinced me more than ever that, next to the digital audio revolution (which is still years away), the most important development for both the broadcasters and the management people in the audio end of TV is two-channel TV audio. But we'd better be sure that we pick the right system before plunging ahead. ■

# The Fulfillment Of Pure Mid-Frequency Performance Has Yet To Evolve.

Until Now.

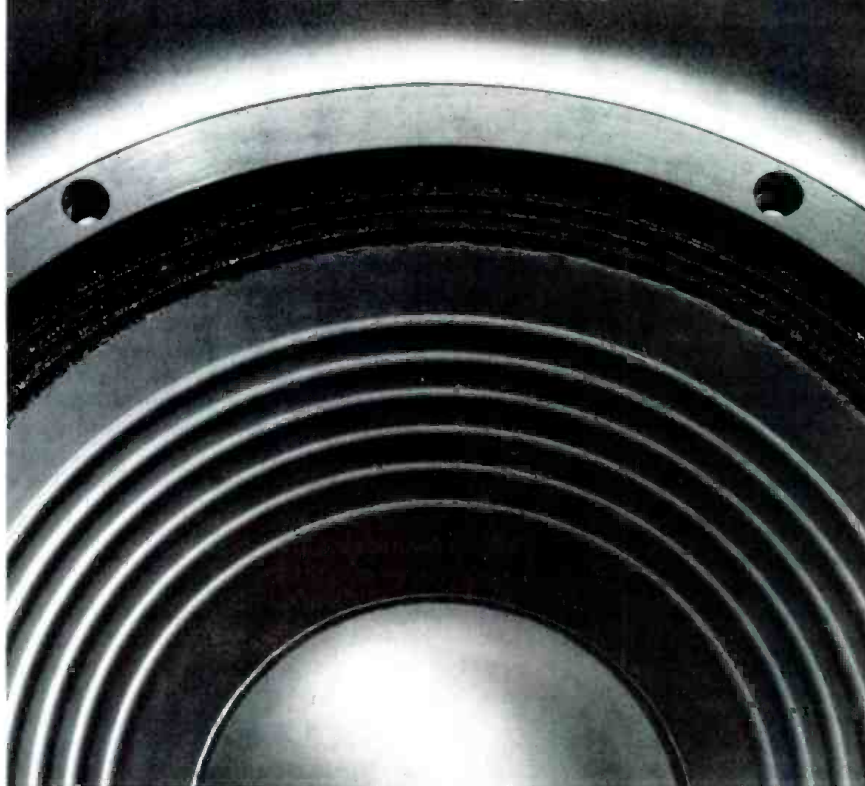

Experience previously unattainable performance in the mid-frequency range, an evolution of pure audio. Discover the best sounding 12" mid-frequency loudspeaker available. Listen... and experience the TM-1201 from TAD.

Assembled in the hands of veteran audio craftsmen, the TM-1201 is especially designed for mid-frequency applications, with a usable range of 200 to 3000 Hz. Ultra-low distortion, smooth extended frequency response and high power handling establish the TM-1201 as a hallmark in the evolution of sound.

Evolutionary in itself, with a lighter, more rigid material than currently used in the field, the polymer graphite cone has true pistonic motion throughout its specified range, with none of the peaks and valleys associated with cone break-up or doubling. In addition, a high power 4" voice coil with edgewound copper conductors better utilizes the flux within the magnetic gap to increase acoustic conversion efficiency. A corrugated cloth surround, for extreme linearity in high power applications, and a rugged 6-spoke die-cast aluminum frame assures both durable and reliable performance.

Conquer the peaks and valleys of sound with the unprecedented mid-frequency performance found in the TM-1201.



**The evolution of sound  
begins with TAD.**

**TAD** Technical  
Audio Devices

A division of U.S. Pioneer Electronics Corp.  
142 Redneck Ave., Moonachie, N.J. 07074  
(201) 440-8234 Telex: 133484 PIONERUSA MOON

*Detailed specifications and performance  
data available upon request.*

**W**ELL, HERE WE ARE again at the Waldorf-Astoria Hotel in fun city, to attend the Audio Engineering Society's 70th convention (October 30-November 2). For dedicated convention-watchers, it's an historic occasion: the last of the Society's three-per-year events for this year, and perhaps for a long time to come.

Since the previous convention in May of this year, the Society has moved ahead with its plans to trim the convention schedule to two per year. The next one will be in Montreaux, Switzerland in March, 1982. After that...? Barring any unexpected changes, there will be a west coast show in the fall of 1982, and another convention "somewhere" in the spring of 1983.

"Somewhere" could mean Europe again (maybe we should hedge and say "overseas"). Or it could mean an entirely new US venue (say, Las Vegas or Nashville, or?). It could even mean back here in New York again. Perhaps by spring, 1983, New York's convention center will be open for business, and the climate for exhibitors and visitors will be made more hospitable. Perhaps gasoline will be 20 cents a gallon by then, which is just about as likely.

Maybe the present convention here at the Waldorf will be the last time the AES convenes in New York. No doubt some exhibitors fervently hope so, as do many out-of-town visitors.

In the meantime, the SPARS "road show" in Nashville has come and gone, and we hear reports that the SPARS leadership is pleased with the results. By AES standards,

attendance was small (some 200 people attended), and there were no exhibitors. Discussion topics were general, but will get more specific at future SPARS conclaves. (For example, SPARS just concluded a computer applications seminar at their pre-AES meeting here in New York—more on this later on.)

It's too early to tell whether the SPARS Nashville experience will lead the way towards a full-blown convention there in the foreseeable future. However, it's not too early to tell that the needs of the industry are being carefully studied by the AES, SPARS, and no doubt others as well.

Some observers link current convention uncertainties to our current economic uncertainty. However, the economy can be used as an argument for more—or for less—conventions, depending on your point-of-view. For instance, "The economy is bad—we can't afford to go to the convention" or, "The economy is bad—we can't afford not to go to the convention." Take your pick.

Since inviting our readers to comment on the subject, we've not exactly been swamped with letters. In fact, this month's letters column contains the entire response to date. Since you're generally not shy about expressing opinions, we'll take the silence as an indication of some uncertainty about what's really wanted by most of you. No doubt, we'll hear from many of you directly this week. ("You know, I was *really* going to write, but...") And, we'll keep an eye on the prevailing mood as we wander around the exhibits. Hope to see you there! ■

# HOLD IT BEFORE YOU BUY A COMPRESSION DRIVER.

Before you choose one of the "old standard" compression drivers, consider this — Yamaha's advanced technology and years of experience have produced a new standard — the JA-6681B high frequency compression driver. Engineered with subtle improvements that make a not-so-subtle improvement in performance and durability.

Yamaha's exclusive suspension consists of beryllium-copper fingers bonded to a rigid, pneumatically

formed aluminum diaphragm whose low mass yields optimum response and low distortion. Since extreme excursions cannot cause the suspension to "take a set," sound quality remains excellent throughout the driver's lifetime.

To deliver more sound per watt and long-term reliability, we use a very powerful ferrite magnet which retains the driver's high sensitivity through thousands of hours of severe use. An aluminum shorting ring prevents

magnetic flux modulation at power levels, further reducing distortion.

These are just a few of the reasons Yamaha outperforms and outlasts the others. For the whole story, write: Yamaha, P.O. Box 6600, Buena Park, CA 90622. Or visit your Yamaha dealer and hear the difference. You'll be glad you held out for a Yamaha.

Because you're serious.

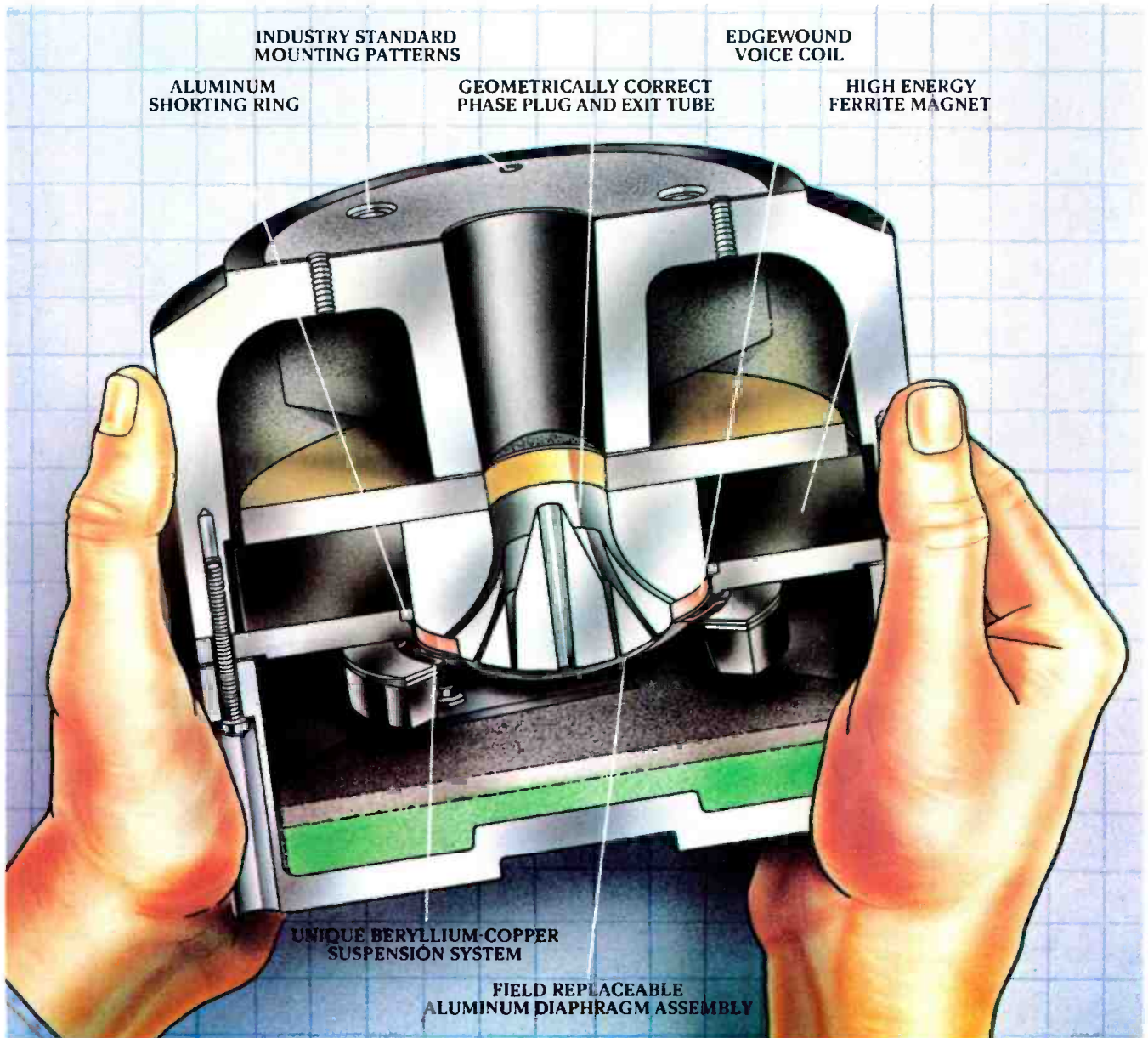

Or Yamaha Canada Music Ltd., 135 Milner Ave., Scarborough, Ontario M1S 3R1.



Circle 27 on Reader Service Card

www.americanradiohistory.com

# If you're ready to move up to a specialized mixer, you're ready for Ramsa.

## The Sound Reinforcement Specialist: Ramsa WR-8716

When your sound says you're professional but your mixer doesn't. When you're wasting your subtlety and style on "make-do" boards. When you're creating compromises instead of clear-cut distinctions. Then you're ready for Ramsa—the new mixers that are specialized so you won't have to compromise.

The WR-8716 is a fully modular sound reinforcement console with 16 input

modules, 4 group modules, and 2 masters. It features 16 input pre-fader solo buttons, 4 group modules with pre-fader insertion patch points, and lockable post-fader solo buttons. There are 6 illuminated VU meters with peak LED's for easy outdoor

reading and a separate stereo variable frequency EQ for monitor sends. Pan pot controls allow panning to the left or right masters while level controls permit 16 x 6 board operation. The left and right direct channel assign function lets you bypass the group modules for individual sources. Portable operation is a snap with easy access connectors.

And the WR-8716 features plastic conductive faders for greater reliability and smooth, low-noise operation; external power supply for light weight, and switchable 48V DC phantom power for condenser mics.





# RAMSA

## The Recording Specialist: Ramsa WR-8816

The WR-8816 recording console includes the same modular construction, input modules, power supplies, and faders as the WR-8716 plus many important recording advantages. Like direct outputs for 4, 8, or 16 track recording and peak-reading LED meters that let you monitor any 4 out of 24 signals with clear, quick response.

You'll command a variable frequency EQ section with 3 frequency settings for the high and low frequencies plus continuously variable

midrange. Stereo echo send replaces the separate mono controls you'll find on competitive boards. And you get two independent stereo monitor controls—one for musician's headphones, one for control room monitors—a special feature for any mixer in this class. And there are other important features

like low noise electronically balanced mic inputs with new high-speed IC's, 16 switchable post-fader solo controls and XLR-type mic connectors.

Ramsa offers a full line of specialty mixers including the more compact WR-8210 recording mixer and WR-130 sound reinforcement mixer. So don't hold down your professional sound, call (201) 348-7470, because you're ready for Ramsa.



**Panasonic**<sup>®</sup>  
PROFESSIONAL AUDIO DIVISION  
Circle 42 on Reader Service Card

# Building Tres Virgos

*Here, authors Jacob (owner) and Millward (worker) give us a look at the different kinds of problems and joys to be found in building a studio.*

## The Owner's View

**I** ALL STARTED innocently enough. The 4-track bedroom studio had grown into a successful 8-track garage studio nestled in the peaceful hills of Marin County, California.

Peaceful through two control room and one studio expansion, peaceful through four years of cutting tape, peaceful before the sessions started running until 4 AM. Funny thing about operating a business in a residential neighborhood; it's illegal. By late '79, we knew our days were numbered. On March 15, 1980 we were evicted.

Partners Mike Stevens, Allen Rice, Robin Yeager, and I were in basic philosophical agreement as to the kind of studio the new Tres Virgos would have to be. First and foremost, it would have to be in an area where we would not be a problem for our neighbors, nor they for us. It should be an easily accessible location with expansion room, and most of all, the new Tres Virgos would have to be a super place to make music.

Since we really didn't have enough cash to finance even the most elementary construction project, the cost of building our studio was of no concern. As long as you're dreaming, you might as well dream big.

Since we were to be a one-room operation, the studio room was our first concern. We wanted to be prepared for the future (remodeling studios is expensive) and equipped with a music room that was designed to be as flexible as possible, large enough to do video, and as varied in area acoustics as we could make it without going to the expense and unpredictability of louvres, adjusting traps and "trick" treatments.

We believed in the basic credo—that form follows function—and the function of a studio room is to serve as a creative space in which to make music.

The other basic element of our philosophy was that recordings are made in the studio, not in the control room! Tape recorders are storage devices and are only as accurate as their input.

Well now, here is the dilemma: if we build a good-sounding studio, we darn well better build a great sounding control room. What good is a studio if you can't hear it?

### LEDE

Our partner, Allen, had taken a Syn-Aud-Con course in 1978 and came home charged up about something called LEDE™ (Live-End Dead-End). It had to do with a new way

of measuring sound, sort of in the third dimension; time. This technology has been labeled Time, Energy, Frequency (TEF™) measurement. (See "Time, Energy, and Frequency Measurements for Sound Definition" in the June 1980 *db*—Ed.)

We spent the next weekend after Allen's class stuffing absorbent material everywhere in the front of the control room. We bought UREI 813 monitors and built some rather unscientific reflective panels in the back of the room. The room sounded better. So much better, in fact, that we soon had groups coming from as far as L.A. to use the "amazing" 8-track garage in Mill Valley.

At the November 1979 AES we talked to a number of designers, all of whom loved our ideas, but were frightened by two basic criteria: we had no money, and we were going to do all the construction ourselves.

I knew that before we could even seriously begin funding a project of this magnitude we needed to know how much it would cost to the cent and exactly what we would get for the money. The word was predictability.

We needed a designer who understood our goals and would be willing to work closely enough with us to assure that what we ordered would be what we got.

It was also necessary for us to find someone who could do a real LEDE™ control room design. You don't get off a winning horse.

The designer was Chips Davis. Chips had been a live sound mixer for many years, working showrooms in Las Vegas for Frank Sinatra, Paul Anka, Wayne Newton and others; he'd toured big bands and he owned his own studio!

Chips had done the first real LEDE™ treatment in his own room with much of the same combination of skepticism and excitement that we'd experienced re-doing the garage. The difference was that Chips did it right.

Most important—perhaps because he lived in Las Vegas—Chips was willing to take a chance with us. Chips felt that we might actually do a pretty good job. Besides, February was a slow month in Vegas.

We were determined that whatever we did, no matter how long it took, the design, the construction and the equipment would be an integrated and complete system. There would be no compromise.

Chips, Allen and I set a budget based on what we realistically felt it would take to build the place, equip it and sustain the operation while we built the four discrete buildings, and 1,800 square feet of office, lounge and off-line facilities within the empty warehouse that was to be our home for at least the next 10 years.

Our construction crew were all musicians who had had extensive construction or allied experience. Each man agreed to take a portion of his pay in credit for time in the finished

*Jerry Jacob is one of the owners of Tres Virgos Recording Studio. Richard Millward is a guitarist/song-writer who worked on the crew that built Tres Virgos.*



The control room at Tres Virgos

room. Our permits said: Owner/Builder, and Allen supervised every aspect of construction. We started with no water or power in the building. Allen and his crew built the place with the care a musician puts into his own instrument.

### DIALING FOR DOLLARS

Mike Stevens and I donned our best "downtown" attire and went dialing for dollars while Robin kept the roof over our heads with illegal sessions for Tom Donald and Tamarin Productions (our in-house jingle company) and "cool" outside clients. The Marin County Sheriff's office was understanding, as were the neighbors (when they saw how hard Robin was trying). They even ignored the now aging court-ordered

eviction.

We evangelized within the industry for time alignment, phase coherence, square wave response and TEF™, and within the two years it took to get Tres Virgos together, we saw more and more support from industry people who were at least "amused" by our zeal and who at best, are now responding with a higher level of technology in both measurement equipment and signal chain components. Frankly, looking back on it, I can easily see why people think we're a little nuts!

Chips choice of Ed Bannon as electronics designer gave us absolute confidence in the fact that the whole system would work the first time. Ed's input in all areas, and his meticulous inspections of every audio, electrical, HVAC, physical and mechanical system really helped us keep on track.

A word about time and money. We projected a net studio construction time of nine months with a four man crew and a 40 hour week. We projected a construction budget below the normal square foot price of a single family California home.

We calculated every inch of wire and sheetrock and screw. We invented systems and fabricated *everything* on site ourselves. We squeezed suppliers, shopped, and squeezed again until they got into what we were trying to do and really helped. We had help everywhere and everytime we needed it. In all, the studio was completed in a net 10 months. The additional down time was spent waiting for more money.

We're in on budget, and close to on-time, except for a seven months mid-construction delay to find a bank and a leasing company to say yes. I think someone must have told the financial community that the recording business is a little soft.

As I write this we are about two weeks from completion and our first session. At this point the control room is behaving exactly as expected.

There have been no major surprises, no major changes in our plans and design and no cost overrun in either construction or equipment.

Was it all worth it? We'll tell you at AES.

An Energy Density plot shows: 1. Amount of energy present as represented in the Time Domain. 2. Amount of total frequency spectrum energy density. 3. Diffused spectrum showing the rate of decay of total frequency energy density in time and amplitude.

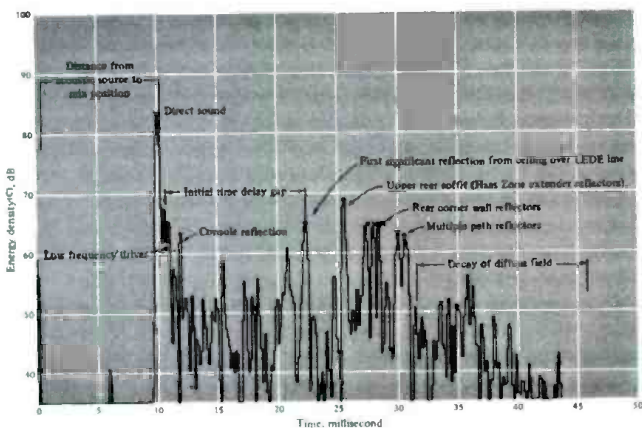

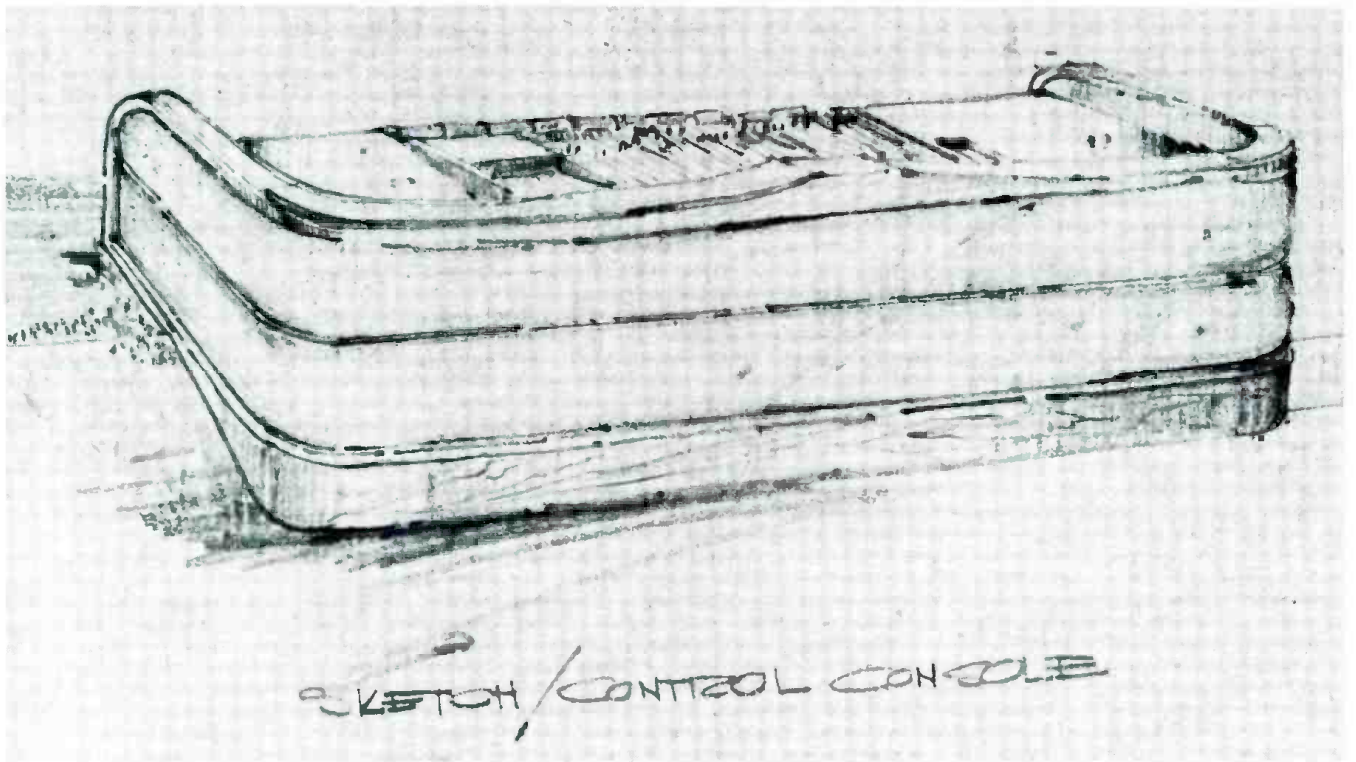

## A Workman's View

It seldom seems that the first view of a project suggests the final product. Yet in my first meeting with Allen Rice, who was to oversee the construction of Tres Virgos Studio, the aim of his plan was brilliantly clear—to construct the best recording studio possible, and build it better than anything yet in operation, period. He had a happy twinkle in his eyes as he explained the blueprints, and it soon became clear that this was to be no ordinary design.

### FAMOUS LAST WORDS

Tradition always had the front of the control room as a hard surface, to aid in enhancing high frequencies. Tres Virgos was to do something totally different. I was immediately thrown into a new world, with a new way of approaching acoustics. LEDE (Live-End/Dead-End)<sup>™</sup> reverses traditional thinking and more. It combined the newest measuring equipment with "time-aligned" monitors to create the most acoustically accurate construction geometry so far. On paper, it sounded terrific! The idea of LEDE had been tossed around the trades, and a few studios had done retrofits in an attempt to implement the LEDE concept; even so, there was a lot of resistance to the idea. Tres Virgos was to be the first studio to be designed for LEDE from the ground up.

I'm a musician; principally a guitarist and songwriter. Doing construction has always been my "day gig" when necessary. I like it because it keeps me in shape and, of course, it never hurts to have more than one skill.

I had experience, having done several remodeling jobs and two studios in the past, but all my experience had only whispered a hint of the job I was about to tackle.

The concept was to approach each phase of the building with a finish carpentry attitude. Allen was in daily contact with Chips Davis, who helped develop LEDE<sup>™</sup>, regarding procedures, measurements and specifications.

It soon became apparent that time was to be the most expendable building material. For example: every one of the three

shells built was glued and screwed. Studs were rejected if they didn't fit perfectly, with a gentle hammer tap to put them in place. Each stud required 12 screws, with another dozen for the fire blocks at 4 and 8 feet. Even with a high-speed screw gun, building to that kind of tolerance takes time. Each wall was rubber mounted to the ceiling rafters and held in place with custom-made isolation systems using 3/8-in. machine bolts. Try that on top of a 12 foot scaffold! Sometimes the torque from the screw gun would spin *me* around instead of the bolts!

Allen was adamant about safety, especially on the scaffolds. We installed safety lines and kept tools and supplies from underfoot. Luckily there were no serious injuries, but the cost was time.

Since all the workmen at Tres Virgos were musicians or engineers, every time a saw or drill started up, everybody would cover their ears (that tended to slow the work up a bit too).

The first shell of framing took three months. It was so solid that once a lumber truck dropped a load of 200 2 x 6's from its bed onto the studio floor, Allen, sitting on the ledge of the control room window framing, didn't even feel the shock as the load hit, raising a huge dust cloud.

Nobody likes to install insulation. But it is one necessity to building a studio. Enough went into Tres Virgos to fully insulate a dozen 4-bedroom homes. I believe it.

We organized insulation jobs so they took up the last hour of the day. The stuff was an irritant, but if you took the proper precautions, it wasn't nearly so uncomfortable. (See "Hazardous Aspects of Commonly Used Acoustical Construction Materials" in last month's issue—Ed.) Masks, glasses (not goggles, they steam up!), a hood sock, gloves and a long-sleeved shirt were worn whenever we had to put up fiberglass. Once the framing was filled with R-19, we tackled sheathing. High density 3/4-in. particle board was the basic wall treatment. Each sheet weighed 110 pounds. All the wall covering was cut to close tolerances to make caulking easier. All sheathing was screwed and glued to studs and caulked between each layer and seam. Then we started getting really hot! When the last piece of particle board in the control room floor was in position, I called Allen over and said: "Jump on this." As he landed, the piece slid into it's space and the entire floor seemed to give

# LIMIT TO THE LIMIT.



## HERE ARE THE INDUSTRY'S MOST DYNAMIC PERFORMERS.

OF COURSE, THEY ALSO COMPRESS, EXPAND, GATE AND DUCK. THAT'S WHY RECORDING AND BROADCAST ENGINEERS ALIKE APPRECIATE THE EXTREME DEPENDABILITY AND MAXIMUM FLEXIBILITY OF AUDIO & DESIGN'S COMPLETE LINE OF COMPRESSOR /LIMITERS. NO OTHER MANUFACTURER IN THE WORLD CAN MATCH THIS SELECTION OF LOW DISTORTION LEVEL CONTROLLERS.

1. THE GEMINI EASY RIDER OFFERS TWO FULL FUNCTION CHANNELS AT A MODEST PRICE.

2. THE EX-PRESS LIMITER IS IDEAL FOR CONTROLLING STEREO MIXES, PLUS IT CAN BE CONFIGURED FOR FM BROADCAST OPERATIONS. 3. KNOWN THE WORLD OVER, THE VOCAL STRESSER COMBINES A COMPLEX LIMITER

WITH FOUR BANDS OF SWEEP EQ. 4. THE ORIGINAL COMPLEX LIMITER FEATURES SEPARATE COMPRESSION, LIMITING AND EXPANSION FACILITIES. 5. FOR SPECIAL APPLICATIONS, THE VOICE-OVER LIMITER AUTOMATICALLY MAINTAINS A PRE-ESTABLISHED MUSIC TO VOICE RATIO. 6. AND, THE UNIQUE SELECTIVE LIMITER CONTROLS LEVEL IN ONE FREQUENCY REGION WITHOUT MODULATING THE REST OF THE PROGRAM.

WITH FEATURES LIKE ADJUSTABLE ATTACK, RELEASE AND RATIO AS WELL AS STEREO COUPLING, "SIDE CHAIN" ACCESS AND "SOFT KNEE" SLOPES AT THE THRESHOLD OF COMPRESSION, THESE EXCEPTIONAL LIMITERS ARE THE MOST PROFESSIONAL CHOICE FOR EFFICIENT, LOW DISTORTION LEVEL CONTROL. CALL TOLL FREE, 800-426-6170 FOR DETAILS ON THESE AND OTHER FINE AUDIO PROCESSORS FROM AUDIO & DESIGN.

AUDIO & DESIGN RECORDING, INC. • P. O. BOX 786 • BREMERTON, WASHINGTON 98310  
TELEPHONE (206) 275-5009 • TELEX 15-2426

AUDIO & DESIGN RECORDING, LTD. • NORTH STREET • READING RG1 4DA • BERKSHIRE, ENGLAND  
TELEPHONE (0734) 53411 • UK TELEX 848722

Copyright 1981 by Audio & Design Recording, Inc.



THE HIT SOUND IN AUDIO SCIENCE

Circle 16 on Reader Service Card

a sigh of pleasure. Virtually no seams were visible. Why is this important?

A tightly and solidly built studio will give the best translation of low frequency sound—the hardest to control. Depending on the particular wall, we used sound board, plywood, sheetrock, particle board in various combinations. The rigid boundary walls go the full shot, with the addition of one inch of concrete on each side.

We were half done! One fact was indisputable, even in open framing and exposed concrete, it was beautiful.

### **SANO ELECTRIC**

After we had framed and sheathed the walls and ceilings, the next job was running all the conduit for electrical and audio lines.

By now, everyone had become compulsively meticulous. We believed that our obsessive attention to detail would make the critical difference between a good studio and a great studio. And also, I think by concentrating on the work, each of us who were to use the studio found an outlet for the frustrations of a project that had passed even the most skeptical estimates for getting done.

The "star-ground" electrical system and audio wiring were an exercise in patience. Bob Missbach and I ran miles of 3/4-in., 1 1/4-in. and 2-in. conduit. Neither of us had done much of this work (our first pipe bends, later replaced, looked like abstract sculpture). As we got the hang of it, Bob suggested our work looked so sanitary that we dubbed the phase "Sano Electric."

The few of us who had seen the electrical runs, now hidden, were awestruck. All the pipes were isolated mechanically by using flex wherever a run went from a wall to a ceiling or to a box.

No conduit made direct mechanical contact with the framing or through wall runs even though the entire system was air tight. The real challenge was the mood lighting system. Four discrete 4-channel track-light systems were installed providing absolute control through a giant dimmer panel that took Bob over a month to design and build.

The real triumph was the control room audio conduit. Starting from the console trench, a dozen 2-inch runs of conduit ran to the center of the room, and then fanned out to their assigned destinations. We built the floor supports *around* the completed conduit array.

Once the electrical and audio runs were done, we started sealing walls in earnest. All through construction, after and between each layer, we caulked with acoustical sealant. The stuff was great, but it never really dried, resulting in a constant battle to avoid minefields of ambushing goo. We must have used enough goo to fill 20 tank cars. I know because at least 500 gallons stuck to my clothes, hair and body.

### **THE FINALE: 10¢ TOURS**

When you begin a studio (this is my fourth; I built a small 4-track room during a layoff) there are a lot of boring big jobs, like framing, and very little human traffic. We would go for days on end when the only visitors were people who had gotten lost on the way to the nearby county dump. Not so as the studio took shape. The work became more involved and meticulous and it seemed that every ten minutes we were stopping while somebody showed somebody else through. Of course, this was sometimes future business, but usually it was somebody's racquetball partner who wanted to impress his date.

Occasionally the visitor knew something about construction, but not very often. You'd tell them, "The whole place is framed 2 x 6 on 16-in. centers, screwed, glued etc.," and they'd look at you with a blank expression.

A good number of industry people who were shown through expressed disbelief at our approach. They'd comment on the size of the drum booth (failing to notice the 20-in. of isolation walls that separated it from the studio) saying, "Isn't this a little tight?" (Now that the refrigerator, the 100 sheets of pectan paneling and our fiberglass stash is out of the booth, it looks its full size. Big enough for drums, not quite big enough to rent out as a disco.)

Anyway, when someone came through who understood what we were trying to accomplish, the effect was heartwarming. We never tired of explaining the details to those who really appreciated them. Yet the 10¢ tours did take up our favorite commodity, time, time, and more time.

I have overheard many discussions about the LEDE concept, and though I know it's difficult to change a person's pre-conceptions through discussion, I feel that once someone comes back to hear our finished room, he/she will be back to record.

Tres Virgos is nearly completed; a statement that will be true for some time now, as we complete the off-line facilities. Like a lot of slogans, "state-of-the-art" isn't a state of anything, it's a flow. Tres Virgos underwent structural and electrical changes and improvements through every stage of construction. All these innovations lengthened the construction time, yet no one connected with the project ever got anxious or up-tight about the delays. The owners, Allen, Robin (Yeager), Jerry (Jacob) and Mike (Stevens) are 100 percent committed to excellence, and, even though none of us imagined the changes we would go through, or the time it would take, the commitment never faltered.

Tres Virgos is our instrument and an instrument is only as good as it is made. We're all waiting to hear the music we will make on our instrument. Wait till you hear mine! ■

## **Tres Virgos Equipment List Main Studio**

### **TAPE RECORDERS**

- MCI 528 B Console (Transformerless)  
—Modified with Aphex VCAs and custom interface circuitry
- MCI JH-24 16/24 Master Recorder (Transformerless)  
—Custom interface circuitry
- Ampex ATR-100 1/2 track Master Recorder  
(Transformerless)—Modified
- Otari 5050 (2) 1/2 track recorders

### **MONITORS**

- Urei 813s
- Urei 811s
- MDM-4s
- Auratones
- AKG-Assorted head phones

### **AMPLIFIERS**

- Crown M-600s
- Crown D-400s
- Crown D-150s
- Crown D-60s
- BGW-750

### **SIGNAL PROCESSING**

- Studio Technologies Ecoplate
- Eventide 949 Harmonizer
- Marshall Time Modulator
- Lexicon Prime Time
- Keplexes/Gain Brains
- Various limiters, equalizers, compressors, springs, tanks, etc.

### **MICROPHONES**

- Assorted; Neumann, PZM, AKG, Beyer, Sennheiser, Electro-Voice, Shure Microphones.

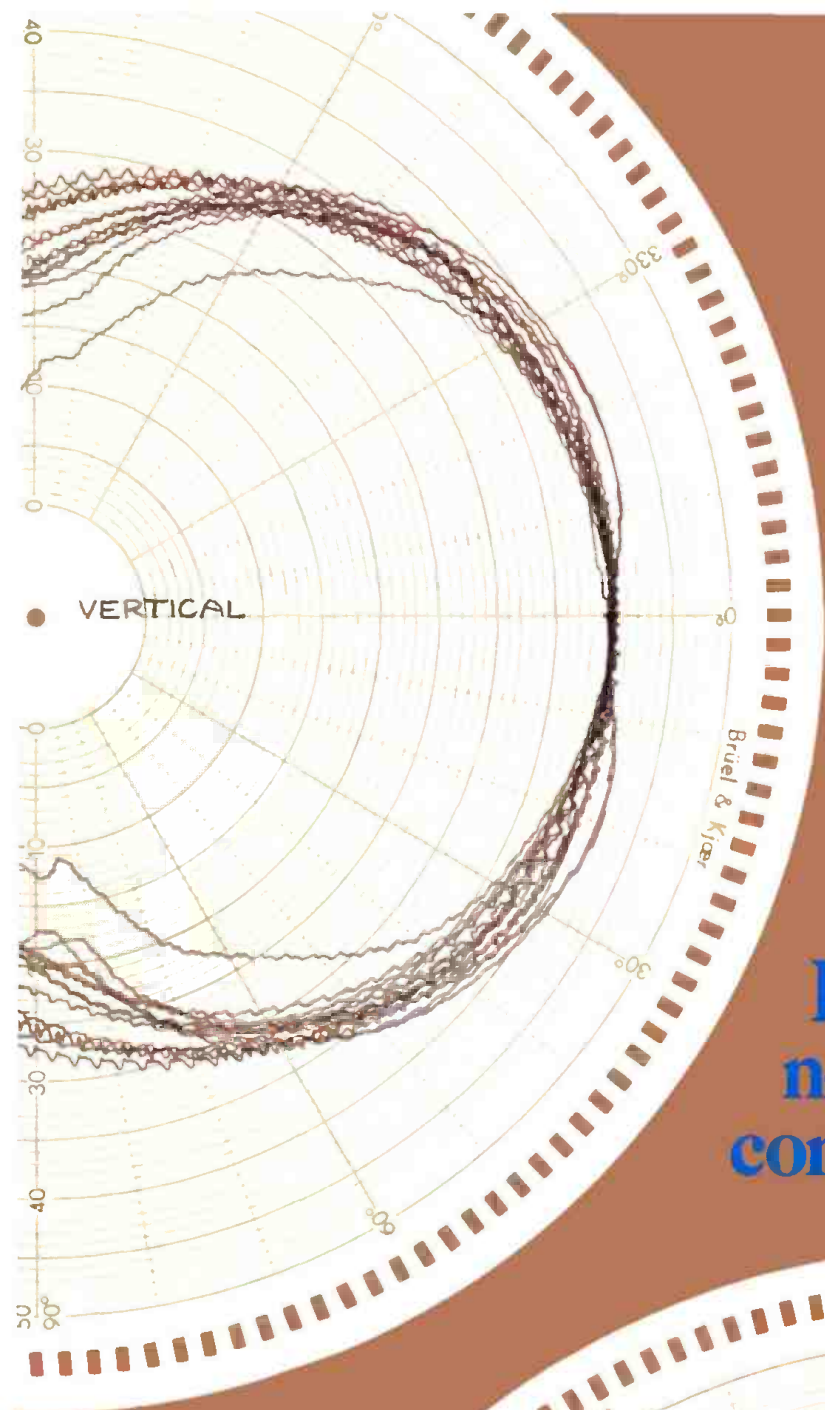

Before you invest in  
new studio monitors,  
consider all the angles.

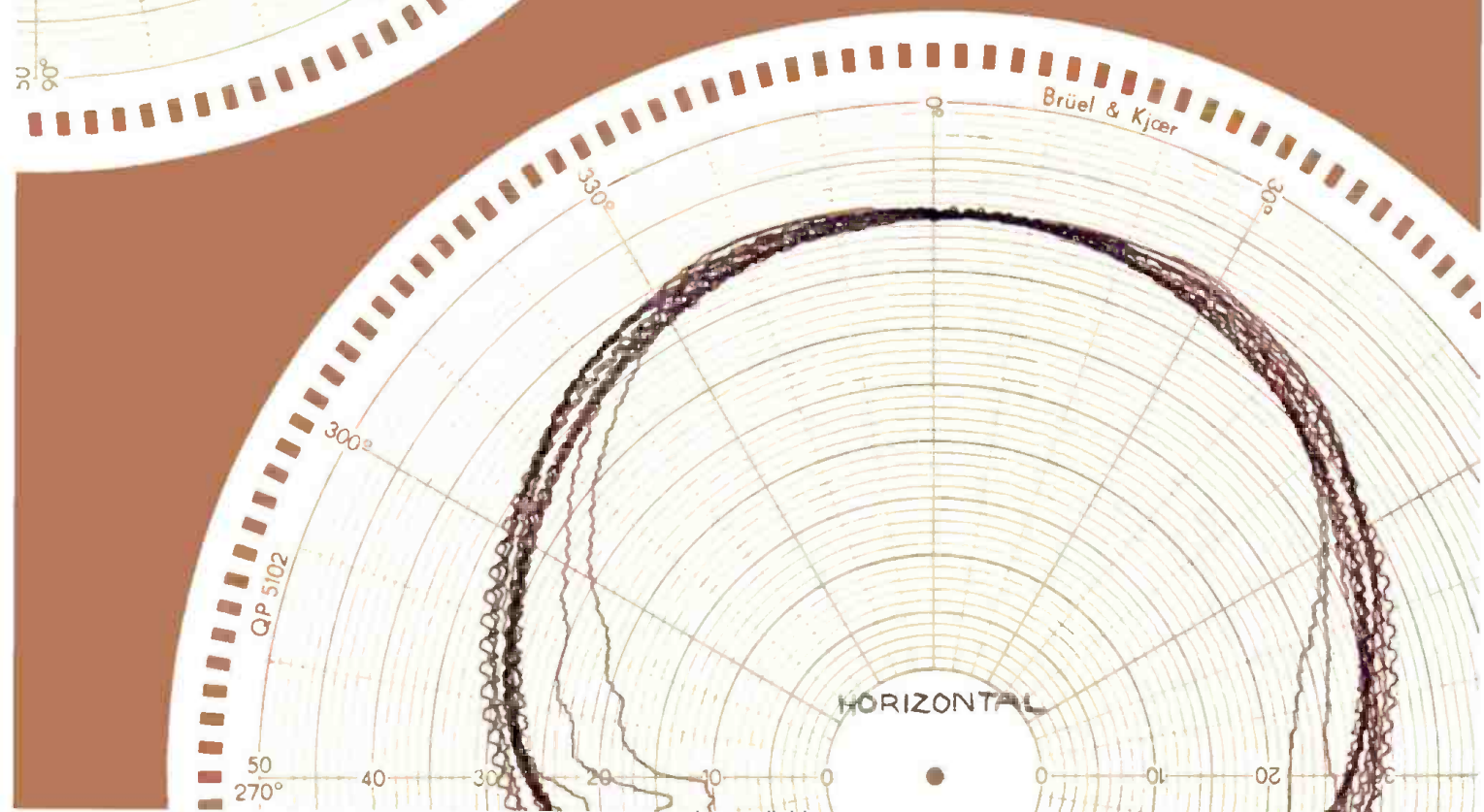

# Introducing the JBL Bi-Radial Studio Monitors.

No one has to tell you how important flat frequency response is in a studio monitor. But if you judge a monitor's performance by its on-axis response curve, you're only getting part of the story.

Most conventional monitors tend to narrow their dispersion as frequency increases. So while their on-axis response may be flat, their off-axis response can roll off dramatically, literally locking you into the on-axis "sweet spot." Even worse, drastic changes in the horn's directivity contribute significantly to horn colorations.

*Polar response of a typical two-way coaxial studio monitor:*

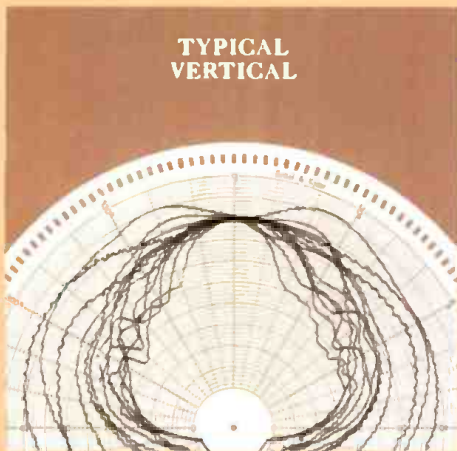
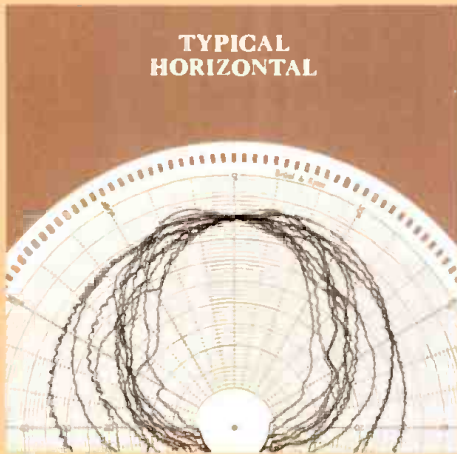

At JBL, we've been investigating the relationship between on and off axis frequency response for several years. The result is a new generation of studio monitors that provide flat response over an exceptionally wide range of horizontal and vertical angles. The sweet spot and its traditional restrictions are essentially eliminated.

*Polar response of a 4430 studio monitor:*

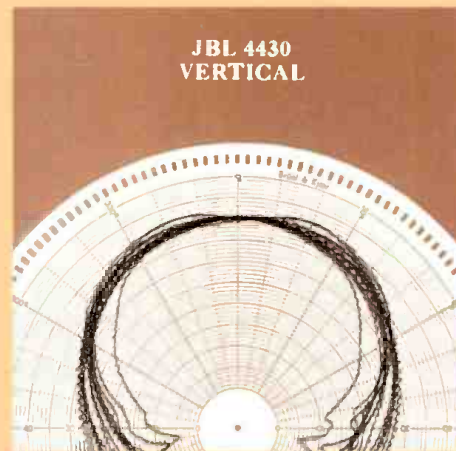
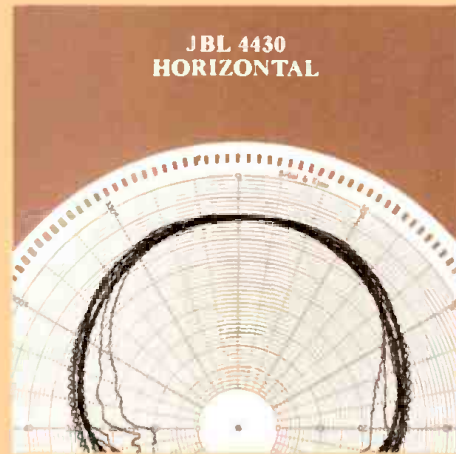

## The Bi-Radial Horn

The key to this improved performance lies in the unique geometry of the monitors' Bi-Radial horn! Developed with the aid of the latest computer design and analysis techniques, the horn provides constant coverage from its crossover point of 1000 Hz to beyond 16 kHz. The Bi-Radial compound flare configuration maintains precise control of the horn's wide  $100^{\circ} \times 100^{\circ}$  coverage angle. Since this angle is identical to the coverage angle of the low frequency driver at crossover, the transition from driver to driver appears seamless and the monitors present a fully coherent sound source.

And the Bi-Radial horn's performance advantages aren't limited to just beamwidth control. The horn's rapid flare rate, for instance, dramatically reduces second harmonic distortion and its shallow depth allows for optimal acoustic alignment of the drivers. This alignment lets the monitors fall well below the Blauert and Laws criteria for minimum audible time delay discrepancies.

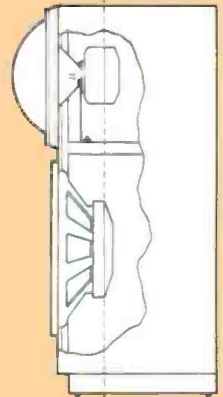

*Acoustic alignment of drivers (4430)*

The practical benefits of the Bi-Radial horn design include flat frequency response and remarkably stable stereo imaging that remain valid over a wide range of listening positions. The design also allows considerable latitude in control room mounting. Finally, the flat on and off axis frequency response of the horn means that less high frequency equalization will be required to match typical house curves.

But while the Bi-Radial horn offers outstanding performance, it's only part of the new monitors' total package.



## Extended Response in a Two-Way Design

Coupled to the horn is a new compression driver that combines high reliability and power capacity with extended bandwidth and smooth, peak-free response. The driver features an aluminum diaphragm with a unique three-dimensional, diamond-pattern surround! Both stronger and more flexible than conventional designs, this surround provides outstanding high frequency response, uniform diaphragm control, and maximum unit-to-unit performance consistency.

*JBL's diamond suspension diaphragm combines performance with reliability.*

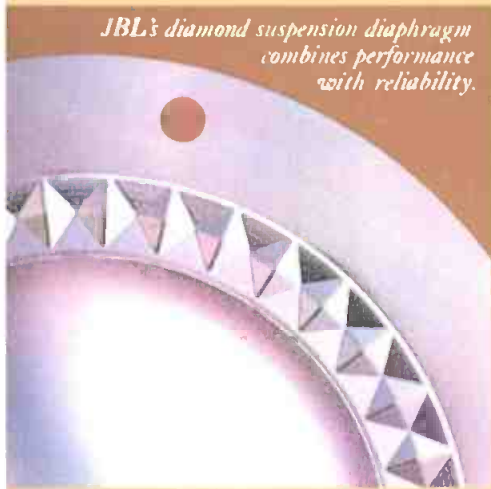

To ensure smooth response to the lowest octaves, controlled midband sensitivity, extremely low distortion, and tight transient response, the Bi-Radial monitors also incorporate the latest in low frequency technology. The loudspeakers' magnetic structures feature JBL's unique Symmetrical Field Geometry (SFG) design to reduce second harmonic distortion to inconsequential levels. Additionally, the speakers utilize exceptionally long voice coils and carefully engineered suspension elements for maximum excursion linearity, and complete freedom from dynamic instabilities for tight, controlled transient response.

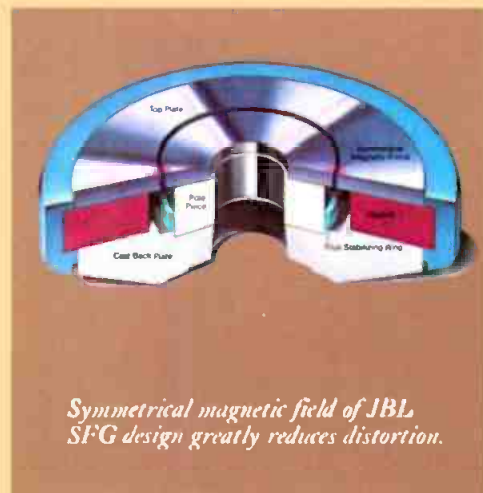

*Symmetrical magnetic field of JBL SFG design greatly reduces distortion.*

## Blending the Elements— The Dividing Network Challenge

Tailored to the acoustical characteristics of the Bi-Radial monitors' high and low frequency drivers, the dividing network provides the smoothest possible response over the widest bandwidth while restricting any anomalies to an extremely narrow band. During the network's development, JBL engineers paid considerable attention to on-axis, off-axis, and total power response. As a result, the electrical characteristics of the network are optimized for flat response

over the monitors' full coverage angle.

The network also provides equalization of the compression driver for flat power response output. This equalization is in two stages with separate adjustments for midrange and high frequencies.

## Judge For Yourself

Of course, the only way to really judge a studio monitor is to listen for yourself. So before you invest in new monitors, ask your local JBL professional products dealer for a Bi-Radial monitor demonstration. And consider all the angles.

1. Patent applied for.



4430

4435

<b>Specifications</b>	<b>4430</b>	<b>4435</b>
Frequency response ( $\pm 3$ dB)	35 - 16,000 Hz	30 - 16,000 Hz
Power Capacity (Continuous Program)	300 W	375 W
Sensitivity (1 W, 1 m)	93 dB	96 dB
Nominal Impedance	8 Ohms	8 Ohms
Dispersion Angle (- 6 dB)	100° x 100°	100° x 100°
Crossover Frequency	1 kHz	1 kHz
Network Controls	Mid Frequency Level High Frequency Level Switchable Bi-Amplification	



**Professional  
Products  
Division**

**James B. Lansing Sound, Inc.  
8500 Balboa Boulevard,  
P.O. Box 2200  
Northridge, California 91329 U.S.A.**

# The Atlantic Studios Project: A Preliminary Report

*The following is a preliminary report on a work in progress. Author Fierstein will return in a future issue with an updated report.*

**A**TLANTIC STUDIOS, a subsidiary of Atlantic Recording Corporation, is presently undergoing the largest reconstruction since its opening in the fifties. The project is immense, both physically and in the amount of planning required. The work is proceeding full time and is still slated to take another six months to complete. The complete rebuilding and relocation of two mastering rooms, two studios, a mix room, a quality control room, three production rooms, and numerous offices and lounges is proceeding with only the slightest actual downtime, thanks to the meticulous planning of the construction sequence.

## PLANNING

The office of Maurice W. Wasserman, A.I.A. was chosen to direct the construction of the entire complex. Perhaps the architect's most difficult task was to fit all of the desired new rooms, as well as the older rooms which were moved and rebuilt, into the new space, while providing the necessary hallway space, fire exits, air conditioning, duct runs and electrical service boxes. Also required was space for increased soundproofing, and convenient accessways for bands loading equipment in and out. Additionally, the rooms had to be built while work continued at the studio, which meant that mastering rooms, offices and lounges were continually being shuffled around as work finished in one area and demolition began in another. Finally, all the engineers at Atlantic had requirements and ideas which they wanted put into practice.

One interesting function performed by the architects was to precisely design the route by which the huge MCI 56-input console (which comes in one piece by the way) would enter the mix room. Exacting planning was used to make the entrance by way of the vocal booth window, which for acoustical reasons had to be made as small as possible. Two weeks before this writing, the console was installed and the moving-in process went perfectly.



*New mix room under construction. On the left is the polycylindrical auxiliary equipment enclosure and the MCI 56 console (wrapped in blankets). On the right is the left monitor enclosure and the vocal room window (through which the MCI console was delivered).*

## ACOUSTICAL TESTING

The place to begin is, of course, in the design stage. Unlike new studios, Atlantic engineers and management knew from experience what new features they wanted in their rooms, and more importantly, what old features they did not want. Originally, Studio A was built with little thought given to acoustical design, in the days before this was standard practice. Yet talented artists and engineers cranked out hit after hit in this room. In my opinion, its good sound was attributable to the rather random treatments of a variety of designers with generally opposing viewpoints.

So we began by measuring existing acoustical parameters, and accounting for the existing problems. The measurements showed that, like many rooms of late, Control Room B (built in 1977) was not transmitting bass efficiently to the mixing position. However, the speakers were feeding back into live

*Alan Fierstein is president of Acoustilog, Inc.*

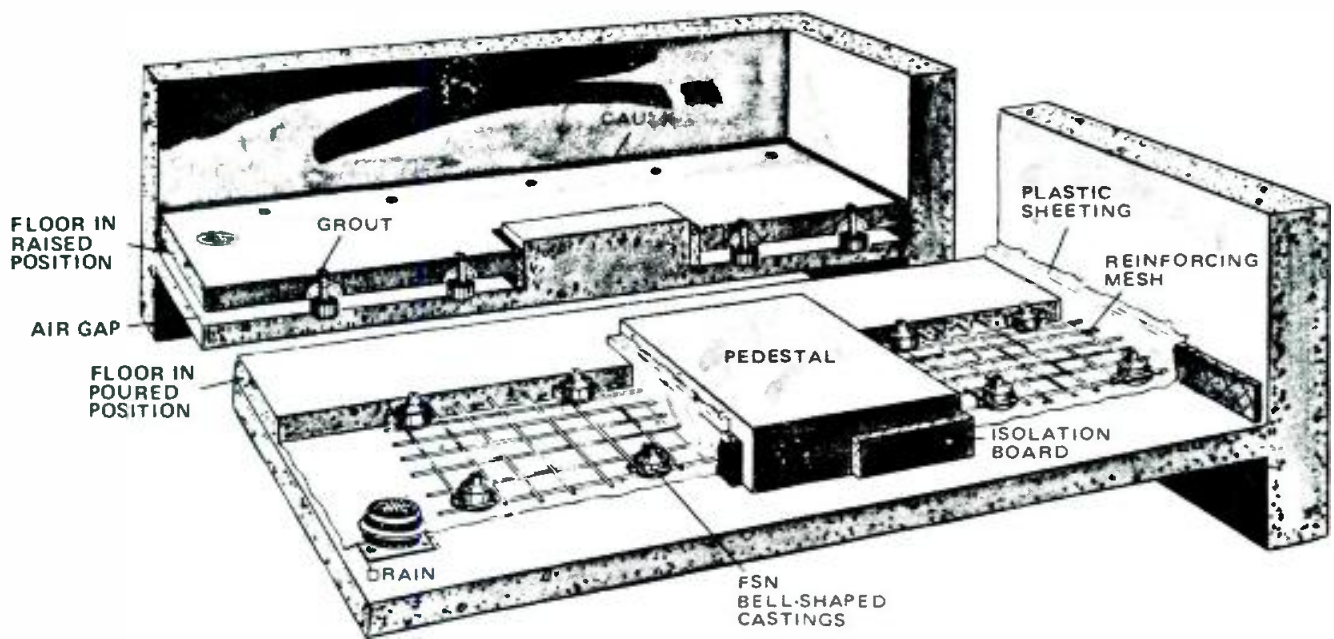

Drawing of poured concrete floor, resting on jack-up mounting. (courtesy of Mason Industries, Inc.)



Detail of jack-up floor system. (courtesy of Mason Industries, Inc.)

microphones in the studio. These problems were caused by the improper speaker mounting, which, by the way, was also present in Control Room A. The two mastering rooms and the mix room shared some of these same speaker mounting problems. Control A also suffered from excessive room reverberation, actually caused by resonance in the window panes. The studios had insufficient isolation between them, and were susceptible to background noise from outside sources such as subways and building pipe vibrations.

It was decided that all the new room designs would incorporate those features which eliminated the common problems, but would of course, differ in those details unique to each room's function. For example, the control rooms, mastering rooms and the mix room will all use totally spring-isolated floors, walls and ceilings, similar acoustic treatments on the room surfaces and special doors and sound locks.

### ISOLATION

The stringent requirements for isolation between rooms were dictated by the studio manager who explained that producers these days are very sensitive about their music and wish to have privacy when doing sessions. The floor is a four-inch reinforced concrete slab which is poured within one set of sound barrier walls, and then lifted up by turning bolts imbedded into spring isolators. Special precautions are taken to guarantee that the concrete slab, and thus the inner walls, do

Front view of new mastering room with UREI speaker in place and cutting engineer George Piros flashing by at high speed. The cutting equipment is the Neumann VMS-70 system.



Rear view of new mastering room showing side wall polycylindrical absorber/diffusers, ceiling cloud, and rear wall cabinetry enclosing mastering computer. Grillwork on ceiling and walls is also shown.



RUBBER PLUG to keep concrete out during pour. Remove plug after concrete has set. Screw adjusting screw into housing to lift floor.

RUBBER WHISKER protrudes after pour.

1336 HOUSING  
Castings are color coded.

REBARS or MESH as reqd. See structural drawings.

FLOATING FLOOR

Grout holes flush after floor is raised.

1" (2.5cm)

FLOOR IN  
POURED POSITION

4-5/8" (11.8 cm)  
5-1/2" (14.0 cm)

POLYETHYLENE SHEET or CONCRETE RELEASE SURFACE

STEEL PLATE

3/4"-10 NC LIFTING & ADJUSTING SCREW

ASSHO SPECIFICATION ELEMENT

FLOOR RAISED TO OPERATING HEIGHT

(courtesy of Mason Industries, Inc.)

## "OR EQUAL" WON'T WORK WITH THE CROWN PSA-2 POWER AMP.



When was the last time you wrote a closed spec? It's hard to believe that "unique" products may still exist.

There is one.

The Crown PSA-2 is the only professional power amp with on-board computers that precisely monitor and control the output devices.

The PSA-2 is the only amp we know that handles problem loads – not by quitting – but by automatically and precisely adjusting its output to fit the load. The PSA-2 keeps on working; you'll

have no trouble with start-and-stop performance because of overload.

That's total reliability – by design. And that design is unique.

There is no "or equal" for the PSA-2. Not even at Crown.

Write or call today for your free copy of the Crown Pro-Amp Info-Pac. It, too, has no equal.



...WHEN YOU'RE READY FOR REAL!

1718 W. Mishawaka Rd., Elkhart, IN 46517, (219) 294-5571

Circle 43 on Reader Service Card

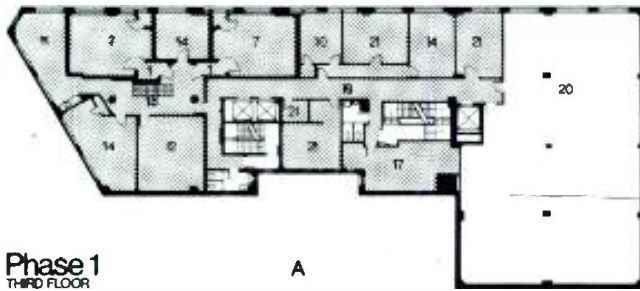

Phase 1  
THIRD FLOOR

A



Phase 2  
SECOND FLOOR

B

Four different views of the construction of Atlantic Recording Studio. (A) completed (B) completed (C) under construction (D) in design phase

**Project Key**—(1) Sound Lock; (2) Iso Booth; (3) Amp Closet; (4) Control Room; (5) Studio; (6) Mix Room; (7) Mastering Room; (8) Tape Copy; (9) Post Production; (10) Quality Control; (11) Lounge; (12) Tape Library; (13) Shop; (14) Office; (15) Reception; (16) Studio Reception; (17) Mechanical Room; (18) Stair Hall; (19) Public Corridor; (20) Tenant; (21) Storage; (22) Shower.

Detail of floor, wall and ceiling suspension systems. (courtesy of Mason Industries, Inc.)

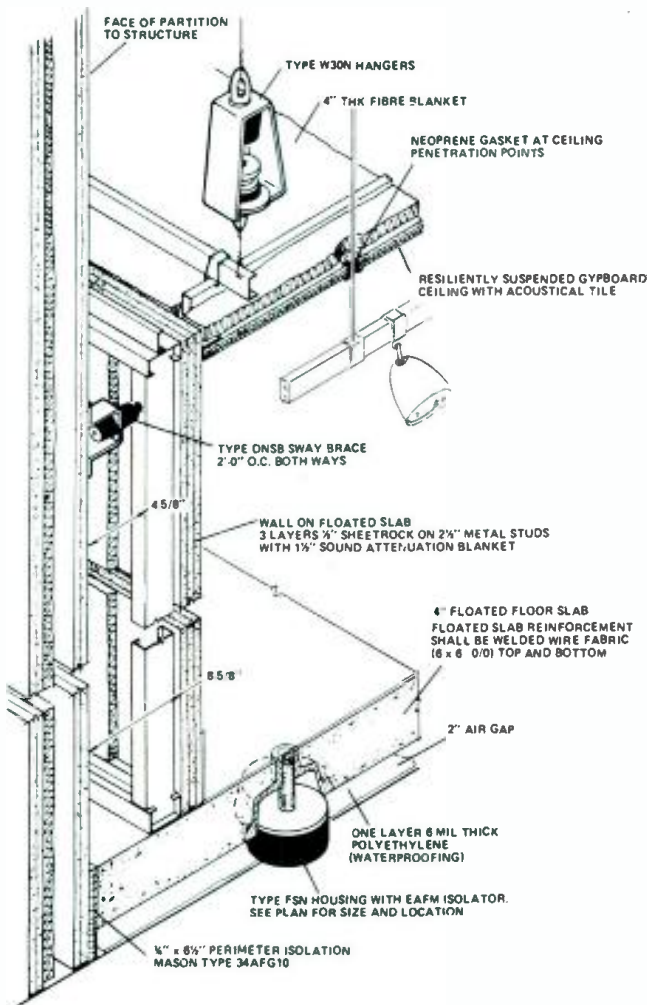

not touch the outer sound barrier walls. After the wall is lifted, the inner walls are built on its perimeter. Sway braces allow future stress on the walls to be accommodated safely, without undue coupling between the inner and outer walls which would have a detrimental effect upon the soundproofing. The ceiling is hung from the structural slab above using combination spring/neoprene hangers; the metal springs isolate the low frequencies and the neoprene prevents transmission of impacts such as footsteps from above. During the entire procedure, frequent inspections of the job details are required by the acoustical consultant and the architect to catch any mistakes before they are forever buried in the walls.

### INTERIOR TREATMENT

Highly-damped bass absorbers in the shape of polycylindrical diffusers were constructed using special bending sheetrock, carefully formed by laminating one layer at a time until the desired thickness was achieved. The final treatment, consisting of a flexible tambour wood stripping which diffuses the high frequencies through the room, was then applied with glue. These "polys" were also used to house the mastering computer in the cutting rooms, and auxiliary equipment in the control rooms.

The wooden grillwork used in the rooms was built at the shop and then transported to the job. The grillwork was designed by the architect to be built in sections large enough to be economical, but small enough to be unscrewed and removed when trimming the room ambience, as was done when the first rooms were finished. Hidden behind the grille are removable fiberglass boards covered by a flameproofed cloth. Additional grillwork was installed to eliminate a strong late reflection off the flat surface of the door, detected by the use of the IMPulser measurement technique. (See the author's "Acoustical Troubleshooting" in the October, 1980 db—Ed.)

The ducts which open into the rooms can carry sound to adjoining rooms or into the hallway, so sound traps were installed at strategic locations along the duct runs. Proper duct sizing and flow considerations such as turns, vanes and tapering were used to insure inaudible noise from the HVAC system. The first measurements made indicate that each mastering room is achieving, even in the semi-finished state, better than NC-16 with the air on and full-power music in the adjacent mastering room. The sheet-metal ducts open into the room in the area between the speakers, where they are subject to severe acoustical excitation. Therefore, we added mastic-faced damping sheets which have eliminated all the audible resonances.

Storage space was provided in liberal amounts, and in such a way to avoid compromising the acoustical design. For example, cabinets on the side wall of the mixing room perform the function of mid-frequency diffusion and are balanced by diffusing beads on the opposite wall. In the mastering rooms, rear wall shelves containing noise reduction units, amplifiers and tape supplies perform the same function, in conjunction with a special ceiling cloud which supports lights, ducts and liberal amounts of low-frequency absorption, more commonly known as "traps."

Though bearing little resemblance to other structures of the same name, the low-frequency absorbers were "tuned" by measurement of the room reverberation as a function of

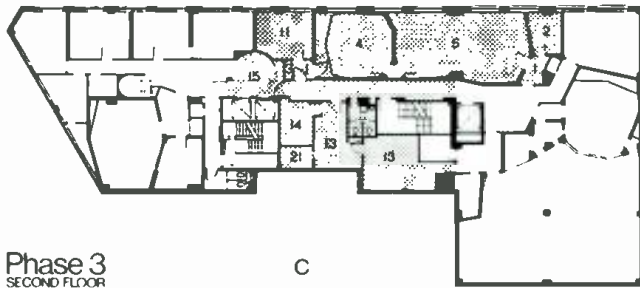

Phase 3  
SECOND FLOOR

C

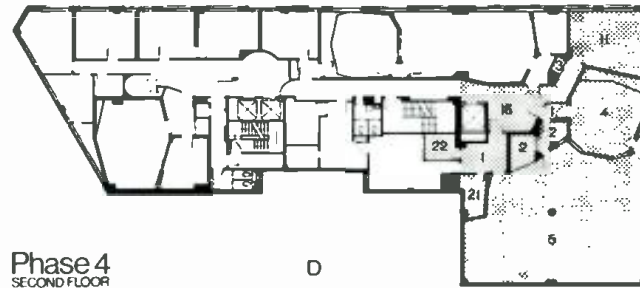

Phase 4  
SECOND FLOOR

D

frequency and by then calculating the necessary absorbing units required to achieve the desired curve of T60 vs. frequency. Differences in construction materials and techniques mandate that this measurement and others be made, and the corrections applied, before assuming that the room is completed and ready for service. This technique has proven itself as being simple and extremely effective in satisfying the ears of the engineers who have to work in these rooms.

An extensive series of speaker tests is presently underway to choose monitors for the various rooms. Using one of the almost-finished mastering rooms, the speakers were tested for power handling capability, smoothness of frequency response, horizontal and vertical dispersion, and sound quality with blind listening tests. It is interesting to note that earlier tests under poor comparison conditions led to quite different results among the engineers. It is my feeling that too often side-by-side listening tests are unfair to all of the loudspeakers in the test, some more than others. But it is a credit to the studio management that they would go to the trouble and expense of comparing the latest choices on the market in order to intelligently pick the right monitors. At this point, the

decisions have not yet been made, so I cannot report them. However, Urei 813 speakers are presently installed in the first mastering room to be completed.

It is gratifying to note that the initial tests in the first rooms finished show that the former design problems are absent here, with plenty of bass at the mixing position, even balance throughout the room, an extremely flat reverberation vs. frequency characteristic, and lack of outside noise.

The engineers all seem quite pleased with the rooms, although there was a bit of disappointment as the rooms shrunk with the installation of the thick, soundproof wall and ceiling surfaces. But the problems of the previous installation are absent, at least in the rooms thus far completed. ■

#### PARTICIPANTS

Dave Teig, General Manager  
Maurice W. Wasserman, A.I.A., Architect, with Jennie Young, Project Manager, and Janet Waterhouse, Designer  
Alan Fierstein, Acoustilog, Inc., Acoustical Consultant  
Harold Rosen Associates, Electro-Mechanical Consultants  
Calcedo Construction Corp., General Contractor

## WE'RE EXPANDING THE PZM™ CHALLENGE!



Now, PZM™ technology is available in two new Crown clip-on mikes. Both offer important improvements.

The problem of microphonics has been practically eliminated. Either mike can be concealed under clothing with minimum distortion or fabric noise.

These PZM mikes sound better than the leading conventional clip-on mike. You'll hear the difference.

They're durable – the only clip-on mikes, in fact, with a full three year warranty.

The base plate of the PZM-2LV rotates on the clip. No matter where it's worn, the cord can be comfortably positioned. In the Crown PZM-3LV "tie-bar" model, the transducer housing is mounted directly to the clip, for a minimum profile.

Both mikes are the product of thorough, careful Crown research. That's your assurance that these clip-on PZM mikes will improve "on-camera" and interview applications just as standard PZM mikes do when used on rigid boundaries.

Challenge yourself. Try PZM. Write or call today for your free PZM clip-on Info-Pac. Includes the latest issue of PZMemo, complete product data and a dealer list.

...WHEN YOU'RE READY FOR REAL!

1718 W. Mishawaka Rd., Elkhart, IN 46517, (219) 294-5571

Circle 38 on Reader Service Card

# Architectural Design for Studio One Sigma Sound Studios

*A report on Sigma Sound Studios from the architect's viewpoint.*

**T**HE REQUIREMENTS FOR Studio One were stated clearly by the owner from the beginning: a large open studio with maximum room volume, which would have the acoustical and environmental flexibility to accommodate either large or small groups; and a control room large enough for the new Sphere console, four tape machines and a battery of outboard equipment. In addition, we were asked to provide offices, a private lounge, a musicians' waiting area and a limited amount of storage—all on the second floor.

The existing conditions within and outside the building posed an additional challenge. The two-story building has brick exterior walls, but the second floor and roof construction consists of ordinary wood-joist framing. The center bearing wall (which had originally divided the building into two row houses) had been replaced years before with steel beams and columns. Public access to the second floor is by a stair at the front of the building, but the freight elevator (manual), and toilets are at the rear. These parameters were increased by two serious acoustic problems. Trolleys operate on the street at the building front, and a few hundred feet farther away there is a main line railroad. Yet the most serious acoustical problem was the location of Sigma's Studio Two directly below, on the first floor.

Given the owner's requirements, and notwithstanding the problematical existing conditions, we were determined to design a successful recording complex with a control room and studio that were clearly separate spaces but which, just as clearly, were parts of a unified whole. We wanted both rooms to feel light and spacious and we wanted the studio to be flexible enough to provide a sense of intimacy as well. Since this studio was to replace Sigma's outdated Studio One, we felt that a completely fresh appearance for the rooms was essential.

## STUDIO ARRANGEMENT

In the general floor layout, the offices and lounge were placed at the building front to take advantage of natural light and to create maximum separation of the studio complex from

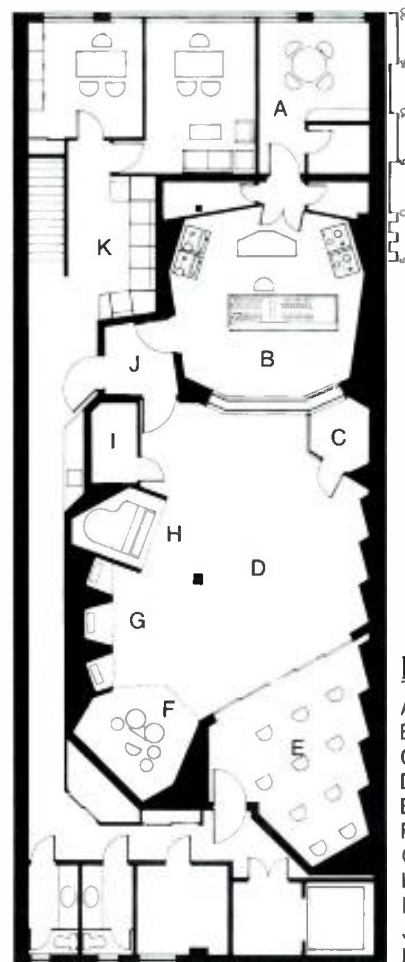

**Key**

A	LOUNGE
B	CONTROL ROOM 1
C	VOCAL BOOTH
D	STUDIO 1
E	STRINGS BOOTH
F	DRUMS
G	GUITARS
H	PIANO
I	STORAGE
J	SOUND LOCK
K	LOUNGE

**Studio No 1  
Sigma Sound Studios  
Philadelphia, Pa.**

*Maurice Wasserman is the architect in charge of the design of Sigma's Studio One.*





*Studio One, showing glass-enclosed string room, drum booth, guitar and piano enclosures.*

street noises. Adjacent to this area is the control room, 22 feet long by 20 feet wide, which is large enough for the very wide Sphere console and for an "island" housing outboard equipment behind it. The console is located within the room for maximum listening in proximity to the speakers enclosed above the control room window. The walls of the control room are splayed and located at distances from the console to create ideal listening conditions as well as to facilitate the operation of equipment close at hand. A unique feature of the room is the fourteen foot bay window which permits maximum visibility of all areas of the studio, string and vocal booths, as well as being constructed around and concealing a column.

The sound barrier construction of both the control room and studio was designed with lightweight materials due to the restriction of limited floor loading capacity. A liner wall, consisting of two layers of gypsum wallboard on metal studs, is fastened with resilient brackets to the exterior walls. To maintain maximum height in the studio, a gypsum wallboard sound barrier is suspended with resilient isolators directly below the sloping roof joists and is designed to serve as the finished ceiling. The isolated floor is a stiff lightweight laminate composed of multiple layers of gypsum wallboard and plywood and resiliently mounted on sealed fiberglass isolator cubes. The stiffness of the floor was greatly improved by the contractor's suggestion to bond the layers together with glue and with adhesive coated staples. All of the isolation devices were supplied by Consolidated Kinetics' Division of Peabody Noise Control.

The studio arrangement was generated by the desire to group musical instruments in particular areas: the drums, guitars and piano in one region; the string musicians (as many as twelve) in another; and a large central open performing space. The 220 square foot string booth is acoustically separated from the studio by five 3-foot, 2-inch sliding glass doors. When the doors are in open position, the central studio receives an additional 17 feet. Yet, should a more intimate appearance as well as "smaller" sound be desirable, the doors are closed and a curtain drawn.

To maximize the studio volume, the barrier walls and isolated ceiling define the room shape. Thus the room reads as surfaces of light walls—the actual gypsum wallboard sound barrier walls—and pale wood strip flooring which has been set at 60 degrees paralleling the sliding glass door/wall. Attached to these surfaces is an inner skin of acoustic treatment. "Clouds" of perforated aluminum panels containing fiberglass batts are suspended below the ceiling. The panels, echoing the 60 degree glass wall angle, parallel the lighting system and are hung at a height to permit continuous indirect light to be bounced off the ceiling. The wall housing the piano, guitars and drums is shaped to accommodate these instruments and includes absorptive and reflective surfaces as well as deep absorptive cavities above the guitar amps. The long wall on the opposite side of the studio has a sawtooth design of folding doors extending into the string booth, which can be opened partially or fully to substantially vary the total room absorption.

## STUDIO LIGHTING

This quality of environmental flexibility is reflected in the studio lighting which consists of two separate systems: one is a direct-indirect fluorescent and the other is direct incandescent. The fluorescent fixtures consists of a lamp partially surrounded by an extruded aluminum tube; they are designed to bounce light off the white ceiling areas between the "clouds" and provide even illumination over the entire studio. An advantage of this system is a substantial energy savings both in lighting and air conditioning loads. The second system of incandescent lighting permits emphasis on the perimeter playing areas, or on spotting and mood lighting of the center of the room. In this way, the studio may change from a feeling of spaciousness to one of intimacy.

Designing and building Sigma's Studio One was not an easy task because the building itself imposed several difficult problems. These problems were overcome and a refreshing scheme for a studio design was developed by a small group of people who were far apart physically (Los Angeles, Philadelphia and New York), but who worked very closely together: Joe Tarsia, President of Sigma; George Augspurger, Acoustical Consultant; Eddie Gigante, Builder; and Janet Waterhouse, Project Designer from Maurice W. Wasserman's office, who saw the design through from initial concept to completion of working drawings. ■



**THE INTELLIGENT  
CLEANS UP**

# The Sound Technology 1500A

It's the first microprocessor controlled audio measurement test system. It can do in minutes what used to take hours with more conventional and ordinary test set-ups. And, it can show you things you've never seen before.

Designed around the most advanced microprocessor hardware, the 1500A will show you the whole story on an integral CRT with adjustable cursor. Push a "Copy" button, and it delivers a hard-copy printout from the optional VP-150 Video Printer.

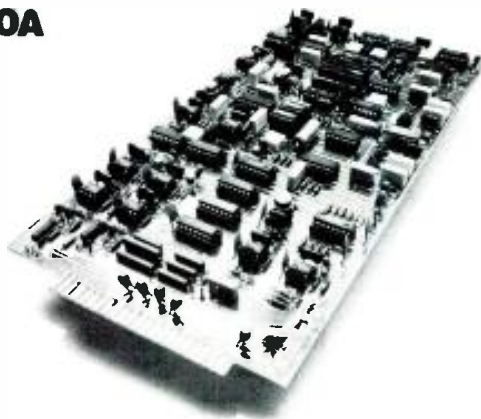

- Quality control for high speed tape duplication systems
- Semi-automated production testing
- Research and development for the audio tape manufacturer
- Quality assurance for the audio distribution network
- Exclusive asynchronous inputs and outputs for remote location testing (satellite, transmitter, studios, etc.)

Here's the kind of data you can get:

- Frequency Response
- Azimuth at 4 discrete frequencies
- 2nd and 3rd Harmonic Distortion Vs. Level
- Wow & Flutter; noise; weighted or flat
- Channel Separation 20Hz - 20k
- Delta Speed & Drift

Because of the modular plug-in design, the 1500A is designed to grow with you. The first plug-in option will be available soon: a spectral noise and flutter card. Other current accessories include a hard-copy printer, flight case, rack mounting ears, and our own test record for phono cartridge analysis.



## Who Can Use It?

Broadcaster. Recording studio. Film sound studio. Audio manufacturer. Audio dealer. Service technician. Researcher. Virtually anyone whose job requires accurate evaluation of audio equipment performance. Wherever you are in the audio spectrum, it can make life a whole lot easier.

Clean up your act with the 1500A. It's intelligent. And so is a phone call to Sound Technology. We'll be pleased to send full information on the 1500A and our other industry standard test equipment.



## What Will It Do?

Conceived to be the ultimate precision test instrument for tape recorder analysis, the 1500A evolved into a comprehensive audio test system for many applications. Here's just a small sample of the varied jobs it will do:

- Complete tape recorder mechanical and electronic performance checks
- Thorough phono cartridge analysis
- One-third octave spectral analysis
- Evaluation of audio quality for VTR's
- Acoustical room analysis including microphone and loudspeaker measurements

Please send me more information on how the Sound Technology 1500A System can help me clean up my act.

NAME \_\_\_\_\_

COMPANY \_\_\_\_\_

ADDRESS \_\_\_\_\_

CITY \_\_\_\_\_ STATE \_\_\_\_\_ ZIP \_\_\_\_\_

PHONE \_\_\_\_\_

**S SOUND** Department 3003102, 1400 Dell Avenue, Campbell, CA 95008  
**T TECHNOLOGY** (408) 378-6540 TELEX: 357445

# TEST SET THAT YOUR ACT.

© Sound Technology 1981

Circle 50 on Reader Service Card

# Contemporary Mixdown Room Design

*In this first of a two-part series highlighting Sigma Sound Studios, the subject is the design of mixdown rooms, as seen in terms of the author's own work for Sigma.*

*Sigma's Studio 1 dates back to 1958. Except for some minor changes, it stayed basically the same for some 22 years. From Frankie Avalon and Chubby Checker, to Teddy Pendergrass and Lou Rawls, it's been the site of many successful recordings. And, while the mystique created by the room's success gave it an international reputation, its sophistication by today's standards was—to say the least—limited.*

*We realized that the space required for today's state-of-the-art recording equipment, and the physical demands of a sophisticated listening environment, could not be met within Studio 1's existing configuration. Therefore, we decided to build (notwithstanding the limitations imposed by available space) a recording facility that would be second-to-none.*

*In our preliminary design meetings, it was determined that we could achieve a studio space of approximately 1150 square feet, and that it should have an acoustic quality suitable for today's live recording sound, provide monitoring for video scoring, lighting suitable for shooting video, a totally-isolated electrical ground system, and an isolation room large enough to hold approximately 15 musicians. The control room would feature a 48-track recording system with SMPTE and video capability. We would require custom four-band equalizers with variable cue and cut-off filters on each input. The automation system would include the capability of remembering all console static settings. Last, and most important, our control room design would provide the best possible stereo monitoring.*

Joe Tarsia, president  
Sigma Sound Studios

**M**OST RECORDING STUDIO control rooms are used for both tracking and mixdown. Of the two, mixdown is generally conceded to be the more demanding in terms of acoustical performance. A room used solely for tracking may well be designed differently than an ideal mixdown environment, but a control room used for both functions will always be optimized for mixdown.

Interestingly, good mixdown rooms are not intended to be "perfect" listening rooms. For their home listening, recording engineers do not replicate their favorite mixdown rooms. Instead, the mixdown room is used as a working tool. It should enable the engineer to assemble a final product that may be multi-layered and very complex, yet which retains its integrity when heard in a wide variety of listening situations. Obviously,

the room must be comfortable, quiet, and acoustically isolated from adjoining control rooms and studios. Beyond these basics, the rooms accepted as "good" by professional recording engineers differ, but not all that much. The range of sizes, design features, and acoustical characteristics is really fairly narrow.

In the years since 1975, I have been directly involved in the design of more than one hundred control or mixdown rooms. I have also had the chance to test monitor speaker performance and make acoustical corrections in another hundred or so rooms. This article describes what I feel are good design practices. Control Room 1 of Sigma Sound Studios in Philadelphia is used as an example. It is one of the most recent designs in which I have participated. Also, it points out not only the characteristics of a successful design, but also the kinds of trade-offs that must be made in the real world.

## CHARACTERISTICS OF GOOD MIXDOWN ROOMS

**Speaker Geometry.** The primary monitors may be any of three or four highly regarded loudspeaker systems (the Sigma control room uses ÜREI 813s). Monitors are located ten to eleven feet from mix center, subtending an angle of about 60 degrees in plan view. The speaker axes cross about three feet behind the console. Speakers are usually flushed into the front surface of the room, although free-standing monitors are by no means non-existent. The loudspeakers can be located above the studio window or, where room geometry permits, slightly above ear level.

The Sigma control room is conventional in that monitors are located above the window, but the room illustrates a couple of refinements that I like to include. First of all, the alcove above the window is left open and unobstructed until the speaker systems are installed and aimed correctly. Then the extension of the baffle surface is developed by trial and error for smoothest response. Everything is hidden behind removable grille cloth panels. In this way, the monitors can be replaced at any time without ripping out half the control room.

Secondly, room front corners are not used for entrances. This means that the speaker shelf can be dropped below door height. In the Sigma room the shelf is about 76 inches above the floor. This puts the sound source roughly 46 inches or 20 degrees above ear level, a good trade-off between optimum listening conditions and studio visibility. It is not quite as lifelike as the ten-degree angle I consider optimum, but it is a familiar and comfortable geometry for recording engineers.

*G. L. Augspurger is an acoustical consultant with Perception, Inc.*

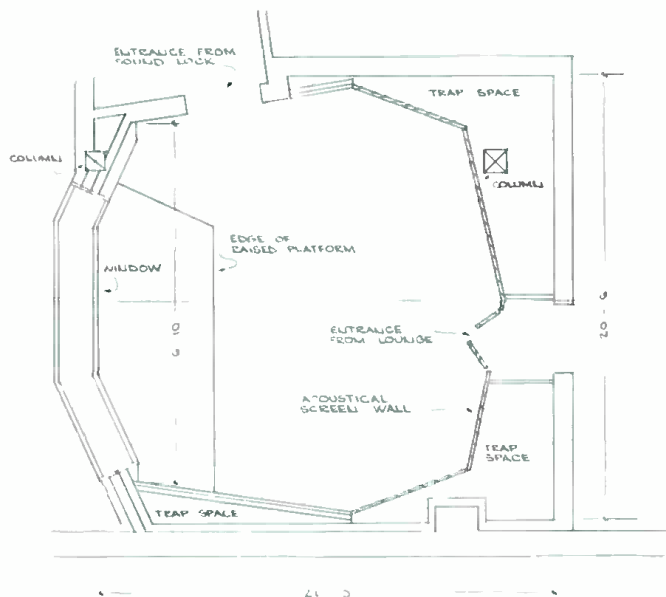

Figure 1. Floor plan of Sigma Sound Studios Control Room 1.

**Room Shape.** The more successful mixdown rooms are bilaterally symmetrical, 16-19 feet wide at the front and 20-24 feet wide near the rear. Because studio floor space is at a premium, the structural shell of most control rooms is no more than 24 feet deep. Room volume lies typically between 4,000 and 6,000 cubic feet. FIGURES 1 and 2 show basic dimensions of the Sigma control room. Given total design freedom, I would have increased overall room depth to 26 feet, but this would have taken up space needed for other functions. The rear wall and rear splays inside the structural shell are made of acoustically transparent wood grillwork. This construction provides a way to adjust room acoustics without affecting the architect's interior design. How the acoustical partition functions is explained in more detail a little further on.

A great deal of myth and magic is associated with the interior ceiling contour of a mixdown room. Some designers swear by the "compression ceiling," which slopes down from the monitor speakers to the console. The obvious counterpart is an "expansion ceiling" which slopes upward. Some rooms have level false ceilings with various areas made of different absorptive and reflective materials.

Although generalizations are dangerous, it is my feeling that a compression ceiling often gives a "punchier" subjective quality than other configurations, but it is also likely to introduce strong tonal coloration because direct and reflected sound waves combine in comb-filter fashion at the mixer's chair. After much discussion, Joe Tarsia and I decided that the relative novelty of an expansion ceiling, plus the probability of more open sound quality was worth a try. In the final design the ceiling plane is broken; the central section slopes upward while the underside of the surrounding soffit is level. Additional high frequency scattering is provided by the massive lighting structure.

**Acoustic Treatment.** In contrast to home listening rooms or small recital halls, mixdown rooms tend to be relatively dead, but not too dead. Reverberation time is less than one-half second, typically between 0.25 and 0.3 second at mid frequencies. The average absorption coefficient lies between 0.25 and 0.5, typically around 0.33. Most monitor loudspeakers have directional characteristics such that the ratio of direct-to-reflected mid-frequency sound at the console is close to unity. Measurements in a number of successful rooms indicate that equal parts of direct and reflected sound is indeed a desirable situation.

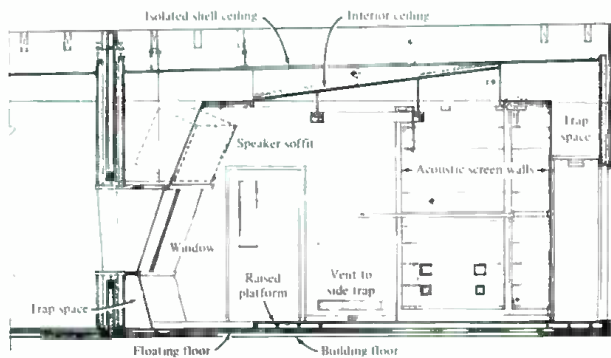

Figure 2. Section view of control room.

Placement of absorptive and reflective elements in the room is a source of passionate argument. Personally, I like to make the front of the room more live than the rear, but only a little. I try to design for similar absorption in all three orthogonal modes: front-to-back, side-to-side, and top-to-bottom. Then, after the room is almost finished, I adjust mid and high frequency reflections by playing with small absorptive and reflective patches until I am satisfied that special effects, echo and inner detail can be heard in their intended relationships.

In most cases there is good agreement between this subjective tuning process and a measured decay slope that is relatively uniform from about 125 Hz upwards. However, you can't work for uniform reverberation time versus frequency and then assume that the room sounds as good as it ever will. There are control rooms in which the addition of about 50 square feet of reflective surface to the floor, a few patches of absorption on the ceiling, and a little extra scattering from the side walls resulted in an easily heard change in the depth of the stereo image, the character of bass instruments, and the amount of echo on the vocal track. Yet the reverberation time and the ratio of direct-to-reflected sound were not changed. What was changed was the directional structure of the reflected sound field.

Maintaining an absorption coefficient of 0.33 down to 30 Hz is almost impossible, yet substantial absorption in the range below 125 Hz is one of the things that separates good mixdown rooms from mediocre ones. Whether by accident or design, reverberation times of good rooms in the 40 Hz region are rarely more than twice those at 1,000 Hz.

### LOW FREQUENCY PROBLEMS AND PARTIAL SOLUTIONS

The question of low frequency performance deserves special consideration, so let's consider it in a little more depth. First of all, we cannot eliminate "standing waves," nor would we want

Figure 3. View toward rear of control room showing "tunable" screen wall.





to. Resonance frequencies are an acoustical attribute of any enclosed air volume. They tell your brain that you are in a room instead of marooned in empty space. If the room's average absorption coefficient is not too great, and if absorptive areas are scattered fairly uniformly on all surfaces, a highly diffuse sound field can be realized at mid and high frequencies. In such a diffuse field reflected sound comes from all directions and the individual resonance frequencies are so close together that the ear cannot separate them. (For more on this point, see last month's Application Note - Ed.)

However, in small rooms the low frequency resonances are far enough apart in frequency that they can be heard as peaks and dips in tonal response. An enclosed volume of 4,000 cubic feet won't produce a diffuse sound field much below 200 Hz no matter how reflective its surfaces or what its shape. Room shape, by the way, has a negligible effect on standing waves; irregular surfaces increase desirable high frequency scattering, but that is a different phenomenon.

We make the situation worse by seating the recording engineer on the center line of the room, where a number of low frequency modes develop pressure minimal (bass suckout). Couldn't we keep high frequency reflective surfaces symmetrical, but make the structural enclosure irregular so that the loudspeakers and listener would be well off the low frequency center? I used to believe in this approach, but after trying it a few times found that it is not a very good idea.

Bilateral room symmetry is implied by the nature of two-channel stereo reproduction. We usually assume that symmetry is needed to provide good imaging and phantom center stability. It turns out, however, that bass summation is even more important. The engineer expects a kick drum on the left speaker to sound the same as on the right speaker. When panned center, as is usually done, the timbre of the drum should stay the same but it should be about 6 dB louder than

on either speaker alone. This will not happen in a non-symmetrical room, especially if the surfaces near the speakers are asymmetrical. Rooms exist in which bass instruments audibly disappear when panned center!

Since few studios can afford the floor space to make the control room shell much deeper than 20 feet, the engineer is also very near the middle of the room front to back. We are now faced with the worst of all possible listening locations. Low frequency response is ragged and thin because bands as wide as an octave can be attenuated ten decibels or more. There is a sharp low frequency null at mix center that changes dramatically in any direction, and the producer behind or beside the engineer hears a completely different tonal balance.

Moving the rear wall up to the mixer's chair indeed boosts bass response, but tonal balance wanders all over the map with any forward or backward shift in listening location. Anyone who has tried to mix in one of these squashed-down rooms knows that its bass performance can be highly misleading.

There is no really satisfactory solution to the problem, at least not until someone is willing to experiment with an electro-acoustical mixdown room. However, if low frequency reflected sound waves can be partially absorbed, the peaks and dips will be much less severe. Experience suggests that in a conventional control room the most effective places for low frequency absorption are under the studio window and across the rear wall, especially in the rear corners.

In Sigma Sound Control Room I there is a substantial trap volume provided by the basic window construction (FIGURE 4). This is loosely filled with a fiberglass blanket and faced with perforated Masonite covered by porous-back carpet.

Vents in the side walls near floor level help suppress a side-to-side 1½ wavelength mode which is often troublesome. Because the vents are relatively small, they have little effect

*Soundcraftsmen*  
MADE IN U.S.A.

**MOST ACCURATE REAL-TIME ANALYZER,  
0.1dB READOUT. . . . . \$499.00**  
*Bar-Graph Sweeps Across The Spectrum  
In One-Octave Steps*

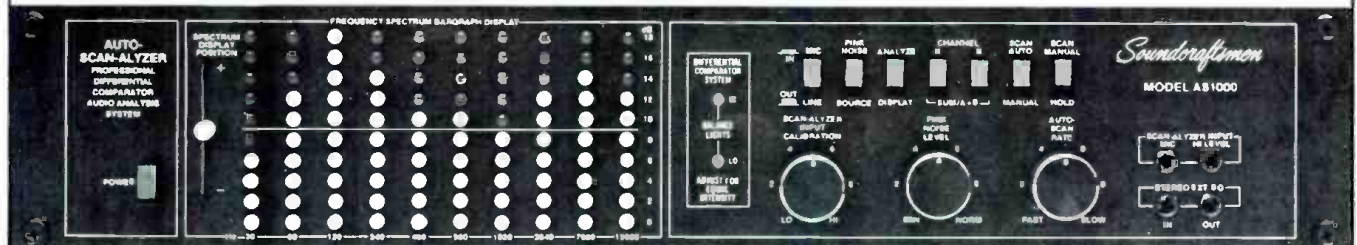

Soundcraftsmen's new Patent Pending Differential/Comparator circuitry approaches EQ analysis with a revolutionary technological concept to provide precise readout with simplified field-usable instrumentation. It enables an accurate analysis of audio imperfections and at the same time compensates for all direct measurement imperfections. As in any high quality measurement system, the end result is directly related to the capabilities of the measuring equipment, and in Soundcraftsmen's case, that measurement readout capability is

1/10th of 1dB (-0.1dB). Until now, every available method of EQ analysis has included errors of 1 to 4dB, due to the response time, the direct measurement circuitry and the actual readability errors inherent in SPL meters, bar-graphs, LED lights, or other graphic displays. Results obtained with these direct measurement methods cannot be precise, because their accuracy is limited by their cumulative tolerances. All of the foregoing EQ analysis inaccuracies are completely bypassed and eliminated by the Differential/Comparator method of measurement.

**THE "ULTIMATE" AMPLIFIER**

375 watts at 4 ohms continuous, 250 watts at 8 ohms, features the new Patent-Pending Vari-Portional/Auto-Buffer system for continuous 2 ohm operation, with NO CURRENT LIMITING. 750 watts at 8 ohms in bridged mono, instantaneous peak power up to 2,000 watts at 8 ohms. Spectrum-energy graphic display enables REAL-TIME OCTAVE-BY-OCTAVE FREQUENCY SPECTRUM ANALYSIS of electronic crossovers, response curves, signal processors, etc., with Pink Noise Test Record included. . . . . 3 models from \$849.00.

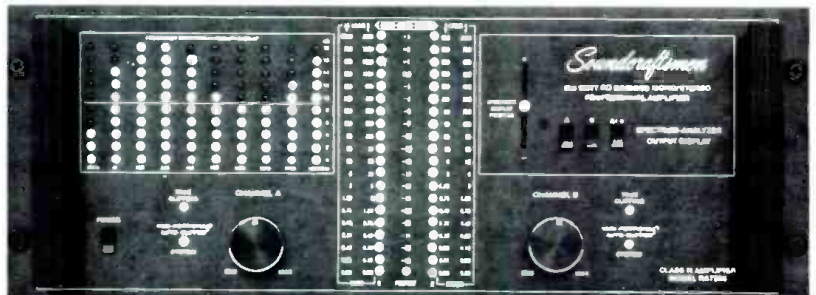

SOUNDCRAFTSMEN INC., 2200 So. Ritchey, Santa Ana, CA 92705 • (714) 556-6193 • CANADA: E. S. Gould, Montreal, Quebec H4T 1E5

Circle 47 on Reader Service Card

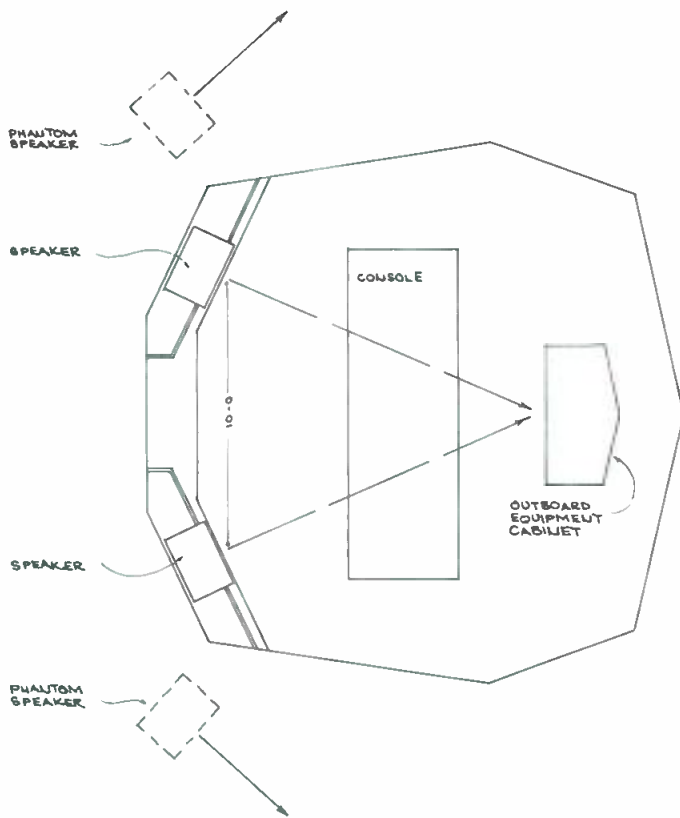

Figure 5. Monitor speaker geometry showing phantom sound sources.

at higher frequencies. However, low frequency pressure build-up at room boundaries tends to squirt air through the vents and into the air volume behind. Rigid fiberglass across the vents increases air flow resistance to the point where these traps act as broadly tuned absorbers rather than conventional Helmholtz resonators.

The rear screen walls were built as wood grillwork backed by open-weave fabric (FIGURE 3). Working behind the fabric, the wall was "tuned" by making some areas reflective, some absorptive, and leaving some transparent. Tuning was done first to optimize low frequency response and then trimmed by ear as explained previously. The space behind the screen wall is irregularly shaped and lined with two-inch thick absorptive treatment. The interior volume is left open to provide space for storage, power supplies and equipment racks. The fact that the traps serve as double-duty spaces helps justify the floor space required.

Some will argue that equivalent low frequency absorption in less space could be achieved with individually-tuned Helmholtz resonators. Other acousticians have had success with these, but my experience has been disappointing. Adjustable screen walls with substantial air space behind have given the best low frequency control in the rooms I have designed. In the Sigma room it was possible to sufficiently "scramble" low frequency resonances such that the subjective bass balance is quite uniform across the width of the console, and indeed almost anywhere in the working area of the room.

In at least 75 percent of the "good" mixdown rooms, low frequency performance is still not quite as solid as we would like. Response below 63 Hz rolls off more rapidly than the free-field response of the monitor speakers. Moreover, once engineers and producers discover the bottom octave, they want to hear it—often at sound levels greater than 110 dB. It is very difficult to supply enough brute force at these low frequencies.

To my way of thinking, since monitor speaker locations are dictated by the requirements of two-channel stereo rather than low frequency performance, the thing to do is to find places where bass energy is coupled most efficiently to the listening location and install sub-woofers there. Often, the best sub-woofer locations will be under the studio window, below the main monitors, thus avoiding problems with localization or arrival times. This turned out to be the case at Sigma, and since management was already favorably disposed to the idea of sub-woofers, they were installed in part of the trap space.

Finding the right spots for sub-woofers and getting them to blend imperceptibly with the main monitors is tricky and time consuming. But, when everything goes right, low frequency performance is extended and a big load is taken off the main monitor speakers. In many rooms, surprisingly little power is needed to drive the sub-woofers. Their function is not just to supply additional low frequency energy but to re-distribute the energy in the room so that it can be heard at the console.

#### DIFFUSION, REFLECTION AND COMB FILTERS

If any major room surface is made totally absorptive, desirable sound diffusion is that much more difficult to achieve. That is why I like to arrange absorptive and reflective areas on all room boundaries. Even so, strong reflections from surfaces near the loudspeakers can be sources of audible tonal coloration.

Looking at FIGURE 2 you can see that the studio window, speaker soffit face, and ceiling of the Sigma control room form more of a directional baffle than a series of reflecting surfaces. However, even with the upward-sloping ceiling, one would expect a reflected wave from this surface to arrive at the console about 2.5 milliseconds after the direct sound. This would be expected to introduce a null in response around 190 Hz and a peak at 380 Hz. Had this occurred, the ceiling would have been vented or its contour changed. As things worked out, however, first-order ceiling reflections are masked by other reflected sound and have not proved troublesome.

## Get Aligned Stay Aligned with STL precision magnetic test tapes

These dependable tapes are used by broadcasters, recording studios, equipment manufacturers, governments and educators throughout the world. Widest variety...Alignment, Sweep, Pink Noise, Level Set, Azimuth and Flutter/Speed. Available on reels, in cartridges and in cassettes. Also, the Standard Tape Manual & the Magnetic Tape Reproducer Calibrator.

Phone for fast delivery or free catalog.



**STANDARD TAPE LABORATORY, INC.**

26120 EDEN LANDING ROAD #5 HAYWARD CALIFORNIA 94545 • (415) 786-3546



There are no substantial first-order reflections from the side walls, as can be seen from the phantom sound sources shown in FIGURE 5. The wall adjacent to each speaker is splayed sufficiently to avoid any reflection back to the center of the console. The opposite wall is far enough away that the first reflection arrives about 12 milliseconds after the direct sound and is attenuated some eight decibels. It simply disappears into the overall reflected sound field.

As noted earlier, the rear screen wall functions partly as a sound diffusing element, having both absorptive and reflective areas. Scattering is further heightened by the presence of the console, the outboard equipment cabinet and the tape machines.

Subjectively, the room has an "open," "airy" quality typical of the rooms that have been the most successful for me. Like anything else, some people will like it and others will not, but reactions thus far have been favorable. Should Sigma Sound Studios want to make acoustical adjustments in the future, substantial changes can be made without affecting the visual design of the space.

#### BACKGROUND NOISE AND SOUND ISOLATION

The sound isolation system used in the new Sigma control room and studio is described more fully elsewhere. Ideally, we would like to have built each isolated space as a completely self-supporting structure, mechanically independent from the building itself. However, the second-floor location and restraints imposed by the existing structure meant that some compromises had to be made. The floating floors are not quite as massive as might be desired, and the number of isolation hangers required to support walls and ceilings is greater than I would have liked.

Nonetheless, the isolation between studio, control room, and adjoining spaces is much better than the majority of commercial studios. The reason is simply that a good isolation system was designed in advance, and the contractor followed it exactly. There are no sloppy joints, no air leaks, and no mechanical connections between isolated structures.

It was known that, with the construction methods used, isolation between the control room and studio would be good, but not good enough to use them as totally independent spaces. In other words, a rock group cannot rehearse in the studio at the same time that someone is using the control room to mix a jazz trio. Therefore, even though three walls are built between the control room and the studio, the window has only two panes of glass: one 1/2-inch thick safety glass and one 3/4-inch laminate, both set in resilient airtight channels. The window construction is capable of more than 40 dB of sound attenuation between studio and control room at 63 Hz, and about 65 dB at 1,000 Hz. This is ample for normal recording practice.

Air conditioning noise is held to near-inaudibility by locating compressors and blowers a good distance away from critical spaces, by using oversize, rigid ducts with high-density fiberglass lining, by keeping any dampers well upstream of supply diffusers, and by designing for low air velocity at all supply and return openings.

#### CONCLUSION

Let me emphasize once again the desirability for acoustical flexibility in mixdown room design. When your room is finished, you should be able to experiment with monitor speaker placement, low frequency absorption, near-field reflecting surfaces, and high frequency scattering without tearing out ceilings or rebuilding walls.

You may wonder why a computer can't be used to predict the exact transfer function from a sound source to any given listening location. The answer is that nobody knows how to write the program. So, until that happy day arrives, it is my belief that any mixdown room, no matter how well designed, can be further improved if provisions have been made for acoustical adjustment. The Sigma Sound Studios control room is an example of how such flexibility can be incorporated into a handsome, well-functioning design. ■

# SEE THE REEL EXCITEMENT IN NEW YORK.

It's new,  
it's from Ampex,  
and it's in  
the Basildon Room at AES.

## AMPEX TOOLS FOR TOMORROW

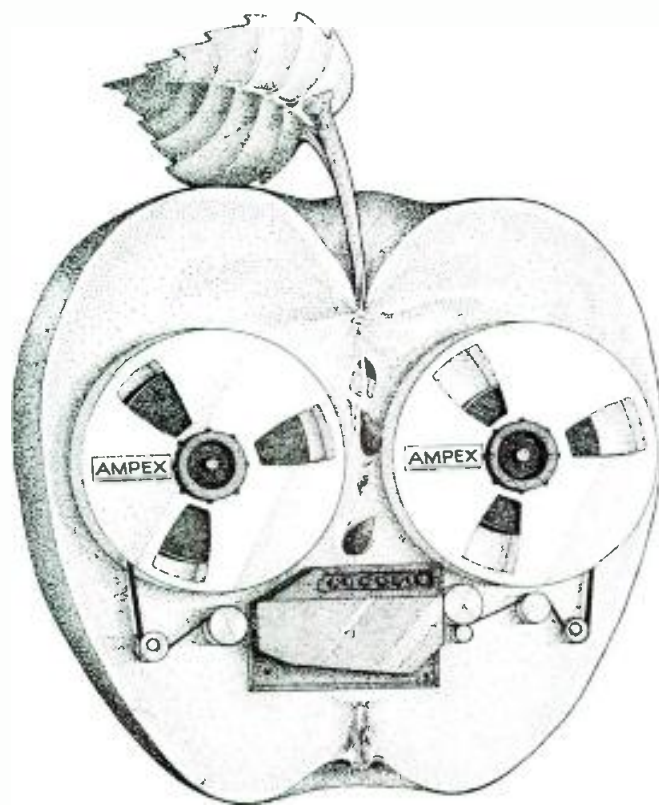

# Still The Best Investment In A Professional Two Channel Tape Machine.

## The Otari MX-5050B

There's a very simple, straightforward reason the MX-5050B has become the world's best-selling professional tape recorder: value. If you were to ignore all of the production features, dismiss the six year track record for unsurpassed reliability, you would still discover that the "B" is the best performing machine for your money. When you shop around you'll find out that it's easy to spend a little less or a lot more, but very difficult to justify to yourself that you are getting more. When you compare other machines, spec' by spec', you'll begin to see why there's more value in putting your money into an Otari. Spec's of course, don't tell the whole story. But, it's a damn good place to start your serious comparisons.

To experience the full potential, and thus the value of any product you purposely put it to the test. After a few hours in the studio or on location, you can become painfully aware of the differences between a professional machine and those with a Hi-Fi heritage. Because Otari's only business is to serve the dedicated audio professional, you won't find cosmetic facelifts every couple of years; or, dredged-up product from another era that's labeled "Pro." At Otari we improve each product by subtle engineering refinements that make the basic product that much better — without fanfare and expensive model changes that you end up paying for. And the "B" is the embodiment of this philosophy. It's been around for three years (5050 Series, 6 years) and we plan you'll keep it around a lot longer. If you're a knowledgeable audio person who already owns an Otari you'll know what we're talking about. If you're not, then it is well worth your time to review the Performance and Feature facts we've

detailed in this ad. If you're in the market for a fully professional, super-reliable two-track, the time you spend to acquaint yourself with the "B" just might mean the difference between spending your money on a machine that will do for now — or deciding to make the investment in a basic creative tool that will pay you back handsomely in the years to come.



### THE FACTS: PERFORMANCE.

Overall Signal-to-Noise: 66 dB unweighted @ 520 nWb/m, 30 Hz to 18kHz.  
Dynamic Range: 72 dB unweighted: 30 Hz to 18 kHz.  
Headroom: +24 dB, Maximum output: +28 dBm.  
Overall Frequency Response: 30 Hz to 22 kHz  $\pm 2.0$  dB (15 ips @ +4 dBm).  
Playback Frequency Response: 31.5 Hz to 20 kHz  $\pm 2.0$  dB (15 ips @ +4 dBm).  
Distortion: less than 0.7%, 1 kHz @ 250 nWb/m.  
Crosstalk: greater than 55 dB, 1 kHz, adjacent tracks.  
Wow and Flutter: less than 0.05% (15 ips).  
Rewind Time: 90 seconds for 2500 feet.

### THE FACTS: FEATURES.

Three switchable speed pairs: 15/7½ or 7½/3¾ ips (automatic equalization).  
NAB/IEC selectable equalization.  
Selectable +4 or -10 dBm output.  
D.C. servo capstan motor with  $\pm 7\%$  varispeed control.  
Selective reproduce for overdubbing.  
Four heads: ½ track erase, record, reproduce, ¼ track reproduce plug-in assembly.  
Noise-free punch-in/outs; transport remote (optional).  
Built-in test oscillator.  
Front panel adjustable bias and equalization.  
Choice of three alignment levels: 185, 250 & 320 nWb/m.  
Dump edit and tape lifter defeat; precision aligned; and indexed splicing block.  
Zero memory return.  
10½" reel capacity; XLR connectors.  
Large, illuminated V.U. meters with adjustable peak-reading L.E.D. indicators.  
Independent Mic/Line mixing (20 dB pad).

### THE FACTS: PRICE.

\$2,295.00 Suggested Professional Net.

Your nearest Otari qualified professional audio dealer has The New Workhorse in stock. Check-out for yourself why you should place your money on the MX-5050B. If your dealer shows you anything but an Otari, tell him, "No thanks. I'm only interested in making a sound investment."

Call us for the name of your nearest dealer.

### The New Workhorse

# OTARI®

OTARI CORPORATION  
2 Davis Drive  
Belmont, CA 94002  
(415) 592-8311

© Otari Corp., 1981

Circle 51 on Reader Service Card

THE NEW  
WORKHORSE

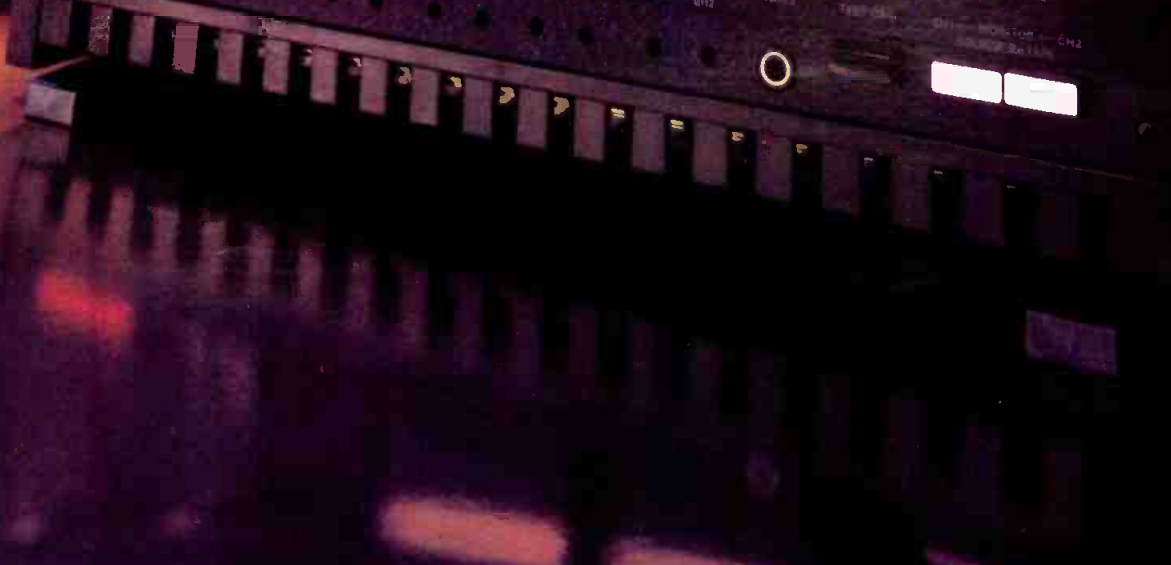

# Resonators and Reverberation

*Some notes and comments on how to design a Helmholtz resonator as well as how to calculate four different reverberation times for the same room.*

**I**N STUDIO CONSTRUCTION projects, sound absorbing cavities are often an integral part of the overall design. Or in some cases, the cavity is designed and constructed later on in order to "smooth out" the overall response characteristics of the room.

Such sound absorbing areas are commonly called "Helmholtz Resonators," after Hermann Helmholtz, who described their properties in his scientific classic, "On The Sensations of Tone" (Dover Publications S753).

## PERFORATED PANELS AND SLOT ABSORBERS

Helmholtz resonators in the studio usually consist of a false wall built out at some distance from the main wall, as seen in Figure 1. The resonator surface may be a perforated panel, or a series of planks (slats) with a small airspace (slot) between each one.

Helmholtz defined the resonance frequency of his early devices in terms of the speed of sound, and the volumes of both the holes and the cavities behind them. However, later writers usually use the following derived equation to determine the resonant frequency,  $f_0$ , of the system:

$$f_0 = 2160 \sqrt{e/dD},$$

where  $d$  = the thickness of the perforated panel or plank, in inches,

$D$  = the distance between the panel (or plank) and the wall, in inches,

$e$  = the open area ratio.

To calculate the open area ratio for perforated panels,

$$e = .785HD^2 / H \cdot V \sin \theta,$$

where  $H$  = the hole diameter,

$H$  = the horizontal distance between hole centers,

$V$  = the vertical distance between hole centers,

$\theta$  = the included angle (if holes are aligned vertically and horizontally,  $\theta = 90$ , and the denominator becomes simply  $HV$ ).

To calculate the open area ratio for slot absorbers,

$$e = r / (w + r),$$

where  $r$  = the distance between the slats (i.e., the slot width),

$w$  = the width of the slats.

As written above, the equation is of limited usefulness, since the studio designer is probably not that interested in discovering the resonance frequency of various combinations of paneling and air cavities. Instead, he already knows the frequency to which the resonator must be tuned, and wants to know how to go about building such a resonator. For example, last month's **db** Application Note described how to determine the resonance modes that are a function of the dimensions of any room. If it appears that a potentially troublesome resonance will occur at a certain frequency, the task is to design an appropriate absorber tuned to that frequency.

Presumably, perforated panels and/or planks are available, and so the primary question is: how deep should the cavity be? For a perforated panel, the equation is simply re-written as:

$$D = 2160 e / (f_0^2 \cdot d).$$

Since the perforated panel comes with pre-drilled holes, all that needs to be done is to measure the distance between the holes and the diameter of the hole. From the point-of-view of the calculations, if the holes are aligned vertically and horizontally, so much the better, since the included angle,  $\theta$ , may be ignored.

For the slot absorber, more design flexibility is possible, though the calculation is now more tedious. Even if the slats are already on hand, there are still two variables remaining; the cavity depth and the spacing between slats.

Usually, the cavity depth is more-or-less determined by other considerations (space available, for example). Therefore, the equation may be re-written to determine the necessary slat spacing,  $r$ , as a function of cavity depth,  $D$ .

$$r = w (f_0^2 dD) / (2160^2 - dD).$$

Note that the greater the slat width, and/or cavity depth, the greater is the distance between the slats. A BASIC computer program is given at the end of this article which computes the required cavity depth and slot width for various configurations of Helmholtz resonators.

## REVERBERATION TIME

Another important consideration of studio design is the calculation of reverberation time. Here, the important variables are the volume and surface area of the room, and the absorption coefficients of the various materials applied to the floor, walls and ceiling. The absorption coefficient is defined as the fraction of incident sound energy which is absorbed by a ma-

# OTARI DP-7000

## The Profitable Producer

The Otari DP-7000 cassette duplication system is the New Workhorse for high-speed (64:1) tape duplication. The sophisticated electronics and tape handling transports are engineered for the demanding environments and use by professional duplicating facilities.

Some of the advanced features which help make the DP-7000 system a reliable, as well as profitable producer are:

- 8 megahertz bias oscillator for higher quality audio and lower overall distortion
- Vertical slant, endless-looped tape bin for longer life to masters
- Dual frequency cue tone oscillator
- Plug-in electronics for ease of maintenance
- Long-life ferrite heads
- Dual capstans on both Master and Slave(s) for lower wow and flutter and more precise tape handling.

Let Otari's over 15 years of experience as a world leader in tape duplication systems go to work for you. An Otari field sales engineer can show you why a DP-7000 high speed duplicator system delivers dependable performance—and a profitable return on your investment.

Contact Mr. Michael Pappas at (415) 592-8311 for complete details on Otari's Profitable Producer.

The New Workhorse

# OTARI

Otari Corporation  
Industrial Products Division  
• 2 Davis Drive  
Belmont, California 94002  
(415) 592-8311 Telex: 910-376-4890  
*Circle 30 on Reader Service Card*

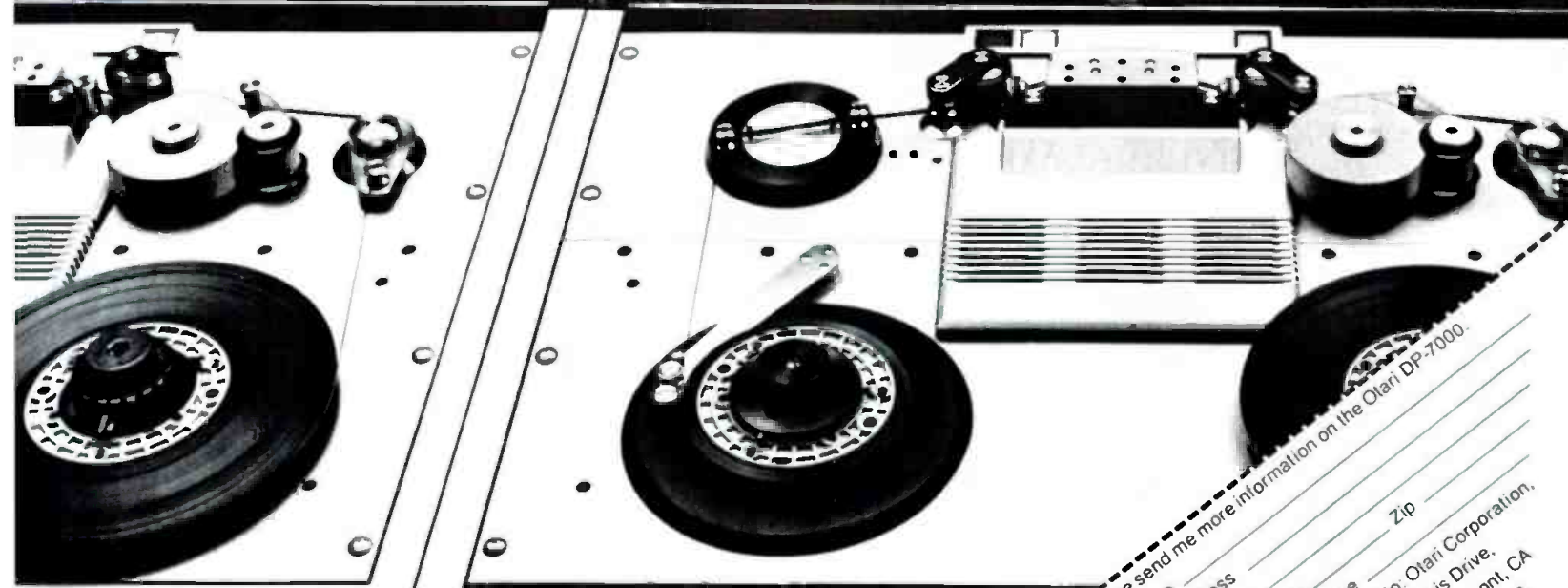
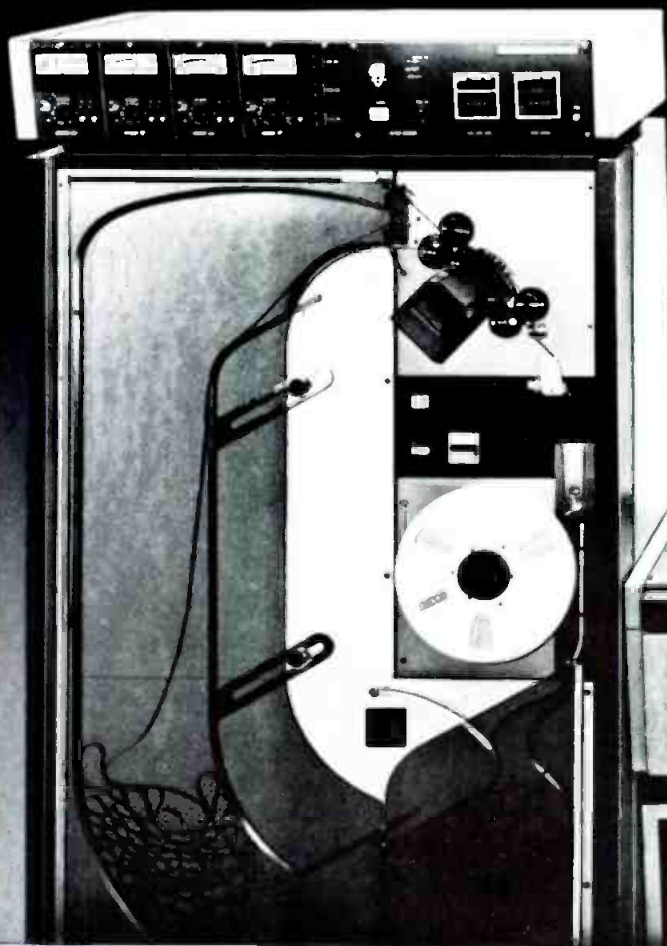

Please send me more information on the Otari DP-7000.

Name \_\_\_\_\_  
Address \_\_\_\_\_  
City \_\_\_\_\_ State \_\_\_\_\_ Zip \_\_\_\_\_  
Phone \_\_\_\_\_  
Mail to: Otari Corporation,  
2 Davis Drive,  
Belmont, CA  
94002

terial. In other words, a perfect reflector would have an absorption coefficient of 0.0, and a perfect absorber would have a coefficient of 1.0. The absorption coefficients for most construction materials are usually published by the manufacturer. (For example, see FIGURE 7 and the boxed insert in last month's Sonex feature.) Since no material has a "flat frequency response," absorption coefficients are typically published at six frequencies (125, 250, 500, 1000, 2000, 4000 Hz, or 128, 256, 512, 1024, 2048, 4096 Hz). Therefore, the studio designer will often specify the reverberation time at each of these frequencies.

### CALCULATING REVERBERATION TIME

After W. C. Sabine<sup>1</sup>, the reverberation time,  $T_s$ , of a room at a certain frequency,  $f$ , is,

$$T_s = 0.049V/A,$$

where  $V$  = the volume of the room, in cubic feet,  
 $A$  = the total absorption of the room, in sabins  
 $= a_1S_1 + a_2S_2 + \dots + a_nS_n$ ,

where  $a_1, a_2, \dots, a_n$  = the absorption coefficients of various materials,

$S_1, S_2, \dots, S_n$  = the surface areas (in square feet) covered by these materials.

The Sabine equation is only useful for rooms with moderate absorptivity. As the total absorptivity increases, it becomes progressively less accurate, as may be demonstrated by calculating the  $T_s$  of an anechoic chamber. Intuitively, we realize that in such a room, all absorption coefficients would be 1 (that is, 100 percent absorptive), and that the reverberation time should be zero. Yet, under these conditions, the Sabine equation becomes  $0.049V/S$ , and the chamber appears to have a reverberation time that is a function of its volume and surface area,  $S$ .

Later authorities (Norris<sup>2</sup>, Eyring<sup>3</sup>) pointed out that the Sabine equation is actually a special case of a more general equation (now known as the Eyring equation), in which the reverberation time is

$$T_E = 0.049V/S \cdot \ln(1 - A_{AV}),$$

where  $S$  = total surface area, in square feet,  
 $A_{AV}$  = average absorption of the room,  
 $-\ln(1 - A_{AV})$  = true absorption coefficient.

Rettinger<sup>4</sup> considers that the Sabine equation is suitable for rooms having a total absorptivity no greater than 0.15, and that above this point, the Eyring equation should be used.

### THE FITZROY EQUATIONS

Some 20 years ago, Fitzroy<sup>5</sup> developed yet another set of equations which may be in closer agreement with actual measured values in a room where each surface area is treated in a different manner. Using Sabine's original absorption coefficients, the equation is

$$T_{FS} = (0.049V/S^2) (X^2/A_x + Y^2/A_y + Z^2/A_z),$$

where  $X, Y, Z$  = the areas of the two parallel wall pairs ( $X, Y$ ), and the floor/ceiling pair ( $Z$ ), in square feet,  
 $A_x, A_y, A_z$  = the total absorption of these areas.

To use Eyring's true absorption coefficients, the denominator,  $A_x$ , is replaced by  $-X \cdot \ln(1 - a_x)$ , where  $a_x$  becomes the average absorption coefficient of wall surface pair. In like manner,  $A_y$  becomes  $-Y \cdot \ln(1 - a_y)$ , and  $A_z$  is now  $-Z \cdot \ln(1 - a_z)$ .

As just noted, when the various room surfaces are treated differently (one wall pair reflective, another absorptive, etc.), the Fitzroy equations may be more accurate than either the Sabine or the Eyring. However, when all surfaces are treated identically (which is unlikely, except in anechoic or reverberation chambers), the Fitzroy equations take on the same values as the simpler Sabine and Eyring. As before, the Eyring (and now, Fitzroy/Eyring) calculation is preferred for absorptivities greater than 0.15. Note too that, as the total absorptivity approaches zero (all surfaces totally reflective), all equations approach the same value.

On paper, let's use these four equations to calculate the reverberation time of a studio whose room dimensions conform to the "Golden Section" room ratios (see last month's Application Note). With a height of 15 feet, the width is 24.3 feet, and the length is 39.3 feet.

We'll label the 15 x 24.3 walls "pair A," and the 15 x 39.3 walls "pair B." To give the wall pairs the same absorptivity, we'll cover pair A with a material whose absorption coefficient is 0.6469, and pair B will be treated for an absorption coefficient of 0.4 (since  $0.6469 \times 15 \times 24.3 = 0.4 \times 15 \times 39.3$ ). This treatment gives us a total absorption of 943.2 sabins, and an average absorptivity of  $943.2/1908 = 0.4943$  sabins per square foot.

Now, we'll specify a wood floor with an absorption coefficient of 0.2, and an absorbent ceiling whose coefficient is 0.8. And while we're at it, let's design another room whose wall surfaces are uniformly treated to give us an absorption coefficient of 0.4943, giving us the same average absorptivity as our first room.

Tabulating this information, and using the various reverberation time equations, gives us

### ABSORPTION COEFFICIENTS

Surface	1st room	2nd room
Walls 'A'	0.6469	0.4943
Walls 'B'	0.4	0.4943
Floor	0.2	0.2
Ceiling	0.8	0.8
— Reverberation time, according to:		
Sabine	0.37 seconds	0.37 seconds
Eyring	0.267	0.267
Fitzroy/Sabine	0.38	0.37
Fitzroy/Eyring	0.278	0.267

From the above, note that when the two wall pairs are treated differently, the Fitzroy equations do not agree with Sabine and Eyring, even though we deliberately designed the walls for the same total absorption. On the other hand, when we apply the average absorptivity to all wall surfaces, the Fitzroy equations agree with their Sabine and Eyring equivalents, as expected.

### AND NOW, BACK TO REALITY

What has all this got to do with the "real world"? In other words, once the room is actually constructed, will on-site measurements bear any resemblance to predicted values? Probably not. In fact, every experienced studio designer probably has his own secret "finagle factor" by which he multiplies (or maybe, divides) the calculated value(s) to arrive a little closer to what his experience tells him will be the actual measurement. Such are the vagaries of design, construction and mother nature.

Perhaps the greatest value in going through the various reverberation time calculations is that doing so helps to identify a general range into which the actual reverberation times may fit. On paper, we may try various materials on either or both wall pairs, as well as on floor and ceiling. In each case, we may note their general effect on the calculated values. For example, will reversing our first wall treatment significantly alter the reverberation time? What will happen if we partially/completely cover the floor with carpet? What if we replace some wood panelling with fiberglass? And so on.

### THE EASY WAY OUT

Of course, a complete set of calculations, at each of six frequencies, for all the materials used in the room, is a long and tedious process. However, our BASIC computer program given here performs the whole operation in just a few seconds. Absorption coefficients and room dimensions and surfaces may be easily changed, as the user determines, "What will happen if...?"

# Helmholtz Resonator Program

The user enters the resonant frequency (160), and is asked to select a perforated panel (180) or slot absorber (190) design. Assuming a perforated panel design is selected (210, X = 1), the user is asked to enter the following information: panel thickness (280), hole diameter (290), and the distance between the holes in two directions (300-310). If the holes are not lined up vertically, then the "vertical" spacing (310) is actually along a diagonal, and the angle at which this intersects the horizontal must be entered (320). If the holes are vertically aligned, this angle is, of course, 90 degrees.

The open area ratio is found (340), and then the cavity depth is calculated (350) and displayed (380). Next, after pressing

the return key (410), the program jumps back (430) to re-offer the selection of perforated panel (180) or slot absorber (190).

Assuming that a slot absorber is selected (210-220, X = 2), the program jumps to the appropriate section (440-590). The user enters the thickness (480) and width (490) of the slats that will be used, as well as the amount of space that is available for the cavity depth (500). The available space is divided into ten equal increments (540), and at each instrument, the required slot width is calculated (550-560) and displayed (570). This gives the user ten choices of slot width, cavity depth that will fit within the available space.

Figure 1. Detail drawing of a Helmholtz resonator.

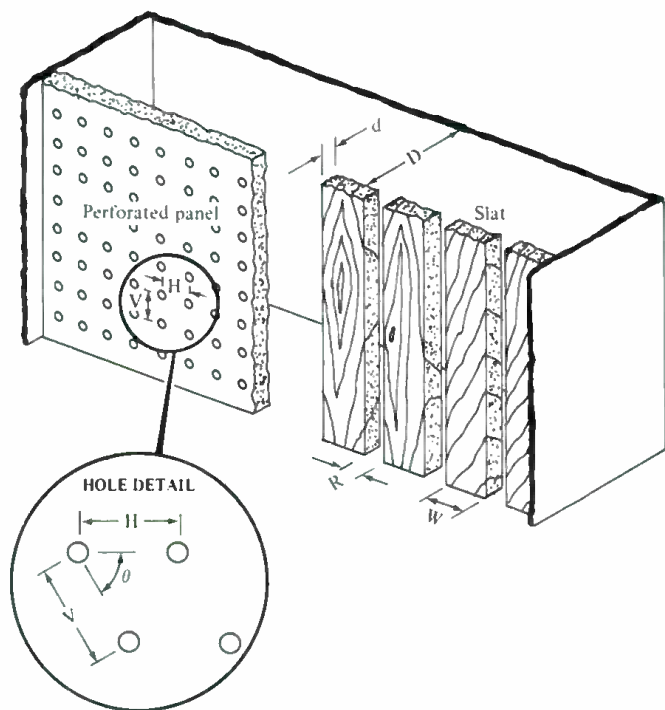

Programmed by Barry Hufker with revisions by John Woram.

```

100 HOME
110 VTAB 10
120 PRINT " - - HELMHOLTZ RESONATOR DESIGN - - "
130 PRINT
140 PRINT "PLEASE ENTER THE FOLLOWING DATA:"
150 PRINT
160 INPUT "          RESONANT FREQUENCY = ";F
170 PRINT
180 PRINT "PLEASE CHOOSE: 1. PERFORATED PANELS,"
190 PRINT "                2. SLOT ABSORBERS, OR,"
200 PRINT "                3. END PROGRAM."
210 INPUT "YOUR CHOICE IS? ";X
220 IF X = 2 THEN GOTO 440
230 IF X = 3 THEN END

240 HOME:VTAB 10
250 PRINT " - - FOR PERFORATED PANELS:"
260 PRINT "          RESONANT FREQUENCY = ";F
270 PRINT
280 INPUT "          PANEL THICKNESS = ";TH
290 INPUT "          HOLE DIAMETER = ";HD
300 INPUT "          HOLE SPACING (HORIZ.) = ";H
310 INPUT "          HOLE SPACING (VERT.) = ";V
320 INPUT "          INCLUDED ANGLE = ";AN
330 PRINT
340 E = .785*HD*2/(H*V*SIN(.5*AN))
350 D = 216*E/(F*2*TH)
360 PRINT "REQUIRED CAVITY DEPTH = ";
370 INVERSE
380 PRINT D
390 NORMAL
400 VTAB 22
410 INPUT "TO CONTINUE, PRESS /RETURN/ KEY. ";AS
420 HOME:VTAB 10
430 GOTO 180

440 HOME
450 PRINT " - - FOR SLOT ABSORBERS:"
460 PRINT "          RESONANT FREQUENCY = ";F
470 PRINT
480 INPUT "          SLAT THICKNESS = ";ST
490 INPUT "          SLAT WIDTH = ";SW
500 INPUT "          AVAILABLE CAVITY DEPTH = ";AD
510 PRINT:PRINT
520 PRINT "FOR CAVITY", "WIDTH OF"
530 PRINT "DEPTH DF", "SLOT IS;"
540 FOR D = AD/10 TO AD STEP AO/10
550 M = F*2*ST*D
560 R = SW*M/(216*E*2 - M)
570 PRINT D, INT(R*1000 + .5)/1000
580 NEXT D
590 GOTO 480
    
```

# Computing Reverberation Time

To begin, the user enters the dimensions in feet (200) and inches (220) for each of the room's dimensions. These entries are converted into feet and decimal feet (230-240) for the purposes of calculation, and are also displayed (260). The room volume (300) and surface areas (310-320) are computed and displayed (350-430).

Next, the user enters the number of materials to be used on each surface area (540-570). If more than five materials are to be used, the program jumps (580) to a notice cautioning the user that too many materials have been selected (1740-1750). This is simply because the screen will not display more than five sets of absorption coefficient data. If this is a problem, the TAB instructions (800, 870) may be tightened slightly to fit more data on the screen.

The screen displays the total surface area of the walls (or floor, ceiling) currently being treated (600), and the area remaining to be treated (640-650). If more than one material

is to be used, this section is repeated (620-740) until each material and its surface area has been entered.

The user is then prompted to enter the absorption coefficients (780) at six frequencies (830) for each material (850). Since these entered values (880) should be greater than 0.0 and less than 1.0, entries outside this range are rejected (890-900) and the CRT offers an explanation (1790-1860), erases the explanation (1830-1840), and waits for the user to re-enter the correct value (1860-1870).

Once all absorption coefficients have been entered for each material on each surface, the user is given the option to review the data entered so far (1010). If a review is requested (1020), the program branches to a sub-routine (1340-1610) which prints out the resultant average absorptivity (1480) for each room surface (1440) at each of six frequencies (1360). The user is asked to approve the data for each surface (1540). If any set of data is rejected (1570), the program branches to another

sub-routine (1620-1720) and allows the incorrect data to be replaced (1670). If this sub-routine is used one or more times during the program, the user must verify that all data is now correct (1600) before continuing. If not, the program returns (to 1030) and immediately branches back to the data-check portion of the sub-routine (1520).

When there are no further changes to be made (1030), the screen displays the headings under which each reverberation time will be printed (1080). Now total absorption and average absorptivity are calculated (1120 and 1160) for each room surface area (1110) at each of six frequencies (1090).

The four reverberation times are calculated (1190-1220) and printed (1240-1270). An asterisk is printed (1170) after the Sabine equation, unless the average absorptivity is greater than 0.15 (1180), in which case the asterisk appears after the Eyring equation. A footnote indicates that the asterisk denotes the preferred calculation (1310) and the program ends (1320).

Programmed by John Woram.

```

100 HOME : VTAB 5
110 PRINT "PLEASE ENTER THE FOLLOWING DATA:"
120 PRINT TAB(10)"FEET";
130 PRINT TAB(20)"INCHES"
140 PRINT "HEIGHT"
150 PRINT "WIDTH"
160 PRINT "LENGTH"
170 V = 7
180 FOR N = 1 TO 3
190 VTAB V : HTAB 10
200 INPUT "":F
210 VTAB V : HTAB 20
220 INPUT "":L
230 D = F + L/12
240 D(N) = INT(D*100 + .5)/100
250 VTAB V : HTAB 30
260 PRINT "":D(N)
270 V = V + 1
280 NEXT N
290 H = D(1): W = D(2): L = D(3)
300 VL = H * W * L
310 X = 2 * H * W : Y = 2 * H * L : Z = 2 * W * L
320 SA = X + Y + Z
330 AR(1) = X: AR(2) = Y: AR(3) = Z/2: AR(4) = Z/2
340 PRINT : PRINT
350 PRINT "ROOM VOLUME, IN CUBIC FEET:"
360 PRINT TAB(17)VL
370 PRINT
380 PRINT "SURFACE AREAS, IN SQUARE FEET:"
390 PRINT "WALL PAIR 'A' = ":AR(1)
400 PRINT "WALL PAIR 'B' = ":AR(2)
410 PRINT "      FLOOR = ":AR(3)
420 PRINT "      CEILING = ":AR(4)
430 PRINT "      TOTAL = ":AR(1) + AR(2) + AR(3) + AR(4)
440 VTAB 22
450 S5(1) = "WALLS 'A'"
460 S5(2) = "WALLS 'B'"
470 S5(3) = "FLOOR"
480 S5(4) = "CEILING"
490 INPUT "PRESS /RETURN/ TO CONTINUE.":A5
500 PRINT : PRINT
510 FOR N = 1 TO 4
520 FR = 128
530 HOME
540 PRINT "FOR ":S5(N)
550 PRINT "HOW MANY MATERIALS WILL BE USED? ";
560 HTAB 35
570 INPUT MT
580 IF MT > 5 THEN GOTO 1790
590 PRINT "TOTAL SURFACE AREA; ":S5(N);" = ";
600 PRINT TAB(33) INT(AR(N)*100 + .5)/100
610 VTAB 5
620 FOR NM = 1 TO MT
630 RA = AR(N) - A
640 PRINT "AREA STILL TO BE COVERED = ";
650 PRINT TAB(28) INT(RA*100 + .5)/100
660 PRINT "NAME OF MATERIAL # ":NM;"?";
670 HTAB 34
680 INPUT "":NS(NM)
690 PRINT "AREA COVERED?";
700 HTAB 28
710 INPUT "":A(NM)
720 A = A(NM) + A
730 PRINT : PRINT
740 NEXT NM
750 A = 0
760 HOME
770 VTAB 2
780 PRINT "PLEASE ENTER THE ABSORPTION COEFFICIENTS"
790 FOR NM = 1 TO MT
800 PRINT TAB( 7;NM) LEFT$(NS(NM),5);
810 NEXT NM
820 PRINT : PRINT
830 FOR F = 1 TO 6
840 PRINT FR;
850 FOR NM = 1 TO MT
860 VTAB 4 + 2 * F
870 HTAB 7 * NM
880 INPUT "":AC(N,F)
890 IF AC(N,F) > .99 THEN GOTO 1790
900 IF AC(N,F) < .001 THEN GOTO 1790
910 SB(N,F) = A(NM) * AC(N,F) + 5M
920 CC(N,F) = SB(N,F)/AR(N)
930 SM = SB(N,F)
940 NEXT NM
950 SM = 0
960 PRINT

```

```

970 FR = 2 * FR
980 NEXT F
990 NEXT N
1000 VTAB 20
1010 INPUT "DO YOU WISH TO REVIEW DATA? ";AS
1020 IF AS = "YES" THEN GOSUB 1330
1030 IF DS = "NO" THEN GOSUB 1520
1040 HOME : VTAB 10
1050 PRINT "REVERBERATION TIME CALCULATIONS"
1060 PRINT : PRINT
1070 FR = 128
1080 PRINT "FREQ. SABINE EYRING FITZ(S) FITZ(E)
1090 FOR F = 1 TO 6
1100 M = 0
1110 FOR N = 1 TO 4
1120 TS(F) = M + SB(N,F)
1130 M = TS(F)
1140 NEXT N
1150 PRINT
1160 AV(F) = TS(F)/SA
1170 V1$ = "": V2$ = ""
1180 IF AV(F) > .15 THEN V1$ = "": V2$ = "*"
1190 RS(F) = .049 * VL / TS(F)
1200 RE(F) = .049 * VL / (-SA * LOG(1 - AV(F)))
1210 FZ(F) = (.049 * VL / SA + 2) * (X + 2 / SB(1,F) + Y + 2 / SB(2,F)
+ Z + 2 / (SB(3,F) + SB(4,F)))
1220 ZF(F) = (.049 * VL / SA + 2) * (X + 2 / (-X * LOG(1 - CC(1,F)))
+ Y + 2 / (-Y * LOG(1 - CC(2,F)))
+ Z + 2 / (-Z * LOG(1 - CC(3,F)/2 - CC(4,F)/2)))
1230 PRINT FR;
1240 PRINT TAB( 8) INT(RS(F) * 1000 + .5)/1000;V1$;
1250 PRINT TAB(16) INT(RE(F) * 1000 + .5)/1000;V2$;
1260 PRINT TAB(24) INT(FZ(F) * 1000 + .5)/1000;
1270 PRINT TAB(32) INT(ZF(F) * 1000 + .5)/1000;
1280 FR = 2 * FR
1290 NEXT F
1300 PRINT : PRINT
1310 PRINT " * = PREFERRED CALCULATION."
1320 END
1330 HOME : VTAB 10
1340 PRINT TAB(11) " - - - - FREQUENCY - - - - "
1350 FR = 128
1360 FOR F = 1 TO 6
1370 HTAB 7 + 5 * F
1380 PRINT FR;
1390 FR = 2 * FR
1400 NEXT F
1410 PRINT
1420 PRINT "SURFACE:"
1430 PRINT
1440 FOR N = 1 TO 4
1450 PRINT S5(N);
1460 FOR F = 1 TO 6
1470 HTAB 7 + 5 * F
1480 PRINT CC(N,F);
1490 NEXT F
1500 PRINT
1510 NEXT N
1520 FOR N = 1 TO 4
1530 VTAB 2 + N
1540 PRINT S5(N);" DATA OK? ";
1550 HTAB 20
1560 INPUT "":A5
1570 IF AS = "NO" THEN GOSUB 1620
1580 NEXT N
1590 VTAB 8
1600 IF OK = 1 THEN INPUT "ALL DATA OK NOW? ";DS
1610 RETURN
1620 OK = 1
1630 VTAB 15 + N
1640 PRINT S5(N);
1650 FOR F = 1 TO 6
1660 HTAB 7 + 5 * F
1670 INPUT "":AC(N,F)
1680 SB(N,F) = AR(N) * AC(N,F)
1690 CC(N,F) = SB(N,F) / AR(N)
1700 VTAB 15 + N
1710 NEXT F
1720 RETURN
1730 VTAB 20
1740 PRINT "SORRY!! THIS PROGRAM WILL NOT ACCEPT"
1750 PRINT "MORE THAN FIVE MATERIALS PER SURFACE."
1760 PRINT : PRINT
1770 INPUT "PRESS /RETURN/ TO CONTINUE.":A5
1780 GOTO 530
1790 PRINT "PLEASE RE-ENTER DATA."
1800 PRINT "ABSORPTION COEFFICIENT MUST BE"
1810 PRINT "GREATER THAN 0, AND LESS THAN 1."
1820 INPUT "PRESS /RETURN/ TO CONTINUE.":A5
1830 VTAB 5 + 2 * F
1840 PRINT TAB(240)""
1850 VTAB 4 + 2 * F
1860 GOTO 870

```

## REFERENCES

1. Sabine, W. C. "Reverberation." *Collected Papers on Acoustics*. Dover Publications, Inc., New York, 1964 (pp. 43-51).
2. Knudsen, V. O. *Architectural Acoustics*. John Wiley & Sons, New York, 1932 (pp. 603-605).
3. Eyring, C. F. "Reverberation Time in 'Dead' Rooms." *J. Acoust. Soc. Am.* 1:217-235 (Jan. 1930).
4. Rettinger, M., *Acoustic Design and Noise Control, Volume 1*. Chemical Publishing Co., Inc., New York, 1977 (pp. 25-27).
5. Fitzroy, J. "Reverberation Formula Which Seems to be More Accurate with Non-uniform Distribution Absorption." *J. Acoust. Soc. Am.* XXX1:893 (July 1959).

NOTE: 1, 2 and 3 are reprinted in *Architectural Acoustics*, T. D. Northwood, Ed., Dowden, Hutchinson & Ross, Inc., Pennsylvania, 1977.



# The Mitsubishi XE-1 Automatic Electronic Editor

*An examination of editing techniques for two-channel and multichannel recordings.*

**T**HU DETAILS of the Mitsubishi PCM Format have already been presented to the readers of *db* (see the February 1980 and January 1981 issues), but a quick refresher course will be helpful in understanding the editing capability of the new XE-1 Automatic Electronic Editor (see FIGURE 1) and the razor-blade procedure for two-channel recordings. Use of the XE-1 Editor is optional and should be left up to each studio to decide, but by offering a choice, the studio may decide to start off with the traditional razor-blade method of today, and later on progress to the more sophisticated techniques that will no doubt become standard practice in the studio of tomorrow. Both methods utilize sophisticated electronic crossfading techniques to accomplish quiet edits, but there are many editing capabilities offered with the XE-1 Editor that are not available with the razor blade method.

Our digital recording system is built around two mastering recorders, a multichannel recorder, a delay unit for disc cutting, and the electronic editor. Future targets for the application of PCM methods are the all-digital mixing console, microphone, and loudspeaker but these are still considered too expensive to be of practical use at this time. The two-channel mastering recorders use digital mastering tape (Ampex 466 and 3M 265) which is  $\frac{1}{4}$ -in. wide and comes on 10-in. reels for a 1 hour record time at 15 ips. There are ten tracks across the tape: one LFE, SMPTE code track, one analog cue track, six PCM data tracks, and two parity (error-correcting) tracks. To provide maximum tape economy and reduce the chance



Figure 1. The XE-1 Automatic Electronic Editor

*Lou Dollenger is the national sales manager for the Digital Audio Division of Mitsubishi Electric Sales America, Inc.*

that a burst or random dropout will affect the data, the two-channel audio data is sampled at a rate of 50.4 kHz, converted to a digital signal using 16-bit linear A/D converters, and written in an interleaved fashion over the six tracks. First, parity is recorded to allow error correctability of the data and simultaneously, a second parity track is written to provide correction for both data *and* parity. This configuration uses a combination of CRC (cyclic redundancy checking) and RSC (Reed-Soloman Code) and allows two-dimensional correction, unlike a single-parity PCM system. (Also, see "Correcting Tape Errors in Digital Magnetic Recording" in the November, 1980 *db*—Ed.) This powerful error-correction has been calculated to require the concealment of errors (interpolation) only once a year and arising of an inaudible error-related noise only once in every 10,000 years of continuous recording. In addition, as this format uses open reel tape to store the data, sound may be easily monitored while recording (read-after-write), shuttled between different locations very quickly, and razor-blade edited as well. The choice of 50.4 kHz as the sampling rate also allows the recorders to be easily modified to allow linear frequency response out to 23 kHz. This improvement to the ultrasonic frequencies above the audible 20 kHz means that we can more closely mimic the performance of good analog recorders in this area.



Figure 2. The X-80A recorder

Figure 3. The X-80 recorder



# HOW DO YOU MEASURE TAPE TENSION?

*If something SOUNDS FISHY it may be your fish scale approach to measuring tension.*



The Tentel Tape Tension Gage is designed to diagnose problems in your magnetic tape equipment. Virtually all recorder manufacturers use and recommend the TENTELOMETER<sup>®</sup> for use with their equipment.

The TENTELOMETER<sup>®</sup> measures tape tension while your transport is in operation, so you can "see" how your transport is handling your tape: high tension causing premature head and tape wear, low tension causing loss of high frequencies, or oscillations causing wow and flutter. Send for the Tentel "Tape Tips Guide". The T2-H20-ML sells for \$245 - complete.

**TENTEL**

1506 DELL AVENUE  
CAMPBELL, CALIF. 95008  
(408) 379-1881  
1-800-538-6894

Circle 48 on Reader Service Card

## EDITING ROUTINE

The most important area where we can mimic analog is in the editing routine. The razor blade method of editing is well proven and on this system means that a studio may immediately edit material economically, and move into fully digital editing later on, as they need it. The method is surprisingly like the analog routine, with a few additional criteria. To preserve the integrity of the data, we recommend the use of cotton gloves for tape handling and the use of a fluorescent video-marking pen to mark edit points. The dirt and oils from handling tape without gloves tends to cause more errors, although these may be temporary (tape can be cleaned). Also, the use of the typical grease pencil tends to cause more tape contamination and headwear than necessary. A new thin-splice tape especially developed for this system allows optimum tape-head contact at the edit, necessary here as we are processing more than 23 kilobits of data per inch per track. The location of the edit point is found by monitoring the mono analog cue track. Due to the track width, format configuration, and tape speed, the signal-to-noise ratio of this track was close to 34 dB on early models, but with the recent addition of a special noise-reduction circuit we can get about 70 dB now, facilitating reliable location of the edit point. Also, the X-80 transport allows servo-controlled "scrubbing" of the tape by manipulation of the idler arms or the impedance and counter rollers—again to guarantee tape and data integrity. Once the edit point is located and marked, vertical cuts are made in the block, the two sections are joined with the tape, and a small (0.5mm) gap is left to accommodate edit detection. If no gap is left, the tension of the transport system will provide one, but if for some reason the two sections are overlapped or the cuts are not vertical, the read head will see two different kinds of data and will note the error and mute.

In analog, the method used to perform a crossfade is physical (the oblique cut). On the X-80 recorder, the crossfade is

performed electronically and is of a 2.5 millisecond duration. FIGURE 4 shows exactly what occurs when the edit passes the read head: detection of massive error and loss of sync-phase is noted, and a crossfade is performed while the data is in buffer memory. This fading technique is necessary to smooth the abrupt transition between the two signals, but is only one of the automatic fades performed on this system. Other fades that are applied automatically occur anytime the digital signal rises or falls rapidly, such as the beginning or end of the recording or into and out of a mute. These electronic smoothing techniques are important to the pristine sound available with digital recording and serve to assure the user that recordings will be as pleasing to the ear as is possible. Another function of this system is the recording of used spliced tape. In the record mode, the circuitry "senses" the splice and records over it, allowing tapes to be used many times. This is usually unbelievable to the analog producer, but is another indication of the real economy of digital recording methods and the power of the error-correcter used here.

There are some edits that could be improved by the re-adjustment of the recording level of the trailing cut, a longer crossfade duration, or more accurate locating and signal monitoring and these require use of the XE-1 Editor. As all electronic editors are really small computers (as is all digital equipment), they can take full advantage of the most recent advances in semi-conductor technology and be programmed to do many things besides just the editing procedure. This is the case with this new editor, as we will soon see.

The XE-1 Automatic Electronic Editor is housed in a desk-type arrangement and includes a processing section, a keypad, and a television monitor. The processor may be rack-mounted in standard 19-in. racks and the keypad and monitor relocated. The XE-1 has an internal SMPTE generator reader and utilizes the code tracks of both two channel recorders and the X-800 32 channel recorder for control. As shown in FIGURE 5, the XE-1 can be used for a number of chores and

# Penny & Giles launches the fader of the future

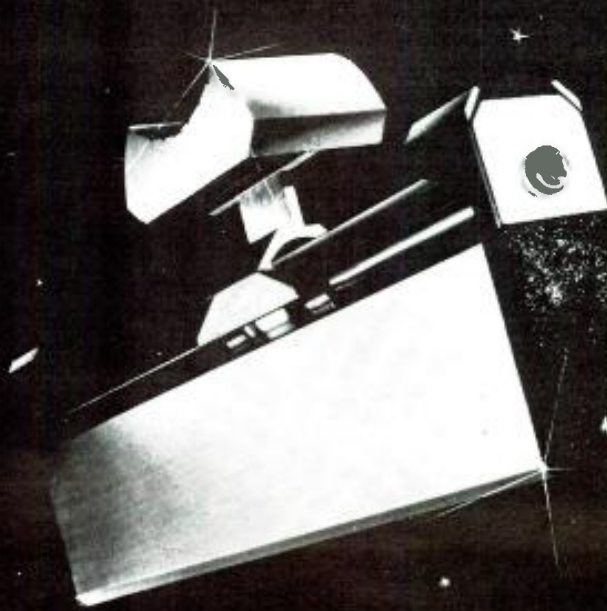

## A New Standard in Fader Technology

Penny & Giles totally new 3000 series sets a new standard in fader technology.

The 3000 combines the world famous Penny & Giles smooth-as-glass feel and total reliability with a break through in cost effective mechanical design.

## Nothing Comes Near Our Faders

Technically, nothing approaches Penny & Giles faders. Our 3000 series have full environmental shielding. They provide stroke lengths from 2.5 inches to 4.094 inches in the smallest body size ever, integral switches, linear, audio taper or VCA outputs, a smoothly positive linear action—in fact all you'd expect from the world's leading fader company.

Get the full details about the fader of the future, now. Call or write.

**Penny & Giles**



Penny & Giles Conductive Plastics Ltd.  
1640 Fifth Street, Santa Monica, California 90401  
Tel (213) 393-0014 • Telex 652337

Circle 49 on Reader Service Card

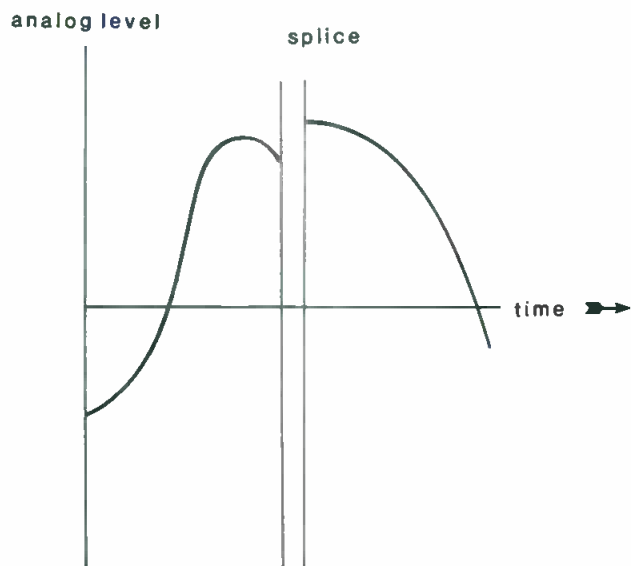

(A) The errors and sync disruption at the gap are detected . . .

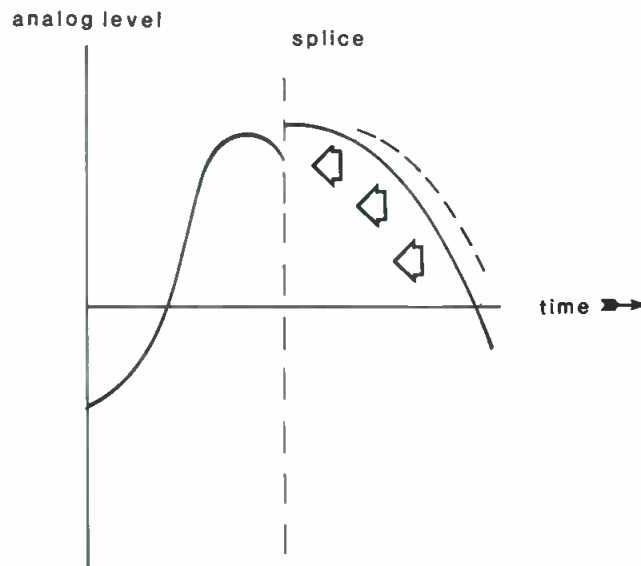

(B) the erroneous portion discarded . . .

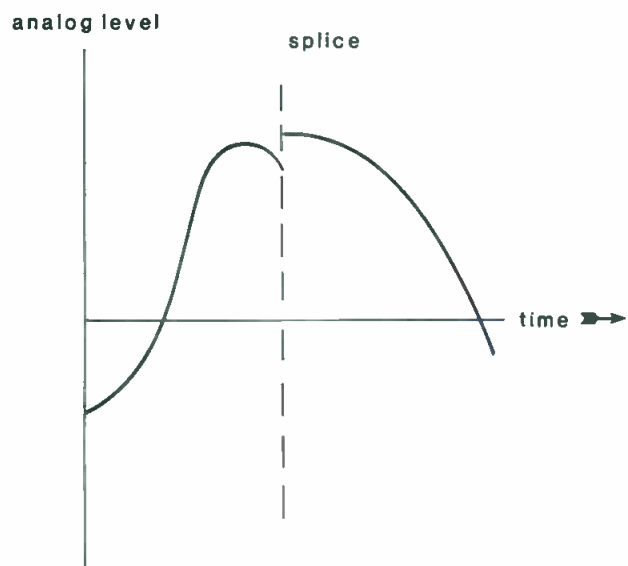

(C) and the signal is joined . . .

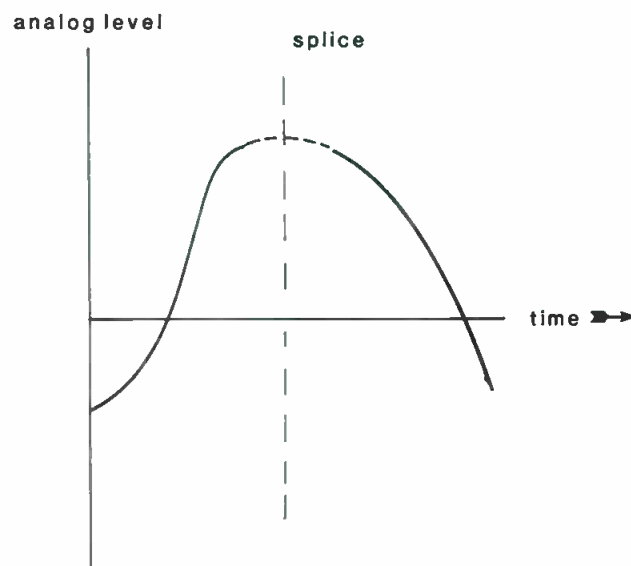

(D) using the fade-in /fade-out technique.

Figure 4. Signal Waveform at the splice

in the two channel editing area allows control over one master and up to three slave recorders. Instead of using a limited-bit memory window, we monitor the analog cue track for location and this gives us an exact indication of the digital signal from the read head. Once the edit point is chosen by memorization of the SMPTE codes, a crossfade time is selected on the keypad. Instead of the 2.5ms duration available with the razor-blade method explained earlier, this duration is freely selectable from 5-100ms in 5 ms steps. When the edit is rehearsed, playback starts from 5 seconds before the edit point and may be stopped anywhere after the edit occurs. Start time is about one second, unlike the 5-10 second threading routine on rotary-head systems. This is another way in which the fixed-head configuration saves time and money (fixed-head transports are also simpler to manufacture and can be sold for less). If the edit point needs to be changed, this may be done again as described earlier, or modified by using a minimum step-shift

key that changes the sub-SMPTE code memory. In the edit mode, the transfer and edit are performed as instructed and the edit should be perfect.

There are times where a second take is performed with more, or less, enthusiasm and the level is different. For these difficult edits, a digital fader is provided to reset the trailing level from +6 dB to minus infinity. In addition, a more appropriate location to edit may be found in a remarkable way. BNC connectors are provided to allow the visual monitoring of the edit point waveform by using any oscilloscope with external triggering. In this way we provide the creative editor with a visual display of the edit as well as an aural one, and the most difficult edits can be performed with relative ease—even edits thought heretofore impossible. These combinations of razor blade XE-1 edits and visual/aural monitoring are two more ways to accomplish the maximum amount of work in the most economical and logical way.

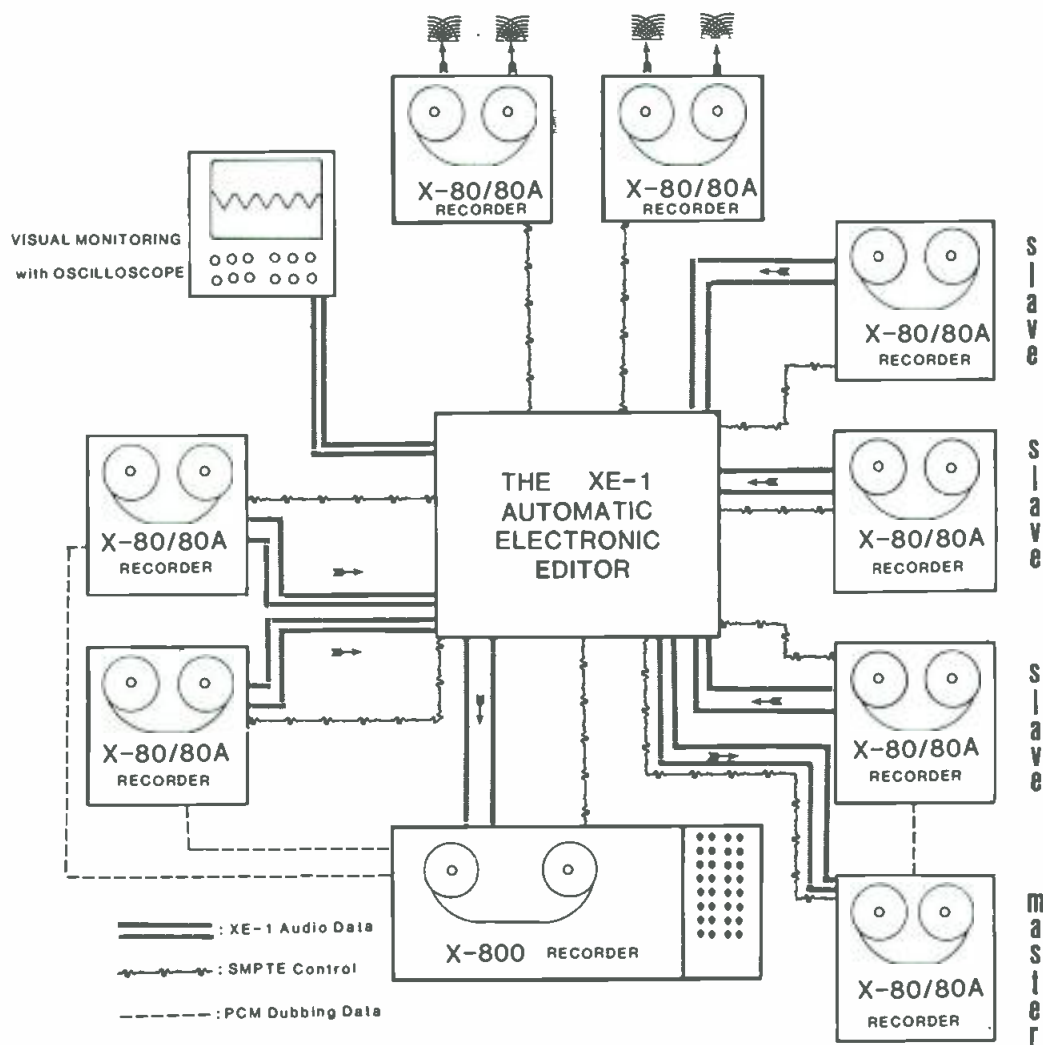

Figure 5. Various modes of the XE-1 Editor

### OTHER EDITING CAPABILITIES

The XE-1 is also programmed to meet other digital recording needs, among them four-channel recording. When used with two X-80 Series recorders, the SMPTE abilities of this editor can lock the recorders together for four-channel recordings, again offering manual or automatic editing capability. This is most useful when a studio that records mostly live dates, jazz, and classical material needs more than two channel capability, but cannot justify the immediate acquisition of a PCM multi-track recorder. Solos can be repaired, different takes inserted, and level reset with this editor— all at a minimum expense to the user. In addition, as four-channel digital mastering is a distinct future possibility for the Philips Compact Digital Audio Disc (C-DAD), this system is fully ready to comply.

The editing of tapes produced on our X-800 32 channel recorder is nearly as flexible. However, razor-blade splicing of the 1-in. tape of this system tends to curl away from the read head during transport and we cannot at this time guarantee that every edit will work as well as it does on the X-80 recorders, but there are two other reasons that make the razor-blading of these tapes impractical. If a physical splice was to be made reliable, it would probably need to be machine-made, as the lining up of the recorder's 44 tracks is more difficult than the X-80's ten-track configuration. In addition, the making of a safety copy would require the acquisition of a second recorder, since we feel that a producer would not feel comfortable in tampering with the audio in its original unmixed form without having this safety copy. As we can see again on FIGURE 5, there

are two ways to accomplish "edits" on the X-800 recorder with and without the XE-1. Since the fixed head design of the X-800 allows the addition of a punch-in head and punch-in may be programmed on the X-800 autolocator to be automatic, we can punch-in and punch-out an insert or add-on edit, again with the internal fading circuitry explained earlier. Another method for editing these tapes would be by using the XE-1 and the ping-pong method of transferring material two channels at a time between the X-800 and X-80 recorder. In this way all of the features of the XE-1 are available to the editor; resetting levels, varying crossfade durations and so forth. In addition, since some material will be at some time on the X-80 tapes, these can be razor blade edited as needed. ■

### REFERENCES

- Kunimaro Tanaka, "The Mitsubishi Electric PCM Format" db January 1981.
- Kunimaro Tanaka, "The Mitsubishi Digital Audio System" db February 1980.
- Kunimaro Tanaka et al. "On tape cut editing with a fixed head type PCM tape recorder" reprint of IEEE Transactions on Acoustics, Speech, and Signal Processing, Vol. ASSP-27, No. 6" December 1979.
- Kunimaro Tanaka, Ietsuya Yamaguchi, et al. "Improved two channel PCM tape recorder for professional use" Preprint of AES 1533(G-3).

## BLACK BOX ACCESSORY



• The Model SB-2 Series Box is a simple way for Bose PM-2 Powermixer users to obtain the extra projection and bass response of stacked pairs of Bose 802 loudspeakers. It plugs directly into the output jacks of the PM-2 unit and allows impedance-corrected connection of two to four pairs of 802 speakers without the need for any additional amplifier power.

*Mfr: Bose Corporation*

*Price: \$38.00*

*Circle 54 on Reader Service Card*

## DIGITAL ENCODING DEVICE

• The Travis Fader is basically a digital encoding device that features no moving parts at all. Infra-red light bridge technology feeds a 6500 series microcomputer that can receive and process information from 4 fader units. Level changes are accomplished by placing a digit (finger tip) anywhere in the shallow fader trough and moving it up or down. There is a row of LEDs next to the fader that tracks level and is analogous to knob position. Located along the bottom of each fader are three switches—Preset 1, Preset 2, and fader Solo Mute. Each fader has two preset level memories that are available by pressing the appropriate momentary switch. Solo/Mute represent the logical corollaries: Solo mutes all other faders that aren't in solo; Mute shuts off just itself; which logic isn't in effect is selected on a command panel elsewhere. The fader output is a 8 bit digital word that routes to the attenuator and to the automation computer.

*Mfr: Sphere Electronics, Inc.*

*Circle 55 on Reader Service Card*

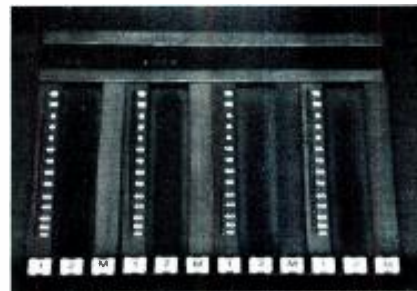

## NEW FROM RCI PRO ADAPTER MODEL 440



A complete two channel amplifier system providing proper interface of pro and semi-pro gear. Its balanced output drives 600 ohm lines at +4 or +8 dBm, keeps on going to +24 dBm before clipping. Dual fixed attenuators provide -10 dB nominal return. A tight  $\pm 1/4$  dB response in a 20-20 KHz bandwidth provides remarkably transparent sound. A super tool at an affordable price. Just **\$219.95** at better Pro Audio Dealers.

**RCI ENGINEERED  
AUDIO SYSTEMS**

8550 Second Avenue  
Silver Spring, MD 20910  
(301) 587-1800

*Circle 39 on Reader Service Card*

## OFFICE COMPUTER

• The HP 125 office computer combines the features of a personal computer, word processor, computer terminal, financial calculator and graphics workstation. It not only manipulates words, numbers, and pictures, but it can also draw data from a mainframe computer. Instead of having to memorize commands, operators can perform most application functions simply by pushing one or more of eight "soft keys," whose functions are labeled on the screen. These keys prompt and guide the user by presenting alternatives in English-language form. Software is available for such diverse functions as accounting, data management, investment analysis, billing and more.

*Mfr: Hewlett Packard*

*Circle 56 on Reader Service Card*



## POWER AMPLIFIERS

• Edecor has announced their new PA series of modular power amplifiers—50, 100 and 150 watts. These amps feature: low distortion under 1 percent THD; a wide variety of input modules for interface with any program source; LEDs to indicate clipping; satisfactory operation down to 85 volts AC line input, and newly designed electronic and thermal protective circuits and handles.

*Mfr: Edecor*

*Circle 73 on Reader Service Card*



*db is the 1*

*Is your ad in the magazine with the largest circulation?*

***db is the 1***

*Is your ad in the magazine whose authors are the leaders in their field?*

***db is the 1***

*Is your ad reaching more of the decision makers in the broadcast and recording markets?*

***db is the 1***

*Is your ad being seen every month?*

***db is the 1***

***Your ad can be in the  
number 1 magazine—db***

For more information write or call us at:  
1120 Old Country Rd, Plainview, N.Y. 11803 (516) 433-6530

## MICROPHONES

- The PE1 and PE2 Series of microphones have been especially designed to provide professional entertainers with quality performance in an attractive package. For visual appeal, the die-cast case of the PE1 and PE2 has a brown Suedecoat finish accented by a raised grille with a black matte finish. In addition to its decorative advantages, the raised die-cast grille also provides pop and wind protection and often eliminates the need for an add-on windscreen. The PE2 Series models also feature two built-in, recessed tone-shaping switches, for presetting either high-frequency boost, or low-frequency cut-off. For reliable performance under all operating conditions, the PE1 and PE2 feature a shock-mounted cartridge which makes each microphone insensitive to handling noise or mechanical vibration. All six models in the PE1 and PE2 Series are unidirectional, dynamic mics. The uniform cardioid pickup pattern of each microphone minimizes undesirable background noise, permits higher amplifier gain before feedback and prevents tone coloration of off-axis performers.

*Mfr: Shure Bros., Inc.*

*Circle 57 on Reader Service Card*



## 2-TRACK IN HALF-INCH FORMAT



- Studer Revox has announced the availability of the Studer A80VU in the 1/2-in. 2-track mastering format. Previously, only the A80RC version has been offered in this format. By employing the wider tape, and thus increasing the track width, the Studer A80VU 1/2-in. improves the signal-to-noise ratio. At an operating level of 510 nWb/m, the weighted S/N of this new machine measures better than -75 dB. In addition, the A80VU 1/2-in. 2-track incorporates Studer's new transformerless line output amplifiers. This new plug-in card employs a Triac-protected, DC-coupled output stage utilizing four power transistors. Frequency response for the amp card is 14 Hz to 50 kHz (+0 -1 dB); THD measures less than 0.01 percent at 1 kHz with +24 dBm output.

*Mfr: Studer Revox America, Inc.*

*Price: \$10,500*

*Circle 59 on Reader Service Card*

## SOFT-WIRED SYNTHESIZER

- Syntauri Corporation has announced a new operating system, alphaPlus, for the alphaSyntauri synthesizer. Designed for digital synthesists, alphaPlus is based on the flexible soft instrument architecture. A single floppy diskette - the standard microcomputer recording medium - is all a keyboard musician needs to have on a new Syntauri instrument. No new hardware, tuning, or special equipment is needed for users to immediately take advantage of alphaPlus' musical features and the user doesn't need computer or programming experience to use the instrument. New features of the alphaSyntauri with the alphaPlus operating system include: Customization through an operating system designed to let the musician specify the overall instrument and digitally save those settings for later recall; Keyboard Dynamics enhanced for live performance with a polyphonic pitch bend controlled by the Apple computer's analog paddle, and Sound Modulation, including a fully controllable vibrato and oscillator detuning. Recording is done live at the keyboard. All play-dynamics, expression and rhythmic variations are digitally recorded for accurate playback. Unlimited numbers of new sounds can be saved on diskettes for fast retrieval.

*Mfr: Syntauri Corporation*

*Circle 58 on Reader Service Card*



## ELECTRONIC CROSSOVER



- The 6000-6 electronic crossover reproduces perfect square waves without aberrations of any kind, according to its manufacturer. It is available in any frequency from 40-16,000 Hz. Metal film resistors are used in the frequency networks, and the frequency can easily be changed by replacing a plug-in module. The unit has a 6 dB/octave slope, and dual level controls are located on the rear panel. The 6000-6 can be used for bi-amping or tri-amping (2 units required). It should be used with separate amplifiers and preamps and is not recommended for use with receivers unless they contain an external processor loop (Pre-out Main-in).

*Mfr: Ace Audio Co.*

*Price: \$175.00*

*Circle 60 on Reader Service Card*



## MIXING CONSOLE

• Available in 6, 8, 12 and 16-channel versions, the 83 Series mixing boards are an upgraded replacement for Biamp's 82 Series mixers. The input channels feature trim control, three bands of EQ, effects/reverb send, monitor send and pan control, with the addition of an LED peak indicator for monitoring channel overload. The LED is an integrating type peak detector which becomes visible with a +8 dBV signal, indicating there is 10 dB of headroom remaining. Each channel has a channel patch jack which is post-EQ and pre-fader. The transformerless, balanced, variable gain input stage utilizes a differential pair of ultra-low noise transistors to perform the high gain (52 dB) function. Output metering is achieved via two 10-segment LED ladders, calibrated to 0 dBV and ranging from -21 dBV to +6 dBV in 3 dB increments. A total of three line level inputs provide effects return access to both submasters and the main and monitor outputs. The reverb is pannable between the main and minor outputs.

*Mfr: Biamp Systems, Inc.  
Circle 61 on Reader Service Card*



## COMPONENT MOUNTING BOX-PHONE JACK



• The Model 4796 is a component jack to phone plug which allows the addition of active and passive networks, voltage dividers, isolation networks or attenuators. The 4796, with a phone jack that accepts 6.35mm PJ-051 plugs, also includes a single PJ-051 plug on the lower portion of the box.

*Mfr: IIT Pomona Electronics  
Price: \$24.75  
Circle 62 on Reader Service Card*

## New Literature

### TAPE RECORDING ROOMS BULLETIN

• Tape recording rooms and their acoustical contribution to the making of "talking books" is the subject of a new, four-page Bulletin, 3.1214. The illustrated Bulletin 3.1214 also includes picture caption references to five Industrial Acoustics Company acoustical products for academic environments. *Mfr: Industrial Acoustics Company, 1160 Commerce Avenue, Bronx, NY 10462.*

### CATALOG OF HARD-TO-FIND TOOLS

• A new 144-page catalog of hard-to-find tools for electronic assembly and precision mechanics is offered free by Jensen Tools Inc. The contents include more than 2,000 tools of interest to field engineers, technicians, telecommunications installers, etc. Major categories covered include: micro-tools, test equipment, soldering equipment, tweezers, screwdrivers, cutters, drafting supplies, power tools and a complete line of tool kits and tool cases. *Mfr: Jensen Tools Inc., 1230 South Priest Dr., Tempe, AZ 85281.*

## FM Wireless Intercom!

Superb, interference free, intercom up to 150 yards! FCC certified and license free. Five channels available. Comfortable, lightweight, and only 11 ounces without standard 9 volt batteries. Soft, foam-filled, vinyl ear cushions provide excellent acoustic seal, reducing ambient noise. Interface capability with "hard-wired" systems. VOX accessory available for "Hands Free" operation. The TR-50 is available in hard hat.



- TV & Film cameramen producers, directors.
  - Football coaches, assistants, spotters.
  - Manufacturing personnel.
  - Security personnel.
  - Theatre crews.
  - Language translators.
  - Tour directors.
- Request Bulletin-3U for TR-50 and other FM wireless models.*
- INTERCOM MODEL TR-50 **\$297.**

# INTERCOM

Manufactured by:

**R-COLUMBIA PRODUCTS CO., INC.**  
2008 St. Johns Ave. Highland Park, IL 60035  
(312) 432-7915 TWX: 910-692-2160

*Circle 17 on Reader Service Card*

## STEREO TAPPED DELAY



• The STD-1 Stereo Tapped Delay is a voltage controlled analog delay which produces six delays simultaneously. Each of the six non-harmonically related taps can be assigned and mixed into either of two stereo output channels. The taps are not equally spaced apart nor are they multiples of each other. The Delay time of the STD-1 varies from 1.3ms to 55.5ms and is continuously variable over a 1 to 5X range. The Sweep Rate varies from .1 to 25 seconds for a complete cycle. The Sweep Modulation control superimposes a higher frequency pattern over the regular sweep allowing vibrato sweeps to random sample and hold sweeps. The Regeneration Level control determines the decay time at long delays (up to 15 seconds) and the amount of resonance at short delays (up to +12 dB). The High Cut control reduces the high frequency content in the fed back signal for a natural decay, and is adjustable from 12 kHz to 800 Hz. The Regeneration Tap selector selects tap 1, 3 or 6 as the source for the regenerated signal. Effects produced by the STD-1 include stereo high flanging, highly resonant flanging, doubling, multi-voice chorusing, echo, reverberation, multiple doppler effects and others.

*Mfr: A/D.A. Signal Processors*

*Price: \$799.95*

*Circle 63 on Reader Service Card*

## TERMINATING DEVICES



• Types 30 and 32 Mag-Master components interconnect with mass header connectors used in computers, data processing, telecommunications, instrumentation and other applications. They are designed for fast plug-connections of mating mass termination cable connectors, and connections to field wiring can be changed quickly via screw connections. Type 30 Mag-Master interface device has two parallel rows with screw terminals on one side (.325 in. centers) and mass header pin connector on the other side on .100 in. centers. Type 32 device is similar in design but with pins on .156 in. centers.

*Mfr: Magnum Electric Corporation*  
*Circle 64 on Reader Service Card*

## UTILITY AMPLIFIER



• The GA-2 solid-state utility amplifier was created primarily for music-on-hold installations. It also serves in such other applications as driving a monitor speaker or group of headphones. It is also suited for telephone line remote or line amplifier. A screwdriver-adjustable volume control is provided for a high-impedance unbalanced auxiliary input, such as a tape player. The auxiliary unit can be connected to either the phono jack input or screw terminal. Output of the GA-2 is two watts rms into 8 ohms at less than 2 percent distortion. At 1.5 watts output, distortion is 0.2 percent. The level across the balanced 600-ohm output is +8 dBm (+2 volts). Frequency response is 50-20,000 Hz, +0 dB, -2.5 dB. Hum and noise is -72 dB below rated output. The 5½-in. x 4¼-in. x 2¼-in. amplifier is easily mounted on a wall or other location.

*Mfr: LSI Bogen*

*Circle 65 on Reader Service Card*

## STUDIO MONITORS



• Cetec Gauss has introduced a new line of studio monitors designated the 7480 and 7350. The Model 7480 utilizes an 18-inch woofer in a 12.5 cubic foot enclosure to provide full 20 Hz to 20 kHz power response and a large compression driver (Model 4081). The Model 7350 utilizes a 15-inch woofer in a 6 cubic foot enclosure to provide full 35 Hz to 17.5 kHz power response, and a compression driver (Model 2080) with constant directivity horn. The Model 7480 features an HF rolloff control in addition to the normal two HF level controls, and a bi-amp system using the 4 ohm 18-in. woofer to take advantage of the output available from the current solid-state power amplifiers.

*Mfr: Cetec Gauss*

*Circle 66 on Reader Service Card*

## MODULAR CART RACK SYSTEM

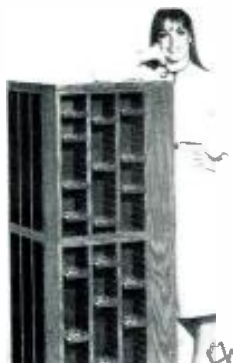

• The System 23 Modular Cart Rack System consists of 6 different sizes of cabinets with the smallest cabinet holding 18 cartridges and the largest 108. The basic units can be bolted together to become a free standing, rotating, four sided cart rack holding up to 1296 cartridges. Other configurations are designed to be set on table tops or to be wall-mounted. Rack mountable units which attach to any standard 19-in. rack with EIA rack mounts are also available.

*Mfr: Ruslang Corp.*

*Circle 67 on Reader Service Card*

## POWERED MIXER

• The 29 Series powered mixer is a combination mixing console, power amplifier, equalizer and reverb unit in a portable package. The Series consists of an 8 and 12-channel version with identical 9-band graphic equalizers and internal convection-cooled power amps. The equalizer may be programmed or patched for independent operation. Center frequencies begin at 50 Hz and extend to 12.5 kHz. The high power internal amp is built to drive 2-ohm reactive loads without shutting down. The 829's power amp is rated at 300 watts per channel at 2 ohms (both channels driven). The amps feature a proprietary, high-efficiency heat exchanger, a thermal feedback circuit and an internal amplifier limiter which eliminates audible clipping. The amp input jacks allow use of the amps independently, and the front panel LED ladders are calibrated to the outputs in percent power, automatically compensating for different load impedances. Input channel jacks consist of one female XLR and one phone jack per channel. The phone jacks are factory programmed for different functions: four channels for channel patch, six channels for line inputs and two for instrument input.

*Mfr: Biamp Systems, Inc.*

*Circle 68 on Reader Service Card*



## COMPRESSOR/LIMITER



• According to its manufacturer, the Model 501 Peak-RMS Compressor-Limiter is a dynamic range processor which combines the features of a peak limiter and an RMS compressor in one package. In addition to the use of a proprietary RMS converter, Symetrix has employed the latest VCA from Allison Research-Valley People, the EGC-101. The use of the EGC-101 in the 501 makes possible broadband distortion specifications of less than .015 percent THD (at any output level), and noise figures of better than -88.5 dBu. Another important feature of the 501 is the "soft knee" characteristic of both the peak and RMS sections. The soft knee permits the transfer from the linear operating region, into compression or limiting, with virtually none of the threshold characteristics of the hard knee limiters. Also incorporated into the 501 is a feed forward side-chain. The 501's signal input and output are automatically balanced using 3-pin XLR type connectors.

*Mfr: Symetrix*

*Price: \$425.00*

*Circle 70 on Reader Service Card*

## MICROPHONE MIXER

• The M267 microphone mixer is designed primarily for use in studios and remote broadcast setups as a single compact console, or as an "add-on" mixer for expanding existing facilities. Featuring balanced, transformer-coupled line and microphone level outputs, the M267 provides a wide frequency response and low noise and distortion. Each of the M267's four balanced microphone inputs has its own volume control, low-cut filter switch and mic/line switch. Active gain controls virtually eliminate the need for input attenuators. The master volume control sets the overall program output level. The M267 incorporates a switchable, fast-attack limiter to cut output overload distortion during loud program segments without affecting normal program levels. In addition to its dual-range, illuminated VU meter, the mixer has an LED peak indicator that shows when program levels approach overload and indicates limiter operation. The M267's front-panel headphone jack accommodates either stereo or mono headphones, and has its own level control and amp/line switch. A built-in, low distortion tone oscillator permits line test and level checks. The M267 is powered by the 120-volt ac line, an integral battery pack, or an external 30 Vdc source.

*Mfr: Shure Bros., Inc.*

*Circle 69 on Reader Service Card*



## TRANSFORMERLESS LINE AMPS

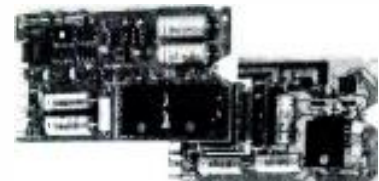

• Studer Revox has introduced a new transformerless line output amplifier which will replace the previous transformer-design card as standard equipment in all new A80VU recorders. The plug-in amplifier card is actively balanced and fully AC floating. The circuit design employs four DC-coupled power transistors in the output stage, with outputs protected by Triac crowbar circuits. The low source impedance of 22 ohms allows the line output to be driven into widely varying balanced and unbalanced loads—such as capacitance loads from long cable runs—with no degradation of audio signal quality. THD is less than 0.01 percent measured at 1 kHz with +24 dBm into 600 ohms. Frequency response is 14 Hz to 50 kHz, +0/-1 dB. The transformerless amp card may be retrofitted into all existing Studer A80 models through simple plug-in replacement.

*Mfr: Studer Revox America, Inc.*

*Price: \$150.00*

*Circle 71 on Reader Service Card*

Closing date is the fifteenth of the second month preceding the date of issue.  
 Send copies to: Classified Ad Dept.  
 db THE SOUND ENGINEERING MAGAZINE  
 1120 Old Country Road, Plainview, New York 11803

Minimum order accepted: \$25.00  
 Rates: \$1.00 a word  
 Boxed Ads: \$40.00 per column inch  
 db Box Number: \$8.50 for wording "Dept. XX," etc.  
 Plus \$1.50 to cover postage

Frequency Discounts: 6 times, 15%; 12 times, 30%

ALL CLASSIFIED ADS MUST BE PREPAID.

REELS AND BOXES 5" and 7" large and small hubs, heavy duty white boxes.  
 W-M Sales, 1118 Dula Circle, Duncanville, Texas 75116 (214) 296-2773.

TASCAM, BGW, JBL, EV, Nikko, Technics, Onkyo, Hafler, Audio Research, Conrad Johnson, dbx, etc. P. K. Audio, 4773 Convention, Baton Rouge, LA 70806. (504) 924-1001.

AKG BX20 reverberation and C414 microphones. FOR IMMEDIATE DELIVERY. UAR Professional Systems, 8535 Fairhaven, San Antonio, TX 78229. 512-690-8888.

### PROFESSIONAL AUDIO EQUIPMENT

Shop for pro audio from N.Y.'s leader, no matter where you live! Use the Harvey Pro Hot-Line. (800) 223-2642 (except NY, AK, & HI). Expert advice, broadest selection such as: Otari, EXR, Ampex, Tascam and more. Write or call for price or product info:

**Harvey Professional Products Division**  
 2 W. 45th Street  
 New York, NY 10036  
 (212) 921-5920

### FOR SALE



**ACOUSTIC TEST INSTRUMENTS**  
 USE TO ADJUST EQUALIZERS, OPTIMIZE SPEAKER PLACEMENT, ETC.

Complete Test Set	\$399
Calibrated Sound Level Meter	\$169
Fractional Octave Pink Noise Generator	\$299
Handbook on Acoustic Testing	\$6

Free broch. HALL ENGINEERING, Dept E4  
 P.O. Box 506 Martinsville NJ 08836  
 (201) 647-0377

USED RECORDING equipment for sale.  
 Dan (415) 441-8934.

REMANUFACTURED ORIGINAL equipment capstan motors for all Ampex and Scully direct drive recorders, priced at \$250., available for immediate delivery from VIF International, PO Box 1555, Min View, CA 94042, phone (408) 739-9740.

BLANK AUDIO AND VIDEO CASSETTES direct from manufacturer, below wholesale, any length cassettes: 4 different qualities to choose from. Bulk and reel mastertape—from ¼-inch to 2-inch. Cassette duplication also available. Brochure. **Andol Audio Products, Inc., Dept. db, 42-12 14th Ave., Brooklyn, NY 11219. Toll free 1-800-221-6578, ext. 1, NY residents (212) 435-7322.**

LEXICON, dbx, & UREI. Most items for immediate delivery. UAR Professional Systems, 8535 Fairhaven, San Antonio, TX 78229. (512) 690-8888.

MICROPHONES BY UPS. Quicker. You'll save more with us. All popular models for immediate delivery. UAR Professional Systems. (512) 690-8888.

THE LIBRARY... Sound effects recorded in STEREO using Dolby throughout. Over 350 effects on ten discs. \$100.00. Write The Library, P.O. Box 18145, Denver, Colo. 80218.

TECHNICS, BGW, EVENTIDE, AKG, Scully, and many more IN STOCK. FOR IMMEDIATE DELIVERY: UAR Professional Systems, 8535 Fairhaven, San Antonio, TX 78229. (512) 690-8888.



HAVE YOU EVER BEEN FRUSTRATED WITH FEEDBACK HOWL EVEN AFTER USING EQUALIZERS? FIND OUT ABOUT OUR FEEDBACK STABILIZERS MOD. NO. 741 XR AND 742 XR.

BODE SOUND CO.  
 1344 ABINGTON PL.  
 NO. TONAWANDA, N. Y. 14120  
 716-692-1670

**FREE CATALOG & AUDIO APPLICATIONS**



**OPAMP LABS INC.**

CONSOLES  
KITS & WIRED  
AMPLIFIERS  
MIC, EQ, ACN, LINE,  
TAPE, DISC, POWER  
OSCILLATORS  
AUDIO TAPE BIAS  
POWER SUPPLIES

1033 N. SYCAMORE AVE.  
LOS ANGELES, CA. 90038  
(213) 934-3566

LEXICON 224 Digital Reverberation. FOR IMMEDIATE DELIVERY. **UAR Professional Systems, 8535 Fairhaven, San Antonio, TX 78229, 512-690-8888.**

AMPEX, OTARI, SCULLY—in stock, all major professional lines; top dollar trade-ins; write or call for prices. **Professional Audio Video Corporation, 384 Grand Street, Paterson, New Jersey 07505. (201) 523-3333.**

USED/MINT CONDITION: Fluke 8050A DMM, Comm Corp RTA ARA-412B + BONG-2, B&K #1801 40MHz frequency counter. **Carl Austin, Box 14225, St. Petersburg, Florida 33733.**

AMPEX, OTARI & SCULLY recorders in stock for immediate delivery; new and rebuilt, **RCI, 8550 2nd Ave., Silver Springs, MD 20910.** Write for complete product list.

PRESTO 8D Lathe w/Vac Table, amps, mod's. Write for details. **Graves Recording Service, P.O. Box 5145, Eugene, OR 97405.**

FOR SALE: 3M-7924 track with 16 track heads, selectake, no modification, (1) BX10 like new, (13) API Graphic Eq's with rack mount. **Contact Clay at (516) 921-9421.**

HI-FI PHONE PATCH \$325. Northern Telcom Speakerphone with balanced mic in/line out. Noise gate on phone line. **Current Designs Corp., 210 East 86th Street, New York, NY 10028, (212) 861-5006.**

ORBAN. All products in stock. FOR IMMEDIATE DELIVERY. **UAR Professional Systems, 8535 Fairhaven, San Antonio, TX 78229. 512-690-8888.**

### SERVICES

ACOUSTIC CONSULTATION—Specializing in studios, control rooms, discos. Qualified personnel, reasonable rates. Acoustilog, Bruel & Kjaer, HP, Tektronix, Ivie, equipment calibrated on premises. Reverberation timer and RTA rentals. **Acoustilog, 19 Mercer Street, New York, NY 10013 (212) 925-1365.**

### JBL AND GAUSS SPEAKER WARRANTY CENTER

Fast emergency service. Speaker re-coning and repair. Compression driver diaphragms for immediate shipment. **NEWCOME SOUND, 4684 Indianola Avenue, Columbus, OH 43214. (614) 268-5605.**

MAGNETIC HEAD relapping—24 hour service. Replacement heads for professional recorders. **IEM, 350 N. Eric Drive, Palatine, IL 60067. (312) 358-4622.**

CUTTERHEAD REPAIR SERVICE for all models Westrex, HAECO, Gramplan. Modifications done on Westrex. Quick turnaround. New and used cutterheads for sale. Send for free brochure: **International Cutterhead Repair, 194 Kings Ct., Teaneck, N.J. 07666. (201) 837-1289.**

### WANTED

WANTED: TRANSCRIPTION discs, any size, speed. Radio shows, music. **P.O. BOX 724—db, Redmond, WA 98052.**

### EMPLOYMENT

POSITION AVAILABLE Audio Engineer (Re-recording Mixer) for film and videotape. Leading NYC studio has spot open for qualified person with experience. Good salary and benefits. Send resume to **Dept. 110, db Magazine, 1120 Old Country Road, Plainview, NY 11803.**

PROJECT ENGINEER—Engineering position with tape manufacturer; lab work and recording experience required. Will work with engineering and sales department, travel required. Submit resumes to **Loranger Manufacturing, Box 948, Warren, PA 16365.**

RECORDING EQUIPMENT SALES help wanted. The continuing expansion of Audiotechniques' New York City offices has created several career opportunities for sales personnel with experience in recording studio, broadcast, and PA equipment sales. These positions offer salary, generous commissions, full benefits including pension. If you are interested in joining one of the oldest and best known professional audio equipment firms in the U.S., please send a resume in complete confidence to **Michael B. Faulkner, Vice President, Audiotechniques, Inc., 1619 Broadway, 4th Floor, New York, NY 10019.**



### Special binders now available.

All you regular **db** readers who, smartly enough, keep all your back issues, can now get our special binders to hold a whole year's worth of **db** magazines in neat order. No more torn-off covers, loose pages, mixed-up sequence. Twelve copies, January to December, can be maintained in proper order and good condition, so you can easily refer to any issue you need, any time, with no trouble.

### They look great, too!

Made of fine quality royal blue vinyl, with a clear plastic pocket on the spine for indexing information, they make a handsome looking addition to your professional bookshelf.

Just \$7.95 each, available in North America only. (Payable in U.S. currency drawn on U.S. banks.)

#### Sagamore Publishing Co., Inc.

1120 Old Country Road  
Plainview, NY 11803

**YES!** Please send \_\_\_\_\_ **db** binders @ \$7.95 each, plus applicable sales tax. Total amount enclosed \$ \_\_\_\_\_.

Name \_\_\_\_\_

Company \_\_\_\_\_

Address \_\_\_\_\_

City \_\_\_\_\_

State/Zip \_\_\_\_\_

• **Rupert Neve Incorporated** has announced the appointment of **David A. Purple** to the position of regional sales manager headquartered in Nashville, Tennessee. Purple comes to Neve from **Harrison Systems Inc.** of Nashville where he held the position of vice president sales. Prior to his employment with Harrison, he was professional product manager for **dbx Inc.** of Newton, Massachusetts. In 1972, Purple was awarded a Grammy for Best Engineered Recording in the Non-Classical category, for his contribution to the recording of **Isaac Hayes'** "Shaft" record. Purple has been involved in the recording of 34 other Gold and Platinum records. David Purple will be responsible for Neve's sales operations in the Southeast, parts of the Midwest, and parts of the Southwest with particular emphasis on broadcast sales.

• **Ansel Kleiman**, president of **Telex Communications, Inc.**, a wholly-owned subsidiary of **The Telex Corporation**, was elected to the Corporation's Board of Directors. Kleiman, with the company since 1964, was appointed a corporate group vice president and president of **Telex Communications, Inc.** in 1973.

• The second stop in a national series of **SPARS** (Society of Professional Audio Recording Studios) Road Shows took place on Thursday, October 29, in New York. The SPARS Road Show concept, developed as a reaction to the nation's sagging economy, is devised to bring SPARS to the industry vs. the industry coming to a SPARS convention. The successful SPARS/Nashville Road Show, held September 18, reinforced the merit and effectiveness of this SPARS program. The SPARS New York Road Show was presented in cooperation with **RCA Recording Studios, Inc.** and sponsored by **Ampex/Magnetic Tape Division; Rupert Neve, Incorporated;** and **Sony Corporation of America/Professional Digital Audio Division.**

• **Soundcraft Electronics U.S.A.** has announced the appointment of **Northwest Marketing, Inc.** as their manufacturer's representative for the locations of Washington, Oregon, Alaska, Western Montana and Idaho. Northwest Marketing will handle the entire line of Soundcraft professional mixing consoles for recording, sound reinforcement and stage monitoring uses.

• **Otari Corporation**, the Northern California-based professional tape recorder manufacturer has announced the appointment of **Mr. John Carey** as product manager. Mr. Carey will be primarily responsible for technical training of the Otari sales representative and dealer networks. Additionally, he will coordinate technical support between the Sales and Service Departments. He has recently held similar technical sales positions with professional audio dealers **Westlake Audio** and **Express Sound.**

• The "Off The Wall" record album creative team of **Michael Jackson**, artist; **Quincy Jones**, producer; **Bruce Swedien**, engineer, and two recording studios, combined talent to garner the first "Scotty" Master Music Maker Award from **3M's Magnetic Audio/Video Products Division.** Good chemistry among team members Jackson, Jones, Swedien and the studios is evident throughout the award-winning album. It is one of the reasons "Off The Wall" sold nearly five million albums. Producer Jones had the vocal and rhythm tracks recorded at **Allen Zentz Studio**, and the horns at **Westlake Audio**, which also did the mixing. The "Scotty" award, which honors extraordinary performance, professional excellence, and cooperation that result in the highest level of recording quality, is an original painting of the winning artist personalized to highlight the gold/platinum recording. In order to qualify for a "Scotty," a recording must first attain gold or platinum status according to the guidelines of the **Recording Industry Association of America.** "Off The Wall" was first certified platinum in December, 1979. Additionally, a recording must be completely mastered and mixed on **Scotch** professional audio tape.

• **Audio + Design** has announced the sale of a large, but undisclosed, quantity of their Express limiters to the **Satellite Music Network.** The S.M.N. is a joint venture involving the **Burkhart/Abrams** consulting firm, the **United Video Services** of Tulsa, OK, **WCCO AM/FM/TV** of Minneapolis, and **John Tyler and Associates** of Dallas. The Express Limiters will be used on the various uplinks to provide high fidelity processing and overall protection. The Express Limiters were supplied to the S.M.N. via **Allied Broadcast Equipment** of Richmond, IN.

• **Edwin W. Hatfield** has been appointed general manager operations of **The BTX Corporation**, effective September 18, according to an announcement by **David Krumholz**, president. Mr. Hatfield succeeds **Ronald C. Barker**, who has left the company.

• **Klark-Teknik Electronics Inc.** has been appointed the exclusive U.S. distributor for **Brooke-Siren Systems** of England. BSS manufactures a range of professional crossovers and accessories, including 3, 4, or 5-way modular stereo crossovers with optional LED metering. All the crossovers include a separate limiter per section, and additionally a HF (28 kHz) and a subsonic (30 Hz) filter. BSS accessories include a Direct Injection Box (AR116), with optional phantom powering (AR117) and a cable and fuse tester (AR125). All sales and service for Brooke-Siren will be handled by Klark-Teknik in New York.

• **Audiocraft Recording Company** of Cincinnati has announced a complete upgrading of its Studio A facilities from 16 to 24-tracks. As it expands its operation to provide audio sweetening services for video, Audiocraft will continue jingle, A/V, film, music and voice over production. The studio's latest addition is an **MCI JH-114** transformerless 24-track recorder with Autolocator III, two **BTX Model 4500 SMPTE** Time Code Synchronizers, **Model 5400V** Time Code Generator, and the **Model 4600** Tape Controller. The recently remodeled Studio A is centered around an **Allen-Heath 28 x 24 Series B** console and features 34 tracks of **dbx** noise reduction and a full complement of outboard gear.

• **Peter Giddings**, marketing director of **Clear-Com** intercom systems, San Francisco, recently announced the promotion of **Mr. Edward Fitzgerald** to national sales director. He also confirmed that commensurate with Clear-Com's new representative policy, agreements with **Sunwest Marketing** (Southern California, Arizona, Southern Nevada), **Gemini Electronics Marketing Inc.** (Oregon, Idaho, Montana, Alaska, Washington), **Pro Rep Company** (Northern California, Northern Nevada) and **Kodo Associates Inc.** (North Dakota, South Dakota, Minnesota, Wisconsin) had been signed.



# MASTERS OF THE STUDIO.

There's as much magic in the mixing board as there is in the keyboard.

That's why, when we award the Ampex Golden Reel, it goes to both the recording artist *and* the recording studio. Together they provide the magic that turns a reel of recording tape into an outstanding creative achievement.

The Ampex Golden Reel Award honors those achievements that were mastered on Ampex

professional recording tape. They've earned a place in the ranks of the world's most successful recorded albums and singles\*.

Along with the Award, we also present \$1,000 to a charitable organization. Since we started the Golden Reel Awards three years ago, there have been over 200 recipients, and more than \$200,000 donated on their behalf.

Congratulations to all of them. The masters on both sides of the microphone.

## AMPEX

Ampex Corporation, Magnetic Tape Division, 401 Broadway, Redwood City, California 94063, (415) 367-3889.

The new UREI Series "A" Time-Aligned™ monitor systems and their equals, the UREI Listening Amplifiers.

For the purest sounds you've ever heard, audition the critically engineered and listener proven UREI professional monitoring systems.

## UREI: The NEW Monitoring Standard

Now available with your choice of three accurate Time-Aligned™ monitors and four sonically superb power amplifiers.

From small intimate listening situations to the most spacious environments... from studio control rooms to massive sound reinforcement, the solution to critical music reproduction for the audio professional is awaiting your evaluation at your authorized UREI dealer.

Evaluate the combined technology of a total UREI monitoring system and you will know and appreciate why your peers have made UREI the *new monitoring standard*.

Time-Align is a Trademark of E.M. Long Assoc., Oakland, CA. All referenced Trademarks are property of, or licensed by, United Recording Electronics Industries, a URC Company.

### UREI From One Pro To Another

United Recording Electronics Industries, a URC Company  
8460 San Fernando Road, Sun Valley, California 91352  
(213) 767-1000 Telex: 65-1389 UREI SNVY  
Worldwide: Gotham Export Corporation, New York  
Canada: E. S. Gould Marketing, Montreal

See your professional audio products dealer for full technical information.

