



IN THIS ISSUE:

- N.Y. AES Convention Roundup
- Tape tension Testing
- Random Noise in Acoustical Measurements

Here's how useful a distortion analyzer can be

Monitor voltage, power, distortion or dB ratio.

No manual nulling controls required (the 1710A is always in auto-null, reaches a null in less than 5 seconds).

Intermodulation Distortion Analyzer optionally available.

Oscillator distortion is typically .001%.

Measure generator signal at load with the push of a button.

± 1 dB Vernier adds fine level control.

Selectable 18 dB per octave filters reject hum and high frequency noise.

Internal oscillator adjustable from +26 dBm to -89.9 dBm in 0.1 dB steps.

Fast pushbutton operation lets you set level, measure voltage or power, then measure distortion.

Turn off oscillator for quick S/N measurement.

Measure voltage or power from 10 Hz to 110 kHz.

Tuning indicators help measure distortion of an external source.

100 k Ω Balanced Input.

Simultaneously select oscillator and analyzer frequency with fast-to-use pushbuttons. 10 Hz to 110 kHz.

View input signal on a scope.

Automatic Set Level is optionally available.

View distortion products on a scope.

Measure distortion down to .002%, voltage or S/N ratios with 100 dB dynamic range.

Two of the above features are so outstandingly valuable that we especially invite your attention to them.

One is the fast, easy measuring you get with pushbutton-selected distortion-measuring circuits (signal source and measuring circuits are simultaneously selected with the same pushbuttons). Pushbuttons make it so simple to measure quickly and to repeat measurements.

Secondly, you can drive virtually any type of circuit from the signal source output — whether

balanced, unbalanced, off-ground or whatever. That's because the signal source output circuit is fully isolated and balanced.

There is no output transformer to introduce noise or distortion.

Besides these outstanding conveniences, you can have the Sound Tech 1710A with an option that enables you to measure intermodulation distortion.

Call Mike Hogue/Larry Maguire to get full information on an instrument recognized everywhere as the standard of the audio field.

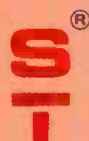

SOUND TECHNOLOGY

1400 DELL AVENUE
CAMPBELL, CALIFORNIA 95008
(408) 378-6540

Circle 10 on Reader Service Card

coming next month

- The second part of the Ampex ATR-100 interview scheduled for this month got squeezed out and will appear next month.
- Michael Rettinger has submitted a studio construction article entitled "The Use of Sheet Lead for Insulation" that will tell you all you wanted to know about this subject.
- And for those of you with ambition to get into audio-visual display work, Robert C. Ehle details "A Homebrew Multi-Media Display."



about the cover

• Chief Engineer Kurt Munkacsy of New York's Big Apple Recording Studio must sometimes resort to extremely drastic means to adjust torque on his machines. He can be seen in more normal pose on the cover of John Woram's "The Recording Studio Handbook." Photo is by Ray Buchner.

db

THE SOUND ENGINEERING MAGAZINE

JANUARY 1977, VOLUME 11, NUMBER 1

- 24 RANDOM NOISE IN ACOUSTIC MEASUREMENTS
Sidney L. Silver
- 28 CHECK YOUR TAPE TENSION
David R. McClurg
- 31 AES CONVENTION REPORT
John M. Woram and Larry Zide
- 2 INDEX TO ADVERTISERS
- 4 LETTERS
- 8 CALENDAR
- 10 NEW LITERATURE
- 14 BROADCAST SOUND
Patrick S. Finnegan
- 18 THEORY AND PRACTICE
Norman H. Crowhurst
- 20 NEW PRODUCTS AND SERVICES
- 33 CLASSIFIED
- 36 PEOPLE, PLACES, HAPPENINGS

db is listed in Current Contents: Engineering and Technology

Robert Bach PUBLISHER	Larry Zide EDITOR
Bob Laurie ART DIRECTOR	John Woram ASSOCIATE EDITOR
Eloise Beach CIRCULATION MANAGER	Hazel Krantz COPY EDITOR
Lydia Anderson ASST. CIRCULATION MANAGER	Ann Russell PRODUCTION
GRAPHICS Crescent Art Service	

db, the Sound Engineering Magazine is published monthly by Sagamore Publishing Company, Inc. Entire contents copyright © 1977 by Sagamore Publishing Co., Inc., 1120 Old Country Road, Plainview, L.I., N.Y. 11803. Telephone (516) 433-6530. db is published for those individuals and firms in professional audio-recording, broadcast, audio-visual, sound reinforcement, consultants, video recording, film sound, etc. Application should be made on the subscription form in the rear of each issue. Subscriptions are \$7.00 per year (\$14.00 per year outside U. S. Possessions, Canada, and Mexico) in U. S. funds. Single copies are \$1.00 each. Controlled Circulation postage paid at Harrisburg, Pa. 17105. Editorial, Publishing, and Sales Offices: 1120 Old Country Road, Plainview, New York 11803. Postmaster: Form 3579 should be sent to above address.

dbx little mother



just had Siamese twins

that give you true stereo tracking compression/limiting at less than 1/6 of the price of that big mother. dbx 162 rms level detectors are coupled to respond to the energy sum of the two inputs to give you precise stereo tracking you could never achieve with two separate compressor/limiters using their individual controls.

Like the dbx 160 little mother, the 162 Siamese twins let you compress any stereo source by any ratio from 1:1 up to infinite compression, and you can limit above any threshold from -38 to +12 dB.

The dbx 162 twins also inherited all the little mother's other excellent features including:

- True rms level detection to most closely simulate human hearing response
- Extremely low distortion even at high compression ratios
- Equivalent input noise -78 dBm (20 to 20,000 Hz)
- 60 dB meter range switchable to input, output, gain change and output sum (A+B)
- Output ground loop compensation and power turn-on, turn-off transient protection
- LED above and below threshold indicators
- Meter "0" VU adjustable from -10 to +10 dBm

For four or more channel operation, 162s are ganged with threshold, compression and gain for all channels controlled by the master unit to provide perfect multi-channel tracking.

For complete information or to arrange a demonstration of the dbx Siamese twins, contact your dbx dealer or circle reader service number or contact:



dbx, Incorporated, 296 Newton Street
Waltham, Massachusetts 02154 • (617) 899-8090

Circle 24 on Reader Service Card

index of advertisers

Ashly Audio	15
BGW Systems	13
California Switch & Signal	17
Cetec	14
Communications Co., Inc.	16
Community Light & Sound	7
dbx, Inc.	2
Electro-Voice	4
ESE	21
Garner Industries	31
Jensen Tools	20
JBL	3
Leader Instruments	8
MCA, Inc.	22, 23
Microtran	30
Orban/Parasound	21
Otari	5
Peavey Electronics	11
Recording Supply Co.	17
SAE	6
Sescom	16
Shure Brothers	Cover 4
Soundcraftsmen	19
Sound Technology	Cover 2
Sound Workshop	8
Standard Tape Lab	6
Willi-Studer America	12
Telex	9
Waters Mfg.	10
White Instruments	10
Woram Audio	21
Brigham Young University	12

db sales offices

THE SOUND ENGINEERING MAGAZINE

New York

1120 Old Country Rd.
Plainview, N.Y. 11803 516-433-6530

Roy McDonald Associates, Inc. Dallas

Stemmons Tower West, Suite 714
Dallas, Texas 75207 214-637-2444

Denver

3540 South Poplar St.
Denver, Colo. 80237 303-758-3325

Houston

3130 Southwest Freeway
Houston, Tex. 77006 713-529-6711

Los Angeles

500 S. Virgil, Suite 360
Los Angeles, Cal. 90020 213-381-6106

Portland

2035 S. W. 58th Ave.
Portland, Ore. 97221 503-292-8521

San Francisco

Suite 265, 5801 Christie Ave.
Emeryville, Cal. 94608 415-653-2122



Five monitors. One sound. Five JBL studio monitors.

You could record with any one, play back on any other, and take your pick among the rest for mixing or mastering.

The only differences are acoustic output, size and cost.

No matter what size your studio is, you can cross reference with any other studio using JBL's.

But reading isn't knowing for sure. Come listen to one. Or two. Or five.

JBL Studio Monitors from \$303 to \$1596.

James B. Lansing Sound, Inc. 8500 Balboa Blvd., Northridge, Calif. 91329.

Circle 29 on Reader Service Card

www.americanradiohistory.com



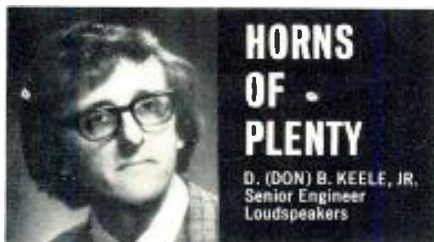

A few years ago, if you were to ask most sound practitioners questions about horn design, each answer would probably be much like the next. A set of assumptions about the value of hyperbolic and exponential horns had taken full root. And products available to the field reflected this unanimity of opinion. Certain shapes and sizes were "best" and differences in horn design were almost exclusively related to materials and minor variations in loading plug and throat characteristics.

Recently, however, intensive restudy of basic horn shape options has led to some new conclusions at E-V. The study aided in the design of new horns (patent pending) with performance differences that can provide meaningful improvements in sound quality if properly utilized.

One study concentrated on determining optimum horn mouth size. Popular belief suggested that "the larger the better" but our studies revealed this to be untrue. When horn mouth size is optimized, internal reflections are significantly reduced compared to both larger and smaller horns. The result is higher acoustic efficiency, especially near and even below the cutoff frequency.

Horn flares also underwent intensive study, with some fascinating results. It was found that the polar lobes typical of most exponential and multicell horns could be virtually eliminated with a multi-flare conical section horn. The conical flare rate is doubled near the mouth to eliminate mid-range beaming typical of exponential horns. The conical flares are combined with an exponential flare near the throat to maintain good response down to horn cutoff. In this new class of horns, constant response throughout the radiation angle, plus uniform beam width at all frequencies is achieved without the complex structure and loading plug problems required by multicell types.

With this new class of horns, plus appropriate drivers, the sound industry enjoys the use of more precise tools for the control of radiated sound. The products assist in more predictable system design, lessen installation problems, and meet the highest performance standards. And the concept has been proven in such recent installations as Pontiac Stadium, Disney World, and Yankee Stadium among others.

This continual challenge of basic assumptions has long been a tradition at E-V. From the unique CDP® dual-horn speaker—still valid decades later—to the current technology of the Sentry® speaker, our products reflect a willingness to upset favorite notions when they stand in the way of industry progress.

Electro-Voice®
INC.
a gulton company

Dept. 173BD, 686 Cecil Street
Buchanan, Michigan 49107

Circle 22 on Reader Service Card

THE EDITOR:

This concerns the article in the October issue by Ronald Ajemian, *The New Breed of Vu Meters*. While Mr. Ajemian properly describes the "tradition" in the field of vu meter standards, he very obviously misunderstands the meaning of the term *vu meter* as it is used in our common engineering language.

In view of the fact that I am presently organizing an effort on behalf of the AES as well as Technical Committee TC29B of the IEC for the purpose of revising and upgrading the standard to which Mr. Ajemian refers (ANSI C16.5-1954 [R1961]), I have become very sensitive to the rather loose way in which such standard volume indicators are referred to. Let me make it clear that the words *vu meter* do not appear in the standard at all, but have grown from the standard as an expression clearly referring to meters which have the looks and ballistics referred to in that standard. It is most regrettable that there has appeared a virtual flood of meters in the market, identical in looks to the standard meter and even labeled with the letters *vu* in each corner of the scale, which in no way resemble the behavior of the standard meter.

It is therefore most unfortunate that *db Magazine* chose to allow an article and a headline which appears to provide "room for improvement" of a standard meter. Had the article been entitled *A New Breed of Program*

MOVING?

Keep **db** coming
without interruption!

Send in your
new address *promptly*.

Enclose your old
db mailing label, too.

Write to:

Eloise Beach, *Circ. Mgr.*
db Magazine
1120 Old Country Rd.
Plainview, N.Y. 11803

Level Indicators. I would have had absolutely no objection. I also welcome the restatement of the ANSI standard which is now under review. But I most emphatically must object to such phrases as "Fig. 4. Led vu meter face." The final sentence is the most disturbing confusion in terms: "The conventional vu meter is still necessary, enhanced by the led vu meter." They cannot *both* be vu meters.

STEPHEN F. TEMMER
President,
Gotham Audio Corporation
New York, N.Y.

Mr. Ajemian replies:

I had no idea that my article would be taken in the wrong way, as Mr. Temmer points out. I recently attended a meeting with Mr. Temmer concerning a revision of vu meter standard (ANSI C16.5-1954 [R1961]). There is much confusion about what should be called *vu meters*.

Regarding my statement, "The conventional vu meter is still necessary, enhanced by the led vu meter," Mr. Temmer is right; they cannot both be vu meters. Actually, the led vu meter is not really a vu meter, even though some manufacturers stamp "vu meter" on them. They should be called *peak program level indicators*.

My article states the difference between the conventional, or standard, vu meter and the led "vu meter," (actually "peak program level indicator.") That is why we need a revision of this standard (ANSI C16.5—1954 [R1961]), so that these led meters will fall into a different class and to determine what type of markings will be on the faces of these meters.

I am going to keep in touch with Mr. Temmer and then will report on any new revisions regarding the subject of vu meters. Sorry for the confusion.

RONALD AJEMIAN
New York Telephone Co.

THE EDITOR:

This afternoon, in connection with preparing for a seminar that I am to conduct, I reviewed many of Norman

once is enough!

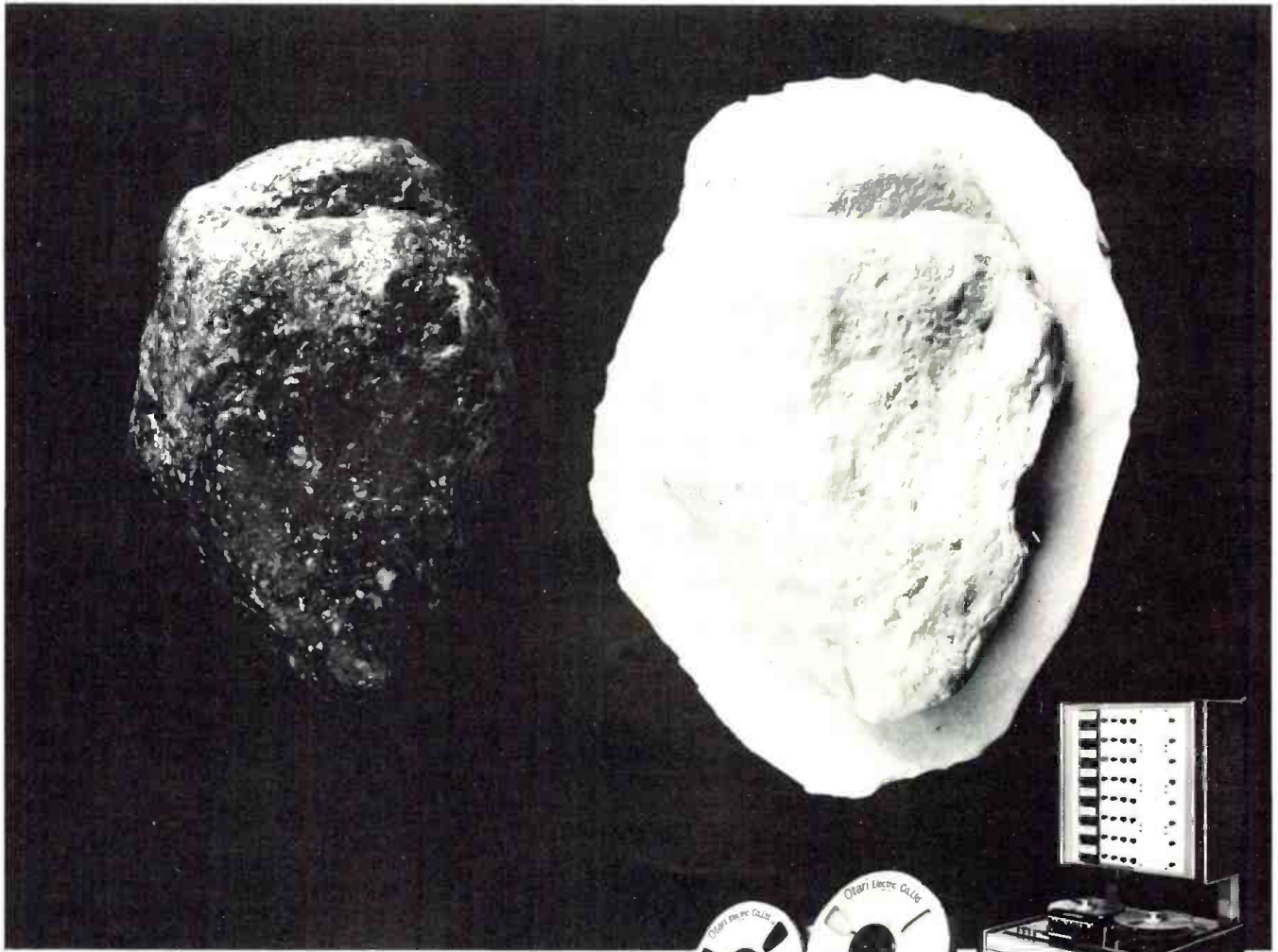

Perfect reproduction stems from creating a perfect system and then recreating the memory contents exactly. A plaster cast makes a fairly good replica of an original, but it is far from perfect. To improve the replica, you must improve the cast. It is the only way.

At Otari, it is our fundamental policy to plan on the basis of creating extremely accurate, highly precise data recorders and duplicators. Only by concentrating in this way on the heart of the duplicating process can we provide product which fill the professional's need for the most perfect reproduction of live sound that is possible.



MX-5050-2S



MX-7308

Trust through experience — one encounter with OTARI equipment and from then on, You will trust the OTARI name.

OTARI

OTARI CORPORATION: 981 Industrial Road, San Carlos, California 94070, U.S.A. Phone: California 415-593-1648 Telex No. 259103764890 OTARICORP SCLS
OTARI ELECTRIC CO., LTD 4-29-18, Minami Ogikubo, Suginami-ku, Tokyo, 167 Japan Phone: (03) 333-9631 Cable: OTARIDENKI TOKYO Telex: J26604 OTRDENKI

Circle 21 on Reader Service Card

WE'VE
MADE
A **move**

TO SERVE YOU EVEN BETTER

STL has moved to a new and larger facility. . .one that will provide even greater quality assurance to a line of recognized precision test tapes. STL gives you the most accurate reference possible in the widest ranges of formats. . .150 mil cassette tapes, tapes in ¼", ½", 1" and 2" sizes, flutter tapes and magnetic test films in Super-8 mm, 16 mm, or 35 mm.

Write for a free brochure and the dealer in your area.

Tape standard catalog items distributed by
Taber Manufacturing & Engineering Co., San Leandro, CA.

STL

STANDARD TAPE LABORATORY, Inc.

26120 Eden Landing Road / Suite 5
Hayward, CA 94545
(415) 786-3546

Circle 15 on Reader Service Card

letters (cont.)

Crowhurst's comments on engineering education in *db* Magazine. Of course, I had read them before, but they are certainly worth reviewing. Mr. Crowhurst's ideas have been so helpful to me on many occasions that I felt it appropriate to drop a line saying "well done."

A great deal of my time is being spent in trying to help engineers catch up with changes that have occurred in the state-of-the-art. The principal problem that I face is defects in their original education. Once the fundamentals have been clarified, catching up is usually simple. Mr. Crowhurst expressed the situation very well in his column in *db* back in November, 1973.

Has Mr. Crowhurst written any books on his philosophy of education? If so, please let me know about them.

Once again, thanks for Mr. Crowhurst's columns. He's one of the few writers on the subject of education with whom I find myself in complete agreement.

JOHN E. CUNNINGHAM
J. E. Cunningham Associates
Lakewood, Ohio 44107

Editor's Note: Mr. Crowhurst has written a number of books. We will be happy to forward inquiries to him.

"Eleven years ago Michael got leukemia. Last spring we got married."

Mrs. Ann Finamore,
Glen Ridge, N.J.

"Michael's thirteenth birthday was supposed to be his last. And now we're celebrating our first anniversary. Because cancer research developed new treatments, Michael's alive. You should see how alive!

"There's a lot more research to be done and a lot more people to save. So give to the American Cancer Society. We want to wipe out cancer in your lifetime."



**American
Cancer Society**
This space contributed by the publisher

The
"Click
and Pop"
machine

only by

SAE



Ever since the invention of the recorded disc annoying "clicks" and "pops" caused by scratches, static and imperfections have consistently disturbed the listening pleasure of music lovers.

Now, SAE introduces the unique model 5000, an Impulse Noise Reduction System which eliminates those unwanted sounds with no adverse effect on the quality of the recorded material.

This breakthrough in electronic circuitry is so demonstrably effective that the SAE 5000 is destined to become an essential part of any sound system.

The SAE 5000 is compact and sleek, built to SAE's exacting standards, and ready to enhance the performance of any system, from the standard receiver/turntable combination, to the most sophisticated audiophile components.

SAE is proud to add the 5000 to their broad line of *Components for the Connoisseur*.

SAE

Scientific Audio Electronics, Inc.
P.O. Box 60271, Terminal Annex
Los Angeles, Cal. 90060

Please send more information on the 5000.

Name _____

Address _____

City _____

State _____ Zip _____

Circle 13 on Reader Service Card



At first glance our cabinets look a little different. Which is understandable. They are.

It's quite plain that these are not your usual assortment of little flake-board boxes with holes. These are functioning enclosures whose dimensions, determined by the laws of physics, have been precisely stated in hand-laminated fiberglass.

All of our enclosures are of a solid round-backed design which frees them from the standing waves and out of phase diaphragmatic panels which plague "the boxes". Our design not only cuts down on unwanted resonances but also creates unparalleled durability and the strength to survive extensive touring and triumph over playful roadies. The GGM, our dual

driver ported bass enclosure, fills a variety of functions. As the bottom end of a PA stack it makes a dynamite low frequency cabinet. Pre-amped and powered it becomes a bass guitar cabinet the likes of which you've never heard. The PBL,

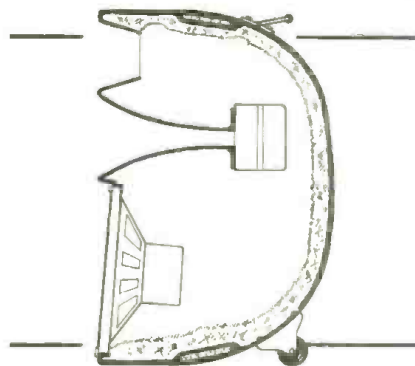

our super portable full-range cabinet, incorporates bass, port and HF horn in one rugged enclosure. Perfect for club PA applications, this unparalleled (literally!) cabinet is perfect for keyboards and other instruments and also happens to be a fantastic side fill stage monitor. And our NC12? Only the loudest, cleanest monitor around. And everything you need to hear is aimed right at your face. Write or call us for more information. It's time you got the best.

	HF DRIVER	LF DRIVER
NC 12	1" - 1 ³ / ₈ "	12"
PBL	1" - 1 ³ / ₈ " - 2" - 2.8"	15"
GGM	n.a.	TWO 15"

Here's Looking at You, Kid!

Community

Community Light & Sound Inc., 5701 Grays Avenue, Philadelphia PA 19143 (215) 727-0900

Circle 20 on Reader Service Card

TWO FORTY TWO A

The **Sound Workshop 242** has been the industry standard for low cost reverberation... until now!



Introducing the **Sound Workshop 242A** Stereo Reverberation System. The same great sound and reliability that made the 242 famous, now with added features to make it a must in the studio, on the road, at the disco, or on the air.

The **242A** features line and mic inputs, peak reading LEDs, independent channel equalization, stereo return from a mono send, full control of dry to reverb mix, plus more. And of course it's **Sound Workshop** quality. We guarantee it. For 2 years parts and labor.

The **Sound Workshop 242A** Stereo Reverberation System. \$450.

bringing the technology within everyone's reach

Sound Workshop
PROFESSIONAL AUDIO PRODUCTS

1038 Northern Blvd., Roslyn, New York 11576 (516) 821-6710

Circle 14 on Reader Service Card

CALENDAR

MARCH

- 14-17 **NOISEXPO '77**, the National Noise & Vibration Control Conference and Exhibition. Holiday Inn, O'Hare/Kennedy. Chicago. Contact: NOISEXPO '77, 27101 E. Oviatt Rd., Bay Village, Ohio 44140. (216) 835-0101.
- 22-24 **Three-day course on Acoustics and Hearing Conservation in Industry**, Rensselaer Polytechnic Institute, Troy, N.Y. Contact: Office of Continuing Studies, Rensselaer Polytechnic Institute, Communications Center 209, Troy, New York 12181. (518) 270-6442.
- 27-30 **NAB Convention Washington, D.C.** Contact: National Association of Broadcasters, 1771 N St., N.W., Washington, D.C. 20036. (202) 293-3500.

APRIL

- 1-3 **Intercollegiate Broadcasting System Convention**. Hyatt Regency Hotel. Washington, DC. Contact: Rick Askoff, IBS, Vails Gate, N.Y. (914) 565-6710.
- 19-24 **High Fidelity '77 Exhibition**. Heathrow Hotel. London, England. Contact: British Information Services, 845 Third Ave., New York, N.Y. 10022 (212) 752-8400.
- 25-28 **AUDEX, the International Audio Exposition**, trade show. Las Vegas Convention Center. Contact: Charles Snitow, 331 Madison Ave., New York, N.Y. 10017. (212) 682-4802.

MAY

- 9-11 **International Conference on Acoustics, Speech, and Signal Processing**, Sheraton-Hartford Hotel, Hartford, Conn. Contact: Clifford Weinstein, B-345, Lincoln Laboratory, P.O. Box 73, Lexington, Mass. 02173. (617) 862-5500 X5465.
- 17-20 **London Electronic Component Show**. Olympia, London, England. Contact: British Information Services, 845 Third Ave., New York, N.Y. 10022. (212) 752-8400.

LEADER LAS-5500
AUDIO SYSTEMS ANALYZER
7 Instruments-In-One!

An extraordinary range of applications for every audio designer, engineer and technician who wants professional results

<p>OSCILLOSCOPE</p> <ul style="list-style-type: none"> • DC to 10MHz bandwidth, AC 2Hz-10MHz (-3dB) • 20mV/Div vert sens. 	<p>ATTENUATOR</p> <ul style="list-style-type: none"> • 600Ω input/output impedance • 0.101dB attenuation range, ±2% accuracy 	<p>DRIFT METER</p> <ul style="list-style-type: none"> • 3KHz ±0.1% test freq. source • 0.3Vrms signal output 	<p>WOW/FLUTTER METER</p> <ul style="list-style-type: none"> • 3KHz ±10% and 3.15KHz ±10% range
<p>AUDIO FREQUENCY OSCILLATOR</p> <ul style="list-style-type: none"> • Frequency, 10Hz-1MHz, 5 ranges • <0.5% distortion, 500Hz-20KHz and better 	<p>AC MILLIVOLT METER</p> <ul style="list-style-type: none"> • Reads as low as 30μV ranging to 100V, 12 steps • ±3% full scale accuracy • 5Hz-100KHz freq. resp. 	<p>DUMMY LOAD</p> <ul style="list-style-type: none"> • To 100W rated power • 8Ω (L.R) impedance 	<p>At \$1995, the LAS-5500 saves up to 50% it's a smart investment!</p>

LEADER
Instruments & Components Division

151 Dupont Street, Plainview, N.Y. 11803 (516) 822-9300
West Coast: 7733 Densmore Ave., Van Nuys, Calif. 91406 (213) 989-2760 In Canada: Omnitronix Ltd., Montreal, Quebec

Circle 31 on Reader Service Card

Old-New Reel Time Recorder

Telex/Magnecord series 1400 broadcast quality recorder/reproducer. An old name that spells reliability. A new design for today's state of the art.

- The Old. Telex/Magnecord products are still made in the USA so parts and service are always available. The series 1400 is still built on a solid die cast aluminum main frame for reliable operation around the clock. It's still available in full, half and

quarter track configurations, has fail safe differential brakes and accepts 8 1/4 inch reels. It also still comes with three motors — but then, that's touching on the new.

- The New. A brushless d.c. servo drive with a crystal oscillator control reference so accurate it virtually eliminates program timing errors. New, three speeds: 3 3/4 - 7 1/2 - 15 ips. New catenary head block for straight tape loading, the convenience of one hand cueing and the bi-level illumination of push button controls. New DTL logic controls eliminate EMI and provide fast, spill

proof tape handling gentle enough for half mil tape. And new electronics, clean to 60 dB S/N at all speeds.

- If you're looking for a real time, reel recorder with old name reliability but designed for today's demands, you'll find it in the Telex/Magnecord series 1400. For complete information please write:



PRODUCTS OF SOUND RESEARCH

TELEX
COMMUNICATIONS, INC.

9600 ALDRICH AVE. SO. • MINNEAPOLIS, MINN. 55420 U.S.A.

Europe: 22, rue de la Legion-d'Honneur, 93200 St. Denis, France

Canada: Telak Electronics, Ltd., Scarborough, Ontario

Circle 32 on Reader Service Card

NEW AUDIO SPECTRUM MONITOR!

1/3 OCTAVE REAL TIME ANALYSIS MODEL 142

FEATURES

• PEAK READING • TWO MEMORIES: CUMULATIVE OR SAMPLE • VARIABLE TIME CONSTANTS (0.1 - 2 SEC.) • CALIBRATED IN DBM • 10-20-30 DB DISPLAY RANGE • 40 HZ to 16 KHZ ON 1/3 OCTAVE ISO CENTERS • 11 x 28 LED ARRAY • BUILT-IN PINK NOISE SOURCE • 3 1/2" x 8" DEEP RACK MOUNT.

USES

• PROGRAM MATERIAL MONITORING • RECORDING AND MIX-DOWN ANALYSIS • PORTABLE SYSTEM ADJUSTMENT • TAPE EQUALIZATION AND CALIBRATION • TRANSMISSION LINE EQUALIZATION • BEFORE-AFTER COMPARISONS • FREQUENCY RESPONSE TESTING

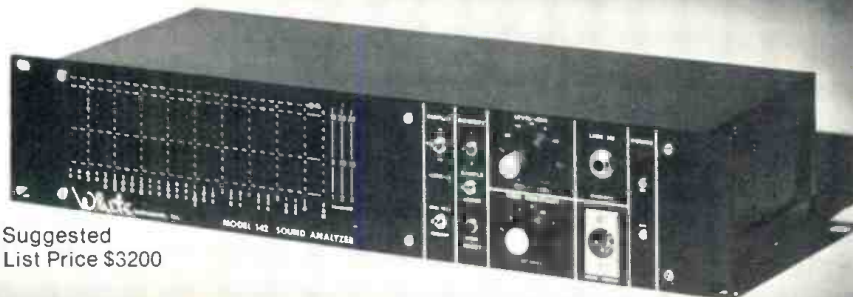

Suggested
List Price \$3200

ALSO: Active and passive equalizers • Other real time analyzers
Dealer inquiries invited

White

Call or write today: WHITE INSTRUMENTS, INC.
P.O. BOX 698 512/892-0752 Austin, Texas 78767

Circle 28 on Reader Service Card



Waters MM faders mean more mixing in less space

With Waters 3/4-inch thin-line conductive plastic faders you can cram 24 channels into an 18-inch mix bay for high density recording studio applications, sound reinforcement and location mixers, and lighting control consoles.

Waters MM faders retain all the superior quality of our accepted LM series including choice of 2 3/4-inch or 4-inch travel; 600 ohm or 10 k impedance; linear, audio or true log characteristic; and our famed trouble-free long service life. For more mixing in less space circle reader service number or call Bob Waters at 617-358-2777 for more information about thin-line faders.



**WATERS
MANUFACTURING, INC.**

LONGFELLOW CENTER, WAYLAND, MA. 01778 • (617) 358-2777

Circle 25 on Reader Service Card

FREE LITERATURE

GERMANIUM TRANSISTORS

Catalog No. 101 details both single and quantity prices on 260 germanium transistors, plus mounting kits, with cross-references of identical transistors from other manufacturers. Mfr: Lansdale, Inc.

Circle No. 91 on R. S. Card.

AMPLITUDE DISTRIBUTION ANALYZER

An extensive data sheet describes Model 4426 amplitude distribution analyzer. Mfr: B&K Instruments, Inc.

Circle No. 92 on R. S. Card.

AUDIO CABLE TESTERS

Descriptions and applications of Model QC-1001 Q-Chek tester are contained in this brochure. Mfr: Switchcraft, Inc.

Circle No. 93 on R. S. Card.

CONNECTORS

A 32-page catalog describes high density, lightweight multi-pin connectors, and their use. Mfr: Malco.

Circle No. 94 on R. S. Card.

REPLACEMENT FUSES

"Can you afford to send a service engineer to tell your customer it was just a blown fuse?" asks this bulletin, which describes the Re-Cirk-It protector for circuit-breakers. Mfr: Heineemann Electric Co.

Circle No. 95 on R. S. Card.

MEASUREMENT DEVICES

"Measurement Computation News" is the title of periodical bulletins describing sophisticated and simple counters, computers, analyzers, logic clips, probes, etc. A checkoff card to request additional literature for various items is included. Mfr: Hewlett-Packard.

Circle No. 96 on R. S. Card.

NOISE BARRIER MATERIALS

A two-page technical sheet describes Cousticomposite multilayer acoustic material. Mfr: Ferry Corp.

Circle No. 97 on R. S. Card.

BUILT-IN KITS

An extensive 96-page mail-order catalog details electronic kits for building everything from simple tools to electric organs, including amps, equalizers, tuners, small consoles, speakers, and receivers. Mfr: Heathkit.

Circle No. 99 on R. S. Card.

(continued)

**At last, a stereo power amp
with professional performance
for less than \$1.00* per watt!**

THE CS-800

The latest high speed, high voltage, discrete technology combines with unique packaging and exclusive features to create the Peavey CS-800, a new stereo power amplifier that is unrivaled by anything on the market at its price.

The CS-800 produces 400 watts RMS of pure, undistorted (0.05% THD) power per channel. Overall, that's 800 watts of solid, high fidelity (5 Hz to 30 kHz) amplification retailing for only \$649.50*. At about 81 cents a watt, that's an incredible value for a stereo power amp with the CS-800's performance and versatility.

Features such as LED's on each channel give precise indication of any possible overload or clipping. A back panel patching facility incorporates small plug-in modules that provide

the CS-800 with balanced inputs and even a two-way electronic crossover. The amp's twenty-four high voltage output transistors are mounted on massive, fan cooled heat sinks for ultimate reliability even under the most demanding operating conditions. Protection circuits are built into each channel to protect speaker systems from any sudden abnormally high DC voltages. A steel reinforced die cast front panel in a 19" rack mountable chassis add to the system's appearance and versatility.

The Peavey CS-800 is a highly professional amp with honest performance at a very reasonable price. Drop by your Peavey Dealer for a demonstration of what the CS-800 can do or write us and we'll send you complete specs. We think you'll be impressed.



Peavey Electronics
Box 2898
Meridian, Ms. 39301

*manufacturer's suggested list price

Circle 30 on Reader Service Card

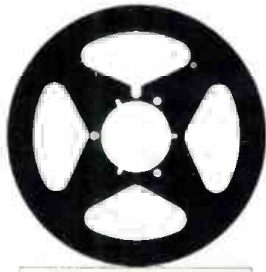

**AUDIO/RECORDING
TECHNOLOGY WORKSHOP**
June 27 - July 15, 1977

WRITE:
Brigham Young University
Special Courses & Conferences
242 HRCB
Provo, Utah 84602

Inquiries concerning pre-requisite
materials due by March 1.

free literature (cont.)

AMPLIFIERS & CONSOLES

An extensive promotional kit includes a catalog listing amplifier and attenuator cards as well as separate punch-holed sheets detailing and illustrating consoles, amplifiers, reverbs, equalizers, and attenuators. Mfr: Robins Broadcast & Sound

Circle 99 on R.S. Card.

TEMPLATES

A brief but informative brochure illustrates templates available for printed circuit, assembly, dual in-line, logic, circle, and geometric drafting. Mfr: Tangent Template, Inc.

Circle 80 on R.S. Card.

CARTRIDGE TAPE MACHINES

A four-page brochure describes the latest line of tape machines from this manufacturer. Mfr: UMC Electronics Co.

Circle 81 on R.S. Card.

TRANSDUCERS/CARTRIDGES

Two brochures, "Dual Magnet Phonograph Cartridges" and "Personal Transducers" are available. Mfr: Audio-Technica.

Circle 82 on R.S. Card.

POWER TRANSFORMERS

Power transformers for power supply, control and filament circuits, and for low-voltage, low-current, plug-in printed circuit power needs are among the power supplies listed in a 12-page short-form catalog. Mfr: Litton Industries (Triad-Utrad)

Circle 98 on R.S. Card.

CARTRIDGE TAPE

An extensive variety tapes and accessories are described in a ten-page product sheet folder. Mfr: Fidelipac.

Circle 83 on R.S. Card.

LINEAR HYBRID AMPLIFIER

Technical data sheets describe three wide bandwidth linear hybrid amplifiers. Mfr: TRW Semiconductors.

Circle 84 on R.S. Card.

HARD-TO-FIND TOOLS

The latest edition of this manufacturer's extensive 128-page catalog lists tools of every description. Mfr: Jensen Tools and Alloys.

Circle 85 on R.S. Card.

E.R.A. DIRECTORY

New York area representatives and manufacturers are listed in the *Directory of Electronic Representatives*, New York Chapter.

Circle 88 on R.S. Card

Check
our

Multi-TRACK RECORDERS



The goal of every studio owner is to have the most reliable recording equipment available, knowing well that "down time" because of equipment failure costs him money. We at **STUDER** proudly feel that we not only have the most reliable recorders but that we also have a service philosophy that other companies envy. Let us tell you about it.

Write or call, Willi Studer America, Inc., 1819 Broadway, Nashville, TN. 37203. Phone 615-329-9576, Telex 55-4453. In Canada, Studer Revox Canada Ltd. Phone 416-423-2831, Telex 06-23310.

STUDER

a standard
of excellence.

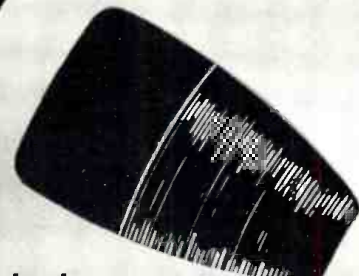

BGW PRIME



BGW is about to whet your appetite with their new Model 100 Stereo Power Amp.

The Model 100 will drive the most difficult loads you can throw at it. Electrostatic headphones and reactive speakers are driven flawlessly due to the 100's unique design. No form of current-limiting is used whatsoever. A precision monitor amp for bi and tri-amped systems, the modular construction of the 100 means one integrated amplifier circuit board with the biggest heat-sink we could package in 1-3/4" of vertical rack space: 340 square inches of efficient sink. No more thermal shutdowns.

There's a sophisticated "loss-of-feedback" circuit with front panel L.E.D.'s. Also unique to the 100, the L.E.D.'s are driven by a one-shot circuit for precise clipping indication.

Instantaneous peaks, which get by most amps, are stretched out in our L.E.D. circuit so you can see them.



On the inputs, you can get optional Cannon XLR's and plug-in transformers...and into 8 ohms you get 33 watts per channel, or 80 watts mono. Into 4 you get a meaty 44. The I M distortion is an incredibly low .01%.

It's about time somebody like BGW would mete with the competition. Check out the Model 100. It's just one of six professional prime cuts...of course, all above the rest.

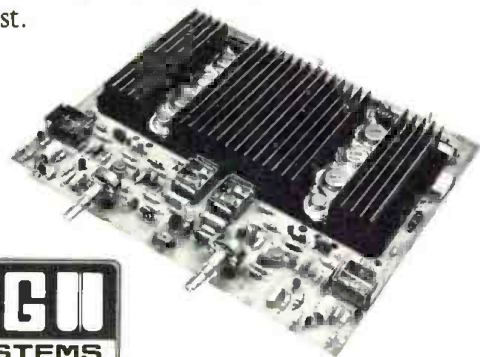

BGW Systems 13130 South Yukon Ave., Hawthorne, Ca 90250 (213) 973-8000
 In Canada: Omnimedia Corp., 6651 Cote de Liesse, Dorval, Quebec H9P 1A3 (514) 610-0071
 Worldwide Export Agents: Telesco International Corp., One Dupont Street South,
 Plainview, L.I., New York, (516) 431-6220

Circle 23 on Reader Service Card

Audio and the F.M. Process

• The f.m. system, as conceived by its designers in the late 1930's, is a high fidelity rf transmission system. Although the specifications were rather ambitious for the audio systems of those days, this is no longer the case. The audio systems of today are far superior to those of yesteryears, and can produce results that to the f.m. designers were only dreams. In some cases, it may appear that the f.m. system has somewhat less fidelity than an *audio-only* system. Many special techniques can be applied to enhance the sound in an audio-only system that cannot be done in the f.m. system. But this in no way detracts from the value of f.m. We must remember that the f.m. system is an rf transmission system that must operate under certain natural as well as regulatory limitations, so it is not free to range as far as can be done with an audio-only

system.

In this column, we will briefly describe the f.m. system and touch upon some of the factors which can deteriorate the system's fidelity, so that those readers who are not fully acquainted with the f.m. process may gain a better understanding of some of its limitations.

THE SYSTEM

Consider first the overall f.m. broadcast system. The audio equipment of the usual broadcasting station is capable of producing a high fidelity signal equal to that found anywhere. Through this system, the station's programming is created and processed. An rf transmission system impresses the audio onto an rf carrier through a modulation process, amplifies the modulated

rf, and feeds it through a coaxial transmission line to an antenna. This is the last control the station has over its signal.

Once the signal leaves the antenna, it is subject to many vagaries which will attenuate the signal, such as atmospheric and man-made noises, the reflection of numerous surfaces which causes phase shifts and cancellations, and it may join with other interfering signals before it arrives at the receiving antenna.

The quality of the receiving system is vital. Even a strong, pure rf signal arriving at the antenna terminals can be seriously deteriorated by a poor receiving system. The receiver must have a good antenna and transmission line, broadbanded and properly tuned stages in the tuner, a broadband detector, and of course, a suitable audio reproducing system.



One Great Performer For Another.

The gauss monitor series.

Now, three great performers that upgrade the standards of professional sound. The Gauss sound is full-bodied and smooth.

All three Gauss monitors feature our 4140 horn. Foam filling in all the cavities eliminates unwanted resonances. And roll off is so good that very little room equalization is needed.

Available with single 15", double 15" and double 12" woofers. Our model 2154 puts out more sound pressure level than any studio monitor on the market today. Our monitors are offered in the bi-amplification mode only; so you may select both crossover frequency and filter slope ... with any of the currently available electronic crossover networks.

So you get our smooth Gauss sound...Great performance that you can hear.

Cetec Audio
A Division of Cetec Corporation

For the Educated Ear.

Main Office

A division of Cetec Corporation
13035 Saticoy Street No. Hollywood, CA 91605
(213) 875-1900 TWX: 9104992669

European Office

A division of Cetec Systems Ltd.
16 Uxbridge Rd. Ealing, London W52BP England
01-579-9145 Telex: (851) 935847

It can be seen that there are many places in which an f.m. system is vulnerable to deterioration so that the end results may be far less than desired. Some of these areas are within the station's control; many of them are not.

Figure 1. The f.m. transmission system.

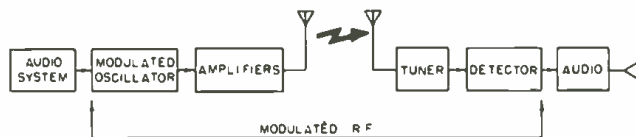

THE MODULATION PROCESS

Most f.m. transmitters of recent vintage use the *direct f.m.*, reactance-type modulator. With stereo, most of the other types of modulators, such as the serratoid, have been replaced. These other types are basically phase modulators and they can cause too much deterioration to the stereo signal.

In direct f.m., the master oscillator (m.o.) of the transmitter itself is modulated. This is done by placing a variable reactance unit across the m.o.'s tank circuit or frequency-determining circuit. Many of the present day exciters are solid state, so the reactance unit often used is a pair of voltage variable capacitor (vvc) diodes. These diodes are back-biased, and when the bias is changed, their capacity changes in an inverse manner.

Modulation takes place in this manner: without audio input to the modulator, the m.o. oscillates at its basic frequency (determined by station as-

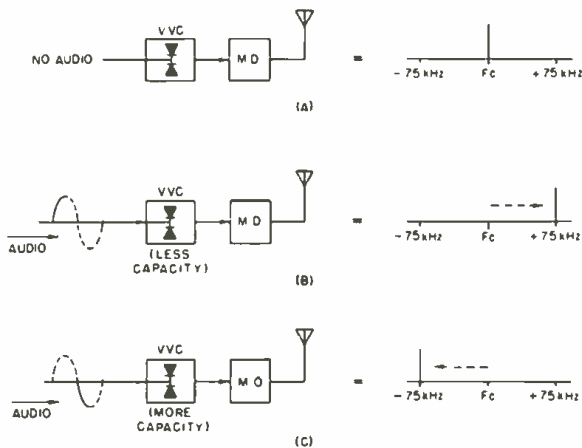
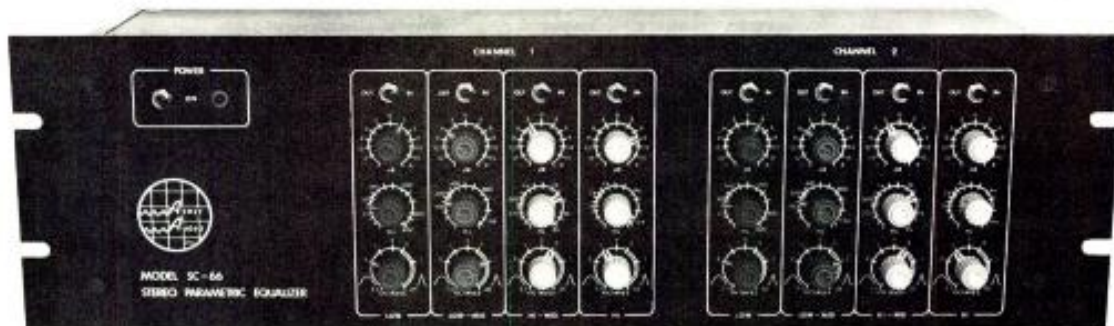

Figure 2. Without audio (A), the oscillator operates on its resting frequency. The amplitude of the audio signal (B), (C), causes the carrier to shift frequency in relation to the audio and at the speed of the audio frequency.

PARAMETRIC PRICE-PERFORMANCE *breakthrough*

\$599

SUGGESTED LIST PRICE



- true narrow-band (.05 oct.) through broad-band (3.3 oct.) equalization
- 50:1 frequency range, each band
- ± 15 dB eq. range, precise center "flat" position
- separate IN-OUT switch for each band
- ultra clean & quiet (-87 dBV noise, $< .05\%$ THD)
- internal power supply

At Ashly, we're definitely into Parametric Eq. We've used it extensively in our big SE series consoles for years. The SC-66 represents the culmination of these years of design, listening, and field testing. You can now have infinite control of all equalization characteristics at your fingertips with accuracy and resolution previously considered impossible. Check out an SC-66 at your pro-audio dealer.

Dealer inquiries invited



ASHLY AUDIO INC.
1099 JAY ST.
ROCHESTER, N.Y. 14611
(716) 328-9560

Circle 38 on Reader Service Card

INTRODUCING A NEW AUDIO CONNECTOR

MODEL: PM-3

FEATURES:



1. Gold contacts
2. Ground lug
3. Mounting holes designed for 1/8 pop-rivets
4. Special non-reflecting finish
5. Ecominical
6. Compatible w/XL's

INTRODUCTORY PRICE OFFER*

50	100	500	1M	10M
\$1.00	.82	.78	.74	.67

..... SOLD IN LOTS OF 50 ONLY

TERMS 5% Discount Cash with order, or COD only, FOB Delivered



(800) 421-1828, (213) 770-3510
TWX 910 346-7023
P.O. Box 590 GARDENA, CA 90247

* OFFER GOOD IN USA ONLY and EXPIRES JANUARY 31, 1977

Circle 37 on Reader Service Card



**MEASURE
REVERB TIME
IN REAL TIME.
Instantly!**

RT-60.

This easy-to-use instrument delivers precise reverb time measurement in instant real time digital read-out. No more chart recorder or time-consuming chart recorder analysis. The RT-60's integrated circuitry incorporates a one-third octave band pass filter system with frequency centers on 250, 500, 1000, 2,000, and 4,000 Hz. It operates on self-contained ni-cad batteries. Mounted in a rugged carrying case, the RT-60 weighs only 3.5 pounds. The dealer net cost, FOB San Diego, is just **\$460.**

Write for your free technical bulletin on the RT-60 — instantly!

**COMMUNICATIONS
COMPANY
inc.**

3490 Noell Street
San Diego, CA 92110
Telephone (714) 297-3261

Circle 33 on Reader Service Card

broadcast sound (cont.)

signed carrier frequency). This is called its *resting frequency*. The program audio is then applied to the vvc's in a manner that will change their bias according to the peak amplitudes of the audio signal. As the bias changes with the audio, so does the capacity represented by these vvc's across the m.o. and thus the carrier frequency is directly caused to swing above and below its resting frequency. The instantaneous swing of the carrier up-frequency or down-frequency, and the distance from resting position, is determined solely by the peak amplitudes of the audio signal. (Note: in direct f.m., only the peak amplitude of the audio determines the extent of the carrier swing. In a phase system, both the amplitude and the frequency of the audio determine the carrier swing.) The swing on either side of the carrier resting position is called the *deviation*. Maximum deviation permitted by the FCC rules for the f.m. broadcast station is 75 kHz, which represents 100 per cent modulation.

MULTIPLICATION AND BANDWIDTH

Oscillators directly operating on vhf frequencies are not practical, so the m.o. works at a lower frequency and its output is passed through several frequency multiplier stages to bring it up to the carrier frequency. Typical multiplication rates are 4 times or more. For example, the authorized carrier for a station is 100 MHz. If the transmitter uses a multiplication rate of 4, then the oscillator will operate at 1/4 of the carrier frequency, or 25 MHz.

But multiplication also multiplies the deviation, consequently, the m.o. does not deviate the full 75 kHz. The deviation is also one fourth, as in the example above—one-fourth of 75 kHz is 18.75 kHz. Thus, when the m.o. hits 18.75 kHz deviation, the carrier will hit 75 kHz deviation.

Now, since the carrier is deviating above and below its resting position, *all* rf stages, antennas, and rf tunable

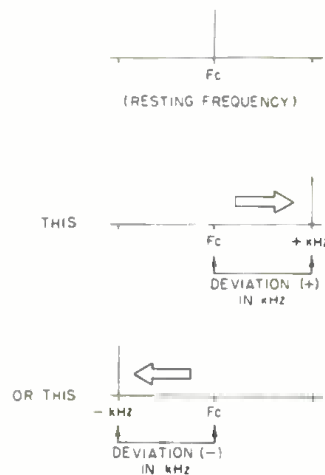

Figure 3. Deviation is the instantaneous carrier swing to one side of resting frequency, either up or down. For sine wave audio, the carrier will swing to maximum excursion in one direction, then back through the resting frequency to the opposite excursion. For sine wave audio, the plus and minus deviation should be equal.

units—including those in the receiver, must be broadband. Also, during the modulation process, numerous sets of sidebands are created, equally spaced, both up-frequency and down-frequency, which are related to the instantaneous audio frequency. The amplitude of these sidebands becomes less as they get further from the carrier, but they extend far beyond the actual carrier deviation.

LIMITATIONS

We only have space to cover a few of the areas in which system fidelity can deteriorate. Consider first the linearity of the modulated oscillator. As the amplitude of the audio increases or decreases, the vvc's must change capacity, proportional to the amplitude change. This capacity change must also change the carrier frequency, both up- and down-frequency, by proportional amounts as it follows the audio peaks. If it cannot, that is, is non-linear (frequency-wise), then the recovered audio at the receiver will be non-linear in amplitude—that is, low.

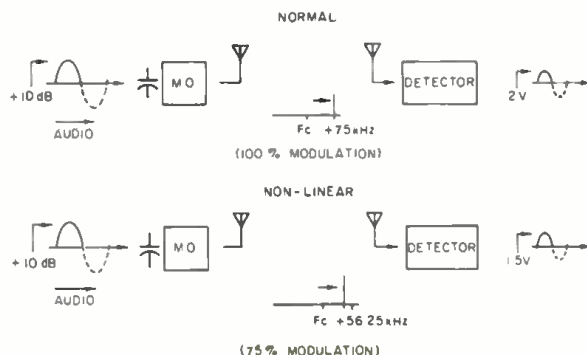

Figure 4. Non-linearity of the vcc's or the master oscillator will cause the recovered audio to be low.

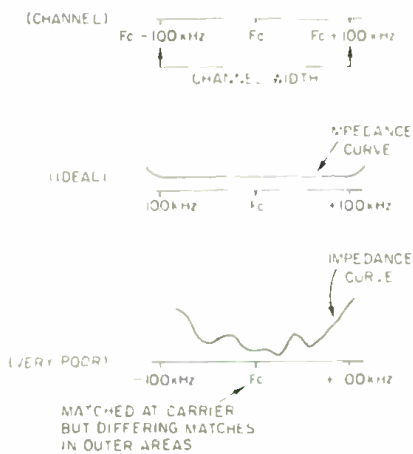

Figure 5. The antenna must present the same impedance to the coax. line all across the channel width or there will be vswr reflection problems.

(What we are doing here is changing audio amplitude variations into frequency excursions. At the receiver, the frequency excursions are converted back to audio amplitude variations.)

For example, if the design which ordinarily creates 75 kHz deviation for a given audio amplitude (100 per cent modulation) is now non-linear, only deviating 75 per cent modulation, the recovered audio will be low by about 2.5 dB. If this non-linearity is also audio frequency discriminatory, the system will have a poor audio frequency response curve as well. In both cases, the system signal-to-noise ratio will suffer. Such non-linearity can be caused by a defective oscillator transistor, vvc, circuit components, or improper biasing of the diodes and d.c. voltages to the modulated oscillator stage. Many of these faults, however, will show up also as frequency instability of the carrier, or the oscillator may stall and cease to oscillate.

NOISE

It only requires a small change in voltage of the vvc's to cause a frequency change—a small change in capacity. The modulated oscillator, and especially the vvc's, are very susceptible to vibration and noise problems. These units are often shock-mounted or the entire exciter mounted in a separate rack to isolate it from vibrations caused by the transmitter power tube blower motors. These vibrations can cause noise modulation of the carrier.

Aside from acoustical problems, the power supplies must be well regulated and filtered to a pure d.c. with little or



Dolby model 334, f.m. broadcast unit, stereo model. (Photo courtesy of Dolby Laboratories, Inc.)

no a.c. ripple. Otherwise, this can cause hum modulation of the carrier.

AUDIO PROCESSING

The FCC rules require that a 75 μ sec. pre-emphasis be used in the transmitter audio, and a complementary 75 μ sec. de-emphasis in the receiver. With today's audio equipment, this boost of 17 dB at 15 kHz is entirely too much. To prevent overmodulation, the modulation is reduced to 35 or 40 per cent for the low- and mid-range audio. This causes signal-to-noise ratio deterioration at the receiver. Many stations use processors so that higher modulation levels can be achieved, and even employ clippers to prevent overmodulation. Such processing, however, causes loss of dynamic range, and the clippers will introduce distortion. This procedure must be used carefully to keep fidelity deterioration to a minimum.

Another factor in this area is the modulation monitor. If it is out of calibration, the station may be actually overmodulating although the monitor shows nothing abnormal. In the other direction, what the monitor says is 100 per cent may be actually much lower. The monitor needs to be checked out and calibrated occasionally by use of the Bessel Zeros and a communications receiver to check the actual carrier deviation.

TUNING AND MATCHING

All stages in the transmitter must be kept properly tuned and broadbanded. These are usually stable once they are set up correctly, but if components are defective or replacements made, the stage must be carefully retuned.

Another important area is the antenna and its match to the transmission line. The antenna must be broadband, at least across the channel width, and it must match the line impedance across the channel width. If it does not, there will be reflections back down the line. These reflections (v.s.w.r.) can cause phase shifts in the sidebands and deterioration, especially of a stereo signal. High v.s.w.r. can also cause damage to the line, the antenna, and the output stage of the transmitter. If this is a problem, the consulting engineer or factory engineers should be called in to tune and match up the antenna and line.

SUMMARY

The f.m. system can produce a high fidelity signal when both the transmitting and the receiving ends are properly designed, tuned and operated. But there are natural limitations as well as operating requirements that can cause a loss of fidelity. Defective components will also contribute to fidelity loss, as will improper audio processing. ■



PRO SOUND I.D. collars protect your sound cables against theft, allow you to color code cable lengths and quickly identify your property. Hot stamped with two lines of copy also advertises your business or group. Available for 3/8" and 1/4" cable in five colors: blue, red, yellow, white and black. Write for data or call:

PRO SOUND T.M.

13717 South Normandie Avenue
Gardena, CA 90249 • (213) 538-9830

Circle 36 on Reader Service Card

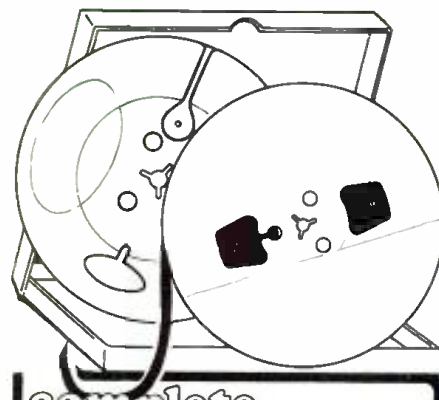

complete
supplies for
**reel to reel
audio recording**

TAPE

AMPEX and Scotch
all professional grades
on reels or on hubs

EMPTY REELS

all sizes, widths
and hub types

BOXES

for all reels, in various colors

LEADER-, TIMING- & SPLICING TAPES

Top Quality Competitive Pricing

Immediate Shipment

Call or Write for Details/Prices



Recording Supply Co.

DIVISION OF POLYLINE CORP.
1233 RAND RD. • DES PLAINES, IL 60016
312/297-0955

Circle 34 on Reader Service Card

● While all of my columns aim to be educational in the context of audio in general and the relationship between theory and practice in particular, a year or two ago they ventured more into the realm of education, which meant less in the realm of audio. Your editor suggested, and later insisted, that my columns should at least have one leg still in audio, even though readership mail showed interest in the educational aspects.

Of course, my books all aim to be educational, in the field of audio, although I have not written anything for publication as a book either on education in audio, or on audio in education, which are definitely not the same thing. But the interest continues. Recently I have had several inquiries as to whether I have written, or am writing, one or other such books.

Soon, I will have prepared as many mediated courses as I have written books of the printed variety. Most of this mediated material has taken the form of audio tapes on cassettes, with workbooks, exercise material, to go with them. The response to my materials is mushrooming, which may explain why I am now being asked for something about "how to do it."

The theory of publishing says that if a sufficient number of the public demand something, someone will fill that demand, sooner or later. Practice modifies that a little. The problem is, how does the publisher know that the public will demand what the public has not seen yet, and will not see unless some publisher takes the initiative to put it out?

Usually, when some new type of book comes out and sells a lot of copies, then every other publisher wants an author who can grab some of the gravy. The real problem is, how do you make the gravy in the first place?

Of course, the record business is plagued with a very similar phenomenon. A musician comes up with a

new kind of sound. Record companies want the proven and tried "best seller" types. So how is the musician who has something that the public will really go for to make that first contact that starts him on a gold platter?

NUCLEUS OF A DIFFERENCE

Probably everyone who has made it has a slightly different story about how. So we will not get into that.

Whether it is developing a new kind of musical sound, or better ways to use mediation for educational purposes, it does not come suddenly. The first efforts, of either, may not be all that different from a hundred others. There is just the nucleus of a difference. But discerning listeners or readers pick up on that difference, respond in a way that tells the originator he has something.

Of course, he was aware that he was trying something. But initiative invariably sparks initiative. A very common response takes the form. "That is a terrific idea, but couldn't you . . ." as the responder's own initiative begins to take off. And so the idea grows. What began as a rather vague nucleus, even if at the time it seemed like a brainstorm, gradually takes more definite shape.

When I started in mediated material, it consisted of something for the student to look at, in a workbook, possibly with provision for him to complete some of the work to involve him in the learning process. The audio tells him what he is looking at, what he should do, gets him thinking about it in a way that allows him to give his maximum concentration to the visual material.

MEDIATED INSTRUCTION

This was the nucleus of the idea that is mediated instruction. Studying from a book involves much heavier, more difficult, concentration. You have all experienced it: reading about a pictorial diagram, and moving your

eyes back and forth between the verbal description and the picture, which must usually have letters, or call-outs, or something to facilitate identifying what the text is talking about.

It gets very heavy going if you have to keep turning the page while you do this. And, however well-designed a book may be, this is inevitable at times. Mediating the material can make this much easier because the audio flowing into the student's ears can feed him the instructional part while he keeps his eyes focused on the picture, the figuring, or whatever it is he is studying.

But that little improvement, effective though it is, and it has turned on a lot of students to learning who were completely turned off before that, was only the beginning. Whatever the subject, for decades the prevalent form of education has spoon-fed the students with something the instructor calls facts, and later a test is administered to see how well the student has retained those facts.

We have encountered mediated material that does exactly the same thing. True, the student can handle it more easily, but when he is through, has he learned the subject any more thoroughly than he would have, admittedly with a little more effort, by the more traditional form?

The true measure of learning is for a student to be able to extend his knowledge, skills, or whatever, by his own efforts, without being spoon fed, or led by the hand. In my younger years, I believed that the only way this could happen was when a dedicated teacher stimulated it to happen, usually in a whole class of students.

So, as I have said before, I was reluctant to move into the field of mediated instruction, for that reason. "There is no substitute for a good and effective teacher." I would say, and teachers would applaud, although, had I the opportunity to have seen them in action, they would not have met those qualifications!

TEACHER'S TRICKS

In the classroom, there are many tricks by which a good teacher can stimulate his students to move forward on their own, rather than waiting to be spoon fed—such as jumping a few of the essential steps deliberately, and then coming back to fill them in if the students cannot make it on their own; or putting in some deliberate mistakes to train the students in catching mistakes.

Things like that are almost impossible to do in a textbook. But they are really easy to incorporate into mediated instruction. Mistakes in a textbook, such as wrong answers in

the back, are never put there on purpose, and usually lead their users to mistrust the book. But you can build mistakes into mediated instruction, just as you would in the classroom. You can jump steps, and come back to explain, later in the tape.

But perhaps the biggest bonus for mediated instruction comes in the way you can integrate testing with instruction. And it becomes a totally different kind of testing from those used traditionally, a far more effective way.

Earlier, I mentioned how responses from appreciative listeners, or participants, contribute to such progress. A little over three years ago, a teacher was observing students testing out one of my mediated courses—one from which I learned a lot, incidentally—and he could see how effective even that primitive effort was, compared with conventional instruction. "Why don't you make something like that for us teachers?" he asked.

That is still something I hope to do. His idea was for something to help teachers use mediation as effectively as he saw it working with that class—and we have made much better material since then. There is a need for this.

RELUCTANT EDUCATORS

Earlier, also, I referred to the reluctance of publishers to venture into something too new, or different. Teachers are even more reluctant. For every teacher who will allow himself in the same room with some mediated instruction, there must be between ten and a hundred who are afraid that those little plastic cassettes that students plug into the tape players will put them out of their jobs.

We can see examples of the same groundless fear in the history of our own industry, too. When those little cassettes first came along, many in the phonograph disc industry thought that they would sound the death knell for discs. Did they? Or is the phonograph industry still alive and well? Most manufacturers put out both, because they realize that each has its own uses.

Mediated instruction will never replace live teachers, unless all the live teachers quit and go home. What it really does, and can do still more as time goes by, is to enrich the capabilities of education. And everyone recognizes that we need that!

When I say that mediation can do still more to augment education, that can happen in two ways. It is already happening throughout the land in one sense—more and more schools are installing resource centers, where various mediated materials are available.

But still, too much of that mediated material has been prepared by people

with little imagination, or perhaps by people who are afraid that if they make it too good, it will provide unfair competition for teachers!

My father used to tell the story of an incident he saw during the time when the horse drawn cabs were trying to stay in business against motorized traffic. In those days, one of the principal forms of motorized transportation was the trolley car, which ran on tracks. The horse drawn cabbies would place their vehicles on the car tracks so the trolleys could not pass, hoping to retain their business that way.

The situation reached an impasse that prompted the trolley car people to do something about it. Inspectors on the cars were instructed to act when this happened. My father was riding the trolley when such action occurred.

The trolley driver turned back to the passenger compartment and signalled the inspector, who was riding there. He came forward, took control, and slammed the trolley into the back of the cab, which rolled over onto its side. The purpose was to make a test case, out of which came a law forbidding horse cabs to deliberately obstruct motorized traffic.

When the cab was over on its side, the cabbie ran round to the driver and inspector in a rage, while my father sat and watched the cabbie's customer climb out the door, which was now top-side of the cab, and run around to board the trolley.

After considerable altercation, the cabbie turned back to his cab, and looked down through the open door. "Blimey, wot 'appened to me fare?" he wanted to know!

Technology results in progress, now as then. Most of the cabbies became trolley car drivers after that, just as disc companies went into the cassette and cartridge business and as, if they are sensible, teachers will get into the business of good mediated instruction. We have already learned a lot, about how to make learning, not only easier, but far better, and we undoubtedly have a lot more to learn. ■

Copies of db

Copies of all issues of *db*—The Sound Engineering Magazine starting with the November 1967 issue are now available on 35 mm. microfilm. For further information or to place your order please write directly to:

University Microfilm, Inc.
300 North Zeeb Road
Ann Arbor, Michigan 48106

Soundcraftsmen — the most flexible Equalizer...
 ANY FURTHER QUESTIONS? PHONE ANTHONY AT (714) 556-6191 COLLECT!

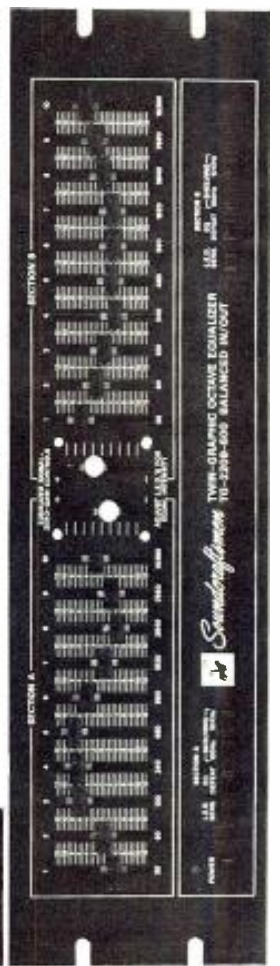

SOUND CRAFTSMEN, 1721 NEWPORT CIRCLE, SANTA ANA, CA 92705



ELECTRET HEADPHONE



- Permanently polarized diaphragms that need no external source of power are featured in Model AT705 electret condenser headphone. The headphones plug into a small adapter that matches impedance circuits and contains a speaker/headphone switch. Frequency response range is 20 Hz to 22,000 Hz. The headphones are equipped with openback A-T ear cups.

Mfr: Audio-Technica U.S., Inc.
Price: Under \$90.00.
Circle 50 on Reader Service Card

OCTAVE EQUALIZER KIT



- Fine adjustments within a narrow band of the audio spectrum are possible with this equalizer. The device has ten slide controls for each channel, one control for each octave of frequency. Switch pops are electronically suppressed by a three-transistor circuit. In addition to a source/tape switch on line 1, an independent line 2 input/output stereo pair is available for equalizing a second program; either of two sources can be reached without plugging or unplugging cables. One of the sources can be equalization in the recording process for a tape recorder. The kit includes a single circuit board, factory-assembled and tested.

Mfr: Dynaco
Price: Kit: \$249. Assembled: \$349.
Circle 51 on Reader Service Card

MIXING CONSOLE



- Transformerless low impedance microphone preamps as well as low noise wide range integrated circuits are used in Model 840 recording/p.a. mixing console. The unit contains 8 inputs and 4 outputs; the output busses are selectable as two stereo busses, with panning, for p.a. and production work. Each input channel has 2-band eq., wide range trim control, monitor and echo sends, pan pot, output bus selection, rotary channel level control, and stereo bus mute switch. Master level controls are provided for echo send, monitor send, the four bus outputs, and the four echo returns. All eight inputs can accommodate line or mic level sources, as well as provide direct output.

Mfr: Sound Workshop
Price: \$800.00.
Circle 52 on Reader Service Card

REVERBERATION CHAMBERS



- Two-channel stereo with separate sound columns are featured in Super C Master-Room reverberation chambers. The units also have variable decay controls and independent reverb and direct signal mix controls on each channel. The chambers also feature both high and low shelf equalization, plus selective frequency peak eq. Shelf controls provide 17 dB boost and 18 dB cut at 150 Hz, and +14 to -12 dB at 20 kHz; peak controls permit up to 10 dB boost at selective frequencies of 1, 5, 2.2, 3.4, 4.5 and 6.0 kHz. Equalization controls permit variation of natural sound ambience for subtle or unusual effects. Options include balanced line transformers and cabling for remoting the sound columns.

Mfr: Micnix Audio Products, Inc.
Price: From \$1,995.
Circle 53 on Reader Service Card

STEREO LIMITER/COMPRESSOR



- Program-controlled attack and release times free Model 418A stereo limiter/compressor to adjust to various types of program material without critical manipulation. The stereo-ganged broadband compressor/limiters are followed by a high frequency limiter with four different time constants, user-selectable by means of a front panel switch, permitting the characteristics of the high-frequency limiter to be tailored to the recording medium following the limiter. Suggested applications include rough mixes, broadcast production, commercials, cassette duplication, and single-channel limiting.

Mfr: Orban/Parasound
Price: \$950.00.
Circle 54 on Reader Service Card

PROGRAM CONTROLLER

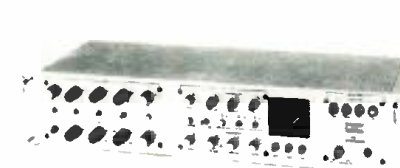

- Combined compressor-limiter-expander and parametric equalizer function are present in the VS-1 Stressor. A routing switcher alters the relationship of the two devices, placing the equalizer either before or after the compressor-limiter-expander. A third position inserts the equalizer into the control circuitry of the compressor section, creating a frequency-sensitive compressor, or alternately, a four-band dynamic equalizer. The equalizer may also be used separately. It is claimed that this combination device makes possible a soft compression slope, retaining dynamics, while maintaining complete control of transients and providing absolute overload protection in the peak limiter section, independent of the compressor settings. The expander section provides up to 30 dB of noise reduction; the limiter section has adjustable asymmetry to allow full positive-peak modulation.

Mfr: Orange County Electronics Corp. Ltd. (Chateau Seven Group)
Price: \$1,492.00.
Circle 55 on Reader Service Card

FREE CATALOG

HARD-TO-FIND PRECISION TOOLS

Lists more than 2800 items: pliers, tweezers, wire strippers, vacuum systems, relay tools, optical equipment, tool kits and cases. Also includes ten pages of useful "Tool Tips" to aid in tool selection.

JENSEN TOOLS AND ALLOYS
 4117 N. 44th Street, Phoenix, Ariz. 85018

Perfect Timing



console mount clocks and timers

Reliable ESE clocks and timers are now available in compact (2" x 3.7" x 3.6") console mount enclosures with bright easy to read .33" red LED's. Provided with rear solder pins for connection to your own switching or the optional remote connector, 6' cable and pushbutton set. Other options include: BCD Output; Crystal Timebase; 220V-AC-50Hz; and Kit Form.

ES-172 12 Hour Clock	\$134.
ES-174 24 Hour Clock	\$134.
ES-370 100 Min. Up/Down Timer	\$171.
ES-371 100 Min. Up/Down Timer with leverwheel preset	\$267.
ES-570 60 Minute Timer	\$134.
ES-572 12 Hour Clock Timer	\$160.
ES-574 24 Hour Clock/Timer	\$160.



Write, Wire or Call: (213) 674-3021
505½ CENTINELA AVENUE • INGLEWOOD, CALIFORNIA 90302

Circle 27 on Reader Service Card



WORAM AUDIO ASSOCIATES
Consultants in Studio Systems
Engineering, Design and Installation

—offering—

A COMPLETE CONSULTATION
SERVICE FOR STUDIO
PLANNING AND
CONSTRUCTION

FREE-LANCE RECORDING
SERVICE IN THE
NEW YORK AREA

516 764-8900
45 Lakeside Dr.
Rockville Centre, N.Y. 11570

The New Reverb Price/Performance Leader:

Introducing the new dual channel Orban/Parasound Spring Reverb. The new 111B retains all of the electrical features of its popular single-channel predecessor and augments them with a new bass control and "quasi-parametric" midrange control. The new midrange equalizer permits stepless adjustment of its ± 12 dB equalization range, as well as continuously variable center-frequency and bandwidth. This equalization flexibility is unparalleled in the low-cost reverb field and effectively complements the simple equalizers usually found on low-cost mixers and consoles.

Included in the new package is our unique "floating threshold limiter" which minimizes "spring twang" and provides absolute protection from overload. And our highly-respected electronics provides a bright, super-clean sound with the best signal-to-noise in the spring reverb field. Most remarkably, the two-channel 111B costs exactly as much as our single

channel model. The only thing you give up is the flexibility of our dual-chassis construction — now the spring is mounted with the electronics.

At \$695 for two channels, the 111B provides the quality alternative to the cheaper, consumer-quality reverbs on the market. With industrial-quality construction, line-level balanced outputs, compact size, and smooth, four-spring (per channel) sound, the 111B is the ideal choice for the user with space and/or budget limitations. And as always, you can count on Orban/Parasound's reliability and prompt service. For more information on the new 111B, see your local Orban/Parasound distributor, or contact

orban/parasound

680 Beach St., San Francisco, CA. 94109 (415) 673-4544



Circle 18 on Reader Service Card

You'll FEEL it as well as see it!..

SENSUR

SPECIAL EFFECTS SYSTEM

With SENSURROUND® Special Effects:

IN RELEASE



IN RELEASE

MIDWAY



COMING
JUNE 17, 1977



when presented in the

ROUND®

Protected by U.S. Pat. No. 3,973,839

ACADEMY AWARD WINNING*
SENSURROUND®
SPECIAL EFFECTS

In the SENSURROUND® Special Effects System, the *sense of feeling* has been added to sight and hearing in motion pictures. The System is designed to surround and engulf an audience with special audible and low frequency, infrasonic effects. The audiences experience the illusion of participation by feeling the air movement generated by the powerful SENSURROUND® horns, which vibrate against their bodies and ears with a sound pressure waveform comparable to an actual earthquake, naval battles or the thrill rides in an amusement park.

*Scientific or Technical Achievement Award (Class II)

from  **UNIVERSAL** AN MCA COMPANY

Circle 16 on Reader Service Card

Random Noise in Acoustical Measurements

Realistic sound measurement must take into consideration transients, reverberation, and diffusion.

IT IS A PARADOX that the existence of noise presents two conflicting aspects in acoustical work. On one hand, it limits the performance capability of electro-acoustic devices, and its reduction is a constant aim of the sound engineer. On the other hand, it provides a remarkably useful test signal for acoustic measurement purposes. Random acoustic noise, for example, derived from a well-controlled electrical source, has a wide and continuous frequency spectrum and amplitude distribution which closely approximates that of actual program material. By spreading the test energy over the entire (or selected portions) of the audible frequency range, it can thus simulate certain features of the transient nature of speech and music.

Speech in the upper frequency range consists primarily of random noise modulated in a number of ways, while in music the components are so closely blended and interlaced with complex waveforms that, for practical purposes, the signals also approach a random noise. The similarity in amplitude density distribution of these naturally occurring phenomena to random noise ensures that the excited room resonances strongly resemble those normally encountered in lecture auditoria and concert halls. Moreover, when used as a sound source in acoustic measurements, e.g., reverberation time, sound distribution, and sound insulation, bands of random noise are useful in smoothing response curves that otherwise may be difficult to interpret.

SOUND-SOURCE EXCITATION

In acoustical terms, a room may be considered as a resonating system having a large number of modes of vibration within the audio frequency range. When a sound source is present in the room, the natural frequencies of the resonant modes are determined by the time delay between reflections, and hence, by the geometrical dimensions of the enclosure. At first glance, the use of sinusoidal wave-

forms would appear to be a simple and convenient way to assess the acoustic properties of a room. But when a pure tone of fairly low frequency is sounded in a room, it may excite some of the normal resonant modes at or near their maximum value. The resulting variations in sound pressure levels, or standing wave patterns, will change completely as the frequency of the source is varied. Excitation of any particular mode, for example, will increase as the frequency interval between the tone source and the resonant frequency of the mode decreases. At all times, the sound intensity level will be the vector sum of the excitation signal and the modal responses.

Now suppose we want to investigate the transient, or reverberant, response of a room. It is customary to fill the enclosure with sound and then observe the effect of suddenly switching off the sound source. At the instant of cutoff, each of the resonant modes will decay exponentially at its own rate and modal frequency, producing a complex frequency spectrum. If several modes of vibration of nearly the same frequency are excited, large amplitude fluctuations, or beats, will occur because of interference with the driving frequency, making it difficult to determine the reverberant response. The less damped the room resonances, as determined mainly by the absorption characteristics of the surface boundaries, the greater will be the fluctuations.

Based on the assumption that a diffuse sound field in an enclosure is random under normal conditions, it is clear that sinusoidal excitation is unsatisfactory as a test signal in the measuring process. It would be desirable that the number of room resonances participating in the decay process be sufficiently great so that the irregularities in the decay envelope, to a large extent, average out.

BAND OF FREQUENCIES

One way to minimize the formation of standing wave patterns is to utilize a *band of frequencies*, centered around the particular frequency of interest. In warble-tone excitation, for example, a pure tone source is frequency modulated at the rate of approximately 5 or 6 Hz through a 10 per cent range in frequency around the mean frequency. The limitation of this type of test signal is that the amplitudes of the component frequencies tend to be widely different from one another. Another method of room excitation involves the use of a special multi-tone

Sidney L. Silver is on the supervisory staff of the Telecommunications Section of the United Nations, where he is in charge of sound and recording.

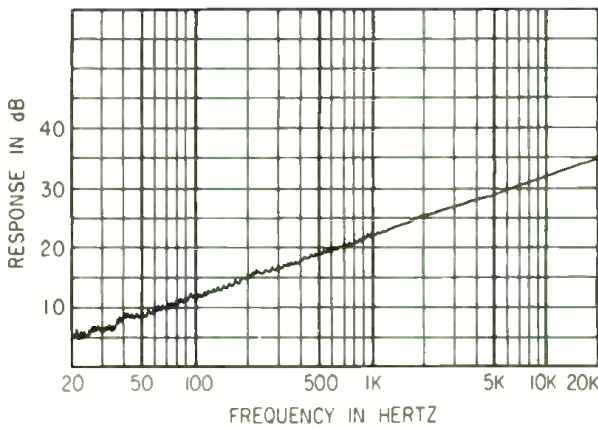

Figure 1. White noise output of a random-noise generator as measured by a third-octave bandwidth.

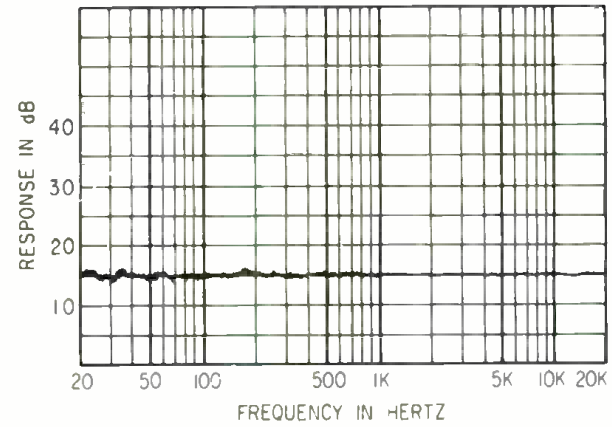

Figure 2. Pink noise output of a filter as measured by a third-octave bandwidth.

generator which delivers a series of pure tones (about 10 or 12 in number) of equal amplitude and closely spaced in frequency. To ensure a constant amplitude output signal, the component tones cannot be multiples of each other. Here the drawback is that a highly complicated and expensive instrument is required to produce a usable multi-tone signal.

For some reverberation time measurements, impulsive excitation, such as gun shots or the sound of a balloon bursting, are employed to excite a room. Impulse signals contain practically all the frequencies in the audio spectrum, but because of their highly transient nature, produce ambiguous data. Also used for acoustic tests are tone-burst waveforms of controlled properties whose spectra cover the desired frequency band.

It has been shown experimentally, however, that random noise is the most suitable and accurate test signal for acoustic measurements.¹ Since all frequencies within a given frequency band are presented simultaneously with equal probability, the advantage is that all room resonances inside the noise band are, in turn, simultaneously excited. Let us now consider in greater detail how random noise is applied as an acoustic sound source.

RANDOM-NOISE GENERATION

Measuring the properties of random noise requires the use of different concepts than those specified for periodic waveforms. Because of its random quality, such noise is usually described by statistical means,² being characterized by its frequency spectrum and distribution of instantaneous amplitudes. If the random noise energy provides a uniform spectrum over the range of 20 Hz to 20 kHz—the generally accepted limits of human hearing—then it is termed *white noise* in that particular band. With this type of signal source, the slope of the noise spectrum will be governed by the type of spectrum analyzer used in measuring the energy distribution.

In a constant-bandwidth analyzer, for example, the bandpass filter has a fixed bandwidth tunable to any frequency in the audio range, so that the output is constant and independent of the center frequency of the passband. However, if the noise source is analyzed with a constant-percentage-bandwidth analyzer, the amplitude/frequency characteristic of the white noise will appear to slope upward with increasing frequency (FIGURE 1). Suppose, for example, the analyzer uses a third-octave-band filter arrangement where the bandwidth is 24 per cent of the center frequency. At 1 kHz, the bandwidth is only 240 Hz, but at 10 kHz, the bandwidth is 2.4 kHz. Obviously, there would be greater noise energy in the third-octave

band centered at 10 kHz than one centered at 1 kHz. Since the noise voltage increases as the square root of the bandwidth, the output of the noise generator increases by a factor of 1.4 when the analyzer frequency is doubled, giving the amplitude/frequency characteristic a rising slope of 3 dB/octave.

In many acoustical measurements, it would be desirable to compensate for the rising slope because excessive power in the upper frequency range might damage the high-frequency units comprising the acoustic source. Correction is made by placing a *pink noise* filter at the output of the generator to provide an inverse characteristic of the rise, so that the resulting signal (FIGURE 2) is measured flat with a third-octave-band analyzer. In effect, the filtering process converts the white noise—having constant energy per unit bandwidth—to pink noise having equal energy per third-octave band. Third-octave-band analyzers, operating in real time, are probably the most widely used of all types of sound analyzers for room acoustic measurements.

The photograph illustrates a commercially available random-noise generator which supplies three different test signals in the audio frequency range, as measured on a one-third octave basis: white noise (flat spectrum), pink noise (−3 dB/octave), and USASI (now called ANSI) noise. The latter is a specially shaped noise curve sometimes applied in sound distribution measurements. (This will be discussed in a later section).

Figure 3. A typical setup for measuring reverberation time.

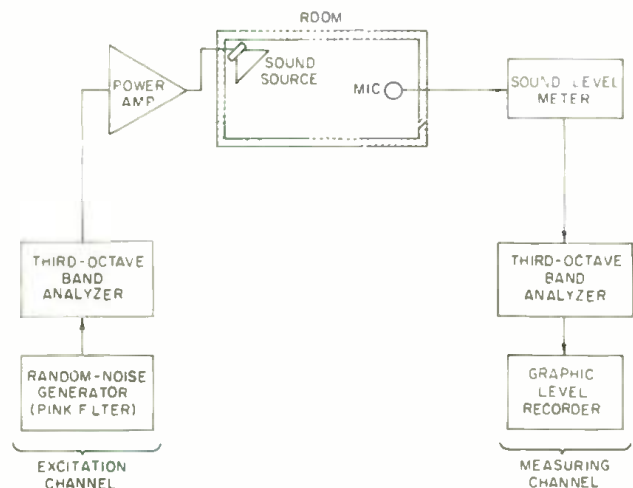

REVERBERATION TIME MEASUREMENTS

The most important measurable parameter used in determining the acoustical qualities of an enclosure is the *reverberation time*. This is defined as the time required for the rms sound pressure level to decay to 60 dB after the original sound source is abruptly switched off. A block diagram of the necessary acoustic hardware is shown in FIGURE 3. The excitation channel consists of a random-noise source passed through a pink noise filter, followed by a third-octave-band analyzer, and a power amplifier driving a heavy-duty loudspeaker. The power amplifier (rated about 175W) should be capable of raising the acoustic level of the random-noise signal sufficiently above the extraneous ambient noise so as to obtain an accurate measurement. Although reverberation time is based on a 60 dB decay, reproducible results can be achieved with any measured decay in excess of 20 dB above the background noise. The response of the loudspeaker should be reasonably smooth without causing undue distortion. Preferred placement is usually in a corner of the room where maximum vibration modes are excited.

The measurement channel employs a microphone that is flat to sounds of random incidence, i.e., it responds equally to all audible frequencies in a diffuse field. The sound-level meter, which serves as a high quality preamplifier, should have as uniform a response as possible to obtain true sound pressure levels, but where an unweighted (flat) position is lacking, it is customary to use the "C"-weighted mode for third-octave-band measurements.

When the sound source is silenced, a decay curve is traced on the level recorder and the slope is averaged by drawing a straight line through the curve. FIGURE 4 shows a typical reverberation decay curve for a third-octave-band of noise centered at 500 Hz, yielding a reverberation time of 1.2 secs. Or, expressed another way, the sound pressure level may be said to decay at the rate of 50 dB/sec. It should be noted that sound decay inherently follows an exponential law, even though the averaged reverberation curve is represented as a linear slope. This is true because the logarithmic response of the graphic level recorder will transform the exponential function into a straight line.

Under certain conditions, the arrangement shown in FIGURE 3 may be simplified by omitting one of the sound analyzers in the chain. If, for example, the broad-band random noise is fed directly to the power amplifier, then the necessary filtering can be performed by tuning the sound analyzer in the measuring channel to the desired third-octave band of noise. Satisfactory results can thus be achieved in many applications, but in the presence of high-level low-frequency background noise, it would be desirable to retain both sound analyzers in the system. By inserting third-octave-band filtering between the noise generator and the power amplifier, it is possible to raise the undistorted low-frequency output of the loudspeaker sufficiently above the ambient noise with considerably less power. Narrow-band excitation thus has the advantage of concentrating the full power output within a particular third-octave band, rather than distributing it over the entire audible frequency range. Selective filtering in the measuring channel increases the dynamic range of the reverberation curves obtained by heavily attenuating the extraneous noise lying outside of the passband.

Automatic recording of reverberation time with frequency can be achieved by a special switching arrangement in the level recorder which synchronously controls the on-off mode of the random-noise generator, the selection of the appropriate filters, and the lifting of the writing pen between decays. By forming the recording paper into a loop, it is possible to trace one decay curve for each third-octave spacing on a single chart throughout the desired frequency range.

In some circumstances, it may be convenient to record

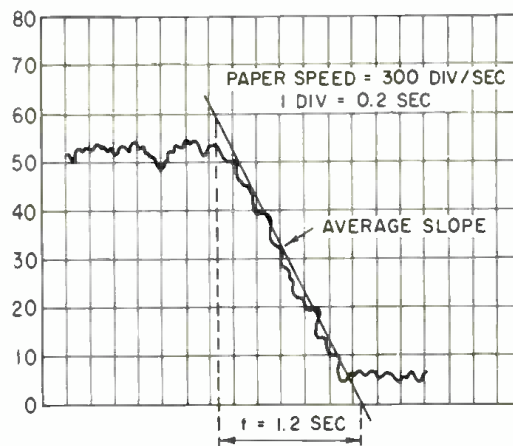

Figure 4. Reverberation time for a third-octave band of noise at 500 Hz.

random-noise test signals and their subsequent decays on magnetic tape as a function of frequency. Prior to the measurement, a dual-track tape machine is used to record a series of third-octave bursts of noise at various center frequencies on, say, channel 1. Referring to FIGURE 5, this channel then supplies the reproduced signals to a power amplifier/loudspeaker system. The resulting reverberant sound in the room is then picked up and recorded on channel 2. Later, in the laboratory, the signals on channel 2 are played back through a third-octave-band analyzer to a level recorder to obtain a hard-copy record of the decaying sound. Of course, this procedure may be simplified by exciting the room with a wide band of pink noise, then recording the reverberant sound with the noise switched off. In the lab, the recording is repeatedly played back until the desired range of third-octave-band analysis is covered. With this technique, however, it may be difficult to obtain an adequate signal/background-noise ratio because of the unfiltered test signal in the excitation channel.

SOUND DISTRIBUTION MEASUREMENTS

Although reverberation time measurements establish the temporal characteristics, or time sequence of the arrival of reflected signals, they do not yield sufficient data as to how the sound pressure levels vary with the listening position. There may be spatial and frequency irregularities which adversely influence the quality of sound transmission so that acoustical conditions are not the same for listeners at various locations in the room. It is common practice, therefore, to measure the distribution of sound using a steady-state random-noise source to help determine where these spatial irregularities exist.

A typical measuring setup for sound distribution is shown in FIGURE 6. In this application, the measuring microphone

Figure 5. Recording of reverberation characteristics on magnetic tape for later analysis.

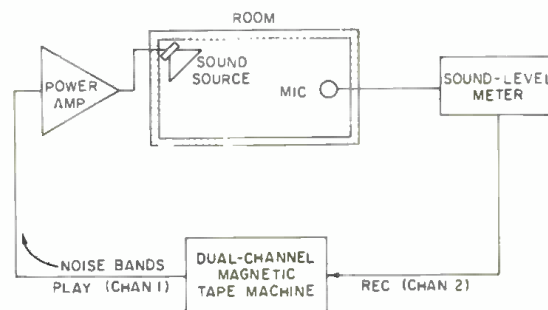

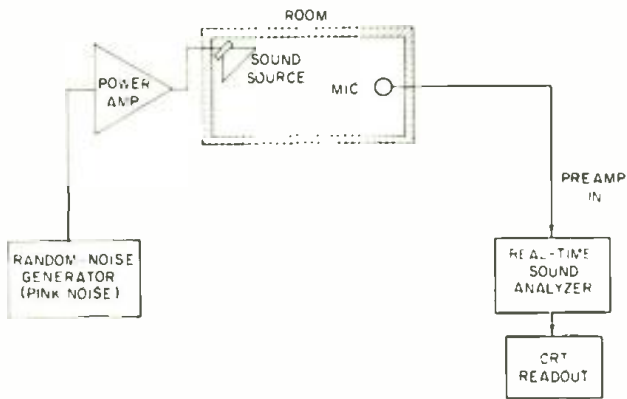

Figure 6. An arrangement for the measurement of sound distribution.

should have a linear random incidence up to around 20 kHz. By moving the microphone from one part of the room to another and measuring the levels of sound pressure at different excitation-frequency bands, it is possible to assess any unevenness in the sound field at any part of the enclosure. An analysis is carried out by means of a real-time analyzer using third-octave-band filtering. Real-time analysis allows the frequency spectrum of interest to be analyzed almost instantaneously and presented as a complete histogram on a display screen. Thus rapid changes in the measuring parameters can be detected immediately, allowing corrective action to be taken to improve acoustical conditions.

The measurement of sound distribution as a function of frequency can be accomplished automatically with the equipment shown in FIGURE 7. In this system, a sweep random-noise generator provides a slowly gliding narrow band of random noise to the excitation channel. Scanning of the entire audio frequency range is achieved by connecting the tuning mechanism of the sweep generator mechanically to the drive motor of the graphic level recorder. This allows the recording of sound distribution as a continuous function of frequency, using frequency-calibrated chart paper moving in synchronism with the tuned frequency.

Sound distribution measurements can sometimes be carried out in a much simpler manner by "shaping" the random-noise spectrum (FIGURE 8), so that it closely approximates the spectrum of the type of sound for which the room is utilized. For example, if the enclosure being measured is a lecture hall used mainly for speech, it is convenient to employ a random-noise source similar to the average human voice. By inserting a suitable bandpass filter between the noise generator and the power amplifier, it may not be necessary to analyze the frequency spectrum

Figure 7. Automatic sound distribution measurement using swept random noise.

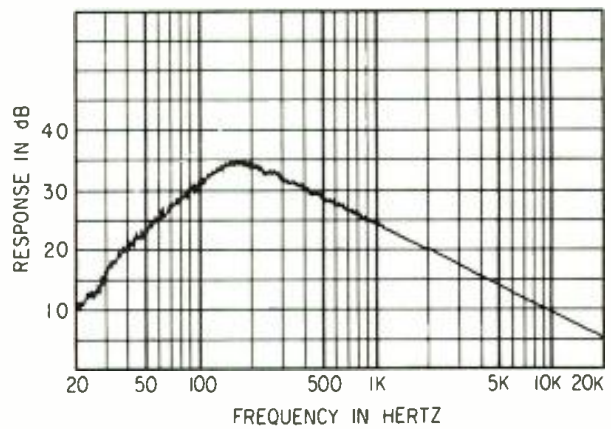
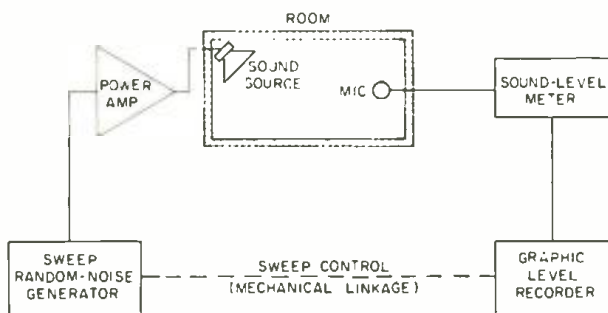

Figure 8. Shaped random-noise spectrum plotted on a unit-bandwidth basis.

in the measuring channel. Instead a portable sound-level meter can be used to take readings at various points in the room. This simplified procedure, however, does not provide the detailed information provided by a frequency spectrum analyzer. In the random-noise generator shown in the photo, the shaped spectrum of ANSI³ noise results from the passage of white noise through a built-in filter arrangement: a high-pass unit with a cutoff of 100 Hz, and a low-pass unit with a cutoff of 320 Hz. The ANSI noise specification roughly simulates the distribution of energy with frequency, in speech and music.

In assessing the distribution of sound in an enclosure, it is also important to know what particular reflections arriving at a given point produce this distribution. When acoustical conditions are such that sound energy flows equally in all directions and the sound pressure is uniform over the entire volume of the room, then the sound field is said to be perfectly *diffuse*. Actually, a completely diffuse room is physically unattainable, but it is possible to modify the normal room modes (using various diffusing devices) so that each portion of the surface boundaries will be exposed to signals propagated from practically all directions.

To obtain a measure of the diffusion of a sound field, the measuring microphone should have a linear response in the audio frequency range to perpendicular (0°) incidence. With the random-noise source in operation, the microphone is mounted on a slowly rotating turntable (about ¼ rpm) capable of sweeping through adjustable angles. Initially, the microphone is aimed at the loudspeaker and then uniformly scanned across the surface boundaries of the room, so that the amplitudes of signals arriving from various angles are measured. The turntable is designed to rotate the microphone in synchronism with the rotation of polar diagram chart paper in the graphic level recorder. For each location, the microphone is rotated once in azimuth by 360 degrees, and the corresponding directional distribution of the arriving reflections is displayed in great detail. Ideally, the polar directional characteristic for a diffuse field should approach the form of a circle. ■

REFERENCES

1. Balachandran, C. G., "Random Sound Field in Reverberant Chambers," *Journal of the Acoustical Society of America*, vol. 31, no. 10, October 1959, pp. 1319-1321.
2. Silver, S. L., "Electronic Measurements Using Statistical Techniques," *Electronics World*, vol. 79, no. 6, June 1968, pp. 49-53.
3. American Standard Specification for General Purpose Sound Level Meters, S1.4-1961. American National Standards Institute, New York, N.Y.

Check Your Tape Tension

Monitoring tape tension not only minimizes synchronization disasters, but sometimes unearths unsuspected malfunctions in your recorder.

ANYONE who watches television commercials knows that "tension" is bad. So it follows that if nervous tension is bad, constant tension must be worse.

But a certain kind of tension is good—in tape recorders, constant tension is not only desirable, it's the very best thing there is. Or did we say constant *torque*?

If you've been around tape machines for a while, you perhaps have heard a conversation like this between recording engineers:

"I know that theory books say constant tension is best. So what's the problem? We have constant tension. We set it every time we do routine maintenance with those big power resistors under the top plate."

"Problem is," says the other engineer, "you haven't set constant tension at all. What you've set is constant torque, and that's where the misunderstanding starts."

What engineer no. 2 means is that with constant torque, the tension changes continuously depending on how much tape is on the reel. While hardly ideal, with audio machines this isn't necessarily all bad just so long as it's within the limits specified by the manufacturer. The point is, the only way to be sure how much tension you have is to measure it, both when the tape is moving and when it has stopped.

One solution is a hand held tension gauge that tells you instantly what tensions you have at any one of several points on the transport. The photograph shows such a gauge in action (manufactured by Tentel of Campbell, California). FIGURE 1 gives typical values for a quarter-inch machine. FIGURE 2 summarizes the advantages and disadvantages of the three most common tension measuring techniques.

Who should use a dynamic tension gauge? Any studio, broadcast station, audio/visual facility, duplication house, or recorder repair depot interested in setting and maintaining consistently high quality in their final product.

The Tentel gauge will measure tension anywhere that the straight portions of its probes can be positioned over the tape. The benefit of this technique is that you can be certain of correct static and dynamic tensions. If the tensions aren't correct, you can quite easily diagnose the trouble with this gauge and the hints I'm going to give you in this article.

TENSION VS. TORQUE

But first, let's head off any misunderstandings you may have about the two terms, tension and torque. They are

related but they aren't the same. Here's the formula that shows their kinship:

$$\text{Tension} = \frac{\text{Torque}}{\text{Radius}}$$

Where *tension* is the pull on the tape from the capstan and take-up motor, *torque* is the hold-back force of the supply motor (mainly), and radius is the radius of the tape on the reel. Since diameter is twice the radius, the formula could also be written:

$$\text{Tension} = \frac{\text{Torque}}{(\text{Diameter} \div 2)}$$

In plain language, as the radius of the tape on the supply reel gets smaller, the tension goes up. At the beginning of the reel you have low tension. At the end of the reel you have high tension.

Now, let's put the formulas back in the dusty drawer and take a practical case. An NAB reel has an overall diameter of 10½ inches. At the beginning of the program, when the supply reel is full, the diameter of the tape is about 9½ inches. But at the end of the reel, it has dropped to 4½ inches, or a factor of over two to one (2.11 to 1). During this time, the tension has doubled from its lower initial value at the beginning when the reel was full to a value twice as large when the reel is empty.

So what is the effect of this two-to-one tension inflation every time we play a reel of tape? Assuming that you have set the tension properly for the machine (either directly with a tension gauge, or indirectly with a spring scale and a piece of string around an NAB hub) you should be within the manufacturer's design values and be able to operate within specifications. However, even with a properly set up constant-torque machine, skew and pitch

Figure 1. Typical values of tape tension for a quarter-inch transport. With any transport, some needle vibration will be observed, but unless a change is noted in the amount of vibration (which should be followed up with a flutter meter check), it is probably normal.

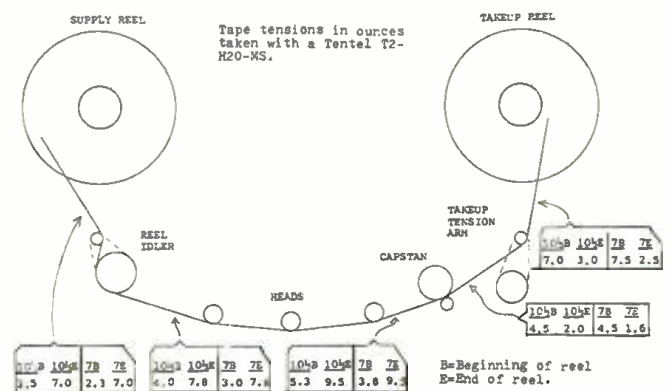

Instrument	Method	Advantages	Disadvantage
The human thumb	Press with moderate force on reel flange or against moving tape.	Quick and free	Gives only a gross approximation at best; can also damage or soil tape.
Spring gauge (fish scale)	Attach to a string wrapped around an NAB hub.	Inexpensive	Static readings only; somewhat slow and awkward to use; may not give accurate reading in horizontal position.
Dynamic tension gauge	Position on moving or stationary tape.	Instant, accurate dynamic tension reading, plus diagnostic capability.	Initial high cost must be balanced against speed and low cost of operation.

Figure 2. Tension measuring techniques

variations still exist. Skew is always there (with its attendant phase shift and track misalignments) but tends to cancel out if the tape is played back on the same machine. Similarly, the pitch varies at each point on the tape by some small amount, which could cause problems when material from either end is spliced together, if perfect pitch is required.

Incidentally, with video recorders, varying tension causes much more severe malfunctions. For that reason, servo systems to provide constant tension are much more common. However in the audio world, only a tiny fraction of the quarter or half-inch machines¹ have constant tension servos (including some models of Studer, Tandberg, and Ampex), but it gets increasingly more common in the one and two-inch multichannel behemoths. Even with constant tension, setting and rechecking initial tension values is just as important as it is in a constant torque arrangement.

EFFECTS OF LOW AND HIGH TENSION

What happens if the tensions are set incorrectly? FIGURE 3 summarizes the effects of excessive values. First of all, with tension too low, the result will be poor head-to-tape contact, which causes high frequency losses and increases dropouts, and mis-tracking or skew, which causes bad track registration and multichannel phasing errors.

Contrariwise, if the tension is set too high, you can experience these problems: 1) tape stretch, which causes timing errors and creates pitch interchangeability problems between machines 2) excessive head wear; and 3) irregular slipping at the capstan, which can give you a bad case of flutter.

Timing error problems from too-high tension can be especially acute if you are dubbing tapes, say, for program automation where the length must be correct to within a

few seconds. A piece of tape acts very much like a rubber band when subjected to the varying tape tensions in a constant torque recorder.

TIMING ERRORS AND PITCH INTERCHANGEABILITY

The amount of timing error caused by tape stretch depends mainly on the thickness of the tape used. Regular, or 1½ mil tape of ¼ inch width has a stretch factor of about 0.1 per cent for each tension increase of one Newton (3.6 ounces of tension).

To take a practical illustration, first record a 1,000 Hz tone for 60 minutes at precisely 15 in./sec. with normal tension (say, four ounces) at the input to the capstan. Then, play the tape back at exactly 15 in./sec., but increase the tension two Newtons to 11.2 ounces. The result will be as follows:

Pitch will go down from 1,000 Hz to 998 Hz and program length will stretch to 60 minutes plus 7.2 seconds. Don't forget that this happens because of tape stretch due to high tension during playback, even though the tape speed is exactly the same in the recording and playback.

Thus it should be obvious that to be able to interchange audio tapes between various recorders, the tensions on each machine must be set up precisely according to the manufacturer's specifications and rigorously rechecked. This includes the master recorder, the duplicator, and the playback machine. It should be equally obvious that constant tension systems avoid this kind of timing error due to tape elongation by eliminating the problem of varying tension in the first place (if all machines are adjusted to the same tension).

DIAGNOSING RECORDER MALFUNCTIONS

Being able to measure static and dynamic tension directly at several critical points in the tape path, as can be done with the Tentel gauge, has several real advantages. For example, dynamic measurements enable you to diagnose common recorder malfunctions. Those include worn idler

Reading dynamic tension on moving tape with a tension gauge.



Figure 3. Tape tension errors and malfunctions

Tension Too Low	Tension Too High
Bad tape-to-head contact. Losses in high frequency response	Timing errors Pitch errors
Skew and mis-tracking Multichannel phase shift Flutter Dropouts	Capstan slippage Tape stretching High erratic flutter

bearings, dragging supply-reel brakes, dirty heads or guides, and other friction-causing malfunctions.

Here's a case in point. At General Recorded Tapes (Santa Clara, California), a routine check of moving tape tension at the input to the head area showed a higher than normal reading on the Tentel tension gauge. At first, the engineer assumed that something had gone wrong with the constant tension control system. However, when the gauge was placed at the output of the supply reel, the tension was normal.

It turned out that the reel idler had a bad bearing which reduced its rotational speed to about half of normal. The effect was to make it act more like a fixed guide than a rotating guide. The odd thing was that it looked all right because it was still turning—the slowing down could not be seen by the naked eye. However, because of its increase in tension, the pitch of that run of duplicated tapes was outside of specs.

It's interesting to note that even in a duplicator or recorder with constant tension (as with the GRT duplicators) a static test with a spring gauge could not isolate the bad idler bearing as the dynamic gauge did.

Incidentally, if you've ever wanted to know what the friction is at a fixed guide or post, you can calculate it quite easily with the formula shown in FIGURE 4 and your jim-dandy four banger calculator.

Another problem common to fixed guides is oxide build-up which increases friction and tension. If the condition is really bad, it can cause slippage at the capstan and irregular flutter. A typical tension value at a fixed guide on the supply side of the transport might be about four ounces or so at the beginning of the reel. If it is significantly higher, say six to seven ounces, then it's apparent that a good deal of friction is being added by oxide, a worn or flat spot, or a related problem.

$$\frac{T_1}{T_2} = e^{\mu\theta}$$

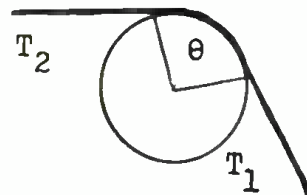

where T_1 is tension out
 T_2 is tension in

μ is coefficient of friction between tape and guide (typical values run from 0.22 to 0.34)

e is a constant, 2.71828

θ is the wrap angle in radians (for example, a 180° wrap would be π (3.1416) x radians)

Figure 4. Calculating frictional value at a fixed guide. With a dynamic tension gauge, readings at the input and output of a fixed guide can easily be taken. To calculate the coefficient of friction between tape and guide, take tension readings and plug them into the formula given above.

A similar malfunction easily diagnosed with a dynamic tension gauge is the effect of dragging brakes in the supply motor. Even though torque or tension may be set properly by a static measurement, (and even if the system has a constant tension servo), a dragging brake can increase tension. Only a dynamic test will reveal the culprit.

TWO MEASUREMENTS SHOW TRANSPORT CONDITION

A general diagnosis of the overall transport condition is also possible by simply taking two measurements with a dynamic gauge. In fact, this is so easy that it can become as routine as demagnetizing and cleaning the heads. Simply take a measurement of tape tension at the input and the output of the capstan and note the values. The difference between them should not be more than about five ounces.

For example, a typical value at the input of the capstan might be 5½ ounces (at the beginning of the reel) and 3 to 4 ounces on the output side. In this case, the total difference is within a one to five ounce spread. But if the supply side had 10 ounces, for example, it would indicate that there was some kind of a problem, either with dirty guides or heads, sticky brakes, bad idler bearings, or some other friction-causing malfunction.

INTENTIONALLY HIGH SETTINGS

Increasing tape tension in a misguided effort to compensate for worn heads is a practice that should be very thoroughly discouraged. In years past, some old-school recording engineers used to do this to brighten up the high end when the gap was worn down. However, as we have seen, this is a sure guarantee for incompatibility of tapes because of pitch or timing errors when played on another recorder.

CONCLUSION

Proper functioning of a recorder transport depends to a major extent on the proper setting and checking of correct tape tensions. A dynamic tape tension gauge quickly and easily performs this task both from a preventive maintenance and a trouble shooting standpoint. In applications such as recording studios, broadcasting, education, tape duplication, and related areas, good recorder maintenance procedures increasingly call for routine checks on the important parameter of tape tension to maintain critical quality standards. ■

1. A kit to convert constant torque machines to constant tension, called TENTROL, is manufactured by Inovonics, of Campbell, Ca.

NEW

MICROPHONE INPUT TRANSFORMERS



MICROTRAN S101-S

FOR PROFESSIONAL SOUND STUDIO APPLICATIONS

EQUIVALENT TO IMPORTED EUROPEAN STUDIO GRADE TRANSFORMERS

Response 30-20 KHz ± 1dB
Turns Ratio 1:1 Through 1:20

Single Threaded Stud Mounting



MICROTRAN S101-SP

7-Pin PC Mounted

Complete Specifications and Price Sheet Available.

Complete line of AUDIO - POWER COMMERCIAL - MIL Transformers

IMMEDIATE DELIVERY FROM DISTRIBUTORS





MICROTRAN

COMPANY, INC.

145 E. Mineola Ave., Box 236, Valley Stream, N.Y. 11582

Circle 19 on Reader Service Card

AES Convention Report

AT THE AUDIO ENGINEERING SOCIETY'S 55th convention (Oct. 29-Nov. 1, 1976), once again some 4,000 society members and friends converged on the Waldorf-Astoria Hotel to drool over the latest in professional audio gear.

Perhaps the word *professional* should be retired, since it seems to imply a price tag that is at least several dB above the threshold of (financial) pain. (For instance, Gotham Audio displayed a new reverberation system that's yours for \$15,000—more on this later).

Actually, much of the new equipment is designed—and priced—to appeal to more conservative budgets. For, much to its delight, the audio industry has discovered a vast market for hardware that fits in a category somewhat above consumer hi-fi, yet not so elaborate or expensive as what we regard as "professional." And with every new convention, more and more of this type of equipment shows up on display.

Companies formerly specializing in either consumer or professional equipment have expanded their product lines to include equipment that falls within this semi-professional category. And, some consumer-type companies have gone a step further and entered the full professional market place as well. Needless to say, the leading companies in pro and semi-pro categories were on hand at the Waldorf to show off their latest toys.

AMPEX ATR-700

Ampex showed its new ATR-700 audio tape recorder, which carries a price tag of \$1,695. The ATR-700 may be the ultimate example of the cross-pollination going on between categories. For believe it or not, the machine is built for Ampex by the Teac Corporation, and once you get past the giggling stage, you may appreciate the logic of this improbable alliance. Teac has been turning out high end consumer machines for years, while Ampex has more or less concentrated on the professional market. But a scaled-down version of an Ampex pro machine would inevitably be compared (unfavorably, no doubt) with its big brothers. And so, we have the ATR-700, a top-of-the-line consumer-type machine incorporating professional-type features, as specified by that old pro, Ampex. The ATR-700 is available with either quarter-or half-track (two channel) or full-track (mono) head stacks, and may be ordered with tape speeds of 3¾, 7½ in./sec. or 7½, 15 in./sec. There are three position bias/eq./record level switches on the front panel for matching the electronics to various tape formulations.

Ampex says it is aiming the ATR-700 at institutional users, as well as broadcast and television studios. The machine may also do well with small budget studios who can't raise the cash for an AG-440 or ATR-100. By the way, the AG-440 series of machines is *not* being discontinued, according to Ampex's Jim Stephenson.

PANASONIC

At the Technics by Panasonic demo room, the company showed off its entry into the semi-pro tape recorder market; the model RS-1500 isolated loop tape recorder, which will sell for about \$1,500. The company is so confident of the machine's speed stability that it has included a built-in stroboscope in the tape path, and Technics says

this is the first machine to have this feature. The RS-1500 is a three-speed machine (3¾, 7½, 15 in./sec.) with half-track erase, record and playback heads, plus an additional quarter track playback head.

SIGNAL PROCESSING DEVICES

From England, Audio and Design Recording showed up with its "Scamp" modular system—a series of plug-in modules which fit into the company's 19 in. rack panel/power supply unit. Modules now available include a compressor/limiter, sweep equalizer, parametric equalizer, dynamic noise filters, an octave band equalizer, and an expander/noise gate. Prices range from \$300 to \$360 per module. In the future, Audio and Design expects to expand the Scamp series to include phasers, delay lines, and other devices.

Orange Country Electronics displayed its VS-1 stessor, a combination parametric equalizer and compressor/limiter expander. A row of push buttons allows the equalizer to be placed before or after the compressor, or in the compressor's side chain. In the latter location, the VS-1 becomes either a frequency-sensitive compressor or a dynamic filter.

The same company's Stereo Audio Processor consists of two compressor/limiter/expander modules, plus an additional high frequency limiter, with selectable pre-empha-

**Wipe tapes clean
in record time.**



Garner Erasers

provide clean erasures in only four seconds—with no noise residue. Tapes are wiped cleaner than new. Our simple, safe, continuous belt operation handles all sizes of reels, cartridges and cassettes from 10½" on down.

Garner Erasers are now fulfilling the exacting requirements of many major organizations around the world... yet are so low priced that the smallest studio or station can afford one.

User reports...

"It is a big improvement over what we used to use, or anything else on the market today."

—Ric Hammond
KNX Radio (CBS)
Hollywood, Calif.



Call today. Or write for
a brochure and names of users.

GARNER INDUSTRIES

4200 N. 48th St., Lincoln, NE 68504
Phone: 402-464-5911



his new Technics three speed quarter-inch deck has full motion sensing and an isolated loop design.

tari showed a rugged half-inch four track unit built around the basic 5050 Mark II series.



The Ampex ATR-700 is a low cost quarter-inch machine built to full professional standards at a modest price.

Owners of the UREI plotter can now buy the model 2010 plug in module that converts the unit to frequency sensing drive.



M615-SR107

Room equalization is simplified with this new Shure package consisting of led readouts and an octave equalizer.

If you have a lot of Doibys installed, this remote control accessory can prove to be a great help.



sis curves. According to the spec. sheet, the limiter section operates as a voltage controlled low pass filter, reducing high frequency energy and avoiding distortion or carrier overmodulation.

Allen and Heath's Forward Delay Limiter contains a one millisecond delay line in the audio signal path, thus allowing the limiter section to react before the signal gets to it. This "negative attack time" feature, plus a compression ratio of infinity, should ensure that no transient peaks slip by.

THE \$15,000 REVERB

And now, for that \$15,000 reverberation system. So far, artificial reverberation has been achieved with either a spring or a plate system. These devices simulate the multiplicity of reflections that are known as reverberation; however they do not actually produce a series of discrete echoes.

Now that digital delay lines are available, it might seem that such devices could be pressed into service as reverberation chambers. However, the typical digital delay line may have only one or two delayed outputs, and cost several thousand dollars. When one of these outputs is fed back into the input, one gets either a sci-fi recirculating effect or a horrendous feedback howl. Neither is very convincing as a simulation of natural reverberation. Adding more outputs helps, but price goes up very quickly, as does setup complexity.

Well, the EMT 250 Electronic Reverberator Unit is the result of some four years of computer-assisted research, aimed at the development of an all-electronic reverberation system. With only nineteen different delay elements, the EMT 250 is not as expensive as an echo-by-echo reconstruction of a natural reverberation pattern, but it's not cheap either. Definitely above your advanced-amateur class.

As a byproduct of the technology required to create this all-electronic reverberation, the EMT 250 is able to perform several other chores as well. For example, instead of using the four reverberation outputs, the unit may be programmed for four delays, each independently variable over a 0 to 315 millisecond range. In addition, slap-back and "outer space" effects are possible, as well as chorus doubling and phasing. In the reveration mode, mid-range decay time is variable within 0.4 and 4.5 seconds, while bass and high frequency reverberation time may be simultaneously programmed to be anywhere from half to twice

as long as the mid-range setting.

MEKTRONIX TAPE EDITOR

And if you have any spare change left after ordering your EMT-250, why not pick up a Mektronix Tape Editor—a splicing block that cuts a serrated edge through any tape width from 1/4 in. to 2 in. It's yours for \$1,180.

Another interesting gadget is El-tech's "Take Finder," a budget priced (\$349.95) variation on the search-and-cue theme. An opto-electrical sensor responds to light reflected off the tape recorder's supply or take-up reel. The light may be interrupted by short strips of black tape affixed to the reel, and the readout will count up or down, depending on tape direction. And depending on your accuracy requirements, one or more markers may be placed on the reel for counting purposes. In effect, the Take Finder counts the number of markers per revolution and registers up to 99,999. It requires no mechanical or electrical connections to the tape transport.

Shure Brothers introduced its M615 equalization analyzer, on the faceplate of which are ten pairs of leds. Each pair represents one of ten center frequencies, spaced at octave intervals from 32 Hz to 16 kHz. The analyzer contains a pink noise source, which may be fed to the system to be tested. The system should contain an octave band equalizer, such as Shure's own model SR107 audio equalizer, if adjustments are to be made.

With an omni-directional microphone plugged into the analyzer, one of the leds in each pair will come on. The upper led indicates an octave band energy level above a preset reference level, while the lower led indicates a below-reference level. The octave band equalizer may now be adjusted until all the leds are extinguished. The system is then flat within a ± 1 to ± 6 dB range. This two-to-twelve dB envelope is continuously variable by means of a front panel potentiometer.

At the booth of Irv Joel and Associates, technical service manager Jim Jordan describes the firm's diagnostic and consulting services. The service is available to studios seeking a complete analysis of their electronic and acoustics system. Included are frequency response tests, wow, flutter and distortion measurements, sonipulsing, plus an analysis of the client's own test tapes and test equipment, recommendations on maintenance procedures, and a thorough documentation of all tests. Although actual maintenance and repair work is not included in the diagnostic service, the company can provide these additional services on request.

Closing date is the fifteenth of the second month preceding the date of issue.

Send copies to: Classified Ad Dept.

db THE SOUND ENGINEERING MAGAZINE

1120 Old Country Road, Plainview, New York 11803

Rates are 50¢ a word for commercial advertisements.

Employment offered or wanted ads are accepted at 25¢ per word.

Frequency discounts: 3 times, 10%; 6 times, 20%; 12 times, 33%.

FOR SALE

AUDIOARTS ENGINEERING, 286 Downs Rd., Bethany, Conn. 06525. Tolex-covered portable 19 in. rack equipment cases.

3M M79's, 16-, 8-, 4-, and 2-track; Helios recording consoles; Tascam 80-8's and 25-2's; dbx n-r; AKG reverb; E-V, Shure, Sennheiser, & AKG microphones; Crown amplifiers, overstocked. Call Ben today at **Rowton Professional Audio, Route 4, Box 5, Paducah, Ky. 42001. (502) 898-6203.**

ONE NEUMANN VG-66 disc cutting rack, 100 watts/channel including monitor amps. **S.N.B. Mastering. (514) 735-2271.**

REELS AND BOXES 5" and 7" large and small hubs; heavy duty white boxes. **W-M Sales, 1118 Dula Circle, Duncanville, Texas 75116. (214) 296-2773.**

AMPEX 354. \$950.00. **(305) 299-1299.**

WHATEVER YOUR EQUIPMENT NEEDS—new or used—check us first. We specialize in broadcast equipment. Send \$1.00 for our complete listings. **Broadcast Equipment & Supply Co., Box 3141, Bristol, Tenn. 37620.**

AUDIO and VIDEO On a Professional Level

Lebow Labs specializes in equipment, sales, systems engineering, and installation—full service and demonstration facilities in-house. We represent over 200 manufacturers of professional and semi-professional equipment for recording, broadcast, sound reinforcement, and commercial sound. Call or write for information and pricing (attention Peter Engel).

LEBOW LABS, INC.
424 Cambridge St.
Allston (Boston), Mass. 02134
(617) 782-0600

MXR'S DIGITAL DELAY system. Maxell tape. Lowest prices. **N.A.B. Audio, Box 7, Ottawa, Ill. 61350.**

COMMUNITY LIGHT & SOUND professional sound products. **Brandy Brook Audio, P.O. Box 165, Seymour, Connecticut 06483. (203) 888-7702.**

ARP 2500, 2600, Odyssey, like new, \$10,000. Consider offers. Call Jack **(203) 795-3600 days.**

AST: THE PROFESSIONAL SOUND STORE. Full line of ALTEC and CROWN professional audio, commercial, and musical sound equipment; GAUSS and CERWIN-VEGA speakers; factory authorized service on most speakers. Large stock of ALTEC replacement diaphragms available. **AST, 281 Church St., New York, N.Y. 10013. (212) 226-7781.**

AUTHORIZED AMPEX sales and service; electrical/mechanical manufacturing and design of studio equipment; motor rebuilding. **F. R. Dickinston, Jr., Inc., P.O. Box 547, Bloomfield, N.J. 07003. (201) 429-8996.**

FREE CATALOG of studio kits, consoles, p.a., discrete opamps. **QCA, Box 1127, Burbank, Ca. 91507.**

DYNACO RACK MOUNTS for all Dynaco preamps, tuners, integrated amps. \$24.95 postpaid in U.S., \$22.50 in lots of three. **Audio by Zimet, 1038 Northern Blvd., Roslyn, N.Y. 11576. (516) 621-0138.**

NAGY SHEAR-TYPE TAPE SPLICERS



FOR CASSETTE ¼ & ½ IN. TAPES
• HAND-CRAFTED
• FIELD PROVEN
• FAST, ACCURATE
• SELF-SHARPENING

NRPD Box 289 McLean, Va. 22101

THE RESONATOR is more than a reverb. Designed for use with any console, including Tascam. \$359.00. **Dyma, Box 1697, Taos, N.M. 87571.**

NAB ALUMINUM FLANGES. We manufacture 8", 10½", & 14". For pricing, write or call **Records Reserve Corp., 56 Harvester Ave., Batavia, N.Y. 14020. (716) 343-2600.**

ELECTRO-VOICE SENTRY PRODUCTS. In stock: Sentry IV-B, Sentry III, and Sentry V monitor loudspeaker systems for professional monitoring and sound reinforcement. Immediate air freight shipment to any N. American destination. Florida dealer inquiries invited. **National Sound Co., Ft. Lauderdale, Florida. (305) 462-6862.**

MODERN RECORDING TECHNIQUES by Robert E. Runstein. The only book covering all aspects of multi-track pop music recording from microphones through disc cutting. For engineers, producers, and musicians. \$9.95 prepaid. **Robert E. Runstein, 44 Dinsmore Ave. Apt. 610, Framingham, Mass. 01701.**

AMPEX 300, 352, 400, 450 USERS—for greater S/N ratio, replace first playback stage 12SJ7 with our plug-in transistor preamp. For specifications, write **VIF International, Box 1555, Mountain View, Ca. 94042. (408) 739-9740.**

DUPLICATOR REPAIR CENTER for all brands of in-cassette duplicators. Factory-trained technicians. Work warranted. Also big selection of new and used duplicators. **Tape and Production Equipment Company, 2065 Peachtree Industrial Court, Atlanta, Ga. 30341.**

DISCOVER A NEW DIMENSION IN SOUNDS THROUGH FREQUENCY SHIFTERS

Featuring professional models 735 and 750 Bode Frequency Shifters for creative sound production, and anti-feedback model 741 for p.a. systems. Also featuring POLYFUSSION synthesizer modules and systems. For details contact:

**Harald Bode
BODE SOUND COMPANY
1344 Abington Pl.,
N. Tonawanda, N.Y. 14120
(716) 692-1670**

(continued)

FOR SALE

THE UNIVERSAL PULSER™

Programs practically all A-V pulsing formats! Counts, transposes, filters, and triggers. Send for literature. **TAPEHEADS, 4020 Beecher St. NW, Washington, D.C. 20007. (202) 338-6510.**

TECHNIARTS, professional audio equipment: AKG, Ampex, Crown International, dbx, Malatchi, Orban Parasound, Sescam, in stock. Professional audio services: audio and acoustical analysis, narrow band equalization, reverberation time, frequency response, and noise level measurements, broadcast and recording systems design, fabrication, and installation. **TECHNIARTS, 8555 Fenton St., Silver Spring, Md. 20910. (301) 585-1118.**

ARP SYNTHESIZERS: Strings, \$1,385; 2600, \$2,190; Axse, \$700; Prosoloist, \$875, Odyssey, \$1,165. **Dickstein Distributing, 1120 Quincy, Scranton, Pa. 18510.**

A FEW competitively priced used Revox A77 and A700 decks available. Completely reconditioned by Revox, virtually indistinguishable from new and have the standard Revox 90-day warranty for rebuilt machines. Satisfaction guaranteed. Write requirements to **ESSI, Box 854, Hicksville, N.Y. 11802. (516) 921-2620.**

AMPEX TAPE. Ampex Audio studio mastering tapes; 631-641, 406-407, and "Grand Master" in stock for immediate shipment; ¼", 1" and 2"; factory fresh. Best prices. **Techniarts, 8555 Fenton St., Silver Spring, Md. 20910. (301) 585-1118.**

PRO AUDIO EQUIPMENT & SERVICES

Custom touring sound, 2-, 4-, and 8-track studios, disco systems. Representing Akai, AKG, Allen & Heath, Altec, Beyer, BGW, Cetec, Cerwin-Vega, Community Light & Sound, dbx, Dynaco, Dokorder, Emilar, E-V, Furman, Gauss, Kelsey, Lamb, Langevin, 3M, Martex PM, Maxell, Meteor, Russound, Revox, Sennheiser, Shure, Sony, Soundcraftman, Sound Workshop, Spectra Sonics, Switchcraft, TDK, TAPCO, TEAC, Technics, Thorens, and more. Offering these professional services: custom cabinet design, room equalization, loudspeaker testing, custom crossover design, electronics modification, and custom road cases. Call or write for quotes, or drop us a line for our latest catalogue. **K&L Sound, 75 N. Beacon St., Watertown, Mass. 02172. (617) 787-4073. (Att.: Ken Berger.)**

PROFESSIONAL SOUND COMPONENTS from Crown, TAPCO, Soundcraft, Eventide, Community, dbx, Gauss, Soundcraftsmen, Spider/Peavey, Sound Workshop, Neumann, and many more. Hear it all at **Gary Gand Music, 172 Skokie Valley Rd., Highland Park, Illinois 60035. (312) 831-3080.**

MCI 528 RECORDING DESK, perfect condition, factory maintained, custom meter panel w/phase meter. \$46,000. **Criteria Recording Studios, 1755 N.E. 149th St., Miami, Fla. 33181. (305) 947-5611.**

CROWN INTERNATIONAL. Complete repair, overhaul, and rebuilding service for current and early model Crown tape recorders and amplifiers. New and reconditioned recorders in stock for immediate delivery. Used Crown recorders purchased and accepted for trade in. **TECHNIARTS, 8555 Fenton St., Silver Spring, Md. 20910. (301) 585-1118.**

MAVIS 15 x 4 road boards for sale; also JBL components and other road gear available. **(616) 392-7043.**

TRACKS!! The complete semi-pro recording center. Get our low prices on Tascam, TEAC, Neotek, Multi-Track, dbx, MXR Pro, Shure, BGW, Tapco and many others. Complete studio packages available. Tracks!! from **DJ's Music Ltd., 1401 Blanchan, La Grange Park, IL 60525. (312) 354-5666.**

NEW YORK'S LEADING DEALER specializing in semi-pro and professional recording and p.a. equipment. Teac, Tascam, Sound Workshop, Nakamichi, dbx, MXR, Dynaco, Ads, Frazier, Eventide, Electro-Voice, Shure, Scotch, Maxell, Otari, Ampex, and more. We go both ways: lowest prices in sealed factory cartons, or complete laboratory check-out and installation. All equipment on display. **AUDIO BY ZIMET, 1038 Northern Blvd., Roslyn, L.I., New York 11576. (516) 621-0138.**

RADFORD

Order Radford direct from England! Immediate dispatch by air of HD250 stereo amplifier, ZD22 zero distortion preamp, Low Distortion Oscillator ser. 3, Distortion Measuring Set ser. 3, speakers and crossovers. Send for free catalogues, speaker construction plans, etc.

WILMSLOW AUDIO

Dept. Export DB, Swan Works, Bank Square, Wilmslow, Cheshire, England

CUSTOM CROSSOVER NETWORKS to your specifications; a few or production quantities. Power capacities to thousands of watts; inductors and capacitors available separately; specify your needs for rapid quotation. Also, PIEZO ELECTRIC TWEETERS—send for data sheet and price schedules. **TSR ENGINEERING, 5146 W. Imperial, Los Angeles, Ca. 90045. (213) 776-6057.**

MM1000 AMPEX 16-track recorder, 15/30; 284 Scully 8-track w/sync master; two ElectroSound 2-track recorders; 280 Scully mono recorder; PDM EMT 156 limiter; all in excellent condition. **Woodland Sound Studios, 1011 Woodland St., Nashville, Tenn. 37206. (615) 227-5027.**

ASPEN'S 16-track recording studio is for sale. Started in 1974 with new MCI, Dolby, 3M equipment. Excellent potential. **Ed Thorne, (303) 925-5530.**

THE LIBRARY . . . Sound effects recorded in STEREO using Dolby throughout. Over 350 effects on ten discs. \$100.00. Write **The Library, P.O. Box 18145, Denver, Colo. 80218.**

CASSETTES AND REEL TAPES, bottom prices. Name brands or custom-loaded with Scotch or BASF. Super mastering computer cassettes loaded with AGFA-GAVAERT. Prepaid shipments. Duplicators, accessories, supplies. Write **Stanford International, Box 609D, San Carlos, Ca. 94070.**

BI-AMPING is the best. Use the new "Quanics" 18 dB/oct. X-over. It's easier and works better than the others. Write and find out how today. **Quanics, 103 N. 143rd, Seattle, Wa. 98133.**

CROWN, dbx, TAPCO, Sony, Otari, AKG, Electro-Voice (microphones, component & monitor loudspeakers). ALL NEW, priced right. **Gold, Box 141, Englewood, Colorado 80151.**

FOR SALE: MCI JH-416 recording console, 16-in/16-out, wired for 24-in/out, excellent condition, \$15,000 or best offer. AKG BX-20E stereo reverb, \$2,500 or best offer. **(614) 663-2544.**

**ONE STOP
FOR ALL YOUR PROFESSIONAL
AUDIO REQUIREMENTS
BOTTOM LINE ORIENTED
F. T. C. BREWER CO.
P.O. Box 8057, Pensacola, Fla. 32505**

STUDIO SOUND—Europe's leading professional magazine. Back issues available from June '73 through June '75. \$1 each, postpaid. **3P Recording, P.O. Box 99569, San Francisco, Ca. 94109.**

AMPEX, SCULLY, TASCAM, all major professional audio lines. Top dollar trade-ins, 15 minutes George Washington Bridge. **Professional Audio Video Corporation, 342 Main St., Paterson, N.J. 07505. (201) 523-3333.**

\$2 MILLION USED RECORDING EQUIPMENT. Send \$1.00 for list, refundable, to **The Equipment Locator, P.O. Box 99569, San Francisco, Ca. 94109.**

3M 4-TRACK/IN CONSOLE, 15-30 i.p.s., excellent, \$3,900; Countryman 967 phase shifter, \$190.00; V.S.O. McIntosh 200 watt, \$400.00; 4 Studer A-80 Mark 1 electronics (100 hrs. use), \$800.00 each; AKG-BX 20E reverb w/remote, \$2,500 or best offer; J.B.L. 4350 speakers, \$1,050 each, still in warranty; Stephens 24-track recorder, latest model, like new, \$20,000. (213) 461-3717, ask for Brian.

EDCOR PM-1 wireless mic and St-3 "Sensatuner," excellent condition, \$375 or best offer. Two Sennheiser cardioid condenser microphones, MKH-406U, 48 volt Phantom version, mint condition, \$750 or best offer. **David Satz, (617) 492-2263.**

SCULLY MS-282-4, portable cases, motion sense, remote, mint condition. (313) 779-1685 Sunday after 6:00 P.M.

TEXAS STUDIO SUPPLY. Lowest prices anywhere! dbx, Sennheiser, Speck, TAPCO, etc. Write for list. **2036 Pasket, Houston, Texas 77092.**

NEW 20 kW f.m. transmitter (never used). Also complete radio automation system. Entire package for sale at reduced price or will sell pieces separately. Write to **Dept. 11, db Magazine, 1120 Old Country Rd., Plainview, N.Y. 11803.**

CUTTERHEAD REPAIR SERVICE for all model Westrex, HAECO, Gramplan. Modifications done on Westrex. Avoid costly down time, maximum 3-day turnaround upon receipt. Send for free brochure: **International Cutterhead Repair, 222 W. Palisades Blvd., Palisades Park, N.J. 07650. (201) 461-8658.**

FREE CATALOG & AUDIO APPLICATIONS



CONSOLES
KITS & WIRED
AMPLIFIERS
MIC, EQ, ACN,
LINE, TAPE, DISC,
POWER
OSCILLATORS
AUDIO
TAPE BIAS
POWER SUPPLIES

OPAMP LABS, INC.
1033 N. SYCAMORE AVE.
LOS ANGELES, CALIF. 90038
(213) 924-7366

DECOURSEY ACTIVE ELECTRONIC CROSSOVERS. Model 110 dividing network; complete with regulated power supply, for bi-amp, tri-amp, or quad-amp. Custom assembled to meet your specifications. Monaural, stereo, or with derived third channel. Plug-in Butterworth (maximally flat) filters; 6, 12 or 18 dB per octave at any desired frequency. OPTIONS: Summer for single woofer systems, VLF hi-pass filters for elimination of subsonic noise, derived third channel. FOR OEM OR HOME ASSEMBLERS: Model 500 or 600 dual filters. Regulated power supplies. Write for new brochure. **DeCoursey Engineering Laboratory, 11828 Jefferson Blvd., Culver City, Ca. 90230. (213) 397-9668.**

FOR SALE: One Langevin AM-4 8-in/4-out audio console w/producer's desk in good condition, w/some spares, \$3,000.00. One Langevin AM-3 8-in/2-out audio console w/Parasound reverb, patch bays, and cabinets, w/some spares—mint condition, \$2,000.00. Contact: **Thomas W. Bethel, Director of Audio Services, Oberlin College, Oberlin, Ohio 44074 or call (216) 775-8272.**

3M SERIES 400 M-23 8-track tape recorder, 6 years old, replaced heads (minimal wear), very good condition, specifications and pictures available upon request, \$6,500. Eight Dolby 361-A noise reduction units, excellent condition, \$600 each. **W. Ramsey. (512) 478-9294.**

RACK LABS STEREO active crossovers and 40 Hz hi-pass filters for hi fi or p.a. Write **Rack Laboratories, 136 Park St., New Haven, Conn. 06511.**

MCI 24-TRACK recording console with producer's desk; matching equipment rack; plus extras. \$19,500. (312) 225-2110, Paul.

TEST RECORD for equalizing stereo systems. Helps you sell equalizers and installation services. Pink noise in 1/3 octave bands, type QR-2011-1 @ \$20. Used with precision sound level meter or B & K 2219S. **B&K Instruments, Inc., 5111 W. 164th St., Cleveland, Ohio 44142.**

AUDIOARTS ENGINEERING parametric equalizer, electronic crossover, disco mixer, stage mixers. **Audioarts Engineering, 286 Downs Rd., Bethany, Conn. 06525.**

WANTED

WANTED: Three Neumann U-87 microphones; AKG BX-20E reverb. Call (201) 359-5520 after 6:00 p.m.; ask for Bernie.

WANTED: TASCAM 4- or 8-track 1/2" recorder with 501 or 701 electronics (and Model 10 consoles, modules & small Neve boards). **V. Bond, Box 1946, Winnipeg, Manitoba, Canada R3C 3R2. (204) 888-6099.**

EMPLOYMENT

AUDIO SALES ENGINEERS. Excellent opportunities and profitable, interesting work for experienced audio sales engineers with 30-year old, nationally-recognized firm. We'd prefer people who are familiar with Acousta-Voicing processes. Wonderful living in sunny San Diego, plus superior fringe benefits. Send resume and salary requirements to **Vic Hall, president, COMMUNICATIONS COMPANY, INC., 3490 Noell St., San Diego, Ca. 92110.**

ELECTRONICS AUDIO TECHNICIAN. Duties include production line testing of electronic music accessories and new product development. Experience in same or related lines and thorough understanding of solid state devices, including linear i.c.s, schematic reading, and usage of test equipment. Mid-Manhattan location. Call Howard at (212) 741-1770 for appointment.

District Sales Manager ALTEC

Selected individual will be responsible for sales of commercial and intercommunication equipment in the southeastern region of the U.S.A. Candidates must possess specific experience and technical expertise in the wiring communications industry and have a proven track record of sales management and achievement. Other requisite skills are sales planning, forecasting, promotional and training activities. Travel required. Bachelor's degree helpful. Send resume with salary requirements in confidence to:

Employment Manager ALTEC

1515 S. Manchester Ave.
Anaheim, Ca. 92803
Equal opportunity employer M/F

EXPERIENCED MUSIC MIXER

For major N.Y.C. studio, expanding staff. Send resume to **Dept. 72, db Magazine, 1120 Old Country Rd., Plainview, NY 11803.**

● **Modular Devices, Inc.**, of Bohemia, N.Y., has moved into new headquarters at 50 Orville Drive, Bohemia. The new facility, which also houses **Modular Audio Products**, triples the firm's working space.

● **Doyce B. Beard** has been named president of **Magnetic Electronics, Inc.**, of Opelika, Alabama. Mr. Beard is also assistant treasurer of the **Orrox Corporation** and president of **Datacount** computer service company.

● **Sharon Rand Burch**, formerly vice president of **Holzer Audio Engineering Corporation**, has formed her own company, **International Cutterhead Repair**, of Palisades Park, N.J. The firm maintains a complete repair and conversion service and will shortly introduce a new stereo cutterhead.

● **Fairchild Industries**, of Germantown, Maryland, has announced the election of two major officers, **Edward G. Uhl** as chairman of the board and chief executive officer, and **John F. Dealy** as president and chief operating officer. Mr. Uhl, who has been president and chief executive officer since 1961 fills the post, long vacant, left by the death of **Sherman Fairchild** in 1971. Mr. Dealy came to Fairchild in 1967 as its general counsel and has occupied the posts of vice-president and chief financial officer.

● Activities at **Superscope, Inc.** of Los Angeles include the establishment of a new department to develop private label business and the establishment of a cassette loader supply and technical service facility in Belgium by the **Superscope Tape Duplicating Products** division. The private label department will be focalized by **G. T. Thalberg**, who had been active in the development of the **Superscope Story Teller** cassette-book. The Belgian facility is at Peronnes-les-Binches.

● **The Automatt**, a new state-of-the-art recording studio, a division of **David Rubinson & Friends, Inc.**, has commenced operation in San Francisco. The studio features advanced don't-spense-the-expense technology, was designed by **Westlake**. Principals in the enterprise are **David Rubinson** and **Fred Catero**. The address is at 827 Folsom St., San Francisco, Ca. 94107.

● A new trade event devoted entirely to audio, dubbed **Audex**, managed by the **Charles Snitow Organization**, 331 Madison Avenue, New York, N.Y. 10017, will take place at the Las Vegas Convention Center April 25-28, 1977. Emphasis will be on stereo compacts and consoles, high fidelity components, radios, magnetic tape recorders and tape products.

● New appointments at **Telex Communications, Inc.** of Minneapolis include **Edward M. Fitzgerald**, as product manager, and **Clarence J. Hoodecheck** as plant manager. Mr. Fitzgerald comes from **ARCAL** distributor stores.

● New group and manufacturing managers have been appointed by **TRW Semiconductors** of Lawndale, California for its CATV/Microwave group. **Dan Newton** has been promoted to the position of group manager, assisted by **Jim Humphrey**, who has taken the position of manufacturing manager.

● Coming from **Sound Systems, Inc.**, **Robert J. Garbutt** has been appointed manager of the professional products department at **Sharp Electronics Corporation** of Paramus, N.J. Mr. Garbutt hopes to develop a broader line in non-broadcast t.v. and a/v products. Other new appointments at Sharp include **Masamitsu (Mike) Akamatsu** as executive vice president in charge of the consumer electronics division and **Gene O. Jadwin** as general manager of a new customer relations and service department.

● **Goldmark Communications Corp.** of Stamford, Conn. has consolidated company activities dealing with their **Transcan** division in a new facility at 98 Commerce Road. It is expected that the new quarters will expedite client needs. In addition to the **Transcan** operation, other **Goldmark** products, **Rapid Transmission and Storage**, and the **Skew Corrector**, will be included in the consolidation.

● A new position at **Audio-Technica U.S. Inc.**, of Fairlawn, Ohio, director of operations, has been filled by **Howard Brown**. Mr. Brown, who was previously with **Bang & Olafsen**, will be responsible for the scheduling and flow of merchandise. **David G. Jensen** has also recently joined the sales staff.

● Sound reinforcement will be the theme of the **Midwest Acoustics Conference in May**. The program will feature audio visual as well as the customary lecture presentations, with special emphasis on new digital time delay methods. Engineering education development is also on the discussion agenda. The all-day conference, scheduled for May 7, 1977 from 8:30 to 6:00, will take place at the Norris Center of Northwestern University. For information contact **Daniel Queen** of **Daniel Queen Associates**, 5524 W. Gladys Ave., Chicago, Ill. 60644. (312) 261-5738.

● Newly opened **Museum of Broadcasting**, at 1 E. 53rd St., New York City, the brainchild of CBS's **William S. Paley**, has a library of 718 radio and t.v. programs and hopes to have 18,000 by the end of five years, spanning the period from 1920 to the present. Sights and sounds from the past are evoked at the push of a button. In addition, the museum contains books on the industry, program scripts, and a card catalog.

● **Francis L. Reed** has been promoted to the position of director of marketing at the **Advent Corporation**, of Cambridge, Mass. Mr. Reed has been with the firm since 1969. Replacing Mr. Reed in the national sales manager spot will be **Richard Railston**. In addition, **Virginia Fried** has been named manager of marketing services.

● **Henry E. Kloss**, founder of the **Advent Corporation** of Cambridge, Mass. and director of its research and development activities, has resigned his position. He will remain as a member of the Board of Directors.

● Two additions to their executive staff have been announced by **Speck Electronics**, of N. Hollywood, Ca. **Robert K. Mallah** will head national sales and advertising activities and **Vincent M. Poulos** will be in charge of design and engineering.

● Coordination of selling efforts in thirteen western states for **Switchcraft, Inc.** of Chicago, is now under the aegis of newly appointed **Ken Yerama**. Mr. Yerama comes to **Switchcraft** from **Panomotor Interswitch & Interlok**, a division of the **Wm. J. Purdy Company**.

John Woram's The Recording Studio Handbook

FOR RECORDING ENGINEERS,
TECHNICIANS AND AUDIOPHILES

The technique of creative sound recording has never been more complex than it is today. The proliferation of new devices and techniques require the recording engineer to operate on a level of creativity somewhere between a technical superman and a virtuoso knob-twirler. This is a difficult and challenging road. But John Woram's new book will chart the way.

The Recording Studio Handbook is an indispensable guide. It is the audio industry's first complete handbook that deals with every important aspect of recording technology.

Here are the eighteen chapters:

- The Decibel
- Sound
- Microphone Design
- Microphone Technique
- Loudspeakers
- Echo and Reverberation
- Equalizers
- Compressors, Limiters and Expanders
- Flanging and Phasing
- Tape and Tape Recorder Fundamentals
- Magnetic Recording Tape
- The Tape Recorder
- Tape Recorder Alignment
- Noise and Noise Reduction Principles
- Studio Noise Reduction Systems
- The Modern Recording Studio Console
- The Recording Session
- The Mixdown Session

In addition, there is a 36-page glossary, a bibliography and five other valuable appendices.

John Woram is the former Eastern vice president of the Audio Engineering Society, and was a recording engineer at RCA and Chief Engineer at Vanguard Recording Society. He is now president of Woram Audio Associates.

This hard cover text has been selected by several universities for their audio training programs. With 496 pages and hundreds of illustrations, photographs and drawings, it is an absolutely indispensable tool for anyone interested in the current state of the recording art.

Use the coupon at the right to order your copy of *The Recording Studio Handbook*. The price is only \$35.00, sent to you with a 15-day money-back guarantee.

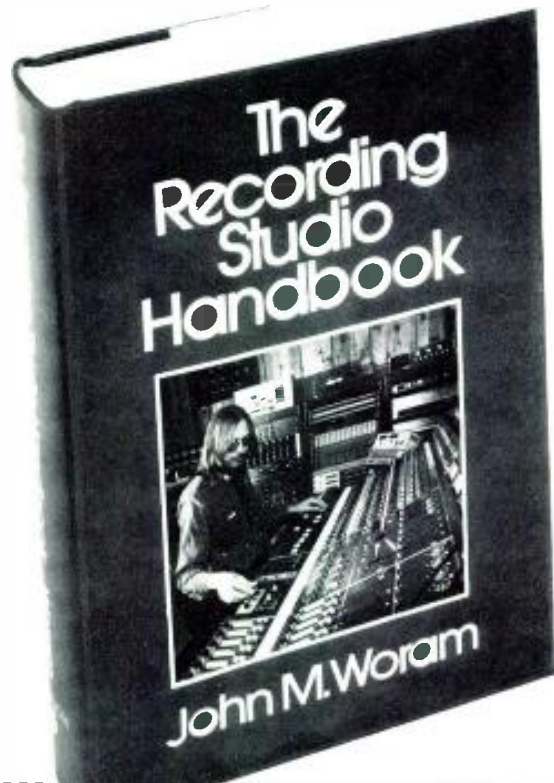

SAGAMORE PUBLISHING COMPANY, INC.
1120 Old Country Road, Plainview, N.Y. 11803

Yes! Please send ___ copies of *The Recording Studio Handbook* at \$35.00 each. On 15-day approval.

Name _____

Address _____

City/State/Zip _____

Total Amount _____

N.Y.S. Residents add appropriate sales tax _____

Enclosed in payment for \$ _____
Outside U.S.A. add \$2.00 for postage

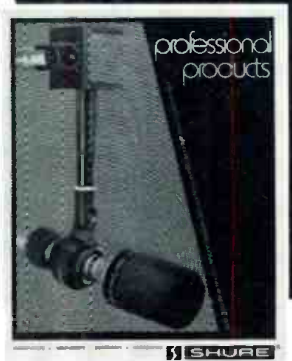

Small wonder.

The world's smallest dynamic-element lavalier microphone is designed to be heard, not seen. Other mini-mics may be O.K. at first, but, as you know, there have been problems with sudden failures... sometimes on the air! The new Shure SM11 lavalier solves the problem with an unusually high quality dynamic element that delivers all the reliability of a desk microphone—yet it weighs less than a third of an ounce.

Rugged, all-around durability and a field-serviceable design

keeps this new breed of lavalier on the air when you need it most. Without batteries or unnecessary wiring. And without a big price tag either.

The SM11 has everything: size, performance, durability, price. That's not just small talk!

Shure Brothers Inc.
222 Hartrey Ave.
Evanston, IL 60204

In Canada:
A. C. Simmonds & Sons Limited

TECHNICORNER

Frequency Response: 50 to 15,000 Hz
Polar Pattern: Omnidirectional
Impedance: 150 ohms (200 ohms actual) for connection to microphone inputs rated at 25 to 200 ohms
Hum Pickup: Less than 35.3 dB equivalent SPL in a 1 millioersted field
Accessories Supplied: Specially designed lavalier assembly; clip-on clasp; tie-tack assembly; connector belt clip.

 **SHURE**[®]

MANUFACTURERS OF HIGH FIDELITY COMPONENTS, MICROPHONES, SOUND SYSTEMS AND RELATED CIRCUITRY.

Circle 12 on Reader Service Card