

**dB**

THE SOUND ENGINEERING MAGAZINE

JANUARY 1971

75¢

**Sound Reinforcement**

J1  
DIO STATION PRODUCTN  
IV OF WASH  
... BLDG  
... DBE

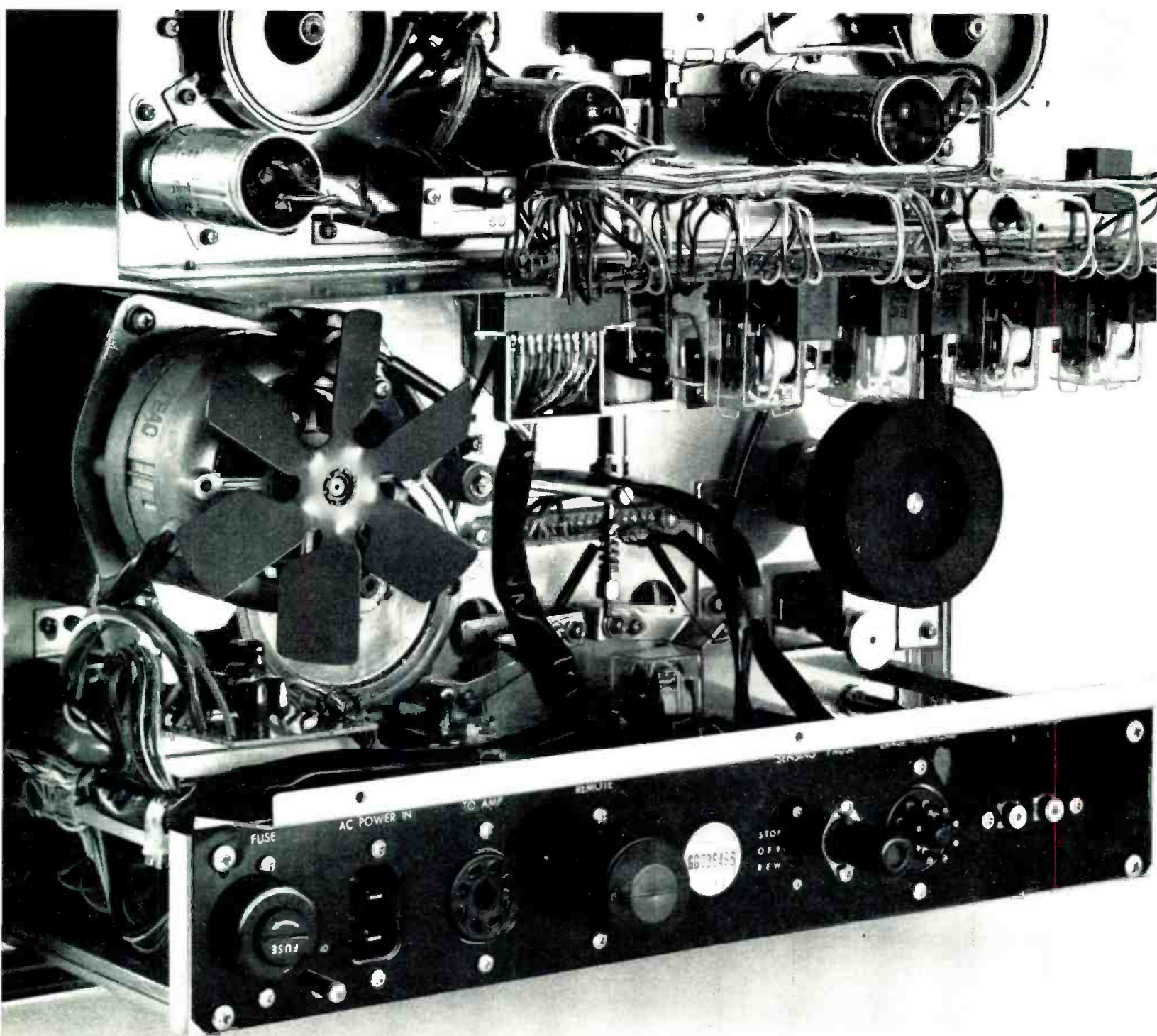

# BACK TALK

When it comes to building sound equipment from the inside out, you could call us the component company. You see, we're one of the few tape deck manufacturers who make all our own critical components – from heads to motors and most of the electronics. After all, who knows better than we do what it takes to make a TEAC?

For instance, our heads are hyperbolic, not conventionally rounded. This means more intimate tape contact, less tape tension, better sound reproduction. Hyperbolic heads are the shape of things to come – and the only kind we'd think of using.

Meanwhile, we still buy outside parts for certain purposes. The ones we buy, we buy because they're the best. The ones we make, we make because they're the best.

And most of the time, we've got it made.

## TEAC

TEAC Corporation of America • 2000 Colorado Avenue • Santa Monica, California 90404



Circle 10 on Reader Service Card



THE SOUND ENGINEERING MAGAZINE

JANUARY 1971 VOLUME 5, NUMBER 1

# COMING NEXT MONTH

• Perhaps the most complete delineation of specifications for attenuators ever published will be offered as developed by engineer Charles King. Each type of attenuator is shown in schematic, and tables of values for losses from 1 to 40 dB give each of the components of the attenuator. This will prove to be a permanent reference.

Walter Jung is represented with *A Transistorized Noise Generator* in which he offers an easy-to-build circuit for a wide-band noise generator.

In *Four Channels and a Mono Signal*, Dr. Walter Gunn of Columbia University outlines a discovery that may well have value to imaginative rock-music producers.

- 16 AUDIO AFLOAT  
Richard L. Lerner
- 23 ROCK AND SPEECH COEXIST IN A THEATER  
Robert Liftin
- 26 SOUND REINFORCEMENT IN A NEW CHURCH  
David L. Klepper
- 31 THE TELDEC VIDEO DISC (CONTINUED)  
Arnold Schwartz/Edward Tatnall Canby
- 2 LETTERS
- 4 THE AUDIO ENGINEER'S HANDBOOK  
George Alexandrovich
- 8 THE SYNC TRACK  
John Woram
- 10 THEORY AND PRACTICE  
Norman H. Crowhurst
- 13 SOUND WITH IMAGES  
Martin Dickstein
- 17 NEW PRODUCTS AND SERVICES
- 34 BOOKCASE
- 35 CLASSIFIED
- 36 PEOPLE, PLACES, HAPPENINGS

db is listed in Current Contents: Engineering and Technology,

# ABOUT THE COVER

• Sound Reinforcement is the topic of this issue. Art Director Robert Laurie has selected an illustration that definitely relates. Photo courtesy of GRT Corporation.

Robert Bach PUBLISHER	Larry Zide EDITOR
Bob Laurie ART DIRECTOR	John Woram ASSOCIATE EDITOR
A. F. Gordon CIRCULATION MANAGER	Marilyn Gold COPY EDITOR
Eloise Beach ASST. CIRCULATION MGR.	Richard L. Lerner ASSISTANT EDITOR

db, the Sound Engineering Magazine is published monthly by Sagamore Publishing Company, Inc. Entire contents copyright © 1971 by Sagamore Publishing Co., Inc., 980 Old Country Road, Plainview, L.I., N.Y. 11803. Telephone (516) 433 6530. db is published for those individuals and firms in professional audio-recording, broadcast, audio-visual, sound reinforcement, consultants, video recording, film sound, etc. Application should be made on the subscription form in the rear of each issue. Subscriptions are \$6.00 per year (\$7.00 per year outside U. S. Possessions, Canada, and Mexico) in U. S. funds. Single copies are 75c each Controlled Circulation postage paid at Harrisburg, Pa. 17105 Editorial, Publishing, and Sales Offices: 980 Old Country Road, Plainview, New York 11803. Postmaster: Form 3579 should be sent to above address.

# letters

The Editor:

I hate to harp on the much debated issue of 4-channel stereo, but I am of the feeling that the equipment-buying public is being duped by the "wonders" of quadrasonic sound. It seems to me that, we have, in recent years, digressed from that which we in the recording profession have tried so diligently to attain: true realism. It is unfortunate, indeed, that much of the recording industry, especially in the realm of popular music, has ignored, indeed tried to get away from, true realism. With the advent of multi-channel recording, and selective post-synchronization, stereo isn't created at the source anymore; rather it is dreamed up by the a & r man and his engineer, with the aid of multi-channel recording gear, and a wealth of pan-pots. Further, the attitude of many engineers today seems to be the-more-the-merrier when it comes to use and positioning of microphones. Have these gentlemen forgotten (indeed, ever known) about things like phase-cancellation, image shift, and frequency-dependent directional characteristics? Do these gentlemen realize that many times a better stereo recording can be had with *one* microphone, rather than 20 or 30? There seem to be rumblings within the industry that a return to simplicity might be in the offing. I say bravo! A binaural recording, with judicious and proper placement of a minimum number of microphones, utilizing techniques of m-s, or intensity, stereo,

can give an effect of realism and third-dimension equal to, or surpassing any multi-channel effort. I would wager that by exposing the recording public to such a recording, with paramount emphasis on true realism, that they'd never go back to a 16-channel "creation" of a full symphony orchestra. To substantiate my point, I quote an article published by Steve Temmer and Gerhard Boré for the AES: "Much research has been done in the field of stereophonics from the standpoint of reproduction through earphones, loudspeakers, two-channel, three-channel, or multi-channel systems. Judgment in the use of different recording techniques has been on the basis of many and varied criteria. These have included attempts to startle the listener; tries at spreading the orchestra out to many times its actual concert width; arbitrary assignment of instrumental sections and vocalists to left and right channels, without regard to representation of realism; and many more. We believe that with the advent of stereo discs and stereo multiplex f.m. a tremendous interest in sound reproduction will be generated; and interest many times that of recent years. And after we have settled down to real *enjoyment* of our newly-discovered dimension, rather than the open-mouthed, startled look one sees nowadays when first confronted with *stereo*, then I believe we will go back and re-examine some of the basic truths of stereo recording with perhaps a view toward a return to realism and a true third dimension."

This article was first published in 1957!! Aren't we about 13 years overdue?

*John Fippen  
Chief Engineer  
Magnetic Studios Corp.  
Columbus, Ohio*

The Editor:

We read Mr. Crowhurst's article on tape duplicating with great interest, and compliment him on his coverage of the subject.

As was pointed out in the article, the available tape speeds shown in Table 1 are a few months old, and we would like to update the information given on Ampex equipment. The maximum master speed has been increased to 240 in./sec., and the maximum slave speed to 120 in./sec. Additionally, the description of the BLM-200 bin loop master on page 38 indicates a maximum capacity of 1200 feet. This has been increased to 1800 feet.

*Peter F. Hille  
Manager, Audio Design Group  
Special Products Division  
Ampex Corporation  
Redwood City, Cal.*

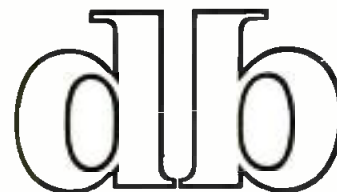

THE SOUND ENGINEERING MAGAZINE

## SALES OFFICES

### New York

Specifax Media Sales, Inc.  
Manfred W. Meisels  
603 East 82nd Street  
New York, N. Y. 10028  
212-249-7768

### Boston

Specifax Media Sales, Inc.  
William H. Fields III  
49 Gray Street  
Boston, Mass. 02116  
617-426-5315

### Chicago

Jim Summers & Associates  
35 E. Wacker Drive  
Chicago, Ill. 60601  
312-263-1154

### Denver

Roy McDonald Associates, Inc.  
846 Lincoln Street  
Denver, Colorado 80203  
303-825-3325

### Houston

Roy McDonald Associates, Inc.  
3130 Southwest Freeway  
Houston, Texas 77006  
713-529-6711

### Dallas

Roy McDonald Associates, Inc.  
Semmons Tower West  
Suite 714  
Dallas, Texas 75207  
214-637-2444

### San Francisco

Roy McDonald Associates, Inc.  
625 Market Street  
San Francisco, California 94105  
415-397-5377

### Los Angeles

Roy McDonald Associates, Inc.  
1313 West 8th Street  
Los Angeles, California 90018  
213-483-1304

### Portland

Roy McDonald Associates, Inc.  
2305 S. W. 58th Avenue  
Portland, Oregon 97221  
503-292-8521

### Pennsylvania

Specifax Media Sales, Inc.  
Andrew N. McCreight  
Box 199  
Chester Springs, Pa. 19425  
215-363-7355

Circle 14 on Reader Service Card →

## advertisers index

Allison Research	11
Automated Processes	33
Bang & Olefsen	9
Crown	7
Electro-Voice	Cover IV
Fairchild Sound	15
Gotham Audio	8, 12
Infonics	10
Koss	5
Mattel	30
ReVox	Cover III
Shure	19
Sony-Superscope	3
Teac	Cover II
Telex	6, 13
Timekeeper	4

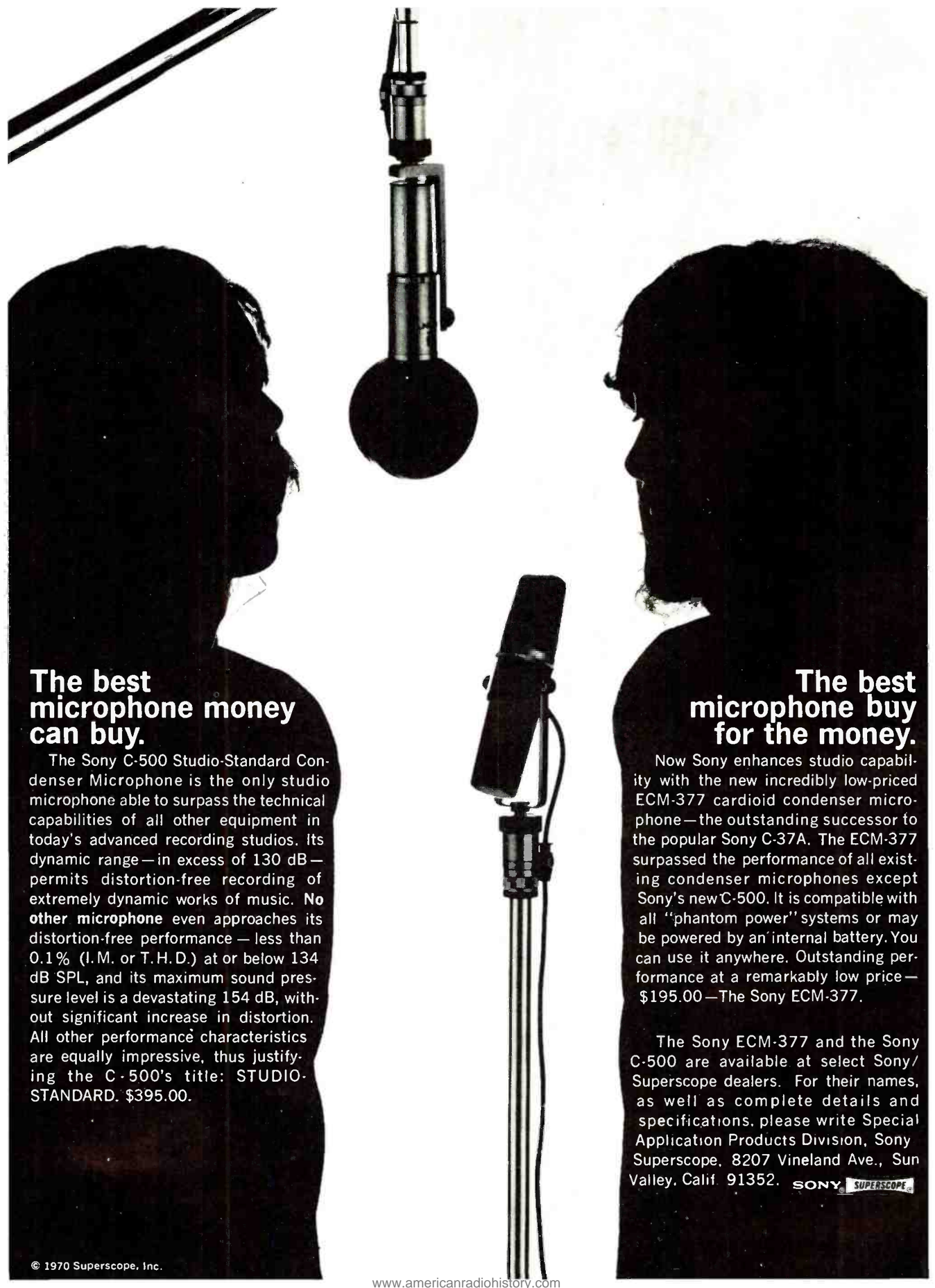

## The best microphone money can buy.

The Sony C-500 Studio-Standard Condenser Microphone is the only studio microphone able to surpass the technical capabilities of all other equipment in today's advanced recording studios. Its dynamic range—in excess of 130 dB—permits distortion-free recording of extremely dynamic works of music. **No other microphone** even approaches its distortion-free performance—less than 0.1% (I.M. or T.H.D.) at or below 134 dB SPL, and its maximum sound pressure level is a devastating 154 dB, without significant increase in distortion. All other performance characteristics are equally impressive, thus justifying the C-500's title: STUDIO-STANDARD. \$395.00.

## The best microphone buy for the money.

Now Sony enhances studio capability with the new incredibly low-priced ECM-377 cardioid condenser microphone—the outstanding successor to the popular Sony C-37A. The ECM-377 surpassed the performance of all existing condenser microphones except Sony's new C-500. It is compatible with all "phantom power" systems or may be powered by an internal battery. You can use it anywhere. Outstanding performance at a remarkably low price—\$195.00—The Sony ECM-377.

The Sony ECM-377 and the Sony C-500 are available at select Sony/Superscope dealers. For their names, as well as complete details and specifications, please write Special Application Products Division, Sony Superscope, 8207 Vineland Ave., Sun Valley, Calif. 91352. **SONY SUPERSCOPE**

# TIMEKEEPER

Write for free catalog of unusual, useful items of particular interest to the Audio Engineer.

STOP WATCHES • TAPE TIMERS • TEST RECORDS • STEREOPHONES • MICROPHONES • HYGROMETERS  
 BAROMETERS • THERMOMETERS • CARTRIDGES • AMPLIFIER MODULES • POWER SUPPLIES • CASSETTE DEGAUSSER

P.O. Box 762 Mineola, N.Y. 11501

Circle 17 on Reader Service Card

George Alexandrovich

## THE AUDIO ENGINEER'S HANDBOOK

### I. c. s and op amps

•More and more often we hear audio engineers mention *integrated circuits*. Not so long ago we were striving to accept the idea of using transistors in professional audio equipment. Controversy over the so-called transistor sound has finally subsided. We now see equipment with integrated circuits not larger in size than a lump of sugar that are doing the job of bulky tube counterparts better and cheaper. From time to time I have been commenting on the state of the technology referring to the use of i.c.s in professional audio. My major objections to i.c.s have been reliability, performance, and cost. It seems that all these faults have been overcome by the ingenuity of the circuit designers as well as improved production methods. Also, earlier i.c.s did not fulfil basic criteria demanded from high-quality circuits. The ability to locate a majority of passive components on a chip in the low-noise, low-distortion, operational-amplifier circuit made the i.c. op amp an attractive package for audio-equipment designers. Prices for these devices have suddenly tumbled down, while performance matches or exceeds that of circuits built from discrete components. Things have been happening so fast that computer-oriented magazines already refer to conventional integrated circuits as *discretes* comparing them to l.-s.i. chips (large-scale integration) with compon-

ent densities of up to one million components per square inch. For the audio industry, these microminiaturized components have only relative value. We shouldn't forget that the i.c. is only a packaging method. The fact that we can build an entire p.-a. amplifying system in the handle of the microphone doesn't solve the problems of switching, gain control, equalization, and a multiplicity of other functions.

Most of the so-called linear amplifiers and operational amplifiers owe their existence to the computer field where millions of these devices are used. The audio field is so far a drop in the bucket for the semiconductor industry. Naturally, specs and application manuals are written for the computer engineer to understand computer terminology requires a bit of research. Well, to help clarify some of the terminology, I have decided to review a typical and popular operational-amplifier circuit ( $\mu A741$ ) including explanation of specified parameters expressed in terms generally not used in audio.

The operational amplifier that can be seen in *Figure 1* is a circuit which consists of basic elements transistors and resistors. When driven from a bipolar power supply it requires no decoupling capacitors. Consequently it is a d.-c. amplifier as well as an excellent audio amplifier. Its distin-

Figure 1. The schematic of the  $\mu A741$  opamp. .

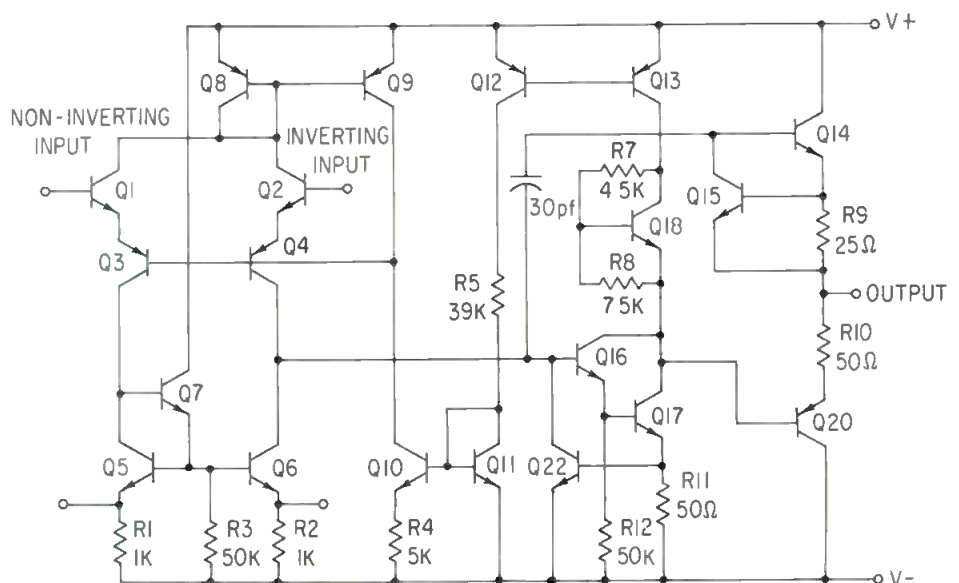

# NEW PRO-4AA

The good sound you monitor is the Sound of KOSS

## Better than speakers

Here is a new, rugged, wide-range dynamic headset with good sensitivity that delivers precision monitoring far beyond that obtained by speakers. You exclude outside noise; you eliminate dis-

turbing room reflections. Freedom from distortion and flatness of response are exceeded only by the famous Koss electrostatic units. You'll find that the "Sound of Koss" is the *good* sound.

### TYPICAL RESPONSE CURVE OF PRO-4AA

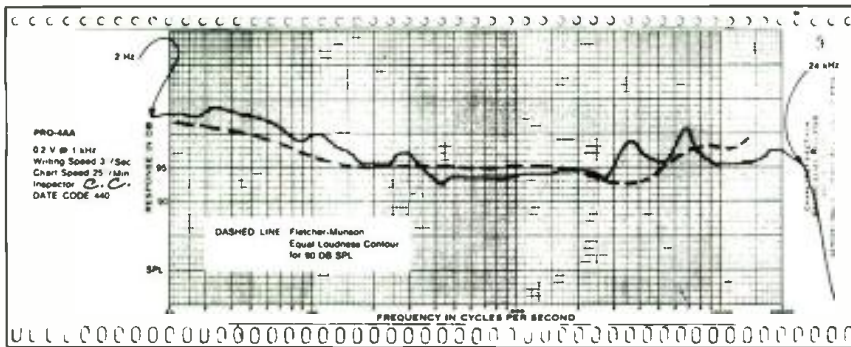

### WHAT THE SPECS DON'T TELL YOU—

**EXTENDED BASS RESPONSE TO 2 CYCLES/SECOND**—The compliance of the diaphragm is large, the seal is good against the ear and the physical design permits very long excursions to give you lo-lo bass at full level—and the PRO-4AA does it with liquid-filled cushions for perfect seal and superlative comfort, whether you wear glasses or not. This bass range response exceeds by 4 octaves that needed to insure good low-end monitoring.

**TAILORED CURVE SHAPE FOR FATIGUE-FREE LISTENING**—Characteristically the PRO-4AA runs  $\pm 3$  dB except below 150 Hz and for a rise at 6.5 kHz. As long as we must have some variation, we put the belly of the curve in the mid-frequencies to follow closely the Fletcher-Munson equal loudness contour for 90 db SPL at 1 kHz. This keeps fatigue low in long, intense sessions because you don't reach for the extremes of the range as you tire and your ears

become less sensitive. Last, but not least, the music sounds good.

**HIGHER HIGHS THAN YOU CAN USE**—The 24 kHz point on the chart is about where the "2" is in the figure 1521—the PRO-4AA needs longer chart paper than this standard charting equipment provides. Even though you can't hear these frequencies, the capability promotes good transient response in the range you do hear.

**WHY DOES KOSS RAISE THE BOTTOM?**—The wide-range coupler used for Koss measurements effects a perfect seal to promote high bass level almost to dc. An air leak to the sealed cavity lowers the bass response level. Koss feels that modern side-burns and luxuriant hair are good for a full 1-second leak or 4 dB less. This makes the PRO-4AA the flattest dynamic headset we know how to design at this time!

See and hear the PRO-4AA at your dealer today or write the factory for a 16-page catalog on "How to Choose Stereophones."



Price \$60.00

### ELECTRICAL SPECIFICATIONS

**Frequency Response Range, Typical:** 10-20,000 Hz ■ **Efficiency:** Medium ■ **Total Harmonic Distortion:** Negligible at 95 dB SPL. ■ **Source Impedance:** Designed to work direct from 4-16 ohm amplifier outputs. When used with headphone jacks where series resistors are employed, response should not be measurably affected, but slightly higher volume settings will be required. ■ **Power Handling Capability:** Maximum continuous program material should not exceed 5 volts as read by an ac VTVM (Ballantine meter 310B or equal) with average indicating circuitry and rms calibrated scale; provides for transient peaks 14 dB beyond the continuous level of 5 volts.

### PHYSICAL SPECIFICATIONS

**Cushions:** Fluid-filled for high ambient noise isolation averaging 40 dB throughout the audible range. ■ **Headband:** Extendable, stainless steel with self-adjusting, pivoting yokes; conforms to any head size. ■ **Boom Mount for Microphone:** Knurled, anodized, aluminum knob on left cup with threaded shaft and 2 compressible rubber washers; accepts all standard booms. ■ **Headset Cable:** Flexible, 4 conductor coiled cord, 3 feet coiled, 10 feet extended. ■ **Plug:** Standard tip, ring and sleeve phone plug. ■ **Element:** One inch voice coil virtually "blow-out proof"; takes surges up to 20 times rated maximum power levels. Has 4 square inches of radiating area from 2 mil thick mylar diaphragm. ■ **Weight of Headset Only:** 19 ounces.

 **KOSS** Stereophones

Koss Electronics Inc., 4129 N. Port Washington Rd., Milwaukee, Wis. 53212 • Koss Electronics S.p.A. Via Valtorta, 21 20127 Milan, Italy

Circle 19 on Reader Service Card

www.americanradiohistory.com

# Telex writes tough new specs on sensitivity and ruggedness in headphones.

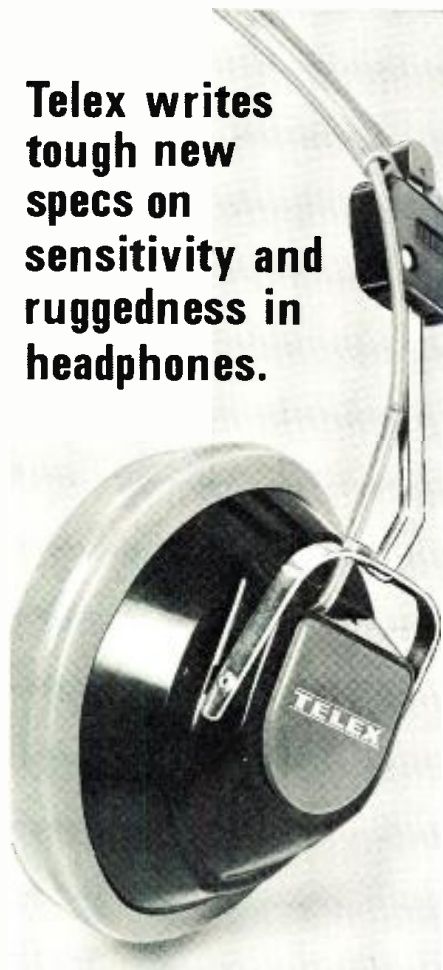

## Communications Series 1320

**HIGH SENSITIVITY AND LOW OPERATING POWER.** Communications Series 1320 headphones are designed around a dramatic new driver that requires only minimal operating power. This added efficiency makes the 1320 Series the most sensitive and versatile headphones available today.

**RUGGED. CONSISTENT PERFORMANCE.** The 1320's rugged new cone provides peak performance without being affected by temperature or humidity. You get consistent, high quality performance, day in and day out, under the most demanding communications conditions. Contact your nearest Telex dealer or write.



PRODUCTS OF SOUND DESIGN BY  
**TELEX**  
 COMMUNICATIONS  
 9600 Aldrich Avenue South  
 Minneapolis, Minnesota 55420

guishing features are two differential inputs, directly-coupled stages, high open-loop gain (over 100 dB), and a complementary output stage with very low output impedance. Negative feedback (from 50-100 dB) externally applied to inverting input reduces the output impedance to 75 ohms and lowers the distortion to less than 0.1 per cent. In order to stabilize the operation of the amplifiers, there is a small capacitive feedback loop rolling off high frequencies. This capacitor is referred to as *internal frequency compensation*. Some i.c.s have terminals for external frequency compensation.

If you follow the phase of signals applied to both inputs you will notice that one input is noninverting while the other is inverting. Signal applied to either input will produce output signal, however, if identical signals are applied to both inputs simultaneously no output will result. This feature is very valuable because it is possible to obtain balanced input without the use of a transformer when the op amp is supplied power from the bipolar or balanced power supply. The output of the circuit can feed the load placed from the output terminal to the common terminal at the power supply without any decoupling capacitors. This is possible because without signal applied at the output there is no voltage between the output terminal and the common centerpoint of the supply (across the load).

If we were given performance specifications for the op amp you would find the following terms:

**Input offset voltage**—is the voltage which has to be applied between the input terminals to obtain zero output. Normally it is measured in millivolts and is important mostly when the op amp is used as a d.-c. amplifier.

**Common mode input voltage**—is a maximum voltage (peak) that can be applied between the two inputs of the op amp and ground before clipping.

**Common mode rejection**—is ability of the amplifier to suppress error voltages at the output when input terminals are at the same potential. It is expressed as a ratio of the amplifier gain of a differential signal to the common mode signal gain.

**Slewing rate**—perhaps one of the most important term for the audio applications. Slewing rate shows the ability of the amplifier to handle high-frequency excursions. It is expressed in volts/microsecond, and is measured using square-wave input and by observing the output on the 'scope. The time it takes signal to rise to 90 per cent of its maximum value is recorded, as well as rate of rise. We know that a 10 kHz signal with an amplitude of 10 volts has a rise time of 25 microseconds. The slew rate of the

$\mu A741$  is 0.5 V/ $\mu$ sec. This is the same as saying 5 V/10 $\mu$ sec. This shows clearly the limitation of the  $\mu A741$  op amp in handling frequencies up to 20 kHz at 10 volts. For audio use we should look for slewing rates of 2 V/ $\mu$ sec or higher if full output at all frequencies is to be achieved.

**Wide band noise**—normally expressed in microvolts r.m.s. In order to convert to more meaningful and more familiar terms for 600-ohm impedance consider:

- 0.7 V - 0 dBm
- 0.7 mV - 60 dBm
- 70  $\mu$ V - 80 dBm
- 7  $\mu$ V - 100 dBm

Since noise voltage is mostly given as measured at the output you can estimate what your signal-to-noise would be. If specification says that the output noise is 10  $\mu$ volts with 20 dB of gain you know that it will be 98 dB below 0 dBm. If noise is expressed as an input noise voltage then in order to find the noise at the output multiply this figure by the amplification factor of the amplifier and convert it to dBm. For example, if broadband noise is specified to be  $\mu$ V referred to the input and the voltage gain of the amplifier is 10 (20 dB) then noise measured at the output should be 10  $\mu$ V. I think it would be appropriate to refresh our memories by correlating

Figure 2. A non-inverting amplifier (A) and an inverting amplifier (B).

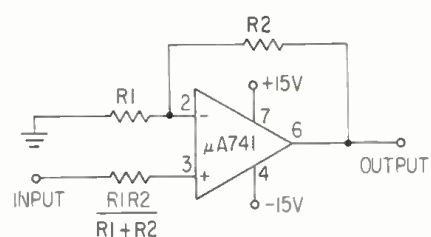

GAIN	R1	R2	B.W.	R <sub>IN</sub>
10	1 k $\Omega$	9 k $\Omega$	100 kHz	400 M $\Omega$
100	100 $\Omega$	9.9 k $\Omega$	10 kHz	280 M $\Omega$
1000	100 $\Omega$	99.9 k $\Omega$	1 kHz	80 M $\Omega$

(A)

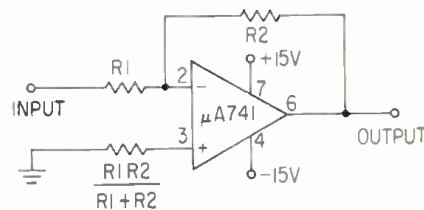

GAIN	R1	R2	B.W.	R <sub>IN</sub>
1	10 k $\Omega$	10 k $\Omega$	1 MHz	10 k $\Omega$
10	1 k $\Omega$	10 k $\Omega$	100 kHz	1 k $\Omega$
100	1 k $\Omega$	100 k $\Omega$	10 kHz	1 k $\Omega$
1000	100 $\Omega$	100 k $\Omega$	1 kHz	100 $\Omega$

(B)



# Crown

## PROFESSIONAL STUDIO EQUIPMENT

3 speeds - 15, 7½ & 3¼ips; hysteresis synchronous drive motor

Specs	15ips	7½ips
w. & fl.	0.06%	0.09%
f. resp. +2dB	40Hz to 30kHz	20Hz to 20kHz
S/N	-60dB	-60dB

computer logic controls for safe, rapid tape handling and editing; full remote control optional

torque reel motors  
 "capable of providing the most faithful reproduction of sound through the magnetic recording medium to date" -Audio magazine, 4/68  
 optional Trac-Sync  
 individual channel equalizers  
 third head monitor with A/B switch; meter monitoring of source, tape, output and source+tape; sound-with-sound, sound-on-sound and echo  
 2 mixing inputs per channel  
 individual channel bias adjust

"construction rugged enough to withstand parachute drops" -Audio magazine, 4/68

\$1790 for basic rack-mount half-track stereo deck, about \$2300 with typical accessories  
 Formica floor console \$295, rugged portable case - \$69

modular construction with easy access to all 10 moving parts and plug-in circuit boards; deck rotates 360° in console, locks at any angle

## RECORDERS & REPRODUCERS

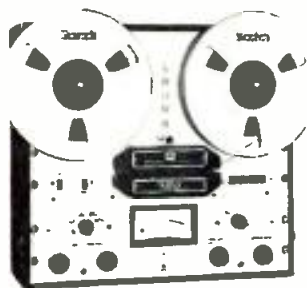

**SX711** Claimed by its pro audio owners to be the finest professional tape recorder value on the market today - price versus performance  
 ■ Frequency response at 7½ips ±2dB 20Hz-20kHz, at 3¼ips ±2dB 20Hz-10kHz ■ Wow & flutter at 7½ips 0.09%, at 3¼ips 0.18% ■ S/N at 7½ips -60dB, at 3¼ips -55dB ■ Facilities: bias metering and adjustment, third head monitor with A/B switch, sound-with-sound, two mic or line inputs, meter monitoring same as CX822, 600Ω output ■ Remote start/stop optional, automatic stop in play mode ■ \$895 for full-track mono deck as shown, \$995 for half-track stereo deck

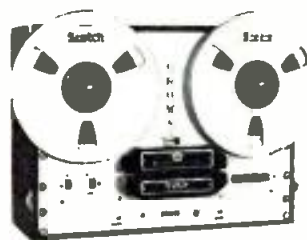

**SP722** Ideal reproducer for automation systems ■ Meets or exceeds all NAB standards ■ Remote start/stop optional, automatic stop in play mode ■ \$595 for half-track stereo reproducer

## STUDIO MONITOR AMPLIFIERS



**D40**

Delivers 40 watts RMS per channel at 4Ω ■ Takes only 1½" rack space, weighs 8½ lbs. ■ IM distortion less than 0.3% from 1/10w to 30w at 8Ω ■ S/N 100dB below 30w output ■ \$229 rack mount



**D150**

Delivers 75 watts RMS both channels at 8Ω ■ IM distortion less than 0.1% from 1/10w to 75w at 8Ω ■ S/N 100dB below 75w output ■ Takes 5¼" rack space, weighs 16 lbs. ■ \$439 rack mount



**DC 300**

Delivers 300 watts RMS per channel at 4Ω ■ IM distortion less than 0.1% 1/10w-150w at 8Ω ■ S/N 100dB below 150w output at 8Ω ■ Lab Standard performance and reliability ■ "As close to absolute perfection as any amplifier we have ever seen" - Audio magazine, 10/69 ■ \$685 rack mount

## CX822

Circle 15 on Reader Service Card

voltage gain in dB and the amplification factor:

GAIN	AMPLIFICATION
0 dB	1
6 dB	2
10 dB	3.1
20 dB	10
40 dB	100
60 dB	1000
80 dB	10,000

## you write it

Many readers do not realize that they can also be writers for *db*. We are always seeking good, meaningful articles of any length. The subject matter can cover almost anything of interest and value to audio professionals.

You don't have to be an experienced writer to be published. But it can be prestigious to be published and it can be profitable too. All articles accepted for publication are purchased. You won't retire on our scale, but it can make a nice extra sum for that special occasion.

Advantage of this particular  $\mu$ A741 amplifier is that it requires few outboard components. *Figure 2* shows a typical amplifier circuit. Values of resistors given and corresponding gains are self explanatory. BW stands for the bandwidth—you will note the higher the gain the narrower the useful bandwidth. Consequently this op amp is useful only up to 30 dB of gain. In both cases (inverting and non-inverting circuits) input terminals have to have a d.c. return path to ground. Direct-current resistance of the source normally accomplishes this. If decoupling is desirable and a capacitor is inserted in series with the input, an additional resistor to ground from the input terminal is in order.

Unbalancing the circuit should be accomplished with special care because noise generally increases substantially. Power-supply noise cancellation is defeated and the balanced input becomes unbalanced.

This has been only a sample of what we can soon expect to come to our field in full force. There have been genuine attempts to compete with i.c.s components in the past couple of years, but the cost of equipment could not be justified. Now that this has been overcome I suggest that anyone who is preparing to work with new i.c.s get magnifying glasses, tweezers, and develop a steady hand. ■

John M. Woram

## THE SYNC TRACK

• As we all know, the recording engineer makes his living by combining the creative process with the technology at his disposal. This was easy enough back in the old days when fingers outnumbered faders. Now, the limitations of the human body are more and more strained—often surpassed—by the requirements of the ultimate mix-down.

It's time to give some passing thought to what automation has to offer. In the recording industry, automation is not quite the specter that it may be in some other places. The thought of automation putting recording engineers out of work is unlikely. Fortunately, there is no formula for microphone placement, nor are there published specs for mixing. Both of which, if they existed, might be fed into some sort of computer, and the recording engineer would eventually join the ranks of the neighborhood ice man.

Although (even in the distant future) it is unlikely that automation may claim much of the creative process, there is no reason why some, and eventually most, of the drudgery cannot be taken over by the machine, freeing the engineer for more attention to the creative aspects of recording.

A study of automation may be divided into two sections. First—what needs to be automated? Second—how do you go about it? Naturally enough, it's fairly easy to determine what needs to be done. It's not so easy to determine how to go about it.

Starting in the studio, it might be nice to have some sort of automated equalizer available. The electronic music synthesizer usually has a few voltage-controlled filters which could be considered semi-automated. If the filter's control voltage is proportional to the frequency of the signal to be filtered, the filtering action will vary according to the pitch of the signal. In other words, the filter will track the signal. This is easy enough on a synthesizer, where the same control voltage may be fed to both the filter and the signal producing oscillator(s).

But what about a filter (or equalizer) that would track *any* instrument? A trumpet player could play a note and the equalizer would be adjusted for the desired quality. Then, as the trumpet played through its range, the equalizer would follow

## The new Stellavox Sp7 will become a giant in the recording industry.



### All 8 lbs. of it.

Up till now, perfect stereo location recording meant lugging unportable portables.

So we've come up with a rugged precision instrument, the Swiss-made Sp7. It's small—8"x10"x3". It's light—only 8 lbs. with batteries. And, despite its size, Sp7's features measure up to any portable you're now using..

Plus giving you several advantages you'll get nowhere else, regardless of size.

Like four standard tape speeds. 3¾, 7½, 15 and 30 ips. It is also continuously variable from 0-30 ips.

Another exclusive: Our many tape head assemblies with up to four heads. They plug in. Are quickly exchanged in the field. And each one contains the components to equalize the electronics precisely for a particular tape speed, track configuration and tape oxide. With Neo-pilot for mono

and "Sychrotone" for stereo sync recording!

Then there's our 10½" real adapter. It gives you more recording time than any portable ever.

Plus: hands-off automatic stereo level control, dual peak indicating meters, internal powering for two condenser mikes, external AC supply and battery charger, and an internal quartz generator.

We expect this tiny Stellavox Sp7 to live up to the highest hopes of the industry. Because you don't have to be big to be a giant.

**Stellavox**

exclusively by

**GOTHAM**

AUDIO CORPORATION

2 West 46th Street, New York, NY 10036 (212) 265-4111  
1710 N. LaBrea Avenue, Hollywood, CA 90046 (213) 874-4444

Circle 21 on Reader Service Card

along, maintaining the same relationship throughout.

This would be a case of automation creating a new control—one that was not previously available. To manually vary equalization in time with a musical line is unlikely—if not practically impossible. Of course, one needs a simple way to extract a fundamental frequency from an instrumental line so that a proportional control voltage can be created. At the moment, this is a tedious, often unreliable, process; however, it should not be too much longer until a good method is perfected.

#### THE NOISE GATE

Coming back to the immediate present, the noise gate is an application of automation that can spare the engineer much grief. On a multi-track tape, not every track contains usable information at all times. (When I think of some tapes that I have meddled with, this could qualify as understatement.) Very often, a lot of energy goes into turning tracks on and off to eliminate chair squeaks, page turning, count-offs, and other assorted sounds that turn up on a finished tape. A noise gate circuit will automatically drop the program level, once the signal level falls below a predetermined threshold point. This goes a long way toward clearing up all those little distracting noises, and lets the engineer concentrate on other more important things. At least one console manufacturer supplies an input module containing a built-in noise gate.<sup>1</sup>

#### GRADUAL GAIN REDUCTION

Frequently, a tune that begins quietly enough will eventually build to a relatively high level. By the time you've attempted to mix the tune a few times, you've got the first entrances down just fine, but by the middle of the song, the levels are peeling the oxide off the tape. So you begin limiting—which is exactly what it may sound like. What about some kind of automatic fader that—during the course of the tune—gradually lowers the over-all output level by some 5 to 15 dB? As you approach the ultimate mix, you find that at 2:00, you're 6 dB too hot. Instead of re-balancing, you just set this whatever-it-is to give you a 3 dB/minute attenuation. At the end of that time, the device could either stop, continue, or gradually return to normal, depending on your requirements. This effect is often attempted by manually lowering the master fader during the mix, but this can be

<sup>1</sup>Olive Electro Dynamics Inc., Montreal, Canada. Module 2010. See also November 1970 Sync Track p. 16, The KEPEX system.

# we call our cartridge "groovy"



## you should read before you laugh!

Cartridge design is no joke with our talented, imaginative Danish designers. When they say "groovy", they're talking about the Bang & Olufsen

SP-12 cartridge and its high compliance, excellent frequency response, and amazing channel separation. □ They call it "groovy" because an ingenious, exclusive Micro-Cross mount for the stylus allows the solid one-piece diamond to float freely in the record groove, reach the most sensitively cut undulations. The result is crystal clear reproduction of every tone hidden in a record. □ Your hi fi dealer knows the story of Bang & Olufsen cartridges and the Micro-Cross design that is carefully created in Denmark, presently earning rave notices from European hi fi experts, and now available in the United States for the first time. Ask him about us. Or write for details now.

**SPECIFICATIONS** ■ Stylus: Naked Diamond (5×17) μ Elliptical (LP). Frequency response: 15-25,000 Hz ±3 dB 50-10,000 Hz ±1½ dB Channel separation: 25 dB at 1,000 Hz 20 dB at 500-10,000 Hz. Channel difference: 2.0 dB Compliance: 25 10<sup>-7</sup> cm/dyne Tracking force: 1.0-1.5 grams. Output: 1.0 mV/cm/sec. 5.0 mV average from music record. Recommended load: 47 K ohms Vertical tracking angle: 15°. Weight: 8.5 grams. Mounting: ½" Standard 5 Terminal connection incl. separate ground pin. Balanced or unbalanced. Replacement Stylus: Original (5×17) μ Elliptical (LP), type: 5430 or 15 μ Spherical (LP), type: 5429. ■ MODEL SP-12..... \$69.95

## Bang & Olufsen of America, Inc.

525 EAST MONTROSE • WOOD DALE, ILLINOIS 60191

Circle 23 on Reader Service Card

# profit from cassette & cartridge duplication



Produce 1,400 to 30,000 C-30 cassettes per 3-shift workday on the new Infonics Super Cassette Duplicator. It offers professional-quality 12,000 Hz frequency response...only **\$3795**

Produce 3 eight-track 150-foot cartridge tapes per minute at 30 ips on the professional Infonics D-8 Duplicator. The single-pass D-8 gives 12,000 Hz response and puts you in the high-profit 8-track business for only **\$6495**

Send for free color brochure today.



**infonics**

1724 Cloverfield Boulevard  
Santa Monica, California 90404  
(213) 828-6471 • Cable: Infonics

awkward, and since you've got other things to do, the tendency is to lower the fader in spurts—usually when it's too late.

An elapsed-time indicator could be a likely source for control signals, used to regulate external devices. Usually changes are to be made at certain specific times. For example, more echo to be added at 1:58, or whatever. While recording, you may want to punch in (and out again) on a previously-recorded track, without erasing the material immediately before and after the segment to be corrected. It usually takes several attempts for the artist to successfully match the quality of the original, and each time the engineer hits the record—or stop—button, the possibility of human error presents itself.

Some studios already have provisions for automatic control of punch-ins, and the feature might eventually be made available on the standard multi-track machine, perhaps as an option.

Once this form of automation becomes more popular, the next step might be a form of multi-track time sharing. Consider the case of a producer who discovers too late that he needs an extra track. As I mentioned earlier, each previously-recorded track is presumably not in use continuously. So-o-o, once you determine where the available open spots are, you could create a "17th track" by jumping from track to track, *pro-*

*vided* there was a way to do this automatically, and later—during playback—to extract this 17th track so that it could be treated independently.

Theoretically, this is possible, though perhaps not really practical. However, the time-sharing techniques may become practical if applied to limiters, or maybe Dolby units. For example, a Dolby unit is used on, say, a low-level guitar track. But when the guitar is not playing, the track is switched off, and the Dolby reassigned as needed. Later in the take, when the guitar is playing loudly, the Dolby unit is not needed, and so it is not reassigned to this track until such time as its presence is required. Similarly, other devices could be switched in and out, as needed. A successful time-sharing system could save the studio a lot of money in equipment duplication.

As automated devices become more readily available, engineers will have to take care that automation does not completely take over. Once the mixer sets his console on automatic pilot and goes out for coffee, the creative process is over. And the final product will probably sound as if it was produced by a computer.

There are many as yet unthought-of uses for automation. However, it must remain a tool for the engineer, and should never stand between him and a truly creative recording job. ■

**NORMAN H. CROWHURST**

## THEORY AND PRACTICE

● Last month we discussed the attributes of twin-T networks in an abstract way: the theory. Now let us look at some applications. Application to tube-type oscillators has been fairly well documented. In each of these, the null form of the network is used, in negative feedback, to prevent feedback occurring at that one frequency. Then positive feedback is used, and usually made adjustable by automatic control, to achieve oscillation at a predetermined amplitude.

There may be theory and practice accommodations in that kind of design, such as working with the practical impedance values involved. Of course, a null is a null, regardless of terminating impedances. But the negative feedback occurs at other frequencies to minimize unwanted frequencies, particularly harmonics. And the degree by which harmonics can be reduced is a matter of theory *versus* practice resolution.

But what seems much more

intriguing to me, is the use of both forms of feedback in the same network: a twin-T that provides positive feedback at the oscillation frequency and negative feedback elsewhere. This kind is used more extensively in solid-state circuits. To illustrate, we will look at two circuits used in electronic organs (of different makes) for generating vibrato.

The first circuit, as usually drawn (*Figure 1-A*) does not look like a twin-T. With supply positive and negative at top and bottom of the schematic (which is the usual arrangement) and the output coming from the emitter of the second transistor, which appears to be an emitter follower of sorts, it is difficult to imagine any gain from the circuit. In fact the two transistors look like a compound emitter follower, of sorts.

There is a feed, from the emitter junction, back through the 0.82 mfd capacitor and the 100 k resistor, and at the same time through the 27 k

(shunted) resistor and one of the 0.39 mfd capacitors, to the base of the first transistor. As transistors provide a current gain, but no voltage gain, in the emitter-follower configuration, we can see that oscillation might be possible, because obviously the output can feed back sufficient current, if the voltage is adequate, as well as the phase change.

But base and emitter have signal in the same phase, basically, so the feedback must somehow reverse phase, which hardly seems feasible, in a relatively simple circuit. And anyway, output voltage is no bigger than input voltage, to provide the drive. Viewed that way, oscillation does not look very feasible. The thing that makes us think it must oscillate, unless the circuit is incorrectly drawn (which has been known to happen on manufacturers schematics), is that it is from the circuit of an organ that works.

One thing that helps understanding is to redraw the whole circuit, so the twin-t configuration is recognizable (Figure 1-B). Carefully check the circuit through, and you will find that nothing has changed but the positional layout: all the connections remain the same.

Now the bottom line of the diagram can be viewed as "ground" of a pair of grounded emitter transistors, with a 1

k collector resistor, but with the supply "up in the air," between collectors and the collector resistor. Actually, of course, the reverse is true: supply has one side grounded, and the whole circuit is up in the air. But it helps to view the transistors as grounded emitter, compounded (the 8.2 k resistor serving to control the relationship between their bias points, although the first stage bias is controlled primarily by the 150 k, 390 k, and 100 k resistors). In this configuration, they have a voltage gain—quite considerable.

The 150 k and 390 k resistors act as a voltage divider across the supply voltage. But as both sides of the supply are at the same signal potential, the two resistors may be viewed as in parallel to signal currents. This figures to about 110 k. Now it looks like a twin-t with two series resistance arms, each close to 100 k, and a shunt arm of something less than 27 k, from the other t junction. The corresponding capacitors are close to the classic 2:1 ratio, using 0.39 and 0.82.

If the resistor shown as 27 k had a value of 50 k, the twin-t would be very close to the classic null type. But making it smaller puts the network into the phase reversal group. As the capacitors are in close to 2:1, and the resistors in close to 4:1, phase reversal

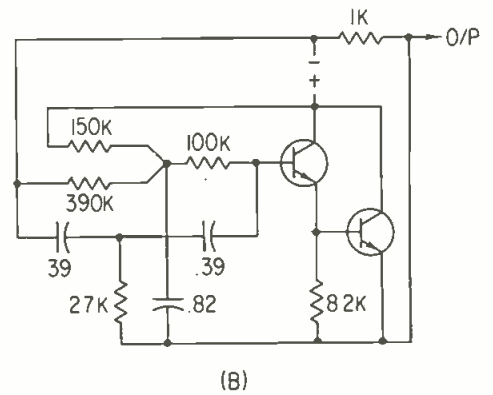
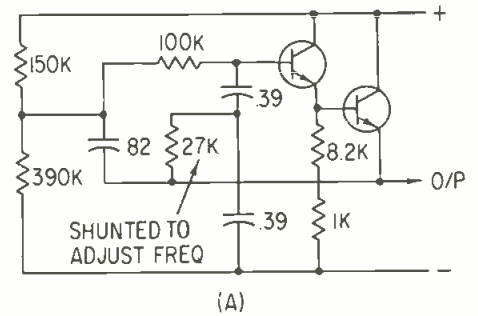

Figure 1. The first vibrato oscillator circuit discussed: (A) as usually drawn, with supply voltages in their usual places; (B) redrawn, to facilitate visualizing twin-t behavior.

will occur where the 0.39 mfd capacitors have a reactance less than 100 k and the 0.82 mfd capacitor has a reactance more than 27 k (or

## MUSIC INDUSTRY?

★ A & M RECORDS ★ MERCURY ★ MOTOWN  
★ COLUMBIA ★ RCA ★ FANTASY · GALAXY ★

## FILM SOUND?

★ RYDER SOUND ★ MANHATTAN SOUND ★ MGM  
★ CINESOUND ★ COLUMBIA ★ WALT DISNEY ★

**KEPEX™** users are **EXPANDING**

Allison has released her new hit 45 RPM record; A KEPEX DEMONSTRATION  
Write for your free copy to

**ALLISON RESEARCH, INC.**

**7120 SUNSET BOULEVARD ★★ HOLLYWOOD, CALIF. 90046**

(213) 874-6615

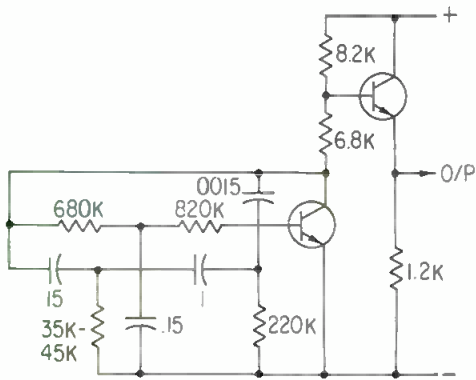

Figure 2. The second vibrato circuit, which is a more-obvious twin-T configuration.

whatever its precise value is).

Assuming the working value of the adjustable component is 25 k, and taking the capacitors as precise 2:1, the phase reversal will be close to a frequency where the ratio in resistance and reactance limbs is close to root-2 either way: about 70 k for the 0.39 mfd, and about 35 k for the 0.82 mfd.

A chart showing operation of twin-T networks for this condition (one is contained in my book *Electronic Design Charts*), indicates that the feedback component at critical frequency is attenuated 28 dB, or about 25:1.

The collector resistor is 1 k, and the resistance path (to signal) from collector to base is a little more than 200 k. However, at critical frequency,

the equivalent impedance is reduced to about this divided by root-2, or 140 k. So the current attenuation will be  $25 \times 140 = 3500$  at the positive feedback point. This is a quick and ready sort of calculation.

It means that if each transistor has a current gain of about 60, making the two-stage gain 3600 ( $60 \times 60$ ), the circuit will oscillate. This is quite reasonable. If the gain is higher, the circuit will still oscillate, and the two 0.39 mfd capacitors will try to hold down the harmonic generation, due to the circuit oscillating too hard.

Now turn to the other circuit (Figure 2). This is a more obvious twin-T. However, it does not have the benefit of two transistors for gain. The second one serves as an emitter follower, to isolate the loading circuits from the collector load of the gain stage. The d.-c. voltage readings on the schematic, along with the circuit values shown, leads to the conclusion that the gain transistor works at a current gain somewhere about 100.

With a 15-volt supply, with 7.5 volts at the first collector, collector current (through  $8.2 \text{ k} + 6.8 \text{ k} = 15 \text{ k}$ ) is 0.5 mA. This voltage, across the bias resistor chain ( $680 \text{ k} + 820 \text{ k} = 1.5 \text{ M}$ ) provides a base current of about 5 microamps. The 220 k base-to-ground resistor will not materially by-pass the base current, because of the much smaller base to emitter voltage.

Now note the twin-T values. Both the output resistor (820 k) and the output capacitor (0.1 mfd) have higher value (capacitor in reactance, rather than mfd. value) than the input values 680 k and 0.15 mfd). The capacitors, while not identical, are close to the same value, but the shunt resistor is around 1/20th of each series resistor. Taking a mean between the close-to-1:1 ratio of capacitor series/shunt values, and the 20:1 ratio of resistor series/shunt values, we may assume that critical frequency occurs when the capacitor reactance is about 4.5 times the shunt resistance or the series resistance divided by about 4.5.

Looking at the same chart (or a similar one) suggests that phase-reversed output is about 20 dB below input, or 1/10th. The question is to establish what input is. If resistance feed worked, it would be 1/100, as for bias current. But signal impedance drops to about 1/4.5 of this, leaving an attenuation of about 1/22. This means the signal delivered to the base will be about 1/220 of output signal. With a gain of 100 for the transistor, oscillation seems highly unlikely.

So let us take a closer look, again because this is a circuit of a working oscillator. Take first the input end of both T's. Reactances of both 0.15 mfd capacitors will be about 150 k. The impedance reflected at the collector (exclusive of the .0015 mfd) from the base circuit, will be 680 k resistor in series with 150 k reactor, paralleled with 150 k reactor in series with 35 k-45 k resistor, or about 140 k largely

## classified

Classified advertising is an excellent and low-cost way to place your products and services before the audio professional. If you are a prospective employer seeking skilled help or an employee seeking a change you will find that the classified pages of *db* reach the people you want. Special low rates apply for this service.

Rates are 50c a word for commercial advertisements. Non-commercial and employment offered or wanted placements are accepted at 25c per word.

Frequency discounts apply only to commercial ads and are

3 times — 10%

6 times — 20%

12 times — 33%

Agency discounts will not be allowed in any case.

Closing date for any issue is the **fifteenth** of the **second** month preceding the date of issue.

This is the old  
EMT-140st  
Reverberation Unit.

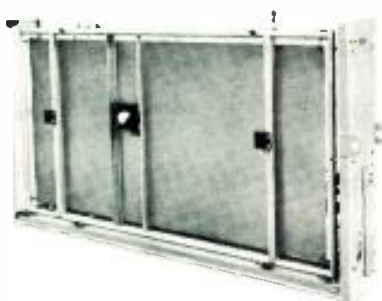

This is the  
new one.



## What's the difference?

We've made the amplifier unit solid state. And you can now obtain an inexpensive decay period remote controller.

Nothing else has changed in this superb unit. The EMT-140st is still the world standard in the recording and broadcasting industries. Its renowned steel plate device gives you the same unmatched stereo/mono performance. And increased fringe area reception for AM broadcasts. And unusual flexibility—its decay period can be varied from 0.5 to 5.0 seconds. (Try *that* with an echo chamber!)

These are just a few of the reasons why every major record company and independent recording studio owns at least one EMT-140st Reverberation Unit. Right now, more than 1000 are in use from coast-to-coast; more than 2000 throughout the world.

For the complete story, write today for our free 8-page brochure. It can make quite a difference for you.

**GOTHAM**  
AUDIO CORPORATION  
2 West 44th Street, New York, N.Y. 10036 (212) CO 5 4111  
In Canada J Mar Electronics Ltd.

Circle 18 on Reader Service Card

reactive.

Paralleled with the 15 k collector load, this will accept close to 1/9th of the output current. These t points will have impedances of 35 k to 45 k largely resistive and 150 k principally reactive, and are loaded, the first through an 0.1 mfd capacitor (impedance about 220 k) the second through an 820 k resistor. The lower impedance element will pass about 1/5 (45 k/220 k) of input current (its share of the 1/9th, or about 1/50th) while the other will pass a much smaller fraction, which is somewhat modified by the current through the 0.0015 mfd.

Now it seems feasible that about 1/100th of the output current can get fed back with phase reversal. In treating this more completely, which can get rather complex (which is why we took this "rough cut" method) it is necessary to realize that base inputs provide a current load, unless they are true emitter followers (which neither of these circuits is) from the viewpoint of the twin-t circuit, while the input end is essentially a voltage source: that developed across the collector resistor, by the transistor's output signal current.

This is approximately a reversal of the theory usually given for deriving twin-t circuit behavior. Maybe these remarks will help show why the comparatively unexpected results can be achieved from circuits, in each of which our first try at understanding seemed to indicate they would not oscillate.

Martin Dickstein

# SOUND WITH IMAGES

## SMPTTE Technical Conference and Equipment Exhibit

• For the 108th time since its organization in 1916, the Society of Motion Picture and Television Engineers has held a conference and exhibit at which technical papers on various subjects were presented and equipment of all kinds in the field of, or associated with, motion pictures and/or television was displayed and demonstrated. The convention took place from October 4th to the 9th in New York City.

Although the SMPTTE is well known by most people in or around the a-v field, it might be well to review a bit about the Society. It is a non-profit organization of people who are concerned with the engineering aspects of motion pictures, television, instrumentation, high-speed photography, and allied arts and sciences. Among those that belong to the Society are, of course, engineers, technicians, and scientists directly involved or associated with the fields with which the organization is concerned. However, there are also executives, educators, students, workers, and dealers in related fields and interested people in many other endeavors.

When it was founded, the main subject of interest was motion pictures. It was not until 1950 that television was recognized and included in its scope, and this field added to the name. From 24 members in the beginning, the organization has grown to about 8,000 with about 800 of these located in more than 60 countries around the world.

Figure 1. The Atlantic Xenon Carousel for xenon bulbs 450 or 900 watt with built-in ignition device and separate power supply.

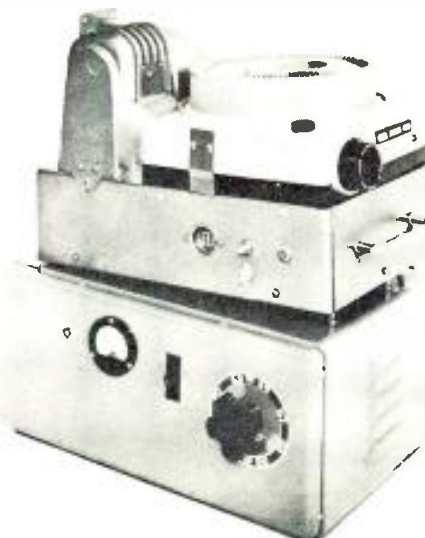

The Society aims to bring together those who wish to exchange ideas, present and hear papers in the technology of fields of interest of the Society, foster advancement of engineering technology, provide a publication of papers, and to sponsor exhibits and conferences for the purpose of advancing the theory and practice of engineering in the fields of the organization's interests.

The Society also develops and maintains American National Standards, also Recommended Practices, and provides films and slides for system testing according to those standards and recommended practices.

The technical sessions, at which nearly a hundred papers were given, ran simultaneously in two different conference rooms. The lecturers were able to make use of many different types of audio and visual equipment during their talks. Slides (35mm and super), 16-mm film with optical or magnetic stripe, overhead projection,

## PROFESSIONAL RECORDING ELECTRONICS



RP-84, professional solid state, monoaural record and playback preamplifier. For tape transports with two or three heads. Selectable equalization from 1-7/8 to 15 IPS. A-B monitor switch. Mixing of mike and line inputs. Bias synth provision for multi-channel application. Phone jack, VU meter, record light. Overall frequency response 30-18,000 Hz ± 3 dB at 7.5 IPS. Compact design makes this an ideal amplifier for all serious recording projects. \$144.95. PB-10 - Playback preamplifier. \$46.20. PA94F - 8 watt playback amplifier. \$91.25. Made in U.S.

PRODUCTS OF SOUND RESEARCH  
**TELEX**  
COMMUNICATIONS DIVISION

9600 Aldrich Avenue South  
Minneapolis, Minnesota 55420

Circle 16 on Reader Service Card

### db binders only \$4.95 postpaid

Heavy-weight binders are now available to hold the thirteen issues of Volumes 1 and 2. Rich brown leather-grained virgin vinyl, with our name printed in black on the spine and front cover, is electronically sealed over rigid board to give your volumes of db lasting protection. Keep your copies preserved in perfect condition, protected from dust and damage.

Please send me \_\_\_\_\_ copies of the db Magazine binder. My check for \$ \_\_\_\_\_ is enclosed (sorry, no c.o.d.).

Name \_\_\_\_\_

Address \_\_\_\_\_  
number and street

city \_\_\_\_\_ state \_\_\_\_\_ zip \_\_\_\_\_

(New York State residents please add 5% sales tax).

Mail to: db the Sound Engineering Magazine, 980 Old Country Road, Plainview, N.Y. 11803.

35mm film, front and rear projection, etc., were all used during the meetings. Voice reinforcement for the lecturers and questions from the floor, audio playback and recording facilities and projection equipment were satisfactorily provided by Bergen Motion Picture Service and Porto-Vox Enterprises with CBS, all under the supervision of Joseph Stiftel, SMPTE.

Topics for the meetings included Special Television and Film Systems, Laboratory Practices, Theater Projection and Studio Film Production, Television Production, Home Video Player Systems, Instrumentation and High Speed Photography, Cable Television, High Speed Videotape Duplication and Videotape Cartridges, and Super 8: Picture, Sound, and Television. In addition to the technical meetings and panel discussions, a special session was run at which equipment papers were

Figure 2. Bell & Howell's new film processor only requires the film to be loaded in daylight, no darkroom facilities are needed.

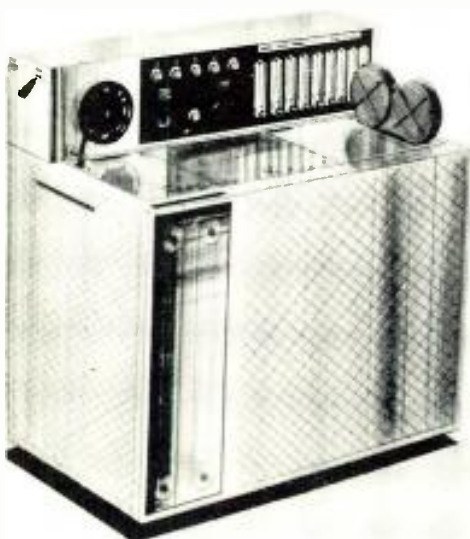

Figure 3. Lowel-Light's new lighting kit for studio illumination.

presented describing new devices which were also demonstrated.

Among the exhibitors were some of the biggest names in the film, TV and a-v fields, such as Arriflex Corp. with many complete optical and audio recording systems with special features and capabilities; General Electric showing and demonstrating a broadcast color camera operable by non-technical personnel; Producers Service Corp., Glendale, Calif., presenting a series of devices for optical printing including a liquid gate; Sony showing its videotape and CCTV equipment; Sylvania its full line of studio lamps; and Tele-Cine exhibiting zoom lenses and video tape-editing programmers.

Atlantic Audio Visual, N. Y., showed several film and slide projectors, re-entry loop devices, Xenon modification kits, and other related equipment. They showed several film strip projectors in operation in conjunction with a slide projector on an irregular surface with images interestingly superimposed. This view, however, was first noticed by visitors to their booth in a large circular front-

surface reflector which zoomed the entire presentation in and out at preset regular intervals automatically. This was accomplished by having the mirror, which was very thin, flexed into concave then convex configurations by a mechanism located behind the mirror. This same effect had been created for an industrial client of the company with a much larger mirror, and the effect was said to be extraordinarily interesting, but dizzying.

As part of their presentation, Atlantic presented to any visitors who wished, a pass to see a full-length movie and a special showing of *Motion*, a short film showing movement in many interesting phases of everyday living. These were shown at a public movie theater near the exhibit. The purpose for the generosity was to show off a remote-control console which Atlantic had built for use in this theater, and many more similar installations. The console, located at the center of the audience seating area, permits the operator to control the sound distribution in the theater. The short film had 6 tracks of magnetic



sound. This film was projected in a three-screen format on the theater's single, wide screen. The audio was fed to five theater sound-system reproducers behind the screen and to ceiling surround speakers.

The console had gain control sliders for each channel, volume meters, three adjustment controls and meters to balance the brightness of the three projectors by regulating the current of the Xenon power supplies, controls to start the projectors, dimmers for the house lights, and three small monitors so that the operator could watch the projectors on CCTV cameras mounted above the 35/70 Zeiss Icon units in the booth.

Among the other exhibitors were Bell & Howell who introduced its new line of FILMOpetite film processors. These are capable of handling super 8mm and 16mm in full daylight with no darkroom required at all. The manufacturer says the units are applicable to operation at CATV and educational stations, schools, industry, with the larger models are for broadcast operations. The units are 48-in. w x 54-in. h x 24-in. d. The cost ranges from \$6,000 to \$18,000.

Eclair, Corp., L.A., showed a completely cordless sync-sound recording camera/recorder system, permitting the cameraman to roam while the soundman stayed where the sound was best with no cables between them.

Lowel-Light Photo Engineering, N. Y., showed a Kombi 3 kit including all the components for many combinations of studio lighting. Units include three Quartz lamps, barndoors, scrims, stands, background supports, etc. Suggested cost was \$545.00.

Magnasync/Moviola Corp., North Hollywood, Calif., showed its new console editor table capable of moving film from one frame per second through a speed of seven times the normal sound speed of the film, through the sprocket gate assemblies.

Nagra Magnetic Recorders, Inc., N. Y., showed its model SN miniature professional tape recorder which is 6 x 4 x 1 in., weighs 1.3 lbs., records at three speeds from 15/16 to 3 3/4 in./sec. Frequency response is stated to be 80-15,000 Hz and signal-to-noise is specified at 60 dB. The unit is fully solid state.

Television Digest, a weekly published in Washington, D. C., provided visitors who desired one, a copy of their paper specially covered for the show by a comprehensive table of Cartridge Videoplayer and Recorder systems including super 8mm. Information provided included date of introduction of the device, characteristics such as speed of the medium used and the cartridge description, and compatibility (if any) with other units. A most interesting chart.

Another educational and interesting conference passes into history, but the 109th such meeting is scheduled for April 25th - 30th, 1971, to be held in Los Angeles. The Society also has provided information that *Film 71*, the 2nd International Conference on Film Technology will be held in London, June 21st - 25th, 1971. It seems that the way present technology is moving forward, the techniques and equipment discussed at the meeting just passed will have to be greatly updated by the time the next sessions come up. It might be well to make plans now to attend both the upcoming conferences. ■

## back issues available

A limited number of back issues of db are available to interested readers who may have missed or misplaced earlier issues. When ordering please indicate date of issue desired and enclose 75c for each copy.

CIRCULATION DEPARTMENT  
db—The Sound Engineering Magazine  
980 Old Country Road  
Plainview, N.Y. 11803

# NOW! TOTAL CAPABILITY WITH THE FAIRCHILD INTEGRA II SYSTEM!

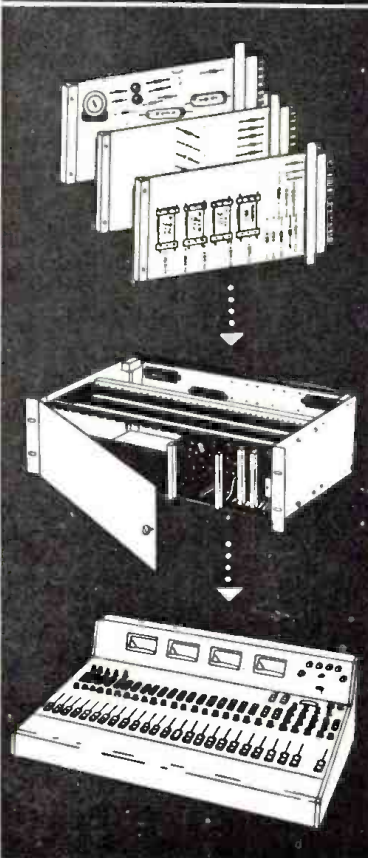

**Capability No. 1:** Easily integrated audio components.

**Capability No. 2:** Simple and efficient construction.

**Capability No. 3:** Practically any complex audio system can be designed.

**Capability No. 4:** Remote control of audio functions (optional).

**Capability No. 5:** Solid-state technology provides compact, efficient, convenient and economical audio control.

**Capability No. 6:** Unmatched convenience in maintenance.

**Capability No. 7:** Advanced light-controlled technology.

**Capability No. 8:** Complete freedom from contact noise, distortion, frequency discrimination and mechanical problems.

**Capability No. 9:** Noise-free and bounce-free perfect switching.

**Capability No. 10:** Space-age standards of component design and manufacture assure highest reliability.

**Capability No. 11:** Complete line of accessories.

**Capability No. 12:** Compatible with your existing equipment.

For complete details and new colorful Integra II brochure write to:

**FAIRCHILD** Sound Equipment Corp.  
10-40 45th Avenue Dept. DB-1 Long Island City, N. Y. 11101

Circle 26 on Reader Service Card

RICHARD L. LERNER

# Audio Afloat

*The Queen Elizabeth II is a floating city in which both vital communication paths and entertainment lines must run.*

**M**OST people aboard a cruise ship give little thought to the sound-reinforcement equipment, beyond noticing an occasional piece of music, or enjoying activities such as dancing. Infrequent attention is paid to the announcements depending on interest. Most passengers never even consider the main reason for the existence of a high-quality sound-reinforcement system on a ship—safety. Certainly *db* but this was the most emphasized point on our tour of the Queen Elizabeth II.

We were escorted on board by Mr. Fredrick A. Towler, who is president of Tannoy America, Ltd., whose parent company, Tannoy, had designed and installed the ship's entire system. Upon arrival in the boarding lounge, we were met by the ship's 3rd Electrical Officer, J. B. Carlile. What followed was a journey into an excitingly different world, one of the excitement of an impending cruise, and the power of a modern day engineering marvel. There was the

*Richard L. Lerner is the assistant editor of db.*

Figure 1. Even at rest, the power and grace of the Queen Elizabeth II urge you to sample gracious living aboard a floating city. She is shown at her Manhattan berth while loading passengers and cargo bound for England.



impression of a palatial resort hotel, with all of the expected activities, and the behind the scenes aura of complete competence, with every eventuality covered. We paid particular attention to the ship's sound systems, but in the process went from stem to stern and from the superstructure down to the propeller shaft.

From a passenger point of view, all of the things advertised in cruise ads were there—swimming pools, dance areas, sumptuous dining areas, romantic nooks, luxurious staterooms, auditorium and conference facilities, gay night life and either entertaining daytime activities or relaxation. No stone was left unturned that would have led to a more enjoyable cruise ship. As an enhancement to all of these values was a tremendous amount of audio equipment. Throughout the ship there were networks of modern transistorized communications and entertainment electronic gear which would seem to be there for passenger and crew convenience or entertainment. There was, however, an overriding purpose, for which anyone would have cheerfully traded convenience or entertainment. The entire system was designed first and foremost for passenger and

*(continued on page 21)*

Figure 2. The equipment used to drive the auditorium sound-reinforcement system, and for the r.f. amplifier loop used for simultaneous language translation in the auditorium.



# NEW PRODUCTS AND SERVICES

## FLUTTER METER

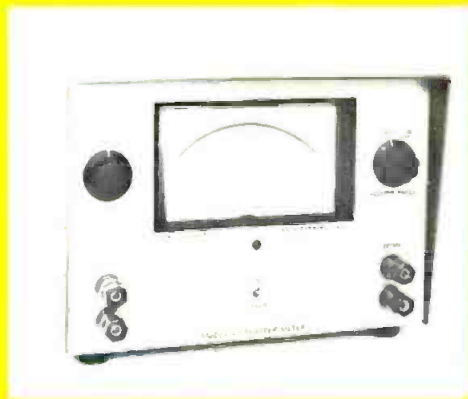

- The model F-1 flutter meter utilizes new circuitry to offer accurate flutter measurements over a wide range of carrier frequencies (2 to 4 kHz) without the need for a precise 3 kHz oscillator. It accepts a wide range of carrier input levels (10 mV to 10 V) without having to adjust a level set control. Operationally, after recording a signal in the range of 2 to 4 kHz on

the recorder under test, one connects the playback signal to the model F-1 and reads the flutter. The speed and simplicity of operation makes it highly suitable for production testing and service. It is especially designed for all forms of tape recorders and turntables. Calibration is made by adjustment of two screwdriver controls. Stability is claimed to be excellent. The input bandpass filter is an active filter with a bandwidth of 2 to 4 kHz and 12 dB/octave slopes. The limiter is an integrated circuit comparator that enables the acceptance of input levels from 10 mV to 10 V (60 dB). The frequency detector is of the pulse-counting type with a unique feedback loop that senses the average incoming carrier frequency and automatically adjusts the detector to provide essentially constant flutter indication (for constant percentage modulation) for average carrier frequencies from 2 to 4 kHz.

*Mfr: BHK Electronics*

*Price: \$340.00*

*Circle 81 on Reader Service Card*

## REMOTE PICKUP AMPLIFIER



- Three independent mixing channels are provided on this all-solid-state Model RPA-1 remote pickup amplifier. Two microphones and a line input are accepted by the unit. A peak-reading dB meter and internal audio limiter have a control range of 20 dB and an attack time of 1 millisecond. It is designed to provide audio mixing facilities for the firm's RPL-2 VHF remote pickup link and may be used as a standard remote amplifier over telephone loops. It also serves as a control head enabling the metering of important operating parameters and power control. It operates from 120 Va.c., 13.5 Vd.c., or internal batteries.

*Mfr: Moseley Associates, Inc.*

*Circle: 76 on Reader Service Card*

## DISTORTION MEASURING SET

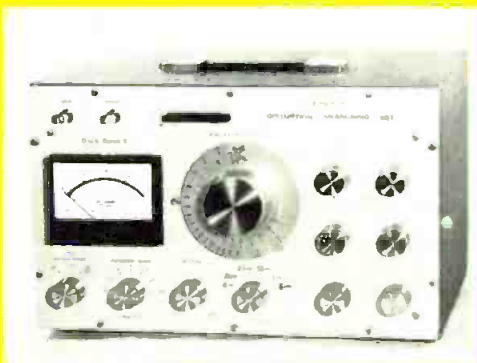

- This unit is complementary to the company's low distortion oscillator. It is direct reading and measures total harmonic content of a complex waveform in r.m.s. values expressed as a percentage of the total. It uses new techniques to enable accurate measurements of total distortion lower than 0.005 per cent of the input waveform. This is a departure from past techniques where it was necessary to use several instruments to measure individual harmonics below 0.1 per cent. The unit is completely portable and is silicon semi-conductor operated with its own internal battery.

*Mfr: Radford Laboratory Instruments Ltd.*

*Distributor in USA: Audionics Inc.*

*Price: \$450.00*

*Circle 75 on Reader Service Card*

## PORTABLE P. A. CONSOLE



- The PA-VI is an advanced design portable mixing console with a power amplifier delivering 250 watts continuous. The console has six input channels, internal reverb, each channel featuring individual volume, and high and low equalizers with reverb send controls. Precise control of the system response is provided by a master gain control, vu meter, four two-position anti-feedback filters, reverb contour and reverb send controls. Other features include echo in/out for tape echo, recording output and four speaker outputs. Optional speakers are available.

*Mfr: Peavey Electronics Corp.*

*Price: \$599.50*

*Circle 83 on Reader Service Card*

## STOPWATCH



- A wrist timer for program directors in radio, t.v. and film has recently been announced. It features utmost legibility for clear error-free reading of even the smallest divisions. It is built in the highest standards of Swiss watchmaking and its 7 jewel movement is shock protected. Dial reading indicates elapsed time; remaining time can be read on 60-minute turning bezel. It features a 1/5 second recorder with a central 0 to 60 minute register. There are two crown functions with time-out and locked return button with a safety bolt.

*Mfr: Heuer Time and Electronics*

*Price: \$62.00*

*Circle 88 on Reader Service Card*

## CARTRIDGE AMPLIFIER

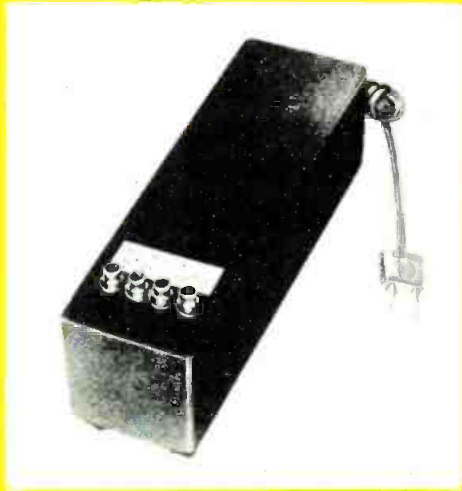

• The MP 235 is a cartridge amplifier to be used in conjunction with the SL-15 Ortofon Cartridge. The amplifier is a replacement for the step-up transformer used with the Ortofon SL-15 pick-ups. It reduces the frequency discrimination, phase shift, ambient pick up and impedance limitations associated with, and inherent in transformers used in this application. The most apparent audio improvement with the MP 235 is claimed to be the clarity and ability to reproduce low-level and complex signals properly.

*Mfr: Elpa Marketing Industries*

*Price: \$60.00*

*Circle 84 on Reader Service Card*

## STUDIO ACCESSORIES

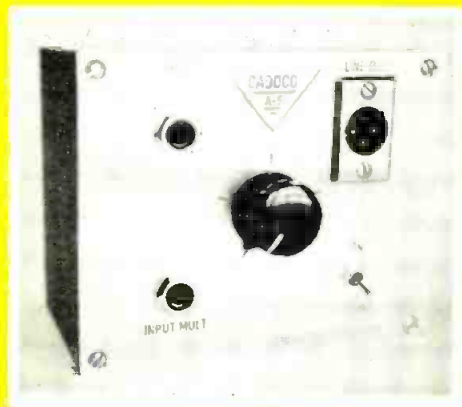

• A new series of accessory products has been designed to provide added convenience and flexibility for recording studios. All units are supplied in 3 X 4 X 5 inch attractive cabinets with aluminum engraved face plates. Among the twelve units presently available are the following: pan pot, vu meter, 80 Hz high-pass filter, 14 kHz low-pass filter, parallel connector box, dual iso-box, high/low impedance device, etc:

*Mfr: Caddco Audio Industries Corp.*

*Circle 86 on Reader Service Card*

## CASSETTE DUPLICATING MASTER

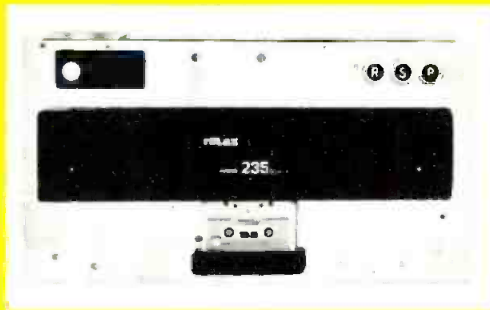

• The 235CM-1 cassette duplicating master transport is directly compatible with the entire Telex 235-1 duplicating system and conforms to the established building-block principle. It features an integrated-circuit logic control which provides end-of-tape sensing for automatic shut off in both

play and rewind modes. This, combined with time-delayed rewind, stop, play, and fast-forward controls insures against tape damage. The unit is equipped with a two-speed (7½-15) hysteresis-synchronous motor with automatic equalization. It is available in both two and four-channel configurations with individual equalization and level adjustment for each channel. There is a master switch for selecting either reel or cassette master system control and a frequency response from 30-10,000 Hz, ±3 dB.

*Mfr: Telex Communications Div.*

*Price: 495.00 (and up, dependent on configuration)*

*Circle 87 on Reader Service Card*

## MID-RANGE EQUALIZER

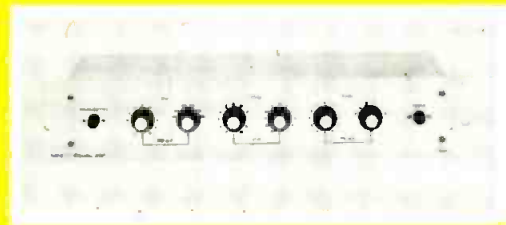

• The MRE-1 is a self-contained mid-range audio equalizer for mounting in 19-inch E.I.A. equipment racks. Two separate "peak" boost controls cover low and high ranges with a choice of twelve discrete frequency steps, while one "dip" control provides twelve overlapping steps of frequency coverage from 200 Hz to 7 kHz. High-impedance balanced input permits bridging or matching opera-

tion, and a maximum output level of +30 dBm eliminates the possibility of overload distortion during use. Equalization may be inserted or removed by a front panel push button on cue. All silicon solid state internal amplifier and regulated power supply minimize temperature considerations and ensure reliable operation.

*Mfr: Tempo Audio Industries Ltd.*

*Circle 77 on Reader Service Card*

## SWITCHING MODULES



• A new series of program and echo assignment switching modules has been developed by Electrodyne Corporation. The basic module, designated as the SML 30808,

performs track assignment to any two of eight program buses utilizing numerical readout lever action switches. Each assignment lever has its own individual mute button. Solo (cue) button is also provided. The plug-in modules are also available with one or two cue level controls, one or two pan pots or with pan pot and level control. Modules are available in two size configurations depending upon functional complexity. The small module, 6 X 1½ X 4 inches, designated SML 30808, is designed for up to four switches for 8-track operation plus room for an additional dual pot. The large module, 9 X 1½ X 4 inches (SML 51608), offers up to eight switches for 16-track use plus room for two additional dual pots.

*Mfr: Electrodyne Corp.*

*Circle 79 on Reader Service Card*

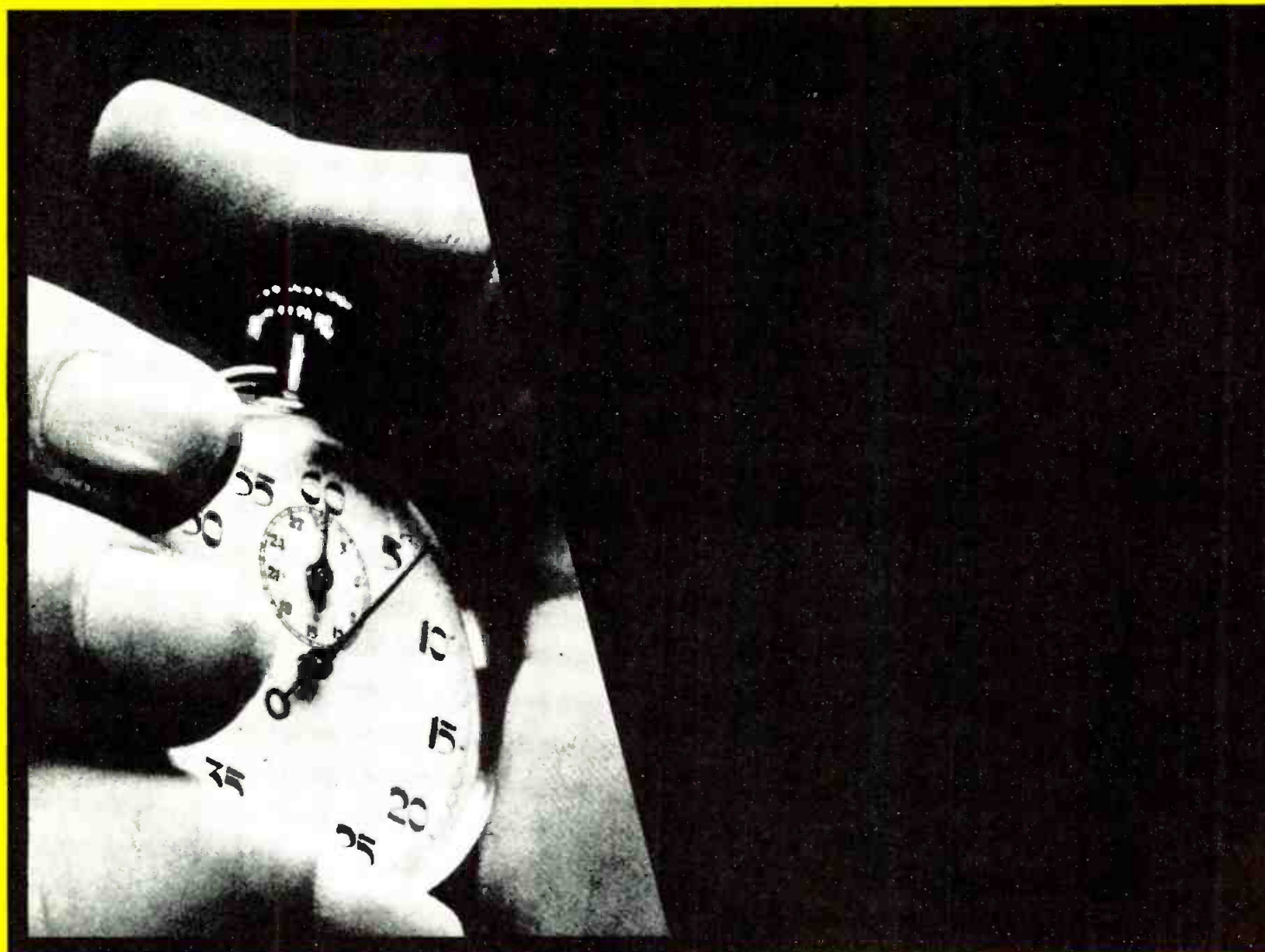

## Solve 7 problems...in seconds.



Something totally new to add to your bag of tricks! We call them *Plug-in Problem Solvers*. They're designed to provide seven common modifications in microphone and sound system setups without soldering or rewiring—just plug them in! The Model A15A Microphone Attenuator that prevents input overload; Model A15PR balanced line Phase Reverser; and A15HP High Pass and A15LP Low Pass Filters to modify low and high frequency response; A15PR Presence Adapter to add brilliance; A15RS Response Shaper to filter sibilance and flatten response; and the A15LA Line Adapter that converts low impedance microphone inputs to line level inputs. Carry them on every job. It's a lot easier than carrying a studio console with you! Shure Brothers Inc., 222 Hartrey Ave., Evanston, Ill. 60204.



Circle 27 on Reader Service Card

## PRO AUDIO ELECTRONICS

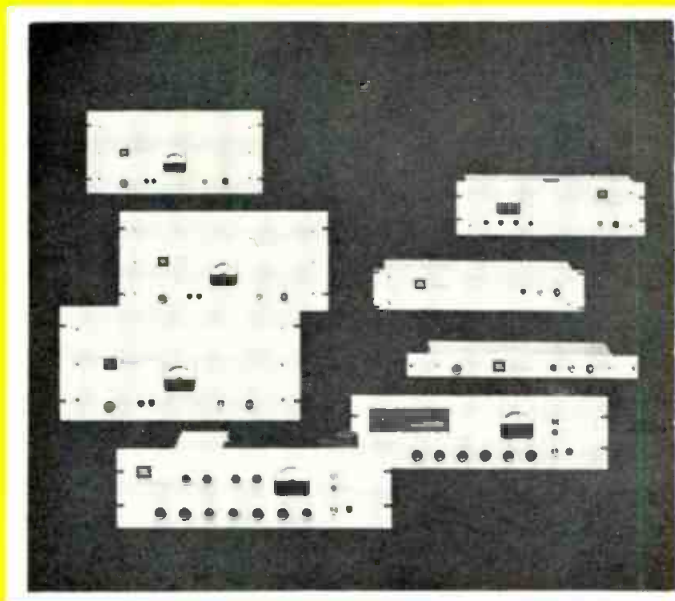

• This company, which earlier introduced a full line of professional loudspeakers, has now added an extensive line of compatible electronics to meet the needs for totally-engineered commercial-sound installation. These products include three new power amplifiers, two

mixer/preamplifiers, and several complementary accessory packages. They are designed to operate at extremely low noise levels (e.g., 6015 power amplifier: -100 dBm at 150 watts into an 8-ohm load). This feature permits the reproduction of extremely quiet program passages from tape, disc, or

live source material. The mixer/preamplifiers have facilities for expanding up to four inputs without affecting performance. Many accessories are available. Large vu meters are standard equipment. Bulletin PAE70 gives full details.

*Mfr: James B. Lansing Sound Inc.  
Circle 80 on Reader Service Card*

### TAPE DUPLICATION SYSTEM



• The high-speed tape-handling systems used in data processing computers provided the inspiration for this company to develop a new method for the mass duplication of magnetic tape.

Termed the DIFFCAP™ system, it consists of a closed-loop single capstan on a differential drive with both in and outgoing pinch wheels. Not only does this single capstan minimize component reliability and maintenance, but provides for constant tension and low flutter rate. The system is designed for a tolerance of less than 3 per cent harmonic distortion. Incorporated in this Model SL-150 high speed duplicating slave, the DIFFCAP provides superior duplicated material for playback at speeds of 3 3/4 and 1 7/8 in./sec. The SL-150 can record up

to 80 tracks at a 32:1 ratio. Operated by one non-technical person, production rates of 6000 cassettes or 12,000 8-track albums per 8 hours shift may be realized at duplicating costs of an average 1/4¢ per copy. Tape sizes can either be 150 mil or 250 mil. The complete system includes the MPR-150 master producer, the SL-150 duplicating slave, and a TW-150 tape winder. Components are available as individual items.

*Mfr: WSK Co.  
Price: \$13,500  
Circle 82 on Reader Service Card*

### CASSETTE LOADER

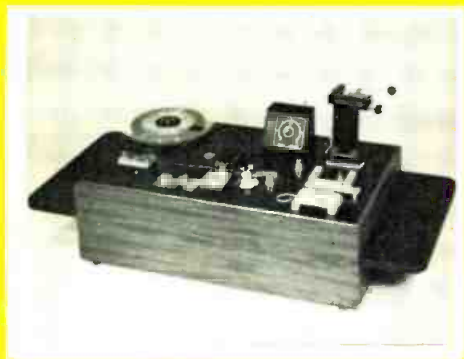

• A new line of factory-proved machines for loading cassettes or

eight-track cartridges features two take-up spindles and an integrally mounted splicer for cassette tape. An automatic cutter operates either from a tone on the tape or an optional timer. All machines are capstan driven by a synchronous motor. The CW-15 series for cassette tape operates at 120 in./sec. while the CW-25 series for 1/4-inch tape operates at 240 in./sec. The optional cassette tape splicer (available separately) may be mounted directly on the machine. This integrated system minimizes the handling of cassettes once they have been loaded. The splicing tape is on the usual roll form with the splicer cutting and applying a suitable length

of tape. All splices are applied square and straight. All machines are provided with a monitoring loudspeaker which allows the operator to hear the program "monkey chatter" and the cut-tone. Any machine can handle 7-, 10 1/2- or 14-inch supply reels and all tape guides are rotating type with ball bearings. The only surface over which the tape slides is that of the sensing head itself. A control is provided to adjust the take-up tensions and the thinnest tape in current use can be successfully handled. Manual or automatic operation may be selected.

*Mfr: Liberty/UA Tape Duplicating Co. Inc.  
Circle 78 on Reader Service Card*

(continued from page 16)

crew safety in the event of an emergency.

The latest international marine regulations insist that it is insufficient merely to alarm, that it is necessary to ring an alarm and then inform people exactly why the alarm was sounded. This makes sense, since just a bell alone would tend to excite without giving a direction. Even crew members tend to forget the meaning of signals, and passengers certainly don't know. Where most ships have many bells, this one has one, and its sound is electronically amplified throughout hundreds of speakers on board the ship. Bell ringing is followed by an announcement or instructions.

In this way a system is established which can provide the dual function of safety and entertainment. As a furtherance to the safety aspects, a complex system of switching priorities has been worked out which gives precedence to sources of emergency announcements, such as the bridge or the chart room.

Certain facilities have their own specialized safety aspects. The first that springs to mind on board a ship are the lifeboat areas. These have individual self-powered control systems located on either side of the bridge, with an overriding control from the bridge. For drills, the rest of

the ship need not be disturbed. A beautifully modulated voice (of a BBC announcer) informs the passengers of the drill, and those concerned gather at the appropriate stations. There they are given a lecture, from a cassette tape, on safety at sea. It isn't necessary to concern all of the passengers on a multi-stop voyage, so none of the entertainment systems are disturbed after the initial announcement. In an actual emergency, it is possible to talk directly from either wing of the bridge to one or all of the lifeboat stations, on that wing even if ships power is lost. The chart room station can override and address all of the boat stations.

During foggy weather, most ships must station men forward and aft, whose job it is to ring a bell loudly and frequently. This goes on day and night as long as the ship is in fog, and adds up to quite a large expenditure of manhours. On the QE 2, however, this menial task is done automatically. A stereo cassette tape, nostalgically recorded on the QE 1 with the sound of a bell for the forward speakers, and a gong for the aft is played continuously through four loudspeakers, two on each end. Regulations require the sound to be discernable for at least one mile, but it is yet to be determined how far the sound actually carries beyond this. At the same time, the only major acoustic device on board which is not electronically

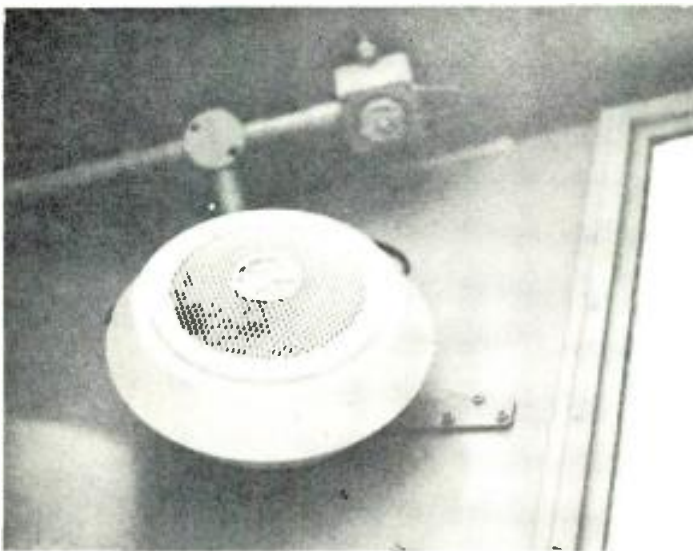

Figure 3. One of the many loudspeakers scattered throughout the ship, and another instance for which the generic word for sound reinforcement systems in Great Britain is Tannoy. These speakers are unobtrusively placed and can be heard clearly when required, with light background music coming from them most of the time.

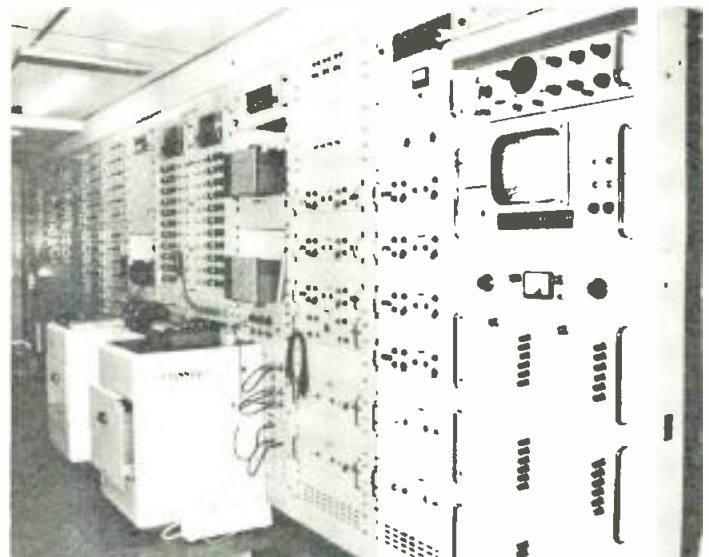

Figure 5. An over-all view of the sound control room also showing the television monitor console.

Figure 4. Neatly tucked away behind an electrical power monitor is the rack of amplifiers used for the engine and electrical control rooms.

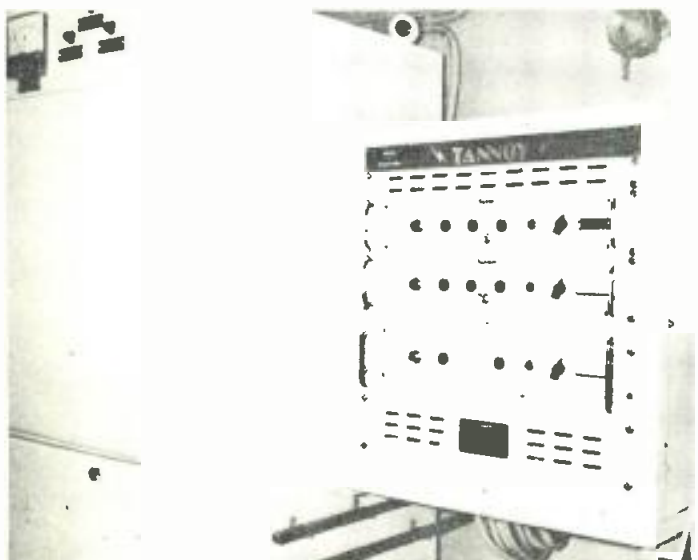
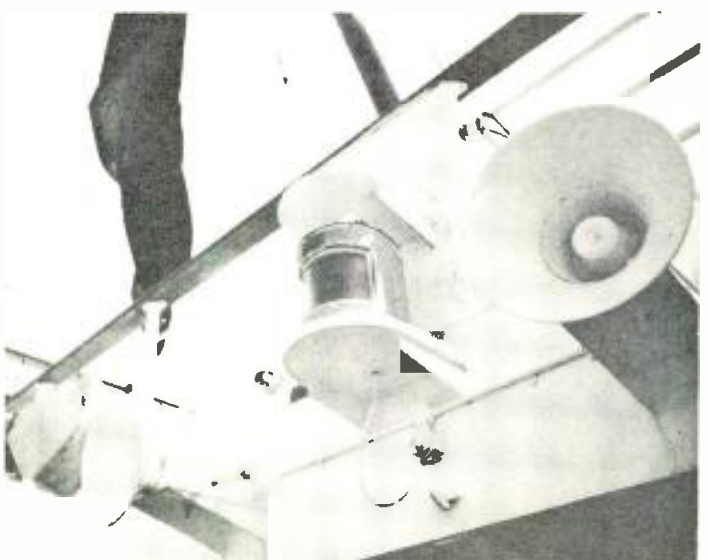

Figure 6. There are four of these loudspeakers, two at the bow and two at the stern. A cassette recording of a bell is amplified and played thru these speakers, satisfying the maritime requirement to ring bells at all times, while the ship is in fog.



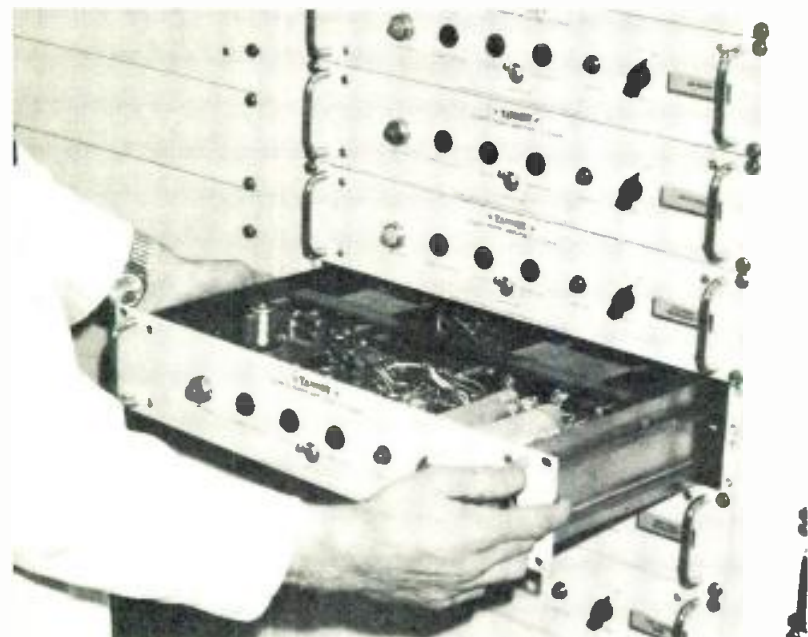

Figure 7. One of the Tannoy 60-watt amplifiers being removed from the rack. There are a total of forty of these, plus many more 60- and 200-watt units located throughout the ship.

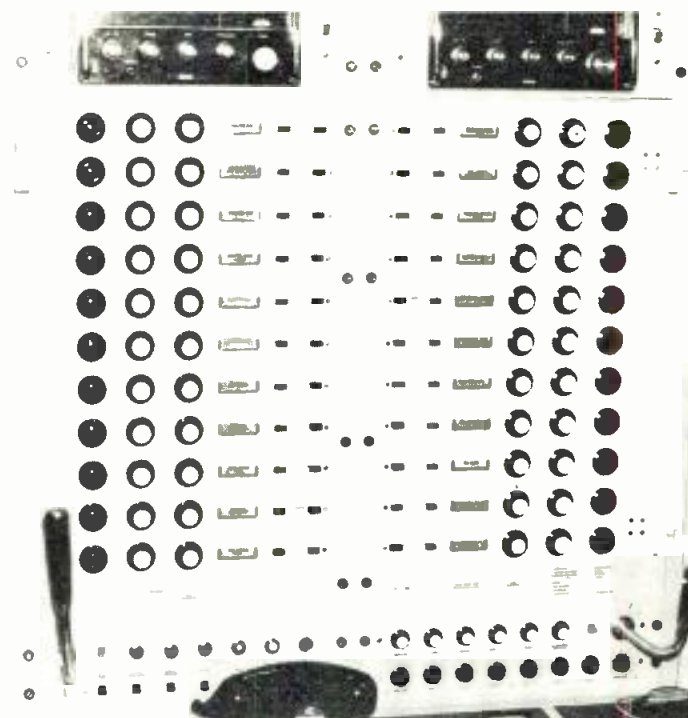

Figure 8. A closer view of the main console level-control system.

powered is used. There are two air-driven fog horns mounted on the mast which are sounded periodically during foggy conditions.

Along with the alarm system controls in the chart room, there are message circuit controls which permit communication with individual parts of the staff sections of the ship. Places like the engine room which have high background noise are equipped with high-power amplifiers and efficient directed speakers, together with special microphones which serve to make clear two-way communications with remote crew areas possible.

In addition to the safety and operational requirements, a complete music-coverage system throughout the ship provides background music, as well as locally-generated news broadcasts, or news received from off-the-air services. The main audio control room has facilities for continuous tape playing on 3M machines, for several radio channels, for t.v., and for cassette and reel-to-reel tape. While in port, local commercial broadcasts can be aired throughout those parts of the ship desiring them. At sea, a good antenna above and the sea all around make for good distance reception.

A ship intended for international travellers must be prepared to cope with language differences. The main auditorium is equipped with sound reinforcement in the usual manner, amplifiers feeding loudspeakers. However, there is a radio-frequency loop (or rather grid) using the chair structures, which carries simultaneous translations generated in the theater control room with up to six channels available. Individual headsets may be adjusted for the channel desired, in complete comfort.

Of course, no cruise ship would be complete without dance bands and entertainment. Each of the large entertainment areas, which at first sight would seem to present great acoustic difficulties, has been equipped with its own sound-reinforcement system, appropriately cut into the safety overrides. The coverage is shaded to decrease at the outboard edges. Those who want to hear the entertainment at a maximum will go toward the source, and those who want the ability to converse can find a less loud area. In this manner coverage is complete, and without excessive hot and cold spots.

There are also discotheques in two places, and a portable set of equipment. In addition the main control room can be operated to play records or tapes into the discotheques.

Interestingly, all of the record players were originally mounted in a gimbal system which have all been removed, since it was found that the normal suspension did a better job even in high seas. Of course, space on board a ship, even one this large, is at a premium. One of the discotheques has a two-hundred-watt amplifier neatly concealed in the maitre d's reservation desk. Just like all the rest on the ship, it is readily accessible for replacement.

Before leaving the vessel, we found time to compare the life of a sea-going audio engineer with that of his landlocked brother, and found that the chief difference was the length of time on the job. Depending, of course, on the length of the cruise, some part of the time in port is free time, and every third cruise is spent vacationing at home. It's a different life, but we tend to think a fascinating one. Particularly this is so because the ship can be considered to be a city of sound, where under one roof are all of the facilities usually found in diverse locations. There are theaters, pools, ballrooms, conference areas, and discotheques. The requirements differ, so that what is required is a jack of all trades who is also master of all of them. ■

### Highlights of the Ship's Communication System

- There is a general purpose sound system throughout the ship, which is used as an emergency alarm system. This is the first ship to rely on this to the exclusion of all other alarms.
- There is a boat order and crew intercommunication system.
- There is an electronic fog warning system for use at anchor.
- There is a six-channel passenger cabin entertainment system tied into the emergency alarm system.
- There is an individual sound-reinforcement system for each public room connected to the alarm override system.
- There are 1800 loudspeakers, of which 1100 are in passenger areas. The total available audio power is 4½ kilowatts, using 60 or 200 watt amplifiers.
- The design of the system permits complete equipment interchangeability, either physically, or through redundant equipment and circuitry.



# Rock and Speech Coexist in a Theater

*The author installed the sound system in the long-running Broadway hit Oh! Calcutta! His approach is direct and simple and he takes issue with some sophisticated methods of theater sound.*

**A**FTER 17 years in the sound-reinforcement business, I'm beginning to feel that there is entirely too much mystery connected with the installation of sound systems in theaters and auditoriums. Phrases such as "tuning the house," "1/3-octave tuners" and such-like are tossed around as though every friendly neighborhood sound installer dabbled with these things every day.

I have no real quarrel with methods that solve real acoustical problems in problem halls involving knowledgeable application of filters and other devices. And I am not making a case against the expertise and experience which any technician in the sound business should have.

My argument is with the over-publicizing of unusual and difficult cases requiring advanced technology, and, near-laboratory skills and facilities. In particular, I am turned off by the procedure—all too common these days—of tackling a sound-reinforcement job by dealing first with the faults of a hall's existing sound system—a rig which might be better junked or ignored and which might include speakers of questionable merit.

To spend time, know-how, and money to flatten out the peaks and valleys of such speakers and only then commencing to perform the necessary tuning of the house, seems to be the height of folly. And not the least of the bad effects of this kind of case-history reporting is that it is discouraging and misleading to those in the sound business. They might do well in setting up an average "well-behaved" small hall or auditorium using a few simple acoustical techniques and the excellent equipment now on the market—equipment which almost literally takes care of many problems or keeps them from cropping up in the first place.

I was recently called in to install a sound system in the Kenneth Tynan-Hilliard Elkins review called *Oh! Calcutta!*. Aside from the shock of seeing a show in which the cast of ten, male and female, spends a good 70 per cent of the time frolicking about in the bare altogether, not to mention indulging in advanced sexual gymnastics, the installation of the sound system at *Oh! Calcutta!* represents the kind of common-sense approach which might well benefit others with the job of installing a modern sound system in an average hall.

How very well the system worked out is testified to by the remarks in *Women's Wear Daily* by Martin Gottfried, one of the more important Broadway reviewers: Among other things, he said, "The sound at *Oh! Calcutta!* is marvelous!"

*Oh! Calcutta!* features a rock band playing amplified instruments and singing in the orchestra pit. In sharp

*Robert Liftin is chief engineer of Regent Sound Studios of New York City.*

contrast to this uproar, is the action on the stage which includes normally spoken dialogue. This means a very big difference in the sound between pit and stage with the possibility of jarring contrast between the two. At the least it is a psychological letdown when the band stops and the actors start talking.

My job was to reinforce the existing acoustics of the theater and do it with a naturalness that would keep the audience from being conscious that there was any sound system there at all. A considerable part of the success of this part of the job would fall on the speakers which I selected to install. And I will have some remark to make on these shortly.

My first job was to deal with the rock band in the pit. This consisted of loud instruments: electric organ, electric piano, fender bass, electric harpsichord, and drums. My first decision was not to amplify the drums. This was because of the time-lag problems. If amplified, the drums would be first heard live, then heard again over the p.a. system.

My second decision was not to pick up the sound of the instruments by placing microphones in front of their speakers. What I did was to tap off the instruments by using a bridging transformer to bridge directly off the output of

Figure 1. Two E-V Sentry II speakers are hung from the proscenium. They amplify the sound from the rock band. Although they are covered by black gauze to render them invisible to the audience, special lighting has revealed the driver elements.

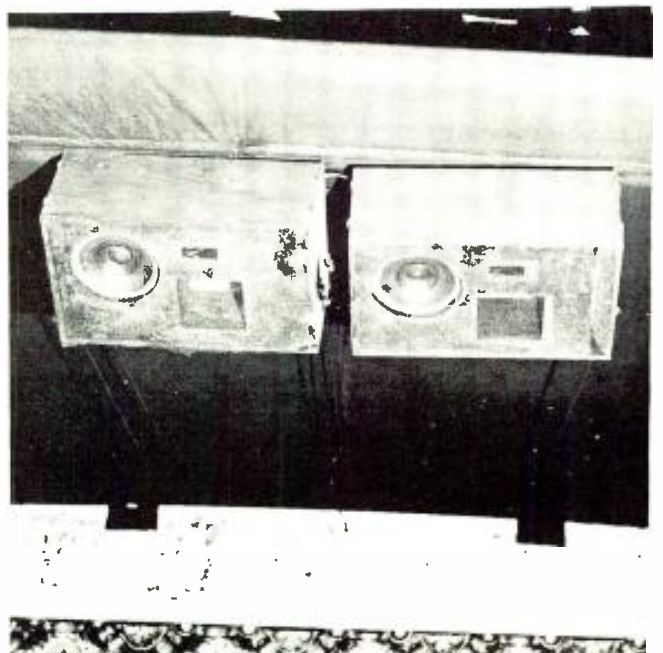



Figure 2. Two more Sentry IIs deliver all the sound from the stage performers. They are installed just a few feet from the proscenium, one on each side.

the speaker amplifiers. Most technicians prefer to patch directly off the instrument, but the performer generally has echo and reverb and he puts highs and lows on his amp and you don't get all that over the sound system. Doing it the way I did it, you get exactly what the performer himself is hearing over his own monitor speaker.

Next, I had to install mics for the rock players in the pit to sing into. Since the musicians were right next to their own speaker cabinets, the orientation of the mics was very important. Here I chose the Electro-Voice RE15 microphone which has an excellent front-to-back ratio and a sharp cardioid pattern. Oriented properly and with the singers close to the mics, we got a maximum of separation between the vocals and the instruments.

The next major use of microphones was for the stage dialogue. And here again I used the RE15s for much the same reason. They picked up a minimum of rock band and a maximum of the people onstage. As a matter of fact, it was amazing to watch the meter needles on the separate mixer-amplifiers which I used for stage and pit. With the footlight microphones and the rock-band microphones only inches away in some cases, the lack of leakage between the two, as shown by the inaction of the meters of one amplifier when the mics of the other system were picking up, was really something to see.

The producers of the show had specified that they wanted a certain kind of sound from the rock band—something resembling the sound in a discotheque. To accomplish this, I hung two Electro-Voice Sentry II speakers over the top of the stage, side-by-side right in the center. These were turned on only when the rock band was playing.

To cover the audience with the sound of dialogue and action from the stage, I again used Sentry IIs, two of them—one mounted on each side of the stage a few feet off

the edge of the proscenium and three or so feet off the deck. With their excellent dispersion pattern and by carefully orienting the speakers, just two Sentry IIs were more than adequate to cover the entire audience in the orchestra seats.

Now I want to say a special word about these Sentry II speakers because they have an important bearing on my whole thesis relative to what is, and what is not, needed in reinforcing the average hall or theater.

The first thing to be said, is that the Sentry IIs are flat speakers. *They are the flattest speakers I have ever encountered in years of working in sound.* This not only means that the sound they will deliver is smooth and easy

Figure 3. The mics used by the rock band singers are often only inches from the footlight stage mics. However, the directional characteristics of the mic (an E-V RE15) prevent leakage problems.



on the ears, but it solved a problem with the "uptown" middle-aged audience which the *Oh! Calcutta!* show is attracting. These are just the kind of people to complain about loud rock music. But we have never had a complaint. What people object to when they hear rock bands, is not the volume, it's the irritation of high, piercing, horn sounds and excessively booming bass sounds. These are the distortions of peaked speakers. You can drive flat speakers like the Sentry IIs much harder than a peaked speaker before anybody gets bothered. And the Sentries can handle great power—30 watts easily.

I like to make a claim about the Sentry II speaker that even the Electro-Voice factory won't make because they are a conservative company. The Sentry II speaker exhibits an almost cardioid-like pattern. We speak of cardioid patterns in connection with microphones, but I can demonstrate what I say about the sharpness of the patterns of the Sentry IIs by taking an RE15 microphone and passing it around the sides, top, back and bottom of the speaker without getting any feedback. It's only when I move the microphone up to the front opening, that squeal begins.

It is this characteristic—this reduction of lobes from sides and back—of the Sentry IIs and its use in conjunction with the RE15s, that permitted us to sharply focus the speakers for excellent sound pickup and dispersion with practically no concern for feedback. It is the reason why the Sentry IIs could be mounted that close to the edge of the stage so that, as far as the audience could tell, the dialogue was coming right from the mouths of the actors and not from speakers.

And it was all done with an absence of hocus-pocus or problems. And, I must mention that the cost is about one-tenth of doing it the more complicated way. In today's theater, all kinds of tricks are being used. Speakers in the back of the house, delay systems—magic so that you can't tell where the sound is coming from. But if such a system is a little bit out, or if the actors are "down" one night, you're in trouble.

Do it the simple way, with speakers that you can position smack up against the stage, with sharply cardioid microphones such as the RE15s—two speakers, eight microphones and you're in business! This is opposed to having to go to filters, having an expert in to tune the whole house, tune the system and then bang! it rains, or it gets cold and people come in with overcoats and the whole sound changes. And the nuisance of having to mount speakers on poles and pipes and gadgets all over the place!

(I don't say that it is never necessary to bring a little advanced technology to a situation. I had a show at the Wintergarden where there was a low end that bounced all over the place. Here I had to install a 100-cycle filter.)

But in the case of most houses—and it really is gratifying to find that a high percentage of halls and auditoriums are acoustically well-behaved—a pair of truly flat speakers and about eight good mics spaced across the footlights will more than do the job. Orienting the speakers properly—and this is most often only a matter of set-it-up-and-listen, set-it-up-and-listen—until the system sounds right, is standard and simple procedure.

You really don't have to be a genius all the time. Start out by designing a flat system. Pick your components to insure flat system response into the room. Then get set up in the room and determine if further work needs to be done. You may find that, by using flat components, no further equalization or tuning will be necessary. On the other hand, if further equalization is necessary, the job is made easier by the simple fact that the system itself need not be corrected for deficiencies.

Proof of the pudding in the case of *Oh! Calcutta!* is that the producers were so delighted with the sound, that they insisted on buying the system outright. Sometimes the easy way is the best way. ■

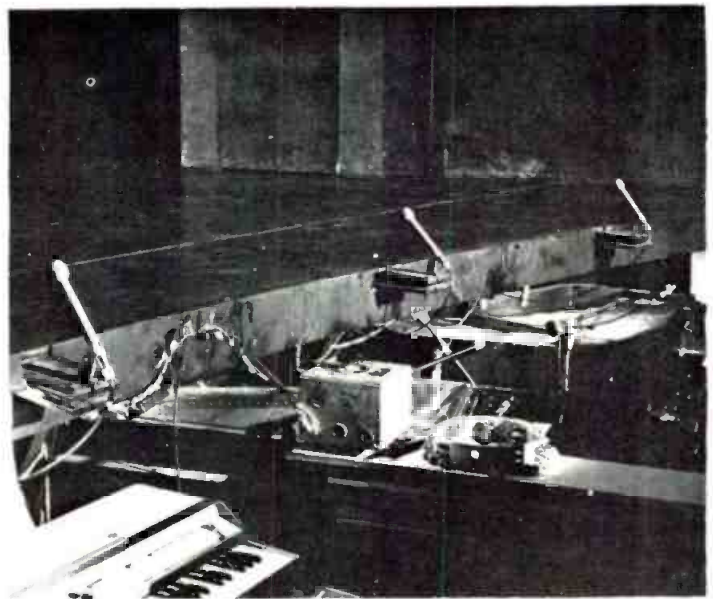

Figure 4. Eight RE15s are spaced across the footlights and handle all the singing and dialogue from the stage. The RE16 model is actually shown but it is identical to the RE15 except for a blast filter. In show productions, it is the RE15 version that is used.

Figure 5. The audio man is situated at the rear of the orchestra seats. He thus hears what the audience hears and can adjust balances and levels accordingly.



DAVID L. KLEPPER

# Sound Reinforcement in a New Church

*Washington D.C.'s new National Presbyterian Church required a total sound-reinforcement system installation. The author describes the design parameters and construction.*

**T**HE new building complex for the National Presbyterian Church, designed by Harold Wagoner and Associates, Philadelphia, Pennsylvania, includes a main church, a chapel, and a social hall. The problem of providing sound reinforcement in these three spaces was solved by three distinctly different techniques, matching the differing architectural, acoustical, and use conditions of the three spaces. The solutions adopted in the church and chapel are somewhat unusual, a pew-back system in the church and a twelve-foot-tall line-source or column loudspeaker system in the chapel; but the social hall system is a straightforward ceiling distributed loudspeaker system.

The first consideration in the design of any sound system is the determination of the intended uses of the system. All three systems are used for local speech reinforcement, and provisions for recording are also required. Only the social hall system is ever used for local playback of recorded sound, but both the social hall and chapel systems may be used for overflow coverage of all activities taking place in the church.

The use requirements may be summarized in a signal-flow chart, indicating the *communications* requirements of the system, as illustrated in Figure 1. Note that the communications requirements of the systems reflect on their acoustical requirements: sound pickup in the church and chapel is from well-defined areas, outside the areas that need be covered; but the social-hall system is capable of reinforcing speech from anywhere in the social hall, including the stage.

## Acoustical and Architectural Requirements

While the *use* requirements differ somewhat for the different systems, the *acoustical* and *architectural* requirements differ markedly. The social hall is a fairly low-ceilinged space, and the suspended acoustical-tile ceiling furnishes a good location for a conventional distributed-loudspeaker system. Indeed, the entire

architectural-acoustical-electroacoustical design philosophy of this room is the absorption of live sound and the provision of amplified sound to the extent practical. Since live sound can originate anywhere in the room, not just on the stage, there is no point in attempting to maintain directional realism for a given source direction. Also, since live sound energy is largely absorbed, there is no problem in synchronizing the time of arrival of amplified sound at the listeners' ears with live sound. The resulting distributed loudspeaker system is relatively simple, conventional, and

Figure 1. The Communications requirements for Fellowship Hall's sound-reinforcement systems.

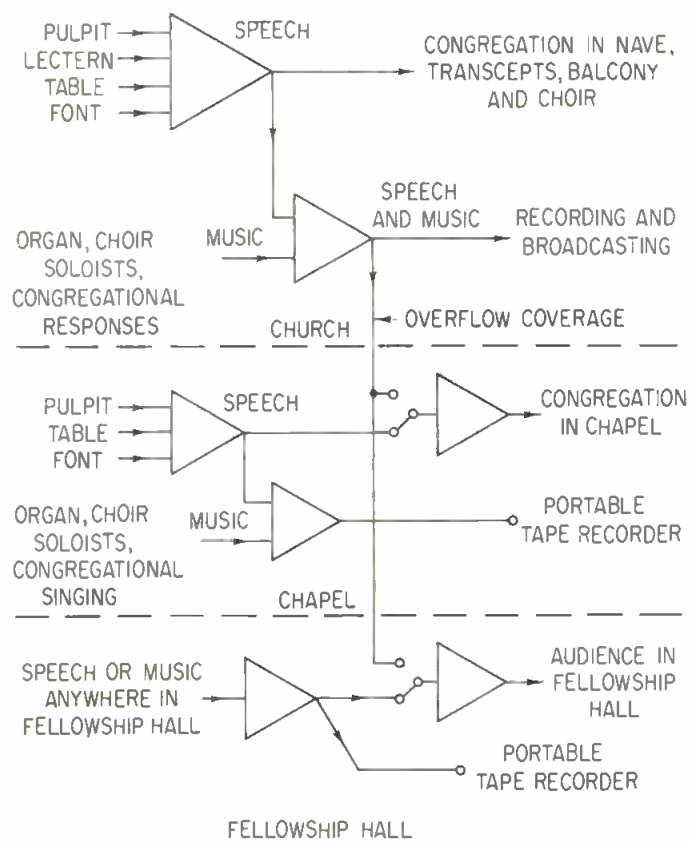

David L. Klepper is with Bolt Beranek and Newman Inc. in New York City.



Figure 2. The front of the chapel showing the column containing the line-source loudspeaker.

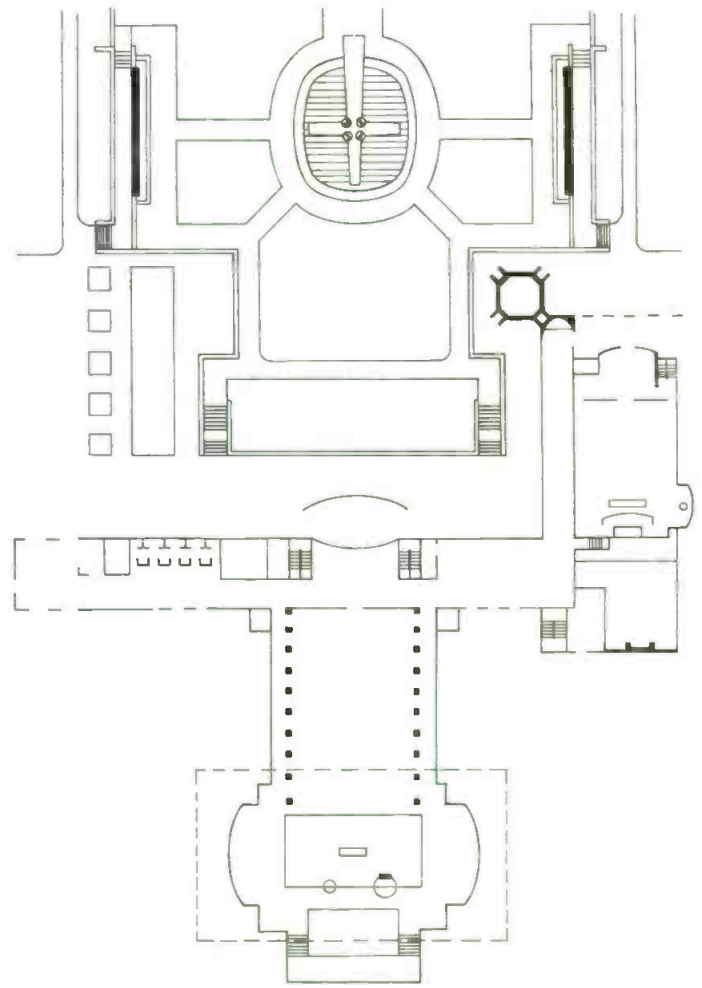

Figure 3. The schematic plan of the National Presbyterian Church of Washington, D.C.

inexpensive.

The chapel, on the other hand, is a basically live, sound-reflecting space, that attempts to *use* live sound energy advantageously for both speech and music sound sources. This space has a lot of acoustical features inherent in its basic design. The organ and its balcony provide echo control without the application of sound treatment; the sloped, ribbed ceiling provides even sound distribution; the pew cushions and carpet minimize any change in acoustics with changes in occupancy; and, although the all-hard wall surfaces surround the listener with music, the reverberation time is sufficiently low to ensure high speech intelligibility, without electronic amplification. The small size of the room make one question whether amplification is needed at all; but the church wishes to accommodate a variety of ministers and lay people, some of whom may wish to chat softly, even whisper, and still be heard.

Synchronization of amplified sound with live sound and the desire for directional realism both suggest the use of a central loudspeaker system for this chapel. Although the architectural design does not provide a good hiding place for an overhead, horn-type directional central loudspeaker cluster, the columns flanking the chancel area were obvious alternate locations for a line-source or column loudspeaker system. The possible objection to such a system in a large reverberant church is lack of directional control in the horizontal plane, but this did not apply in this chapel because it is not wide enough or reverberant enough for the side-wall reflected sound energy to be a problem.

The line-source loudspeaker actually installed is twelve-feet high, placing the entire seating area effectively in the near field through most of the frequency range. It is mounted most inconspicuously in the left column and is matched by a dummy grille on the right. *Figure 2* shows

Figure 4. The church looking toward the chancel.

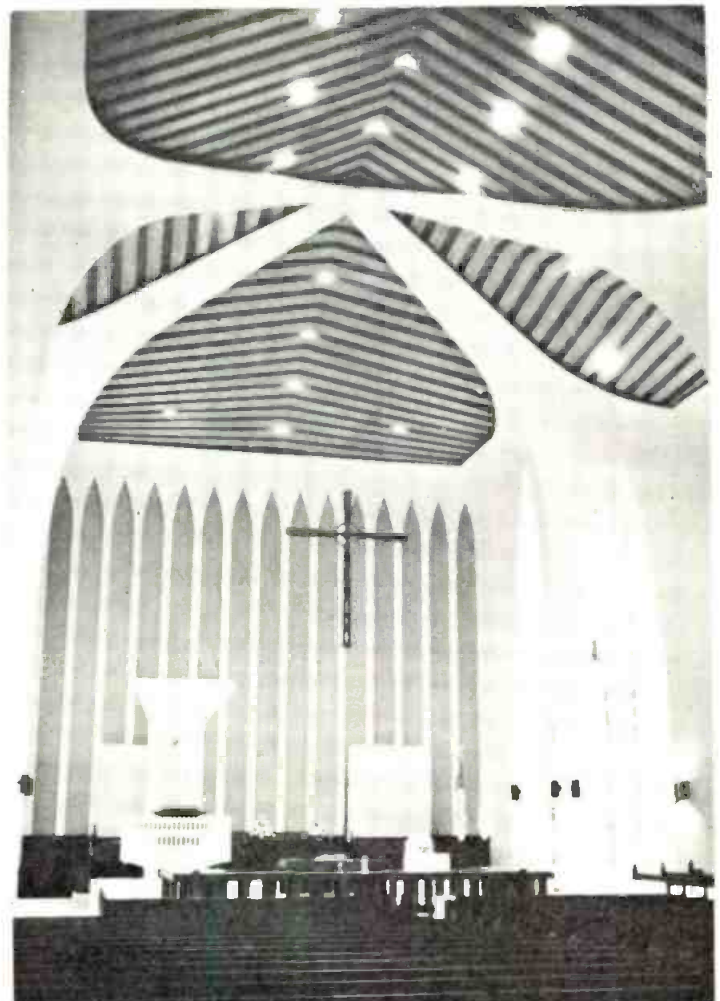

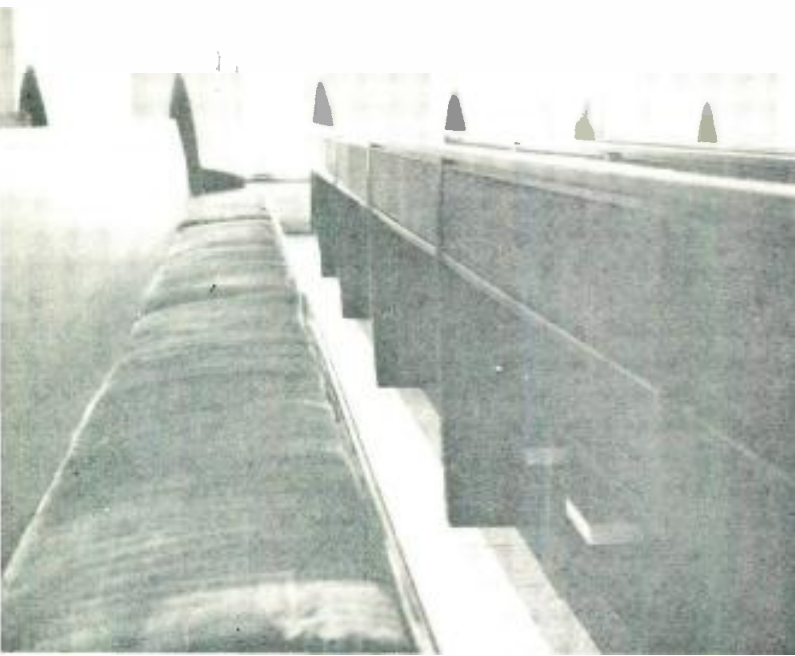

Figure 5. The pews on the main floor showing the continuous speaker grill.



Figure 6. The pews on the balcony showing the individual speaker enclosures.

how well the loudspeaker system is blended into the architecture. Since coverage from one loudspeaker system is sufficient, the addition of a second system in the right column would merely have added phase-interference problems.

The main church's acoustical and architectural requirements were the most demanding of any of the three spaces. The acoustical design was intended to match the visual aspects of this cathedral-like space, with a design mid-frequency reverberation time of approximately three seconds with full occupancy, to favor the organ, choir, and congregational singing. *Figure 3* is a plan of the main church. All interior surfaces are hard, primarily plaster, except for a very limited amount of sound-absorbing treatment on the lower transept and lower rear walls. This treatment is intended to control long-delayed reflections that have been found to produce too much confusion, for both speech in music, in the center of the crossing in other churches. Given the large size of the church and the relatively high reverberation time, the burden of providing high speech intelligibility falls clearly to the sound-amplification system.

In the interest of directional realism and synchronization of the amplified with live sound, our first choice for a loudspeaker system in this space would be a directional central system, with amplified sound energy concentrated on the seating area, which is made sound-absorbing regardless of occupancy by pew cushions. Actually, since there are pews on four sides of the chancel (the two side transepts and the choir area, four central loudspeaker systems would be required.

Architectural requirements ruled out the use of a central-system solution, however. *Figure 4* looks toward the chancel. Looking at this, one is struck by the architectural simplicity that prohibits the use of a suspended central cluster that might be ideally located. A ceiling location was impractical, acoustically; central systems fifty-feet high introduce their own echo problems for listeners in front rows. Similarly, the side walls and columns were too far apart for a line-source or column loudspeaker system to be completely successful.

The solution adopted was a pew-back system, with one loudspeaker for approximately every three listeners throughout the nave, balcony, transepts, and choir areas. The architect had little difficulty in integrating the loudspeaker enclosures with the pew designs, as can be seen

from *Figures 5* and *6*. Everyone is close enough to a loudspeaker to hear clearly despite the natural reverberation of the church.

#### DELAY

During the design of the pew-back system, considerable thought was given to incorporation of a delay device to synchronize the amplified sound with live sound and to improve both directional realism and intelligibility. Tape-loop delay equipment was available, but we hesitated to burden the church with the maintenance (replacement of loops and cleaning of heads) such equipment requires. Although the system was designed to permit addition of such equipment, we held off recommending it or specifying it for initial construction.

Tests in the completed church confirmed the desirability of adding delay equipment. Fortunately, acoustical delay equipment, employing a driver, pipe, microphones, and an anechoic termination, was by then available, requiring no more maintenance than normal sound-system components; and delay was added to the church system. *Figure 6* shows the delay system driver and pipe, mounted in the attic above the church ceiling.

#### DETAILED DESIGN AND EQUIPMENT

*Figure 7* is the functional diagram of the complete system, showing the three sub-systems serving the three spaces. It is a logical extension of the simple signal-flow diagram shown in *Figure 1*.

To provide for competitive bidding, we usually permit the contractor to choose between several alternates for each major item of equipment when preparing specifications. The contractor for this project was American Amplifier of Washington, D.C., and they selected the following equipment from the alternates we presented:

#### MICROPHONES

- Unidirectional speech ..... RCA BK-5B
- Omnidirectional speech ..... Electro-Voice RE55
- Lavalier ..... Electro-Voice 649B
- Omnidirectional music ..... AKG

#### MIXER-PREAMPLIFIERS

- RCA BN-16B

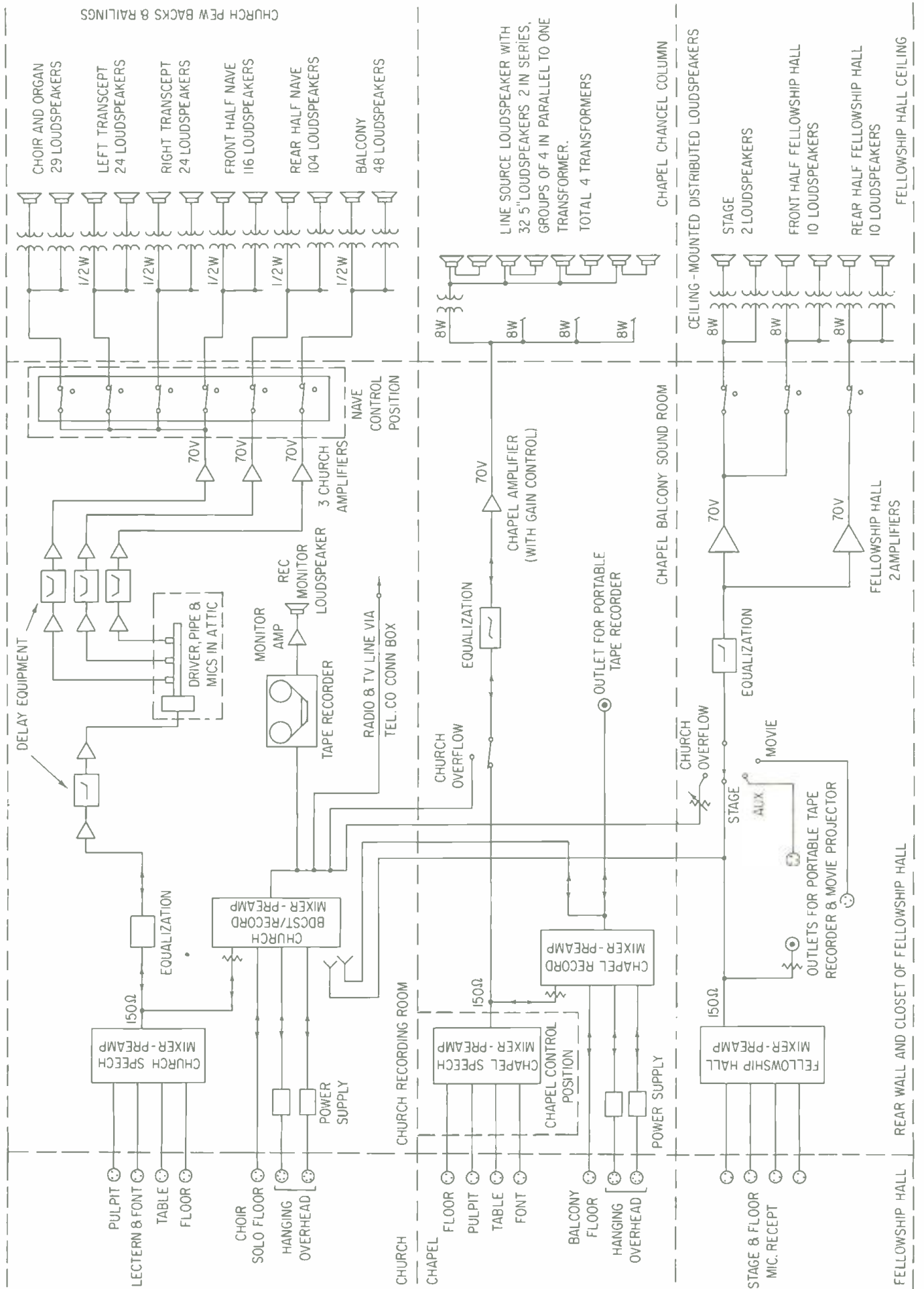

Figure 7. A simplified functional diagram of the sound reinforcement system described in the text.

**POWER AMPLIFIERS**

Langevin AM50BT  
 Langevin AM100  
 RCA MI-9289B

**LOUDSPEAKERS**

Pew-back ..... KLH 12.5 (345)  
 Line-source ..... KLH 12.5 (32)  
 Ceiling distributed ..... Jensen K-950 (22)

**MATCHING TRANSFORMERS**

UTC LS-33  
 RCA MI-12368  
 RCA MI-12370

**BUILT-IN TAPE RECORDER**

Ampex AG-440 (1/2-track, mono)

**PORTABLE TAPE RECORDER**

Ampex AG-600 (1/2-track, mono)

**DELAY SYSTEM**

Ancha Electronics *Delay-a-Voice* using  
 Altec components

Detailed design included incorporation of loudspeaker cut-out switches in the two distributed systems, the main church and social hall, to permit coverage to be restricted to occupied areas, and separation of the music recording signal from the speech reinforcement system, permitting music to be recorded without being amplified, in both the chapel and the main church. These design elements may be seen clearly in the functional requirements.

A basic requirement for optimum operation of any sound reinforcement system is control by an operator who

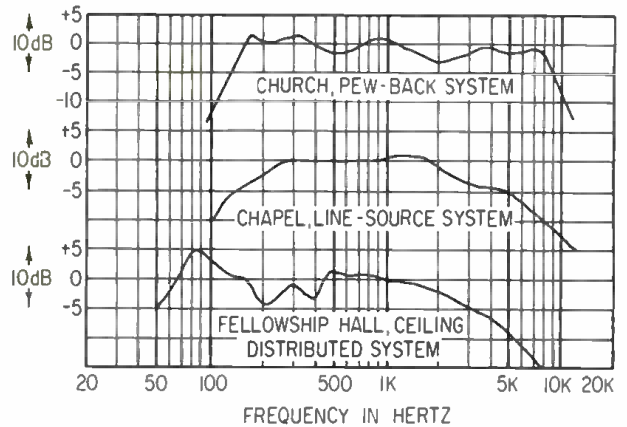

Figure 8. Frequency-response curves for typical listener locations.

hears the sound he controls and sees what is taking place. The locations of the speech reinforcement mixer-preamplifiers meet this requirement in all three spaces.

The church speech mixer is combined with the lighting controls into a console at a rear pew; the chapel speech mixer is also combined with lighting controls into a console in the balcony; and the social hall mixer is mounted in the rear wall.

**COVERAGE AND FREQUENCY RESPONSE**

Uniformity of coverage for all three systems was satisfactory; the pew-back church system is within  $\pm 2$  dB, as measured at head height in the 4000 Hz octave band using a pink-noise source.

Figure 8 shows typical frequency response measurements on the three completed systems, following equalization. Although more detailed, third-octave or critical band equalization could produce even more uniform curves, we believe the results would be academic and not worth the additional expense, especially since the systems as equalized with relatively simple, broad-band networks sound natural and have a good margin of gain before feedback.

The church's staff and members appear pleased with these systems. Of course, the systems themselves are seldom singled out for praise; rather they are considered as part of an over-all acoustical environment that is, in turn, part of the over-all architectural environment provided by the architect, his consultants, and the contractors who collaborated on the project. ■

**RECORD CUTTER**

We are seeking a professional in the art of record production. This position will include the responsibility for design and development of recording systems, cutting of record masters, repair, maintenance, and calibration of recording equipment. Your qualifications should include an educational background in electronics or physics, 3-5 years experience in the electronics or recording industry.

You must be energetic and willing to accept responsibility. If you feel qualified to take credit for all recording material produced by the world's largest toy company, send your resume, to:



Chuck Raber  
 Mgr. Professional Employment

5150 Rosecrans Ave.  
 Hawthorne, Ca. 90250

An equal opportunity Employer



# The Teldec Video Disc

*These are continuations and conclusions of two discussions of the technology and impact of disc video recording that were begun last month*

## ARNOLD SCHWARTZ

**P**ROBABLY the most ingenious invention in the Teldec video-disc system is the playback transducer. This month I will discuss the video-disc playback system in much the same way that I discussed the essential features of the recording system last month.

### AUDIO DISC SYSTEM PLAYBACK LIMITATIONS

We can begin by analyzing the bandwidth and wavelength response limitations of current audio-disc playback in order to understand the problems that had to be overcome in developing video-disc playback. Current audio-disc playback is based on a *high-impedance groove*, and a *low-impedance playback stylus*. This means that the record groove wall should be as rigid as possible, and the playback stylus should move as easily as possible when driven by the groove modulation. *Figure 1* shows a simplified equivalent circuit of an audio playback stylus in a record groove. Groove modulation is represented by a velocity generator; the internal impedance of this generator is a shunt compliance. The external load of the playback tip is represented by a mass, a compliance and a damping resistor. The tip compliance is so high in comparison to the groove compliance that it can be neglected in the discussion that follows. The velocity ( $V_c$ ) of the playback tip is constant up to a frequency that is just below the stylus-groove resonance. This resonance, takes place when the groove compliance ( $C_G$ ) resonates with the mass at the stylus tip ( $m$ ). At frequencies above stylus-groove resonance the velocity, and therefore the cartridge output, drops rapidly at a 12 dB/octave rate. The greater the groove stiffness (*i.e.* the smaller the compliance), and the smaller the mass at the tip, the higher the frequency of this resonance. The video disc requires a bandwidth 200 times greater than the audio disc. Basically, the compliance of the groove is determined by the physical properties of vinyl, and cannot be decreased significantly. Since the stylus-groove resonant frequency is proportional to  $\frac{1}{\sqrt{m}}$ , an increase in resonant frequency by a

Figure 1. The equivalent circuit of audio disc playback.

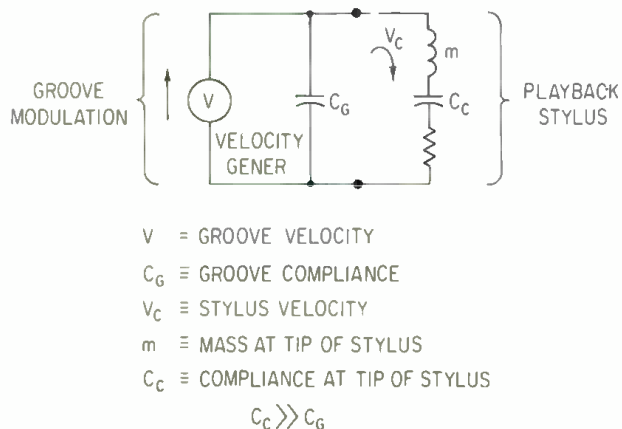

## EDWARD TATNALL CANBY

**S**PACE ran out on me last month, just as I started to make comparisons of the Teldec disc with the CBS electronic video recording system, EVR.

EVR is both a movie projector and a still projector and this has enormous implications for education as well as some significance in entertainment. EVR, in other words, encompasses both the moving-picture film, and the film strip or slide projection. So far, it is the *only* system with this vital capacity. The video tape systems do it with, shall I say, clumsiness. It isn't natural to the magnetic arrangement, as I sense it, though it can be done. Videotape likes to move and keep moving.

What happens on Teldec is almost grotesque. The stylus skips exactly as it might on an audio disc. Supposedly, according to the claims, it skips *one groove* back on each turn, to keep the same picture on the screen. Instead, it skips a lot of grooves, but not regularly—sometimes less, sometimes more. The effect is ludicrous, all too easily slapstick. Titters in the audience. Exactly the impact of a skipped lp groove on the radio! There was no stopped motion. Only repeated hunks of regular-speed motion.

Since the stylus is suspended freely, I do not see how they figure to remedy this. I can imagine a batch of schoolkids watching *that* kind of replay! Hysterical giggles in seconds. Total indiscipline. No learning. It's fine (though funny) for replaying a hockey goal, the ball whopping into the goal area over and over again, zanily. Or maybe a knockout in boxing, the loser toppling to the ground, then toppling again. Not good for serious use. And totally useless for real *stills*, as in EVR. Filmstrip material. Document filing. Information retrieval, etc.

Perhaps German ingenuity will produce a true still picture by precise control of the stylus travel. If so, good. But they definitely do not have it now and this closes off many areas of exploitation if, to be sure, not the largest ones. The Teldec picture definitely is a movie, not a still.

More important is the limitation on playing time. The 12-inch video disc now plays 12 minutes, the 9-inch model only five (for commercials and spot announcements or for kiddie shows). Asked about extended play, the Teldec engineers themselves said that the maximum might be fifteen minutes. Larger disc? Impracticable in the thin-foil format, as well as clumsy. Smaller groove/higher speed? Not if the present system is standardized, as apparently it will be. Here, then, is a major limitation, if you call it that, as compared to all the other systems. Moreover, there are unmentioned further complications; the present figures, I gather, apply to the 50-Hz European disc. Over here, it'll go faster. Not 1500 but 1800 rpm. Necessarily? I assume so, for comparable results.

Magnetic tape now leads the cartridge field in unbroken play time, and could lead further with new tape formulations. An hour is feasible, even Teldec admits. RCA's SelectaVision will do about the same with its plastic tape, embossed with the signal. EVR runs a clumsy 2 X 25 minutes (rewind, play the second track) for B/W and 25 minutes for color, one play only; super-8 film does about

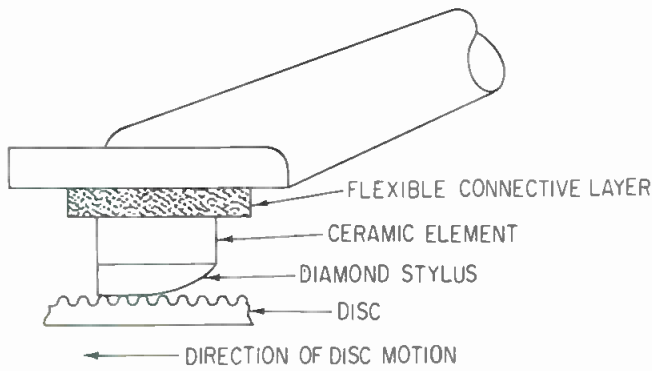

Figure 2. The pressure pickup system used to play the Teldec video disc.

factor of 200 requires a decrease in stylus tip mass of  $(200)^2$ . In other words, the mass of the stylus tip would have to be reduced by a factor of 40,000 for the present audio cartridge to resonate above 3.5 MHz and be useful for video playback.

Another serious playback problem is that of wavelength response (see Feedback Loop of August 1970). What are the changes needed to extend the wavelength response from the present audio disc minimum of  $0.6 \times 10^{-3}$  inch to the video-disc requirement of  $0.08 \times 10^{-3}$  inch? The wavelength response is proportional to  $(RF_z)^{-1}$ , where  $R$ =playback tip radius, and  $F_z$ =tracking force. Extending the wavelength response requires a decrease in the quantity  $(RF_z)^{-1}$  by a factor of 7.5. This means that the product  $(RF_z)$  itself would have to decrease by a factor of  $7.5^3 = 422$ . Since 2.0 grams and 0.0007 inch represent typical values of  $R$  and  $F_z$ , the tip radius and tracking force would be vanishingly small—and the practicality of such a playback system would be correspondingly slight. Such a small tip would cause record damage, while rapid tip wear would increase the radius and degrade the playback performance.

### VIDEO DISC PLAYBACK SYSTEM

The Teldec video-disc playback system turns the classical audio playback system upside down, and thus solves the seemingly insurmountable problems of frequency and wavelength response. The Teldec system is based upon a *low impedance groove*, and a *high impedance playback stylus*. Figure 2 shows the basic features of the Teldec video-playback cartridge. An asymmetrical runner-like diamond stylus is rigidly connected to a ceramic piezo-electric element. The electrical output of the ceramic element is proportional to changes in *pressure*. The stylus rests on the peaks of the modulation. As each peak approaches the stylus it is gradually compressed by the rounded-off leading edge. On the other hand, the compressed modulation peaks are instantaneously relieved as they glide out from under the abrupt vertical trailing edge of the stylus. This instantaneous load relief causes a corresponding pressure change at the ceramic element and produces an electrical output proportional to this instantaneous pressure change. There is virtually no motion of the stylus or transducing element.

A simplified equivalent circuit for the video-disc playback is shown in Figure 3. The groove modulation is represented by a constant displacement generator since the video-disc modulation is constant amplitude. The generator's internal impedance is a relatively high shunt compliance. The external load of the stylus is represented by an extremely small compliance, a mass, and a damping resistor. The only resonance of interest here is the self resonance of the mass and compliance of the ceramic element. By making the element sufficiently stiff (small compliance) it can be made to resonate beyond the upper frequency limits of the video pass band. The compliance of the groove has virtually no

the same. But the Teldec disc runs only 12 minutes. A major difference. Though it will play indefinitely if you use a changer.

Teldec is making noises about the changer to come. They are familiar ones. We've heard those noises before.

Teldec thinks the changer will easily take care of the length problem. I have my doubts. No changer, no matter how fast, can compete with a parallel system that does *not* need changing. Only necessity, and lack of direct competition, will make a changer feasible for material that should play in unbroken form. (Operas on lp, for example.) On the other hand—the changer does have its uses. The biggest usefulness, clearly, as for a self-chosen intermix of *different* discrete programs. That is the way we use lp changers and it is the way the juke box works. What's more, it is most effective in short-length material, oddly enough. 45-rpm selections. Lps with many short pop items on them. And so, projecting ahead, we look at the tv situation.

I think the Germans may have misjudged our television content. Most tv material, you will note, runs much longer—even excising the commercials—than its equivalent did in the older radio days. Most shows add up to a good 45 minutes, often much more. Radio rarely went beyond a half hour. Radio news is in five-minute segments, and up to fifteen minutes in extended roundups. Television news runs on and on. It is the nature of the dual medium to demand more attention for a longer time span.

Twelve minutes of tv viewing is, thus, equivalent to the 3-minute 45 disc in all its billions. Very short, if very useful. We need merely decide where a *very short* program, comparable to 45 disc, will fit into the tv picture and we have the Teldec future in our hands. Complete with changer *primarily* for intermixed discrete shorts, not for full-length programs with breaks. (I do not think that we can equate commercial interruptions with actual breaks, as in a changer. The commercials flow continuously with the show, straight out and straight back. No break! We hardly notice them. But we definitely would notice real breaks, and find them highly objectionable.)

Teldec, then, is going to find its place—with its changer—in the tv *short-short* area, and not in the long-haul programs, if I guess well. Commercials, of course! Perhaps on the air like cartridges and cassettes; also, probably, in the home, mailed or delivered like printed leaflets, inserted in magazines, papers and so on. Huge field. Play them, casually, the way we now leaf through the supermarket ads. Propaganda in short-short form. Political messages. Helpful household hints. A million other ephemeral items—throw them out after playing. (More ecology?)

Then there's education and entertainment in the short-short area. To me, that means only one thing, on a large scale. Kiddie stuff. Most educational material for older children and high school or college is necessarily long. But with little kids it's a matter of attention span. And so the tv disc short-short is a natural, both in the vast elementary education field and in the home market.

Education will also use the other systems. EVR will excell with its control over single frames, slow forward or reverse, regular motion, all with perfectly equal ease. Marvelous for older education. Also for all sorts of document and information filing, etc. Longer-play film material will use the long-haul systems, to a distinct advantage over Teldec and its changer. Longer tv programs, too. A changer is bad. Unbroken play is a gift.

That is perhaps the immediate picture, as of the next few years. The next major jump, still misty and imprecise, will come when, following on RCA's laser techniques, recorded television moves on in two startling directions: (A) Large, flat wall screens. (B) Three-dimensional or partly 3-D images via holography. I have a bit of studying to do before I can expound these. I figure I have the time. ■

## SCHWARTZ, *continued*

effect on the self resonance of the ceramic element. The constant displacement generator, which represents the video signal, causes a constant force on the ceramic element at all frequencies below resonance.

The problem of wavelength response associated with the audio-disc method of a spherical tip scanning the groove modulation does not apply to the playback system described above. The limits of wavelength response in this system of video playback are probably related to the resolution of the vertical trailing edge of the stylus, and would be a function of the integrity of the intersection of the horizontal and trailing vertical planes of the stylus.

Because the stylus rides on the crests of the modulation the amplitude of the pressure change will not correspond directly to the amplitude of the modulation waveform. However, it must be remembered that video information is stored as frequency modulation, and that there is no need for the pressure variations to be the analog of the waveform modulation. As long as the frequency of the pressure-relief impulses corresponds to the recorded frequency the detected (demodulated) video waveform will not be distorted.

### VIDEO-DISC PLAYER

The video-disc player differs from the audio disc player in that the pickup is supported by an overhead carriage and not by the record, while the arm is driven radially by a gear and pulley arrangement. The disc itself is rotated by a spindle; there is no turntable. At a speed of 1,500 r.p.m. a cushion of air is formed between the thin record and the stationary platter. *Figure 4* shows the basic features of this mechanism. Positive drive of the pickup is required because of the low tracking force and the shallow groove. Since the pickup is fixed in place the disc is floated up to the stylus. The pickup's compliant mounting allows the stylus to track slight eccentricities. The disc takes on a slightly convex shape as it passes under the pickup. Little record wear takes place because of the light tracking force and the wider area contact of stylus and groove; it is claimed that the disc can be played 1,000 times before the signal-to-noise ratio begins to decrease. ■

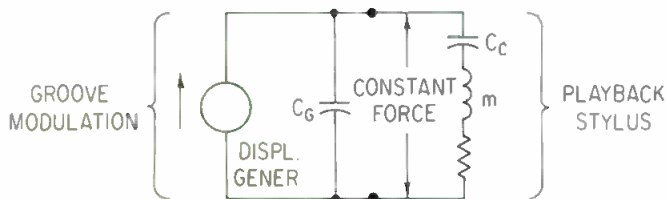

$C_G \equiv$  GROOVE COMPLIANCE

$C_C \equiv$  PRESSURE PICKUP COMPLIANCE

$m \equiv$  EQUIVALENT MASS OF CERAMIC ELEMENT

$$C_G \gg \gg C_C$$

Figure 3. The equivalent circuit of the video disc playback system.

Figure 4. The operation of the Teldec video disc player.

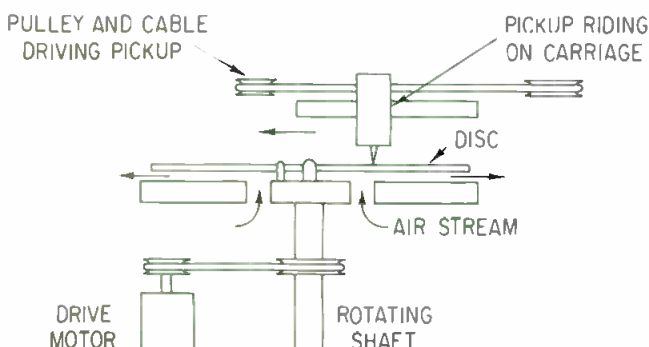

# Comprehensive!

## MICROPHONE PRE-AMPLIFIER

### Model 312



Transformer coupled input and output. Exceptionally low noise ( $-129$  dBm),  $+30$  dBm output capability with low distortion. Adjustable gain. Utilizes Model 2520 operational amplifier.

## LINE AMPLIFIER

### Model 325



Bridging input. Output capability greater than  $+30$  dBm. Adjustable gain, transformer coupled output. Can function as line amp, booster amp or "no loss" combining network. Utilizes Model 2520 operational amplifier.

In both components, the output transformers are unique, permitting simultaneous multiple outputs.

## SPECIAL PURPOSE AMPLIFIERS

### Models 330P, 330T, 330F, 330G

Models available for RIAA Phono, NAB Tape, and Magnetic Film. Low noise, adjustable gain, high output capability. Equalization adjustable.



330F provides both 18 and 35 mm. curves, externally selectable. Model 330G: Fixed frequency sine wave oscillator with up to  $+12$  dBm transformer coupled output. Utilize Model 2520 operational amplifier.

All are PC cards ( $2\frac{3}{4}$ " x  $4\frac{1}{2}$ " x  $1\frac{1}{2}$ "") permitting standard modular use. Power supply decoupling and reverse voltage protection are provided.

## CARD FRAMES • Models 411, 405



Eleven amplifiers mount in Card Frame Model 411,  $3\frac{1}{2}$ " high, 6" deep, and 19" wide. Five amplifiers mount in Card Frame Model 405, which is 10" wide.



**AUTOMATED PROCESSES, INC.**

35 CENTRAL DRIVE, FARMINGDALE, NEW YORK 11735 • 516-694-9212

In Canada: PERCEPTION INDUSTRIES, INC.

Circle 20 on Reader Service Card

# BOOKCASE

As a service to our readers we are pleased to offer these books from prominent technical publishers. All prices listed are the publishers' net. Shipping charges are included.

Use the coupon at the bottom of the page or give the complete title, author and coupon number. Be sure to indicate quantity on the special instructions line if more than one copy of a title is wanted. Full payment must accompany your order. We cannot ship c.o.d. Checks or money orders should be made payable to Sagamore Publishing Company, Inc. Because of the time required to process orders, allow several weeks for the receipt of books.

## Radio Broadcasting

*edited by Robert L. Hilliard.* Each of the five chapters has been written by a prominent educator with an extensive background of practical experience in commercial and educational broadcasting. 190 pages; 6 1/4 x 9 1/2; indexed; clothbound. **\$6.95**

Circle 2 on Coupon Below

## Radio Transmitters

*Gray and Graham.* Provides, in a logical, easy-to-understand manner, a working knowledge of radio transmitters for quick solution of problems in operation and maintenance.

1961. 462 pp. **\$16.00**

Circle 40 on Coupon Below

## Electronic and Radio Engineering, 4th Ed.

*Terman.* A thorough coverage, in easy-to-understand terms, of those principles and techniques which are the basic tools of the electronic and radio engineer. 1955. 1.078 pp.

**\$19.50**

Circle 39 on Coupon Below

## Radio Engineering Handbook, 5th Ed.

*Henney.* Prepared by a staff of specialists, this working manual of radio science provides information on each of the branches of radio engineering, with emphasis on working practice, final working formulas, dimensions, and actual useable circuits.

1959. 1.800 pp. **\$31.50**

Circle 36 on Coupon Below

## The Technique of the Sound Studio

*by Alec Nisbett.* This is a handbook on radio and recording techniques, but the principles described are equally applicable to film and television sound. 264 pages; 60 diagrams; glossary; indexed; 5 1/2 x 8 1/2; clothbound. **\$13.50**

Circle 1 on Coupon Below

## Passive Audio Network Design

*by Howard M. Tremain.* A complete and comprehensive guide to the design, construction, and testing of all types of attenuators, equalizers, and wave filters for the practicing audio technician or engineer. 288 pages; 5 1/2 x 8 1/2; softbound. **\$5.50**

Circle 5 on Coupon Below

## Transistors for Audio Frequency (Audio-Frequency Amplification)

*by Guy Fontaine.* 1967. This systematic and detailed treatment of the application of transistors in audio-frequency amplifiers shows how the published transistor characteristics are related to the principles of design. An ideal textbook or reference on the subject for engineers and advanced technicians. 384 pages; 5 1/2 x 8; illus.; clothbound. **\$7.95**

Circle 12 on Coupon Below

## Closed-Circuit Television Handbook

*by Leon Wortman.* Gives comprehensive detailed information about the field in an easy-to-understand presentation, suited to those who plan to use, install, and service cctv. 288 pages; 5 1/2 x 8 1/2; clothbound. **\$5.95**

Circle 18 on Coupon Below

## An Alphabetical Guide to Motion Picture, Television, and Videotape Production

*Levitan.* This all-inclusive, authoritative, and profusely illustrated encyclopedia is a practical source of information about techniques of all kinds used for making and processing film and TV presentations. Gives full technical information on materials and equipment, processes and techniques, lighting, color balance, special effects, animation procedures, lenses and filters, high-speed photography, and much more. 1970. 480 pp. **\$24.50**

Circle 35 on Coupon Below

## NEW EDITION

## Integrated Circuits

*Motorola.* This complete, authoritative volume of design and construction techniques for modern integrated circuits covers theory, thin-film techniques, diodes, transistors, thermal design, and other vital aspects.

1965. 373 pp. **\$13.75**

Circle 30 on Coupon Below

## Basic Bibliography of Science and Technology

*McGraw-Hill.* Important to the researcher, librarian, or student, this reference book lists and describes over 8,000 outstanding books in every scientific and technical field. A topical index organizes all subject headings into about 100 general categories enabling the reader to locate quickly the listings which pertain to his field of interest.

1966. 738 pp. **\$19.50**

Circle 34 on Coupon Below

## Noise Reduction

*Beranek.* Designed for the engineer with no special training in acoustics, this practical text on noise control treats the nature of sound and its measurement, fundamentals of noise control, criteria, and case histories. Covers advanced topics in the field.

1960. 752 pp. **\$19.50**

Circle 33 on Coupon Below

## The Audio Cyclopedia (2nd ed.)

*by Dr. Howard M. Tremain.* New and updated, here is the complete audio reference library in a single volume. It provides the most comprehensive information on every aspect of the audio art. This new edition includes the latest audio developments including the most recent solid-state systems and integrated circuits. It covers all subjects in the fields of acoustics, recording, and reproduction with more than 3400 related topics. Each topic can be instantly located by a unique index and reference system. More than 1600 illustrations and schematics help make complicated topics masterpieces of clarity. 1760 pages; 6 1/2 x 9-3/8; hardbound. **\$29.95**

Circle 20 on Coupon Below

## Circuit Design for Audio, AM/FM, and TV

*Texas Instruments.* Texas Instruments Electronics Series. Discusses the latest advances in electronic design and application which represent the results of several years research and development by TI communications applications engineers. Emphasizes time- and cost-saving procedures throughout. 1967. 352 pp. **\$14.50**

Circle 32 on Coupon Below

## Acoustics—Room Design and Noise Control

*by Michael Rettinger.* 1968. The enormous problems and hazards presented by noise are dealt within an orderly and practical manner. With many charts, graphs, and practical examples, the text covers the physics of sound, room acoustics, and design, noise and noise reduction. 392 pages; hardbound. **\$17.50**

Circle 21 on Coupon Below

Sagamore Publishing Company, Inc.

980 Old Country Road, Plainview, N. Y. 11803

Please send me the books I have circled below. My full remittance in the amount of \$..... is enclosed. N.Y. State residents add 5% sales tax.

1 2 3 4 5 6 7 8 9 10 11 12 13 14 15 16 17  
18 19 20 21 22 23 24 25 26 27 28 29 30 31 32  
33 34 35 36 37 38 39 40

Name .....

Street Address .....

City ..... State ..... Zip.....

Special Instructions .....

Canada and foreign: Add \$1.00 per book

**Acoustical Tests and Measurements**  
by *Don Davis*. Provide; a solid understanding of the entire subject of acoustical measurements; based on actual field test work, using commercial equipment. 192 pages; 5 1/2 x 8 1/2; hardbound. **\$6.95**

Circle 7 on Coupon Below

#### Television Broadcasting

*Chinn*. A practical, compact technical guide to the equipment, systems, facilities, good engineering practices, and operating techniques of television broadcasting. 1953. 695 pp. **\$17.00**

Circle 37 on Coupon Below

#### Handbook of Electronic Tables & Formulas, (3rd edition)

A one-stop source for all charts, tables, formulas, laws, symbols, and standards used in electronics. Includes an 8-page, full-color fold-out chart showing latest FCC allocations for the entire frequency spectrum. 232 pages; 5 1/2 x 8 1/2; hardbound. **\$5.50**

Circle 8 on Coupon Below

#### Handbook of Broadcasting, 4th Ed.

*Abbott and Rider*. This non-technical handbook sets forth clearly and thoroughly the fundamentals of radio and television broadcasting. Over 100 illustrations amplify the text.

1957. 531 pp. **\$9.50**

Circle 38 on Coupon Below

#### Electronic Musical Instruments

by *Richard H. Dorf*. Now in its third edition and sixth printing since its first appearance in 1954, this is considered the authority on electronic organs. 393 pages; 239 diagrams and photographs. **\$10.00**

Circle 19 on Coupon Below

#### Intermodulation and Harmonic Distortion Handbook

by *Howard M. Tremaine*. A complete reference guidebook on audio signal intermodulation and harmonic distortion. 172 pages; 5 1/2 x 8 1/2; softbound. **\$4.25**

Circle 9 on Coupon Below

#### Solid-State Electronics

*Hibberd*. A Basic Course for Engineers and Technicians. An extremely practical reference book for anyone who wants to acquire a good but general understanding of semi-conductor principles. Features questions to answer, problems to solve. 1968. 169 pp. **\$9.95**

Circle 31 on Coupon Below

#### Practical PA Guidebook: How to Install, Operate and Service Public Address Systems

by *Norman H. Crowhurst*. 1967. This book gives all the basics needed to become a successful PA operator, in any situation where the reinforcement, relay, or distribution of sound can provide a service. 136 pages; 6 x 9; illus.; softbound. **\$4.50**

Circle 15 on Coupon Below

## CLASSIFIED

Closing date is the fifteenth of the second month preceding the date of issue.

Send copy to: Classified Ad Dept.

db THE SOUND ENGINEERING MAGAZINE

980 Old Country Road, Plainview, New York 11803

Rates are 50c a word for commercial advertisements. Non-commercial and employment offered or wanted placements are accepted at 25c per word.

---

### FOR SALE

---

MODULES FOR ALL TYPES of applications. Discrete to thick film IC devices. Preamplifiers to power amplifiers. New Catalog with schematics, \$1.00. PM Electronics, Inc., Box 46204, Seattle, Washington 98146.

---

SEVEN NEW LANGEVIN EQ251A program equalizers, never used; \$160.00 each. Department H1, db Magazine, 980 Old Country Road, Plainview, N.Y. 11803.

---

SCULLY 8-TRACK, 18 months old. Complete with sync-master, remote control, etc. \$8500.00. (612) 521-7631

---

COMPLETE TAPE DUPLICATING SYSTEM. Convertible 8-track/4-track. One inch master and bin with ten 1/4-in. slaves. Reliable, trouble-free operation. Some support equipment available. Greatly reduced price. P.O. Box 65856 Los Angeles, Calif. 90065 Stn. 967

---

SCULLY TAPE RECORDERS — one to twenty-four track and model 270 auto players, many models in stock for immediate delivery. SCULLY LATHES — Previously owned and rebuilt. Variable or automatic pitch. Complete cutting systems with Westrex heads. MIXING CONSOLES — Custom designed using Wiegand Audio Lab modules. From \$7,000.00. Wiegand Audio Laboratories, 3402 Windsor Road, Wall, New Jersey 07719. Phone: 201 681-6443.

---

SOLID-STATE AUDIO PLUG-IN OCTAL (1" Dia x 2" H) modules. Mic preamps, disc & tape preamp-equalizers, tape bias osc. & record ampl., power amps & power supplies. Send for free catalog and audio applications. Opamp Labs., 172 So. Alta Vista Blvd., Los Angeles, California 90036.

---

WORLD FAMOUS DOLBY SYSTEM, used by virtually every major record company now available for home use. ADVENT Model 100 (\$250) and ADVOCATE Model 101 (\$125). Connect one of these devices to a good tape recorder and the recordings you make will have 90% (10dB) less noise than before. NOW you can make perfect copies at 3 3/4 ips. You cut tape costs in half, double uninterrupted recording time, increase dynamic range, reduce distortion, tape saturation and head wear—in short you will make recordings better and cheaper than you could at 7 1/2 ips.

Please write us. We will send information on these products and where to buy them. Advent Corp. Department AA, 377 Putnam Ave. Cambridge, Mass. 02139

---

### WANTED

---

16-INCH DISCS WANTED containing old radio programs, comedy, drama, childrens shows, news, mystery, etc. or taped copies of the discs. Don Maris, 1926 Cherokee Lane, Norman, Oklahoma 73069.

---

### EMPLOYMENT

---

PROFESSIONAL RECORDING PERSONNEL SPECIALISTS. A service for employers and job seekers. Call today! Smith's Personnel Service, 1457 Broadway, N.Y.C. 10036. Alayne Spertell 212 WI 7-3806.

---

SOUND RECORDING ENGINEER—with at least four (4) years experience in 16 and 8 track recording and mix-down techniques. Must be competent in recording session procedure, to work independently at any time. The latest and most sophisticated recording equipment and studio facilities have been installed and are in production. For immediate attention and interview, write or call: Mr. Donald Redinger, WRS Recording Studios, 210 Semple Street, Pittsburgh, Pennsylvania 15213. Phone (412) 683-6300.

---

SALESMAN & CO-PRODUCER for very unusual Sound Production house. Call on ad agencies and educational packagers. Creativity and ability to develop projects essential. Some familiarity with sound recording. Call 212-799-4800.

# PEOPLE, PLACES, HAPPENINGS

• RCA's line of professional audio equipment for sound reinforcing systems in auditoriums, stadiums and other large installations will be administered by the aural broadcasting products group in the RCA communications systems division, Camden, N.J., it was announced today. Byron E. Fincher, manager, radio station equipment products, said customers requiring the high-power speakers, amplifiers, and other equipment in the line could augment such sound systems with broadcast-type audio consoles, cartridge tape machines and related items. RCA professional audio equipment is marketed through a worldwide distributor organization. Mr. Fincher also announced that H. F. Mueller would continue as professional audio product administrator and as liaison with the distributors.



Kaylor

• Kenneth K. Kaylor is the new director of sales, audio-video systems division, Philips Broadcast Equipment Corp. Mr. Kaylor had been the company's regional sales manager in their North Hollywood office since 1967. Prior to that he held managerial marketing positions with Fairchild Camera and Instrument and CBS, Hollywood. The division's products include complete studio and mobile color t.v. broadcast equipment, closed-circuit t.v. systems, professional and commercial audio systems, and motion-picture projection and sound systems.

• The Federal Trade Commission has scheduled a hearing on April 13th on proposed trade regulations regarding the advertising of power output of sound power amplification equipment for home entertainment products. The FTC believes that the most reliable method of rating power output of an amplifier is by its r.m.s. or continuous power capability. In the absence of an industry standard the Commission

believes its proposed method will provide the consumer with a valid and meaningful basis for comparison. Interested parties are invited to present their data, views or arguments at the hearing in Washington.



• The magnetic products division of the 3M Company is expected to move into their new multi-million dollar research laboratory early this year. Located at the Company's 265-acre headquarters, the laboratory will concern itself with the division's Scotch Brand audible range, video, computer, and instrumentation product lines. The extensive facilities include climatically-controlled research areas, clean room facilities, environmental chambers as well as sound rooms for evaluation of consumer equipment. Mastering tapes can also be machine tested and provisions for testing and evaluating various video tape formulations are also included.

• Infonics, the Santa Monica based manufacturer of high speed tape duplicating equipment, has appointed Paul C. Lloyd to the position of over-all responsibility for quality assurance. Mr. Lloyd was director of quality control at the instrumentation tape recorder division of Leach Corp. and also held key quality control positions with Granger Associates and Varian Associates. In another action, William E. Johnston was named national service manager. He had held similar positions with StenoCord Corp., Nye Systems and Gray Mfg. Co.

• Ovation Records announces the production of a complete catalog of compatible quad records using the Electro-Voice Stereo-4 encoder/decoder system. Dick Schory, president of Ovation claims this is a breakthrough in recorded home entertainment especially since it is compatible with existing stereo equipment and has the ability of enhancing two-channel discs now on the market. The catalog will feature a broad variety of pop, jazz, rock, easy listening country and western, and r & b.

• Automated Processes Inc. is growing. They have added additional manufacturing facilities at 176 Central Ave. Farmingdale, N.Y. to manufacture their expanding line of audio components according to president, Louis Lindauer.

• Sound 80, the busy Minneapolis studio, now has disc mastering and record production facilities under the direction of Mike Wolsted and Bob Berglund, who recently joined the staff. Facilities include the first Neumann VMS 70 computerized solid-state mastering chain installed in the U.S. Their new building at 2709 E. 25th St. is coming along and should be ready for operation by this date.

• Edward C. Ittner Jr. has been named vice president, marketing and planning, of the recording automation group of Dictaphone Corp. it was announced by Claude H. Smith, group vice president. His responsibilities will include the over-all marketing and product planning of Scully and Metrotech division products. Ittner comes from GRT Corp. where he was vice president for marketing audio and video tape products.



Garmon

• Realignment of Altec Lansing, University Sound, and Intercommunication divisions under a single top management team was announced by LTV Ling Altec, Inc. This new division will headquarter at Anaheim, California and will be known as ALTEC with William F. Garmon as president. H. S. "Moe" Morris, who will retire as president of Altec Lansing will continue in the role of consultant to the new management. Others in the new management team include company veterans, W. H. Johnson, executive vice president; James J. Noble, senior vice president for engineering; Don Davis, vice president for marketing-industrial products; Don Palmquist, vice president for marketing-consumer and distributor products; and C. E. Van Liew as vice president-manufacturing.

# IF YOU DO ANYTHING WITH 1/4" TAPE, YOU CAN DO IT BETTER WITH REVOX

- Automated broadcast operations
- Scientific analysis
- On location mastering
- Tone or time changing
- Audio tape quality control
- Electronic music synthesis
- Noise analysis
- Film synchronization
- Radio telescoping
- Language laboratory
- Machine tool control
- Phonetic analysis
- Radio telemetry
- Industrial research
- Information retrieval
- Electrocardiography
- Making calibration tapes
- Tape mastering with SELFSYNC
- Data storage from digital computers

And that's a simple statement of fact.

From the moment it was introduced, the Revox A77 was hailed as a recording instrument of unique quality and outstanding performance. The magazines were unanimous in their praise. Stereo Review summed it all up by saying, "We have never seen a recorder that could match the performance of the Revox A77 in all respects, and very few that even come close."

So much for critical opinion.

Of equal significance, is the fact that the Revox A77 rapidly found its way into many professional recording studios.

But what really fascinates us, is that the A77 has been singled out to

perform some unusual and highly prestigious jobs in government and industry. The kinds of jobs that require a high order of accuracy and extreme reliability.

Take NATO (the North Atlantic Treaty Organization) for example. When they wanted a machine to standardize on, a machine that would lend itself to use in a wide variety of circumstances. And most importantly, a machine that was simple to use, the logical choice was the Revox A77.

Or take the governmental agency that wanted an unfailingly reliable tape machine to register and record satellite bleeps. The choice? Revox.

Or the medical centers that use

specially adapted A77's for electrocardiographic recording.

We could go on and on (see accompanying list), but by now you probably get the point.

No other 1/4" tape machine combines the multi-functioned practicability, unfailing reliability, and outstanding performance of a Revox.

If you have a special recording problem that involves the use of 1/4" tape, write to us. We'll be happy to help you with it.

And if all you want is the best and most versatile recorder for home use, we'll be glad to tell you more about that too.



**REVOX  
DELIVERS  
WHAT ALL  
THE REST  
ONLY PROMISE.**

Revox Corporation  
212 Mineola Avenue, Roslyn Heights, N.Y. 11577  
1721 N. Highland Ave., Hollywood, Calif. 90028  
In Canada: Tri-Tel Associates, Ltd., Toronto, Canada

Circle 11 on Reader Service Card

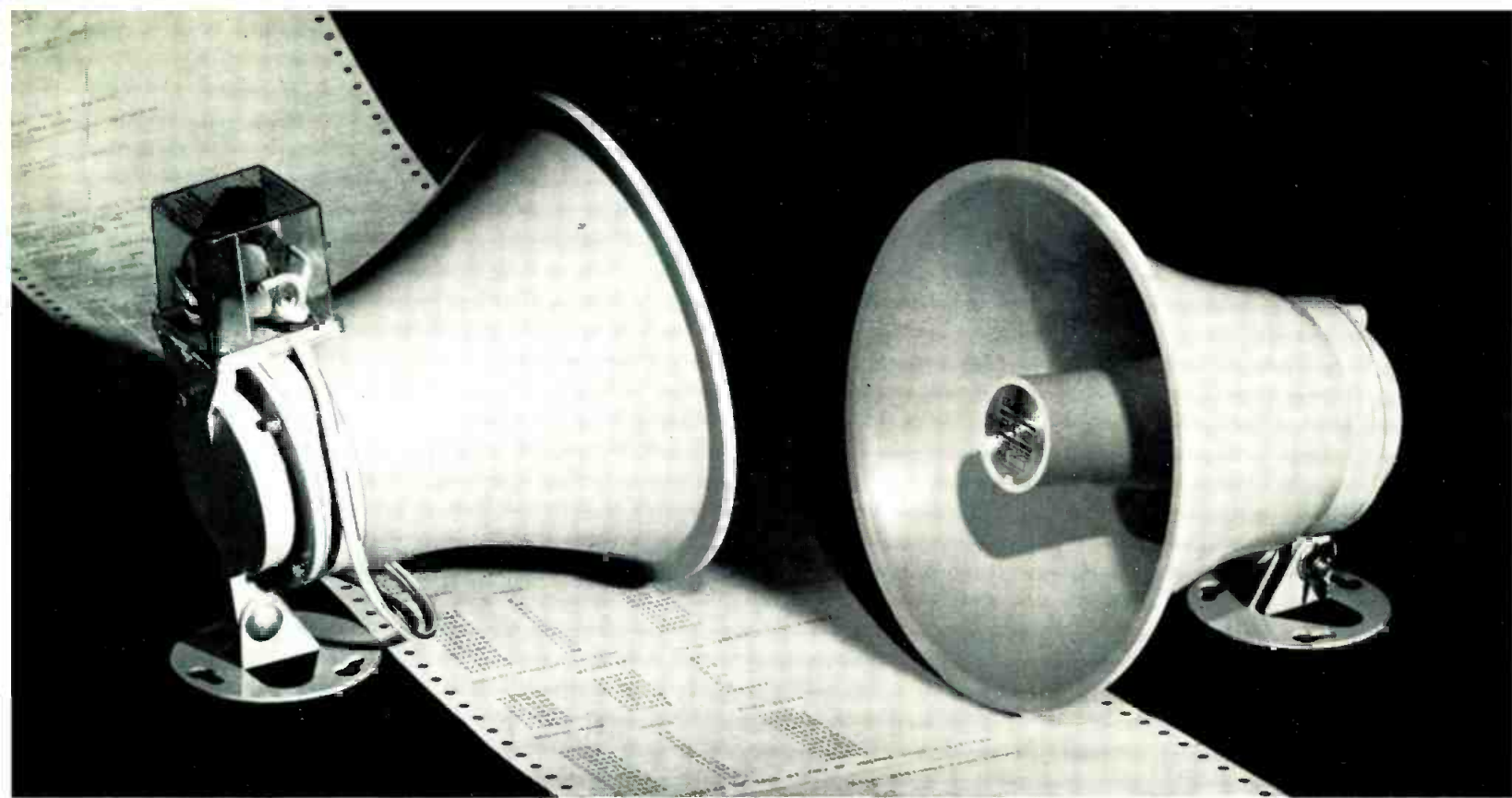

## Now that the new Electro-Voice PA12 is here...the competition is either underpowered, or overpriced...or both.

**E-V** The new E-V PA12 may not look very startling, but appearances can be deceiving. Because while it's priced with the lowest-cost U.S. made compression-driver reentrant horns, it performs like units costing as much as 28% more. Here's proof — in capsule form — gleaned from published data:

### High Efficiency Driver

Of course the engineering didn't stop with the new Implex horn. We are using a new Kapton voice coil form that is unusually rugged. Literally a space-age plastic unaffected by extremes of heat — or almost anything else! And a sophisticated new driver assembly that gets the

as the PA12 because it's vacuum-varnished to resist moisture, corrosion, and fungus. (\$7.25 List; Zone 2, \$7.60.)

### Comprehensive Spec Sheet

And wait until you see the spec sheet. An honest frequency response curve, plus complete octave band polar response information. Real, meaningful data that permits accurate layouts. And helpful nomographs to simplify power and distance calculations. It's all there.

### New Flush-Mounting PA12F

There's more. The new PA12F flush-mounting speaker. So shallow it fits between ceiling joists or wall studs. With a cast aluminum outer bell finished in neutral Mesa tan. Electrically similar to the PA12. 6" diameter and 3-7/16" deep to back of flange. \$33.00 List; Zone 2, \$34.50.



All told, the PA12 and PA12F reflect a most businesslike approach to paging. With advantages in performance and cost that can help you on every installation. Your E-V distributor can arrange a demonstration, or write us today for details. But do it soon. Your competition won't wait!

ELECTRO-VOICE, INC., Dept. 116BD  
686 Cecil Street, Buchanan, Michigan 49107

**Electro-Voice**<sup>®</sup>

a GULTON subsidiary

Specification	E-V PA12	Competitor 1	Competitor 2
Power Handling .....	12 watts	6 watts	10 watts
Dispersion .....	130°	125°	120°
Sound Pressure Level (at 4' on axis with full rated power) .....	119 db	112 db	119 db
Horn Diameter .....	7-1/2 in.	6-1/4 in.	7-13/16 in.
List Price .....	\$27.00 (Zone 2: \$28.40)	\$29.25	\$34.60

### Computer Calculated Horn

The PA12 is indeed better. But frankly, we could hardly help ourselves. Our design goal was simply the creation of a good, new, low-cost paging speaker. But to save time we first developed a computer program to help in the usually tedious and often inexact layout of the reentrant horn.

The computer not only saved time (and money) but gave our engineers the tool needed to create a significantly superior horn. With much better response at the extremes of the range, plus a smoother, peak-free curve, and higher efficiency.

most from every ounce of ferrite magnet.

All this adds up to higher intelligibility, higher efficiency, and better value than you have come to expect for the price. Which means that even on competitive bids you can afford to specify better sound without reducing your profit.

### Vacuum-Varnished Transformer

But the PA12 has more going for it than sound. For instance the TR-12 25-volt (or 70.7-volt) transformer. Simple to attach. Easy to check settings in its transparent snap-on case. Quick to adjust with push-clip terminals. And just as reliable

high fidelity systems and speakers • tuners, amplifiers, receivers • public address loudspeakers  
• microphones • phono cartridges and styli • aerospace and defense electronics

Circle 12 on Reader Service Card

www.americanradiohistory.com