

The Sound Engineering Magazine

# SE

JANUARY 1968 60¢

## Sound Reinforcement

PLUS  
a report on Crolyn tape



INTERNATIONAL  
-ELECTROACOUSTICS INC  
333 6TH AVE  
NEW YORK N Y 10014

# WHAT YOU DON'T SEE IS OUR BEST PRODUCT... THE SOUND OF KOSS

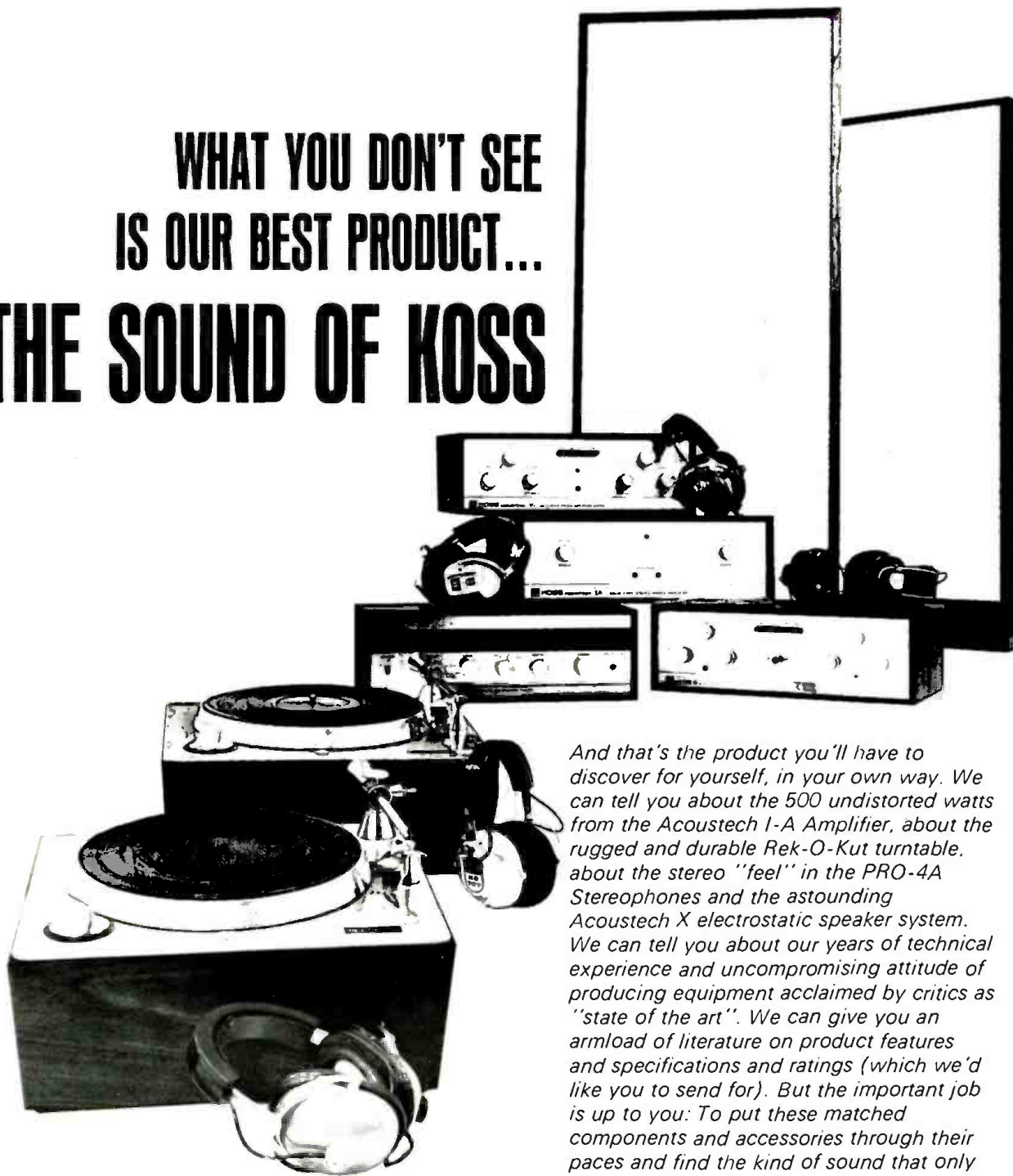

*And that's the product you'll have to discover for yourself, in your own way. We can tell you about the 500 undistorted watts from the Acoustech I-A Amplifier, about the rugged and durable Rek-O-Kut turntable, about the stereo "feel" in the PRO-4A Stereophones and the astounding Acoustech X electrostatic speaker system. We can tell you about our years of technical experience and uncompromising attitude of producing equipment acclaimed by critics as "state of the art". We can give you an armload of literature on product features and specifications and ratings (which we'd like you to send for). But the important job is up to you: To put these matched components and accessories through their paces and find the kind of sound that only someone like you can detect. Happy Hunting.*

*Equipment shown (clockwise from lower left): Koss Pro-4A Stereophones, \$50.00; Rek-O-Kut B12-H turntable with S-320 tonearm, \$199.95; Koss KO-727 Stereophones, \$34.95; Rek-O-Kut B-12GH with S-320 tonearm, \$144.90; Acoustech VIII tuner, \$349.00; Koss K-6 Stereophones, \$26.50; Acoustech I-A power amplifier, \$395.00; Acoustech V-A integrated control amplifier, \$399.00; Koss PRO-600A (600 ohm) Stereophones, \$55.00; Acoustech X electrostatic speaker system, \$1690.00; Koss SP-3XC Stereophones, \$24.95; Acoustech VI pre-amp control center, \$249.00.*

**KOSS** KOSS ELECTRONICS INC.

2227 N. 31st Street Milwaukee, Wisconsin 53208  
Export Cable: STEREOFONE/Koss-Impetus  
2 Via Berna/Lugano, Switzerland

Circle 25 on Reader Service Card

# Coming Next Month

● February's **db** will explore several aspects of the highly complex problem of microphones.

Albert B. Grundy has prepared an article that unravels the complicated problem of specification and measurement of condenser microphones.

Robert Schulein of Shure Brothers, Inc. is writing under the title Microphone Specifications, Microphone Loading: What Do They Really Mean? This will be an in-depth discussion of microphone level specifications and will show why common forms of level measurement are not always accurate and sometimes are misleading. Part of this article will cover microphone loading considerations for the various types of microphone in common use.

And FEEDBACK LOOP columnist John McCulloch will examine microphone acoustical problems and polar patterns.

Plus the next installment of George Alexandrovich's HANDBOOK, THE FEEDBACK LOOP, NEW PRODUCTS AND SERVICES, PEOPLE, PLACES, HAPPENINGS — and more.

Next month in **db** The Sound Engineering Magazine.

# About the Cover

● The story of an interesting system that was — and is no more. Shown is the main control room of the Czech pavilion at the recent Expo 67. The equipment is by Philips and it is discussed along with other sonic and visual features of the fair on page 16.

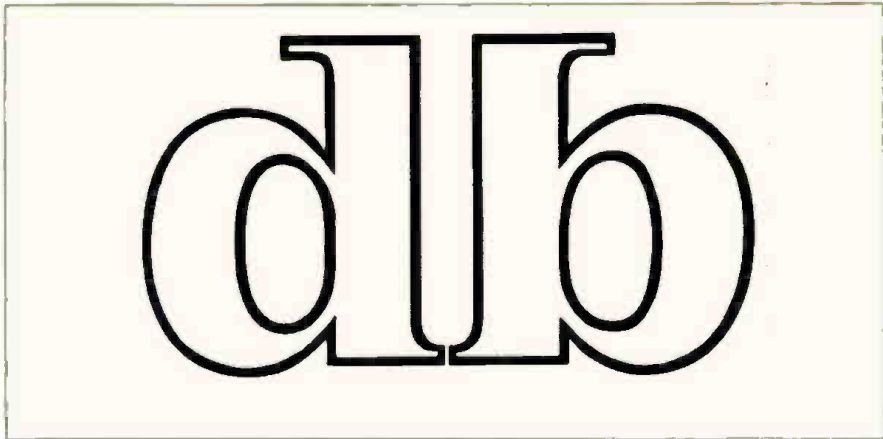

January 1968 · Volume 2, Number 1

## Table of Contents

Sound Reinforcement at Expo 67 <i>Martin Dickstein</i>	16
Speaker Impedance Matching in Sound Systems <i>J. F. Walthier</i>	21
Creative Sound in the Legitimate Theater <i>Robert J. Kerr</i>	24
Crolyn Tape: Does it Solve Problems? <i>Larry Zide</i>	28

## Departments

The Feedback Loop <i>John A. McCulloch</i>	2
Letters	6
The Audio Engineer's Handbook <i>George Alexandrovich</i>	8
New Products and Services	30
Classified	31
People, Places, Happenings	32

## SALES OFFICES

### New York

980 Old Country Road  
Plainview, N.Y. 11803  
516-433-6530

### Chicago

Gerald L. Taylor  
333 N. Michigan Ave.  
Chicago, Illinois 60601  
203-332-7683

### Denver

Roy McDonald Associates, Inc.  
846 Lincoln Street  
Denver, Colorado 80203  
303-825-3325

### Houston

Roy McDonald Associates, Inc.  
3130 Southwest Freeway  
Houston, Texas 77006  
713-529-6711

### Tulsa

Roy McDonald Associates, Inc.  
2570 S. Harvard Ave.  
Tulsa, Oklahoma 74114  
918-742-9961

### Dallas

Roy McDonald Associates, Inc.  
Semmons Tower West  
Suite 411  
Dallas, Texas 75207  
214-637-2444

### San Francisco

Roy McDonald Associates, Inc.  
625 Market Street  
San Francisco, California 94105  
415-397-5377

### Los Angeles

Roy McDonald Associates, Inc.  
1313 West 8th Street  
Los Angeles, California 90017  
213-483-1304

### Portland

Roy McDonald Associates, Inc.  
2035 S.W. 58th Avenue  
Portland, Oregon 97221  
503-292-8521

**Robert Bach** PUBLISHER

**Larry Zide** EDITOR

**Bob Laurie** ART/PRODUCTION DIRECTOR

**Marilyn Gold** COPY EDITOR

**Charles N. Wilson** ASSISTANT EDITOR

**Richard L. Lerner** ASSISTANT EDITOR

**A. F. Gordon** CIRCULATION MANAGER

**David Pollens** ASST. CIRCULATION MGR.

## Editorial Board of Review

**George Alexandrovich**

**Sherman Fairchild**

**Norman Anderson**

**Prof. Latif Jiji**

**Philip C. Erhorn**

**Daniel R. von Recklinghausen**

**Paul Weathers**

**db**, the Sound Engineering Magazine is published monthly by Sagamore Publishing Co., Inc., 980 Old Country Road, Plainview, L. I., N.Y. 11803. Telephone: (516) 433-6530. Entire contents copyright 1968. Subscriptions are issued to qualified individuals and firms in professional audio. Application must be made on an official subscription form or on a company letterhead. Interested non-qualified readers may subscribe at \$5.00 per year (\$6.00 per year outside U.S. Possessions, Canada, and Mexico). Single copies are 60¢ each. Controlled circulation rates paid at N. Abington, Mass. 02351. Printed in U.S.A. at North Abington, Mass. Editorial, Publishing, and Sales Offices: 980 Old Country Road, Plainview, New York 11803. Postmaster: Form 3579 should be sent to above address.



# The Feedback Loop

—JOHN A. McCULLOCH

## Single Coil 'Locking' Relay

● In the construction of new facilities or the modification of existing ones, a circuit is desired to remotely control or actuate several lines or pieces of equipment. In addition it is desirable to control the switching device with a *push-on push-off* momentary contact.

The normal method of allowing a single momentary contact to both turn-on and turn-off is accomplished with the use of a latching type of relay. This is a sizable (comparatively), double-coil device. Because of space requirements ABC-TV required a method of energizing and holding a single coil, and upon re-making the same contacts, dropping out the relay.

The single contact switch may be paralleled by as many duplicating switches as required, remembering that *any* button being energized will alter the state of the relay. Also switch 2 (sw 2) may be inserted in the circuit to permit remote cut-off only. Remote lock-off may be obtained by making this switch a positive-action switch, rather than momentary contacts.

The procedure for selecting resistors ( $R_1$ ) and ( $R_2$ ) is as follows:

1. Determine the d.c. resistance of the relay coil to be used.
2. Select  $R_1$  and  $R_2$  to equal a convenient value about  $2\frac{1}{2}$  times the coil resistance.
3. Determine the wattage necessary for  $R_2$ , as that is the holding resistor and will draw the same current as the coil as long as the coil is energized.

A value of approximately  $\frac{1}{3}$  the coil resistance is chosen for resistor  $R_3$ . A smaller value would permit faster recycling of the relay, but the surge current drawn when the relay is turned-off could damage the contacts. With *high* rated contacts (10 amperes) I have used as low a value for  $R_3$  as 20 per cent of the coil resistance. The procedure given for  $R_3$  is an approximation, and should the resistance chosen not provide positive turning-off action of the relay, a lower value should be

tried. It is suggested that the highest value consistent with the action of the relay in turning-off be selected to give as much life to the contacts as possible.

The value of the capacitor ( $C_1$ ) should be chosen to hold a sufficient charge to supply the relay during pull-in operation. A typical value might be 500 mfd at 50 V. for a 24-28 V. relay system.

### Dynamic Microphone Overload

In a recently published article the following statement is made:

"...the transistors are not overloaded. This is not a very serious problem when dynamic microphones are used, because their output is normally about  $-60$  dBm and does not rise higher than about  $-35$  dBm."

This statement points out a great fallacy in some users' understanding of the dynamic microphone. How many times have I heard a mixer, when listening to a playback, say, "listen to that dynamic microphone overload."

A properly designed dynamic microphone will not overload under any reasonable level. But, just what constitutes a reasonable level?

During the design and construction of the dynamic element, it is desirable to permit the maximum amount of movement possible without causing a loss of output level, or adding excessive mass to the coil or diaphragm. If the limit is set, such that the diaphragm will not touch or bottom until a certain sound level or pressure is exceeded, then any sound pressure up to this limit will not cause the microphone to overload and produce distortion of the waveform.

How can this be proved? And is it reasonable to expect a sufficiently high limit of sound pressure before bottoming in the microphone, so that it will not overload at our "reasonable level"?

I do not know exactly what procedures are used by other manufacturers, but at E-V each microphone design is checked with a 60 Hz sine wave in a closed cavity, at a sound pressure of 130 dB. It is mandatory that the microphone reproduce a clean sine wave at this level. Additional checks are made at higher levels, and at different frequencies to prove out the design under consideration. In addition, each professional microphone, as part of its manufacturing process is subjected to the same 60 Hz—130 dB S.P.L. test, with the result being observed on an oscilloscope. The waveform must be clean or the particular unit microphone is rejected and scrapped.

A properly designed dynamic micro-

phone thus will not overload under any reasonable level (130 dB S.P.L.).

What does this mean to the mixer in his use of the microphone? It means that for any musical pickup the microphone will perform with a clean pickup of the instrument or voice. The distortion we may experience is now due to the high (but clean) output of the microphone overloading the *input stage of the first amplifier*.

How is a microphone, rated at  $-55$  dBm, going to overload a preamplifier with a maximum rated input of  $-22$  dBm? (I am using the RCA BA-31 as an example.) First—the microphone is rated by applying a signal level, that being equal to 94 dB S.P.L. Second—the input rating of the amplifier is the absolute maximum input before overload is encountered. Unlike tube amplifiers that had a few dB leeway, and gave a small warning in slightly increased distortion, the typical transistor unit will reproduce a clean signal when fed with a sine wave at  $-22$  dBm, and a clipped, distorted signal when hit with  $-20$  dBm. Again, unlike the tube amplifier which had a soft shoulder the transistor amplifier will evidence sudden, severe distortion when subjected to overload. There is no safety margin and so one must be created by the user.

In a typical session of today's sound, the instruments are loud, and the vocals often screaming. For maximum separation and reduction of acoustical phase distortion, the mixer is forced to place the microphones close, often within a few inches. With this type of pickup, the impact to the diaphragm is often on the order of 120 to 125 dB S.P.L. average level, and hard hits, or 'beats' can push this to 130 dB S.P.L.

With this kind of level, let's re-examine the output of the microphone. The typical  $-55$  dBm rated microphone can, in these cases, put out a signal of  $-19$  dBm, . . . 3 dB over the maximum rated input of the amplifier! Should the output of the microphone be merely

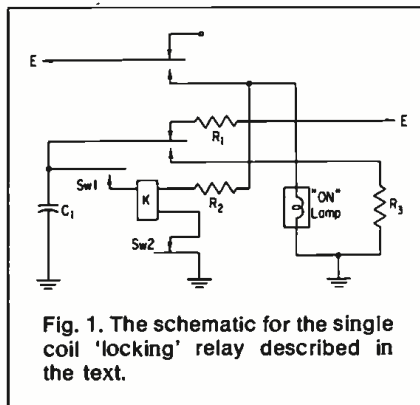

Fig. 1. The schematic for the single coil 'locking' relay described in the text.

# Introducing The Exciting New Look of HEATHKIT® Instruments

The most exciting innovation in electronic instrumentation is the new ultra-functional styling format from Heath. New instruments from Heath feature a cabinet frame consisting of the front and rear panels and side rails which completely support the component chassis independently of the top and bottom cabinet shells. This allows complete freedom for assembly, checkout, and calibration. The sturdy side rails conceal retractable carrying handles. The die-cast front panel bezel styled in chrome and black, the back side rails, and the beige front panels and cabinet shells give the new instruments an appearance as up-to-date as their functional performance. See these new instruments and more in the new 1968 Heathkit catalog.

**A NEW! Deluxe Solid-State Volt-Ohm Meter . . . Battery Plus Built-In AC Power** Features 8 DC and 8 AC voltage ranges from 0.5 v. to 1500 v., full scale; 7 ohmmeter ranges x1 (10 ohms center scale), x10, x100, x1k, x10k, x100k and x1 megohm; 11 megohm input resistance on DC ranges; 1 megohm on AC ranges; internal battery or 120/240 v., 50/60 Hz AC power for portable or "in-shop" operation; large, easy-to-read 6" 100 uA meter; separate switches for individual functions; single test probe with finger-clip flip switch for all measurements; simple circuit board construction. Kit IM-16, no money dn., \$5 mo. \$44.95; Wired IMW-16, no money dn., \$7 mo. \$64.95

**B Solid-State High Impedance Volt-Ohm-Milliammeter** All silicon transistors plus FET's. Features 9 AC and 9 DC voltage full scale ranges down to 150 mv; 11 current ranges from 15 uA to 1.5A full scale; 7 resistance ranges (10 ohms center scale) measure one ohm to 1000 megohms; AC plus battery power for portability; 6" 200 uA meter with zero center scale for + & - voltage measurements without switching; accuracy of  $\pm 3\%$  full scale on DC volts,  $\pm 5\%$  on AC volts; separate range switches for each function; 1% precision resistors; 10-turn thumbwheel zero adjustment; fast circuit board construction. 10 lbs. Kit IM-25, no money dn., \$8 mo. \$80.00; Wired IMW-25, no money dn., \$11 mo. \$115.00

**C NEW FM Stereo Generator For RF, IF and FM Stereo Alignment** Produces virtually all signals for trouble-shooting & aligning multiplex adapters, FM tuners and receivers. Generates mono FM or composite stereo FM signals. Crystal-controlled 19 kHz ( $\pm 2$  Hz) pilot signal, adjustable from 0 to 10%; for checking tuner lock-in range. Switch-selection of 400 Hz, 1000 Hz, 5000 Hz, 19 kHz, 38 kHz, and 65 kHz or 67 kHz SCA signals for complete alignment capability. 100 MHz sweep signal (adjustable  $\pm 2$  MHz) for overall RF and IF alignment. Built-in crystal controlled marker oscillator for IF and dial tracking checks. Phase test capability. No balance adjustment needed for equal right and left channel modulation levels. Kit IG-37, no money dn., \$8 mo. \$79.95

**D NEW Variable Regulated High Voltage Power Supply** Features new 6 v. and 12 v. AC filament voltages; also furnishes B+ from 0 to 400 volts DC, bias from 0 to -100 volts DC; separate panel meters monitor B+ output voltage & current; voltmeter switched to read C-volts; output terminals isolated for safety; high voltage and bias may be switched "off" with filaments still "on" for maximum testing efficiency and safety. Kit IP-17, no money dn., \$6 mo. \$59.95; Wired IPW-17, no money dn., \$9 mo. \$89.95

**E NEW Solid-State Regulated Low Voltage Power Supply** New Zener reference-voltage power supply. New up-dated circuit that is virtually immune to overload from exotic transients. Relay-protected against short circuit & overload. Provides 0.5 to 50 volts DC with better than  $\pm 15$  millivolts regulation. 4 current ranges: 50 mA, 150 mA, 500 mA & 1.5 A. Adjustable current limiter: 30 to 100% on all ranges. Panel meter shows output voltage or current. Choice of kit or assembled versions. Kit IP-27, no money dn., \$8 mo. \$76.95; Wired IPW-27, no money dn., \$11 mo. \$119.95



## FREE 1968 CATALOG

Describes these and over 300 kits for stereo/hi-fi, color TV, amateur radio, shortwave, test, CB, marine, educational, home and hobby. Save up to 50% by doing the easy assembly yourself. Mail coupon or write Heath Company, Benton Harbor, Michigan 49022.



HEATH COMPANY, Dept. 74-1  
Benton Harbor, Michigan 49022

Enclosed is \$ \_\_\_\_\_, plus shipping.

Please send model (s)  
 Please send FREE Heathkit Catalog.  
 Please send Credit Application.

Name \_\_\_\_\_ (Please Print)

Address \_\_\_\_\_

City \_\_\_\_\_ State \_\_\_\_\_ Zip \_\_\_\_\_

Prices & specifications subject to change without notice.

TE-170

Circle 28 on Reader Service Card

db January 1968

3



# start with SUPER SOUNDS FAIRCHILD



New FAIRCHILD 42 input TV Network Mixer.

## FAIRCHILD REVERBERATION SYSTEMS...

Now FAIRCHILD has created two electro-mechanical reverberation systems that produce a sound termed by recording studio mixers—the experts who know what they hear—as “extremely natural sound possessing the quality of good acoustical reverb chambers.” The two models differ more in their flexibility and cost rather than in reverberation effect.

### MODEL 658A

The 658A is a complete solid state reverberation system with electronically controlled reverb time adjustments up to 5 seconds; mixing control for adjustment of reverberated to non-reverberated signal ratios; reverb equalization at 2, 3 and 5 KHZ. Size: 24 1/2 x 19"



### MODEL 658B

Compact, reverberation system for the 'big' sound in a small space. Contains reverb equalization in mid and low frequency range; level control; solid state design. Size: Only 5 1/4 x 3 x 10" deep.



The “sound” of the Model 658A and 658B REVERBERTRONS will satisfy the most demanding audio engineer. Their pricing and size makes them even more appealing.



## FAIRCHILD CONAX

The world-accepted standard to control high frequency spillovers due to pre-emphasis. Maintain high levels even with brass and crashing cymbals in FM and recording.

Write to FAIRCHILD — the pacemaker in professional audio products — for complete details.

## FAIRCHILD COMPACT COMPRESSOR MODEL 663

Allows creation of those up tight levels that contribute materially to presence and loudness combined with overload protection. The FAIRCHILD Model 663 Compact Compressor produces no distortion despite the amount of compression used... no thumps, no noise. The 663 provides adjustable release time and up to 20 db of compression. Model 663 NL comes with unity gain and additional gain if needed with +18 dbm output.



## FAIRCHILD PROGRAM EQUALIZER MODEL 664NL



An ideal no loss equalizer for broadcast and recording. The FAIRCHILD Model 664NL allows the production of the “hot, solid commercial” sound standard with major recording studios; transforms any conventional console into ‘Big Board sound’. 1 1/2" x 5 1/4" high unit provides equalization up to 10 db at 4, 6, 8, 10, or 15 KHZ and low end equalization up to 10 db. Rolloffs also provided. The Model 664NLB has equalization at 2, 3, 4, 5, and 7.5 KHZ for motion picture demands. The FAIRCHILD Program Equalizer contains equalization plus 18 dbm amplifier output. Put life into your sound with the FAIRCHILD Equalizer.

## FAIRCHILD LIMITER MODEL 670

Fast attack Stereo Limiter (50 microseconds) with low distortion and absence of thumps. Sum and difference limiting position eliminates floating stereo image. Includes regular channel A and B limiting. Dual controls, dual meters provided. Used throughout the world. Flexible release times make it indispensable in stereo recording and broadcasting.

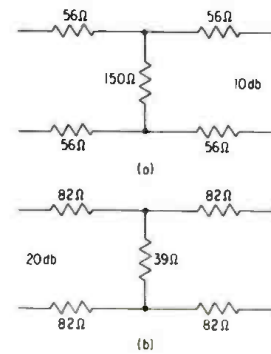
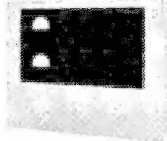

Fig. 2. Balanced H pads designed for 150-ohms impedance. (a) shows the values for a 10 dB loss; (b) shows 20 dB.

equal to the maximum input of the amplifier, what is going to keep it at this level, and what has happened to the musical transients? The solution is simple, reduce the input level to the amplifier. Now we have our safety margin.

Some consoles are providing input attenuation, by means of selectable pads, in line, before the first amplifier. If your console does not have such a device, a single pad (switchable to preserve signal-to-noise ratio when you do not need the reduction) can be purchased in fixed units of reduction, either for in-console or as plug-in devices in the microphone line. In FIGURE 2, values for a 10 dB and a 20 dB symmetrical, balanced H pad designed for impedances of 150 ohms are shown. To change impedance for your system, multiply the values given by the ratio of the desired impedance match divided by 150 (Z/150).

The selection of the proper amount of padding necessary is sometimes difficult, as it is desirable to maintain as high an input level to the amplifier as possible. This will preserve a good signal-to-noise ratio, and still maintain a margin for peaks and transients. I have found, for me, a good margin, by allowing 10 dB above the loudest planned input, and padding to the nearest convenient point.

When you are first getting to know a console and the various microphones, as well as a new microphone technique, it might be useful to utilize a wide range VU meter (−60 dBm to 0 dBm or above) to analyze the various input levels you are encountering.

In conclusion, if you have distortion due to overload (or suspect it) first check the input level to the amplifier, either by measuring or by heavily padding. If distortion still occurs, then suspect a damaged dynamic microphone.

# FAIRCHILD

RECORDING EQUIPMENT CORPORATION  
10-40 45th Ave., Long Island City 1, N. Y.

# Jensen CALSTAR\* COLUMN SPEAKERS

CALSTAR *Controlled-Angle Lobe-Suppressed Twin-Array Reproducers* are the result of an exhaustive study of directional sound radiation by Jensen engineers. In a CALSTAR column, an array of small woofers, covering the lower frequency range, is combined with a shorter array of tweeters covering the high frequency range (where the polar sharpening would otherwise become severe). Next, the signal distribution to each element is "tailored" so that the effective array length decreases as the frequency increases. The final result is a column design in which the vertical coverage angle is unusually constant for all frequencies and therefore exceptionally uniform sound quality and high speech intelligibility are achieved throughout the audience area. The exact signal distribution at each frequency provided by the pattern shaping networks has also been chosen to suppress unwanted side lobes.

Write for Specification Sheet No. CSP-114, and for Jensen technical bulletin #45 "Speaker System Layout is Easy with Jensen Iso sonic Contour Charts."

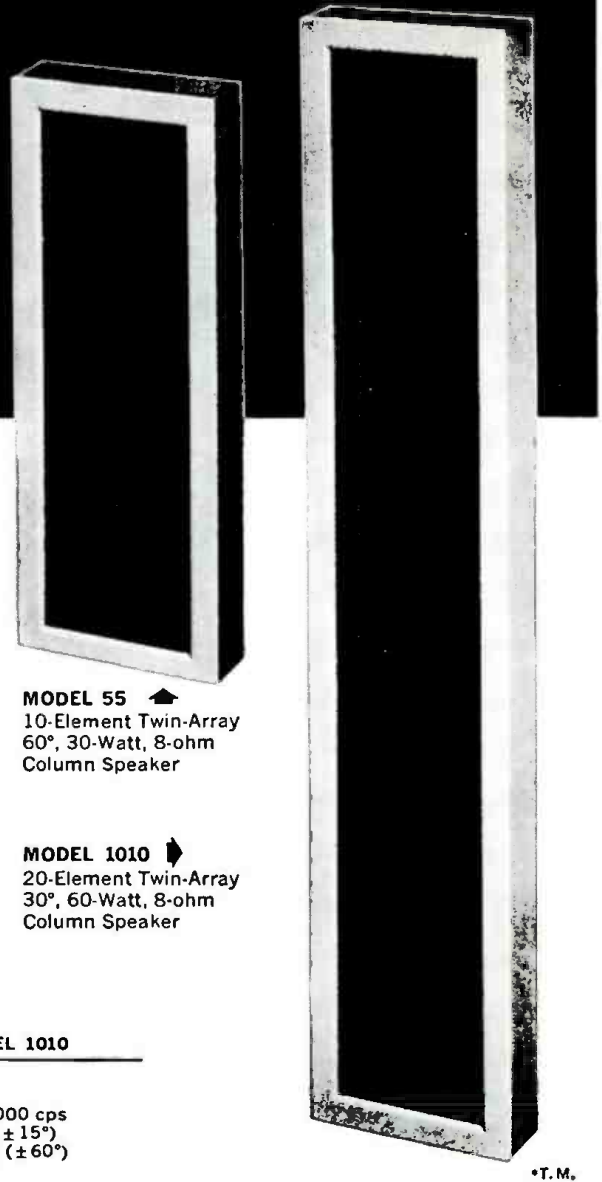

**MODEL 55** ↑  
10-Element Twin-Array  
60°, 30-Watt, 8-ohm  
Column Speaker

**MODEL 1010** ↓  
20-Element Twin-Array  
30°, 60-Watt, 8-ohm  
Column Speaker

\*T.M.

## TECHNICAL SPECIFICATIONS

MODEL 55			MODEL 1010			
8 ohms	.....	Input Impedance	.....	8 ohms		
30 watts	.....	Power Rating <sup>1</sup>	.....	60 watts		
100-10,000 cps	.....	Frequency Range	.....	100-10,000 cps		
60° total (±30°)	.....	Vertical Coverage	.....	30° total (±15°)		
120° total (±60°)	.....	Horizontal Coverage	.....	120° total (±60°)		
20 db	.....	Lobe Suppression <sup>2</sup>	.....	20 db		
2000 cps	.....	Crossover Frequency	.....	2000 cps		
30"H, 11½"W, 3¾"D	.....	Dimensions	.....	56¾"H, 11½"W, 3¾"D		
Sensitivity Table <sup>3</sup>						
25'	50'	100'	Input Power, watts	25'	50'	100'
90.0	84.0	78.0	5	94.5	88.5	82.5
92.0	86.0	80.0	7.5	96.5	90.5	84.5
93.0	87.0	81.0	10	97.5	91.5	85.5
95.0	89.0	83.0	15	99.5	93.5	87.5
96.0	90.0	84.0	20	100.5	94.5	88.5
98.0	92.0	86.0	30	102.5	96.5	90.5
—	—	—	60	105.5	99.5	93.5

1. Maximum speech and music level as indicated by VU meter. (Peak power is substantially higher.)
2. Maximum level outside main lobe relative to main lobe intensity.
3. Axial free field sound pressure level at listed distance (db above .000204 dynes/sq. cm.) in 800-1250 cps warble frequency band.

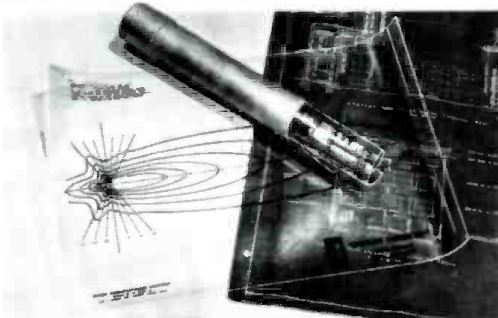

Jensen Iso sonic Contour Charts for CALSTAR Column Speakers. Large 14" x 20" transparent plastic templates; set of two in mailing tube with full instructions — \$1.00 postpaid.

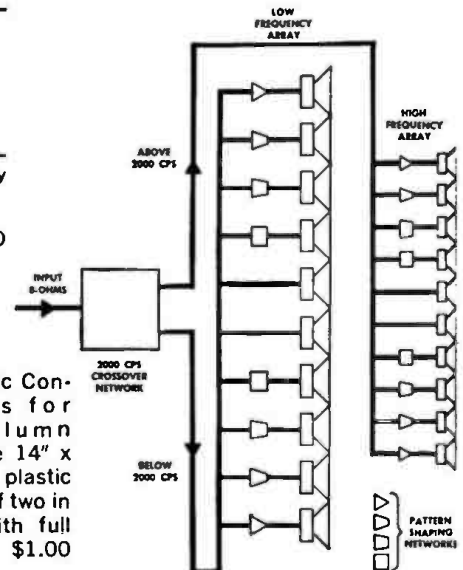

Jensen Manufacturing Division, The Muter Company, 6601 South Laramie Avenue, Chicago, Illinois 60638

Most compact, portable, reliable professional audio recorder ever made!



That's what our engineers call the AG-600. And you know they speak the truth!

If you know any recorder by name, it's probably our 600 Series. 35,000 professionals have used it during its 13-year history. Now we've completely revamped it: new compact solid-state electronics; new two-speed improved die-cast transport; improved clutch system; 3-digit tape counter (at last!); choice of head configuration, 1- or 2-channel, full-track, half-track, two-track or quarter-track, stereo or mono; portable or rack-mount editions.

And so it sounds as good as you recorded it . . .



buy the AA-620 speaker-amplifier.

Whether you want to do on-location monitoring or build a nutshell studio, this is the unit to choose: 20 watts of solid-state output; 2 speakers in tuned enclosure with crossover network that give essentially flat acoustical response from 65 Hz to 10 kHz; amplifier with separate bass/treble step equalizers is system-matched to its speakers; case matches that of the AG-600 recorder (but the electronics match any professional-quality recorder); rack-mount version needs only 12 1/4" vertical space.

And while you're at it, get a great stereo/mono mixer, too!



Solid state, only 19 x 3 1/2 x 9 1/2", the AM-10 mixer gives you extreme versatility for stereo/mono applications. 6 positions, 2 channels; handles up to 4 microphones and 2 lines, or 6 mikes with accessory preamps, each of which can separately feed channel A, B, or both; S/N ratio is -122 dbm, input terminated; output to 600 ohm line at +4 dbm; can be used with all professional recorders or as a studio mixer.

Details? Prices? More information? Write Leon Wortman, 401 Broadway, Redwood City, California 94063.

# AMPEX

Career opportunities? Write Box D, Redwood City, California 94064.

Circle 31 on Reader Service Card

# Letters

## Measurement Techniques

The Editor:

I have just received my first issue of your new magazine entitled *db*, and permit me to congratulate you on such a fine publication. Having been in the professional audio field since 1945 (and interested in it since some time before that) I can see the need for such a publication. Most of the other audio publications (and I am sure you know them) have gravitated more and more toward the audio consumer and record reviews so that there is a hole in the audio engineering publications field. I wish you success.

I would like to offer a few comments on the article written by Mr. Norman Crowhurst entitled *Measurement Techniques and Standards*. Mr. Crowhurst described the proper system for measuring the gain and frequency response of an amplifier, using that from EIA Standard RS-219. This in turn was derived from a paper by W. L. Black and H. H. Scott which was in *Proceeding of IRE*, October 1949 and also in *Audio Engineering Magazine* for October and November 1949.

Mr. Crowhurst makes the point that the insertion gain as measured by the EIA Standard technique may not be the same as that encountered in some other application. This is indeed true, but the fault lies *not* with the measuring system but rather with the fact that the insertion gain of an amplifier depends greatly upon the value of the resistance of the source from which it is fed. This is readily seen from an inspection of the equation for insertion gain as given in the EIA Standard. If an amplifier is measured by the fundamentally correct method of the EIA Standard, and the value of source resistance is used as will be encountered in an actual system, then everything will come out right.

Furthermore, the EIA equation takes into account that the insertion gain of an amplifier is independent of the value of load into which an amplifier feeds.

Mr. Crowhurst has also encountered problems with measuring frequency response in that measurements in say a 500 ohm system (with 500 ohm source) do not correlate with performance in a system with say a 10,000 ohm source. This effect is perfectly normal, and is due to the very great effect of source re-

sistance upon frequency response measurements. The answer of course is that meaningful measurements are always made from a source having a value the same or near that in an actual system.

Melvin C. Sprinkle, Project Engineer  
Page Communications Engineers, Inc.  
Washington, D.C.

## Mr. Crowhurst Responds

*Melvin Sprinkle's comments leave me puzzled as to why his attitude seems critical. My article did not criticize the EIA standard — in fact I said it was the best that could be done toward a universally true statement. As I was a member of both EIA (then RETMA) and IEEE (then IRE) committees that evolved these definitions, I could hardly say otherwise! And Mr. Sprinkle does not deny that incorrect termination affects results.*

*But he seems to miss the main point to which I sought to draw attention: one does not operate any amplifier between an attenuator from a tone source and an output meter under such precise measurement conditions; one operates an amplifier between other audio units.*

*Under these circumstances, discrepancies occur that the user may not suspect. For example, he may connect a 500 ohm output to a 500 ohm input, and expect the insertion gains of the two units to add up. This assumes that each unit, as well as requiring 500 ohm termination, also presents 500 ohm termination for the other unit. If either does not do precisely this, the result will not fulfill expectations.*

*I believe, too, if Mr. Sprinkle has ever made such measurements, he must have found that deviation from correct termination will invalidate specified frequency response, sometimes at least, before he goes as far as his suggested use of 10,000 ohms for a 500 ohm circuit. In some cases I have encountered, varying the termination from a nominal 500 to 350 or 700 has been enough to put response beyond specified tolerances.*

*As Mr. Sprinkle has been in audio so long, he must have run into such discrepancies. I can't see how he could have avoided it. Maybe it's so commonplace to him, he doesn't realize that some, who have not lived with it so long, are apt to fall into a trap he learned about a long time ago.*

*My own background in audio dates from 1933. When I came to the States nearly 20 years later, this kind of thing was commonplace to me, I admit. But I found plenty of American audio men for whom it was not! Hence I feel my reference to such pitfalls was justified.*  
Norman H. Crowhurst, P.E.



# Our microphones are now transistorized.

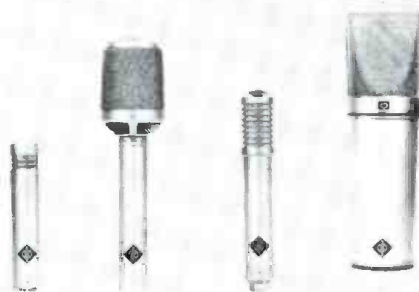

## And that's not the only good news.

Now, it's easier than ever for you to own the world's finest microphone. Because we've reduced the price of the entire line—by as much as 30%.

Of course, Neumann FET condenser microphones give you several other advantages. Long-life DC battery operation, for example.

The flexibility of central compatible power.

And a two-year guarantee.

Performance? Identical to their tube predecessors. And that's the most exciting news of all.

 **Gotham**  
Audio Corporation

2 West 46th St., N.Y., N.Y. 10036 In Canada: J. Mar. Electronics Ltd.



# Medallion quality sound



## DuKane's complete sound system brings unsurpassed quality to 100...or 100,000

Anywhere—the auditorium, the athletic field, the concert hall, the exhibition hall, the arena, the stadium—you'll hear the action clearly amplified and reproduced with DuKane Medallion Sound equipment.

Medallion Sound is a compilation of sophisticated elements which produce the very best in big sound.

The complete system starts with the choice of an appropriate professional microphone, then broadcast-quality solid state preamplifiers and, to meet the acoustic requirements of each location, power amplifiers and coordinated speaker-reproducer systems.

The quality is incomparable because every component has been perfected, coordinated, and tested for your total satisfaction. Find out all about this new adventure in sound. Write for complete information:



**DUKANE CORPORATION**

COMMUNICATIONS SYSTEMS DIVISION

ST. CHARLES, ILLINOIS 60174

DEPT. DB-18

CS-158-A

Circle 33 on Reader Service Card

# The Audio Engineer's Handbook

—GEORGE ALEXANDROVICH

## Disc Mastering

● Before the beginning of the commercially-recorded tape business, the end product of every sound recording establishment was a disc. Even today, with many studios setting up and running tape duplicating machines, most work is still in disc mastering.

Fortunately, we have established standards for discs, resulting in recordings that are reproducible on almost any playback equipment. Basically there are now twelve-inch LPs for 33.33 RPM and seven-inch, wide-hole discs for 45 RPM. A few other slow-speed discs exist but there is no tendency to create new speeds, pre-emphasis curves, or physical forms. There are mono discs (presently being phased out of existence by stereo) and stereo discs.

Commercially-recorded tapes compete with discs. There are single-track, two-track, four-track, and eight-track tapes. There are open reels, cartridges, and cassettes. They run at 15, 7.5, 3.75, 1.825, and/or 0.937. There are ¼-inch wide tapes and 150 mil tapes. Thus it is impossible to design a playback machine that will take all the recorded tapes on today's market. Unless standardization in tape duplicating is established soon (and this seems unlikely) the market will be flooded with all kinds of tapes and machines, creating even more confusion for the consumer.

Because of this and other factors, there is reason to believe that tape is not about to succeed the disc as the prime dispenser of consumer music in recorded form. Therefore, it is appropriate for us to turn our attention to the transfer room and see if we are capable of producing discs consistent in quality with present day technology and expectations. Since it is desirable to offer a single disc suitable for play on stereo or mono systems, we will concentrate on stereo recording techniques and set-ups.

A disc represents the transfer of recorded information from another recording medium (tape) capable of

convenient storage and without deterioration. Magnetic impulses are changed into mechanical groove excursions subject to dimensional and structural limitations. Our job is to achieve this information transfer without exceeding these mechanical limitations, and with specific emphasis on the ability of this information to be faithfully traced by the playback stylus. We have excellent phonograph transducers today, but there are limitations to groove excursions set by theoretical calculations and substantiated by practice. Since record grooves are subjected to wear and contamination, our aim is the greatest groove modulation consistent with longer record life and cleaner sound. We must utilize all the techniques of signal treatment at our disposal if we are to get maximum recording levels with minimum distortion, maximum loudness, and lowest noise—and still manage to reproduce a good replica of the master tape.

To begin, it is of paramount importance to know how to adjust our system for desired performance.

## Playback Calibration

To assure that the sound reproduced from disc pressing is an exact replica of the master tape, we require flat frequency response throughout the system. So first we must calibrate our playback equipment.

This is easily accomplished by using one of the test records on the market that has been cut to conform with the RIAA equalization curve. When playing this disc on the playback setup, connect a VU meter across the output of the amplifier so that if you are unable to adjust for flat response, any deviations can be logged. For all practical purposes, deviations of less than 1 dB from flat are acceptable. At the extremes of the spectrum (20 Hz and 15 kHz) deviations can be as great as 2 dB.

At the same time, adjust for channel balance. There should be less than 1 dB difference in output level between channels. It is also important to check



## THE ACC-1608 “ON THE RIGHT TRACK”

### DO AWAY WITH “TEMPORARY, HALF-FUNCTIONAL” SYSTEMS... THIS 8-TRACK AUDIO CONTROL CONSOLE DOES THE WHOLE JOB!

Up till now you 8-track people have had to make do with baling wire and chewing gum imitations of professional audio control console equipment. *No longer.* Electrodyne has specifically designed the ACC-1608 for your use. The same Electrodyne engineering and quality has been used in the ACC-1608 along with that *little bit more* that continually creeps into our products. For starters we designed the ACC-1608 to completely handle your 8-track recording. There are 16 microphone or line inputs, expandable to 20.

Complete 6 position equalization with echo send and cue on each channel is provided along with independent outputs for 8 channel, 2 channel and monaural. There are 2 stereo pan pots, illuminated pushbutton switches and complete monitor switching and level controls. Wrapping things up are the optional features. You name it, and you can have it! Sure, for a price you say... Try us on price, you'll find *baling wire and chewing gum* are much higher. Let the ACC-1608 get you *on the right track*, all eight of them.

Write or phone for complete literature on the ACC-1608 as well as the complete Electrodyne console and audio components line. Quotations on 12, 16 and 24 track consoles available on request.



## ELECTRODYNE

10747 Chandler Blvd., North Hollywood, Calif. 91601  
Telephone: area code 213/766-5602 or 213/877-3141  
Cable Address: "ELECTRODYNE" North Hollywood, Calif.



your tape machine for flat response with a standard test and alignment tape, particularly if you are dealing with tapes made elsewhere.

To check the alignment of the cutter amplifier and the performance associated with the recording chain, feed a signal from the sine-wave generator into the cutting amplifier and thus cut a disc. Some systems can be pre-aligned by using the feedback signal to analyze the response of the cutter. Feedback is seldom a wide-band indicator in the cutting system, however, and cannot be relied upon entirely. That is why cutting and then playing back on an already calibrated playback system is the most accurate and reliable method.

Prior to feeding any signal into the recording amplifier, rig up a momentary switch that connects to the signal generator only when it is depressed. This will permit you to feed signal at critical frequencies for very short durations (two or three seconds). Carefully read the manufacturer's instructions for system alignment noting the maximum allowable test levels. This will prevent damage to the cutter itself.

One more word of caution—check the signal generator for flat frequency response and proper termination. Too many hours have been lost needlessly by maintenance men and engineers because signal generators were inaccurate.

### Light Patterns

To help establish a reference level for the cut, you can use light patterns to measure the amplitude of groove modulation. This method is simple and sufficiently accurate for all practical purposes. All you need is a flashlight, ruler, and a signal generator to provide the signals which are to be measured. (See FIGURE 1.) The modulated groove of a disc recording will reflect light off those excursions which have part of their surface at the correct angle to the incident light. Measuring the total width of the reflection (which is proportional to the amplitude) gives the result.

The accuracy of this method is dependent on the accuracy of signal generator frequency and the speed of disc rotation. Since these are easily controllable within 2 per cent our results can be as accurate.

A convenient reference for light-pattern measurements is 1000 Hz at the standard speed of 33.33 RPM. For maximum accuracy the cut should be made at the outer grooves of the disc.

Feed a signal of safe amplitude into the left (inner) channel and cut. Then,

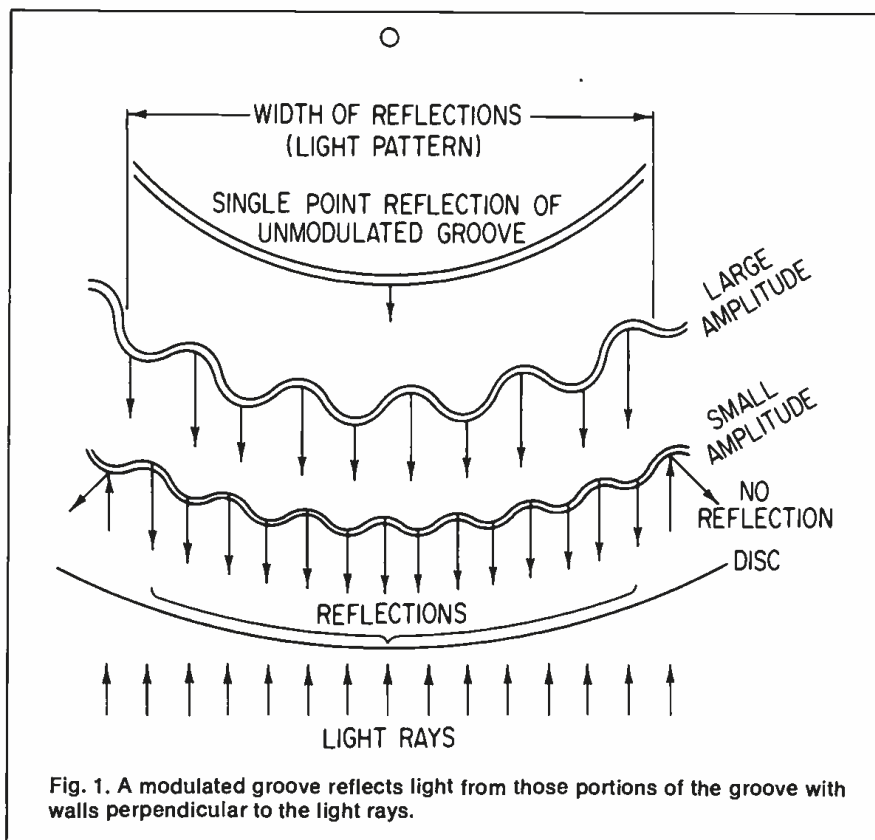

Fig. 1. A modulated groove reflects light from those portions of the groove with walls perpendicular to the light rays.

holding the flashlight as shown in FIGURE 2 (at the side of your head), direct the beam onto the disc so that the light hits it at about 45 degrees. Now measure the width of the recorded signal's reflection and log it. A 3.8 cm/sec. recorded velocity (an acceptable LP reference level as it appears on RCA RIAA test records) makes a light pattern 28-mm wide (approximately 1 1/4 in.). The larger the recorded amplitude, the wider the pattern. As mentioned before, the width of the pattern is proportional to the amplitude or, when converted into the electrical output of the disc playback system, to the voltage. Consequently, double the width of the pattern is an amplitude increase of 6 dB. A 2 dB increase is equivalent to the widening of the reflection by a factor of 1.25. So, when considering the pre-emphasis curve, 10 kHz would be five times (14 dB) as wide as a 1 kHz signal. This Christmas tree pattern is shown in FIGURE 3.

### Equalization

Now that we have mentioned the pre-emphasis curve, let us examine the reasons for using it. If we play the disc which has been recorded with an unmodulated or silent groove, we will hear surface noise at a noticeable level. If our playback system is flat, this noise

will be extremely high as in FIGURE 4A. In order to reduce this high-frequency surface noise produced by the playback stylus, we have to reduce the response of our playback equipment at the high frequencies (FIGURE 4B). As a compensation, we emphasize those frequencies during the recording process. The combined result of both alterations of frequency response is a flat characteristic with much reduced noise.

(In practice, the recording process also cuts bass response to reduce groove excursion; thus bass boost is also required in the playback equalization (FIGURE 4C).

Test records designed for system analysis are cut with precisely controlled pre-emphasis. Of course, playback am-

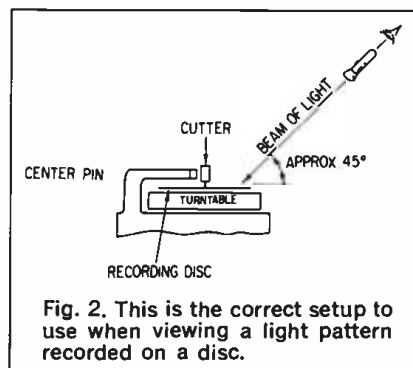

Fig. 2. This is the correct setup to use when viewing a light pattern recorded on a disc.



# AR-3a

***Acoustic Research announces a new speaker system.***

In 1959, our first advertisement for the AR-3 stated, "it has the most musically natural sound that we were able to create in a speaker, without compromise." This judgment was supported by distinguished writers in both the musical and engineering fields. Hirsch-Houck Laboratories, for example, agreed that "the sounds produced by this speaker are probably more true to the original program than those of any other commercially manufactured speaker system we have heard." For nearly nine years the AR-3 has been the best speaker we could make.

However, technical development at Acoustic Research, as at many companies in the high fidelity industry, is a never-ending search for improvement. After much effort we have found a way to better the performance of the AR-3. The new speaker system, the AR-3a, has even less distortion, more uniform dispersion of sound and still greater power handling capability. The improvement can be heard readily by most listeners; it has been brought about by the use of newly designed mid-range and high-frequency units, and a new crossover network. Only the woofer and the cabinet of the AR-3 are retained in the new system. The AR-3a is priced from \$225 to \$250, depending on cabinet finish, and is covered by AR's standard five-year speaker guarantee.

Detailed information on conversion of an AR-3 to an AR-3a is available from  
**ACOUSTIC RESEARCH, INC., 24 Thorndike St., Cambridge, Mass. 02141**

plifiers have a built-in post-emphasis curve. The most popular of these curves are the RIAA and NAB systems. There are a few European curves, but they are all basically similar.

### Making the Cut

Since we are prepared to cut sustained tones, it is imperative that we reduce recording level sufficiently to prevent destruction of the cutter fuses caused by high recording current at the upper frequencies. 1 kHz levels should be cut about 10-15 dB below the zero reference (1¼-in. light pattern). Feed signal from the generator directly into the power amplifier, bypassing all equipment capable of modifying the results (limiters, compressors, equalizers, etc.). Remember to go through the momentary switch. Most modern stereo systems have the necessary pre-emphasis networks built into the power amplifier to match the cutter characteristics.

Now cut a series of frequencies in short bands, feeding the signals for periods no longer than three or four seconds. Start at the outside of the record with 1 kHz, then go to 15 kHz, then in 1 kHz intervals go down to 1 kHz again. Cut them in reducing steps of one octave (half the previous frequency): 500, 250, 125, 62, and finally 30 Hz.

A properly adjusted system will produce a light pattern on the cut that resembles a Christmas tree—hence the name. If you play this record with the calibrated playback system, all frequencies should have the same amplitude at the output. Deviations of less than 2 dB are tolerable but should not be neglected.

Before adjusting the system to rectify irregularities in the frequency response, refer to the manufacturer's instruction manual. You can do more harm than good by adjusting the wrong controls.

For the sake of simplification, I have only discussed frequency response adjustment of the left or inner channel. Use the identical procedure for the right channel, except that light pattern indications should be taken from the farther side of the disc.

Next month I will discuss 45-45 cutters versus lateral-vertical systems. In addition, I will examine the cutting of maximum levels with peak protection, and comment on phase relationships between channels, a crucial factor in the cutting of stereo/mono compatible discs.

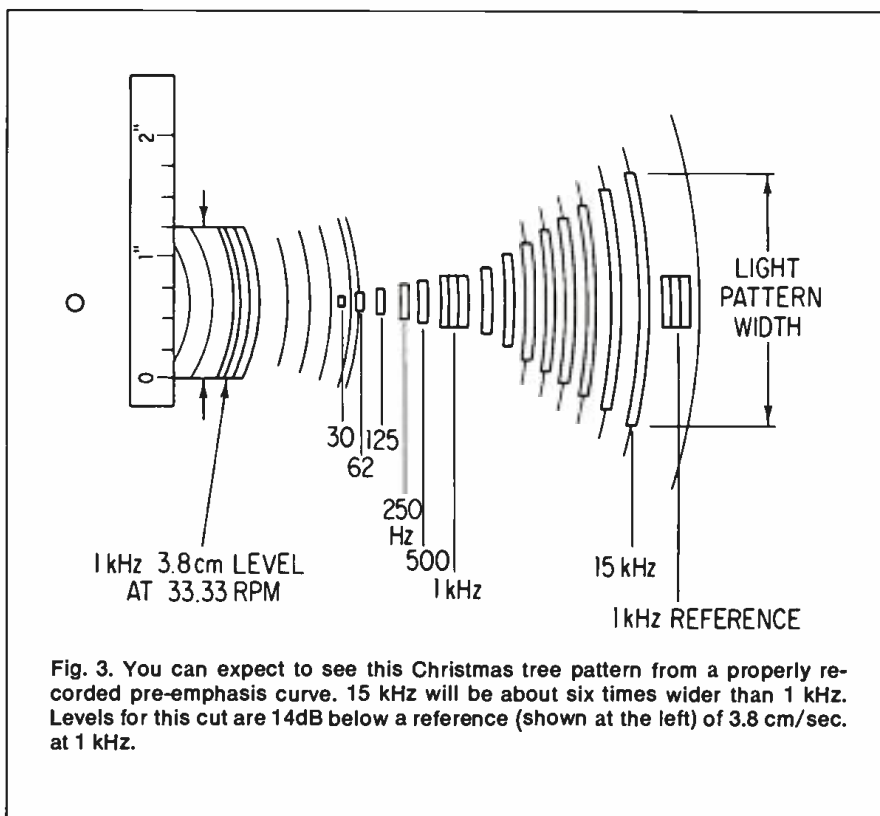

Fig. 3. You can expect to see this Christmas tree pattern from a properly recorded pre-emphasis curve. 15 kHz will be about six times wider than 1 kHz. Levels for this cut are 14dB below a reference (shown at the left) of 3.8 cm/sec. at 1 kHz.

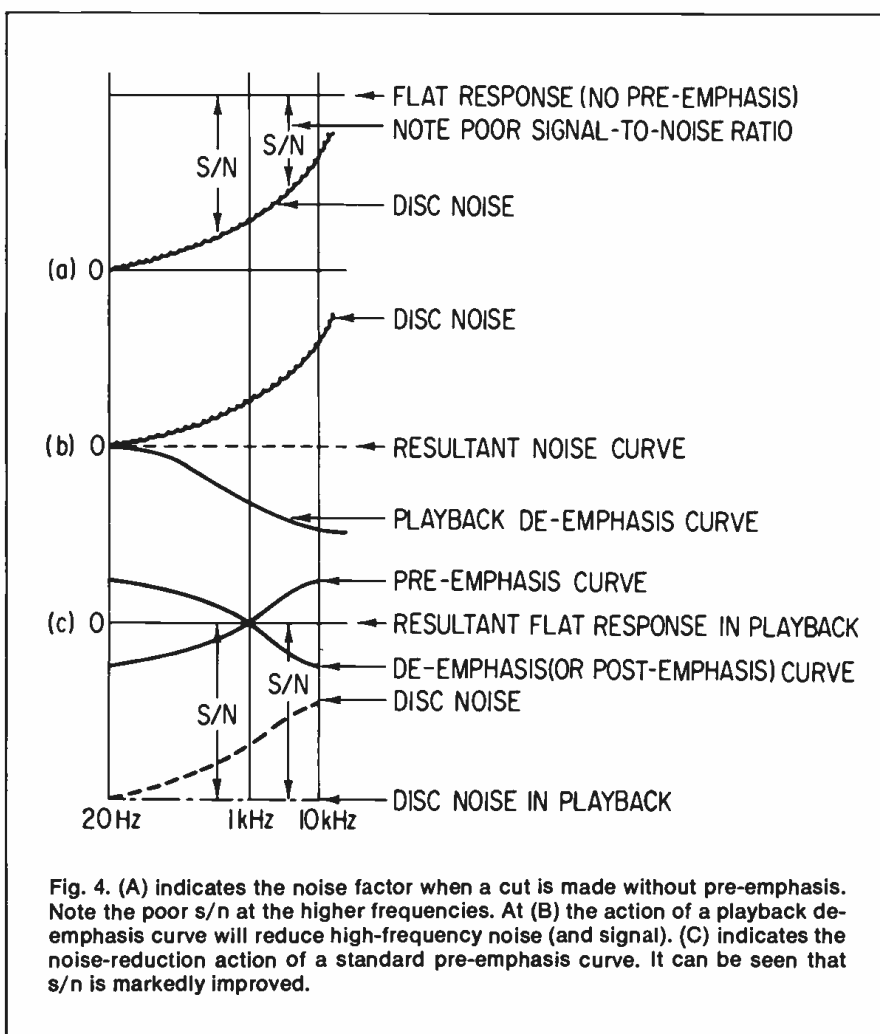

Fig. 4. (A) indicates the noise factor when a cut is made without pre-emphasis. Note the poor s/n at the higher frequencies. At (B) the action of a playback de-emphasis curve will reduce high-frequency noise (and signal). (C) indicates the noise-reduction action of a standard pre-emphasis curve. It can be seen that s/n is markedly improved.





# Formal Announcement

**ARROW**  **ELECTRONICS, INC.**

*is proud to  
announce a new  
arrival.....*

## **AMPEX PROFESSIONAL 4 TRACK RECORDING SYSTEM**

**NOW AMPEX INTRODUCES A  
NEW GENERATION OF PROFES-  
SIONAL AUDIO RECORDERS.  
NOW WITH TRANSPORT RIGID-  
ITY PREVIOUSLY LIMITED TO  
HIGHER COSTING MACHINES.**

**FLEXIBILITY** allows you to add three channel capability to a monophonic machine by installing two additional panels of electronics, changing heads and head cabling. For the first time, you can build a single channel full track Ampeg up to a four channel, four track recorder.

**OBSOLETE PROOF** allows you to expand without replacement. You can keep pace with the changing requirements of the industry, by using the building block increments of Ampeg's new generation in professional audio recorders.

**JEWEL BEARING SCRAPE FLUTTER IDLERS** minimizes scrape flutter (especially important to production of master tapes).

**AUTOMATIC TAPE LIFTERS** with electrical and mechanical override ease the tape away from the heads during rewind and fast forward modes.

**FAST HEAD CHANGES** You can remove a 1/4 inch head assembly and replace with a 1/2 inch head assembly or change from four track to three track operation in a few minutes.

**AMPEX ONE YEAR WARRANTY ON ALL PARTS**

Model AG. 440

**WE HAVE A COMPLETE LINE OF AMPEX PROFESSIONAL RECORDING EQUIPMENT TAPE DECKS, CONSOLES ETC. IMMEDIATE DELIVERY ASSURED! CALL OR WRITE MR. HOWARD WINCH, BROADCAST DEPARTMENT, 516-694-6800 • 212-JA 6-0300**

**ARROW**  **ELECTRONICS, INC.**

900 ROUTE 110 • FARMINGDALE, L.I., N.Y. 11735

Circle 36 on Reader Service Card



# NEW CATALOG!

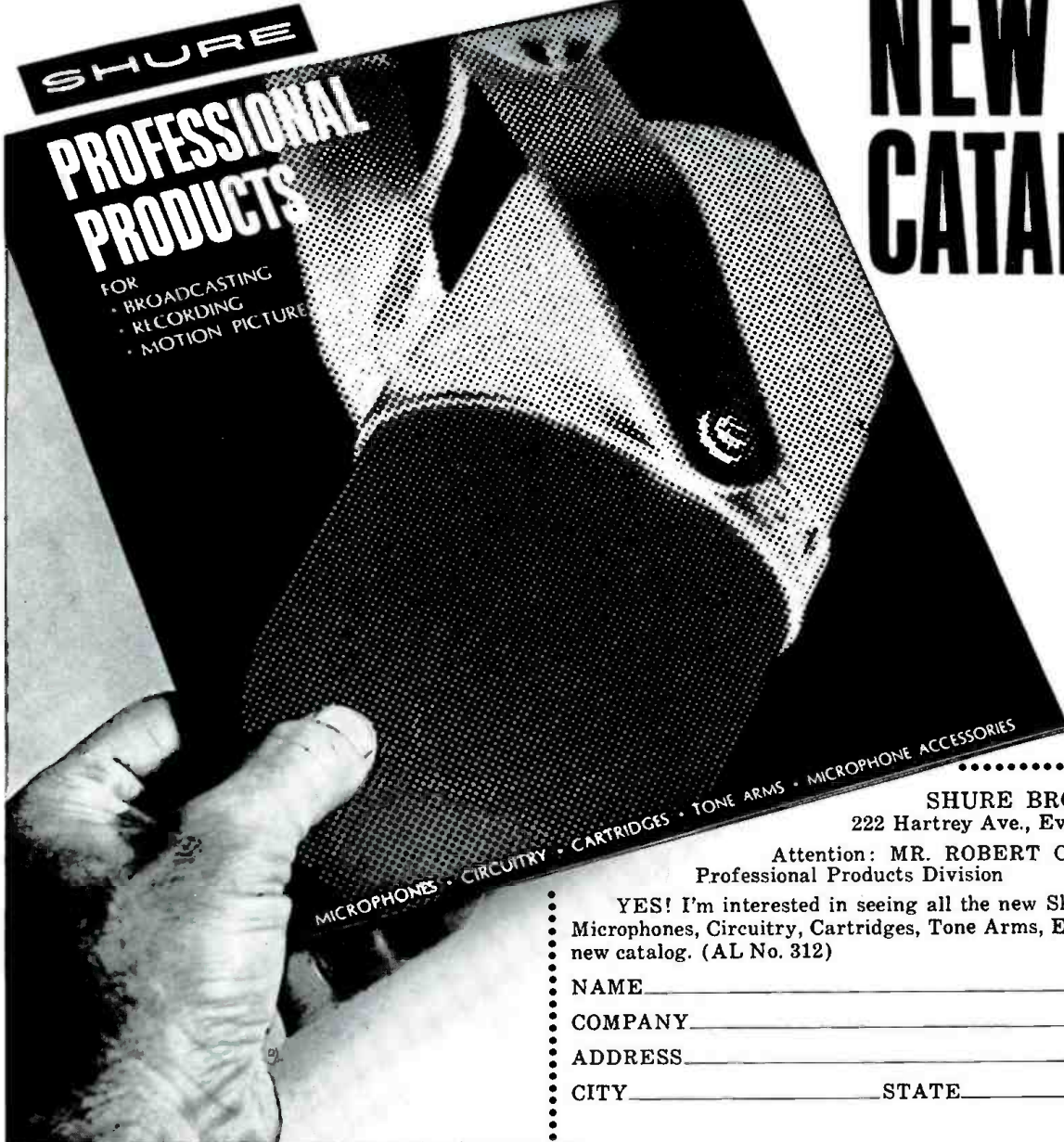

SHURE BROTHERS, INC.  
222 Hartrey Ave., Evanston, Ill. 60204

Attention: MR. ROBERT CARR—Manager,  
Professional Products Division

.....  
● YES! I'm interested in seeing all the new Shure Professional  
● Microphones, Circuitry, Cartridges, Tone Arms, Etc. Send me your  
● new catalog. (AL No. 312)

● NAME \_\_\_\_\_  
● COMPANY \_\_\_\_\_  
● ADDRESS \_\_\_\_\_  
● CITY \_\_\_\_\_ STATE \_\_\_\_\_ ZIP \_\_\_\_\_  
●

# Editorial

**O**VER THE YEARS there have been subtle changes in that field of audio known as commercial sound (or more simply—p.a.). Once, the life of a p.a. man was straightforward. All he had to do was provide enough amplification to help a soft-voiced speaker or singer reach the back of a hall. Moderate wattage brute-force amplifiers, horn speakers, and feedback were the norm. Good sound was unheard of—it was considered adequate to be reasonably intelligible.

The revolution in consumer sophistication helped end that era and prodded the operators that remained to offer more in sound amplification than mere volume. Today's sound man is a multi-faceted expert. He must know microphones, speakers, amplifiers, acoustics and more to compete. Even the present name of the field reflects this new technology. It is no longer p.a. It is now *sound reinforcement*.

The demands of several world's fairs played a key role in shaping the field as we know it. This issue of *db* examines the cream of the sound systems at Montreal's recent Expo 67. The innovations discussed in Martin Dickstein's survey hint of an audio revolution still to come. We are now seeing the sound reinforcement engineer become increasingly involved with the *visual* aspects of a production. He may eventually be replaced by a professional versed in both audio and visual technology.

The need is already apparent. Video recording has unloosed an avalanche of applications that are intimately related to the sound field. Companies formerly identified with sound reinforcement are now heavily involved in cctv and vtr systems, plus motion picture and slide synchronization equipment. Tomorrow will see still more of this.

If we are to avoid the sonic tragedy of commercial television, where the sound man is almost an afterthought, it will be necessary for more audio pros to become involved in audio-visuals. Fortunately, this is a lucrative field, making it self-attracting.

Only the sound engineer has the technical experience to handle audio-visuals skillfully and creatively. His is the challenge . . . and the responsibility . . . of directing this open-ended field.

L. Z.



# Sound Reinforcement at Expo 67

Martin Dickstein\*

*World's Fairs have become a showcase for new developments in sound systems. Expo 67, which closed this past October, saw many innovations. Our man-at-the-Fair looks at the most interesting structures and systems.*

**S** EVEN years ago, when bids for the next *official* World's Fair were being considered by the Bureau of International Exhibitions, the nod went to Russia and the Soviets started to make plans to hold a "first category" exhibit. Two years later, however, they withdrew and Canada, the other country under consideration, won the honor. Coincidentally, the year chosen for this huge display, 1967, was also an anniversary year for Canada. Nothing could stop this show from being the biggest fair ever.

As more and more nations, states, provinces, private exhibitors, world organizations, and municipalities signed up for space it became apparent that existing techniques were not good enough and that displays had to be larger, more complex, and novel in order to stand out among the competition. The fact that Montreal, rather than Moscow, became the site for Expo 67 gave the chance to many of us to feast our eyes and ears on the presentations to be offered by the *first* sanctioned World's Fair on North America.

Some of the structures were purely functional and were designed to perform as lecture halls, movie theaters, arenas or combinations of these applications. Others were specifically made to house a variety of shows including live talent in different fields of show business. A great number, however, were built to provide a setting for some startlingly new audio-visual displays, the likes of which had not been seen or heard before.

Among the multi-function auditoria included were the **Expo Theater**, **Theater Port-Royal**, the **Salle Wilfrid-Pelletier**, the **Theater Maisonneuve** and the **duPont Auditorium**. Each of these required a specially designed sound distribution

system and a thorough study of acoustic requirements to provide the best listening possible everywhere in the hall.

An illustration of some of the functions and uses of these theaters and their relative sizes will present an idea of the required sound distribution treatment. **Expo Theater** was built in the shape of a wedge to seat 2,000 people. Its uses were for popular entertainment, musical shows by a variety of performers from many foreign countries and it was also the site of the **International and Canadian Film Festivals**. The theater was designed without a center aisle, continental style, with provision for 1,300 seats in the orchestra and 700 in the balcony. The upper level of seats did have a center aisle. The stage was 120 feet wall-to-wall, 45 feet deep, had a proscenium opening 28 feet high and 50 feet wide and a grid elevation of 77 feet. The pit was large enough for an orchestra of 60 musicians. Equipment was provided for a variety of sound reproduction and projection functions.

Some of the performances given at this theater were the *Swiss Folkloric Gala*, *Hello Dolly*, the musical comedy *Half a Sixpence*, Marlene Dietrich, the Lehar operetta *The Land of Smiles*, Jack Benny, many country-and-western performers, Duke Ellington and Pearl Bailey, and the finale of the International Poetry Gala. In addition, the theater was used for *The 8th Montreal International Film Festival*, *The Fifth Festival of Canadian Films* and *A World Retrospective of the Animated Cinema*.

For a quick comparison, the **Wilfrid-Pelletier Theater** had 3,000 seats on four levels from orchestra to the third balcony with the farthest seat 140 feet at the highest point and 112 feet at the orchestra level. The stage was 55 feet deep, 100 feet wide and the grid was 80 feet high. The orchestra pit could hold 100 musicians.

\**Television Utilities Corp., LIC, New York*

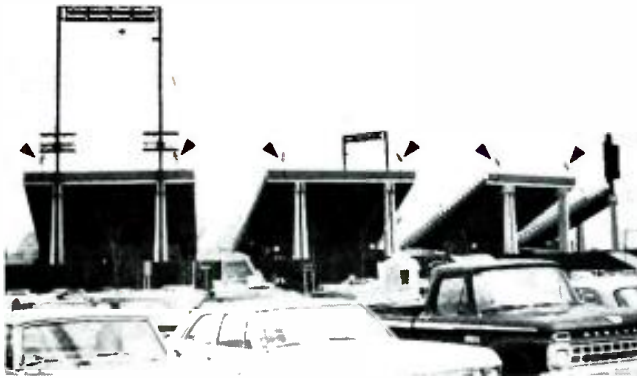

Fig. 1. Autostade Stadium — the arrows show the location of some of the 38 sound columns used for distribution.

The other two theaters were smaller. The **Port-Royal** held 800 while the **Maisonneuve** could seat 1,300. The former had a proscenium height of 80 feet which could be scaled down to 40 feet. The proscenium of the latter was 60 feet high.

The **duPont Theater**, with 372 seats, was built for lectures, films and small group performances such as poetry readings. For the 800 scientific films scheduled to be presented and the many lectures and meetings held here, the specifications called for two 35mm sound projectors, two large RCA theater units mounted high at a calculated angle and orientation, a modified 100 watt amplifier, two equalizers with provisions for bass cut and 6 dB boost in the 3,000 to 8,000 Hz range for voice intelligibility, a four-channel mixing console and an assortment of directional, cardioid and lavalier microphones.

The largest outdoor arena, called the **Autostade**, was built to hold 25,000 spectators of sports events and spectacles. Among the shows given at this amphitheater were *The Ringling Bros.-Barnum and Bailey Circus* (staged for the first time in the open); *The Canadian Air Force Tattoo*; a musical extravaganza starring Maurice Chevalier, with 700 men, many horses, motorcycles and jeeps; and the *Wild Horse Spectacular, and Great Western Rodeo*.

The oval-shaped amphitheater was formed by 19 precast seating sectors. The slope upward of the seats created the shape of a bowl. The seats could be dismantled and re-assembled elsewhere or enlarged to contain 40,000 seats. The turf was 535 feet long by 212 feet wide. This was surrounded by a six-lane rubberized asphalt running track a quarter mile in length.

For sound distribution, 2 sound columns were located at the rear of the audience, one on each side of each seating sector (see FIGURE 1). Each of the 38 columns contained 6 Altec 403's. Six more columns containing Altec 755C speakers were used to cover the field. As no directionality of originating sound was required the prime consideration for location of the speakers was mass coverage. Fortunately, there was little outside interference from traffic or airplanes.

Amplification was achieved by using ten 175-watt amplifiers paired by Altec Sequer units to prevent loss of feed or level in the event one of the amplifiers became defective. Mixing was done with two Altec 1567's in the control room and two more portable units. Constant level control was



Fig. 2. A view of the Kaleidoscope pavilion (and the crowds that waited to visit it).

maintained by compressors.

In addition, a performer paging system, a rehearsal paging unit and a management monitoring system were also provided with horns and 60 watt amplifiers.

An interesting but disturbing acoustic effect was created during those shows requiring the laying of a hard floor or paving of the ground. Sound from one side of the arena would bounce off the hard surface and create an echo on the other side of the bowl. The number of times such a situation existed, fortunately, were few.

### Kaleidoscope

Among the private exhibits designed for effect, both inside and out, was **Kaleidoscope**. The structure was conceived by 6 Canadian chemical corporations to present *Man and Color*. The exterior of the circular building was made up of 20-foot high fins (FIGURE 2) colored on both sides to conform to the color spectrum and thus creating an illusion of movement of the building as the visitor walked by. Inside, the building was shaped like a cross with four chambers around a central core. One of the chambers was used for loading and unloading the visitors to the pavilion. The other three were presentation theaters.

With the use of mirrors to reflect many times a single image on an 8- by 10-foot screen, the viewer was surrounded by color patterns and lights. He was actually inside the kaleidoscope. The films shown were taken of real objects as well as surrealistic patterns. Multi-reflections of these images created an all-around sensation. The program depicted a typical day.

The audience entered a completely dark room. The sky is starlit as the sun starts to rise. The horizon seemed infinite. As the morning effect progressed, the colors and patterns changed accordingly. The second chamber illustrated the middle of the day. Colors and images were more vivid and changes were more violent and drastic. The third room depicted the return of evening. Colors changed to a more peaceful mood. As the chamber darkened, the stars re-appeared.

Throughout the performance, sound, both natural and electronic, as well as traditional music heightened the various effects. The audio, dubbed onto the sound track of the 35mm film, was distributed through three speakers at the back of each of the rooms. As source location was not important, those rear speakers proved sufficiently effective.



Fig. 3. The Canadian Katimavik exhibition building. A 190-seat revolving theater was inside this inverted pyramid.

Fig. 4. The two Philips ten-track tape units used at the Czech Division display in their pavilion. Each of the ten tracks had a different control function for the display.

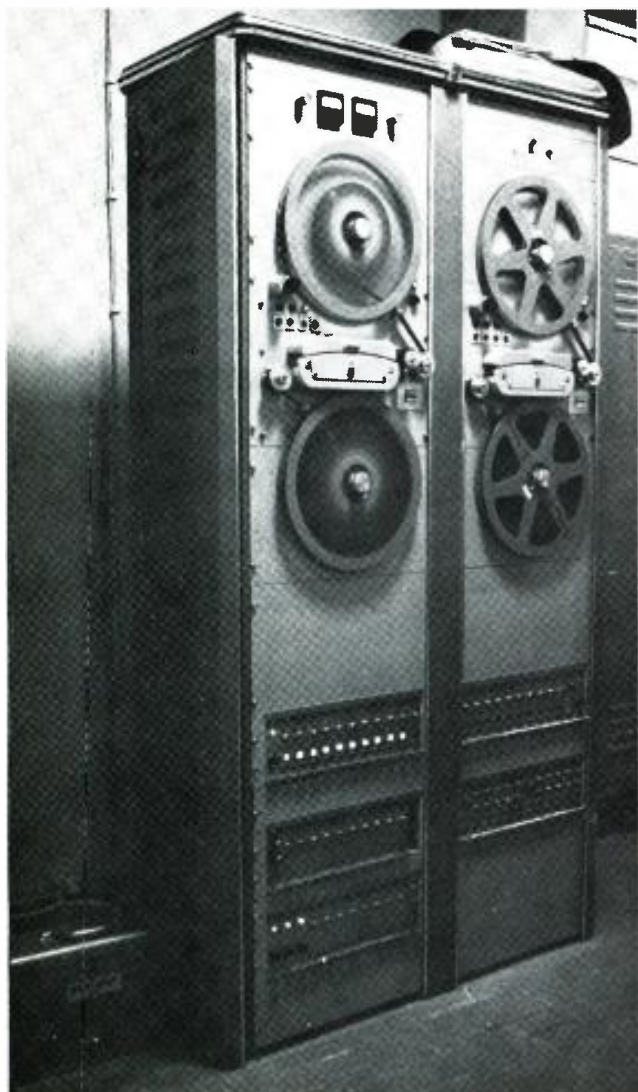

In most exhibits such as this one just described, where the audience is moved between chambers, great care is taken to prevent leak-through from one auditorium to the other. In this exhibit, leak-through was actually *provided* between chambers by feeding sound from one chamber into the speakers of the adjacent one. The purpose for the mixed feed of sound between rooms was to maintain an over-all perspective for the listeners as they went through the different presentations. As the audio consisted of sound and music only, there was no problem with intelligibility.

### Katimavik

One pavilion in which there was evidently some difficulty in preventing leak-through was at the Canadian **Katimavik**. The structure, an inverted pyramid (FIGURE 3), contained many displays showing life in Canada. One of the feature demonstrations was in a 190-seat revolving theater.

The five-theater turntable rotated through a similar number of 4½-minute shows in which the 950 spectators were told the story of Canada. The first film was on a single screen. No sound problem. The second contained two screens, one vertical and the other horizontal. Here, the sound was still front projection and there were no problems. The coverage was adequate and the program material did not require any great variations in levels.

The third theater presented an amusing animated cartoon on three screens. The presentation depicted musically the mixing of cultures ranging from *Rule Britannia* through *Alouette* to American music and then to an ethnic folk festival. The action was much more lively to enhance the comedy effect. The sounds were louder and the mixing of one selection on top of another required an over-all higher level of sound. Also, speakers in the ceiling over the audience were used to add to the montage.

The fourth chamber exhibited the industrial expansion of Canada on a single screen and the audio consisted of lowered levels of music. The fifth theatre showed the people of Canada and jazz was mixed with modern sounds as musical accompaniment. The relative levels of the last three chambers caused slight leak-through into the quiet ones.

### Man in the Polar Regions

Another exhibit in which the audience sat on a rotating turntable was **Man In the Polar Regions**. This presentation varied from the previous one in that this turntable rotated continually during the performance while the other stopped in each segment.

The rotating platform, 80 feet in diameter, made its complete round in just over 20 minutes. The turntable was divided into four pie-sections around a stationary core containing all the projectors, synchronizing equipment, power units and sound amplification equipment. The movement of the theater was slow enough to permit the audience to enter and leave the first theater, at one point in the circumference, without realizing the turntable was still moving.

Around the perimeter of the theater were twelve screens. A similar number of projectors, each with a sound-on-film continuous loop of the same length, was started by a micro-switch activated as the partition between theater segments passed by. Each length of projection film and black leader was accurately timed to permit the machines to stop when the projection time was over. Each was then started again at the proper time to continue the cycle. Images could be shown on one, two or three screens at a time within any chamber.



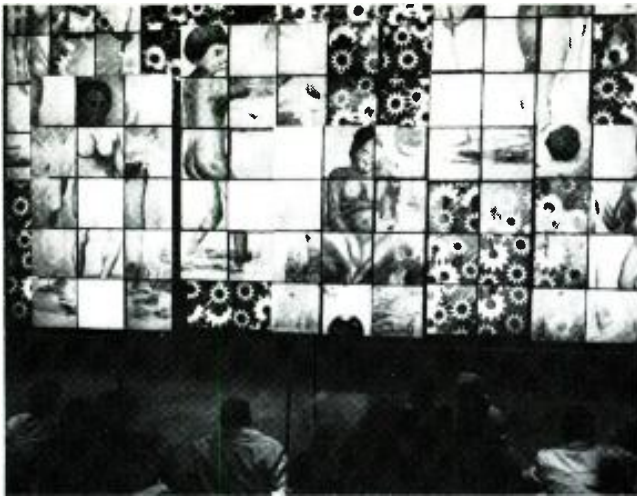

Fig. 5. A view of the Diapolyecran screen during the presentation at the Czech pavilion. Each square represents a separate projection.

By recording sound on any one or more of the films available to each segment at any one time, the sound followed the movement of the projected images around the loop in synchronization with the audience. A speaker was located under each screen.

Each theater was enclosed on the left and right sides by high walls. Adjacent walls were separated by a passageway for entry and exit from the core. This large air gap decreased greatly the possibility of sound from one chamber leaking through to the next.

### The Canadian Pulp And Paper Association

This exhibit presented another interesting use of sound in a circular theater. In the first of two theaters, the audience stood in the center of the room around which the wall undulated in the manner of a sine wave. This wall was the projection surface for six slide machines and a 16mm film projector located in circular housings suspended from the center of the ceiling. The upper housing was stationary and contained the slide projectors. The lower one was movable and could rotate through almost 360°. This one housed the film unit.

The presentation, depicting the history and uses of paper, combined slides, film and live actors. The performers worked on a 2½-foot wide ramp built in front of the wall and made to rise and fall in line with the bottom of the projected images. As the performers were required to move around the room to coordinate with the characters in the pictures, microphones were located at selected points either mounted on floor stands or hung against the screen wall. Movement had to be quick, precise and accurately timed as the actors were required during the show to reach out to the screen, take an object from the character in the picture and then return it to the proper point on the screen so that the effect of this illusion was not lost.

An 82-channel programmer controlled the movement of the 16mm housing, the lights, the action of the slide projectors, and the opening and closing of microphones and speakers as the show moved around. Recorded sound was distributed by speakers in the wall while live sound covered the audience from carefully located sound columns. The microphones were a close-talking lavalier type to help avoid the possibility of feedback.

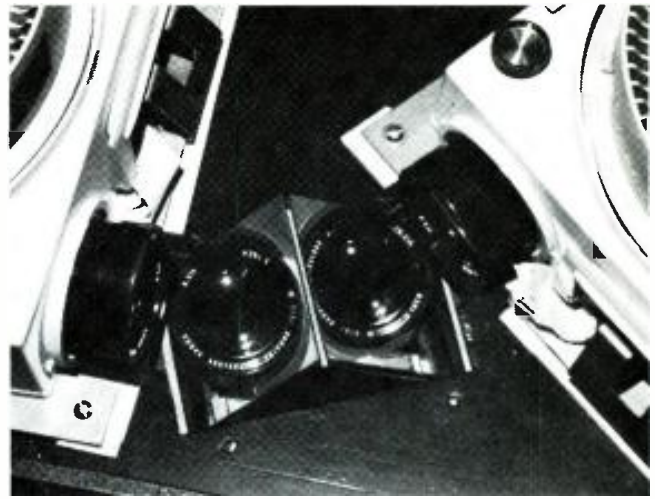

Fig. 6. Two of the six Carousel projectors used for rear-screen projection at the Kodak pavilion. Each pair operated as a single unit, dissolving to the other for smooth transitions.

### Czechoslovakia

By far, one of the most ambitious audio-visual undertakings at the Fair was the presentation at the Czechoslovakian pavilion. Soft classical music, distributed by well-spaced ceiling-mounted speakers followed the visitor during his tour of the main floor to see glass work made in that country. On the upper level, two panoramas of multi-screen projection and surround sound awaited the people.

The first chamber consisted of several displays of novel projection techniques. One was called *Polyvision* and comprised twenty slide projections, eight movie screens, two rear-projection displays and several rapidly rotating bodies shaped like a sphere or hyperboloid and made of thin metallic strips. Between the rear projection screens, located toward the back of the stage area, and the front multi-screens there were two semi-transparent mirrors placed at angles of 45° to the horizontal. With slide projectors mounted inside movable cubes and projecting on static or rotating surfaces, rear projection and reflections of projections seemingly suspended in mid-air, the eight-minute display was indeed a novelty.

Another presentation, called *Diavision*, consisted of a specially treated screen which appeared to be a large picture print. With the proper change in lighting the picture seemed to disappear and the audience could look through the mesh to a multitude of projection screens. Another part of the display consisted of three layers of stretched nylon thread in the general shape of a loom. The entire frame was set into swinging motion while the third layer was set into oscillation about its axis of symmetry. All of the 160 cords then acted as a screen for the projection of 35mm images making them appear to be three-dimensional.

Throughout this entire performance, surround music and sound effects were distributed from speakers located all around and above the audience. A Philips ten-track tape machine controlled the entire exhibit. One track was used for music and sound, another for controlling groups of loudspeakers, three for feeding signals to decoders and relays for triggering a myriad of control film and light circuits and the last five tracks to feed as many decoders for the control of 36 projectors each. Two such control machines (FIGURE 4) were used to provide continuous showing.

The second auditorium offered an eleven-minute show



Fig. 7. This behind-the-scenes view at Kodak shows the set-up used for the water screen projection. The hydraulic system used to create the water screen extends from the right to the center. The black boxes in the foreground each contain a pair of projectors as seen in Fig. 6. Each is covered, but a cutout allows the image to be reflected by mirrors onto the wall mounted mirrors (upper left), then to the water screen.

called *Diapolyecran*. This presentation took place on a 32-foot by 20-foot wall divided into eight horizontal rows of fourteen cubes, each cube being two feet on a side. Each cube contained two slide projectors modified with an electromagnetic diaphragm permitting picture changes of less than 0.05 seconds. Each projector had 80 slides. Each cube could be moved horizontally to one of three positions with a total move of 24 inches. Thus, the wall could form a solid picture, a picture with some images forward of the wall or to the rear, or any desired combination.

The control system consisted of a 35mm film with each frame divided into a checkerboard pattern of 840 squares. Show control made use of 784 of the spaces while the remainder were used for system measurement. By programming black and white spaces as required and then shining light through them onto a similar mosaic of photo-resistors, slide changes and cube movement could be accurately synchronized for proper system operation and an extraordinarily effective display. This exhibit used 224 slide projectors, over 12,000 slides, nearly 20,000 electrical impulses available every second and over 5 million bits of control information. Specially written music along with sound accompanied this elaborate demonstration. The Czechs proved they had progressed in the field of audio-visuals since they won gold honors at the 1958 Brussels Fair.

It is interesting to note in passing that the French pavilion also made use of a patterned 35mm film for control. In this exhibit, a magnetic sound track of electronic music, created by using many oscillators to produce true tones, harmonics, and different wave forms, was piped to speakers while the control information was utilized to trigger lights in time with the music. Colors, brightness, and sudden flashes created a startling visual display synchronized with the variations in the musical score.

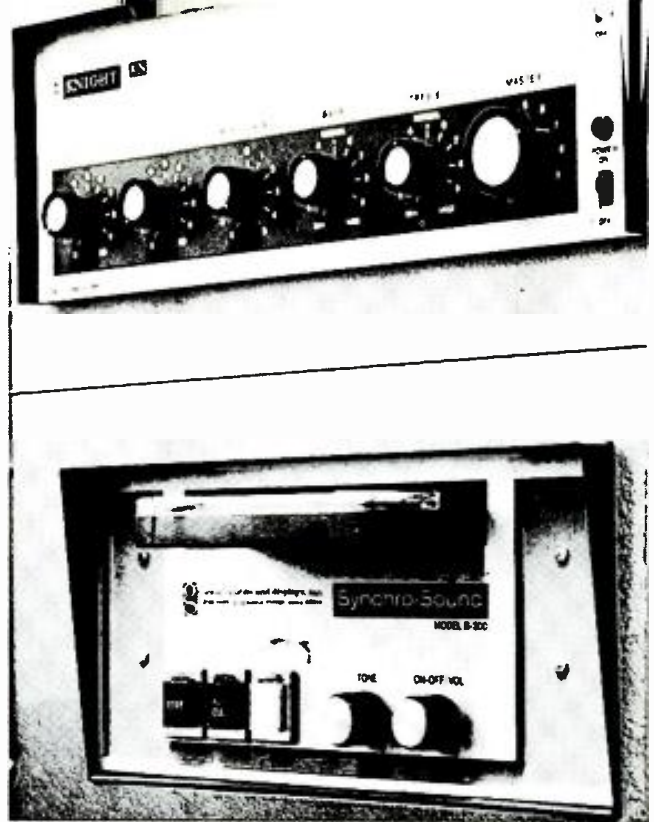

Fig. 8. This amplifier, a Knight KN3235C, and the tape loop player, a Synchro-Sound B-300, controlled the Kodak exhibit. The tape carried a sound channel while also providing a second channel pulse which controlled a punched belt. This belt (not shown) activated the show system's components.

## Kodak

An interesting exhibit in which a multi-track tape was used for sound and control signals was Kodak, one of the few exhibitors participating in every World's Fair since 1893. Six Carousel slide projectors (FIGURE 6) were used for the first five minutes of the presentation to display pictures on a conventional screen. The last three minutes were used to project three pairs of slide units, through prisms and mirrors, onto a rear-projection screen made of water.

The 3,000 tiny vertical jets of water, streaming from above and below, were produced by a hydraulic system controlled by a punched paper tape triggered by the cues on the sound tape. Changes of slides (1½-second lap-dissolve or instantaneous) as well as variation of jet pressure and direction flow were all controlled by the tape. The display consisted of city skylines shimmering, fishes swimming (a natural), fireworks exploding, butterflies floating and go-go girls go-going. Sound on the first of the two magnetic tracks was distributed through speakers mounted above the screens (out of the way of the water).

A World's Fair of this magnitude had to prove that it was the biggest and best ever. It did. It also proved the importance of sound and the proper design and engineering of the distribution systems. It showed the value of the services of a competent audio-visual engineer in endeavors of this nature. Expo 67 also disproved the belief that there is nothing new under the sun. Let's see and hear what the next Big Show of 1970, in the Land of the Rising Sun, will have to offer.

\* \* \*

We would like to express our thanks to Bob Vogel of Freeport, L.I.; Glen Twombly of Ponoma, N.Y.; Ron Ward, Toronto; and the P.R. and engineering departments of Expo for their invaluable help.

# Speaker Impedance Matching in Sound Systems

J. F. Walthier, Jr.\*

*Every engineer can benefit from a fundamental review of the techniques of matching speakers to a sound reinforcement system.*

**E**FFICIENT transfer of power from the amplifier to the loudspeakers is of prime consideration in connecting a sound system. To deliver its maximum rated power output, the amplifier's output impedance must match the combined impedance of the loudspeaker load. The method of connection used to obtain efficient transfer of power will vary depending upon the size of the loudspeaker load to be connected to the amplifier. The load will be determined by the number of loudspeakers in the sound system and the voice-coil impedance of the various speakers.

Loudspeakers, as used in today's sound systems, usually have a voice-coil impedance of 4, 8, or 16 ohms. In order to simplify loudspeaker transmission, line connection, impedance calculation and a flexible method of controlling power delivered to loudspeakers, most amplifiers are equipped with a multi-screw terminal strip on the rear panel.

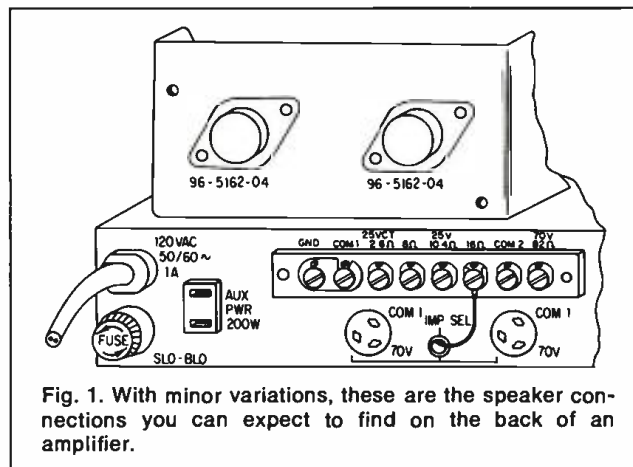

Fig. 1. With minor variations, these are the speaker connections you can expect to find on the back of an amplifier.

\*Asst. Director,  
Engineered Systems Sales  
Lear Siegler, Inc.  
Bogen Communications Division



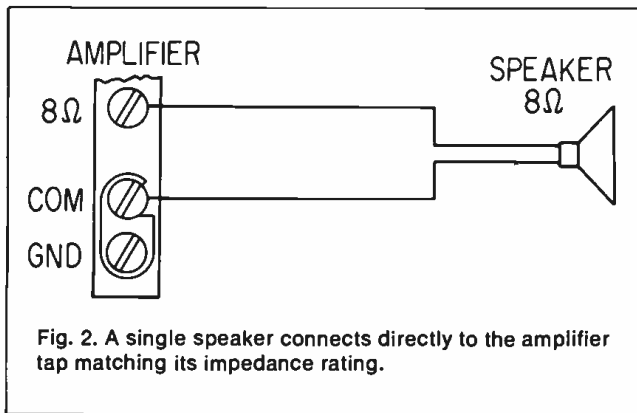

Fig. 2. A single speaker connects directly to the amplifier tap matching its impedance rating.

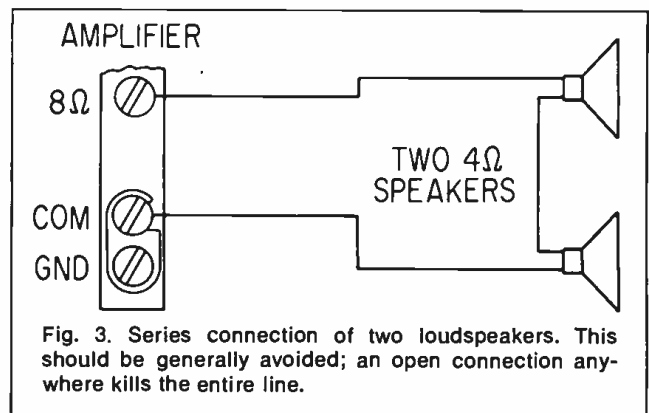

Fig. 3. Series connection of two loudspeakers. This should be generally avoided; an open connection anywhere kills the entire line.

The output terminal strip, as provided by most amplifier manufacturers, have 4, 8, 16 ohms, as well as 25-volt and 70-volt output taps. A typical output terminal strip on the rear panel of an amplifier is shown in FIGURE 1.

The various methods used for loudspeakers connection are commonly referred to as impedance matching. The three methods in use are *direct voice-coil connection*, *constant impedance* and *constant voltage*.

In the *direct voice-coil connection method*, the amplifier output is connected directly to the loudspeaker voice coil and no matching transformer is required. The direct voice-coil connection method is employed for simple systems requiring only a few loudspeakers and short runs of wire (not over 200 feet in length).

For installation of a single loudspeaker, a single 8-ohm speaker is properly matched to an amplifier when the transmission line is terminated at the 8-ohm output of the amplifier as shown in FIGURE 2. Similarly, if the loudspeaker has a 16-ohm voice coil, its connection is made to the 16-ohm tap.

When loud-speakers are connected in series (see FIGURE 3) the total impedance is equal to the sum of their individual voice-coil impedance. When two 8-ohm speakers are connected in series, their total load impedance is 16-ohms; connections are made to the 16-ohm tap on the amplifier and to the common or ground terminal. In the same manner, when two 4-ohm speakers are connected in series, the total impedance is 8 ohms, and connections are made to the 8-ohm amplifier output tap.

Wherever possible, the series arrangement should be avoided, because a broken wire, anywhere in the circuit, will cause the entire circuit to become inoperative. When loudspeakers are wired in parallel, as shown in FIGURE 4, the total load impedance is found by dividing the impedance of any one loudspeaker by the total number of speakers in the system. For example, two 8-ohm speakers would be wired to the 4-ohm output tap. Two 16-ohm speakers, wired in parallel, would be connected to the 8-ohm tap on the amplifiers.

It is generally not advisable to use any combination of loudspeakers that have a combined impedance of less than 4 ohms, because operation with less than 4-ohms impedance will result in extensive power loss.

In some cases, it may be impossible to find a satisfactory match for a group of loudspeakers in parallel for connection to the available output impedance taps. In this event, it may be necessary to use a series/parallel connection shown

in FIGURE 5.

To find the total impedance for a series/parallel connection, combine the two formulas, series and parallel. Compute the impedance separately for each group of speakers, then consider each group as a single loudspeaker and compute the total impedance as a parallel combination. FIGURE 5 shows four 8-ohm speakers connected as a series/parallel arrangement. Speakers A and B present a series impedance of 16 ohms. Similarly, speakers C and D another 16 ohms. Paralleling the two groups (A+B and C+D) results in an impedance of 8 ohms. When connected to the 8-ohm output a perfect match results.

A second method of impedance matching is the *constant-impedance method*. This requires the use of a matching transformer. The constant-impedance method of connection was adopted years ago for installations where the direct voice-coil method was impractical, because of long transmission lines, or the use of many loudspeakers in a system. The constant-impedance method provides a convenient means for connecting loudspeakers, so that various speakers within a system can be operated at different power levels. This is especially useful in large industrial and commercial systems, that have high noise as well as quiet areas.

In the constant-impedance method of connection, a high-impedance line, usually 250 or 500 ohms, is used. The high-impedance line from the amplifier is connected to the individual loudspeaker voice coil through a line-matching transformer with a secondary winding that is properly matched to the loudspeaker voice coil. The primary windings of these line-matching transformers are connected by the installer to the proper primary impedance tap to control the amount of power that a particular loudspeaker will draw. Most line-matching transformers have four impedance taps.

The constant-impedance connection method has worked well in the past, but it has a number of serious disadvantages. Among these are the complex and complicated computations that are required in a large sound system, using many loudspeakers. Another difficulty is that in the large, high-power systems, high voltages, frequently in excess of 200 volts, are developed across the transmission lines.

This problem is a very serious one, due to the dangerous shock and fire hazards these voltages present. Another problem and inconvenience encountered when using the constant-impedance connection method is that when a system requires moving or enlarging, it is necessary to readjust every transformer in the system. In a great many cases, it may even be necessary to replace the transformers in order to

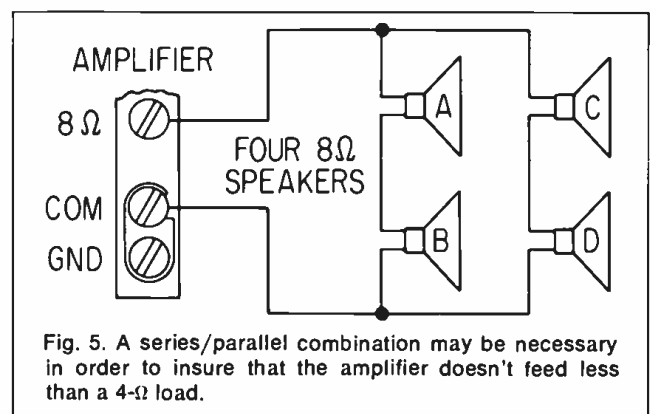
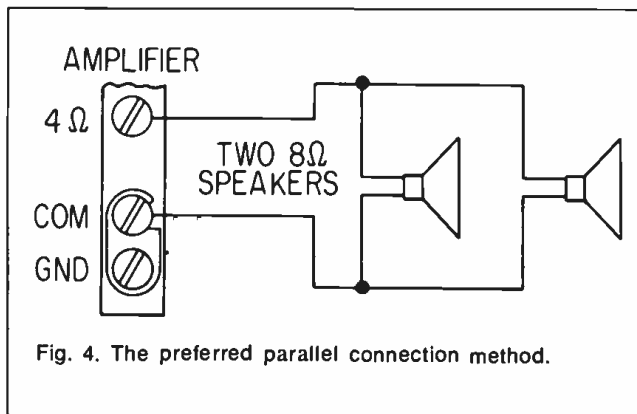

provide the correct impedance tap. It is for these and other reasons that the constant-impedance method of connection is rarely used in sound-system installations today.

In order to correct these disadvantages of the constant-impedance connection method, a new system of impedance matching has been developed. This new system, known as the *constant voltage method*, has virtually superseded the constant-impedance method.

The constant-voltage system was developed by the **Committee on Sound Systems of the Radio Electronic Television Manufacturers Association**. In developing the constant-voltage system, the committee complied with the recommendations of Underwriters Laboratories, with regards to line voltage selection for the rated output of the amplifier. The constant-voltage system, as recommended by the committee, was accepted and adopted by the trade.

An amplifier designed for the constant-voltage system will deliver a maximum voltage when operating at its full-rated power output. Most amplifiers provide 70-volt (actually 70.7 volts) and 25-volt taps at the multi-screw output terminal strip (see FIGURE 1). It should be understood that in the constant-voltage system the 70 volts or 25 volts nomenclatures represent the highest voltage the amplifier will develop and that these voltages will appear only when the amplifier is operating at its full-rated power. The voltage will accordingly be less when the amplifier is operating at levels below the output as rated by the manufacturer. Standardizing on the output voltage simplifies the computation of transformer taps required for varying sound levels of the loudspeakers. The line-matching transformers for use in constant-voltage systems are available for operation with the two standard line voltages, 70 and 25 volts. The size of the transformer will depend on the power it is designed to handle.

The transformers, as a general rule, have taps for matching loudspeakers with 4, 8, or 16-ohm voice coils. Constant-voltage transformers have taps marked in watts. This makes it convenient for the technician and installer to select the required transformer wattage from the multi-wattage tap to provide the sound level for each loudspeaker. Care should be taken to insure that the total power consumed by all loudspeakers in the system is equal to or less than the power rating of the amplifier.

Large sound systems, with long transmission line runs, usually are wired to 70-volt lines. This reduces power loss caused by long transmission lines. Systems requiring shorter transmission line runs or systems such as school or hospital (using home run transmission lines) are usually installed

with 25-volt lines. It should be noted that there has been a general trend for greater use of the 25-volt line, as many local building codes are requiring that 70-volt transmission lines be run in conduit or armored BX-type cables.

If constant-voltage transformers with taps marked in watts are not available, transformers designed for use in the constant-impedance system with taps marked in impedance can be used. To determine the wattage delivered by a transformer marked in impedance, the formula to use is  $Z = E^2/P$ . In this formula,  $Z$  equals the desired impedance tap,  $E$  the voltage, and  $P$  the power (in watts). For the 70-volt system, the formula is  $Z = 5000/\text{desired power}$ , in watts. For the 25-volt system, the formula is  $Z = 625/\text{desired power}$ , in watts.

Besides the obvious advantage of eliminating detailed mathematical calculations, another very important advantage of the constant-voltage system is that when the system is expanded, requiring additional power, higher powered amplifiers may be substituted. No changes or rewiring of the speakers already installed are required. Another advantage is that after a system has been installed, and it is found that a loudspeaker is too loud or not loud enough, it is a simple matter to change the transformer tap on the loudspeaker so that it will handle more or less power as required.

This is just as simple as changing a light bulb in a lamp. If it is too bright, you change the bulb to one of less wattage. If it is not bright enough, you change the bulb for one of greater wattage. In the constant-voltage system, it is also possible to switch loudspeakers in and out of the circuit, at will, with no noticeable increase or decrease in volume of the remaining speakers. This is not true in the constant-impedance system, as any change in the number of loudspeakers affects the impedance match of the system.

It must be remembered that manufacturers of amplifiers devote a lot of time and spend much money to provide amplifiers with a rated power output at a fixed amount of distortion and frequency response. If the loudspeakers are not connected properly, the amplifier will not perform efficiently and the specifications as listed by the manufacturer will not hold true. The time required to insure that the loudspeaker system is properly connected will reward the installer with a system that will provide better quality sound and a more reliable system, with fewer service problems. It will also result in a more flexible system that can be easily expanded or relocated. Most important it will help assure a more professional installation and a more satisfied customer.

# Creative Sound in the Legitimate Theater

Robert J. Kerr\*

*The theatrical sound engineer must know more than his electronics. The author discusses the psychology of legitimate theater sound and gives some hints on breaking into this field.*

SOMEWHERE in the deep crevices of prehistory the *Stone Age Theater and Drinking Society* presented a family situation comedy dealing with the fine art of catching a wife. Stars being what they are, even in the stone age, the leading lady undoubtedly objected to being bashed over the head, even in the name of artistic verisimilitude. The resourceful director solved this situation by faking the blow on stage and instead bashed the head of an apprentice off-stage to give the proper sound. Such activities no doubt caused some attrition in the apprentice ranks until an enterprising stage hand found that a carefully selected melon not only gave a realistic sound when bashed but had a squishy overtone that enhanced the effect. Thus was born the art of theatrical sound effects.

Over the centuries a great number of ingenious devices have been created to generate sound effects and before the

---

\*E. I. du Pont de Nemours & Co (Inc)  
Wilmington, Delaware



days of recording every theater worthy of its name had a wind machine and a thunder sheet. The development of radio and sound recording saw the art of sound effects grow to a new high, and every radio station had a library of some recorded sound effects. Throughout the development of sound recorders and recordings, both amateur and professional legitimate theater has had some beneficial fallout. Almost all theaters had a record player and, more recently a tape recorder to play pre-show music and some sound effects. Even gypsy theatrical groups who give shows in schools, fire houses, womens' clubs, etc. have someone who owns a tape recorder and who can be conned into "doing sound."

In spite of the widespread availability of the magnetic tape recorder, this marvelous instrument is almost never used at anywhere near the limit of its creative potentiality. A real opportunity exists for the professional sound engineer in the field of creative sound in the legitimate theater.

A few modern playwrights have had the perception, imagination, and knowledge to write sophisticated sound plots into their shows. Best known of these writers is Tennessee Williams. Even in one of his earliest and most orthodox works, *The Glass Menagerie*, Williams makes effective use of sound to help set the mood of the various scenes. It was, in fact, Williams' extraordinary theatrical experience, *Camino Real* that first introduced me to the full potential of creative sound.

My work, over the years, has been conducted primarily at **The Players Club of Swarthmore** where a group of serious amateurs and professionals in the field of audio have endeavored to advance theater sound. We started with a portable sound console in the balcony, and when we had proven our point, the club management presented us with a permanent sound booth. See **FIGURE 1**. Using an audience location (balcony enables the sound operator to play the sound

equipment as one would a musical instrument. The operator is self-cuing since he can see all that is going on on the stage. Volume levels can be trimmed to differing size audiences and for subtle variations in the dramatic requirements as the play progresses. Operator error fluffs are reduced because the operator is in more direct contact with the stage action, and free of the normal distractions taking place in the wings. The balcony location is not entirely free of problems though, since operators are known to get wrapped up in the show and miss cues. During shows with infrequent cues, the more gregarious operators have been found backstage over a cup of coffee when the cue came.

## Preparation

Hand in hand with moves to improve the ability to run sound cues is improvement in the quality of the preparation. Here the professional recording engineer makes his most dramatic initial contribution. Few tape recorder owners know how to make good dupes of records or tape.

This inadequacy starts with the records and record playing equipment. The acquisition of good records and good care is essential. People listening to *music* on scratchy records will accept this noise as a limitation of the recording or system, but present a scratchy *sound effect* and credibility goes up the flue. As a matter of fact, few things can reduce a highly dramatic moment to a laughable farce as effectively as a sound effect that's punctuated by recurring crackles. Directors have been observed with great tears streaming down their cheeks as carefully constructed dramatic moments collapse under the weight of a stylus stuck in a record groove.

Actually there is no excuse for this, since good record players are available that will not damage records. And a little effort at cleanliness will keep discs pristine.

The preparation of the final performance tapes will require skill in tape editing, since about half of the effects needed will have to be modified to get the best results. The choice of the recorder will make a great difference in the ease with which editing can be accomplished; this will be discussed later under *equipment*. The different cues on the tape should be separated by light-colored leaders. Some system should be worked out for accurately positioning the tape leader on the performance machine to obtain a uniform lead time from machine start to sound start. The leader should be applied with the dull side out and written upon, so that each cue can be identified as to content, number, and script page reference. Many a wrong cue has been played because the operator lost his place and was not able to identify where he was. (I shall not deal with the actual preparation of special material, since there are standard procedures in various tape recording texts and the professional recording engineer usually has this skill.)

Pre-show music, overtures, and bridges are where the gulf between the potential and its accomplishment is often particularly great. The best way to get good music is to find someone with a good knowledge of musical literature and theater to select appropriate compositions, tape them and play them for the director for his approval. After the music plot is made up, the director should be asked to come early some rehearsal night to hear the selections. Under the title of the care-and-feeding-of-directors, playing selections during or immediately after the press of rehearsal problems will result in a vacant nod of assent, only to be followed after opening night by the question, "Where the hell did you get that noise you were playing"?

Fig. 1. An audience-eye view of the sound booth at The Players Club of Swarthmore. Note the rear theater speaker directly under the booth's window. A small tv camera is at the upper left. This pipes a picture backstage so that offstage personnel can see the stage action.



The audio engineer will have to recognize that the initiative for a creative sound project will have to come from him. The most effective entry is usually to volunteer to make the sound tape for the next show. Don't push new ideas too hard. Even the most advanced theater has an induction period for new ideas.

If financial remuneration can be temporarily subverted for artistic fulfillment, the most rewarding work can be found with the summer stock companies. These groups are usually made up of serious and highly-skilled actors who are interested in advancing their acting skills in some of the more challenging but perhaps less popular theatrical works. By their more *avant garde* nature, these plays offer more opportunity for creative sound work. The directors are also more open to experimentation. In a more pragmatic vein I must state that such companies may have a very tenuous financial structure and due caution should be observed before your own financial or equipment commitments are made. Nevertheless I highly recommend a summer with a stock company for anyone who has a creative bent and a good knowledge of audio techniques.

It is highly likely that there is a good amateur theater group near to anyone reading this article. Here the audio engineer or enthusiast will find an opportunity for a long-term association with theatrical sound on a less frantic schedule than the new-show-every-week routine of summer stock. The show fare of the amateur company is usually conservative and the quality of preparation given to the music and sound effects may be the only opportunity for a contribution by the sound department in many productions.

The sound engineer with an idea to sell to an amateur must walk gently. The amateur is usually not stupid but he has gotten along for many years without creative sound and is apt to be very much entrenched in his ideas. Start slowly and don't press too many new concepts at once. Directors may suspect audio engineers want to use their show for a display of acoustical pyrotechnics. You must convince them that you are subservient to his desire for the best possible show. Above all, do not try to run in on a performance something you have been unable to sell the recalcitrant director during rehearsals, for that will surely be your final contribution. Once you have proven your ability to do a good job on some relatively conservative sound work, and the directors come to trust your motives, you will find your services and opinions sought.

### The Equipment

Since most modern theaters have *some* sort of sound system, the first item of importance is the tape player and/or the tape recorder. For the player, the most important features to be sought are the ability for fast *start* and *stop* and accurate cuing, combined with relative silence in operation. Silent operation is necessary when the equipment's location is in close hearing proximity to the audience. In my experience, the most satisfactory machine for this purpose is any one of a series of Ampex machines starting with the *A* series through the *960*, *1260* and ending with the recently discontinued *F 44*. At one point Ampex manufactured a play-only machine on the *960* frame. This unit with playback pre-amps was the *936*, and as a transport only, was the *934*. We use two *936*'s at **The Players' Club**. These machines rest with the electronics and electrical circuits in the *play* mode so that starting the tape involves a mechanical release of the brakes and engagement of the capstan idler to start the tape. These machines have established stable tape motion



Fig. 2. A view of the stage as seen from the sound booth. The stage is set for the play *Romanoff and Juliet*. Small footlight microphones relay stage sound backstage through AVC amplifiers.

within a quarter-inch of tape movement. This permits tight cuing. By wedging down the stop button (except on the *F 44*) short and fast cue sequences can be started and stopped rapidly with a simple thumb motion. Since no electrical contacts are made during the start/stop operation there is an inherent freedom from pops. In most service the head hum shield is not necessary so that it may be removed to allow for accurate cuing.

While they may be hard to find on today's marketplace, I recommend the use of a half-track format in theater tapes as opposed to the common quarter-track. This is primarily a question of safety since the left track in a quarter-track format is somewhat unreliable. (In a mono-only theater system the right channel only of a quarter-track machine may be used.)

### The Hall Sound System

The over-all sound reproducing system should be one capable of handling substantial power, especially in the bass end. A passing jet plane effect (common in modern plays) loses something rather essential when accompanied by frequent contact of the speaker voice-coil structure against the rear stop. If the financial limitations of the theater permit, a multiple channel system gives the maximum opportunity of expression. **The Players Club** system is a basic six-channel system. Two large auditorium speakers are suspended on the rear wall backstage with 160 watts available for drive, two smaller speakers are at the front of the theater with 80 watts driving, and two are at the rear of the auditorium with 80 watts available.

In addition to the basic system there are extra lines for special effects such as an FM wireless microphone and extra





Fig. 3. A view of the sound console at The Players Club. The telephone headset connects with the lighting panel backstage. The Gralab photography timer is used to backtime music for synchronized-with-action endings. The two recorders are Ampex 936 units. The integrated stereo amplifier (upper left) and the stereo preamplifier (to its right) are both Scottkits.

speakers. Stress should be placed on the necessity for at least one wide-range, high-power-capability channel. Such systems can be found on the used-equipment market if budget considerations prevent the purchase of new equipment.

In building the system for a theater, allowance should be made for expansion to a multiple channel system if such a system is not already extant. The system of the **Players Club** auditorium allows many special effects. *Guys and Dolls* has a telephone sequence to advance the plot and to cover a scene change. For this sequence we wrote some additional dialogue and played the scene across the theater on two different channels. During *Auntie Mame* the fox chase scene was played with a four-channel joy stick level control which permitted directing the sound to the point of the theater desired. The operator simply followed the action around the theater thus creating a spectacular effect. Such effects are only limited by the imagination of the sound engineers and the directors.

### System Operation

Operation is by no means the least important part of the story. As in all phases of theater audio the operator must remember that the primary purpose is to be a part of a total effect of several arts combined to tell a story, convey an idea, and entertain. As such, sound is rarely an end in itself. To this purpose the sound must blend with the total effect. The balcony or rear-theater location allows the sound engineer to sense differences due to differing sized audiences and variations in the performance. Simple sound effects such as car sounds, airplanes, shots, etc. are easy enough, but must be at proper loudness and of course sound in simulation of what they are intended to be.

Sounds such as crowd noises, factory sounds, thunder storms, all of which are supposed to run under a scene are a special problem. These sounds must be started at a level high enough to establish their nature to the audience and then faded into the background so as not to interfere with the speaking. A more complicated example of this occurs in a play called *The Human Voice* where New York street sounds ride under the entire action. Conversation pauses occur during which the level of the street noises is raised to provide a bridge between phone calls. Occasionally a sound must run under for a period and then fade. Unless the script calls for an abrupt cessation, these effects should sneak out so that the audience is not aware of the cessation. The best way is to find an intense moment in the action of a noisy period and fade the effect gently out.

Frequently, when a particularly appropriate bridge selection is available, the music bridge may be bled into the scene after the curtain opening to cover initial action without speaking. One example that comes to mind is a scene from *Auntie Mame* where a paper hanger is seen several seconds before a character enters to speak. The bridge was continued until the second character entered and was about to speak. Such methods can enhance the sense of continuity in a play.

Cues and bridges should be run so that they are tight up against the stage cue. The operator reaction and recorder delay should be taken into consideration so that the operator leads the actual stage cue by a few words. This practice helps the pace of the show and gives the actors confidence. (One occupational hazard is getting clobbered by the director because you got so interested in the show that you blew the cue. So stay alert!)

The sound engineer should avoid certain types of cues. Doorbells and telephones should be real sounds operated from the prompter's box. A telephone cue on tape is hard to reproduce properly and a muffed cue must be rewound, recued, and played if on tape. The prompter has only to come to and press the button. Taut operation of sound cues is a mark of professionalism.

For the most part affiliation with one theater will either not support a sound engineer full-time or will involve a time commitment beyond the capability of one man. Often the person preparing the sound tape will not be willing, or able, to operate for all shows. The solution is to enlist the services of the serious amateur. In almost any area there are serious amateurs who have good recording equipment. These people are often anxious to utilize their equipment and sharpen their skills. In addition they usually have a good knowledge of music and artistic sensitivities which give an appreciation of theater arts.

With a little searching, people can be found who are not equipped to prepare tapes but who are interested in becoming operators. In a short while a staff can be built up which will permit a whole season of shows to be staffed with out an excess load on any one person. This procedure has worked out well at **The Players Club** for the past five years and has provided the directors with the confidence to undertake plays with complicated sound plots as well as experimenting with new and special effects.

In summary, the sound engineer, either professional or amateur, will find much satisfaction and the opportunity to learn new skills. The publicity associated with such activities will afford the professional with many new contacts, opportunities such as the sale of sound systems, consulting jobs, preparation of special tapes for commercial use, recording engagements, and a host of other profitable work.



# Crolyn Tape: Does it Solve Problems?

Larry Zide

**O**N November 21, 1967 the New York Section of the AES held its regular meeting at the Fine Recording Studios in New York City. The formal title of the program was A Discussion and Demonstration of Chromium Dioxide Tape. The speaker: Robert J. Kerr, Research Engineer, Photo Products Department, E.I. du Pont de Nemours Co.

This was not the premier of Crolyn ( a registered trade mark of du Pont's). Early last summer a press conference was held to unveil this new tape. At that time, du Pont scientists would not comment on the audio applications of this new tape. Their discussions were limited to instrumentation, computers, and helical-scan video tape recorders. Nevertheless, it was apparent even then that a tape that showed marked improvement in its ability to store bits of information, and with less noise, was going to have audio value as well.

This AES invitation was tendered to du Pont to examine Crolyn's audio uses. At this date, du Pont admits to not yet fully exploring the audio requirements and possible applications. What follows, therefore, is more a progress report than a ready-to-use (in audio) commercial product.

You are not likely to find much, if indeed anything, in your chemistry textbooks on chromium dioxide. (This is the new magnetic material used by du Pont instead of conventional iron oxides.) Chromium dioxide is an invented synthesis derived from chromium trioxide. The first small amounts were produced by Dr. Paul Arthur Jr. of du Pont's Central Research Department several years ago. They were made by decomposing chromium trioxide in the presence of water at a temperature near 900° F and under pressures of 30,000 pounds per square inch. This discovery is the basis of U.S. Patent 2,956,955 issued to Dr. Arthur and assigned to du Pont.

Here are the highlights of Mr. Kerr's talk on Crolyn.

"For the first part, I want to talk about the properties of chromium dioxide and chromium dioxide tapes in a general way. It is synthesized in the form of acicular, single domain particles which can be varied in length from 4 to 400 micro-inches with a normal aspect ratio of ten to one. (FIGURE 1.) Coercivity can be varied from 25 to over 700 Oersteds. The particles have the rutile crystal structure and exhibit both shape and magnetocrystalline anisotropy.

"The saturation flux density ( $B_s$ ) for chromium dioxide is 6100 Gauss and the Curie Point is 126° C.

"Crolyn magnetic tapes are well suited to the precision

needs of video, instrumentation, computer, and audio recording. In general Crolyn magnetic tapes selected for development have coercivities of from 360 to 530 Oersteds with residual flux densities up to 1600 Gauss. The excellent dispersion of chromium dioxide and the narrow range of particle size leads to tapes with optimum smoothness and orientation as shown by ratios of  $B_r/B_s$  of 0.90. Additional benefits include low noise and low print through. Coating thicknesses of present Crolyn magnetic tapes range from 80 to 250  $\mu$ in. with residual  $B_r$ 's for half-inch tape of 0.4 to 1.25 Maxwells.

"The advantage Crolyn tape shows in its magnetic properties translates into very practical advantages in the fields of video and audio. To demonstrate this we have specially modified a commercial helical-scan video recorder to run at half speed. As designed, this machine uses half-inch tape with a lineal tape speed of 7.5 in/sec. The head rotates at 1800 rpm and the resultant head-to-tape speed is 430 in/sec.

"In this modified machine we have reduced the lineal tape speed to 3.75 in/sec. and the head rotation speed to 900 rpm. The resultant head-to-tape speed is 215 in/sec. The FM recording system, however, has been left unchanged. Thus, the recording densities are exactly twice as great as on the full-speed machine.

"We have prepared comparison tapes by splicing together a length of high-quality iron oxide tape of a type recom-

Fig. 1. This electron photomicrograph of chromium dioxide crystals at 50,000 times magnification illustrates the uniform, needle-like particles which permit better orientation.



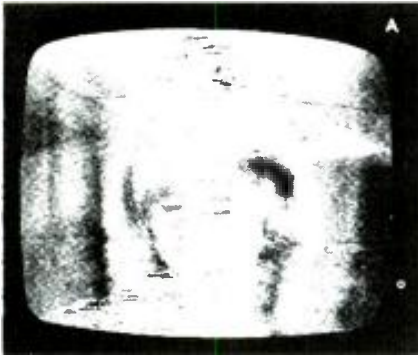
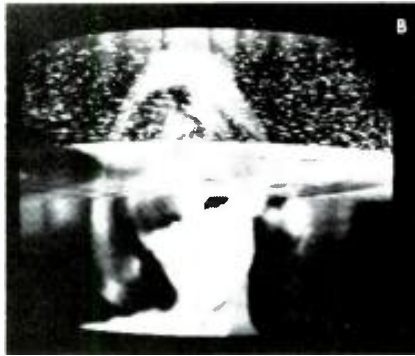

Fig. 2. (A) shows iron oxide video tape, recorded and played back at half speed. In (B) the splice between iron oxide and



Crolyn tape shows a significant difference. At (C) the image is entirely from Crolyn. Picture quality is virtually iden-



tical at the slow speed with iron oxide video tape at the normal 7.5 in/sec.

mended for use on helical-scan recorders, followed by a length of Crolyn. To achieve an accurate comparison we have adjusted the write currents to the optimum values for each tape. If we demonstrate this on an unmodified machine there will be very little difference observable between the tapes. However, the half-speed machine shows the marked differences observable in FIGURE 2. Note that the iron oxide tape is extremely noisy (FIGURE 2A) and the highlight areas have black streaks in them, the result of inadequate short wavelength response on the tape. In the cross-over (FIGURE 2B) and the all-Crolyn picture (FIGURE 2C) the difference in signal-to-noise is, I believe, quite obvious.

"It was recognised early in our work that Crolyn would offer advantages for audio, especially for mastering, where improved signal-to-noise ratio is always desired—and for slow speed recording, where signal-to-noise ratio and good short wavelength response were important. Both of these uses require coating thicknesses of other than 200  $\mu$ in."

From here on we depart from Mr. Kerr's prepared text, to report on his demonstrations.

One of the findings made by du Pont was that Crolyn displays much less high-frequency hiss under d.c. magnetization than do iron oxide tapes. To demonstrate this, a 3 kHz tone was recorded onto a loop composed of half Crolyn and half iron oxide. Separate tape channels were used so that the optimum recorder settings for each tape could be used. In A-B comparison Crolyn was significantly cleaner and seemed brighter—this in spite of the fact that both tapes were within a dB of each other in frequency response. The tone sounded relatively *fuzzy* on iron oxide, with an attendant rise in background noise.

Fig. 3. Robert J. Kerr of du Pont delivering his lecture before the N.Y. AES group.



A second demonstration, (both were on a 3.75 in/sec. machine using a low-noise premium iron oxide), showed that the bias noise levels of iron oxide and Crolyn are comparable.

The demonstrations exposed as clear cut a difference in audio as was visible in the slow-speed video tape pictures.

In sum, Mr. Kerr had this to say, "Signal-to-noise is, of course, dependent upon the relationship of the noise to the usable output, and this tape sample has 3 dB more 3 per cent harmonic distortion output and saturation output than the low-noise mastering tape. This is in spite of the fact that the Crolyn tape we are showing is only 370  $\mu$ in. thick in comparison to 470  $\mu$ in. for the low-noise tape.

"The greatest use of Crolyn properties, of course, comes when machinery is designed to take best advantages of the tape and where tapes have been tailored for the application. It is expected that you of the professional audio field will find Crolyn a significant advantage in your work."

Of course, when you will get this advantage is hard to say. The du Pont representatives were not willing to commit themselves on a production-type audio tape other than to say that sometime in 1968 seems likely. Nor, at this stage of development would they make a commitment on price, but it is likely that Crolyn will certainly cost somewhat more than conventional audio tapes. Since it does represent an advance in the state-of-the-art, particularly in slow-speed recording, its higher cost will be justified by other savings.

With the quality advancement that seems inherent in Crolyn, we can only wonder what degree of improvement lies ahead when this new tape is combined with a noise-reduction system such as the Dolby unit.

Fig. 4. Mr. Kerr loads a tape loop preparatory to demonstrating audio differences described in the text.





# New Products and Services

## Condenser Microphone



The Hammond M-100 condenser microphone features an omnidirectional pattern with extended frequency response and high sensitivity. The power unit case houses the stabilized a.c. power supply plus storage space for microphones and cables. The basic M-100 system comes with one microphone and power supply. A M-100S version features two microphones for stereo along with a dual power supply. Both versions come with fifteen feet of microphone cable (per mike) and nine feet of output cable. Microphone stand adapters are also provided. Important specifications include—frequency range: 20-20,000 Hz,  $\pm 3$  dB; sensitivity: 2 mV/microbar; load impedance: 50 ohms to 2 megohms unbalanced. Finish is anodized aluminum, dimension of the microphone head is  $3\frac{3}{8} \times \frac{7}{8}$  inches, and the power supply operates off 110-120 V a.c. and consumes 12 watts.

*Mfgr: The Microsound Company*

*Price: M-100 mono—\$149.50*

*M-100S stereo—\$229.50*

*Circle 75 on Reader Service Card*

## Sound Pressure Measurement



The model MD 321 N is a dynamic microphone that is equipped with a twelve-inch long probe with a diameter of  $5/16$ -inch. This makes it ideal as the active element of a sound pressure measurement system or for sound registration in confined areas and the localization of acoustic leakages. Frequency range extends from 50-15,000 Hz. An individual calibration curve is supplied with each microphone. Output level is  $-68$  dBm with reference to  $1 \text{ mw}/10 \text{ dynes}/\text{cm}^2$ .

*Mfgr: Sennheiser Electronic Corporation*

*Price: \$145*

*Circle 76 on Reader Service Card*

## Portable Voltmeter/Amplifier

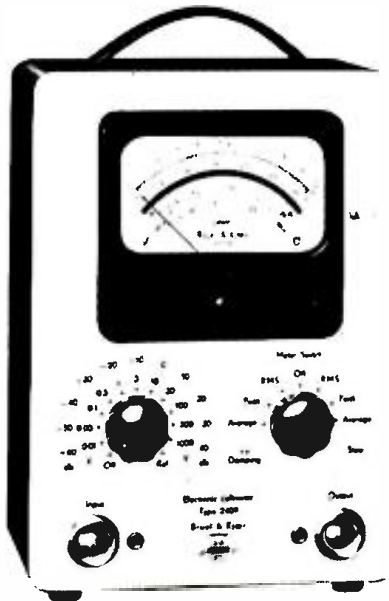

The B & K model 2409 produces true RMS measurements for signals from 2 Hz to 200 kHz, and measures a.c. voltages from 1 millivolt to 1000 volts. It indicates true RMS, average, or peak values. Weight is 10 lbs, the meter scale is four-inch and graduated in volts (0 to 10 and 0 to 31.5), dB (0 to 20), and dBm (0 to 22.2). The unit can operate simultaneously as a monitoring voltmeter and a calibrated amplifier, with up to 45 volts peak undistorted output. Attenuation is calibrated in 10 dB steps, frequency response is flat within  $\pm 0.2$  dB, and high calibration stability is from a built-in zener diode source. There is also a model 2416 that is identical to the 2409 except that it is in a standard rack-mount case.

*Mfgr: B & K Instruments*

*Price: on request*

*Circle 77 on Reader Service Card*

## Monitor Amplifiers



Two new solid-state plug-in type monitor amplifiers that deliver sine-signal power at an output of 10 watts over the frequency range of 20-20,000 Hz have recently been announced. The model AM 10AP (no output transformer) and the AM 10APT (with a 1:1 output transformer) are recommended for use as control room program monitors. Output short-circuit and input overdrive protection are provided without causing distortion during normal operation. A thermally actuated cut-off switch removes power from the system in the case of prolonged overload or short. Response is  $\pm 0.5$  dB at a level of  $+30$  dBm into rated load. An input of 70 mV RMS is sufficient to drive the amplifier to full rated output ( $+40$  dBm—10 watts). Harmonic distortion does not exceed 0.3 per cent over a range of 30-15,000 Hz when operated at rated power output into rated load. Noise generation is below  $-40$  dBm total absolute. Amplifiers may be rack mounted (in a special mounting frame) with two amplifiers occupying  $5\text{-}1\frac{1}{4}$  inches of vertical space.

*Mfgr: Langevin*

*Price: on request*

*Circle 78 on Reader Service Card*

## Paging Horn

Compactness and versatility are the claims made for these new horns. Only  $8 \times 9$  inches with a sound level of 121 dB and a dispersion of  $110^\circ$ , these units will handle 15 watts of power. It is claimed thus that they fill a gap between 7.5 and 30 watt units. The two versions are the AP-15 which is a straight  $8\text{-}\Omega$  model and the AP-15T which is a 70/25V transformer version. Either unit requires only a screwdriver to mount and connect with field replacement of diaphragms possible without soldering.

*Mfgr: Atlas Sound*

*Price: AP-15 — \$33.25*

*AP-15T — \$43.25*

*Circle 79 on Reader Service Card*



# Sound-Track

## Modern Stereo Magnetic Recording TAPES America's Finest at Amazingly Low Prices

### TECHNICAL DATA

Signal to DC noise ratio minimum .....	65 db	Lubrication to decrease wear and reduce noise .....	silicones
High frequency sensitivity @ .5 mil wave length .....	+ 2.0 db	Recommended operating temperature 40°F to 140°F	
Frequency response using NARTB equalization @ 7 1/2 IPS ± .5 db, 40-16,000 CPS		Recommended storage conditions ... 70°F @ 40-60% RH	
Frequency response using NARTB equalization @ 15 IPS ± .7 db, 30-20,000 CPS		Base materials .....	acetate or polyester film
Harmonic distortion .... 0.8% max @ 1000 CPS 8 db below saturation		Base thickness .....	0.5 mil, 1.0 mil or 1.5 mil
Print through @ 1000 CPS saturated signal 49 db below signal		Tape width slit .....	0.246 ± .002
Erasing field for 60 db signal oersteds .....	800	Lengths .....	per standard reels
Modulation noise approximately 60 db below signal @ 1% distortion		Coating .....	ferric oxide
Dropout .....	none	Coating thickness .....	.40 mil ± .05
		Intrinsic coercivity .....	260 + 10 (HCl) oersteds
		Retentivity (BRS) - GAUSS .....	900
		Relative bias for maximum low frequency output .....	5.0 ma
		Low frequency sensitivity .....	0 db

**Northridge Magnetics, Inc.** 19017 Parthenia St., Northridge, Cal. 91325

Circle 38 on Reader Service Card

## Classified

Looking for a qualified professional to fill a job opening?

Trying to sell some audio equipment privately?

Want to get an audio engineering position in another city?

USE **db** CLASSIFIED ...

A UNIQUE NEW EMPLOYMENT AND EQUIPMENT EXCHANGE FOR THE WHOLE AUDIO INDUSTRY

**db**

THE SOUND ENGINEERING MAGAZINE now offers a classified advertising section to firms and individuals in all areas of audio—recording, commercial sound, broadcasting, manufacturing, film and tv sound, etc.

Rates are inexpensive: 25¢ per word for employment offerings, situations wanted and other non-commercial ads; 50¢ per word for commercial classified ads.

Closing date is the fifteenth of the second month preceding the date of issue. Send copy to:

Classified Ad Dept.

**db**

THE SOUND ENGINEERING MAGAZINE  
980 Old Country Road  
Plainview, New York 11803

### FOR SALE

**Scully Tape Recorders** — One to twelve track. Two, four, and eight track models in stock for immediate delivery.

**Scully Lathes** — Previously owned and rebuilt. Variable or automatic pitch. Complete cutting systems with Westrex heads.

**Mixing Consoles** — Custom designed using Electrodyne, Fairchild, and Universal Audio modules. From \$4000.00.

**Wiegand Audio Laboratories**, 221 Carton Avenue, Neptune, N.J. 07751, Phone: 201 775 5403

### EQUIPMENT WANTED

**Wanted** — used recording lathe, must be in perfect condition and reasonable. Please send photo if possible. Box B db Magazine 980 Old Country Rd. Plainview, NY 11803

### EMPLOYMENT

**AUDIO ENGINEERS.** Ground floor opportunities in a new manufacturing facility for experienced audio amplifier and com-

ponent design engineers. Also positions available for Technical Writers and Service Manager. Send resume or call collect: 215-TR4-6363

W. Brereton. **Strom Communications Corp.**, 10th and Walnut St., Chester, Pa. 19013

### Wanted — Professional Audio Salesman.

Must know equipment in broadcast and recording field. Prefer some experience in sales, but willing to train sales oriented audio man. Send resume to Box A—db Magazine 980 Old Country Rd. Plainview, N.Y. 11803

**Employment Opportunity.** YOUNG PROFESSIONAL, or about to be professional recording engineer who would like training and entree in the film recording field. Strong technical background in audio is necessary. So are intelligent, willing ears that can listen, and an inclination towards free-lance work. All replies treated in strict confidence. **Recording Equipment Company**, 114 West 70th Street, New York, N.Y. 10023

# People, Places, Happenings

## People



**Noble**

**A. A. Ward**, president of **LTV Ling Altec, Inc.**, tells us of the appointment of **James Noble** as director of engineering. Mr. Noble's duties are broadened by this promotion (he was chief engineer for electronics) and he will have complete design engineering responsibility for Altec products in the public address, motion-picture theater, telephone, and high-fidelity fields. This includes speakers, microphones, transducers, sound equipment, amplifiers, and related products. Mr. Noble has spent his entire business career with Altec Lansing, having joined the company in 1941, shortly after it was formed.

**Julius Brick**, president of **Melcor Electronics Corp.**, announced the appointment of **Don Richter** as sales manager for the Melcor professional audio product line. Mr. Richter will direct all sales and marketing activities associated with Melcor's professional audio components. Prior to joining Melcor, Mr. Richter was with the **RCA Victor Recording Co.** in New York where he held the position of manager of recording.



**Bredek**

**G. Leblanc Corporation's** president **Vito Pascucci** has just announced the appointment of **Charles V. Bredek, Jr.** as general sales manager. He had formerly served as regional sales manager. In his new position, Mr. Bredek directs the national sales program for the company's entire line of instruments. This includes Leblanc (Paris), Noblet, Normandy, Vito, and Holton models. Mr. Bredek joined Leblanc five years ago and has worked in the credit, orders, sales, and dealer-service departments before his appointment as sales manager for the Noblet-Normandy line. He was in charge of export sales before being named regional sales manager.



**Sommer**

**Edwin J. Sommer** has been named president of **Regency Electronics, Inc.**, of Indianapolis, Indiana. Mr. Sommer, previously a Regency board member, also assumes the presidency of two subsidiary companies — **Metrotek Electronics** and **Shepherd Industries**. The new president has stated that recent new product introductions, as well as some marketing innovations, make the Regency future look bright.

## Places

December 1, 1967 was the date for the official ribbon cutting ceremonies at **EICO's** new headquarters plant. The new air-conditioned **EICO** building in the Canarsie section of Brooklyn is a

one-level 100,000-square foot manufacturing structure. In addition to management offices, it houses enlarged facilities for engineering, quality control and consolidated production of both wired and kit equipment. And it provides amply for future expansion. All eight of the company's product lines — **Cortina Stereo**, **EICOCRAFT** bubble-packaged kits, cb radio equipment, amateur radio equipment, shortwave, automotive electronics, and test instruments for the service industry, production line, laboratory, school, and home.

## Happenings

**Concord Electronics Corporation's** industrial products division is now to be known as **Concord Communications Systems**. The division markets a line of video tape recorders, cctv systems, and related video products to business, education, industry, and the profession. According to **Arthur D. Gaines**, director of marketing for the Los Angeles firm, the name change is a result of product line expansion and new marketing programs.

Plans have been completed for the **1968 Midwest Acoustics Conference** to be held in Evanston, Illinois, on April 11, 1968. The conference will feature ten technical papers covering a variety of subjects in the field of acoustics, to be presented by members of the staff at **Northwestern University**. A tour of the engineering laboratories will be included in the program. Following the technical session, a dinner program will be held at the **Orrington Hotel**, Evanston, Illinois (the evening of the 11th). The **Midwest Acoustics Conference** is sponsored by the **Midwest Section, Audio Engineering Society**; **Chicago Acoustical and Audio Group**; and the **Chicago Section of The Institute of Electrical and Electronic Engineers**. The objective of the conference is to provide a means whereby the university can describe their work in acoustics to members of industry.

Mark your calendars also for the period from April 29th through May 2nd. These are the dates for the **34th National Convention of the Audio Engineering Society** to be held in Hollywood, California. The place is the **Hollywood Roosevelt Hotel**. In addition to an extensive technical paper presentation program, a selected number of manufacturers will exhibit their latest professional audio equipment. **Don Davis** of **Altec-Lansing**, 1515 South Manchester Anaheim, California 92803 is convention chairman.

# Harvey's is selling stuff you may not know exists.

There's an information gap in the broadcast and recording fields today. Sometimes we find ourselves distributing an exciting new product that many professionals don't even know exists.

For example, did you know that there's a new boom headset with built-in microphone that's so light you can actually forget you're wearing it? It can pick up two different signals at once. It's interchangeable with any standard boom headset. And if you want one now, Harvey's is the only place you can get it.

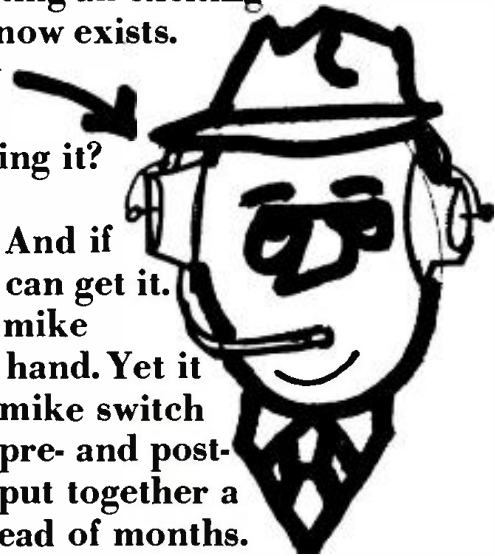

Also, there's now a complete console mike channel so small, you can hold it in your hand. Yet it includes a fader, program equalizer, line-mike switch with input pad, reverb-send channel and pre- and post-echo switch. With a few of them you can put together a complete console in a couple of days instead of months. It's revolutionary—yet, just about the only people who know of it are Harvey customers. Because just about the only place you can get it is Harvey's.



There's much more that's new. We have several new low-cost microphones that sound just as good as the most expensive mikes of a few years ago.

And so on. And so on.

Harvey's is in the habit of finding new equipment and distributing it before anyone else does. Often before anyone else knows about it, in fact. That's why almost every major sound studio and radio station already deals with Harvey's.

Help us close the information gap in the broadcast and recording fields. Call or write Harvey's regularly.

Open an account, if you want, and we'll start sending you our newsletter.

You don't necessarily have to buy anything. We'll just feel a lot better if you, at least, know what exists.

## Harvey Radio Co., Inc.

Professional A/V Division, 2 West 45th St., New York, N.Y. 10036 (212) JU 2-1500



This was the E-V Model 635.  
It started a tradition  
of excellence in  
dynamic microphones.

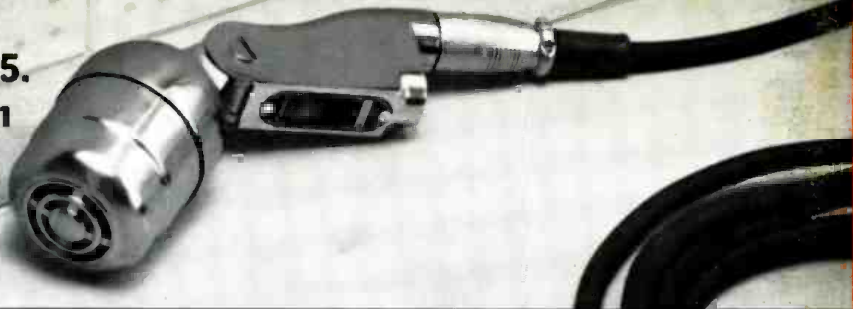

This is the new  
E-V Model 635A.  
It's better  
in every way!



Model 635A Dynamic Microphone \$82.00 List. (Normal trade discounts apply.)

**E-V** How can a microphone as good as the E-V Model 635 be made obsolete? By making it better! It wasn't easy. After all, professional sound engineers have depended on the 635 since 1947.

During this time, the 635 earned a reputation for toughness and dependability that was unrivalled by other omnidirectional dynamics. And internal changes through the years have kept the 635 well in the forefront of microphone design.

But now the time has come for an all new 635: the Electro-Voice Model 635A. It's slimmer, for easier hand-held use. Lighter, too. With a slip-in mount (or accessory snap-on Model 311 mount) for maximum versatility on desk or floor stands. The new, stronger steel case re-

duces hum pickup, and offers a matte, satin chromium finish perfect for films or TV.

The new 635A is totally new inside, too—and all for the best. A new four-stage filter keeps "pops" and wind noise out of the sound track, while guarding against dirt and moisture in the microphone, completely eliminating any need for external wind protection. Of course you still get high output (—55db) and smooth, crisp response. And you can still depend on the exclusive E-V Acustalloy® diaphragm that is guaranteed against failure for life\* (it's that tough)!

We expect to see plenty of the "old" 635's in daily use for years. But more and more, the new 635A will take over as the new standard. It's easy to find out

why: just ask your E-V Professional Microphone distributor for a free demonstration in your studio. Or write us today for complete data. We'll be proud to tell you how much better the new Model 635A really is!

\*The E-V Professional Microphone Guarantee: All E-V professional microphones are guaranteed UNCONDITIONALLY against malfunction for two years from date of purchase. Within this period, Electro-Voice will repair or replace, at no charge, any microphone exhibiting any malfunction, regardless of cause, including accidental abuse. In addition, all E-V microphones are GUARANTEED FOR LIFE against defects in the original workmanship and materials.

**ELECTRO-VOICE, INC.**, Dept. 1818D  
686 Cecil Street, Bucharan, Michigan 49107



Circle 27 on Reader Service Card

[www.americanradiohistory.com](http://www.americanradiohistory.com)