

ICD

audiocraft

for the **HI-FI** hobbyist

**Audiolab Test Reports:
Harman-Kardon, Shure,
Sargent-Rayment**

**How much distortion
is on your tapes?**

**Perfectionist's power
amplifier pictorial**

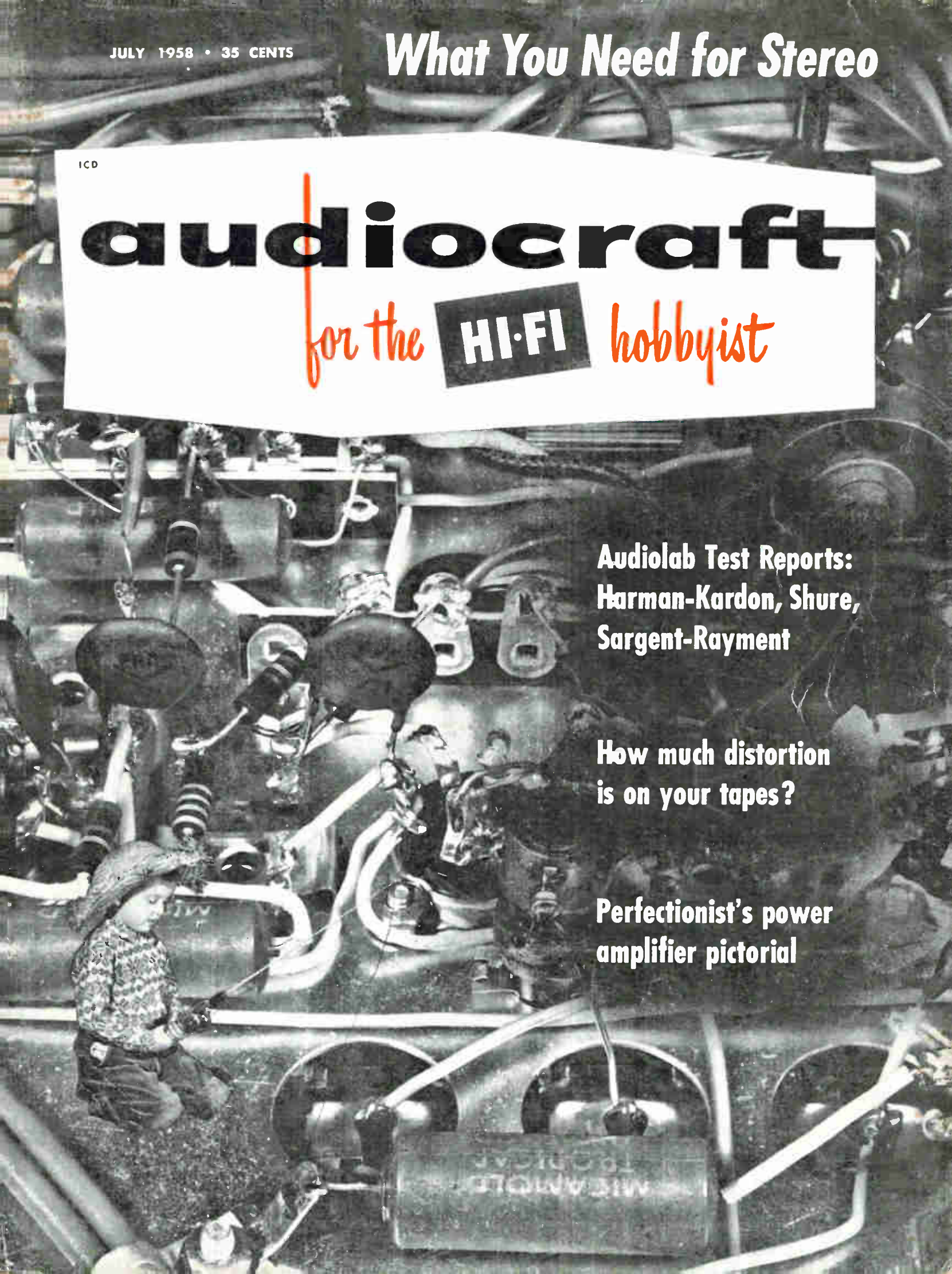

Garrard models change. Garrard ideals do not. Meaningful new features are added. Time-proven features are carefully retained. Gadgets, for the sake of gadgetry, are sternly rejected. The all-important fact to remember is that thirty-five years of experience in designing, testing, and building fine record players, guide us in offering you the present Garrard models.

Garrard

**WORLD'S FINEST
RECORD PLAYING
EQUIPMENT**

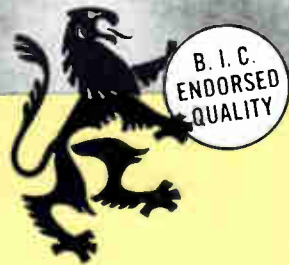
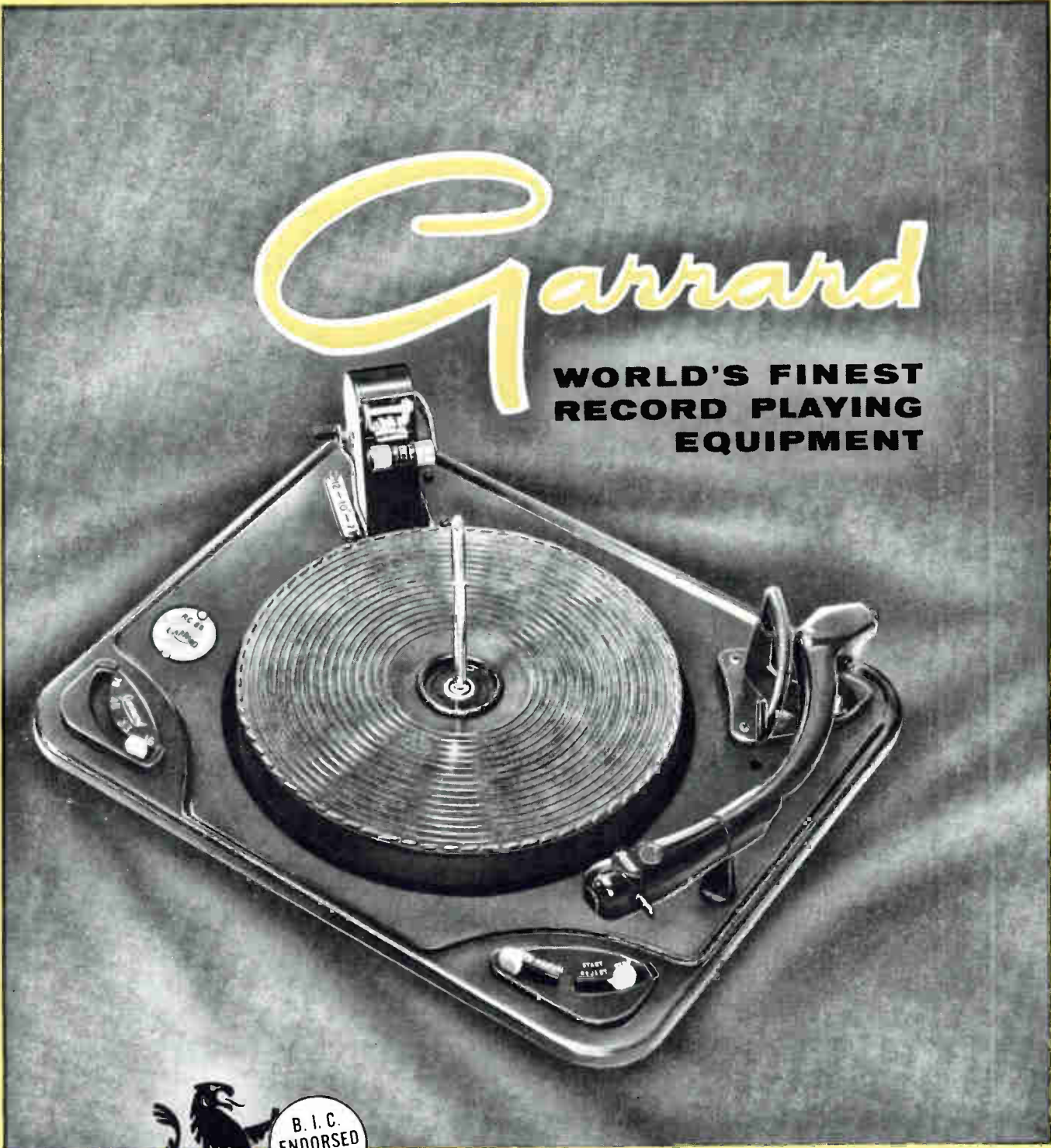

*There's a Garrard for every high fidelity system
Fully wired for stereophonic and monaural sound*



Model 301 PROFESSIONAL TRANSCRIPTION TURNTABLE
—Each speed variable!
Each unit with its own performance test report. \$89.00



Model RC98 4-SPEED SUPER AUTO-MANUAL CHANGER
Continuous + or — variable control on all speeds. \$67.50



Model TPA/10 TRANSCRIPTION TONE ARM
—Professional performance, jewel-like construction and exceptional versatility. \$24.50



Model RC88 4-SPEED DELUXE AUTO-MANUAL CHANGER
Exclusive pusher platform protects your records. \$54.50



Model T Mark II 4-SPEED MANUAL PLAYER
A superior unit for quality budget systems. \$32.50



Model RC121/12 4-SPEED INTERMIX AUTO-MANUAL CHANGER
Fine performance with economy and compactness. \$42.50

For information write:

GARRARD SALES CORPORATION, Dept. GG-98, PORT WASHINGTON, N. Y.

University P·S·E

PROGRESSIVE · SPEAKER · EXPANSION



THE ONLY GENUINE PLAN FOR BUILDING A SPEAKER SYSTEM
EASY ON YOUR BUDGET • NEVER OBSOLETE

 <p>Why is P·S·E never obsolete?</p>	 <p>How can I improve my present system —or add stereo?</p>
<p>A: Every University speaker component has built-in versatility and flexibility, such as dual impedance and adjustable response woofers . . . speakers that may be used for mid-range and/or treble response . . . adjustable networks. Even our enclosures and kits were designed with P·S·E in mind. All these features guard against obsolescence. And when you start or expand your system with University P·S·E, your original speaker(s) will always be an integral part at every stage...never discarded.</p>	<p>A: Very easy with P·S·E. Whatever your present equipment, the variety and flexibility of University's speakers assure compatible integration, while the unique versatility of University crossover networks and filters makes possible almost any number of crossover frequencies and impedances to <i>custom</i>-improve the system you now have. Thus P·S·E is also the smart way to add stereo. If you are starting from scratch, you can budget your stereo speaker system from beginning to end.</p>
 <p>How is P·S·E easy on my budget?</p>	 <p>Why is P·S·E the only <u>genuine</u> plan?</p>
<p>A: With P·S·E you can start as modestly as you like—with one extended range speaker, for example—and save part of your speaker budget until you've had more listening experience in your own home. Then, as your tastes develop and your budget allows, you can build up in successive, relatively inexpensive steps to a great variety of magnificent speaker systems. You are thus able to devote most of your initial budget to the selection of quality amplifying and program source equipment which cannot be economically altered or substituted later on.</p>	<p>A: Because <i>all</i> University speaker components are <i>especially matched</i> and designed with <i>exclusive</i> built-in features that provide the versatility essential to such a plan. Because University makes the <i>world's widest range</i> of quality speaker components—woofers, mid-range, extended range, 2- and 3-way Diffaxials, tweeters, networks—that give you an almost <i>unlimited selection</i> of superb speaker systems to start or develop until you gratify your ultimate aspirations!</p>

HOW P·S·E WORKS...a typical example

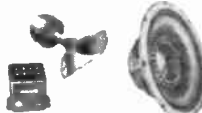

Get this P·S·E booklet at your high fidelity dealer. It lists all the more popular systems you can build the P·S·E way, plus complete specifications on all University speakers, networks, enclosures and enclosure kits. Or write Desk ' University Loudspeakers, Inc., 80 South Kensico Ave., White Plains, N. Y.

 <p>STEP 1 Start with the University Diffusicone-8 and realize immediate listening satisfaction.</p>	 <p>STEP 2 Improve the high frequency reproduction to beyond audibility by adding the Model HF-206 Hypersonic Tweeter and N-2B L/C crossover network.</p>	 <p>STEP 3 Reinforce bass response with the Model C-12W Adjustable Response 12" woofer and N-2A L/C network. The Diffusicone-8 now functions as a mid-range speaker. The result . . . the deluxe multi-speaker system you want tomorrow but started today . . . the P·S·E way!</p>
--	--	--

LISTEN

University® sounds better



How Good is a Wide Range Speaker?

by William Sherwood
Audiospeaker Laboratories
Pomona, California

Only yesterday this question might have caused heated argument. Proponents both of single speaker wide range systems and of multiple speaker systems have been able to develop persuasive cases for their particular favorite. Until now the cause for multiple speakers has had a definite edge. Why "until now"? Because, as the result of a newly completed research and development program, Audiospeaker Laboratories is introducing a completely new enclosure design. Used in this enclosure the wide range speaker can thumb its nose at the most complex 3-way and 4-way speaker systems.

Multiple speaker systems have a drawback profoundly disturbing to the discerning listener. This is a tendency to sound complex. One hears the speaker system as much as the music. The cause is that several speakers having different and distinct audio personalities are playing at the same time in different but overlapping ranges. To the person solely interested in the musical content the complexity of the multiple speaker system can become tiresome.

The single cone wide range speaker is inherently more musical because it is less obtrusive. The sound is simple, the music itself always has priority. In theory the single cone wide range speaker has always appealed as an ideal device. Yet it has not been without its own problems. Chief among these is often excessive intermodulation distortion, a result of a single cone handling the entire frequency range. Another is harmonic distortion at low frequencies — in order to reproduce highs the mechanical design is not usually ideal for clean bass response. These and other non-linear attributes have always spoiled the real musical quality that should be the exclusive property of the wide range speaker. It has been better in theory than in practice.

But, no more. The Audiolab Anechoic Speaker Enclosure makes it possible to use a single wide range speaker, or co-axial, and produce sound not only as clean as any multiple speaker system but far more musically satisfying. Now the question can be approached from a fresh viewpoint. How good is the wide range speaker? In most cases as good as anything else that can be devised, and in some cases better, when used in this new enclosure.

The Audiolab Anechoic Speaker Enclosure uses acoustic principles new to the world of high fidelity. It is neither just another variety of some well known type nor a modification, as is so often the case with "new" enclosures. It is absolutely unique, the first significantly new enclosure design since 1941.

Occupying an average floor space of only one square foot with a height of four feet, the enclosure is a totally closed box of moderate internal volume dimensions. There are no ports or ducts. The reason: ported enclosures have low

frequency non-linear peaks by virtue of being based on the Helmholtz resonator. The Helmholtz resonator is strictly a *frequency discriminating* device (read about it in any book on acoustics) and ported enclosures behave much the same.

The Anechoic Speaker Enclosure is unlike any other totally closed box. In the ordinary variety, large or small, the acoustic impedance is such that the air presents mainly a stiffness against the back of the cone. The amount of this stiffness increases as the box becomes smaller. It is detrimental because it raises the system resonance so that low frequency output (determined by the system resonant frequency) is lost. With any conventional speaker the only method of fighting the problem is to make the box extremely large. The long-standing and valid objection to this is decorative — the resultant enclosure is unwieldy and unattractive.

But new principles of design based on known acoustical phenomena are used in the Anechoic Speaker Enclosure. The air inside is "seen" by the speaker mainly as a mass and a resistance, not as a stiffness. This is due to (1) the shape, (2) the internal damping design, material and configuration. Because of the mass load the trapped air has little or no effect on the speaker's free air resonant frequency. The system resonance can never be too high and adequate bass response, without harmonic distortion, is assured *regardless of what speaker is used!* The acoustical resistive loading on the speaker is optimum, excellent damping being obtained throughout the entire frequency range. This has three profoundly important results: (1) transient response is exceptional at all frequencies, (2) mid and high range intermodulation distortion is reduced to below audibility, (3) there is no sharp peaking at resonance, hence the bass response is linear and without "boom". It might be well to warn the listener who, hearing no bass boom and transient overhang, may feel the enclosure lacks bass. Far from it! With virtually any wide range speaker, irrespective of size or price, 30-cycle sine wave output at audible acoustic levels can be obtained.

Because of its shape the Anechoic Speaker Enclosure is ideal in pairs for stereo purposes. And because truly gilt-edged performance can be had with a single wide range speaker the total cost for a completed system is within the most modest budget. Prices, in finished mahogany, birch, walnut, hardwood from \$59 to \$89. Black plywood

utility model from \$39 to \$59. Three sizes for 8-inch, 12-inch, 15-inch speakers. See and hear the Audiolab Anechoic Speaker Enclosure at your favorite hi-fi shop today, or write the manufacturer for descriptive literature.



A product of

Audiospeaker Laboratories
P.O. Box 1082 Pomona, California
Plant: 1114 E. Emporia St. Ontario, California

audiocraft

Roy F. Allison
Editor
Eleanore B. Wright
Assistant to the Editor
Philip C. Geraci
Associate Editor
Eleanor Gilchrist
Art Assistant
R. D. Darrell
Joel Ehrlich
J. Gordon Holt
Joseph Marshall
Contributing Editors

Charles Fowler
Publisher
Warren B. Syer
Associate Publisher
Claire Eddings
Advertising Sales Manager
Andrew J. Csida
Marketing and
Merchandising Manager
Lee Zhitto
Western Manager

THIS MONTH'S COVER: It's a closer look at the KT-500 innards. The little boy, we're afraid, is in for a disappointment. You see, he's fishing for bass, and how much bass can he find at 455 Kc? He should try the amplifier on page 24. Cover by Phil Geraci



THE MAGAZINE FOR THE HI-FI HOBBYIST

JULY 1958
Volume 3 Number 7

The Grounded Ear <i>What's new in sound reproduction</i>	4	<i>Joseph Marshall</i>
Book Reviews	6	<i>Richard D. Keller</i>
Audionews	12	
Electronic Firsts <i>Capacitors and induced currents</i>	14	<i>Monroe Upton</i>
Editorial <i>Stereo at home and abroad</i>	17	
Readers' Forum	17	
Stereo System Techniques <i>How to select components for your stereo high-fidelity system</i>	18	<i>Joel Ehrlich</i>
The Lafayette KT-500 Stereo Tuner <i>An AUDIOCRAFT kit report</i>	20	
Pictorial Diagram <i>The Perfectionist's Power Amplifier</i>	24	
Audiolab Test Reports <i>This month: Harmon-Kardon Solo II, Model TA-12; Shure Professional Dynetic Cortridge; Sargent-Rayment SR-570 omplifier</i>	26	<i>Hirsch-Houck Laboratories</i>
Using Test Instruments <i>Signal Generators, Part II</i>	32	<i>Joseph Marshall</i>
Tape News and Views <i>Tracking down tape distortion</i>	34	<i>J. Gordon Holt</i>
Puzzlements <i>When ears and test instruments disagree</i>	36	<i>Norman H. Crowhurst</i>
Sound-Fanciers' Guide <i>Reviews of exceptional tape and disc records</i>	38	<i>R. D. Darrell</i>
Audio Aids <i>Short cuts for the experimenter</i>	40	
Traders' Marketplace	46	
Professional Directory	46	
Advertising Index	48	

ADVERTISING

Main Office — Claire Eddings, The Publishing House, Great Barrington, Mass. Telephone: Great Barrington 1300.

New York — 1564 Broadway, New York 36. Telephone: Plaza 7-2800.

Chicago — John R. Rutherford & Associates, Inc., 230 East Ohio St., Chicago 11, Ill. Telephone: Whitehall 4-6715.

Los Angeles — 1520 North Gower, Hollywood 28. Telephone: Hollywood 9-6239.

Audiocraft Magazine is published monthly by Audiocom, Inc., in Great Barrington, Mass. Telephone: Great Barrington 1300. Editorial, publication, and circulation offices at: The Publishing House, Great Barrington, Mass. Subscriptions: \$4.00 per year in the United States and Canada. Single copies: 35 cents each. Editorial contributions will be welcomed by the editor. Payment for articles accepted will be arranged prior to publication. Unsolicited manuscripts should be accompanied by return postage. Entered as second-class matter October 1, 1955, at the post office, Great Barrington, Mass., under the act of March 3, 1879. Additional entry at the post office, Pittsfield, Mass. Printed in the U. S. A. by the Ben Franklin Press, Pittsfield, Mass. Copyright 1958 by Audiocom, Inc. The cover design and contents of Audiocraft Magazine are fully protected by copyrights and must not be reproduced in any manner.

The Grounded Ear

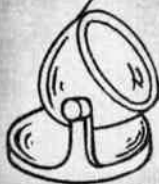

by Joseph Marshall

**What's new
in sound
reproduction?**

How Hi the Fi for \$30?

I have remarked previously on the fact that new developments in circuitry and components, especially tubes, have resulted in reduced prices of high-fidelity amplifiers. Still, it was a surprise when Heath announced an integrated 12-watt amplifier, complete with equalized pre-amp and tone controls in a steel cabinet, for just under \$30 in kit form. In these times, when prices of everything keep rising even in the midst of a financial recession, one does not have to be a cynic to wonder if \$30 can really buy enough amplifier fidelity to be honestly designated "high." Accordingly, it was with great curiosity that I put together one of the EA-2 kits and subjected it to both laboratory and listening tests for a period of two months.

The curves in Figs. 1, 2, and 3 are those printed in the Heath instruction booklet. They are shown rather than my own because my measurements showed

no significant departure from them. I do not think there is any question that these curves are well within the standards of genuine high fidelity; in fact, it would not have been easy as late as two years ago to obtain such curves with combinations of control units and amplifiers costing several times more.

The amplifier is even better in listening than in measurement. It takes big peaks a good deal more cleanly, especially at the bottom end, than a 12-watt amplifier of such compact size has any business doing. This is because it will actually deliver considerably more than 12 w before breaking up. My specimen did not begin to deform a 400-cps wave form noticeably until 15 w, and delivered a good clean 10 w at 20 cps. I found that the EA-2 drove the moderately inefficient AR-2 speaker easily to any level which we could tolerate in our town apartment. As it happens, the damping factor of the EA-2 (a relatively low 4.3) is particularly favorable for the AR-2, and to my ears it was a very felicitous combination. The low damping

Continued on page 44

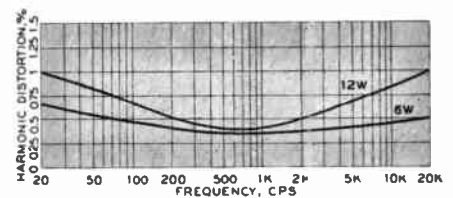

Fig. 1. Harmonic-distortion curves.

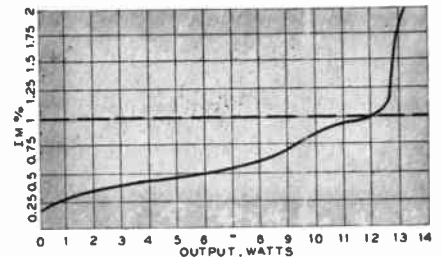

Fig. 2. Intermodulation distortion.

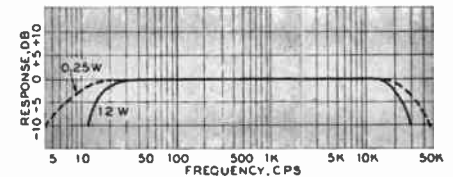
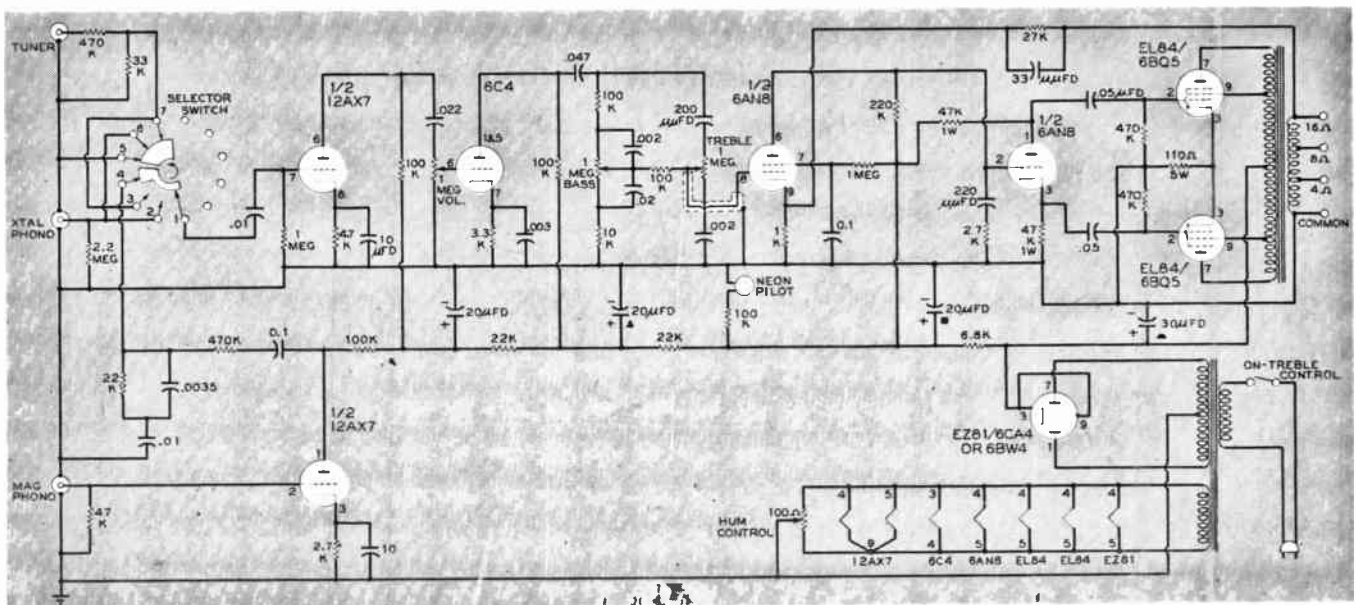

Fig. 3. Response at two output levels.

Schematic of the Heath EA-2 12-watt control amplifier, which is available in kit form at slightly under \$30.



the experts say... in High Fidelity the best buys are



EICO
KITS and WIRED

BETTER ENGINEERING Since 1945 EICO has pioneered the concept of test instruments in easy-to-build kit form — has become world-famous for laboratory-precision instruments at low cost. Now EICO is applying its vast experience to the creative engineering of *high fidelity*. Result: high praise from such authorities as Canby of AUDIO, Marshall of AUDIOCRAFT, Holt of HIGH FIDELITY, Fantel of POPULAR ELECTRONICS, Stocklin of RADIO TV NEWS, etc. — as well as from the critical professional engineers in the field.†

SAVE 50% Mass purchasing, and a price policy deliberately aimed to encourage mass sales, make this possible.

EASY INSTRUCTIONS You need no previous technical or assembly experience to build any EICO kit — the instructions are simple, step-by-step, "beginner-tested."

DOUBLE 5-WAY GUARANTEE Both EICO, and your neighborhood distributor, guarantee the parts, instructions, performance . . . as well as *lifetime* service and calibration at nominal cost . . . for any EICO kit or wired unit.

BEFORE YOU BUY, COMPARE At any of 1200 neighborhood EICO distributors coast to coast, you may examine and listen to any EICO component. Compare *critically* with equipment several times the EICO cost — then *you* judge. You'll see why the experts recommend EICO, kit or wired, as best buy.

† Thousands of unsolicited testimonials on file.



HFS2
Speaker System



HFT90 FM Tuner
with "eye-tronic" tuning



HF61 Preamplifier

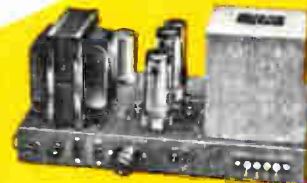

HF60, HF50 Power Amplifiers



HFS2 Speaker System: Uniform loading & natural bass 30-200 cps achieved via slot-loaded split conical bass horn of 12-ft path. Middles & lower highs from front side of 8½" cone, edge-damped & stiffened for smooth uncolored response. Suspensionless, distortionless spike-shaped super-tweeter radiates omni-directionally. Flat 45-20,000 cps, useful to 30 cps. 16 ohms. HWD: 36", 15¼", 11½". . . rates as excellent . . . unusually musical . . . really non-directional" — Canby, AUDIO. "Very impressive" — Marshall (AUDIOCRAFT). Walnut or Mahogany, \$139.95. Blonde, \$144.95.

HFT90 FM Tuner equals or surpasses wired tuners up to 3X its cost. New, pre-wired, pre-aligned, temperature-compensated "front end" — drift-free. Sensitivity, 1.5 uv for 20 db quieting, is 6X that of other kit tuners. DM-70 traveling tuning eye. Response 20-20,000 cps ± 1 db. Cathode follower & multiplex outputs. Kit \$39.95*. Wired \$65.95*. Cover \$3.95. *Less cover, excise tax incl.

HF61A Preamplifier, providing the most complete control & switching facilities, and the finest design, offered in a kit preamplifier, . . . rivals the most expensive preamps . . . is an example of high engineering skill which achieves fine performance with simple means and low cost." — Joseph Marshall, AUDIOCRAFT. HF61A Kit \$24.95, Wired \$37.95, HF61 (with Power Supply) Kit \$29.95, Wired \$44.95.

HF60 60-Watt Ultra Linear Power Amplifier, with Acro TO-330 Output Transformer, provides wide bandwidth, virtually absolute stability and flawless transient response. . . . is one of the best-performing amplifiers extant; it is obviously an excellent buy." —AUDIOCRAFT Kit Report. Kit \$72.95. Wired \$99.95. Matching Cover E-2 \$4.50.

HF50 50-Watt Ultra-Linear Power Amplifier with extremely high quality Chicago Standard Output Transformer. Identical in every other respect to HF60 and same specifications up to 50 watts. Kit \$57.95. Wired \$87.95. Matching Cover E-2 \$4.50.

HF30 30-Watt Power Amplifier employs 4-EL84 high power sensitivity output tubes in push-pull parallel, permits Williamson circuit with large feedback & high stability. 2-EZ81 full-wave rectifiers for highly reliable power supply. Unmatched value in medium-power professional amplifiers. Kit \$39.95. Wired \$62.95. Matching Cover E-3 \$3.95.

HF-32 30-Watt Integrated Amplifier Kit \$57.95, Wired \$89.95.

HF52 50-Watt Integrated Amplifier with complete "front end" facilities and Chicago Standard Output Transformer. Ultra-Linear power amplifier essentially identical to HF50. The least expensive means to the highest audio quality resulting from distortion-free high power, virtually absolute stability, flawless transient response and "front end" versatility. Kit \$69.95. Wired \$109.95. Matching Cover E-1 \$4.50.

HF20 20-Watt Integrated Amplifier, complete with finest preamp-control facilities, excellent output transformer that handles 34 watts peak power, plus a full Ultra-Linear Williamson power amplifier circuit. Highly praised by purchasers, it is established as the outstanding value in amplifiers of this class. Kit \$49.95. Wired \$79.95. Matching Cover E-1 \$4.50.

Prices 5% higher in the West

HF12 12-Watt Integrated Amplifier, absolutely free of "gimmicks", provides complete "front end" facilities & true fidelity performance of such excellence that we can recommend it for any medium-power high fidelity application. Two HF12's are excellent for stereo, each connecting directly to a tape head with no other electronic equipment required. Kit \$34.95. Wired \$57.95.

HFS1 Two-Way Speaker System, complete with factory-built cabinet. Jensen 8" woofer, matching Jensen compression-driver exponential horn tweeter. Smooth clean bass; crisp extended highs. 70-12,000 cps ± 6 db. Capacity 25 w. Impedance 8 ohms. HWD: 11" x 23" x 9". Wiring time 15 min. Price \$39.95.

MAIL COUPON FOR CATALOG

EICO® 33-00 Northern Blvd., L.I.C. 1, N.Y.
Show me how to SAVE 50% on professional Test Instruments and High Fidelity. Send me free catalog and name of neighborhood distributor.

Name
Address
City Zone State AC-7



HF52, HF20
Integrated Amplifiers



HF12 Integrated Amplifier



HF30 Power Amplifier



HFS1
Speaker System



33-00 Northern Boulevard, L. I. C. 1, N. Y.
Over 1 Million EICO instruments in use the world over.

© 1958

by RICHARD D. KELLER

book reviews



Electronic Semiconductors

Eberhard Spenke; pub. by McGraw-Hill Book Co., New York; 402 pages; \$11.00.

This book is intended for scientists engaged in the design and development of semiconductor devices and materials. It has been translated from the original German by four RCA scientists.

Although it is statedly not addressed to experienced semiconductor specialists but to the beginners, a thorough mathematical and theoretical background is a very definite *must* for anyone tackling this text. You could almost say it is a Shockley brought up-to-date. It gives rigorous treatments of the Zener effect, acceleration, and kinetics of electrons, quantum mechanics of the hydrogen molecule, the band model, Fermi statistics of electrons in crystals, imperfection equilibria, and boundary layer conditions in semiconductors. Questions and problems are included after each chapter.

Feedback Theory and Its Applications

P. H. Hammond; pub. by the Macmillan Co., New York; 348 pages; \$7.00.

There are some books that are strictly for the edification and enlightenment of the Ivory Tower scientists and Ph.D.'s. This is one of them.

Rather than try to evaluate the book on its own merits, which would require a vigorous analysis of the correctness of its Laplace transforms and Nyquist diagrams, I will merely say that it is intended for post-graduate engineers and physicists, and let the preface explain the contents:

"Linear feedback theory is introduced by starting from the differential equation of motion of a system and proceeding via the Laplace transformation to a flow diagram representation in operational form. After a discussion of the properties conferred by feedback and, particularly, by negative feedback, the question of stability is considered and the Nyquist criterion is derived.

"Applications of the theory to certain electronic circuits are then described, particular attention being paid to the DC coupled virtual earth amplifier and its use as an analogue computer element. The synthesis of stabilizing networks is illustrated by the use of phase-gain characteristics.

"Servomechanisms and other control

systems are introduced using linear theory and with examples from hydraulic and electrical servomechanism practice. Linear theory is shown to be inadequate to explain behaviour in many applications and two chapters are devoted to nonlinear analytical techniques using phase plane constructions and describing function methods respectively. These techniques are illustrated by a study of the behaviour of an electrical position controller with inherent nonlinearities. A separate chapter is devoted to control systems employing on-off elements such as relays; the properties of on-off controllers are discussed by means of phase planes and describing function methods, and the optimization of the transient response is considered."



Transistor Physics and Circuits

Robert L. Riddle and Marlin P. Ristenbatt; pub. by Prentice Hall, Inc., Englewood Cliffs, N. J.; 428 pages; \$10.00.

Here is a nicely integrated volume on transistor theory and circuits—one of the best yet for the serious transistor student and user.

The book is written on the technical-institute level and requires merely a background knowledge of algebra, trigonometry, and the basic sciences. It should serve nicely as a transistor-circuit-theory source for electronics technicians, designers, and radio amateurs, and as a thorough introduction to the subject for electrical engineers.

Several features are particularly noteworthy. First, the book is divided into two parts, with the first part given over to a concise, clear review of physics, crystal structures, the physical action of transistors, and a summary of present-day transistors. The second and longest part starts with an electrical review and

continues with chapters on transistors as circuit elements followed by the subjects of small-signal and large-signal amplifiers, bias stabilization, feedback, noise, and oscillators and multivibrators—all of the material, up-to-date and thorough.

Standard hybrid h-parameters are used and chapters are arranged so that the book can serve as a very good reference of current information. Lest the reader misunderstand, this book does not contain complete practical circuits, but rather the theory for designing such circuits. Problems and experiments are given throughout.

TV and Radio Tube Troubles

Sol Heller; pub. by Gernsback Library, Inc., New York; 224 pages; \$2.90, paper-bound.

This book will be a help to TV and radio technicians since it goes right to the heart of most of their professional troubles—tubes.

The book is arranged to facilitate troubleshooting and provide a handy reference of needed information on tube troubles, their causes, effects, and solutions.

Since TV sets have three or four times as many tubes—and consequently, tube problems—as radios, most of the information concerns TV repair. The hobbyist will probably find enough material here to keep the home sets burning, particularly if he has some test equipment and some extra tubes on hand for substitution (one of the quickest cures).

Learning Electricity Fundamentals

Leonard R. Crow; pub. by Howard W. Sams Co., Inc., Indianapolis, Indiana; 408 pages; \$5.95.

This is an introduction for the teenager into the fascinating world of electricity. In easy stages the author takes him all the way from electrostatic pith balls to high-voltage circuit breakers and in the interim clears up all sorts of difficult concepts such as maxwells, gauss, rotating fields, and the differences between work, energy, and power.

He gives lots of practical examples as he explains magnetism, transformers, generators, and motors, and he winds up by describing the rules, regulations, and procedures involved in fully wiring a residential house.

You've
been
asking for

HEATHKIT

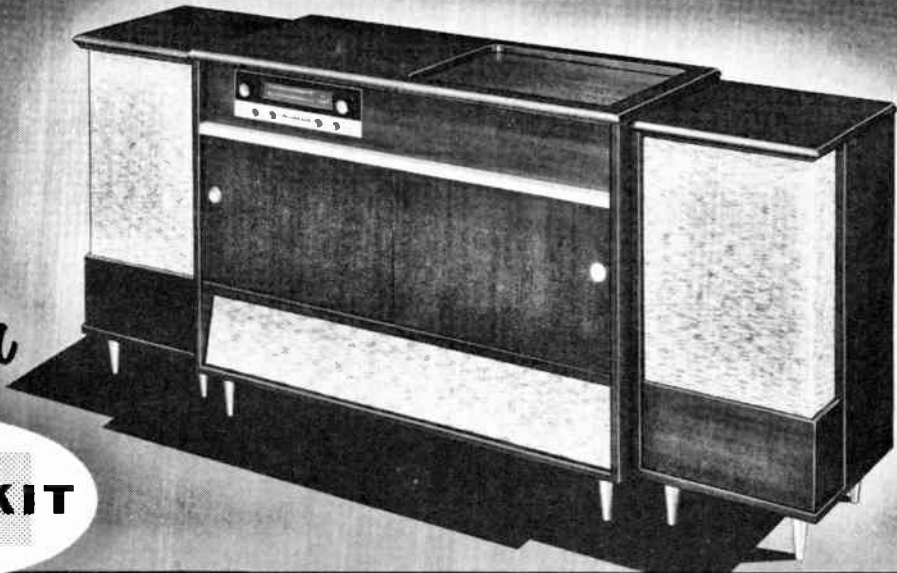

stereo sound equipment... and here it is!



stereo tape deck kit

HEATHKIT
MODEL TR-1D **\$143⁹⁵**

Enjoy the wonder of Stereophonic sound in your own home! Precision engineered for fine performance, this tape deck provides monaural-record/playback and stereo playback. Tape mechanism is supplied complete. You build only the preamplifier. Features include two printed circuit boards—low noise EF-86 tubes in input stages—mic and hi-level inputs—push-pull bias-erase oscillator for lowest noise level—two cathode follower outputs, one for each stereo channel—output switch for instantaneous monitoring from tape while recording. VU meter and pause control for editing. Tape speeds 3 $\frac{3}{4}$ and 7 $\frac{1}{2}$ IPS. Frequency response ± 2 db 40-12,000 CPS at 7 $\frac{1}{2}$ IPS. Wow and flutter less than .3%. Signal-to-noise 55 db at less than 1% total harmonic distortion. NARTB playback equalization. Make your own high quality recordings for many pleasant listening hours.

stereo equipment cabinet kit

HEATHKIT MODEL SE-1
(Price to be announced soon)

Beautifully designed, this stereo equipment cabinet has ample room provided for an AM-FM tuner—tape deck—preamplifier—amplifiers—record changer—record storage and speakers. Constructed of $\frac{3}{4}$ " solid-core Philippine mahogany or select birch plywood, beautifully grained. Top has shaped edge and sliding top panel. Sliding doors for front access. Mounting panels are supplied cut to fit Heathkit units with extra blank panels for mounting your own equipment. Easy-to-assemble, all parts are pre-cut and pre-drilled. Includes all hardware, glue, legs, etc. and detailed instruction manual. Speaker wings and center unit can be purchased separately if desired. Overall dimensions with wings 82" W. x 37" H. x 20" D. Send for free details.



DELUXE AM-FM TUNER KIT

HEATHKIT
MODEL PT-1 **\$89⁹⁵**

Here is a deluxe combination AM-FM tuner with all the advanced design features required by the critical listener. Ideal for stereo applications since AM and FM circuits are separate and individually tuned. The 16-tube tuner uses three circuit boards for easy assembly. Prewired and prealigned FM front end, AFC with on/off switch—flywheel tuning and tuning meter.



STEREO PRE- AMPLIFIER KIT

HEATHKIT MODEL SP-1
(Price to be announced soon)

This unique two-channel control center provides all controls necessary in stereo applications. Building block design lets you buy basic single channel now and add second snap-in channel later for stereo without rewiring. 12 inputs each with level control—NARTB tape equalization—6 dual concentric controls including loudness controls—built-in power supply.



55 WATT HI-FI AMPLIFIER KIT

HEATHKIT
MODEL W-7M **\$54⁹⁵**

First time ever offered—a 55-watt basic hi-fi amplifier for \$1 per watt. Features EL-34 push-pull output tubes. Frequency response 20 CPS to 20 KC with less than 2% harmonic distortion at full output throughout this range. Input level control and "on-off" switch provided on front panel. Unity or maximum damping factors for all 4, 8 or 16 ohm speakers.



12 WATT HI-FI AMPLIFIER KIT

HEATHKIT
MODEL UA-1 **\$21⁹⁵**

Ideal for stereo applications, this 12-watt power package represents an outstanding dollar value. Uses 6BQ5/EL84 push-pull output tubes. Less than 2% total harmonic distortion throughout the entire audio range (20 to 20,000 CPS) at full 12-watt output. Designed for use with preamplifier models WA-P2 or SP-1. Taps for 4, 8 and 16 ohm speakers.

For complete information on above kits—Send for FREE FLYER.

HEATH COMPANY • a subsidiary of Daystrom, Inc. • Benton Harbor 18, Mich.

easy-to-build

high quality

HEATHKITS®

Look . . . how simply you can assemble your very own high fidelity system! Fun-filled hours of shared pleasure, and an everlasting sense of personal accomplishment are just a few of the rewards. Heathkits cost you only HALF as much as ordinary equipment and the quality is unexcelled. Let us show you how easy it really is! . . .



(✓) Install a .001 μ f disc condenser from socket B7 (NS) to ground lug B11 (NS). Cut the leads so that they are just long enough to reach and dress the condenser close to chassis, over the wires already present.

() Connect a 470 K Ω resistor (yellow-violet-yellow) from socket B7 (S) (2) to B8 (NS). Mount as close to the socket as possible.

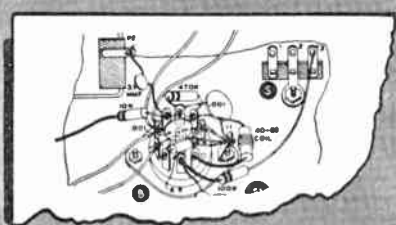

Step-by-Step Assembly Instructions . . .

Read the step . . . perform the operation . . . and check it off—it's just that simple! These plainly-worded, easy-to-follow steps cover every assembly operation.

Easy-to-follow Pictorial Diagrams . . .

Detailed pictorial diagrams in your Heathkit construction manual show where each and every wire and part is to be placed.

Learn-by-doing Experience For All Ages . . .

Kit construction is not only fun—but it is educational too! You learn about radio, electronic parts and circuits as you build your own equipment.

Top Quality Name-Brand Components Used in All Kits . . .

Electronic components used in Heathkits come from well-known manufacturers with established reputations. Your assurance of long life and trouble-free service.



HEATHKIT

bookshelf 12-watt amplifier kit

NEW

MODEL EA-2

\$27.95

There are many reasons why this attractive amplifier is a tremendous dollar value. You get many extras not expected at this price level. Rich, full range, high fidelity sound reproduction with low distortion and noise . . . plus "modern" styling, making it suitable for use in the open, on a bookcase, or end table. Look at the features offered by the model EA-2: full range frequency response (20—20,000 CPS \pm 1 db) with less than 1% distortion over this range at full 12 watt output—its own built-in preamplifier with provision for three separate inputs, mag phono, crystal phono, and tuner—RIAA equalization—separate bass and treble tone controls—special hum control—and it's easy-to-build. Complete instructions and pictorial diagrams show where every part goes. Cabinet shell has smooth leather texture in black with inlaid gold design. Front panel features brushed gold trim and buff knobs with gold inserts. For a real sound thrill the EA-2 will more than meet your expectations. Shpg. Wt. 15 lbs.

TIME PAYMENTS AVAILABLE ON ALL HEATHKITS WRITE FOR FULL DETAILS



chairside enclosure kit

NEW

This beautiful equipment enclosure will make your hi-fi system as attractive as any factory-built professionally-finished unit. Smartly designed for maximum flexibility and compactness consistent with attractive appearance, this enclosure is intended to house the AM and FM tuners (BC-1A and FM-3A) and the WA-P2 preamplifier, along with the majority of record changers, which will fit in the space provided. Adequate space is also provided for any of the Heathkit amplifiers designed to operate with the WA-P2. During construction the tilt-out shelf and lift-top lid can be installed on either right or left side as desired. Cabinet is constructed of sturdy, veneer-surfaced furniture-grade plywood $\frac{1}{2}$ " and $\frac{3}{4}$ " thick. All parts are pre-cut and pre-drilled for easy assembly. Contemporary available in birch or mahogany, traditional in mahogany only. Beautiful hardware supplied to match each style. Dimensions are 18" W x 24" H x 35 $\frac{1}{2}$ " D. Shpg. Wt. 46 lbs.



CE-1C Mahogany
CE-1CB Birch

CONTEMPORARY



CE-1T Mahogany

TRADITIONAL

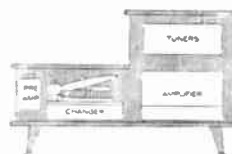

Be sure to specify
model you prefer

\$43⁹⁵
each



HEATHKIT

high fidelity FM tuner kit

For noise and static free sound reception, this FM tuner is your least expensive source of high fidelity material. Efficient circuit design features stabilized oscillator circuit to eliminate drift after warm-up and broadband IF circuits assure full fidelity with high sensitivity. All tunable components are prealigned so it is ready for operation as soon as construction is completed. The edge-illuminated slide rule dial is clearly numbered for easy tuning. Covers complete FM band from 88 to 108 mc. Shpg. Wt. 8 lbs.

MODEL FM-3A \$25.95 (with cabinet)



HEATHKIT

broadband AM tuner kit

This tuner differs from an ordinary AM radio in that it has been designed especially for high fidelity. A special detector is incorporated and the IF circuits are "broadbanded" for low signal distortion. Sensitivity and selectivity are excellent and quiet performance is assured by a high signal-to-noise ratio. All tunable components are prealigned before shipment. Incorporates automatic volume control, two outputs, and two antenna inputs. An edge-lighted glass slide rule dial allows easy tuning. Your "best buy" in an AM tuner. Shpg. Wt. 9 lbs.

MODEL BC-1A \$25.95 (with cabinet)

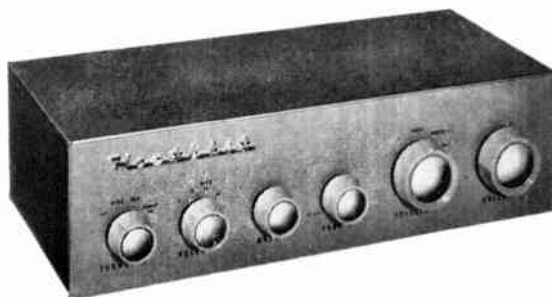

HEATHKIT

master control preamplifier kit

Designed as the "master control" for use with any of the Heathkit Williamson-type amplifiers, the WA-P2 provides the necessary compensation, tone, and volume controls to properly amplify and condition a signal before sending it to the amplifier. Extended frequency response of $\pm 1\frac{1}{2}$ db from 15 to 35,000 CPS will do full justice to the finest program material. Features equalization for LP, RIAA, AES, and early 78 records. Five switch-selected inputs with separate level controls. Separate bass and treble controls, and volume control on front panel. Very attractively styled, and an exceptional dollar value. Shpg. Wt. 7 lbs.

MODEL WA-P2 \$19.75 (with cabinet)

pioneer in
"do-it-yourself"
electronics

HEATH



subsidiary of Daystrom, Inc.

COMPANY • BENTON HARBOR 18, MICHIGAN



HEATHKIT 25-WATT

MODEL W-5M

\$59⁷⁵



HEATHKIT 70-WATT

MODEL W-6M

\$109⁹⁵

high fidelity amplifier kits

To provide you with an amplifier of top-flight performance, yet at the lowest possible cost, Heath has combined the latest design techniques with the highest quality materials to bring you the W-5M. As a critical listener you will thrill to the near-distortionless reproduction from one of the most outstanding high fidelity amplifiers available today. The high peak-power handling capabilities of the W-5M guarantee you faithful reproduction with any high fidelity system. The W-5M is a must if you desire quality plus economy! Note: Heathkit model WA-P2 preamplifier recommended. Shpg. Wt. 31 lbs.

For an amplifier of increased power to keep pace with the growing capacities of your high fidelity system, Heath provides you with the Heathkit W-6M. Recognizing that as loud speaker systems improve and versatility in recordings approach a dynamic range close to the concert hall itself, Heath brings to you an amplifier capable of supplying plenty of reserve power without distortion. If you are looking for a high powered amplifier of outstanding quality, yet at a price well within your reach, the W-6M is for you! Note: Heathkit model WA-P2 preamplifier recommended. Shpg. Wt. 52 lbs.

HEATHKIT DUAL-CHASSIS

MODEL W3-AM

\$49⁷⁵

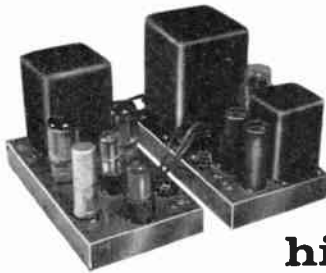

HEATHKIT SINGLE-CHASSIS

MODEL W4-AM

\$39⁷⁵

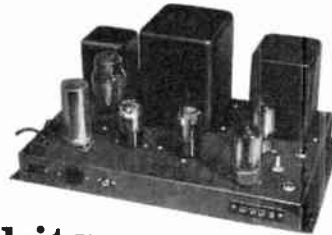

high fidelity amplifier kits

One of the greatest developments in modern hi-fi reproduction was the advent of the Williamson amplifier circuit. Now Heath offers you a 20-watt amplifier incorporating all of the advantages of Williamson circuit simplicity with a quality of performance considered by many to surpass the original Williamson. Affording you flexibility in custom installations, the W3-AM power supply and amplifier stages are on separate chassis allowing them to be mounted side by side or one above the other as you desire. Here is a low cost amplifier of ideal versatility. Shpg. Wt. 29 lbs.

In his search for the "perfect" amplifier, Williamson brought to the world a now-famous circuit which, after eight years, still accounts for by far the largest percentage of power amplifiers in use today. Heath brings to you in the W4-AM a 20-watt amplifier incorporating all the improvements resulting from this unequalled background. Thousands of satisfied users of the Heathkit Williamson-type amplifiers are amazed by its outstanding performance. For many pleasure-filled hours of listening enjoyment this Heathkit is hard to beat. Shpg. Wt. 28 lbs.

HEATHKIT

high fidelity amplifier kit

MODEL A-9C **\$35⁵⁰**



For maximum performance and versatility at the lowest possible cost the Heathkit model A-9C 20-watt audio amplifier offers you a tremendous hi-fi value. Whether for your home installation or public address requirements this power-packed kit answers every need and contains many features unusual in instruments of this price range. The preamplifier, main amplifier and power supply are all on one chassis providing a very compact and economical package. A very inexpensive way to start you on the road to true hi-fi enjoyment. Shpg. Wt. 23 lbs.

HEATHKIT

electronic crossover kit

MODEL XO-1 **\$18⁹⁵**



One of the most exciting improvements you can make in your hi-fi system is the addition of this Heathkit Crossover model XO-1. This unique kit separates high and low frequencies and feeds them through two amplifiers into separate speakers. Because of its location ahead of the main amplifiers, IM distortion and matching problems are virtually eliminated. Crossover frequencies for each channel are 100, 200, 400, 700, 1200, 2000 and 3500 CPS. Amazing versatility at a moderate cost. Note: Not for use with Heathkit Legato Speaker System. Shpg. Wt. 6 lbs.



HEATHKIT "LEGATO"

high fidelity speaker system kit

Wrap yourself in a blanket of high fidelity music in its true form. Thrill to sparkling treble tones, rich, resonant bass chords or the spine-tingling clash of percussion instruments in this masterpiece of sound reproduction. In the creation of the Legato no stone has been left unturned to bring you near-perfection in performance and sheer beauty of style. The secret of the Legato's phenomenal success is its unique balance of sound. The careful phasing of high and low frequency drivers takes you on a melodic toboggan ride from the heights of 20,000 CPS into the low 20's without the slightest bump or fade along the way. The elegant simplicity of style will complement your furnishings in any part of the home. No electronic know-how, no woodworking experience required for construction. Just follow clearly illustrated step-by-step instructions. We are proud to present the Legato—we know you will be proud to own it! Shpg. Wt. 195 lbs.

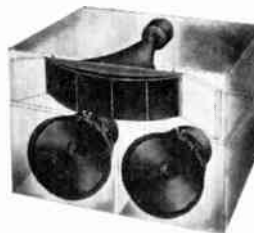

MODEL HH-1-C
(imported white birch)
MODEL HH-1-CM
(African mahogany)
\$325⁰⁰ each



**HEATHKIT
BASIC RANGE**

**HEATHKIT
RANGE EXTENDING**

high fidelity speaker system kits

MODEL SS-1 **\$39⁹⁵**

A truly outstanding performer for its size, the Heathkit model SS-1 provides you with an excellent basic high fidelity speaker system. The use of an 8" mid-range woofer and a high frequency speaker with flared horn enclosed in an especially designed cabinet allows you to enjoy a quality instrument at a very low cost. Can be used with the Heathkit "range extending" (SS-1B) speaker system. Easily assembled cabinet is made of veneer-surfaced furniture-grade 1/2" plywood. Impedance 16 ohms. Shpg. Wt. 25 lbs.



MODEL SS-1B **\$99⁹⁵**

Designed to supply very high and very low frequencies to fill out the response of the basic (SS-1) speaker, this speaker system extends the range of your listening pleasure to practically the entire range of the audio scale. Giving the appearance of a single piece of furniture the two speakers together provide a superbly integrated four speaker system. Impedance 16 ohms. Shpg. Wt. 80 lbs.

Free Catalog!

Don't deprive yourself of the thrill of high fidelity or the pleasure of building your own equipment any longer. Our free catalog lists our entire line of kits with complete schematics and specifications. Send for it today!



HEATH

COMPANY • BENTON HARBOR 18, MICHIGAN

*pioneer in
"do-it-yourself"
electronics*

D a subsidiary of Daystrom, Inc.

- Please send the Free HEATHKIT catalog.
- Enclosed is 25c for the New HI-FI book.

name _____

address _____

city & state _____

ALSO SEND THE FOLLOWING KITS:

QUANTITY	ITEM	MODEL NO.	PRICE

Enclosed find \$..... Please enclose postage for parcel post—express orders are shipped delivery charges collect. All prices F.O.B. Benton Harbor, Mich. NOTE: Prices subject to change without notice.



Audionews

SCOTT STEREO-DAPTOR

A new product from H. H. Scott is the *Stereo-Daptor* which acts as a control center for stereo systems using two separate amplifiers. Both amplifiers are



Scott tubeless stereo control unit.

simply plugged into the back of the *Stereo-Daptor*. A master volume control then obviates the necessity of rebalancing both systems when the volume is changed. Other controls include volume-loudness controls for both amplifiers, and tape-monitor control and switch positions for channel reversal and monaural playback from either system. Connecting cables are furnished. The price of the unit is \$24.95.

ROBERTS STEREO RECORDER

Roberts Electronics' *Model 90-S* tape recorder is designed for monaural recording and playback, and for stereo playback (stacked). Features include a hysteresis-synchronous motor, professional terminal-board amplifier construction,

New recorder with hysteresis motor.



positive controls, illuminated VU meter, index counter, vertical and horizontal operation, and two tape speeds. Stereo playback is said to be flat within ± 2 db from 40 to 15,000 cps. The recorder may be used for stereo recording when a second amplifier is used. Price is \$349.50.

STEREO TUNER AND AMPLIFIER

Two new stereo units have recently been added to Sargent-Rayment's line of high-fidelity components.

The *SR-380* FM-AM tuner with stereo preamp facilities contains stereo inputs for tape heads (three positions of equalization for 15, $7\frac{1}{2}$, and $3\frac{3}{4}$



Sargent-Rayment tuner and amplifier are designed for stereo applications.

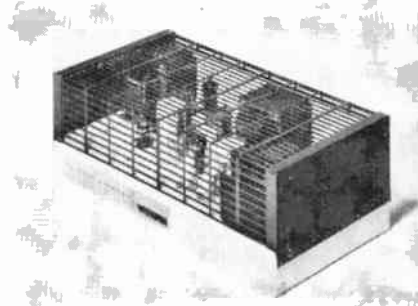

ips), phono cartridge (both magnetic and ceramic), and space for possible future application. The FM section has a multiplex output. Another FM or AM source is needed for stereo reception. FM sensitivity is said to be $3 \mu\text{v}$ for 20 db quieting even with a mismatched antenna. Rumble and scratch filters are included. Price of the unit is \$189.60.

The *SR-534* stereo amplifier provides 17 w on each channel. According to the manufacturer, IM is less than 1% at rated output and less than 0.5% at 10 w. Frequency response is reported as ± 0.5 db from 10 to 50,000 cps at 1 w. Price of the *SR-534* is \$106.60.

PRINTED-CIRCUIT KIT

The new *SeeZak* printed-circuit kit enables the builder to construct prototype circuits, check them out, and determine how they will function in a system. The kit contains a laminated plastic pegboard, fifty terminals which snap into place with the twist of a screw driver, and a 3-foot length of 28-gauge wire. Carbon Ohmite resistors are used, and the wire is laid into place in notches in the terminals so that the circuit can be tested before soldering. Complete information is available from the manufacturer, the U.M.&F. Manufacturing Company.

RONETTE STEREO CARTRIDGE

Ronette's *Binofluid* stereophonic cartridge is available mounted in the Ron-



Ronette cartridge uses clip-on stylus.

ette Fonofluid transcription arm (either the 12-inch or the 16-inch model), and alone for use in a new record player or as a replacement in an existing arm. The dual-element unit is said to be 100% compatible with both monaural and stereo discs. Lateral and vertical compliances are reported to be 3.5×10^{-1} cm/dyne; optimum stylus pressure is 4 to 6 grams. Frequency response is said to be flat from 20 to 15,000 cps with a rolloff at 14,000 cps. The cartridge uses a clip-on stylus.

COAXIAL SPEAKER

Atlas' *Coax-Projector Model WT-6* is a 15-inch bell-type coaxial horn speaker with built-in electronic divider. The woofer is a high-efficiency driver loaded with a folded exponential horn; the tweeter is a wide-angle horn. Power capacity of the unit is 15 w. Further information may be obtained from the manufacturer.

For more information about any of the products mentioned in Audionews, we suggest that you make use of the Product Information Cards bound in at the back of the magazine. Simply fill out the card, giving the name of the product in which you're interested, the manufacturer's name, and the page reference. Be sure to put down your name and address too. Send the cards to us and we'll send them along to the manufacturers. Make use of this special service; save postage and the trouble of making individual inquiries to a number of different addresses.

2 NEW
SARGENT-RAYMENT

Stereo Reproducers

for advanced high fidelity installations



**SR-380 FM-AM TUNER WITH STEREO
PRE-AMP AND TONE CONTROL \$189.60**

This Hi-Fi instrument represents the full accomplishment of a challenging objective — the combining on one chassis of a dual channel professional stereo pre-amp and tone control with that of a Deluxe FM-AM Tuner.

Some of the outstanding features are:

- Stereo (dual) inputs for tape heads with 3 positions of equalization for 15 (NARTB), 7 1/2, and 3 3/4 I.P.S., phono cartridge (both magnetic and ceramic), tape recorder, and aux. The FM position has a stereo channel input for use with the future FM multiplex transmission. It may now be used for stereo FM-FM or FM-AM by inserting another FM or AM source.
- Extremely stable FM sensitivity of 3 uv for 20 db quieting, which

- is unaffected by a mismatched antenna.
- Push-button operated rumble and scratch filters.
- Stereo balance control.
- Push-button type channel reverse and monaural-stereo switches.
- Elimination of hum and heat due to absence of power supply.

**SR-534 34 WATT
BASIC STEREO AMPLIFIER \$106.60**

The SR-534 offers clear cut superiority in design, construction, endurance and, most important, performance. The design is that of two independently controlled and terminated 17 watt sections. Each section is capable of delivering power beyond usability in the average home installation with distortion characteristics found only in the most expensive basic amplifiers.

Some of the outstanding features are:

- 17 watts power output each section, 34 watts output for combined dual channel monaural use.
- Less than 1% Intermodulation Distortion at rated output. Less than 0.5% I.M. at 10 watts output.
- Frequency response of ± 0.5 db 10 to 50,000 c.p.s. at 1 watt.
- Ideal regulation with the new GZ34 rectifier tube working in conjunction with an extra large transformer.

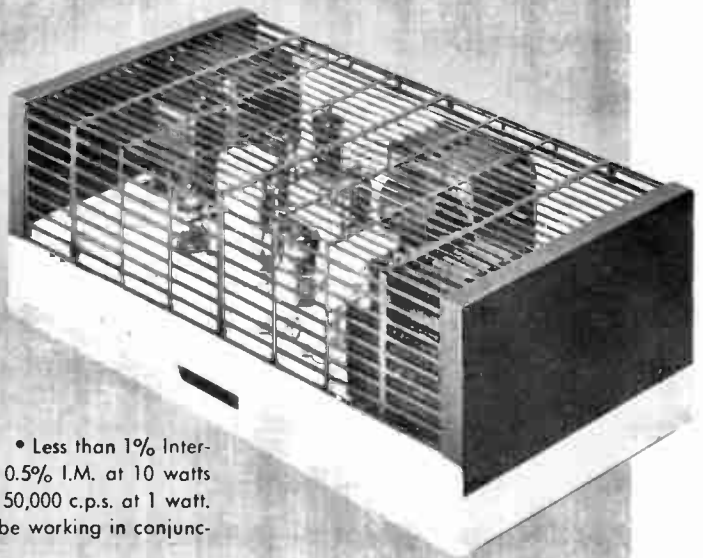

Write for complete brochure on all SR Stereo Reproducers.

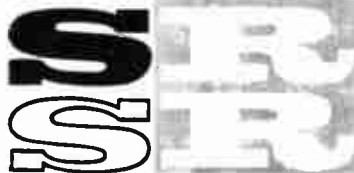

SARGENT-RAYMENT CO.

4926 East 12th Street, Oakland 1, California



Now you can get the incomparable Weathers Synchronous Turntable in *kit form*. Ready to mount in existing cabinet and sound system. *Can be assembled in a few minutes with only pliers and screwdriver . . . no soldering necessary.*

Designed on a New Principle

Light: Light construction eliminates the mechanical noises inherent in weight and mass—to a noise level which is 25 db less than the noise recorded on the best phonograph records available today.

Compact: Motor and turntable (with your tonearm) can be assembled on a 14 $\frac{1}{8}$ " x 15 $\frac{1}{8}$ " motorboard with a total overall height of only 2 $\frac{1}{2}$ ".

Smooth: The Weathers Turntable comes up to synchronous speed in $\frac{3}{4}$ of one revolution of the platter. Its very small 12 pole synchronous motor drives the aluminum turntable at exactly synchronous speed regardless of variations in line voltage or load.

Silent: The unique Weathers Turntable Bearing Assembly is the lowest friction and quietest bearing ever produced. The new principle drive system eliminates the mechanical noise caused by heavier equipment. Acoustic feedback, rumble, wow and flutter are practically eliminated from the Weathers Turntable. This kit includes the Weathers conical spring shock mountings which isolate the turntable from floor and table vibrations.

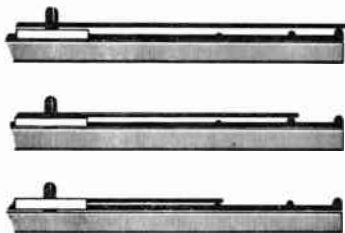

Plus the Weathers Discushion: A turntable pad of such design that records are suspended by their outer dimensions only, with no part of the playing surfaces touching any supporting areas, eliminating the greatest source of record contamination and noise.



Weathers Industries, 66 E. Gloucester Pike, Barrington, N. J.
DIVISION OF ADVANCE INDUSTRIES, INC.

Export: Joseph Plosencia, Inc., 401 Broadway, New York, N. Y.

WEATHERS TECHNICAL MAGIC IS SOUND

Electronic Firsts



by MONROE UPTON
 Author of "Electronics for Everyone"

TODAY, books on all phases of electricity tumble from the presses like school kids from the exits at recess time. It was different back in 1675, when the first book on the subject in English appeared, written by the Hon. Robert Boyle. Only a few natural philosophers were interested and nothing more on the subject was published for many years. The book's title reveals its character: *The Mechanical Origin of Electricity* (London). Boyle, who is also known for his work in chemistry, was among the first to practice and promote the experimental method in scientific research.

He describes a simple, common-sense experiment for answering a basic question about electricity. Previously, the large charged body was always held in the hand, or fixed solidly, inviting the uncharged body to come to it. Boyle wanted to know if the mountain would come to Mohamet. Fixing solidly an *uncharged* body, he found that a charged body *was* attracted to it. Boyle correctly inferred from this that electrical attraction, like ideal love, is a *mutual* affair, and not one-sided.

The charged body *induces* an opposite (unlike) charge in an uncharged body. Opposite charges attract. Like charges repel. But just how is an opposite charge induced? This question was never satisfactorily answered until after J. J. Thomson's discovery of the electron in 1897.

Electrons help to explain, for example, how electrostatic induction operates through the coupling capacitor used between plate and grid in a hi-fi amplifier. This capacitor passes the changing audio frequency voltage in the plate circuit to the grid of the next tube for more amplification.

On each cycle's negative half, electrons pile up on the plate side of the capacitor. The negative charge repels electrons on the other side of the capacitor, the grid side, leaving it positively charged. (This is how an opposite charge is induced). Some of the repelled electrons go out onto the grid, making the grid negative. On the positive half of the cycle all charges are reversed. Thus an amplifier's grid swings positive and negative in unison with the audio frequency voltage from the preceding tube's plate circuit.

WHY DOES THE FISHER

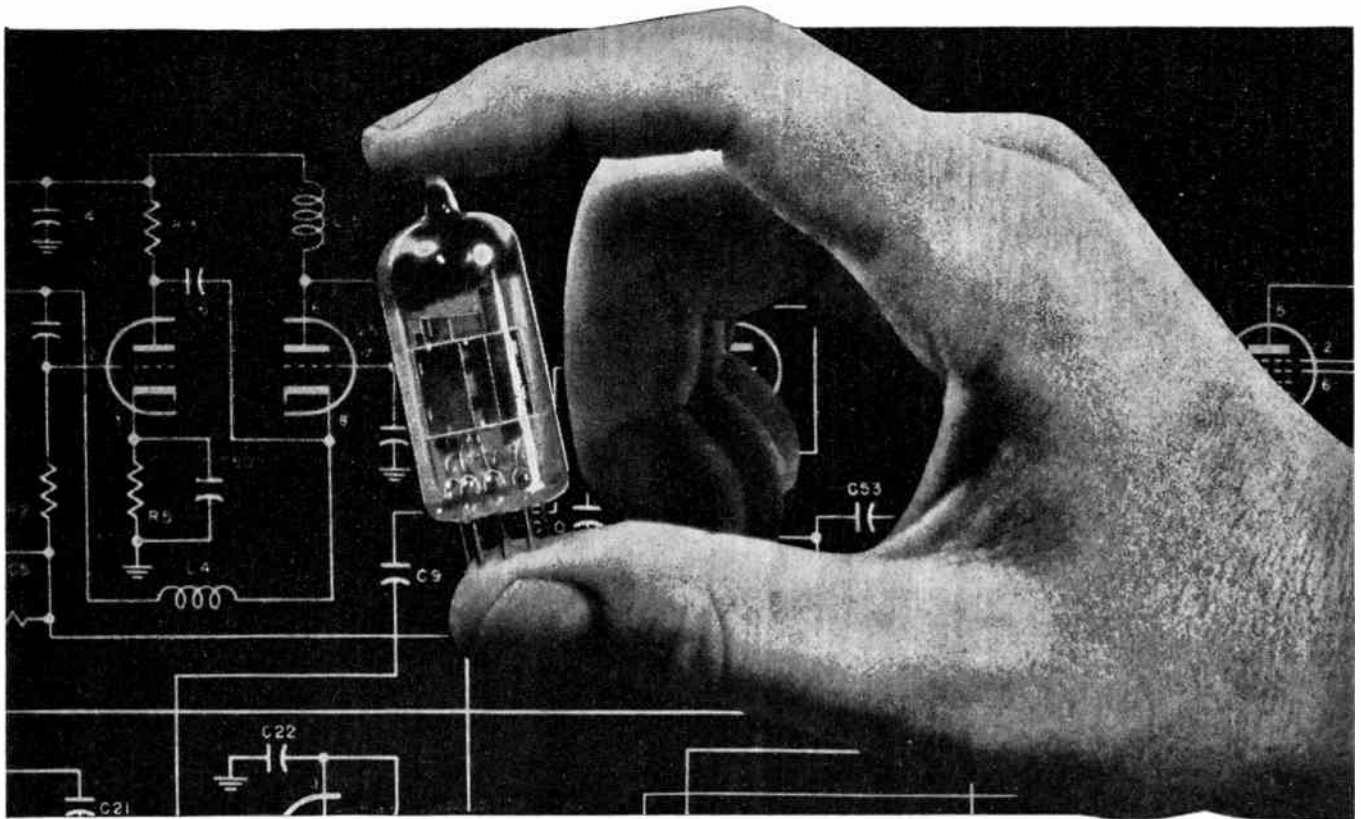

USE A GOLD CASCODE?



THE FISHER FM-90X

Everybody Knows...

that only Gold Cascode RF amplification brings FM sensitivity to the theoretical limit, allowing reception at tremendous distances.

Only FISHER has it!

Everybody Knows...

that four IF Amplifier stages are necessary for maximum bandwidth coupled with maximum selectivity, plus a vast increase in gain.

Only FISHER has it!

Everybody Knows...

that Zero-Time-Constant, Dual-Dynamic Limiters operate instantaneously, eliminating any possibility of impulse and random noise

Only FISHER has it!

Everybody Knows...

that two tuning meters permit micro-accurate tuning plus orientation of the antenna for highest possible signal strength.

Only FISHER has it!

Everybody Knows... that only a GOLD CASCODE FM tuner CAN be *the* best! And the world's *only* FM tuners using the costly GOLD CASCODE are those made by FISHER. No amount of wild claims by envious competitors can change that simple fact! The costly GOLD CASCODE achieves the *highest possible gain* with the *lowest possible noise*, accounting for its amazing sensitivity. Its inherent gain is *twice* that of the RF tubes used in other FM tuners. On this type of tube, with its gold-plated grid—and **ONLY** this type of tube—is it possible to have the *microscopically small gap* between grid and cathode necessary to achieve absolute-maximum sensitivity.

You can *spend* more, but you cannot *buy* a finer instrument than a FISHER GOLD CASCODE tuner. The superior claims made for FISHER tuners are based on actual production units *exactly like the one you can buy*, not on a hand-tailored 'laboratory-pet' sample. Listed at the left are *other* important features, found **ONLY** in THE FISHER. If you have any doubt about the superiority of FISHER tuners, ask your dealer to permit a home trial, under identical conditions, alongside *any other make of tuner, regardless of price*. **YOU** be the judge!

WRITE TODAY FOR COMPLETE SPECIFICATIONS

FISHER RADIO CORPORATION
21-31 44th Drive • Long Island City 1, N. Y.

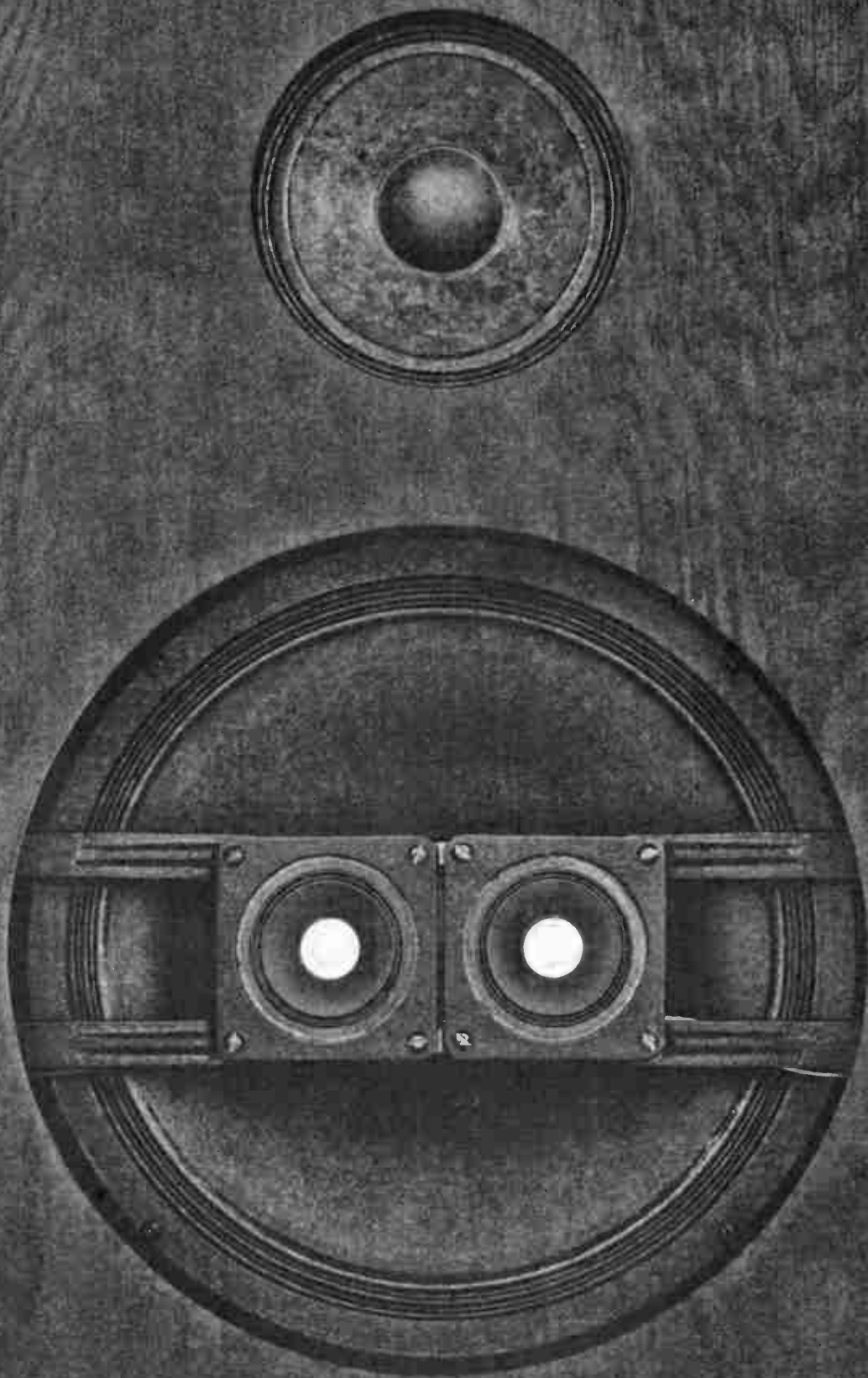

A TRIO MATCHED FOR MUSIC / In this B-302A, as in all Bozak Speaker Systems, the three basic Bozaks speak with a single voice / assemble them in a sturdy infinite baffle— power them with the finest associated equipment—add more of them at any time to extend bass-range, power and realism / for the very best in sound, see a franchised Bozak dealer

THE R. T. BOZAK SALES COMPANY / Darien, Connecticut



Stereo at Home and Abroad

Gentlemen:

I recently received with much pleasure several back issues of your publication, including January 1958. I was particularly interested in the article by Ben Zale entitled "Perfectionist's Power Amplifier." Unfortunately, I am in that electronic limbo of not being completely divorced from pictorial diagrams or attached to schematics. I am wondering if enough people are in the same predicament to make it feasible to supply a pictorial diagram and template for a nominal cost. A simple drawing like that of Fig. 1 on page 23 of the same issue ("A Practical Gadget for Gadgeteers") would more than suffice. Thank you very much for attention to this inquiry; and if such a pictorial is feasible, please bill me for it.

Drake S. Reid, Lt. (j.g.), USN
U.S. Naval Receiving Station
Washington, D.C.

Evidently enough people were in the same predicament; this is one of several dozen letters asking the same question. On page 25 you'll find the pictorial diagram, with our compliments. —ED

Gentlemen:

Congratulations! The "Audiolab Test Reports" in the April 1958 issue are extremely fine. This sort of editorial courage has been needed in the audio field for a long time.

L. B. Dalzell
Encino, Calif.

Gentlemen:

Being an old subscriber to the Audio League as well as a charter member of AUDIOCRAFT, it goes without saying that I was delighted to see you start the "Audiolab Test Report" series. I am sure that there are many others who feel as I do, and consider this new addition as a very important part of your magazine.

As the Audio League found out, publishing a magazine, journal, etc., without advertising is a very difficult thing to do, and publishing this kind of material in a periodical with advertising I believed impossible to do—so my hat is off to you, and I hope you will keep up with this kind of material in the future.

James M. Hartshorne
Ithaca, N.Y.

IN THE EFFORT to keep abreast of stereo developments in this country, we may have lost touch with what has been going on overseas; indeed, a good many of us probably have forgotten that the first publicly demonstrated modern stereo-disc system was that of English Decca (London Records here). Announcement of this vertical-lateral system precipitated demonstrations of other types of stereo discs, some still in process of development. Principally because of its theoretical advantages, the Westrex 45/45 system was accepted immediately, if unofficially, by foreign record firms as well as our own. Last October the large companies estimated that stereo records would become available this fall at the earliest.

Well, the third annual London Audio Fair was held April 18 to 21, almost exactly six months after the Westrex system was first officially unveiled. What was the main feature of the show? You guessed it—stereo sound on disc records, pressed by a major manufacturer, Pye. These are now available at record stores throughout England. The same company has scheduled the release of inexpensive stereo phonographs for June.

The Pye stereo discs include Halle Orchestra recordings of Mozart, Beethoven, Sibelius, and Dvorák symphonies, and a selection of opera overtures. There is also a Bach Widor organ recital by Ralph Downes, and sundry light and pops collections. Presumably, this appetizing fare will be available soon from Pye's present American associate, Mercury. Pye's surprise forced Decca and EMI (Capitol-Angel) to distribute sample stereo records to exhibitors at the show. Both companies are known to be building up a substantial backlog of stereo pressings for fall release, and still have not—at the time this is written—indicated that they will be available any sooner. But if Pye is here, can EMI and Decca be far behind?

IT APPEARS that we'll have a summer stereo bonanza from our own sources, too. RCA is scheduled to release at least 25 stereo discs, and machines to play them on, in June. American Decca will release its first dozen stereo records in June also, according to *The Billboard*. Another dozen are due from Columbia in June or July. Releases in June, July, or August are scheduled by Capitol,

Angel, Mercury, and London. And, of course, we have some already from Audio Fidelity, Esoteric, Elektra, Hallmark, HiFiRecords, ABC Paramount, Urania, Vanguard, Vox, and possibly others. By late summer several of the major phonograph manufacturers will be selling stereo phonographs; and the avalanche of high-fidelity components for stereo record-playing systems is well under way.

There's news on the tape front, too. Although it isn't easy to get definite information from RCA on future plans for its 3¾-ips, four-channel stereo tape cartridge, reliable sources report that the company has developed an adapter unit which will make the cartridge usable with existing reel-type tape machines. The selling price: about \$30. But as of the middle of May, other tape-machine manufacturers are simply not talking when asked about cartridge-handling facilities on new models.

In a lengthy news release from Ampex, however, we are promised low-priced, high-quality, 3¾-ips, four-track stereo tapes by midsummer. When these materialize on a commercially available basis they will probably be on reels rather than in cartridges (except, possibly, those from RCA). Ampex emphasizes the *future* practicability of tape cartridges or magazines, and says it "... has significant developments which will lead to industry-wide standardization of such a magazine-load concept." In the meanwhile, according to the Ampex statement, the new tapes will be fully compatible with present 7½-ips, two-track stereo tapes, and will result in no compromise in quality. Present machines will, of course, require modifications to play the new tapes.

If there is no compromise in quality, with the new tape system, it puts tape in dollars-and-cents competition with disc records as we know them today. The cost of raw tape and the time required for tape duplication have, together, been responsible in the main for high recorded-tape prices. With a four-to-one advantage in the former factor and at least a two-to-one advantage in the latter, the new system could put the cost per minute of playing time on tape below that of disc records. We'll reserve judgment until we hear some of the new tapes.

Anyway, this should be an exciting year for audiocrafters! —R.A.

NOW that stereo discs are here, owners of high-fidelity systems are faced with a major problem: that of converting their systems to stereo. Until now the need for stereo reproduction facilities has not been pressing. Most hi-fiers are quick to admit that stereo sound has advantages, but many have not yet converted because there has been only a limited amount of stereo source material—and it has been expensive, except for occasional stereo broadcasts. Now this is changing. In a short time we will have large repertoires on inexpensive stereo discs, and the equipment

disc played on the same system. Even if a stereo reproducer is used, the sound quality on monophonic records is not so good. This can be attributed to the simple fact that the compromise monophonic output of the 45/45 system is not as satisfactory, in most cases, as that of a single-channel disc for which the original microphone setup was adjusted for monophonic reproduction.

It is a far different story when we play a stereo disc on a stereo system. Then, all the quality we associate with an LP record is obtained, with the added beauty of stereo. But there are problems

speaker already on hand is a flat-wall speaker, there is no reason that the new unit *must* be the same; if a corner is available, and a corner enclosure seems desirable, by all means use it! As a rule of thumb, most enclosures, at a given price, work better if designed for corner use than if not. But if no corner is available, two flat-wall speakers can just as well be used. The speakers should be no closer than 5 ft. from one another, with the ideal spacing somewhere around 7 ft. apart. An ideal wall might be 7 ft. long with two corners available. This should face into a room no longer than 25 ft. For a longer room, the speakers should be farther apart. In no case should the speakers be more than 15 ft. apart.

Although few wish to believe it, the second half of a stereo system doesn't have to be as good as the first half. We are less able to discern faults in stereo reproduction. Thus, when selecting the second enclosure, not so much attention must be paid to the low-end reproduction; since lows are quite non-directional, the main speaker system can handle them alone. The enclosure should be sturdy and should fit in with the décor of the house. If it goes down to 75 cps or thereabouts, fine. The second speaker system should be selected for efficiency, lack of distortion, and sound color (this is purely subjective; only you know what sound you like, and you must hear a speaker to select it). A speaker that goes to 80 cps without doubling is a better choice than one that goes down to 30 cps (on harmonics). Pick a speaker you can afford and one that sounds the way you like it. You don't *need* a three-way speaker system for the second channel. A coaxial or wide-range speaker of good quality is good enough, at least for a start.

The second amplifier also can be a fairly modest one. A ten-watt is often adequate unless you are using it to drive one of the new low-efficiency loudspeakers. Under these circumstances, a 20- or 30-watt amplifier should be chosen. There are one or two combination units now on the market designed to bring a conventional system up to date, and there will be more in the following months. Most of these are a combination of one reasonably sized amplifier and a double control section. Some contain both channel's preamplifiers and control sections, while others have one preamp and only input-selection facilities for the main channel, along with a master gain control. Others fall midway between these two extremes. They are not too expensive and represent the simplest conversion. Simply hook up one of these and, with the stereo cartridge and another speaker, you're in business for stereo. Some will use the present amplifier while others will dispense with its services. Alternatively, if you have

Stereo

System Techniques

How to select components

for your stereo system

by JOEL EHRLICH

with which they can be played is available at moderate prices.

Further affecting the outlook is the possibility that stereo discs may *supplant* conventional disc records. This may well occur because the stereo disc is quite compatible from the standpoint of the mass-market, low-price, "hi-fi" phonograph, on which mostly 45's are played. Of course, it may be argued that this does not apply as well to the 12-inch LP. But far more LP records are sold to people having phonographs than to those having high-fidelity systems.

On the average "hi-fi" phonograph it makes little difference whether a conventional LP or a stereo disc is played. Unless I compare one against the other directly, I am unable to determine which is being played on most of these ubiquitous units. In view of this fact it seems likely that the major record companies will soon abandon their dual-line policies and issue stereo discs only.

When this happens it will affect adversely only the audiophile who does not yet have a stereo system. Stereo discs are not really compatible when played with a conventional high-quality cartridge on a high-fidelity system. While the disc will rarely be harmed, the sound quality is not so good as that of a conventional

in converting an existing system to stereo which should not be minimized. Not least among them is the fact that another loudspeaker and enclosure are needed. This means both a substantial expenditure and that another bit of space must be stolen from the living room. It cannot be just any space; it must be a well-selected site calculated to yield maximum stereo realism.

Many are under the impression that stereo can be discerned only when the listener is centered between the speakers and about 5 ft. in front of them. This is not so. Just as we are able to perceive sound separation and motion from the side of a theater, so we should be able to appreciate this same spatial effect from the side of a room, provided that we are not too close to either of the speakers. Thus, ideally, stereo speakers should be placed at the ends of a short wall of a room facing into its long dimension.

If you have one corner speaker and the adjacent corner along the shorter wall is anywhere from 5 to 12 ft. from it, the ideal choice would be another corner speaker enclosure. If the original enclosure is a corner unit and another corner is not available, a flat-wall speaker can be used quite easily. And if the

two good preamp-control units already, you can tie them together with a simple stereo master-control box (such as the Scott Stereo-Daptor), and get by with only another basic power amplifier. The requirements for the second amplifier are not nearly so stringent as for the main unit, but it should be a good unit made by a reputable firm. While slightly more distortion can be tolerated, a good amplifier will never have much to begin with.

A completely integrated stereo pre-amplifier presents a whole new set of problems. In addition to two sets of the controls we are accustomed to having on a conventional unit, there are theoretical grounds for adding controls for master gain, balance, master bass, master treble, function selector, master input selector, etc. If the new unit is designed primarily for stereo, no need exists for a variable record equalizer, since all stereo records are cut to the RIAA curve. If it is to play conventional records also, a more flexible equalizer may be desired. Provision must be made for putting both channels in parallel for monaural sources. All inputs must be duplicated. There must be two phono inputs, two tuner inputs, two inputs for everything. Since the tape recorder will be more in demand in a stereo system, tape and regular outputs must be provided.

In addition to the volume control for each channel, a common control is needed so that the volume can be raised or lowered without having to rebalance the entire system again. A balance control is needed so that the relative level of each channel can be adjusted easily to be in balance with the other channel. The individual channel volume controls function as level-set controls in a stereo system. Common tone controls are needed (at least in theory) for the same reason as the common volume control. The individual channel tone controls would function more in the line of preset tone controls, enabling you to adjust both channels so that they sound alike. In a stereo system, there will be more need for scratch and rumble filters. These will have to be individually selectable for each channel.

When the unit is functioning for a monaural input, in addition to the two channels being tied together, provision must be made to permit the selection of the correct input; for example, in a system having an AM input on one tuner input and an FM input on the other, some means must be made for selecting between them. This too would apply to sets having an FM and a multiplex-FM input, one on each channel.

The preamp will need input-level controls and will also need output-level controls, because the gain of the two amplifiers may be different. Provision

Continued on page 46

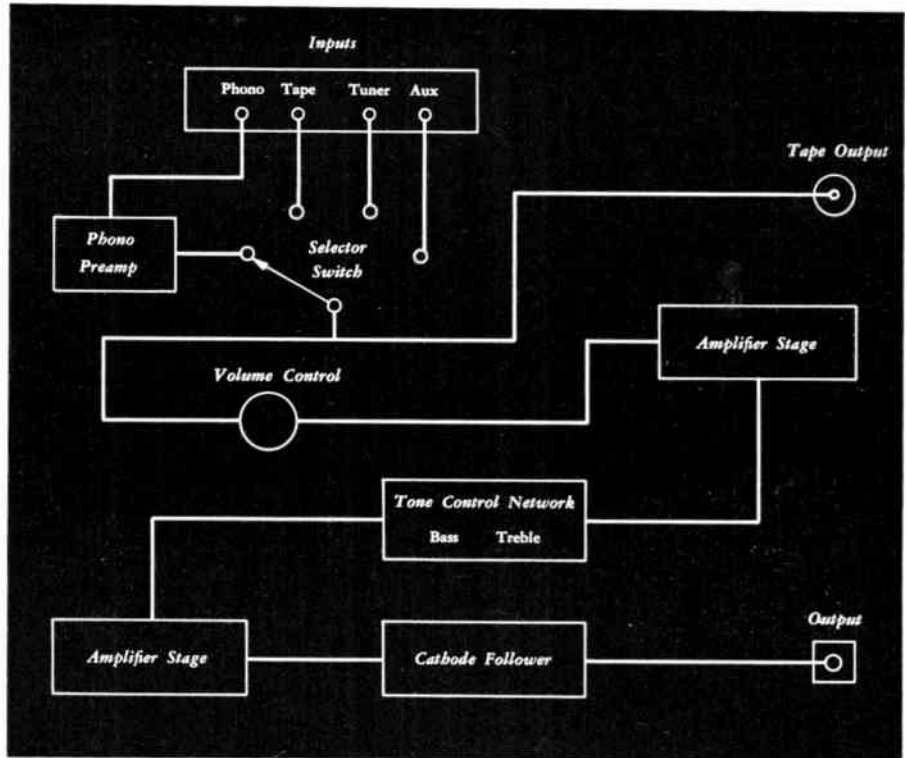

Most single-channel (monophonic) preamplifiers in high-fidelity use today are composed of these basic sections.

Stereo preamps will be arranged like this; will handle two separate channels with some control functions ganged.

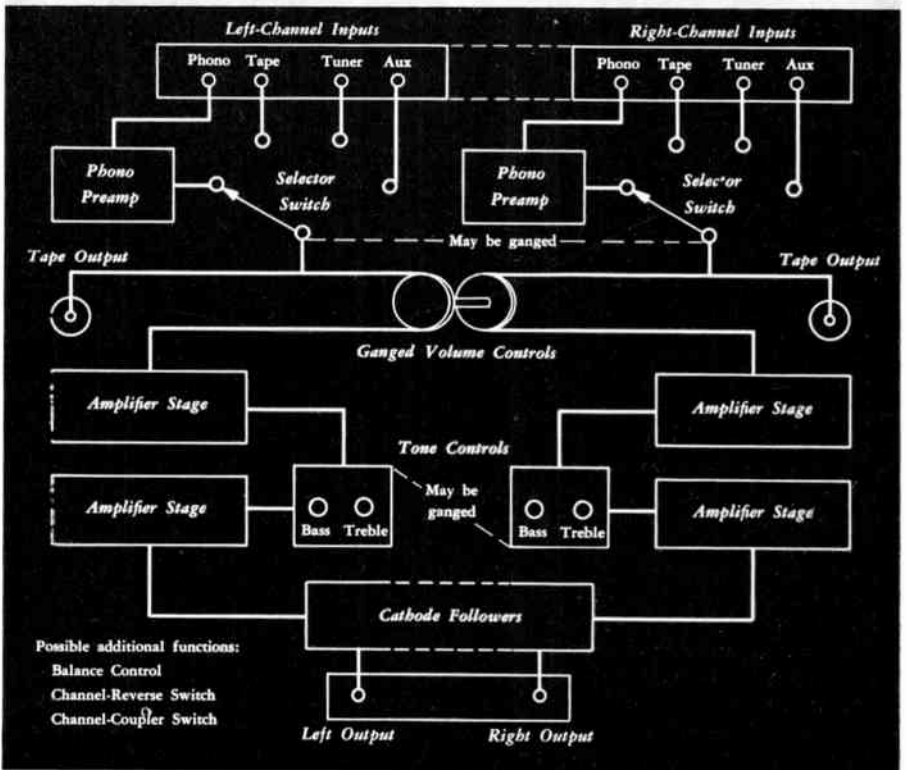

- Possible additional functions:
- Balance Control
 - Channel-Reverse Switch
 - Channel-Coupler Switch

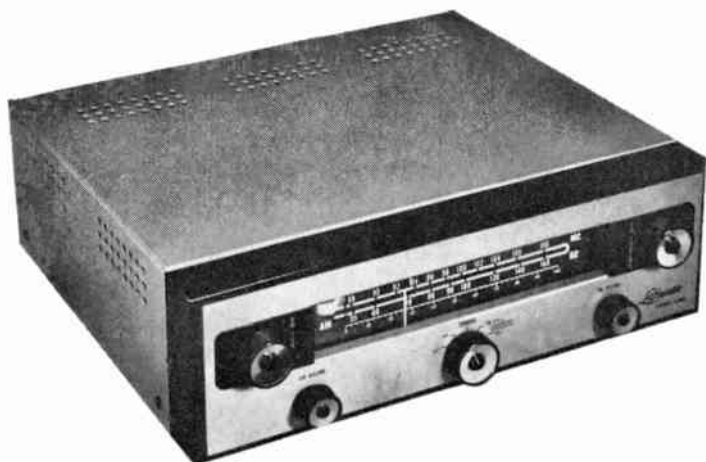

The Lafayette

KT-500

STEREO

Tuner Kit

An audiocraft kit report

It's 2 tuners in 1. It's pre-aligned. It's a snap to build.

STEREOPHONIC radio broadcasting has become more and more common of late. In the New England area alone, at least three stations are on the air with regularly scheduled stereo programming, and here as well as in other sections of the nation, experimental stereo transmissions are broadening the scope of this new medium, and bringing the breathtaking aura of stereo to many who never have heard it.

Stereo broadcasting has one incontrovertible advantage: minute for minute, broadcast stereo, as with broadcast music in general, can be cheaper for the consumer than any of the hitherto available stereo media. Assuming that the cost comparison is based on the sound source, a pair of radios or tuners costs the listener less than a stereo tape recorder-player or pickup cartridge plus enough

tapes or discs to equal the variety obtainable from radio. This factor will assume greater significance as stereo broadcasting increases in prevalence.

Until recently, reception of stereo transmissions required the use of *two* radio tuners, since most FM-AM combinations double up on components in such a way that the AM and FM signals are available only one at a time. A few sets have separate networks, but in order to make use of them, the output circuits must be reworked.

Fortunately, much of this difficulty is being removed. Lafayette Radio is one of the first manufacturers to unveil a totally separate AM and FM tuner kit on a single chassis, in which both bands can be tuned individually and fed to any two-channel stereo system. This is done with a unit not much larger in size than

conventional FM or AM tuners and at a price (\$74.50) comparable to many ready-built FM-only tuners.

The KT-500, although somewhat complex (see photos), is amazingly easy to build, requiring in the neighborhood of 8 to 10 hours. Our kit worked immediately when it was finished, and worked very well. Complete instructions are given in the manual for alignment with equipment no more complex than a screw driver! Broadcast stations are used instead of an RF generator, and the tuning eye on the receiver functions as an alignment indicator. How accurately this can be done is explained in the Test Results section of this report.

The tuner covers the standard 550- to 1,600-Kc AM and 88- to 108-Mc FM bands. The AM (445 Kc) and FM

Text continued on page 22

Figs. 1 and 2. These are the printed-circuit boards which hold most of the FM section circuitry. The RF board (left) contains the tuning gang, RF amplifier, oscillator, mixer stages. Photo at right shows the foil side of the RF and IF boards after soldering.

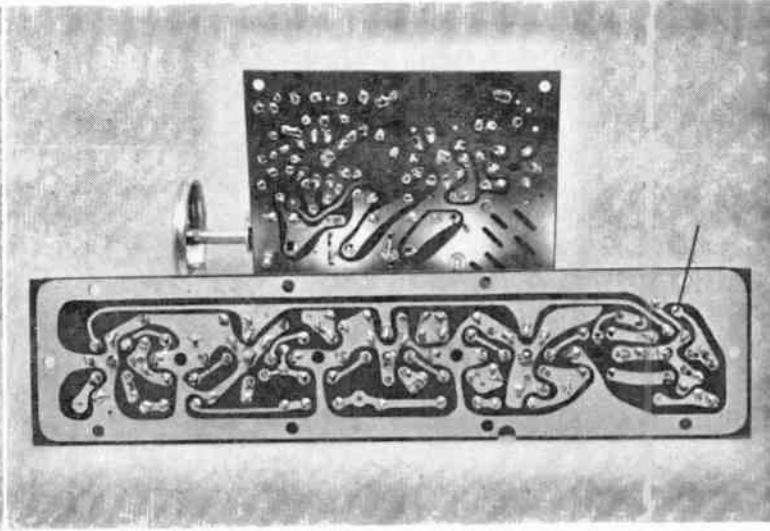
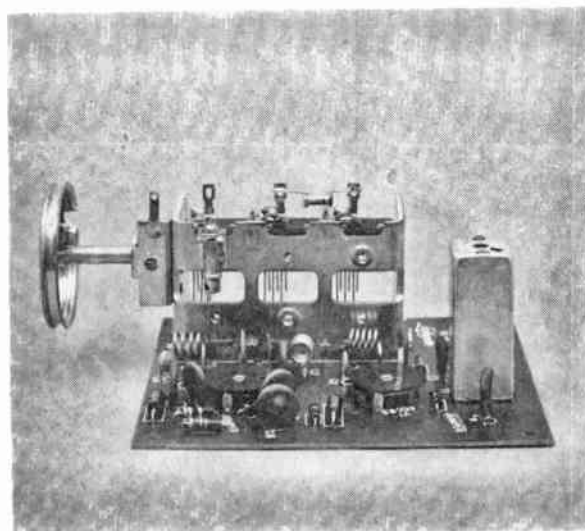

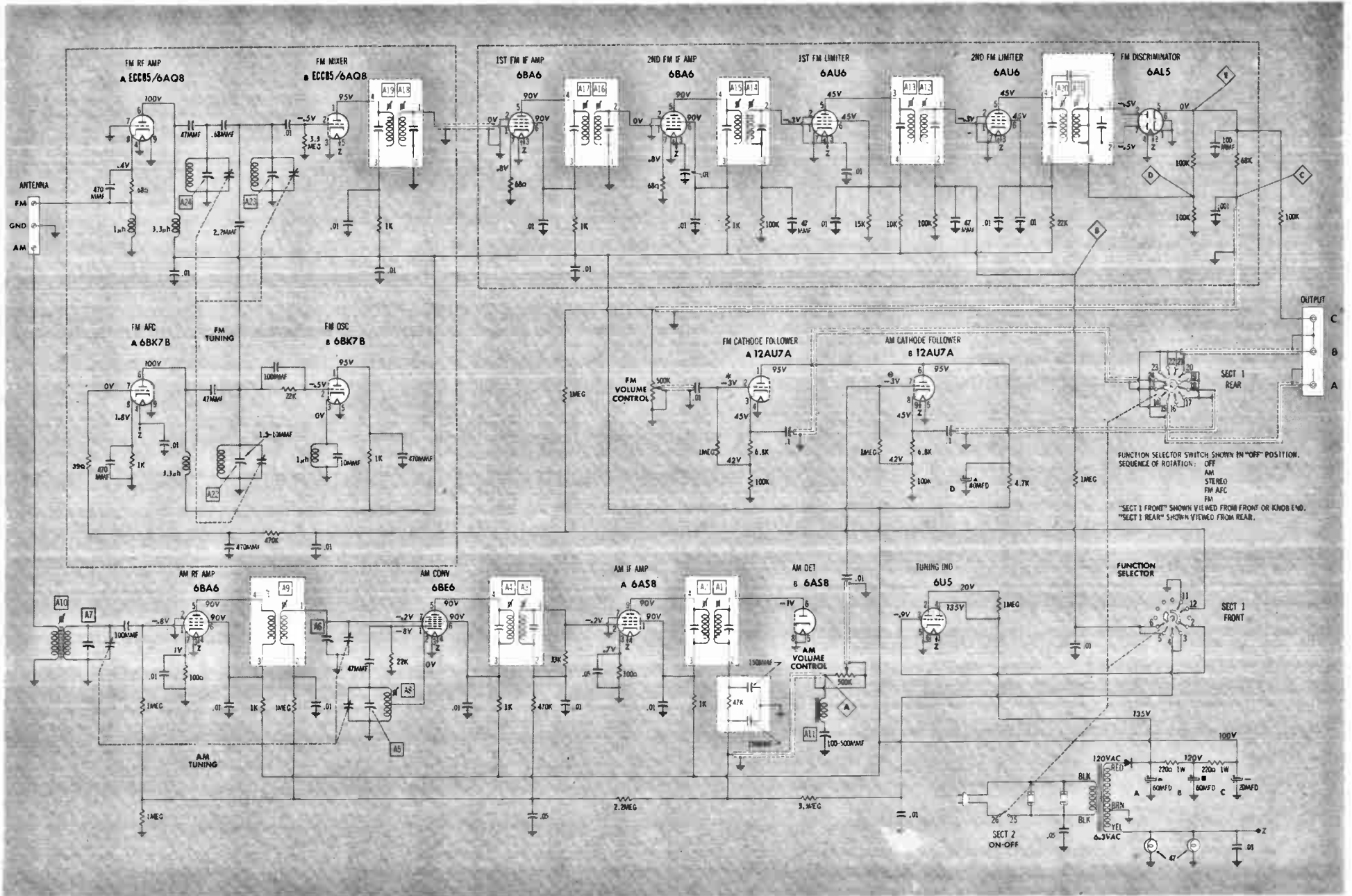

Schematic of the Lafayette KT-500 stereo FM-AM tuner. FM components are shown at the top, and AM components at the bottom. Sections in dotted lines are printed-circuit boards.

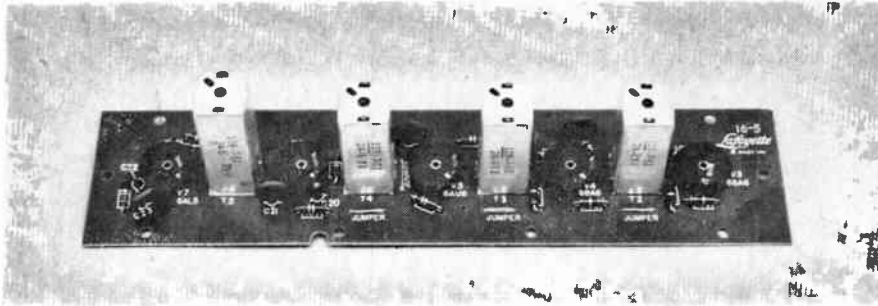

Fig. 3. This is a top view of the IF printed-circuit board, which supports the IF amplifiers, limiters, and discriminator. Transformers snap into place easily.

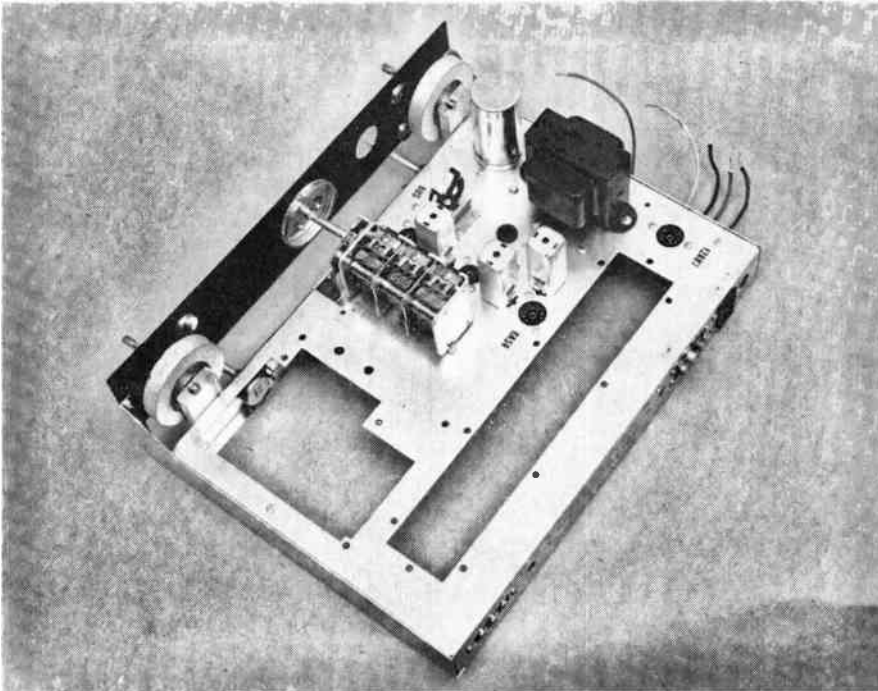
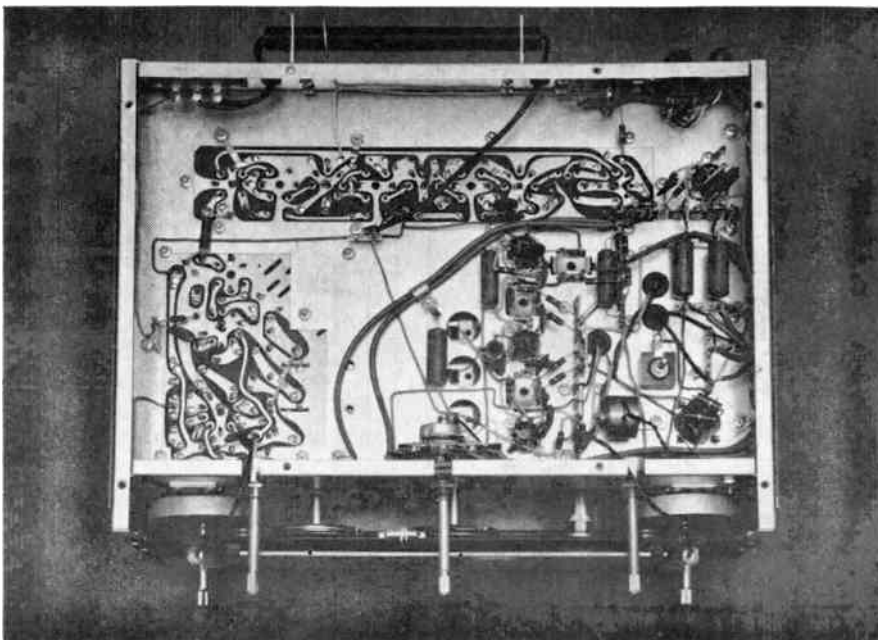

Fig. 4. AM components are visible in this photo of the main chassis, shown as mechanical assembly has been finished and before soldering operations are started.

Fig. 5. After soldering, the bottom of the tuner looks like this. FM components are at the top and left. The AM section and power supply are on the lower right.



Continued from page 20

(10.7 Mc) intermediate frequencies are standard. The circuits of both AM and FM sections are based on proven super-heterodyne and Armstrong formulas. The FM side has an RF stage for maximum sensitivity, dual limiters, and a Foster-Seeley discriminator. A tunable ferrite antenna coil is built into the back of the set, and AM reception, even of weak stations, is adequate without an external antenna. Both AM and FM sections have separate VOLUME controls (separate pre-amps are thus not really essential) and both channels work from a cathode follower, providing a low-impedance signal path to amplifiers which may be located 10 to 20 ft. from the tuner.

FM sensitivity is excellent, with 25 db of quieting available from an antenna signal of only 4 μ v. The limiters are driven to saturation at about 10 μ v. This means that the tuner will work well in strong-signal areas with the simplest of antennas, and perform beautifully in fringe areas with directional antennas. FM distortion (see Test Results) is extremely low. The de-emphasis network follows the prescribed curve perfectly, providing an output which varies no more than 1/2 db over the 20- to 20,000-cps range. Bandwidth on the AM side is 8 Kc.

One final feature, of impending value for stereo, is an extra output jack on the rear panel which lets you feed a nonde-emphasized FM signal to a multiplex decoder (this you must provide yourself, when they are available). When stations in your area begin multiplex-FM transmissions, the KT-500 will detect both signals simultaneously.

The Circuit

In analyzing the circuit, we'll consider the FM components first. The antenna (unbalanced, 300 ohm) is connected to one-half of an ECC85 dual triode which is operated in typical grounded-grid fashion to provide extremely low-noise amplification of the RF signal. The output from this stage is tuned by one section of the FM tuning capacitor and capacity coupled to the other section of the tube, which functions as a mixer for the RF signal and the oscillator signal from one-half of a 6BK7B. Oscillator and mixer stages are tuned by the remaining two sections of the tuning gang.

The intermediate signal from the mixer is passed through two IF amplifier stages (6BA6's) which increase its amplitude so that the two limiters (6AU6's) which follow can maintain it at a constant level, independent of amplitude variations, for proper operation of the discriminator. The 6AL5 discriminator converts carrier fluctuations into audio voltages once more.

The discriminator output is connected, without de-emphasis, to output jack C.

This signal will be used in conjunction with an external decoder to receive multiplex-FM stereo when it is available.

The detected audio signal is connected to a de-emphasis network with a time constant of 75 microseconds, and then passed to the FM VOLUME control. From here, the audio signal passes through one-half of a 12AU7 which functions as a cathode follower. The signal from the de-emphasis network is also applied to the 6BK7B oscillator-AFC tube as a control voltage to provide automatic frequency control when the SELECTOR switch is in the FM AFC position. When the SELECTOR is in the FM position, the control voltage is shorted to ground.

With the selector switch in either FM AFC or FM positions, a filtered signal from the grid circuit of the second limiter is fed to the 6U5 electronic eye tube, which functions as a tuning indicator, the eye closing as the signal increases. When the SELECTOR switch is in the AM or STEREO positions, control voltage for the 6U5 is obtained from the AM section.

On the AM side, the signal from the ferrite rod antenna is applied to a 6BA6 which is an AM RF amplifier. Its grid circuit is tuned by one section of the AM tuning gang. The remaining sections tune the AM oscillator coil.

The output from the RF amplifier is coupled through the tuned RF transformer to the 6BE6 converter. The resultant 455-Kc IF signal is transformer-coupled to an IF amplifier stage (pentode section of the 6AS8) and then detected by the diode portion of the same tube. The output from the detector passes through the AM VOLUME control to the second section of the 12AU7 cathode follower tube. The filtered output from the detector also serves as AVC voltage for the other AM stages.

Construction

The designers of the KT-500 have gone to great lengths to insure easy and rapid assembly of the tuner kit. Two features, particularly, speed the job, and also guarantee that a home-built tuner will perform very nearly as well as a factory-built model. Printed-circuit boards are supplied (Figs. 1 and 2), to accommodate all the FM circuits with the exception of the cathode-follower output. The use of PC boards minimizes variations in stray wiring inductances and capacitances. As a result of this, not only is assembly speeded up, but the KT-500 meets manufacturer's specifications with the very simple alignment of tuned circuits as directed in the assembly manual.

The AM stages are assembled in more conventional manner, but here, too, drilled holes for components are so arranged that resistors and capacitors can

Continued on page 42

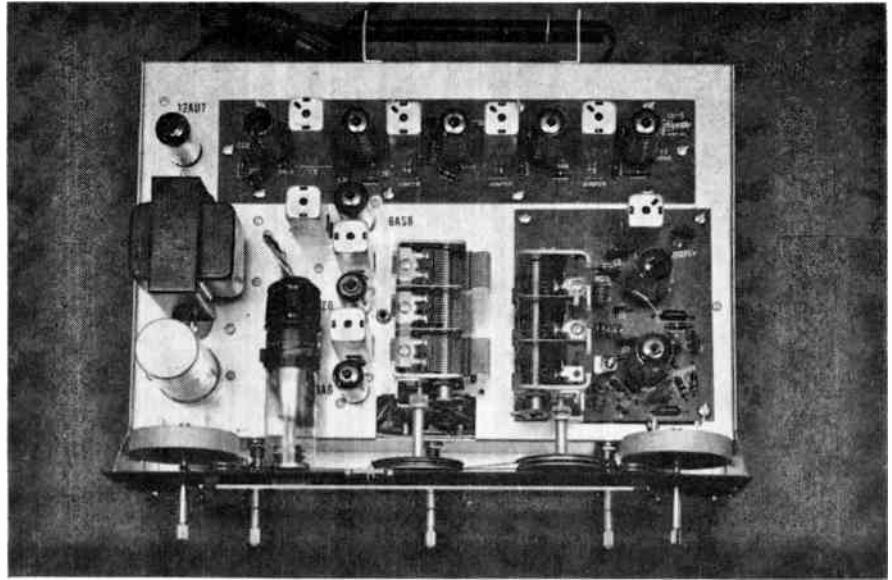

Fig. 6. Here is a top view of the completed tuner. The handle-like protrusion near the top of the picture is the ferrite coil which serves as the AM antenna.

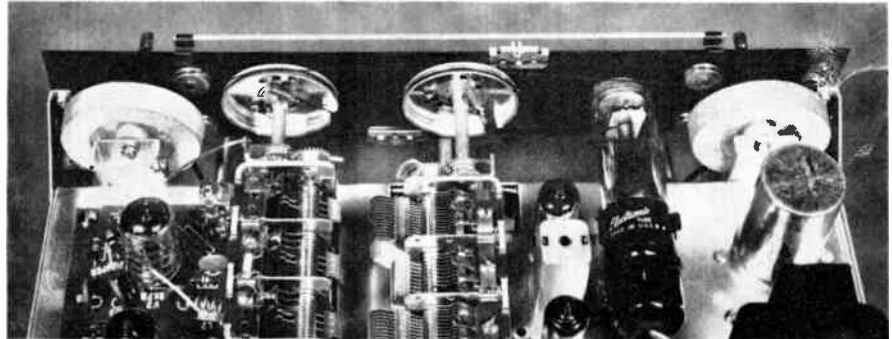
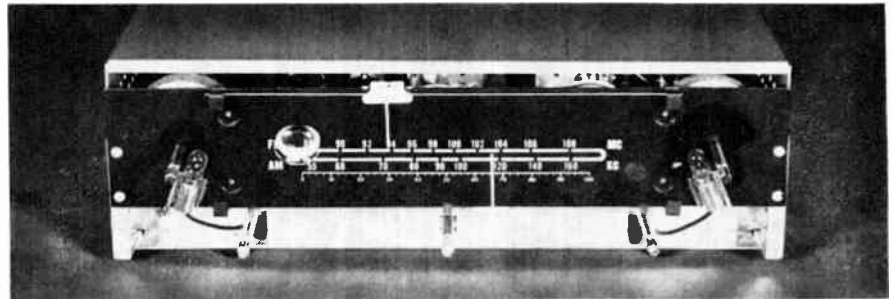
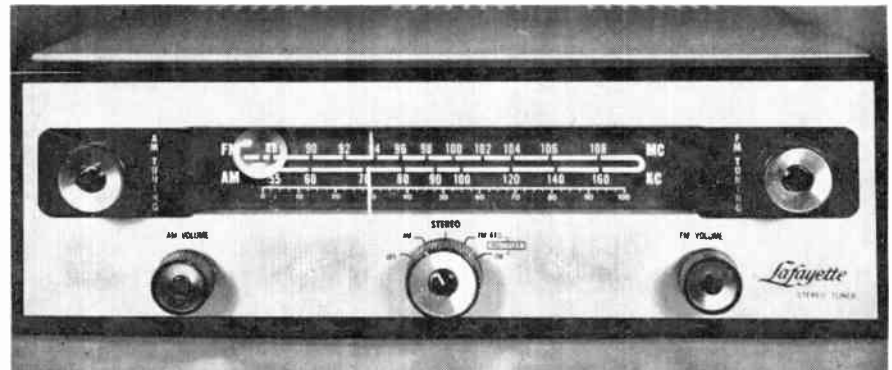

Fig. 7. This closer view of the tuning assembly shows some of the rollers which guide the dial cords. Note the separate pulleys on the tuning gangs.



Figs. 8 and 9. The front of the finished tuner is shown here with and without the front panel in place. Note that the FM tuning indicator slides along the top of the glass plate, whereas the AM indicator glides along the bottom edge.



Last January, Audiocraft published the circuit of a super-deluxe 36-watt power amplifier. This article created such a stir among audiophiles that we were swamped with letters. Here, at last, in response to reader demand, is a pictorial diagram of the

Perfectionist's Power Amplifier

When Ben Zale, an audiophile from Philadelphia, first submitted his reworked Mullard circuit to us, we recognized the quality which he had built into the design — the precision resistors which were used throughout the amplifier and power supply, the rugged chokes and oil-filled capacitors which insure a signal-to-noise ratio of 90 db plus, the Ultra-Linear output stage built around the highly touted EL34. But we had no idea that this design would envelop the fancy of audiophiles across the nation, arousing in them a flurry of letter writing such as we have not seen in Great Barrington in many a moon.

Many built the amplifier from the schematic and photos which appeared in the January issue. But many others, eyes gleaming as they read the almost fantastic distortion figures, wrote pleading letters, urging us to send them individual pictorial diagrams, and offering to pay whatever necessary, so that they, like their more experienced brothers in audiophilia, could reap the benefits of this audiophile's dream come true. The pile of correspondence was too great to be ignored, and here is our answer.

On the facing page are two pictorials, one each for the amplifier proper and the power supply. Below is a chart listing voltage readings at tube sockets and at other significant points throughout the amplifier.

The pictorial shows, as unfortunately the January schematic did not, that the Acro TO-300 output transformer has the conventional output windings to match 4, 8, or 16-ohm speakers. The feedback network, although described by Mr. Zale as being evolved for 16 ohms, in practice effectively functions for all output impedances. In one or two instances a conflict arose between the parts list and the schematic — this should in all cases be resolved in favor of the schematic, and, of course, in favor of the parts values as listed on the facing page.

Finally — and, let's face it, we goofed — the power transformer was listed in the parts list as a UTC H-86, or equivalent. We searched our catalogues for an H-86, to no avail. Feeling that readers would similarly share our exasperation, we decided to purchase an "equivalent," and ultimately chose the Triad R-26A which, although it has more windings than we needed (the unused ones are shown on the pictorial soldered to an out-of-the-way terminal strip), came closest to matching the voltage and current requirements of Mr. Zale's design.

And that's the story of the Perfectionist's Power Amplifier; it is tedious and involved, but for those who have built or can now build one of these magnificent machines, well worth every word of it. Happy listening.

Voltage Chart

Pin	EF86	ECC83	EL34-1	EL34-2	GZ34	Power Cable
1	124 v DC	375 v DC	38 v DC	38 v DC	NC	NC
2	0	89 v DC	6.3 v AC	6.3 v AC	5 v AC	6.3 v AC
3	2.5 v DC	99 v DC	470 v DC	470 v DC	NC	6.3 v AC
4	6.3 v AC	6.3 v AC	490 v DC	490 v DC	500 v AC	480 v DC
5	6.3 v AC	6.3 v AC	5 v DC	5 v DC	NC	490 v DC
6	95 v DC	385 v DC	NC	NC	500 v AC	NC
7	0	97 v DC	6.3 v AC	6.3 v AC	NC	NC
8	2.5 v DC	99 v DC	38 v DC	38 v DC	5 v AC	Ground
9	0	6.3 v AC	—	—	500 v DC	Ground

DC bias at center lug of filament balance potentiometer: 22 v

More detailed information about the Perfectionist's Power Amplifier may be found in the original article which appeared in the January, 1958, issue of Audiocraft, pages 16-19.

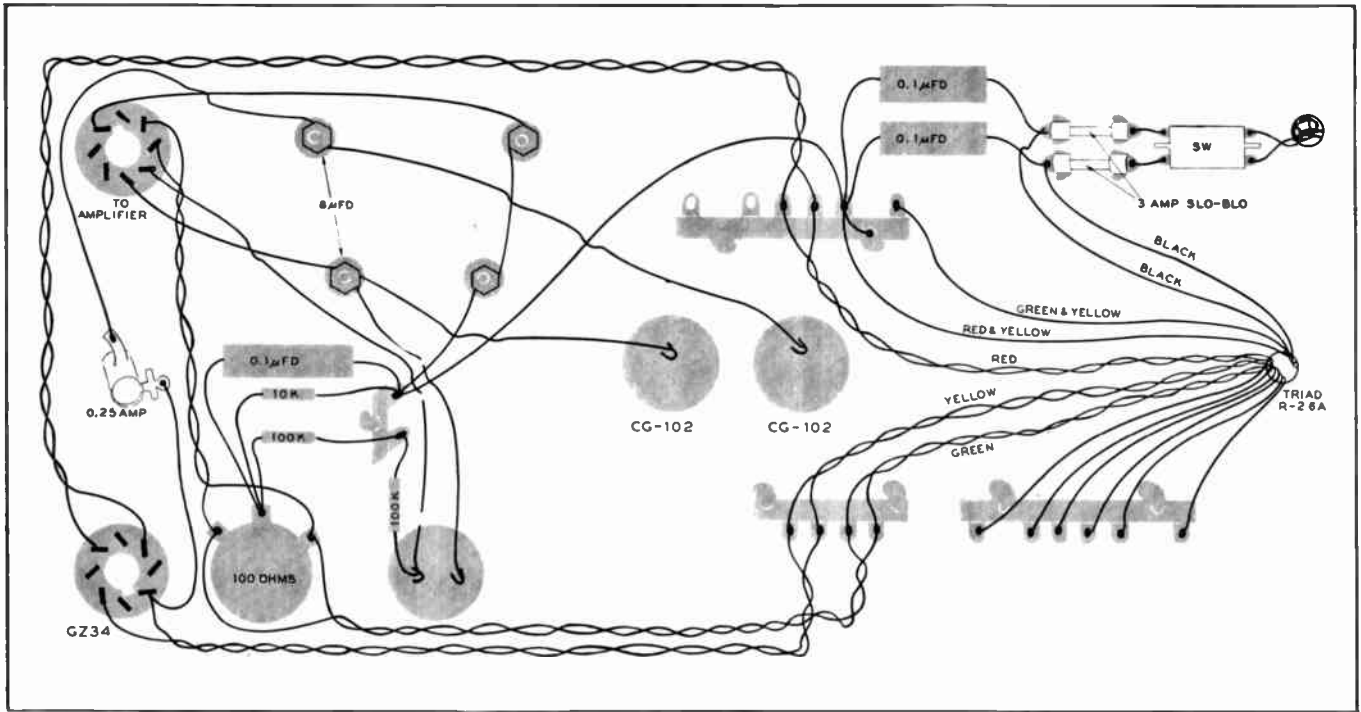

This is the power supply, which should be built on a separate chassis. The gray circle to the right of the 100-ohm filament balancing potentiometer is the UTC CG48C choke. Power cable to amplifier is connected to octal socket marked "to amplifier." Terminal strip in lower right corner holds unused wires from Triad R26A power transformer. AC cord is at upper right corner.

This chassis contains the amplifier proper. 500-ohm adjustable resistors appearing near the top and bottom right corners must be set to the position which provides 38 v DC at pin 1 and 8 of the EL34 output tubes. The condition of extremely low distortion is to a large degree dependent upon the critical setting of these resistors, and resultant output-stage balance.

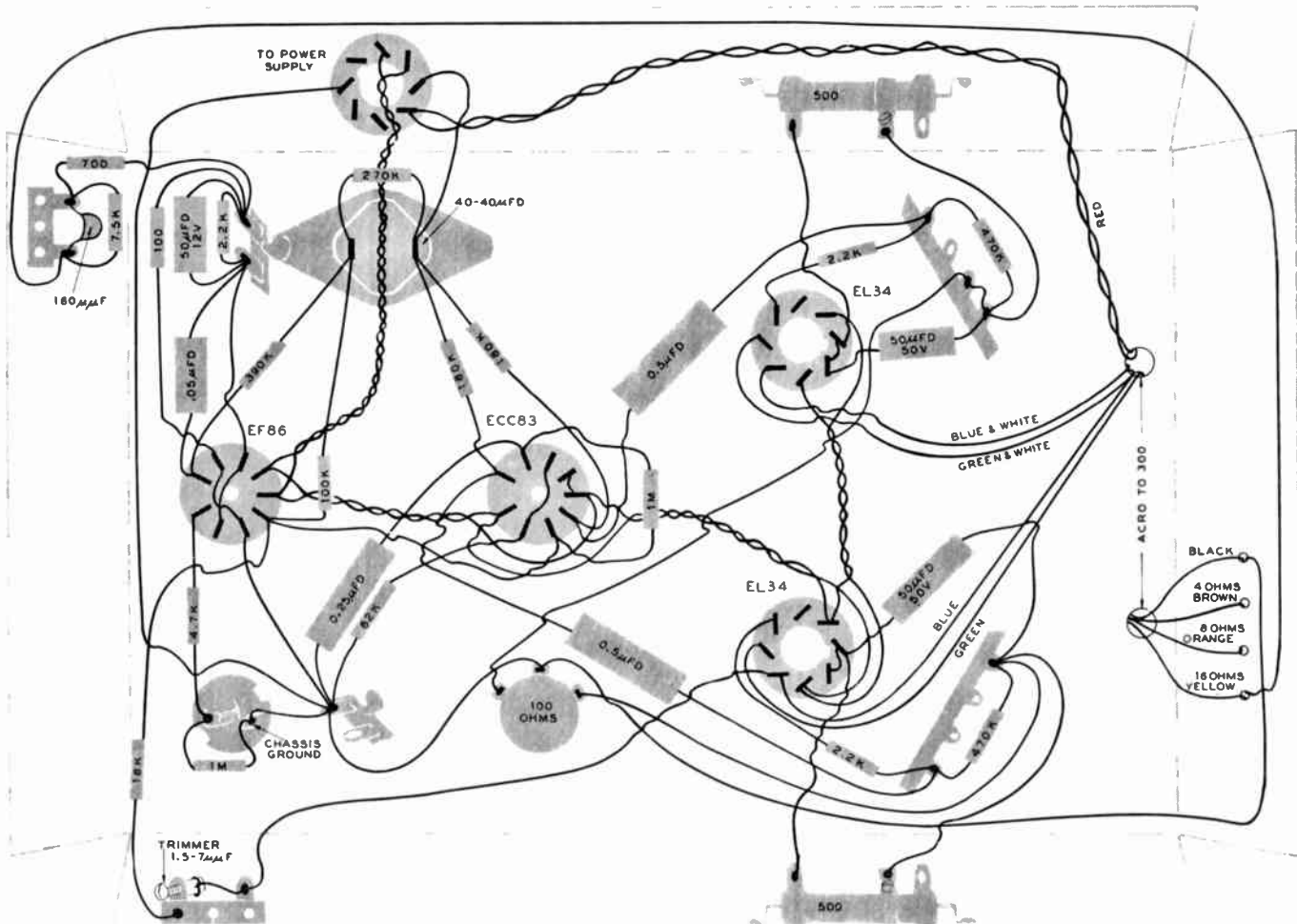

AUDIOLAB

Test Reports

*An objective analysis
of high-fidelity components*

AUDIOLAB TEST REPORT POLICY

These reports are prepared by an organization whose staff was responsible for the original Audio League Reports, and which has no connection directly or indirectly with any manufacturer or publisher in the high-fidelity field. The reports are published exactly as they are received from Hirsch-Houck Laboratories. Neither we nor manufacturers of the equipment tested are permitted to delete information from or add to the reports, to amend them in any way, or to withhold them from publication; manufacturers may add a short comment at the end of a report, however, if they wish to do so.

SHURE PROFESSIONAL DYNETIC CARTRIDGE

The Shure M5D Professional Dynetic phono cartridge is basically similar to the cartridge design of the Studio Dynetic pickup introduced last year. The physical design of the Professional Dynetic is such that it can be installed in any standard tone arm, including record-changer arms. In order to make it more suitable for use in record changers, the lateral compliance has been reduced to 3×10^{-11} cm/dyne, which is still quite high.

The Dynetic cartridges employ a moving magnet, in the form of a rod about $\frac{1}{2}$ in. long and less than $\frac{1}{16}$ in. square. It rotates about its long axis and induces a voltage in fixed coils. The stylus is at the end of a cantilever shoe, the other end of which drives the magnet. The tip radius of the stylus is 1 mil, instead of the 0.7-mil radius used in the Studio Dynetic. The entire cartridge is in a black bakelite case.

Shure recommends a 27-K load resistor for this cartridge, and states that a higher value will produce a slight increase in high-frequency response. The

Response to Components 1109 test record, sweeping from 100 cps (left) to 10 cps.



tracking force should be 3 to 6 grams in typical arms. The output voltage is rated at 21 mv at 1,000 cps with a 10 cm/sec stylus velocity.

Test Results

We mounted the cartridge in a Fairchild 281 arm. The cartridge output was



Shure Professional Dynetic Cartridge.

amplified without equalization and viewed on an oscilloscope.

One of the oscilloscope photos shows the frequency response of the Shure cartridge playing the Elektra 35 test record. This slowly sweeps from 20 Kc to 200 cps (it goes to 20 cps but we stopped the test at 200 cps since we were not equalizing the low frequencies). This picture was taken with 5 grams tracking force and a 27-K terminating resistance, as recommended by Shure. There appears to be a gradual and slight falloff of response above 2 Kc, followed by an abrupt drop somewhere above 10 to 12 Kc.

The second photo was taken with the Components 1109 record, which sweeps from 100 cps to 10 cps. The output of the cartridge was equalized with a Dynakit preamplifier (RIAA). The purpose of this is to show the presence of any resonances in the low-frequency region and to give a rough idea of the lateral

compliance, which determines the low-frequency resonance in any given arm. The only sign of a resonance is the slight 1- or 2-db rise in the vicinity of 30 cps, but this seems to be too high in frequency to be the arm resonance with a cartridge having such a high lateral compliance.

An independent, purely qualitative, but very severe test of a cartridge's lateral compliance is to play the lowest frequencies on the Cook Series 60 Chromatic Scale Test Record. On one side of this record the recorded levels have been applied with Fletcher-Munson compensation. At 31 cps (the lowest frequency) there is some 38 db of boost compared to the 1,000-cps level. Very few cartridges will track this material without excessive vertical force. The Shure M5D in the Fairchild 281 arm stayed with the groove at a 5-gram force, with only a slight amount of buzzing being audible in the reproduced sound. This is exceptionally good tracking, and tends to confirm the high compliance of the stylus assembly.

Conventional point-by-point response curves were taken with the Cook 10LP

Response to Elektra 35 test record, slow sweep, 20 Kc (left) to 200 cps.



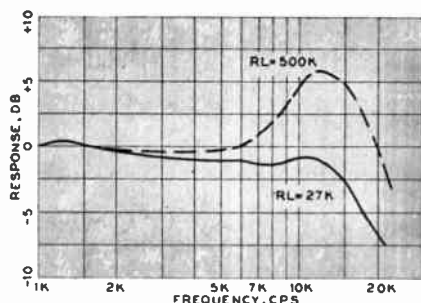

Folkways FPX-100 test record, 78 rpm.

(33 1/3-rpm) and Folkways FPX-100 (78-rpm) records. The output voltage of the cartridge was read directly on a meter and no equalization was used. Therefore, the curves show only the response over 1,000 cps. The shape of the high-frequency rolloff agrees well with the sweep-record photos.

We also made these measurements with a 500-K terminating resistance (the input resistance of the meter). These are plotted with dashed lines. They show a pronounced improvement in high-frequency response, which we would call more than "slight." There is a peak at 12 Kc, which is not large. Although we

did not attempt to determine the optimum terminating resistance, it seems likely that the 27-K is too low.

Summary

The Shure M5D cartridge, properly terminated, provides a smooth response to approximately 15 Kc, which is entirely satisfactory. It is apparently mechanically rugged, and is not subject to induced hum in normal installations (though it is slightly more susceptible to this than the low-impedance moving-coil cartridges). Its needle talk is very low, and its tracking of large recorded amplitudes, particularly at low frequencies, is superior to many more expensive types.

In our listening tests we found it to be very agreeable. There was no sense of strain on loud passages. Even when terminated in the 27-K resistance, the loss of highs was not objectionable and would probably not be noticed except by direct comparison to a cartridge having a good response in the 10- to 20-Kc region. When the terminating resistance is increased, this deficiency is eliminated without any audible penalty.

In view of its low price (\$27.50),

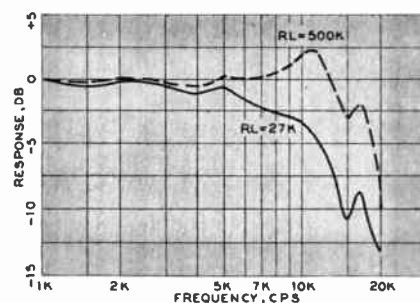

Response, Cook 10LP record, 33 1/3 rpm.

the Shure Professional Dynetic represents an excellent value. It is available with a 2.7-mil sapphire stylus for \$15, but the removal and replacement of the stylus assembly (which includes the magnet) is so simple that one could probably use a single cartridge and merely interchange styli if one wished to play 78-rpm records.

Manufacturer's Comment: With regard to the proper value of input resistance, the instruction sheet which accompanies the M5D states, "The recommended input resistance is 27,000 ohms. Higher values will give increased high-frequency response." If the user desires an increase in high-frequency response (and this can be a matter of personal listening preference) then he should certainly use a 47-K or even higher value of input resistance.

Your AUDIOLAB TEST REPORTS on high-fidelity components

HARMAN-KARDON SOLO II, MODEL TA-12

The Harman-Kardon Solo II is a complete tuner-amplifier, housed in a compact, attractive package. It offers an impressive array of features, including an FM-AM tuner, a phono preamplifier with three equalization positions, rumble and scratch filters, a four-position LOUDNESS-contour selector, and BASS and TREBLE tone controls; and a 12-watt power-amplifier section. A front-panel switch permits selection of either or both of two speakers. A tape output provides access to the signal ahead of the LOUDNESS and tone controls. A switched AC convenience outlet is provided.

An unusually complete instruction booklet accompanies the TA-12. Not only does it thoroughly cover the installation and operation of the unit, but it includes alignment instructions for the tuner, detailed performance specifications, and frequency-response and distortion curves. This is in sharp con-

trast to some equipment we have seen, for which a bare minimum of information is supplied to the purchaser.

The Solo II, like the other items in the Harman-Kardon line, employs printed circuitry to a great extent. The



Harman-Kardon Solo II, Model TA-12.

tuner and amplifier are on separate printed boards, with only the power supply located on a conventional chassis. This type of construction allows greater reproducibility of performance between units of the same type, and effects manu-

50-cps square wave, at 1 watt output.

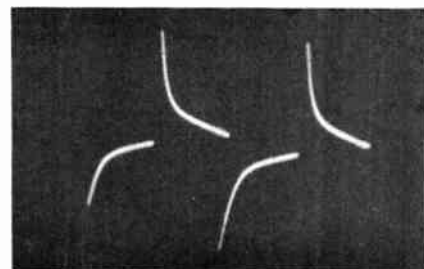

facturing economies which may result in the buyer getting more for his dollar.

Although the Solo II was used, listened to, and appraised as a whole, it was tested as though it were a separate tuner and amplifier. For all practical purposes this is the case, since Harman-Kardon sells separate tuners and amplifiers which are identical to the corresponding sections of the Solo II.

Amplifier Section

The power-amplifier section of the Solo II acquitted itself very well. As the curves show, the IM and 1,000-cps harmonic distortion are very low in the normal listening range under 5 w. The amplifier will deliver its rated 12 w down to below 30 cps, and will put out at least 10 w from 20 to 15,000 cps. This is, we feel, very acceptable performance for an amplifier in this price range. The 20-cps harmonic distortion does not fall to much below 1% at any power level, but this, again, is typical of low-priced amplifiers we have seen.

50 cps, bass control at 2:30 o'clock.

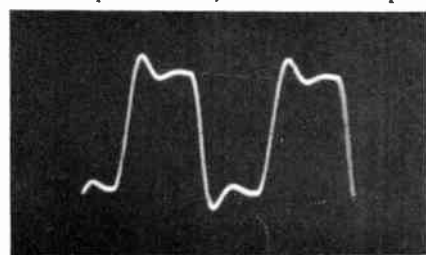
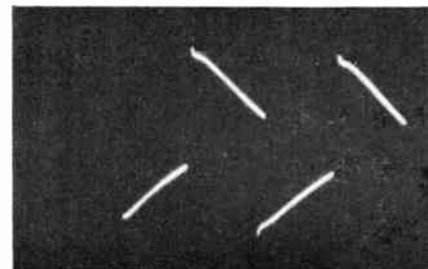

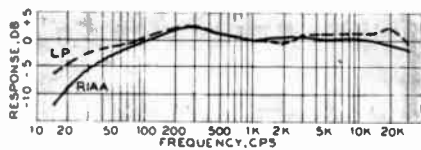

Equalization, second unit tested.

The stability of the amplifier is satisfactory. We were unable to make it oscillate under any capacitive load we tried. The 10-Kc square wave shows considerable ringing, but its amplitude decreases under capacitive loading. This suggests that there is no tendency for the amplifier to "take off" on its own at high frequencies. Maximum power out-

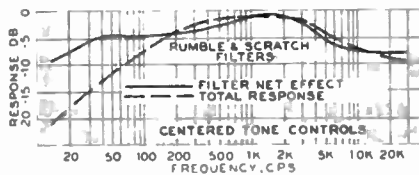

Rumble and scratch filters.

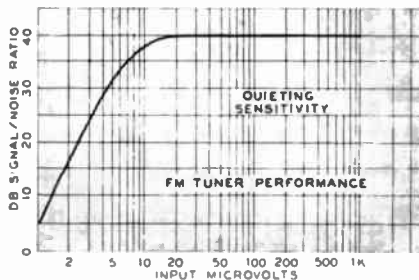

Tuner sensitivity.

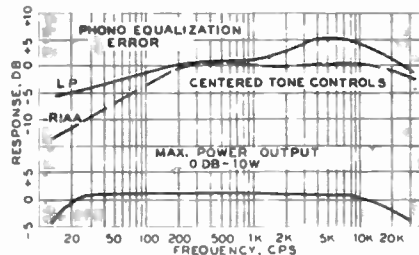

Equalization and amplifier response.

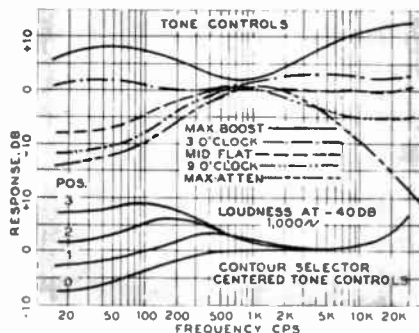

Tone and loudness-control curves.

put with a 3- μ fd capacitor across an 8-ohm load (to simulate the effect of an electrostatic speaker) was 2.5 w.

The damping factor, measured on the 8-ohm output terminals, was 6.3. Specifications list the DF as 5.

Going through the preamplifier, the hum levels were very low, except under open-circuit conditions on the PHONO

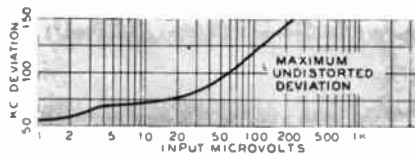

Maximum undistorted deviation.

input. Even in this case, the hum adjustment on the Solo II could be set to reduce hum to -54 db relative to 10 w, which is inaudible under practical conditions of use. With the input shorted (as it is effectively when using a low-impedance magnetic cartridge), the hum falls to -69 db.

The sensitivity of the amplifier is high. Only 0.64 v on the AUX input, or 5.2 mv on the PHONO input, at 1,000 cps, drives it to 10 w output. Crosstalk between inputs was too low to measure.

The first discrepancy we found between the published specifications of the Solo II and our measurements was in the tone controls. There was an appreciable loss of low-frequency response with the BASS tone control in the middle position. It was severe enough to make the unit sound thin in listening tests. The BASS control had to be advanced to its 2:30-o'clock position to obtain reasonably flat response. The 50-cps square-wave response illustrates this dramatically. Abrupt fall-off of the top of the square wave with centered tone controls indicated a loss of low-frequency response. The optimum appearance of the square-wave output was obtained at the same BASS-tone-control setting which produced the flattest response in our steady-state frequency-response measurements.

A second unit was tested, with substantially the same frequency-response characteristics.

The TA-12's specifications call for 0.5 db flatness from 15 to 30,000 cps. By proper tone-control adjustment this can be very nearly achieved, but the flat condition does not occur at indicated tone-control positions. Without instruments, it would be virtually impossible to obtain the advertised flat response. The amplifier power response is stated to be down less than 1 db from 12 w at 25 Kc, but our measurements indicate that it falls somewhat short of this figure. In fairness, it must be admitted that power measurements are difficult to perform with an accuracy of better than 1 db, particularly at high frequencies where considerable individual judgment must be exercised in determining the maximum "undistorted" power output.

The tone-control deficiencies affected the loudness-contour measurements. One can judge the true response by applying the necessary correction from the tone-control curves. The phono equalization was measured at the tape output, so was unaffected by the tone controls. The bass deficiency in the LP and RIAA character-

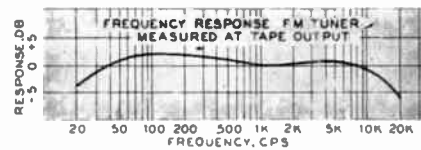

FM-tuner frequency response.

istics is apparently in the equalization circuits.

The rumble and scratch filters are completely ineffectual. They are so mild in their action, and affect such a wide range of frequencies, that it is hard to see why they have been included.

FM Tuner

The FM tuner section of the Solo II performed very well. It actually exceeded slightly the specified sensitivity (5 μ v for 30 db quieting); we measured 4.5 μ v. The ultimate quieting was 40 db, which is as good as one finds in any but the most expensive tuners, and it reaches this level at only 20 μ v.

We also measured the maximum undistorted frequency deviation as a function of signal strength, and have plotted this on the same co-ordinates as the quieting curve. We have coined the term "effective sensitivity" to denote the lowest signal strength at which the signal-to-noise ratio ("quieting") is 30 db, and at which a frequency deviation of 75 Kc can be accommodated without clipping or other gross distortion. This figure actually defines the lowest signal levels at which the receiver might be said to be useful in a home music system. If the sensitivity has been obtained by using narrow IF bandwidth, or by IF regeneration (which will cause distortion), this figure will reflect the fact. In the case of the Solo II, a 70-Kc deviation can be handled at as low as 4 μ v. Because of normal measurement errors involved in determining maximum undistorted deviation, we think a good case could be made for rating the effective sensitivity of the Solo II as 4.5 μ v. This is very good, especially for a low priced unit such as this.

The frequency response of the FM tuner is ± 2 db from 25 to 15,000 cps,

Amplification Tests

Reference level - 10 w

Input	Aux	Phono (RIAA)
Sensitivity	0.64 v	.0025 v
Crosstalk	-	Less than hum
Hum and Noise		
(Max. gain except where noted)		
Input shorted	-74 db	-69 db
Input Open	-74 db	-46 db
		(-54 db best adjustment)
Input shorted		
Ref gain*	-74 db	-51 db
Minimum Gain	-75 db	-

Note: hum balance control position different for each input.

*Aux A = 0 db } 1,000 cps
Phono A = 40 db }

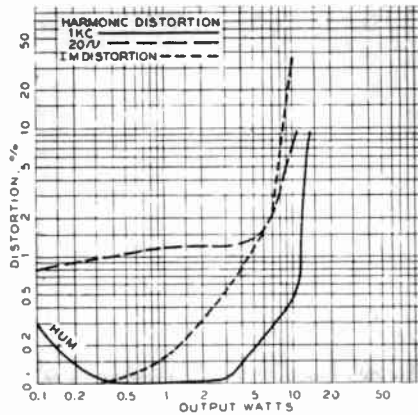

Amplifier distortion.

which is good, although not nearly so good as the specified $\frac{1}{2}$ db from 20 to 20,000 cps.

The IM distortion of the tuner is appreciably higher than that of some more expensive tuners we have tested, but much less than we have found on some competitively priced units. Although the distortion could not be called low, we consider it typical of what one can expect to find in an inexpensive tuner. Incidentally, it is necessary to tune the signal in quite critically to get the distortion this low; and the AFC system, though effective, does not help too much. A keen and critical ear is the best tuning indicator, other than a low-distortion signal generator and IM analyzer.

The warm-up drift was greater than that of many other low-priced tuners, but was reduced to reasonable proportions by the AFC, which is really a necessity. In any case, it is not necessary to re-tune the set after a station is selected.

AM Tuner

We did not perform any tests on the AM tuner. Except for a few high-priced

units, we have never heard an AM tuner that has any place in a high-fidelity system. This one, which is pleasant-sounding and sensitive enough for use in the metropolitan area without an outside antenna, is no better or worse than most. It is certainly acceptable for occasional listening to AM stations, and is a vast improvement over a table-model radio, but we did not find it suitable for use in the AM side of an AM-FM stereo broadcast, since its frequency response was so restricted compared to the FM channel.

General

The output tubes and filter capacitors are operated conservatively: tube dissipation is 92% of rated level under quiescent conditions, and 64% at full output; filter capacitors operate at 94% of rated voltage. Line leakage is low enough to eliminate the hazard of a shock: 0.75 ma. As a further, very desirable safety precaution, an interlock system prevents application of line voltage to the unit when the cover is removed.

Following our amplifier tests, and before the tuner tests were conducted, the tuner became inoperative because of a tube and resistor burning out. A second unit was obtained for the tuner tests (and to confirm our findings regarding the tone controls). This has been in service for some time, with no signs of distress. We have no reason to believe that the failure in the first unit was anything but a normal component failure, which need have no relation to the design of the equipment.

When the BASS tone control is set for flat response, rather than to its middle position, the listening quality of the Solo II is excellent. There are no unpleasant distortions, hum, or noise to

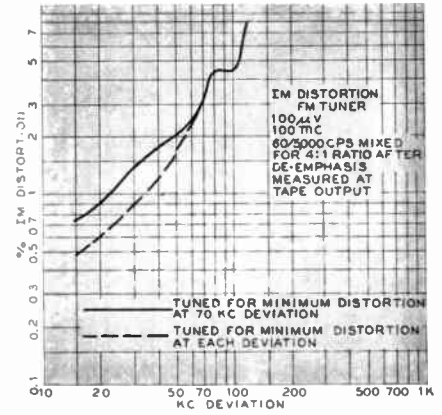

Tuner distortion.

distract the listener. It is easy to tune, and simple to operate in all respects. We have listened to it for hours on end, with a moderate-priced speaker system of good quality, and we feel that this very reasonably priced unit fully qualifies for the adjective, "high-fidelity."

Summary

The Harman-Kardon Solo II, Model TA-12, is a combination of a good-quality low-priced amplifier and a better-than-average low-priced tuner, which offers a lot of performance for the price. In most respects, we have found the manufacturer's specifications accurate. The low-frequency response of the amplifier is severely attenuated, however, and while it can be compensated for fairly well with the tone control, this leaves considerably less bass boost at the user's disposal than the amplifier's specifications indicate.

If this unit is judged by ear, rather than by instrument, it proves to be satisfactory for low- and medium-priced high-fidelity systems, even with the deficiencies noted.

Your AUDIOLAB TEST REPORTS on high-fidelity components

SARGENT-RAYMENT SR-570 POWER AMPLIFIER

The Sargent-Rayment Super Seventy (Model SR-570) is a basic power amplifier rated at 70 watts output. A pair of KT88 output tubes are used, in a tapped-screen connection. The amplifier is generally similar to a Mullard design which has achieved considerable popularity in England, except that the SR-570 is much more powerful.

The input stage is a low-noise EF86, followed by a 6SN7-GTB push-pull driver. A pair of GZ34 slow-heating rectifiers are paralleled in the power supply. The amplifier is constructed on an attractive off-white chassis with a protective cage over the tubes. Over-all dimensions are 7 in. high by $6\frac{3}{4}$ in. wide by 14 in. long, and it weighs $24\frac{1}{2}$

lbs. It contains an octal socket for supplying heater and plate power to a tuner or preamplifier. This amplifier is avail-

Sargent-Rayment SR-570 amplifier.

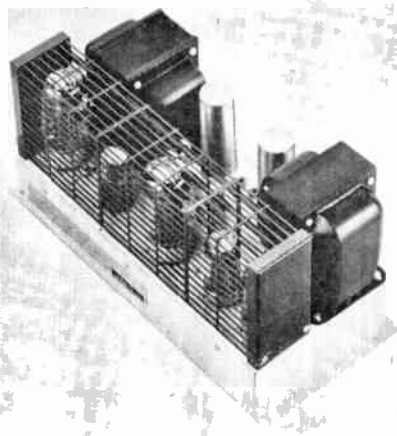

able with a Sargent-Rayment FM-AM tuner which is powered from it. It also has a gain control with a lock nut, an AC outlet, and a plate-current balancing adjustment for the output tubes. Meter jacks are provided to facilitate this operation.

The description of the SR-570 could well fit a number of the most expensive high-powered amplifiers on the market. Considering this, we were surprised to see the SR-570 priced at only \$119.50. At this price it is nearly competitive with some of the high-powered kit amplifiers.

Test Results

The low-level frequency response of the SR-570 is as flat as we have ever seen. Not the slightest deviation from flatness could be found from 20 to 10,000 cps, and it was down only 0.2 db at 20 Kc.

This is well within the normal errors of our test equipment.

We were able to drive it only to 62 w output before clipping of the output wave form was detected. This is only about 1 db down from the rated 70 w. It would put out over 50 w at 20 and 20,000 cps, which is a very respectable power. The 1,000-cps harmonic distortion was extremely low up to about 40 w output. In fact, it was well below 0.1% below this power level, which is also approaching the limitations of the test equipment. The 20-cps harmonic distortion stayed below 0.3% up to about 15 w, after which it rose to the 2% level at 30 w. The IM distortion increased slowly from 0.25% at very low levels to 0.5% at 15 w, and rose more rapidly to 2% at 75 w.

The greater power indications obtained from IM measurements indicate that the output-tube bias and/or plate voltage shifted appreciably at large steady-state outputs, but that with the transient wave forms of music the amplifier can deliver 75 w without undue distortion.

It is interesting to note that the 20-cps distortion was measured with the output-tube balance adjusted for minimum distortion as read on our distortion meter. This adjustment did not coincide with the balanced condition as determined with a meter connected to the jacks on the amplifier. When so balanced, the low-level distortion at 20 cps increased from about 0.2% to about 0.4%. This, of course, is still a low figure at this frequency, and the IM and 1,000-cps-distortion figures were not affected by this slight difference in balance conditions.

The response to 60-cps and 10-Kc square waves is shown in the accompanying photos. There is a low-amplitude ringing at about 150 Kc visible on the 10-Kc wave form. The overload trace, with input signal presented horizontally and the output vertically, shows only a slight kink in the middle and no tendency to collapse or otherwise behave badly.

We found that when driven to high outputs at low frequencies, there was a tendency for the amplifier to exhibit short bursts of very high-frequency oscillation on the output wave form. This

60-cps square wave.

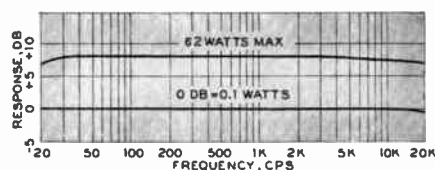
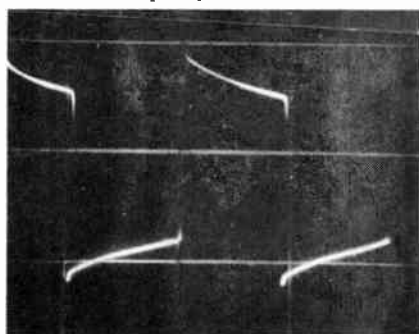

Frequency response at two levels. Reference for upper curve: 0 db = 10 w.

condition was quite rare when the output-tube balance was adjusted for minimum 20-cps distortion, but became much more pronounced when the metering jacks were used to balance the amplifier. A shunt capacitance of .03 μ fd on the 8-ohm output terminals would produce oscillation, and if the balance was not

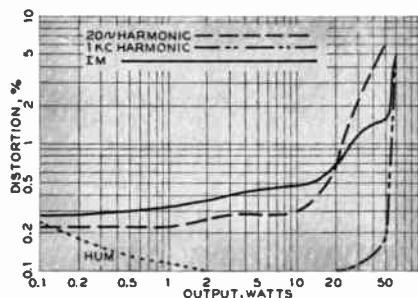

IM and harmonic distortion.

optimum, as little as .003 μ fd caused instability. The oscillation was also affected by the setting of the gain control, being worst at maximum gain.

We suspect that this high-frequency oscillation was caused by the proximity of the gain control and the 16-ohm output terminal, which are only a fraction

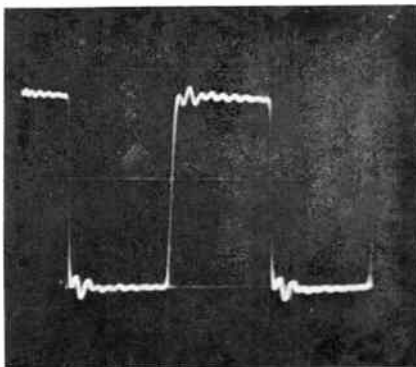

10-Kc square wave.

of an inch apart. The slight change in phase shift caused by placing a finger against the feedback resistor appears to make the amplifier stable.

The damping factor is rated at 15. Our measurements indicate a DF of 10. The amplifier is very sensitive, since only 0.2 v is needed to drive it to 10 w output. Hum is down 74 db from 10 w at all gain-control settings, which corresponds to 82.5 db down from 70 w (the manufacturer's literature states that it is down 90 db from 70 w). It is faintly audible in a moderately efficient speaker when one's ear is placed next to the speaker in a quiet room—in other

words, quite negligible. Power-line leakage current to the chassis was 0.59 ma.

As a check on the manner in which an amplifier might drive an electrostatic speaker, we connected a 3- μ fd capacitor across the 8-ohm output terminals and measured the maximum output voltage at 10 Kc. It was a little difficult to determine this output for the SR-570 amplifier since the output did not definitely limit or clip. The first signs of distortion became visible at 15 w, but 50 w could be developed without severe distortion. We can see no reason why this amplifier cannot be used with any electrostatic speaker system in a home installation.

The SR-570 is outstanding in the conservatism of operation of its tubes. The KT88's are loafing along at about 75% of rated dissipation. The two GZ34 rectifiers are also running very lightly, and the filter-capacitor ratings are never reached or exceeded, even during warm-up, because of the use of slow-heating rectifiers (actual filter operating voltage is 95% of the rated value). The tubes are mounted well away from the filter capacitors and are well ventilated. One would expect this amplifier to deliver trouble-free service for extended periods.

In listening tests, the SR-570 proved to be as clean sounding as its measurements would indicate, and there is little we can say except that we could find no criticism of its performance as a result of our tests.

Summary

The Sargent-Raymont SR-570 Super Seventy is a well-built, very conservatively operated amplifier, capable of delivering well over 60 w over the audio range and over 50 w at the upper and lower extremes of frequency. Its middle-frequency distortion is unusually low, less than 0.1% up to 40 w output, and its over-all performance makes it suitable for use in a high-quality system using the lowest-efficiency speaker systems and/or electrostatic speakers. We believe that a slight rearrangement of the input and output terminals would eliminate the tendency towards high-frequency oscillation under certain conditions of drive and loading.

At its price of \$119.50, the SR-570 is a top value.

1-Kc overload, 90 watts.

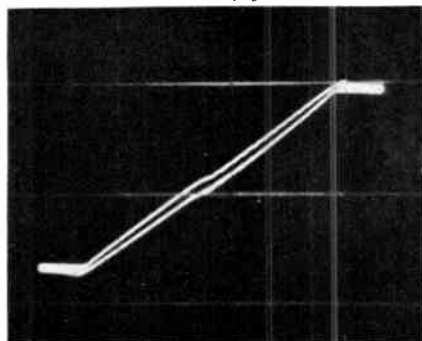



**BUILD
YOUR
OWN JBL
ACOUSTICAL
ENCLOSURE
FROM
DETAILED
PRODUCTION
PRINTS**

get the greatest thrill

high fidelity can give you...



THE HARKNESS Model C40



Model C34



full range, rich, clean sound from precision JBL Signature loudspeakers mounted in an acoustical enclosure you make with your own hands. Reward your painstaking craftsmanship with speakers designed for the perfectionist. JBL Signature units, such as the Model D130, are acknowledged by foremost authorities to be the finest made. The D130 is the only 15" extended range speaker made with a 4" voice coil. It is unsurpassed in efficiency and transient-handling ability. The JBL Model 175DLH gives you smooth, crisp reproduction of frequencies above 1200 cps. The 175DLH is equipped with an acoustical lens, an exclusive JBL development, for even distribution of highs over a 90° solid angle. Any speaker, if it is to give you accurate bass reproduction, must be mounted in a properly engineered acoustical enclosure.

BUILD A JBL BACK-LOADED FOLDED HORN

Designed specifically for the JBL D130, the JBL back-loaded folded horn is probably the most widely-used enclosure of its type ever manufactured. The cabinet is relatively small—less than 40" in its greatest dimension—and yet, ingeniously folded within, is an exponentially tapered horn path with an effective length of six feet. The horn adds an octave of accurate, clean, deep down bass. There are two versions of the horn: Model C34 stands vertically and may be placed in a corner, although corner placement is not required. Model C40, the Harkness, is a low-boy folded horn that is independent of wall or corner for proper functioning. Prints are designed for direct, simple, clear instruction, and time-saving construction. Cost is three dollars per set.

USE THIS FORM TO ORDER YOUR PLANS

Now you can build this most popular JBL enclosure from detailed production prints which include a complete list of materials, all dimensions, and instructions for assembly.



JAMES B. LANSING SOUND, INC.
3249 Casitas Avenue, Los Angeles 39, California
Gentlemen:

Enclosed find \$ _____ for

_____ Model C34 Production Prints @ \$3.00 per set.
_____ Model C40 Production Prints @ \$3.00 per set.

Please print clearly or type your name and complete address:

Name _____
Address _____

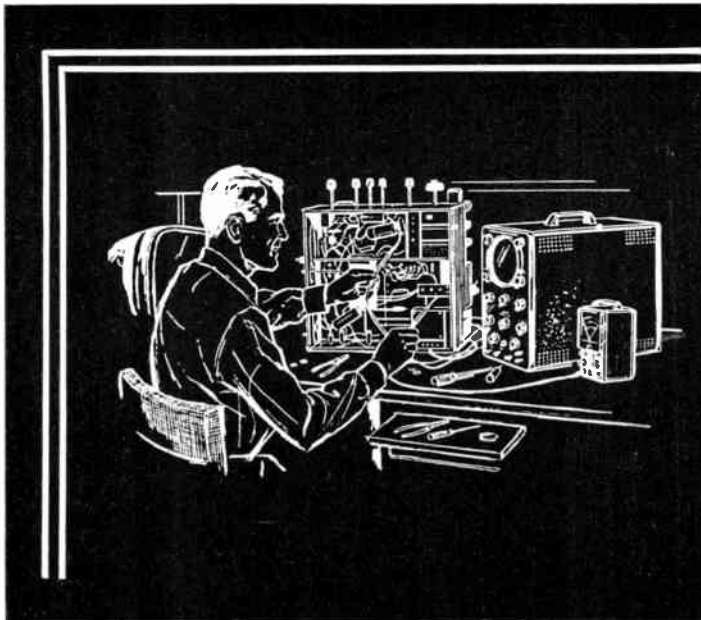

USING TEST INSTRUMENTS

by Joseph Marshall

Signal Generators, Part II

A CONSIDERABLE number of signal or test generators are available both in kit form and factory wired at prices ranging from around \$20 upward. Although there are some variations in circuitry, in frequency range covered, in the type of dial mechanism and dial calibrations, and in other minor respects, the general features of modern signal generators are fairly standard.

Almost all signal generators provide continuous coverage of the frequency range from around 150 Kc to 110 Mc in from five to eight tuning bands. Some cover this range on fundamentals—that is, the basic or primary resonant frequency of the oscillator circuit. This is advantageous in some degree from the point of view of avoiding errors and confusion. Unlike sine-wave audio generators, however, which have very little harmonic content, radio-frequency generators have high harmonic content and, as we shall see later, such harmonics may be quite useful all the way up to the twenty-fifth and even higher in some applications. Therefore, signal generators are useful far above their highest fundamental frequency range. In fact, in most generators the highest calibrated band (in the region between 30 and 450 Mc) usually is the second harmonic of the next lower fundamental band.

In the high-fidelity field, a signal generator is required for testing and adjusting AM and FM tuners. The most useful frequencies for these purposes are:

1) the region of 455 Kc, for the intermediate-frequency amplifiers of AM tuners; 2) 550 to 1,600 Kc, for adjusting and testing the front ends and overall performance of AM tuners; 3) the region of 9 to 11 Mc, for intermediate frequency amplifiers of FM tuners; and 4) 88 to 110 Mc, for the front-end and over-all adjustment of FM tuners.

The output requirements of signal generators for such purposes are not very critical. Most available units have a maximum output of approximately 0.1 v (100,000 μ v), and this is usually sufficient for testing and alignment purposes. The minimum signal available at the output terminals is seldom less than 5 or 10 μ v; but there is no great need in high-fidelity servicing for extremely low output levels and, fortunately, as we shall see, there are ways of obtaining a much lower signal when that becomes desirable or necessary.

Most signal generators provide for attenuating the output signal in two steps: first, there is a step or "coarse" attenuator, operated with a rotary switch which reduces the output level in steps of approximately 20 db—the second step gives 1/10th the voltage output of the first step; the third 1/100th the first-step output; and so on. In addition there is a continuous or "fine" control consisting of a potentiometer which permits continuous adjustment of the output on any of the several steps. Sometimes these controls are calibrated so that it is pos-

sible to get a rough idea of the output voltage from the position of the indicators on the control knobs. Meters for reading the output voltage are not usually found on inexpensive instruments; this is not much of a handicap for routine adjustment and testing, although a meter is very useful for making gain or sensitivity measurements.

In almost all modern instruments the output is obtained through a coaxial terminal—usually a microphone connector—so that a shielded cable can be used to reduce radiation. Incidentally, it is not advisable to shorten or lengthen the cables that come with a given generator. They are usually of a length calculated to minimize standing-wave effects at the higher frequencies, and any substantial change may result in a considerable difference in output level on the uppermost band or two.

The accuracy of a signal generator is a function of the stability of the oscillator, the accuracy of the dial marking, the mechanical stability of the dial mechanism, and the accuracy of calibration of each individual instrument. In the category of instruments we are discussing, the accuracy of setting by dial calibration is of the order of 1.5 to 2%, assuming reasonably accurate calibration of the individual instrument. However, higher accuracy can be achieved with even the simplest generator when it is needed, as we shall see, by direct comparison with signals from broadcast stations.

Modern generators are more stable than older ones. The costlier units often have regulated power supplies to prevent drifting with changes in line voltage. It will be found that in modern generators the absence of voltage regulation is not serious (at least for test purposes). The voltage of power lines is more stable today than it used to be; and in any

case, it often happens that a change in line voltage of 10 v on either side of the standard 117 v will produce a frequency change that is a small fraction of 1%.

More serious is drift caused by temperature changes within the generator. There is almost invariably a pretty considerable drift in the first half-hour after a generator has been turned on. For that reason, it is a good idea to let a generator warm up at least a half hour before it is used for any purpose, such as alignment, in which accuracy and stability of frequency are important. In the next part we will go into methods of checking calibration and drift.

It is convenient to be able to have the RF signal modulated by an audio frequency signal. Consequently, every modern signal generator contains an audio generator. This permits a choice of an unmodulated RF signal, a modulated RF signal, and in most cases, an audio signal alone. It is usually possible to adjust the percentage of modulation from 0% to 50%, by means of a panel control which varies the audio voltage delivered by the modulator to the RF oscillator or buffer.

An approximate calibration of the percentage of modulation is helpful or, at least, some indication of the point at which 30% modulation is obtained. The sensitivity of receivers is specified in terms of the input RF voltage required to obtain an output of $\frac{1}{2}$ w of a 400-cps tone which modulates the carrier 30%. A generator which makes such a signal available, and which also provides some means of measuring its own output voltage, thereby provides a means of measuring or checking receiver sensitivity. This is the reason also why the audio tone supplied by most generators is at 400 cps.

Usually, only a 400-cps tone is provided. There are more elaborate and expensive signal generators which contain a variable audio oscillator covering a

far wider range, in some cases the entire audio range from 20 to 20,000 cps. For hi-fi servicing or testing it is preferable to have a separate audio generator, and if kit-type instruments are purchased the two instruments will cost less than a single unit that combines them. An audio generator will be used far more in high-fidelity testing than an RF generator, and a separate audio generator is likely to have superior characteristics.

Most signal generators permit the injection of an external audio signal to modulate the RF; hence a separate audio generator will serve nearly as well as an internal generator when several audio modulation frequencies are needed. From 3 to 10 v of external audio are required to modulate an RF generator to 30%; and this voltage is readily available from the many audio generators on the market.

External audio signals are usually injected through the same jacks or binding posts which serve to bring out the internal audio. The modulation control affects the injected signal as well as the internal audio. An instruction booklet of specifications usually shows the external audio voltage required to obtain 30% RF modulation.

The ability to inject a variable external audio voltage is very desirable in a generator used for testing high-fidelity equipment. It permits, for example, the running of an over-all response curve and simple adjustment of whistle filters.

In almost all cases the internal 400-cps audio is available separately and can be used for trouble shooting the audio portions of tuners and radios. In this mode of operation the modulation control becomes the audio output-level control.

Because the audio generators employed in signal generators are of the simplest type, the wave form of the audio output is by no means as pure as that of audio generators. In the latter

ERRATA

Dynaco Inc. has brought to our attention several errors in the schematic diagram for the Dynakit Preamplifier ["The Dynakit Preamplifier," an AUDIOCRAFT kit report; March 1958, p. 17], and also some manufacturer's changes in connections for the "Special" input circuit. Please mark back copies accordingly:

A permanent connection should be shown between selector switch wafer B and the small section of wafer A.

The arrow on selector switch terminal D4 should be extended to make permanent contact with wafer D.

The junction of the 47-K resistor and the .002- μ fd capacitor, below the TREBLE tone control, should *not* be connected to the junction of the lower end of the BASS tone control and the lower .0075- μ fd capacitor; instead, it should be connected to the junction of the upper end of the BASS tone control and the upper .0075- μ fd capacitor.

In the note, "Connections at D for Special Input," the RIAA instructions are correct as printed. New connections for MICROPHONE and TAPE HEAD inputs are:

Microphone—Strap 33 μ fd from A to C. Strap B to D.

Tape Head—Strap 33 μ fd from A to C. Strap 18 K from B to C. Strap No. 3 to No. 6.

the distortion is usually no more than 1%; the distortion of the simple audio oscillators used in signal generators is likely to be considerably higher. Therefore, in the hi-fi field the audio signal of a signal generator is useful mostly for signal tracing and trouble shooting, and is of limited usefulness in tracking distortion except when the fault is so serious that the wave-form distortion is extremely high. Thus, the audio output of a signal generator is in no sense a substitute for an audio generator.

The Eico (left) and Heath RF signal generators provide a wide coverage of frequencies most needed in alignment operations. These units are available in kit form for home construction.



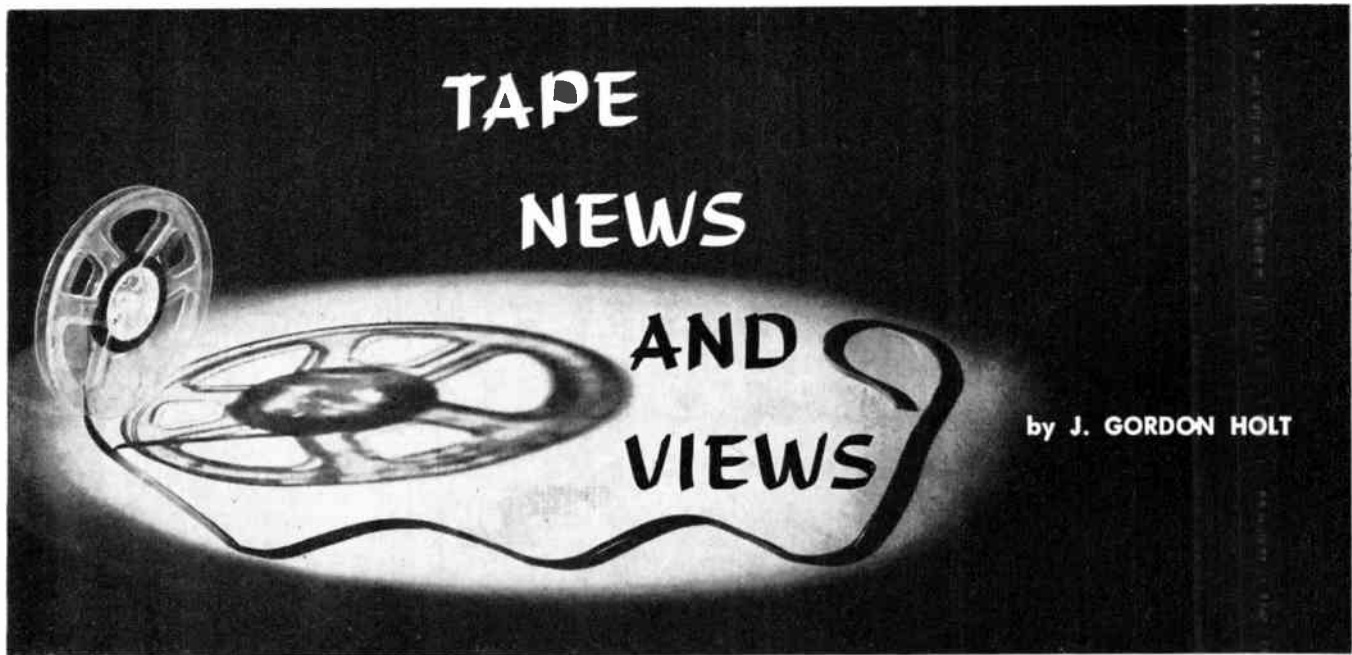

Distortion: fact or fiction?

IT WAS ORIGINALLY my intent to devote this month's column to a bold exposé of the distortion menace in magnetic recording. To this end, I devoted some time to conducting a series of tests on various well-known brands of tape, in an effort to confirm or refute the assertion (not mine) that some tapes have inherently lower intermodulation distortion than do others. Well, this is true. At least I proved it to my own satisfaction, anyway. But what I *didn't* expect to find was that there is evidently little correlation between *measured* tape IM distortion and *audible* tape IM. As a matter of fact, my informal tests seemed to indicate that, as far as magnetic recording is concerned, the old reliable IM measurement isn't worth much.

Last month we saw how and why ultrasonic bias affects signal-to-noise ratio and high-frequency response. It is common knowledge that it affects distortion as well, but how much it affects

Fig. 1. Procedure for testing tape IM.

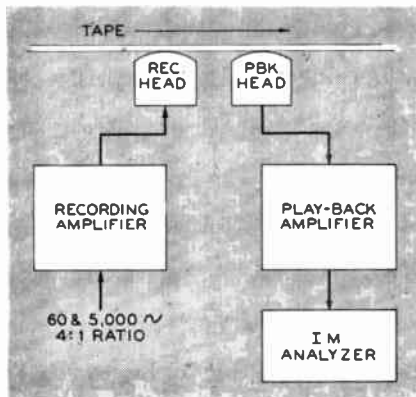

distortion is less commonly known. Let's consider for a moment the heretical idea that tape has set high fidelity back twenty years. This is good for a heated discussion in any circle of recordists, because tape can be made to have wide frequency range, linear response, low noise, and supposedly low distortion. It does not seem that 1% or 2% harmonic distortion (the figures which are most often quoted for tape at high recording levels) is too much out of line; after all, many amplifiers are rated for maximum power output at this distortion level, and there are still some people who cling doggedly to the view that the human ear can't perceive 1% harmonic distortion anyway, so why worry about it?

But 10% intermodulation distortion is another matter altogether. There are very few persons who would seriously deny the audibility of 10% IM to anyone with normal hearing acuity; yet in digging into the literature on tape distortion I find that figures of 10% IM are not at all uncommon, and that IM levels of 20% and higher aren't too unusual either. Such figures, mind you, are supposedly produced at recording levels that are *below* what is considered the overload point of the tape.

These surprising figures lead to the question, how hi-fi is tape?

Anyone with an intermodulation analyzer producing 60 and 5,000 cps (or thereabouts) can measure the IM from his tapes by means of the hookup shown in Fig. 1. The arrangement shown is for connection to a recorder having a separate playback head with its own play-

back preamp, but the test procedure may be applied equally well with a little more tedium to any tape recorder. The measurements thus obtained can be used to show that there is a definite optimum value of bias current which will produce minimum measured distortion, and that this optimum value is just slightly higher than that which gives maximum output from the tape (Fig. 2). If you have a harmonic distortion analyzer lying

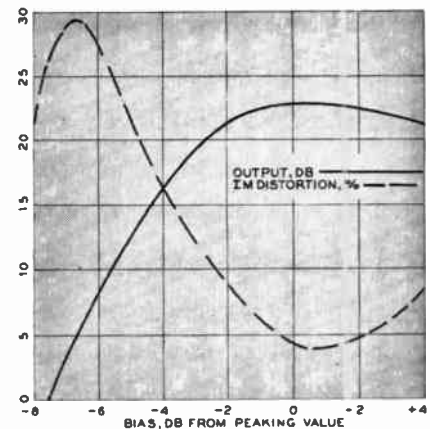

Fig. 2. Effect of bias on distortion.

around too, you may also be able to confirm the fact that harmonic distortion follows measured IM, reaching its minimum value at the same bias current, and increasing progressively but much less rapidly on either side of this optimum bias setting.

Testing at several levels below and above the tape-overload point will show that measured IM starts to get quite severe at recording levels which are well below the normal tape-overload point. Checking for *minimum obtainable* IM will, however, reveal some astonishing distortion figures.

I first ran across a statement to this effect in Herman Bursteir's and Henry

C. Pollack's comprehensive book, *Elements of Tape Recorder Circuits*, and was not too surprised because I had long ago noticed that overloaded tapes became muddy before becoming strident. What *did* shake me up, though, was a table of "typical" IM figures that Messrs. Burstein and Pollack had compiled to support their statement. They looked utterly impossible, so I decided to try some testing on my own. They proved to be correct.

I collected four samples each of five types of tape, picking each sample from a different batch of tape. Using the setup in Fig. 1, each sample was run through an Ampex 600 recorder (7½ ips) and was biased for minimum measured IM with the usual 4:1 test-signal ratio (measured on playback). The bias setting was then checked by more conventional means (using a 500-cps tone), and if both bias-control settings coincided, the IM tests were run at that setting. If they did not, a setting midway between the two was used for the tests. Two readings were taken on each roll of tape, at zero and -10 db playback levels, and the mean of the readings for each tape type was taken as the distortion from that kind of tape.

Here are the results: brands A and B gave mean values of 6.5% IM at zero level and 3.5% at -10 db. Brand C gave 10% at zero and 4% at -10 db, brand D gave 11% at zero level and 5.5% at -10 db, and brand E tape gave—hold your hat—20% IM at zero level and 4% at -10 db. Dropping the level lower than -10 db did not reduce the IM readings significantly in any instance.

These results were reproducible on several different occasions, but it should be emphasized that they are only comparative. The test procedure may not have been beyond reproach, and it is possible that the same tapes, tested in the same way at 15 ips or on another recorder, might give different readings. But the most significant thing, as far as I'm concerned, is that the measurements did not seem to coincide with the *sound* from these tapes. My ears tell me that brand E is *not* muddier-sounding than brand D, but that, if anything, brand D actually *sounds* less clean on musical material than does brand E. Similarly, I have observed that brand C and brand E are almost indistinguishable from one another when reproducing music, and that brands A and B are audibly cleaner than are any of the others. Finally, 3.5% IM seems much too high as a minimum IM value for brands A and B; their recordings simply don't sound that bad to me. And as for 20% for brand E, this seems way out of line.

Frankly, I have to conclude that either IM tests are not valid for tape, or that we need a new set of standards for evaluating tape IM test results. The *compara-*

Continued on page 47



Robert Bell, assembly foreman at AR

FACTORY INSPECTION for AR SPEAKERS

A stethoscope is used in the production testing of every Acoustic Research speaker system, to detect possible air leaks in the cabinet. The speaker is driven by a twenty-cycle signal, and if there are any leaks a characteristic rushing sound can be picked up at the trouble spot.

This test procedure is necessary because the sealed-in air of an **acoustic suspension enclosure** is a basic working element of the speaker system. In conventional speakers the cone works against the springy stiffness of its mechanical suspensions; in AR speakers this stiffness is missing, and the cone works instead against the springiness of the enclosed air-cushion. Like the new air-suspension cars, the speaker literally rides on air.

The patented AR system requires a small cabinet, so that the enclosed air will be springy enough. And since the air-cushion does not bind or reach its elastic limit as do mechanical springs, the AR-1 has created new industry standards in the low-distortion reproduction of music. The "bookshelf" size of AR enclosures is associated with an absolute advance rather than a compromise in speaker bass performance.

AR speakers have been adopted as reference standards, as test instruments for acoustical laboratories, and as monitors in recording and broadcast studios. Their most important application, however, has been in the natural reproduction of music for the home.

The AR-1 and AR-2, two-way speaker systems complete with enclosures, are \$185 and \$96 respectively in either mahogany or birch. Walnut or cherry is slightly higher and unfinished fir is slightly lower in price.

Literature is available on request.

ACOUSTIC RESEARCH, INC. 24 Thorndike St., Cambridge 41, Mass.

What's to blame when ears and test instruments disagree?

by NORMAN H. CROWHURST



THERE seems to be a continuous conflict between people who prefer to believe their ears and those who have absolute faith in specifications. Since the ultimate purpose of hi-fi equipment is to provide listening pleasure, I must confess some sympathy with those who at least allow their ears to speak to them. At the same time, when one's ears appear to contradict the findings of test equipment, there must be a good reason somewhere.

A little while ago a group of us were invited to a man's house to hear a home-constructed transformerless amplifier. This particular version employed goodness knows how many tubes, working in push-pull parallel, to enable it to match a 16-ohm loudspeaker system. I think he used it also as an auxiliary house-heating system. He had about 80 db of feedback, in multiple loops, he assured us, and the distortion was better than 0.5% at full power, and considerably below this at lower levels. A wonderful amplifier! He also had his own special loudspeaker system, which probably *was* good.

One claim he made for the amplifier was logically true: that it "delivered the goods" right down to 10 cps, or some such figure, still with better than 0.5% distortion. Imbued with the excellence of these figures, he was convinced that nothing he had ever heard came anywhere near it for quality. Along with the rest of the group, I sat and listened for a whole evening to his choice of records to demonstrate the system's excellence. Some were familiar and some were not, naturally.

I wanted to come right out and say, with my usual candor, "I think it stinks."

Instead, I thought by so doing I might prejudice the opinions of others. It would be more valuable to compare notes *after* listening. Apparently they all felt the same, because no comment was made by anyone until afterward. Then we found we all agreed.

None of us had any doubts that the amplifier did what he said it did according to measurements. But all of us had heard better, much better. It sounded rough. The frequency response of the system was probably as smooth as the man said it was. We could not identify any of the more familiar forms of IM distortion. But it had a rough sound that seemed spread all over the spectrum, not associated with any particular frequency range.

On the other side of the ledger, I get letters every so often from people who have amplifiers with little or no feedback, sometimes quite old ones. They tell me their friends say these amplifiers sound "cleaner" than the more modern designs which have large amounts of feedback. Some even take the extreme view that feedback is good only on paper; that in practice, you are better off without it.

It must be conceded, of course, that feedback really does something, not only on paper. Apart from its use in improving the precision with which an ICBM can be aimed at (or from) Moscow, it can make pentode output circuits function as well as triodes, and a lot more economically. Some may contest this point, and I simply ask them to try an A-B test, using a well-designed unit of each type.

But my early lessons in economics make me immediately distrustful of any-

one who promises me something for nothing, whether it's a merchandising program or a matter of amplifier design. When people start using feedback to knock down distortion to figures far below audibility, and at the same time to achieve frequency response from geographical regions on out to those used only by insects, none of which can possibly make high fidelity *sound better*, I get an uncomfortable feeling that something has to suffer. People who trust their ears confirm this from purely physiological experience. But what happens, and why don't the measurements show it?

Unfortunately, none of the tests used employs test signals that resemble typical program material. Sine-wave tests can be run at various levels to show that the amplifier has plenty of dynamic range—at least to one frequency at a time. Intermodulation tests show that the by-products are inaudible, when only two frequencies are handled at once. Square-wave tests investigate the performance on a "transient" wave form that is repeated at very unrealistic rapidity. Tone-burst tests may come a little nearer to detecting practical flaws, but they are very little used as yet. But what can happen that these tests do not show? Plenty.

Suppose we have an amplifier that, without feedback, would give 5% second- and 3% third-harmonic distortion. With 20 db of feedback, these are reduced to 0.5% and .03%, respectively. But the feedback also adds, out of phase, nearly 5% second and 3% third at the input. So the forward part of the amplifier will produce 5% of 5% of 4th, or 0.25%; 5% of 3% and 3% of 5% of



6th, or 0.3%; and 3% of 3% of 9th, or .09%. Admittedly these too will be subject to feedback, and so will be reduced to .025%, .03%, and .009%, respectively. They do not show up on measurement, because they are too small.

But two factors make the picture a little different with an amplifier working on actual program material: there comes a point at which feedback does not reduce the higher components, at the upper limit of the over-all frequency response (usually between 100 Kc and several megacycles). At best, the amplifier still has its full amplification without feedback. At worst—and this often happens—there is positive feedback, and the amplifier is producing its full quota of distortion to these frequency components.

Testing with just one sine wave, or even with two, the number of by-products of distortion that can fall in this turnover frequency range is only one or two. But now the second factor: when handling program material with many component frequencies, the number of possible by-products falling in this frequency range multiplies at a high-power exponential rate, depending on the order by which the distortion is multiplied.

Many thousands of distortion by-products, of very small magnitude individually, will appear in this critical range, producing a composite that can now generate further distortion, because of the uncontrolled nonlinear distortion at this point. This further distortion will now produce sum and difference components. And many of the difference components will be down in the audio range again. Of course, feedback will be available to reduce them once more.

These components are very randomly related to the original frequencies, however, quite unlike the usual first-order intermodulation products. Consequently they will fall within areas of the frequency spectrum at which the ear will be more acutely sensitive to them, being momentarily free of program frequencies.

Wherever these occur momentarily, such remote-order distortion products can become audible as a general roughness or "gritty" effect.

This effect can occur because too much feedback is pushed to too high a frequency. But surely there is no harm in going well down? Distortion products do not go down to subaudio frequencies, do they?

Maybe not, but local distortion, internal to the amplifier, can produce subaudio components of considerable magnitude. Remember that the effect of a curvature which produces second harmonic, or any even-order distortion, also produces a DC term which may be regarded, under steady test conditions, as a shifting of the tube's operating point

Continued on page 44



For the stereo perfectionist

The new ESL GYRO/JEWEL

- ▶ No longer need perfectionists compromise with inferior or makeshift stereo pickups. From the distinguished laboratories which achieved the world-famed ESL Concert Series and C-60 Series cartridges comes a new milestone in audio progress: the ESL GYRO/JEWEL, the stereo cartridge of tomorrow.
- ▶ If you are technically minded, you will be pleased to learn that the triumphant design of the ESL GYRO/JEWEL is based upon two of ESL's patented, subminiature D'Arsonval movements, coupled to the stylus shoe by ESL's unique new Gyro/Jewel.
- ▶ You will be pleased, also, to learn that the ESL GYRO/JEWEL excels in vertical compliance (5×10^{-6} cm/dyne), lateral compliance (5×10^{-6} cm/dyne), dynamic mass (.003 gms), channel separation (20 to 25 db), and frequency response (± 3 db from 30 to 15,000 cps, with response extending well beyond 20 kc).
- ▶ But only through actual listening can you realize the vast superiority of the ESL GYRO/JEWEL. Compare it at your audio dealer's, and you'll want to own this stereo cartridge that's years ahead. Only \$85; write for details.



FOR LISTENING AT ITS BEST

Electro-Sonic Laboratories, Inc.

Dept. C • 35-54 Thirty-sixth Street • Long Island City 6, N.Y.

DYNAKIT PREAMPLIFIER

Acclaimed as the finest available
—by laboratory test or critical listening—in money-saving kit form!

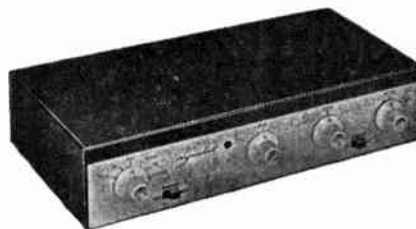

This handsome new control unit gives crystal clear, noise-free reproduction from any modern program source. Its unique all feed back design by David Hafler sets a new standard of preamplifier performance. The design of the Dynakit preamplifier is a synthesis of outstanding features which produce smoother, more natural sound.

only **\$34.95** net
(slightly higher in West)

NEW! Dynakit Stereo Control Kit

ADDS COMPLETE STEREO CONTROL FUNCTIONS TO TWO PRE-AMPLIFIERS FOR ONLY **\$12.95**

DATA SHEET AVAILABLE ON REQUEST

★ UNEQUALLED PERFORMANCE

Actually less than .1% distortion under all normal operating conditions. Response ± 5 db 6 cps to over 60 kc. Distortion and response unaffected by settings of volume control. Superlative square wave performance, and complete damping on any pulse or transient test.

★ EASIEST ASSEMBLY

All critical parts supplied factory-mounted on XXXP printed circuit board. Eyeleted construction prevents damage to printed wiring. This type of construction cuts wiring time by 50% and eliminates errors of assembly. Open simplified layout offers complete accessibility to all parts.

★ LOWEST NOISE

Integral dc heater supply plus low noise components and circuitry bring noise to less than 3 microvolt equivalent noise input on RIAA phono position. This is better than 70 db below level of 10 millivolt magnetic cartridge.

★ FINEST PARTS

1% components in equalization circuits to insure accurate compensation of recording characteristics. Long life electrolytic capacitors and other premium grade components for long trouble-free service.

★ HIGH FLEXIBILITY

Six inputs with option of extra phono, tape head, or mike input. Four AC outlets. Controls include tape AB monitor switch, loudness with disabling switch, full range feedback tone controls. Takes power from Dynakit, Heathkit, or any amplifier with octal power socket.

★ OUTSTANDING APPEARANCE

Choice of bone white or charcoal brown decorator colors to blend with any decor. Finished in indestructible vinyl coating with solid brass escutcheon.

Descriptive brochure available on request. Pot. Pending

DYNACO INC. 617 No. 41st St., Phila. 4, Pa.

Export Division:
25 Warren St., New York 7, N.Y.

Sound-Fanciers' Guide

by R. D. Darrell

SINCE I've nothing good to say as yet about the first stereo discs, or, more accurately, about their sonic and dimensional qualities as reproduced by one of the first, relatively low-cost, ceramic stereo cartridges, I want to beg off reporting on them for the time being. Later, when I can either confirm or disprove my initial impressions of excessive channel blending and its consequent dilution of the stereo effect by listening tests with a wider variety of program materials and pickup types than those available to me at the present moment, I hope to emerge from my present state of Missourian dubiety.

A wealth of more immediately rewarding releases, in both conventional-LP and stereo-tape form, has been piling up to demand one of this column's semi-annual "house cleanings" in which a maximum of audiophile specialties are surveyed with a minimum of generalized discussion. The latter would be superfluous this month in any case, since most of the works currently on hand fall into familiar categories, and among them there are a considerable number of belatedly received stereo-tape versions of recorded performances previously reviewed in single-channel editions. Yet, although I shan't dwell at any length on the differences between the two mediums, I want to stress once again the purely educational value of listening carefully to just what, and how much, stereophony can add to a recording previously known or simultaneously A-B'd in its monophonic version. Often stereo seems well worth the extra cost and augmented home-equipment facilities; sometimes it doesn't. In either case the decision must be a personal one, determined as much by the nature of the program materials and the individual listener's sonic tastes as by specific technological distinctions.

Fanfarish and Percussive

Recommended with only mild reservations to the connoisseur of brass timbres are the LP programs, *Tower Music* (Pezel, Reicha, et al.) with the Chamber Brass Ensemble on Golden Crest CR 4008 and *Around the Horn* (Mozart's Third Horn Concerto, a Haydn Trio, and



miscellaneous solo pieces) with Joseph Eger on RCA Victor LM 2146. The former is particularly interesting for its invigorating seventeenth- and eighteenth-century music; the latter, for the virtuosity of its soloist and his illuminating commentary, with illustrative examples, on the French horn's history, development, and capabilities. My quibbles are only that historically correct cornets or *Zinken* were not used in the Pezel sonatas, and that the close miking and dry acoustics, for all their keen-edged brilliance, give scant notion of the old-time *Stadtpfeiffer* ensemble's distant-tower-top and nur-of-doors atmosphere; on the horn disc too many trifling transcriptions are included, and Eger himself, while a worthy successor to Dennis Brain as a technician, still has much to learn in interpretative — especially Mozartear — subtlety and authority.

Even more exciting sonically are Fennell's Eastman Symphony Wind and Percussion Ensemble's belated stereo tapings of *Ruffles and Flourishes* and Sousa *Marching Along* programs on Mercury

MS 5-13 and MWS 5-14 respectively. Dazzling as was the LP version of the former (MG 50111, reviewed here in January 1957), the tape is indescribably more sensational and the choice of marked channel separation between the brass (right) and drums (left) is particularly effective in achieving a maximum of sparkling clarity while still maintaining the breezy spaciousness unique to stereo. The properly more blended Sousa marches, however, strike me as less extraordinary, partly because of the lack of variety in their unremittingly slam-bang performances, partly since the recording itself either is older (it was originally LP'd as MG 50105 in early 1956) or dryer.

Also extremely dry, for all its sizzling crispness, is *Conflict: A Study in High-Fidelity Percussion* by the Phil Kraus Ensemble on Golden Crest CR 4004, but it has a fascinating diversity of transient-rich clatter (including the Colgrass suite, *Three Brothers*, previously done in the warmer *Breaking the Sound Barrier* Urania stereo taping), and you'll be well advised to heed the special warning about not letting the low-level start of Douglas Allen's title piece fool you into setting your volume control so high that the later climaxes are likely to blow either your window or speaker cone right out of their moorings! More "open" in quality, although there still is little reverberation, is the Ninth Regiment Bagpipe Band's *Bagpipes and Drums* on Audio Fidelity AFLP 1857, one of the best of the pipe-and-percussion recorded programs to date. But, although its mostly quick-march materials are better varied in performance styles than usual, I find despite whatever traces of well diluted Scots blood may run in my veins that, while a little bagpiping can be tremendously exciting for me, my enthusiasm tends to drain out long before a second LP side is completed.

Twangy and Tangy

It was with some relief that I switched over to a batch of guitar and harp recordings, starting off with two tapes of the exuberant *flamenco* improvisations by Sabicas, solo in Elektra (via Livingston) EL 7-4 BN, paired with Mario

Escudero in Montilla FMT 1001. Both are first-rate, but the latter program is more varied musically and its duos profit more markedly by stereo potentialities. Still better varied, less strenuously demanding, and more poetic is Laurindo Almeida's LP of *Duets with the Spanish Guitar* (Capitol PAO 8406), in which the guitar piquancies share honors with Martin Ruderman's graceful fluting and Salli Terri's really enchanting alto voice in a Brazilian and French miscellaneous program in which I liked best of all the lyrical Villa-Lobos *Bachianas Brasileiras* No. 5 and Jayme Ovalle's nostalgic *Azulao*—a tune no less haunting and perfect of its kind than the already famous one by Villa-Lobos.

Oddly enough the two harp releases on hand are both jazz programs and each is unusual for the rare effectiveness with which so ordinarily sedate an instrument is exploited in unfamiliar styles. Adele Girard (in *Jazz on Harp*, Stere-o-Craft TN 100) is the more natural jazzist, bringing considerable heat as well as lilt to her imaginatively arranged performances with a background rhythm group. But although Verlye Mills (in *Harp with a Beat* on HiFi-Record and HiFiTape R 606) is more of a concert harpist, her playing is ingeniously blended as an added color element in the Billy May Band's vivacious *divertissements*, topped by a brisk *Carlsbad Caper* and very amusing jazzing-up of Rachmaninoff's C-sharp minor Prelude. Both stereo versions are excellent, with effectively marked channel separation, but while the LP of the Mills-May program is equally crisp and clean, it seems rather bodiless in direct comparison and certainly far less sonically distinctive.

The same criticism applies also to the same company's single-channel taping of R 603, Bruce Prince-Joseph's *Swingin' Harpsichord* (which I first heard nearly a year ago, but felt didn't warrant SFG review), when compared with its current stereo version issued under the same number. But if the offbeat sonics are much more attractive, and all details more transparently revealed in stereo, the accompanying Manhattan Trio still seems timorously cowed and Prince-Joseph's own overfancy elaborations are seldom in either good classical or good jazzical taste. How much better this novelty program could have been is vividly demonstrated in its few moments when the harpsichord's potentialities for perkiness and expressive floridity are best

exploited—as in *Fiddle Faddle* and the declamatory opening of *Cumana*.

Aeronautical and Musicological

As a home-entertainment programmer who relishes nothing better than extreme chronological, typological, stylistic, and other contrasts in my aural fare, I take special delight in being able to jump this month all the way from the edge-of-the-space-age documentary to one analyzing the ominously named, long obsolete, but

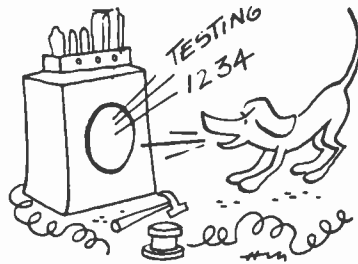

historically important "meantone" temperament. (No, no, Elmer: that is *not* an occupational disease of hi-fi fanatics!) The former is Ward Botsford's *aficionado* tribute to the U. S. Air Force: *A Portrait in Sound*, with narration by Arthur Godfrey, which I heard in its stereo taping (Phonotapes S 908), but which probably is just as interesting in the LP, Vox PL 10520, since stereo doesn't add a great deal except perhaps in improved separation of radio and intercrew communications chatter from characteristic flight-noise backgrounds. Anyway, the outstanding sheerly sonic moments here—a sound-barrier crash-through and a missile take-off—are available more cheaply in stereo in a Cameo short tape, SC 411, \$4.98, which is good enough for odd-sound fanciers alone, although any listener who wants to know more about the operation of the Strategic Air Command will, of course, insist on having the whole story.

This documentary is typical in that it is the sort of thing all except specialists will seldom want to replay (except perhaps for friends' delectation) after they've heard it once or twice for themselves. The other one is entirely different in that it (and its scholarly 31-page booklet) can be studied with cumulative enlightenment almost endlessly. Although its primary market certainly will be among teachers, musicologists, and acousticians rather than audiophiles, I can't resist urging it on the latter if only as an ear sharpener. Most hi-fi fans,

myself not excluded, develop keen ears for timbre distinctions and dynamic differentiations, but in general tend to neglect acquiring a comparable acuity for minute pitch differences. And the present *Meantone Temperament* in *Theory and Practice* (Musurgia LP album A 2) provides superb opportunities for analyzing such differences, in addition to lucid illumination (both in its recorded illustrations of characteristic intervals alone, as well as in contemporary musical pieces—played on a specially tuned harpsichord and organ by Robert Conant—and in its descriptive notes by J. Murray Barbour and Fritz A. Kuttner) on a vitally significant historical phenomenon: the tuning system that prevailed for keyboard instruments prior to, and for some time concurrent with, the "equal" temperament we know so exclusively today. Incidentally, you'll also learn a great deal about tuning systems in general, not least what (to use an old phrase with monetary transposed into acoustical connotations) "a whale of a difference just a few cents* make!"

Bearding the Behemoths Again

Although I've hunted down many a mighty Wurlitzer in the past with the most lethal armor-penetrating shells in my verbal arsenal, they just won't seem to stay down. In fact they seem to thrive on such treatment, for a small herd of the "beasts" in both basements and theaters has been growling savagely at my heels again this month. And at least one uncommonly noble critter has roared so dulcetly and eloquently that even what I thought were my impervious heart and ears have been forced to relent and abstain from attempted mayhem.

Maybe I was weakened by the preliminary "no-quarter" battle in which I could find no mercy for Leon Berry's Audio Fidelity Vols. 2 and 3 (AFLP 1829 and 1844), although I couldn't object quite so strenuously to the timbres and "effects" of the former disc's Hub Rink Wurlitzer as I did to the latter's rebuilt organ in Berry's own basement. Nor did the memory of George Wright's delightful piano playing in last month's Varsity Five taping help me to approve his return to the console, for while the stereo tapes (HiFiTapes R 710 and R 712) of the *George Wright Sound* and

Continued on page 45

*Surely none but a novice audiophile will be so lacking in basic acoustical backgrounds that he'll fail to identify a "cent" as a microtonic interval equal to one twelve-hundredth of an octave!





Correcting Kicking Meters

In some instruments, such as the Heath Audio Analyzer, the meter pointer kicks violently to the right when the instrument is shut off. While the meter is built to take this, the user may have greater peace of mind if the "pegging" can be reduced. All that needs be done is to wire a 0.1- μ fd (or larger) capacitor, 600-volt rating, across the switch.

Herman Burstein
Wantagh, N.Y.

Pencil-Iron Rest

Overheating and top-burning difficulties common to pencil-type soldering irons are minimized by this easily constructed bench stand, which combines the functions of a convenient iron rest and heat control. The unit dissipates heat rapidly, maintaining a soldering tip at a good constant working temperature.

The front section, or tip rest, consists of eight turns of No. 8 solid soft aluminum TV ground wire wound on a 1-inch dowel or similar form (I used a seven-pin miniature-tube shield), spaced out to

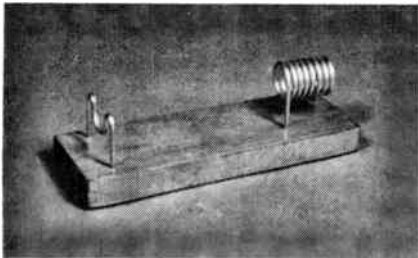

form a coil 1½ in. in length. A straight length of 1⅛ in. is left at each end of the coil for legs. The rear section is a 6½-inch length of aluminum wire formed to cradle the handle.

The base of the prototype is a ¾-by-8-by-2¾-inch block of wood in which mounting holes are drilled to a depth of ⅜ in., using a No. 29 drill bit, to hold the aluminum upright. A drop of Duro Plastic Aluminum or liquid solder in each hole before inserting the wires will anchor the assembly solidly. Glue or synthetic cements are unsuitable because of the heat. For most pencil irons the handle rest should be spaced approximately 5 in. from the tip section.

Heat dissipation is controlled by adjusting the spacing between the front-unit turns. Ungar standard 27½-watt

tips work very satisfactorily with the specifications given. However, for Ungar "hi-heat" tips and the Wall 40-watt pencil, it is necessary to compress the rear five turns to obtain a greater conductive surface.

I have found, using this bench stand, that soldering tips remain in good condition for considerable periods with no other attention than an occasional brisk rubbing with a piece of old terry-cloth toweling or other coarse cotton material. Applying a small amount of fresh solder to the tips at the time of wiping will keep them bright and clean, and will assure trouble-free connections.

The design is readily adaptable to larger irons if No. 8 solid hard-drawn aluminum clothesline wire is substituted in proportionately larger-diameter coils.

J. A. Bannister
Point Edward, Ont.

Applicator for Antistatic Spray

For those who like to use an antistatic spray on records the problem of a satisfactory application medium soon arises. Application cloths furnished with some products quickly become contaminated and introduce air-borne dust as well as dirt removed from other records. Cloths selected at random may release lint which can further complicate the problem.

Effective, inexpensive, disposable applicators are Hoppe's Gun Cleaning Patches, available in any sporting goods store. They come in a variety of sizes but the No. 4 size, measuring 2¼ in. across, is just about right. A package costs about 35¢ and lasts a long time.

Try spraying the patch lightly and then applying it to the record. This avoids the excesses sometimes experienced when the spray is aimed directly at the record.

Fred Bauer, Jr.
Memphis, Tenn.

Leveling Turntables

Audiophiles using transcription turntables often have trouble in keeping them dead level. I tried all sorts and types of different spirit levels, but these were not very satisfactory because it is difficult to get a true reading over the whole surface of the turntable with such a small instrument.

To solve this problem and to make my

Connoisseur turntable very easily adjustable, I mounted the base plate on four corner springs with a screw through each. Then using a small spirit bubble about 3 in. long, I screwed this to a piece of hardwood which had been planed true. In the center of the underneath side of the hardwood I drilled a hole just big enough and deep enough to accommodate the turntable spindle. Placing the level on the turntable, the turntable itself may be rotated in any position, and can be adjusted to a virtually flat position.

B. Stagg
Toronto, Ont.

Man-Made Interference

When a house is being built or wiring altered, the electrical contractor should be requested to make sure that BX cable and metal conduit do not touch any metal objects, particularly water pipes.

A bad case of crackling noises and instantaneous variation in volume in an AM radio was traced to a recently installed BX cable touching a cold water pipe. Every time the cold water was turned off, enough vibration was set up in the pipe to jiggle the contact between cable and pipe. The interference produced was noticeable all over the house, even on a portable battery-operated AM radio. Other minute mechanical vibrations in the house also affected the contact enough to produce considerable interference.

Any two sizeable pieces of metal making poor contact can cause this trouble, and they should be tied together electrically, or else well separated.

This same interference was noticeable on an FM radio when tuned to a weak station, and probably would have degraded TV reception also.

Henry F. Robbins
New York, N.Y.

Stylus Timer

All record manufacturers caution the purchaser of their products against the use of worn styli. The best way to avoid trouble in this respect is to keep a record of the time a particular stylus has been in service and to keep a close watch on stylus condition when the playing hours exceed the recommended value.

Many schemes have been proposed to aid in keeping track of stylus hours. Perhaps the simplest and most painless method is to mount a small counter of the Veeder-Root type right on the motor board. This counter is not connected to anything else electrically or mechanically. It should be of the kind operated by a small handle or lever which counts one every time the handle is pressed. These are quite inexpensive.

It is very simple, and the habit is quickly formed, to press the counter lever every time that an LP side has been

played. The number of hours the stylus has been in use is then about one third of the indication shown on the counter dials.

Edwin Waldemar
Levittown, Pa.

Determining Loudspeaker Polarity

The commonest method suggested for determining the polarity of loudspeakers is by the use of dry cells. It may seem strange, but often a loose dry cell is harder to scare up than a milliammeter, and the method I have used for some years involves the latter.

Connect a low-range milliammeter across the speaker terminals and move the cone inward. The needle will swing one way or the other, and the speaker terminals can be appropriately marked. Anything below 5 ma will work satisfactorily.

One additional advantage to this method is that it is possible to check a speaker hiding behind a grille cloth. Blowing sharply at the cone will move it sufficiently.

David J. Milliken
Northboro, Mass.

Hum with Changing Pitch

The hum that was coming through my music system was quite unusual in that it continually changed pitch. Rewiring the arm several times and changing the tubes in my preamp did not help at all. Neither did a check of the wiring and appliances in the house.

Later it occurred to me that the two TV transmitters within a half mile of the house might have something to do with it. I stayed up late that night and when the TV stations went off the air my hum disappeared. Next morning it was back again. Inserting a 100,000-ohm 1/2-watt resistor between the phono input and the first grid of my preamp eliminated the hum completely. I believe that a choke would work as well.

George E. Matelutte
San Francisco, Calif.

Plug Holder

After chasing RCA-type phono plugs over the workbench for several years, I finally decided that I would have to think of something in the way of a jig to hold them while they were being soldered. One day I spied one of my wife's spring-type clothespins and my problem was solved.

The notch is about the right size to grip the shell of the plug firmly without bending it, and the plug can be shifted to either side for solder on either the shield or inner wire of a cable. To make the job easier, the clothespin can be clamped upright in a vise to hold it steady.

L. E. Johnston
Madison, Wis.

NOW...enjoy your HI-FI OUTDOORS

PATIO, GARDEN, TERRACE, PORCH

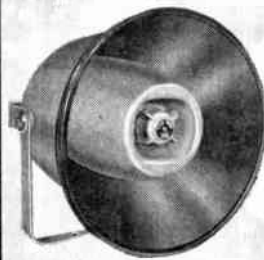

with the new WT-6 ATLAS HI-FI COAX-PROJECTOR

all-weather construction... install it, forget it!...
or take it with you wherever you listen.

True HIGH FIDELITY TWO-WAY system—not just a "compromise" of two horns coupled to a single diaphragm. The WT-6 comprises a weather-proof cone type driver (with 6-inch throat) coupled to its individual woofer horn; a separate pressure-type driver loaded to its separate tweeter horn. The built-in crossover electronic filter supplements the electro-mechanical frequency-limiting characteristics of the 2 individual reproducers—providing for smooth frequency division as each speaker functions within its engineered range of frequencies.

All-weather... high efficiency... compact... for all indoor and outdoor uses... universally adjustable "U"-type rugged steel mounting... finished in high temperature baked modern beige enamel.

POWER RATING 15 watts continuous
FREQ. RESP. 140-15,000 cps
IMPEDANCE 8 ohms. DISPERSION 120°
DIMENSIONS bell opening 15", overall depth 12"

See the WT-6 at your local distributor. Send for catalog AC-7

ATLAS SOUND CORP.
1449 39th St., Brooklyn 18, N. Y.

net
\$34.50



When Converting Your Phono to Stereo...Use

The ERIE AUDIO-AMPLIFIER KIT featuring "PAC" and an ERIE Printed Wiring Board

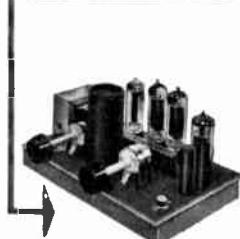
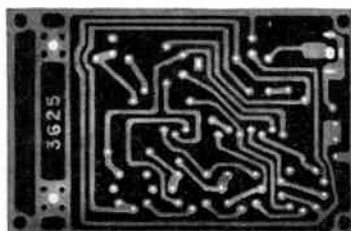

MODEL
PAC-AMP-1

With these Plug-in Components:

- ERIE "PAC" (Pre-Assembled Components)
- ERIE PRINTED BOARD
- OUTPUT TRANSFORMER
- FILTER CAPACITOR
- VOLUME CONTROL and SWITCH
- TUBE SOCKETS
- CAPACITORS
- TONE CONTROL
- TUBES

SPECIFICATIONS FOR ERIE STANDARD AUDIO-AMPLIFIER

- Frequency Response: 30 cycles to 12,000 cycles +0, -3.5 db.
- Sensitivity: 0.56 volt RMS (input at 1 KC) for 2 watt output.
- Power Output: 2 watts • Input Impedance: 2 megohms.
- Output Impedance: 4 ohms • AC Power Consumption: 17 watts.
- Overall Dimensions: 6 3/8" L x 4 3/8" W x 3 7/8" H • Shipping Weight: 2 lbs.

See and hear it at
your local distributor
or Write for
nearest source.

ERIE Electronics Distributor
DIVISION
ERIE RESISTOR CORPORATION
ERIE, PA.

be installed with extremely short leads. This, too, helps insure conformity with factory-built units.

The KT-500 is a marvel of home construction kits in one important respect: all of the parts fit their intended holes, slots, and cutouts perfectly, with no undue shoving or twisting. The open construction of the KT-500 makes soldering on undersurfaces simple, quick, and neat (see Figs. 3-9).

Stringing the dual dial cords is probably the trickiest part of the job. Although tricky, it is not impossible, if the directions are followed explicitly.

Three rolls of radio solder are included in the KT-500 kit. The only items the builder must supply to do the job, from unpacking to final use in a high-fidelity system, are a screw driver,

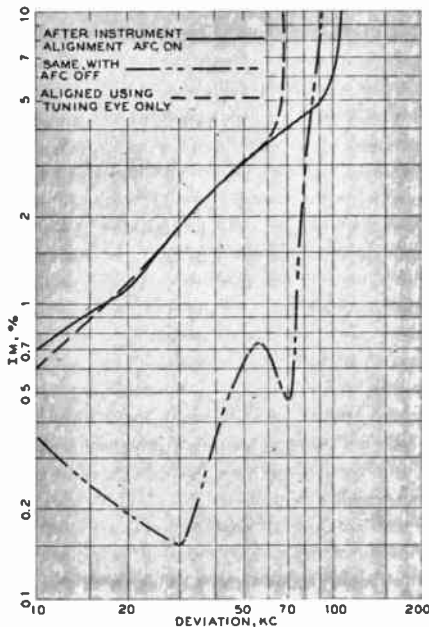

Fig. 10. IM before and after alignment.

a pair of pliers (needle-nose as well as an adjustable-jaw, if possible) and a soldering iron. We used a pencil iron (virtually a necessity on the printed-circuit board) for all but three or four joints, where the six or more wires wrapped around a solder lug dissipated the heat of the pencil iron too quickly to insure a good bond.

The final stage of assembly is not really assembly at all, but touching up of all tunable circuits for maximum gain. As noted before, the 6U5 tuning eye is used as an indicating device (instead of a VTVM or oscilloscope), and the only tools required are an insulated screw driver (preferably fiber) and an amplifier-loudspeaker system.

To touch up the AM alignment, the receiver is tuned to a local station near the high end of the dial for which the exact frequency is known. The trimmers on the tuning gang are adjusted so that

the tuning eye closes as much as possible. Connecting the tuner to an amplifying system is helpful; results of tuning corrections are then audible and the job can be done with somewhat more assurance that the right station is tuned in. The tuning eye will close on any station, and the trimmers permit a considerable shifting of the oscillator frequencies.

The dial is then shifted to a low frequency on which a local station is known to broadcast. Inductances (the RF can, oscillator coil, and a ring on the ferrite rod) are then tuned for maximum closure of the tuning eye. With the trimmer capacitors adjusted at the high end of the dial, and inductances peaked at the low end, the dial should track properly over the entire AM band. If it doesn't, the adjustments should be made again.

With the oscillator aligned, the AM IF slugs are trimmed for maximum sensitivity (again, until the tuning eye closes). Finally, the 10-Kc whistle filter is set for minimum interstation beat. This can best be accomplished by tuning to a spot between two stations, and adjusting a trimmer capacitor while listening to the sound on a speaker system.

Trimming the FM section is somewhat more involved, but no more difficult. To align the RF stages, the three RF coils (each of which are four or five turns of heavy wire with an air core of about one-quarter inch) are brute-forced to the right width by inserting a screw-driver blade and twisting. A small ruler is helpful for this operation, since the exact width (accurate to 1/16 in.) is given in the instruction manual. If the coils are not accurately spaced, the FM dial will not track all stations at their indicated frequencies. Otherwise, reception will not be seriously affected. The coils come very close to the right size, and only slight spreading is necessary.

The trimmers on the FM tuning gang are turned fully clockwise, then backed out 1/8 turn each. The screw in the oscillator trimmer is backed out until the head is 11/16 in. from the capacitor foil. A station near 102 Mc is selected, preferably one which does not completely close the tuning eye, since a strong signal will overload the circuits and slightly detune the oscillator. If the station does not coincide with the dial setting, the oscillator trimmer is slowly adjusted (while simultaneously moving the dial in the right direction) until the station agrees. Then the trimmers are adjusted for maximum closure of the tuning eye.

The IF transformers are adjusted for maximum eye closure, using a signal near 102 Mc; again, use one that does not fully close the tuning eye. Finally,

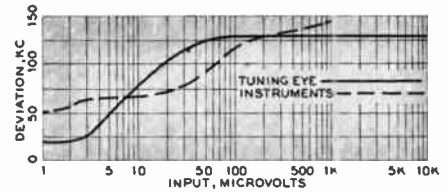

Fig. 11. Maximum undistorted deviation.

the discriminator is peaked by setting the primary (the below-chassis slug) for maximum sensitivity. Only slight adjustment of the primary should be made, since the transformer is already preset to the position which should produce maximum linearity. It tunes broadly, and it is possible, if the slug is turned too far, to tune the secondary to the wrong frequency. This will raise distortion, and necessitate alignment with a sweep generator and oscilloscope in order to correct it.

As a matter of fact, it might be well to advise KT-500 kit builders to omit the discriminator primary adjustment altogether (alignment point A20) since it is the alignment step most dependent upon precise frequency control. In our kit, this slug was properly set to begin with. We adjusted it for maximum sensitivity, but so doing slightly increased

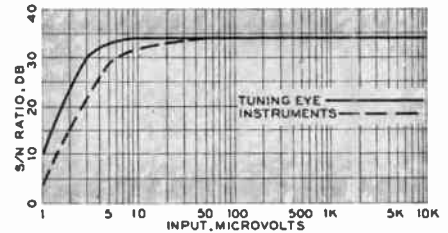

Fig. 12. Quieting-sensitivity curves.

distortion. It is better to leave the primary alone, and adjust only the secondary for the null point which produces the least hum, hiss, and distortion (determined by ear) when the eye indicates maximum closure on the station selected.

AUDIOCRAFT Test Results

After our tuner had been aligned with the tuning eye, listening tests disclosed that it was extremely sensitive on both AM and FM. The Great Barrington area is considered "deep fringe" for practically all FM listening, yet the KT-500 pulled in stations more than twice the distance of the normal FM service area. Furthermore, it did this with sufficient quieting for enjoyable listening, and with audibly low distortion. On AM, the ferrite rod antenna when properly tuned obviated the need for an outdoor antenna even up here in the mountains,

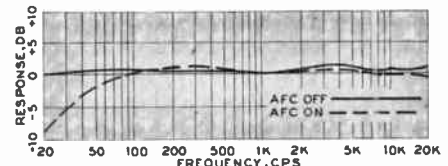

Fig. 13. Frequency response of KT-500.

which is as unlikely a reception area as you'll find.

Although alignment of both AM and FM sections appeared to be satisfactory, we wanted to know *exactly* how close it came. Consequently, we had the tuner subjected to a complete alignment with a crystal-calibrated sweep generator and an oscilloscope, optimizing every adjustment with minimum distortion (and not maximum sensitivity) as the criterion. The tuner was tested for distortion, sensitivity, and noise rejection before and after the instrument alignment, and the results of those tests appear in Figs. 10-13.

From a study of the sensitivity-distortion graphs, Figs. 10-12, it is evident that alignment of the FM section using the tuning eye as an indicator results in maximum sensitivity. However, this also results in minimum IF bandwidth and a consequent increase in distortion. It is interesting to note, however, that distortion after tuning-eye alignment is almost the same as distortion *after* instrument alignment when the AFC is switched on. But since the drift of the

give a reasonable indication of station tuning. The ear must be the final judge. But note that this is not an unusual condition, and that the distortion is relatively low no matter how tuning is accomplished.

The maximum signal-to-noise ratio of 34 db was limited by residual hum, and not by tube hiss as normally expected. The AM signal rejection was also limited by hum, although listening tests indicated that rejection was perfect.

The frequency response of the FM section, Fig. 13, shows a deviation of no more than 0.5 db from 20 cps to 20 Kc. However, when AFC is used, response drops sharply below 100 cps to a low of -8 db at 20 cps. Increasing the AFC time constant undoubtedly would have avoided this condition.

The AM section appears to be quite sensitive, and will be usable in most localities without an external antenna. Distortion (determined on AM only by listening tests) is quite low. The most serious objection, to the AM reception and to the tuner as a whole, is the restricted AM bandwidth of 8,000 cps,

COMING NEXT MONTH

- Stereo Cartridge Roundup** by Joel Ehrlich
Specs and prices of all cartridges designed for stereo discs
- Installing an FM Antenna**
An AUDIOCRAFT photo how-to-do-it feature
- Audiolab Test Reports** by Hirsch-Houck Laboratories
Gray AM-3 preamplifier; Marantz 40-watt amplifier;
H. H. Scott 330-C stereo FM-AM tuner
- The Grommes LJ-6K Amplifier** An AUDIOCRAFT kit report
A 10-watt control amplifier for budget systems

tuner is negligible after three minutes of operation, there is little reason for using AFC. If a fully modulated signal is received, however, distortion is likely to rise, and the use of AFC in this instance will *decrease* distortion. The condition of minimum IM distortion accrues from an extremely critical tuning of the transmitted carrier. Unfortunately, this tuning cannot be determined accurately by using the tuning eye (when AFC is switched off), since the 6U5 takes its control voltage from the grid circuit of the limiter. Current variations here are relatively gradual, permitting the 6U5 to function over a broad tuning range. Furthermore, variations at the limiter are independent to some degree of the discriminator, and since distortion is achieved only when the discriminator is critically adjusted to the precise center of the carrier wave, limiter grid current (and thus closure of the 6U5 tube) may remain relatively constant while the discriminator fluctuates several thousand cps off center.

For practical purposes, however, (and when AFC is used) the tuning eye will

which results in a maximum frequency range of 4,000 cps. It would seem to us that the usefulness of the KT-500 would have been greatly increased for stereo use had an additional IF stage and stagger tuning been employed to stretch the AM bandwidth to a more acceptable degree. On the other hand, this would have necessitated instrument alignment—a dilemma we wouldn't want to have to resolve.

When the tuner is used for stereo, the lack of high-frequency response in the AM channel appears to shift the balance of the orchestra in the direction of the speaker served from the FM channel. This is quite bothersome, particularly if one's ears have become accustomed to tape stereo, with full frequency range in both channels.

Alignment of the tuner using the tuning eye will be acceptable to all but the most critical user. This feature, as well as the generally low distortion on the FM channel and excellent sensitivity of the tuner as a whole, combines with simplicity of construction to make the KT-500 a pleasure to build and use.

ADD HOLT STEREO!



MONAURAL THEN SOUNDS LIKE STEREO.

New encased model 6 tube converter and amplifier complements any hi fi system. It begins where hi fi leaves off. Connects in 2 minutes.

\$65.00 postpaid in U.S. Sold direct, only, on moneyback trial.

Order yours or send for folder. Read what customers and Hi-Fi magazines say.

NOW IN KITS, TOO

Kit, complete, \$45 postpaid.

STEREO by HOLT

4712 W. Magnolia Blvd.
Burbank, California

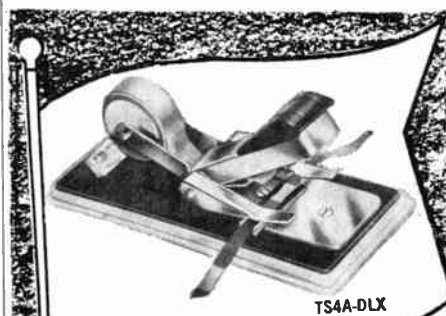

TS4A-DLX

GIBSON GIRL® . . .

TAPE SPLICERS

Six Models from 1.75 to 55.00

● ROBINS GIBSON GIRL tape splicers assure you of PROFESSIONAL SPLICES IN SECONDS! They are the accepted standard of the professional and industrial users of recording tape because of their ease and reliability of operation and high standards of workmanship. The only splicers which cut and trim the splicing tape and tape edges with an indented trim cut, making THE SPLICE WITH THE GIBSON GIRL SHAPE.

AT DEALERS EVERYWHERE
Write for FREE Catalog of ROBINS' Phone and Tape Accessories!



ROBINS

INDUSTRIES CORP.
FLUSHING 54 • NEW YORK

the sound of

TALENTED

hands

In an era of mass production and automation there are still some products which are individually assembled by hand — slowly with painstaking care and attention to details. Vitavox loudspeakers are fine examples of this skilled workmanship in the art of sound reproduction. They are created for the high fidelity enthusiast who listens with his ears and his heart — rather than trying to digest a table of specifications. The DU120 Duplex Coaxial Full Range Loudspeaker is truly one of the most remarkable achievements in audio craftsmanship in the twentieth century!

VITAVOX
Duplex
Coaxial
FULL RANGE
LOUDSPEAKERS



Made in England
by Vitavox Ltd.,
London

at leading hi-fi dealers

ERCONA CORPORATION

(Electronic Division)

16 West 46 St., Dept. 72, New York 36, N.Y.

In Canada: Astral Electric Co., Ltd.
44 Danforth Road, Toronto 13

*A quick and easy way to find
the reference you want — exactly
when you want it —*

HIGH FIDELITY

A Bibliography of
Sound Reproduction

Compiled by K. J. Spencer
Foreword by G. A. Briggs

This new book, imported in a limited quantity from England and available in this country only through the publishers of *Audiocraft Magazine*, is a volume whose value to everyone seriously interested in high fidelity need not be outlined.

It contains approximately 2,600 entries that represent the whole field of published information and research on high quality sound reproduction, from the subject's very early days up to and including June 1957. \$6.00

AUDIOCRAFT MAGAZINE
Great Barrington, Massachusetts

I enclose \$..... for which please send me
..... copies of HIGH FIDELITY: A BIBLIOGRAPHY
OF SOUND REPRODUCTION. (Add 55¢
postage for foreign orders except Canadian.)

NAME

ADDRESS

No C.O.D.'s or charge orders please

PUZZLEMENTS

Continued from page 37

with a change in signal level. This you can see in any amplifier by measuring plate currents or voltages while changing the input level.

Add to this another fact, that certain kinds of program have a dominantly asymmetrical wave form, and we have plenty of reason to suspect that improper handling of feedback at subaudio frequencies can cause trouble (you don't need an output transformer to get into this sort of trouble, either). But what does this do to the reproduction?

Any change of operating points in the single-ended part of the amplifier, caused either by level changes and individual stage nonlinearity, or by asymmetrical program wave form, will give any low-frequency response peak (usually between 0.2 and 2 cps) a kick, and set the amplifier's whole internal loop bouncing.

Bouncing the amplifier operating voltages in this way will produce cyclic intermodulation of much more serious magnitude than is ever measured by standard methods. It may even swing the amplifier to points of cutoff in individual stages, which the feedback cannot override and may actually exaggerate.

GROUNDING EAR

Continued from page 4

factor might be less of a virtue with speakers requiring greater damping.

How Heath can deliver so much for so little money is their secret. But how the performance is achieved is evident from the circuit diagrammed in Fig. 4. The output stage uses a pair of EL84's working into a compact but fairly heavy tapped-screen output transformer. The driver portion is the familiar pentode amplifier directly coupled to a split-load phase inverter. There is a single feedback loop, and the amount of feedback is not too great by today's standards. Stability at the high end is provided by a step network in the grid circuit of the inverter, as well as by the usual capacitor across the feedback resistor. The margin of stability is very good indeed; the square-wave response demonstrates this. Incidentally, an independent version of the power section of the EA-2 (without the preamp) will soon be available at \$22.50.

The relatively low feedback factor means that the power section has high sensitivity and can be driven with something less than 0.2 v. The preamplifier section, therefore, is operated at very low levels at which it produces little distortion. It is for this reason, presumably, that there is no feedback in the preamp section. One-half of a 12AX7 input tube is used as a preamp for magnetic cartridges. The equalizer is of the

Added to these effects we may have the "sudden-overload" effect, which is partially a by-product of the feedback, as discussed in "Puzzlements" for the February 1958 issue. That occurs only when short-duration peaks in the program draw grid current in the output stage. The effects we have just discussed can also occur at much lower levels.

The amount of feedback, and the way the loops are deployed, should be arranged a) so that the stability margin of the whole amplifier is not dependent on the output loading (many amplifiers may avoid these effects with the academic but impractical resistance load, while becoming quite bad with practical loudspeakers connected), and b) so that the damping factor is between 2 and 10.

A damping factor of 4 or 5 is adequate for most purposes, but values between 2 and 10 may be considered acceptable. Values higher than 10 are meaningless in relation to loudspeaker performance, and make the amplifier's problems almost impossible.

Frequency response *with feedback* needs to be no wider than the audio range. A response that is 3 db down at 20 cps and 20 Kc is quite adequate, although I am told an amplifier with this specification would be difficult to sell, because so many have "better" ones.

simple interstage-bypass type between the first and the second sections. Only one equalizer is provided — for the RIAA curve. There are two other inputs: one for piezoelectric (crystal or ceramic) phono cartridges and another for a tuner. The crystal channel is loaded to 2.3 megohms, which should provide pretty good equalization for most piezo cartridges. The radio channel has an attenuator. Even so, it would be possible to overload it with a tuner input providing too strong a signal.

A 6C4 provides additional amplification ahead of the tone controls, which provide an excellent range of cut or boost. There is a hum-balance control and, at least with the AR-2, the hum level seems to the ear to be better than the measured 47 db on the magnetic-phono channel and 63 db on the tuner channel. Unless very efficient speakers with peaks at hum frequencies are used, the hum should not be at all bothersome. Incidentally, the distortion figures at low levels include the noise component, and the actual distortion is, therefore, lower than the curves indicate.

Heath is not the only company offering such bargains. For some months EICO has had an integrated 12-watt amplifier (the HF12) in kit form for \$35, and recently Allied has introduced its Y-786 integrated 18-watt amplifier kit at \$40. Although I have not tried either, my experience with the Heath BA-2 makes it possible for me to believe that they offer similar hi-fi value per dollar.

SOUND FANCIER

Continued from page 39

George Wright Plays the Conn Electric Organ, which I heard sometime ago in single-channel versions, struck me as considerably superior technically, the bigger but still dry acoustical ambiances made the throbbing schmaltz even harder to take aesthetically. And aesthetic suffering again triumphed over engineering appreciation when I had to listen to both stereo-tape and LP versions of *The Genius of George Wright* (R 713) and *George Wright's Impressions of My Fair Lady* (R 715), where again my same objections still apply.

I was still resistant when I heard the Cook stereo tape of *Pipe Organ in the Mosque*, Vol. 1 (1050 ST), which I missed long ago in BN-LP form, although I did review some of the later Reginald Foort releases in the same series. The music he plays (*Hungarian Rhapsody No. 2*, *In a Persian Market*, and the like) deserves slapdash performances and bleating sonics even less than Wright's pops, although I must admit that the smoothly blended stereo does provide more natural big-auditorium sound here. And there is even bigger, more brilliant sound in Dick Leibert's *Leibert Abroad* and *Mighty Wurlitzer in Stereo* (Westminster-Sonotape SWB 7041 and 7066), but again the *molto vibrato* sentimentality and synthetic percussive effects gag me. But I weakened a bit with Audio Fidelity's *Electronic Organ* (AFLP 1856) with Jack Anderson's Baldwin instrument heard both solo and with quintet accompaniment, since here at least there are more interesting and distinctive sonic qualities (but also curiously thudding pedal tones), even though the performances themselves are as sideslipping and syrupy as all the rest.

It took Paul Klipsch and Weldon Flanagan to throw me for my first (admitted) loss in this field: the *Palace in Dallas* Klipschtape (KST 7002) not only has the most ingratiating and unexaggerated stereophonics of any theater-organ release I've yet heard, but Flanagan's rebuilt Wurlitzer has markedly cleaner and more piquant timbres than any other I've encountered, and for a final miracle Flanagan actually plays with reasonably steady rhythm, considerable buoyancy, and a minimum of schmaltz. In fact I'm beginning to regret that I ever got — or at least played — this tape; it raises the horrid notion that some day I might actually get to *like* listening to a theater organ. But no, no, a thousand times no.

Symphonic Enhancements and Disenchantments

What stereo can do at its best in transforming topnotch single-channel recordings into miraculously finer ones is dem-

onstrated conclusively in Frederick Fennell's program of six short pieces, *Music of Leroy Anderson* (Mercury MVS 5-30), which has everything I praised in the LP edition (MG 50130) plus the indescribable sonic intangibles achievable solely in the new medium. And much the same metamorphosis can be heard in Felix Slatkin's *Overture* collection (Capitol ZF 36), although here it is in strictly sonic terms only: the hard-driving performances themselves gain no added distinction over their LP versions (P 8380, SFG Feb. 1958). On the other hand, Mercury's tapings of the Gershwin Concerto in F by Eugene List and Howard Hanson (MDS 5-9) and Hanson's *Fiesta in Hi-Fi* program of showpieces by young American composers (MAS 5-28) gain less than I should have expected over the initially powerful and brilliant MG 50138 and MG 50134 LP's (reviewed here last April and January respectively).

Similarly definite but hardly decisive gains are evident in the direct comparison of stereo-tape and LP versions of Carmen Dragon's symphonic pops program, *A World of Music* (Capitol ZF 38 and PAO 8412), and the Menuhin-Dorati performance of Bartók's Violin Concerto (Mercury MFS 5-10 and MG 50140), each of which is—in very different musical ways—so effective monophonically that no LP-only listener needs be too envious of his stereophile colleagues. And with Mercury's Albeniz-Arbós Iberia Suite (MBS 5-19 and MG 50146) and Offenbach-Rosenthal *Gaité Parisienne* (MCS 5-15 and MG 50152), by Dorati and the Minneapolis Symphony, even the marked stereo enhancements cannot make the overly ponderous performances more palatable to my ears, nor, in the case of the latter work, compensate for the loss of the LP coupling of the Strauss-Dorati *Graduation Ball*, which is much more zestfully—and no less brilliantly—played.

Yet much as I enjoy Prokofiev's barbaric *Scythian Suite*, for which Dorati's somewhat brutal treatment (this time with the London Symphony) is well suited, I'll still pass up the LP (Mercury MG 50157) in order to have the coupling alone—the blazing *Love for Three Oranges Suite*—in stereo (MWS 5-18). And sensational as the latter may seem, the even more exuberant *Lieutenant Kije Suite*, in the most exciting of the many superlative recorded performances we have had from Fritz Reiner, the Chicago Symphony, and RCA Victor (BCS 96), sets even loftier new highs for symphonic authenticity, kaleidoscopic orchestral colors, and fabulously wide dynamic range. I haven't heard this *Kije* in its LP edition (LM 2150), but I don't want to. After the thrilling experience of its incomparable stereo realization, anything less must inevitably be anticlimactic.

WITH
Sonotone®

STEREO
PHONO CARTRIDGES

you can
hear the
difference

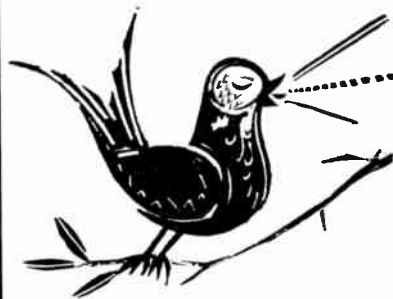

When you buy or modernize
your record player, insist
on Sonotone Ceramic
Phonograph Cartridges

for everything in hi-fi
GET THE MONEY-SAVING 1958
ALLIED CATALOG



featuring the
world's largest
stocks of systems
& components

free!
SEND FOR IT

Here's your complete money-saving guide to Hi-Fi. Own a fine custom quality Hi-Fi music system at no more than the cost of an ordinary phonograph. See dozens of ALLIED-Recommended complete Hi-Fi systems, plus the world's largest selection of components (amplifiers, tuners, changers, speakers, enclosures and accessories). Want to build-your-own?—see our exclusive Hi-Fi KNIGHT-KITS. For everything in Hi-Fi—for everything in Electronics, get the FREE 1958 ALLIED Catalog.

ALLIED RADIO AMERICA'S
HI-FI CENTER

ALLIED RADIO CORP. Dept. 89-G8
100 N. Western Ave., Chicago 80, Ill.

Send FREE 1958 ALLIED Catalog

Name _____

Address _____

City _____ Zone _____ State _____

PROFESSIONAL DIRECTORY



Get more FM stations with the world's most powerful FM Yagi Antenna systems.



Send 25¢ for booklet "Theme And Variations" containing FM Station Directory.

APPARATUS DEVELOPMENT CO.
Wethersfield 9, Connecticut

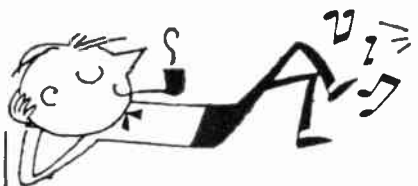

TAPE RECORDERS
EXCEPTIONAL VALUES
HI-FI COMPONENTS
NATIONAL BRANDS
WRITE FOR FREE CATALOGUE
CARSTON 215 VV E. 88 ST.
NEW YORK 28, N.Y.

World
Renowned
HARTLEY
Speakers

Now Available to
DEALERS,
SERVICE-MEN,
CUSTOM-INSTALLERS
Lowest Franchise
Requirements in the
Hi-Fi Industry

WRITE - WIRE - PHONE

HARTLEY PRODUCTS CO.

521 East 162nd Street, New York 51, N. Y.
LUdlow 5-4239



**YOU'LL BE
SLIGHTLY
AMAZED . . .**

when you receive
our reply. Write
us your hi-fi re-
quirements now—
you'll be glad you
did.

KEY ELECTRONICS CO.
120 Liberty St.
N.Y. 6, N.Y.
EVergreen 4-6071

TRADERS' MARKETPLACE

Here's the place to buy, swap, or sell audio equipment. Rates are only 20¢ a word (excluding name and address) and your advertisement will reach 20,000 to 35,000 readers. Remittance must accompany copy and insertion instructions.

HI-FI HAVEN, New Jersey's newest and finest sound center. Write for information on unique mail order plan that offers professional advice and low prices. 28 Easton Ave., New Brunswick, N.J.

ENJOY PLEASANT SURPRISES? If so, write us before you buy any hi-fi. You'll be glad you did. Key Electronics Co., 120 Liberty St., New York 6, N.Y. EVergreen 4-6071.

WILL BUILD all types of kits, hi fi, etc. 30% above cost. Write for details. Howard's Radio Service, Box 528, Myrtle Creek, Oregon.

STEREO TECHNIQUES

Continued from page 19

for playback from a tape head will doubtless be included in the preamp, but the monitor circuit so popular these days will have to be revised so that it can work for stereo. As you can see, a stereo central control and switching system could get quite complex. Some of these controls are more important in practice than others, however, and in most commercial units some must be omitted.

Tuners must now be selected with stereo in mind. These days, almost all stereocasting is being done with one AM and one FM transmitter. This means

ing comes along, better antennas will be required in outlying regions. If you are buying an FM antenna, think ahead.

Since the reason many listeners are getting interested seriously in stereo is the stereo disc, let us now turn to the choice of a turntable. When speaking of a "turntable" I do not mean to slight record changers. All that applies to a turntable applies to a record changer. It should be noted that it will be somewhat more difficult to make a changer meet the requirements, but it can be done.

First, and most important, the turntable must have low rumble. Rumble is predominantly a vertical vibration of the turntable. A stereo reproducer cartridge has far more vertical sensitivity



that a combination tuner should be capable of simultaneous outputs on AM and FM, and capable of tuning them independently of one another. In some areas, stereocasting is done with two FM transmitters (two stations working together). In this case, either two FM tuners must be bought or else a dual FM tuner (which does not today exist) must be obtained.

In contrast to these two simulcasting stereocasting techniques, the future will probably see quite a bit of FM multiplexing. This means that you should select a tuner which has a multiplex outlet, so that a multiplex converter (when they become available) can be connected simply to the set. And when multiplex-

than a standard pickup. Thus, it will reproduce much more of this vertical rumble.

A good motor and fine machine work will be more important than ever. Of course, the turntable should have good speed regulation—not that stereo records are any more sensitive to flutter, but it is just something to avoid at all times. Hum radiation must be minimized, for in a magnetic stereo cartridge there are two coils to pick up hum. If you select a record changer, it should be one that permits tracking at a low stylus force, because pressures are multiplied by the smaller stylus size. In addition, the trip mechanism must be quite gentle, since the records and cartridges are more fragile.

When selecting a tone arm for stereo discs, choose one with very good vertical pivots and sensitive lateral pivots. Since the cartridge and disc are both more delicate than the conventional types, better arms are in order here. The arm should be one that cannot tilt; it must keep the stylus perpendicular to the disc at all times. This precludes some of the older viscous-damped designs. Viscous-damped tone arms can be used, but the manufacturer's instructions must be carefully followed and the damping adjusted precisely. Unfortunately, one of the better viscous-damped tone arms still on the market is not good for stereo records because it can tilt from side to side. The newest arm from this same manu-

LOWEST QUOTES ON HI-FI components, tape recorders, tapes. Write to Dept. A, Professional Hi-Fi, Box 62, Canal St. Station, New York 13, N.Y.

TAPE RECORDERS: hi-fi components, tapes at wholesale prices! Free catalogue. Carston, 215-V, E. 88 St., N.Y.C. 28.

VIKING TAPE DECK FF 75 SR Stereo playback; mono record never used. Won't fit in set as planned. Highest offer gets it. E. G. Nafziger, M.D., Box 497, California, Pa.

TAPE RECORDERS, hi-fi components, tapes. Unusual values. Free catalog. Dressner, 69-02D 174 St., Flushing 65, N.Y.

FOR SALE: JansZen 1-30 electrostatic tweeter, blond cabinet, in new operating condition, \$120. Goodmans B-1200 bass-reflex enclosure with Acoustical Resistance Unit-damped port, walnut finish, \$30. Tech-Master Model 19 60-watt control amplifier, \$80. Pickering Fluxvalve-Unipoise pickup and arm, .001 diamond stylus, new condition, \$40. Box JWH, AUDIOCRAFT Magazine, Great Barrington, Mass.

facturer is quite good, especially in its angle of cartridge lift on warped records.

Many of the stereo cartridges will be released with an arm. In most cases it is essential to follow the cartridge manufacturer's recommendation. This is not always the case, but the manufacturer will advise you if you are in doubt. As for record changers, some of the better machines today are virtually useless for stereo because of vertical rumble. One of the best changers on the market is a serious offender. So don't judge by monaural standards; this is stereo, and it is sufficiently different to require a whole new set of standards.

When selecting a tape recorder, care should be taken to ensure that it gives you good stereo. It should be a *stacked* stereo unit; the staggered system is pretty much outdated. The unit should record stereo as well as play it back, and it would be a good idea to get a unit that also records and plays back monophonic tapes. The recorder should have built-in erase facilities, so that you don't have to bulk-erase a tape each time before recording nor use new tape each time. The recorder should be one that is designed for use with a component high-fidelity system. Package types simply duplicate your main loudspeakers and amplifiers, with less quality; but if you plan to carry the recorder about quite a bit, it is not a bad idea to get a unit with both speakers and amplifiers. Make sure, in any case, that the unit has outputs that permit its use with a component system without going through the amplifiers of the recorder.

The recorder should have better than neon-type record-level indicators. It should also have provision for monitoring either the signal off the tape or the signal being fed to the record head. The best type of volume indicator is, of course, a VU meter. Almost as good is a "Magic Eye" tube. There should be an indicator for each channel. There should also be a level control for each channel. The machine should be at least a dual-speed unit, capable of operation at both $7\frac{1}{2}$ and $3\frac{3}{4}$ ips. Since stereo tapes are or will be available in both these speeds, this is only reasonable.

In sum, it is clear that the advent of stereo records is just cause for re-examination of present high-fidelity systems. Because any other type of phonographic reproduction will not be adversely affected by the compromise compatibility of the stereo disc, it is sensible to assume that it will replace the conventional disc in relatively short order. Since a genuine high-fidelity system, with its inherently lower distortion and better reproduction potential, is adversely affected by the stereo disc's compromised monophonic fidelity, the system must be changed to keep up with the times. This, then, is the time to start converting your system to stereo.

TAPE NEWS

Continued from page 35

tive readings, however, may serve a useful purpose in comparing tapes with one another. Even though the low-level distortion figures don't sound the way they read, they do agree with subjective results. For instance, compare my comments about relative sonic cleanness with the —10-db measurements. The order of "preference" is the same. Zero-level readings may be indicative of the way in which the tapes respond to marginal overload, although this is a possibility that I haven't yet investigated or observed (since I do not ordinarily twiddle my thumbs while the meter pins on fortissimi).

As for the apparently exaggerated readings, this I can't explain. It may be the same kind of phenomenon which makes a tape, recorded from a fuzzy and strident disc, sound cleaner than the disc. Or it may be due to the fact that an IM analyzer of the type I used (SMPTE) will read as IM the amplitude variations caused by random inconsistencies in oxide thickness or formulation.

This bears further investigation. Maybe I'll have some definite answers at a later date.

Selection Spotters

Several readers have written to inquire about the availability of revolution counters for use in spotting isolated selections on a recorded tape. In the same letter many of them have complained because they know these devices can't cope with the idiosyncrasies of tape winds, but they don't know of anything else to use. Well, someone has come up with what appears to be the ideal solution to this knotty problem.

Tape Indxs, made by Datrel (520 Fifth Ave., New York 36), are small, flexible plastic tabs, each with a number at one edge and a gummed surface on the other edge. The gummed surface adheres to the back of the tape, the numbered tab sticks out from between the layers of wound tape, and the tab is so shaped that it will pass smoothly through pressure pads, tape guides, and enclosed head assemblies without peeling off, crinkling out of shape, or disturbing the tape travel.

When the tape is wound on its reel, each protruding tab marks the beginning of a selection. If the Indxs were accurately placed, the tape can be shuttled to the desired tab and started right at the opening note of the selection.

Gummed labels are also included for identifying reels and boxes, and the whole package sells for \$1 for 30 Indxs and labels. Good deal!



NORELCO® presents

the world's

second finest*

pickup cartridge



NORTH AMERICAN PHILIPS CO., INC.
High Fidelity Products Division, Dept. 2C7
230 Duffy Avenue, Hicksville, L. I., N. Y.

Dynaco Output Transformers



Featuring para-coupled windings, a new design principle (patents pending). These transformers use advanced pulse techniques to insure superior square wave performance and undistorted reproduction of transients. Dynaco transformers handle full rated power over the entire audio spectrum from 20 cps to 20 kc, without sharp rise in distortion at the ends of the band which characterizes most transformers. Conservatively rated and guaranteed to handle double nominal power from 30 cps to 15 kc without loss of performance capabilities.

Specifications:

Response: Plus or minus 1 db 6 cps to 60 kc. Power Curve: Within 1 db 20 cps to 20 kc. Square Wave Response: No ringing or distortion from 20 cps to 20 kc. Permissible Feedback: 30 db.

MODELS

A-410	15 watts	EL-84, 6V6, 6AQ5	14.95
A-420	30 watts	5881, EL-34, KT-66	19.95
A-430	60 watts	KT-88, EL-34	29.95
A-440	120 watts	KT-88, 6550	39.95
A-450	120 watts	PP par KT-88, EL-34	39.95

(all with tapped primaries except A-440 which has tertiary for screen or cathode feedback)

Additional data on Dynakit and Dynaco components available on request including circuit data for modernization of Williamson-type amplifiers to 50 watts of output and other applications of Dynaco transformers.

DYNACO INC.

617 N. 41st, Philadelphia 4, Pa.

Export Division: 25 Warren St., New York, N.Y.

New! Years Ahead!

LAFAYETTE STEREO TUNER KIT

THE MOST FLEXIBLE TUNER EVER DESIGNED

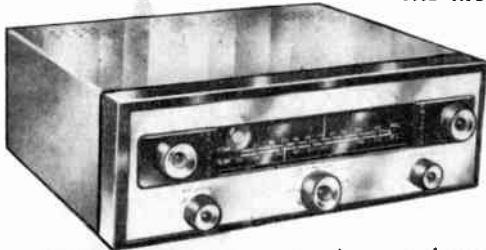

Use it as a
**Binaural-
Stereophonic
FM-AM tuner**

Use it as a **Dual-
Monaural
FM-AM tuner**

Use it as a
**straight
Monaural
FM or AM
tuner**

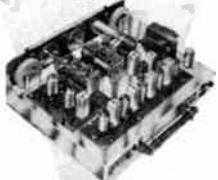

KT-500 IN KIT FORM
74.50
ONLY 7.45 DOWN
7.00 MONTHLY

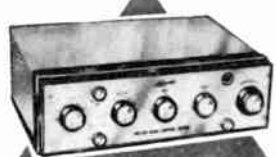

KT-300
39.50
IN KIT FORM



KT-400
69.50
IN KIT FORM

ONLY 6.95 DOWN -
7.00 MONTHLY

- Multiflex Output for New Stereo FM
- 11 Tubes (including 4 dual-purpose) + Tuning Eye + Selenium rectifier Provide 17 Tube Performance
- 10KC Whistle Filter • Pre-aligned IF's
- Tuned Cascade FM • 12 Tuned Circuits
- Dual Cathode Follower Output
- Separately Tuned FM and AM Sections
- Armstrong Circuit with FM/AFC and AFC Defeat
- Dual Double-Tuned Transformer Coupled Limiters.

More than a year of research, planning and engineering went into the making of the Lafayette Stereo Tuner. Its unique flexibility permits the reception of binaural broadcasting (simultaneous transmission on both FM and AM), the independent operation of both the FM and AM sections at the same time, and the ordinary reception of either FM or AM. The AM and FM sections are separately tuned, each with a separate 3-gang tuning condenser, separate flywheel tuning and separate volume control for proper balancing when used for binaural programs. Simplified accurate knife-edge tuning is provided by magic eye which operates independently on FM and AM. Automatic frequency control "locks in" FM signal permanently. Aside from its unique flexibility, this is, above all else, a quality high-fidelity tuner incorporating features found exclusively in the highest priced tuners.

FM specifications include grounded-grid triode low noise front end with triode mixer, double-tuned dual limiters with Foster-Secley discriminator, less than 1% harmonic distortion, frequency response 20-20,000 cps \pm 1/2 db, full 200 kc bandwidth and sensitivity of 2 microvolts for 30 db quieting with full limiting at one microvolt. AM specifications include 3 stages of AVC, 10 kc whistle filter, built-in ferrite loop antenna, less than 1% harmonic distortion, sensitivity of 5 microvolts, 8 kc bandwidth and frequency response 20-5000 cps \pm 3 db.

The 5 controls of the KT-500 are FM Volume, AM Volume, FM Tuning, AM Tuning and 3-position Function Selector Switch. Tastefully styled with gold-brass escutcheon having dark maroon background plus matching maroon knobs with gold inserts. The Lafayette Stereo Tuner was designed with the builder in mind. Two separate printed circuit boards make construction and wiring simple, even for such a complex unit. Complete kit includes all parts and metal cover, a step-by-step instruction manual, schematic and pictorial diagrams. Size is 13 1/2" W x 10 3/4" D x 4 1/4" H. Shpg. wt., 18 lbs.

The new Lafayette Model KT-500 Stereo FM-AM Tuner is a companion piece to the Models KT-300 Audio Control Center Kit and KT-400 70-watt Basic Amplifier Kit and the "Triumvirate" of these 3 units form the heart of a top quality stereo hi-fi system.

KT-500.....Net **74.50**

LAFAYETTE MASTER AUDIO CONTROL CENTER with BINAURAL CHANNEL AND DUAL VOLUME CONTROL

- Self-Powered • DC On All Filaments • 24 Positions of Equalization
- Tape Head Input, High Impedance
- Dual Cathode Follower Output Stages

This is not only the finest hi-fi preamp characterized by unmatched features, but it has been functionally designed to keep pace with the conversion of your present hi-fi system to binaural (Stereophonic) sound. Incorporates an extra channel and dual volume control for binaural reproduction. Features include DC on all tube filaments, negative feedback in every stage, dual cathode follower output stages and latest printed circuit construction. Less than 0.09% 1M distortion and less than 0.07 harmonic distortion at 1V. Hum and noise level better than 80 db below 3V. Uniformly flat frequency response over entire audible spectrum, 7 inputs for every type of phono, tuner or tape. Tasteful styling, brilliantly executed. Size 12 1/2" x 9 1/2" x 3 3/4". Shpg. wt., 10 1/2 lbs.

KT-300—Lafayette Master Audio Control Kit Complete with cage and detailed assembly instructions.Net **39.50**

LT-30—Same as above completely wired and tested with cage and instruction manual.Net **59.50**

DELUXE 70 WATT BASIC AMPLIFIER

- Conservatively Rated At 70 Watts • Inverse Feedback
- Variable Damping • Metered Balance And Bias Adjust Controls
- Available in Kit and Wired Form

Here's ultra-stability in a 70 watt basic power amplifier employing highest quality components conservatively rated to insure performance and long life. Features matched pair KT 88's and wire range linear Chicago output transformer, variable damping control, meter for bias and balance and gold finish chassis. Frequency response 10-100,000 cps \pm 1 db. Hum and noise 90 db below full output. 1M distortion less than 1 1/2% at 70 watts, less than 0.3% below 30 watts. Harmonic distortion less than 2% at 70 watts from 20 to 20,000 cps \pm 1 db. Output impedance 4, 8 and 16 ohms. Handsome decorative cage perforated for proper ventilation. Size 14 1/2" x 10 x 7 3/4" including cage and knobs. Shpg. wt., 40 lbs.

KT-400—Lafayette 70 watt Deluxe Basic Amplifier Kit complete with cage and detailed assembly instructions.Net **69.50**

LA-70—Same as above completely wired and tested with cage and instruction manual.Net **94.50**

ADVERTISING INDEX

Key No.	Advertiser	Page
1	Acoustic Research, Inc.	35
2	Allied Radio Corp.	45
3	Apparatus Development Co.	46
4	Atlas Sound Corp.	41
5	Audio Fidelity Records	Back Cover
6	Audiospeaker Laboratories	2
7	Bozak, R. T., Sales Co.	16
8	British Industries Corp.	Inside Front Cover
9	Carston Studios	46
10	Dynaco Inc.	37, 47
11	EICO	5
12	Electro-Sonic Laboratories	37
13	Ercona Corp.	44
14	Erie Resistor Corp.	41
15	Fisher Radio Corp.	15
8	Garrard Sales Corp.	Inside Front Cover
16	Hartley Products Co.	46
17	Heath Co.	7-11
18	High Fidelity: A Bibliography of Sound Reproduction	44
19	Holt Radio	43
20	Key Electronics Co.	46
21	Lafayette Radio	48
22	Lansing, James B., Sound, Inc.	31
23	North American Phillips Co.	47
	Professional Directory	46
24	Robins Industries Corp.	43
25	Sargent-Raymont Co.	13
26	Sonotone Corp.	45
19	Stereo by Holt	43
	Traders' Marketplace	46
27	University Loudspeakers, Inc.	1
28	Viking of Minneapolis	Inside Back Cover
13	Vitavox speaker	44
29	Weathers Industries	14

Lafayette Radio

165-08 LIBERTY AVE.
JAMAICA 33, N. Y.

DEPT.
AC-G

PLEASE INCLUDE POSTAGE WITH ORDER

Send FREE LAFAYETTE Catalog 305

Name

Address

City..... Zone.... State.....

CUT OUT
AND MAIL
TODAY



Information service for audiocraft readers

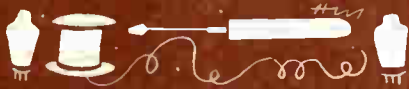

We've made it easier than ever for you to secure prompt additional information about products advertised or mentioned editorially in this issue.

HERE'S ALL YOU DO:

1. Tear out one of the two lower cards along its perforated edges.
2. Fill in your name and address in the space provided at the top of the card. Please type, or print in ink, if at all possible.
3. To get additional information about products advertised in this issue, look up the advertiser's name in the index on the page facing this one. In the column at the left will be found the advertiser's current key number. Simply circle this number in the central section of your card. Do this for each advertiser in whose products you are interested.
4. If you want more information about products described in our Audionews department, or mentioned in other editorial sections, print the product names and the numbers of the pages on which they appear in the spaces provided in the lower section of the card.
5. Drop the card in the nearest mail box. We'll do the rest.

Note that two cards are supplied. You can keep one as a spare, for possible later use, or let a friend use the extra card.

Use this service—everything, even the postage, is free. A special service to Audiocraft readers.

THESE CARDS
FOR THIS ISSUE ONLY

Use this service



BUSINESS REPLY CARD
FIRST CLASS PERMIT NO. 62, SEC. 34.9, P. L. & R., GREAT BARRINGTON, MASS.

audiocraft

POST OFFICE BOX 600
GREAT BARRINGTON, MASS.

N 7-8

**AUDIOCRAFT
READERS'
SERVICE**

● PLEASE TYPE OR PRINT ●

NAME
STREET & NO.
CITY ZONE STATE

ADVERTISED PRODUCTS	1	2	3	4	5	6	7	8	9	10	11	12	13	14	15
(See Key Nos. in index on page at left)	16	17	18	19	20	21	22	23	24	25	26	27	28	29	30
	31	32	33	34	35	36	37	38	39	40	41	42	43	44	45
	46	47	48	49	50	51	52	53	54	55	56	57	58	59	60

PRODUCTS	PRODUCT	PAGE
MENTIONED	PRODUCT	PAGE
EDITORIALY	PRODUCT	PAGE
(Including	PRODUCT	PAGE
AUDIONEWS)	PRODUCT	PAGE

**AUDIOCRAFT
READERS'
SERVICE**

● PLEASE TYPE OR PRINT ●

NAME
STREET & NO.
CITY ZONE STATE

ADVERTISED PRODUCTS	1	2	3	4	5	6	7	8	9	10	11	12	13	14	15
(See Key Nos. in index on page at left)	16	17	18	19	20	21	22	23	24	25	26	27	28	29	30
	31	32	33	34	35	36	37	38	39	40	41	42	43	44	45
	46	47	48	49	50	51	52	53	54	55	56	57	58	59	60

PRODUCTS	PRODUCT	PAGE
MENTIONED	PRODUCT	PAGE
EDITORIALY	PRODUCT	PAGE
(Including	PRODUCT	PAGE
AUDIONEWS)	PRODUCT	PAGE

Subscription

SERVICE PAGE

Because we have so many requests for subscription information, we have decided to publish the full subscription story — all in one place — the result being this page. We hope you'll use it.

audiocraft

Great Barrington, Mass.

Please enter my subscription, starting with the next issue, at the **SPECIAL RATE** of 3 years for only \$9.00.

FOREIGN POSTAGE: \$1.00 per year outside the U. S. A., its possessions, and Canada.

- My remittance is enclosed. I prefer two years for \$7.00.
 Please send me your bill. I prefer one year for \$4.00.

N 7-8

NAME _____

ADDRESS _____

CITY _____ ZONE _____ STATE _____

- Gift subscriptions attached. Send me the following back issues:
 Group subscriptions attached. 1 2 3 6 7 8 9 10 11 12 13 14 15 16 17 18
 19 20 22 23 24 25 26 27 28 29 30
 @ 35¢ each. Payment enclosed.



BUSINESS REPLY CARD
 FIRST CLASS PERMIT NO. 2, COPAKE FALLS, N.Y.

audiocraft

POST OFFICE BOX 50
 COPAKE FALLS, N.Y.

N 7-8



BUSINESS REPLY CARD
 FIRST CLASS PERMIT NO. 2, COPAKE FALLS, N.Y.

audiocraft

POST OFFICE BOX 50
 COPAKE FALLS, N.Y.

N 7-8



REGULAR SUBSCRIPTION RATES

Three years — Nine Dollars. *Save \$3.60 over the single copy cost.*
 Two years — Seven Dollars.
 One year — Four Dollars.
(Add \$1.00 per year for postage on all subscriptions sent to addresses outside of the United States, its possessions, and Canada.)

BARGAIN GROUP SUBSCRIPTION RATES

(One-Year Subscriptions Only)
 Here's a real saving! Just get together a group of subscriptions and submit them all at one time.
 First Subscription — \$4.00.
 Each additional subscription — \$3.00.
 Send the list to our Circulation Department (and mark it SPECIAL GROUP SUBSCRIPTION RATE) with a check or money order in the appropriate amount.

GIFT SUBSCRIPTIONS

You will find that a subscription to AUDIOCRAFT makes the perfect gift for any occasion. If you submit more than one subscription (at the same time), the special group rates shown above will apply. We will acknowledge your gift, to the person receiving it, with a special gift announcement card signed with your name, if you request us to do so.

BACK COPIES

Following back copies available at 35¢ each.

	No. 1 Nov. 1955	No. 2 Dec. 1955	
No. 1956	No. 1957	No. 1958	
3 Jan.	15 Jan.	27 Jan.	
6 Apr.	16 Feb.	28 Feb.	
7 May	17 Mar.	29 Mar.	
8 June	18 Apr.	30 Apr.	
9 July	19 May		
10 Aug.	20 June		
11 Sept.	22 Aug.		
12 Oct.	23 Sept.		
13 Nov.	24 Oct.		
14 Dec.	25 Nov.		
	26 Dec.		

Please circle number on card at upper left and enclose your remittance. Sorry we cannot bill for single copies.

Look to the
LEADER—
to stay ahead!

Telephone:
TUxedo 1-2636



Viking OF MINNEAPOLIS
9600 Aldrich Avenue South, Minneapolis 20, Minnesota

Whether you are a stay at home listener, a roving recordist, or a meter-minded, evaluating, son-of-a-pro, you'll find something new, sparkling, and downright surprising at your nearby Viking dealer's.

HOW DID IT COME ABOUT? For three years Viking has led the parade as the largest manufacturer of tape decks and tape system components. For three years we've listened attentively as audiophiles and dealers told us the kind of tape equipment they would like to see. Now, at Viking dealers, you'll see the results of the research program you initiated.

FIRST, of course, you'll find the Viking "75" — virtually unchanged, as befits the deck that has won its place as the *work horse* of the industry; the *most used* deck in homes, language teaching, and secondary commercial applications. Front panel speed change is now standard.

NEW THIS YEAR, the sparkling "85." Featuring Viking's famous *flutter-filter* belt drive, but with two motors for high-speed fast forward and rewind and rotary controls for e-a-s-y and truly foolproof tape motion control. Room for five heads, including the new quarter-track heads for long play tapes.

PLUS THE NEW VIKING "95." Commercial in every respect. The "95" brings you *flutter-filter* belt drive, but with a hysteresis synchronous motor. The result: a new standard for tape transport performance. The "95" features 10½-inch reels, dynamic braking and tape tensioning, and typical Viking simplicity.

New stocks are now shipping to Viking dealers — see and hear the **BIG THREE** by Viking.

For a complete catalog and specifications on decks, recording amplifiers and accessories, write Viking's Customer Service Department.

Yours for the best of tapes,

VIKING OF MINNEAPOLIS



AUDIO FIDELITY RECORDS

Lend an ear to some of the most exciting, earth-shaking sounds and musical effects ever recorded . . . and the Fi is fantastically high! These are not ordinary recordings but true hi fi recordings of the total recordable frequency spectrum with full emotional depth and meaning!

\$5.95 each monaural album \$6.95 each Stereodisc*

WRITE FOR FREE CATALOG • 770 ELEVENTH AVENUE • NEW YORK 19, NEW YORK

*REG. APP. FOR

AUDIO FIDELITY STEREODISCS*

