

# Should You Buy a Stereo Recorder?

MARCH 1958 • 35 CENTS

# audiocraft

for the **HI-FI** hobbyist

**Kit Report: the Dynaco  
preamp-control unit**

**How to make a simple  
distortion meter**

**Build a rear-loading  
corner horn enclosure**

**First report on the  
new 16-rpm records**

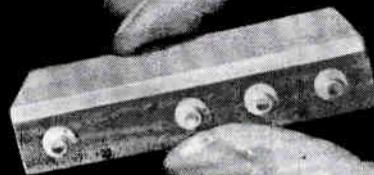



**NEW!**

# MODEL TPA/10 THE DISTINGUISHED TRANSCRIPTION TONE ARM

BY

# Garrard

Some of the  
significant questions  
being asked about it  
... and their  
exciting answers



Q

How much is the Garrard Tone Arm?

A

\$24.50

Is it built to give me professional-quality performance?



Yes... because this precision design, by incorporating the smallest number of pivots, reduces traversing friction to an absolute minimum. This also results in the least amount of wear and tear on records, through the use of spring-loaded, cone-type ball-bearing pivots... similar to those you will find in the finest chronometers. The vertical pivot is a specially-designed bearing, combining the features of a ball-bearing journal suspended on a single ball thrust.

What else is "different" about this Tone Arm?



Why is it important for me to be able to set it to any length?

Infinite versatility! It is the only tone arm which is fully adjustable in length and tracking angle. This means that with the Garrard arm, you can make every adjustment you would conceivably wish to make on a tone arm.

For two reasons: (1) You can set it for the longest position permitted by the space you have available now. (2) If you change the installation, you will be able to readjust this arm, keeping the important benefits of using a "longer" arm... playing a full 16" record.

Doesn't this require changing tracking angle?

How do I adjust the tracking angle?

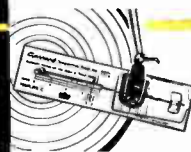

Yes, of course. In fact, there are many opinions regarding optimum tracking angle for any given length.

With the protractor which is supplied with the tone arm. In a few seconds, this ingenious accessory lays out the recommended angle on which to align the cartridge for the arm length you are using. Since there are various opinions regarding the optimum tracking angle at various radii, this protractor will also enable you to set the angle at any desired radius.

Will it take any cartridge, and is it easily installed?



Yes, the removable head will take just about any cartridge on the market. This tone arm is designed to be used with any transcription turntable, and adjusts easily for height and stylus pressure. The special templates supplied show you the exact mounting location. Incidentally, the instructions are the clearest and most complete we have ever seen with a tone arm.

Where can I see the Garrard Tone Arm, and how can I recognize it?



It is at your high fidelity dealer, and you will certainly recognize it through its handsome appearance... glistening chrome with white enamel. Look for it in a distinctive blue and white box.

DEPT. GC-98, GARRARD SALES CORPORATION • PORT WASHINGTON, N.Y.

THERE'S A  
**Garrard**  
WORLD'S FINEST RECORD PLAYER  
FOR EVERY HIGH FIDELITY SYSTEM



301  
Turntable  
\$89.00



RC98  
Super Changer  
\$67.50



RC88  
Deluxe Changer  
\$54.50



RC121  
Mixer Changer  
\$42.50



Model T Mark II  
Manual Player  
\$32.50



Explosive, indefatigable "Hamp" ... at the drums, at the piano, at the vibes. "Hamp" at his swingin' best! AFLP 1849

Traditional happy New Orleans Mardi Gras Dixie plus the excitement of Festival Time packed into a great new album! Volume 6 AFLP 1862

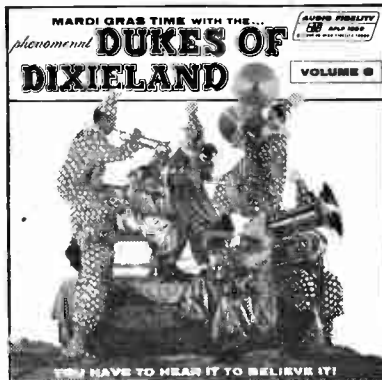

Rousing, frantic music from the Middle East. Mike Sarkissian and his Cafe Bagdad Ensemble. AFLP 1865



Steam engines . . . Diesel engines . . . earth-shaking dynamics of a vanishing era captured in high fidelity. AFLP 1843

Easy listening as Jack Anderson, at the Hammond Organ, opens a magic portal to a vast panorama of sound. AFLP 1856

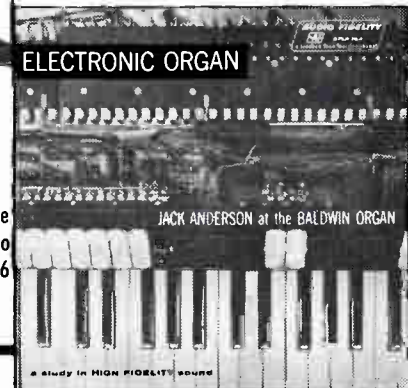

records with excitement!!!

# AUDIO FIDELITY

TOTAL FREQUENCY RANGE RECORDINGS

For sheer exciting entertainment AUDIO FIDELITY produces the newest, up-to-the-minute, most delightful recorded creations. With the greatest sound engineering in High Fidelity . . . and the Fi is *fantastically* High!

each 12 inch LP — \$5.95

WRITE FOR FREE CATALOG — Dept. AC 2  
770 ELEVENTH AVENUE, NEW YORK 19, N. Y.



Wild, colorful, exciting, hand-clapping, heel-stamping authentic Spanish Gypsy music. Recorded in Spain. AFLP 1852



Brilliant new recording star! Witty arrangements plus a high-spirited performance add up to hours of delightful listening pleasure. AFLP 1864

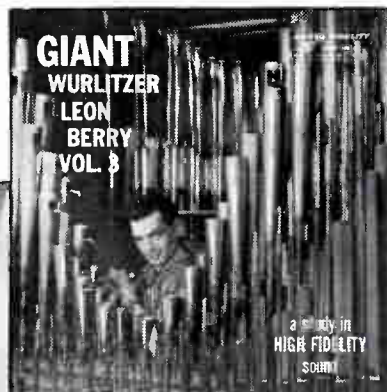

Leon Berry, plus the Giant in the basement and a fabulous technique add up to an exciting listening session of all-time favorites. Volume 3. AFLP 1844



Skirling Bag Pipes, rattling snares and booming bass drums! Well-known melodies, superb hi-fi! 9th Regiment Pipe Band. AFLP 1857

**the pause that will keep your records young**



## **an exclusive feature of the new Glaser-Steers GS-77**

Your records can be a lasting joy, their original brilliance preserved for many hundreds of performances. This takes special care to guard against undue record wear. The new GS-77 handles records more gently than any other automatic record playing mechanism.

**TURNABLE PAUSE** is a dramatic example of this fact. During the record-change cycle, the GS-77 turntable comes to a complete halt, and doesn't resume motion until the stylus has come to rest in the run-in groove of the next record. This completely eliminates the grinding action which occurs where records are dropped onto a moving turntable or disc.

The GS-77 **TONE ARM** affords further protection. Improved mass distribution and low pivot friction have so minimized arm resonance and tracking error that these flagrant causes of groove and stylus wear are now virtually eliminated. In addition, the arm has been so designed that stylus pressure between the first and top records in a stack does not vary more than 0.9 gram.

**SPEEDMINDER** goes still further—for by simply setting the appropriate stylus into play position, the GS-77 automatically plays at the correct record speed, and in the microgroove position, intermixes 33 $\frac{1}{3}$

and 45 rpm records regardless of their sequence in the stack.

The GS-77 is the perfect high fidelity record changer. It combines traditional turntable quality with modern automatic conveniences—and it does this with incredible mechanical simplicity. No wonder

... audiophiles are switching to the new **GLASER-STEERS GS-77**

See your hi-fi dealer today, or write to:  
**GLASER-STEERS CORPORATION**  
20 Main Street, Belleville 9, New Jersey

In Canada: Glaser-Steers of Canada, Ltd., Trenton, Ont.  
Export: M. Simons & Sons Co., Inc. N. Y. 7, N. Y.

# audiocraft

THIS MONTH'S COVER: Noting the trend toward slower record speeds, we unveil our brainchild, the AC Minidisc, which revolves at 3 3/4 rpm (revolutions per week), takes a .00001 stylus, has a guaranteed frequency response of from 1.769 to 1.942 cph (cycles per hour) with RIAB playback, and unmeasurable (above 100%) IM. The Dynakit preamp (shown for size comparison) will not quite match the equalization needs of our Minidisc. Cover by Phil Geraci.



**Roy F. Allison**  
Editor  
**Eleanore B. Wright**  
Assistant to the Editor  
**Philip C. Geraci**  
Associate Editor  
**Eleanor Gilchrist**  
**Norman C. Dellert**  
Art Assistants  
**R. D. Darrell**  
**J. Gordon Holt**  
**Joseph Marshall**  
Contributing Editors

**Charles Fowler**  
Publisher  
**Warren B. Syer**  
Associate Publisher  
**Claire Eddings**  
Advertising Sales Manager  
**Andrew J. Csida**  
Marketing and Merchandising Manager  
**Arthur J. Griffin**  
Circulation Manager  
**Frances A. Newbury**  
Manager, Book Division  
**Lee Zhitto**  
Western Manager

THE MAGAZINE FOR THE HI-FI HOBBYIST

MARCH 1958

Volume 3 Number 3

<b>The Grounded Ear</b> <i>What's new in sound reproduction</i>	<b>4</b>	<i>Joseph Marshall</i>
<b>Book Reviews</b>	<b>6</b>	<i>Richard D. Keller</i>
<b>Audionews</b>	<b>12</b>	
<b>Editorial</b> <i>Announcing the Audiolab Test Reports, a unique testing service</i>	<b>15</b>	
<b>Readers' Forum</b>	<b>15</b>	
<b>The Dynakit Preamp</b> <i>An AUDIOCRAFT kit report</i>	<b>16</b>	<i>Joseph Marshall</i>
<b>Stereo and Your Tape Recorder</b> <i>Should you buy a recorder now?</i>	<b>20</b>	<i>Joel Ehrlich</i>
<b>How to Make a Distortion Meter</b> <i>An easy-to-construct device for harmonic-distortion measurement</i>	<b>22</b>	<i>Rufus P. Turner</i>
<b>Build a Folded-Horn Enclosure</b> <i>Complete blueprints and construction data</i>	<b>24</b>	<i>Harvey P. Jones</i>
<b>Transistors in Audio Circuits</b> <i>Part IX: Medium- and high-power transistors</i>	<b>26</b>	<i>Paul Penfield, Jr.</i>
<b>Tape News and Views</b> <i>How to cure transport troubles</i>	<b>28</b>	<i>J. Gordon Holt</i>
<b>Audio Aids</b> <i>Short cuts for the hi-fi hobbyist</i>	<b>31</b>	
<b>Puzzlements</b> <i>What effect do volume-control settings have on distortion?</i>	<b>32</b>	<i>Norman H. Crowhurst</i>
<b>Sound-Fanciers' Guide</b> <i>Reviews of exceptional tape and disc records</i>	<b>34</b>	<i>R. D. Darrell</i>
<b>Professional Directory</b>	<b>46</b>	
<b>Traders' Marketplace</b>	<b>48</b>	
<b>Advertising Index</b>	<b>48</b>	

## ADVERTISING

Main Office — Claire Eddings, The Publishing House, Great Barrington, Mass. Telephone: Great Barrington 1300.  
New York — 1546 Broadway, New York 36. Telephone: Plaza 7-2800.  
Chicago — John R. Rutherford & Associates, Inc., 230 East Ohio St., Chicago 11, Ill. Telephone: Whitehall 4-6715.  
Los Angeles — 1520 North Gower, Hollywood 28. Telephone: Hollywood 9-5831.

Audiocraft Magazine is published monthly by Audiocom, Inc., in Great Barrington, Mass. Telephone: Great Barrington 1300. Editorial, publication, and circulation offices at: The Publishing House, Great Barrington, Mass. Subscriptions: \$4.00 per year in the United States and Canada. Single copies: 35 cents each. Editorial contributions will be welcomed by the editor. Payment for articles accepted will be arranged prior to publication. Unsolicited manuscripts should be accompanied by return postage. Entered as second-class matter October 1, 1955, at the post office, Great Barrington, Mass., under the act of March 3, 1879. Additional entry at the post office, Pittsfield, Mass. Printed in the U. S. A. by the Ben Franklin Press, Pittsfield, Mass. Copyright 1958 by Audiocom, Inc. The cover design and contents of Audiocraft Magazine are fully protected by copyrights and must not be reproduced in any manner.

# The Grounded Ear

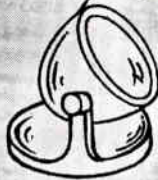

by Joseph Marshall

## 16 $\frac{2}{3}$ -RPM Music Records

It has been nearly two years since the 16 $\frac{2}{3}$ -rpm record speed was first introduced and, although most modern changers and some turntables provide for this very slow speed, it has been used almost entirely for the "talking-book" type of recordings. Vox is the first of the major recording companies to produce music recordings which are playable with 1-mil styli for this speed. Now that the ice has been broken I have no doubt that other labels will follow suit, especially since the Vox releases sound a lot better than I expected them to.

These records are dubbed from the tapes used for Vox's standard LP catalogue. Each disc contains roughly an hour of music on each side, or two hours per disc. They are completely compatible with present equipment in the sense that they are recorded with the same groove width as 33 $\frac{1}{3}$ -rpm LP's, and can be played with the same stylus, equalizers, etc. However, they will sound better with some equipment than with other. For example, pickups with 0.5-mil or 0.7-mil styli will have less translation loss at the high frequencies,

*Jacket of first Vox 16 $\frac{2}{3}$ -rpm record.*

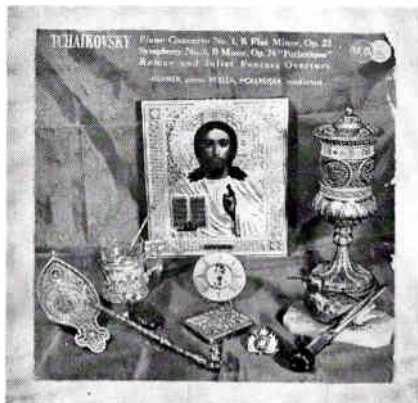

and these records will sound noticeably brighter with them. The Shure Dynetic, Fairchild XP3, and Pickering cartridges with 0.5-mil styli are particularly suitable.

But they are surprisingly good with the more conventional cartridges too; and with some of the older magnetics, which slope beyond 8,000 cps, and with most crystals and ceramics, they are not much inferior to standard LP's. The bass end is not affected by the slower speed (except as noted later). Nobody with a critical ear would trade the extra playing time for the higher quality of today's high-fidelity LP's; but I think a lot of people with less demanding sonic tastes will be content with them, and they will find obvious applications in "do-it-yourself" substitutes for commercial background-music services.

There are going to be some problems, however. I wonder how suitable those changers with the fourth speed will really prove to be. This speed presents even more severe rumble problems than 33 $\frac{1}{3}$  rpm. Moreover, playing these records produces some terrific subsonic surges which are going to get a lot of amplifiers into trouble. I found, for example, that the combination of the Dynakit preamp with my Apartment Amplifier (described in the preceding "Grounded Ear" column), which was perfectly stable with 33 $\frac{1}{3}$ -rpm records, would not do for the 16 $\frac{2}{3}$ -rpm records unless the preamp was fed from a separate power supply. If my experience is at all typical it suggests that one of these recordings will provide an excellent test for subsonic stability.

Furthermore, wow is going to be a larger problem, and variation in speed is likely to produce a quicker deterioration of quality. Vox recommends that the turntable be permitted to revolve for several minutes before the record is played so that the motor can come up to speed. But this is not easy with some changers, which are designed so that the turntable stops when the arm is not on

*What's new for your  
future in sound  
reproduction?*

the record. If the speed is significantly lower than 16 $\frac{2}{3}$  rpm, the treble response will seem much poorer.

However, these are far smaller problems than those accompanying the first LP's; indeed, their challenge may well result in improved equipment for the higher speeds. Meanwhile, assuming that the price will be reasonably comparable to that of 33 $\frac{1}{3}$ -rpm LP's of the same disc size, it is a safe bet that these slow-speed records are here to stay.

## Imported Audio Tubes

More and more, new hi-fi equipment comes supplied with British, Dutch, or German tubes. There has been some alarm in the American tube industry over this competition from imports. I find it impossible to muster much sympathy. This situation is the result of the indifference of the American tube industry to the needs of high fidelity,

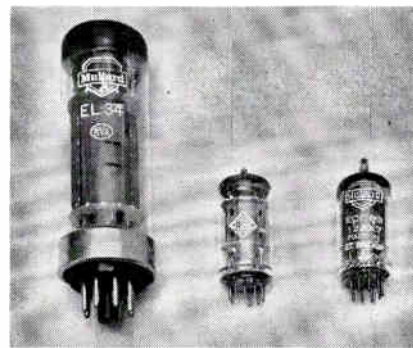

*Three representative imported tubes.*

and I trust it will serve as a lesson for the future.

For years we have been crying for tubes better suited to hi-fi use. Only one American manufacturer paid any heed; Tung-Sol developed the 5881 and 6550 output tubes. Manufacturers abroad in general have been doing far better. The British KT66 was and still is a superb audio tube. The EL34/6CA7 and the EL84 have, between them, just about taken over the entire hi-fi market for output tubes. The KT88, based on the 6550, appears to be more linear than

*Continued on page 42*

# AR1

## AR2

### ACOUSTIC SUSPENSION\* SPEAKER SYSTEMS

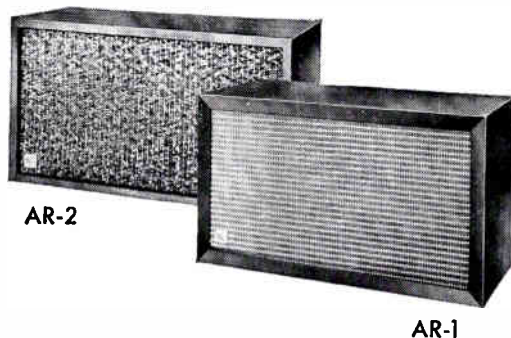

## Quotation from High Fidelity

(From Roy F. Allison's article "New Directions in High Fidelity,"  
a survey of progress in reproducing equipment design since 1952.)

"It is difficult to draw a line between new methods of exploiting old techniques and radically new developments in loudspeaker systems, but I will risk a charge of arbitrariness by citing three of the latter produced commercially during the past five years. First, the acoustic suspension principle, by means of which linear deep-bass response was obtained (with a decrease in average acoustic efficiency) from a very small system for the first time."

\*The acoustic suspension speaker requires a cabinet of small size, so that the enclosed air-spring--without which the special speaker mechanism cannot operate properly--will provide sufficient restoring-force to the cone. This air-spring is more linear than the finest mechanical suspensions that can be devised. Therefore the small enclosure, far from involving a compromise with quality, has established new industry standards in low-distortion speaker performance. (Covered by U.S. Patent 2,775,309 issued to E. M. Villchur, assignor to Acoustic Research, Inc.)

Prices for AR speaker systems, complete with cabinets, are \$89.00 to \$194.00. Literature is available on request from:

**ACOUSTIC RESEARCH, INC. 24 Thorndike St., Cambridge 41, Mass.**

## Electronic Firsts



by **MONROE OPTON**

Author of  
"Electronics for Everyone"

**T**ODAY'S dynamic loudspeaker, with its copper or aluminum voice coil attached to a paper diaphragm, was patented in 1898 by Sir Oliver Lodge (British patent 9,712).

Early workers in wireless had borrowed the telephone's earphone, later going to a pair of headphones. Sir Oliver obtained greater efficiency from a large paper diaphragm attached to a coil floating in a magnetic field than could be had from a small iron diaphragm over a pair of pole pieces. However, before the birth of the three-element tube, without which amplification was impractical, the receiver's signal was too feeble to operate a speaker.

When radio broadcasting came along, in the early 20's, the engineers skipped over the Lodge invention to the older headphone for the first speaker, merely adding to it a horn. The horn provided a directional effect, plus some amplification because of better coupling with the air. This "primitive" speaker not only had a very limited frequency range, it overloaded easily to create a rattle that came from the metal diaphragm touching the pole pieces. Its tinny sound contributed to the opinion held by many in those days that radio was only a fad for those too limited to learn how to play mah-jongg.

Very ingenious improvements were made upon the "moving iron" type of speaker, greatly improving both its frequency range and its power-handling capacity. But when Magnavox came out with the first "moving coil" job, the superiority was so obvious that it immediately became the standard transducer for all types of radio receivers. And it probably will be king for a long time to come before it is dethroned by the rival electrostatics and ionics.

**T**HE *paragrele* was invented by the Abbé Martholon, described in his book, *Meteoric Electricity*, published in France in 1787. This ingenious electrical device consists of a number of high, pointed conductors, well grounded, and spaced close together. The metallic points draw from the air quantities of electricity that is about to push raindrops from the clouds. Thus the *paragrele* prevents rain from falling. As George Gobel would put it, "You can't hardly find them no more."

by RICHARD D. KELLER

# book reviews



## Low Cost Hi-Fi

Donald Carl Hoefter; pub. by Fawcett Publications, Inc., Greenwich, Conn.; 144 pages; 75¢, paper-bound.

A lot of illustrations and good information is packed into this magazinelike book. It is divided into a number of separate articles on the various phases of hi fi, all by the same author, who has done a nice job of injecting his personality and his considered opinions into each of them.

Such titles as "How to Spot a Bargain," "Kits Cut Costs," "Hi-Fi's Best Buys," "Repair Your Own and Save," and "Yours for the Asking" (listing free literature available from manufacturers) are a clue to the value of this book to the audio newcomer working with a slim budget. And the author's fresh style and candid opinions will appeal to all who enjoy digging into the many faceted mysteries of hi fi, and who want to expand their sound systems at minimum expense.

## Stereophonic Sound

Norman H. Crowhurst; pub. by John F. Rider Publisher, Inc., New York; 118 pages; \$2.25, paper-bound.

This well-illustrated book is evidently the first on the subject of stereo, and it provides a very good introduction and discourse on the subject.

The author goes beyond mere elementary descriptions and into the physiological and psychological aspects of hearing and direction sensing. He discusses the results and limitations of many of the tests which have been conducted to find out how the human hearing mechanism determines the directionality of sound. The importance of loudness versus phase difference, and system frequency range, transient response, and recording- and listening-room environments are covered thoroughly and interestingly.

A great deal is said about the various types of systems—two channel, three channel, Stereosonic, and coded single

channel—and the various program mediums such as radio, disc, films, and tape. Various schools of thought on recording procedures are presented, with suggestions about types of equipment—loudspeakers, enclosures, and their placement.

Stereophonic sound is still essentially in its infancy and many of its ramifications and subtleties are as yet little known. This book compiles most of the current thinking on the subject and should stimulate still further thought and research.



## Repairing Hi-Fi Systems

David Fidelman; pub. by John F. Rider Publisher, Inc., New York; 204 pages; \$3.90, paper-bound.

The growth of the hi-fi kit business in the last few years is right in line with the burgeoning national do-it-yourself trend. Surprisingly enough, a large percentage of the people who build their own amplifier and speaker systems also order oscillator and oscilloscope kits to check their finished products.

To these people, as well as to established radio and TV repairmen, the author addresses this book. At the offset, he carefully segregates high-fidelity equipment from general run-of-the-mill radio-TV and cautions that the quality of servicing skill and care must be much better on the finer sound systems.

He lists the various types of distortion which can corrupt sound and then discusses such audio servicing techniques as signal tracing and square-wave testing, giving complete coverage to the available audio test equipment in both kit and manufactured versions, with specifications and operating procedures.

Most of the book is concerned with fairly comprehensive servicing techniques on amplifiers, pickups, loudspeakers, AM and FM tuners, record players and

changers, and tape recorders. Numerous tables are given throughout the book summarizing the material of each chapter in a convenient form.

This book is not, certainly, in the same near-engineering category as Joseph Marshall's *Maintaining Hi-Fi Equipment* (Gernsback), but it does fill a definite need for amateurs and semitechnical people.

## Transistor A. F. Amplifiers

D. D. Jones and R. A. Hilbourne; pub. by Philosophical Library, New York; 152 pages; \$6.00.

There has been comparatively little on the book market concerning the application of transistors to audio amplifiers. Now that Shea's book, *Transistor Audio Amplifiers* (Wiley), is more or less outdated, a few pamphlets and booklets and a number of magazine articles are all that is left. So it was that this book, dated July 1957, held promise as a practical, up-to-date guide on how to apply these tiny devices to high fidelity. Unfortunately, that hope has not been fulfilled.

Primarily, the book discusses five transistor audio amplifiers with outputs ranging from 1 to 20 watts. All of them are similar in design, with higher-rated transistors and components used to obtain the higher power outputs. There are also theoretical discussions of complementary symmetry outputs and regulated power supplies (without any circuit values).

The transistors used in all the circuits are British-made and practically unavailable in the United States, and there is not enough information given to ascertain which American units could be substituted for them, although undoubtedly such do exist. There is some worthwhile material here, but Americans will evidently have to wait a little longer for any real transistor help, meanwhile utilizing the practical booklets of circuits available from manufacturers such as GE, RCA, Raytheon, and Sylvania as guides.





the experts say... in High Fidelity the best buys are **EICO**<sup>®</sup>

**EICO**  
KITS and WIRED

**BETTER ENGINEERING** Since 1945 EICO has pioneered the concept of test instruments in easy-to-build kit form — has become world-famous for laboratory-precision instruments at low cost. Now EICO is applying its vast experience to the creative engineering of *high fidelity*. Result: high praise from such authorities as Canby of AUDIO, Marshall of AUDIOCRAFT, Holt of HIGH FIDELITY, Fintel of POPULAR ELECTRONICS, Stocklin of RADIO TV NEWS, etc. — as well as from the critical professional engineers in the field.†

**SAVE 50%** Mass purchasing, and a price policy deliberately aimed to encourage mass sales, make this possible.

**EASY INSTRUCTIONS** You need no previous technical or assembly experience to build any EICO kit — the instructions are simple, step-by-step, "beginner-tested."

**DOUBLE 5-WAY GUARANTEE** Both EICO, and your neighborhood distributor, guarantee the parts, instructions, performance . . . as well as *lifetime* service and calibration at nominal cost . . . for any EICO kit or wired unit.

**BEFORE YOU BUY, COMPARE** At any of 1200 neighborhood EICO distributors coast to coast, you may examine and listen to any EICO component. Compare *critically* with equipment several times the EICO cost — then *you* judge. You'll see why the experts recommend EICO, kit or wired, as best buy.

† Thousands of unsolicited testimonials on file.



HFS2  
Speaker System



HFT90 FM Tuner  
with "eye-tronic" tuning



HF61 Preamplifier

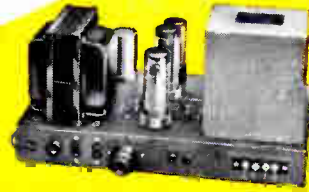

HF60, HF50 Power Amplifiers



**HFS2 Speaker System:** Uniform loading & natural bass 30-200 cps achieved via slot-loaded split conical bass horn\*\* of 12-ft path. Middles & lower highs from front side of 8½" cone, edge-damped & stiffened for smooth uncolored response. Suspensionless, distortionless spike-shaped super-tweeter\*\* radiates omni-directionally. Flat 45-20,000 cps, useful to 30 cps. 16 ohms. HWD: 36", 15¼", 11½". " . . . rates as excellent . . . unusually musical . . . really non-directional" — Canby, AUDIO. "Very impressive" — Marshall (AUDIOCRAFT). Walnut or Mahogany, \$139.95. Blonde, \$144.95.

**HFT90 FM Tuner** equals or surpasses wired tuners up to 3X its cost. New, pre-wired, pre-aligned, temperature-compensated "front end" — drift-free. Sensitivity, 1.5 uv for 20 db quieting, is 6X that of other kit tuners. DM-70 traveling tuning eye. Response 20-20,000 cps ±1 db. Cathode follower & multiplex outputs. Kit \$39.95\*. Wired \$65.95\*. Cover \$3.95. \*Less cover, excise tax incl.

**HF61A Preamplifier**, providing the most complete control & switching facilities, and the finest design, offered in a kit preamplifier, " . . . rivals the most expensive preamps . . . is an example of high engineering skill which achieves fine performance with simple means and low cost." — Joseph Marshall, AUDIOCRAFT. HF61A Kit \$24.95, Wired \$37.95, HF61 (with Power Supply) Kit \$29.95, Wired \$44.95.

**HF60 60-Watt Ultra Linear Power Amplifier**, with Acro TO-330 Output Transformer, provides wide bandwidth, virtually absolute stability and flawless transient response. " . . . is one of the best-performing amplifiers extant; it is obviously an excellent buy." —AUDIOCRAFT Kit Report. Kit \$72.95. Wired \$99.95. Matching Cover E-2 \$4.50.

**HF50 50-Watt Ultra-Linear Power Amplifier** with extremely high quality Chicago Standard Output Transformer. Identical in every other respect to HF60 and same specifications up to 50 watts. Kit \$57.95. Wired \$87.95. Matching Cover E-2 \$4.50.

**HF30 30-Watt Power Amplifier** employs 4-EL84 high power sensitivity output tubes in push-pull parallel, permits Williamson circuit with large feedback & high stability. 2-EZ81 full-wave rectifiers for highly reliable power supply. Unmatched value in medium-power professional amplifiers. Kit \$39.95. Wired \$62.95. Matching Cover E-3 \$3.95.

**HF-32 30-Watt Integrated Amplifier Kit \$57.95.** Wired \$89.95.

**HF52 50-Watt Integrated Amplifier** with complete "front end" facilities and Chicago Standard Output Transformer. Ultra-Linear power amplifier essentially identical to HF50. The least expensive means to the highest audio quality resulting from distortion-free high power, virtually absolute stability, flawless transient response and "front end" versatility. Kit \$69.95. Wired \$109.95. Matching Cover E-1 \$4.50.

**HF20 20-Watt Integrated Amplifier**, complete with finest preamp-control facilities, excellent output transformer that handles 34 watts peak power, plus a full Ultra-Linear Williamson power amplifier circuit. Highly praised by purchasers, it is established as the outstanding value in amplifiers of this class. Kit \$49.95. Wired \$79.95. Matching Cover E-1 \$4.50.

Prices 5% higher in the West

**HF12 12-Watt Integrated Amplifier**, absolutely free of "gimmicks", provides complete "front end" facilities & true fidelity performance of such excellence that we can recommend it for any medium-power high fidelity application. Two HF12's are excellent for stereo, each connecting directly to a tape head with no other electronic equipment required. Kit \$34.95. Wired \$57.95.

**HFS1 Two-Way Speaker System**, complete with factory-built cabinet. Jensen 8" woofer, matching Jensen compression-driver exponential horn tweeter. Smooth clean bass; crisp extended highs. 70-12,000 cps ± 6 db. Capacity 25 w. Impedance 8 ohms. HWD: 11" x 23" x 9". Wiring time 15 min. Price \$39.95.

**MAIL COUPON FOR CATALOG**

EICO® 33-00 Northern Blvd., L.I.C. 1, N.Y.  
Show me how to SAVE 50% on professional Test Instruments and High Fidelity. Send me free catalog and name of neighborhood distributor.

Name .....

Address .....

City ..... Zone ..... State .....

AC-3

\*\* Patents pending by Hegeman Laboratories



HF52, HF20  
Integrated Amplifiers



HF12 Integrated Amplifier

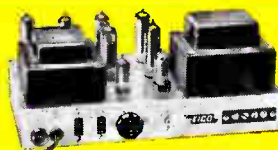

HF30 Power Amplifier



HFS1  
Speaker System



33-00 Northern Boulevard, L. I. C. 1, N. Y.  
Over 1 Million EICO instruments in use the world over.

© 1958

easy-to-build

high quality

# HEATHKITS®

**Look** . . . how simply you can assemble your very own high fidelity system! Fun-filled hours of shared pleasure, and an everlasting sense of personal accomplishment are just a few of the rewards. Heathkits cost you only HALF as much as ordinary equipment and the quality is unexcelled. Let us show you how easy it really is! . . .



- (✓) Install a .001 µfd disc condenser from socket B7 (NS) to ground lug B11 (NS). Cut the leads so that they are just long enough to reach and dress the condenser close to chassis, over the wires already present.
- ( ) Connect a 470 KΩ resistor (yellow-violet-yellow) from socket B7 (S) (2) to B8 (NS). Mount as close to the socket as possible.

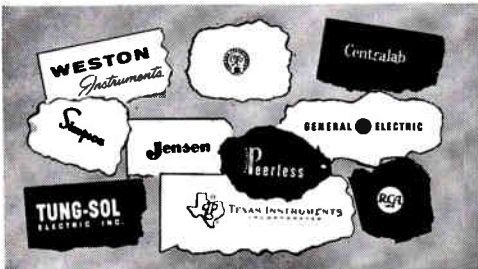
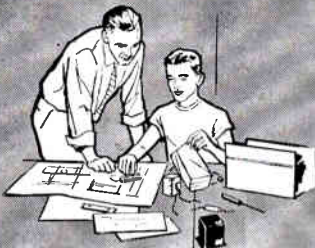
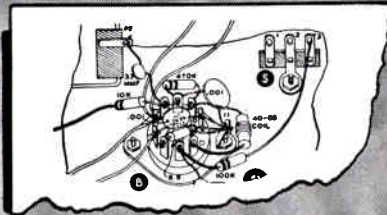

### Step-by-Step Assembly Instructions . . .

Read the step . . . perform the operation . . . and check it off—it's just that simple! These plainly-worded, easy-to-follow steps cover every assembly operation.

### Easy-to-follow Pictorial Diagrams . . .

Detailed pictorial diagrams in your Heathkit construction manual show where each and every wire and part is to be placed.

### Learn-by-doing Experience For All Ages . . .

Kit construction is not only fun—but it is educational too! You learn about radio, electronic parts and circuits as you build your own equipment.

### Top Quality Name-Brand Components Used in All Kits . . .

Electronic components used in Heathkits come from well-known manufacturers with established reputations. Your assurance of long life and trouble-free service.



HEATHKIT

## bookshelf 12-watt amplifier kit

# NEW

MODEL EA-2

**\$25<sup>95</sup>**

There are many reasons why this attractive amplifier is a tremendous dollar value. You get many extras not expected at this price level. Rich, full range, high fidelity sound reproduction with low distortion and noise . . . plus "modern" styling, making it suitable for use in the open, on a bookcase, or end table. Look at the features offered by the model EA-2: full range frequency response (20—20,000 CPS ± 1 db) with less than 1% distortion over this range at full 12 watt output—its own built-in preamplifier with provision for three separate inputs, mag phono, crystal phono, and tuner—RIAA equalization—separate bass and treble tone controls—special hum control—and it's easy-to-build. Complete instructions and pictorial diagrams show where every part goes. Cabinet shell has smooth leather texture in black with inlaid gold design. Front panel features brushed gold trim and buff knobs with gold inserts. For a real sound thrill the EA-2 will more than meet your expectations. Shpg. Wt. 15 lbs.

**TIME PAYMENTS AVAILABLE ON ALL HEATHKITS WRITE FOR FULL DETAILS**



## chairside enclosure kit

# NEW

This beautiful equipment enclosure will make your hi-fi system as attractive as any factory-built professionally-finished unit. Smartly designed for maximum flexibility and compactness consistent with attractive appearance, this enclosure is intended to house the AM and FM tuners (BC-1A and FM-3A) and the WA-P2 preamplifier, along with the majority of record changers, which will fit in the space provided. Adequate space is also provided for any of the Heathkit amplifiers designed to operate with the WA-P2. During construction the tilt-out shelf and lift-top lid can be installed on either right or left side as desired. Cabinet is constructed of sturdy, veneer-surfaced furniture-grade plywood  $\frac{1}{2}$ " and  $\frac{3}{4}$ " thick. All parts are pre-cut and pre-drilled for easy assembly. Contemporary available in birch or mahogany, traditional in mahogany only. Beautiful hardware supplied to match each style. Dimensions are 18" W x 24" H x  $35\frac{1}{2}$ " D. Shpg. Wt. 46 lbs.



CE-1C Mahogany  
CE-1CB Birch

**CONTEMPORARY**



CE-1T Mahogany

**TRADITIONAL**

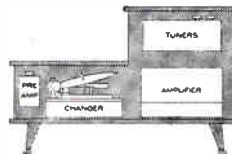

Be sure to specify model you prefer

**\$43<sup>95</sup>** each



**HEATHKIT**

### high fidelity FM tuner kit

For noise and static free sound reception, this FM tuner is your least expensive source of high fidelity material. Efficient circuit design features stabilized oscillator circuit to eliminate drift after warm-up and broadband IF circuits assure full fidelity with high sensitivity. All tunable components are prealigned so it is ready for operation as soon as construction is completed. The edge-illuminated slide rule dial is clearly numbered for easy tuning. Covers complete FM band from 88 to 108 mc. Shpg. Wt. 8 lbs.

**MODEL FM-3A \$25.95 (with cabinet)**



**HEATHKIT**

### broadband AM tuner kit

This tuner differs from an ordinary AM radio in that it has been designed especially for high fidelity. A special detector is incorporated and the IF circuits are "broadbanded" for low signal distortion. Sensitivity and selectivity are excellent and quiet performance is assured by a high signal-to-noise ratio. All tunable components are prealigned before shipment. Incorporates automatic volume control, two outputs, and two antenna inputs. An edge-lighted glass slide rule dial allows easy tuning. Your "best buy" in an AM tuner. Shpg. Wt. 9 lbs.

**MODEL BC-1A \$25.95 (with cabinet)**

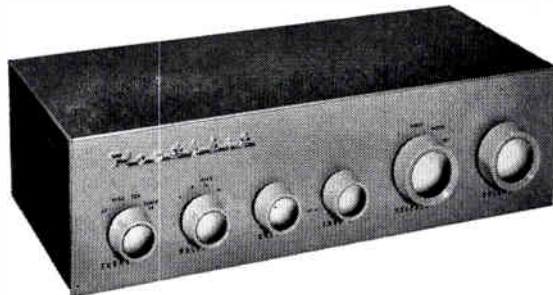

**HEATHKIT**

### master control preamplifier kit

Designed as the "master control" for use with any of the Heathkit Williamson-type amplifiers, the WA-P2 provides the necessary compensation, tone, and volume controls to properly amplify and condition a signal before sending it to the amplifier. Extended frequency response of  $\pm 1\frac{1}{2}$  db from 15 to 35,000 CPS will do full justice to the finest program material. Features equalization for LP, RIAA, AES, and early 78 records. Five switch-selected inputs with separate level controls. Separate bass and treble controls, and volume control on front panel. Very attractively styled, and an exceptional dollar value. Shpg. Wt. 7 lbs.

**MODEL WA-P2 \$19.75 (with cabinet)**

pioneer in  
"do-it-yourself"  
electronics  
**HEATH**



a subsidiary of Daystrom, Inc.

**HEATH COMPANY • BENTON HARBOR 18, MICHIGAN**



**HEATHKIT 25-WATT**

MODEL W-5M  
**\$59<sup>75</sup>**



**HEATHKIT 70-WATT**

MODEL W-6M  
**\$109<sup>95</sup>**

**high fidelity amplifier kits**

To provide you with an amplifier of top-flight performance, yet at the lowest possible cost, Heath has combined the latest design techniques with the highest quality materials to bring you the W-5M. As a critical listener you will thrill to the near-distortionless reproduction from one of the most outstanding high fidelity amplifiers available today. The high peak-power handling capabilities of the W-5M guarantee you faithful reproduction with any high fidelity system. The W-5M is a **must** if you desire quality plus economy! Note: Heathkit WA-P2 preamplifier recommended. Shpg. Wt. 31 lbs.

For an amplifier of increased power to keep pace with the growing capacities of your high fidelity system, Heath provides you with the Heathkit W-6M. Recognizing that as loud speaker systems improve and versatility in recordings approach a dynamic range close to the concert hall itself, Heath brings to you an amplifier capable of supplying plenty of reserve power without distortion. If you are looking for a high powered amplifier of outstanding quality, yet at a price well within your reach, the W-6M is for you! Note: Heathkit model WA-P2 preamplifier recommended. Shpg. Wt. 52 lbs.

**HEATHKIT DUAL-CHASSIS**  
MODEL W3-AM

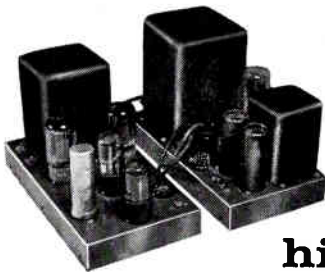

**\$49<sup>75</sup>**

**HEATHKIT SINGLE-CHASSIS**  
MODEL W4-AM



**\$39<sup>75</sup>**



**high fidelity amplifier kits**

One of the greatest developments in modern hi-fi reproduction was the advent of the Williamson amplifier circuit. Now Heath offers you a 20-watt amplifier incorporating all of the advantages of Williamson circuit simplicity with a quality of performance considered by many to surpass the original Williamson. Affording you flexibility in custom installations, the W3-AM power supply and amplifier stages are on separate chassis allowing them to be mounted side by side or one above the other as you desire. Here is a low cost amplifier of ideal versatility. Shpg. Wt. 29 lbs.

In his search for the "perfect" amplifier, Williamson brought to the world a now-famous circuit which, after eight years, still accounts for by far the largest percentage of power amplifiers in use today. Heath brings to you in the W4-AM a 20-watt amplifier incorporating all the improvements resulting from this unequalled background. Thousands of satisfied users of the Heathkit Williamson-type amplifiers are amazed by its outstanding performance. For many pleasure-filled hours of listening enjoyment this Heathkit is hard to beat. Shpg. Wt. 28 lbs.

**HEATHKIT**



**high fidelity amplifier kit**

MODEL A-9C **\$35<sup>50</sup>**

For maximum performance and versatility at the lowest possible cost the Heathkit model A-9C 20-watt audio amplifier offers you a tremendous hi-fi value. Whether for your home installation or public address requirements this power-packed kit answers every need and contains many features unusual in instruments of this price range. The preamplifier, main amplifier and power supply are all on one chassis providing a very compact and economical package. A very inexpensive way to start you on the road to true hi-fi enjoyment. Shpg. Wt. 23 lbs.

**HEATHKIT**

**electronic crossover kit**



MODEL XO-1 **\$18<sup>95</sup>**

One of the most exciting improvements you can make in your hi-fi system is the addition of this Heathkit Crossover model XO-1. This unique kit separates high and low frequencies and feeds them through two amplifiers into separate speakers. Because of its location ahead of the main amplifiers, IM distortion and matching problems are virtually eliminated. Crossover frequencies for each channel are 100, 200, 400, 700, 1200, 2000 and 3500 CPS. Amazing versatility at a moderate cost. Note: Not for use with Heathkit Legato Speaker System. Shpg. Wt. 6 lbs.



## "LEGATO"

### high fidelity speaker system kit

Wrap yourself in a blanket of high fidelity music in its true form. Thrill to sparkling treble tones, rich, resonant bass chords or the spine-tingling clash of percussion instruments in this masterpiece of sound reproduction. In the creation of the Legato no stone has been left unturned to bring you near-perfection in performance and sheer beauty of style. The secret of the Legato's phenomenal success is its unique balance of sound. The careful phasing of high and low frequency drivers takes you on a melodic toboggan ride from the heights of 20,000 CPS into the low 20's without the slightest bump or fade along the way. The elegant simplicity of style will complement your furnishings in any part of the home. No electronic know-how, no woodworking experience required for construction. Just follow clearly illustrated step-by-step instructions. We are proud to present the Legato—we know you will be proud to own it! Shpg. Wt. 195 lbs.

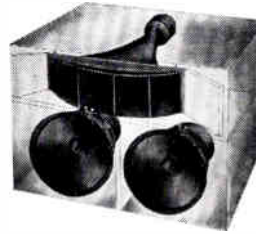

MODEL HH-1-C  
(Imported white birch)  
MODEL HH-1-CM  
(African mahogany)  
**\$325<sup>00</sup>** each

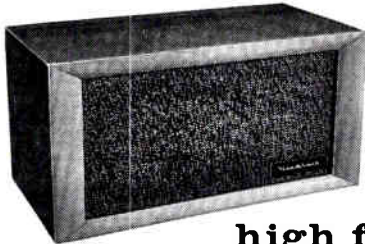

**HEATHKIT  
BASIC RANGE**

**HEATHKIT  
RANGE EXTENDING**

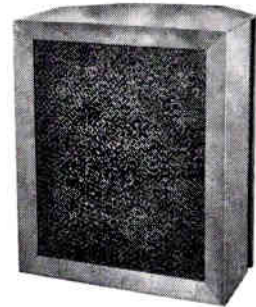

### high fidelity speaker system kits

MODEL SS-1 **\$39<sup>95</sup>**

A truly outstanding performer for its size, the Heathkit model SS-1 provides you with an excellent basic high fidelity speaker system. The use of an 8" mid-range woofer and a high frequency speaker with flared horn enclosed in an especially designed cabinet allows you to enjoy a quality instrument at a very low cost. Can be used with the Heathkit "range extending" (SS-1B) speaker system. Easily assembled cabinet is made of veneer-surfaced furniture-grade 1/2" plywood. Impedance 16 ohms. Shpg. Wt. 25 lbs.

Designed to supply very high and very low frequencies to fill out the response of the basic (SS-1) speaker, this speaker system extends the range of your listening pleasure to practically the entire range of the audio scale. Giving the appearance of a single piece of furniture the two speakers together provide a superbly integrated four speaker system. Impedance 16 ohms. Shpg. Wt. 80 lbs.

MODEL SS-1B **\$99<sup>95</sup>**

## Free Catalog!

Don't deprive yourself of the thrill of high fidelity or the pleasure of building your own equipment any longer. Our free catalog lists our entire line of kits with complete schematics and specifications. Send for it today!



### HEATH

*pioneer in  
"do-it-yourself"  
electronics*

### COMPANY • BENTON HARBOR 18, MICHIGAN

**D** a subsidiary of Daystrom, Inc.

- Please send the Free HEATHKIT catalog.
- Enclosed is 25c for the New HI-FI book.

name \_\_\_\_\_

address \_\_\_\_\_

city & state \_\_\_\_\_

#### ALSO SEND THE FOLLOWING KITS:

QUANTITY	ITEM	MODEL NO.	PRICE

Enclosed find \$..... Please enclose postage for parcel post—express orders are shipped delivery charges collect. All prices F.O.B. Benton Harbor, Mich. NOTE: Prices subject to change without notice.



# Audiocraft

## GE AMPLIFIER

Production of a new 20-watt amplifier, *Model PA-20*, has been announced by the General Electric Company.

The compact, leather-grain cabinet with gold-brushed escutcheon is compatible with a wide range of component styles. If a custom installation is desired, the power and preamp sections may be separated and mounted individually. All components are factory tested and inspected.

An LC tuned circuit is incorporated in the rumble filter for a sharp cutoff of 12 db per octave below 40 cps, according to the manufacturer. Inputs provided are for HIGH and LOW MAG, RAD-TV, AUX-1, and AUX-2; there are outputs for tape, preamp, and speaker.



*General Electric Model PA-20 amplifier.*

Controls included are SELECTOR, BASS, TREBLE, LEVEL, LOUDNESS, RUMBLE FILTER, and POWER, as well as 2 screw-driver level controls for Aux-1 and Radio inputs.

Specs state that frequency response is 20 to 20,000 cps, harmonic distortion is below 1%, and hum and noise are 60 db below 20 watts on phono and 75 db below 20 watts on high-level inputs. The suggested price for the PA-20 is \$99.95.

## ALTEC SPEAKER SYSTEMS

Altec Lansing has announced four new speaker systems in their 1958 line.

The first is the *Laguna 830A* consisting of two 15-inch 803A woofers, the 802 high-frequency driver mounted on the 511B horn, and the 500D 500-cps dividing network. The frequency response is said to be from 30 to 22,000 cps without peaks or other misleading frequency accentuations.

The *Capistrano 831A* uses one 15-inch woofer, an 800E dividing network, and the 802 tweeter with the 811B horn. A range from 35 to 22,000 cps is guaranteed by the manufacturer.

The *Corona 832A* is a corner design with the same components as the *Capistrano*.

The last model in the series is the *Verde 833A*, a moderate-size enclosure housing a 602B Duplex loudspeaker. Frequency response is said to be 35 to 22,000 cps.

All models are available at Altec dealers.

## IRISH DOUBLE-PLAY TAPE

Recently introduced by ORRadio Industries is the *No. 400 Irish* double-play recording tape. The Mylar polyester base enables the tape to withstand a pull of 3 lbs. without distortion (a tape recorder generally exerts a pull of 6 to 16 oz.). The tape also has the advantage of the Irish Ferro-Sheen process which bonds the oxide coating firmly to the base. A 7-inch reel carrying 2,400 ft. of tape is priced at \$11.95.

## SCOTT AMPLIFIER

H. H. Scott, Incorporated, has recently added several new features to their *Model 99-D 22-watt* amplifier without raising the price; it is still \$99.95. Now included are a front-panel SPEAKER SELECTOR switch, a front-panel TAPE MONITOR switch, and redesigned tape-

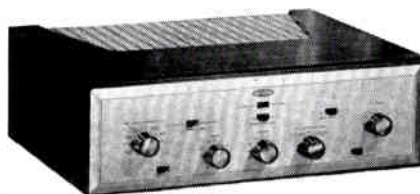

*New feature added; price remains same.*

recording jacks accessible on the rear panel. Otherwise, the unit is just as it was before.

Further information on the 99-D may be obtained free from the manufacturer.

## STEREO TUNER AND AMPLIFIER

Madison Fielding has recently announced manufacture of a matched stereo tuner and stereo amplifier for the basis of a stereo system.

The *Series 330 FM/AM* tuner provides facilities for monaural, stereo, and multiplex reception. Specs for the FM section state that sensitivity is 2  $\mu$ v for 20 db quieting, frequency response is

uniform within 1 db from 20 to 20,000 cps, and that IF bandwidth is 355 Kc at 3-db points and 420 Kc at 6-db points. AFC is provided for drift-free operation. Sensitivity in the AM section is said to be 15  $\mu$ v per meter loop sensitivity and 3  $\mu$ v with direct antenna connection. AVC is incorporated in the circuit and there is a separate tuned RF stage for selectivity. Controls included are AM TUNING; FM TUNING; selector for AM, FM, STEREO, ON, and OFF. The tuner is available for \$129.95; price of matching cabinet is \$19.95.

The *Series 320 40-watt* stereo amplifier has one low-level and two high-level inputs for each channel and 4-, 8-

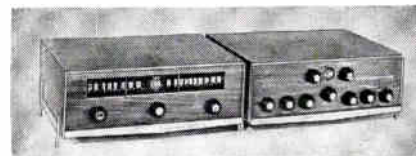

*Matching stereo tuner and amplifier.*

and 16-ohm speaker outputs and tape-monitor output. Controls on each channel are provided for EQUALIZATION, BASS, TREBLE, VOLUME, LOUDNESS, POWER, and CALIBRATE. Controls for both channels are POWER, MASTER VOLUME, and SELECTOR. The frequency response, according to the manufacturer, is within 0.5 db from 20 to 20,000 cps; power response is said to be constant at 20 watts per section from 20 to 20,000 cps,  $\pm 1$  db; hum and noise are stated as being down 55 db at full output in phono position and better than 75 db in high-level positions. The price of the amplifier is \$169.95, and of the matching cabinet is \$19.95.

Both models are available in walnut, mahogany, or korina finishes.

## NEW STARLIGHT TURNTABLE

Metzner Engineering Corporation has announced the *Starlight Model 80* turntable, styled in coffee and gold and selling for \$49.50, audiophile net. Continuously variable speed control from 16 to 84 rpm is provided by a built-in illuminated stroboscope, and a filter eliminates speaker pops when the power switch is operated. The 3½-pound turntable has an automatically retracting 45-rpm center hub and is center-driven by the motor shaft; metal-to-metal contact is avoided in the drive system to keep

*Turntable has built-in stroboscope.*

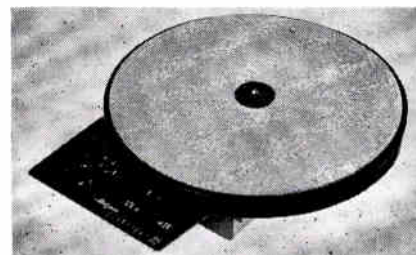

rumble at a minimum. Wow and flutter are said to be less than 0.25% with rumble stated as 40 db below NAB standard level.

### KNIGHT TAPE RECORDER

A two-speed (3¾ and 7½) tape recorder, the Knight Model KN-4010, is being offered by Allied Radio Corporation.

Included in the recorder are two built-in speakers and a roving speaker, an



*Interlock prevents accidental erasure.*

8-watt push-pull amplifier, a transistorized preamp, and high-frequency AC erase. An automatic shut-off stops the machine the instant a tape is finished and a special safety interlock prevents accidental erasure. Dual neon-bulb indicators show when volume is at correct level for recording. Inputs are provided for recording from mike, radio, or TV, and output from the recorder's preamp may be fed directly into a hi-fi system.

The KN-4010 is supplied with microphone, 5-inch reel of tape, and take-up reel. It is listed under Allied Stock No. 91 RZ 750 and is priced at \$129.95.

### BIDIRECTIONAL MICROPHONE

The Fen-Tone Corporation's *Trix Sixty Special* is a miniature bidirectional ribbon-velocity microphone comprised of a

*Bidirectional ribbon-velocity mike.*



triple horse-shoe magnet supporting a relatively long corrugated limp aluminum ribbon, encircled with four breath shields. This method of assembly is said to prevent gaging and spurious vibrational nodes. Although designed as a studio microphone, the *Trix Sixty Special* can be used for PA work as well.

Frequency response is said to be flat from 50 cps to 12 Kc,  $\pm 2$  db; output at 50 ohms referred to hi-Z is rated at  $-58$  db. The microphone measures 4 in. by 1¾ in. and costs \$96.50 including 18 ft. of balanced shielded cable.

### SHERWOOD AMPLIFIER

Sherwood's new 36-watt amplifier, the Model S-1000 II, features eleven front panel controls: SELECTOR for five inputs, EQUALIZATION, BASS, TREBLE, LOUDNESS, LOUDNESS compensation switch, TAPE MONITOR switch, PRESENCE, SCRATCH FILTER, RUMBLE FILTER, and PHONO LEVEL. Outputs are provided for 16, 8, and 4 ohms. The output-tube balance control is adjustable with meters, and the phono preamp and tone-control amplifier are operated from a quick-warm-up DC filament supply.

Power output is stated as 36 watts (72 watts peak) at 1½% IM distortion. Other manufacturer's specs are: inverse feedback, 21 db; frequency response at 36 watts, 20 to 20,000 cps  $\pm 1½$  db; preamp sensitivity, 2½ mv; preamp noise level, 60 db below rated output.

Size of the S-1000 II is 14 by 10½ by 4 in. and its shipping weight is 24



*Amplifier includes preamp section.*

lbs; price is \$109.50 for the chassis only. Cabinets are available in brown or black Flextone, and gold-tooled mahogany, black, tan, or white leatherette.

*For more information about any of the products mentioned in Audio-news, we suggest that you make use of the Product Information Cards bound in at the back of the magazine. Simply fill out the card, giving the name of the product in which you're interested, the manufacturer's name, and the page reference. Be sure to put down your name and address too. Send the cards to us and we'll send them along to the manufacturers. Make use of this special service; save postage and the trouble of making individual inquiries to a number of different addresses.*

### DOUBLE-PLAY RECORDING TAPE

Minnesota Mining and Manufacturing Company has recently added *Scotch No. 200* double-play magnetic recording tape to its line. It is made from durable polyester film and is said to withstand a pull of 3.6 lbs. before stretching. The 7-inch reel, which retails for \$11.95, contains 2,400 ft. of tape and is capable of recording for four full hours at 3¾ ips or two hours at 7½ ips. The 10½-inch reel holds 4,800 ft. of tape and will record for 16 hours at 1⅞ ips; it retails for \$26.90.

### DYNAMIC ELECTRONICS PREAMP

The latest product off the line from Dynamic Electronics is the Model PA-110 preamp. This simple and inexpensive unit is designed for use with a variable-reluctance pickup or tape recorder, and it uses the controls on the existing amplifier in the sound system. According to the manufacturer, frequency response is 11 to 25,000 cps,  $\pm 1.5$  db; noise-and-hum level is 60



*Preamplifier is very small and compact.*

db below 10 mv; and the over-all gain is 34 db. The PA-110 is housed in a black and copper shielded cabinet and measures 6 by 3¼ by 3½ inches; weight is 2½ lbs. \$12.95 is the list price.

### AUDIOLAB WOOFER

The Audiolab *Custom 16* woofer can be used in any type of enclosure and is said to have excellent transient response because of dynamic braking. 15 to 30 watts can be handled depending on the frequency and type of enclosure; frequency response is 26 to 1,000 cps, according to the manufacturer. Harmonic distortion varies from 2 to 5% at 40 cps and 4 to 7% at 30 cps depending on the enclosure. Price of the speaker is \$89. Further information is available from Audiospeaker Laboratories.

*May be used in any type of enclosure.*

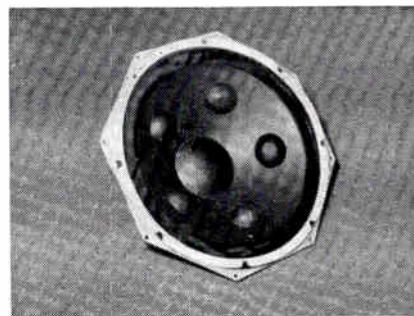

*Indisputably  
the Finest!*

**UNIVERSITY'S  
NEW 315-C  
3-WAY  
15" DIFFAXIAL**



*This speaker protected by U. S. Patent nos. 2,641,329; 2,690,231; 2,751,996 and other patents pending.*

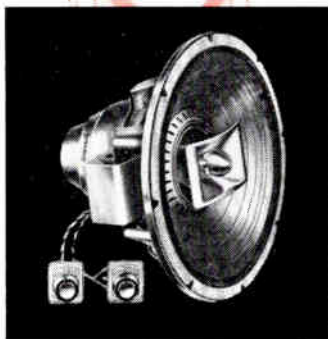

**THESE ARE THE REASONS WHY**

Exclusive self-stabilized woofer cone structure and dual spider construction ensure lifetime centering of moving system, for all extreme excursions.



University-controlled processing of imported cone pulps results in consistently uniform, distortion-free response.



Exclusive, massive flux-contoured 6 pound Gold Dot Alnico 5 magnet provides efficient power drive for deepest low frequencies, free of transient distortion.

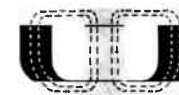

Extra-long voice coil ensures purity of maximum low frequency energy conversion during periods of extreme cone excursion.

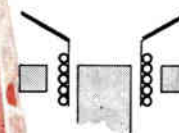

Exclusive University-formulated long polymer lattice permeates rim suspension for effective acousto-mechanical rim damping.

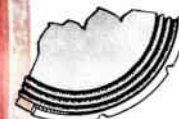

True through-axial construction permits balanced tweeter, mid-range and woofer acoustic integration without design compromise.

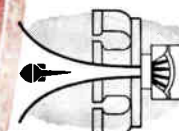

Exclusive hypersonic tweeter incorporating radial phasing equalizer automatically balances all high frequencies for smooth, realistic reproduction.



Exclusive "reciprocating-flare" horn now has wave front equalizer for more uniform wide-angle treble coverage.



Exclusive multi-sectional Diffusicone provides controlled diffraction for linear mid-range response and dispersion.



Continuously variable dual control network integrates and blends mid-range and tweeter for concert realism regardless of room acoustics.



Response: 25 cps to inaudibility; Power capacity: 50 watts, integrated program; Total magnet wt.: 6½ lbs. Alnico 5; Impedance: 8-16 ohms; Depth: 12"; User net: \$156.00. UNIVERSITY LOUDSPEAKERS, INC., 80 SO. KENSICO AVENUE, WHITE PLAINS, N. Y.

**LISTEN**

*University sounds better*







## Next month -- Audiolab Reports

Gentlemen:

I noticed in the December *Radio & TV News* that you have an FM station list available for \$.50. Do you also have a list of United States and Canadian AM stations? I am in desperate need of such a list since I am an AM listener. I get many western U.S. and Canadian stations I have never heard of before but have no list for positive identification. Please let me know where I can get such a list. Thank you.

F. S. Dombrowski  
Okauchee, Wis.

*We do not have available a list of AM stations similar to our FM station list. You can obtain information on AM stations, however, in the Broadcasting Yearbook, obtainable from Broadcasting, Broadcasting-Telecasting Bldg., 1735 DeSales Street, N.W., Washington 6, D.C. The price is \$3.00.*

— ED.



Gentlemen:

I am a charter subscriber to your publication, and will continue to subscribe. *Audiocraft* is a truly fine semitechnical journal, as well as being good reading. Like many others, my only wish is that there should be more of it! I have been pleased to note the gradual increase in the number of articles and features, and hope that you will continue to increase the depth of your coverage.

I was very interested in "Two-Track, Three-Channel Stereo" by Paul Klipsch. There are probably a great many persons, like myself, who have heard just enough stereo to be interested, but who would like to know more about it. Might I suggest, or request, a comprehensive series of articles on stereo reproduction?

Donald K. McKay  
Hamden, Conn.

*A series, almost exactly of the sort you describe, was begun in our February issue.*

— ED.

WITH the next issue *Audiocraft* Magazine will begin publication of laboratory test reports on commercial high-fidelity components.

This will represent another in our long list of "firsts." It may well be the most important of all, however, for these reports will differ from the usual consumer-magazine equipment reports in three significant ways:

1) They will be prepared from completely objective laboratory tests, with comment limited to remarks that will provide information for interpretation of the results. There will be no vague generalities and no omission of embarrassing facts. Tests will be standardized, so that similar units will be tested under identical circumstances. Thus, the results will be truly comparative.

Further, these objective tests will be chosen so as to obtain instrumental results that will reflect, as accurately as present-day knowledge permits, the quality of performance which the equipment will yield in practical use. In this way the advantages of subjective evaluation will be combined to a maximum degree with the far more sensitive and accurate indications of instrumental tests. We believe this to be an extremely important consideration; it explains why we have decided *not* to include microphones, loudspeakers, and speaker enclosures among those products to be tested. Although it may be possible to judge a mike or a speaker system on the basis of objective tests alone, the tests would have to be so elaborate—and the results would take so much space in the magazine—that they would be impractical for us to undertake at this time. All other hi-fi components will, however, be covered.

2) The tests and report preparation will be done by Hirsch-Houck Laboratories, Mount Vernon, New York—an entirely independent company, not connected with us in any way. This company is managed by Julian Hirsch and Gladden Houck. Messrs. Hirsch and Houck carried out tests and wrote all reports for the former Audio League, which many readers will remember as the originator of objective reports on hi-fi equipment. The Audio League had an enviable reputation among manufac-

turers and subscribers alike for competence, fairness, and absolute integrity. This tradition is maintained by Hirsch-Houck Laboratories; it is undoubtedly the finest and most capable organization in the world for the work we have assigned them.

3) It is explicit in our arrangement with Hirsch-Houck that we will not be permitted to modify, cancel, or withhold a report once it has been undertaken. A manufacturer may request that we not begin a report on his equipment for any good reason, such as impending obsolescence, but we are not bound to comply even with this. After a report is prepared a copy will be sent to the manufacturer; if he feels that his product has been treated unfairly he may correspond with the laboratory directly. Should the laboratory find that his objections have validity they may revise the report accordingly—but we cannot do so ourselves, nor can a manufacturer "kill" an unfavorable report. He may, if he desires, append a short comment.

We believe that this will constitute an equipment reporting service of unparalleled value to high-fidelity equipment consumers. Our Audiolab Test Reports will be impartial, reliable, and of maximum utility, because of the integrity and competence of the testing organization. They will separate the good equipment from the not-so-good because punches will not be pulled when they are deserved. They will be free of personal prejudice, because the basis of judgment will be objective instrument tests. They will be free of any taint of pressure from advertisers, because we have bound ourselves to publish the reports exactly as written by Hirsch-Houck Laboratories—and they owe allegiance to no manufacturer.

Several reports are already in progress for the April issue. They include the McIntosh MC-60 amplifier and C-8 pre-amp combination, and the EICO HF-52 amplifier.

AND with *this* issue we launch another new department: "Electronic Firsts," by Monroe Upton, author of the popular *Electronics for Everyone*. We hope you'll find his anecdotes of "pre-electronic" history as amusing and fascinating as we did.

— R.A.

THE quality of a superb amplifier is to a large extent wasted if it is preceded by a preamplifier-control unit whose performance is much poorer than that of the amplifier. Until a short time ago, the design of control units did not keep step with the improvements in power amplifiers, particularly in respect to transient response and low distortion, with the result that most of the electrical distortion in hi-fi systems originated *before* the amplifier.

Recently, however, preamp-control units have been receiving more attention from designers. The Dynakit preamplifier comes astonishingly close to the ideal of hi-fi performance—that is, to control the signal without leaving any degrading evidence, either measurable

the plate of the second tube to the cathode of the first. But there is one very significant difference from the usual feedback-pair equalizer. Note the 100-K resistor that joins the two cathodes. This provides *positive* feedback which increases the gain of the pair very markedly. The increased gain yields two benefits: 1) it permits complete boost at the bass end for the phono equalizers, and yet 2) leaves enough additional gain to provide an appreciable amount of feedback even at the bass frequencies which, in other circuits, receive little benefit from feedback. In addition to the positive and negative voltage feedback, each tube has an unbypassed cathode resistor to supply current feedback. This combination provides an unusually

NARTB-equalized input for a tape head. Instructions are provided for all three possibilities; the extra parts required (a 12- $\mu$ fd capacitor and an 18-K resistor) are now supplied with the kit. There is a low-pass RF filter provided by the 10-K series resistor and the input capacitance of the input tube, to bypass strong local radio signals picked up by the cartridge, which might otherwise overload the circuit and might be rectified to produce audible interference.

The LOUDNESS control is a very simple tapped-control type, with compensation furnished only when the VOLUME control is below half rotation. It provides both bass and treble compensation, quite satisfactorily. It can be completely dis-



*A preamp with unmeasurable distortion? Once only a fantastic dream, the idea's here to stay, in*

# The Dynakit Preamplifier

*An audiocraft kit report*

*by Joseph Marshall*

or audible, of its work. Distortion of all types is so low that for any practical purpose, even for laboratory service, the Dynakit preamp can be called distortionless. This performance is all the more astonishing in view of the price: \$35.

## The Circuit

A quick and nonanalytical glance may give the impression that the Dynakit circuit, Fig. 1, is a fairly conventional one. Analysis will reveal several differences from standard circuitry far more important in effect than they might seem on paper. For one thing, every stage has at least two feedback circuits; the first two actually benefit from three.

The first 12AX7 supplies amplification and equalization for the phono and tape-head or mike channels. Equalizing networks are in the feedback loop from

high feedback factor which is reflected in the extraordinarily low distortion.

Three equalization curves are provided for the phono channel: RIAA, LP, and 78. The 78-rpm curve provides a 6-db-per-octave boost below 500 cps, and a 6-db rolloff at 10,000 cps. The input resistance of the phono channel is 50,000 ohms—a good compromise value that will work well with most pickups. Lower values can be obtained simply by inserting a resistor across the output of the pickup at the turntable. For example, a 56-K resistor will give a total resistance of 27,000 ohms, for Pickering cartridges.

There are two phono inputs, one for low-level and another for high-level cartridges (only one can be used at a time). There is another input marked SPECIAL which can be wired to provide still another switched phono input with RIAA equalization, a mike input, or an

abled, however, by a front-panel switch.

High-level inputs are provided for RADIO, TAPE and TV sources (Fig. 2). There are no input level controls because they aren't needed; no amplification is supplied before the main VOLUME control. All inputs not in use are grounded to eliminate crosstalk.

The tone-control circuits are new, although they have superficial resemblance to the Baxendall type. Another 12AX7 is used, with the tone-shaping network in the two-stage feedback loop. More than 20 db of cut or boost at 20 cps is furnished by the BASS channel; the TREBLE channel provides some 14 db of boost and (in our specimen) 20 db of cut at 20,000 cps (only 14 db is specified). Most of the bass boost is applied below 100 cps where it is most needed by good speaker systems and doesn't muddy up the lower middle range. The high-frequency boost also



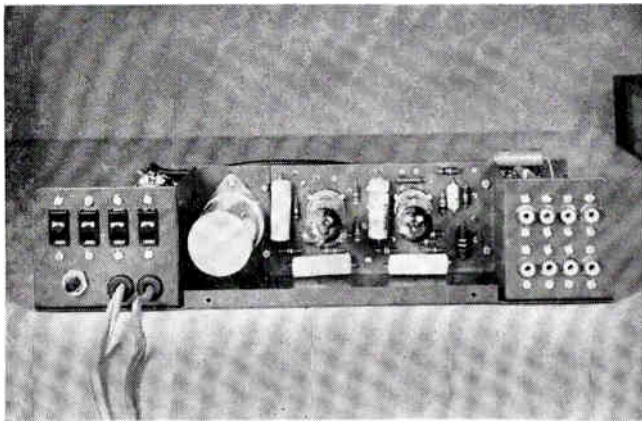

Fig. 2. Rear view of the chassis shows inputs and AC outlets.

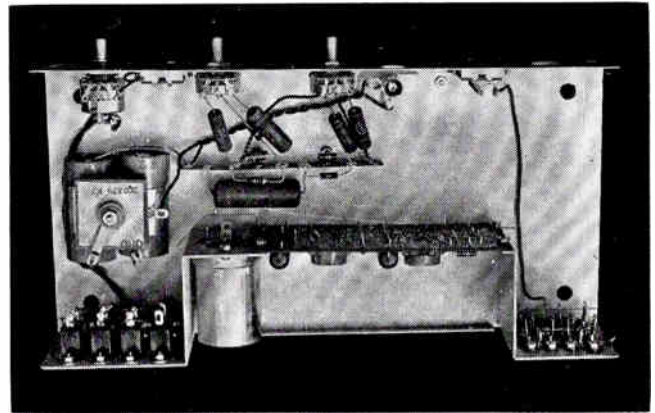

Fig. 3. Power supply and tone controls are partially wired.

is mounted, the remaining interconnections are made.

It is a good idea to use the scale marked on the pictorial diagrams to cut the leads to the size specified. And, if you like to make strong mechanical joints at terminals, allow an extra quarter inch in length for each piece. Also, as you do each step, check it against the big pictorial diagram.

The steps in construction have been especially well worked out to make wiring to the printed-circuit board as simple and orderly as possible (Fig. 4). To minimize any possibility of damage to the etched foil, the board has tinned eyelets where the wires are to be soldered. We suggest that the soldering iron be applied from the front (the side on which the components and tubes are mounted) while the wire is pushed in from the back. In this way you are far less likely to damage the printed circuit. The completely wired chassis is shown in Fig. 5.

Adjustments are very minor and simply made. We found that the tone controls centered in the flat spot within less than 1/16 inch when we simply set the knobs as suggested at the 7-o'clock position. Setting the hum balance is also not critical. It can be done perfectly well by ear. Instructions for connecting the power cable are based on the idea that the preamp will be

used with a Dynakit or Heathkit amplifier, and an octal plug is provided so that after wiring it can be plugged directly into such amplifiers. The voltages can be supplied by any amplifier or other gadget which will yield between 200 and 350 v DC and 6 v AC. But note below that 350 v B+ yields the optimum performance; lower voltages result in somewhat higher distortion. (The red wire in the cable is for the positive high voltage; the black is for the ground. Green and white leads are for the 6 v AC.)

The source of 6 v AC must be "floating"—that is, not grounded at any

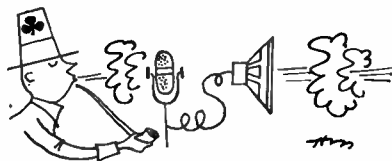

point. In some amplifiers, the filament chain is grounded at the center point of the filament winding on the transformer or through a built-in hum control. This can be made to work by simply disconnecting the ground from the center tap on the hum balance control entirely. Then the balance pot in the preamp will provide an AC ground for both amplifier and preamp.

### AUDIOCRAFT Test Results

It is seldom that a piece of equipment amazes us, but the Dynakit preamp certainly did. Fig. 6 shows the frequency response at various levels of output with and without the LOUDNESS-control compensation. Note that our measured response with the VOLUME control at maximum is absolutely flat from 10 to 40,000 cps, and slopes to only 3 db down at 100,000 cps. Note also that the response below 10 cps is within 1/2 db to 6 cps, down 1 1/2 db at 5 cps, and 4 db down at 4 cps. The low-end response remains absolutely flat whatever the position of the VOLUME control (with LOUDNESS off). The high end slopes as the VOLUME control is moved down, but the slope always begins beyond 20,000 cps.

The LOUDNESS-control compensation comes in at half rotation. We liked its effect because the largest part of the boost was below 100 cps, just as with the BASS control, so that it did not result in the boomy, muddy sound some loudness controls produce. It also provided some boost at the high end: 5 db maximum at 20,000 cps. All these curves were taken with a constant 0.25-volt input, which produced an output of about 2.5 v with the VOLUME control at maximum.

Because the high-level inputs go di-

Fig. 4. Rear of PC board shows how connections are made.

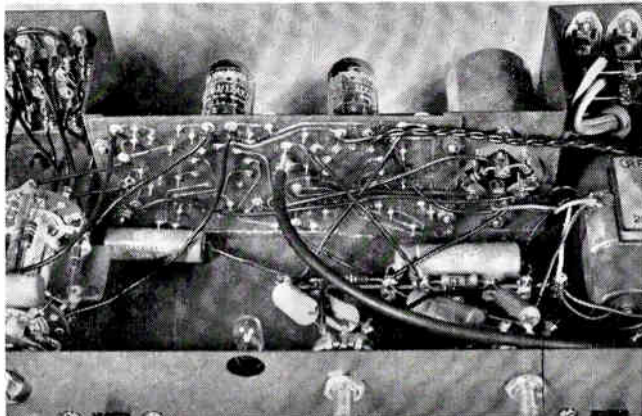
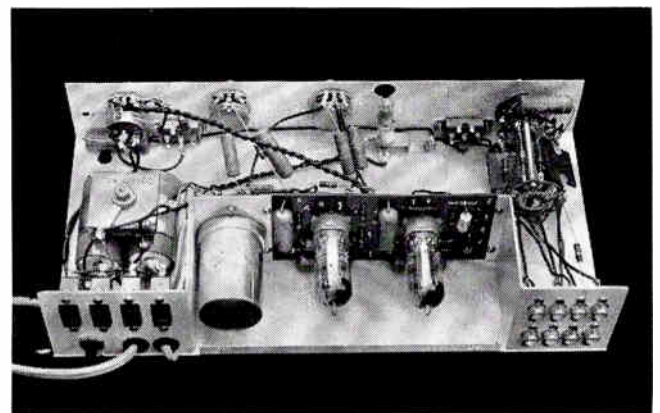

Fig. 5. Completed preamp testifies to simplicity of wiring.



rectly into the VOLUME control it is virtually impossible to overload the Dynakit preamp, although the loudness contour will vary with the input voltage. It is suggested that the volume controls on radio and TV be adjusted with the preamp VOLUME control just past the middle point (where the LOUDNESS control is inoperative) to produce a rather loud "concert-hall" loudness which requires no compensation. Then, as the volume is reduced to a more comfortable level, loudness compensation will come in.

Fig. 7 shows the tone-control contours, and Fig. 8 the phono equalization curves. Because precision capacitors are used, these curves follow the specs very closely. The RIAA and LP curves depart from the theoretical by less than 1/2 db. The 78 curve is similarly close to that

This is presumably a result of the fact that feedback is reduced as the B+ voltage is reduced.

We do not claim the figures and curves to be absolutely accurate. It is extremely difficult even with the finest laboratory equipment to measure such low levels of distortion accurately. Wherever we indicate zero distortion, we recorded no reading whatever; it is quite possible that there may nevertheless be distortion on the order of one hundredth of one percent. Incidentally, the distortion does not increase as the VOLUME control is turned down, so long as the output voltage is kept below 2 or 3 volts.

Even more extraordinary and satisfying is the harmonic distortion curve which includes the *entire* preamp—from the phono input (with RIAA

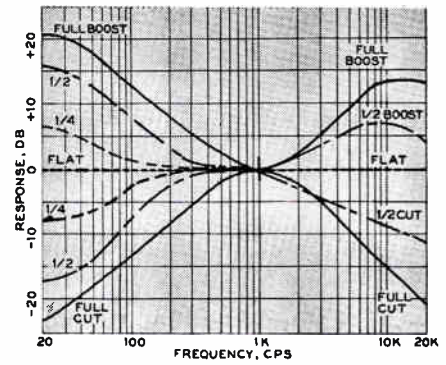

Fig. 7. Contours of the tone controls.

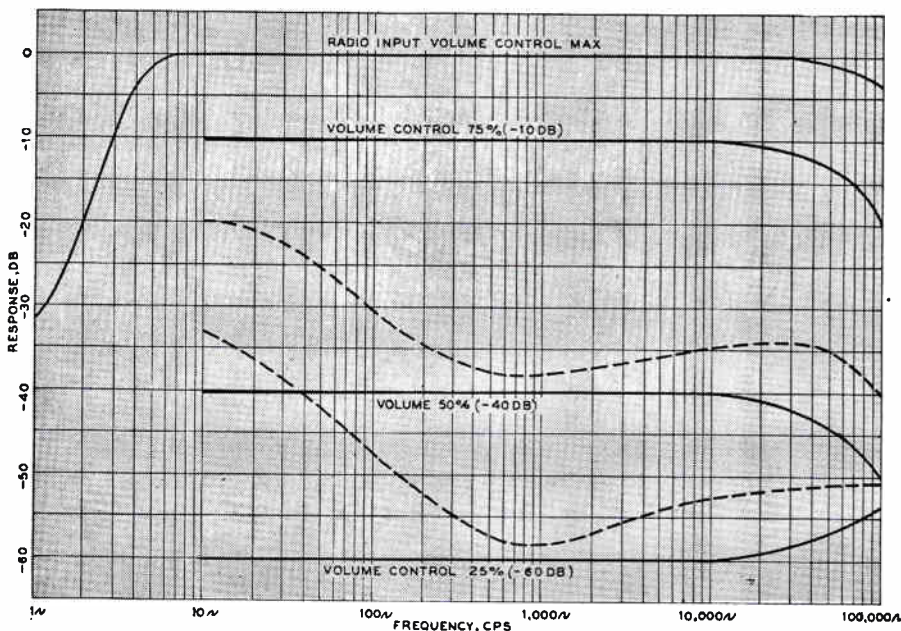

Fig. 6. Frequency response of the Dynakit preamplifier at several settings of the volume control. The dotted line shows response with loudness compensation added.

specified and, you will note, delivers some 27 db of boost as 20 cps.

Distortion curves in Figs. 9 and 10 are really extraordinary. We must note to begin with that, although the kit will operate with any B+ voltage between 150 and 350 v, and with very little difference in gain as the voltage is changed, the distortion *will* vary with applied voltage. The curves shown were taken with 350 v. Whereas with 350 v B+ the IM at 2 volts (equivalent sine-wave voltage) was less than 0.1%, with 200 v B+ the IM went up to 0.3% at 2 volts output. Harmonic distortion also increases at the bass end with lower voltages, as the following brief table shows:

Harmonic Distortion			
	200 v	250 v	350 v
50 cps	0.5%	0.1%	.05%
500 cps	.01%	0	0
5,000 cps	0	0	0

equalization) to the output. Input voltage was adjusted at various frequencies to produce an output of 1 1/2 v—enough to drive most modern amplifiers to full output. Obviously, it took a great deal less input at 20 cps than at 20,000 but the method approximates an absolutely flat recording without recorded distortion. It will be noted that the distortion is 0.2% or less throughout the audio range. Actually, the distortion itself is considerably lower than the curves indicate because the readings include hum and tube noise which of course are much higher in the phono channel. This noise may well account for as much as 50% of the total reading.

It is difficult to do the same sort of test for IM distortion. The regular 4-to-1 ratio of 60 to 6,000 cps gave a figure too low to read—well below 0.1%. To come closer to the real situation

Continued on page 42

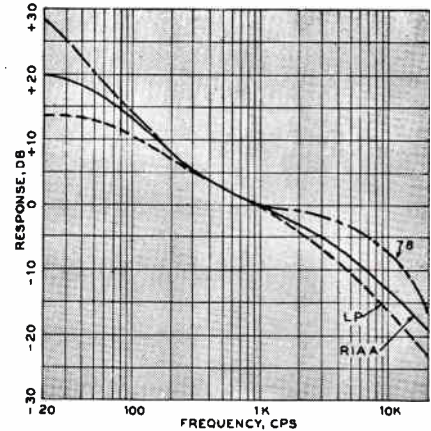

Fig. 8. Equalization of phono channel.

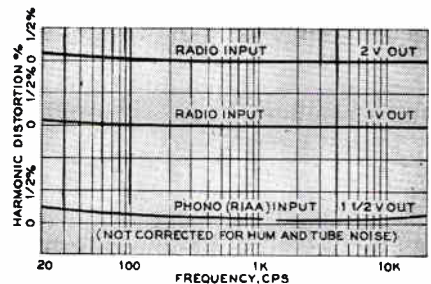

Fig. 9. Harmonic-distortion percentage.

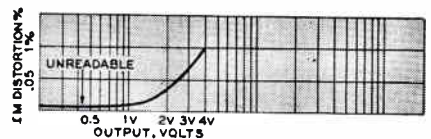

Fig. 10. Curve indicates IM distortion.



Fig. 11. 10 KC square wave from Dynakit (below) is much like original (above).



by JOEL EHRLICH

*Just because stereo discs are on the way, don't  
put your recorder in moth balls. It  
may be more useful than ever.*

S  
T  
E  
R  
E  
O

*and your  
tape recorder*

is the *only* medium easily used in the home for recording with fidelity.

Let's look at it another way. In addition to playing commercial tape records, the tape recorder functions as the "memory" of a high-fidelity system. Any especially good concert or other program can be saved indefinitely by means of the recorder. FM, TV, and AM broadcasts, disc-recorded material, and live sources are all available to the recorder through the control unit of the hi-fi system. With a good recorder, the entire system is used to play back the home-made tape, thus yielding maximum sound quality.

More than anything else, the recorder has the facility of being able to put you in two places at once. You can, with at most a slight modification, record one program source and listen to another at the same time—or watch a television show, or attend to company. Aside from its many other functions, the recorder preserves that which you cannot listen to as it is broadcast.

This is probably the best place to mention my feeling about tape players. The primary virtue of tape, it seems to me, is the fact that it can be recorded upon at home. Of course it has other important virtues too, such as fidelity, long life, resistance to mechanical wear,

and continued high-fidelity response. But now that stereo is available on discs as well as recorded tapes, the most important advantage of a tape recorder is the fact that tape, alone of all home media, can be used to *record* sound with little or no trouble (depending upon your aptitude and moment of inertia). So why buy a player when, for so little more, you can have a recorder?

The major expense in any tape system is the transport mechanism, and one is involved in both player and recorder. The parts missing in the player that are needed for recording are the erase head, the bias/erase oscillator, the level indicator, some means of mixing the bias with the signal, and some switching to go from record to playback mode and vice versa. At the very most, another tube and a few resistors and capacitors—not much in terms of money. Let us not think in terms of a tape player; let us think (and talk) of a tape recorder, a much more practical device.

Now, back to the question of the future of stereo tape. For several years we've had single-channel recorded tapes on the market. Even though recorded stereo tapes are predominant at the moment, sales of these monophonic (monaural) tapes have held up suffi-

#### The Law

Although there is nothing in the annals of legal history which *specifically* prohibits off-the-air recording for purely personal enjoyment in one's own home, we cannot take the stand to advocate the widespread and indiscriminate practice of radio recording—either stereo or monaural—without tempering Mr. Ehrlich's suggestions with a warning. Don't, under any circumstances, try to sell your pirated treasures, and never place any fee upon your Saturday night living room listening sessions. Home recording is strictly for fun, and for fun it must remain.

**I**N view of the current discussion about stereo disc reproduction, it might be supposed that all the manufacturers of recorded tapes are preparing to fold their tents and fade into obscurity.

Happily, this is not the case. People with tape players will continue to buy recorded tapes, although it is logical to expect sales to fall off a bit once the new stereo disc gets moving. But stereo discs have no greater chance of eliminating the home use of tape than tape had of eliminating conventional discs. Many a pessimist had predicted that tape would put an end to the use of discs. It hasn't happened so far, and there is no indication that it will. The same should hold true for stereo discs and stereo tape. The reasons are obvious: tape is admittedly the more flexible medium, and

ciently to indicate that at least a portion of the public prefers tape even for non-stereo listening. Note that we have had records of the identical works, at a far lower cost. Thus, the argument for the death of recorded stereo tapes — the fact that there'll be stereo records available of the same works for less money — is proven to hold little water.

There are good reasons for this lack of co-operation on the part of tape (it won't fall down and die as it is supposed to): it sounds better than anything else; it is less likely to suffer damage at the hands of the inexperienced; it can never be scratched; and if it is broken, it can be spliced.

Suppose we look again at tape with emphasis on the recording part of the tape recorder. Fully 50% of record wear occurs during the first three to five months we own the record. This is because while the record is new, it gets more playing than all the other records in a collection. As we get to know the music and the particular performance better, we play it less, concentrating on new favorites. Here too is an ideal spot for a tape recorder. Many people now tape-record their disc records when they are new. Until they stop playing the number regularly, they listen to the tape. Then they simply erase the tape, return the record to the rack, and put something else on the tape. Others never use the records at all: the tape is always played, and the record is kept locked away so that, should something happen to the tape, a new tape recording can be made. Records preserved this way never wear out; and the tapes don't either. As much as this applies to conventional records, it applies with even more force to stereo discs, for which the surface wear will be somewhat greater. The use of tape here makes obvious sense.

With stereo discs here it is easy to visualize a not-too-distant day when all FM and TV broadcasting will be stereo by the multiplex method. There is already quite a bit of simulcasting (AM and FM each carrying one channel) and even some early multiplexing. Disc jockeys, surprisingly, will be a potent force in bringing this about on a large scale; they will have stereo records, and the forces of competition will prompt them to demand stereo broadcast facilities.

Of course, we'll probably have a lot of AM/FM simulcasting at first, but FM multiplexing will grow and grow and grow. Again, the advantages of a superior answer will force the issue. It might well be noted here that any stereo-casting will have to be compatible, but let's not get into a discussion of that just now — it makes a good article by itself. In any event, we are sure to have some form of stereocasting quite soon, and this will be a fine source of material for

*Continued on page 36*

## An automatic recorder switching box

This easy-to-build device removes two stereo sources from your hi-fi system's control input circuits when you want to record them while listening to something else, to prevent the selector switch shorting them out. They are reconnected automatically when you're through recording.

The AC line cord is connected to a switched power socket on your tuner, thus being turned on and off with it. When the tuner is turned on, the thermal delay relay (Ry2) immediately applies power to the release coil (a) of the latching relay (Ry1). After the built-in delay of the thermal relay, the power is removed (note the arrow signifying the normally closed condition of Ry2); but relay Ry1 remains latched in the released position. This connects the output of the tuner(s) or other high-level stereo sources to the control units, for normal listening. When it is desired to record while listening to another source (i.e., to separate the system), the button (S1) is depressed, applying power to the latching coil (b) of Ry1, opening the circuit with the tuner(s) and the control unit(s). At the same time, the red neon lamp, which is lighted whenever the unit is in "normal" (relay released) condition, is extinguished and the green neon "recording" (relay latched) lamp is lighted. After recording, the tuner(s) is turned off. Then, upon cooling, the thermal relay (Ry2) makes contact again. Since no power is being applied to the circuit (it was removed when the tuner was turned off), no change takes place. The next time the tuner is turned on, however,

power is immediately applied to the release coil (a) of Ry1, until Ry2 opens again due to its thermal action. The circuit is returned to its "normal" condition.

Parts for the circuit are few, and the entire device is quite inexpensive and simple to construct. Parts layout is noncritical except that AC leads should be kept away from audio leads, and all shielded wire should be used for the audio leads. The parts needed

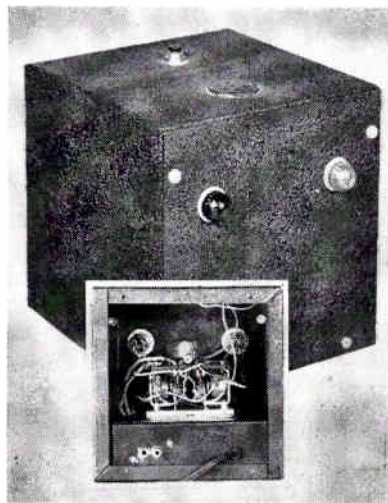

*Two views of recorder switching box.*

are: an Amperite No. 115C5 thermal relay, an octal socket, a fuse and fuse post, four phono jacks, one normally open momentary-contact single-pole push-button switch, two neon lamps and sockets, and a four-pole double-throw latching relay (117 v AC).

*Schematic of switching box. Any electrically equivalent relay may be used.*

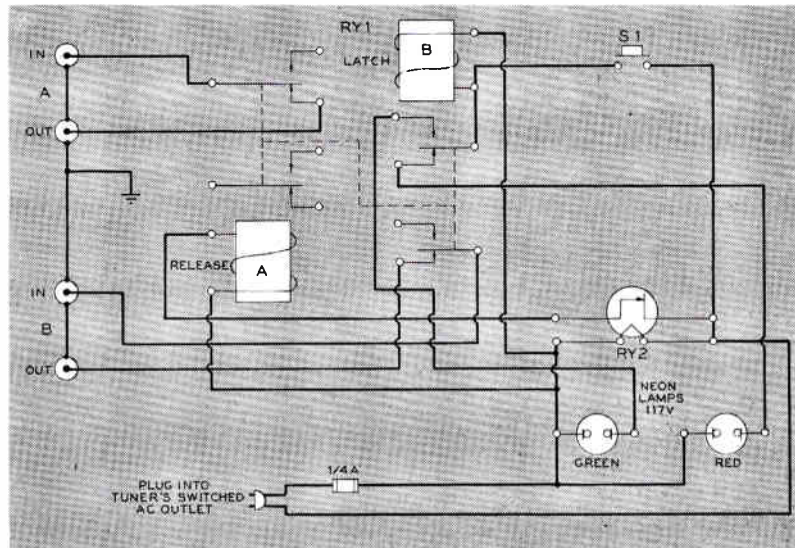

# How to

by RUFUS P. TURNER

# Make a

# Distortion Meter

*Essentially a rejection filter, this device can be used with an audio oscillator and VTVM to measure harmonic distortion*

**I**N high-quality sound work, *fidelity* refers to the faithfulness with which a signal is amplified and reproduced. This faithfulness disappears when distortion enters the picture. Hi-fi signifies low distortion in its broadest meaning.

Distortion is an inevitable by-product of amplifier and loudspeaker operation. Actually, we would like to amplify a signal without introducing any distortion whatever, but this is not possible with practical components and circuits. Modern design has reduced distortion to small amounts but a little of it still is present in the highest-quality equipment.

There are several kinds of distortion. One kind that is particularly important to hi-fiers is nonlinear distortion, which is a general term for both harmonic and intermodulation distortion. A circuit producing harmonic distortion generates extraneous frequencies which are multiples (harmonics) of the signal frequency. Thus, if a 400-cps signal is passed through a distorting amplifier, the output will contain not only the amplified 400 cps but also weaker signals of 800, 1,200, 1,600, and 2,000 cps and perhaps higher harmonics as well. These frequencies mix together to pro-

duce a sound that is not the same as the original. In some instances, the result is displeasing to the ear.

Harmonic distortion can be measured in amount. It is expressed as a percentage of the signal voltage represented by the total RMS harmonic voltage. Thus, a 1-volt, 1,000-cps fundamental with .05 v of 2,000-cps energy, .02 v at 3,000 cps, and .009 v at 4,000 cps would have a total RMS harmonic voltage of  $\sqrt{.05^2 + .02^2 + .009^2}$ , or .055 v. This being 5.5% of 1 volt, the total distortion in this instance is 5.5%.

A rule of thumb, which is not necessarily accurate and which varies with listeners, says that harmonic distortion of a single tone becomes noticeable to the ear when it reaches the level of 5%. In music reproduction, 1% is often audible. For a high-quality modern amplifier, harmonic distortion should always be less than 1%.

Distortion in a particular system is apt to vary with frequency and with power output. An amplifier may have low harmonic distortion at one frequency but high distortion elsewhere in the spectrum. It is common for many simple amplifiers to exhibit high fidelity at low power levels but to become quite

poor when delivering appreciable power output. Distortion measurements accordingly are very important in checking amplifier performance.

## Measuring Distortion

It might seem that a good way to measure distortion would be to apply a pure sine-wave signal to an amplifier and then to look at the output signal with an oscilloscope, noting how much the output wave form differs from that of the original. This can be done, but the accuracy of this method is not very good because the variations in wave shape (as seen on a 5-inch scope screen) are so small, for the distortion percentages usually encountered in practice, that the variance is hard to measure on the screen. Furthermore, this process is too slow if you have to make measurements at a number of frequencies.

A different method has been standard practice for a number of years. In this scheme, the fundamental frequency is removed from the output signal by means of a rejection filter. Any voltage left is that due to all the harmonics. If this voltage value then is divided by the full output voltage before the filter, and the result multiplied by 100, the

Fig. 1. Equipment setup for measuring harmonic distortion with filter (shown here in white block) described on these pages.

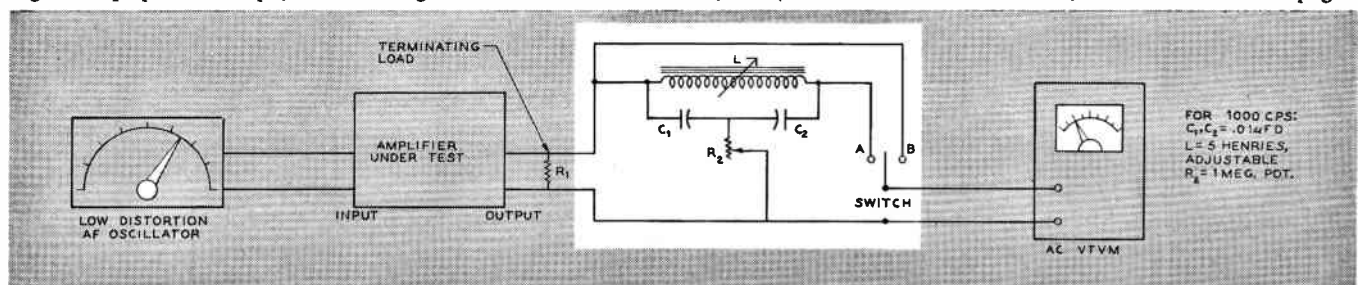



answer is very nearly the harmonic distortion in percent. Thus: where  $E_1$  is the voltage before the filter, and  $E_2$  the voltage after the filter, % distortion =  $(E_2/E_1) \times 100$ .

A simple circuit employing this principle of measurement is shown in Fig. 1. Here, the test signal is supplied to the amplifier under test by a low-distortion audio oscillator or signal generator. The amplifier is terminated by a loudspeaker (if you don't mind the noise) or by a load resistor  $R_L$ , equal to the output impedance of the amplifier. The rejection filter (a bridged-T network) consists of choke  $L$ , capacitors  $C_1$  and  $C_2$ , and potentiometer  $R_1$ . When switch  $S$  is thrown to position A, the voltmeter indicates the voltage after the filter (that is, after the fundamental frequency has been removed.). When  $S$  is at B, the meter indicates the voltage before the filter. In operation,  $S$  is thrown first to B and the voltage read as  $E_1$ .  $S$  then is thrown to A, and potentiometer  $R_1$  and the slug of choke  $L$  are adjusted for deepest dip (null) in the deflection of the meter. This voltage is read as  $E_2$ . The distortion percentage then is calculated as  $100 (E_2/E_1)$ . The meter can be made to indicate distortion percentage directly, and all calculations avoided, simply by adjusting the amplifier output for a deflection of exactly 1 volt when  $S$  is at B.

The values given in Fig. 1 for  $C_1$ ,  $C_2$ ,  $L$ , and  $R_1$  are for 1,000-cps rejection.  $C_1$ ,  $C_2$ , and  $R_1$  may be changed for other frequencies. In order for this method of measurement to be accurate, choke  $L$  must have high  $Q$ ; otherwise it will reduce the harmonic voltages, as well as the fundamental, and will give a false reading of harmonic content. A suitable adjustable component is the UTC Type VIC-15.

Some resistance-capacitance circuits also are rejection filters. RC networks are appealing because they are compact and simple. One such circuit is the Wien bridge, (consisting of two capacitors and two resistors) which has appeared in many instrument circuits. But the Wien bridge cannot be used in place of the LCR network in Fig. 1 because it tunes too broadly for this application. However, it can be used in a feedback amplifier to provide sharp tuning. A commercial distortion meter consists of such a tuned feedback amplifier with a self-contained AC vacuum-tube voltmeter.

An instrument incorporating the components indicated by the white block in Fig. 1 can be fashioned for handy use with any low-distortion audio oscillator and VTVM. Using the materials listed below, assemble the instrument as shown in Fig. 2. Parts placement is not critical, and a smaller—or larger—chassis base may readily be used. Although the unit pictured contains banana jacks, any

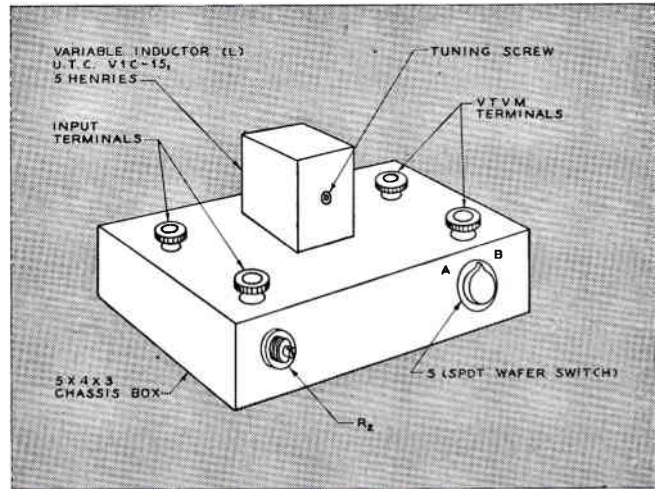

Fig. 2. The rejection filter can be built into a 5x4x3-inch Minibox as shown above. The choke is mounted on top of the chassis so that the tuning screw will be easily accessible.

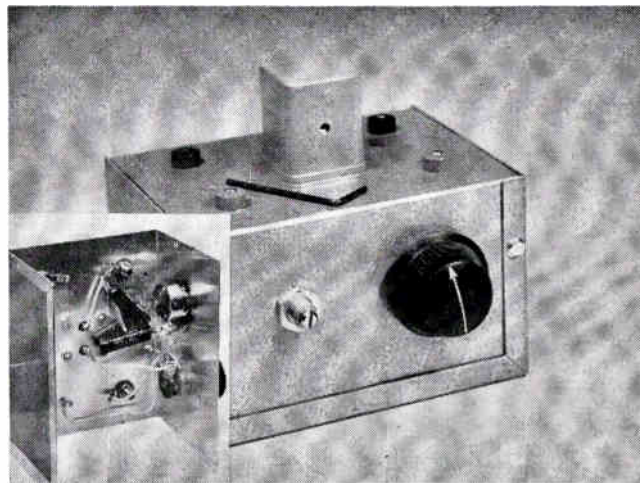

Fig. 3. Two views of the completed unit. The "L" shaped object in the larger photograph is an Allen wrench used to tune the choke. Parts arrangement inside box is optional.

other type of input connector may be used to adapt it to your own system. A photograph showing inner construction details appears in Fig. 3, and a curve indicating rejection of the filter at the fundamental frequency (1,000 cps) is given in Fig. 4.

### Parts List

1 UTC VIC-15 5.4-henry variable inductor	\$ 7.35
2 red banana jacks	.26
2 black banana jacks	.26
1 SPDT switch	.50
1 Minibox, 5 x 4 x 3 in.	1.24
1 potentiometer, 1 meg, linear	1.32
2 capacitors, .01 $\mu$ fd	.36
<b>Total</b>	<b>\$11.29</b>

Fig. 4. Filter rejection at the resonant frequency. Steep drop is due to high  $Q$  of the choke. Tuning is very critical.

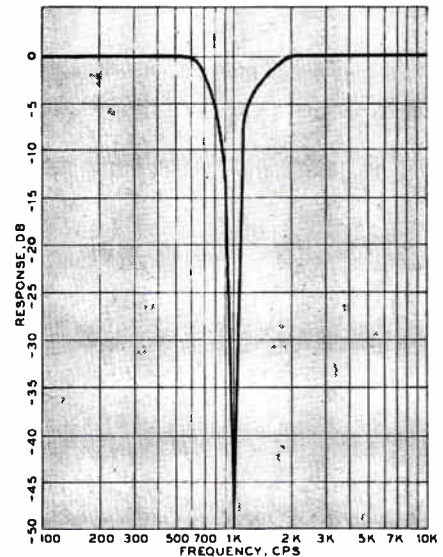

# BUILD

## A FOLDED-HORN

### ENCLOSURE

*Here are complete plans for a  
folded-horn enclosure designed by Jensen*

by HARVEY P. JONES

THE JENSEN Manufacturing Company makes available plans for "Construction of Compact Back-Loading Folded Horn Cabinets for 12-inch and 15-inch Loudspeakers."\* Dimensions of the two cabinets are identical except for height. This design is not available commercially, but the principle involved deserves greater recognition; its simplicity makes it easy to build, and it produces excellent sonic results. In size and proportions it "lives" well in a medium-size listening room where some of the larger folded-horn enclosures are overpowering in mass.

Considerable latitude is possible in the exterior treatment of this enclosure. My own modification is shown in Fig. 1. I have mounted within the enclosure a Jensen H-530 15-inch coaxial speaker.

While this design is said to sound well when located on a side wall, it looks much better in a corner and undoubtedly produces a much superior response in such a location. So placed, this enclosure gives a very satisfying "big" and clean sound with no apparent peaks and with a complete lack of boominess and boxiness. Lows seem to go down into the 40- or 50-cps region with little loss.

The back-loading feature of these designs is achieved by providing a relatively small enclosure back of the loudspeaker diaphragm with the horn throat at the front of this chamber. For frequencies above approximately 300 cps the design provides acoustic crossover, so that radiation above this frequency is suppressed in the horn. Interference with the radiation directly from the front of the diaphragm is thereby prevented.

Complete plans for building this folded-horn enclosure appear on the

\*Technical Bulletin No. 3A, The Jensen Manufacturing Company, Technical Service Department, 6601 South Laramie Avenue, Chicago 38, Illinois.



*The completed folded-horn enclosure.*

opposite page. The construction notes call for adequate bracing against vibration and resonance. In addition, I provided for full-length glued and screwed cleats where the vertical members join the base, as well as in other places where there seemed any reason (or excuse) for their inclusion. Glubond, made by Swift and Company, was found a highly satisfactory adhesive. It is probably related to other white water-soluble liquid adhesives now readily available.

It is imperative that  $\frac{3}{4}$ -inch plywood be used throughout. Ordinary fir plywood "good one side" is sufficient for

all except exposed surfaces. In my own case these are walnut veneer on lumber core. The top and bottom are finished with thin veneer strips glued to the edges by means of liquid Glubond. This is an easier process than it may sound, because the adhesive sets in a very short time once it comes in contact with wood.

The drawing shows panel sizes and cutting angles. Carefully follow these figures and recheck them before cutting to prevent wastage. In assembling the horn all joints must be airtight, particularly near the loudspeaker where the pressure is rather high. Air leaks will decrease efficiency substantially in the low-frequency range because of pressure loss. Use wood screws and glue to insure tight joints. Construction must also be quite rigid. You can test the panels with a mallet or with your fist; a solid rather than a drummy sound will indicate solid construction.

The front baffle is removable for loudspeaker installation. Bracing cleats stiffen this baffle and do not touch the side cleats or the front edges of the V-shaped sound chamber. Use felt strips around the mounting cleats to insure an airtight seal for the baffle. The baffle can be held by decorative wood screws around the edges.

The top is held on by cleats glued at the top edge of the sides, and screws, up through these cleats, pull down the overhanging top. Any irregularity in the sawing of the vertical units is nicely taken care of by a 29-cent roll of Mortite calking compound which, when laid along the edges of the vertical units, fills all voids completely as the screws are turned to draw down the top of the cabinet; yet this calking compound permits later removal of the top without difficulty.

As shown in the illustration, both plastic and metal grille coverings are used. The metal is for appearance as well as for protection of the speaker cone from possible damage by one member of our family who still belongs to the lollipop set.

The exposed walnut areas of the enclosure were stained with Glidden's water stain, which was followed by several coats of rubbing varnish. Minnesota Mining's Wet-or-Dry abrasive paper in a fine grade was used (wet) between each varnish coat. The final coat was rubbed with rottenstone and oil.

So that the base of the enclosure would clear the corner of the rug on which it is placed, short  $\frac{1}{4}$ -inch strips of wood were tacked and glued at B, C, and D. Through these were driven large diameter Domes of Silence—the rubber-backed type. This three-point suspension insures a wobble-free cabinet. In addition, sash handles were screwed into the centers of the No. 1 panels to aid in moving the unit around on

*Continued on page 48*

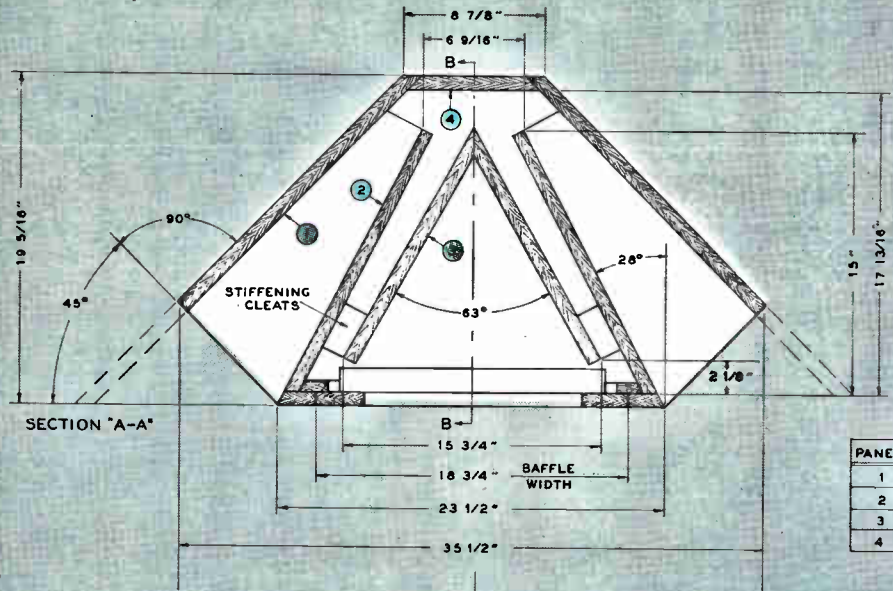

Follow these  
**BLUE PRINTS**  
to build your own  
folded-horn enclosure

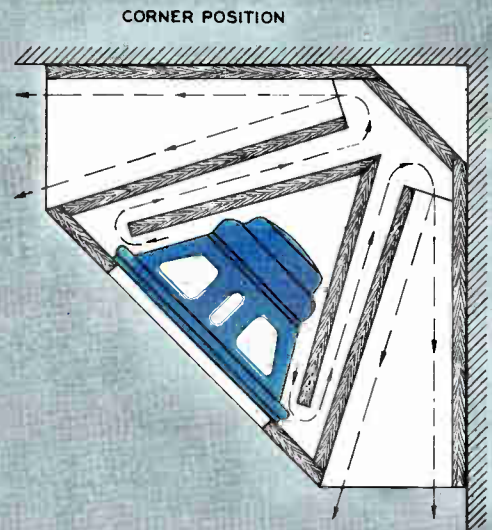

PANEL	REQ	LENGTH	ANGLE
1	2	19 9/16"	45°
2	2	17"	62°
3	2	15 1/16"	58 1/2°
4	1	8 1/4"	45°

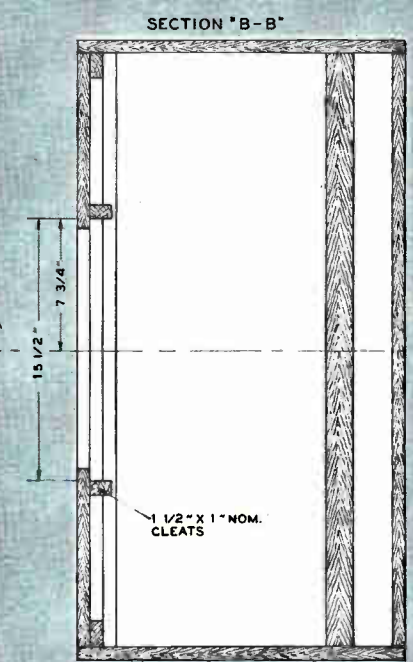
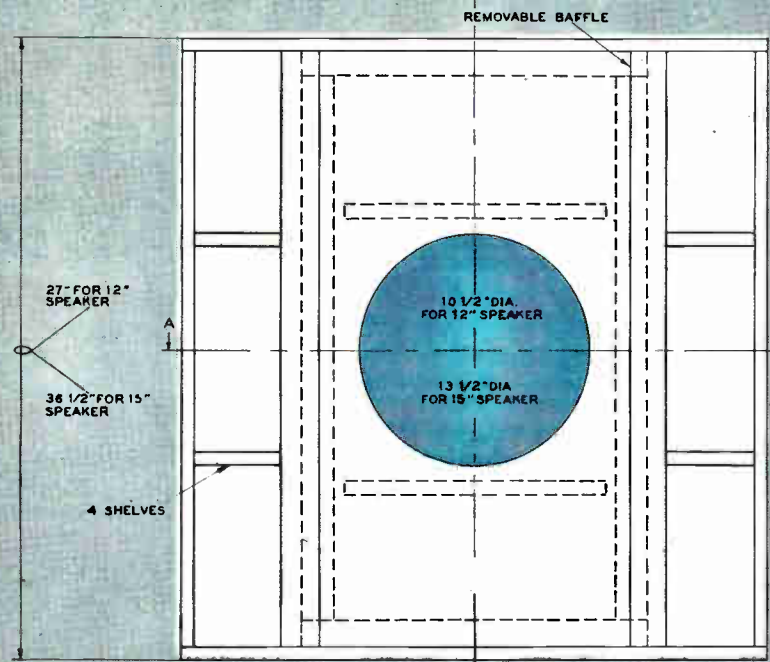

### Construction Notes

1. Cut vertical panels from 3/4 inch plywood to sizes indicated in the block near the center of this page.
  2. Cut top, bottom and front panels to sizes shown on drawings.
  3. Assemble the enclosure, using screws and glue on all but the top and front baffle.
  4. Prepare exterior with finish desired, and place grille cloth on front baffle.
  5. Install speakers, and attach front baffle.
- (See text for comprehensive directions)

# TRANSISTORS

by PAUL PENFIELD, Jr.

*in audio circuits*

## Part IX: Medium and high-power transistors

### Tips and techniques for output-stage designers

POWER transistors are sufficiently different from low-power models that it is necessary to describe them separately. The emphasis is on high-current operation and high-power dissipation, giving the transistors somewhat different characteristics.

In addition, output circuits are designed to operate the transistor close to the limits of the device, where distortion is quite a problem. Thus it seems appropriate to discuss those characteristics which contribute to distortion in power transistors.

#### Temperature Effects

The reader who has followed this series from the beginning knows that transistors are affected much more by high temperatures than are other electronic parts. There are two main reasons for keeping the temperature down. First, at high temperatures the transistor will not operate well in the circuit, because of large cutoff current and changes in parameters. And second, at high enough temperature the transistor will be damaged.

The first effect will not harm the transistor, but nevertheless it is a real temperature limitation. The second effect is caused by one or more of the following: (1) unwanted impurities on the surface of the germanium or silicon may wander inward at high temperatures, destroying

the very delicate donor and acceptor impurity balances; or (2) the indium alloy used in making the emitter and collector regions may melt; or (3) the donor or acceptor impurities themselves may wander about because of increased vibration from the higher temperatures, destroying the sharp junctions necessary for transistor action.

For these reasons, do not operate or store a power transistor (or any other transistor, for that matter) above its maximum rated temperature, which is around 80° to 100° C. for germanium transistors and 150° C. or higher for silicon models. If the temperature limit imposed by the increased cutoff current is lower than the storage temperature limit, you can't operate the transistor even as high as the latter figures.

#### Removing the Heat

Design of power transistors involves not only the electrical properties but the thermal properties as well. All the power dissipated in a transistor appears as heat, and unless you get rid of this heat efficiently, the transistor will heat up and, possibly, be destroyed.

Typical modern high-power transistors are shown in Fig. 1. The transistors are made to bolt securely on a radiating fin or chassis, and the collector junction, which generates most of the heat, is located close to the copper mounting.

Fig. 2 shows a cutaway view of a power transistor. As the dotted lines representing heat flow indicate, the heat comes out of the collector junction where it is generated, through the transistor mounting base, through the insulating washer, and through the chassis to the surrounding air. The collector junction—which is the hottest point in the transistor—will obviously be hotter than the ambient air, and it is important to know just how much hotter it is.

The formulas governing heat flow are very much like the formulas governing simple electrical circuits, so it is not difficult to compute how hot the collector junction is.

Heat flows through a material only because one end is hotter than the other. As Fig. 3 indicates, the difference in temperature between end 2 and end 1 of a rod of material,  $(T_1 - T_2)$ , is equal

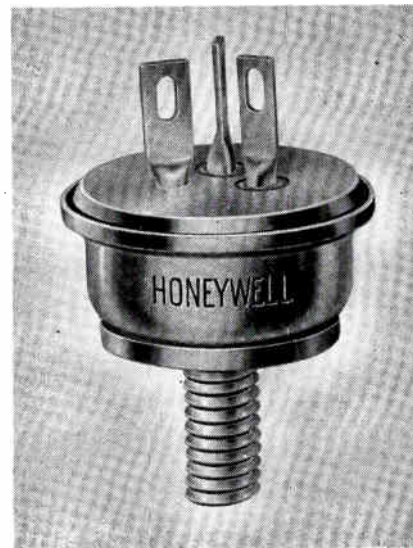
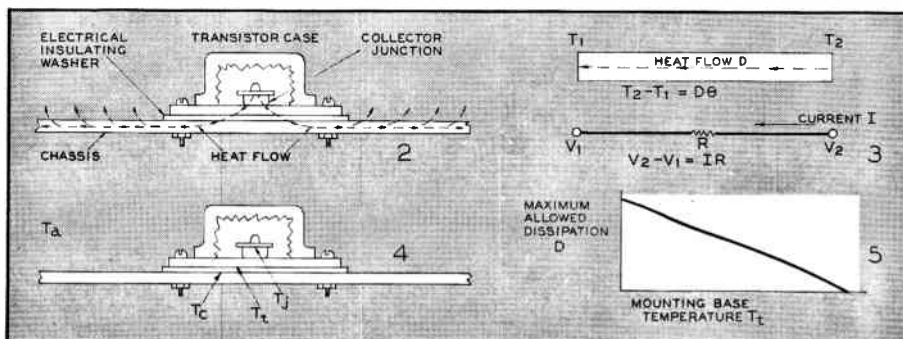

Fig. 1. Examples of two typical high-power transistors for output-stage use.

Fig. 2 shows a cutaway view of a power transistor, and Fig. 3 diagrams the heat flow. Fig. 4 illustrates the thermal circuit, and Fig. 5 is a "derating" curve.



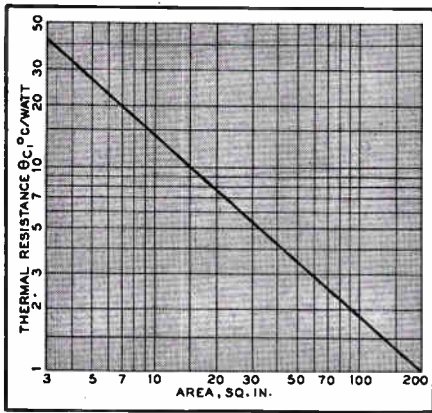

Fig. 6. Curve indicates the thermal resistance of chassis to heat flow.

to a constant  $\theta$  times the heat flow  $D$ .  $\theta$  is known as the thermal resistance, by analogy with the similar electrical quantity. In the bottom half of Fig. 3, the voltage across a resistor,  $(V_2 - V_1)$ , is just equal to a constant  $R$  (the resistance) times the current  $I$  flowing through the resistor. If you think of the two situations you will find much in common. Thermal resistances combine together in series and in parallel the same way electrical resistances do.

Because of this analogy, you can use your knowledge of electrical circuits to advantage in analyzing the heat flow problem. Fig. 4 shows a little more clearly the thermal circuit: it is the temperature drop across the transistor proper,  $(T_j - T_c)$ , the temperature drop across the insulating washer,  $(T_c - T_w)$ , and the temperature drop from the chassis to the surrounding air,  $(T_w - T_a)$ . If we call the three corresponding thermal resistances  $\theta_j$ ,  $\theta_w$ , and  $\theta_a$ , then the junction temperature  $T_j$  is

$$T_j = (\theta_j + \theta_w + \theta_a) D + T_a \dots (1)$$

where, as in Fig. 4,  $T_a$  is the temperature of the air.

Each of the three thermal resistances is easy to calculate. The transistor manufacturer usually gives the value of  $\theta_j$  in his specification sheet, or else supplies a "derating curve" like Fig. 5, from which the thermal resistance  $\theta_j$  is just

Fig. 9. "Input-characteristic" curve reflects important cause of distortion.

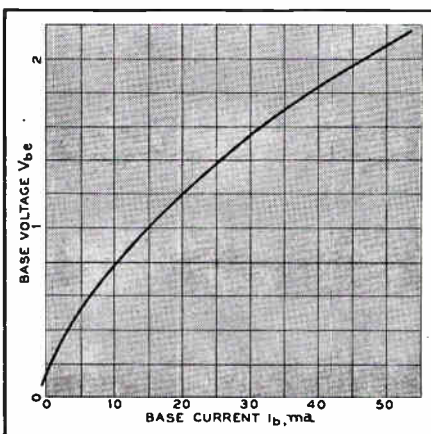

the difference in temperature over which 1 watt more or less dissipation is allowed.

Do not be misled by a plot such as Fig. 5, incidentally, into thinking that you can actually safely dissipate the power indicated. The scale on the bottom reads "Transistor mounting-base temperature," which is of course considerably higher than the ambient temperature!

The thermal resistance of the insulating washer depends on its thickness. Mica washers usually run about  $0.3^\circ\text{C}/\text{watt}$  thermal resistance, for each mil of thickness,\* meaning the usual 1- or 2-mil washers would run about  $0.5^\circ\text{C}/\text{watt}$ .

Anodized aluminum washers are also available with roughly the same thermal resistance.

The insulating washer is used only, of course, when the mounting base of the

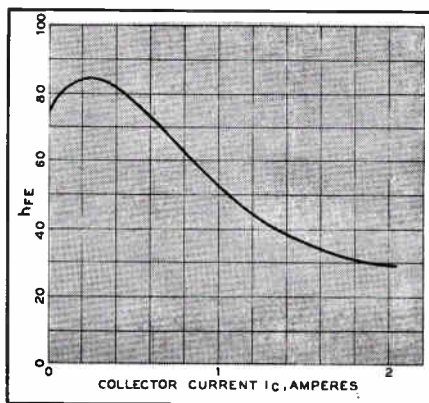

Fig. 8. The "beta-fall-off" curve.

transistor cannot be electrically tied to the chassis. When no washer is used, call  $\theta_j$  zero.

It is supposed that the insulator is making good thermal contact to the surfaces it touches. If the transistor is mounted "dry" there will inevitably be air gaps interrupting the heat flow. To keep these out, some material must be put between the surfaces to fill up these holes. Silicone grease is sometimes used, but ordinary nonconducting automobile grease is just as good. Apply it to both sides of the washer before mounting the transistor.

The thermal resistance of the chassis-to-air heat flow,  $\theta_a$ , can be read from Fig. 6. The curve shown is for the case in which both sides of the chassis are exposed to free air. If the chassis surface is horizontal and only the air on top is free, multiply the thermal resistance from Fig. 6 by 1.5; if only the bottom air is free, multiply by 3. If the chassis surface is vertical and only one side has free air on it, multiply by 2.

The curve shown in Fig. 6 applies to pieces whose longest dimension is less than 25 in. Aluminum chassis are better

\*A mil is .001 in.

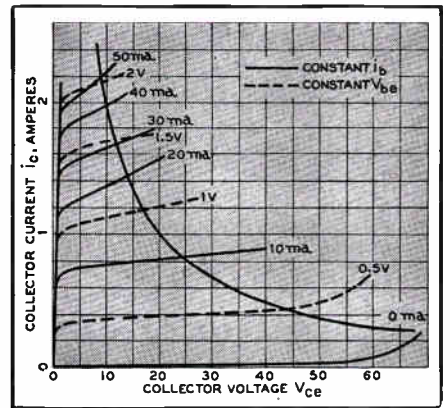

Fig. 7. Typical set of characteristic curves for a modern power transistor.

than steel ones for heat-removing purposes.

It should be mentioned that the free-air method of removing heat, described above, is the most common but not the only method. Some transistors come equipped with fins which help to get rid of the heat by acting as so much more surface exposed to air. Sometimes transistors are cooled by forced air; that is, air is blown against the transistor or chassis by a fan.

Water-cooling transistors is also possible but not too practical, since the expense and bulk of water-cooling (or refrigerating) equipment would be more than the expense and bulk of equivalent vacuum tubes which could run at higher temperatures.

## Power-Transistor Electrical Features

Power transistors have roughly the same type of volt-ampere curves as were shown for transistors in general in Part 3 of this series. A typical set of characteristic curves is shown in Fig. 7. Note that both the base-to-emitter voltage  $v_{be}$  and the base current  $i_b$  are used as running parameters. Although really all the information we need for circuit design is contained in this graph, it helps to look

*Continued on page 43*

Fig. 10. Nonlinearities as shown here create most of transistor distortion.

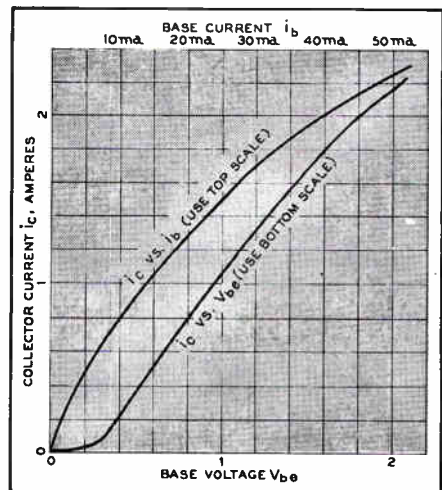

# TAPE NEWS AND VIEWS

by J. GORDON HOLT

*Are you troubled by speed irregularities, dropouts, or fading highs? Maybe your transport mechanism is due for an overhaul. Here's how to go about it.*

A WEEK or so ago I became involved in a heated discussion with an indignant young man who wanted to know why tape manufacturers couldn't be a little more careful about their quality control. He was firmly convinced that all makers of recording tape were taking the gullible buying public<sup>1</sup> for a ride by selling shoddy products, and then blaming their poor performance on the tape recorders with which they were used.

Bit by bit the story came out. He had just bought a highly touted nonprofessional tape recorder for several hundred dollars, and every time he recorded something with it, dead spots and uneven high-frequency response were apparent when the tape was played back. He had observed that when he re-recorded some of his defective tapes using different program material, the same defects appeared at the same spots on the tape, so of course the trouble had to be with the tape.

He had penned insulting letters to a few of the tape companies, and two of them had seen fit to answer with the thoroughly untenable intimation that his *tape recorder* was at fault. This did not sit well with the young man, and he nearly became violent when I told him that his recorder did in fact have a reputation for being susceptible to dropouts and varying high-frequency response. He laid aside his brass knuckles when

I added that there *was* something he could do about it. I'm glad to be able to report that he licked his troubles with nothing more than a screw driver and a standard alignment tape.

Unfortunately, all such problems are not so easily eliminated as his were, but most of them can be ironed out to the point where they will constitute nothing more than a minor annoyance.

The most common complaint is, of course, speed variation—wow, flutter, and irregular changes in speed that may occur once a week or several times a minute. If the recorder has never had particularly good speed regulation, there probably isn't much that can be done about it unless the factory is willing

to tackle it. Speed variation that develops in a previously satisfactory machine, however, is usually traceable to dirt or misadjustment of the drive system, the drag brakes, or the take-up clutch. The first thing to do is to open up the mechanism and carefully clean all pulleys, belts, idlers, and brake drums with gasoline or with the cleaning fluid sold under the name of Long Life. Non-lubricated friction-drag devices such as clutches and brakes should be wiped with cleaning solvent; very few tape recorders use lubricated brakes, and, if the service manual does not plainly specify oiling one or more of these pads, the presence of oil on them is an unmistakable sign of trouble.

A dirty or oily brake or clutch pad may be cleaned by dropping the entire pad assembly into a container of solvent, kneading the pad with the fingers to work the oil out of it. Then dry it by pressing it against a piece of blotting

Fig. 1. The arrows point to potential trouble spots in a typical tape recorder.

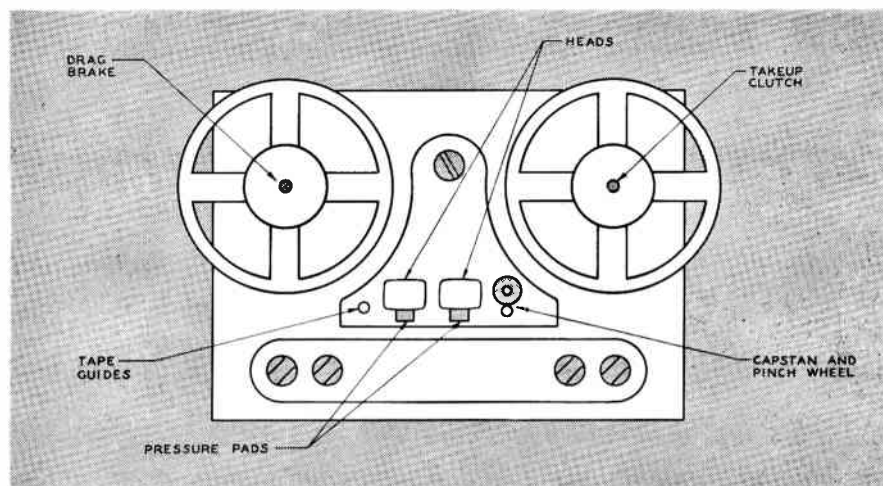

<sup>1</sup>I understand that it is customary in such discussions about "the consumer" to picture him as a dim-witted boob with one hand over his eyes and the other digging for his wallet.

paper, and let it stand overnight before reinstalling it.

If the recorder is new, it should not need lubricating unless any pulleys are obviously bone dry. One that has been used for some time will probably need oiling; follow the instructions in the service manual, being careful *not* to overoil anything. Next, clean the heads, tape guides, capstan, and pinch wheel, and if the recorder uses head pressure pads, clean these too.

Put the whole thing back together again and listen to the 3,000-cps flutter-test section of a standard test tape.<sup>2</sup> The cleaning procedure outlined above should have cleared up most cases of speed variation, but if wow or flutter is still excessive, note the rate at which the variations occur and then look for that part of the drive system which is revolving at the same rate. This part will probably be the source of the trouble, and should be checked for eccentricity, binding bearings, dents, and burrs on its contact surface, and for excessive bearing play.

Flutter, wow, and noncyclic variations in speed are often caused by slippage of the tape on the capstan or by incorrect take-up or drag-brake tensions. If the capstan system is gripping the tape properly, it should be possible to take a 1-mil (extra-play) acetate tape or to stall the capstan drive by holding the tape while the recorder is running. This is not true of all recorders, but if slippage does occur when the tape is held

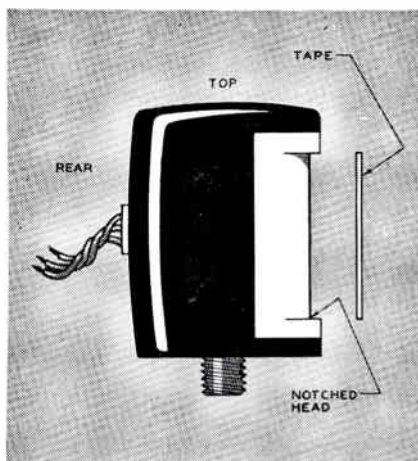

Fig. 2. Abrasive action of tape passage can wear sharp notches in head surface.

Tape burbles are random interruptions of tape travel, caused by a sticky splice or by a burr on the edge of the feed reel catching on the tape. Burbles cannot always be entirely avoided, but they can be minimized simply by not using sticky tapes or defective reels.

Some current-model recorders depend entirely upon holdback braking tension to maintain intimate tape-to-head contact, and anything that causes a burble on such a recorder will break this contact and create a dropout. Dropouts—random losses of signal—are generally induced by interruptions of tape travel or by imperfect head alignment. Clumps of unhomogenized oxide on the tape may cause dropouts, but

can form a "channel" virtually the same width as the tape across the pole pieces. As long as the tape is perfectly straight the notch shoulders will not interfere with its motion in any way. If, however, the tape has developed any longitudinal bends, it will occasionally ride up over the shoulders and cause loss of highs or a mild dropout. If notching becomes bad enough to be troublesome, the head(s) should be replaced or returned to the manufacturer for honing.

On non-pressure-pad recorders, a much more serious (and common) cause of dropouts is backward or forward leaning of the heads. A head that is canted forward, for instance, will bear more heavily on the upper part of the tape, so that as soon as there is a momentary letup in tension, contact may be lost at the bottom of the head. A canted head will also wear out fairly rapidly and unevenly.

Head canting is best spotted by exposing the heads and then bouncing a light off the surface of the tape where it folds over the head. With the drag brake partially released and the recorder running, perfect contact with a new head will create a light reflection of uniform width (Fig. 3). Figs. 4 and 5 show a couple of the *not* all that it might be, or when heads are badly or unevenly worn.

Head canting can usually be remedied by simply juggling the head fastening

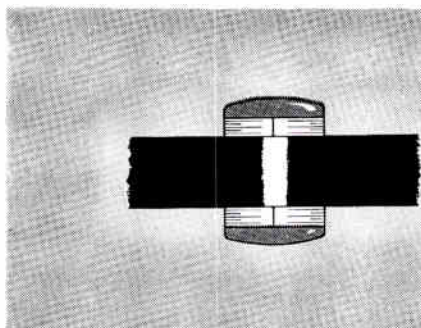

Fig. 3. Perfect head contact creates a light-reflection pattern of equal width.

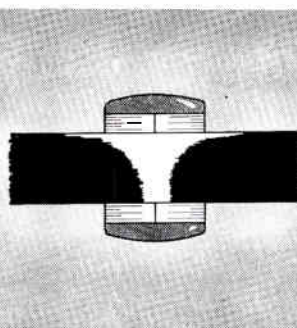

Fig. 4. Spreading pattern indicates extreme head wear or poor tape contact.

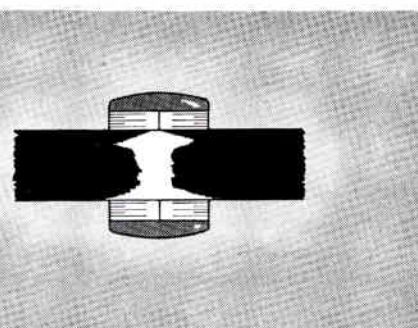

Fig. 5. Broad reflections at edges of tape show presence of wear notches.

back, see what the service manual has to say about it before overlooking this as a possible source of trouble.

Take-up and holdback tensions are often fairly critical, and if these are badly out of whack they can accelerate head wear and permanently damage tapes by stretching them out of shape. Spillage or stretching when switching out of high-speed modes may be the result of poor synchronization between the feed and tape-up-reel braking systems. Check these against the recommendations in the service manual.

<sup>2</sup>A flutter test tape may be made by recording a 3,000-cps signal from an audio oscillator, although the "doubling" of speed variation that takes place when playing this will make it more difficult to recognize its repetition rate.

these nodules are rarely encountered on high-quality recording tapes.

A recorder which uses head pressure pads will not be susceptible to dropouts, or to varying high-frequency response due to fluctuating contact, as long as the pads are kept clean and are replaced as soon as they wear to about half the original thickness. When holdback tension is the sole source of head contact, head wear will be slower and more even, but susceptibility to dropouts may be quite a bit more pronounced, particularly if the heads are not properly aligned or have become notched from tape abrasion.

Fig. 2 shows how these wear notches

screws back and forth or by shimming up the head with thin pieces of celluloid until the light pattern looks as close to ideal as possible. Then use an alignment tape to trim up the azimuth alignment.

Actually, a recording head is not likely to become canted in normal use, and so does not have to be checked for it very often. Occasionally, however, a new recorder will have somewhat canted heads—as was true of the one bought by the indignant young man. It is wise to check this before coming to trust implicitly the ability of a new machine to turn out top-fi tapes with the consistency of a professional studio recorder.

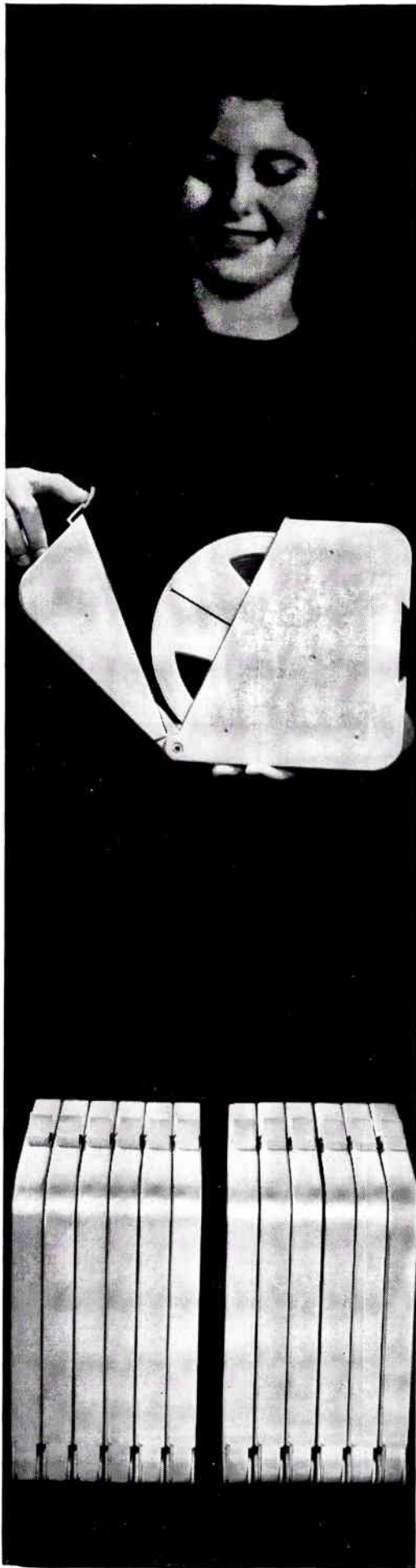

# SONORAMIC

## THE QUALITY RECORDING TAPE IN THE NEW PERMANENT PLASTIC CONTAINER

Sure, Sonoramic might cost a few pennies more. *But*—it buys you the unique protection and convenience of Sonoramic's new permanent plastic container.

This exclusive product is a high impact, shatter-proof, polystyrene box styled in a handsome slote gray. The container protects tape against dust and dirt; opens at the flick of a finger; stacks neatly side by side on shelf, bookcase, table or can be mounted on a wall. It also comes with a handy indexing system on pressure-sensitive labels which is keyed to the unique Ferrodynamics *Selection Finder* reel.

More important—the box holds Sonoramic's new wide latitude recording tape.

This tape is a giant step forward in recording tape engineering. It guarantees the user distortion-free recording and maximum performance regardless of make of recorder, line voltage fluctuations and tube age and head condition. Lubricated-for-a-lifetime too, to eliminate squeal, layer-to-layer adhesion and deposits on heads.

Feature of the new Sonoramic line is the Tensitized Double-Play Mylar\*—2400 feet on a 7" reel—which is twice as strong as ordinary magnetic tapes with the same playing time. Whatever your tape needs—for the home or for professional use—you'll find a Sonoramic tape to fit your needs.

For extra convenience, and at no extra cost, the tape comes in the exclusive Ferrodynamics easy-to-thread V-slot *Selection Finder* reel.

\*A DuPont trademark.

*To the first 50 people who respond to this advertisement—we'll be happy to send out a free Sonoramic tape container. (And if you're not in the first 50, we've a pleasant surprise for you anyhow.)*

*Write to Dept. D-103, Ferrodynamics Corporation, Lodi, New Jersey.*

SONORAMIC IS A PRODUCT OF THE



CORPORATION  
LODI, NEW JERSEY



## Detachable Speaker Rings

In reference to Mr. Wynn's suggestion [see Oct. 57 issue, p. 31] for preventing the cardboard speaker ring from sticking to the mounting board, I would suggest simply rubbing the contact surface with a wax candle or block of paraffin.

Lt. Cmdr. F. W. Ewald  
Oahu, Hawaii

## Light For Equipment Cabinet

When the average music listener with a components music system finally gets around to putting these into a cabinet the problem of a light for the inside of the cabinet usually arises. In looking for a suitable unit for such a purpose, two requirements must be kept in mind: a bulb large enough to do the job and a unit small enough to fit conveniently into the cabinet.

While radio supply houses list panel lights of various sorts, a commercially available night light found in a hardware store fits the bill very nicely. The unit I used was a Snapit light with prongs designed to fit directly into a wall outlet. These were covered with a friction-fit fiber insulator to cover the base of the unit which housed the socket and the switch. This insulation was easily removable and, since I did not want the additional bulk of a female socket for the

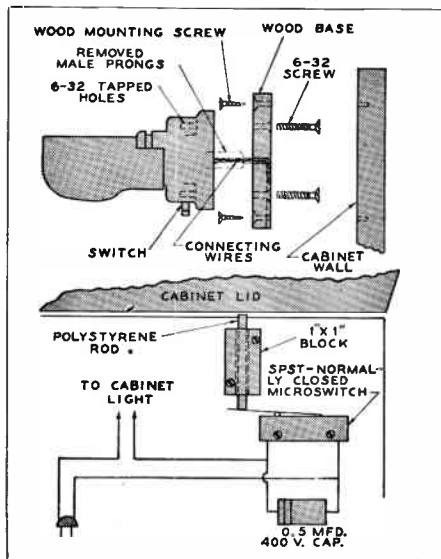

light, I removed the fibre cover around the male prongs and bent these out so that they could be clipped off (or sawed with a small hack saw). Two No. 20 hookup wires were then soldered to the stubs of the male prongs, which were now cut short enough to allow the unit to be mounted flush with its base. There were two convenient holes already in the plastic of the switch housing which were tapped to take a 6-32 screw. A small square of  $\frac{1}{4}$ -inch-thick wood was cut slightly larger than the diameter of the



# audio aids

light base to serve as a new base for the lamp. Two holes were drilled to match the tapped holes and two for mounting screws. The base was sanded and stained to match the interior of the cabinet and a hole cut for the wires with a groove for them in the back of the new base.

The bulb is a 7-watt type that has relatively long life and is readily available for replacement. The Snapit light comes with an ON-OFF switch on the side which can be used to operate the light.

Since the light was used in a cabinet with a lift-up top it was decided to make the light switch automatic, so that it would go on when the top was opened. A small microswitch was secured from a surplus counter in a radio supply house. This was mounted, out of sight under other equipment, on the wall of the cabinet. It was of the normally closed type with a long extension wafer to actuate the switch. Above this wafer a 1-by-1-inch piece some 3 in. long was mounted, through which a hole slightly larger than  $\frac{1}{4}$  in. had been drilled. The hole acted as a guide for a  $\frac{1}{4}$ -inch piece of polystyrene rod. The position of the switch was adjusted so that when the top of the cabinet was closed the rod pressed the switch open, turning off the light (See diagram). A 0.5- $\mu$ fd 400-volt paper capacitor across the switch terminals completed the installation.

Edward T. Dell, Jr.  
Millis, Mass.

## Hardware Sorter

When building a kit, it's a nuisance to have to look through a pile of assorted hardware for just the right nut, washer, solder lug, spacer, or what-have-you. To keep the little beggars sorted and within easy reach, I tried driving several 2-inch nails all the way through a 4-by-8-inch piece of  $\frac{1}{8}$ -inch wood (the top of a cigar box or even a piece of heavy corrugated cardboard would do very well) about  $1\frac{1}{2}$  in. apart. Then I strung each kind of hardware on a separate nail. Make sure that you have at least one nail that is skinny enough for 3-48 nuts.

Eleanore B. Wright  
Sheffield, Mass.

## Restless Tie Points

Anyone who has tried to cinch down the nut and bolt holding a tie point to a chassis knows what a squirmy little cuss it can be. Inevitably, the last twist of the screw driver will turn the whole works out of line; then, to get it straight, you must loosen the screw and start all over.

Try placing the lock washer between the tie-point foot and the chassis, rather

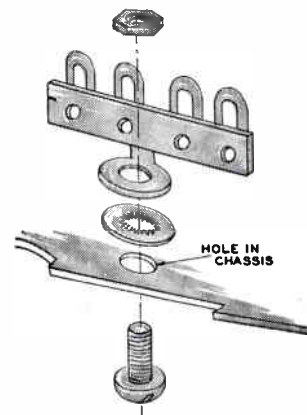

than directly under the nut. The little teeth on the lock washer grip the two metal parts and everything stays put without the usual juggling and fussing.

L. E. Johnston  
Madison, Wis.

## Radioactive Dust Brush

A radioactive record brush can be made very simply. Place the pickup with the needle resting on a piece of cardboard. A ten-cent camel's-hair brush, cut through the ferrule, is leaned at an angle of about  $45^\circ$  against the pickup shell directly in front of the needle and cemented there.

An ordinary commercial radioactive capsule can then be cemented between the brush and the needle.

The brush sweeps each record clean of dust as it is being played. No static charge is built up because the surrounding air is ionized by the action of the radioactive capsule. The weight of the brush and capsule is not great enough to affect the action of the pickup arm.

L. M. Garrett, M.D.  
Corpus Christi, Tex.

# What is the best setting of volume controls and input levels to guarantee least distortion and noise?

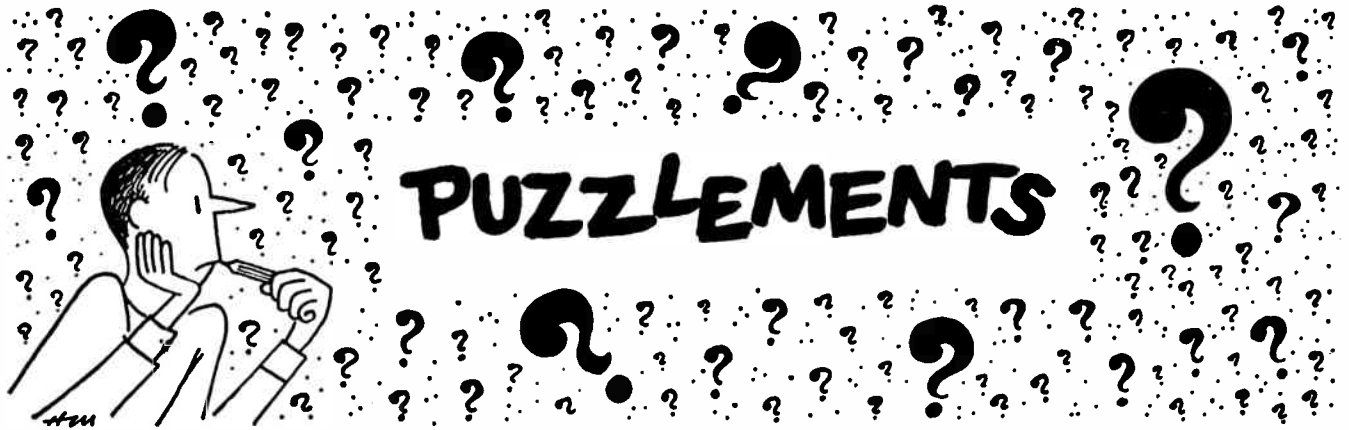

by NORMAN H. CROWHURST

WHY should a pickup cause distortion on my preamplifier at home, when it did not on the demonstration preamplifier at the store where I bought it? Could the input impedance of my preamplifier be wrong, or something?" When this question was asked, I thought at first that perhaps the distortion of which my questioner spoke was disturbed frequency response brought about by working the pickup into too low an input resistance, for example.

This will cause loss of high frequencies in many magnetic or moving-coil cartridges. In the case of a crystal or ceramic, working into too low an input resistance will cause loss of low frequencies. But this was not the explanation in this case. He really meant *distortion*. He went on to explain that when he played the pickup at home it "broke up" on loud passages, which it did not do when it was played at the store.

Well, one possible explanation of this could be that his previous pickup had ruined his record but did not show the distortion it produced. This is noticed quite frequently in changing to an improved pickup. For example, a pickup that has an inferior high-frequency response may damage or destroy the high-frequency component in the recording. Because it does not respond to these frequencies the reproduction from it may sound quite good in spite of this damage. But when an improved pickup is used to play the same disc it does respond to the higher frequencies; and the fact that the previous pickup has caused damage makes the reproduction now sound distorted.

If this is the explanation, of course it can always be discovered by playing some new discs that have not been

played with the older pickup. In this particular case, this check had been made and still the distortion was present when louder passages were played.

Next I asked him whether he had noticed a difference in the setting of his volume control with this pickup compared with the old one. Was it possible that the volume did not need to be turned up so far to get the same loudness with this pickup? He had not particularly noticed, but he thought it was possible that the same loudness might be reached when the control was a whisker lower down.

As he wasn't too sure about this, the next step was to pull out the schematic for his particular preamplifier. It proved to follow the general arrangement de-

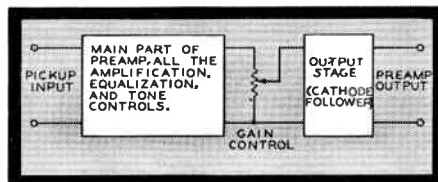

Fig. 1. Basic arrangement of the preamp discussed in this month's puzzlement.

picted in Fig. 1. The volume or gain control was immediately before the output stage. This means that a pickup giving a higher-level output may cause some stage before the gain control to run into distortion, although the gain control may be turned down so that the level fed to the power amplifier is still well within distortion limits. Of course, this makes it exhibit the same symptoms as if the pickup itself were distorting: turning the gain down does not eliminate the distortion *before* the control; it only turns down the volume it produces.

The input resistance for the preamplifier was 47 K and that specified for the particular pickup was also 47 K—nothing wrong here. But probably the

output from the pickup was about 6 db higher than that which the preamplifier had been designed to handle.

Since the gain control has a logarithmic taper designed to accommodate at least 40 db change in gain from one end to the other, a matter of 6 db would be only about one number difference on the marked scale—about the kind of difference one might expect between one recording and another. Consequently it would not be surprising that the user did not notice the fact it was operating at a slightly lower position.

The quickest way to check this would be to insert some attenuation at the input and see whether or not it removes the distortion. To achieve 6 db attenuation, a 47-K resistor in series with the input will halve the voltage, while a 100-K resistor in shunt will result in the correct loading resistance for the pickup, as shown in Fig. 2.

This, of course, should be connected close up to the input socket and carefully shielded. Making up a small attenuator of this sort and temporarily shielding it with aluminum foil, we attached it to the preamplifier. The pickup now behaved perfectly without producing any distortion on the loud passages. Since then my friend has put the attenuator in a neat little box mounted on the back of his preamplifier, and is very happy with his new pickup.

This is just one of the troubles that high-fidelity equipment users can get into by incorrect use of volume or gain controls. In this case it would appear to be poor design on the part of the pre-

Fig. 2. How the distortion was overcome.

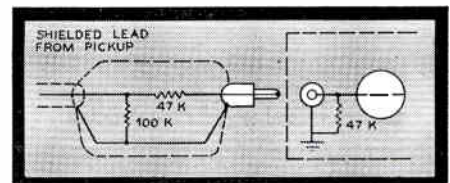

amplifier. After all, one is entitled to expect that a preamplifier should handle any of the usual group of magnetic pickups at the low-level input, and any of the crystal or ceramic group at the high-level input.

For this purpose, the gain control — or at least part of it, if a ganged dual arrangement is used — should be nearer the front end of the preamplifier, to insure that operation with a pickup giving more output than average does not cause distortion of some later stage.

Logically, equalization and gain control should both come quite early in a preamplifier. Tone controls can come a little later, and a loudness control may be immediately before the output, because this serves a different function from the gain control. The purpose of a loudness control is to alter the level at which the program is played. Consequently, turning down the loudness control is not likely to result in any distortion, because the gain control should take care of the maximum level that a given record will deliver.

But another wrong use of volume controls that can result in poor performance concerns the relative adjustment of the control on the preamplifier and the one on the basic amplifier, which is usually intended to be preset. The confusion can of course be complicated if one has a basic amplifier with a gain control and a preamplifier with both a gain control and a loudness control.

Whatever the combination of controls, the system should be operated so the output from the preamplifier at the maximum loudness level you will ever want to hear is about the maximum output level the preamplifier will give before beginning to run into distortion. This will probably be a position with both the gain controls at an intermediate setting; that is, with neither of them turned all the way up.

There seems to be a strong temptation to arrange the system so that one or the other of the controls is wide open to give the maximum desirable loudness. Suppose the basic amplifier is capable of 50 watts for 0.5 v input, and the maximum loudness you need in your living room requires only about 0.1 v input to the amplifier. If the basic amplifier has its gain control turned all the way up, then the gain control on the preamplifier must be turned pretty well down so that at maximum loudness the preamplifier gives only a peak audio output of 0.1 v. This means the background noise and hum from the preamp-control stages beyond the gain control can be larger than necessary, possibly by 20 db or more, and can result in more hum and noise from the system. This will be worse if the preamplifier gain control is used to operate the system at even lower levels: the audio will turn down

*Continued on page 40*

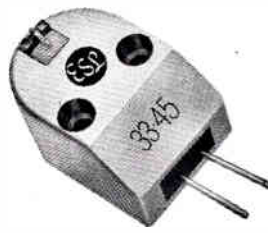

THE CARTRIDGE THAT'S

*Years Ahead*

If you always insist upon the very best, here is the one phono pickup for you: the superlative new ESL C-60 Series electrodynamic cartridge.

Your ears will soon tell you of the C-60 Series perfection in record reproduction: unmatched clarity, smoothness, and naturalness. No other pickup is so truly musical.

The reasons why are many, including a response which is inherently linear, unlike the inherently non-linear response of most pickups. The C-60 Series is distinguished, too, by complete absence of system damping. Only an undamped cartridge can actually have the extraordinarily small dynamic mass of the C-60 Series (only one one-thousandth of one gram), its superb transient response, and its ability greatly to increase the life of records and styli.

Frequency response of the C-60 Series is flat within one db from 18 cps to 20,000 cps (Elektra 35 test record), and response extends well beyond 30,000 cps. No need to change the input resistor of your preamplifier for the C-60 Series, because its magnificent performance is completely unaffected by load resistance. And no transformer is required with modern preamplifiers.

Complete details of C-60 Series superiority may be obtained without cost from ESL. Meanwhile, visit your record dealer's, and hear this cartridge that's years ahead!

THE *Automatic*  
RECORD CLEANER

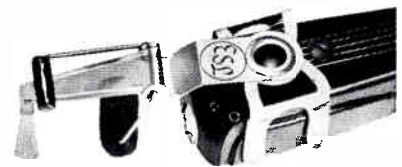

If you always insist upon the very best, here is the one record cleaner for you: the unique new ESL Dust Bug.

Experts the world over acclaim the Dust Bug as the surest, safest way to clean records and eliminate surface static. They acclaim its convenience, too, because the Dust Bug cleans records automatically while they are being played.

The Dust Bug for record changers (above) is easily slipped onto the arm of your changer. Special Dust Bug fluid is provided in a dispenser. After a wipe with the dispenser across the Dust Bug bristles and plush pad, the changer is operated as usual. The Dust Bug sweeps each groove scrupulously clean just before it is played by the stylus, and eliminates the record static which would attract more dust.

Extend the life of your valuable records and styli with the ESL Dust Bug. The changer model, with fluid in dispenser, costs only \$4.75. If yours is a manual player, the regular model Dust Bug is only \$5.75 complete. Try it at your dealer's today.



FOR LISTENING AT ITS BEST

Electro-Sonic Laboratories, Inc.

Dept. C • 35-54 Thirty-sixth Street • Long Island City 6, N.Y.

for

# LOWEST hum...noise... microphonics

in a high- $\mu$  dual triode . . .



the

## Amperex®

**ECC83** A PLUG-IN  
REPLACEMENT FOR THE 12AX7

### MICROPHONICS:

Negligible in amplifiers requiring an input voltage of at least 50 mv for an output of 5 watts. No special precautions against microphonics necessary even though the tube is mounted in the near vicinity of a loudspeaker with 5% acoustical efficiency.

### HUM AND NOISE LEVEL:

Better than -60 db relative to 50 mv when the grid circuit impedance is no greater than 0.5 megohms (at 60 cps), the center tap of the heater is grounded and the cathode resistor is by-passed by a capacitor of at least 100 mfd.

### OTHER Amperex TUBES FOR HIGH-FIDELITY AUDIO APPLICATIONS:

EL84/6BQ5	9-pin power pentode; 17 W PP
6CA7/EL34	High-power pentode; 100 W PP
EF86/6267	Low-noise high- $\mu$ pentode
ECC81/12AT7	Low-noise medium- $\mu$ dual triode
ECC82/12AU7	Low-noise low- $\mu$ dual triode
ECC85/6AQ8	High- $\mu$ dual triode for FM tuners
GZ34/5AR4	Cathode-type rectifier; 250 ma.
EZ80/6V4	9-pin rectifier; cathode; 90 ma.
EZ81/6CA4	9-pin rectifier; cathode; 150 ma.

At All Leading Electronic  
Parts Distributors

**Amperex**  
**ELECTRONIC CORP.**  
230 Duffy Ave., Hicksville, Long Island, N.Y.



## Reviews of highest-fi disc

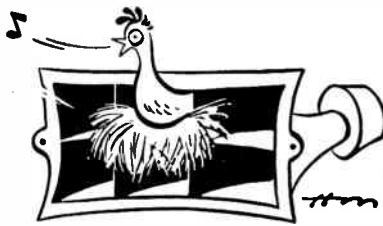

# Sound-Fanciers'

THE Big News at the moment I write (likely to be even bigger by the time these lines appear in print) is of course that onetime wild dream of hi-fi pie in the sky: the *stereo disc*. Contrary to my skeptical expectations, developments have been fantastically speeded up and it already appears that the vital question of a standard processing system has been settled — in favor of the Westrex 45/45 groove-cutting technique. At least it is this system which has been employed both for the first stereo disc to be produced for within-the-industry circulation and the first American experimental pickup models.

I haven't yet gotten my itching fingers on (or even been able to hear the latest preview demonstrations of) either the Fairchild or Pickering stereo-cartridge prototypes, and so haven't yet been able to play stereophonically the most exciting disc in my bulging Christmas stocking: Audio Fidelity's pioneering "Compatible Demonstration Record for Test and Laboratory Purposes," AFLP 1872. It isn't available to the public, but is accompanied by the welcome news that, when stereo AFLP's are produced for general release, the price tag will be no higher than that for this company's conventional LP's — \$5.95.

### Preliminary Compatibility Report

Now, one swallow of course isn't adequate proof that summer is actually here, but at least the first one is a sure harbinger of its imminent approach. It won't be long now. Meanwhile, it behooves all of us to keep our enthusiasm within reasonable bounds and to remember that so revolutionary a new era can't possibly usher in — immediately — an audio millennium. Until I can check for myself the stereo reproduction of the present disc and the other companies' prototypes which should soon follow it, I can only provide, at this time, a none too enthusiastic and quite tentative evaluation of the claim to compatibility as judged by a single-channel performance with a standard LP pickup equipped with a one-mil stylus rather than the half-mil one utilized in the new stereo-cartridge designs.

Being luckier (or more insistent) than Mr. Darrell, we were able to get our hands on a Fairchild prototype stereo pickup and so could hear AFLP 1872 in 3-D. It is very, very good — nearly as good as the equivalent stereo tape played on a professional-quality machine. The technical quality is so close to that of present monophonic discs that any differences are of negligible importance, compared to the marked improvement in realism conveyed by stereo. The pickup played monophonic discs in excellent fashion also.

We know that Mr. Darrell's standard pickup is of a type that has high vertical compliance over a limited excursion range. This is no disadvantage for standard records, but it is for stereo records which have considerable vertical groove motion. His dissatisfaction is undoubtedly caused by this cartridge limitation. Playing AFLP 1872 with a standard cartridge having greater vertical excursion capability, we found the resulting monophonic sound to be of quite good technical quality; whether continued playing with such a cartridge would damage the record for later stereo use remains to be seen. — ED.

The present stereo disc is indeed playable monaurally in this way and both channels seem reasonably well represented and blended, but the quality is (as probably must be expected) far below that of the regular LP processings of the same recorded materials. Aurally,



and tape records

## Guide

by R. D. DARRELL

the single-channel playback of the disc is perhaps passable (not unlike that of the earliest LP's as reproduced with the then available microgroove pickups), but tonally rather bodiless and certainly not free from distortion. I'm sure this might sound acceptable enough to an indiscriminating audio novice, but when it is compared with the standard LP versions, it gives only a hint of the wide frequency range, dynamic impact, and crispness of transient response for which Audio Fidelity is deservedly celebrated.

Just to make sure of this, I immediately went back to the original LP's (AFLP 1851 and 1843) of the Dukes of Dixieland *Marching Along* selections and the excerpts from *Railway Sounds: Steam and Diesel* which are represented in the stereodisc prototype. The former, which I reviewed so enthusiastically last October, still strikes me as a sonic masterpiece; and the latter, which I had heard before only in show demonstrations last fall, proved to be equally impressive technically, although perhaps lacking a bit in drama, since, for all its superb documentation of clanks, chuffs, bells, and horns, it fails to include any of the high-speed, roaring-past express trains which were so electrifying in the memorable *Rail Dynamics* disc with which Emory Cook first achieved fame away back in 1951. But of course the real test still remains to be made in direct stereo comparisons of the new disc versions with those released earlier on tape. I still haven't received the railway reel (AFST 1843), but my unqualified delight in the Dukes' Vol. 3 (AFST 1851) was expressed here in last January's column—and if the stereo disc, in true stereo reproduction, can come even close to that, the success of the new two-channel groove medium will certainly be assured.

### The New Approach to New Music

One thing is sure: no one is more likely to welcome the opening of a second stereo front than the contemporary composer, who got his first real break in years when LP's came along to bring his works to infinitely more listeners

*Continued on page 44*

MARCH 1958

NEW FROM FISHER—

AND  
BEST  
IN  
ITS  
CLASS!



## THE FISHER "100" 30 Watt Amplifier

FROM THE DRAWING BOARD, through every painstaking step of development and testing, to the proud accomplishment of the finished product, FISHER leadership is in evidence throughout! Now, FISHER announces a magnificent new power amplifier so outstanding in design, so superior in performance and so conservatively built that it will give you many years of "clean," trouble-free service.

**HIGH POWER!** 30 watts of power delivered to the speaker terminals in continuous sine-wave operation; 70 watts of reserve peak power to handle orchestral transients and peaks up to 30 milliseconds in duration, with no trace of clipping, ringing or raggedness.

THE FISHER "100" has ample reserve power to drive even the lowest-efficiency loudspeaker system. Its absolutely clean tonal output eliminates listener fatigue and adds markedly to the enjoyment of your home music system. Hear it at your dealer now! **\$9950**

WRITE TODAY FOR COMPLETE SPECIFICATIONS

FISHER RADIO CORP. • 21-31 44th DRIVE, L. I. CITY 1, N. Y.



**ISAAC STERN**  
**makes his home**  
**recordings on**



**That alone is not**  
**the reason why**  
**you should use**



**Here's why**  
**you should use**



**It's the best-engineered tape in the world**  
**...gives you better highs... better lows... better sound all around!** Saves your tape recorder, too—because the **IRISH FERRO-SHEEN** process results in smoother tape...tape that can't sand down your magnetic heads or shed oxide powder into your machine. Price? Same as ordinary tape!



Available wherever quality tape is sold.  
**ORRadio Industries, Inc., Opelika, Alabama**  
 Export: **Morhan Exporting Corp., New York, N. Y.**  
 Canada: **Atlas Radio Corp., Ltd., Toronto, Ontario**

## STEREO

*Continued from page 21*

off-the-air recordings. It will make a stereo recorder virtually indispensable.

We have been talking about stereo tapes and stereo taping. Let's look at monaural tape and taping for a while. One virtue of tape, monophonic or stereo, is that it can be used to record something broadcast at an inconvenient time. Assume that you live in New York and like to listen to the New York Philharmonic Symphony every Sunday (3:05 through 4:30 P.M.). To listen means that you'll miss *Wide Wide World*, *Omnibus*, or any of the many fine television programs that seem to be confined to Sunday afternoons. These conflict with the Philharmonic. If you must decide between them, you are being cheated—there is no need to miss either. With a tape recorder in the house, you can record the Philharmonic while you watch television. In its most simple (and probably most costly) form, you need another television set not connected to your sound system, and a tape recorder connected to your tuner (or whatever you wish to record). The recorder preserves the concert while you do something else.

Another, less costly method would be to connect the recorder to the "recorder output" (if you have such) of your tuner, while you set the main selector switch of your system to TV. There is one catch here: most good audio equipment has a selector switch that shorts out all the inputs not in use at the time, to prevent crosstalk. This would prevent the use of your tuner and TV simultaneously, because the output from the tuner would be automatically shorted by the selector. Thus, you would have to unplug the tuner from the control unit. Since the small phono plugs and jacks will not take too much plugging and unplugging, a switch will have to be inserted.

Such a switch need only be an SPST (single-pole, single-throw) toggle switch mounted in a small aluminum box with two phono jacks mounted thereon. The unit is so wired that, with the switch on, there is a through connection between the tuner and the control; with the switch off, this connection is broken. In use, the switch is normally left on. When you wish to record from the tuner while listening to something else, merely set the switch to the OFF position and proceed. Use shielded wire throughout to prevent hum pickup, and keep all leads as short as possible. One such switch can be made for each input so that you can record from any of them. For stereo, use a double-pole, single-throw switch (DPST) and four phono jacks.

There is one minor fault with this device: you can forget to throw the

*Continued on page 38*

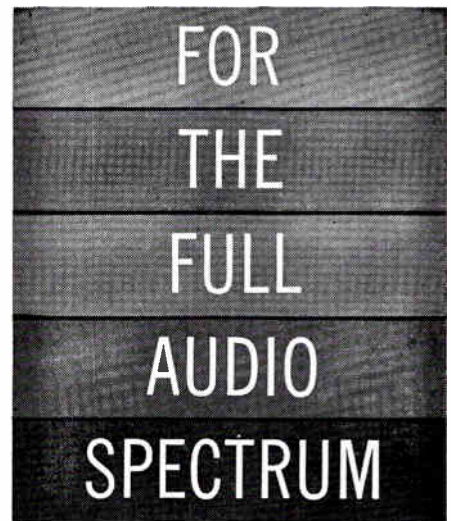

## Ultra Linear II

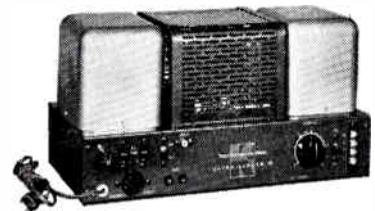

Do you hear the timpani in the symphony, or the clarinet in a quartet? From vibrant restless lows to delicate highs, Ultra-Linear II reproduces the full audio spectrum the way it should sound... smooth, clean, natural. Graceful or tantalizing, music floats out with an airiness that spells fatigue-free listening hour after hour.

Acrosound Ultra-Linear II provides realistic amplification with new Hybrid\* feedback that features complete stability and excellent square wave response on all types of output loads. Complete printed circuit, power transformer and choke are all made by Acro plus the new T0-600 output transformer especially designed for the circuit and constructed to the top standards of Acro's world famous quality. Simple layout provides top performance with only 2 hours of construction time.

\*pat. pending.

Power output 60 watts; response 20 cps. to 20 kc. within 1 db. of 60 watts; less than 1% IM distortion at 60 watts; hum level 90 db. below full output; 1.8 volts RMS for 60 watts output; output impedances are 4, 8, and 16 ohms; 7" x 15 1/8" x 8" h.; tubes used are 12AU7, 12AX7, 6Z34, 2-EL34 or 6CA7; variable damping from 0.5 to 15; weight 30 lbs.; Color:—Two-tone metallic brown.

AVAILABLE THROUGH LEADING DISTRIBUTORS \$79.50 complete kit (\$83.00 west coast); \$109.50 wired and assembled (\$113 west coast).

**Acro Products, 369 Shurs Lane, Phila. 28, Pa.**

Please send literature on illustrated Ultra-Linear II Amplifier.

Name .....

Address .....

City ..... State .....

**ACRO PRODUCTS COMPANY**

369 SHURS LANE, PHILADELPHIA 28, PA.

make the most of your work... use a high precision **JBL LOUDSPEAKER!**

You will put many hours into learning the fundamentals, and then the fine points of high fidelity. You will spend your time and energy freely in building the very finest sound system you know how. Remember this when choosing your loudspeaker. Get a speaker of the highest precision—one that bears the symbol "JBL"—one that is worthy to demonstrate your own best efforts. JBL precision and advanced design are responsible for JBL efficiency—highest in the world. JBL efficiency gives you the smoothest, cleanest, most realistically lifelike sound you can get.

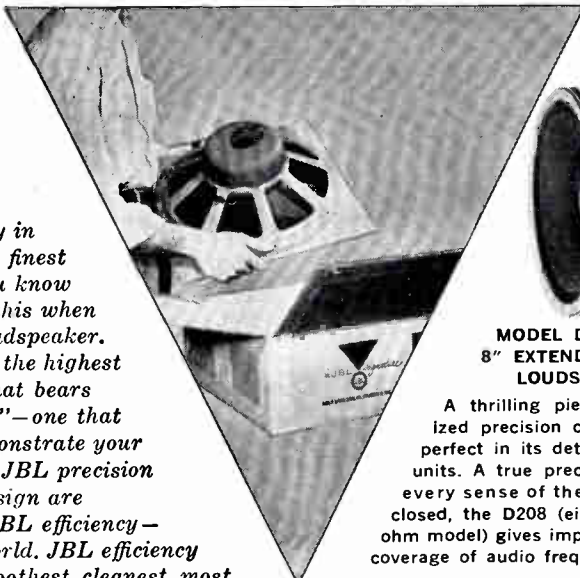

**MODEL D123  
12" EXTENDED RANGE LOUDSPEAKER**

An outstanding value, the D123 at first glance is most unusual because of its shallow structure—only 3 1/8". More unusual is the crisp, clean bass it generates. Listening will develop great respect for the D123's smooth response, excellent handling of transients, and pleasingly lucid highs.



**MODEL D208/D216  
8" EXTENDED RANGE LOUDSPEAKER**

A thrilling piece of miniaturized precision craftsmanship. As perfect in its details as larger JBL units. A true precision transducer in every sense of the term. Properly enclosed, the D208 (eight ohms, D216 is 16 ohm model) gives impressive, rich, full range coverage of audio frequency range.



**MODEL 075 HIGH FREQUENCY UNIT**  
Exciting to behold, the precision-machined 075 embodies a new concept in high frequency reproduction. A ring, rather than a diaphragm, radiates sound energy into the annular throat of an aluminum exponentially tapered horn. Above 2500 cps, 075 sets a new standard for linear reproduction.



**MODEL D130 15"  
EXTENDED RANGE LOUDSPEAKER**

The only speaker of its kind... only one made with a 4" voice coil... only single unit speaker to give you complete, true high fidelity coverage of the entire audio spectrum. Your basic speaker. Use alone at first, later add JBL high frequency unit and dividing network for supreme excellence of JBL 2-way system.

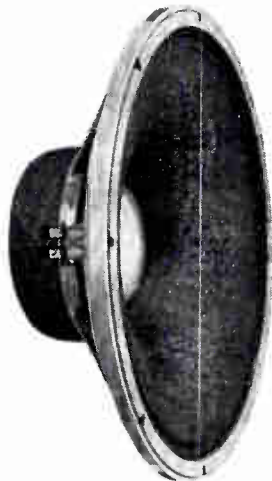

**MODEL 175DLH  
HIGH FREQUENCY ASSEMBLY**

The finest of high precision drivers designed for 1200 cycle crossover is combined with a machined exponential horn and acoustical lens for optimum sound reproduction in the home. The lens, an exclusive JBL development, acoustically illuminates a 90° solid angle with equal intensity regardless of frequency.



**MODEL 086 KIT OF  
PROFESSIONAL  
COMPONENTS**

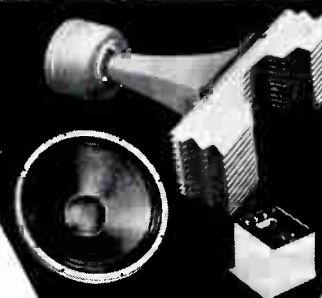

The finest speaker complement made. Designed for theaters, used in the Hartsfield, available for other applications to industry and the serious high fidelity enthusiast.



Only a few of the many precision JBL products are shown on this page. Whatever your needs, you will find exactly the right system or unit for you in the complete, free JBL Signature catalog. Send for your free copy. A limited number of technical bulletins are also available. Please ask only for those in which you are vitally interested.

Please send me the following:

- Free Catalog of JBL Signature Products
- Name and address of Authorized JBL Signature Audio Specialist in my community

TECHNICAL BULLETINS ON:

- D130     D123     D208
- 175DLH     075

NAME \_\_\_\_\_

ADDRESS \_\_\_\_\_

CITY \_\_\_\_\_ ZONE \_\_\_\_\_ STATE \_\_\_\_\_

"JBL" means **JAMES B. LANSING SOUND, INC.** 3249 Casitas Avenue, Los Angeles 39, California

**I was almost  
through with hi-fi...**

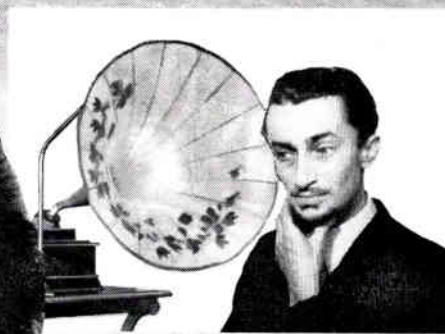

**...until I heard a  
NORELCO speaker!**

My brother-in-law is an electronic engineer. He told me what hi-fi components I should buy. He kept repeating something about series impedance in crossover networks and shunt capacitance with electrostatic driver loads. My TV repairman also told me what to buy — only he didn't agree with my brother-in-law. He was hipped on push-pull-parallel triodes in Class A. The salesman in the hi-fi salon shook his head sadly about *both* of their recommendations. I was ready to quit. I started to negotiate with the antique shop for their 1906 wind-up gramophone, complete with morning-glory horn.

Then, at a friend's house, I heard a NORELCO speaker in a NORELCO enclosure. Peace swept over me in a warm, caressing tide. Man, this sounded like *music!* Sweet highs, smooth lows, clean middles — and not an oscilloscope on the premises! I asked my brother-in-law and my TV repairman to stop confusing me, fired my psychoanalyst and bought a NORELCO speaker. I have been a delighted and electronically unencumbered listener ever since. (You can be, too — and you can get some valuable information you can understand from North American Philips Co., Inc., High Fidelity Products Division, 230 Duffy Avenue, Hicksville 2, Long Island, N. Y.)

**NORELCO®**  
*loudspeakers*

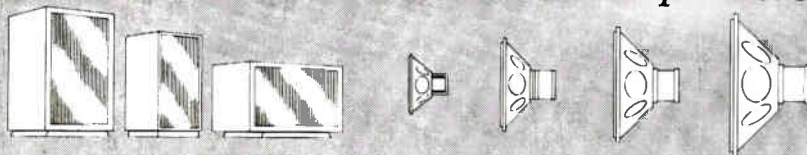

a complete line of 5" to 12" high-fidelity speakers and acoustically engineered enclosures

**STEREO**

*Continued from page 36*

switch to the ON position after use. The gadget described in the box on page 21 remembers for you.

Having been sidetracked by the technical for a moment, let us study how recording off the air applies to stereo. It has already been mentioned that stereocasting is bound to increase as we get more stereo discs. This, in turn, means that stations and networks will have to build stereocasting facilities. Is it not then logical to assume that there will be stereocasting of live events on a routine basis? Once this becomes the case, we will be able to record live stereo off the air extensively. Don't forget that far too many good concerts and the like are not recorded for release to the public, but are broadcast only. There are just too many good things for record companies to record them all. They wisely prefer to remain with the standards, which are good commercial ventures, and which they can sell a lot of. Again, let us not get sidetracked here. Back to the main track: with a stereo recorder you will be able to record and save these

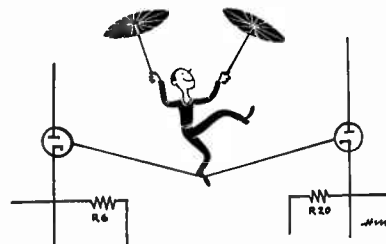

memorable events. It is clear that a stereo recorder will be a handy thing to have around. We can assume, from the above, that there will be a lot of these machines sold. And if there are many recorders in use, there will certainly be a market for recorded stereo tapes.

It should be pointed out that throughout this article I have been talking about a quality tape recorder. I do not mean to imply that package tape recorders are worthless, or anything of the sort. I do say that they do not fit into the scheme of a high-fidelity system. For a tape recorder to be a part of such a system, it should not be a packaged unit. It should have no built-in power amplifier or speaker; they duplicate those in the hi-fi system, without their quality.

By now, it should be apparent that I don't think much of what the skeptics are saying about the future of tape. Tape will become more and more important to the home listener; and it will be a smart man who early recognizes its potential, and uses every bit of it. See your audio dealer today. Talk tape with him — he'll be happy to help you.



**FREE!** A Must For Every Hi-Fi Enthusiast  
**LAFAYETTE CATALOG**



**NEW 180 PAGE ELECTRONIC CATALOG FEATURING THE BEST BUYS IN THE BUSINESS**  
 The newest and largest assortment of Electronic, Radio and TV parts, Hi-Fi and Public Address Components and systems, Test Equipment, tubes, Transistor Kits and miniaturized components for transistor circuitry, Ham Equipment, Builders Kits, Tools, Books, Microscopes, Binoculars, Telescopes, Cameras, and Drafting Equipment.—**ALL AT LOWEST PRICES**—Catering to the economy minded dealer, serviceman, engineer, technician, experimenter and hobbyist. **CRAMMED FULL OF MONEY SAVING BUYS. SEND FOR YOUR FREE COPY TODAY.**

**New! YEARS AHEAD!**

**Lafayette STEREO TUNER KIT**  
**THE MOST FLEXIBLE TUNER EVER DESIGNED**

- 11 Tubes + Tuning Eye + Selenium Rectifier • 12 Tuned Circuits
- Dual Double-Tuned Transformer Coupled Limiters.
- Separately Tuned FM and AM Sections • Dual Cathode Follower Output
- Armstrong Circuit with FM/AFC and AFC Defeat



**KT-500 IN KIT FORM**  
**74.50**

More than a year of research, planning and engineering went into the making of the Lafayette Stereo Tuner. Its unique flexibility permits the reception of binaural broadcasting (simultaneous transmission on both FM and AM), the independent operation of both the FM and AM sections at the same time, and the ordinary reception of either FM or AM. The AM and FM sections are separately tuned, each with a separate 3-gang tuning condenser, separate flywheel tuning and separate volume control for proper balancing when used for binaural programs. Simplified accurate knife-edge tuning is provided by magic eye which operates independently on FM and AM. Automatic frequency control "locks in" FM signal permanently. Aside from its unique flexibility, this is, above all else, a quality high-fidelity tuner incorporating features found exclusively in the highest priced tuners.

FM specifications include grounded-grid triode low noise front end with triode mixer, double-tuned dual limiters with Foster-Seeley discriminator, less than 1% harmonic distortion, frequency response 20-20,000 cps  $\pm 1/2$  db, full 200 kc bandwidth and sensitivity of 2 microvolts for 30 db quieting with full limiting at one microvolt. AM specifications include 3 stages of AVC, 10 kc whistle filter, built-in ferrite loop antenna, less than 1% harmonic distortion, sensitivity of 5 microvolts, 8 kc bandwidth and frequency response 20-5000 cps  $\pm 3$  db.

The 5 controls of the KT-500 are FM Volume, AM Volume, FM Tuning, AM Tuning and 5-position Function Selector Switch. Tastefully styled with gold-brass escutcheon having dark maroon background plus matching maroon knobs with gold inserts. The Lafayette Stereo Tuner was designed with the builder in mind. Two separate printed circuit boards make construction and wiring simple, even for such a complex unit. Complete kit includes all parts and metal cover, a step-by-step instruction manual, schematic and pictorial diagrams. Size is 13 3/4" W x 10 3/4" D x 4 1/2" H. Shpg. wt., 18 lbs.

The new Lafayette Model KT-500 Stereo FM-AM Tuner is a companion piece to the Models KT-300 Audio Control Center Kit and KT-400 70-watt Basic Amplifier Kit and the "Triumvirate" of these 3 units form the heart of a top quality stereo hi-fi system.

KT-500.....Net **74.50**

**LAFAYETTE MASTER AUDIO CONTROL CENTER**  
**with BINAURAL CHANNEL AND DUAL VOLUME CONTROL.**

- Self-Powered • DC On All Filaments • 24 Positions of Equalization
- Tape Head Input, High Impedance • Dual Cathode Follower Output Stages

This is not only the finest hi-fi preamp characterized by unmatched features, but it has been functionally designed to keep pace with the conversion of your present hi-fi system to binaural (Stereo) sound. Incorporates an extra channel and dual volume control for binaural reproduction. Features include DC on all tube filaments, negative feedback in every stage, dual cathode follower output stages and latest printed circuit construction. Less than 0.09% IM distortion and less than 0.07 harmonic distortion at 1V. Hum and noise level better than 80 db below 3V. Uniformly flat frequency response over entire audible spectrum. 7 inputs for every type of phono, tuner or tape. Tasteful styling, brilliantly executed. Size 12 3/4 x 9 1/2 x 3 3/4". Shpg. wt., 10 1/2 lbs.

KT-300—Lafayette Master Audio Control Kit Complete with cage and detailed assembly instructions. Net **39.50**

LT-30—Same as above completely wired and tested with cage and instruction manual. Net **59.50**

Net ..... **94.50**

**DELUXE 70 WATT BASIC AMPLIFIER**

- Conservatively Rated At 70 Watts • Inverse Feedback • Variable Damping
  - Metered Balance And Bias Adjust Controls • Available In Kit and Wired Form
- Here's ultra-stability in a 70 watt basic power amplifier employing highest quality components conservatively rated to insure performance and long life. Features matched pair KT 88's and wire range linear Chicago output transformer, variable damping control, meter for bias and balance and gold finish chassis. Frequency response 10-100,000 cps  $\pm 1$  db. Hum and noise 90 db below full output. IM distortion less than 1 1/2% at 70 watts, less than 0.3% below 30 watts. Harmonic distortion less than 2% at 70 watts from 20 to 20,000 cps  $\pm 1$  db. Output impedance 4, 8 and 16 ohms. Handsome decorative cage perforated for proper ventilation. Size 14 1/2 x 10 x 7 3/8" including cage and knobs. Shpg. wt., 40 lbs.

KT-400—Lafayette 70 watt Deluxe Basic Amplifier Kit complete with cage and detailed assembly instructions. Net **69.50**

LA-70—Same as above completely wired and tested with cage and instruction manual. Net **94.50**

Net ..... **94.50**



**KT-300 IN KIT FORM**  
**39.50**



**KT-400 IN KIT FORM**  
**69.50**

**HIGH FREQUENCY TWEETER WITH ACOUSTIC LENS**

**New!** DIRECT IMPORTATION MAKES THIS PRICE POSSIBLE!

- FREQUENCY RESPONSE FROM 2000 CPS TO BEYOND AUDIBILITY
- LOUVERED ACOUSTIC LENS FOR UNIFORM SOUND DISPERSION
- HANDLES 25 WATTS OF POWER
- PRICED EXCEPTIONALLY LOW

**14.95**

New high frequency tweeter featuring a louvered acoustic lens for uniform sound dispersion and capable of handling up to 25 watts of distortion-free power. The directional tendency of high frequency notes is overcome by the natural wide dispersion angle of the short horn and the acoustic lens which disperses and radiates the high notes smoothly throughout the entire listening area. The lens is detachable for panel mounting, with a separate base for the tweeter furnished for external mounting where desired. Aluminum voice coil has 16 ohm impedance. Size: 4 1/4" long x 3" diameter, lens extends 2 1/2". Requires a crossover network, preferably one with a level control, such as the LN-2. With full instructions. Shpg. wt., 5 lbs.

NW-7.....Net **14.95**

**Lafayette Radio** DEPT 165-08 LIBERTY AVE. AC-C JAMAICA 33, N. Y.

Send FREE LAFAYETTE Catalog 305

Name ..... CUT OUT AND MAIL TODAY

Address .....

City..... Zone.... State.....

# New Releases On CAPITOL STEREO TAPE!



## YOUNG PERSON'S GUIDE TO THE ORCHESTRA

Britten's witty symphonic demonstration of all the instruments.

## VARIATIONS ON A NURSERY TUNE

Dohnanyi's famed exploration of a familiar theme.

Felix Slatkin conducts the Concert Arts Orchestra, with Victor Aller, Pianist (ZF-23)

## Other Classical Releases in "Full Dimensional Sound" Stereo

### WM. STEINBERG, PITTSBURGH SYMPHONY:

Beethoven: *Symphony No. 7* (ZF-22)

### CARMEN DRAGON, HOLLYWOOD BOWL SYMPHONY ORCHESTRA:

*Russkaya!* (ZF-24)

### ERICH LEINSDORF, LOS ANGELES PHILHARMONIC:

Ravel: *Daphnis et Chloe, Suite 2*  
Debussy: *La Mer* (ZF-25)

### WM. STEINBERG, PITTSBURGH SYMPHONY with NATHAN MILSTEIN:

Dvorak: *Concerto for Violin and Orchestra* (ZF-26)

### LEOPOLD STOKOWSKI:

Gliere: *"Ilya Mourometz"*  
(*Symphony No. 3 in B Minor*)  
Houston Symphony Orch. (ZF-27)

## Popular Releases in Stereo

FRANK SINATRA:  
*Where Are You?* (ZD-17)

JACKIE GLEASON:  
*Velvet Brass* (ZD-19)

GORDON JENKINS:  
*Stolen Hours* (ZC-18)

LES BAXTER:  
*Ports of Pleasure* (ZC-20)

JOHNNY RICHARDS:  
*Wide Range* (ZC-16)

"THE STARS IN STEREO" (ZD-21)



2 CHANNEL — 7½ IPS — FOR IN-LINE HEADS

## PUZZLEMENTS

Continued from page 33

with the volume control, but the hum and noise level will stay at the same level as that produced at maximum power.

At the other extreme, some like to have their preamplifier gain control wide open at the maximum desirable loudness in their living room. To achieve this they turn the gain control on the basic amplifier down to the desired setting. This method minimizes hum and noise admirably but can sometimes produce distortion troubles similar to the one with which we started off this discussion. Most preamplifiers are provided with more gain than they are ever likely to need, except perhaps if the most insensitive of pickups happens to be used. But with an average pickup, working the preamplifier wide open will produce a greater output than is needed, with resultant distortion from preamplifier stages *beyond* the volume control. True, the gain control on the input to the basic amplifier will reduce this output to the level proper to give the desired loudness. But it will not eliminate the distortion already produced, this time in the output stages of the preamplifier.

Best results are obtained from a compromise setting in which neither control is operated wide open. The volume control should be adjusted to produce the maximum working voltage for which it is designed, usually in the region of 1 or 2 volts. This is then attenuated by the input control of the basic amplifier so as to give the maximum loudness that will ever be desired in the living room.

Now, to get the best operation throughout one can use the control on the preamplifier to work the system at lower loudness levels. Alternatively, equally good results can usually be obtained, if so desired, by using the input level control on the basic amplifier as a volume control, unless the preamp has a loudness control just for this purpose. There is no trouble provided you don't turn the volume down on one amplifier and then later on turn it up on the other, so as to disturb the correct balance of the settings for maximum loudness.

Sometimes this may happen by one member of the household turning up the volume, on one control, while another member alternately turns it down, using the other one. Either way, you will end up either with an excessive background and hum level, or else with some distortion you didn't begin with. Make sure everyone knows which control you decide upon as the proper one to use.

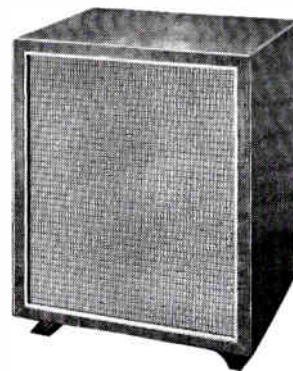

## LARGO

The new Permoflux "Largo" begins with a powerful enveloping bass foundation that can only be compared with the live performance! The Transition to the middle tones of the orchestra and voice is accomplished without any apparent "crossover" junction even though a separate mid-range radiator is used. Electrical compensation circuit within the cross-over network insures velvety shimmering high treble reproduction, that renders the upper register in its natural acoustical timbre.

Reproduction like this, free of cabinet size restrictions, finds a welcome place in the home of the decor-conscious audiophile. The moderate enclosure size is in good taste in today's living rooms, and the aesthetic simplicity of design compliments the finest decor.

### Specifications

Enclosure size	21W x 14D x 23
Impedance	8 ohms
Frequency Response	38 to 15,000
(free field conditions)	
Price — Utility	\$79.50 — Solid Color
	Mahogany Etc.
— Furniture	\$89.50 — Lustrous
	Wood Grain
Power Handling	20 Watts



• FOR QUIET LISTENING •

## PERMOFLUX DIMENSI-FONES

Permoflux DIMENSI-FONES are unexcelled for Stereo listening! They furnish a quality of reproduction comparable to the best hi-fidelity speaker system.

The natural acoustical advantage of being "directly coupled" to the original performance via Permoflux DIMENSI-FONES must be heard to be appreciated. DIMENSI-FONES provide late hour listening at high volume levels without disturbance to others. Complete your hi-fi ensemble with a set of professional high quality DIMENSI-FONES.

Available now at your Hi-Fi Dealer or write for free booklet "16 Ways to Use DIMENSI-FONES." (Please include your local Dealer's name and address.)

## PERMOFLUX PRODUCTS CO.

4101 San Fernando Road  
GLENDALE 4, CALIFORNIA

Save yourself time and trouble  
by ordering your books directly from us.  
Just fill in the coupon below.



# audiophile's bookshelf

## Suggestions for your library

### THAT CRAZY AMERICAN MUSIC

By ELLIOT PAUL

An informed, witty, unorthodox, highly opinionated, always fascinating account of the development of American music — from pre-Revolutionary days to jazz, boogie, and rock 'n' roll, by the author of *The Last Time I Saw Paris*. What he says carries weight. How he says it makes vigorous, illuminating, sometimes searing reading. Not only for music lovers, but for all who enjoy good, lively writing. \$4.00 259

### UNDERSTANDING HI-FI CIRCUITS

By NORMAN H. CROWHURST

Here the audiophile will find the answers to questions often confusing. The chapters are: special output stages, feedback, damping, inverter and driver stages, input stages, matching, equalization, speaker distribution and crossovers, loudness and volume controls, tone controls.

Hard cover, \$5.00 254 Soft cover, \$2.90 255

### HIGH FIDELITY: A PRACTICAL GUIDE

By CHARLES FOWLER, Publisher, AUDIOCRAFT Magazine

Here at last is *the* book for the beginner — one that neither under- nor overrates his knowledge or ability to understand high fidelity. With unusual clarity and in just the right amount of detail it explains the principles involved and their application. Thus the reader is able to exercise an informed and reasoned judgment as to what would best suit his own taste, his available space, and his purse — in building, in buying, or in adding to his high-fidelity system. In short — a complete, intelligible, and literate exposition for the novice high fidelitarian. \$4.95 234

### MAINTAINING HI-FI EQUIPMENT

By JOSEPH MARSHALL

A much needed book on the specialized approach necessary to service high-fidelity equipment. The author discusses not only electronic faults, but the mechanical and acoustical defects which cause a hi-fi system to function less than perfectly. The book is clearly written and well indexed. Hard cover, \$5.00 232 Soft cover, \$2.90 233

### HANDBOOK OF SOUND REPRODUCTION

By EDGAR VILLCHUR, inventor of AR loudspeaker systems and president of Acoustic Research, Inc.

Here is A-1 information about all aspects of sound reproduction, acoustics, and the necessary components. Written by one of the foremost authorities in the field, the book is organized in a way similar to home training courses. It fully covers a difficult technical subject in a manner which will provide pleasure and profit to the high-fidelity enthusiast. \$6.50 249

### FM Stations Up-to-Date

Here, in convenient booklet form, is a complete geographical listing of FM stations in the United States and Canada. The list was compiled by Bruce G. Cramer directly from FCC records, and originally appeared in AUDIOCRAFT Magazine. With additional changes and corrections to bring it up-to-date, it has been reprinted as a booklet. The price is only 50¢. 264

## Records in Review-1957

The Third High Fidelity Annual

Edited by Joan Griffiths

Associate Editor, HIGH FIDELITY Magazine

Here, between the covers of a single volume, is the expert guidance needed by everyone who would make intelligent purchases of LPs and tapes.

This book, the only one of its kind, contains over 900 reviews of classical and semiclassical music, and the spoken word that have appeared in HIGH FIDELITY Magazine from July 1956 through June 1957. Written by some of this country's distinguished music critics and intended for both instruction and pleasure, the material is arranged for convenient use. Reviews cover both the merits of performance and the quality of recording. An index of performers is included.

RECORDS IN REVIEW is published by The Wyeth Press, an affiliate of HIGH FIDELITY Magazine. The book is printed in clear type on fine quality paper, attractively bound and jacketed. \$4.95 257

### ORDER TODAY

#### HIGH FIDELITY RECORD ANNUAL 1955 HIGH FIDELITY RECORD ANNUAL 1956

Both edited by Roland Gelatt

Comments on the first two annuals:

"High Fidelity's panel of reviewers includes some of the best-known men in the business. Their reviews not only are comprehensive in their comparisons of editions, but frequently they contain information about certain works that is difficult to find elsewhere." — NOTES

"The record collector who is bewildered by the sheer number of discs which are issued each year will find this book valuable as a means of bringing order out of chaos." — CHICAGO TRIBUNE

1955 Annual — \$4.95 201 1956 Annual — \$4.50 237

Book Department  
AUDIOCRAFT Magazine  
Great Barrington, Mass.

I enclose \$..... for which please send me, postpaid, the books indicated by circled numbers below. (No C. O. D.'s or charge orders, please.) Foreign orders sent at buyer's risk. Add 55¢ per book for postage on foreign orders except Canadian.

Binder 1 (holds 14 issues)	223	\$3.50		
Binder 2 (holds 12 issues)	245	\$3.00	201	249
Unmarked binders	265	\$2.75 ea.	223	254
NAME .....			232	255
ADDRESS .....			233	257
			234	259
			237	264
			245	265

## GROUNDING EAR

*Continued from page 4*

its prototype, and is finding rapid acceptance. Only the production of tubes markedly superior to these is likely to recapture the market for American output tubes.

More dismaying to American manufacturers has been the growing use of imported versions of the various hi-fi twin triodes and rectifiers. Again, the initial penetration was due to better performance. My experience is typical. I replaced American 12AX7's and 12AU7's in two preamplifiers with random and unselected British Mullards. In both instances the noise and hum

were reduced by more than 6 db. Replacing a 5AW4 with a GZ34, I obtained 25 volts additional plate voltage and higher output on peaks; and the presence of a cathode provided better protection for my four output tubes during warm-up.

Manufacturers tell me that they find the imported double triodes and output tubes far more uniform in characteristics also, and thus they insure closer conformity of production amplifiers to specifications. I understand that the imported tubes are also cheaper to the manufacturers in large lots and this, no doubt, helps them not a little. But basically their popularity is due to their superiority of performance. It is notable that this is the only aspect of high

fidelity today in which imported products are superior to the domestic.

I note in a financial journal that some elements of the tube industry are considering asking for greater tariff protection. I trust they will consider instead a solution which would please all and give them far greater future protection: that of rolling up their sleeves and producing better audio tubes.

## DYNAKIT

*Continued from page 19*

existing in an RIAA-equalized record, the proportion was varied to ratios of 1 to 2 and 1 to 4, but the reading was still under 0.1%.

Square-wave response in the flat tone-control positions, with the VOLUME control at maximum, is so good in our model that the preamp can be used to increase the sensitivity of a scope at audio frequencies. Even the 10,000 (Fig. 11) and 20-cps square waves were very close to the original; there was no sign of ringing. The transient response of the preamp alone, with an independent power supply, was better than any test we could devise to try it. Transient performance of a combination of the preamp and a power amplifier sharing the same power supply would depend a great deal on the stability of the power amplifier. With the Dynakit amplifiers for which, presumably, the preamp was tailored, it remains excellent indeed.

Hum and noise are completely insignificant and will be inaudible even with low-level cartridges at any level anybody could possibly tolerate in the home. The gain is sufficient to operate a Fairchild pickup without a transformer, for example, although the loudness compensation is then not of much use.

The preamp's heavy-gauge cabinet provides very good shielding against stray magnetic fields. Since there is little heat to dissipate, the unit can safely be installed in closed spaces such as a turntable base or cabinet.

There can be differences of opinion on such matters as whether three phono equalization curves are sufficient, whether there ought to be input level controls or more and different main controls, and so on. It seems to us that Dynaco has worked out a preamp-control combination that will suit the great majority of people: simple and inexpensive, yet flexible enough to take care of most contingencies and tastes.

But even the most demanding of hi-fi perfectionists could not ask for more performance in terms of the high-fidelity essentials — wide-band response, almost complete freedom from distortion, faithful equalization of modern recordings, and superb transient response.



An audio system is like a chain. For optimum performance, all the links must be equally strong... there can be no compromise with "weak-link" components in the system.

It was on this premise that the Ampex A122-SP Portable Stereophonic System was designed. Each link in the chain — from recording and playback heads to speaker — was forged to the same exacting standards and precision tolerances which guide the manufacture of world-famous Ampex professional recording and playback equipment.

**Heads** — Facing surfaces of head gaps lapped to an optical flatness so precise they reflect a single light band (1/2 micron) on flatness gage. This, plus initial surface polish of 6-8 micro-inches, insures sustained frequency response with negligible change in characteristics over many thousands of hours of operation — many times longer than with ordinary heads.

**Amplifier-Speakers** — Ampex-designed, Ampex-built as an integral part of system... yet may be used separately with other units of your system (has front-panel input switching for Tape, Tuner, TV, or Phono). Amplifier sensitivity 0.25 v for maximum power output; 20-20,000 cps  $\pm$  1/2 db output with well under 1% harmonic distortion. Speaker features unusually high total gap energy, converts a maximum of output power into sound energy, with smooth, peak-free response.

**Complete Specifications** — Write today for free new full-color brochure containing complete specification sheet and description of full line of unmounted units, consoles, modular table-tops and portables.

**AMPEX AUDIO, INC.**  
1038 KIFER ROAD,  
SUNNYVALE, CALIFORNIA  
Please send free full-color folder:

3



NAME \_\_\_\_\_

ADDRESS \_\_\_\_\_

CITY \_\_\_\_\_

AR<sup>INC</sup>  
**QUOTATION**  
*from*  
**The Audio League Report\***

"We are now using the AR-1W as our reference speaker.

"As a result of extensive listening and laboratory tests, we are of the opinion that the AR-1W is one of the outstanding low-frequency reproducers available to-day. It may well be the most outstanding. At any rate, we do not specifically know of any other speaker system which is truly comparable to it from the standpoint of extended low frequency response, flatness of response, and most of all, low distortion."

\*Authorized quotation #55. For the complete technical and subjective report on the AR-1 consult Vol. 1, No. 11 of the independent consumer periodical THE AUDIO LEAGUE REPORT, Mount Vernon N. Y.

Prices for Acoustic Research speaker systems, complete with cabinets, (AR-1 and AR-2) are \$89.00 to \$194.00. Size is "bookshelf." Literature is available from your local sound equipment dealer, or on request from:

**ACOUSTIC RESEARCH, INC.**  
 24 Thorndike St., Cambridge 41, Mass.

**you  
 asked  
 for  
 it!**

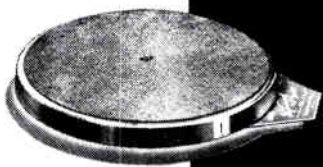

\*Hi-Fi, p. 6, July '55

The answer to the requests of many economy minded audiophiles is the belt driven **COMPONENTS PROFESSIONAL JR.** Turntable with outstanding features like: Constant speed 4 pole induction motor—speed accuracy 1/2 of 1%: wow & flutter 1/4 of 1% — noise level more than 60 db. down — accessory pulleys available for all speed operation—non-slip turntable.  
 Audiophile net only \$39.50.  
 Hear it at your dealer now or write for more details to: Dept. B

**COMPONENTS**  
 CORPORATION

DENVILLE **CC** NEW JERSEY

The turntable with the **PERFORMANCE GUARANTEE**

**TRANSISTORS**

*Continued from page 27*

at this same information in different ways to show more clearly the distortion-producing elements.

Fig. 8 shows the common "beta-fall-off" curve, showing the value of  $h_{FE}$  for every value of collector current. This quantity  $h_{FE}$  is defined as the ratio of collector current  $i_c$  to base current  $i_b$ , so it is not quite equal to  $\beta$ , or  $h_{fe}$ , which is the increase of collector current  $i_c$  divided by the small increase of base current which causes it. However, the two curves look very similar.

The theoretical reasons for the rise at low current followed by the dropoff at higher currents are complicated, but the people who design power transistors understand them, and it is quite possible that future transistors will have a more nearly constant value of  $h_{FE}$ .

Fig. 9 shows the so-called "input characteristic" which is a chart of how the base current  $i_b$  is related to the base-to-emitter voltage  $v_{be}$ . Unfortunately, it is decidedly nonlinear—another important cause of distortion. Notice the direction of the nonlinearity: as the voltage is increased, the current at first is very small but soon increases rapidly. This curve was drawn for a particular collector voltage but, as mentioned in Part 3 of this series, the lines for various voltages all fall very close together.

The two nonlinearities shown by these two graphs are the most important ones in a transistor, and account for the majority of the distortion found in power-transistor stages.

One other way of presenting essentially the same information may be even more informative. Fig. 10 shows two plots: one of the collector current (at a constant voltage) as a function of input current, or base current  $i_b$ ; the other of the same collector current as a function of the input voltage, or the base-to-emitter voltage  $v_{be}$ , again at a constant collector voltage.

The gradual curving of the first curve reflects the dropoff in  $h_{FE}$ , as we saw in Fig. 8. The second curve has a sharp bend at low collector currents caused by the nonlinear input characteristic, Fig. 9, and it also has a relatively straight portion beyond the point at which the two nonlinearities cancel, being in opposite directions.

The curving of these graphs is important in designing power transistor stages with low distortion.

**Present Uses**

Present-day power transistors are not useful at frequencies much above the audio range, with the exception of certain experimental high-frequency types.

It is difficult but not by any means impossible to design a high-fidelity audio

*Continued on next page*

*Artisan*  
**ELECTRONIC ORGAN**

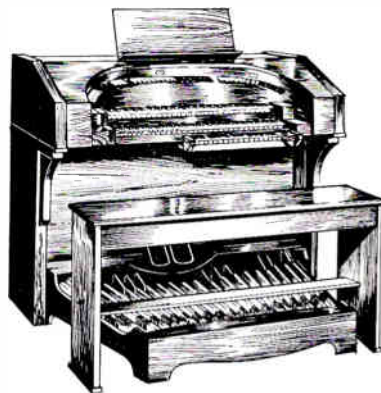

**A Theatre Organ  
 for YOUR HOME!**

The majestic sounds of the great theatre organ come thrillingly alive to your touch with the Artisan "King of Kits." Singing strings... resonant brasses... delicate reeds... even the rousing crescendo of the full pipe organ... all are yours to command with the Artisan Home Model!



**New  
 12" LP  
 ALBUM  
 \$2.98**

Hear the amazing tonal range and real theatre-organ quality of the Artisan Home Model in this new album played by prominent recording artists of the Theatre Organ. Complete with explanatory notes, this new album will become a treasured part of your record library.

**PORTFOLIO OF ORGAN FACTS  
 only \$1.00**



Jam-packed with material on organ building, tonal registrations, schematics, accessories, etc. Don't buy any organ until you have examined this portfolio of Organ Facts!

Please send the following: (postage paid)

- 12" LP Album "Artists at the Artisan"
- Portfolio of Organ Facts
- Both for special price of \$3.40

Enclosed is  check  M.O. for \$\_\_\_\_\_

Name.....

Address.....

City.....State.....

**ELECTRONIC  
 ORGAN ARTS, INC.**  
 4878 EAGLE ROCK BLVD.  
 LOS ANGELES 41, CALIF.

So simple it's  
like magic...

# Grommes Little Genie HI-FI KITS



LAYER-BUILT • COLOR-GUIDE

Before you build another kit see this new method of Kit Assembly. Each kit is complete with all parts and the new exclusive "Little Genie" Instruction Book.

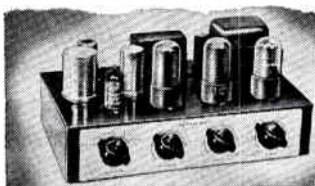

NEW  
**LJ-6K**  
\$24<sup>95</sup>

**LJ-6K** 10 Watt Amplifier (Little Jewel). Highest value in the low priced field, with built-in pre-amplifier and record compensator on phono channel. Freq. Response:  $\pm 1\text{dB}$  20 to 20,000 CPS at 1 watt. Distortion: 2% harmonic or less at 10 watts. In Charcoal and Brass. Shpg. Wt. 10 lbs. Complete Kit and instructions.....Net 24.95

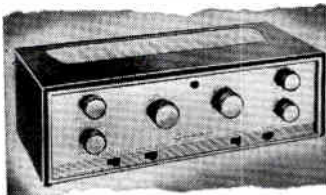

NEW  
**207AK**  
\$44<sup>50</sup>

**207A-K** Hi-Fi Pre-amplifier. The ideal control unit with self-power feature for use with any basic amplifier. True flexibility with 10 separate controls. Feedback throughout for low distortion and wide frequency response. In charcoal gray and brass. Shpg. Wt. 10 lbs. Complete Kit and instructions.....Net 44.50

**NEW 250A-K**  
60 Watt Basic Hi-Fi Amplifier. For use with a pre-amplifier (such as 207A-K). New advanced circuitry for true high fidelity with exceptional reserve power. Shpg. Wt. 40 lbs. Complete Kit and instructions.....Net 79.50

**61PG-K**  
20 Watt Amplifier. With built-in pre-amplifier and all controls. Modern flat compact design for tabletop or cabinet installation. Shpg. Wt. 20 lbs. In Charcoal and Brass. Complete Kit with instructions.....Net 59.50

See your Hi-Fi Dealer or write ...

**Grommes**—A Division of Precision Electronics, Inc.  
Dept. A-3 9101 King Ave., Franklin Park, Illinois

Send complete Kit details.  Send.....Kit.  
 COD (\$5 enclosed).  Postpaid. (Full payment enclosed. Enclose name of Dealer. (if any.)

Name.....

Address.....

City.....Zone.....State.....  
10-day money back guarantee on all Kits

## TRANSISTORS

Continued from preceding page

power stage. But the design is quite a bit easier when response beyond 7,500 cps is not required. For this reason the first applications for power transistors seem to be in auto radios, portable phonographs and other low-fidelity instruments.

There are also a number of nonaudio applications that are interesting. The power oscillator can convert direct current into AC in quantities large enough to be useful. Power transistors will also be found useful in converting AC to DC when used with certain types of rotating generators. And power transistors are used in place of vibrators in many applications, including auto radios. But the major field of application is still audio amplification.

Next month we will take up circuits for power transistors.

## SOUND FANCIER

Continued from page 35

than ever could have heard them in isolated concert performances, but who has still been handicapped by the single-channel medium's inadequacy in reproducing spaciouly the full variety and richness of sonic colorations characteristic of so much present-day composition. For the sound fancier in particular the ideal approach to new music is via stereo, where, however strange or unintelligible the melodic and harmonic idioms may seem, there never is any lack of sheerly sonic fascinations.

Moreover, stereo has a unique power of restoring genuine freshness to novelties which have made a sensation when they first appeared on LP, but whose edge and impact are quickly lost on repetition. An apt instance is Carl Orff's *Carmina burana*, which achieved so remarkable a triumph in its 1953 debut on Decca DL 9706, but which had become almost passé when it was reissued as part of the complete *Trionfi* trilogy (see Nov. 1956 SFG) and later alone in a superior recorded performance in last year's Angel 35415. Now it reappears again on the Vanguard LP, VRS 1007, where it is likely to galvanize only listeners who have never heard the work before, since the recording, fine as it is, doesn't markedly surpass Angel's, and the performance by the Hartford Chorus and Symphony under Fritz Mahler is less polished even though it is enlivened by uncommon gusto. But it also appears simultaneously in a stereo taping (VRT 3011-2, two 7-inch reels) and here it is a brand-new and more-electrifying-than-ever revelation.

Now, I'm not one of those taken in by Orff's pretense that he is re-creating



NEW!

Custom-Engineered TEST TAPE to check head alignment, frequency response, flutter and wow, signal-to-noise ratio on your tape machine. PLUS — a special stroboscopic leader for testing speed. Livingston's answer to the need for performance-insurance for valuable equipment. Use on 7.5 ips Stereophonic (stacked and staggered), Dual Track and Full Track machines. Individually laboratory produced.

"LX-1E" \$9<sup>95</sup>

NEW!

Livingston "ALL-PURPOSE TAPE RECORDER CLEANER." At last, a chemically pure cleaner that squeeze-sprays ALL parts of your machine — magnetic heads, tape guides, drive belts, etc. Will not damage tape or reel. Best of all, ONE operation does it, from spillproof, unbreakable bottle!

Only \$149

NEW!

More Livingstonettes! The ultimate in stereo entertainment in pop price series: LIST: \$6.95

DANCING ALONG IN STEREO .....	2001C
PEER GYNT SUITE .....	2002C
ENCHANTING STRAUSS .....	2003C
LENNY HERMAN GEMS .....	2004C
MUSIC FOR A MIDNIGHT MOOD .....	2005C
MULLIGAN MEETS MONK .....	2007C
TOE-TAPPIN' DIXIE .....	2008C
MUSIC FOR A DREAMY MOOD .....	2009C

All tapes available either stacked or staggered.

NEW!

Demonstration treat! 300 ft. of outstanding excerpts, frankly designed to whet your appetite for our superb Livingstonettes. Yours for 50c with coupon below.

Livingston Audio Products Corp. N  
Box 202, Caldwell, N. J.

Gentlemen:  
Enclosed is 50c for your Stereo "Demonstration Treat". My machine is stacked (in line)   
staggered (displaced) .

NAME.....  
ADDRESS.....  
CITY.....ZONE.....STATE.....

# LIVINGSTON

LIVINGSTON AUDIO PRODUCTS CORP.  
Box 202, Caldwell, New Jersey

authentically medieval and renaissance music making or that he has anything really profound, old or new, to say. But so what? He has (I think deliberately and perhaps somewhat cynically) contrived a sure-fire, sensational best seller, and when one hears his catchy tunes and even catchier rhythms clothed in the genuinely intoxicating sonics and big-auditorium acoustics they are given here, all aesthetic considerations can be forgotten as one is caught up willingly in the whirlwind of aural titillations. The floor-shaking bass drum here, the sizzling rattle of percussion, and irresistible lilt of quasi-cowboy and nursery-tune fragments, the overwhelming blasts of full choral and orchestral sonorities are all unqualified audiophile delights. If you want to bowl your friends over with an ultradynamic display of stereo's full powers, you can't go wrong with these tapes!

### Easy Impressionism — Hard Expressionism

In less brutally obvious, more impressionistic music, two further proofs of stereo's reinvigorating ability are to be found in the tapes of Ibert's nose-thumbing *Divertissement* and Debussian *Escales* (RCA Victor ACS 54 and ACS 57, by the Boston Pops and Symphony Orchestras under Fiedler and Munch respectively). The corresponding LP versions (in LM 2084 and 2111) are fine examples of current single-channel technology all right, but to depict the rollicking ribaldries of the suite or the Mediterranean atmosphere of the *Ports of Call* triptych, it takes the glowing pigments and widespread canvas of the best stereo sound. I have never been too impressed with *Escales* before, but I am

#### AUDIOLAB TEST REPORTS

Coming next month — see page 15

here, although perhaps more so by the Bostonians' ultrasensuous tone coloring than by Ibert's somewhat posterish designs. For me, the composer is infinitely more imaginative in his saucy suite of circus pieces, one of Fiedler's earliest triumphs in the days of 78's, but one which never could be captured with all its razzle-dazzle intact until auditorium-authentic sonic vibrancy and acoustical expansiveness could be brought back truly alive into our living rooms.

And even with the most difficult of all modern music, that utilizing the twelve-tone technique as first explored by Arnold Schoenberg, stereo miraculously eases the burden on one's ears and so at least prepares the way to a better intellectual comprehension of the implacably severe logic involved. His Suite, Op. 29, for a chamber ensemble led by Gunther Schuller is what I think of as "looks-and-glances" music: nervously

*Continued on next page*

# COMING to your city HIGH FIDELITY MUSIC SHOWS

See and hear the latest in HIGH FIDELITY  
from leading high fidelity manufacturers . . .

Don't miss these public showings of Hi-Fi Equipment . . . from the most economical units for the budget-minded to spectacular home music theatres . . . compare and enjoy them all. Components and complete systems will be displayed.

## THREE DAYS OF CONTINUOUS DEMONSTRATIONS

1 P.M. to 10 P.M.

SPRING 1958

March 7-9	Pittsburgh	Hotel Penn-Sheraton
March 21-23	Newark	Hotel Robert Treat
March 28-30	Baltimore	Lord Baltimore Hotel

Rigo Enterprises, Inc. 500 North Dearborn Street, Chicago 10, Illinois

## LISTEN TO JansZen\*

HEAR THE SPEAKER WITHOUT A "VOICE"

The JansZen Electrostatic has no voice of its own. It does not add to the music . . . exaggerate the instruments . . . distort the sound. Instead, it reproduces music with a clarity that borders on the superb. The JansZen Electrostatic, combined with the new JansZen Dynamic . . . a widely acclaimed, low frequency counterpart . . . gives you a complete, high quality loudspeaker that produces the musical realism you've always wanted but could never obtain.

Listen to JansZen\*. Write for literature and the name of your nearest dealer.

The Model 130 Electrostatic Tweeter . . . the most nearly perfect loudspeaker. \$184 in mahogany.



The Z-200 . . . a combination of the 130 Electrostatic and 250 Dynamic. The woofer and tweeter are so smoothly matched and blended that nearly perfect realism results. \$329 in mahogany.

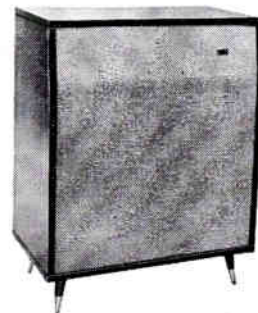

**Hear the Music, Not the Speaker**

\*Designed by Arthur A. Janszen

Products of NESHAMINY ELECTRONIC CORP., Neshaminy, Pa.

Export Division: 25 Warren Street, N. Y. C. 7 • Cable Simonrice, N. Y.

# DYNAKIT PREAMPLIFIER

An Outstanding Companion Kit  
to the World Famous Dynakit Amplifiers

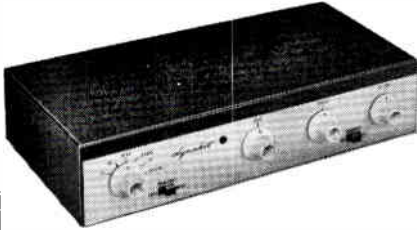

This handsome new control unit gives crystal clear, noise-free reproduction from any modern program source. Its unique all feed back design by David Hafler sets a new standard of preamplifier performance. The design of the Dynakit preamplifier is a synthesis of outstanding features which produce smoother, more natural sound. Compare these features with any other units regardless of price.

#### ★ Unequaled performance

Actually less than .1% distortion under all normal operating conditions. Response  $\pm 5$  db 6 cps to over 60 kc. Distortion and response unaffected by settings of volume control. Superlative square wave performance, and complete damping on any pulse or transient test.

#### ★ Easiest assembly

All critical parts supplied factory-mounted on XXXP printed circuit board. Eyeleted construction prevents damage to printed wiring. This type of construction cuts wiring time by 50% and eliminates errors of assembly. Open simplified layout offers complete accessibility to all parts.

#### ★ Lowest noise

Integral dc heater supply plus low noise components and circuitry bring noise to less than 3 microvolt equivalent noise input on RIAA phono position. This is better than 70 db below level of 10 millivolt magnetic cartridge.

#### ★ Finest parts

1% components in equalization circuits to insure accurate compensation of recording characteristics. Long life electrolytic capacitors and other premium grade components for long trouble-free service.

#### ★ High flexibility

Six inputs with option of extra phono, tape head, or mike input. Four AC outlets. Controls include tape AB monitor switch, loudness with disabling switch, full range feedback tone controls. Takes power from Dynakit, Heathkit, or any amplifier with octal power socket.

#### ★ Outstanding appearance

Choice of bone white or charcoal brown decorator colors to blend with any decor. Finished in indestructible vinyl coating with solid brass escutcheon.

#### ★ Best buy

Available from your Hi-Fi dealer at only \$34.95 net (slightly higher in the West), and yet the quality of performance is unexcelled at any price.

Descriptive brochure available on request. Pat. Pending

**DYNACO INC.**

617 N. 41st. St., Philadelphia, Pa.

Export Division:  
25 Warren St., New York 7, N.Y.

## SOUND FANCIER

Continued from preceding page

scrambling or languishing episodes which impertinently unearth from my mind's disorderly catchall attic Robert Burns's apostrophe to a mouse:

*Wee, sleekit, cow'rin', tim'rous beastie,  
Oh what a panic's in thy breastie!  
Thou need na start awa' sae hasty,  
Wi' bickering brattle!*

I doubt that this is what Schoenberg had in mind, but even though what he did have may remain a mystery to most listeners, no true audiophile can fail to be intrigued by the deftly dovetailed sonic spots and splashes (especially those contributed by three different varieties of clarinet) here. I would hesitate to recommend the original LP version (Period SPL 705 of 1955) except to twelve-tone specialists, but in the stereo taping (Period PST 7) the suite is immensely easier—and more provocatively stimulating—to take; and this despite the fact that the recording here (obviously made in the days of early two-channel experimentation) lacks the full expansiveness and warmth of more recent stereo technology.

### Contemporary (Nonstereo) Parade

It is unfortunate that the inestimable advantages of stereo are as yet seldom available to the less celebrated contemporary composers. The advent of the stereo disc probably will give them a better break before long, but meanwhile they are at least getting (both quantitatively and qualitatively) far more adequate representation on LP's than they ever dared hope for in earlier years. Most effective technically is Mercury's series of Eastman-Rochester Symphony performances under Howard Hanson, the latest of which (MG 50147) presents Kent Kennan's skillfully scored, brief *Three Pieces* and Bernard Roger's decidedly childish, inconsequential, and imitative five fairy tales, *Once Upon a Time*, plus a much more imaginative and expressive ballet, *Gold and the Señor Commandante*, by William Bergsma. All of them are superbly recorded, but it is the nervously vital Bergsma score which most dramatically exploits the extremely wide dynamic range and crisp transient response here.

Neither the Composers' Recordings nor the Louisville commissioned-works (available on subscription only) series is distinguished by such brilliant recording, but both of these continue to give a hearing to many less familiar composers and to a wide range of musical styles. The outstanding new release in the former series is the coupling (CRI 114) of Henry Cowell's *Persian Set* and Lou Harrison's Suite for Violin, Piano, and Small Orchestra, both of which are

## PROFESSIONAL DIRECTORY

FM/Q 

### ANTENNAE

Get more FM stations with the world's most powerful FM Yagi Antenna systems.

To be fully informed, send 25¢ for book "Theme And Variations" by L. F. B. Carini and containing FM Station Directory.



**APPARATUS DEVELOPMENT CO.**  
Wethersfield 9, Connecticut

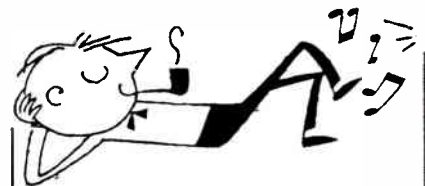

**TAPE RECORDERS**  
EXCEPTIONAL VALUES  
**HI-FI COMPONENTS**  
NATIONAL BRANDS  
WRITE FOR FREE CATALOGUE  
**CARSTON** 215 VV E. 88 ST.  
NEW YORK 28, N.Y.

SIX BRANDENBURG  
CONCERTOS



**BACH'S**  
greatest works  
in distinctive  
performances  
conducted by  
HERMANN SCHERCHEN  
exclusively  
on tape

**Omegatape**



**YOU'LL BE  
SLIGHTLY  
AMAZED . .**

when you receive our reply. Write us your hi-fi requirements now—you'll be glad you did.

**KEY ELECTRONICS CO.**  
120 Liberty St.  
N.Y. 6, N.Y.  
EVergreen 4-6071

**4  
STEREO  
TAPES  
FREE**

Highlights of Concertape, Livingstan, Omegatape and Replica libraries plus . . .

maximum savings on all Stereo Tapes from most complete stock anywhere! All for \$9 full year membership

**STEREOPHONIC  
MUSIC SOCIETY, INC.**

303 Grand Ave., Palisades Pk., N.J.



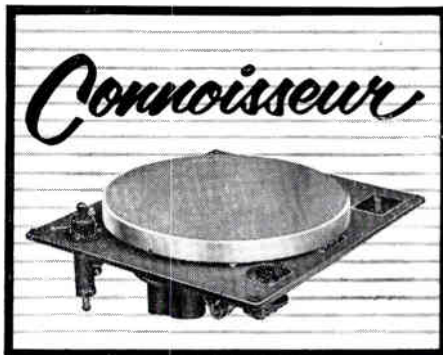

...for those who are!

A turntable worthy of its name . . . the last word for those who demand the finest and will accept nothing less. Many hours and many skilled hands go into the creation of each Connoisseur turntable to insure its remarkably silent and precision operation. Traditionally fine English quality, non-magnetic 12" lathe-turned table, hysteresis motor. Rumble; better than 50 db down (7 cm/sec. and 500 cps). Wow; less than 0.15% of rated speed. Size 13½ x 15". **\$110.00**

Companion "Dynabanced" tone arm with Mark II super-lightweight pickup. Frequency response 20-20,000 cps ±2 db at 33¼ rpm.



complete: with diamond stylus **\$49.50**  
with sapphire stylus **\$34.50**

At selected Hi-Fi dealers or order direct  
**ERCONA CORPORATION**  
(Electronic Division)  
551 Fifth Ave., Dept. 41, New York 17, N.Y.  
In Canada: Astral Electric Co. Ltd.  
44 Danforth Road, Toronto 13

save your records!

adjust your stylus pressure  
with "pRescription-accuracy"

**AUDAX  
STYLUS  
BALANCE**



**\$3.95  
NET**

- a precision instrument with lab-calibrated weights.
  - no springs — no inaccurately-printed scales.
  - the only way to obtain correct stylus pressure.
- Send 10c for 24-page book, "Electronic Phono Facts"

**AUDAX — DIV. OF REK-O-KUT Co., Inc.**  
Dept. AC, 38-19 108th St., Corona 68, N. Y.

Canada: Atlas Radio, Toronto • Export: Morhan Exp., N. Y.

rather too closely miked for my taste, but exceptionally well performed by no less a conductor than Stokowski. Both pieces are notable for unusually piquant and ingratiating tonal coloring: Cowell's with biting reeds and vibrant guitar-strumming "Tar" evocations of mid-eastern idiom ingeniously translated into vivacious western rhapsodic tunes and rhythms; Harrison's with more distinctively original and poetic adaptations of Balinese-gamelan sonorities, exploited here with the same skill and expressiveness which distinguished this composer's exciting *Canticle No. 3* in the recent *Breaking the Sound Barrier* stereo tape (and LP) from Urania.

I was much less impressed by the uninspired, slapdash, pretentious Piano Concerto by Antonio Lora, and the excessively lugubrious, meandering Variations by Adolph Weiss, in unpleasantly thin recorded performances by F. Charles Adler (CRI 113). And I was frankly bored throughout Robert Whitney's Louisville LOU 57-1 and 57-6 programs of (in the former) Paul Nordoff's querulously ineffectual *Winter* Symphony and the Swiss composer's (Paul Müller-Zürich) skillfully assured Cello Concerto (a long way behind Virgil Thomson's magnificent one, on Columbia ML 4468 of some years ago); and in the latter the Britisher Edmund Rubbra's languishing Violin Improvisations, Irving Fine's lush *Serious Song*, a lament for string orchestra, and Harold Morris's pretentious *Pas-sacaglia, Adagio, and Finale*.

*Opéra comique* devotees may relish the lively and colloquial *School for Wives* by another Swiss contemporary, Rolf Liebermann (LOU 57-3) despite the somewhat amateurish performance under Maurice Bomhard's direction. But for me the finest Louisville achievements of the past year (ranking with the Vincent and Jolivet disc LOU 57-2, praised in this column for Aug. 1957) are to be found in the 57-5 and 57-4 releases. The former couples Ned Rorem's introspective but richly lyrical and moving *Design for Orchestra* with a neoromantic, almost Brahmsian *Suite symphonique* by still a third Swiss contemporary, Bernard Reichel. The latter (57-4) is perhaps the hardest of all on non-modern-tempered ears, for it is a formidably long and intense solo for soprano (mostly in the high register) with orchestra. Nevertheless, this *Idyl of Theocritus* by Roger Sessions is unmistakably one of the most powerfully evocative and dramatic grand-scaled works ever essayed by an American composer. And once one surrenders to its dark magic, both the occasional shrillness of Audrey Nossman's voice and the consistent harshness of Sessions's grating dissonances become inevitably right for the passion, fury, and final bitter resignation of this setting of what has been not unjustly termed the greatest love poem in all literature.

**ROBINS' AUDIO ACCESSORIES**



- |   |          |         |
|---|----------|---------|
| <b>GIBSON GIRL® TAPE SPLICERS</b>         |          |         |
| 1. "Hobbyist"                             | H-4      | \$ 1.75 |
| 2. "Semi-Pro"                             | SP-4     | 3.50    |
| 3. Junior                                 | TS4A-JR  | 6.50    |
| 4. Standard                               | TS4A-STD | 8.50    |
| 5. Deluxe                                 | TS4A-DLX | 11.50   |
| 6. Industrial (5 sizes to 1")             | (net)    | 55.00   |
| <b>ROBINS' TAPE AND PHONO ACCESSORIES</b> |          |         |
| 7. Splicing Tape                          | ST-500   | .39     |
| 8. Head Cleaner                           | HC-2     | 1.00    |
| 9. Jockey Cloth for Tapes                 | JCT-2    | 1.00    |
| 10. Tape Storage Cans                     | TCT-7    | .80     |
| 11. Tape Threader                         | TT-1     | .98     |
| 12. Changer Covers (2 sizes)              | CC-1,2   | 2.00    |
| 13. Turntable Covers (2 sizes)            | CC-3,4   | 2.50    |
| 14. "Clean Sound" for Records             | CS-4     | 1.00    |
| 15. Jockey Cloth for Records              | JC-1     | 1.00    |
| 16. KleeNeedle                            | NB-1     | 1.50    |
| 17. Phono-Cushion. 10"x12"                | PC-10,12 | 1.50    |
| 18. Atomic Jewel                          | SE-90    | 5.00    |
| 19. Acoustic Insulation                   | AM-9     | 2.75    |

At Dealers Everywhere  
**ROBINS INDUSTRIES CORP.**  
BAYSIDE 61, NEW YORK

for everything in hi-fi  
GET THE MONEY-SAVING 1958  
**ALLIED CATALOG**

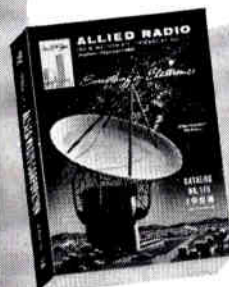

featuring the  
world's largest  
stocks of systems  
& components

**free!**  
SEND FOR IT

Here's your complete money-saving guide to Hi-Fi. Own a fine custom quality Hi-Fi music system at no more than the cost of an ordinary phonograph. See dozens of ALLIED-Recommended complete Hi-Fi systems, plus the world's largest selection of components (amplifiers, tuners, changers, speakers, enclosures and accessories). Want to build-your-own?—see our exclusive Hi-Fi KNIGHT-KITS. For everything in Hi-Fi—for everything in Electronics, get the FREE 1958 ALLIED Catalog.

**ALLIED RADIO** AMERICA'S HI-FI CENTER

**ALLIED RADIO CORP.** Dept. 89-C8  
100 N. Western Ave., Chicago 80, Ill.

□ Send FREE 1958 ALLIED Catalog

Name \_\_\_\_\_

Address \_\_\_\_\_

City \_\_\_\_\_ Zone \_\_\_\_\_ State \_\_\_\_\_

...the ultimate goal  
of the  
critical listener

**marantz**

*Audio Console*  
preamplifier, complete \$171\*

*Power Amplifier*  
\$198\*

*Electronic Crossover*  
\$90\*

\*slightly higher west of  
the Mississippi

write for literature

**marantz company**  
25-14 Broadway, Long Island City 6, N. Y.

**AR INC.**

Quotation from  
**AUDIO ETC.\***  
Howard Tinsell Cady

"I've had the new Acoustic Research speaker system in use for some time now and I must admit that I am delighted with it, so far. This is the speaker that, uniquely, substitutes a springy pillow of air for the stiffness in the usual speaker cone.

... the highs impressed me immediately as very lovely, smooth, unprepossessing, musical (for music) and unusually natural. No super hi-fi screech and scratch... As to the lows... I was no end impressed, from the first time I ran my finger over a pickup stylus and got that hearty, wall-shaking thump that betokens real bottom bass to the time when I had played records and tapes on the speaker for some months on end.

... (The AR-1) marks... a major advance in speaker design."

\*Quotation from AUDIO magazine, Vol. 39, No. 8, authorized by the publishers and author.

The AR-1 and AR-2, "bookshelf" size speaker systems complete with cabinets, are priced from \$89 to \$194. Literature is available at sound equipment dealers, or on request from:

**ACOUSTIC RESEARCH, INC.**  
24 Thorndike St., Cambridge 41, Mass.

**FOLDED HORN**

Continued from page 24

housecleaning days. This baby is heavy! There is very little clearance within the unit for the back end of the speaker. The H-530 just makes it, but the G-610 Triaxial requires the removal of its dust cover. According to Mr. Karl Kramer, Manager of Technical Services for the Jensen Company, this procedure has no undesirable effect on the tone or performance of the speaker.

The discussion thus far assumes the use of a coaxial or triaxial speaker, and these will mount with the least effort. However, in separated two- or three-way systems the woofer may be mounted as shown for unitary systems. Long middle-range units may be mounted behind a suitable opening at the top of the front baffle and an airtight box mounted in an opening in the V to accommodate the driver end of the component. Be sure the joints around such a box are well caulked. A tweeter may be mounted in the front baffle without complications, but, again, be sure there are no leaks where it joins the baffle.

An interesting variation to this enclosure would be to omit the two No. 1 panels and allow the walls in the corner of the room to act in their stead. Such a departure has Mr. Kramer's blessing and would save on cost and weight. In such a case I should be inclined to make the top and bottom as before, and to install a two-by-two brace between them at the outer extremities for support of the outer edge of the grille work.

**TRADERS' MARKETPLACE**

Here's the place to buy, swap, or sell audio equipment. Rates are only 20¢ a word (excluding name and address) and your advertisement will reach 20,000 to 35,000 readers. Remittance must accompany copy and insertion instructions.

**BUILD** — A 40 watt ultralinear hi-fidelity amplifier. For the ultimate in hi-fidelity listening only an ultralinear amplifier does it. Plans include schematic chassis layout, parts list, and descriptive literature. \$3.00. Dennis Page, 428 N. Taylor St., Oak Park, Ill.

**TAPE RECORDERS**, hi-fi components, tapes. Unusual values. Free catalog. Dressner, 69-02D 174 St., Flushing 65, N. Y.

**WILL BUILD ALL TYPES** of kits, hi fi, etc. 30% above cost. Write for details. Howard's Radio Service, Box 528, Myrtle Creek, Oregon.

**ENJOY PLEASANT SURPRISES?** If so, write us before you buy any hi-fi. You'll be glad you did. Key Electronics Co., 120 Liberty St., New York 6, N. Y. EVergreen 4-6071.

**ADVERTISING INDEX**

Key No.	Advertiser	Page
1	Acoustic Research, Inc.	5, 43, 48
2	Acro Products Co.	36
3	Allied Radio Corp.	47
4	Amperex Electronic Corp.	34
5	Ampex Corp.	42
6	Apparatus Development Co.	46
7	Audax, Inc.	47
8	Audio Fidelity Records	1, Back Cover
9	Audiophile's Bookshelf	41
10	British Industries Corp.	Inside Front Cover
11	Capitol Records	40
12	Carston Studios	46
13	Components Corp.	43
14	Connoisseur	47
15	Dynaco Inc.	46
16	EICO	7
17	Electronic Organ Arts	43
18	Electro-Sonic Laboratories	33
14	Ercona Corp.	47
19	Ferrodynamics Corp.	30
20	Fisher Radio Corp.	35
10	Garrard Sales Corp.	Inside Front Cover
21	Glaser-Steers Corp.	2
22	Grommes	44
23	Heath Co.	8-11
24	International Pacific Recording Corp.	46
25	JansZen	45
26	Key Electronics Co.	46
27	Lafayette Radio	39
28	Lansing, James B., Sound, Inc.	37
29	Livingston Audio Products	44
30	Marantz Co.	48
25	Neshaminy Electric Co.	45
31	North American Philips Co.	38
24	Omegatape	46
32	ORRadio Industries, Inc.	36
33	Permoflux Products Corp.	40
22	Precision Electronics, Inc.	44
	Professional Directory	46
34	Rigo Enterprises, Inc.	45
35	Robins Industries Corp.	47
36	Stereophonic Music Society	46
	Traders' Marketplace	48
37	University Loudspeakers, Inc.	14
38	Viking of Minneapolis	Inside Back Cover

# Information service for audiocraft readers



We've made it easier than ever for you to secure prompt additional information about products advertised or mentioned editorially in this issue.

### HERE'S ALL YOU DO:

1. Tear out one of the two lower cards along its perforated edges.
2. Fill in your name and address in the space provided at the top of the card. Please type, or print in ink, if at all possible.
3. To get additional information about products advertised in this issue, look up the advertiser's name in the index on the page facing this one. In the column at the left will be found the advertiser's current key number. Simply circle this number in the central section of your card. Do this for each advertiser in whose products you are interested.
4. If you want more information about products described in our Audionews department, or mentioned in other editorial sections, print the product names and the numbers of the pages on which they appear in the spaces provided in the lower section of the card.
5. Drop the card in the nearest mail box. We'll do the rest.

Note that two cards are supplied. You can keep one as a spare, for possible later use, or let a friend use the extra card.

Use this service—everything, even the postage, is free. A special service to Audiocraft readers.

THESE CARDS  
FOR THIS ISSUE ONLY

*Use this service*



## BUSINESS REPLY CARD

FIRST CLASS PERMIT NO. 62, SEC. 34.9, P. L. & R., GREAT BARRINGTON, MASS.

### audiocraft

POST OFFICE BOX 600  
GREAT BARRINGTON, MASS.

3-8

**AUDIOCRAFT  
READERS'  
SERVICE**

• PLEASE TYPE OR PRINT •

NAME .....  
STREET & NO. ....  
CITY ..... ZONE ..... STATE .....

ADVERTISED PRODUCTS	1	2	3	4	5	6	7	8	9	10	11	12	13	14	15
(See Key Nos. in index on page at left)	16	17	18	19	20	21	22	23	24	25	26	27	28	29	30
	31	32	33	34	35	36	37	38	39	40	41	42	43	44	45
	46	47	48	49	50	51	52	53	54	55	56	57	58	59	60

<b>PRODUCTS</b>	PRODUCT .....	PAGE .....
<b>MENTIONED</b>	PRODUCT .....	PAGE .....
<b>EDITORIALY</b>	PRODUCT .....	PAGE .....
(Including	PRODUCT .....	PAGE .....
<b>AUDIONEWS)</b>	PRODUCT .....	PAGE .....

**AUDIOCRAFT  
READERS'  
SERVICE**

• PLEASE TYPE OR PRINT •

NAME .....  
STREET & NO. ....  
CITY ..... ZONE ..... STATE .....

ADVERTISED PRODUCTS	1	2	3	4	5	6	7	8	9	10	11	12	13	14	15
(See Key Nos. in index on page at left)	16	17	18	19	20	21	22	23	24	25	26	27	28	29	30
	31	32	33	34	35	36	37	38	39	40	41	42	43	44	45
	46	47	48	49	50	51	52	53	54	55	56	57	58	59	60

<b>PRODUCTS</b>	PRODUCT .....	PAGE .....
<b>MENTIONED</b>	PRODUCT .....	PAGE .....
<b>EDITORIALY</b>	PRODUCT .....	PAGE .....
(Including	PRODUCT .....	PAGE .....
<b>AUDIONEWS)</b>	PRODUCT .....	PAGE .....

# Subscription

## SERVICE PAGE

Because we have so many requests for subscription information, we have decided to publish the full subscription story — all in one place — the result being this page. We hope you'll use it.

### audiocraft

Great Barrington, Mass.

Please enter my subscription, starting with the next issue, at the **SPECIAL RATE** of 3 years for only \$9.00.

FOREIGN POSTAGE: \$1.00 per year outside the U. S. A., its possessions, and Canada.

- My remittance is enclosed.
- Please send me your bill.
- I prefer two years for \$7.00.
- I prefer one year for \$4.00.

3-8

NAME \_\_\_\_\_

ADDRESS \_\_\_\_\_

CITY \_\_\_\_\_ ZONE \_\_\_\_\_ STATE \_\_\_\_\_

- Gift subscriptions attached.
- Group subscriptions attached.
- Send me the following back issues:  
1 3 6 8 13 14 16 17 19 20 22 23 26 27  
payment for which is enclosed.

Postage  
Will be Paid  
by  
Addressee

No Postage  
Stamp Necessary  
if Mailed in the  
United States

### BUSINESS REPLY CARD

FIRST CLASS PERMIT NO. 2, COPAKE FALLS, N.Y.

### audiocraft

POST OFFICE BOX 50  
COPAKE FALLS, N.Y.

3-8

Postage  
Will be Paid  
by  
Addressee

No Postage  
Stamp Necessary  
if Mailed in the  
United States

### BUSINESS REPLY CARD

FIRST CLASS PERMIT NO. 2, COPAKE FALLS, N.Y.

### audiocraft

POST OFFICE BOX 50  
COPAKE FALLS, N.Y.

3-8

### REGULAR SUBSCRIPTION RATES

Three years — Nine Dollars. *Save \$3.60 over the single copy cost.*

Two years — Seven Dollars.

One year — Four Dollars.

*(Add \$1.00 per year for postage on all subscriptions sent to addresses outside of the United States, its possessions, and Canada.)*

### BARGAIN GROUP SUBSCRIPTION RATES

(One-Year Subscriptions Only)

Here's a real saving! Just get together a group of subscriptions and submit them all at one time.

First Subscription — \$4.00.

Each additional subscription — \$3.00.

Send the list to our Circulation Department (and mark it **SPECIAL GROUP SUBSCRIPTION RATE**) with a check or money order in the appropriate amount.

### GIFT SUBSCRIPTIONS

You will find that a subscription to **AUDIOCRAFT** makes the perfect gift for any occasion. If you submit more than one subscription (at the same time), the special group rates shown above will apply. We will acknowledge your gift, to the person receiving it, with a special gift announcement card signed with your name, if you request us to do so.

### BACK COPIES

At present we have on hand a supply of the November 1955 (No. 1), January (No. 3), April (No. 6), June (No. 8), November (No. 13), December (No. 14) 1956, February (No. 16), March (No. 17), May (No. 19), June (No. 20), August (No. 22), September (No. 23), December (No. 26) 1957, and January (No. 27) 1958 issues of **AUDIOCRAFT**. Copies are available at 35¢ each. To order yours, use the card at upper left, checking the appropriate box at the bottom of the card and circling the number of the issue or issues you want. Please be sure to enclose payment with your order as we cannot bill for single copies.

### IMPORTANT

We cannot be responsible for currency sent through the mail. When remitting, please be sure to send only check or money order.

# Viking

The World's Simplest Tape Deck  
and the most effective

Rugged simplicity for enduring performance. The finest of bearings and the ultimate in machining tolerances in capstan and drive members — where precision counts.

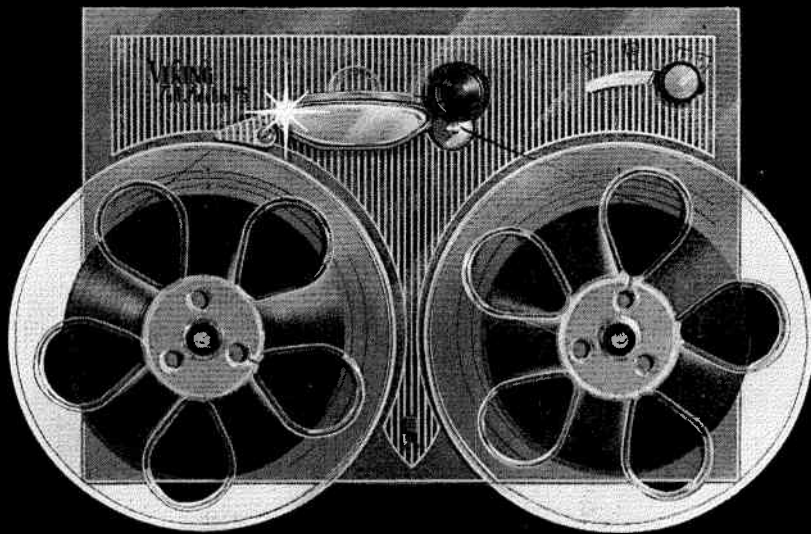

The Model FF75SR  
Monaural Erase/Record  
and Stereo Play



The Model FF75ES  
Stereo Erase/Record  
and Playback

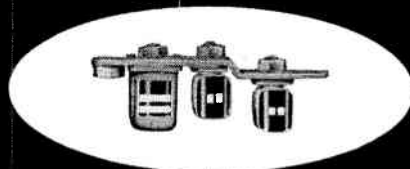

With Viking Tape Components you buy only what you need now. Convert later with complete flexibility. Monaural decks as low as \$66. A complete high-performance stereo recorder and player for less than \$300.

Buy Viking components from your regular dealer. For assistance in planning your tape system, write Viking's Customer Service Department.

The Recorder with the high "RP" Factor



**Viking** OF MINNEAPOLIS

9600 Aldrich Avenue South, Minneapolis 20, Minnesota

EXPORT DIVISION: 23 Warren Street, New York City 7, New York  
Cable: SIMONTRICE, New York (All Codes)  
IN CANADA: Alex L. Clark, Ltd., 3745 Bloor St. W., Toronto 18, Ontario

*the highest standard in  
high fidelity recording*

# AUDIO FIDELITY

*\*total frequency range  
recordings*

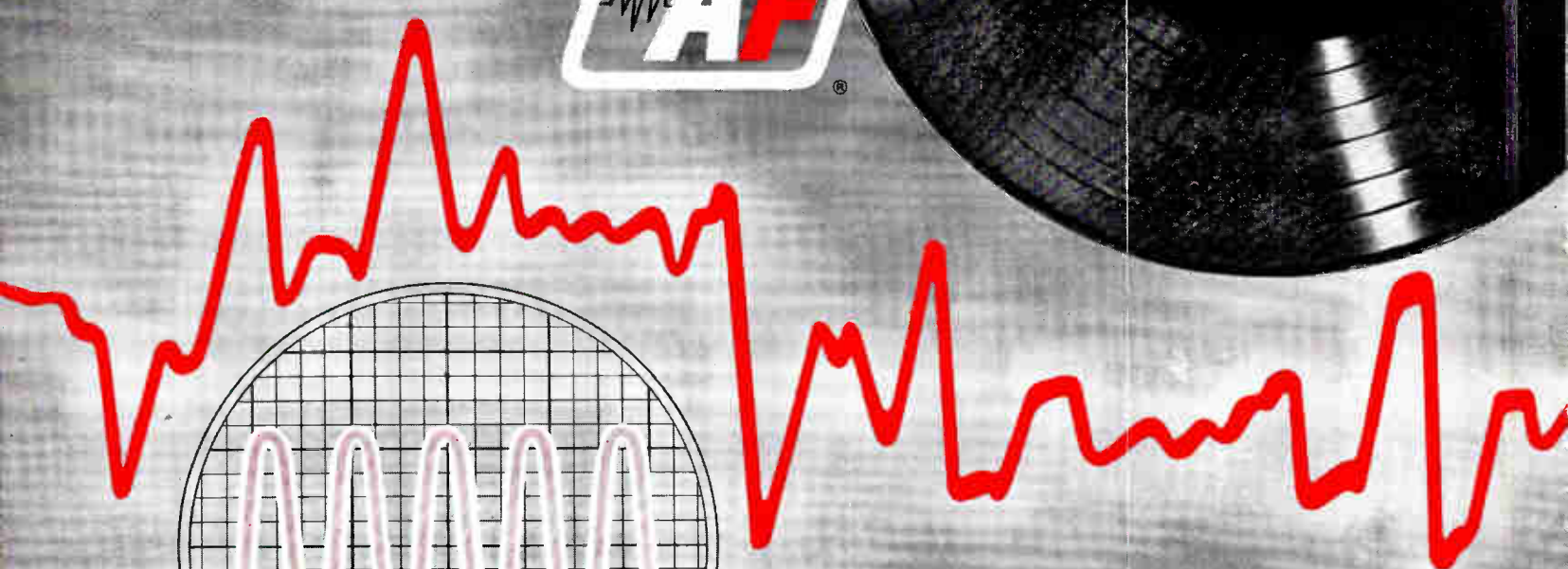

*In the strictest sense of the word  
only AUDIO FIDELITY records  
are High Fidelity records!*

TFRR#

**AUDIO FIDELITY** records brings you unsurpassed sound reproduction — with new positive microphone techniques emphasis on clarity, brilliance and quality of recording consistent with maximum definition and minimum distortion, realizing the ultimate in signal to noise ratio, plus engineering techniques to maintain maximum level and dynamic range. Pressed on pure virgin vinyl specially formulated to result in the long-wear of the high frequency groove etchings as well as the long life of the recording.

*Please write for free catalog*

**AUDIO FIDELITY INC.**

770 Eleventh Avenue, New York 19, N. Y.

