

A musical extravaganza of exciting toe-tapping novelty tunes. AFLP 1825

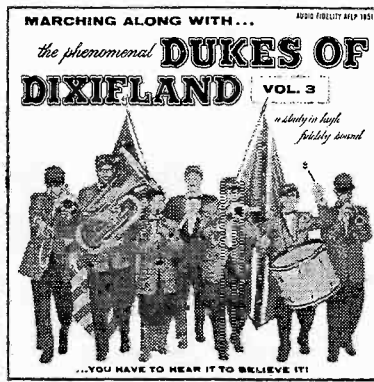

Dixieland Marches in the Dukes' unique styling converts the ordinary to the unusual! AFLP 1851

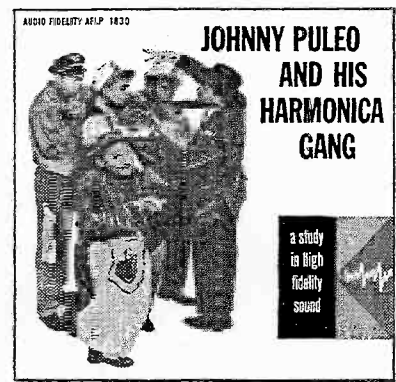

A lovable little guy, a zany group and a breath-taking display of harmonica mastery! AFLP 1830

the choice of High Fidelity Fans Everywhere...

AUDIO FIDELITY

TOTAL FREQUENCY RANGE RECORDINGS

Here is the powerful and vital sensuous impact of sound in its purest and most natural form. This is true high fidelity as you always want it to sound!... not just records... each a Wonderful Emotional Experience!

recorded in brilliant High Fidelity Sound
\$5.95 each 12 inch LP



Music from an afternoon at the Bull-fights. Luxuriously packaged with four color illustrated book of Bullfight scenes. Volume 4 AFLP 1835



Moon-drenched Cha Cha rhythms alive with the mystery of exotic Latin nights. AFLP 1837



Exotic, tantalizing music from the mysterious Middle East. AFLP 1833



Sirius Tango melodies from the land of the Gauchos. AFLP 1838



America's most famous marches brilliantly and excitingly performed by the BANDA TAURINA. AFLP 1836

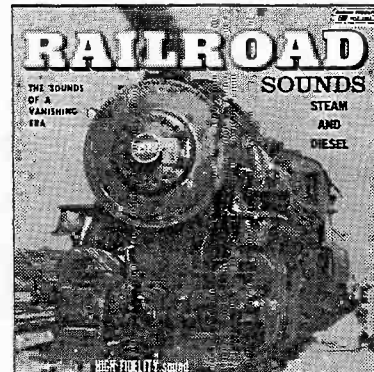

A documentary of the sounds of a vanishing era captured in dazzling Hi-Fi. AFLP 1843



"Fog" standards on the most brilliant Theatre Organ in the Western Hemisphere. AFLP 1829

 **AUDIO FIDELITY** 770 Eleventh Ave., New York 19, N. Y.

**Removes all static and dust while record is played;
new moving coil microphones and transistor amplifier**

ESL DUST BUG

The problems of dust, lint, and static buildup on phonograph records and pickup styli have been solved by this ingenious new invention which cleans the record as it is being played. The plush pad is slightly moistened with special, harmless activating fluid supplied in a replaceable applicator. This helps to loosen groove dust and dirt, which is then collected by the pad. It also neutralizes the static charge present in all records. Every point on an LP record is cleaned by the wide pad approximately one hundred times during a single play.

ESL Dust Bug, complete with Dust Bug Fluid in applicator \$5.75

The automatic record cleaner



ESL MOVING COIL MICROPHONES



Highest fidelity at moderate cost

Electro-Sonic Laboratories is pleased to announce a complete new line of superb moving coil microphones, microphone transformers, and miniature earphones. For every application—broadcasting, professional recording, home recording, dictating machine, and public address—there is a low impedance ESL microphone specifically designed to provide the highest quality of performance at sensible cost.

A brochure describing the entire line of ESL moving coil microphones and accessories is available free upon request.

ESL TRANSISTOR AMPLIFIER

This hum-free, low-distortion amplifier can provide improved performance with moving coil microphones, for which it is a preamplifier, and with ESL electrodynamic cartridges, for which it is a pre-preamplifier. As its frequency response is flat and unequalized, it does not replace the conventional phono preamplifier. It permits use of greatly superior low-impedance microphones—such as the ESL—with medium-price tape recorders.

*Voltage gain: 20-30 db (1:10-1:20 voltage step-up) • Signal-to-noise ratio: minus 50 db
Frequency response: 20-20,000 cps \pm 1/2 db • IM distortion: 1/10 of 1% • Input impedance: 100 ohms • Output impedance: 2,000 ohms • Battery life: 1 year • Hum level: zero*

ESL-1A, complete with battery \$16.50

Hum-free low impedance amplification

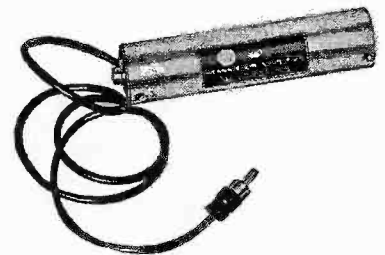

FOR LISTENING AT ITS BEST

Electro-Sonic Laboratories, Inc.

Dept. C • 35-54 Thirty-sixth St • Long Island City 6, N.Y.

*Additional information available
free upon request to ESL*

audiocraf



Roy F. Allison
Editor

Frank R. Wright
Managing Editor

Philip C. Geraci
Editorial Associate

Eleanor B. Wright
Editorial Assistant

Roy Lindstrom
Art Director

Eleanor Gilchrist
Art Assistant

R. D. Darrell
J. Gordon Holt
Joseph Marshall
Contributing Editors

Charles Fowler
Publisher

Warren B. Syer
Associate Publisher

Claire Eddings
Advertising Sales Manager

Arthur J. Griffin
Circulation Manager

Frances A. Newbury
Manager, Book Division

THE MAGAZINE FOR THE HI-FI HOBBYIST

OCTOBER 1957
Volume 2 Number 10

The Grounded Ear <i>What's new in sound reproduction</i>	4	<i>Joseph Marshall</i>
Book Reviews	10	<i>Richard D. Keller</i>
Audionews	12	
Editorial	15	
Readers' Forum	15	
The Electronic Organ: King of Kits <i>Part I: Electronic Instruments, past and present</i>	16	<i>Frank R. Wright</i>
Transistors in Audio Circuits <i>Part VIIa: Transistor input stages</i>	18	<i>Paul Penfield, Jr.</i>
Phono-Transformer Switching <i>A switching circuit for two cartridges</i>	20	<i>Herman Burstein</i>
Mobile Ampex <i>Recorder built into an automobile dashboard</i>	21	
Using Test Instruments <i>The oscilloscope, Part IV (conclusion)</i>	22	<i>Donald Carl Hoefler</i>
Deluxe Stereo System <i>Audio rig with a personal touch</i>	26	
Knight-Kit FM Tuner <i>An AUDIOCRAFT kit report</i>	28	<i>Joseph Marshall</i>
Audio Aids	31	
Sound-Fanciers' Guide <i>Reviews of exceptional disc and tape records</i>	32	<i>R. D. Darrell</i>
Professional Directory	46	
Advertising Index	48	

ADVERTISING

Main Office — Claire Eddings, The Publishing House, Great Barrington, Mass. Telephone: Great Barrington 1300.

New York — Frederick H. Wallin, 280 Madison Ave., New York, N.Y. Telephone: Murray Hill 3-4449, 3-4450.

Chicago — John R. Rutherford & Associates, Inc., 230 East Ohio St., Chicago, Ill. Telephone: Whitehall 4-6715.

Los Angeles — Brand & Brand, Inc., 6314 San Vicente Blvd., Los Angeles, Calif. Telephone Webster 8-3971.

Audiocraft Magazine is published monthly by Audiocom, Inc., in Great Barrington, Mass. Telephone: Great Barrington 1300. Editorial, publication, and circulation offices at: The Publishing House, Great Barrington, Mass. Subscriptions: \$4.00 per year in the United States and Canada. Single copies: 35 cents each. Editorial contributions will be welcomed by the editor. Payment for articles accepted will be arranged prior to publication. Unsolicited manuscripts should be accompanied by return postage. Entered as second-class matter October 1, 1955, at the post office, Great Barrington, Mass., under the act of March 3, 1879. Additional entry at the post office, Pittsfield, Mass. Printed in the U. S. A. by the Ben Franklin Press, Pittsfield, Mass. Copyright 1957 by Audiocom, Inc. The cover design and contents of Audiocraft Magazine are fully protected by copyrights and must not be reproduced in any manner.

The Grounded Ear



by Joseph Marshall

THERE has been considerable experimentation during the past year and a half with styli of $\frac{1}{2}$ -mil radius. The reason for such experiments is that, at very high frequencies (above 10 Kc, especially), the normal 1-mil needle is forced upward by pinch effect, since the groove becomes narrower at very high instantaneous cutting velocities. A $\frac{1}{2}$ -mil needle, on the other hand, can follow the wave form more faithfully to provide both a higher output at the high end of the spectrum and lower distortion. Pickering has been offering $\frac{1}{2}$ -mil styli for Fluxvalve cartridges; Emory Cook, whose V-groove recordings are particularly well suited to the smaller needle, has been a strong advocate of them.

The smaller stylus does entail some new problems, however. Among them is the possibility of greater record wear because of the smaller area of contact between stylus and record. Another is that, on shallow-groove records, the needle may have a tendency to trace with the tip only, rather than with the sides; and its looseness in the wider groove can produce unbearable distortion and, possibly, some damage when the needle is driven hard. This disadvantage can be overcome by the use of an elliptical needle shape: 1 mil wide to fit any type of groove snugly, but only $\frac{1}{2}$ -mil or less deep, to conform to the narrow cuts at very high frequencies. An elliptical stylus (2.5 by 1 mil) was used by Ferranti in its 78-rpm cartridge and resulted in a response to beyond 20 Kc. About a year ago Fairchild announced that it would supply elliptical styli (optionally and at higher cost) on its 225-series cartridges. But Fairchild found that the problem of obtaining good elliptical needles at a reasonable price was far greater than was anticipated. Only a few diamond cutters could produce acceptable styli, and the cost was prohibitive. Therefore, the commercial offering was abandoned, although it is still hoped eventually that a source of these needles good enough to justify offering them will be found.

About a month ago, Fairchild sent me

a handmade version of the 225/XP with an elliptical stylus. To say that I am delighted with it would be an understatement.

Its performance follows theoretical expectations. First, the high-frequency response is considerably increased in amplitude. In effect, the elliptical needle produces a rising response beginning at about 5 Kc. This is quite plain to a sharp ear in listening and obvious on measurement. The shape of the curve above 5 Kc will depend on the material from which the recording is made. On the Elektra 35 test record, which is made of a stiff material, the rising response is smooth and the peak rise is $3\frac{1}{2}$ db, with a +1-db response at 20 Kc (see graph). On the Cook 10LP the rise is similar, but there is a fairly sharp peak at 17 Kc. This peak can pretty safely be ascribed to groove-needle resonance since there is no sign of it at all on the Elektra. This is further verified by the response on the Folkways FPX 100, recorded and played back at 78 rpm; this shows no discontinuity at 17 Kc, such as would be evident if the peak were due to pickup resonance. Here we have a big, but wide, peak at

about 12 Kc. The Cook 10 at 78 rpm produces a similar curve. Altogether these curves indicate a response which, in the absence of groove-needle resonance, would rise to 3 or 4 db at around 15 Kc, and slope to zero db at about 22 Kc. The groove-needle resonance on the Cook 10LP is not bad either, being only 4 db above the main curve on either side.

At first glance these curves may not seem to represent any improvement at all. The normal 225A with a round 1-mil needle is within 1 db to 17 Kc, and other wide-range pickups have similar flatness. If the boost were the only thing the narrower stylus provided, its virtues would be questionable. Some systems with highly efficient tweeters already have too much response in this region, and the additional boost would call for changing the balance. The real improvement is not evident on frequency-response curves, but is plainly audible to the ear and visible on scope traces. First, the high-frequency wave form is more faithful to the original. Second, the transient response is quite superior. This is evident with square-wave traces but equally obvious to the ear. The result in listening value is better definition of extreme highs, especially when they are heard within a complex mass of sound. Thus, in my copy of Mussorgsky's *Pictures at an Exhibition*, the rolling tambourines in one of the crescendos are clearly identifiable; with many of the best previous pickups they were not too distinctly defined and many people mistook them for overload distortion. Also, the improved transient response makes the percussive highs with sharp envelopes sharper and cleaner. This is particularly noticeable on the high notes of piano and xylophone, plucked strings, brushed snare drums, etc. The effect of all this is very much like the effect on visibility produced by washing a window, or on the colors of a great master when a picture has been skillfully cleaned of surface grime. It is not so much that the ear hears any more as that what it hears is more sharply defined and identifiable. The best records are

Response curves of the elliptical stylus with respect to several test records. Only the high frequencies are graphed, since that is where response is most improved.

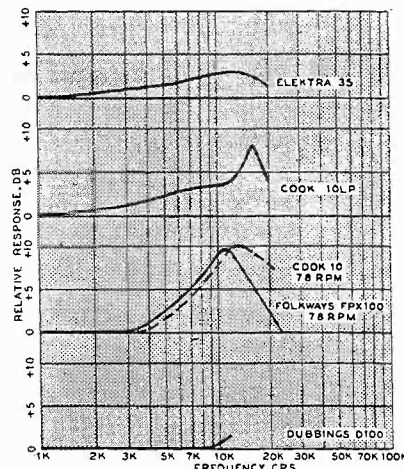

scarcely distinguishable from original master tapes, and good pressings sound like fresh lacquer masters played with 1-mil needles. In short, another layer of coloration and obscuration is removed from the reproducing system.

I have repeatedly observed that there is a price to pay for everything, and this improvement does not escape the truism. I have pointed out that tweeters may require rebalancing unless the treble boost of the smaller needle simply makes up for a loss in some other part of the system. Some tweeters may turn out to be either too efficient or just not good enough to stand the boost. Then too, if the best records sound better, the worst will sound much worse. Distortion which was previously obscured by system fuzziness will now be resolved into annoyance. Also, the elliptical needle seems easier to overdrive than the larger round 1-mil needle and some records which sound fine on a regular 225 cartridge will show distortion in some peaks. Many of the pop recordings which are cut, apparently, 6 to 10 db higher than classics, and are troublesome even to the very best round-needle pickups, may be intolerable with the elliptical. Audiophile recordings, on the other hand, can have every quality of stereo reproduction except the right-and-left directionality. Finally, the smaller needle produces groove-needle resonance at a lower frequency. The 225 with the 1-mil stylus does not resonate with the Cook test record within the 20-Kc top of the recording, but, as the curve in the graph shows, this one resonates at 17 Kc. This will not be as much of a point in the future as it may be now. Cook's Microfusion disc is much stiffer; so, apparently, is Audiophile's new disc. It is highly probable that this is merely the beginning of a trend to stiffer plastics.

To summarize, the elliptical needle on a cartridge of first quality such as the Fairchild provides a still closer approach to the ideal of perfect reproduction. But remember that the elliptical needle is still experimental, and not available commercially.

Dynakit Front End

I have had a number of letters from people who want to convert the older

Continued on page 40

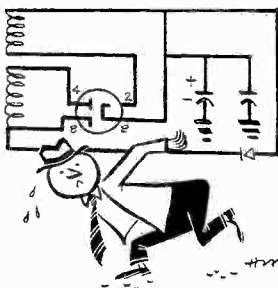

ALLIED knight®-kit HI-FI EQUIPMENT

EASY-TO-BUILD HI-FI EVERYONE CAN AFFORD

- ★ World's Finest Hi-Fi in Kit Form
- ★ Beautiful Custom-Styled Line
- ★ Advanced, Easiest-to-Build Design
- ★ Money-Saving Hi-Fi At Its Best

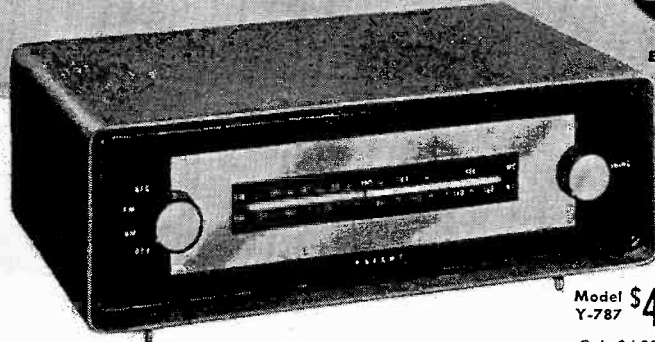

EASY TERMS AVAILABLE

Model Y-787 \$49⁹⁵

Only \$4.99 down

NEW knight-kit FM-AM Deluxe Hi-Fi Tuner Kit

featuring:

- Full FM-AM Coverage
- 2.5 μ v FM Sensitivity
- Automatic Frequency Control
- Printed-Circuit Board
- Pre-aligned RF & IF Coils
- Tuned RF Stage on FM
- Neon Glow Tuning Pointer

The best-looking, best-performing Hi-Fi tuner your money can buy! Covers full AM broadcast and 88 to 108 mc FM. Sensitivity is 2.5 microvolts for 20 db of quieting on FM; 3 microvolts for 10 db signal-to-noise ratio on AM. Also has drift-compensated oscillator; built-in AM ferrite antenna; cathode follower outputs; two outputs—one for recorder, one for amplifier. Handsome, custom-styled case, 4 x 13 x 8". Ready for easy, money-saving assembly.

Model Y-787. Net, F.O.B. Chicago, only \$49⁹⁵

NEW knight-kit 30-Watt Complete Hi-Fi Amplifier Kit



Model Y-762 \$76⁹⁵
Only \$7.69 down

- All-New Custom Styling
- New Printed-Circuit Switches
- 3 Printed-Circuit Boards
- 8 Inputs • Full Equalization
- Full 30-Watt Hi-Fi Output

Build the best and SAVE! Linear-deluxe Williamson-type power amplifier—flawless response $\pm 1/2$ db, 15-100,000 cps at full 30-watt level! Equalization for all records within $1/2$ db of recommended accuracy. Extra features: separate Bass and Treble, Level and Loudness Controls; Rumble Filter; Variable Damping; A-AB-B speaker selector; custom cabinet, 4 1/4 x 15 x 15". 32 lbs. Model Y-762. Net, F.O.B. Chicago, only \$76⁹⁵

THERE IS AN EASY-TO-BUILD knight-kit FOR EVERY HI-FI NEED

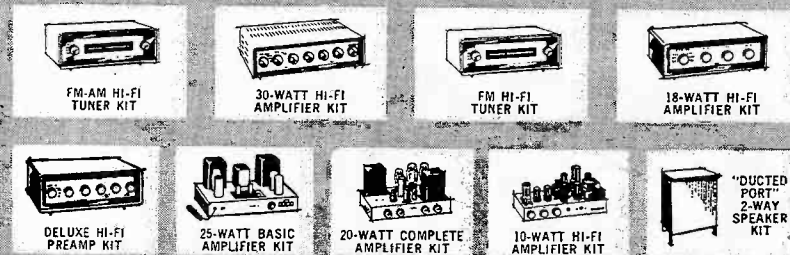

FREE!

404-PAGE
1958
ALLIED
CATALOG

Send for this value-packed catalog featuring the world's largest selection of Hi-Fi Kits, components and complete music systems, including Everything in Electronics. Send for your FREE copy today.



See our 1958 Catalog for full details

ALLIED RADIO
America's Hi-Fi Center

ALLIED RADIO CORP., Dept. 54-K7
100 N. Western Ave., Chicago 80, Ill.

Ship the following Hi-Fi KNIGHT-KITS:

_____ \$_____ enclosed.

Send FREE 1958 ALLIED 404-Page Catalog

Name _____

Address _____

City _____ Zone _____ State _____

our
37th
year

*treat your family
to all the fun and enjoyment
of fine high fidelity at
one-half the price you
would expect to pay*

HERE'S ALL YOU NEED

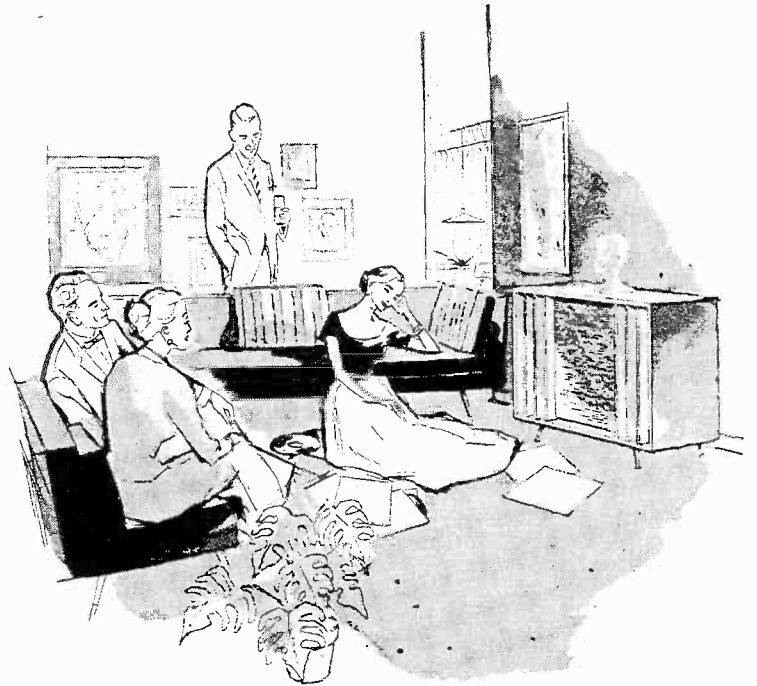
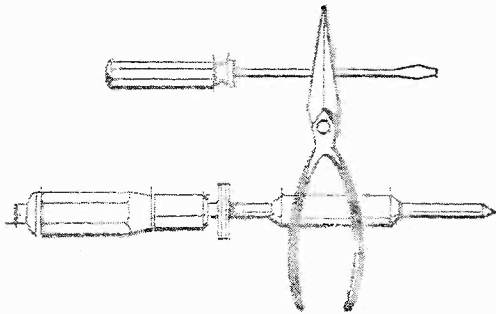

to build your own



HI-FI



FM TUNER

AM TUNER

PREAMPLIFIER

**HEATHKIT
HIGH FIDELITY FM TUNER KIT**

This FM tuner is your least expensive source of high fidelity material! Stabilized oscillator circuit assures negligible drift after initial warmup. Broadband IF circuits assure full fidelity, and 10 microvolt sensitivity pulls in stations with full volume. High-gain cascade RF amplifier, and automatic gain control. Ratio detector gives high-efficiency demodulation. All tunable components prealigned. Edge-illuminated dial for easy tuning. Here is FM for your home at a price you can afford. Shpg. Wt. 7 lbs.

MODEL FM-3A \$25.95 (with cabinet)

**HEATHKIT
BROADBAND AM TUNER KIT**

This tuner differs from an ordinary AM radio in that it has been designed especially for high fidelity. The detector uses crystal diodes, and the IF circuits are "broadbanded" for low signal distortion. Sensitivity and selectivity are excellent. Quiet performance is assured by 6 db signal-to-noise ratio at 2.5 uv. All tunable components prealigned. Incorporates AVC, two outputs, and two antenna inputs. Edge-lighted glass slide rule dial for easy tuning. Your "best buy" in an AM tuner. Shpg. Wt. 8 lbs.

MODEL BC-1A \$25.95 (with cabinet)

**HEATHKIT "MASTER CONTROL"
PREAMPLIFIER KIT**

This unit is designed to operate as the "master control" for any of the Heathkit Williamson-type amplifiers, and includes features that will do justice to the finest program material. Frequency response within $\pm 1\frac{1}{2}$ db from 15 to 35,000 CPS. Full equalization for LP, RIAA, AES, and early 78's. Five switch-selected inputs with separate level controls. Bass and treble control, and volume control, on front panel. Very attractively styled, and an exceptional dollar value. Shpg. Wt. 7 lbs.

MODEL WA-P2 \$19.75 (with cabinet)

**HEATHKIT "BASIC RANGE"
HIGH FIDELITY SPEAKER SYSTEM KIT**

The very popular model SS-1 Speaker System provides amazing high fidelity performance for its size because it uses high-quality speakers, in an enclosure especially designed to receive them.

It features an 8" mid-range-woofer to cover from 50 to 1600 CPS, and a compression-type tweeter with flared horn to cover from 1600 to 12,000 CPS. Both speakers are by Jensen. The enclosure itself is a ducted-port bass-reflex unit, measuring 11½" H x 23" W x 11¾" D and is constructed of veneer-surfaced plywood, ½" thick. All parts are pre-cut and pre-drilled for quick assembly.

Total frequency range is 50 to 12,000 CPS, within ±5 db. Impedance is 16 ohms. Operates with the "Range Extending" (SS-1B) speaker system kit later, if greater frequency range is desired. Shpg. Wt. 30 lbs. **MODEL SS-1 \$39.95**

**HEATHKIT "RANGE EXTENDING"
HIGH FIDELITY SPEAKER SYSTEM KIT**

The SS-1B uses a 15" woofer and a small super-tweeter to supply very high and very low frequencies and fill out the response of the "Basic" (SS-1) speaker system at each end of the audio spectrum. The SS-1 and SS-1B, combined, provide an overall response of ±5 db from 35 to 16,000 CPS. Kit includes circuit for crossover at 600, 1600 and 4000 CPS. Impedance is 16 ohms, and power rating is 35 watts. Measures 29" H x 23" W x 17½" D, and is constructed of veneer-surfaced plywood, ¾" thick. Easy to build! Shpg. Wt. 80 lbs.

MODEL SS-1B \$99.95

...and save!

**HEATHKIT "LEGATO"
HIGH FIDELITY SPEAKER SYSTEM KIT**

The fine quality of the Legato Speaker System Kit is matched only in the most expensive speaker systems available. The listening experience it can bring to you approaches the ultimate in esthetic satisfaction.

Frequency response is ±5 db 25 to 20,000 CPS. Two 15" theater-type Altec Lansing speakers cover 25 to 500 CPS, and an Altec Lansing high frequency driver with sectoral horn covers 500 to 20,000 CPS. A precise amount of phase shift in the crossover network brings the high-frequency channel into phase with the low-frequency channel to eliminate peaks or valleys at the crossover point. This is one reason for the mid-range "presence" so evident in this system design.

The attractively styled "contemporary" enclosure emphasizes simplicity of line and form to blend with all furnishings. Cabinet parts are pre-cut and pre-drilled from ¾" veneer-surfaced plywood for easy assembly at home. Impedance is 16 ohms. Power rating is 50 watts for program material. Full, smooth frequency response assures you of outstanding high fidelity performance, and an unforgettable listening experience. Order HH-1-C (birch) for light finishes, or HH-1-CM (mahogany) for dark finishes. Shpg. Wt. 195 lbs.

MODELS HH-1-C or HH-1-CM \$325.00 each



A subsidiary of Daystrom, Inc.
Benton Harbor 18, Mich.



"BASIC" SPEAKER SYSTEM

RANGE EXTENDER

HEATHKITS

*World's finest
electronic equipment
in kit form...*

"LEGATO" SPEAKER SYSTEM

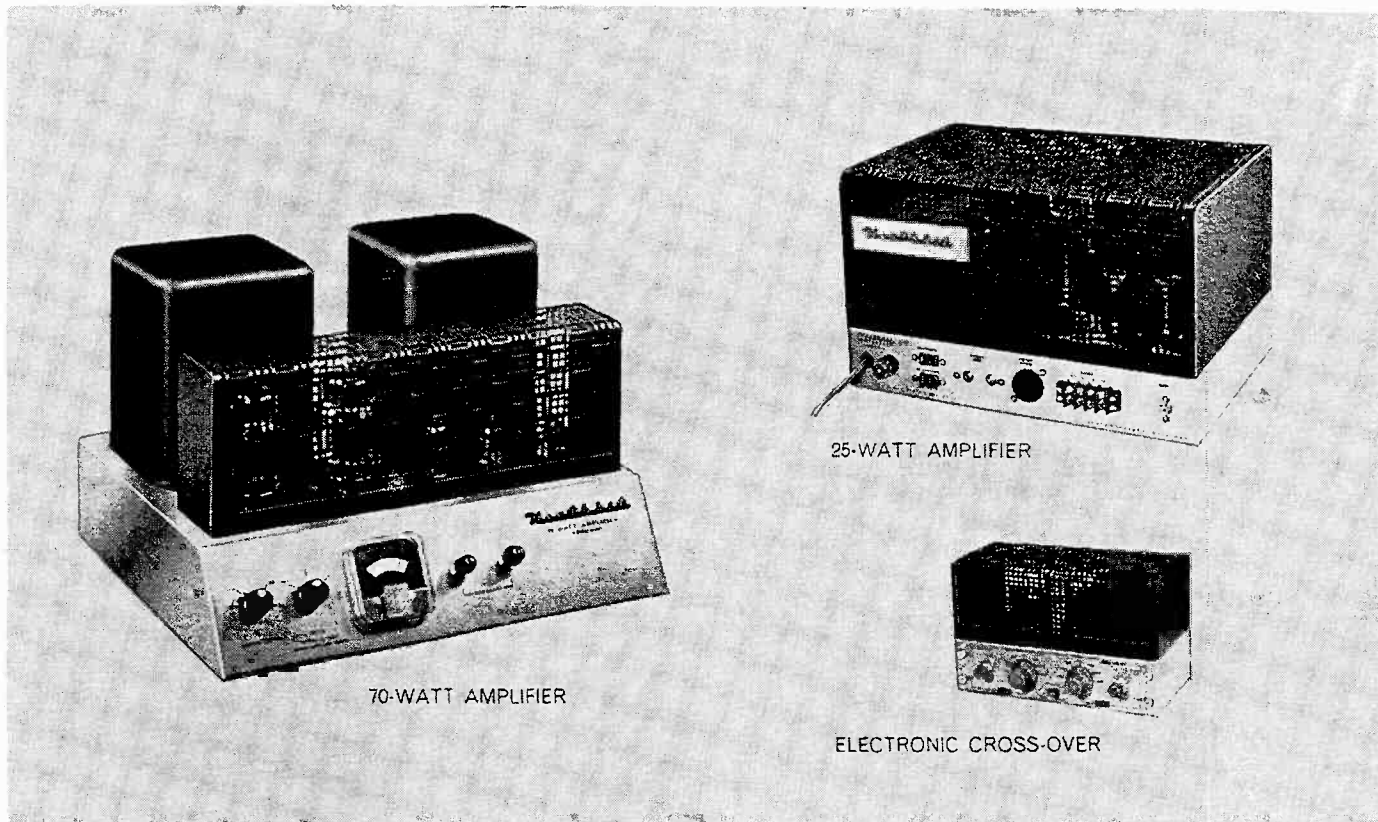

easy-to-build designs by **HEATH** *insure*

You get more comprehensive assembly instructions, higher quality circuit components, and more advanced design features, when you buy HEATH hi-fi!

HEATHKIT 70-WATT HIGH FIDELITY AMPLIFIER KIT

This new amplifier features extra power reserve, metered balance circuit, variable damping, and silicon-diode rectifiers, replacing vacuum tube rectifiers. A pair of 6550 tubes produce full 70-watt output with a special-design Peerless output transformer. A quick-change plug selects 4, 8 and 16 ohm or 70 volt output, and the correct feedback resistance. Variable damping optimizes performance for the speaker system of your choice. Frequency response at 1 watt is ± 1 db from 5 CPS to 80 KC with controlled HF rolloff above 100 KC. Harmonic distortion at full output less than 2%, 20 to 20,000 CPS, and intermodulation distortion below 1% at this same level. Hum and noise are 88 db below full output. Variable damping from .5 to 10. Designed to use WA-P2 preamplifier. Express only. Shpg. Wt. 50 lbs. **MODEL W-6M \$109.95**

HEATHKIT 25-WATT HIGH FIDELITY AMPLIFIER KIT

The 25-watt Heathkit model W-5M is rated "best buy" in its power class by independent critics! Faithful sound reproduction is assured with response of ± 1 db from 5 to 160,000 CPS at 1 watt, and harmonic distortion below 1% at 25 watts, and IM distortion below 1% at 20 watts. Hum and noise are 99 db below rated output, assuring quiet, hum-free operation. Output taps are 4, 8 and 16 ohms. Employs KT66 tubes and Peerless output transformer. Designed to use WA-P2 preamplifier. Express only. Shpg. Wt. 31 lbs. **MODEL W-5M \$59.75**

HEATHKIT ELECTRONIC CROSS-OVER KIT

This device separates high and low frequencies electronically, so they may be fed through two separate amplifiers driving separate speakers. The XO-1 is used between the preamplifier and the main amplifiers. Separate amplification of high and low frequencies minimizes IM distortion. Crossover frequencies are selectable at 100, 200, 400, 700, 1200, 2000, and 3500 CPS. Separate level controls for high and low frequency channels. Attenuation is 12 db per octave. Shpg. Wt. 6 lbs. **MODEL XO-1 \$18.95**

25-WATT AMPLIFIER

ELECTRONIC CROSS-OVER

HEATHKIT W-3AM HIGH FIDELITY AMPLIFIER KIT

Features of this fine Williamson-type amplifier include the famous Acrosound model TO-300 "ultralinear" transformer, and 5881 tubes for broad frequency response, low distortion, and low hum level. Response is ± 1 db from 6 CPS to 150 KC at 1 watt. Harmonic distortion is below 1% and IM distortion below 1.3% at 20 watts. Hum and noise are 88 db below 20 watts. Provides output taps of 4, 8 or 16 ohms impedance. Designed to use WA-P2 preamplifier. Shpg. Wt. 29 lbs. **MODEL W-3AM \$49.75**

HEATHKIT W-4AM HIGH FIDELITY AMPLIFIER KIT

A true Williamson-type circuit, featuring extended frequency response, low distortion, and low hum levels, this amplifier can give you fine listening enjoyment with a minimum investment. Uses 5881 tubes and a Chicago-standard output transformer. Frequency response is ± 1 db from 10 CPS to 100 KC at 1 watt. Less than 1.5% harmonic distortion and 2.7% intermodulation at full 20 watt output. Hum and noise are 95 db below full output. Transformer tapped at 4, 8 or 16 ohms. Designed to use WA-P2 preamplifier. Shipped express only. Shpg. Wt. 28 lbs. **MODEL W-4AM \$39.75**

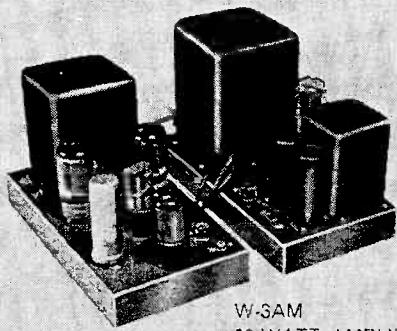

W-3AM
20-WATT AMPLIFIER

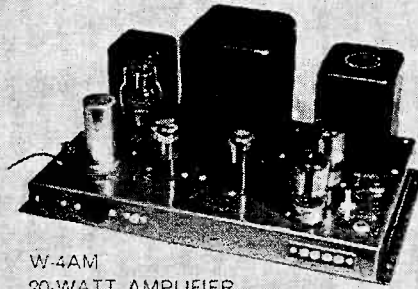

W-4AM
20-WATT AMPLIFIER

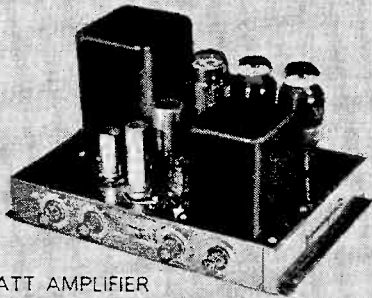

A-9C
20-WATT AMPLIFIER

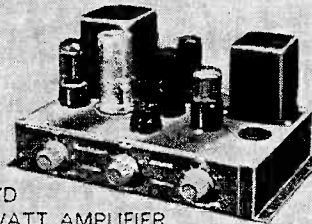

A-7D
7-WATT AMPLIFIER

HEATHKITS

*World's finest
electronic equipment
in kit form...*

...top HI-FI performance

HEATHKIT A-9C HIGH FIDELITY AMPLIFIER KIT

This amplifier incorporates its own preamplifier for self-contained operation. Provides 20 watt output using push-pull 6L6 tubes. True high fidelity for the home, or for PA applications. Four separate inputs—separate bass and treble controls—and volume control. Covers 20 to 20,000 CPS within ± 1 db. Output transformer tapped at 4, 8, 16 and 500 ohms. Harmonic distortion less than 1% at 3 db below rated output. High quality sound at low cost! Shpg. Wt. 23 lbs. **MODEL A-9C \$35.50**

HEATHKIT A-7D HIGH FIDELITY AMPLIFIER KIT

This is a true high fidelity amplifier even though its power is somewhat limited. Built-in preamplifier has separate bass and treble controls, and volume control. Frequency response is $\pm 1\frac{1}{2}$ db from 20 to 20,000 CPS, and distortion is held to surprisingly low level. Output transformer tapped at 4, 8 or 16 ohms. Easy to build, and a fine 7-watt performer for one just becoming interested in high fidelity. Shpg. Wt. 10 lbs. **MODEL A-7D \$17.95**

Model A-7E: Same as the above except with extra tube stage for added preamplification. Two switch-selected inputs, RIAA compensation, and plenty of gain for low-level cartridges. Shpg. Wt. 10 lbs. **\$19.95**

HOW TO ORDER...

Just identify the kit you desire by its model number and send check or money order to address below. Don't hesitate to ask about HEATH TIME PAYMENT PLAN.

*Pioneer in
"do-it-yourself"
electronics.*

HEATH COMPANY

A subsidiary of Daystrom, Inc.
Benton Harbor 18, Mich.

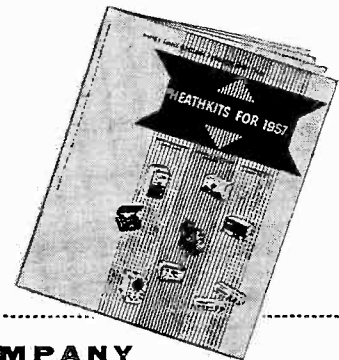

NAME _____

ADDRESS _____

CITY & STATE _____

*Please send **FREE** Heathkit Catalog*

by RICHARD D. KELLER

book reviews



Transistor Circuits and Applications

John M. Carroll; pub. by McGraw-Hill Book Co., New York; 283 pages; \$7.50.

This book consists of reprints of 106 feature technical articles that appeared in *Electronics Magazine* during the period from 1950 to 1956. It gathers in one place many authoritative articles which should be of value to circuit designers and engineers, and some which are simple enough in scope to be of benefit to amateur experimenters and hobbyists. All the basic amplifier, oscillator, pulse, and switching circuits are shown with typical component values; and numerous applications of transistors to home-entertainment, military, broadcasting, communications, computing, control, industrial, scientific, and medical equipment are described.

Operating characteristics of some 200 commercially available transistors are listed, although, as in most other transistor books today, the list is considerably behind the times (listing JETEC-registered transistors only as high as the already outdated 2N137) due to the introduction of many new types in recent months.

The engineering level and degree of competence of these articles vary considerably. Also, data in earlier articles (which are not identified herein as to date of publication) are now mostly of historical interest.

The volume should be of primary interest to design engineers who desire a compact source of *Electronics* articles, but the home experimenter will still find Lou Garner's *Transistor Circuit Handbook* his best bet.

Resonant Circuits

Alexander Schure, ed.; pub. by John F. Rider Publisher, Inc., New York; 64 pages; \$1.20, paper-bound.

Another in the well-written Electronic Technology Series, this work falls into Rider's Group 1 category of simplified booklets covering the electrical bases for electronics. These books are simplified to the extent that almost any beginner can obtain excellent insight into the subject covered, but even advanced en-

gineers will often find that some stumbling block in their previous thinking on the subject is cleared away by the straightforward presentation.

In *Resonant Circuits*, simplified mathematics is used to the extent necessary for an understanding of both parallel and series resonant circuits, as well as resonant coupled circuits and transmission lines with distributed constants.

Perhaps some day the contents of this series of booklets can be combined into an ideal textbook for first-year students. With the background on basic electrical and electronic concepts presented as clearly as it is in these booklets, a student could quickly progress to more advanced engineering and mathematical concepts with a minimum of confusion and misunderstanding.

Understanding Hi-Fi Circuits

Norman H. Crowhurst; pub. by Gernsback Library, Inc., New York; 224 pages; \$5.00, cloth-bound; \$2.90, paper-bound.

There's lots of good solid material in this book. Most of it, of course, is strictly for the advanced hobbyist with plenty of technical savvy, particularly the hobbyist or engineer interested in audio design and experimental work. To such a person, it offers hours of illuminating reading. For instance, comparisons are made between many types of output circuits, including triode, pentode, tapped screen, cathode follower, unity coupled, and others, with breakdowns of the advantages and disadvantages of each.

Similar comparisons are made concerning negative and positive feedback circuitry; damping and stability margins; the many types of inverter and driver stages; input circuits with relation to noise, hum, microphonics and distortion; stage matching; equalization; speakers and crossover networks; loudness and volume controls; and various types of tone-control circuits.

It should be noted that the author has not made this a mathematical or engineering text, but, rather, he has used a discussion type of approach in analyzing and comparing the many basic types of audio circuits which have been

evolved up to the present time. As in his series of articles in *Audiocraft*, he has utilized charts, curves, and graphs in an effective over-all format.

Transistor Circuit Engineering

Richard F. Shea, ed.; pub. by John Wiley & Sons, Inc., New York; 468 pages; \$12.00.

This book deservedly takes its place beside the other Shea works, *Principles of Transistor Circuits* and *Transistor Audio Amplifiers*, as a standard text and reference in the transistor field. The coauthors are members of the General Electric Electronics Laboratory at Electronics Park in Syracuse, New York. All are top authorities in their fields.

The book was prepared to show how transistor theory can be put to work in typical circuits in just about all potential fields of application, as in audio and DC amplifiers, tuned amplifiers, RF and video amplifiers, oscillators, modulators, detectors, switching circuits, regulated power supplies, etc. Typical circuits are designed step by step to show the major points of consideration. The importance of proper biasing and bias stabilization is given due emphasis, and basic transistor characteristics and curves are covered in considerable detail.

Transistor Circuit Engineering is right up-to-date and should be welcomed by any design engineer. A number of typical problems at the end of each chapter will encourage its use as a college text as well.

Frequency Modulation Receivers

J. D. Jones; pub. by Philosophical Library, Inc., New York; 114 pages; \$6.00.

This British text concentrates entirely on the reception of FM, with stage-by-stage descriptions of the principles and operation of frequency-modulation receivers.

The work goes into considerable mathematical detail concerning the choice of circuit values, and, after covering each stage thoroughly, winds up with the schematic of an FM superheterodyne receiver. All in all, a bit stilted and unwieldy.

one of the really great contributions to more Lifelike high fidelity music reproduction

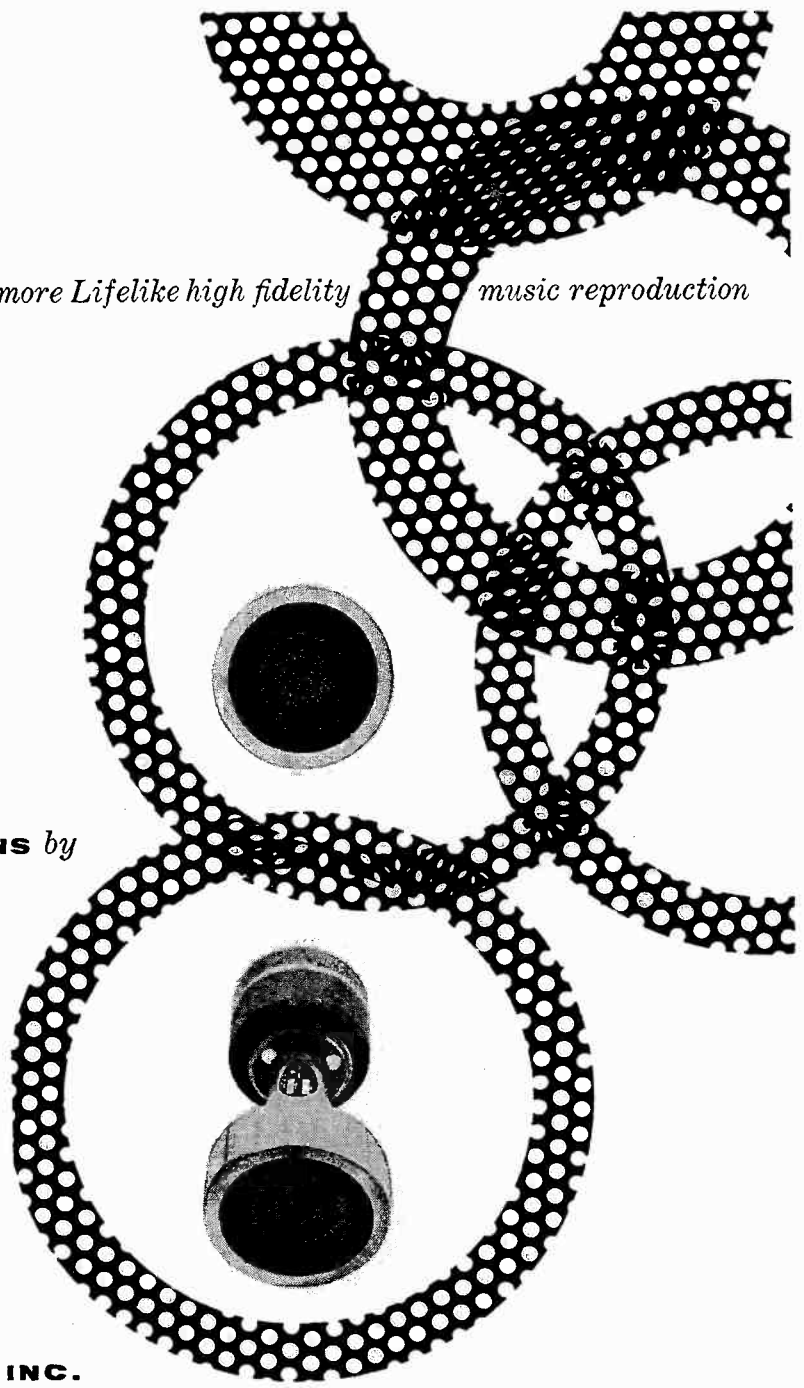

the **ACOUSTICAL LENS** *by*

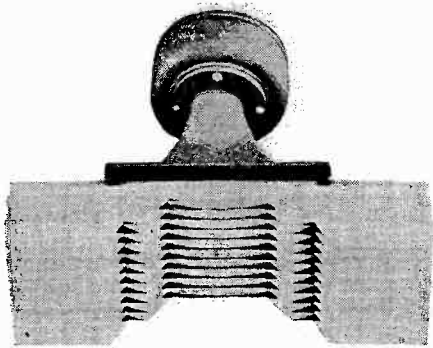

JAMES B. LANSING SOUND, INC.

The first entirely satisfactory solution to the problem of high frequency acoustical lens distributes sound evenly throughout the listening area with The phase disturbance due to the displacement of each horn mouth — each a horn is eliminated. With design based upon the most advanced optical-Acoustical Lens is a true lens . . . projecting sound waves in a wide pattern in light rays. True acoustical lenses are made only by James B. Lansing the lens is given in James B. Lansing Bulletin number SB1004. A free copy



beaming is the acoustical lens. The equal intensity regardless of frequency. separate sound source — of a multicellular acoustical theory, the JBL Signature the same way your slide projector refracts Sound, Inc. A complete discussion of will be sent to you if you will write . . .

"JBL" means **JAMES B. LANSING SOUND, INC.** • 2439 Fletcher Drive • Los Angeles 39, California

Audionews

ACROSOUND AMPLIFIER KIT

The Acrosound *Ultra-Linear II* is a 60-watt power amplifier supplied in kit form with all critical wiring preassembled on a printed-circuit board. A full-choke, capacitor power supply is used, and tubes are operated well within their ratings.

The heart of the amplifier is the new Acrosound TO-600 output transformer which combines low leakage reactances between windings with a novel feedback winding providing a degree of feedback relatively unaffected by the reflected impedance of the speaker system.

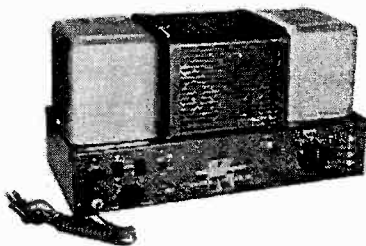

Ultra-Linear II 60-watt power amplifier.

Rated output power of the *Ultra-Linear II* is 60 watts, 120 watts on peaks. IM distortion is said to be less than 1% at 60 watts for any standard combination of test frequencies. Harmonic distortion is said to be less than 1% at any frequency between 20 cps and 20 Kc at power output within 1 db of 60 watts. Frequency response, according to the manufacturer, is flat within 1 db from 18 cps to 30 Kc at 60 watts, and, at 1 watt, flat within 1 db from 5 cps to 100 Kc. Hum is stated to be 85 db below rated output.

The price of the *Ultra-Linear II* kit is \$79.50. The amplifier is also available completely assembled for \$109.50.

NEW MAGNETIC TAPE

A new magnetic tape which is said to reduce print level by 8 db and increase high-frequency response has been announced by Minnesota Mining and Manufacturing Co. Called Scotch brand magnetic tape No. 131 *Low Print*, it is stated by the manufacturer to have the lowest print level of any magnetic tape on the market.

Print, the firm explained, is the

phenomenon by which a recorded signal on tape will slightly magnetize the adjacent layer of tape on the reel. The result is that, under the most critical conditions, a faint echo of the signal can be heard on playback at a high gain level.

Although print rarely, if ever, is detectable in most tape-recording applications, it may be a problem in recordings made on highest-quality professional recorders where the noise level of the machine is exceptionally low.

The new tape comes in a grey box marked for professional use, and can be identified by a gold *Low Print* seal on the cover.

ELECTRONIC-DRIVE TURNTABLE

A new high-fidelity 4-speed turntable was announced recently by Fairchild Recording Equipment Company. Unique to the *Model 412-4* turntable is the use of a hysteresis-synchronous motor to provide "variable" speed: 16 $\frac{2}{3}$, 33 $\frac{1}{3}$, 45, and 78 rpm. Fairchild achieves variable speed from a hysteresis motor through the use of a new electronic drive unit, an accurate variable-frequency electronic power source which drives a hysteresis motor at 30, 60, 81, or 141 cps. The desired frequency is selected by a single control switch. Adjustments are provided for varying the turntable speed $\pm 3\%$. Voltage and frequency fluctuations are reported not to affect the operation of the electronic drive. The unit will function normally on 50 or 60 cps current.

A novel feature of the unit is that it can be purchased without the electronic drive. This model, the *Model 412-1*, operates at one speed, 33 $\frac{1}{3}$ rpm.

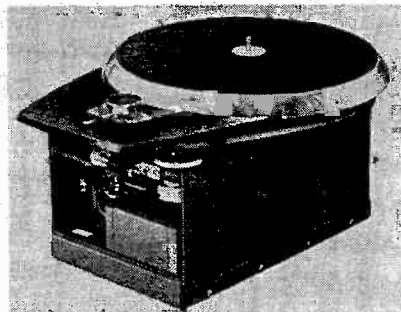

The 412-4 frequency-controlled turntable.

The electronic drive can be added to the 412-1 to convert it to 4-speed operation.

The price of the *Model 412-1* single-speed turntable is \$79.95. The 412-4 4-speed turntable is priced at \$159.95. The electronic drive is available separately for \$84.

FULL-RANGE SPEAKER

The new Stephens *Trusonic 80FR* is a full-range 8-inch loudspeaker with a frequency response said to be from 40 to 15,000 cps. Free-air resonance of the 80FR is 50 cps, according to the manu-

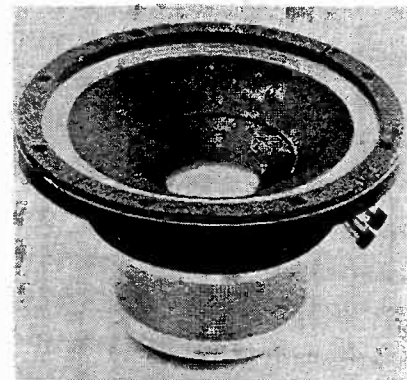

80FR full-range eight-inch loudspeaker.

facturer. It can handle 20 watts continuous power and 50 watts peak. A newly designed cone is said to reduce spurious resonances.

Impedance of the 80FR is 16 ohms; its magnet weight is 1 lb. The size of the speaker is 8 $\frac{1}{4}$ in. in diameter by 4 $\frac{1}{4}$ in. deep. The net price is \$31.50.

TRANSISTOR RECEIVER KIT

A self-powered, portable, transistor receiver kit has recently been announced by the J. W. Miller Company. This receiver, the *Miller Model 555*, is said to deliver four-transistor performance from a circuit employing only three transistors and two crystal diodes.

The receiver uses one transistor as a combined mixer and oscillator stage. The second transistor is used in a special "reflexed" circuit which combines the functions of an IF amplifier and an audio amplifier. One of the crystal diodes functions as a detector, while the

second is employed in an automatic-gain-control circuit. The remaining transistor functions as an audio power amplifier, delivering approximately 25 mw to the 2¾-inch PM speaker.

The receiver requires no external antenna or power source. Power is supplied

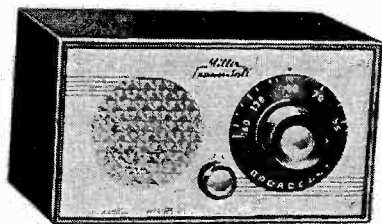

This receiver kit uses three transistors.

by a miniature 9-volt battery which will operate the receiver for about 300 hours. All components are mounted on a printed-circuit board. All coils and transformers are adjusted at the factory. The kit is supplied with detailed step-by-step instructions and pictorial diagrams.

Price of the Model 555 transistor receiver kit is \$29.50.

AUDIO-CART

The *Audio-Cart*, a stand to hold tape recorders at desk height, has recently been placed on the market by Universal Woodcrafters, Inc.

The *Audio-Cart* is constructed of furniture veneer, and has 3-inch wheels so that it will roll easily. There are three front compartments for storing 27

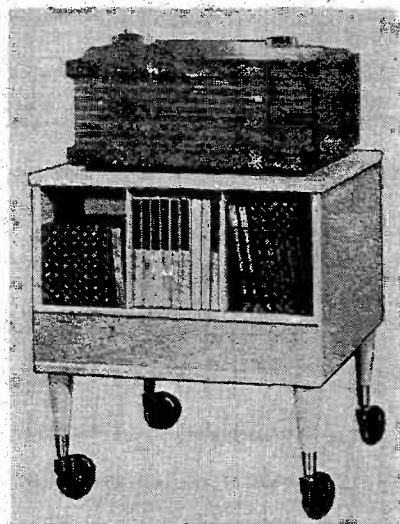

Audio-Cart stores tape and recorder.

reels of tape. A rear accessory compartment provides additional storage room for microphones, extra tape reels, extension cords, and other associated equipment.

The list price of the *Audio-Cart* is \$29.95.

LISTENERS' GUIDE

Classical-music listeners in the Los Angeles area can now subscribe to a new program guide. Entitled *Music Listeners' Guide*, the new publication's coverage includes programming of classical music on radio (both FM and AM), opera on television, and a listing of live concerts and recitals.

Subscriptions to *Music Listener's Guide* are \$3.00 a year; single-copy price is 35¢. For information, write to The Music Listener, P. O. Box 147, North Hollywood, Calif.

DUAL-SPEED TAPE RECORDER

The *Model 1500* dual-speed tape recorder recently introduced by the Wollensak Optical Company employs miniaturized components and all-metal construction. The unit measures 6½ in. by 10¼ in. by 11¾ in., and weighs 18 lbs. It accepts 7-inch reels. Tape speeds are 7½ ips and 3¾ ips.



Wollensak miniaturized tape recorder.

Frequency response of the 1500 is said to be flat, ±3 db, from 40 to 15,000 cps at 7½ ips, and flat, ±3 db, from 40 to 8,000 cps at 3¾ ips. At both speeds, signal-to-noise ratio is -48 db, wow and flutter less than 0.3%, and over-all distortion less than 0.8%, according to the manufacturer.

Complete with ceramic-type, wide-range microphone, two reels (one with tape), and cords, the Wollensak 1500 dual-speed tape recorder retails at \$189.50.

For more information about any of the products mentioned in Audio-news, we suggest that you make use of the Product Information Cards bound in at the back of the magazine. Simply fill out the card, giving the name of the product in which you're interested, the manufacturer's name, and the page reference. Be sure to put down your name and address too. Send the cards to us and we'll send them along to the manufacturers. Make use of this special service; save postage and the trouble of making individual inquiries to a number of different addresses.

MIRAGRIP RECORD HANDLER

With the increasing sensitivity of micro-groove records and high-fidelity reproduction equipment, even the slightest fingerprint on the playing surface of a record may cause noise and distortion. Designed to prevent such occurrences,

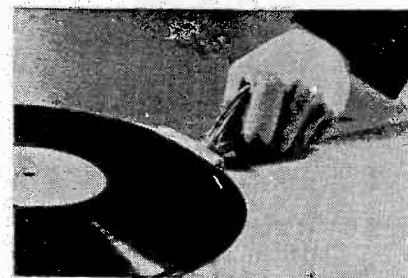

Record handler prevents fingerprints.

the *Clarovox Miragrip* record handler picks up records easily and firmly, with no danger of slipping. The plierslike design is such that the *Miragrip* can be conveniently used with one hand.

The metal handles and body are chrome plated and the rubber gripping sleeves are available in a variety of colors.

The *Miragrip* is manufactured by *Clarovox Products* of Coventry, England, and is available in the United States through *Ercona Corp.* The Canadian distributor is *Astral Electric Co., Ltd.*, Toronto.

LAFAYETTE 70-WATT AMPLIFIER

Lafayette Radio is now producing a 70-watt, wide-range amplifier designed by *Victor Brociner*. The amplifier is said to be capable of producing 70 watts continuously, 80 watts momentarily, and instantaneous peaks of 160 watts. IM distortion, according to the manufacturer, is less than 1.5% at 70 watts at 60 and 7,000 cps; harmonic distortion is less than 2% within 1 db of 70 watts

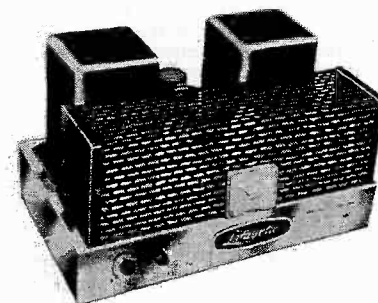

Lafayette's new 70-watt amplifier kit.

from 20 to 20,000 cps.

The amplifier is equipped with a *Chicago* output transformer. Output impedances are 4, 8, and 16 ohms.

The amplifier is available in kit form as the *KT-400* at \$69.50, or fully wired as the *LA-70* at \$94.50.

Save yourself time and trouble
by ordering your books directly from us.
Just fill in the coupon below.

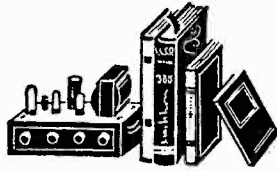

audiophile's bookshelf

Three recent books by three experts

HANDBOOK OF SOUND REPRODUCTION

By **EDGAR VILLCHUR**, inventor of AR loud-speaker systems and president of Acoustic Research, Inc.

Here is A-1 information about all aspects of sound reproduction, acoustics, and the necessary components. Written by one of the foremost authorities in the field, the book is organized in a way similar to home training courses. It fully covers a difficult technical subject in a manner which will provide pleasure and profit to the high-fidelity enthusiast. \$6.50 **249**

HIGH FIDELITY: THE WHY AND HOW FOR AMATEURS

By **G. A. BRIGGS**, designer and manufacturer of Wharfedale loudspeakers.

"... holds something for everyone. For the amateur, for whom it was written, it holds a bit of everything, in suitably compressed form, and must inevitably leave him with a feeling that he has acquired a general working background to the whole subject. . . . It deserves a wide readership, and I am certain it will secure it." — *HI-FI NEWS (England)* \$2.95 **250**

UNDERSTANDING HI-FI CIRCUITS

By **NORMAN H. CROWHURST**

Here the audiophile will find the answers to questions often confusing. The chapters are: special output stages, feedback, damping, inverter and driver stages, input stages, matching, equalization, speaker distribution and crossovers, loudness and volume controls, tone controls. Hard cover, \$5.00 **254**
Soft cover, \$2.90 **255**

Now available — the revised edition of *Greene & Radcliffe's extremely popular*

THE NEW HIGH FIDELITY HANDBOOK

A complete, practical guide for the purchase, assembly, installation, maintenance, and enjoyment of high-fidelity music systems. Includes the latest information on equipment. 250 illustrations, diagrams, and plans. \$4.95 **251**

"... Messrs. Greene and Radcliffe, two gentlemen whose knowledge of hi-fi is only slightly less than awesome. Whoever said that 'reading maketh a full man' was right — at least as concerns this book. Read it through, and you will arise full of knowledge." — *Deems Taylor*.

WHAT TO LISTEN FOR IN MUSIC

By **AARON COPLAND**. The revised edition of a book which made it possible for thousands to increase their enjoyment of music through creative listening. \$3.95 **247**

THE FORMS OF MUSIC

By **SIR DONALD TOVEY**. Written by one of the most literate and profound of modern interpreters of music, these essays are drawn from those articles which Tovey prepared for the *Encyclopaedia Britannica*. Paper, \$1.35 **239**

Book Department
AUDIOCRAFT Magazine
Great Barrington, Mass.

I enclose \$..... for which please send me, postpaid, the books indicated by circled numbers below. (No C.O.D.'s or charge orders, please.) Foreign orders sent at buyer's risk. Add 55¢ per book for postage on foreign orders except Canadian.

Binder 1 (holds 14 issues)	223	\$3.50	
Binder 2 (holds 12 issues)	245	\$3.00	201 245
NAME	232	249	
ADDRESS	233	250	
	234	251	
	237	254	
	239	255	

Continuing best sellers

HIGH FIDELITY RECORD ANNUAL: 1956

Edited by **ROLAND GELATT**. The second volume of *High Fidelity Record Annuals*. Included in this collection are reviews of classical and semiclassical music and the spoken word which appeared in *HIGH FIDELITY Magazine* from July 1955 through June 1956. Comparisons with recordings of previous years are emphasized. A performer index is included. \$4.50 **237**
HIGH FIDELITY RECORD ANNUAL: 1955 \$4.95 **201**

MAINTAINING HI-FI EQUIPMENT

By **JOSEPH MARSHALL**. A much needed book on the specialized approach necessary to service high-fidelity equipment. The author discusses not only electronic faults, but the mechanical and acoustical defects which cause a hi-fi system to function less than perfectly. The book is clearly written and well indexed. Hard cover, \$5.00 **232** Soft, \$2.90 **233**

HIGH FIDELITY: A PRACTICAL GUIDE

By **CHARLES FOWLER**, Publisher, *AUDIOCRAFT Magazine*

Whether your budget is small or large, whether you are a beginner or a devotee from way back, this complete and definitive guide can help you get the most enjoyment out of your high-fidelity system.

Here is the practical expert advice needed by everyone who has, or expects to have, a high-fidelity system. Starting with an introduction to sound, the author then describes the various links in the hi-fi chain, explaining their features and specifications so as to provide the most helpful criteria for evaluating, and for selecting and matching components. \$4.95 **234**



EDITORIAL

Gentlemen:

We wish to call your attention to page 10 of your August issue. On this page (your "Audionews" department) there appears an announcement of a new 60-watt Ultra-Linear amplifier kit, featuring our Acrosound TO-330 output transformer, to be sold by Lafayette Radio Corp. This announcement contains an error.

Please be advised that we are not supplying our TO-330 to Lafayette. At the present time, we are only supplying the TO-330 to one manufacturer: EICO. We would appreciate your advising your readers of this fact.

Jack Snyderman
Sales Manager
Acro Products Co.
Philadelphia, Pa.

Latest information from Lafayette is that the kit has been completely redesigned. It is rated at 70 watts, has built-in metering facilities, and utilizes a Chicago output transformer. Full details are published on page 13.—ED.

Gentlemen:

Page 13 of the August issue invites comment on cover design. I must agree with Mr. Cleveland of Troy; the cover is too crumbly for so fine a magazine.

Why not use a full-cover photo bled on four sides and a much smaller sig cut? Eliminate those hideous block-letter teasers on articles which are so packed together they defeat their purpose in actually being hard to read at a glance. If they must be used to boost stand sales, a different typography cut in like the sig would help.

The present cover counters all objectives of good modern design: cleanness, simplicity, so many little areas.

Keep up the editorial good work.

E. E. Hoaglan
Omaha, Nebr.

Gentlemen:

I agree entirely with Mr. Eugene I. Cleveland's well-put opinion of your new cover. "Cheap, gaudy, and commercialized" describes it exactly. The sad thing is that it isn't even new, but an inferior variation of the old one.

Title, date, price, the picture and its caption, and the three boxes announcing the feature articles are located generally as before, but the proportions have been spoiled. The picture and the

Continued on page 46

A FEW years ago there began to appear in the catalogue specifications for FM tuners a mysterious reference to a "Multiplex output," a "Detector output," or some similar added ingredient. If any word of explanation was given, it usually involved the phrase, "for future FM multiplex stereo broadcasts." The number of tuners now in use which have these special output jacks is certainly very high—but the number of opportunities to use them has been certainly very low, if not indeed zero.

Well, what are these things for? And are they potentially useful, or just a sales gimmick like the "TV sound" input jacks that appeared suddenly on millions of radios when television was just a bright glow on the horizon? To get answers for these questions, let's look at FM multiplexing in its present state of development.

In frequency modulation, as every reader of this magazine is aware, the amplitude of the radio-frequency carrier wave is held constant, and its frequency is varied in accordance with the audio modulation. The frequency of the audio determines the rate at which the carrier is varied around its center frequency; the amplitude of the audio determines how far away from center frequency the carrier deviates. Theoretically, the limit on carrier deviation is determined only by the carrier center frequency, but practically the 100% modulation point is taken as ± 75 Kc from the carrier center frequency. This determines the maximum dynamic range of the system: 75-Kc deviation of the carrier will produce more signal output from a receiver than, say, 50-Kc deviation, so that the former will be correspondingly higher above the system noise level.

In fact, the potential dynamic range is so great that FM subcarrier channels can be added to the main carrier without serious degradation of the signal-to-noise ratio. An ultrasonic frequency (41 Kc, for example) is set up as a subcarrier, and this is frequency-modulated by a second audio signal. Then this ultrasonic FM subcarrier frequency-modulates the main radio-frequency carrier in the same way as the primary audio channel. At the receiver, the main carrier is amplified and detected in the usual way. But the output of the main detector now contains not only the audio intelligence of the main channel, but the ultrasonic subcarrier as well, which is frequency-modulated by the second audio channel signal. The second channel cannot be heard at this stage, of course; it is necessary to feed the sub-

carrier to another FM detector circuit tuned to the ultrasonic carrier frequency. The output of *this* detector contains the audio intelligence of the second channel.

Two subcarrier channels can be added to the main carrier without significant loss of quality, making it possible to broadcast three separate programs simultaneously from a single FM transmitter. This process is called FM multiplexing. And the purpose of the "Multiplex output" jack is to feed an ultrasonic subcarrier from your tuner's detector to an external subcarrier detector, on these two premises: that FM stations will eventually broadcast stereo programs using the main channel and one subcarrier channel, and that the requisite subcarrier-detector units will be commercially available.

Several FM stations are using a subcarrier to furnish background music for restaurants, stores, and other businesses of similar nature. The regular station commercials are deleted, and the station charges a fee for this service. A few FM stations have found a solution to their economic troubles in this way; it is reasonable to suppose that others will do so. At least one station—WGHF-FM, in Brookfield, Connecticut—is making tentative, experimental stereo broadcasts via FM multiplex.

It is reasonable to ask why, if three channels are available, two are not used regularly for stereo broadcasts and one for the background-music service. There are some good reasons: first, multiplexing equipment is expensive to the stations, and it would be unreasonable to expect them to make further substantial investments in nonprofit-making equipment before they get on their pecuniary feet. Second, no adapter units are yet available. Complete multiplex receivers are made for the background-music service, but they are quite expensive and unnecessary, and may not be available to home users. Third, if simple adapter units were available to everyone, there would be nothing to prevent piracy of the background-music service by any commercial establishment. Standards and operating procedures will have to be agreed on to prevent this before multiplex stereo broadcasting can be established on a large scale.

To sum up, it seems likely that your tuner's "Multiplex output" may eventually be put to good use—but not for some time yet. Perhaps you can shorten the interval of waiting by writing to local FM outlets; they are glad to receive expressions of interest and suggestions for programming.—R.A.



PART I: Electronic Instruments, Past and Present

BUILDING an electronic organ is not a task to be undertaken lightly. When it was first suggested that someone on the staff of AUDIOCRAFT construct an electronic organ from a kit, the response to the call for volunteers was less than overwhelming. While most of us here are fairly experienced kit builders (by necessity as well as by inclination), building an electronic organ from a kit seemed such an ambitious project that we thought twice before taking on the job. When I decided to come to the rescue of the magazine's honor,

I had no previous experience nor any special talent that particularly qualified me for the project. My knowledge of electronic-organ lore was next to nil. About the only things to be said in my favor were that I had built some kits successfully and that I was optimistic.

Let me say right here at the beginning of the article that I don't think an electronic-organ kit makes a good starting point for the amateur kit builder just launching his career. If you have never used a soldering iron, slipped

spaghetti over a lead, or learned how an electric current behaves when it meets a resistor, a capacitor, or an inductor, you'd better do some initial experimenting on a device less complicated and less expensive than an electronic organ.

With the welter of things going on in the world today, it's a wonder that we know as much about as many things as we do. I confess, though, that a knowledge of electronic musical instruments was one of the things that had escaped me in the confusion. When they had been invented and by whom, what forms they had taken, and the state of their current development were unknown quantities. Once I became engrossed in the work of assembling an electronic organ for myself, however, these questions gradually assumed more importance. To get off to a proper start, then, let's look very briefly at the history of electronic musical instruments. Readers interested enough in the subject to pursue it further will find a short bibliography at the end of the last installment.

Beginnings

One of the first instruments to produce music electrically was the Telharmonium, invented in 1903 by Thaddeus Cahill. Dr. Cahill is perhaps better known for his invention of the electric typewriter, but the Telharmonium is impressive in its own right. The instrument consists of a number of alternating-current generators (Fig. 1), each producing a sine wave of a different frequency. A keyboard (Fig. 2), similar to that of an organ, enabled the player to combine

Fig. 1. The alternators (tone generators) for the Telharmonium. They had to be large since this was before the time of vacuum tubes and vacuum-tube amplifiers.

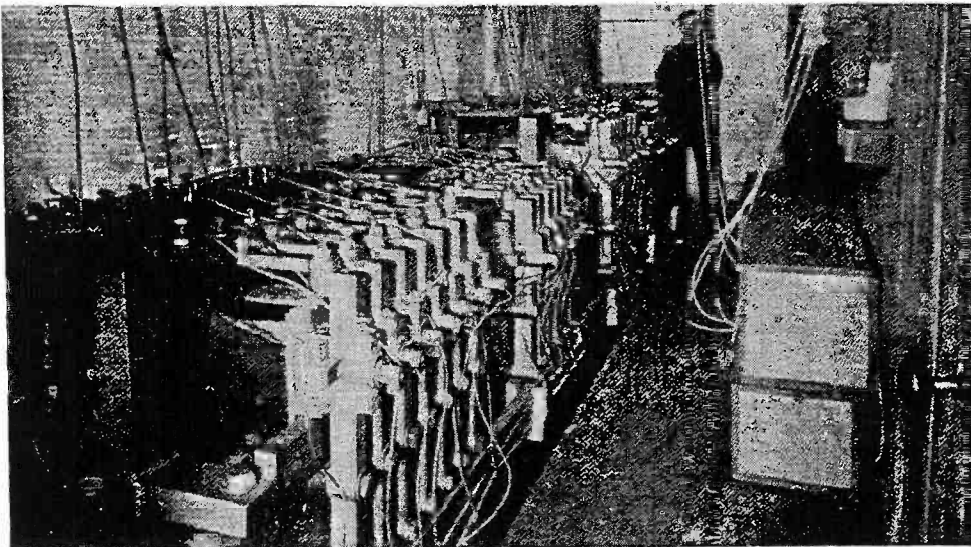

Culver Service



the outputs of whatever generators he wished to produce musical tones of different pitches. The composite current from the generators passed through a telephone receiver, and the receiver's diaphragm produced sound waves corresponding to the frequency of the electric current. Any number of receivers could be connected to a single keyboard, and it was Dr. Cahill's plan to pipe the music into the homes of subscribers, using an arrangement similar to that of the telephone system.

It was not until after the vacuum

tube was invented that any additional significant progress was made in the development of electrical musical instruments; but, once the vacuum tube became available, things began to happen with comparative rapidity. Instruments were developed along two lines: one type can be designated *electromechanical*, and the other, *electronic*.

Electromechanical Instruments

Tone, in electromechanical instruments, is produced by mechanical means. In the electronic carillon, for example, tuned metal bars are struck and caused to vibrate by hammers. Some electromechanical instruments retain sounding boards; others do not; but, in all cases, energy is generated by mechanical means and is transformed into electric current and amplified by a device employing vacuum tubes. After amplification, the electrical impulses are changed back into sound by means of loudspeakers.

The Superpiano, developed in 1927 by E. Spielmann, an Austrian, was the first of more serious attempts in this direction. The keys of the Superpiano act on lamps, the light of which passes through rotating discs and is transformed into electrical impulses by means of photoelectric cells.

An American contribution to the electromechanical line of development is the Rangertone of Richard H. Ranger. This instrument employs electrically controlled tuning forks as sound generators.

Courtesy R. A. Moog

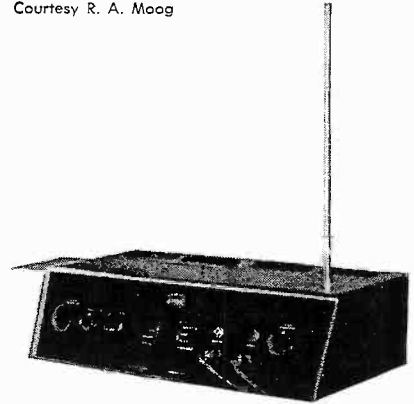

Fig. 3. The modern Thérémín. Its prototype was first electronic instrument.

Here again, sound energy developed by the tuning forks is transformed into electrical energy, amplified, and changed back into sound by loudspeakers.

Electronic Instruments

Tone, in electronic instruments, is generated by an oscillating electric circuit with a distinct frequency. Some electronic generators oscillate at frequencies well above the audible range, producing audible frequencies as beats or difference tones; others oscillate at the audio frequency desired.

The Thérémín¹, also known as the Thérémínvox and the Aetherophone (Fig. 3), the first truly electronic instrument, was invented in 1924 by Dr. Leon

Continued on page 34

¹A description of the Theremin and its modern version is given in: Robert Moog, "Music from Electrons," AUDIOCRAFT I (June 1956), p. 16.

Fig. 2. The Telharmonium's keyboard. The instrument is reported to have been capable of producing a variety of instrumental tones.

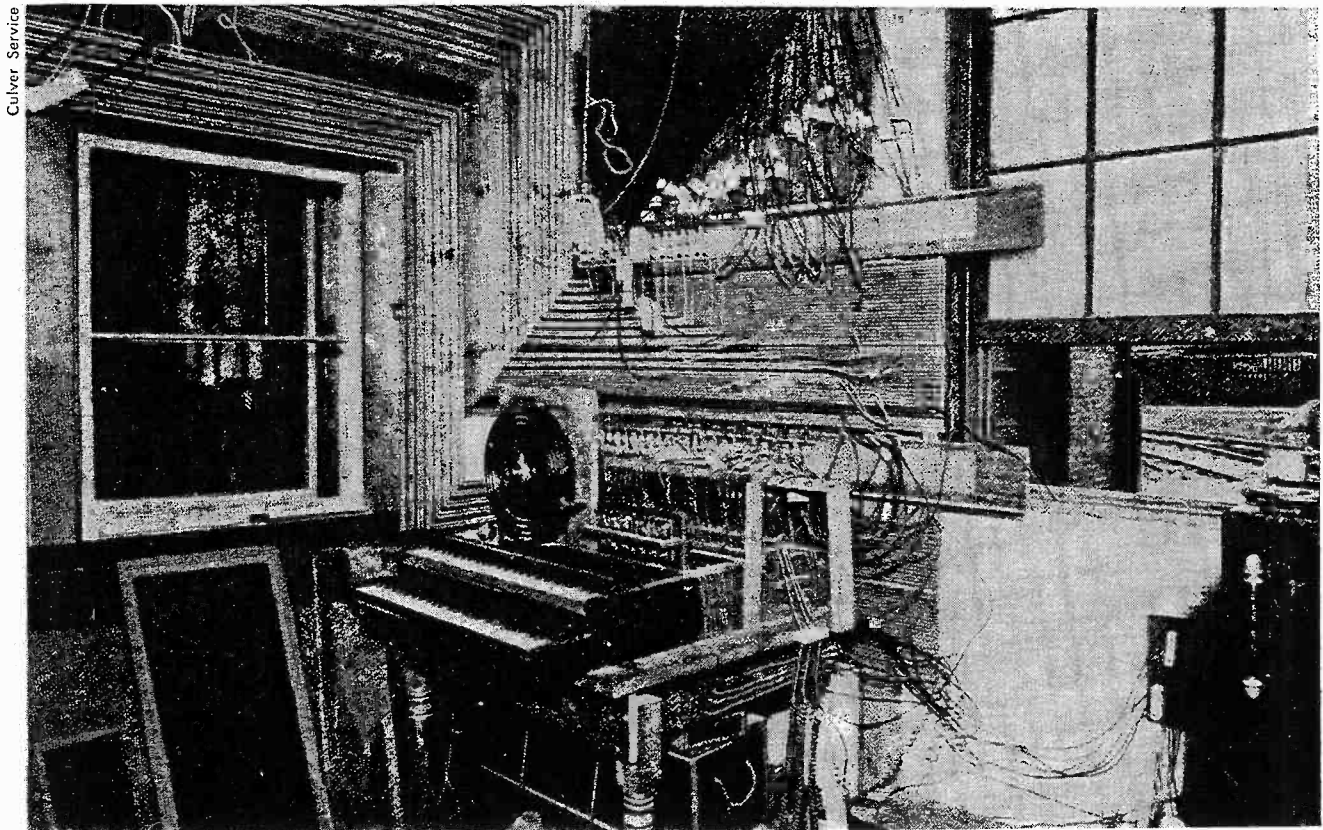

Culver Service

TRANSISTORS in Audio Circuits

by PAUL PENFIELD, JR.

VIIa: Transistor Input Stages

This part of the series represents a turning point. Until now the material has been mostly theoretical: the physics and mathematics of transistors in audio circuits. Generally speaking, from now on the more practical aspects will be emphasized.

To be a good circuit designer one must know the fundamentals discussed in previous articles of the series. That is, after all, why they were presented. However, the reader who was either unable or unwilling to read the first six parts, or who is not sure he has understood it all, will be able to follow the more practical installments. This series was written so that a knowledge of the preceding material would be helpful, although it is not absolutely essential.

THE first stage in a transistor amplifier is quite important. In practice many types of audio input signals are encountered, from many kinds of sources, and for best operation the input stage should be designed to fit the particular source.

Transducers

Any device that produces an electrical signal in response to some externally applied stimulus is an input transducer. Familiar audio transducers include microphones, phono cartridges, magnetic-tape heads, photocells, etc.

All transducers are characterized by an internal impedance, Z_p , and a certain "average" output voltage, E , when left open-circuited. That is, all transducers can be represented, over the frequencies of interest in the audio range, by an equivalent circuit such as that shown in Fig. 1. The only differences among the various types of transducers, as far as AC analysis is concerned, are those of internal impedance or value of the equivalent signal source.

For example, a dynamic microphone

might be represented as a voltage source of .001 v (one millivolt) in series with a resistor of 150 ohms. Although this is not valid for an extended frequency range, it may be fairly accurate over the audio range.

Isn't the value of the voltage generator dependent on how loudly you speak into the mike? The answer, of course, is "yes," and indeed the sensitivity of the microphone is determined by this relationship. But for our purposes we assume that the person is speaking with average loudness, and similarly, the phonograph cartridges are playing average records.

In practical cases, finding this equivalent circuit involves carefully reading the specifications of the transducer, deter-

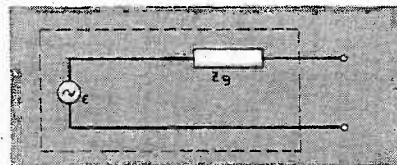

Fig. 1. Equivalent transducer circuit.

mining what reference level and what notation is being used, and relating this to the sound intensity (or record-groove displacement or velocity) expected. Or, more simply, the open-circuit output voltage can be measured in practical cases, and tests made to determine the magnitude and nature of the internal impedance.

Limitations of the Transistor

The AC sensitivity of an amplifier is always determined by noise. In Part III of this series some of the concepts of transistor noise were introduced. In particular, the noise figure (NF) was described as the ratio of amplifier noise output to that part of the noise output produced by the generator resistance. The noise figure is a good means for comparing two transistors for noisiness, but the quantity of interest is the signal-to-noise ratio, S/N .

The relation is simple, however. S/N is equal to a quantity characteristic of the transducer (and not of the amplifier), divided by the amplifier noise figure. If these numbers are given in decibels, as is customary, the second should be subtracted from the first.

The noise figure, then, should be minimum if the highest possible signal-to-noise ratio is desired. With this in mind, we will see how to bias the transistor for least noise figure.

Besides the noise problem, the designer is often faced with a problem of providing for operation with least power drain from the batteries. Biasing so as to avoid thermal drifts—that is, providing bias stabilization—is important, as was discussed in Part IV. Biasing for least power loss is essentially a matter of cut and try: design a circuit, find the power drain, and if it is too high, change the circuit to reduce it. Almost always this means raising the stability factor, S , so here a compromise is necessary. Biasing of the first stage must be a compromise between these three requirements—low power drain, good stability, and low noise.

Biasing for Least Noise

The noise figure for typical junction transistors, customarily specified in terms of the 1,000-cps component, will range from as low as 3 db for very quiet transistors to 40 or 50 db for poor units. The characteristics of low-noise transistors are of most interest, since these will be the ones selected for use in an input circuit.

The noise figure depends on the generator resistance the transistor is connected to, and on the bias point (usually expressed in terms of emitter current and collector-to-base voltage); but strangely enough, it is not dependent to any significant degree on the configuration used. That is, for a given source resistance, and a given bias point, the noise figures for the three configurations—grounded-emitter, grounded-base, and

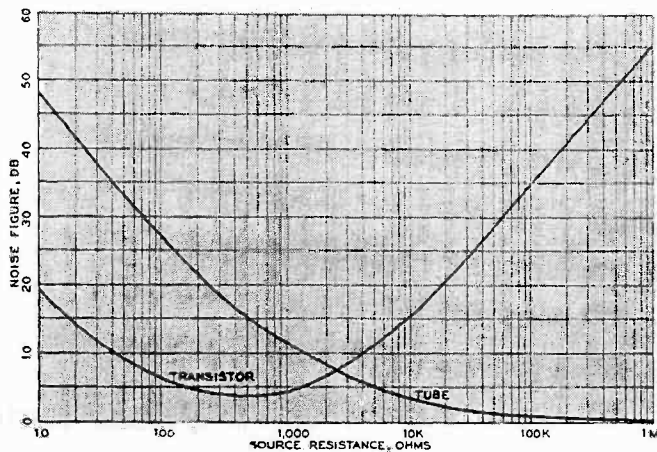

Fig. 2. The effect of source resistance on noise figure.

grounded-collector—are roughly the same. Although this is a controversial point, it seems fairly well settled now. Choice of configuration is immaterial for the noise figure, give or take a couple of decibels.

The effect of source resistance on the noise figure is shown in Fig. 2. This graph, and the two that follow, were intended to be representative only; while they will not be exact for any given transistor, they do show the general trends. Graphs like these are usually available for commercial low-noise transistors.

Note that there is an optimum source resistance, at which the noise figure is minimum. The minimum is very broad, however, so the "best" resistance is not at all critical.

For comparison, the same sort of plot for a vacuum tube (a rather good low-noise type) is shown. It is clear that the transistor is advantageous for low-impedance transducers, such as tape playback heads, while the vacuum tube holds the edge for higher-impedance devices. Again, do not treat the curves too seriously. They show general trends only.

Figs. 3 and 4 show the effect of bias point on noise figure. In general, the less emitter current, the less noise. Various transistors have different curves, but generally, for a very high signal-to-noise ratio, use a low-current condition.

Fig. 4 shows that below roughly 10 volts there is little to be gained by any particular collector voltage bias. Some transistor types show a rise in noise figure at less than 1 volt; others do not.

These two conditions together imply that, to minimize noise problems, operation at low power is desirable. This concept of operating at low power has been carried to an extreme in the so-called "hushed amplifier," in which collector voltages are held to mere millivolts. Here ordinary transistors are operated in such a way that the noise is reduced considerably, at the cost of a severe loss in gain. However, signal-to-noise levels

are comparable to, and often better than, those obtained with normal operation of special low-noise transistors.

With these general rules for choosing bias point with noise level, battery drain, and stability in mind, the requirements for various transducers can be examined.

Microphones

Crystal mike: for the first type of transducer, consider a crystal microphone. This has a source impedance of megohms, with an equivalent source voltage of perhaps .05 volt. Also, the source impedance is reactive, and, unless the microphone is connected to a high terminating resistance, the frequency response will be disturbed. Thus we have the problem of a generator which must work into a high impedance.

A choice must be made as to configuration. Recall from Part VI that the grounded-collector circuit has high input resistance, while the grounded-emitter circuit has medium input resistance. Since the noise figure will be the same for the two configurations, the choice is to be made on the bases of gain requirements and input resistance.

In the first place, the grounded-collector circuit is often hard to bias with much stability. If the high input resistance of this circuit is to be used, the bias resistors shunting the base must be higher than this. Furthermore, the input resistance is very dependent on the load resistor, and hence is not so stable as could be desired; if the load or any of the transistor parameters varied, the resistance seen by the microphone would change.

A simple alternative is to place a series resistor in the base lead (past the point where the bias is applied) of a grounded-emitter stage, to bring the input resistance up to that of the common-collector circuit. Then the value of input resistance will be almost constant, independent of parameter changes in the transistor, load changes, and temperature. Furthermore, neither the signal-to-noise ratio nor the gain suffers appre-

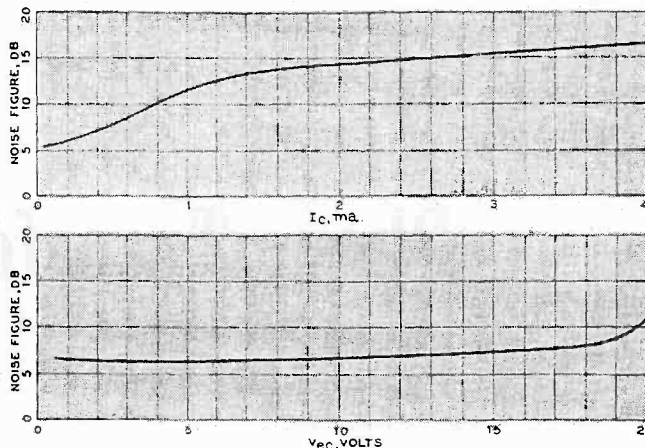

Figs. 3 (above) and 4. Bias point effect on noise figure.

ciably. The gain is the same because, as you will recall, the grounded-emitter and grounded-collector circuits have almost identical current gains, and here, if the resistance seen by the microphone is the same, the input current will be the same in the two cases. The noise figure will not suffer because, if the bias resistors in the second case are comparable to the input resistance of the grounded-emitter stage alone, the transistor is connected to a source impedance which is low. Thus, although the voltage appearing at the base of the transistor is far below that at the microphone, the noise factor (see Fig. 2) is correspondingly lower, or nearly so. The grounded-emitter circuit seems to be better in all ways, in spite of the fact that impedances are not matched.

In this case, neither the common-collector circuit nor the common-emitter circuit with the added resistor does a very good job. A better alternative is shown in Fig. 5—a transformer is used.¹ The secondary impedance should

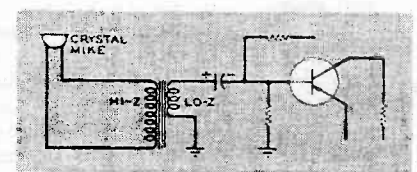

Fig. 5. Transformer-coupled input stage.

be roughly the input impedance of the grounded-emitter stage, and the primary should be the resistance of the microphone response, generally 250,000 ohms or more. This circuit provides the best gain and best signal-to-noise ratio, but offers the disadvantages of size, weight, cost, as well as the frequency limitations of the transformer.

All in all, then, the best advice on crystal microphones is, "don't connect

Continued on page 36

¹Fig. 5 and others to follow are meant to show only the input coupling method, and not necessarily the preferred method of biasing, except where indicated.

Phono-Transformer Switching

by HERMAN BURSTEIN

IN the design of electromechanical devices an advance in one direction often involves a sacrifice in another, and this holds true for phono pickups. Among the finest of present-day cartridges are those with the least output, sometimes as little as 1 mv at 1,000 cps for average recorded levels on a modern disc. Such a cartridge requires not only the usual preamplification, but also pre-amplification by means of an input transformer, in order to obtain enough voltage to drive the rest of the audio system satisfactorily.

Few control amplifiers provide as much gain as the audiophile would like to have when using a pickup with extremely low output. Even when there is enough gain, an input transformer is desirable as a means of improving the signal-to-noise ratio. In other words, the transformer increases the ratio between the input signal and the noise and hum generated in the control amplifier, largely in the first phono preamplification stage.

The ESL Concert Series, a magnetic pickup of the moving-coil type, is an example of a cartridge with outstanding sound quality but with very low output voltage. This contrasts with magnetic pickups of the variable-reluctance

variety, some of which produce as much as 34 db more signal, about 50 mv, under the same conditions. An input transformer is a virtual necessity with a cartridge such as the ESL.

However, installation of a transformer may well raise a problem for the audiophile who plays 78-rpm records extensively, as well as the long-playing types. Many persons are willing to invest in the cost of a fine cartridge for playing high-quality LP's but they often employ a less expensive pickup, with higher output and other different characteristics, for 78's. They are then faced with the problem of eliminating the input transformer when switching to the pickup used for 78's. This is necessary not only because of gain considerations, but because the input transformer is unlikely to match the second cartridge correctly, usually resulting in a loss of gain and a drop in high-frequency response.

Of course the input transformer can be added to or removed from the circuit by the expedient of manually changing cable connections each time that one switches cartridges. But this procedure is time-consuming, annoying, and not a very neat nor workmanlike answer to the problem. The satisfactory solution is to incorporate a switch in the

audio control unit which will insert or delete the input transformer at will. Such a switch, at least at low levels, also has the advantage of permitting an A-B comparison between reproduction with and without the transformer; of course, when the switch is flipped so that the transformer is out, the gain of the control unit must be simultaneously turned up to produce the same level as with the transformer in.

The illustration shows an arrangement I improvised for switching an ESL 301F input transformer in and out of the circuit. The hardware required was a double-pole double-throw switch, and two phono jacks for the shielded-cable connection to the input and output of the transformer. The switch is preferably of the slide type, make-before-break, in order to avoid thumps when switching. However, a toggle switch is easier to install, requiring a circular rather than rectangular cutout, and is satisfactory if you remember to turn the gain control down before switching. The switch can be installed either on the front or back panel, depending upon available room and convenience of access in use.

The phono jacks for making connection to the transformer were mounted on the rear panel. It is important that the ground side of these jacks be insulated from the metal panel in order to avoid a hum-producing ground loop; two different paths to ground behave like a turn of wire, picking up hum by induction in the presence of a 60-cps magnetic field produced by AC leads, transformers, etc. I used a double thickness of adhesive tape as an insulating material between the phono jacks and the rear panel. Holes for the jacks were drilled large enough for the metal casing of the jack to clear the panel adequately. The effectiveness of these insulating measures was then checked with an ohmmeter.

The ground terminal of the phono in-

Pictorial diagram illustrating a switching arrangement which may be used to switch an input transformer in or out of a phono-preamp grid circuit.

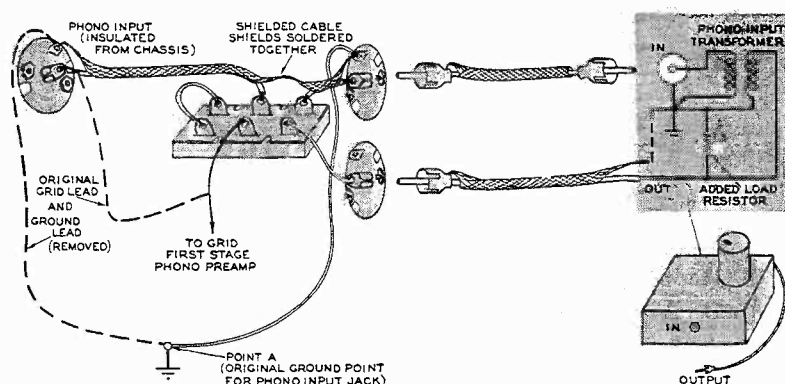

Mobile



Ampex

TAPE recorders and automobiles have gone together for quite some time, thanks to an ingenious little device called an inverter, which transforms 6- or 12-volt DC current from automobile batteries into 115-volt AC. But never before have we come across a tape recorder actually *built into* the dashboard of a car. Perhaps this is because few dashboards are commodious enough to accommodate a tape-transport mechanism, but whatever the reason, Radio Monte Carlo in Monaco has transformed the unlikely into a very practical commercial eventuality.

An Ampex 601 transport mechanism has been flush-mounted in the dash panel of a French Citroën DS-19. Preamp controls are located beside the transport where they are easily accessible to the driver. The original Ampex VU meter, detached from its normal mounting plate, has been placed vertically beside a voltmeter and frequency meter in a custom panel where it is instantly visible to the operator from any position.

Some license was taken with normal Ampex switching

circuitry by Radio Monte Carlo engineers who wanted an arrangement which would permit simultaneous recording from two microphones. They achieved this by installing two switchable inputs, a configuration which also will permit the playback signal to be blended with a microphone.

Despite such lavish improvisations, the Radio Monte Carlo motorcar still can function as an automobile, since no rider room has been sacrificed for the installation. Cables, mikes, and related gear are housed in the trunk.

Remote broadcasting — in which microphones are situated to pick up sounds which occur at some distance from the studio — once was a complicated procedure, and not unusually a costly one. Radio stations were forced to maintain trucks which were veritable radio stations on wheels. Even small transmitters were installed which broadcast to receivers usually mounted atop the buildings housing the home stations. The advent of tape recording reduced the problem with regard to both cost and complexity.

And now Radio Monte Carlo has gone one step further.

Parking-lot view of the Radio Monte Carlo Citroën DS 19. Note the Ampex recorder as seen through right front window.



Photos courtesy Ampex Playback

Close-up of Citroën dashboard, showing recorder, switching panel, and housing for volt, frequency, and VU meters.

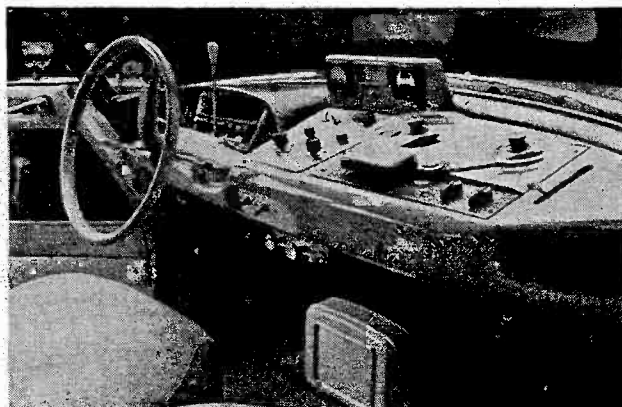

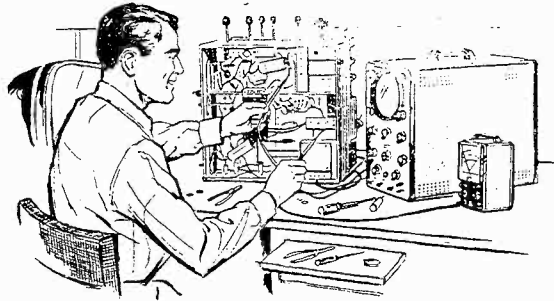

Using Test Instruments

The Oscilloscope, PART IV (Conclusion)

by DONALD CARL HOEFLER

AUDIOPHILES have found the oscilloscope an exceedingly useful tool for keeping their high-fidelity radio systems in top condition, both for trouble shooting and alignment. This month we'll discuss the use of the scope for alignment of both AM and FM tuners. In order to understand the procedure, we should first know how the hi-fi tuner differs from the ordinary commercial set.

Any modulated radio signal, whether it be AM or FM, consists not only of the station's assigned carrier frequency, but also of a number of *sideband* frequencies on either side of the carrier. An AM station on 710 Kc, for example, with an audio range up to 10,000 cps, is actually transmitting a band of frequencies covering 710 plus-and-minus 10 Kc, or from 700 to 720 Kc. In the case of FM the sidebands are much wider, being as much as 75 Kc above and below the carrier.

Since these sidebands contain all of

the audio information, there will be frequency-response distortion in the tuner unless it transmits the entire channel without discrimination. In the average low-grade commercial radio set, using sharply peaked intermediate-frequency (IF) transformers, this sort of frequency discrimination is inevitable. This is shown graphically in Fig. 1A: attenuation begins as little as 2,000 cps each side of the carrier, and at 6 Kc away from the center frequency the response is down by about one-half. It follows that the audio response must be down at least 6 db at 6 Kc.

When a transformer is overcoupled, on the other hand, the characteristic double-humped curve of Fig. 1B is obtained. This would provide a much wider passband, in this case about 19 Kc, with a rather sharp cutoff at 10 Kc either side of center. Such a cutoff is desirable for avoiding interference from AM stations on nearby channels, but the dip in the center of the curve would result in poor low-frequency response.

The tuner shown in Fig. 2 uniquely

combines these two characteristics: the input IF transformer *Q* is coupled as in Fig. 1B, while the output IF transformer *R* is sharply peaked as in Fig. 1A. The resultant of these two curves is seen in Fig. 1C, with a reasonably flat response up to about 9.5 Kc either side of the center frequency, and with a sharp cut-off around 10 Kc.

In order to see such a wave shape on an oscilloscope, we need the entire band of frequencies, instead of just one at a time as we have discussed heretofore. The scope is perfectly capable of showing us such a picture, but we also require a new type of signal generator, one that to the scope and to the eye will appear to generate all the frequencies simultaneously.

This instrument is known as a sweep-frequency generator, and it will be discussed in detail in a future article. Since this instrument is not so common as the ordinary RF signal generator, we will confine ourselves this month to alignment methods employing only an RF generator and a scope. This limitation imposes some restrictions on the operator, but since improvisation is part of the audio hobbyist's stock in trade, we'll see what we can do without some of the refinements.

But first, always remember to TURN THE POWER OFF whenever making or breaking any connections on electronic equipment. We'll mention a number of times disconnecting an instrument from one circuit and connecting it to another. If you always remove power before performing these operations, you'll run no risk of getting an electrical shock which can be highly unpleasant, and sometimes lethal.

A vacuum-tube voltmeter can be used

Text continued on page 24

Fig. 1. Appearance of wave shapes on oscilloscope with sharply peaked IF transformer (A); overcoupled transformer (B); and both curves when properly combined (C).

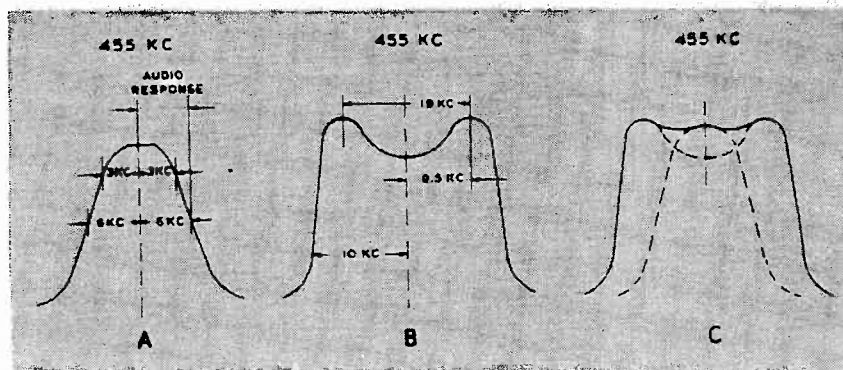

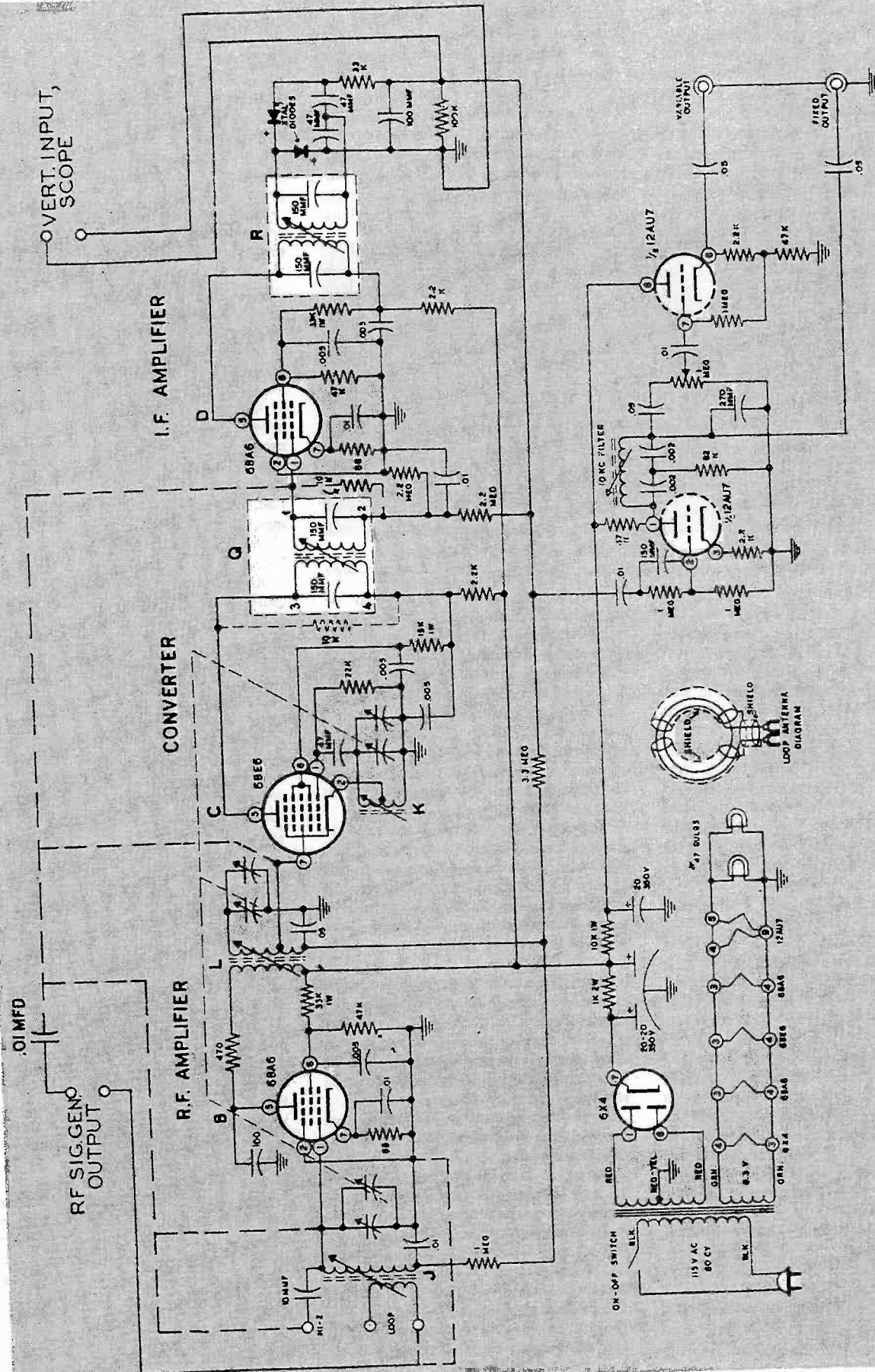

Fig. 2. Schematic diagram of a typical AM radio tuner, showing the points at which connections may be made to the vertical input of an oscilloscope, and several test points for connection to an RF signal generator. The dotted lines indicate periodic connections which are made in order to peak each transformer.

Text Continued from page 22

in place of the scope in most of these operations. But since the scope is the more versatile tool, we'll assume its use even when looking only for an indication of voltage maximum.

In AM tuner alignment the scope is connected across the detector output, as shown in Fig. 2, after first being calibrated as a voltmeter with 4 v peak.* Since the alignment operation always

The secondary of *Q* is then tuned for maximum, the resistor is moved to the primary side across terminals 3 and 4, and the primary winding similarly peaked.

Alignment of the front end of a receiver or tuner is a little trickier, involving not simply the single intermediate frequency, but all the frequencies in the band or bands to which the set tunes. Furthermore, the tuning indi-

for maximum. Then peak up the trimmer capacitor across the antenna coil *J*. Set both units to 600 Kc, and, while rocking the tuning dial back and forth, adjust coil *J* slug for maximum. This entire RF alignment procedure can also be repeated several times for a fine touch-up. Then the resistor across *Q* is finally removed, and the set is ready to go.

Alignment of an FM tuner with ratio detection is basically quite similar to the AM procedure just described. In the circuit shown in Fig. 3, the scope is connected across the output of the ratio detector, and the generator, set to 10.7 Mc, is connected to the input of the first IF amplifier tube *D*. Leaving the secondary of coil *Y* alone for the moment, and beginning with the *Y* primary, the coils *Y* and *X* are peaked. Then with the generator connected to the input of the mixer tube *C*, the mixer-oscillator alignment is similar to that for the AM set. The procedure for the RF section is also basically the same, except that the input signals should be at the extremes of the FM band, perhaps 90 and 106 Mc.

Adjustment of the ratio detector requires that the scope be moved to a position across the volume control. With a constant RF or IF signal being applied by the generator, the secondary coil of *Y* is adjusted for zero voltage indication. The core slug should be moved back and forth a few times to indicate that a voltage appears either side of the correctly tuned position. If this is not the case, tuning has not gone through a null, and the core must be moved farther in or out until a true dip is obtained.

The only truly accurate way of aligning an FM discriminator is by the sweep-generator method to be discussed in a future issue, and the next best is that just described for the ratio detector. But there is another system which will usually give fairly good results, and it requires only an AM generator covering the IF frequency of the tuner, plus a scope or VTVM. This method assumes that both primary and secondary of the discriminator transformer are tuned to the center of the IF frequency, and not stagger-tuned in a bandpass arrangement. Under these conditions the discriminator can be temporarily converted into an AM detector, and the alignment is simply for maximum output.

The circuit modification is accomplished as shown in Fig. 4, with one plate of the tube grounded, and the center tap on the transformer secondary opened up. The local oscillator and automatic volume control should also be disabled, either by grounding or pulling tubes.

Then with the signal generator set to the center of the IF frequency, and

Text continued on page 39

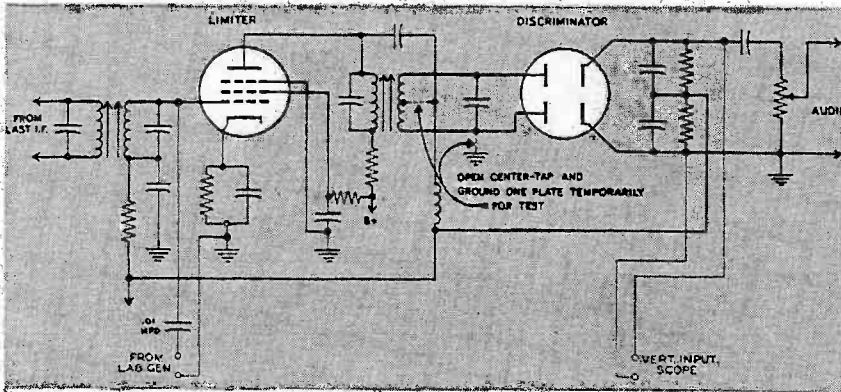

Fig. 4. Alternative method of aligning an FM discriminator by converting it to an AM detector, and adjusting the slugs for maximum output, using an oscilloscope.

proceeds backwards from output toward input, our first concern will be the last IF transformer *R*. The generator is therefore connected to the stage just ahead of it, through a .01- μ fd capacitor to the grid of tube *D*. The ground side of the generator cable goes to any convenient point on the chassis.

The generator is set to the intermediate frequency of 455 Kc, with AM modulation on. The scope is adjusted so that 3 cycles of the modulation wave form appear on the screen. Since the internal modulation of most signal generators is 400 cps, the scope sweep is set to around 133 cps.

Now, with all power on for an adequate warm-up period, the secondary of transformer *R* is adjusted for maximum indication on the scope. In this particular tuner, the detector output for most reliable readings should be about 4 v. The generator output should, therefore, be adjusted so that 4 v is indicated when *R* is tuned to maximum.

A screw-driver adjustment on the transformer varies the position of an iron-core slug on this set, while in other cases the inductance may remain constant as small trimmer capacitors across the windings are changed. After the secondary of *R* is peaked, the primary is then tuned in similar fashion.

Since transformer *Q* has a double-peaked response, we will temporarily change its characteristic to look like Fig. 1A by using a 10,000-ohm loading resistor. This is first connected between terminals 1 and 2, while the generator is moved over to the input of tube *C*.

cator should "track," or read fairly accurately at all points on the dial.

It will be noted in Fig. 2 that the oscillator coil *K* and the mixer coil *L* each have three variable devices in their respective circuits. One of them is the main ganged tuning capacitor, which also operates in the RF section ahead of tube *B*. In addition, each has a small trimmer capacitor which is adjusted at the high end of the spectrum, while the core slugs align the low end.

The generator is now connected to the input of tube *B*, and tuned to 1,600 Kc, with modulation. The tuner dial is also set to this frequency, and the trimmer capacitor across *K* adjusted for maximum indication on the scope. Then both the generator and tuner are set at 1,400 Kc, and the trimmer across *L* is adjusted for maximum, while the main tuning dial is rocked slightly back and forth. This rocking is necessary because the maximum output is obtained only when the mixer and oscillator circuits are both properly tuned with a single setting of the main ganged capacitor.

Now the generator and tuner are tuned to the low end of the band, say 600 Kc, and the slug *K* is adjusted for peak output, followed by the slug in coil *L*. It is then a good idea to repeat the entire mixer-oscillator alignment procedure, to correct for any interaction between circuits. Going through the steps several times will do no harm, because each repetition will probably give just a little finer touch-up.

RF alignment is accomplished by connecting the generator to the antenna terminals as shown. With the generator set at 1,400 Kc, tune the main capacitor

*Donald Carl Hoefler, "Using Test Instruments," *AUDIOCRAFT*, II (June 1957), p. 29.

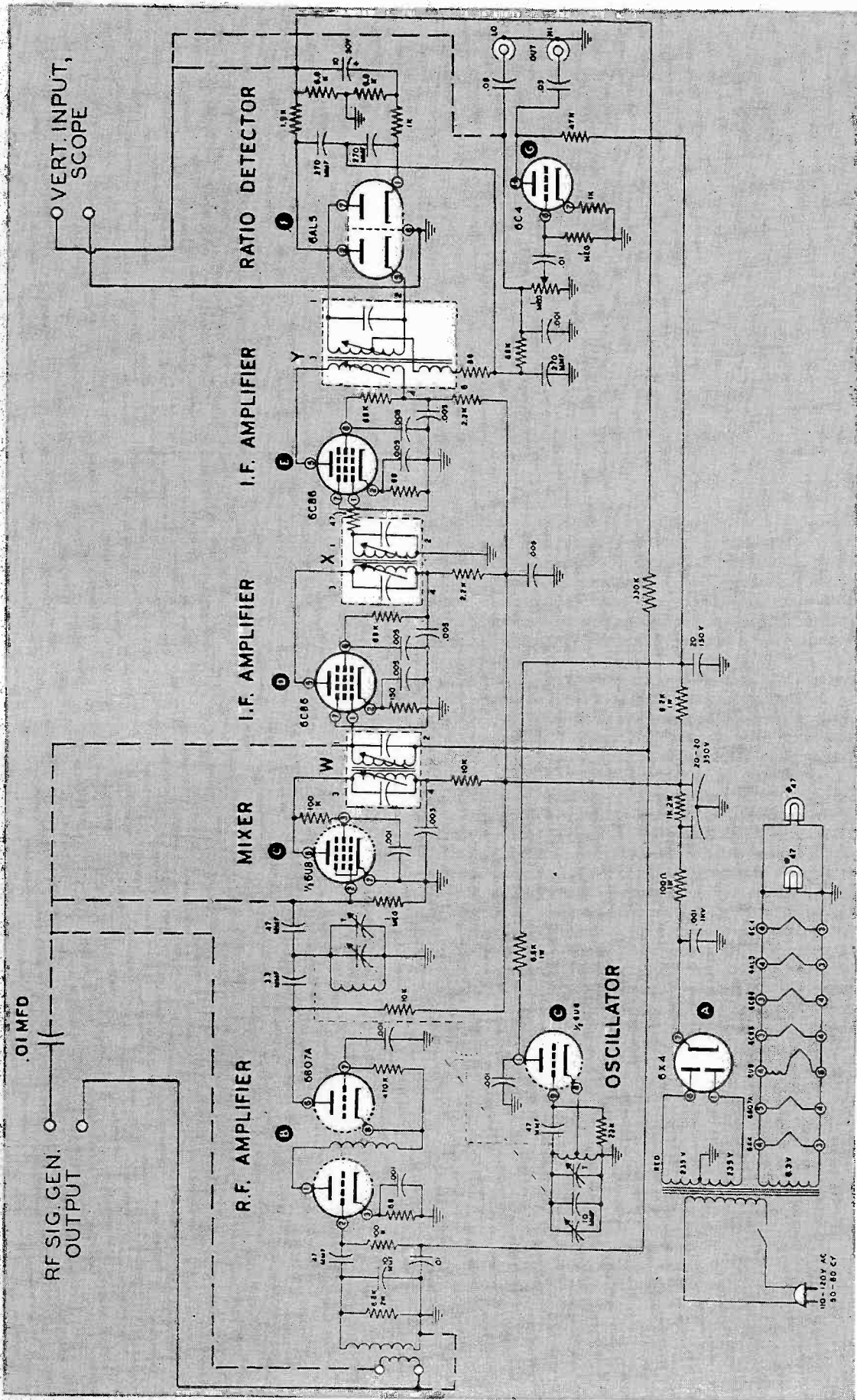

Fig. 3. Schematic diagram of a typical FM radio tuner, showing connecting points for the oscilloscope and RF signal generator. The methods involved in FM tuner alignment are basically the same as those followed to align an AM tuner, but the frequencies differ. The text contains a complete description of the method to be followed in an FM tuner alignment.

The heart of the system includes, from top to bottom: an Ampex 400 recorder used for monaural recording and playback; McIntosh 20 W-2 preamp for monaural playback; Ampex 612 stereophonic reproducer; Browning AM-FM tuner; and 2 Altec 35 watt amplifiers.

deluxe stereo system

STEREO systems being elaborate per se, herein is described a super-deluxe assembly which overshadows almost any that we know of. Constructed with a preponderance of high-quality components, this rig will do everything but talk, and it requires but a reel of tape to make it do that. Ampex 400 recorder, McIntosh preamp, Ampex 612 stereo player, and Altec amplifiers and speakers produce sound which probably is as low in distortion and wide in range as presently available components can make it. The rig is assembled in the home of Richard H. Cobb, Jr., of Sarasota, Florida, who says that, although the sea and trees in the background aren't essential to perfect reproduction, they do add that final touch to an already luxurious and ear-soothing setting.

Most deluxe audio rigs of any description contain a touch of personal innovation, and Mr. Cobb's system is no exception in this regard. He has built a mu-metal shield around the Browning tuner to isolate it from power supplies located directly above. Mounting of the Ampex 400 on the rack above the 612 reproducer permits tape from the 10½-inch reels to wind over the heads of the 612, for stereo playback of extra-long tapes. And the tape twister which he designed (see illustrations) could well be a boon to any tape recordist who is plagued with occasional warped reels. All in all, this appears to be a rig *par excellence*, and one which Mr. Cobb can exhibit with pride.

From behind, the equipment rack bares its array of interconnecting cables, power supplies, amplifier chassis, and tape transport intricacies. Placement of power supplies was chosen to reduce hum pickup to a minimum.

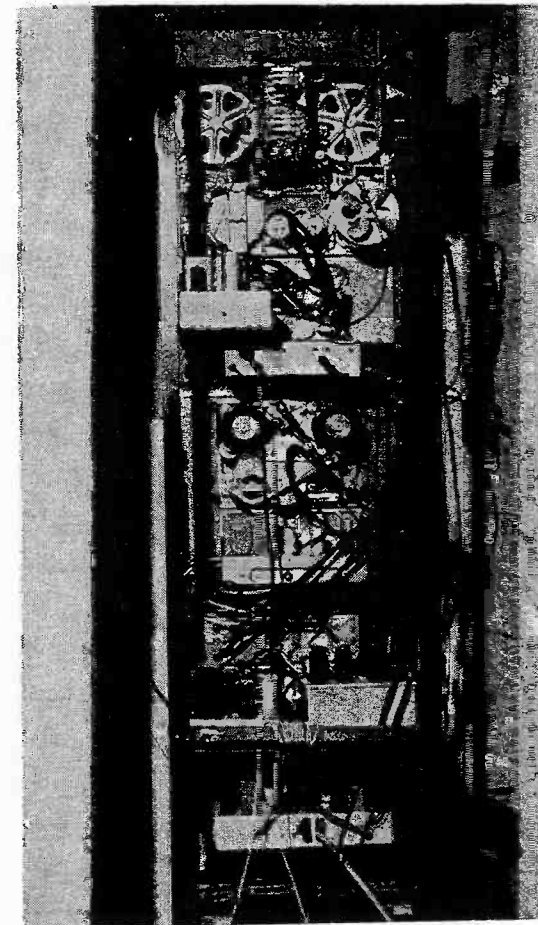
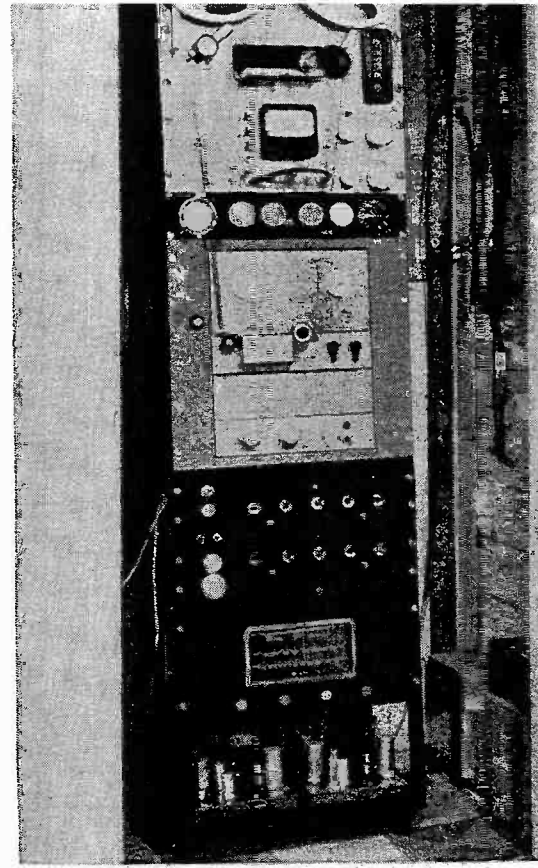

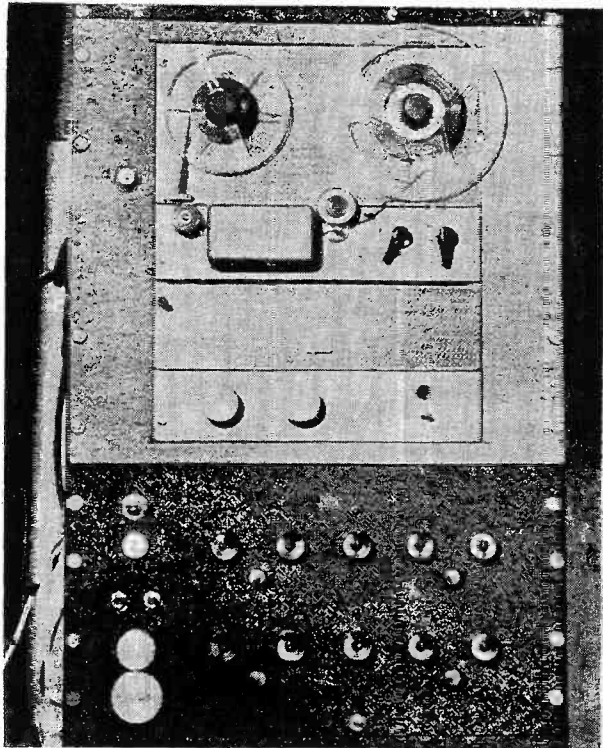

The Ampex 612 stereo reproducer is positioned directly above the switching panel. Switching circuitry is designed so that the stereo signal to the speakers can be reversed — that is, right microphone signal into left speaker — if desired.

This is a close-up of a tape twister designed by Mr. Cobb which quarter-turns the tape as it comes off the supply reel. This keeps tape from rubbing against the sides of a warped reel and causing annoying chatter.

Detail drawing of construction of tape-twisting device shown in photo at right.

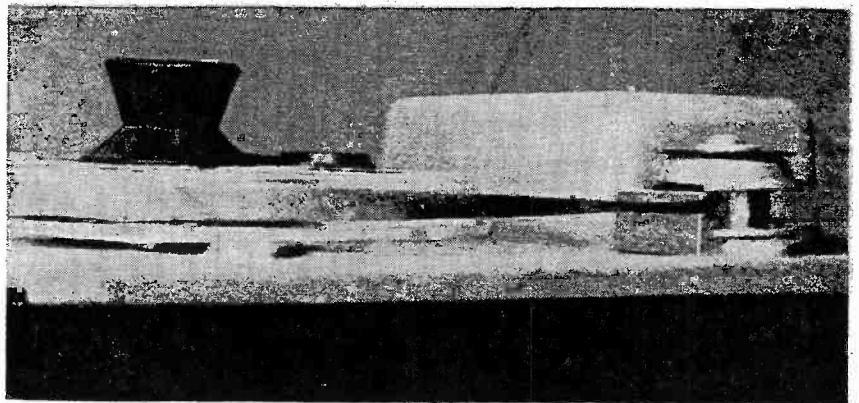
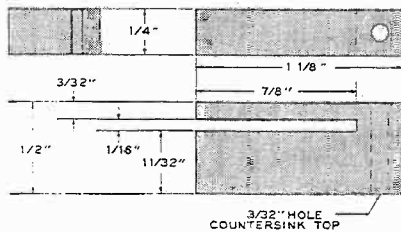

Two Altec 620 speaker systems complete Mr. Cobb's stereo layout. Within the enclosures the speakers are positioned to deliver highs to the inside and lows to the outside, which tends to reduce the bothersome separation effect.

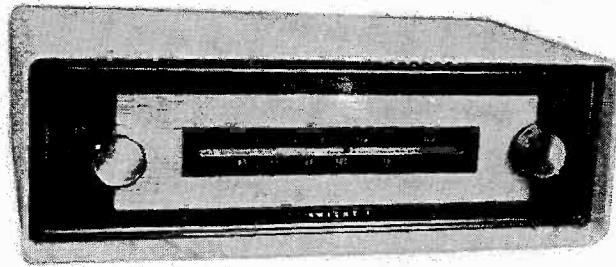

Knight-Kit FM Tuner

CONSTRUCTION of an FM tuner or receiver at home has been, until recently, a project which only an experienced and courageous technician dared undertake. At the very high frequencies of FM broadcasts, problems of stability, tuning linearity, and adequate sensitivity are acute and critically dependent on dimensional accuracy. Often a fraction of an inch in the length of a lead, or in its placement, can make the difference between excellent performance and very poor or highly unstable performance. The distributed capacitance and inductance represented by wiring and parts placement can throw the tuning off by as much as half the FM band and sometimes shove it completely out of the band. And the equipment and knowledge needed to correct such errors are not to be found in every living room.

We have, therefore, watched the ar-

rival of kits for FM tuners with some misgivings, wondering if the manufacturers were not overestimating the competence of their possible customers—as well as their own ability to turn out a reasonably foolproof kit. Having heard good reports of the \$39.95 Knight-Kit FM tuner, we asked Allied Radio Corp. of Chicago, one of whose products is the Knight-Kit line, to send a kit for an AUDIOCRAFT report. To eliminate the suspense, let us say at the beginning that this kit seems to be about as easy to build as any amplifier, preamp, or instrument kit, and is, in fact, less complicated than some. Anyone who can handle a soldering iron with some competence should have no trouble in making this FM tuner, whose performance will compare well with commercial units. Especially gratifying was the discovery that adequate performance could be obtained with only the uncritical align-

ment procedure described in the manual, which involves peaking the RF trimmer and adjusting the oscillator trimmer at one point on the dial with the signal of an FM station, and without any instruments of any kind.

The secret of this notable achievement lies in the use of a carefully laid out printed-circuit board for the entire signal portion of the tuner. This insures uniformity of distributed inductances and capacitances, eliminates the problems of optimizing wire and lead length, and lead dressage—and, of course, minimizes the need for judgment or skill in assembling and positioning components at VHF.

The circuit of the tuner is given in Fig. 3. It begins with a broad-band untuned cascode RF stage, followed by a 6BA7 mixer with a single tuned coil in between. Half of a 12AT7/ECC81 is used as an oscillator, and the other half

Fig. 1. A portion of the Knight-Kit instruction manual, showing circuit-board parts placement.

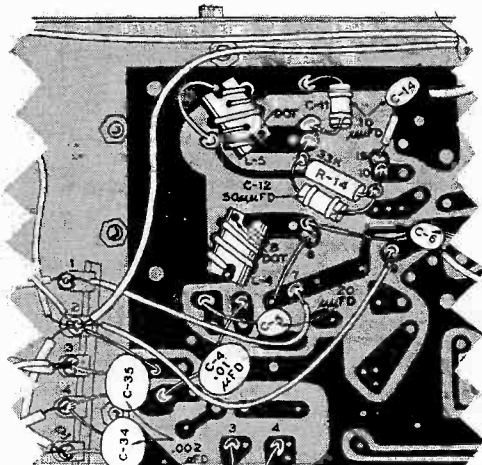
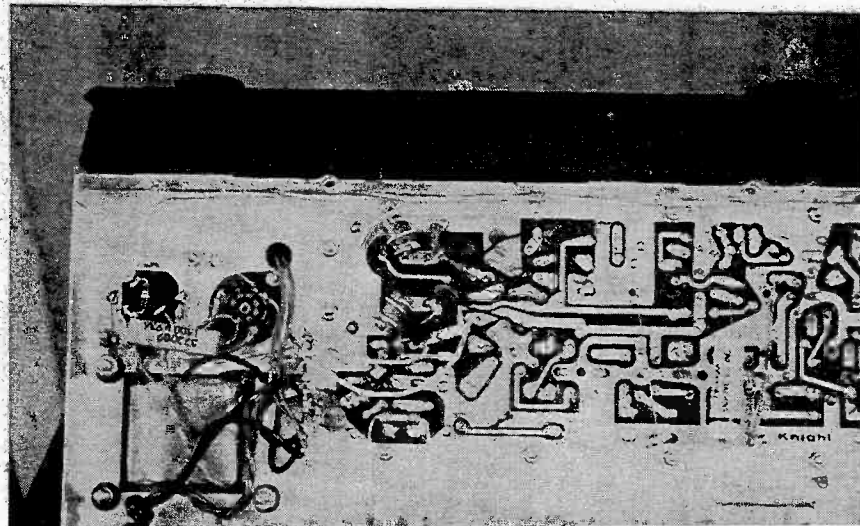

Fig. 2. The underside of the chassis shows the printed-circuit board in place, and connections to the power supply, antenna, and output jacks.



as the automatic-frequency-control tube. The AFC can be disabled by a front-panel switch. There are two IF stages using 6AU6's, followed by a ratio detector which, in turn, feeds half of a 12AU7/ECC82 as an audio amplifier. The output is a cathode follower using the other half of this tube. There are two paralleled output jacks, one for the controlled input of an amplifier or preamp and the other for a tape recorder. The rectifier is a 6X4 whose output is smoothed by a simple but effective RC filter. There is no volume control, a fact that will please some people much less than others. However, if one has no need for the extra output jack, a midget control could be mounted in its place to set the output level.

Construction Notes

Assembly is quite simple and very well described in the instruction manual. The three dozen resistors are supplied and numbered on cards, and the printed-circuit board is printed with corresponding numbers. Step-by-step instructions (Fig. 1) provide a check against possible error in placing the resistors by specifying the value of the resistance as well as the color code for each resistor.

The first step is simply that of inserting the leads of resistors and capacitors into the holes on the printed-circuit board. This can be facilitated if the leads are first bent close to the body and at right angles to it—except for the two or three cases in which the spacing between holes is greater than the length of the resistor. All the components are mounted, and the protruding ends of the leads bent back to hold them temporarily in place, before any soldering is done. We suggest that, as each component is placed in position, a check be made against the circuit-board diagram in the instruction manual, which not only pictures every unit but gives its value as well. Care at this point will reduce the possibility of trouble later. Fortunately, in the few cases where a mistake is most likely to be made by putting one end of a component in the wrong hole, it is almost certain to be discovered when the time comes to place the adjoining component.

Soldering the circuit board is the most critical part of the construction. The foil in this particular board is heavy enough so it is not likely to disintegrate while it is being soldered, but the right kind of iron will greatly facilitate the soldering process. One of the pencil types with a small tip and a 50-watt element is probably the safest; but a gun-type iron with a small tip will work nicely. Be sure the joints are good and that the solder flows well. "Cold joints" will cause all sorts of trouble in performance. Care must be taken not to use too much solder, so as

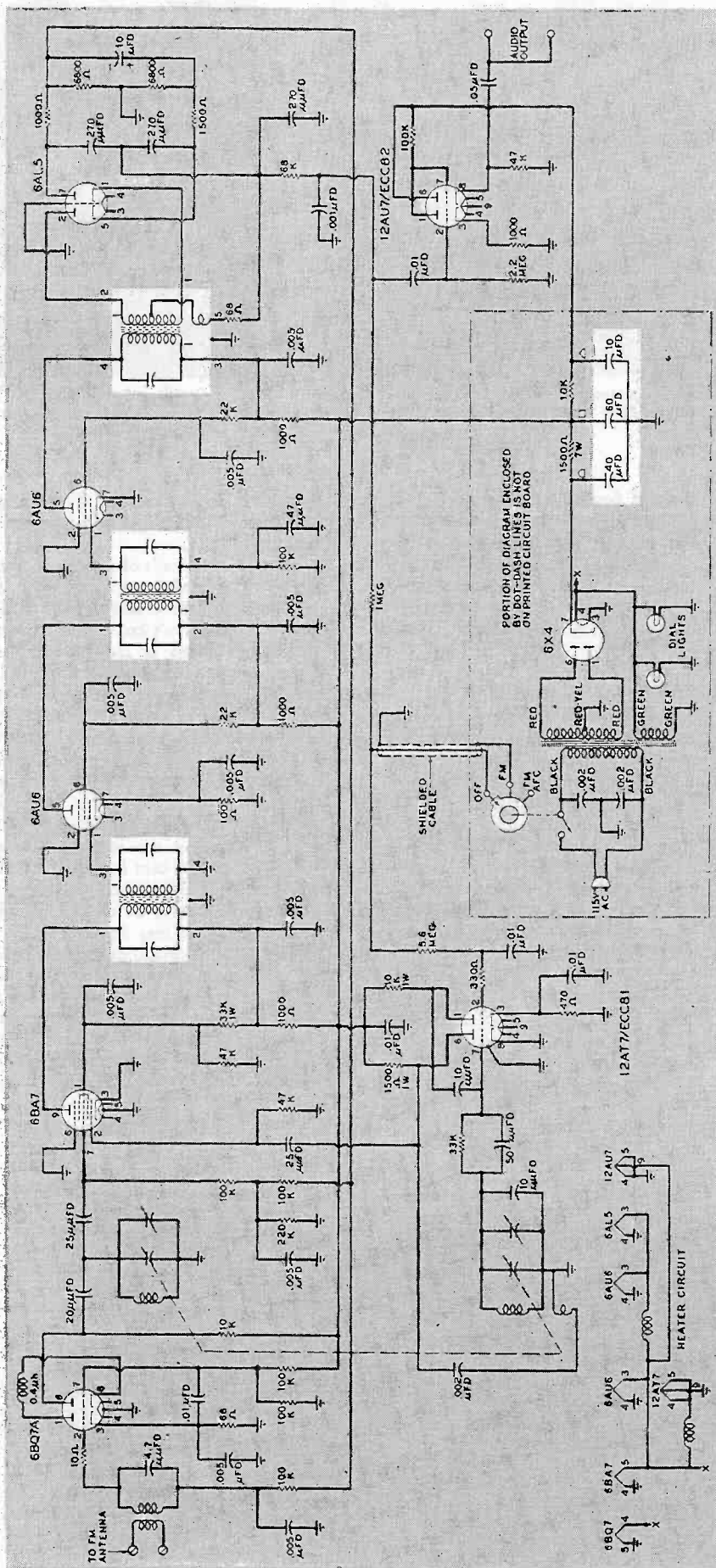

Fig. 3. Schematic diagram of the Knight-Kit FM tuner.

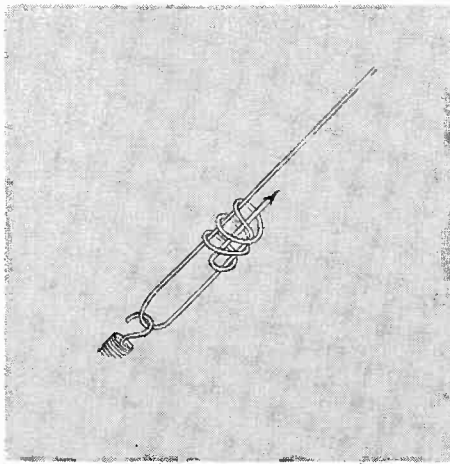

Fig. 4. A nonslip knot for the dial cord. Follow arrow, push knot against spring and pull cord.

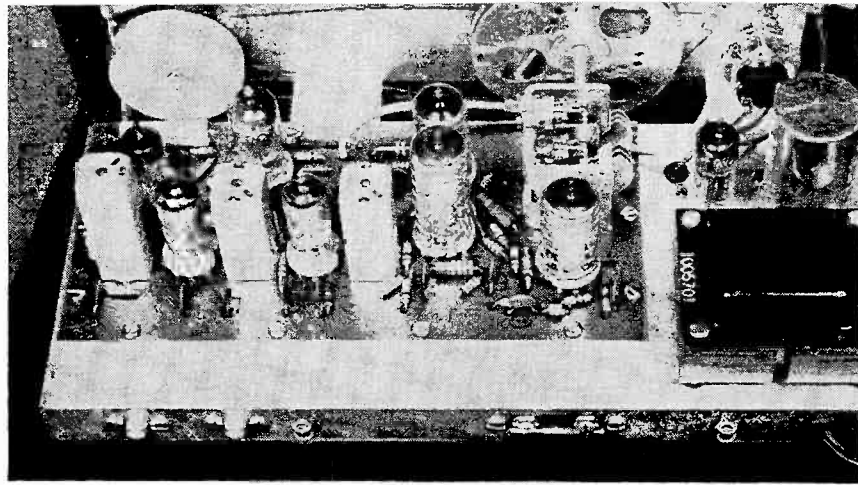

Fig. 5. The top side of the completed tuner shows the uncluttered layout which is possible with printed-circuit boards, which also speed assembly.

to avoid flow of excess solder across the bakelite aisles, which would short-circuit adjacent conductors. Leads can be clipped off as the soldering proceeds to make other leads more accessible (Fig. 6). Incidentally, a pair of diagonal cutting pliers is almost indispensable for a neat job.

After the board is completely assembled and soldered on this side, it is put aside while the power transformer and other components are mounted on the metal chassis. Then the board is mounted on the chassis and the wiring is completed from underneath (Fig. 2). Here, too, there is little possibility of running into trouble. There is a slight ambiguity in the instructions for mounting the RF and oscillator coils, which say, in part, "Push these two leads [of the coil] as far as possible into the holes." The constructor will find, however, that there are little crimps on the leads of the coils which will permit the leads to be inserted just so far and no farther. It occurs to us that some people might decide to straighten out the crimps so the leads can be pushed farther into

the holes. Do *not* do this. Those ridges have been made deliberately to establish a limit.

Two or three leads of components that go on the board from underneath are very close to the frame of the tuning capacitor. We don't know if any trouble would be caused if they touched the frame, but we suggest care in placing and clipping them to avoid this possibility. If the soldering is done in big gobs there is also the possibility that one or both of the two metal shields, which go across the printed-circuit board underneath, might ground out a portion of the circuit. The possibility is probably remote, but the instructions warn of it, and double care here will forestall the need for trouble shooting.

Those who have never strung a dial system with cord may find this tricky, although the instructions and diagrams are quite clear (Fig. 7). The most likely source of trouble is that of getting the string too loose. Be sure, therefore, when making the final tie to the spring that the cord is taut enough to extend the spring. Also, be sure you make a good

nonslip knot. We find the jam knot diagrammed in Fig. 4 easy and firm. It is borrowed from our trout-fishing experience. Fig. 5 shows the tuner after completion, with all tubes inserted.

AUDIOCRAFT Test Results

We have already pointed out that alignment is not difficult. In areas close to FM stations the peaking process described in the manual will be adequate. But there will be a shift in dial position at the high end when the tuner is inserted into its steel cabinet. Therefore, when setting the oscillator trimmer, adjust it so that the desired station comes in slightly higher on the dial scale than its actual frequency. For peak performance the tuner can be aligned with a VTVM according to further instructions in the manual, or by a technician with the proper instruments and experience. This may make some difference in the weak-signal sensitivity.

The performance of the Knight tuner is excellent; especially gratifying is the low distortion. In this respect it is better

Continued on page 46

Fig. 6. The underside of the printed-circuit board before mounting. Note that a few component leads have been soldered, but not clipped.

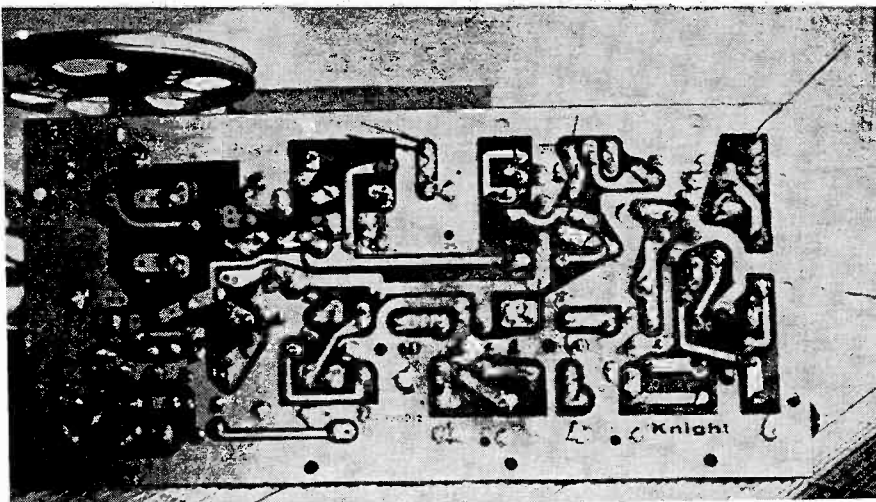
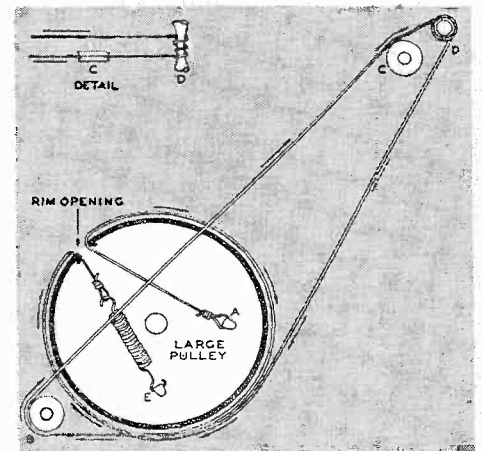

Fig. 7. To install the dial cord, follow the arrows from A, and attach the spring at E.





Calibrate It Yourself

One of the few valid criticisms one can make of kit test equipment is that the calibration is apt to be poor. Any instrument that is a generator (such as an audio signal generator, a voltage calibrator, or a square-wave generator) puts out a wave form, important qualities of which (such as frequency and amplitude) are read from the position of a knob. Since the panels of these instruments are mass produced, they cannot be calibrated to take into account variations in construction, components, and so on.

If it matters to you whether you get 3.5 volts or 4.2 volts output, or whether the frequency is 12 Kc or 13 Kc, don't trust the panel markings. Instead, go to the trouble of marking the panel yourself, putting on it your own calibration points.

Masking tape (or one of the tapes made specifically for writing on) can be applied to the panel and the calibration points accurately marked.

In calibrating, be sure to check against a good standard. To get frequency check points, make Lissajous figures with power-line frequency, or the carrier frequency of a radio station. Check voltage outputs with a good voltmeter, or against a known voltage on an oscilloscope. Even calibrating amplifier or oscilloscope gain controls is often helpful.

The motto of all scientists—mistrust your equipment, especially if you haven't calibrated it yourself—is an equally good motto for audiophiles.

Paul Penfield, Jr.
Cambridge, Mass.

Soldering Aid

"Audio Aids" (February 1957) contained an item on the use of a hemostat as a soldering aid to prevent heat damage to capacitors and resistors. Another simpler gadget to accomplish the same purpose is a modified Mueller No. 60 standard 2-inch alligator clip.

The clip's jaws should be flattened out, duck-bill fashion, for about $\frac{3}{8}$ in. at the tips, and filed smooth to provide maximum contact surface. The serrated outside edges can be smoothed off with

a file and the instrument is ready for use.

The tool is self-locking. It can easily be inserted in compact assemblies and can be lodged against the chassis for maximum heat conduction. It is especially useful when replacing small components on printed-circuit boards, both as a heat conductor and for strain relief on fragile resistors.

The solder ferrule at the lead end of the clip is handy for storage purposes. Just drive a short finishing nail upright in a convenient place on the workbench or tool rack and set the clip over it.

Total cost: 8¢ and 10 minutes' tinkering.

J. A. Bannister
Point Edward, Ont.

Sealing Speaker Enclosures

Most plans for reflex-type speaker enclosures suggest using foam-rubber gaskets between the cabinet itself and the back. This is O.K., but it is sometimes hard to find the foam rubber for the gaskets.

As a substitute, try using ordinary rubber electrical tape (not the new stuff, but the old-fashioned rubber kind) as

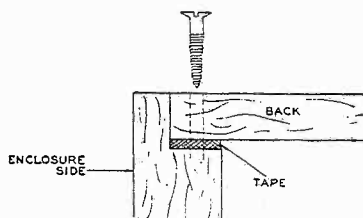

Simple way to seal speaker enclosure.

shown here. If the joint has been made with average precision, the rubber tape will be quite satisfactory.

L. E. Johnston
Madison, Wis.

Speaker Mounting Gasket

When one has occasion to remove a speaker from a cabinet, it's often found that the unit will not pull loose from the wood surface after the mounting screws or bolts have been removed. This is because the paper or cardboard ring which holds the cone in place (and

forms a slightly compressible mounting cushion) has become cemented to the wood finish through overlong association. This happened to me with a shellac finish inside the cabinet, but it can occur as easily with varnished, painted, or unfinished wood.

I put up with this nuisance for some time, losing some of the cardboard from each speaker as it was pried loose. Then I decided that audio fans, including myself, would be wiser to take precautionary measures to prevent this unpleasantness. In brief, before mounting a speaker on any surface, cut out and lay under it several rings of wax paper, parchment, metal foil, or any similar, nonporous, flat material. This gasket will facilitate removal of the speaker from the cabinet, should that ever be necessary in the future.

Harry L. Wynn
Derry, Pa.

Marking Wiring Diagrams

In the Audio Aids column for February of this year, Mr. Paul Penfield, Jr., submitted an idea about marking wiring diagrams in order to avoid miswiring. This is a good idea, but I think it can be improved upon.

Take the schematic and fasten over it a sheet of clear cellophane of about the same size. If the diagram is $8\frac{1}{2}$ in. by 11 in. or smaller, an ordinary clip board can be used to grip both the schematic and the cellophane. For larger wiring diagrams, a piece of plywood of the same dimensions or somewhat larger gives backing, and masking tape will hold schematic and cellophane in place. The cellophane used should be heavier than ordinary wrapping cellophane: thick enough to lie flat without wrinkling, but thin enough to be pliable.

Marking is done with a "china marker" pencil on the cellophane over the wiring indicated beneath.

Advantages of this system are that the diagram itself does not get marked and become hard to read, corrections and erasures are easily made with a cloth, and the cellophane can be reused many times.

David H. Marsh
Arlington, Va.

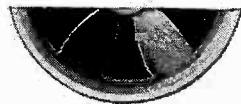

you think

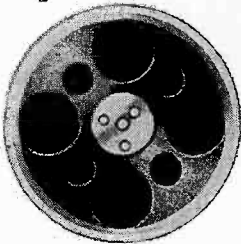

that brands

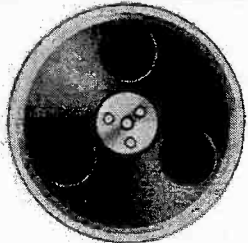

of recording tape

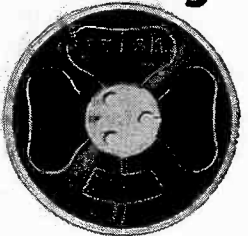

are alike...

try

BRAND
ferro-sheen!

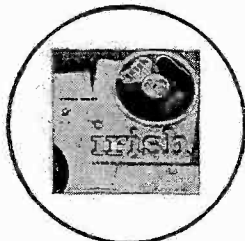

Available wherever quality tape is sold.
ORRadio Industries, Inc., Opelika, Alabama
Export: Morhan Exporting Corp., New York, N.Y.
Canada: Atlas Radio Corp., Ltd., Toronto, Ontario

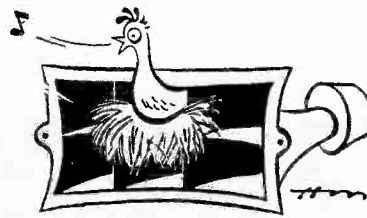

Sound-Fancier

THE steady flow of correspondents' inquiries for lists of technically outstanding demonstration recordings and the "best" choices for a beginning stereo-tape library puzzled me for a time, until it dawned on me that, although I have been making such recommendations in almost every SFG column, published so far, many readers have come in late, or sporadically, and in any case cannot fairly be expected to remember everything published in this column since its debut in the July 1956 issue of AUDIOCRAFT. Occasional reviews or summaries obviously are useful and moreover have the special advantage of embodying the reviewer's reconsidered evaluations. After all, the best proof test of any outstanding recording is not only its ability to impress on a first hearing, but also the effectiveness with which it stands up to further playings.

And, since the fall hi-fi show and audio fair is one when both new converts and veteran sonic *aficionados* are particularly concerned with technical characteristics, both in seeking prime examples of the latest recording triumphs and the severest tests of the exploitable frequency and power ranges of new-model reproducing equipments, the present month is an ideal one for summarizing the past year or two's most notable

achievements. One of the accompanying lists is devoted to LP's exclusively (although a few works are also available in single-channel tape form); while I certainly don't pretend that it contains only unanimously accepted "bests," it does represent the time-tested winnowing of my own demonstration and display favorites. The other list, devoted to stereo tapes, it only incidentally representative of sensationally effective recording (although it does contain some of the finest examples of all), since for this list the primary criterion was all-round musical-plus-technical attractions—as befits the selections which I can most unhesitatingly recommend for the basic nucleus of a stereo-tape collection. Of course, neither list can be claimed to exhaust the likely possibilities. There are many other works which I should have liked to include (and probably some others equally worthy with which I am not yet familiar). But at least I can fairly claim that each selection I have included represents the nearest approach I can make to a sure-fire choice.

Potential Further Candidates

It is only because there has not yet been opportunity for sustained repetitive "time testing" that I have not added several brand-new releases to my favorite

SFG-Recommended Demonstration LP's

(Excluding earlier releases listed in the "Show-Off" Records Chapter of *Building Your Record Library*, Roy H. Hoopes, ed., New York, 1956.) Note: An asterisk following the order number indicates that a single-channel tape version is also available. The date in parentheses refers to the issue of AUDIOCRAFT in which an SFG review appeared.

The Regimental Band and the Massed Pipers of the Scots Guards. Rhodes, dir. Angel 35271 (Jul. 56).

Liszt: *Bénédiction* and *Sonata*. Levy, piano. Unicorn UNLP 1035 (May 57).

British Band Classics. Eastman Symphonic Wind Ensemble; Fennell. Mercury MG 50088 (Aug. 56).

Kodály: *Háry János Suite*. Philharmonic Symphony Orchestra of London; Rodzinski. Westminster W-LAB 7034* (Oct. 56, Aug. 57).

Panorama of Musique Concrète. London/Ducretet-Thompson DTL 930-90 (Apr. 57).

Tchaikovsky: *1812 Overture.* Minneapolis Symphony; Dorati. Mercury MG 50054 (Nov. 56).

Spotlight on Percussion. Goldberg and Clarke. Vox DL 180* (Jul. 56).

Bell, Drum and Cymbal. Saul Goodman. Angel 35269 (Sept. 1956).

Fiesta en España. Salicru and Molero. Audio Fidelity AFLP 1819 (Sept. 57).

Arranged for You. Dean Kincaide. Weathers w-5610 (Sept. 1957).

Check & Double Check. Westminster TRC (Sept. 56).

Adventures in Cacophony. Audio-ophile AP 37 (Mar. 57).

The Compleat in Fidelity. Cook 1044 (Nov. 56).

Guide

by R. D. DARRELL

technically outstanding LP's. Wöldike's Haydn *Military* and *Clock* Symphonies (Vanguard VRS 492) are a sure bet in their matchless combination of musical and technical perfection. While I shall probably rehear them most often in their stereo versions (VRT 3002-3), the LP's lack only the enhanced spaciousness of an airy acoustical framework which is to be achieved in the new medium; otherwise, the disc versions are a sheer joy to one's ears—as well as to one's mind and heart. The *Military* Symphony is particularly interesting in its unexag-

Continued on page 41

SFG-Recommended "First" Stereo-Tape Choices

- Tchaikovsky: *Nutcracker* Ballet. Philharmonic Symphony Orchestra of London; Rodzinski. Sonotape SWB 9003-4 (or, abridged, SWB 9002).
The Orchestra. Special Orchestra; Stokowski. Capitol ZH 8.
 Rachmaninoff: Second Piano Concerto. Entremont/Goehr. Concert Hall CHT BN 19.
 Debussy: Nocturnes. Boston Symphony; Monteux. RCA Victor CCS 12.
 Haydn: *Military* Symphony. Volk-soper Orchestra; Wöldike. Vanguard VRT 3002.
 Handel: *Water Music*. Frankfurt Opera Orchestra; Bamberger. Concert Hall CHT BN 14.
 Handel: *Messiah*—Excerpts. Handel & Haydn Society Chorus & Zim-bler Sinfonietta; Stone. Boston BC 7-9 (via Livingston).
 Saint-Saëns: *Organ* Symphony. Vien-na Philharmonic Symphony Or-chestra; Swarowsky. Urania UST 1201.
 Prokofiev: *Romeo and Juliet*. NBC Symphony; Stokowski. RCA Vic-tor DCS 18.
 Mendelssohn: *Italian* Symphony. Pro-Musica Symphony; Van Remoortel. Phonotapes-Sonore s 705.
 Antheil: *Ballet mécanique*. Los Angeles Ensemble; Craft. Omega-tape ST 6009.
 Offenbach: *Gaité Parisienne*. Boston Pops Orchestra; Fiedler. RCA Victor ECS 15.
 Stereo Alignment. Sonotape SWB AL 101.



THE "Californian" SPEAKER ENCLOSURES

PRE-FINISHED KIT only \$40.50 AUDIOPHILE NET

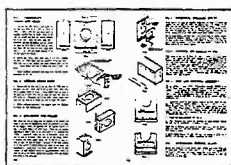

The best looking, best engineered, and easiest-to-build economically priced kit ever offered.

The handsome wood finish of its St. Regis Panelyte top has grain and beauty sealed in. Not even a lighted cigarette can harm it. Users will thrill to the superb tone of Jensen's new Bass Ultraflex[®] design (richness without booming, and without damping the highs). Fully illustrated 4-page manual gives easy-to-follow step by step instructions.

The "Californian" enclosures are available as factory built cabinets or in kits. Top and bottom of kits are all finished — no painting, varnishing, sanding or covering required.

AVAILABLE TWO WAYS	FACTORY BUILT	PRE-FINISHED KITS
The Californian... 24x29x15 inches deep For 12" or 15" speaker AUDIOPHILE NET	DSE-1 \$54.50	DSE-1K \$40.50
The Californian Jr... 19½x23¾x13½ in. deep For 8" or 12" speaker AUDIOPHILE NET	DSE-2 \$44.50	DSE-2K \$32.50
Blonde or mahogany finish, same price *TM of and Lic. by Jensen Mfg. Co.		

ARGOS

PRODUCTS COMPANY

310 MAIN STREET • GENOA, ILLINOIS

Craftsmanship in Cabinets

Ask your Parts Distributor or write Dept. A for FREE Catalog

Artisan CONSOLES

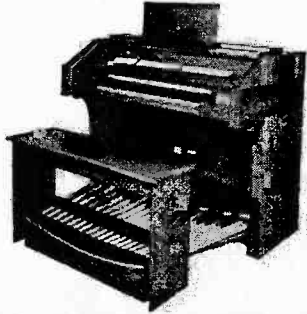

ENTERTAINMENT - CHURCH - CONCERT

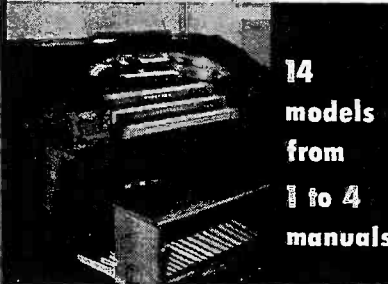

14
models
from
1 to 4
manuals

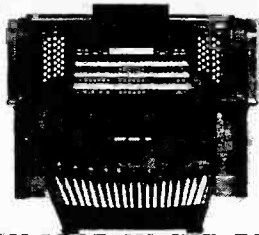

AVAILABLE IN KIT FORM

These magnificent electronic instruments look and sound like giant pipe organs! Exclusive features include independent ranks of tone generators . . . split vibrato . . . dual expression pedals . . . plus many other features.

ELECTRONIC PARTS

FOR ASSEMBLING
NEW ORGANS
FOR AUGMENTING
EXISTING ORGANS
ETCHED CIRCUIT
TONE GENERATORS
AMPLIFIERS
TONE CHANGERS



ATTACHMENTS FOR ANY ORGAN



ELECTRIC
"TOY COUNTERS"
(genuine percussions)

ORCHESTRA
BELLS



ELECTRIC
MARIMBAS

WE SUPPLY EVERYTHING FOR THE ORGAN BUILDER

FOR COMPLETE INFORMATION . . . Catalog and Brochures which illustrate various "Build-It-Yourself Organs" and percussion Kits, including parts lists, prices and additions, conversions and attachments to organs . . . send \$1.00.

ELECTRONIC ORGAN ARTS, INC.

Dept. 22, 4878 Eagle Rock Blvd.
Los Angeles 41, California

ELECTRONIC ORGAN

Continued from page 17

Thérémin. It is a monophonic or pure-melody instrument on which not more than one note can be played at a time. The pitch of the instrument is varied by movements of the player's hand about an upright antenna. The capacitance of one of two superaudio-frequency oscillators is varied by the changes in proximity of the player's hand to the antenna, and the resulting tone is the beat frequency between the outputs of the two superaudio-frequency oscillators.

The principle of operation of the *Ondes musicales* or *Ondes Martenot*, built in 1928 by the French composer Maurice Martenot, is similar to that of the Thérémin. In this case, however, the capacitance of the variable oscillator is controlled by a cord, one end of which is fastened to a ring on the player's finger. The instrument is provided with a kind of manual to indicate the proper placement of the player's

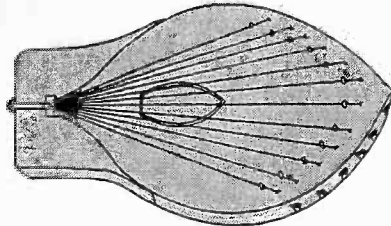

Fig. 4. Sound transducer for the *Ondes musicales*. Strings across face vibrate sympathetically with instrument's tone.

hand for a given note. A key makes it possible to avoid glissando between notes by cutting off the electric current. The *Ondes musicales* can either be played through an ordinary loudspeaker or through a special *diffuseur-resonateur* (Fig. 4), a transducer with taut strings stretched across its face. These strings are tuned to various frequencies.

Several other instruments are related to the *Ondes musicales* in principle. The Hellertion, constructed by Helberger and Lertes of Leipzig in 1930, and the Trautonium, built the same year by Trautwein of Berlin, are close relatives. In 1931, the United States produced the Emicon, the first instrument

of the type having a true keyboard with a separate key for each note. All of these instruments are monophonic.

The Givelet-Coupleux organ, constructed in Paris in 1930, is an instrument suited to the production of chords and polyphony. One of the characteristic features of the Givelet-Coupleux organ is the use of one complete oscillator circuit for each note. The original instrument was provided with two manuals and pedal, with 23 speaking stops.

One of the most widely known "electronic" instruments, the Hammond organ, was invented in 1934 by Laurens Hammond in Chicago. The Hammond is not, strictly speaking, an electronic instrument at all. Its tones are generated by electromagnetic induction. In the interest of simplicity, the Hammond organ and others operating on similar principles are generally referred to as electronic organs.²

The tone-generating system of the Hammond organ (Fig. 5) consists of 91 rotating steel discs. The periphery of each disc is contoured so that, as it rotates close to a magnetized steel bar, the steel rim of the wheel is effectively brought closer to the magnet and then taken further away. As this process occurs, the change in the magnetic field induces a small voltage in the coil of the magnet. The wave form of the voltage is approximately sinusoidal, and the frequency varies in accordance with the number of high spots on the rim of the disc.

Present-Day Instruments

During the late 1930's and early 40's, development of electronic-organ mechanisms proceeded more rapidly. The fruits of this work, coupled with progress made in the field of electronics in general, made possible the less bulky, more nearly perfect instruments that came on the market after World War II. Today, in the United States, there are perhaps seven or eight different makes of electronic organs generally available, with most manufacturers producing several models. These present-day instruments differ from one another in varying degrees, but the main differ-

²The Hammond Organ Company, however, does not apply the term *electronic* to its instruments.

Fig. 5. Simplified drawing of the tone wheel devised by Laurens Hammond in 1934. The Hammond organ is an electromechanical rather than an electronic instrument.

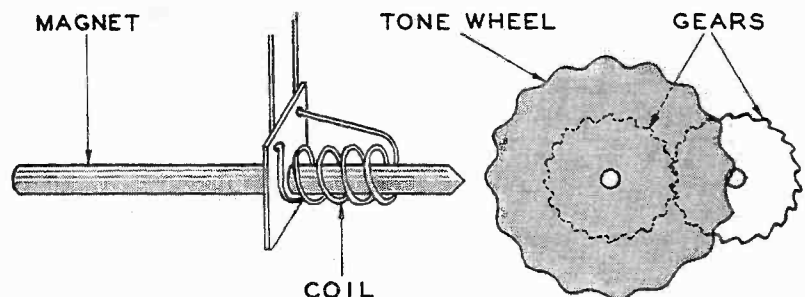

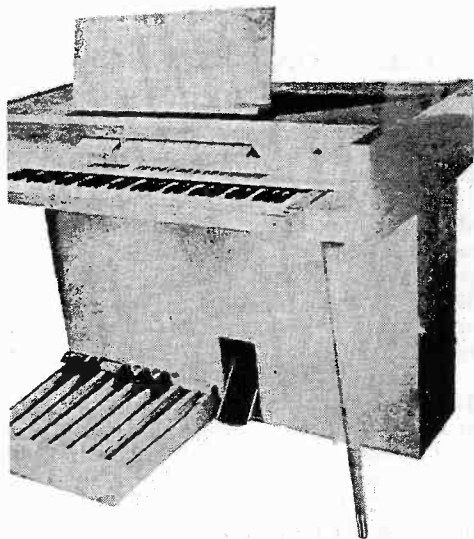

Fig. 6. The Artisan Spinet is a modern electronic organ that can be built from a kit. Complete details about construction of this instrument will be given in later installments of this article.

ence lies in their methods of tone generation. Modern tone generators are refinements of the earlier types mentioned above and, like them, may be classified as being either electromechanical or electronic.

Representative of the electromechanical instrument is today's Hammond organ with its rotating-disc tone-generating system. The Wurlitzer, another electromechanical instrument, uses a different method of tone generation. Its generators are brass reeds which are set vibrating by wind from a fan. The reeds, in conjunction with metal studs mounted above them, act as variable capacitors. The changes in capacitance correspond with the motion of the reeds, so the amplified voltages are replicas of the reed vibrations.

A photoelectric tone generator is employed in a new organ, the Kimball, just introduced this past summer. I learned of the introduction of this instrument only a short time ago and have been unable to get detailed information about it.

Modern electronic tone generators have developed along several different lines. Electronic organs which most successfully imitate true pipe-organ tone use an independent oscillator for each note of the scale. Through the use of independent oscillators, any combination of notes can be played simultaneously, making it possible to employ a large number of couplers and increasing the instrument's tonal potentialities. The cost of this system is understandably great because of the large number of high-quality circuit elements involved. Some commercial instruments utilizing independent oscillators are the Allen, Artisan (Fig. 6), and Conn organs.

Another system of tone generation popular today uses frequency division as

Continued on next page

spectacular...new Tape System Components PENTRON

• STEREO • MONAURAL

Select the Tape units to meet your needs

Pentron combines professional features and custom styling with building-block flexibility. You buy what you want and add to your system when you desire—from the simplest monaural system to the all inclusive stereo systems.

PENTRON LEADERSHIP FEATURES

- Precision made and tested professional head assembly with Azmur-X spring loaded screw adjustment.
- Simple single rotary control.
- Four outputs plus two AC convenience outlets.
- Mounts VERTICALLY, horizontally, or at any angle.
- Speed change lever at front panel.
- Removable pole pieces in heads, as easy to change as a phono needle.
- Automatic self-energizing differential braking.

basic specifications

TM series mechanisms

COMBINATION HEAD:
Frequency response:
40-14,000 cps with proper equalization. Signal-to-Noise: 55 db with CA units.
track width: .093"; gap width: 1.1 mil; impedance of record section: 6000 ohms; inductance of erase section: 60 mh • STACKED HEAD: track width: .080"; gap width: .15 mil; impedance: 3500 ohms • FLUTTER: under 0.4% at 7 1/2 ips; under 1% at 3 1/2 ips. • CAPSTAN DRIVE: Idler driven • MOTOR: 4 pole induction type, individually balanced • OUTPUTS: 4 standard pin jack outputs to accept shielded phono plug • CONVENIENCE OUTLETS: two auxiliary AC outlets controlled by mechanism power switch. Supplied with removable mounting brackets with shock mounts.

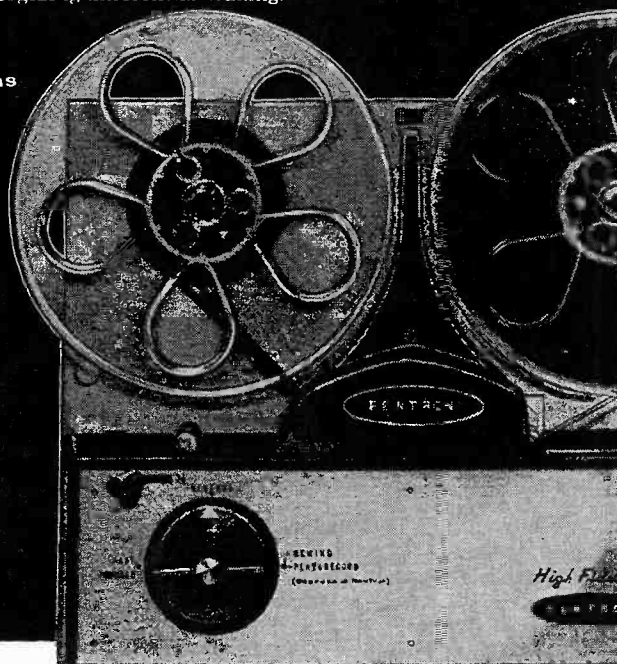

preamplifiers



CA-11

Tape Playback only. Response: 20-20,000 cps. Signal-to-Noise: 55 db



CA-13

Tape playback preamp and record amplifier. Response: 20-20,000 cps. Signal-to-Noise: 55 db



CA-15

Stereo dual channel playback. Response: 20-20,000 cps. Signal-to-Noise: 60 db

ALL CA UNITS HAVE SAME PHYSICAL DIMENSIONS AND REQUIRE SAME CUTOUT.

HEAR PENTAPE RECORDED TAPES—"GREATEST SOUND EVER FOUND"



786 S. Tripp Avenue
Chicago 24, Illinois
Canada: Atlas Radio Ltd. Toronto

Send brochure on tape components

Name _____

Address _____

City & State _____

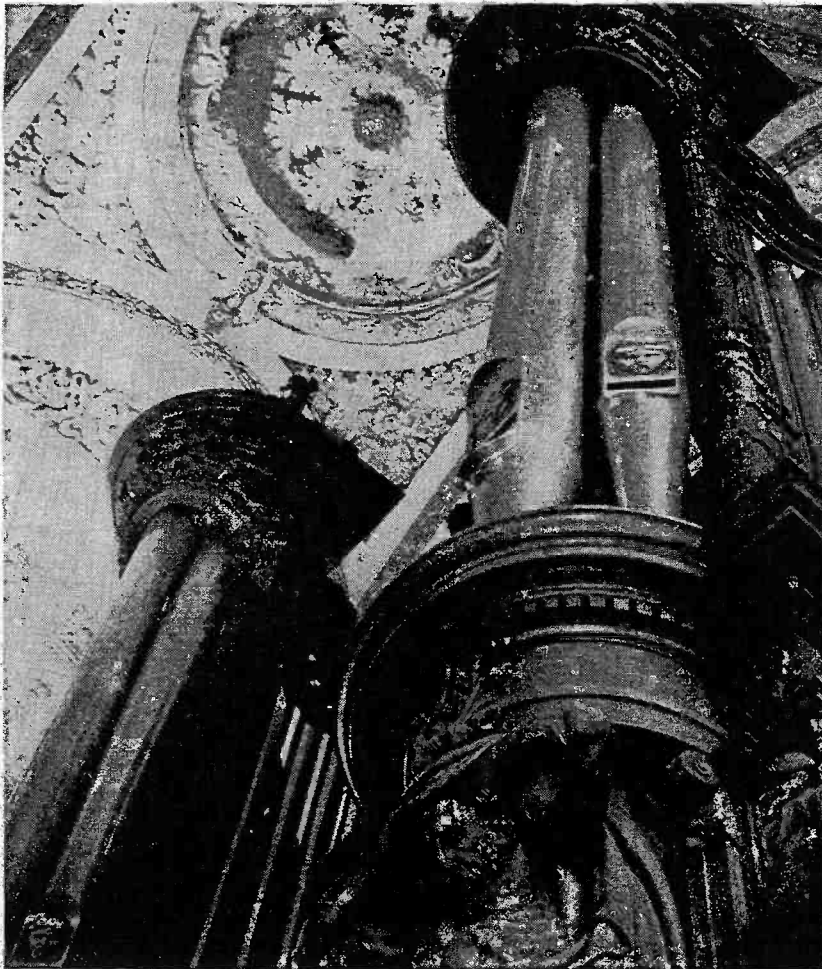

The "King of Instruments"—an Aeolian-Skinner organ installation.

The sound of the organ is one of the most difficult to reproduce, because of its wide tonal and dynamic range, and because of the large amount of fundamental energy that appears at extreme bass frequencies.

At a recent public demonstration, staged by the Audio League at St. Mark's Church, Mt. Kisco, N. Y., the recorded sound of an Aeolian-Skinner organ (from stereo tape) was instantaneously alternated with that of the "live" instrument. The reproducing equipment selected included four AR-1 speaker systems. Here is some of the press comment on the event:

The Saturday Review (David Hebb)

"Competent listeners, with trained professional ears, were fooled into thinking that the live portions were recorded, and vice versa. . . . The extreme low notes were felt, rather than heard; without any 'loudspeaker' sound. . . ."

AUDIO (Julian D. Hirsch)

"Even where differences were detectable at changeover, it was usually not possible to determine which sound was live and which was recorded, without assistance from the signal lights. . . . facsimile recording and reproduction of the pipe organ in its original environment has been accomplished."

audiocraft

"It was such a negligible difference (between live and recorded sound) that, even when it was discerned, it was impossible to tell whether the organ or the sound system was playing!"

The price of an AR-1 two-way speaker system, including cabinet, is \$185.00 in mahogany or birch. Descriptive literature is available on request.

ACOUSTIC RESEARCH, INC. 24 Thorndike St., Cambridge 41, Mass.

ELECTRONIC ORGAN

Continued from preceding page

its basis. By this method, the pitches for the top octave of notes are generated by 12 tuned oscillators; all other pitches are obtained by frequency division. The system is simple and inexpensive, but it cannot produce good ensemble tones. The Baldwin, Minshall, and Lowery are organs employing this type of tone generator.

The shared oscillator, used in the Thomas organ, provides a third method of tone generation by which one oscillator is used to produce more than one note, although not, of course, at the same time. This system greatly reduces the cost of the instrument in which it is employed; its disadvantage is that adjacent or nearly adjacent notes cannot be played simultaneously.

The transistor, too, has found its way into the electronic organ. There is now an instrument manufactured by the Gulbransen Company of Melrose Park, Illinois, that uses transistor oscillators. Unfortunately, I have no additional information about it, but it appears, certainly, that a transistorized instrument could have many advantages over one employing vacuum tubes.

Although the electronic musical instrument is still technically in its infancy, even its severest critics will admit that it has made a place for itself in today's musical world. Its possibilities for further development in the future are practically unlimited.

So much for electronic instruments in general. Next month we'll get down to cases with an examination of the Artisan Spinet in particular. We'll see how it works and find out just how much of a job it is to put a small electronic organ together from a kit.



TRANSISTORS

Continued from page 19

them to transistor input stages." Because of the high impedances required, vacuum tubes are much better equipped for this job.

Dynamic mikes: here the advantages of transistors show up. Not only is a

costly input transformer eliminated (as compared with vacuum-tube amplifiers), but less noise can be expected.

There are no particular problems in coupling dynamic microphones of 150 or 50 ohms impedance to transistor amplifiers. The simplest circuit (Fig. 6) is perfectly satisfactory. The loss due to mismatch is slight, and the frequency

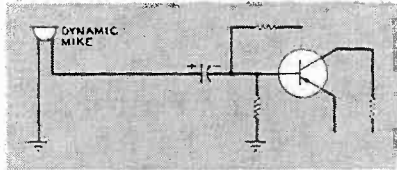

Fig. 6. Simple circuit for coupling a dynamic mike to a transistor amplifier.

discrimination produced by the difference between the nominal impedance and the input impedance is small.

The same ease of coupling is obtained with other low-impedance microphones. For example, in intercom systems a small loudspeaker is usually employed as the microphone. The input transformer ordinarily used can be eliminated by resorting to the circuit in Fig. 6, replacing the dynamic mike by the new transducer.

Ribbon microphones work with the same input circuit.

Similarly, a pair of magnetic earphones can be coupled as a microphone with the same type of input circuit, although of course the sound quality will be poor. The many types of magnetic contact microphones can be handled in the same way. But here there is an equalization problem, similar to that for a magnetic phono cartridge.

Carbon mikes: a carbon microphone has, in effect, a built-in amplifier, so it needs some driving power and puts out a rather high signal. Better over-all results can be achieved with a dynamic mike and one stage of amplification using a transistor: better fidelity, less noise, and less battery drain. However, for those who want to use a carbon mike, Fig. 7 offers one coupling solution.

The single-button mike has for its load a potentiometer which serves as a

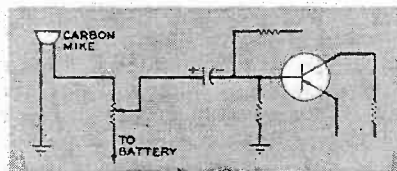

Fig. 7. Possible solution to coupling problem when using a carbon mike.

volume control. The DC biases for the mike and the transistor are different, and are isolated from each other by the capacitor.

Another interesting possibility for a single-button mike is to bias it with the

Continued on next page

OUTPERFORMS THEM ALL!

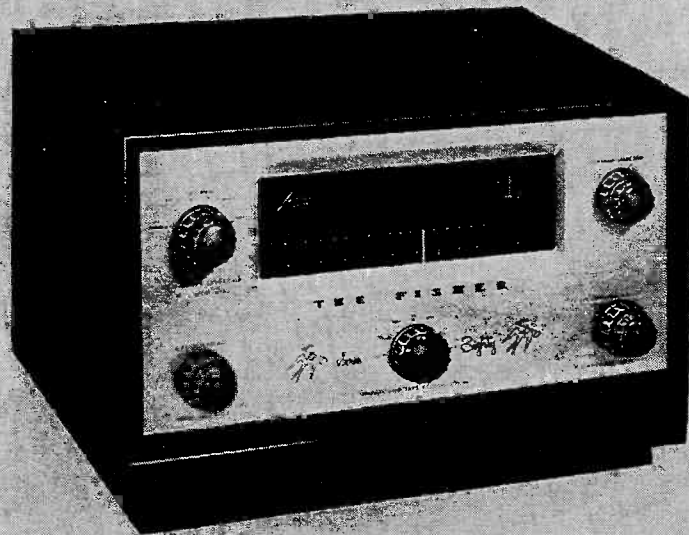

THE FISHER FM-AM Tuner Model 80-T

The TWO meters of THE FISHER 80-T (for micro-accurate tuning) are typical of the outstanding specifications that have won its acclaim as today's most advanced, professional tuner. The 80T includes complete audio controls. The roster of those who use THE FISHER includes leading organizations in research, broadcasting and educational fields. THE 80-T provides a level of performance that far exceeds even their most critical specifications. These same high standards of performance, together with the uncompromising quality of workmanship for which THE FISHER is famous, are available to you, for use in your own home. Hear it now, at your dealer's!

\$19950

Mahogany or Blonde Cabinet, \$17.95

Outstanding Features of THE FISHER Model 80-T

- The Model 80-T features extreme FM sensitivity—1.5 micro-volts for 20 db of quieting.
- Full limiting on signals as low as one microvolt. ■ Separate FM and AM front ends, completely shielded and shock-mounted. ■ Separate tuning meters for FM and AM.
- 72-ohm, plus exclusive balanced, 300-ohm antenna inputs for increased signal-to-noise ratio. ■ Supplied with AM loop and FM dipole antennas. ■ Adjustable AM selectivity.
- AM sensitivity better than one microvolt for full output. ■ Inherent hum non-measurable.
- Distortion below 0.04% for 1 volt output. ■ Four inputs. ■ Separate tape-head playback preamplifier (with NARTB equalization.) ■ Preamplifier-Equalizer has sufficient gain to operate lowest level magnetic cartridges. ■ Six choices of record equalization. ■ Multiplex and cathode follower outputs. Frequency response, on FM, within 0.5 db, 20 to 20,000 cycles. ■ Super-smooth flywheel tuning mechanism. ■ 16 tubes. ■ EIGHT CONTROLS: Selector, Variable AFC/Line Switch, Station Selector, Bass, Treble, Equalization, Volume, 4-Position Loudness Contour. ■ Self-powered. ■ DC on all audio filaments. ■ Beautiful brushed-brass front panel. ■ SIZE: 12¾" wide x 8¾" deep x 6" high. ■ WEIGHT: 21 pounds.

Prices Slightly Higher in the Far West



Write today for complete specifications.

FISHER RADIO

Corporation 21-31 44th Drive, L. I. City 1, N. Y.



TRANSISTORS

Continued from preceding page

emitter current, using a grounded-base amplifier. Fig. 8 shows the circuit.

It is also possible, because of the large output from the carbon mike, to use the same sort of circuit with a power transistor, feeding the base circuit directly. Double-button mikes can be used this way to drive push-pull power stages.

Condenser mikes: the best advice on condenser microphones, as for crystal microphones, is not to use transistor input stages. The problems with a con-

denser mike are even more difficult. For reasonable low-frequency response, the microphone must work into a resistance upward of 10 megohms—well nigh impossible with present transistors. If a high enough series resistor is put in the circuit, the noise problem will be severe, and the frequency response will suffer if

Fig. 8. An alternative coupling method for use with a single-button microphone.

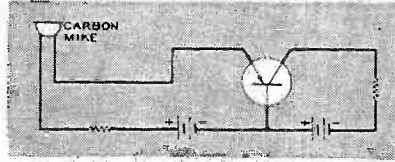

AMPEX STEREO

SIGNATURE OF PERFECTION IN SOUND

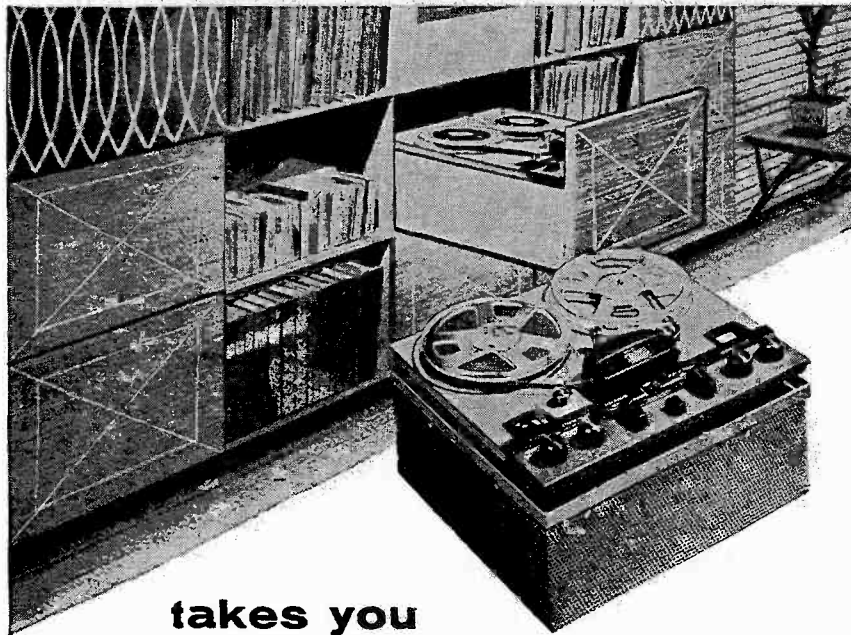

takes you BEYOND THE HI-FI BARRIER!

Add Ampex Stereo to your system, and you've pierced the last barrier that stands between you and the long-sought goal of actually experiencing the complete realism of the original performance. Hear it once, and you'll never be satisfied with anything less.

Ampex is most-wanted because it is best-engineered. You can install this precision tape-deck in the secure knowledge that it is not only the finest equipment available today, but years from now will still be outperforming everything in the field.

In addition to the Ampex Model A124-U recorder-stereophonic reproducer shown here, there are portables, modular units, and consoles complete with their own AM-FM tuners and record changers.

AMPEX

CREATORS OF THE VIDEOTAPE TELEVISION RECORDER; MAKERS OF AMERICA'S BEST-ENGINEERED, MOST-WANTED AUDIO EQUIPMENT



AMPEX AUDIO INC.
1038 KIFER ROAD, SUNNYVALE, CALIFORNIA
Please rush free Ampex Stereophonic Sound brochure to:

NAME _____
ADDRESS _____
CITY _____

this is not done. In short, for good results use a vacuum-tube amplifier here.

Often condenser microphones are supplied with an amplifier which has an output impedance of 50 or 150 ohms, and which can be used with input circuits designed for dynamic microphones. In this case, the same considerations hold as for dynamic microphones; do not hesitate to use transistors to advantage.

SWITCHING SYSTEM

Continued from page 20

put jack on my control amplifier was already insulated from the rear panel, as is the case in many such units. The manufacturer minimizes hum by finding a more suitable ground point, usually close to the first stage of the preamplifier. In the drawing the ground point is labeled A. The original ground connection between the phono input jack and point A was removed and routed to the ground terminal of the new phono jack designated for connection to the input of the ESL transformer. This terminal was then connected to point A. Had the original ground connection been retained as well, a very pronounced ground loop would have been formed.

As the illustration shows, both windings of the ESL transformer are grounded inside the box on which the transformer is mounted. To prevent a ground loop, it is therefore important not to make a connection between the ground terminals of the jacks to which the transformer is connected.

Since the ESL transformer has a phono jack at the input, it is necessary to make up a shielded cable with a phono plug at each end to connect this input to the proper control amplifier jack (upper jack, center, in the drawing on page 20). Output of the transformer is carried by a shielded cable with a phono plug already attached, which can be inserted into the appropriate control amplifier jack (lower jack, center). Transformers for other low-level cartridges have different connections, but the input and output circuits should be treated in the same way.

It can readily be seen that, when the switch is thrown to the right, the signal from the phono cartridge is fed by the upper part of the switch to the input of the transformer; and the amplified signal from the transformer is fed by the lower

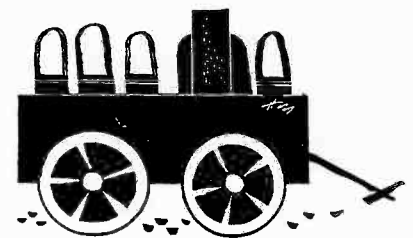

arm to the grid of the phono preamplifier tube. When the switch is thrown to the left, the signal from the cartridge goes directly to the tube grid.

As a final note, it should be pointed out that readers using the ESL 301F transformer should provide a load resistor of 1.5 K in order to obtain relatively flat bass response. Although as much as 6 db more output can be obtained by working into higher loads, this advantage is purchased at the cost of reduced response in the region of 50 cps. You can easily mount the 1.5-K load resistor, as I did, in the box that supports the transformer. This permits the required load resistor for the cartridge used with 78 records to be mounted at the grid of the phono preamplifier tube. The latter resistor is ordinarily of much higher value, usually in the range of 27 K to 100 K, and therefore does not significantly affect the load upon the secondary of the ESL transformer. Another alternative is to solder the load resistor for the 78 cartridge directly across the terminals of this cartridge. Such soldering should be done quickly with a very small soldering iron to avoid possible damage to the cartridge; a pliers should be held to the work as a heat shunt.

TEST INSTRUMENTS

Continued from page 24

the modulation on, it is connected to the input of the last IF or limiter amplifier. The scope is connected directly across the discriminator load, and the transformer secondary and primary are adjusted for maximum, repeated a couple of times. When the alignment is completed, the receiver is put back into service by restoring the discriminator, oscillator and AVC circuits to normal.

When working on high-impedance or high-frequency circuits, it is often neces-

Courtesy Heath Company

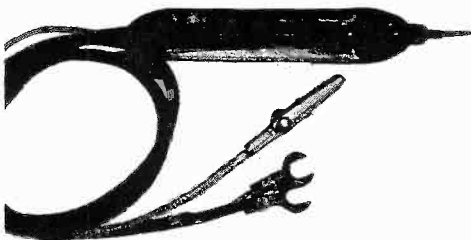

Fig. 5. The Heathkit demodulator probe.

sary to observe the precaution of using some isolation in the form of a resistor or capacitor in the scope input lead. While a shielded lead is often necessary to avoid stray pickup, it has the disadvantage of adding considerable capacitance across the circuit under observation.

If the input resistance or capacitance

Continued on next page

THIS IS THE WAY
A GREAT TAPE RECORDER
IS
BUILT

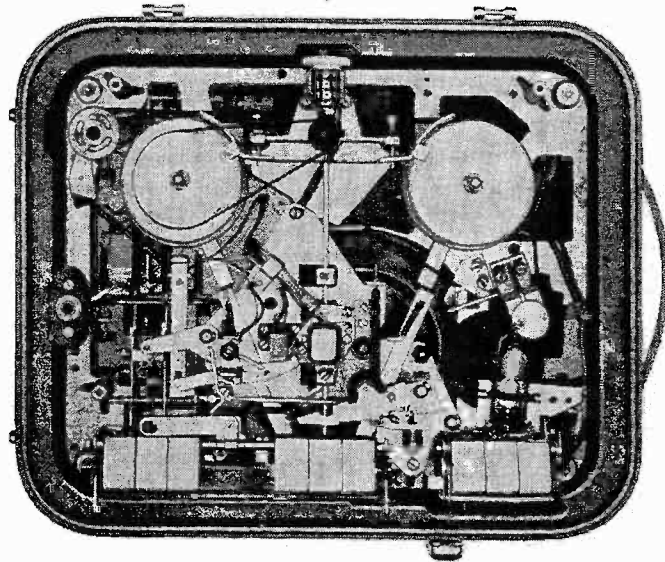

the new imported

NORELCO® 'CONTINENTAL'

the
world's
most
advanced
all-in-one
portable
RECORDER

- engineered by Philips of the Netherlands, world pioneers in electronic design
- precision-crafted by Dutch master technicians
- styled by the Continent's top designers
- three speeds (7½, 3¾, and 1⅞ ips) . . . twin tracks . . . pushbutton-controlled
- special narrow-gap (0.0002 in.) magnetic head for extended frequency response
- built-in wide-range Norelco speaker
- lightweight . . . easily portable . . . rugged
- can also be played through external hi-fi system

For the name
and address
of your nearest
Norelco dealer,
write to

NORTH AMERICAN PHILIPS CO., INC.
High Fidelity Products Division
230 DUFFY AVENUE
HICKSVILLE, L. I., N. Y.



COMPONENTS



JUNIOR and DUO-SPEED
TURNTABLES ARE...

DOWN

65 DB

(SIGNAL TO NOISE RATIO)

TODAY

DOWN

65 DB

TOMORROW

DOWN

65 DB

NEXT YEAR

AND

BELT DRIVE

DOES IT!



JUNIOR,
\$39.50

DUO-SPEED,
\$49.50

COMPONENTS
CORPORATION

DENVILLE, NEW JERSEY

Department JD3

P.S. High Fidelity May TITH says, "The Duo-Speed's performance in the rumble, flutter, wow department is superb."

TEST INSTRUMENTS

Continued from preceding page

of the scope circuit has a tendency to act as a shunt to the circuit being tested, detuning may result, and false indications will be given by the test instruments. The best way around these problems, as well as a means of increasing the over-all usefulness of the scope, is through the use of a demodulator probe.

With its own demodulator, the scope can go anywhere, not being limited to working at a point following the detector in a set. It will show the modulation envelopes and over-all bandpass characteristics at any point in the RF or IF circuits, and can also be used as a signal tracer or gain analyzer.

The detector in a typical demodulator probe is a crystal diode, mounted on an etched circuit board for minimum ca-

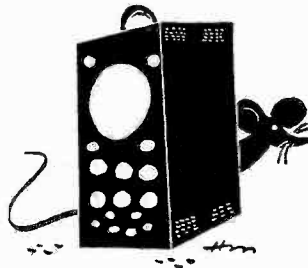

pacitance. All components are shielded by a metal probe housing, which is grounded to prevent hand capacitance effects from causing deflection of the scope trace. A photo of such a probe is shown in Fig. 5.

Next in this series will be a discussion of RF generators, and their applications in hi-fi audio work.

GROUNDING EAR

Continued from page 5

Williamson-type amplifiers to new front-end circuitry. I have just learned that the Dyna Company, 617 North 41st Street Philadelphia 4, will supply, for \$10, a preassembled printed-circuit board which contains all the components for the front end of the Dynakit Mark II and the socket for the 6AN8 tube. Use of this assembly would greatly simplify such conversion, and also, of course, the building of entirely new amplifiers. Assembly requires cutting a single square hole and making only a few connections to the output tubes and the power supply. This conversion ought to result

The regular feature, "Tape News & Views," does not appear this month because J. Gordon Holt has been on vacation. Mr. Holt's column will be back in AUDIOCRAFT in November.

NEW—

from the leader in sound...

CAPITOL STEREO TAPE!

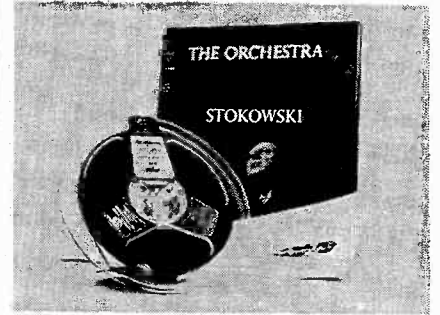

LEOPOLD STOKOWSKI:
The Orchestra

Mr. Stokowski conducts eight works featuring the sections of the orchestra, alone and in combination. Astonishing orchestral sound in breathtaking stereo. Full-color booklet. (ZH-8)

Other "Full Dimensional Sound" Stereo Releases

ROGER WAGNER CHORALE:
House of the Lord (ZF-9)

WM. STEINBERG, PITTSBURGH SYMPHONY:

Toch: Third Symphony (ZF-7)

HOLLYWOOD BOWL SYMPHONY ORCHESTRA:

L'Italia (ZF-3)

Gypsy (ZF-6)

Symphonic Dances (ZF-5)

Bolero & Capriccio Espagnol (ZF-4)

'A STUDY IN STEREO'

A breathtaking showcase of stereo's vast range featuring Capitol's big-name artists. (ZH-2)

'INTRO TO STEREO'

A narrated journey through the wonders of stereo — music and real-life sounds. (ZA-1)

Top Stars in Stereo

NAT "KING" COLE:
Love is the Thing (ZD-11)

KENTON IN HI-FI (ZD-10)

GEORGE SHEARING: *Black Satin* (ZC-13)

FRED WARING & THE PENNSYLVANIANS
IN HI-FI (ZD-12)



2 CHANNEL — 7½ IPS — FOR IN-LINE HEADS

AUDIOCRAFT MAGAZINE

in greater stability, particularly a cleaner low end and freedom from high-frequency ringing. However, it is not an operation which should be undertaken

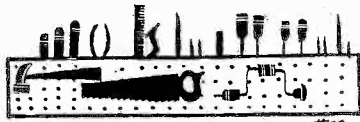

by the inexperienced. The feedback loop will require readjustments for which no one can give instructions except in the most general terms. But those who have sufficient knowledge to make this and the other readjustments of circuit and parameters which would be required, should find the assembly a great time and money saver.

SOUND FANCIER

Continued from page 33

gerated treatment of the Turkish-music episodes for percussion: at first hearing, less sensational than in the famous Scherchen-Westminster versions, but on consideration, obviously better proportioned to the work as a whole as well as more authentically close to what one hears in a live concert-hall performance, where the percussion is not spotlighted in front of the rest of the orchestra, but is heard — with no loss of crispness or brilliance — well in back of the other choirs.

I was especially anxious to hear the *Hi-Fi Fiedler* (RCA Victor LM 2100) program of Rimsky's *Coq d'Or* Suite, Rossini's *William Tell* Overture, and Tchaikovsky's *Marche slave*, since I had been informed (when asked to write the liner notes) that the RCA Victor

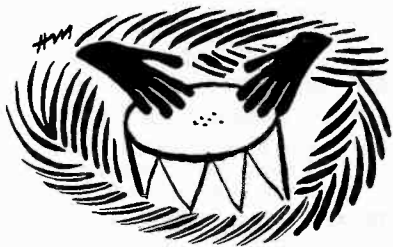

engineers themselves believed these recordings to represent their finest current standards. From that, I had naturally expected something out of the ordinary (which the engineering here certainly is), but I hadn't been prepared for the rigorous refusal to exploit the obvious possibilities of display sensationalism. The music here of course possesses wider dynamic and coloristic qualities than the Haydn symphonies above, yet for all its blazing brilliance the recording proves primarily impressive for the crystalline purity with which it transmits naturally balanced concert-hall sonorities, all the

Continued on next page

Look over the BEST BUYS in HI-FI ... from EICO®

HF60, HF50

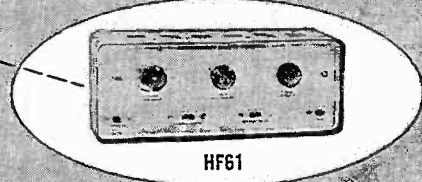
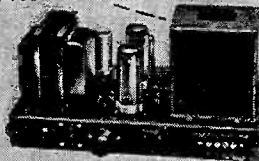

HF61

HF20

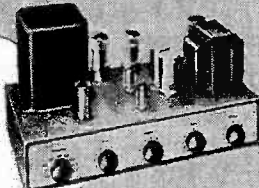

HF52

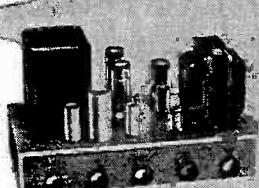

HF12

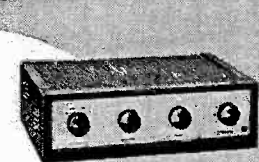

HF51

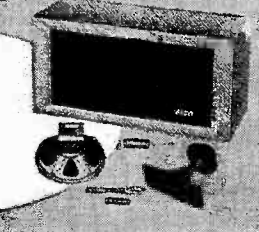

EICO is a pioneer (1945) in kit test equipment — leads the industry in distributor sales to trained and critical users.

EICO has achieved this acceptance because

- EICO engineering policy is to stress electrical and mechanical quality, soundness and functional completeness.
- EICO prices are low because they are justly related to costs and geared for volume sales.

The same engineering and price policy underlies all EICO high fidelity equipment. You can examine and compare EICO at any of the 1200 neighborhood distributors and hi-fi specialists throughout the U.S. Judge EICO's claims for yourself before you buy.

Write for FREE Catalog AC-10.

HF61 Master Control PREAMPLIFIER

KIT \$24.95 WIRED \$37.95
with Power Supply: KIT \$29.95 WIRED \$44.95

Does not add distortion or detract from wideband or transient response of finest power amplifiers at any control settings. High-quality feedback circuitry throughout & most complete control & switching facilities. Feedback scratch & rumble filters, equalizations, tone controls. Centralab Senior "Compentrol" loudness control, concentric level control. 4 hi-level, 2 lo-level switched inputs. Extremely flat wideband freq resp: ± 0.5 db 12-50,000 cps. Extremely sensitive. Negligible hum, noise, harmonic or IM distortion. 4-7/8" x 12-5/16" x 4-7/8". 8 lbs.

HF60 60-WATT Ultra-Linear POWER AMPLIFIER with ACRO TD-330 Output Transformer

KIT \$72.95 WIRED \$99.95

EF86 volt ampl direct-coupled to 6SN7GTB K-coupled phase inverter driving two U/L-connected p-p EL34 output tubes. GZ34 extra-rugged rectifier. Rated output: 60 w (130 w pk). IM Distortion: less than 1% at 60 w; 0.5% at 50 w. Harmonic Distortion: less than 0.5% from 20-20,000 cps within 1 db of rated power. Sine Freq. Resp: at 1 w: ± 0.1 db 15-35,000 cps at any level from 1 mw to rated power. Square Wave Resp: excellent 20-25,000 cps; 3 usec rise-time; Sens: 0.52 v for 60 w. 7" x 14" x 8". 30 lbs. Matching Cover E-2, \$4.50.

HF50 50-WATT Ultra-Linear POWER AMPLIFIER

KIT \$57.95 WIRED \$87.95

Extremely high quality output transformer with extensively interleaved windings, 4, 8, and 16-ohm speaker taps, grain-oriented steel, fully potted in seamless steel case. All other specs equivalent to HF60 but on 50 w level. Matching cover E-2, \$4.50.

HF20 20-WATT Ultra-Linear Williamson-type INTEGRATED AMPLIFIER complete with Preamplifier, Equalizer & Control Section

KIT \$49.95 WIRED \$79.95

Sets a new standard of performance at the price, kit or wired. Rated Power Output: 20 w (34 w peak). IM Distortion: 1.3%. Max Harmonic Distortion: below 1%, 20-20,000 cps. within 1 db of 20 w. Power Resp (20 w): ± 0.5 db 20-20,000 cps; Freq Resp (1/4 w): ± 0.5 db 13-35,000 cps. 5 feedback equalizations. Low-distortion feedback tone controls. 4 hi-level & 2 lo-level inputs. Conservatively rated, fully potted output transformer; grain-oriented steel, interleaved windings. 8 1/2" x 15" x 10". 24 lbs. Matching Cover E-1, \$4.50.

HF52 50-WATT Ultra-Linear INTEGRATED AMPLIFIER complete with Preamplifier, Equalizer & Control Section

KIT \$69.95 WIRED \$109.95

Power amplifier section essentially identical to HF50, including output transformer, GZ34 rectifier, etc. Includes all-feedback equalizations (5 pos.) & tone controls. Centralab loudness control & separate level control that does not affect response at any setting. Cathode follower output to tape. Correct input loading for new ceramics. Zero cross-talk Biamplification input & output facilities. 8 1/2" x 15" x 10". Matching Cover E-1, \$4.50.

HF12 12-WATT Williamson-type INTEGRATED AMPLIFIER KIT \$34.95 WIRED \$57.95

Complete with Preamplifier, Equalizer & Control Section. Equalized direct tape head & magnetic phono inputs. Power Output: 12 w cont., 25 w pk. IM Dist.: 1.3% @ 12 w. Freq. Resp.: 1 w: ± 0.5 db 12-75,000 cps; 12 w: ± 0.5 db 25-20,000 cps. 2-EL84, 3-ECC83/12AX7, 1-EZ81.

HF51 TWO-WAY SPEAKER SYSTEM \$39.95 complete with FACTORY-BUILT CABINET

Jensen heavy-duty 8" woofer & matching Jensen compression-driver exponential horn tweeter. Smooth clean bass & crisp, extended natural highs. Overall response: ± 6 db 70-12,000 cps. Power-handling capacity: 25 w. Impedance: 8 ohms. Bookshelf size: 23" x 11" x 9". 25 lbs. Wiring Time: 15 min.

EICO® 33-00 Northern Blvd., L.I.C. 1, N.Y. AC-10
Please send FREE catalog & name of neighborhood distributor or hi-fi specialist.

NAME.....
ADDRESS.....
CITY.....ZONE.....STATE.....
Prices 5% higher on West Coast

*we are
ashamed*

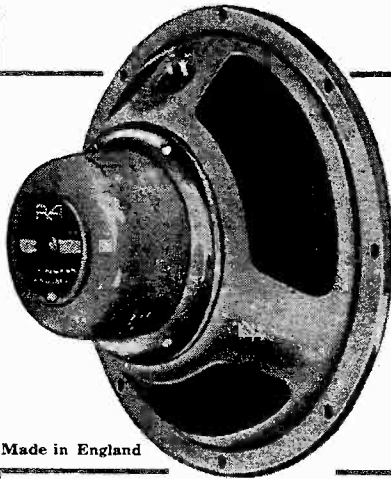

Made in England

*to mention
the price!*

New  Coaxial 700 Series Mark III

Some manufacturers are ashamed to mention the price because it is so high . . . we hesitate because it is so low! We know that most Audiophiles feel they have to make a big investment to get a quality speaker. They spend hours reading claims that look impressive on paper but fall down severely when translated into actual performance. All we ask is that you close your eyes and listen to the majesty of sound that floats out of the R & A coaxial phenomenon. Compare it with others . . . or your present speaker. Your eyes will pop when your dealer whispers the price to you—less than the cost of 2 good seats at the Met!

8" x 10" and 12" models— all with Alcomax III Aniso-tropic Magnet systems of 12,000 Gauss Flux Densities.

Buy it . . . try it . . . we back our claims with a money back guarantee. At hi-fi dealers everywhere!

ERCONA CORPORATION

(Electronic Div.)

551 Fifth Ave., Dept. 3, New York, N. Y.
In Canada: Astral Electric Co. Ltd.
44 Danforth Road, Toronto 13

SOUND FANCIER

Continued from preceding page

way from the most powerful climaxes right down to the most delicate pianissimo details. These works, too, are also available in stereo (CCS 40 and BCS 41) and of course are even more wide-canvassed aurally there—yet, like the Haydn symphonies, scarcely more lucid or sonically true to the scores themselves.

Two other superb examples of the present-day ideal in recording—pellucid authenticity to the original sonic blends and contrasts—are the set of four Haydn Piano Sonatas by Ernst Levy on Unicorn UNLP 1036 and the *Music of Bali* by the Pliatan Gamelan Orchestra on Westminster XWN 2209 (two 12-inch). The wondrously bright and "ringing" piano tone in the former is as much of an aural delight as that of Levy's early Kresge Auditorium Liszt and Beethoven recordings; and in some ways this disc is even more impressive for its sense of dramatic power held in reserve rather than fully exploited. Here, too, much to my surprise, Levy's readings strike me as less pretentious and mannered—indeed, ideally suited to Haydn's quirky humor and eloquent songfulness, as well as to his bolder flights of harmonic and archetectonic daring. The Balinese album is also notable for the restraint and tastefulness with which it encompasses the wide range of gamelan dynamics and timbres from the wildest chattering and jangling to the coolest glassy tinkles. Musically it is more varied than most previous Balinese releases and, although some of the pieces may seem interminable to some occidental ears, those of the true sound fancier will be fascinated throughout—and not least by the strange, quite *musique-concrète* effects in the incantatory *Kèchak* for unaccompanied male chorus.

Contrasting Hi-Fi Approaches

It may be easier to appreciate just what is being attempted in these latest refine-

**DON'T DRIVE YOUR
CAR LIKE A TANK**

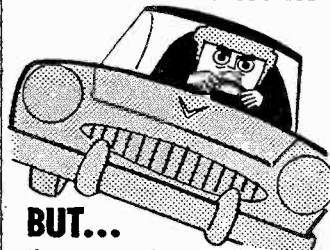

BUT...

If you want to drive a tank join the
NATIONAL GUARD

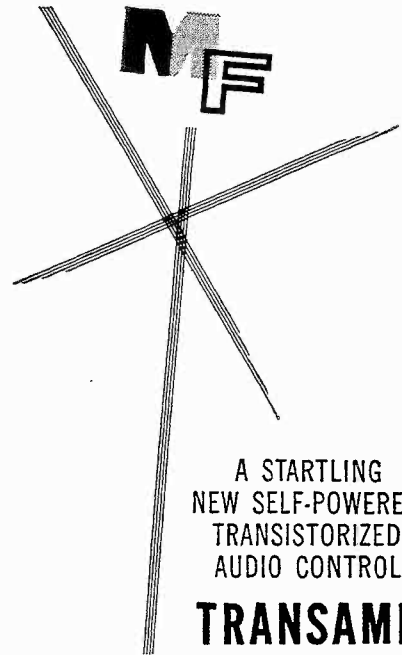

A STARTLING NEW SELF-POWERED TRANSISTORIZED AUDIO CONTROL TRANSAMP

MADISON FIELDING PRE-AMPLIFIER PR-45



\$69.95

ALL-TRANSISTOR FRONT END

Completely eliminates HUM and MICROPHONICS.

MATCHED FUNCTION OUTPUT CONTROL

Selects either 1 or 3-volt output for best Signal-to-Noise Ratio when used with ANY BASIC AMPLIFIER regardless of rated output or sensitivity.

MINIATURIZED CHASSIS

Measures only 8" by 5 1/4" x 2 3/4" with completely separate power-supply.

CHECK THESE FEATURES

HUM—Non-Measurable.

NOISE—Non-Measurable in 1-volt position.

GAIN— 10 mv in phono for 3 volts at 1000 cps.
100 mv in tape and tuner positions for 3 volts output.
300 mv in Aux position for 3 volts output.

FREQUENCY RESPONSE—Plus or Minus 0.25 db, 20 tp 20,000 cycles.

FILTERING—Rumble and Noise Filters with 12/db octave slope. Rumble: 50 and 100 cycles; Noise: 4 and 8 kilocycles.

TONE CONTROLS—Variable crossover feedback type.

DISTORTION—For 1 volt output; in the order of 0.2%

LOW IMPEDANCE OUTPUT

EQUALIZATION—RIAA in phono, with settings for LP, AES, and EUR. NARTB 7 1/2" per second tape playback characteristics.

For complete catalog see your local dealer or write

MADISON FIELDING CORPORATION
Creators of Distinctive Audio Instruments

863 Madison Street, Brooklyn 21, New York

ments (perhaps even more than developments) of high-fidelity techniques if one retraces some of the paths broken earlier. Listen first, for example, to the Camden LP reprint (CAL 352) of Toscanini's Beethoven Seventh Symphony which in its original 1936 78's (RCA Victor M 317) was considered an outstanding recording of its time. Passing over the fact that as a performance it still remains unsurpassed (although in one minority view it seems more vehement than even the inexhaustible vitality of the music demands), it still has its definite excitements—yet for all its strength, how bodiless and "juiceless" tonally it now sounds!

Then hear the *Hi-Fi Feast for Orchestra* (Westminster XWN 18451), which reprints two 1955 display programs by Quadri originally issued on W-LAB 7004 and 7009 (and in part on Sonotape SW 1005 and 1020). Throughout, this is a spectacular demonstration of hi-fi's tremendously expanded frequency and dynamic ranges, but a considerable part of its effectiveness stems from a close-up prominence of percussion, brass, and other spotlighted solo parts, marvelously dramatic and undistorted, but quite unlike what one is ever likely to hear even in the front-row seats of an actual concert hall. Add to this Quadri's interpretative mannerisms and strange tempo choices and one has almost a hi-fi parody

of the Dukas *Apprenti sorcier* and Saint-Saëns *Danse macabre*, for examples. Some of the other pieces in this extensive program (notably the Chabrier *Marche joyeuse* and *Revueltas Sensemaya* and *Cuaubnahuac*) come off more successfully. Yet while the crispness of the transients throughout makes this an audiophile's delight, more musically discriminating listeners will realize (today more easily than a couple of years ago)



that such engineering triumphs have been won only at the high cost of a loss in auditorium authenticity and aesthetic equilibrium.

But at least this is fine *sound*, whereas Markevitch's highly publicized first American recording—the Brahms First Symphony with the Symphony of the Air (Decca DL 9907)—pleases me neither sonically nor musically. My finding the reading so torpid and ponderous may be discounted as an idiosyncratic prejudice (although I've vastly admired Markevitch's conducting of other, modern works for which I feel he is

Continued on next page

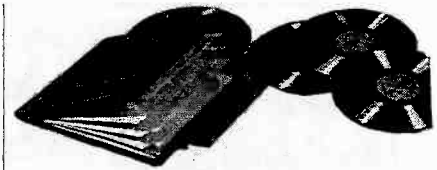

If you are interested in CONTEMPORARY MUSIC

... or would like
to learn about it—

Enjoy finest Contemporary music at its high-fidelity best . . . brilliantly played by one of the nation's outstanding symphony orchestras . . . flawlessly recorded by Columbia Masterworks . . . and interpreted as *the composer intended*.

This is a rare opportunity to possess exclusive **FIRST EDITION RECORDS**—first recordings of newly commissioned works by leading composers, played superbly by the renowned

LOUISVILLE ORCHESTRA

Robert Whitney, Conductor

These "collector's item" recordings are available for a limited time, *from the Society only*. They are a priceless collection of new, exciting music . . . the finest expressions of living composers the world over.

"Splendid sound".

Cleveland Plain Dealer

"... a service to music unequalled".

Christian Science Monitor

"... the reproduction is a model of clarity".

St. Louis Globe-Democrat

"... recording and performances, excellent".

Pittsburgh Post-Gazette

"... quality higher than critics dared hope".

Time Magazine

In addition to their musical brilliance and technical perfection, First Edition Records give you the satisfaction of establishing yourself as a patron of today's finest music. The Louisville Philharmonic Society is a non-profit organization . . . income from record sales is used in the commissioning of still further works.

● ● ● SEND TODAY FOR ● ● ●
INFORMATION ON FREE TRIAL RECORD

LOUISVILLE PHILHARMONIC SOCIETY
Dept. D-6, 830 S. Fourth St., Louisville 3, Ky.

Please send me free, complete information on exclusive First Edition Records and free record offer.

Name _____

Address _____

City _____ State _____

GRAY'S NEW "MICRO-BALANCED" DUAL VISCOUS-DAMPED HIGH FIDELITY TONE ARM

... guarantees maximum tracking stability, because of sealed viscous-damping on *BOTH* vertical and horizontal pivots, and complete static balance around the vertical pivot.

The Gray "Micro-Balanced" arm offers a maximum of compliance and responsiveness with all popular cartridges, that is beyond the experience of most High Fidelity enthusiasts. For details, please write.

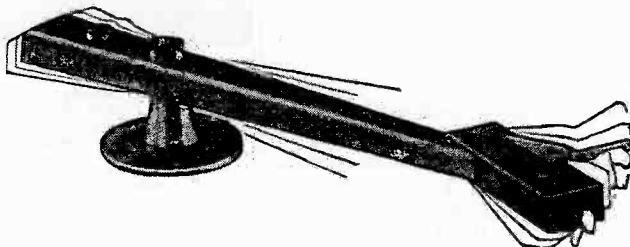

THE GRAY MANUFACTURING CO.
ARBOR STREET • HARTFORD, CONN.

IMMEDIATE DELIVERY!

The NEW
DYNAKIT

Mark III

60 WATT POWER AMPLIFIER KIT



\$79⁹⁵

when ordered by mail

NEW PRE-AMPLIFIER KIT



\$34⁹⁵

when ordered by mail

HI-FI COMPONENTS EXCLUSIVELY

HOLLYWOOD ELECTRONICS

7460 MELROSE AVE.
HOLLYWOOD 46
CALIFORNIA
WEBSTER 3-8208

HOLLYWOOD ELECTRONICS

7460 Melrose Ave., Hollywood 46, Calif.
Please ship the following:

- DYNAKIT Mark III — \$79.95
- DYNAKIT Pre-Amplifier — \$34.95

___Check, ___Money Order for \$___enclosed.
In California add 4% sales tax — Shipping charges C.O.D.

Name _____

Address _____

City _____ Zone _____ State _____

SOUND FANCIER

Continued from preceding page

temperamentally far better suited), but surely there can be no excuse today for the intolerable bottom heaviness (and badly focussed low-frequency tonal qualities) in what otherwise might be a fine modern recording. Well, the Deutsche Grammophon engineers have done such fine work on their own home grounds (they were perhaps the first to formulate the present ideals in tonal purity) that they certainly can be forgiven the present miscalculation of unfamiliar conditions. Meanwhile, this disc is a valuable reminder that the vast powers at the resource of hi-fi recording can work more harm than good if they are allowed to get out of control or to distract attention from the music and scoring to which they should be wholly subservient.

"Quieter" vs. Bolder Virtues

A matchless example of this subservience of technique to content (here also characteristic of the interpreter no less than of the engineers), as well as what I like to call hi-fi's "quieter" virtues (i.e., its nonsensational transparency and tonal authenticity) is the album of the three Mozart Sonatas and two smaller piano pieces by Landowska (RCA Victor LM 6044). I have sometimes been bold enough in the past to quarrel with the Grande Dame's Bach harpsichord performances on grounds of overvehemence and stylistic mannerisms, but here (despite the fact that she adds ornamentations not actually included in the scores and "arranges" the *Ländlerische Tänze*, K. 606, which have been preserved only in string-trio scoring), everything not only seems well within legitimately Mozartean tradition, but infectiously communicates Mozart's most characteristic



vital blend of lyricism and imagination. The properly small piano tone throughout is reproduced with immaculate cleanliness and sparkle.

Nearly as good technically, if not quite as enchanting interpretatively, is the disc of three Mozart Violin Sonatas (K. 301, K. 304, and K. 380) by Wolfgang Schneiderhan and Carl Seemann (Decca DL 9886); and the Bach Sampler from Vanguard (SRV 105, \$1.98), which reprints from earlier large-scale albums Prohaska's fine if slightly hurried Second Brandenburg

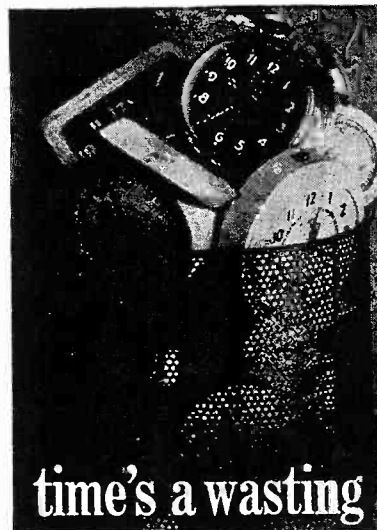

time's a wasting

The clocks keep ticking away. We need your dollars to make each minute count in the fight against cancer.

With \$70, we can buy an eyepiece micrometer...\$48 buys a laboratory flowmeter...\$15 buys an instrument sterilizer...\$3.75 a hematocrit reader.

Only you can decide how much you can afford to send. But send it *today*, to help us keep moving ahead in the struggle to save lives. Send your check to "Cancer" c/o your local Post Office.

AMERICAN CANCER SOCIETY

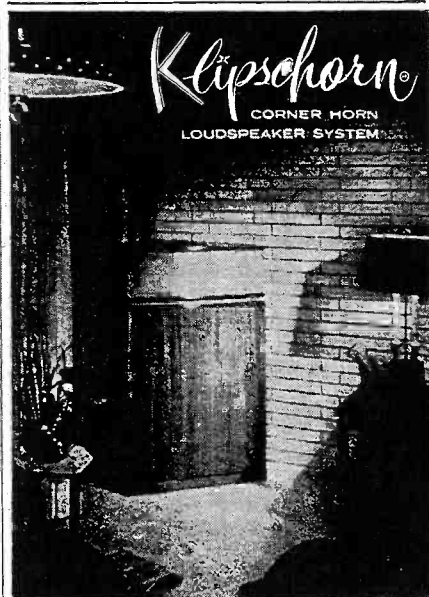

Klipschorn
CORNER HORN
LOUDSPEAKER SYSTEM



Developed by the pioneer corner horn designer, Paul W. Klipsch, the KLIPSCHORN system stands unique in extended uniform range and freedom from distortion.

Available in unfinished plywood utility models as well as in fine hand finished styles as illustrated. Write for our brochure which contains an excellent bibliography of technical papers and performance data on KLIPSCHORN* and SHORTHORN* loudspeaker systems.

KLIPSCH & ASSOCIATES
HOPE, ARKANSAS
*Registered Trade Marks

Concerto, vivacious B-minor Suite, the famous Air from the D-major Suite, and — from a more recent release — Jan Tomasow's fine-spun performance of the E-major Violin Concerto.

But devotees of hi-fi's more extraverted characteristics, and of scintillating sound for its own proud sake, should not despair; there is still plenty of genuinely sensational brilliance available, but now for the most part confined to repertoires where its predominance over musical contents is either harmless or desirable. Listen to the *Dukes of Dixieland*, Vol. 3 (Audio Fidelity AFLP 1851) wherein the Unreconstructed Southerners' percussion really sizzles, and their tuba shakes the house foundations in music which calls for exactly such extremes: a batch of uninhibited New Orleans professionals, topped by *When Johnny Reb Comes Marching Home*. Or hear the same company's *Mallet Magic* (AFLP 1825), wherein Harry Breuer demonstrates his virtuosic mas-

tery of marimba, vibraphone, and xylophone in musical trifles or parodies (like the *Bumble Bee Bolero* and *Sambra macabre*, a long way after Ravel and Saint-Saëns respectively). Most of these pieces would be quite pointless except for the zippy razzle-dazzle of their varied percussive sound qualities.

Outside such specialized repertoires, however, the future for sheer sonic sensationalism in the single-channel medium now seems severely limited. In my opinion the arena for further refinements and developments has shifted squarely to the stereo medium where *everything* begins to seem possible — even a satisfactory reconciliation of hi fi's quietest and most blatant virtues, with the former enlivened by tonal luminosity and buoyancy, and the latter made more aurally attractive by their wider dispersal in an expanded acoustical ambience. But that, of course, is another chapter in the breath-taking serial saga of current audio progress!

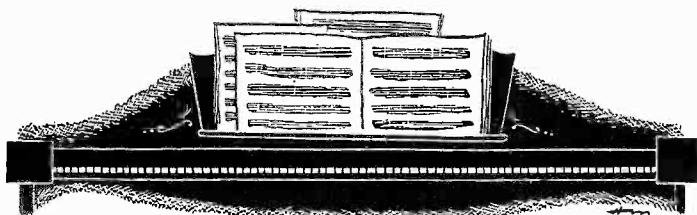

COMING to your city HIGH FIDELITY MUSIC SHOWS

See and hear the latest in HIGH FIDELITY
from leading high fidelity manufacturers . . .

Don't miss these public showings of Hi-Fi Equipment . . . from the most economical units for the budget-minded to spectacular home music theatres . . . compare and enjoy them all. Components and complete systems will be displayed.

THREE DAYS OF CONTINUOUS DEMONSTRATIONS 1 P.M. to 10 P.M.

1957	Miami	October 18, 19, 20	McAllister Hotel	
	Seattle	November 8, 9, 10	New Washington Hotel	
	St. Louis	November 22, 23, 24	Statler Hotel	
1958	January 10-12	Minneapolis	April 11-13	Newark,
	January 31-	Milwaukee	April 25-27	New Jersey
	February 1, 2		September 4, 5, 6	Indianapolis
	February 21-23	Cleveland	October 3-5	Cincinnati
	March 7-9	Pittsburgh	October 17-19	St. Louis
	March 9-16	Miami	November 1-3	Kansas City
	March 28-30	Buffalo	November 14-16	Denver
				Seattle

Rigo Enterprises, Inc. 500 North Dearborn Street, Chicago 10, Illinois

Telematic CUSTOM HIGH FIDELITY KITS

AM/FM TUNER

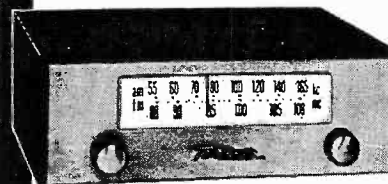

2 uv for 20 DB quieting, AFC plus Defeat, Full Frequency Response, 300 KC bandwidth.
Model KC-400 Less Cage \$34.95 (FED. EX. TAX INC.)
Wired and Tested 59.95

20-WATT INTEGRATED AMPLIFIER

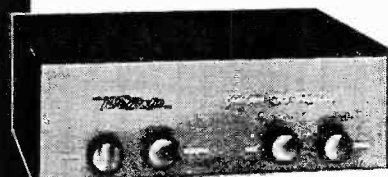

Power Response CONSTANT at 20 Watts, 1 ± DB Full Frequency Response, Infinite Equalization Bass Treble Controls; 3 Hi, 1 Low inputs.
Model KC-401 Less Cage \$46.00
Wired and Tested 64.95

Exclusive! STEREOPHONIC KITS

AM/FM STEREOPHONIC TUNER WITH WIRED FM FRONT END

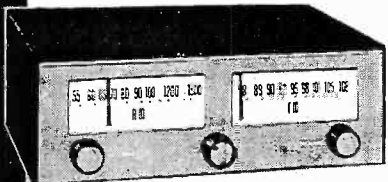

NEW DIMENSIONS IN SOUND—Each section used individually or together—0.9 uv for 20 DB quieting, 330 kc Bandwidth 3-gang variable AM tuning, 15 uv per meter loop sensitivity.
Model KB-402 Less Cage \$69.95 (FED. EX. TAX INC.)
Wired and Tested 99.50

40-WATT STEREOPHONIC AMPLIFIER

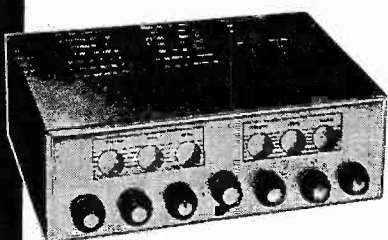

NEWEST DEVELOPMENT IN STEREOPHONIC SOUND FOR THREE DIMENSIONAL LIFE-LIKE REALISM!
Twin 20-Watt Channels—Each with FULL PRE-AMP sections and Master Volume Control.
Model KB-403 Less Cage \$ 82.50
Wired and Tested 109.50

For full details, see your local dealer or write

TELEMATIC INDUSTRIES, INC.

20 HOWARD AVENUE, BROOKLYN 21, N. Y.

...the ultimate goal
of the
critical listener

marantz

Audio Console
pre-amplifier, complete. \$171*

Power Amplifier
\$198*

Electronic Crossover
\$90*

*slightly higher west of
the Mississippi

write for literature

marantz company
25-14 Broadway, Long Island City 6, N. Y.

Better Results With
ROBINS' AUDIO ACCESSORIES!

GIBSON GIRL® TAPE SPLICERS

1. Semi-Pro	SP-4	\$ 3.50
2. Junior	TS-4JR	6.50
3. Standard	TS-4STD	8.50
4. De luxe	TS-4DLX	11.50
5. Industrial (5 sizes to 1")	(net)	55.00

ROBINS PHONO AND TAPE ACCESSORIES

6. Splicing tape	ST-500	\$.39
7. Jockey Cloth for Tapes	JCT-2	1.00
8. Tape Threader	TT-1	.98
9. AUD-O-FILE	AF-50 (net)	23.99
10. Changer Covers	CC-1, 2	2.00
11. Turntable Covers	CC-3	2.50
12. Disclosures	E10, 12 (pkg)	1.20
13. Jockey Cloth for Records	JC-1	1.00
14. KleeNeedLE	NB-1	1.50
15. Phono-Cushion, 10", 12"	PC-10, 12	1.50
16. Atomic Jewel	SE-90	5.00

At Dealers Everywhere

ROBINS INDUSTRIES CORP.
BAYSIDE OF NEW YORK

KNIGHT-KIT TUNER

Continued from page 30

than many higher-priced, ready-made units, and not greatly inferior to the expensive wide-band tuners. This may be accounted for, perhaps, by the fact that informal alignment without instruments results in a wider than usual IF band width. No trouble was experienced with drift after the initial ten minutes on local stations, although on remote, weak stations it was necessary to retune several times during the first hour after which the AFC was able to hold the signal in tune. Selectivity and adjacent-channel suppression were not remarkable, but judged adequate for all but a few especially troublesome installations. In fact, for use in primary signal areas the tuner left little to be desired.

With careful alignment the weak-signal sensitivity was surprisingly good,

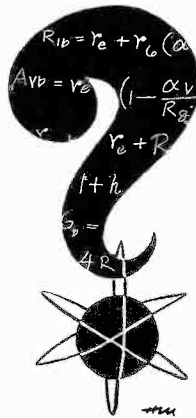

and we are convinced that our sample unit exceeded the specified or claimed sensitivity. The distortion remained low and the noise suppression was good. The tuner is also very handsome in its case. We should say that this unit would be completely satisfactory in the great majority of locations. For a kit costing under \$40, that is a high recommendation indeed.

READERS' FORUM

Continued from page 15

boxes have been squared off in an ugly fashion, and the type used in the caption and the feature announcements is unappealing and too large.

I suggest an immediate return to the old cover, although I suppose you must get the magic words, *hi-fi*, in there.

J. Peter Denny
Durham, N.C.

Gentlemen:

About Mr. Eugene I. Cleveland's letter stating that he dislikes your new cover design, I say your correspondent doesn't

PROFESSIONAL DIRECTORY

SIX BRANDENBURG
CONCERTOS

BACH'S
greatest works
in distinctive
performances
conducted by
HERMANN SCHERCHEN
exclusively
on tape

Omegatape

FM/Q
antenna systems

High gain broadband FM Antennae for max. tuner sensitivity to 72 or 300 ohm inputs. Provides optimum signal level for best recording of high fidelity broadcasts.

APPARATUS DEVELOPMENT CO.
FM/Q Dept. Wethersfield 9, Conn.

**UNHAPPY
WITH
"HI"
HI-FI
PRICES?**

Write us your Hi-Fi Needs.
KEY ELECTRONICS CO.
120 LIBERTY ST.
NEW YORK 6, N.Y.

TRADERS' MARKETPLACE

Here's the place to buy, swap, or sell audio equipment. Rates are only 20¢ a word (excluding name and address) and your advertisement will reach 20,000 to 35,000 readers. Remittance must accompany copy and insertion instructions.

COMPLETED-TESTED HEATHKIT W5M \$55.00. Fred Bauer, Jr., P. O. Box 7307, Memphis, Tenn.

STOP GUESSING. Build Impedance Bridge for measuring inductance, capacitance, resistance. Description, circuitry, photos, \$3.00 postpaid. Lawrence, 3820 Purdue St., Houston 5, Texas.

UNHAPPY WITH "HI" hi-fi prices? So alright already... Write already. Key Electronics Co., 120 Liberty St., New York 6, N. Y. EVergreen 4-6071.

Want a reprint of the FM station list that appeared in AUDIOCRAFT earlier in the year? The list has been revised and is now available. See the ad on page 48 for complete details.

FM BECOMES HI-FI
WITH THE
RIGHT ANTENNA

TACO
"do-it-yourself"
FM ANTENNAS

Here's a powerful FM antenna that will provide the necessary signal-to-noise ratio essential for true Hi-Fi results . . .

The antenna is a twin-driven, 6-element yagi design providing 7 db gain throughout the FM band. It is packaged complete with mast, mount, stand-off insulators, transmission line and everything you need to make a beautiful FM installation, including complete, easy-to-follow instructions.

List price \$27.95

Write for complete details . . .

TECHNICAL APPLIANCE
CORPORATION
SHERBURNE, N.Y.

Audio Craftsmen!
Newest Grilles & Fine Woods for Hi-Fi
Speaker Enclosures
Send for Complete Catalog...
New 1958 Edition Just Out!



Get This Giant Catalog Of

WOOD
& WOODWORKING
MATERIALS

TOOLS—PLANS—SUPPLIES

World's Largest Selection of
Finest Domestic and Imported
Woods, Mouldings, Hardware Tools
—ALL AT LOW MONEY SAVING PRICES!

Your complete wood buying
guide and project book. Craftsman
is your best, most com-
plete source of finest kiln-dried
domestic and rare imported
woods, beautiful wood inlays,
colorful bandings, matched
plywoods, embossed mould-
ings, carved ornaments, new-
est woodworking tools, "hard
to find" cabinet hardware and
fittings... more than 1,500 items!
Packed with newest scroll saw pat-
terns, project ideas and money
making plans. Enclose 25c (re-
funded with first order) to help
pay mailing, handling cost. Write

132 PAGES

Many in
full color
packed with
rare, fancy & im-
ported woods...
veneers, ply-
woods, patterns,
tools, ornaments,
hardware... ev-
erything for
the woodworker.

MAIL COUPON
NOW!

CRAFTSMAN WOOD SERVICE CO., 2729 S. Mary St., Dept. M10 Chicago 8

CRAFTSMAN WOOD SERVICE CO.,
2729 S. Mary St., Dept. M10 Chicago 8, Ill.
Enclosed find 25c (refundable with order). Rush me new
CRAFTSMAN WOOD CATALOG.

NAME _____
ADDRESS _____
CITY _____ Zone _____ STATE _____

know the meanings of the words *cheap*,
gaudy, or *commercialized*.

I feel that your new cover is an im-
provement over the previous one. My
congratulations to Roy Lindstrom for
his good artistic sense.

J. Simard
Quebec, Que.

Gentlemen:

I'm afraid I must agree with Mr.
Cleveland's opinion of your new cover.
If I didn't already know what was in-
side the cover, I would have a much
lower opinion of the magazine.

I like your index page, but the cover
is definitely below the standard set by
the design of the rest of the magazine.

Roy J. Irvine
Harlingen, Tex.

*Since reader reaction to the new cover
design was generally unfavorable, we
are trying something a little different.
Let's hear what you have to say about
this one.* — Ed.

Gentlemen:

As a charter subscriber to AUDIOCRAFT,
I have been restrained from writing this
letter for nearly two years by a huge
inertia factor. Now, however, here is
your plug. AUDIOCRAFT is a fine maga-
zine; technical enough for a nonelectrical
engineer (myself), interesting and in-
formative enough for nontechnical read-
ers (several neophyte friends).

I would like to make one minor criti-
cism. Why can't record reviewing be
left to the publications it belongs in;
e.g., HIGH FIDELITY, the *Saturday Re-
view*, and so on? I fail to see why
technical journals and hobby magazines
should spend precious white space doing
ineffectually that which is best done by
periodicals whose prime business it is.

William Rosenstein
Brooklyn, N.Y.

*Our record reviews are intended to do
that which is done ineffectually in the
standard review publications: that is,
to comment specifically and reliably on
the technical quality of new disc and
tape releases. We hope they have suc-
ceeded in doing so.* — Ed.

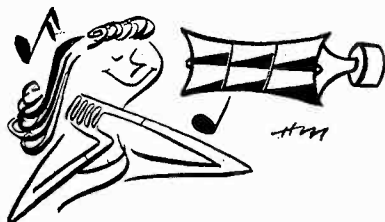

Gentlemen:

On the weekend preceding the IRE
convention in New York last spring I
attended a Sunday-afternoon concert at

Continued on next page

"LIVING SOUND" IS THE LUXURY
OF LISTENING TO REALISTIC REPRODUCTION
THROUGH *Morelco*® TWIN FULL RESPONSE SPEAKERS
Write today to Dept. M10 for brochures and attractive prices of these unique speakers.
NORTH AMERICAN PHILIPS CO., INC. • 230 Duffly Ave., Hicksville, L. I., N. Y.

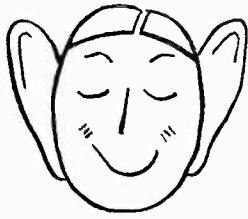

ADD HOLT STEREO!

Guaranteed to improve any Hi Fi with money-back trial. Begins where hi fi leaves off.

Works from monaural source, (radio, ordinary single track records and tape.) Connects in 2 minutes.

Happy customers in 30 states and 7 foreign countries.

\$62.00 postpaid in U.S. Sold direct, only. Order yours today or send for folder with High Fidelity magazine "Test Report." Read what customers say.

STEREO by HOLT

4712 W. Magnolia Blvd.
Burbank, California

Note: No waiting, now, but no foreign orders, please, except through exporters.

FM stations up-to-date...

Here, in convenient booklet form, is a complete geographical listing of FM stations in the United States and Canada. The list was compiled by Bruce G. Cramer directly from FCC records, and originally appeared in *AUDIOCRAFT Magazine*. With additional changes and corrections to bring it up-to-date, it has just been reprinted as a booklet.

Only a limited number of copies of *FM Stations Up-to-Date* are available, so, to be sure of getting one, place your order soon. The price is only 50¢.

Order from:

Book Department
AUDIOCRAFT Magazine
Great Barrington, Mass

READERS' FORUM

Continued from preceding page

Carnegie Hall. After settling down to enjoy the music, a fellow in the row ahead of me turned to his companion and whispered, "Not enough bass, don't you think?"

I thought the remark was rather funny at the time, but the funniest part was the fact that I agreed with him. The Philharmonic sure wasn't putting out the bass the way my speaker system can!

If it is the purpose of high fidelity to reproduce sound accurately and uncolored, one has no choice but to compare the output of the hi-fi system with the original sound. It is all too easy to base the comparison on other hi-fi systems or on a standard arrived at by listening to electronically reproduced music. This will hardly be news to some people, but many strive uncon-



sciously, I think, to match other hi-fi systems or their own preconceived ideas of what music should sound like.

Avoiding the question of whether it is right or wrong to color the sound, such coloration should, at least, be consciously done. Perhaps the advice comes a trifle late; the *March Educational Forum* reported that in 1955 classical-music concerts drew 35,000,000 people—more than twice the number drawn by organized baseball!

Paul Penfield, Jr.
Cambridge, Mass.

Gentlemen:

I have been a reader of your magazine almost since its beginning, but I do not have a copy of the December 1955 issue, which I'd like to obtain to complete my file. Would you put a note in "Readers' Forum" to the effect that I should be willing to pay a good price for a copy of this issue in reasonable condition?

George G. McKinley
P. O. Box 468
Glasgow, Ky.

ADVERTISING INDEX

Key No.	Advertiser	Page
1	Acoustic Research, Inc.	36
2	Allied Radio Corp.	5
3	American Cancer Society	44
4	Ampex Corp.	38
5	Apparatus Development Co.	46
6	Argos Products Co.	33
7	Audio Fidelity Records	I, Back Cover
8	Audiophile's Bookshelf	14
9	Capitol Records	40
10	Components Corp.	40
11	Craftsman Wood Service Co.	47
12	EICO	41
13	Electronic Organ Arts	34
14	Electro-Sonic Laboratories	2
15	Ercona Corp.	42
16	Fisher Radio Corp.	37
17	FM Stations Up-to-Date	48
18	Gray Research & Development Co.	43
19	Heath Co.	6-9
20	Hollywood Electronics	44
21	Holt Stereo	48
22	International Pacific Recording Corp.	46
23	Key Electronics Co.	46
24	Klipsch & Associates	44
25	Lafayette Radio	Inside Back Cover
26	Lansing, James B., Sound, Inc.	11
27	Louisville Philharmonic Society	43
28	Madison Fielding Corp.	42
29	Marantz Co.	46
30	North American Philips Co.	39, 47
22	Omegatape	46
31	ORRadio Industries, Inc.	32
32	Pentron Corp.	35
	Professional Directory	46
15	R & A Coaxial	42
33	RCA Components Division	Inside Front Cover
34	Rigo Enterprises, Inc.	45
35	Robins Industries Corp.	46
36	Technical Appliance Corp.	47
37	Telematic Industries, Inc.	45
	Traders' Marketplace	46