

# audiocraft

MAY

THE HOW-TO-DO-IT MAGAZINE OF HOME SOUND REPRODUCTION

35 CENTS

## THIS MONTH

Complete information necessary to assemble your own pickup arm.

Using test tapes to keep your recorder at its peak performance.

124 watts in a 24-foot room: ultimate home sound system?

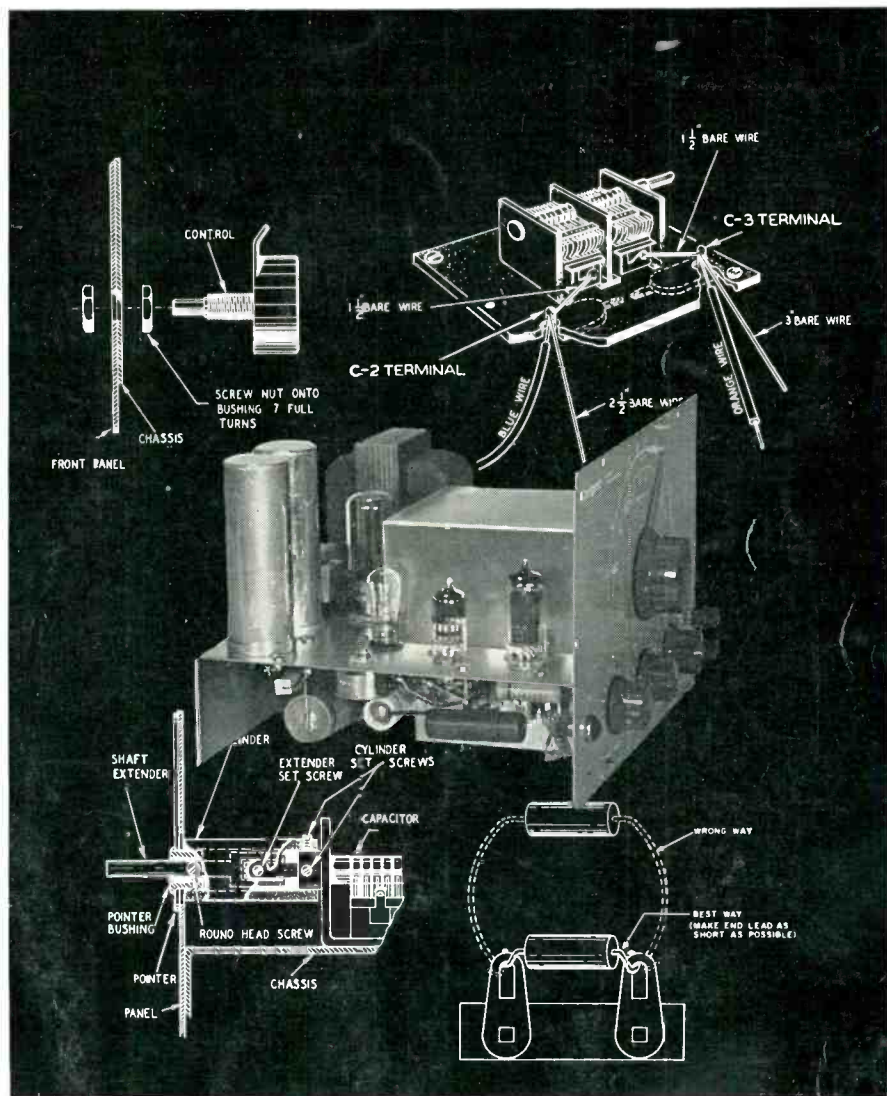

### KNIGHT AUDIO GENERATOR KIT

One of the most versatile and useful of test equipments is a good audio oscillator. Featured in this issue is an AUDIOCRAFT kit report on the Knight Audio Generator, easy to build and inexpensive.

# High



Certainly, one of these cabinets would make your high fidelity music system fit more attractively into your home...



# fidelity



Each is something special... there are modern designs and there are traditional designs... something for every taste...



### CUSTOMIZED CABINETS BY RIVER EDGE

More than 30 models in 9 finishes, each with two important high fidelity features: 1) Scientific design: components fit properly into their areas, are correctly ventilated, and (in the case of speaker enclosures) tone is developed according to proven engineering principles. 2) Panels factory-cut to fit your choice of components—you or your dealer can easily, quickly install the equipment.



# can



Best of all, these River Edge customized cabinets are constructed and finished as well as they look...

### LOW COST KITS BY RIVER EDGE

Though they cost little, these kits offer the same fine furniture features as River Edge finished cabinets. Component and speaker enclosures are easy to assemble, without special tools. You assemble some kits; others are pre-assembled, ready for paint or stain.



# start



### CUSTOMIZED CABINETS BY



# here



Write for complimentary copy of the new River Edge Customized Cabinet Guide. Fully illustrated, describing all River Edge cabinets, finishes, prices and other information you need in planning your high fidelity system.

### MAIL THIS COUPON TODAY

RIVER EDGE SALES CORPORATION  
Dept. VE-96 Port Washington, N. Y.

Send me the River Edge Customized Cabinet Guide.

Name \_\_\_\_\_

Address \_\_\_\_\_

City \_\_\_\_\_ Zone \_\_\_\_\_ State \_\_\_\_\_

A quality-endorsed product of the British Industries Group  
GARRARD, LEAK, WHARFEDALE,  
GENALEX, R-J, RIVER EDGE, MULTICORE components

RIVER EDGE SALES CORPORATION • PORT WASHINGTON, NEW YORK



GROW WITH *signature* sound



Now you can enjoy your very first year of audio! With a complete line to choose from, you can begin with a Signature precision transducer and grow with J.B.L. all the way. You start with a Signature Extended Range Speaker, install it in a fine enclosure designed, engineered and constructed by James B. Lansing Sound, Inc. Later, you add a Signature Dividing Network and High Frequency Unit to attain the ultimate excellence of a Signature Two-way System. Your nearest Authorized Signature Sound Specialist will help you lay out a plan for progressive purchase that will fit your needs exactly. Write for his name to: James B. Lansing Sound, Inc., 2439 Fletcher Drive, Los Angeles 39, California.



BEGIN WITH A J.B.L. SIGNATURE EXTENDED RANGE SPEAKER...



A 15" MODEL D130 \$76.00



A 15" MODEL D130 \$76.00



OR A 12" MODEL D123 \$54.50



INSTALL THE SPEAKER IN A FINE J.B.L. SIGNATURE ENCLOSURE...



*back-loaded folded horn*

A MODEL C34M \$135.00



A MODEL C37M \$104.00



*minimum volume reflex*

A MODEL C38M \$54.00

**DETAILED PRINTS AVAILABLE**  
Complete plans for any enclosure shown here, and other Signature enclosures, are available for \$2.50 a set from your Audio Dealer or Signature Factory.



LATER ADD A J.B.L. SIGNATURE DIVIDING NETWORK...



*1200 c.p.s. crossover*

A MODEL N1200 \$35.25



*2500 c.p.s. crossover*

A MODEL N2500 \$15.00



*2500 c.p.s. crossover*

A MODEL N2500 \$15.00



AND A SIGNATURE PRECISION HIGH FREQUENCY UNIT...



*driver-horn-Koustical lens assembly*

A MODEL 175DLH \$118.50



*made with ring radiator*

A MODEL 075 \$54.50



*made with ring radiator*

A MODEL 075 \$54.50

*Great  
performance...  
with your living room  
in mind...*



Jensen CT-100 Concerto in Mahogany \$164.50, Blonde Korina \$168.00

## Jensen TRIPLEX and CONCERTO *Authentic* HIGH FIDELITY LOUDSPEAKERS

All of us know that big speakers should make better hi-fi sound than smaller ones; the difference lies in the extreme low end. But more often than not space and decor problems just won't allow the big reproducer in the living room.

However, your fidelity can be very high indeed in more modestly dimensioned cabinetry. For your living room we suggest you consider Jensen's fine reproducers the Triplex and Concerto 3-way and 2-way systems. They are distinguished by *authentic* high fidelity performance far beyond their modest size and cost. Speaker kits are available, too, if you wish to build or build-in your speaker system. Manual 1060 tells how. It's available immediately, sent postpaid for 50 cents. Send for your copy now.

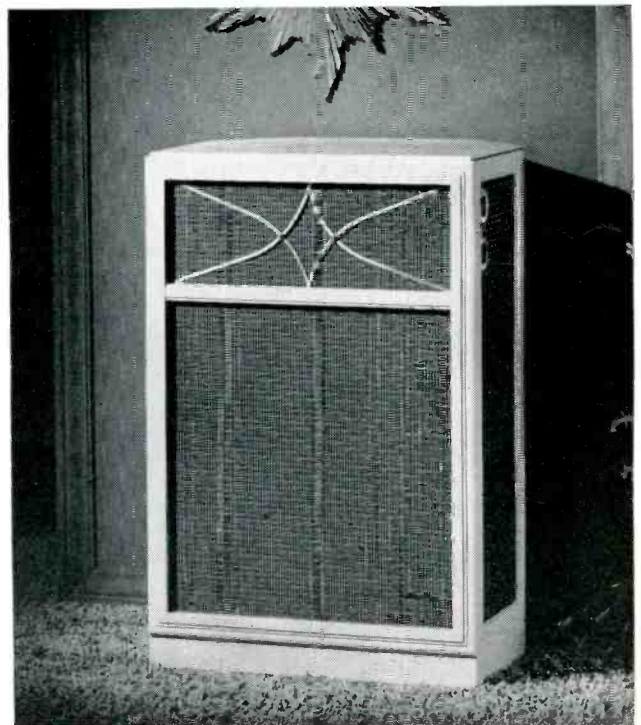

Jensen TP-200 Triplex in Mahogany \$312.70, Blonde Korina \$316.80

**Jensen** MANUFACTURING COMPANY  
Division of The Muter Company • Dept. M, 6601 S. Laramie Ave., Chicago 38, Illinois • In Canada: Copper Wire Products Ltd., Licensee

May 1956

Volume I Number 7

# audiocraft

## THE HOW-TO-DO-IT MAGAZINE OF HOME SOUND REPRODUCTION

Authors new in this issue, in order as they appear at the right:

Paul Klipsch is probably less in need of introduction to readers than any other person in the field of audio. His development of the Klipschorn—the first speaker system employing a folded bass horn that utilized a room corner as a horn extension—marked a turning point in home sound reproduction. The Klipschorn is still used as a standard of comparison. Mr. Klipsch supervises its manufacture in his Hope, Arkansas, factory, making improvements as they become possible and developing smaller speaker systems such as the Shorthorn and Rebel series in his spare time.

J. E. Richardson is a senior at Georgia Tech. and lives in Atlanta. He says his interest in high fidelity goes back five years; that makes him (relatively) an old-timer in audio. Unusually devoted to the do-it-yourself school, he has built his entire audio system from turntable to speaker system (a Klipschorn!). This is his second published article.

John J. Stern is an M.D. eye specialist in Utica, N. Y., a cellist in an amateur quartet, and a tape recordist. His free time is occupied rather completely by making, listening to, reading about, and recording music. Occasionally he manages to find an opportunity to write about it too. Dr. Stern's wife sings and plays the piano, his daughter plays the clarinet, and his son plays both flute and violin. One question: who decides what to listen to?

CHARLES FOWLER, *Publisher*

ROY F. ALLISON, *Editor*

FRANK R. WRIGHT, *Managing Editor*

FRANCES A. NEWBURY, *Editorial Assistant*

ROY LINDSTROM, *Art Director*

ELEANOR GILCHRIST, *Art Assistant*

LUCIEN AIGNER, *Photography*

*Contributing Editors*

R. D. DARRELL

J. GORDON HOLT

JOSEPH MARSHALL

WARREN B. SYER, *Business Manager*

SEAVER B. BUCK, JR., *Circulation Director*

Branch Offices (Advertising only)—New York: Room 600, 6 East 39th Street. Telephone: Murray Hill 5-6332. Fred C. Michalove, Eastern Manager. - Chicago: John R. Rutherford and Associates, 230 East Ohio St. Telephone: Whitehall 4-6715. - Los Angeles: 1052 West 6th Street. Telephone: Madison 6-1371. Edward Brand, West Coast Manager.

The Grounded Ear, by Joseph Marshall <i>What's new and significant in sound reproduction.</i>	4
Audionews	6
Tips for the Woodcrafter, by George Bowe <i>This issue: Finishing.</i>	8
Sound Servicing, by Irving M. Fried <i>This issue: Down with distortion.</i>	10
Tape News and Views, by J. Gordon Holt <i>This issue: Monitoring and volume indicators.</i>	12
Readers' Forum	15
Editorial	15
Impedances in Multi-Speaker Systems, by Paul W. Klipsch <i>Some drivers must be matched, others needn't be.</i>	16
The Knight Audio Generator <i>An AUDIOCRAFT kit report.</i>	18
Designing Your Own Amplifier, by Norman H. Crowhurst <i>Part III: Phase inverters.</i>	21
A Hi-Fi Milestone <i>Reproducing the organ at Saint Mark's, Mount Kisco.</i>	24
A Home-Built Pickup Arm, by J. E. Richardson <i>This fine arm can be made from balsa and scrap metal.</i>	26
Better Bass with Buster, by Ernest B. Schoedsack <i>Firm, solid bass is a first essential for realism.</i>	28
Audio Aids	32
Checking Your Tape Recorder, by Herman Burstein <i>Simple test procedures to keep your recorder working properly.</i>	34
Optical Tape Timer, by John J. Stern, M.D. <i>An inexpensive footage or recording time indicator.</i>	35
Basic Electronics, by Roy F. Allison <i>Chapter VII: Capacitance.</i>	36
Sound Sales Directory	44
Symbols and Abbreviations	46
Professional Directory	46
Traders' Marketplace	48
Advertising Index	48

Audiocraft Magazine is published monthly by Audiocom, Inc., at Great Barrington, Mass. Telephone: Great Barrington 1300. Editorial, publication, and circulation offices at: The Publishing House, Great Barrington, Mass. Subscriptions: \$3.50 per year in the United States and Canada. Single copies: 35 cents each. Editorial contributions will be welcomed by the editor. Payment for articles accepted will be arranged prior to publication. Unsolicited manuscripts should be accompanied by return postage. Entered as second-class matter October 1, 1955, at the post office, Great Barrington, Mass., under the act of March 3, 1879. Additional entry at the post office, Pittsfield, Mass. Printed in the U. S. A. by the Ben Franklin Press, Pittsfield, Mass. Copyright 1956 by Audiocom, Inc. The cover design and contents of Audiocraft Magazine are fully protected by copyrights and must not be reproduced in any manner.



# The Grounded Ear

by Joseph Marshall

## How Much Feedback?

It is a natural human tendency to believe that if  $x$  quantity of anything is good,  $4x$  of the same is that much better. The virtues of negative feedback are so many, and its apparent ability to correct faults of design so great, that it has come to be looked on rather as snake oil used to be by some of our forefathers: the infallible cure-all for audio troubles. Among non-professional designers and builders especially, there seems to be a compulsion to use all the feedback possible, and even to measure the excellence of the design by the feedback factor attained. I must admit that I have, on occasion, found myself guilty of this delusion.

Actually, there is nothing about feedback that exempts it from the general laws applying to all circuitry. For that matter, it is also subject to the general principle that an excess of any virtue can become harmful. If the right amount of feedback can do wonders, too much feedback can ruin an amplifier and, indeed, most home-built and many commercial amplifiers are notable for the evil effects of excess feedback. Many a Williamson amplifier, for example, even with its low distortion and wide frequency range, is distinguished also by extremely poor definition and transient response caused by an overambitious feedback loop that throws the amplifier into infra- or ultrasonic hangover, ringing, or even outright oscillation. This is not the fault of Mr. Williamson or his circuit. He was careful to point out the possible pitfalls of too much feedback and avoided it in his own versions.

How much feedback do we really need? The answer, of course, is enough to perform its functions and no more. The functions of feedback are several: to increase the band width, to reduce distortion, and to damp the loudspeaker to the extent that electrical damping helps. We can immediately get into an argument about how much band width is necessary, or how much you need to reduce distortion, and how much electrical damping one needs; it would take a book to cover all the

considerations and answer the question with some finality. Although I belong to the school that believes a band width several octaves wider than the audio range is desirable, and also the one that wants to reduce distortion to the vanishing level, I would like to point out that after a certain point the pressure toward those ends can become academic. For example, band width has to be increased by at least an octave to be significant; an increase in flatness of response from, let us say, 75 Kc to 100 Kc is not going to make much difference except on a frequency-response curve. Audio-frequency square waves, for example, will not look significantly different. Also, once the distor-

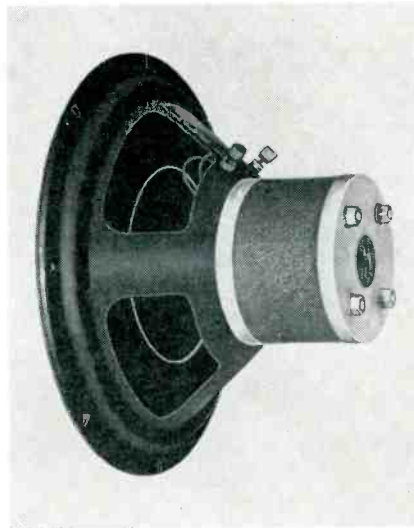

Hartley 215: good bass from small cone.

tion is reduced below a certain figure, further reductions are not only hard to come by but very difficult to measure, let alone to hear. I do not suggest that we should settle for the merely good enough instead of attempting to approximate the ideals of perfection. But I do want to point out that there comes, in every design, a time when the further pursuit of the ideal has to be measured against the practical consideration of obtaining something useful and usable. At that point it may well be that further improvement would not be worth the heroic effort needed to

achieve it. Additional band width and lower distortion, obtained at the expense of degraded transient response and definition, would be a poor bargain.

So, instead of talking further about such generalities, let us get on to consideration of how much feedback to use for a specific design. This is a completely practical problem. Every design, —indeed, every amplifier—has, so to speak, a built-in feedback factor which is a function of its time constants, gain, wiring, individual tubes and transformers, and so on. It will take so much feedback and no more before going off the cliff into some degree of instability. How do you determine the proper amount? Opinions will differ, no doubt, but my experience has been that the following method gives excellent results:

Feed a 10-Kc square wave at a listenable level into the amplifier, with your speaker system connected, and observe the output on a scope. Now adjust the feedback until you obtain a trace which has practically no ripple on the top, yet does not round or tilt at the leading edge significantly. If you obtain a reasonably good approximation of a square wave, with no peaks on the top, the probability is very high that you have a stable design; an amplifier that passes a 10-Kc square wave with reasonable fidelity will have no trouble whatever handling any musical or sound transient.

You may find it difficult or impossible to do this; or you may find that to accomplish it you must reduce feedback so much that distortion is too high. If you can increase the feedback without producing ringing on a 10-Kc square wave you can pretty safely do so. But if increasing feedback does increase ringing, you'll have to take other measures first. Try reducing distortion in each stage of the amplifier by changing components, balancing, and so on; then try to adjust phase shifts within the feedback loop by any of the many methods in which this can be done<sup>1</sup>.

<sup>1</sup>Haffer, David, "Modernizing your Williamson Amplifier", AUDIOCRAFT, December 1955; also Fried, Irving M., "Sound Servicing", AUDIOCRAFT, February and March 1956.

In any case, do not drive the feedback loop beyond the minimum ripple point; the price you pay in instability will almost certainly be greater than the reward in lower distortion or wider band width.

A 10-Kc square wave presumably furnishes no adequate test of low-frequency stability. I have found in practice, though, that with today's tubes, circuits, and output transformers, an amplifier that passes the 10-Kc test will almost invariably pass the test for low-frequency stability. It is simple to verify this. If the oscillator has a range switch, simply switch it rather roughly to the next position and back. This will insert a low-frequency transient under the 10-Kc square wave. The trace will bounce at least once. If it settles down quickly you're all right. But if it bounces for several cycles, you'd better back off feedback or improve the low-frequency response and phase shifts inside the loop<sup>2</sup>, or correct the mutual coupling through the power supply.<sup>3</sup> Switching a low-frequency square wave (20 to 60 cps) on and off is even better.

#### How Big a Speaker Cone?

In a recent letter to *Audio Magazine*, H. A. Hartley complained that he is being forced to produce his excellent speakers in larger diameter simply because many audiophiles refuse to believe that a small cone can have good low-frequency response. I do not want to seem to be plugging Mr. Hartley's 9-inch speakers, but I can verify that this belief is unfounded. Granted, the larger the cone the more air it can move but, among other things, the larger the cone the harder it is to move it and to stop its motion. Speaker design is an especially vivid proof of the old saying that a designer's job is to remove himself from the horns of a dilemma or, at least, to cut off the points of the horns so that they no longer gouge fatally. There are just about as many ways of producing a good speaker as there are good designers attacking the problem. Note how speaker designs differ one from another and how several speakers can achieve much the same end using entirely different means. There are many variables involved; the combinations of the variables which can produce good results are possibly beyond tabulation, to say nothing of complete exploration. In the end, a good loudspeaker is in a real sense the work of an artist rather than an engineer.

No single quality or attribute of a speaker determines its performance and,

*Continued on page 44*

<sup>2</sup> *Ibid.*

<sup>3</sup> Marshall, Joseph, "Practical Audio Design", *AUDIOCRAFT*, February and March 1956.

## Exciting News!



ONLY  
**\$39.50**

A HEAVY WEIGHT  
BELT-DRIVEN TURNTABLE

## THE "PROFESSIONAL" "Junior" by Components

Small, compact, precisely engineered — and packed with the distinctive features usually found in much more expensive turntables.

- Belt-Driven 12" Weighted turntable of non-magnetic polished aluminum
- Plays 4 speeds\*
- Non-slip Cork Pad
- No noisy rubber idlers
- Rumble more than 60 db down, flutter and wow less than 0.25%.

Finished plywood mounting base 13½" x 13½" x 3" \$10

The PROFESSIONAL Junior is a worthy companion to Component's distinguished PROFESSIONAL, a complete turntable unit, ready to play, with 25 pound belt-driven turntable. **\$99.50**

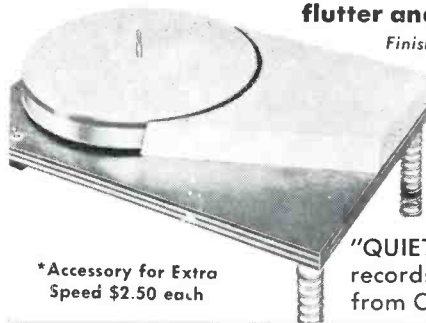

\*Accessory for Extra Speed \$2.50 each

"QUIET, PLEASE" — Microgroove rumble test records 89c at your dealer, or \$1.00 postpaid from Components.

### Components Corporation

DENVILLE, NEW JERSEY





# Audionews

## SNAP-IN CONTROL FOR PRINTED CIRCUITS

A self-supporting, snap-in variable resistor for printed wiring has recently been announced by the Electric Component Division of Stackpole Carbon Co. This control, known as the Stackpole Type LR-70, measures only 57/64 in. in diameter and stands 7/8 in. off

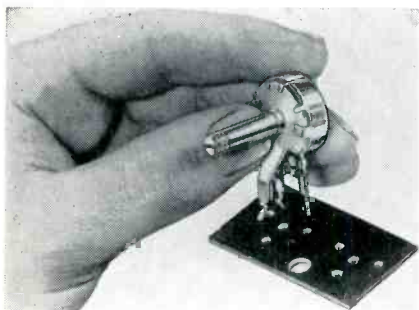

Variable resistor for printed circuits.

the mounting board. It is supported by four legs—the three regular voltage taps, and a larger, case ground leg. No mounting hardware is required since the legs merely snap into the printed wiring board to form a strong support. Terminals are heavily tin-lead coated for fastest soldering with dip solder techniques.

These variable composition resistors are said to be widely applicable in TV, FM, and AM receivers, auto radios, and other printed-circuit chassis where space is limited. Gold-plated ring-spring and hub-spring contactors assure smooth, quiet operation. Cases are nickel plated.

The shaft is firmly supported by a 3/32-inch extruded bushing, and may be left round or equipped with flat, screwdriver slot, split knurl, diamond or straight knurl, or tongue. Single or double-pole snap switches are available with ratings from 15 amps, 15 volts DC; to 6 amps, 125 volts AC-DC.

The LR-70 is rated at 0.75 watts for values above 10,000 ohms, and 0.5 watts below 10,000 ohms.

## BROADCASTING STATIONS OF THE WORLD

*Broadcasting Stations of the World* is the title of a publication issued by the U. S. Government Printing Office, Division of Public Documents. The work

is in four parts and lists all known radio broadcasting and television stations *except those in the continental United States on domestic channels*. The four parts are listed below.

*Part 1*, According to Country and City (information is indexed alphabetically by country and city). 1955. 259 pages. Catalogue number Pr 34.659:955/pt. 1. \$1.25.

*Part 2*, According to Frequency (information is indexed according to frequency in ascending order). 1955. 245 pages. Catalogue number Pr 34.659:955/pt. 2. \$1.25.

*Part 3*, According to Station Name or Slogan (this compilation is indexed first by call letters and second by station name or slogan). 1955. 217 pages. Catalogue number Pr 34.659:955/pt. 3. \$1.00.

*Part 4*, FM and TV Stations (two sections, one for frequency modulation broadcasting stations and the other for television stations, each separately indexed by country and city and by frequency, include the same elements of information as parts 1 and 2, plus additional pertinent data necessary to distinguish audio, video, polarization, and other technical factors applying in their range of the spectrum). 1955. 72 pages. Catalogue number Pr 34.659:955/pt. 4. 60¢.

This publication should be ordered directly from the Superintendent of Documents, Government Printing Office, Washington 25, D. C. Rules require that remittances be made in advance of shipment of the publication. Check or money order should be payable to the Superintendent of Documents. When ordering be sure to give the catalogue number of the publication you want.

## PLASTIC PHONO-CUSHION

The *Phono-Cushion*, PC-10, a product of Robins Industries Corp., is a disc of Polyester foam which is placed on the turntable of a record player. These plastic foam mats, which are claimed by the manufacturer to be superior to foam rubber, are produced in several colors. Transmission of motor rumble and vibration to the record and needle are said to be reduced or eliminated entirely with the use of the Phono-Cushion. Other features are the cushioning effect on records as they fall in automatic

machines and reduction of magnetic attraction between the cartridge and steel turntables. The cushion also prevents record slippage and pick-up of lint from the nap of the turntable.

The Phono-Cushion is 9¾ in. by 3/16 in. thick. It fits all turntables and automatic players. The units are packed in plastic envelopes which can be re-used for storage of ten-inch records.

## CBS-HYTRON POWER TRANSISTORS

A new series of power transistors featuring high power gain and uniformity of characteristics has been developed by CBS-Hytron. Four variations are available, offering a wide range of current gain and operating supply voltage.

Highly efficient heat dissipation is said to be an outstanding feature of these units. The use of a copper base, which is bolted to the chassis, allows the heat to flow from the power transistor to the chassis, providing a large area of heat radiation.

A pair of CBS type 2N156 power transistors in a radio receiver can furnish 8.5 watts of audio power output to the loudspeaker with less than 85 milliwatts of drive power input, according to the manufacturer.

The CBS types 2N155, 2N156, 2N157, and 2N158 are high-power P-N-P germanium-alloy junction transistors, featuring uniformity of input characteristics and excellent reliability.

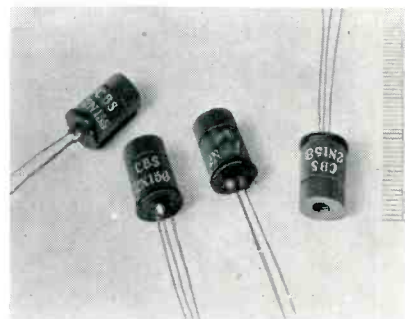

CBS-Hytron high-gain power transistors.

Their electrical characteristics include high gain at high current levels and low saturation currents. Simplicity of construction permits ready adaptability to various mechanical layouts.

Complete data are available by request; Bulletin E-259.



## MAGNETIC RECORDING TECHNICAL DATA SHEET

A technical discussion on the effect of coating thickness on frequency response of magnetic tape is the subject of *Sound Talk* Bulletin No. 31, available free on request from Minnesota Mining and Manufacturing Co., Dept. A6-30, St. Paul, Minn.

The three-page bulletin—illustrated by four charts—is intended for broadcast engineers, electronics specialists, and amateur technicians interested in magnetic recording.

It covers "optimum" recording conditions, bias and audio recording currents, and their effects on high- and low-frequency response of tapes with various oxide coating depths.

In addition, these effects on specific *Scotch* brand magnetic tapes are summarized.

## MIRATWIN CARTRIDGE

The *Miratwin Type MST 2* cartridge, just introduced by Audiogersh Corporation, is a variable-reluctance magnetic cartridge for both microgroove and standard-groove records. It consists of two independent and non-reacting units mounted back to back in a turnover mount. There is said to be no magnetic connection between the two styli. The *Miratwin* has a high output voltage which, coupled with a minimum of hum pickup, is reported to result in improved signal-to-noise ratio. Output for a stylus velocity of 10 cm/sec is 55 mv for microgroove records and 45 mv for standard-groove records, according to the manufacturer. Frequency response is said to be flat,  $\pm 2$  db, from 20 to 18,500 cps on vinylite on the microgroove unit and within  $\pm 4$  db on the standard-groove unit. Recommended stylus force is 6 to 8 grams.

The *Miratwin* is available either with two sapphire styli, as Model MST-2A, or with a 3-mil sapphire and a 1-mil diamond, as Model MST-2D. No tools are required to replace the styli, for the stylus assembly of either unit may be removed by lifting the shield surrounding the stylus with the fingernails. The opening for the stylus assembly is so constructed that, when the replacement is made, the stylus automatically finds the correct position. The cartridge



*Miratwin* cartridge has high output.

element is removed from the holder without the use of tools, and mounting screws and terminal connections are easily accessible.

## FERROGRAPH TAPE RECORDER

The new line of British *Ferrograph* tape recorders is available to the American market for the first time.

All Series 3A *Ferrographs* have three individual motors, one of which is a specially designed "Octquad" synchronous hysteresis capstan motor said to provide long-term speed stability. Two portable models of this dual-track magnetic recorder are available, with speeds of  $3\frac{3}{4}$  and  $7\frac{1}{2}$  ips, and  $7\frac{1}{2}$  and 15 ips, respectively. Both models accommodate 1,750-foot reels of standard tape, have one-knob selector control, auto-stop switch, 60-second rewind, separate bass and treble controls, and output for a 15-ohm extension speaker.

The manufacturer states that frequency response is flat,  $\pm 2$  db, between 50 and 10,000 cps at  $7\frac{1}{2}$  ips, and between 40 and 15,000 cps at 15 ips. Signal-to-noise ratio is said to be better than 50 db between 200 and 12,000 cps. It is claimed that the output stage



The *Ferrograph* portable tape recorder.

provides  $2\frac{1}{2}$  watts of distortion-free power into a 15-ohm self-contained elliptical speaker. Overall dimensions are  $18\frac{1}{2}$  in. by  $17\frac{1}{2}$  in. by  $9\frac{3}{4}$  in., and the weight is less than 50 pounds.

*Ferrograph* recorders and tape decks are also available for custom installation or rack mounting to meet special requirements.

## BULLETIN ON E-V AMPLIFIERS

A comprehensive bulletin on Electro-Voice Circlotron Power Amplifiers, Amplifiers with Controls, and Music Control Centers with Preamplifiers has been issued by Electro-Voice, Inc.

Bulletin No. 222 gives complete data, specifications, and prices on E-V 15-, 20-, 30-, and 50-watt power amplifiers; 15- and 20-watt enclosed Low-Boy amplifiers with external controls; and enclosed Music Control Centers for use

with E-V power amplifiers and AM-FM tuners.

The bulletin also includes information on the new E-V 100-watt high fidelity amplifier for multi-speaker installations and professional applications.

Free copies of Bulletin No. 222 are available on request.

## PORTABLE TRANSISTOR TESTER

The new General Electric portable transistor tester shown here is expected to be a boon to radio and television ser-



Transistor tester is new item by GE.

vice technicians and hobbyists. The transistor tester will check all types of junction transistors for short circuits, opens, leakage, and current gain. It is being sold with five universal replacement transistors and a transistor interchangeability chart by authorized GE tube distributors.

## V-M BINAURAL CONVERSION KIT

A new *Stere-o-matic Binaural Conversion Kit* is available which adapts any V-M tape recorder to play pre-recorded, staggered-head binaural tapes. In playback, a single magnetic tape bearing two separate sound tracks passes the staggered heads. One track is heard through the speaker in the tape recorder, and the other through a separate speaker two to ten feet away. The second speaker may be that of a radio or TV set.

The *Stere-o-matic Binaural Conversion Kit* is manufactured by the V-M Corporation. It retails at \$16.95; the installation fee is \$10.00. Information about the kit is available on request.

## HIGH FIDELITY DEMONSTRATION SYSTEM

A complete *High Fidelity Demonstration System* especially designed to help record dealers demonstrate and sell more high fidelity records has been announced by Gray Research and Development Co. of Manchester, Conn.

The system consists of the Gray Viscous Damped Tone Arm, Turntable, Amplifier, Pre-amp, and Speaker. It is available on a very liberal long-term rental-purchase plan.

Complete information is available from the manufacturer.

# TIPS FOR THE WOODCRAFTER

by George Bowe

## Wood Finishing

Many a home craftsman who can produce cabinet work of professional quality shudders when the time comes to apply the finish. As handsome as his handiwork may look in its smoothly sanded, unfinished state, he knows that a finish must be applied for protection as well as to accent the beauty of the grain. Ah, but there's the question—will the finish beautify or will it label the workmanship amateurish?

Although wood finishing is a time-honored art, I have found that the average amateur craftsman can produce a more-than-adequate finish if he will acquaint himself with the fundamentals and carefully follow directions. The subject is a large one and we'll confine this discussion to the area affecting home sound reproduction. Let's begin with a glossary of a few of the terms used in finishing:

*Antiquing*—A finishing technique to give the appearance of age and wear. Sometimes called *highlighting*, or *glazing*.

*Bleach*—Any chemical solution used to lighten the color of wood.

*Denatured alcohol*—A solvent for shellac.

*Filler*—Any inert material to fill or level porous surfaces.

*French polishing*—A hand-rubbed finish using prepared French polish or shellac diluted with alcohol and applied with a cloth pad, a drop of linseed oil added occasionally.

*Lacquer*—A fast-drying finishing material containing nitrocellulose in combination with various gum resins and solvents.

*Linseed oil*—A vegetable oil pressed from the seeds of the flax plant. Heating and filtering the raw material produces raw linseed oil. When heated to a high temperature, to admit a small amount of metallic drier, it becomes boiled linseed oil.

*Oil stains*—Oil-soluble colors in naphtha or a similar solvent are called oil stains of the penetrating type; oil-soluble colors in naphtha or turpentine, but with pigment colors and a binder such as linseed oil, are called pigment oil stains. The latter type of stain is intended for soft woods that absorb

stain readily; it has little effect on hard wood.

*Penetrating stain*—Stain color in oil or alcohol. For hard, close-grained woods.

*Primer*—The coat of finishing material that is applied first to the bare wood or metal.

*Pumice stone*—A natural stone which is pulverized to produce a soft abrasive. Extensively used in rubbing finishing coats.

*Rottenstone*—A type of limestone with negligible cutting action, but a good polisher. The Belgian and English grades are the only suitable types for furniture rubbing.

*Sealer*—General term applied to any finished coat applied over another to seal it in, or on bare wood to seal the pores and stop suction.

*Shellac*—A natural gum resin soluble in alcohol. The standard mix is 4 pounds of resin to 1 gallon of alcohol



and is called a 4-pound cut. The natural color of prepared shellac is orange. White shellac is obtained by bleaching orange shellac.

*Solvent*—Any liquid capable of dissolving a certain material is said to be a solvent for that material. For example, turpentine for paint, alcohol for shellac, lacquer thinner for lacquer.

*Steel wool*—Fine strands of steel used for rubbing various finishes, removing rust, etc. Commonly made in 7 grades: Nos. 3, 2, 1, 0, 2-0, 3-0, and 4-0. The last grade, 4-0, is very fine and will not scratch the finest surface.

*Thinner*—A general term applied to a blended lacquer solvent.

*Water stains*—Colored dyes soluble in

water. Good water stains are not available generally but they can be obtained.

The technique of finishing varies with the individual professional craftsman and with the materials used, but here is a basic schedule for general application of stained finishes:

- 1) Sandpaper the work very carefully.
- 2) Apply the stain.
- 3) If coarse, open-grained wood is used, apply paste filler.
- 4) As a sealer, apply a wash coat of shellac.
- 5) Rub with steel wool.
- 6) Apply top coats of varnish, shellac, lacquer, etc.
- 7) Rub to a satin finish.

Now let's take these operations step by step. Thorough sanding is the very basis of a fine finish. With new wood use a fine grade of sandpaper and always sand with the grain. Be certain to eliminate all scratch marks or the stain will amplify them. Garnet paper is superior to the less expensive flint types. When sanding a large surface wrap the sandpaper around a wood block. For sanding turnings in furniture legs, a strip of emery cloth does nicely. Dust all surfaces thoroughly before proceeding.

For staining, all that is needed is the stain and a brush or cloth to apply it, and some clean, lintless cloths to remove excess stain. It is hardly worth while to mix your own stains because manufacturers produce at least half-a-hundred stain colors to choose from. If you cannot get exactly the shade you want in one color, blend two or more colors in any desired proportion. For instance, the orange color of an antique maple stain can be toned down with a touch of the same brand of walnut stain. Do the mixing in daylight (artificial light does not give true colors). Before applying the stain generally, try it out on a portion of the wood not exposed to view to be sure the shade is satisfactory. Once the stain is applied to the entire piece, leave it on long enough for it to penetrate and give the desired color. The longer the stain remains on the wood the darker the color will be. When the proper tone has been reached, wipe off the excess stain with a cloth. If the color is not deep enough, wait



until the first coat is dry and then apply a second coat. Open-grained woods such as mahogany, oak, walnut, chestnut, and ash should have a paste filler to provide a smooth surface, unless a rustic effect is desired. Fillers are available in stock colors such as natural, white, light and dark oak, red and brown mahogany, light and dark walnut, and a few others. However, most any shade can be matched by mixing oil colors or dry colors with the filler. Mix the color slightly darker than desired since the filler will be lighter when dry. Thin the filler with turpentine and apply it to the wood across the grain and then lightly brush it out with the grain. When the filler loses its gloss and takes on a flat appearance (usually in about 20 minutes), wipe off the excess with a hard, lint-free cloth. Follow the same procedure as when applying it—first, across the grain and then lightly with the grain. Let the work dry overnight.

The next step is a sealer coat, and 1 part of 4-pound cut shellac to 4 parts denatured alcohol also makes a good wash coat. The sealer coat brings out the high lights and adds transparency to the finish. For dark brown and red mahogany finishes use orange shellac. For a light finish white shellac is preferred. Mix the two when a medium finish is desired. An unpleasant gray cast is produced on a dark finish if white shellac is used, while orange shellac produces an amber effect when working with light woods. Many times the amber tone is desirable with a maple stain and for this effect use orange shellac.

Steel wool, judiciously used, is a time and work saver in wood finishing. After the shellac sealer has dried completely, rub lightly with the grain using fine steel wool. Be extra careful as you reach the edges of the wood. Let up on the pressure or you may find yourself digging into the wood and removing some of the stain. Clean away all traces of the steel wool before attacking the final coats.

What shall the top coats be and how many? The choice of the finish coats is up to you. Whatever you choose, I suggest three coats for beauty and protection. Let's examine the variety of finishes available. Varnish is extremely durable and does not mar nor stain easily. Perhaps it is the most difficult finish for the amateur, but it is recommended for surfaces that must be waterproof. When using varnish, work in a room as dust-free as possible. Never varnish in damp weather. Regular varnish has a high gloss, but a flat-finish varnish is also available giving a soft, hand-rubbed effect without the work.

Lacquer is another durable finish, and one that dries very rapidly and

therefore does not collect much dust while drying. It makes an exceptionally smooth finish, but a bit of practice is needed to do a good job. For brushing, lacquer should be diluted one-third with lacquer thinner. Flow the lacquer on and don't try to brush over the stroke again; overlap the preceding stroke as little as possible.

Shellac is inexpensive and generally wears well although it is not as resistant to heat and liquids as some other finishes. However, it is one of the best all-around finishes because it is easy to apply and it dries quickly. Don't use shellac as it comes from the container—reduce it with alcohol. With 4-pound cut shellac the first coat should be 2 parts of alcohol to 1 of shellac; the second coat should have 3 parts of alcohol to 4 parts of shellac; for a third coat mixture use 1 part alcohol to 4 parts shellac.

With any of these finishes rub lightly after the first and second coats with fine steel wool. Then comes the crowning touch after the third and final coat—a rubdown with powdered pumice stone and oil. Use a thin oil such as No. 10 motor oil or sewing machine oil. Mix the powder with the oil until it becomes a light, creamy mixture. Apply it to the finish with a soft cloth or piece of felt, rubbing with the grain of the wood. Rub lightly to prevent wearing through the finish. When the desired satin luster has been achieved uniformly, clean the surface with a cloth dampened with turpentine. Allow a week for the finish to harden, then polish by rubbing with rottenstone and oil. Clean with a cloth slightly dampened with carbon tetrachloride and finish the job with a polishing cloth or a soft chamois.

In addition to the conventional finishes just discussed, there are numerous new ones now available—synthetics, plastics, penetrating sealers. Some of them give surprisingly good results with a minimum of work. Some of the sealers are colored so that staining, sealing, and finishing can be done in one operation. There are also stain wax finishes that are especially suitable for paneling and built-ins. The use to which a surface will be subjected should be an important factor in the choice of a finish. Talk this over with your dealer and ask for his recommendation.

Modern blond finishes frequently require bleaching the wood by the use of chemicals. Buy a commercial furniture bleach and follow directions carefully. Always remember that working with bleaches is working with acids, so wear rubber gloves and avoid getting any of the bleach on your clothes. It may be necessary to make several applications on some woods. Don't be afraid to lighten more than

*Continued on page 42*

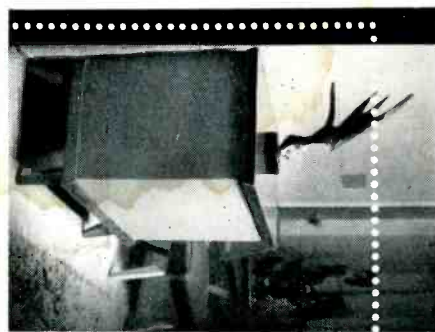

## .....Systematic GROWTH into the Elegant.... **BOZAK B-305**

In a living room of average size, the music-lover of above-average taste in décor and audio quality will delight in the quiet elegance and restful fidelity of the Bozak B-305—in its class the purest voice for a fine music system. With 30 clean Watts, performance from 35 cycles to beyond 16 kc is phenomenal for subtlety of detail and effortless handling of dynamics. Transient response is outstanding; distortions vanish.

The ingly-low, listening ease and realism unapproached by any speaker system near its price. The infinite-baffle cabinet is in walnut birch, or mahogany veneers. If you wish, grow from a single B-207A Coaxial to the full three-way B-305 with two coaxials and a mid-range—without carpentry, tuning the enclosure, or balancing the speakers. From the lowest orchestral tones to the ultra-sonic shimmerings of the triangle, it's all there in its proper values—and it's all yours, with a Bozak B-305. Write for full information on

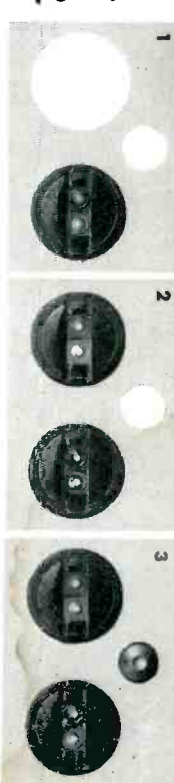

*The Very Best in Sound*  
Export Office: Electronics Manufacturers' Export Co., Hicksville, N. Y.  
**The R. T. BOZAK SALES Co. • Box 966 • Darien • Conn.**

1. E-305 Enclosure with B-207A Coaxial; 20 Watts; 40 cycles to beyond 16 kc.
  2. E-305 Enclosure with two B-207A's; 30 Watts; 35 cycles to beyond 16 kc.
  3. The full B-305: two B-207A's, one B-209 Mid-range, N-102 Network; 30 Watts; 35 cycles to beyond 16 kc with superb clarity of the "middles".
- Bozaks start at \$83.85



## SOUND SERVICING

by Irving M. Fried



### Down With Distortion!

In writing this I must assume that if you are to be able to apply this information gainfully, you will own or have access to an oscilloscope, a vacuum-tube voltmeter, and the most useful of all tools in audio, the intermodulation analyzer. Let us assume, too, that you have a stable power amplifier (if not, go back through the last two issues), that it has no appreciable hum, and that it is putting out somewhere near its rated power.

The very next criterion on amplifier performance is its intermodulation distortion. And it is here that, again, many highly regarded home-built units (as well as many famous-name ready-builts) fall down. Let us suppose, for instance, that your amplifier, instead of having "under 1% IM at 50 watts", actually has 0.7% at 1 watt, and 27% at 50 watts (typical of actual measurements I have made). What do you do next?

The wise man generally tries the easier measures first. And the easiest thing to do to an amplifier, in trying to improve its performance, is change its tubes. Change the cheapest tubes first (not the output tubes). The following order of tube changes is the general practice of the writer, who is 1) lazy, and 2) interested in keeping down total repair costs and tube replacements.

First tube change: the driver stage. In many circuits, the relative imbalance in the balanced drive stages is very critical. You may, on the first tube replacement, reduce low-level intermodulation amazingly. If not, try one or two other tubes in the same socket (of the same tube type, naturally).

Next step: the stages preceding the balanced stages. Generally, unless a tube is just about dead, you can't improve distortion measurements much by working back in those stages—but there are exceptions. For instance, one of the new kits using a pentode voltage amplifier as an input stage is critical as to tube condition.

Last step on tubes: the output stage. Don't believe that, just because the tubes seem balanced on static measurements, they can't be contributing distortion. Intermodulation distortion is a general look-see at amplifier performance—an output stage can be in

perfect static balance, yet put out completely unbalanced (and distorted) signals to the output transformer.

In many cases, merely exchanging the two output tubes will lower intermodulation distortion, correcting some sort of dynamic imbalance. Or you may find that just one new output tube, put in the proper socket, will bring back the specified performance. But when the IM is far beyond "specs", chances are you need two new and fairly evenly matched output tubes. How evenly matched? That depends on the circuit and the quality of the output transformer. Some circuits are extremely critical in the matter of output tube balance; generally, these are the ones with all the balance pots. Other circuits have tolerances of 10% or even 20% imbalance before distortion goes up very much.



If the amplifier runs properly after tube replacement, you can skip the rest of this article; it is for those unhappy souls for whom tube-jiggling is no help in reducing measured distortion.

Often, because of original imperfections or later deterioration, tube changing can't produce the performance quality of which the circuit is inherently capable. The remaining sections will not deal with complete redesign of circuitry for better performance: biasing, decoupling, hum control, output transformer choice, and stage-by-stage design; it will deal with what you can do to restore performance. Alas, many amplifier circuits today cannot possibly meet the claims made for them, no

matter how perfect the condition of the circuit resistors and capacitors.

Provided that the circuit is properly designed, low intermodulation readings are generally contingent on balanced AC voltages into and out of the output stages. Therefore, if you want a quick check on where the distortion originates, check through the driver stage as follows: send a single tone signal into the amplifier; you can use the low-frequency component from the IM analyzer or, better, an audio oscillator. With your vacuum-tube voltmeter set to AC, read the voltages on the grids of the output stage. If they are not within a few per cent of equality, you can expect most of your distortion to originate before that point. If the voltages are almost or exactly symmetrical, you can expect most of the trouble to be in the output stage.

Let us say, for instance, that you measure 10 volts on one side of the circuit (at the output tube grid), and 15 volts on the other. You have drive troubles. Check back through each balanced stage, until you find the place where the AC voltage readings are the same on each side. Then, you can expect the trouble to be within the stage that unbalances the readings.

Since you have already tried tubes, that shouldn't be the reason. But before you go ahead, try another tube anyway (or tubes, if the sides of the balanced stages are in separate tube envelopes). Then, if the voltages are still significantly unbalanced, check the following: 1) plate-load resistors (from B+ to each plate—these should be matched within 1%); 2) any cathode resistors that aren't common to each side—these should also be matched; 3) voltages at the plate and cathode terminals on each side—even when the resistors are close in value, current drain may vary side-to-side for other mysterious reasons, such as partial shorts in the sockets themselves!

What else should you check? Well, turn off the input signal and measure, at the most sensitive DC-volts position, the DC that leaks through the coupling capacitors between stages; if one grid is biased up even a few volts, the cutoff characteristics and power-handling ability are severely limited. Remedy, if you find anything but infinitesimal leakage: replacement.

Then, if you really want maximum



balance, feed in a low-frequency signal, say 20 cps, and then a high-frequency signal, and check the balance stage by stage. Let us say that the low-frequency signal is larger on one side than another, while a middle-range signal is balanced throughout; you should check your interstage capacitors by substitution, and the grid resistors also, since one side may be giving more phase shift at a given frequency than the other. You may even want to check the signal out of the phase inverter. If it is unbalanced here, you will have to know a great deal about phase inverter theory for proper repairs. Probably the best thing to do in that case is check all resistor and capacitor values for agreement with the schematic diagram.

If the high-frequency signal is unbalanced, while middle-range signals are not, you should check the phase inverter or any special phase-correcting networks to ground from either side. Remember that certain circuits are purposely unbalanced at frequency extremes, for purposes of stability.

After playing around with tubes, resistors, and capacitors, and balancing all stages, if you still just can't get low distortion readings you might be successful by careful unbalancing! I have found that certain "problem" amplifiers seem to improve in every respect when I purposely unbalanced a plate load resistor on one side by 10%! The reason might be basic imbalance in the output transformer, or some other real defect; the fact remains that purposeful drive imbalance may improve performance when nothing else helps.

One other avenue of improving performance remains: optimizing bias voltages. If an amplifier has a fixed-bias output stage, or adjustable cathode bias, the experimenter can change bias while reading intermodulation and adjusting for lowest readings at low and high power output. One note of caution—make sure the amplifier puts out its rated power after adjustment, and that voltages on the output stage are normal, just to make sure you aren't over-dissipating the tubes.

You can also try adjusting the bias stage by stage. Generally, this means removing the feedback connection and checking IM in each stage, while changing the cathode resistor, until you get the desired drive with minimum distortion over the operating range.

If, after all these stratagems, your distortion is still high, you ought either to 1) recalibrate the IM analyzer, 2) throw it away, or 3) sell the amplifier to a "friend" and buy a better one.



FAIRCHILD

The BEST-DESIGNED  
Arm You  
Can Buy!



**FAIRCHILD**  
Model 280  
PLUG-IN  
TRANSCRIPTION  
ARM

No matter how good your pickup, it will *not* sound right unless mounted in a proper arm! The 280 SERIES ARMS (newly improved in ruggedness and appearance) make even the best cartridge sound better because they feature:

1. Fundamental resonance below audibility with any high quality cartridge.
2. Accurately calibrated offset and overhang for perfect tracking of all records.
3. Laterally balanced—No delicate leveling required—no skidding across records.
4. Quick Cartridge Change (Audio League says "Less than 5 second dead interval").
5. Accepts all standard cartridges (even GE turnaround) as PLUG-IN.
6. NO HUM when removing cartridge slide—leave volume on full, if desired. and many other exclusive high-performance features. Net Prices: 280A (12") \$33.95; 281A (16") \$35.95.

See your nearest Quality Hi-Fi dealer or write:

**FAIRCHILD RECORDING EQUIPMENT CO.** 9th Ave. & 154 St., Whitestone 57, N. Y.

The most modern  
**CONTROL CENTER**  
and **PREAMPLIFIER**  
you can buy!



**FAIRCHILD**  
Model 240  
PREAMPLIFIER -  
EQUALIZER

where **PERFORMANCE . . . not PRICE** is **PRIMARY!**

**Modern One-knob equalizer** (type used in professional studios) — gives *correct* equalization *quickly, automatically* and the same everytime—both turnover and roll off.

**Modern Cascade input circuit**, gives highest gain with least noise (another Fairchild "first").

**Modern Exclusive "Red-Knob" Listening Level Control**—Obsoletes conventional loudness controls—gives low-level compensation that *sounds right*.

**Modern Exclusive "Balanced-Bar" Tone Control**—Easiest of all to see—Easiest to use.

**Modern Styling** by Raymond Loewy Associates.

And many other features...Net \$98.50

The most quoted source of High Fidelity information

## THE AUDIO LEAGUE REPORT

You can guess if you wish — but those who really want to know subscribe to . . .

### THE AUDIO LEAGUE REPORT

The only consumer testing and evaluating service devoted exclusively to high fidelity equipment. Factual, authoritative, unbiased—completely independent and supported solely by subscription. Read by the experts and those desiring the plain unvarnished truth.

If you cannot afford to make mistakes in the selection of high fidelity components—or want to know their true comparative performance, you should subscribe to

### THE AUDIO LEAGUE REPORT

P. O. Box 555

Pleasantville, N. Y.

Full remittance must accompany order. Twelve issues only \$4., \$7. for 24, \$9. for 36. The entire file of Volume 1 (twelve issues) available for \$4. or as part of a 36-issue subscription. Special introductory offer: Two recent issues for \$1.

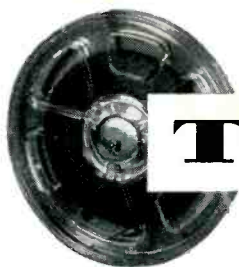

# Tape News and Views

by J. GORDON HOLT

## Monitoring and Volume Indicators

One of the more important differences between a live program and a disc recording is the much wider volume range of the original. Overcutting a disc recording is a cardinal sin, with consequences that may include crisscrossing grooves and chipped cutting styli; any one of these little technical flaws can spoil the whole recording. Not so with tape, however.

The most that is likely to happen if a tape is grossly overloaded is a blast of profoundly impressive distortion and, perhaps, partial magnetization of the record head. But the tape will not break or disintegrate, and the oxide won't fall off. We can still play the overloaded tape, and it can be enjoyed most of the time as long as the whole thing isn't distorted. As an example of what a hopelessly overloaded tape might sound like, there is the last band, first side, of Emory Cook's weird "Compleat in Fidelity" disc. This band is subtitled "Technical Section: Wide-Range Distortion (Organ)."

The point of this month's discussion is that it is *not* necessary to hold the volume limits of a tape recording within narrow bounds. Too many recordists tend to ride gain like radio engineers, keeping themselves in perpetual anxiety as to whether the signal will either overload the tape when it gets loud, or disappear under the hiss and amplifier hum when it gets soft. For the owner of a really poor tape recorder, this extraordinary caution is probably justified—he has, perhaps, found from sad experience that his recorder is noisier than acoustic disc recordings and that it folds up and splatters when the neon bulb shows overload. But for the average home recorder, these limits are not nearly as close together as many users seem to believe. It is often possible to realize much more fully the potential dynamic range of the tape medium than is done.

I am not advocating unrestrained use of high-level overload as a means of whooping up tape recordings. The peak volume that begins to produce audible stress on tape should still be considered the upper limit, but in the other direc-

tion there is often considerable room for expansion.

In figures, 60 or 65 db is usually quoted as the "ultimate" attainable signal-to-noise ratio of a top-quality professional tape recorder. It is also asserted that the best LP disc recordings can take 50 db, with 55 db sort of pushing things a bit.

This means that, for all intents and purposes, a commercially produced disc cannot have the recorded volume range of a top-notch tape.

A reasonably good tape recorder should be able to transcribe satisfactorily the entire volume range of a live orchestra or organ performance, as long as the listener is willing to accept one or two inevitable compromises. The signal-to-noise ratio of a recorder is generally stated as the difference in db between the peak recording level (3% distortion point of the tape) and the measured noise produced in the absence of a recorded signal. This does not, however, mean that if the volume of

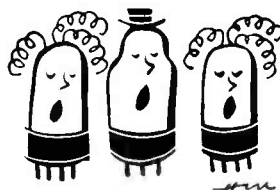

the signal falls below the noise level it will be immediately and irrevocably lost to the listener. It can in fact go considerably below the noise level and still be audible and even enjoyable for short periods of time, because the accompanying noise is constant in level and distributed evenly.

Clicks and pops on discs would not be nearly as annoying as they usually are if the *average* noise level were not so low. These same blemishes on, say, an old shellac record are far less noticeable because the average noise level is higher.

The ear can readily adapt to a fairly high noise level as long as the noise remains constant. This ability to tolerate unchanging noises partially offsets the effects of very low recording levels on tape. The actual volume at which the tape hiss is audible to the listener will

also depend largely on the smoothness of the reproducing system; an unpeaked speaker system will reduce even a fairly high hiss level to the point of inaudibility without affecting the recorded signal level or range.

A great deal of the emotional impact of music comes from the expression of controlled dynamics, so if a recordist can accept a slightly higher noise level on his tapes, it will pay him to set his record volume to just below the overload point on high-volume passages, and to let the low-level passages take care of themselves. If some experience with this full-dynamic-range technique shows that the hiss and hum are annoying enough to detract from the enjoyment of the music, then experimentation might be in order to see how far the very low-level passages must be pulled up until a satisfactory compromise is reached. But the starting point should always be full-range—the closer this can be approached, the more effective is likely to be the recording.

If at all possible, the level should be set before starting to record. When pirating something off the air, this is simply a matter of tuning in to the preceding program and setting to that. With live performances, though, this may prove more difficult, since it is almost impossible to anticipate beforehand just how loud things are likely to get. The best thing to do, of course, is to try making a few trial recordings during a rehearsal, with the mike in different spots and at different level settings. At that time, a mental note can be made of the volume-control setting that gives a peak record-level indication on the loudest program passages.

On a recorder having a single neon bulb for volume indication, "peak recording level" usually means that point at which the bulb glows fairly brightly. The single-bulb indicator, though, gives no accurate indication of what is going on below the overload point. For this reason many home recorders have two indicator bulbs, one indicating maximum undistorted recording level and the other lighting up only when the tape is overloaded. The best setting for this type of system is that at which the *NORMAL* bulb glows on the loudest passages, but



the OVERLOAD bulb glows rarely or not at all.

The "magic-eye" indicator used in better-quality home recorders enables the recordist to keep a more constant check on what goes on the tape, since it will register signals ranging from overload (eye closed or overlapping), through normal recording level (eye just barely closing on loudest passages), down to considerably below full volume. The trouble with neon bulb indicators is that they indicate when there is too great a recording level, but do not show when the level is set too low. A magic-eye indicator, though, will give indications over a fairly wide volume range.

Professional equipments invariably have VU meters, since they provide accurate indications of program intensity over a very wide volume range. VU meters are calibrated either in Volume Units, from -20 to +4 db, or in per cent modulation, with the 100% mark coinciding with the zero VU mark on the scale. The usual meter face has both calibrations, with one or the other being above the scale arc as the major scale. When recording, the zero-db or 100% modulation point represents "normal" or full recording level, which is usually taken to be the 1% or 2% harmonic distortion level of the tape at 400 or 1,000 cps.

The main differences between a VU meter and a magic-eye indicator are their respective dynamic characteristics and their ranges of indication. A magic eye responds instantaneously to transient peaks in the program material, since the varying electron beams have, for all intents and purposes, no inertia at all. A VU meter's indicator, though, has a very definite inertia which limits its response to short-duration peaks, and the movements are additionally damped to prevent violent overshoot when the needle flips upward. For this reason, it is customary to calibrate the meters to read full record level at considerably less than the actual overload point of the tape, to leave room for safe handling of transients that won't show up on the meter.

The VU meter's main advantage is that it very accurately indicates program levels well below the maximum recording level, so it is usually not necessary to wait for program peaks before the record level can be set accurately. Also, it gives quantitative indications of changes in volume.

A major reason why VU meters are not generally applicable to home recorders is that they are designed to be used across a 500- or 600-ohm line, which is available only in professional-type recorders. One type, though, which has recently become available from the Kilpatrick Electronic Laboratory, incorporates a vacuum-tube voltmeter circuit which enables the meter to be

bridged directly across a high-impedance circuit in any recorder. It is supplied with adapters that can be plugged between the appropriate tube and its socket in the recorder. It is also possible with some recorders to connect a standard VU meter, such as those made by Marion Electrical Instrument Company, Burlington Instrument Company, Weston Electrical Instrument Corporation, Triplett Electrical Instrument Company, and Simpson Electric Company, directly into the speaker output circuit of a tape recorder which has its own power amplifier and speaker and which uses the same control for both record and playback volume. Such a connection requires a resistive network to bring the level into the meter down so that it reads zero for normal recording level. It might also necessitate additional circuit modifications to keep the meter connected if the recorder automatically silences the speaker while recording, plus a switch to defeat the meter while playing back.

Even if there is enough power available to drive a standard VU meter from a high-impedance source, this type of connection should be avoided. The inherent electrical non-linearity of the meter will introduce serious distortion in the signal if it is bridged across a high-impedance source.

Audible signal monitoring can generally be done through the high fidelity system that the recorder is being used with. But under certain circumstances, particularly when using a microphone for live recording, it will be necessary to use headphones. These should not be carelessly chosen, for the quality of the phones will determine how much the recordist is able to tell about program quality and quantity. Using a good pair of phones, it is possible to tell how a recording will actually sound *before* it has been recorded, just by listening to the signal going into the recorder.

This requires considerable practice, because the acoustical balance of even the best headphones is usually quite different from that of a loudspeaker system. It takes some time to learn that when bass is just barely audible from the phones it may be quite strong in the signal itself.



Communications headphones are practically useless for recorder monitoring. Besides having extremely poor frequency characteristics, they tend to load the signal circuits of some recorders so much

*Continued on page 45*

## new knight-kit buy! AUDIO GENERATOR KIT

with these exclusive advantages:

- Output constant  $\pm 1$  db all the way out to 1 MEGACYCLE
- Less than .25% distortion



EASY TO  
ASSEMBLE

Model F-137  
ONLY

**\$31.50**

F.O.B. Chicago

### BUY DIRECT AND SAVE!

Save money—have performance equal to instruments at many times the price! Provides wide range, low distortion audio frequency source for checking high fidelity amplifiers and other audio equipment. Frequency range: 20 cps to 1 mc in 5 ranges; not over 1 db variation over entire range. Output: 10 volts into any load, even as low as 600 ohms. Less than .25% distortion from 100 cps through the audible range; less than .5% when driving 600 ohm load at maximum output. Continuously variable step-attenuated output. Circuit as developed by U. S. Bureau of Standards. Complete kit with all parts, professional ease and complete instructions. Shpg. wt., 17 lbs.

Model F-137, Audio Generator Kit. Net only **\$31.50**

ORDER NOW—USE COUPON BELOW

**free** ALLIED'S  
SPECIAL 100-PAGE  
HI-FI CATALOG



This leading 100-page book shows you how to select a Hi-Fi music system at lowest cost. Tells you what to look for in each unit; shows many handsome, practical installation ideas. Offers you the world's largest selection of complete systems and individual units from which to make your money-saving choice. To understand Hi-Fi, to own the best for less, you'll want this invaluable catalog. It's FREE—write for your copy today.

**ALLIED RADIO**  
America's Hi-Fi Center

OUR  
35th  
YEAR

ALLIED RADIO CORP., Dept. 89-E-2  
100 N. Western Ave., Chicago 80, Ill.

Send me Model F-137 Audio Generator Kit. \$.....enclosed. (Send check or money order.)

Send FREE High Fidelity Catalog.

Name.....

Address.....

City.....Zone.....State.....

*More and more discriminating people are discovering this unique*

## COMPLETE RECORD MAIL ORDER SERVICE

Quick, intelligent service. We can supply you  
with anything currently available on disc.

Complete catalog of the famous WESTMINSTER W-LAB SERIES. SINGLE	12 inch records	\$ 7.50
Westminster Test record TRC . . . Check and Double Check.	12 inch	\$10.00
Victor LM 1802. "An Adventure in High Fidelity"	12 inch	\$ 4.98
Victor LM 1922. The Sounds and Music of the RCA Electronic Synthesizer.	12 inch	\$ 3.98
Capitol SAL 9020. A Study in High Fidelity.	12 inch	\$ 6.95
Capitol SAL 9027. Further Studies in High Fidelity.	12 inch	\$ 6.95
Vox DL 130. This is High Fidelity.	12 inch	\$ 6.95
Vox DL 180. Spotlight on Percussion.	12 inch	\$ 6.95
Full line of Cook Laboratories remarkable records, including Voices of the sea . . . Earthquake . . . Steel band . . . Mariachi.	10 inch	\$ 3.98
Audio Fidelity AFLP 1081. The Brave Bulls. Music of the bullfight ring	12 inch	\$ 4.98
AFLP 1803. Drum Rhythms of Cuba, Haiti and Brazil.	12 inch	\$ 5.95
AFLP 901. Merry-go-round music.	10 inch	\$ 5.95
AFLP 902. Drums of the Caribbean.	10 inch	\$ 4.00
AFLP 904. Circus and Calliope Music.	10 inch	\$ 4.00
AFLP 906. Bawdy Songs and Backroom Ballads.	10 inch	\$ 4.00
Superb realisation of the full sound of the cathedral organ of Grace Cathedral, San Francisco, played by Richard Purvis.		
Hi-Fi Records R 703 and R 704.	two 12 inch	\$ 4.95 ea.
The sound of the mighty Wurlitzer organ, played by George Wright, realistically captured on Hi-Fi Records R 701, R 702	two 12 inch	\$ 4.95 ea.
Richard Dyer-Bennet 1. At last, a brand new high fidelity recording by this famous folk singer, of English and American folk songs. A true presentation of his superb artistry.	12 inch	\$ 4.95
Sounds of nature . . . Birdsongs . . . Frogs etc. on Ficker and Cornell University Records. Ficker 12 inch \$7.95 Cornell 12 inch \$7.75	10 inch	\$ 5.00
THE SPOKEN WORD. Caedmon's unique catalog of plays, poetry, prose, stories . . . High fidelity recordings of great literature by Poe, Whitman, Chaucer, Faulkner, Millay, Dylan Thomas, O'Casey, Tennessee Williams, Ogden Nash, Colette Macleish, Auden, Sitwell. Some read by the authors, others by famous actors.	All 12 inch	\$ 5.95
McIntosh MM 105. Breaking the Sound Barrier.	12 inch	\$ 4.98
Music Minus One. Fine recordings of great chamber music, with missing instrumental parts, permitting you to play your own instrument with the recorded ensemble. Wonderful for the amateur and professional chamber music player. Catalog on request. All LP records, complete with score.	All 12 inch	\$ 4.98

- ★ Every order over \$6.00 is mailed POSTAGE FREE anywhere in the U. S. A. On orders of less than \$6.00, please add 40¢ to cover mailing charges.
- ★ Our service is fast, prompt and courteous. All records are sold at the manufacturer's suggested list price only.
- ★ THE MUSIC BOX is devoted to mail orders exclusively. The general public does not have any access to our stock, which is handled only by two people.
- ★ When ordering, simply list the records needed, plus your check or money order to cover their cost. To avoid delay, list substitutions, since we will never make substitutions without your written permission. Sorry . . . no C.O.D.'s.

**The Music Box**

BOX 637, GREAT BARRINGTON, MASS.



# READERS' FORUM

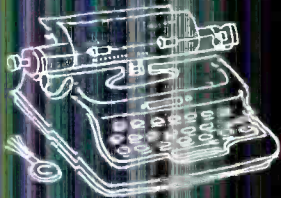

Gentlemen:

There has been some interest in the use of various brands of output transformers in the Dynakit Mark II circuit (AUDIOCRAFT, April 1956).

Although many of the better grade output transformers on the market can possibly be used in the circuit, I would like to point out that the phase characteristics of different transformer designs require different means of feedback compensation. For that reason, transformer substitutions should not be made without checks on the stability characteristics of the amplifier.

In addition, some of the performance specifications of the Dynakit are due to the optimum choice of impedance match with the A-430 transformer and EL-34/6CA7 tubes. The 4,300 ohm primary impedance and 10% screen loading were empirically established for clean, efficient operation. This is the only transformer specifically designed for this application and the use of stock transformers of other characteristics cannot be expected to give comparable performance. Impedance mismatches will either decrease maximum power or increase distortion as compared to correct matching.

David Hafler  
Dyna Company

Gentlemen:

On page 4 of the December issue of AUDIOCRAFT—there is an article by Joseph Marshall about the Pro-Plane Corner Coupler speaker system that interested me very much. Somewhere, the usually reliable Mr. Marshall has erred. He states that the system sells for less than \$100. I wrote the Pro-Plane people and received a circular which quotes this system at \$135. Quite an increase over \$100.

Can you tell me what happened?

John M. Cooper  
Cincinnati, Ohio

*Our sincere regrets that the price was incorrect. The error was caused by a simple misunderstanding.*—ED.

# EDITORIAL

WITHIN the past year, or a little more than a year, there have been several large-scale demonstrations of live and recorded sound compared directly. Everyone has heard of G. A. Briggs' daring experiments in the Royal Festival Hall and Carnegie Hall, for which he used Wharfedale speakers, Quad Amplifiers, Ferranti and Leak pickups, and Garrard turntables. An A-B demonstration of live *vs.* recorded organ in Saint Mark's Episcopal Church, Mount Kisco, is described fully on page 24 of this issue; the reproduced sound so perfectly duplicated that of the organ that no one could be sure which was playing. And on February 14, the Philadelphia Orchestra's second Pension Foundation Concert in the Academy of Music was entitled "Soundorama". M. Robert Rogers, president of WGMS (Washington, D. C.) was commentator for a program designed to show, in part, the present degree of advancement in sound reproduction techniques. Here also the orchestra alternated with recorded sound; reports indicated that the magnificent sound of the live orchestra was simulated "with remarkable fidelity". Equipment used included Ampex tape recorders, eight Jensen Imperial speaker systems, six Fisher 50-watt amplifiers, and three Fisher 80-C control units. Ampex has scheduled a San Francisco demonstration sometime in March of three-channel stereo *vs.* live sound; no reports had been received at the time this was written.

Now, all these demonstrations made use of components—from microphones to loudspeakers—that are readily available to the amateur recordist and sound enthusiast. Some are rather expensive, admittedly, but all are standard items that can be and are bought for home use. Does this prove that high fidelity equipment has reached such a state of perfection that completely realistic sound reproduction can now be obtained in the home? Not without qualification. Rather, we feel, it proves that nearly perfect sound reproduction is now possible *in the environment of the original sound*, or in one very much like it. That isn't a minor accomplishment by any measuring standard—but it can't "bring the symphony orchestra into your living room".

The best equipment is capable of creating a realistic illusion of solo

instruments or voices, and even small ensembles, just about anywhere if the recording has been made close-up so as to minimize the acoustic properties of the recording studio. Played in a small room, the sound takes on the acoustics of that room; and it is believable, because it could have originated in the playback room and because the original dynamics can be duplicated exactly. It would be equally believable if played in a concert hall, because the same conditions would be met. In the same way a close-up stereo recording of the Boston Symphony Orchestra, made and played back in Symphony Hall, could sound very much like the orchestra; played back in the Academy of Music, it is possible that you couldn't distinguish it from the live BSO. But played in your living room it would sound like a ridiculous, bright, loud, impossibly close miniature of the real thing.

Very well, you say, record it from a distance or add another microphone to get some of the big-hall reverberation on the tape. That certainly helps, and it is exactly what *is* done on commercial recordings. It doesn't help enough to make the playback completely convincing, though, and it seems doubtful that this objective can be accomplished through improved recording techniques alone—if indeed, it can be accomplished by any means. To begin with, recorded reverberation doesn't have the same subjective effect on the listener as the original because its directional characteristics are not the same. Second, you can make a living room fairly dead acoustically at high frequencies, but not at low and lower middle-range frequencies; its own reverberation, so different from that of a large hall, prevents achievement of a realistic atmosphere of spaciousness. Again, a small room does not have the same effect on bass propagation as a large one—it may well be that a loudspeaker system for home sound reproduction might sound more convincing if it weren't perfectly "flat" at the low end.

It is for these reasons primarily that we caution the hi-fi neophyte not to expect his new sound system to bring a *perfect* replica of the BSO into his living room. It won't fit.—R. A.

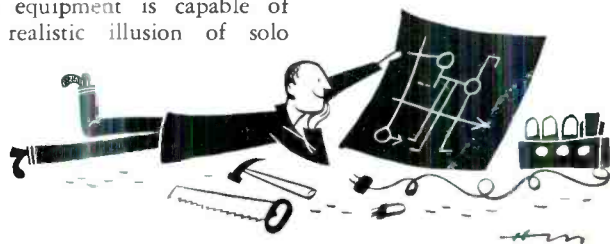

by Paul W. Klipsch

## Impedances in Multi-Speaker Systems

WHENEVER a home listener decides to assemble his own speaker system, or to replace one driver in an existing system, he must consider the twin factors of speaker efficiency and impedance. Efficiency is, broadly speaking, the ratio of acoustical power output to electrical power input. In the same kind of baffle one speaker that is more efficient than another will give more acoustic output for the same input power. If woofer A is more efficient than woofer B, for example, and they are of the same impedance, then replacing woofer A with woofer B in an existing system will result in a loss of relative bass output.

The impedance of a loudspeaker is a combination of the DC resistance of the voice-coil winding, a component

speaker load to the 16-ohm output tap when it is possible to do so; maximum power can then be developed in the broad range where the actual speaker impedance is close to the rated value. On the other hand, if the power requirements of the speaker system do not approach the amplifier's rated power, it may be possible in some cases to compensate for differences in efficiency of the various speakers in a system by connecting one of them to a mismatched amplifier tap. If an 8-ohm speaker is connected to a 16-ohm tap it will receive more power from the amplifier (at normal power levels) than it would if it were connected to the 8-ohm output terminals. These matters are examined in more detail in the following sections.

### Woofer Impedance

There are several types of bass speaker systems. Starting with the simplest:

1) *Cone speaker in large flat or infinite baffle.* The voice-coil impedance is a fraction of an ohm above the DC resistance at a trough that is usually somewhere between 200 and 400 cps. The first impedance peak will be from 1.5 to 10 times the resistance; somewhere between 30 and 70 cycles, the peak impedance will be from 20 to 100 ohms. The actual value will depend on the quality of the magnet (the better the driver, the higher the impedance peak); the quality of baffle (the better the baffle, the lower the peak); and many other factors, including the amount and type of elastomer used on the compliance rings. According to IRE definition, the nominal impedance is that of the voice coil in the first trough. The impedance curve resembles that of an unmounted speaker very closely.

Now, suppose such a woofer is used in a 3-way system that crosses over at 1,000 and 5,000 cps, and is designed for 16 ohms nominal impedance. The woofer has a damaged cone and the only available woofer replacement is 8 ohms. What to do?

Assuming the 8-ohm woofer exhibits substantially the same efficiency as the original 16-ohm woofer, the replacement will draw twice as much current, and have 3 db increased input and output. Since the woofer efficiency is

lower than that of the associated mid-range "squawker" if the latter is of horn type, the extra 3 db is beneficial—but this is not an unmixed blessing. The gain is obtained at the cost of drawing twice as much current from the amplifier; the amplifier needs to be twice as big. "Twice as big", however, may be misleading. If one watt was needed before, two will now be needed. So don't rush to trade your 10-watt amplifier for a 20, or a 20 for a 40. The mismatch probably will still let the amplifier coast along at peaks on the order of a tenth of its rated power.

About the crossover network. Unless some special protection is needed, the simpler networks have proved to be best. The one shown in Fig. 2 would apply to this specific case. Note that L1 is 2.5 mh. With the new 8-ohm driver unit, twice as much current is drawn; to keep the crossover point the same the inductance should be reduced to 1.25 mh. Of course, the wire size should be such that the resistance is very small compared to 8 ohms, say 0.8 ohm if we tolerate 1 db dissipation loss. But this inductance change is not absolutely necessary. The speaker

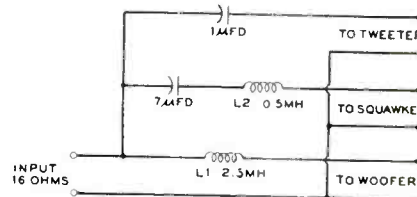

Fig. 2. A three-way crossover network.

change, then, could be made with no compensating changes at all, but with the admitted desirability of reducing L1.

One warning. If you have an amplifier of *genuine* high quality, just skip this part. But if you have a cheap "hi-fi" amplifier typical of some for which the rating is, say, 10 watts, but the actual capacity at 50 cps is only 1 watt, you can bet the overloading will be worse with the speaker mismatch than it was before.

As another example, take the same setup as before, but substitute a 4-ohm replacement woofer. The mismatch is now 4:1 instead of 2:1, and that is too much. The amplifier is not only being asked for more, but its capacity

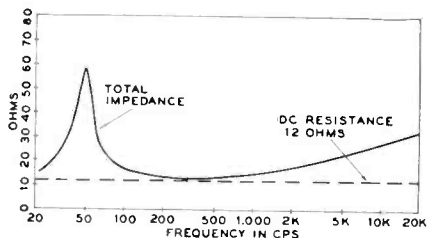

Fig. 1. Typical speaker impedance curve.

of radiation resistance from the air load on the diaphragm, and a reactive component. At low frequencies, this reactance is due primarily to resonance of the diaphragm and its suspension; at high frequencies, to the inductance of the voice coil. The impedance curve of a typical unmounted, wide-range speaker rated at 16 ohms is shown in Fig. 1. As shown, the DC resistance as measured with an ohmmeter would be about 12 ohms. Total impedance varies radically with frequency; there is a sharp rise at the bass resonance frequency, then a trough at which the impedance is close to the nominal 16 ohms, and then a gradual rise as the frequency increases.

Modern feedback amplifiers are relatively insensitive to the load impedance, so far as distortion is concerned, provided they are not operated close to their maximum power capabilities. But they must have loads of the proper impedance in order to develop *maximum* undistorted power. That is why it is preferable to connect a 16-ohm



to give more is reduced. One trick is to hook the woofer to the 8-ohm tap, as in Fig. 3. This reduces the mismatch back to a tolerable 2:1. The inductor L1 becomes 0.63 mh. If an 8-ohm tap is not available, the manufacturer of the amplifier may be able to supply a transformer with both 8- and 16-ohm taps. But—regardless of mismatching—never use an external matching transformer. The exciting current of one transformer is bad enough; most of the distortion derives from the transformer. To compound the felony with still more transformer-caused distortion is not going to help the listener-fatigue problem.

2) *Acoustic phase inverter or bass reflex.* The speaker impedance is more complicated, usually exhibiting two bass peaks instead of one, and usually of lower amplitude. The nominal impedance is that of the major trough following the paired peaks. The same substitution considerations apply as for infinite-baffle woofers.

3) *Combination horn and direct radiator,* especially corner-horn back-loading systems. While the essential function is that of a direct radiator, the bass range is extended and bass efficiency increased by connecting a horn throat to the back of the cone radiator through an acoustic low-pass filter. The cone is used for two ranges, being horn loaded up to 150 or 200 cps, and acting as a direct radiator up to, say, 1,000 cps. The nominal impedance is the trough impedance in the direct radiator range. Thus, for a 16-ohm system, a 16-ohm drive unit would be best, this unit showing about 12 ohms DC resistance. As in the former cases, you can get away with an 8-ohm driver in a 16-ohm system.

4) *Horns, specifically with closed back air chamber* (Klipschorn, Georgian, Classic, Imperial, Patrician, etc.). The throat impedance of the horn contains both resistive and reactive components, the reactive quantities exceeding the resistive values in the lowest octave. This means that the current in the voice coil and the resultant force would be used up mostly in overcoming the reactance instead of in driving the useful radiation resistance. It happens that the reactive component varies with frequency in the manner of a capacitance, but with the opposite sign. Thus it is possible to add an acoustic capacitance of proper size to cancel out the inductive reactance of the horn throat. The back air chamber performs this function and unloads the diaphragm of reactive forces. Thus the diaphragm faces only the radiation resistance of the horn throat, with some minor uncanceled reactance values. Hence the cone moves faster with a given input current, generates more back voltage, and exhibits a higher impedance than it would in a simpler loading system. Typically, the impedanc

will be 8 times the DC resistance at the first peak and twice the resistance at the trough. The geometric mean is 4, so the effective impedance is considered to be 4 times the resistance. Thus, for a nominal impedance of 16 ohms, it is necessary to use a driver having a voice coil of about 4 ohms DC resistance. The only two acceptable drivers for the Klipschorn and Georgian are the Electro-Voice 15WK which, as manufactured, averages a DC resistance of 3.4 ohms plus or minus 0.2, and the Stephens 103LX-2, at 3.6 ohms plus or minus 0.2. Typical impedances are 25 to 35 ohms at 36 cps and 6 to 8 ohms at 56 cps. No substitutions or mismatches can be tolerated in these systems if full tonal range and freedom from distortion are to be expected. Similarly, other bass horns with closed rear cavities should be used only with their recommended drivers.

Since many speaker systems are fixed in the matter of driver impedances, what about the owner of an amplifier

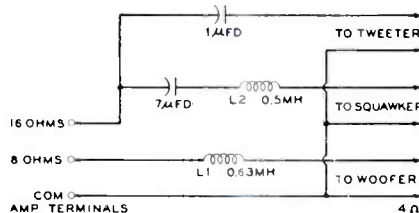

Fig. 3. Substituting a four-ohm woofer.

with only an 8-ohm nominal output impedance? This one is easy; use it right out of the box without modifications. There will be a small over-all loss of volume and available power output, but the amplifier probably has a margin of ten times as much power as it will be called upon to deliver. The internal impedance of the 8-ohm amplifier will be less than it would be for 16 ohms, though, and the resulting distortion in the speakers will be less. This assumes, of course, that the amplifier is a good one with sufficient but not excessive negative feedback, adequate transformers, and undistorted power output in both the infrasonic and ultrasonic ranges as well as the audible range.

If these assumptions are not valid, better dump the amplifier. In any case, don't strain at the gnat of a small impedance mismatch in a favorable direction, and swallow the half-breed camel of a speaker with non-standard impedance.

### Middle-Range Mismatches

Usually, the middle range is the most important and the most neglected. It's wise to get this driver to match in impedance even if replacement costs are involved. Fortunately, if it is the most important and most neglected, it is also the least costly. The best driver in the present state of the art, for middle-range application, should cost between \$25

and \$55. Since 16 ohms is standard to the extent of wide acceptance in quality equipment, it is suggested that this value be adhered to. The capacitors alone for a 4-ohm crossover network would cost enough to warrant the 16-ohm choice.

The middle range is so important that it would be well to enlarge on the subject further, especially as applied to horns.

Mismatching electrical impedances is no worse than mismatching acoustic impedances. A mismatch in acoustic impedances occurs when a horn terminates in a throat or mouth, or changes area abruptly, or turns a corner. Thus, the middle-range horn must be properly designed, have adequate mouth area for the maximum wave length to be handled, and must be smoothly tapered and straight in axis. Disregarding any one of these conditions will result in severe reflections and a response characterized by a series of severe peaks and troughs. The sound is imperfect; it is not true reproduction, and a comparison of a recording with the original sound makes very evident the coloration imparted by irregular middle-range response.

While reflexed and folded middle-range horns are still being used in good-quality equipment, they should be regarded as economic expedients to be replaced soon with acoustically matched straight-axis horns. Some reflexed horns are fairly smooth up to 2,000 cps, but they become severely reflective above that frequency, and even up to 2,000 cps they cannot approach the quality of a properly designed straight-axis horn.

### Tweeters

Since the power contained in most program material above 4,000 cps is of the order of milliwatts compared to peaks of several watts at lower frequencies, impedance mismatching and drawing extra power from the amplifier is not only permissible but desirable for the tweeter. An 8-ohm tweeter has been deliberately mismatched into the 16-ohm Klipschorn system to compensate in part for the inevitably low efficiency of all good tweeters.

The maximum attainable efficiency of a tweeter at 10,000 cps is around 10% (the exact figure depending on the test method) except by resort to resonances and peaking. Better tweeters exhibiting smoothness and freedom from peaking show only about 5% efficiency. Since woofers can achieve 50% or more, the 10-db difference has to be made up some way. By mismatching, 3 db is gained. By restricting the radiation angle to 20° vertical compared to 60° in the middle range, another 4 db is picked up. The remaining 3 db is a bagatelle compared to the 6-db peaks and troughs encountered in the

Continued on page 12

# The Knight Audio Generator

An AUDIOCRAFT kit report



**E**SSENTIAL to even the most elementary home audio test setup is a source of variable-frequency sine-wave tones: an audio oscillator or generator. Fortunately, there are several such instruments available as inexpensive kits which, when properly assembled, may perform as well as ready-built units—at substantial savings to the assembler. The Knight Audio Generator is one of the newest. It has a number of unusual features and utilizes an oscillator circuit developed recently at the National Bureau of Standards.

This is the bridged-T RC oscillator, perfected by Peter Sulzer of the NBS laboratories. The circuit as applied in the Knight kit is given in Fig. 1. A 6CB6 pentode is used as the oscillator stage, with feedback from the following 6CL6 in three loops: two positive and one negative feedback loop. All are from the cathode of the 6CL6. The main positive loop returns to the 6CB6 cathode circuit through a 20- $\mu$ fd capacitor and a 3-watt incandescent lamp; the amount of feedback is controlled by the setting of a potentiometer in the 6CB6 cathode resistor string. Amplitude of oscillation

is held constant by the lamp, whose resistance varies according to the voltage across it. The second positive feedback loop is the 25  $\mu$ fd capacitor directly from cathode to cathode; this is to compensate for high-frequency losses and thereby hold the output constant with frequency.

The negative feedback loop goes to the 6CB6 grid through a variable bridged-T RC network. Such a circuit has the characteristic of passing a very wide range of frequencies except for one, which it rejects rather completely. Negative feedback is applied to the 6CB6 control grid, then, in opposition to the positive feedback at all frequencies except that at which the network is tuned; thus, oscillation can occur only at that frequency.

Tuning is accomplished over the range of a decade by means of a two-section variable capacitor; the lowest tuning range is 20 to 200 cps. Decades are changed by the FREQUENCY RANGES switch, located in the lower center of the front panel; this changes resistance values simultaneously in both sections of the bridged-T network. Tuning ranges

are 20 to 200, 200 to 2,000, and 2,000 to 20,000 cps; 20 Kc to 200 Kc; and 200 Kc to 1 Mc. The extension beyond normal audio frequencies at the upper end permits close examination of the high-frequency characteristics of amplifiers and preamplifiers; it is an unusual and valuable feature.

Output of the oscillator section is taken from a potentiometer in the cathode circuit of the first 6CL6. This is the OUTPUT LEVEL control, at the lower left on the front panel. It is followed by another 6CL6 operating as a cathode follower so as to isolate the oscillator completely from the output load; no matter what is connected to the output terminals it has no effect on the oscillator frequency.

The output terminals of the instrument are connected to the final 6CL6 cathode circuit through a voltage divider switch that is marked, on the front panel, VOLTAGE ATTENUATION. In its maximum clockwise position maximum output is obtained, since the "hot" output terminal is then connected directly to the cathode. Output impedance is low (200 ohms) in that position, and up to 12 volts with a high-impedance load or 10 volts with a 600-ohm load, depending on the position of the OUTPUT LEVEL control, can be obtained. As the switch is turned counterclockwise each successive position inserts 20 db attenuation steps, giving a total of 80 db reduction in maximum output. The last switch position turns off the AC power.

Fine tuning within each decade range is accomplished by the large knob in the center of the panel. This is a vernier control: that is, the tuning capacitor is equipped with a gear-reduction drive, so that several complete turns of the tuning knob are required for the full swing of the indicator dial. Extremely fine adjustment of frequency can be obtained because of this provision.

## Construction Notes

This can really be called "The Complete" kit. Not only is every part furnished, but solder and colored connecting wires, pre-cut to exact length and tied, are

Fig. 1. Circuit of the Knight Audio Generator kit. Operation is explained in text.

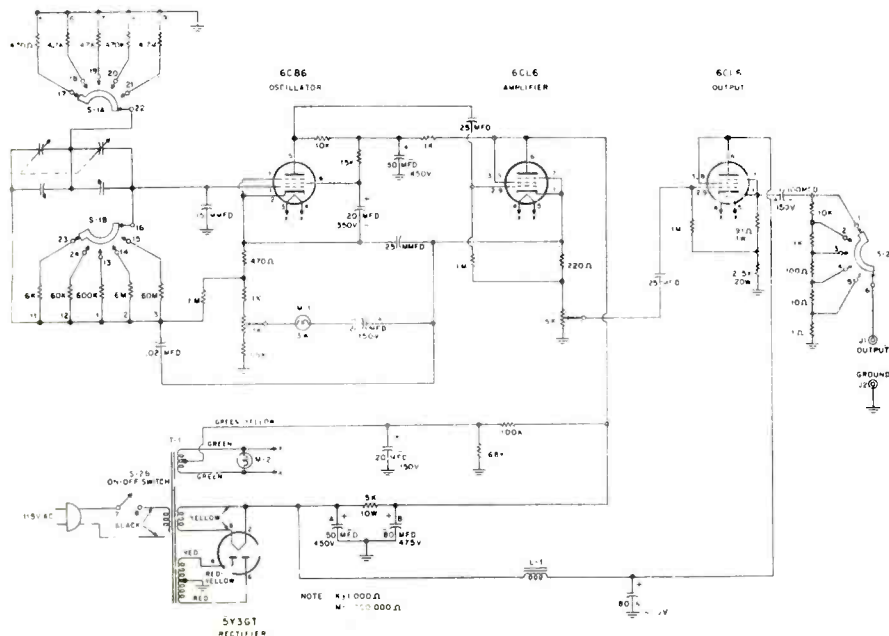



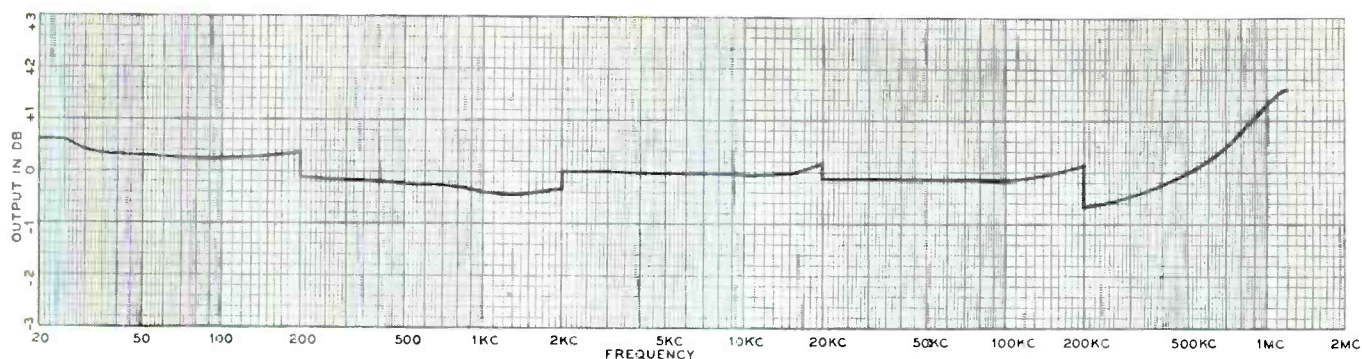

Fig. 2. Output of the generator according to frequency. The abrupt transition points are at frequencies of band switching.

supplied too! Directions are just as complete; large pictorial diagrams show the location of every part and wire, and the step-by-step instructions are clear and unambiguous. Soldering instructions are given for those who need them.

Because our kit was one of the first sold, possibly, there were a few minor parts missing. These were noticed when checking off the parts list, and a letter to Allied Radio Corporation (distributors of Knight equipment) brought them to us promptly. Following every direction explicitly it took us just 11½ hours to check the parts, assemble and wire the kit, and make the necessary calibration adjustments. Only a high-impedance AC voltmeter is needed for calibration, although it is easier if you have an oscilloscope too.

Here are a few miscellaneous comments on construction of this kit, noticed as we proceeded in its assembly:

When mounting the binding posts on the front panel, scrape off the enamel inside the mounting holes. The shoulder washers will seat better. — When mounting the ceramic trimmer capacitors, be very careful not to use too much force tightening the nuts. Ceramic cracks easily. — Under the paragraph "Assembling the Pointer", the first instruction calls for putting two set screws into the pointer mounting cylinder. If you begin to wonder where the second set screw is, look in the cellophane envelope holding some of the dial parts. — Before installing the pointer mounting cylinder, enlarge the hole near its front end by redrilling or using a reamer. This makes it easier to align the bushing set-screw with this hole later. — Both the FREQUENCY RANGES switch and the dual-section tuning capacitor have shields that must be installed after wiring is completed. The nuts for the bottom shield are easy enough to get on with any sort of wrench, but a nut driver is needed for the upper shield nuts. — In calibrating it is necessary to adjust two trimmer capacitors so as to obtain proper readings over the range of the dial. Both trimmers affect the tuning frequency, so it is possible (within limits) to hold a given frequency by moving one trimmer one way and the other trimmer the op-

posite way. At only one such combination of trimmer settings, though, will the voltage output be relatively constant across the dial range; this is the proper combination to use, even if it causes slight inaccuracies in dial frequency readings. In our kit it did, as pointed out in the following section, although the inaccuracies occurred mostly at the ends of the dial range and were not serious.

Congratulations are due Allied for the excellence of the instruction book. Besides the information noted previously, it includes charts of normal resistance and voltage readings, service hints, data on resistor and capacitor color codes, and operating instructions. These are all helpful and important to kit builders.

#### AUDIOCRAFT Test Results

Specifications for the Knight Audio

Generator, given by the manufacturer, are as follows:

*Frequency Range:* 20 cps to 1 Mc, in five bands.

*Output:* continuously variable, 0 to 10 volts RMS into 600-ohm load. Flat within  $\pm 1$  db over entire range.

*Output Impedance:* 200 ohms.

*Distortion:* less than 0.3% over entire audio spectrum at full rated output.

*Price:* \$31.50.

The frequency range and output uniformity specifications are met handily, as Fig. 2 shows. Small abrupt changes in the curve are at points of position changes of the FREQUENCY RANGES switch. It can be seen that the output is indeed flat well within  $\pm 1$  db over the whole range; as a matter of fact, it extends to 1.2 Mc within the specification. This curve was taken with the VOLTAGE ATTENUATION switch in the "O Low-Z"

*View under chassis. Power resistor at right is kept away from the electrolytic.*

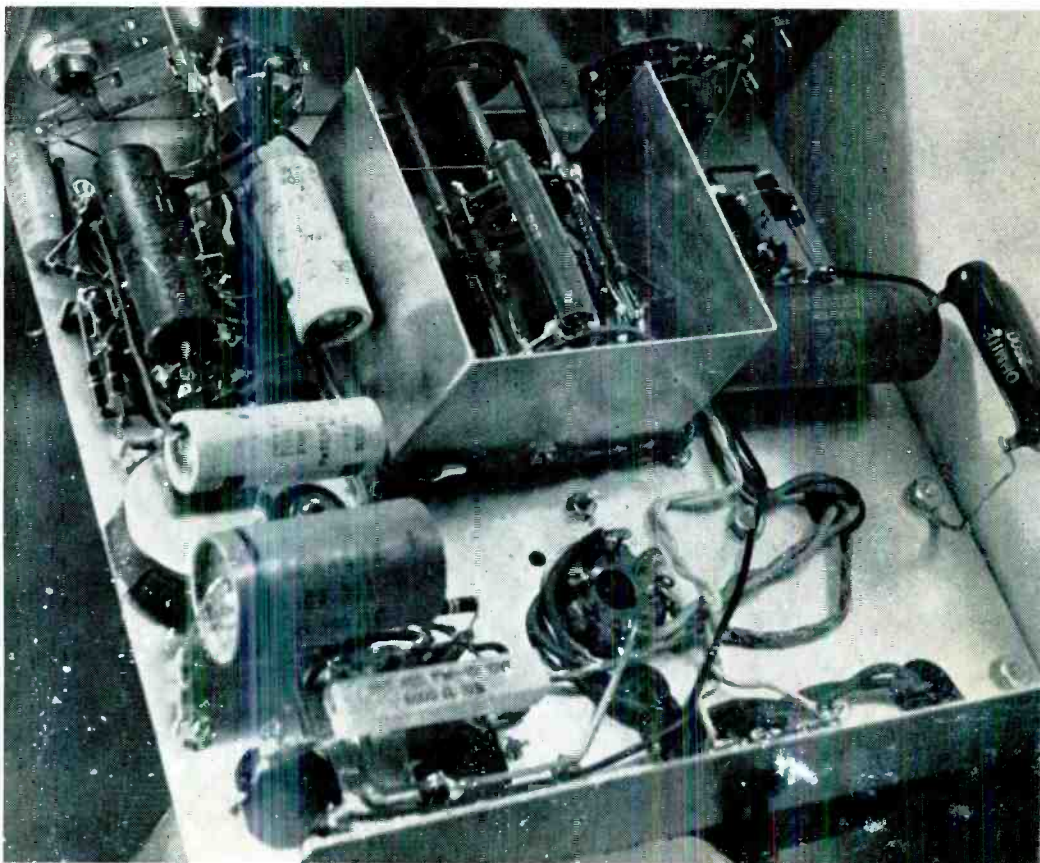



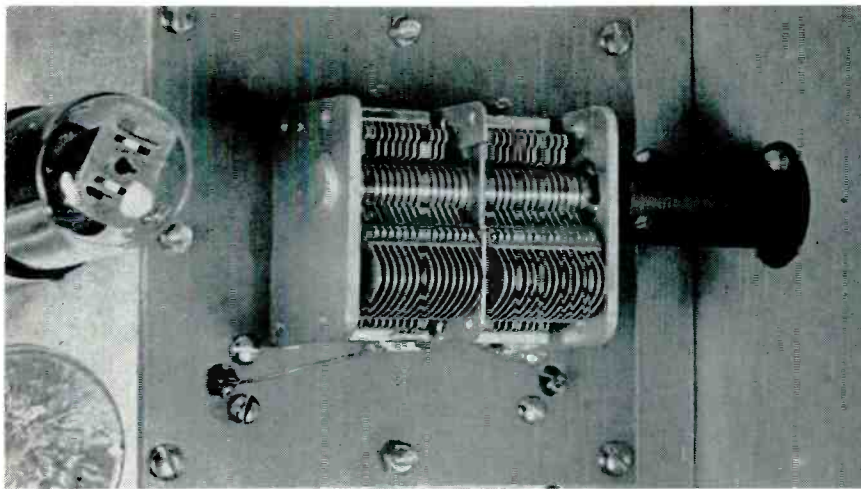

Tuning capacitor with shield removed. See the text note about pointer cylinder.

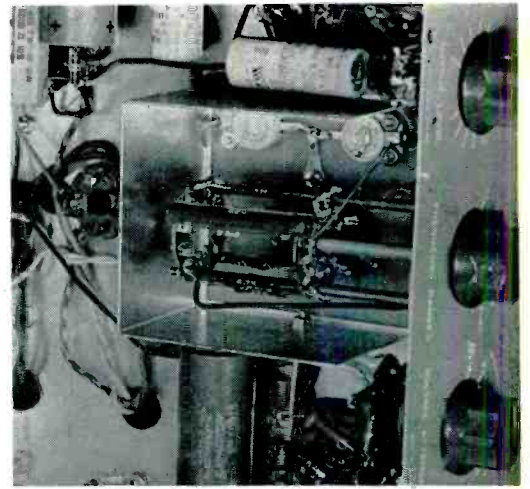

Frequency range switch & trimmer capacitors.

position, for which the output impedance is actually 200 ohms. A load of 600 ohms was used. The addition of 8 ft. of shielded cable across the output terminals had no discernable effect on the output at high frequencies with or without the 600-ohm load. In the "20 DB" attenuation position of the switch, however, the output impedance is not 200 but about 1,100 ohms. With the proper 600-ohm load, the cable again had no significant effect on the high-frequency output; with a high-impedance load, output at low and middle frequencies rose because of improper voltage-divider action, and the output (relative to 1 Kc) was down 1 db at 150 Kc, 3 db at 250 Kc, 6 db at 500 Kc, and 12 db at 1 Mc. In lower positions of the switch the output impedance is less than 100 ohms, so the load is unimportant as long as it exceeds 300 ohms. To be sure of proper attenuation, and to prevent high-frequency rolloff

in the "20 DB" position, use the recommended 600-ohm load. If you work mostly with high-impedance inputs, simply install a 600-ohm resistor permanently across the output terminals.

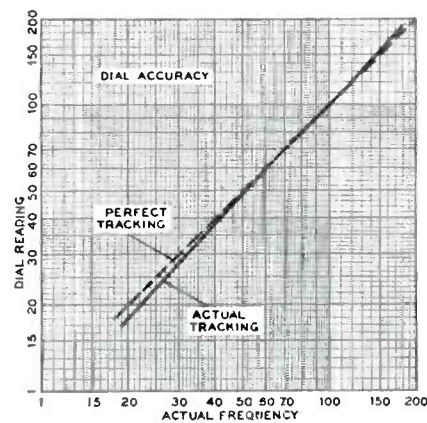

Fig. 3. How the dial readings correspond to actual generator output frequencies.

It was mentioned before that the dial calibration was not precisely correct. That is a function of circuit tolerance, and it is quite possible that our kit was exceptional in this discrepancy. Even so, as Fig. 3 shows, the maximum error was 2 parts in 20 at the extreme low-frequency end and 5% at the extreme high-frequency end. At intermediate positions it was even less. Frequency stability is excellent.

Distortion of a single sine wave is impossible to measure accurately below 1% without precision harmonic-detection equipment, which we do not yet have. We can only say that we are sure the distortion is substantially below 1% throughout the audio range, and quite probably meets the specification in this respect.

In short, this audio generator is a fine piece of test equipment, and should serve adequately the needs of any home experimenter or service organization.

Front view of the generator, showing controls. Tuning knob is geared down.



The voltage attenuation and AC power control.

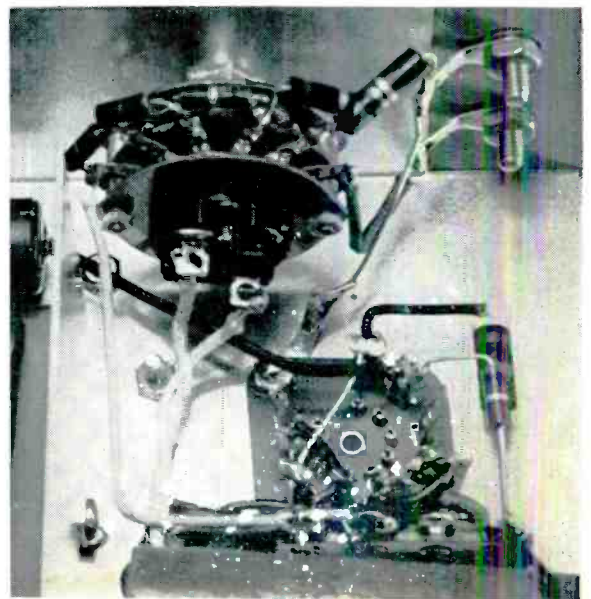





# Designing Your Own Amplifier

by Norman H. Crowhurst

## Part III: Phase Inverters

**M**OST modern amplifiers have push-pull output stages, for reasons that will be more apparent when we discuss that part of the design. With push-pull output it is possible to get much more power from tubes and other components of reasonable size, with much less distortion. But before we can operate output tubes (or any other stage) in push-pull, we must convert the single-ended signal handled by most voltage amplifiers to the pair of oppositely phased signals needed for push-pull drive. This can be achieved with a *phase inverter* or *phase splitter*. Two principal kinds of circuits can be used: the transformer phase inverter and the various types of tube inverter. Before going into their design, their relative merits should be stated briefly.

The simplest circuit to design uses transformer coupling. In the early days transformers were not very good—they introduced a significant part of the overall amplifier distortion. Modern transformer materials and design have remedied this situation, so that now transformer coupling can be the best as well as the simplest, except for one serious obstacle: the problems in apply-

ing feedback over an amplifier using interstage transformer coupling are much greater than with RC-coupled types. For this reason, with the current trend toward amplifiers having large amounts of feedback, it is not surprising

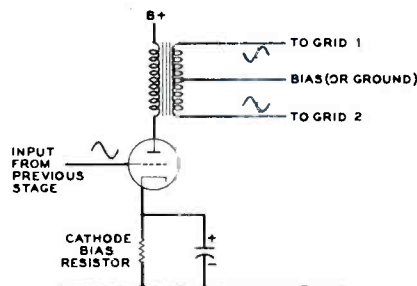

Fig. 1. Circuit of phase inverter using a series or direct-coupled transformer.

to find that inter-stage transformers are little used. Furthermore, good transformers are costly. But to obtain the same signal-voltage swing from RC-type tube inverters, a greater B+ supply voltage is invariably necessary, as will become evident later in this article.

### Series Transformer

The merit of the transformer circuit is the simplicity with which two voltages of opposite phase can be provided on its secondary by the use of a center tap, as shown in Fig. 1. The reason why transformer coupling can handle a larger swing, using the same B+ supply, will become evident from Fig. 2, which shows characteristic curves of a 6SN7 tube (one half) or a 12H4, a miniature single triode having the same characteristics.

The dotted line in Fig. 2 represents the DC voltage drop in the primary winding resistance of the transformer. This way, with a supply voltage of just over 260 volts, we can have 250 volts on the plate at 7 ma plate current, and the voltage swing at the plate can be from 90 volts to 410 volts—*much higher than the supply*. This is because, although the transformer has only a

low primary *resistance*, it has a very high *impedance*. To obtain the necessary bias for the operating condition of Fig. 2, —8 volts, the bias resistor should be about 900 ohms. The preferred value of 910 ohms will be near enough.

The excursion shown in Fig. 2 is 160 volts in the negative direction, and 150 volts in the positive. This is an off-center effect of 5 volts in a peak-to-peak swing of 310, representing only about 1.6% harmonic distortion.

Fig. 3 shows one of the problems associated with this circuit. The primary inductance makes the load line open into an ellipse at lower frequencies. This not only reduces the maximum swing, but produces distortion quite rapidly. This ellipse—the widest possible before really serious distortion sets in—shows an AC voltage of 290 peak-to-peak, for a current swing of 14 ma, representing a reactance of 21 K. To respond without distortion down to 20 cps, the inductance would have to be 200 h with 9 ma flowing, which is quite an inductance!

Reducing the current could be done by biasing the tube back a little further, and that would seem to make the inductance easier to get; but we lose more than we gain, because lowering the oper-

Fig. 2. Load line representing one possible operating condition with series transformer coupling. The dotted line represents DC drop from the transformer primary-winding resistance; this operating condition requires a cathode-bias resistor of 910 ohms, with a B+ supply that puts 250 volts on the plate.

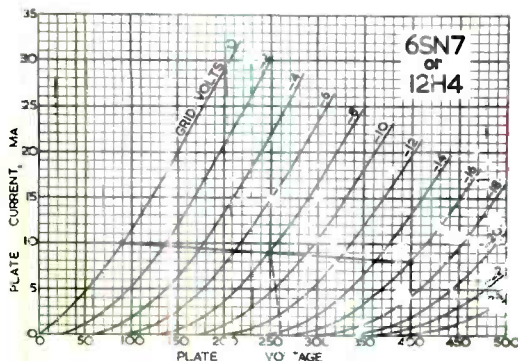
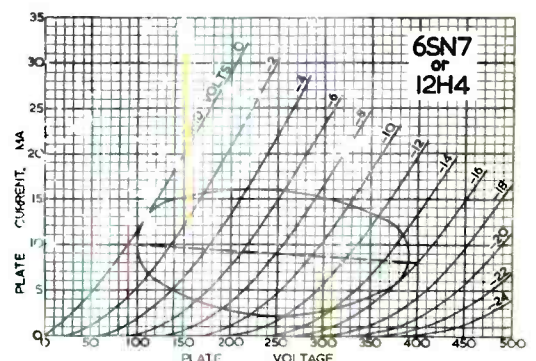

Fig. 3. The ellipse approximating the load condition for minimum permissible shunt reactance has been sketched over the load line in Fig. 2 (shown dotted).



ating point on Fig. 3 means that the width of ellipse permitted is narrowed and we need much more inductance. The gain in inductance does not keep pace with need for more.

### Parallel-Fed Transformer

One way around this is to apply the parallel-fed method of connection shown in Fig. 4. That keeps the plate current out of the primary, so a transformer utilizing a better core material can be used. This will be a much more compact unit, with a considerably improved frequency response. Also, the possible improvement in design makes practical a transformer with a bigger voltage step-up from primary to secondary, so that the loss in signal-handling capacity resulting from the parallel-fed connection (because of reduced plate voltage) can be made up in the transformer.

But we can take the design of this stage as a starting point for considering the various RC-type tube inverters, which will make it easy to compare relative performance. Fig. 5 shows the load line for a plate resistor of 25 K from a supply voltage of 275. Bias for maximum signal swing should be -7 volts, permitting a swing from 0 to -14 volts. Plate voltage at this operating point is 182, for a current of 3.8 ma. This means the bias resistor should be 1,800 ohms.

The peak-to-peak plate swing, from 75 to 265 volts, is 190 volts. This should be compared with 310 volts for the series transformer with a lower supply voltage. If the change permits us to double the transformer step-up ratio we shall be better off. The distortion is not so good, however. Mid-point between 75 and 265 is 170 volts, so the swing is 12 volts off-center in 190, a distortion of about 6.3%.

The dotted ellipse represents a shunt

Fig. 5. A typical load line for parallel-fed transformer inverter, with a plate-load resistor of 25 K and a bias resistor of 1,800 ohms. B+ is 275 volts. Compared with series coupling, maximum output swing is considerably restricted, but improved transformer design may compensate for this by providing increased step-up. The ellipse represents minimum permissible shunt reactance.

reactance that permits a peak-to-peak current of 4.8 ma at a peak-to-peak voltage of 180, about 37.5 K. The inductance to maintain this to 20 cycles is 300 h, which is reasonable with no DC in the primary.

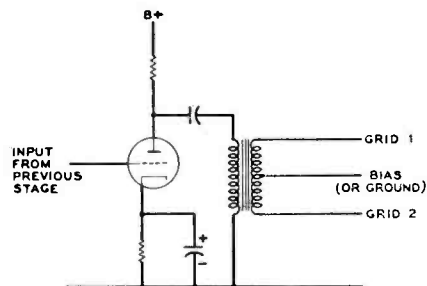

Fig. 4. Parallel-fed transformer phase inverter. DC is kept out of the primary.

### Split-Load Inverters

The 6SN7 is representative of tubes used for RC-type inverters, so we will continue making comparisons of circuits using this tube. All tube-type inverters effectively use one tube section to provide inversion without any gain. The difference lies in the method of sacrificing the tube gain to provide the reversal of phase, and the merits of each circuit are connected with this feature. A transformer does have the advantage that, if the turns on each half of the secondary are equal in the first place, nothing is likely to throw them out of balance subsequently. But using a tube as an inverter means that balance tends to be more or less dependent on the

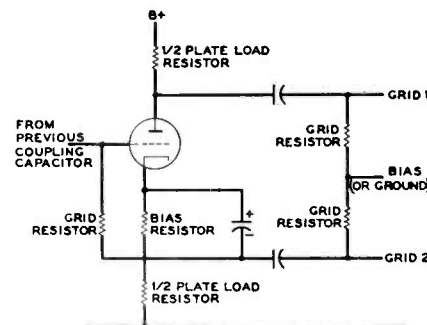

Fig. 6. A split-load inverter. Significant components are marked on diagram.

gain of the tubes. Some circuits avoid this deficiency, at the expense of something else.

Probably the simplest type of RC phase inverter is made by simply putting half of the plate load in the cathode circuit, as shown in Fig 6. It does not matter where the resistance in series with a tube is, so long as it has the same effect in restricting the plate-to-cathode voltage according to the current the tube draws. A load line for this method of operation can be drawn in exactly the same manner as for a normal voltage-amplifier stage, using a resistance value made up of the two resistances in series.

With the same operating conditions for the 12H4 (or half of a 6SN7) that we just considered for a parallel-fed transformer load, but putting 12.5 K in the plate and 12.5 K in the cathode, and with the same bias, we would have a total maximum swing of 190 volts peak-to-peak or 95 volts peak-to-peak for each output. In the more conventional RMS units, that is about 33.5 volts.

This is further restricted because we have to use grid resistors for the following tubes. Output tubes should have grid resistors of not more than about 250 K. Using this value to construct a load line, the total shunt effect across 25 K will be 500 K, giving an AC load line of 23.7 K. This is shown in Fig. 7. The maximum swing is between 79 and 260 volts, or 181 volts peak-to-peak, with a distortion of 6.9%. Although this is second harmonic distortion it is in the same phase on each output tube grid and cannot be cancelled. Some reduction will occur because of feedback in the cathode of this tube, leaving about 1.5% which is comparable with the transformer type although the swing is much smaller.

There is the limitation with this kind of circuit: the output swing is not very great. For some output tubes requiring a bias less than 45 volts, this drive voltage would be adequate; but, for other types, a phase inverter that gives a larger swing will be necessary.

This kind of circuit does, of course, avoid all the problems encountered in the transformer-coupled circuit. There are no shunt reactances of a value anything like as low as those we have been discussing. But another disadvantage of this circuit is that it has very little gain; in fact, as considered from the grid of the phase inverter to the grid of each output tube, it actually has a loss. Assume that the circuit is being driven at full amplitude so we have 90 volts peak-to-peak being supplied to each output tube grid. This 90 volts appears between cathode and ground of the inverter tube. To get this output in

Fig. 7. Load lines for the various RC phase inverters discussed in the text. The same operating point as given in Fig. 5 is assumed, with 275 volts B+.

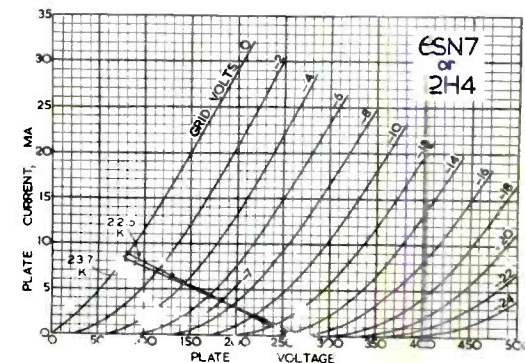
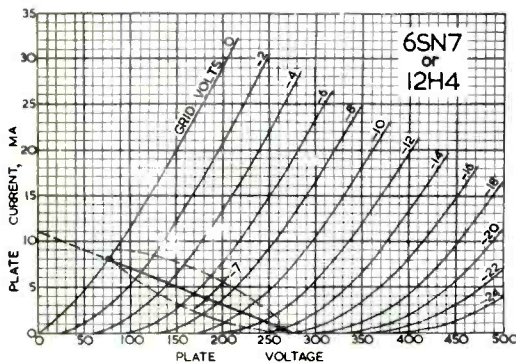



its plate circuit the tube requires a *grid-to-cathode* voltage swing of 7 volts peak, or 14 volts peak-to-peak. This is over and above the voltage appearing at the output from *cathode to ground*, so the total voltage necessary from *grid to ground* will have to be 104 volts peak-to-peak.

We need to put in 104 volts, then, to get out 90 volts for each output grid. It is quite easy to get a swing of 104 volts from a similar amplifying tube, operated single-ended; a suitable circuit is shown at Fig. 8. The first stage has a 25-K plate resistor. A 470-K grid return to the off-ground bias point is adequate for the second stage, or phase splitter. But because this resistor is connected between points with a swing of 104 and 90 volts respectively, it will

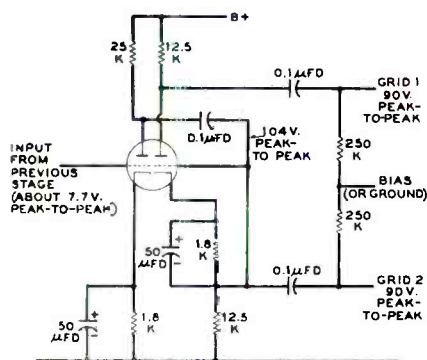

Fig. 8. Complete double stage of the split-load inverter. The values shown are based on design figures in the text.

draw much less current from the 104-volt circuit than if it were connected to ground. The voltage difference across it is only 14 volts, instead of 104 volts, so the current will be divided by 104/14. The *effective* AC resistance in parallel with the first stage's 25-K plate resistor will be 470 K multiplied by 104/14, which is about 3.5 M. The shunting effect of this can be ignored.

Going back to Fig. 5 to calculate the gain of this stage, 14 volts swing gives an output of 190 volts swing—a gain of 13.5. So an output of 104 volts swing will require an input of 7.7 volts swing, or about 2.7 volts RMS.

The response of the phase splitter section will be 3 db down at the frequency for which the coupling capacitor reactance is equal to the grid resistors, 250 K. With 0.1- $\mu$ fd capacitors this is 7.5 cps; good balance and response will certainly be maintained down to 20 cycles. For the previous stage: the *effective* grid resistor that determines response is 3.5 M, which extends the response down to below 0.5 cps with 0.1  $\mu$ fd.

This kind of inverter gives good balance, because the balance is determined by the equality of the plate and cathode resistors. They can be selected precisely and can be expected to remain

fairly well matched. Frequency response can be made as good as we want, but harmonic distortion is not as low as has been claimed, and the output voltage is limited.

If the kind of output stage we're thinking of needs more than 90 volts to swing each output tube, we have to consider another kind of phase

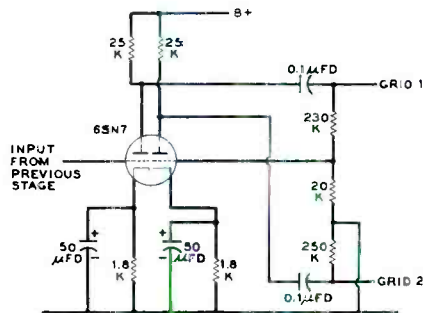

Fig. 9. Paraphase circuit has higher maximum output swing than the split-load circuit, because each output comes from an individual complete plate load.

splitter. Unless we are prepared to furnish an appreciably larger B+ voltage, the only way out is to use some kind of phase splitter in which each output comes for an entire plate load. This means we must use a separate plate circuit to drive each grid. If we can do this, using a 6SN7 tube and the same operating values we have already discussed, we shall get the full 190 volts (or nearly that) from *each* plate circuit.

### Paraphase Inverter

A simple system of using both plates for drive, known as a paraphase circuit, is shown in Fig. 9. We will continue using the same basic circuit values to get the advantage of relative performance comparison. But here the 250-K output grid resistors are coupled one to each plate, which brings the AC loads down to about 22.5 K. This is shown on Fig. 7 also. A maximum swing between 82 volts and 254 volts is obtained, using the same bias point and 14 volts grid swing. This is a gain of 12.3, and the distortion is about 8.1% which is much higher than the split-load type ended up with.

In this case, however, each tube will produce second harmonics of opposite phase, which will cancel at least partially in the output. At full load the distortion in the output originating from the phase inverter would probably be about 3%. But the distortion will not be so high at the same level as in the previous circuit. The figures just discussed are for a swing of 172 vols. To get approximately the same output swing as the first circuit, we can use a grid swing from -3 to -11 volts (or, better still, from zero to -8 volts, using a new operating point). This gives 100

volts peak-to-peak output swing, and reduces the distortion on each side to 2%. The resultant in the output will be well under 1%.

To complete the design, though, we need a drive for the second tube section equal to that for the first section. Since the gain is 12.3, we need to tap off 1/12.3 of the output from the first half, which will be in opposite phase to its input. The values shown give this, and provide the same total resistance in each grid circuit. Frequency response will be similar to that of the split load circuit, if similar values are used, so there is no need to discuss this again.

This kind of circuit will usually work quite well with a low-gain tube such as the one we have chosen. It is not too successful, however, when used with a high-gain tube in which the amplification factor is subject to considerably greater variation with operating conditions. This is particularly likely to happen if the heater voltage fluctuates, which alters the operating temperature of the tube and hence its space charge. Low-gain tubes are not so susceptible to this kind of variation.

The fact that the balance of the drive to the two halves of the output is dependent at all upon the exact gain of the tube is considered a disadvantage by some, for which reason methods have been devised to equalize the output so it is less dependent upon the gain of the individual tubes. We will not at this point go through the full design procedure, but merely indicate the method.

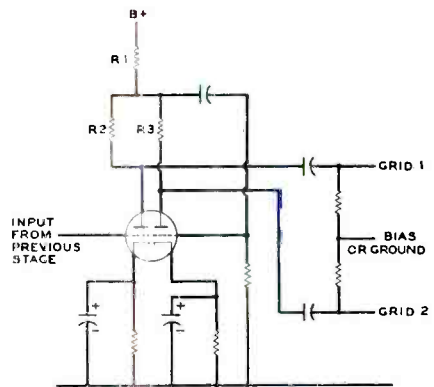

Fig. 10. Modification of the paraphase circuit, intended to minimize any out-of-balance condition caused by variations in individual tube characteristics. This is called the floating paraphase circuit.

### The Floating Paraphase

Instead of using a predetermined tap in the grid circuit to obtain drive for the second stage, a common section of plate resistor is employed in the floating paraphase circuit, in Fig. 10.

Plate currents of both tubes pass through R<sub>1</sub>. The second tube needs a grid swing that is only a fraction of

*Continued on page 40*



*Speakers (AR and Janszen) were match for pipes (Aeolian-Skinner).*

## A Hi-Fi Milestone

*Photos by Dombert*

ON March 2, 1956, at 8:30 p.m., occurred an event of singular importance to the high fidelity industry. It was then that the sound of a large organ was first reproduced, with complete success, in an A-B comparison with the original. It happened at Saint Mark's Episcopal Church in Mount Kisco, New York, where these photographs were taken.

The organ, one of national renown, is an Aeolian-Skinner, 3 manual and pedal, with 38 stops, 53 ranks, and 3,000 pipes. It is divided into two sections, one on each side of the altar

area; the main section on the right includes the pedal. Tests with a sound-level meter disclosed that the maximum average level at a distance  $\frac{2}{3}$  of the church length from the organ was about 84 db and that, to reproduce this level with wide-range, low-efficiency speakers, 375 watts of amplifier power were needed. Enough speakers were needed in turn to handle such power with very low distortion. All components, however, were standard units available to the home listener and recorder, from microphones to loudspeakers.

Two recordings were made of each

selection simultaneously: binaural, on a Magnecord binaural recorder, and monaural, on an Ampex 350. Microphones used were an Altec 21-C, an Electro-Voice 655-C, and two Telefunken U-47M's. All the microphones were situated close to the organ pipes so as to avoid dual reverberation. Speakers were placed directly adjacent to the pipes also, and levels were set in playback to produce the same sound level as the organ. Reproducing the pipes at the right were three Acoustic Research AR-1's and a Janszen electrostatic speaker (utility model). Below

*Six amplifiers could produce a total of 425 continuous watts.*

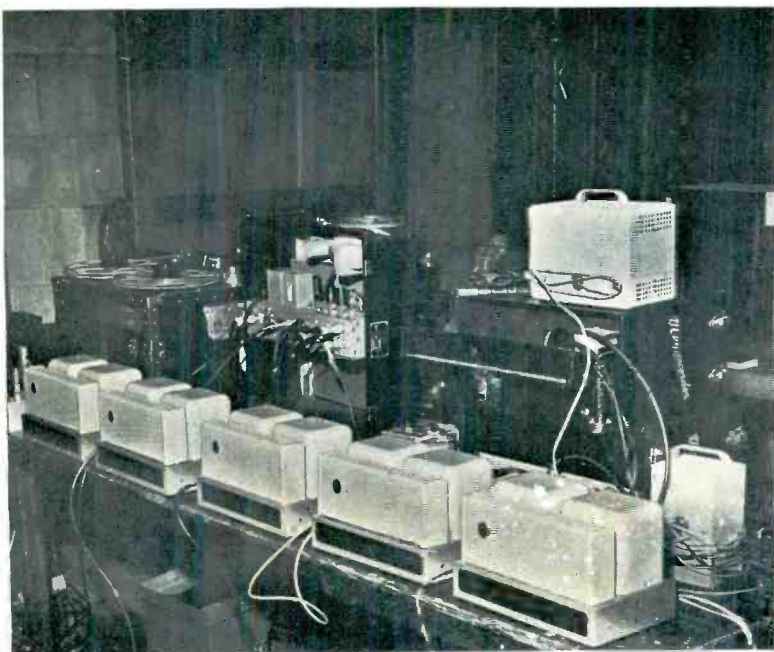

*Ampex single-channel and Magnecord stereo recorders set up.*





the pipes at the left were another AR-1, a Bozak B-305 system, and a Janszen model 1-30 electrostatic. Five Fairchild 75-watt power amplifiers (Model 275) and a 50-watt Fisher amplifier (Model 50-AZ) were used to drive these speakers. In binaural playback, the speakers at the right reproduced the sound picked up by the binaural mike at the right, and those at the left reproduced the sound picked up by the binaural mike next to the left-hand pipes. In monaural playback both sets of speakers were fed the same material, of course.

An elaborate switching and signaling system was set up so that either binaural or monaural playback, or the live organ, could be selected instantaneously and switched one with another. This required great precision and alertness on the part of Edgar Hilliar, the organist, as well as the equipment operators. Lights on an indicator board were arranged to show which of the three was "playing" at any given moment. The many changeovers were accomplished without a hitch; in some instances the

*Directly right: Organist Edgar Hilliar supplied live sound on cue to alternate with a previously recorded performance.*

*Below: Pipes on left side of the church, and the speakers which reproduced sound that stereo microphone picked up there.*

*Lower right: Right-hand pipe section and loudspeakers, as seen by the audience.*

audience would have been unaware that a switch had been made had they not been able to see the lights.

The monaural reproduction was remarkable. It had everything—wide frequency range, dynamic range, inaudible distortion, smoothness—except the vital directionality or perspective necessary for a complete illusion of the real thing. There was never any doubt of the source on anyone's part when the monaural system was in oper-

ation. But the binaural playback was a different matter. Between it and the live organ there was no audible difference except for a very slight change in emphasis of the lower high-frequency range, and this was noticeable only in certain passages at the moment of switching. It was such a negligible difference that, even when it was discerned, it was impossible to tell whether the organ or the sound system was playing!

*Continued on page 41*

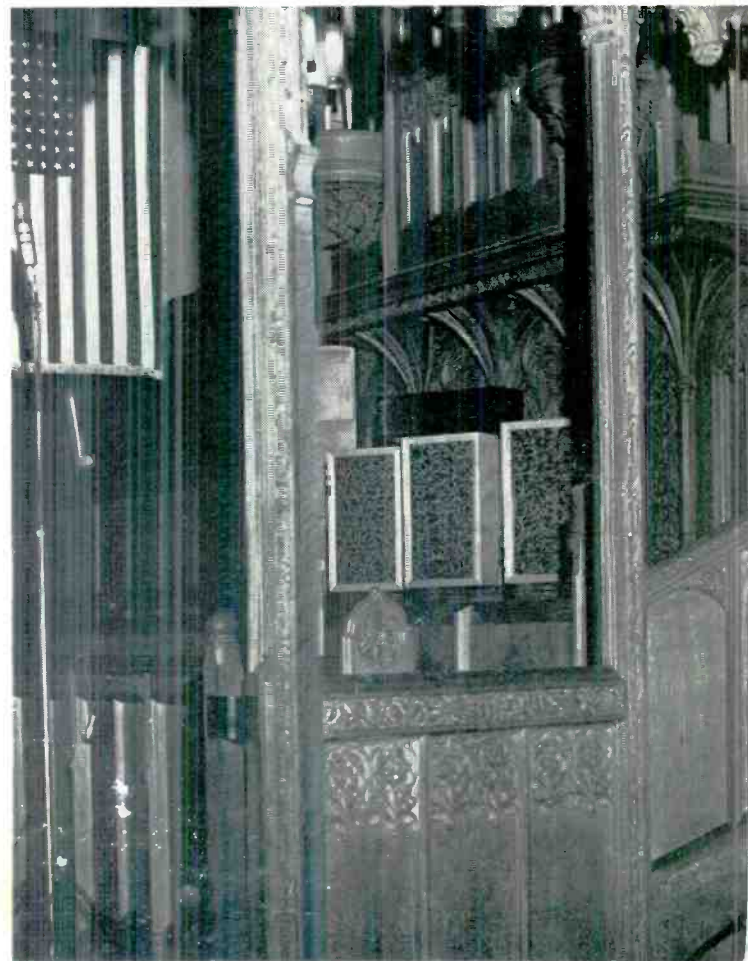
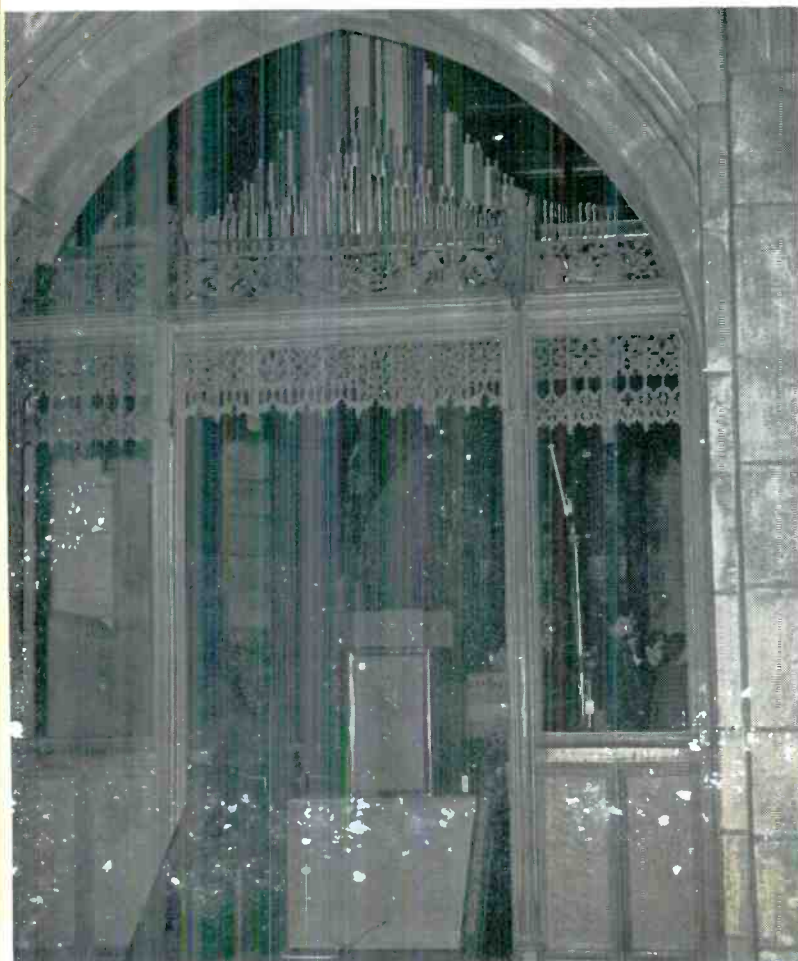



by J. E. Richardson

## A Home-Built Pickup Arm

THE phonograph pickup arm is one of the purely mechanical links in the high fidelity chain, and the design problems are among the most difficult to solve. Many approaches have been tried, but the most popular is still the pivoted arm. The pickup described in this article, Fig. 1, is of this type.

Balsa wood was chosen for construction of the arm because it is light, easy to work, and has as little tendency toward resonance as any of the woods. An undesirable feature is that balsa is soft and can be dented, but that is not as objectionable as one might think because of the care most high fidelity equipment receives.

There are two basic pivot-arm design shapes: straight and offset. For the shortest arm possible with the least tracking error, the offset arm is used.

To obtain perfect tracking, the stylus would have to be tangent to the record groove at all times. Reduction of tracking error to true insignificance is impossible with a pivoted arm of any reasonable length, so, as in most designs, there must be compromises. The trick is to approach perfection as closely as possible within given design limitations.

All parts used to make this pickup are readily available, with the possible exception of the ball bearings. These are standard but, because of their small size, may not be in stock in your locality. A machine shop will be a great help, however, in locating the

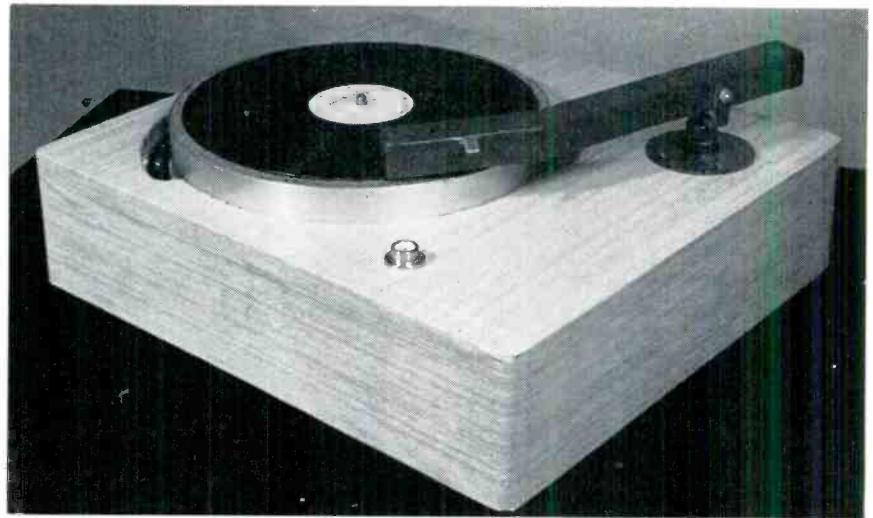

Fig. 1. Home made arm in use. Author also added heavy rim to low-cost turntable.

bearings. The amount of metal required is so small that many shops will give you enough scrap to make most of the other parts.

Cost of construction will vary depending on your locality, how much material can be obtained from scrap, and the amount of machine work paid for. Even if you have all the machine work done for you, the total cost should not exceed \$10.

Following is a materials list with the approximate costs:

1/16 × 2 × 3-inch balsa sheet ..... \$0.15

1 × 3 × 36-inch hard balsa plank (sold only in 36-inch lengths)	1.00
2 ball bearings, 3/4 in. O.D., 1/4 in. I.D. (Fafnir WA 3466)	2.75
1/2-inch pipe flange	0.15
4 × 5 × 1/16-inch piece of lead sheet	0.25
3 × 3-inch piece of 12-gauge aluminum sheet	—
6 × 1/2 × 1/8-inch aluminum sheet	—
3 in. 1/2-inch brass pipe	—
1 in. 3/8-inch iron rod	—

Fig. 2. Scale drawing of pickup arm. This should be enlarged by transferring outlines to paper ruled in 1/4-inch squares.

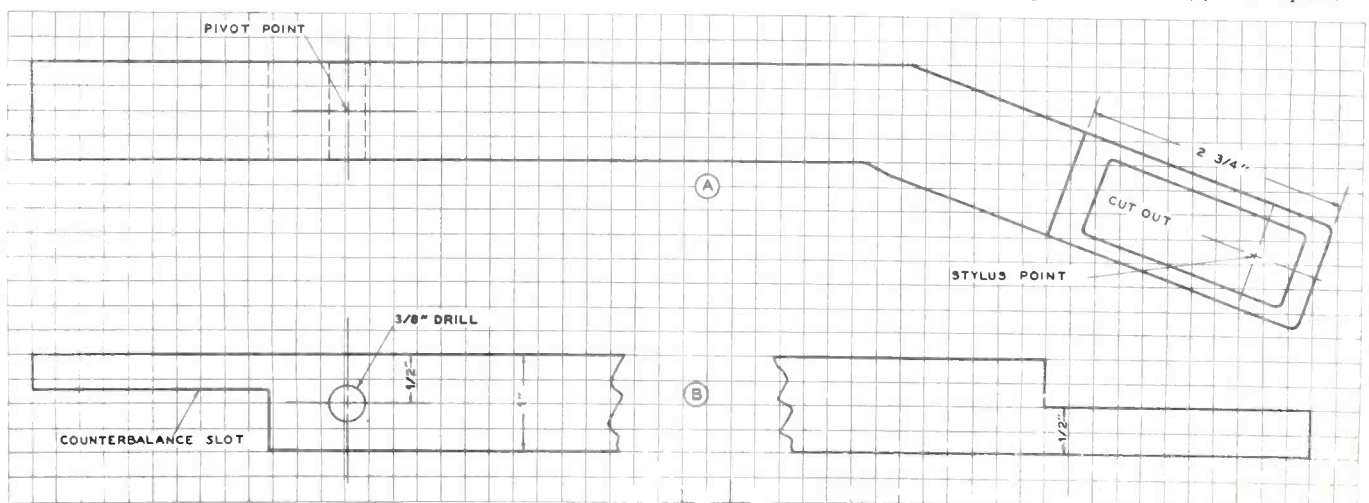



3 in. 1/2-inch iron rod	—	
1 bottle sanding sealer	0.15	
1 bottle airplane dope or lacquer (gray)	0.15	
		\$4.60

### Construction

The template, Fig. 2A, is first enlarged to full size by transferring the outlines to a paper ruled off into 1/4-inch squares. Each square will correspond to one square in Fig. 2. Pin the full-size drawing to the balsa plank with a piece of carbon paper between them. The arm outline is then traced, transferring the design to the balsa. Cut out the arm with either a jig saw or coping saw. The cartridge and counterbalance slots are cut as shown in Fig. 2B. Save the wood scrap; it will be used later.

Drill a 3/8-inch hole with a twist drill in the pivot location shown, making certain that the hole is drilled

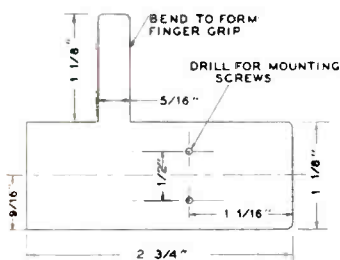

Fig. 3

true. Cut a 1/8 by 1/8-inch slot extending from the cartridge cutout to the pivot point, centered in the under side of the arm, to house the shielded cable.

The cartridge mounting plate is cut, bent, and drilled as shown in Fig. 3, then glued in place with Duco cement. (If a dual-stylus "turn-around" cartridge is to be used, drill a 1/8-inch hole for the stylus shift lever.) The scrap balsa

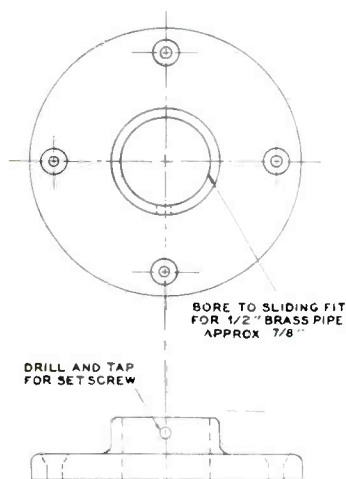

Fig. 4

cut from the arm is trimmed and used to fill in the space above the cartridge mount. When using a dual-stylus cartridge, a hole and recess will have to be

cut so that the lever arm knob can be turned. Two pieces of 1/16-inch sheet balsa 1 by 2 3/8 in. are then cut and

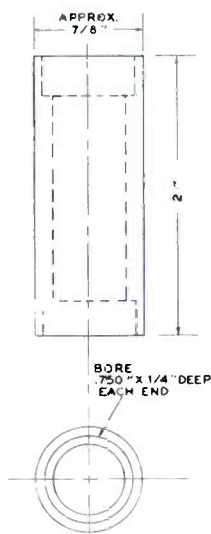

Fig. 5

glued in place to cover the counterbalance slot in back of the arm.

A 3/8-inch iron rod is cut 1 in. long, and a 1/16-inch hole 1/8 in. deep is drilled in each end. To insure centering these holes it is best to drill them with the rod in a lathe. Insert the

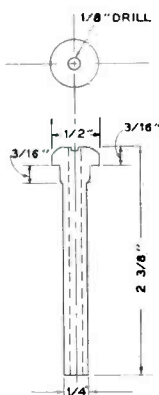

Fig. 6

drilled rod in the 3/8-inch arm pivot hole, gluing if necessary to obtain a snug fit.

The arm is then ready for finishing. Sand a slight round on all edges, and fill low spots with wood putty. Apply two or three coats of sanding sealer, sanding between coats. For the main finish I had excellent results with three or four coats of model airplane dope (lacquer).

To make the base plate, the 1/2-inch pipe flange is bored to approximately 7/8 in. Use the 1/2-inch brass pipe to determine the exact bore diameter; the pipe and base must combine in a sliding fit. The actual bore diameter will depend upon the type of brass pipe used, so check the fit as the bore is made. A hole for a small set screw is then

drilled and tapped, as shown in Fig. 4.

Cut a 2-inch piece of the 1/2-inch brass pipe to form the bearing case. Bore each end to receive the 3/4-inch ball bearing with a slight force fit, as in Fig. 5. Turn and drill the pivot shaft (Fig. 6) in a lathe from the piece of 1/2-inch round rod. Use a collet to hold the rod in the lathe. Drill the center hole, then cut off the shaft.

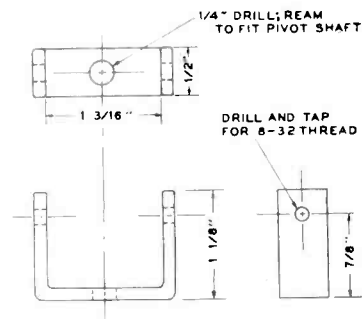

Fig. 7

The yoke is then measured, drilled, and tapped, as shown in Fig. 7, from a piece of 1/8 by 1/2 by 2 1/2-inch aluminum stock, and bent to shape. Round the ends with a file if you want a more finished appearance.

The needle bearings, made from 8-32 brass screws, are turned on a lathe to a point. Cut off the head and slot, as

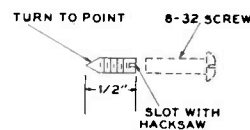

Fig. 8

detailed in Fig. 8. Cone-point set screws can be used if they are available. Brass nuts are used to lock bearings in place on the yoke.

To make the counterweights, cut eight 1 by 2 3/8-inch strips from the 1/16-inch lead sheet. Stack the strips and drill two 1/8-inch mounting holes through them, one on each side of the centerline.

The base is now ready for painting and assembly. It is easier to paint

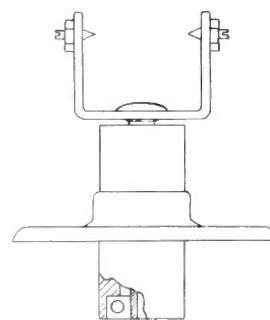
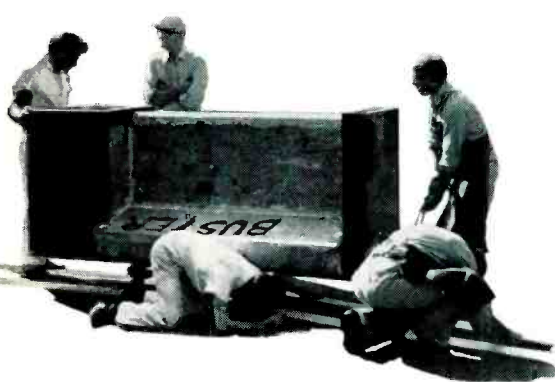

Fig. 9

the parts first, using two or three coats of model airplane dope or pigmented

*Continued on page 40*



by ERNEST B. SCHOEDSACK

## Better Bass with BUSTER

*A three-amplifier multi-speaker-enclosure home audio system.*

IF that caption sounds weighty, it is because it is meant to be. This article could have had a better heading, such as "124 Watts in a 24-foot Room", or "There's Always Room at the Bottom", but its title is intended to dispel any idea that, because of elaborate innovations, this system is just a piece of gadgetry.

It is the end product (to date) of a serious and successful effort to improve music reproduction, and it incorporates some unorthodox practices.

The principal innovation is the use of individually powered speakers in separate (and separated) enclosures. Obvious objections to such an arrangement had to be overcome, and the advantages had to be explored and developed. Then the whole had to be fitted comfortably into a fair-sized living room.

### Basic Principles

The beginnings of this system go back several years to when, inspired by an article in an early number of HIGH FIDELITY Magazine, it was decided to have an air coupler. Seeing no reason why it should be the cumbersome box shown in the plans, it was made in the form of a modernistic library table<sup>1</sup>.

The coupler was, of necessity, located several feet from the middle-range and high-frequency units; later, performance was improved by supplying it with its own amplifier, restricted to low frequencies by means of a variable crossover filter preceding it and the high-range amplifier. Although the coupler has since been replaced by a better-looking table enclosing two woofers, and the balance of the system completely revamped, three basic principles were evolved from this experience:

First, that of bi-functionalism in speaker enclosures. It doesn't require much ingenuity to design these pieces so that they will serve also as useful articles of furniture. If you can't hide it, make it into a bookshelf, a table,

or sit on it! There would, of course, be no reason for such camouflage if home builders would insist that architects exercise some sonic sense. All components would be not only located properly with regard to acoustics, but concealed. The customary practice of completing a house and then, as an afterthought, installing the sound equipment in any available location, should be as obsolete as leaving out the heating system and later moving in a stove. My own house was bought ready-built with no provision for sound; fortunately, the living room is acoustically quite good, though only 16 by 24 ft.

Second, that of the superiority of the variable crossover filter over conventional dividing networks which separate the high and low frequencies after amplification. The variable crossover functions between the preamplifier and two amplifiers, one for each frequency section. With it, the optimum crossover frequency can be selected, and volume balance between bass and treble speakers controlled by the amount of *input* allowed each amplifier, rather than the conventional method of throttling one speaker or the other with a volume control *after* signal amplification. It

should be noted that, in order to avoid high-frequency rolloff from cable losses, the connection between the filter's high-frequency output and the high-range amplifier's input should be as short as possible, and the filter's high-frequency output volume control left wide open. Balancing is best done with the bass output volume control only; therefore, the high-frequency amplifier should be of relatively lower gain unless it has its own level control. These precautions are still more important in a three-channel system with two crossover filters, but, if they are observed, there will be no high-frequency rolloff.

This system has advantages other than that of direct coupling between amplifiers and speakers, not the least of which is its ability to satisfy, with complete flexibility, the proportionately greater power requirement of the bass at very low frequencies. Given speakers capable of really low bass response, and able to handle high power without harmonic distortion, the extra energy made available by a separate amplifier can make the troublesome lower register do anything that is wanted.

It takes more wind (or watts) to

Fig. 1. Table at right is infinite-baffle enclosure for pair of 15-inch woofers.

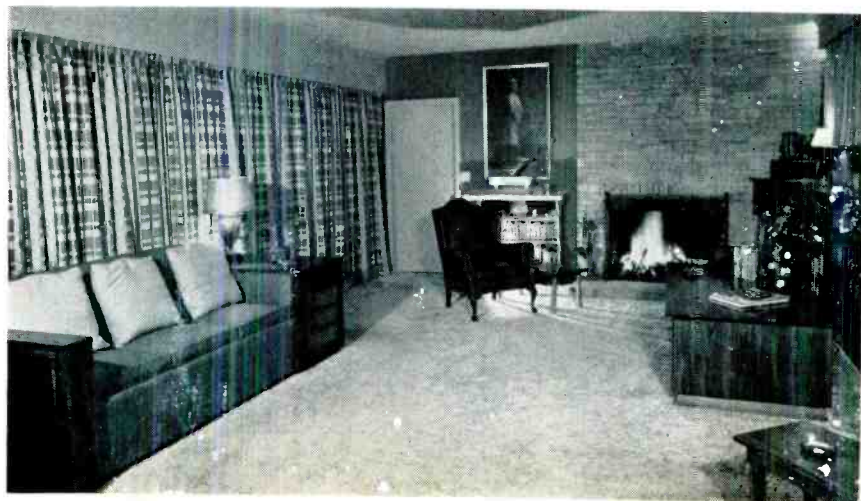

<sup>1</sup>HIGH FIDELITY, Vol. 2, No. 4, p. 33.



blow a tuba than a piccolo. This statement requires clarification, for it can be shown that the average distribution of energy in musical sounds is concentrated more in the lower middle range than in the deep bass. Thus, reason some, it takes as much or more power to reproduce fully the sounds of some upper-range instruments than those of bass instruments. The fallacy of this reasoning lies in the word "average". It is true that more *average* power is produced at middle frequencies than in the bass, but the occasional bass tones require great power to reproduce when they do occur. The introduction of additional large units is necessary in order to move effectively large masses of air at pedal-tone range, and to overcome the very common fault of low-frequency fall-off. Therefore, my kind of a tuba *does* require more watts than a piccolo.

While it isn't strictly true that "There's Always Room at the Bottom", there very often is, and not always in small sound systems either. For fuller information on crossover filters, see "The Bi-amplifier System", by Roy F. Allison<sup>2</sup>.

Third, the principle that, *given certain conditions and restrictions*, speakers reproducing different sections of the tonal spectrum can be mounted in individual enclosures and physically separated without deterioration to the smoothness of the entire range and with



Fig. 2. Interior construction of Buster.

marked improvement in naturalness, vitality, and perspective, plus a quality perhaps best described as *caliber*.

Please note the emphasis placed on "certain conditions and restrictions". These will be dealt with shortly.

There is a small but dedicated group of experts who insist that the entire musical range should issue from one orifice, or even one speaker, which makes one wonder if they have ever listened to the wide-spread sound sources of a symphony orchestra. This is known as the "point-source" school of sonics; a better name might be the key-hole school of listening.

There is no argument with these purists about what happens when a loudspeaker is widely separated from

the high-frequency tweeter with which it normally operates. The thin overtones that give the various instruments their individual characters, and the human voice intelligibility, are rudely torn from their parent fundamentals; the resulting shredded sound is most unpleasant.

In contrast to the disastrous results of moving speakers apart at high-fre-

axis (a fourth dimension)", "acoustical delay", and so on. One of them claims stereophonic reproduction from monaural sources. The common objective is to recreate the differences in time required to reach the ears for sounds originating at different distances and angles. This they do by means of devices within a single cabinet which delay or lengthen the paths of certain fre-



Fig. 3. Upholstered Buster, a sub-woofer enclosure, makes a comfortable seat too.

quency dividing points, there is a great improvement in caliber of large systems, where the bass and middle-range sources are often moved as far apart as the size of the cabinet permits, but with frequency division comparatively low—usually at 800 to 400 cps, and in some systems somewhat lower. It can be observed that the lower the crossover frequency, the farther apart these sources can be effectively located.

The lower and longer the sound waves, the broader is the blending pattern of the fundamentals, and their overtones and partials, with those of the adjoining frequency range.

In my old air-coupler layout the bass and middle-range sources were nearly 6 ft. apart. Using the variable crossover, the most satisfactory dividing point was found to be 150 cps. It seems evident that the distance by which speakers may be advantageously separated is directly related to the crossover frequency, the optimum point of which drops in sharply increasing ratio as the distance is extended.

The first of the certain conditions governing the physical separation of frequency sources, then, is the selection of a crossover frequency suitably low for the distance of separation.

Some manufacturers have recognized the merits of placing different frequency ranges in acoustic perspective. In describing the methods employed, they use such terms as "three-dimensional audio vibrations occurring along a time

frequency ranges. Thus, an acceptable illusion of natural perspective may be achieved.

In the system being described, this objective is approached in more direct fashion and on a broader scale. The sources of different frequency ranges are placed in individual enclosures and actually spread out at different distances and angles, in accordance with principles determined by experiment.

The table-type infinite baffle now used, Fig. 1, contains about 20 cu. ft. of air, and mounts two 15-inch Wharfedale woofers. Their basic cone resonance is at 28 cps. The nearest of these speakers is over 7 ft. from the middle-range source. In conformance with the established rule, crossover frequency was dropped to about 100 cps. The result is not only perfect blending, but a better, broader bass, and a tremendous improvement in the virility of the entire range. At such a low crossover frequency there is never any unpleasant sense of shifting from one speaker to the others.

I find it difficult to convince persons who have never heard a system using such low crossover points that this is true, until they have had the experience. Let us take for example that splendid cello recording, Bloch's *Schelomo*, played by Zara Nelzova and the London Philharmonic (London LL 1232). Although the lowest note on the cello is about 55 cps, Miss Nelzova does not skip about the room from speaker to speaker,

as some skeptics expect her to do. Instead, with the present further extended speaker arrangement (described later), she seems to sit about five feet in front of the corner enclosure, and she *stays* there. The lowest notes of the cello still seem to be coming from only one source, but are richer and warmer than when played by a single speaker; this is because of the non-directional contribution by the separated woofers in the very lowest partials of the cello's complicated tonal structure. It is a

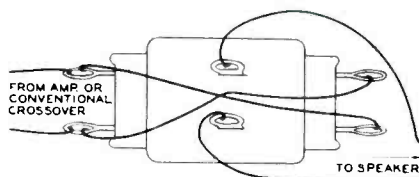

Fig. 4. Speaker phase-reversing switch.

routine experience to see first-time auditions, especially professionals, rushing about and pressing ears to various enclosures before they accept the validity of this phenomenon, and settle back to enjoy the smoothest, richest, and most realistic cello reproduction that they have ever heard.

This woofer cabinet is made of wood built up to a thickness of 1½ in. with an ash center post, a lot of insulation, and a sand-ballasted<sup>3</sup> speaker panel. It is as sturdy as a Steinway

The so-called *drawbacks* of low cone resonance are low efficiency, and a tendency to peak at the basic resonance when the speaker is enclosed in an infinite baffle. Low efficiency was a detriment when high amplifier power was either impossible to get or too expensive, but now good clean watts are plentiful. A 50-watt Fisher amplifier drives these woofers at a fraction of capacity, with plenty of reserve for peak demands.

As for a tendency to peak, when this occurs at 28 cycles, down where sound should begin to be felt more than heard, I do not find it at all objectionable—preferable, in fact, to the use of woofers with higher basic resonance which must resort to various types of acoustical aids in their struggles to reach such a low response. These devices often cause varying degrees of cabinet coloration, hang-on, or boominess not present in a well-designed and constructed infinite baffle direct radiator.

There is another argument against the use of direct-radiating low-resonance woofers which goes like this: having no front loading, the speaker has nothing to push against but the normal atmosphere. Therefore there are said to be but two choices, both bad; either to use an underdamped speaker and get sloppy bass, or an overdamped speaker and get no bass at all! It is

maintained that the *only* way to get acceptable bass is to use a vast number of woofers to build up sufficient radiation resistance or, preferably, to obtain this resistance by using a horn for front loading.

Here is a large area for differences of opinion involving scientific tests and personal likes and dislikes. Later in this article I will submit another answer to the problem of frontal radiation resistance for cone speakers, for what it is worth. It has proven quite worth while to me.

This subject cannot be dismissed without mention of the revolutionary achievement of Edgar M. Villchur, who, with his AR-1 woofer, has carried the principle of the free-moving, low-resonance, low-efficiency, totally rear-enclosed, direct-radiating cone to the ultimate degree with the greatest success. A few of these amazing little boxes, strategically placed, would provide as fine and broad a bass as could be desired, and would make either camouflage or concealment very easy.

The second of the conditions necessary for successful speaker separation is that all units must have good dispersion, which they should have in any system, of course. But now good room coverage by all speakers becomes doubly important, to insure good blending with the other speakers units. The subject of speaker placement in regard to room acoustics is well covered in an article by William C. Bohn<sup>4</sup>.

Use of such low crossover frequencies requires a middle-range speaker capable of full response well below the unusually low crossover point; horns are not recommended for this section because of the impractical size which would be required, and their characteristic low-end cut-off, which mitigates against easy blending.

### Enter Buster

The gratifying results of reinforcing and broadening the bass led to speculation as to what might happen if this were further extended. But before such exploration could be attempted, several problems had to be solved. The first of these was space and location, as the new unit should be proportionately larger and more powerful than the existing bass. It was decided that the only possible place for the thing was across the room from the big table enclosure, in a space already occupied by a davenport and an end table. So the new contraption would have to be not bi-functional, but tri-functional, serving as speaker enclosure, davenport, and end table.

This daring broad jump would require, according to the rule established,

a crossover frequency much lower than provided for in anything readily available. The lowest crossover point in the filter being used was 90 cps. Walter M. Jones, of the Jones Apparatus Company, was appealed to; he responded with enthusiasm, coming up with a 55-cps modification of his original model! This was a big move in the right direction.

Then what woofer? As there would be room for only one in the new design, it would have to be complementary to the two 15-inchers across the room, in power handling and air-moving capacity. It would also have to be capable of responding to the lowest recorded frequencies. The 15¾-inch German-made Wigo was selected, mostly because of its design and specifications. The open-back cast aluminum rigid girder-type frame resembles that of the Wharfedale but is much heavier. The Wigo has no mounting bolt holes at all. Instead, it is held in place by steel clamps with ⅜-inch bolts which, in addition to being very strong, make mounting safe and easy. The cone is a stiff piston, but large-volume air displacement and low cone resonance are provided by a wide Fibreglas surround. So great is the excursion capability that the cone is prevented from striking the edge of the speaker panel or the grille cloth by a gasket about ½ in. thick, in addition to a very thick frame rim. The power-handling capacity is rated at 50 watts, and the magnet is very powerful. Despite its liberal lineal excursion, this speaker has good damping and provides

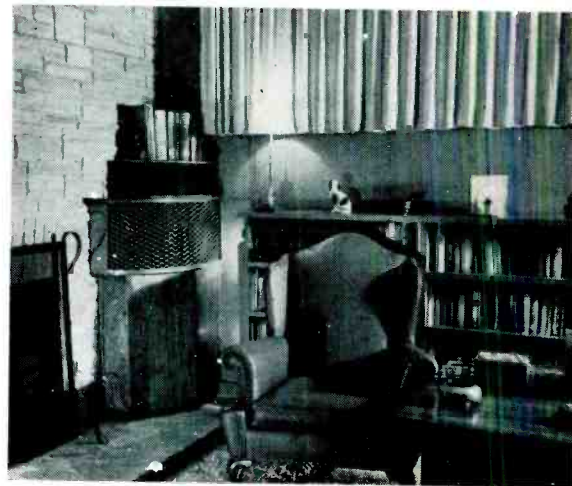

Fig. 5. Middle- and high-frequency units.

clean-cut bottom bass. The choice was a good one.

A 60-watt McIntosh amplifier drives the Wigo easily with a low input setting.

The expensive and irrevocable nature of this project made it necessary to take all possible precautions against failure. The first was to design a good piece of furniture, which would at least be something to sit on. If not to listen

<sup>3</sup>Schoedsack, Ernest B., "Load It with Sand", *AUDIOCRAFT*, December 1955, p. 32.

<sup>4</sup>Bohn, William C., "Out of the Speaker Into the Room", *AUDIOCRAFT*, November 1955, p. 24.



to. Large margins of safety were allowed in size, strength, and weight, all in proportion. This may not be refined engineering, but it is good sound engineering, and no pun intended. The entire structure of the davenport-end-table is hollow, with a volume (exclusive of insulation) of about 29 cu. ft. Every section is double-skinned and sand-filled, with the exception of the outside of the end farthest from the speaker and the outside of the seat back, which are strongly braced. The sand spaces vary in thickness from  $\frac{3}{4}$  to  $1\frac{1}{2}$  in., and are divided into sections by hardwood strips. These not only lend rigidity to the structure but prevent the  $\frac{1}{2}$ -inch plywood sand jackets from bulging. Fig. 2 shows the lower view of this assembly as it was being moved into the house.

Over 400 pounds of sand were thus swallowed up, and an estimated 300 pounds of hardwood, plywood, bolts, screws, glue, and upholstery were used. The speaker weighs 33 pounds. Early in construction the thing naturally acquired the name of Buster.

Further assurance of good low-frequency response was provided by a port consisting of eighty  $1\frac{1}{2}$ -inch holes, located in the back and connecting with one of the devious intricacies of a hollow seat-back section. The idea was that the port should serve as a pressure vent in an acoustical labyrinth, not as a bass reflex port, because a Helmholtz effect was not wanted. The port would provide an alternate choice with the infinite baffle, which of course the enclosure would be with the port closed. As it turned out, there was not much difference with the port closed or open; only a slightly better response around 30 cps with it open, so it was left unstopped. Either way there are no audible peaks, and no boom, which may be partly due to the limited frequency range spanned and the liberal proportions used in every department. Fig. 3 is a closeup view of Buster after installation.

At any tolerable room volume, Buster is just coasting, without fatigue to himself or the listener.

Buster has another unusual feature—no bottom. The floor is a concrete slab, heavily padded and carpeted, non-vibrant and non-resonant. The weight of the structure makes an air-tight seal with the carpet. This eliminates the need for removable speaker or access panels which might shake loose; everything is permanently screwed, bolted, and glued together. Access to the speaker is simple; it is only necessary to turn Buster over. I said simple, not easy. It is no trick at all for four strong men.

Because the two woofer enclosures face each other at a distance of 9 ft., Fig. 1, some phasing trouble was anti-

ipated. An easy method of phasing is to connect the leads of one of the speakers to be phased with the center terminals of a double-throw two-pole switch; the poles on one end of the switch are connected by crossed wires to those on the other end, which in turn connect with the amplifier. See the sketch in Fig. 4. Throwing the switch reverses polarity, inverting the phasing of the speaker. Using a frequency test record, or a signal generator, the switch is moved back and forth, and the position giving the best results is selected. This method is much better than disconnecting, interchanging, and reconnecting the speaker leads, for during the time required for this operation one is apt to forget critical differences in the comparative sound.

In this case, reversing polarity had little effect at the crossover frequency, where a difference was to be expected, while in one switch position there was considerable improvement around the

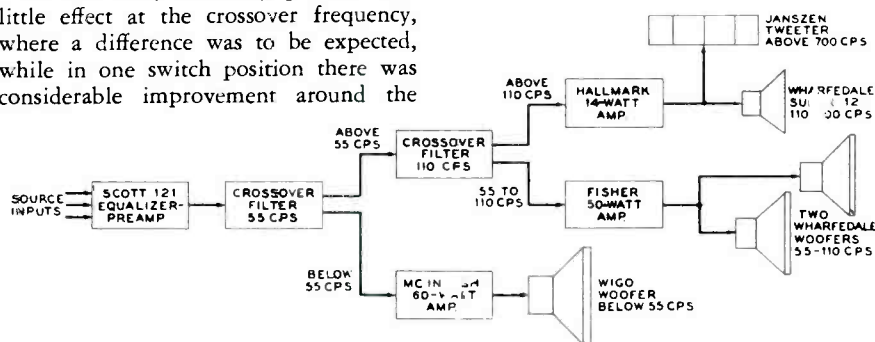

Fig. 6. Block diagram of Mr. Schoe'sack's sound system from preamplifier onward.

30-cps region. Here is the alternate method, previously mentioned, of raising radiation resistance. The opposing woofer units, with their closely overlapping crossover slopes, work together on effectively the same mass of air, improving the low-end performance of both. This method is probably not perfect; it is certainly not commercial; it produces impressive and pleasing results.

At this point a reasonable question would be: is all the additional work and expense involved in developing such a bass worthwhile? This can be answered by beginning with a quote from an article by R. S. John in *HIGH FIDELITY*: "It was found that the audible response to the lowest frequencies generated by musical instruments had a most beneficial effect on the entire frequency range." It should be added that to realize fully these benefits, low-frequency response, or *depth* alone, is not enough. The bass should also have large air-moving capacity, or *mass*, and a third dimension, *breadth*. Their combined effect may be more psychological than precisely measurable, but the same can be said of the effect of music itself.

Skeptics may be convinced by a simple but dramatic demonstration. First the preamplifier is plugged directly into the amplifier serving the middle-

range and high units, so that they handle the whole range without being limited by the crossover filters. This section is a superior two-way system in itself, but at any volume it sounds puny compared to what happens when the preamp is plugged into the upper crossover filter, bringing in the two 15-inch woofers over seven feet away. The impact is dynamic, not only in the bass, but in the virility of the whole range. The contrast is almost equally striking whether or not the music being played has any very low frequencies. Caliber is not just a matter of loudness, nor does it depend entirely upon extended bass response.

Then the preamp is plugged into the lower crossover filter, and its high-frequency channel into the upper cross-

over filter, and Buster enters the picture. Buster's influence is usually felt immediately, if only as a subtle pressure. Even at moderate volume levels the two low crossover frequencies, being only one octave apart, furnish an overlap to bridge audibly the long base-line of the triangular speaker arrangement. As the pitch descends to 55 cps, where many systems show signs of quitting, Buster goes lustily to work, and the lower frequency waves spread out to form a firm foundation for the triangular tonal pyramid. If sensational sound is asked for instead of music, Ertry Cook's earthquake record, with a little increase in the lower amplifier input, can make Buster tremble—400 pounds of sand and all. But this is not good for windows and plaster. Californians don't like it much.

### The Upper Sections

While so much attention has been devoted to the bass, the middle-range and high-frequency sections have not been neglected. There is so incorporate deviations from customary practice. They occupy, Fig. 5, the preferential corner location which would ordinarily be allotted to the bass. This was done to insure full middle-range response, well down below the crossover frequency, as well as for full and equal room coverage for all the upper frequencies. Plac-

*Continued on page 41*

<sup>1</sup>John, R. S., "The Better the Bass, the Better the Sound"; *HIGH FIDELITY*, Vol. 2, No. 2, p. 46.



## How To Get Odd Resistance Values

Occasionally, when building up a circuit, you will find on the schematic a resistor or two marked with an asterisk. Looking down the parts list, you may discover that parts so marked are for an odd value of resistance, or that the resistances must be matched to within 1%.

Here is a way to match one resistor to another *exactly*. If, for example, you want two matched 2,250-ohm resistors, obtain two resistors of 2,200 ohms (a standard value) with a tolerance of 5%. With an ohmmeter, determine which resistor's value is closest to 2,250 ohms. Then, with a file (flat, round, or triangular), file away the body of the resistor until the proper value is at-

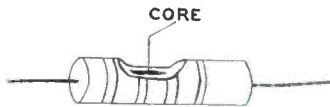

Filing resistor to obtain desired value.

tained. The second resistor can be matched to the first by the same method.

Most composition resistors are molded into an outer shell of bakelite. As soon as you have filed through this insulating shell, the inner core of the resistor, which is darker in color, will be seen. Then go slowly and measure the resistance after each stroke with the file. It's very easy to remove too much, and, once it's taken away, you can't put it back.

W. H. Hardy  
Sacramento, Calif.

## Measuring Flutter and Wow

Rapid speed variations of several tenths of a per cent will pass unnoticed except in very unusual program material, and figures in this range are now common in the better turntables and tape recorders. A critical ear will be able to notice variations much smaller than this in a nominally steady, pure tone; .03% is detectable in a reasonably lively room (3 Kc at 3 cps flutter). You may have been disconcerted by this when you attempted to test your new table by playing a constant-frequency test record, and yet have been unable to

notice any disturbance of piano or organ recordings. Due to the short wave length of high audio frequencies, a very slight change in frequency may produce a large intensity change at the ear. In fact, if you listen to an oscillator tone while sitting right in front of the speaker, the intensity will fluctuate due to motion of your head. Diffusion of the highs in your system can be tested by listening for an apparent flutter as you move about the room.

Another property of that lo-fi but versatile instrument, the ear, may be turned to account to *measure* speed variations—its ability to detect difference tones. (Your ear has terrible IM specs!) As an example, let us test a turntable. First, play a constant-frequency band of a test record and, at the same time, play a variable-frequency oscillator through another speaker. Failing another amplifier and speaker, or a mixer input to your main amplifier, you can probably arrange to induce enough of the oscillator frequency in the preamp stage. You should have no difficulty in setting the frequencies the same, and in observing beats when they are approximately the same. (It is best when the intensities are equal.) You will not be able to count beats, however, since one of the frequencies is varying, not just different. The trick consists of detuning the oscillator until the beats occur at a recognizable musical pitch. The absolute variation in the record frequency appears as the variation of the difference tone; this much larger *relative* variation can be recognized as a musical interval. It won't be very musical because of its irregularity, but it should be quite obvious.

To illustrate the sensitivity of the method, suppose the input frequencies are about 10 Kc, and the difference is adjusted to be about 165 cps (E below middle C); then a 0.1% variation at 10 Kc, or 10 cps, will be the variation at 165 cps, or 6% which is very nearly a semitone. The calculations can be refined as may seem appropriate. Lest a 1% flutter sound like Uncle Willy gargling, or the difference tone be hard to hear, it is best to start near 1 Kc and experiment with your equipment to optimize recognition of the

difference tone. Then work up to higher frequencies until the wow and flutter are measurable. The method described measures peak variations if they tend to be one-sided, as due to a "flat" on an idler wheel, or peak-to-peak if they amount to a general tremolo. With a tape recorder, of course, one observes the combined effects of variations in both recording and playback. It may make a difference just how the tape is loaded for playback.

Further modifications and applications of the technique will occur to the experimenter, such as making a mixer deliberately non-linear to get strong electrical intermodulation, or observing slow-speed drift due to warm-up or load changes, if you are sure of your oscillator stability. The basic method is much more useful than an expensive professional RMS wow-and-flutter meter since much can be learned from the instantaneous pattern of variation that is helpful in locating and minimizing mechanical imperfections.

Dr. John D. Seagrave  
Los Alamos, N. Mex.

## Determining Grid Bias

Did you ever wish to know the correct grid bias for a tube operated at voltages other than those given under "typical operating conditions" as listed in tube manuals? Measuring and plotting a series of plate-characteristic curves is a laborious method of obtaining this information. Perhaps even after plotting

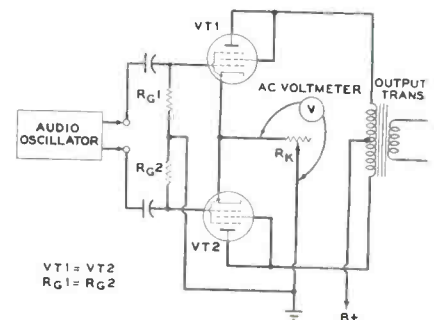

Circuit to determine optimum bias.

the curves you were in doubt as to their accuracy, the calculations involved, or interpretation of these data. I recently faced this problem when attempting to use an audio pentode in a triode Class-



A<sub>1</sub> voltage-amplifier circuit, and wanted to know the proper grid bias for best linearity and lowest distortion with the tube triode connected (plate tied to screen grid).

An empirical method for determining this is to set up a pair of the tubes in question in a push-pull circuit with arbitrarily selected values for B+ voltage, plate-load resistor, grid resistor, etc. Both cathodes are tied together and connected to one end of a rheostat or potentiometer (preferably wire wound) with a maximum resistance several times the expected value for the cathode-bias resistor. Typical values for this rheostat will be 1 K to 10 K. The slider terminal of the rheostat is connected to B— and to the free end of the grid-return resistors. An audio voltage is fed into the circuit from grid to grid, and the *audio* voltage developed across the rheostat is inspected with a sensitive AC VTVM (e.g. Heathkit AV-2), a sensitive oscilloscope, or even a pair of headphones. Starting with the rheostat set for maximum resistance, the resistance is adjusted for a null or minimum reading on the AC VTVM or other indicating device. The more sensitive the indicating device, the more exact this null point will be. If a sensitive 'scope is used, don't be surprised if the wave form at null is rather bad. When the *audio* null has been found, measure the DC voltage across the rheostat with a high-resistance voltmeter. This DC voltage is the correct grid-bias voltage for best linearity of these tubes under the operating conditions you have chosen. Of course, you must not select the null at the zero-resistance end of the rheostat, since both audio and DC voltages will be zero at that point. Another warning: do not feed the grids with more than twice the maximum driving voltage estimated for a single tube.

If the tubes are operating linearly, the increase in plate current in one tube is exactly balanced by an equal decrease in plate current in the second tube, and the net change across the rheostat is zero, hence no audio voltage is developed. If the tubes are biased to a non-linear position on their operating curve, the increase in plate current of the first tube will not be balanced by an equal but opposite change in the plate current of the second tube, the net change across the rheostat will not be zero, and an audio voltage will be developed. The magnitude of the audio voltage will be proportional to the amount of non-linearity.

This method works very well for a Class-A amplifier, either single ended or push pull. If the two tubes are badly mismatched, the null will not be as sharp as it will be when the tubes are closely matched. This fact can be used to estimate the degree of mis-

match or to select a pair of closely matched tubes if a number of tubes are available for test.

Eminger Stewart  
Stanford University  
Stanford, Calif.

### Fixing Turntable Wobble

Some changers, even some of the better ones, have turntables that will not run true. These turntables are usually of pressed steel.

To determine whether a turntable wobbles, turn it on and hold a piece of chalk against the rim. If the chalk line is not equally distant from the top of the turntable at all points around the rim, the turntable is not true. To correct this condition, take pieces of cardboard of different thicknesses and cut them to fit half the turntable. Beginning with the thinnest, place the cardboard on the low side of the turntable until a good flat record placed on top will run level. Glue the cardboard to the turntable and cover with a sponge-rubber mat. By leveling the turntable in this way, distortion and record wear can be reduced to a minimum.

Terry McConnell  
Petoskey, Mich.

and the tip is negative, because the current flows from the center tap to ground. The same cable can be used to balance the final stage of a Williamson-type amplifier, if the leads are reversed at the meter end.

Milton Ogur  
Brooklyn, N. Y.

### Chime Test for Distortion

The audio experimenter will find that a recording of chimes offers a severe test of the distortion characteristics of any amplifier. The record I use is Mercury's MG 20001, hymns and Christmas carols with chimes and organ. One amplifier in my possession, which uses cathode loading on a single beam power tube with a direct-coupled driver, gives crystal-clear reproduction from this record. On other amplifiers less well suited to the handling of sharp transients, an accompanying mushy or scratchy sound can be heard as each chime note is struck. Although this annoying type of distortion is inherent in some records, the fault does not always lie with the disc. It is very easy, however, to blame the poor sound on the record until it is played through a quality amplifier.

Harry L. Wynn  
Derry, Pa.

### Beautifying Aluminum Chassis

Unpainted aluminum chassis offer several advantages to builders of hi-fi equipment: they are light in weight and sturdy enough for most applications; and, more important, they can be punched, drilled, and worked with much greater ease than other metals. The softness of aluminum, however, shows scratches readily. Here is a procedure I have found quite good when working with aluminum.

After all drilling, punching, and other mechanical work has been completed, give the chassis an even and thorough scrubbing with soap-filled steel wool, such as *Brillo* or *S.O.S.* pads. Wash the chassis well in hot water, and polish dry with a soft, clean cloth.

This operation removes fingerprints, pencil marks, and minor scratches. Minute burrs and roughness around holes and punch-outs are completely smoothed, giving the chassis the appearance of a commercially stamped unit. In addition, it takes on a beautiful chrome-like luster which is retained indefinitely under ordinary circumstances.

Decals, if any are to be used, should be applied at this point, and one or two coats of clear *Krylon* sprayed over them.

This extra bit of work will produce an attractive piece of equipment that even your most non-technical friends will admire.

N. V. Becker  
Hollywood, Calif.

### AUDIO AIDS WANTED

*That's right—we'll pay \$5.00 or more for any shortcut, suggestion, or new idea that may make life easier for other AUDIOCRAFT readers, and which gets published in our Audio Aids department. Entries should be at least 75 words in length, and addressed to Audio Aids editor. No limit on the number of entries.*

### Meter Jack

A simple addition to the power supply of any amplifier is a closed-circuit jack (the type that will take a PL55 plug) wired between the center tap of the high-voltage secondary and ground. This is the safest and most convenient point in the circuit to measure total DC load for testing purposes. A cable can be prepared with the PL55 at one

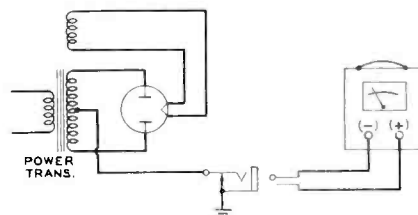

Connection for B+ current checks.

end, and whatever plugs are needed to fit the particular ammeter used at the other end.

Care should be taken with polarity, as it is opposite to that generally applied to the PL55 in the Williamson circuit. Here the shaft of the plug is positive

# Checking Your Tape Recorder

by HERMAN BURSTEIN

**E**VEN the least expensive home tape recorders are fairly complex affairs, performing a substantial number of basic functions. It is a tribute to their manufacturers that most such machines manage to give a good deal of service before having to undergo repair. Durability alone, however, is not enough for high fidelity purposes. Of vital importance is maintaining the *quality* of service. Long before the recorder breaks down, performance may be degraded.

By now, audiophiles are generally aware that amplifiers must be checked periodically for balance, tuners for sensitivity and alignment, phonograph arms and cartridges for stylus force, styli for wear, phonographs for accuracy and steadiness of speed, and so on. Tape recorders are no exception. They probably head the list of high fidelity components that should be regularly checked.

There are five basic performance requirements of a tape recorder: 1) accurate speed; 2) steady speed; 3) low distortion; 4) high signal-to-noise ratio; 5) reasonably flat frequency response over a wide range. It is no small feat for a recorder to operate properly in all respects at once. In fact, regular checks will show that something does go wrong once in a while — not enough to prevent use of the machine, but enough to spell the difference between high fidelity and other degrees of fidelity.

In order to check and adjust a tape recorder *precisely*, a costly array of instruments is needed, including a sine-wave generator, oscilloscope, sensitive AC voltmeter, flutter meter, harmonic-distortion meter, and IM-distortion meter. This does not mean that an audiophile who suspects his recorder is not up to par must forthwith bundle it off to the manufacturer or an authorized service agency to confirm his suspicion. He can check his recorder's performance in all essential aspects by simple and relatively inexpensive means consisting of a test tape, a phonograph frequency record, and an inexpensive test-level indicator. The home recordist, without previous technical knowledge or skill, can use these test devices to measure each basic performance characteristic of his tape recorder.

There are several test tapes on the

market, including those made by Ampex, Audio Devices, Dubbings, and Minnesota Mining and Manufacturing Company. Of these, the most comprehensive for home-recorder use are the Dubbings tapes: the D-110, for machines operating at 7.5 ips, and the D-111, for those operating at 15 ips. They contain timing signals, several 400-cps tones for ascertaining signal-to-noise ratio and maximum permissible recording level, a prolonged 3,000-cps tone for checking wow and flutter, a prolonged 5,000 or 10,000-cps tone for azimuth alignment, and a series of frequencies from 30 to 7,500 cps or 30 to 15,000 cps.

A number of phonograph test records are readily available, including those made by Cook, Clarkstan, Dubbings, Folkways, and others. For the purposes to be described below, any of these or similar test records are suitable, provided that they contain discrete (not sweep) frequencies covering the range of at least 50 to 10,000 cps.

Virtually any multimeter with reasonable sensitivity — 10 volts or less full-scale reading on AC volts — should be suitable for the tests to be described. I have seen such meters, usually of foreign make, advertised for \$10 or



less. Probably the least expensive of any test-level indicator is the Dubbings D-500 indicator. It consists of three bulbs which light successively as increasing voltage is applied. The bulbs light at levels 3 db apart, and measurements can be made covering a range of 8 db. According to whether a bulb turns dull red, orange, or yellow, readings can be made with an accuracy of about 1 db, altogether sufficient for

check purposes. Whatever level indicator is used can be attached across the leads to the tape recorder's internal speaker or the leads to the speaker of the user's sound system. If a sensitive indicator such as an AC VTVM is used, connection can be made at the tape recorder output intended for feeding a power amplifier.

## Speed Accuracy

Professional standards call for recorder speed to be accurate within 0.3%. This means that in a ten-minute period the machine will gain or lose slightly less than two seconds. It should be pointed out that the professional studio requires great timing accuracy in part because it usually makes several generations of tape, often on different machines. For example, duplicates may be made from a master tape, and these duplicates may be used as sub-masters to make more copies. Here, then, are three generations. Sometimes as many as six generations are made. Consequently, an initial error of two seconds may eventually amount to considerably more. Although accuracy within 0.3% is also desirable for home use, errors up to 1% or more will often go unnoticed by musically untrained ears in the event that a tape recorded at exact speed is played back on a machine off speed. An error of 1% corresponds to a deviation of six seconds in a ten-minute period.

The Dubbings test tape provides a simple check of speed accuracy. It contains three timing beeps exactly five minutes apart, with a voice announcement preceding each one. The tape is played back on the machine undergoing test, and the time between beeps is measured with a stop watch having a second hand.

## Speed Stability

Variations in speed are referred to as wow and flutter. Wow consists of slow changes, roughly under ten times per second, while flutter consists of more rapid changes, as high as several thousand times per second. Wow and flutter modulate the audio signal and thereby produce signals not originally present. In other words, speed variations produce frequency modulation.

*Continued on next page*



# OPTICAL TAPE TIMER

by John J. Stern, M.D.

SOME tape recorders have footage counters. Others have scales printed underneath the take-up reel to indicate the time elapsed. Both devices are useful in locating a selection on a tape or in estimating remaining recording time. But there are other tape recorders, particularly the more expensive ones, which do not have any timing device.

It is simple to add one by pasting a strip of paper under one reel, marking on the paper the positions of the tape accumulated on the hub at intervals of three or five minutes. This gives a rough estimate but is not very convenient. Smaller time intervals can hardly be accommodated on the strip, and one has to squint closely at the markings to get readings that are even reasonably close to correct.

I have added to my Concertone tape recorder a timing device which is exceedingly simple, yet highly accurate. It uses no moving parts. Its principle can be applied easily to any other tape recorder.

The only two components are a light source and a screen. Light is projected on the screen in such a manner that the shadow of the tape accumulating on the take-up reel falls on the screen markings. The sketch will explain this.

I use as a light source a small pocket flashlight (lipstick-size) with self-focusing bulb — the kind that has a

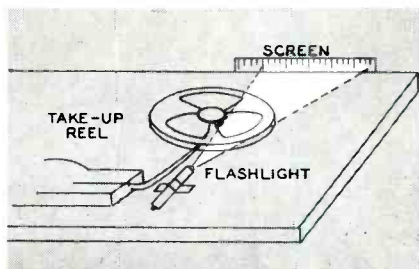

*This simple, accurate, and inexpensive recording time indicator is easily made.*

small lens at the tip. This is necessary for a sharply defined shadow on the screen. The flashlight is mounted in a bracket cut out of an aluminum sheet with ordinary scissors. Holding the flashlight at the level of the tape, the bracket must be oriented so that the light cone from the flashlight covers the outer half of the take-up reel from hub to rim. It can be mounted with two screws on the base plate of the tape recorder, or with metal-gluing cement or even masking tape, but care must be taken that the light source is absolutely rigid.

The screen is a strip of paper or cardboard mounted opposite the light, also at the level of the tape, at the far end of the take-up reel. It is desirable to mount the light as close to, and the screen as far from, the reel as practi-

cable, in order to obtain a wide spread of the indicating shadow on the screen.

Once both components are mounted, there is only the timing to be done. A stop watch is best, but any watch with a second hand will do. An empty reel is put on the take-up side, a full one on the supply side, and the light is flashed on the screen to locate the zero point (the shadow of the empty hub). Then the tape is started and timed with the watch. After one minute the tape is stopped, and the position of the shadow is marked on the screen; this is repeated for each succeeding minute of tape travel. That's all there is to it if only one type of reel and of tape is used. If reels of different hub diameter or extra-thin tape are used, a second set of marks must be added on the screen.

There are many refinements and modifications that can be made on this principle. The flashlight can be replaced by a filament transformer and a pilot-light socket with a self-focusing bulb, for instance. But that complicates matters needlessly, and the battery-operated flashlight lasts a long time since it is switched on only occasionally. Other improvements can certainly be conceived—tape-recordists are notoriously ingenious; but even in its simplest form, as described, this timing device will work well if a little care is taken to install it properly.

*Continued from preceding page*  
and the rate of modulation appears as unwanted audio frequencies.

The human ear is most sensitive to speed variations at frequencies around 3,000 cycles. When playing a test tape at such frequencies, if wow is present in even slight degree, the note will have discernible pitch variation. If flutter is substantial, the note will have an audible tremolo or will sound "hoarse" rather than pure.

## Distortion

Sensitive human ears can detect distortion—harmonic or intermodulation—when it exceeds a very small amount. Yet it is not uncommon to find tape recorders operating in such fashion as to generate relatively tremendous quantities of distortion, especially intermodulation, during loud passages. IM distortion may then reach 10% or more. This sometimes accounts for the breakup effect observed during peaks on tape recordings or on phonograph records made from tape.

Various elements of a tape recorder

may be responsible for distortion: the record preamplifier or playback preamplifier, the bias oscillator, or the record head. Most frequently, however, distortion occurs because the tape is overloaded—that is, subjected to excessively large amounts of audio signal. Although a tape recorder has an indicator (magic-eye tube, neon lamp, or VU meter) to warn the user against over-recording, the indicator may be functioning improperly so that it continues to give a "safe" reading when the recording level reaches a point of noticeable distortion.

With the three test devices previously described, a fairly accurate check can be made as to whether the record indicator gives proper warning of distortion. The Dubbings tape contains a 400-cps tone recorded at a level resulting in 2% harmonic distortion. The level indicator is attached across the speaker leads or the recorder's voltage output jack to measure tape recorder output while this 400-cps tone is played back. Gain of the recorder or sound system amplifier is increased until there

is enough signal to produce a clear reading on the indicator. The next step, using a fresh roll of tape, is to record a 400-cps tone at a level equal to that of the Dubbings tape—the level which, in playback at the same volume control setting, produces the same reading on the indicator. The source of the 400-cps tone is a phonograph test record, assuming a phonograph is available which can be fed into the tape recorder.

In the case of a machine with separate record and playback heads, it is only a few moments' work to find the 2% distortion recording level, because playback can be accomplished simultaneously with recording. In the case of a machine with a single record-playback head, trial and error is necessary to find the proper recording level because the tape must be rewound each time before playback.

When it has been determined what setting of the tape machine's gain control will cause a 400-cps tone to be recorded at a level corresponding to

*Continued on page 38*

# BASIC ELECTRONICS

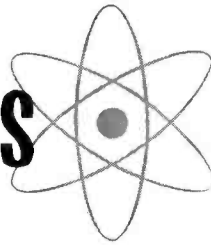

## VII: Capacitance.

### Capacitance

The point has been made in this series that work is done whenever a charge moves or is moved from one potential to a lower or higher potential. If there



Fig. 1. Paper-dielectric capacitors.

is a difference in potential at two points in a circuit or in a conductor, free electrons in the conductor move in such a manner as to equalize the potentials; only if the difference in potential (voltage) is maintained externally is there continuous charge flow (current). The work done, it will be recalled, is

$$W = EQ$$

where  $W$  is work in joules,  $E$  is potential difference in volts, and  $Q$  is charge in coulombs.

But if the difference in potential is *not* maintained externally it is soon neutralized by the charge flow. It follows that any isolated conductor, whether charged or not, has the same potential at any point on its surface; further, any charge impressed on the conductor will generally be distributed uniformly over its surface. The potential of any charged object is, of course, proportional to the density of charge on its surface. If the surface area is increased, the total quantity of charge must be increased for the same charge density.

Visualize a sphere that is, say, 4 sq. in. in area. A charge of 40 coulombs is imparted to the sphere. The charge density is then 10 coulombs per sq. in., which represents a certain potential. Now suppose the same charge is impressed on a sphere of 2 sq. in. This represents a charge density of 20 coulombs per sq. in., or a potential exactly twice the first. If the charge on the smaller sphere is reduced to 20 coulombs the charge density—and the potential—are halved, so that they are equivalent to the charge density and the potential of the larger sphere. Evidently, then, the potential of any charged object is directly proportional to the quantity of

charge, and inversely proportional to its capacity to accept charge. This is expressed as follows:

$$E = \frac{Q}{C}$$

where  $E$  is the potential in volts,  $Q$  is the charge in coulombs, and  $C$  is a quantity determined by the charged object's size and shape. It is known as the *capacitance* of the object, for it is a measure of its ability to act as a reservoir of charge. Generally, the larger the surface area of the object, the greater is its capacitance.

Capacitance is a most useful property that is exploited in a great many ways. Various amounts of capacitance are available in practical components called

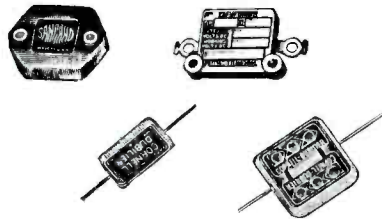

Fig. 2. Mica-dielectric capacitors.

*capacitors*. Because the capacitance of a conductor is increased when another conductor is brought near it, the practical capacitor consists of a pair of *plates*, usually of relatively large area, separated by an insulating medium called the *dielectric*. In a so-called "paper" capa-

ditor, shown in Fig. 1, the plates are sheets of metallic foil separated by a specially impregnated paper; the sandwich thus formed is rolled into cylindrical shape for compactness, and sealed within a hard plastic body for durability. Connections to the foil sheets are made by pigtail leads brought through the body. In "mica" capacitors the insulating material is a thin sheet of mica; these capacitors, because they are not rolled, usually have flat bodies as in Fig. 2. Ceramic capacitors are made with a ceramic titanate material as the dielectric. They may be tubular in shape (although not rolled), but are usually fabricated in flat disc form, as Fig. 3 shows.

Variable capacitors, such as the tuning condensers in radios, utilize air as a dielectric. Each *plate* of such a capacitor may consist of several rigid half-discs, mounted side-by-side but separated; one set of half-discs can be rotated to intermesh with the other set (without touching) to any desired degree. The amount of mesh determines the capacitance. Two or more capacitor sections called *gangs* are often assembled together, so that they can be varied simultaneously. One- and two-gang variable capacitors are shown in Fig. 4. Much smaller variable capacitors, called *trimmers*, usually have only one half-disc for each plate and may have mica as a dielectric. Capacitance may be controlled by rotating one plate over the

Fig. 3. Ceramic-dielectric capacitors may be flat, as shown, or tubular in shape.

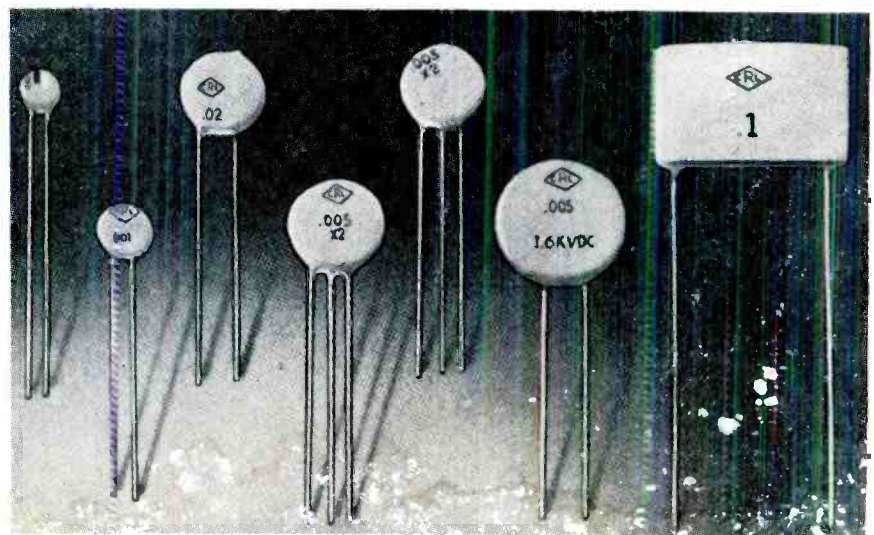



other, thereby changing the effective plate area, or by changing the spacing between the plates. Several trimmers are drawn in Fig. 5.

When extremely high values of capacitance are required the electrolytic capacitor is often used. Aluminum or tantalum foil is employed as one plate, and an ionic compound as the other; when a voltage is impressed across the capacitor plates with the positive potential on the foil, an oxide film is formed that serves as an effective dielectric. Further current flow is prevented by the film, so long as the oxide-forming voltage is not exceeded and the foil never becomes negative with respect to the other plate. Electrolytic capacitors are shown in Fig. 6.

The operation of a capacitor is easy to understand. Consider a capacitor of two parallel plates connected to the terminals of a battery, as in Fig. 7. The left-hand capacitor plate is very close to the other plate so that their electrostatic influence on each other is strong. The negative potential on the outer surface of the left plate tends to repel free electrons on the other plate, and these are accepted readily by the positive battery terminal. At the same time the positive-going right capacitor plate attracts free electrons to the inner side of the left plate, and these are supplied readily by the negative battery terminal. In short, charge flows from the right capacitor plate through the battery to the left plate, until the potential between the plates is equal to the battery voltage.

This charge is directly dependent on the battery voltage, of course; it is also dependent on the capacitance. Rearranging the previous formula we obtain

$$C = \frac{Q}{E}$$

where  $Q$  is in coulombs of charge and  $E$  is in volts. The formula in this form serves to define the capacitance of a parallel-plate capacitor as the ratio of the charge on one of the plates to the voltage across the capacitor. It also defines the unit of capacitance (the farad, after Michael Faraday): A farad is that capacitance that will receive a charge of 1 coulomb with 1 volt across it. The dimensions of the farad are coulombs per volt; the commonly ac-

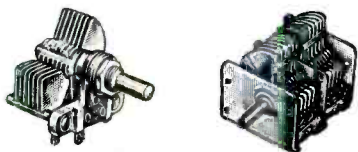

Fig. 4. Variable capacitor assemblies.

cepted symbol is fd. Unfortunately, a farad is an extremely large capacitance. A 1-fd capacitor is never encountered

in practice, so capacitances are always expressed in microfarads ( $\mu\text{fd}$ ) or micromicrofarads ( $\mu\mu\text{fd}$ ), which are equivalent respectively to millionths and trillionths of farads.

Now, what determines capacitance? We have already seen that it is proportional to the surface area of the plates,

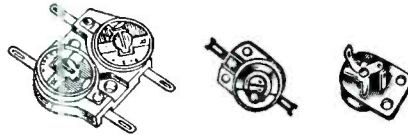

Fig. 5. Small variable-capacitor trimmers.

because that affects the charge density. A greater surface area furnishes more free electrons. Capacitance is also related inversely to the spacing between the plates; as the plates are brought more closely together the intensity of the electrostatic field between them increases for a given potential difference, so that the force on the free electrons is increased. Finally, capacitance is affected by the permittivity ( $\epsilon$ ) of the dielectric material between the plates. This property in electrostatics corresponds to permeability in electromagnetics (see Chapter V); it is a measure of the degree to which a material "permits" establishment of an electrostatic field. Permittivity is equal numerically to the dielectric constant, since the permittivity of a vacuum is 1 and the dielectric constant of a material is defined as the ratio of its permittivity to that of a vacuum.

Therefore, the capacitance of a parallel-plate capacitor is directly proportional to the plate area and the di-

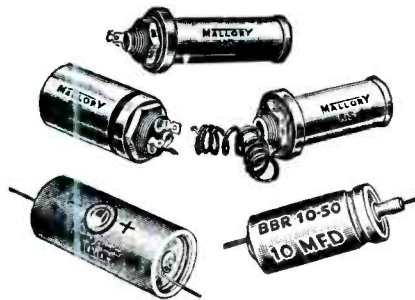

Fig. 6. Several electrolytic capacitors.

electric constant of the insulating medium, and inversely proportional to the spacing between the plates. The exact formula is

$$C = \frac{8.7 \epsilon A \times 10^{-9}}{s}$$

where  $C$  is capacitance in  $\mu\text{fd}$ ,  $\epsilon$  is the dielectric constant of the insulating medium,  $A$  is plate area in sq. cm, and  $s$  is the plate spacing in cm.

Dielectric constants of some typical materials are given in the following table.

Material	Av. Dielectric Constant
Air or vacuum	1
Cellulose acetate	7
Glass	7
Mica	6
Nylon	3.6
Paper	2.5
Phenol	5.5
Polyethylene	2.3
Porcelain	7
Quartz	4
Rubber	2.5
Varnished cloth	2.3
Water (pure)	81
Wax	2.5

Suppose we examine more closely the charge and discharge of a capacitor, as

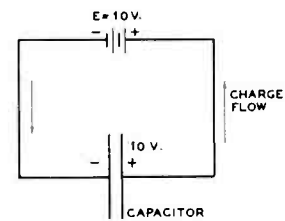

Fig. 7. The capacitor charging process.

was done for inductance in Chapter VI. Fig. 8 is a circuit similar to that used before, except that the switch has only two positions. In position 1 a capacitor is connected in a circuit with a series resistor; in position 2 a battery is inserted in the circuit in series with these elements. The battery resistance is negligible compared to  $R$ . Rather than a milliammeter to measure current, we use now a voltmeter across  $C$ . The capacitor value is chosen as  $3\frac{1}{3} \mu\text{fd}$  simply to achieve correspondence with the RL circuit in Chapter VI, as will be plain later. Proper schematic notation is used for the capacitor; the curved plate indicates the outside foil or case of the capacitor.

Assume that the circuit has been left for a relatively long time with the switch in position 1. Then, at a moment  $T_1$ , the switch is thrown to position 2, connecting the 10-volt battery in the circuit. Since there is no charge on the capacitor at  $T_1$ , it offers virtually no opposition to current; initial current is limited only by the resistor. The current begins, then, at a value determined by  $E/R$ :  $10/1,000$ , or 10 ma. And because there is no charge on  $C$  at  $T_1$ , there can be no voltage drop across it—the entire battery voltage is developed across  $R$ .

As soon as the current begins, however, a charge starts to build up on the capacitor, causing an ever-increasing voltage to be developed across it. This voltage limits the current which, in turn, limits the rate of charge build-up on the capacitor. The result is that current decreases rapidly at first, then at a slower and slower rate as the capacitor becomes more fully charged and

the current approaches zero; voltage across the resistor, which is directly proportional to the current, drops rapidly at first from its original 10-volt value, then more slowly as the rate of current decay decreases; voltage across the capacitor rises rapidly at first because the current (therefore the rate of charge) is high initially, but it rises less and less rapidly toward 10 volts as the current decreases. This, too, is a process that is never completed, theoretically, because every increment of potential difference across the capacitor limits the current so that the next charge increment is smaller.

Voltage across the capacitor rises according to the formula

$$e = E \left( 1 - e^{-\frac{t}{RC}} \right)$$

where  $e$  is instantaneous capacitor voltage;  $E$  is the battery voltage;  $e$  is the base of natural logarithms (about 2.718);  $t$  is the elapsed time in seconds;  $R$  is the circuit resistance; and  $C$  is

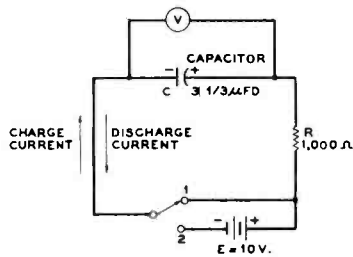

Fig. 8. Circuit showing capacitor action.

the capacitance. This is plotted in Fig. 9. The similarity to Fig. 4 in the last chapter will be noted; again, the abscissa scale is marked off in seconds from  $T_1$ , and the curve shape is identical. An important difference is that now voltage across the capacitor—*not* current through it—is marked on the ordinate scale.

An RC circuit such as this has a "time constant" also that is very useful in estimating charge and discharge

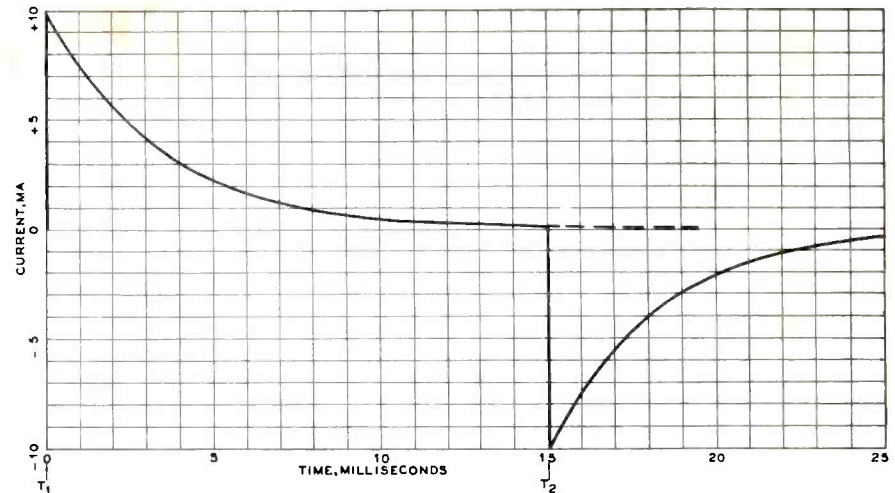

Fig. 10. Current decreases toward zero as the capacitor charges or discharges.

times. The time constant is the product of  $R$  and  $C$ ;  $T = RC$ . (This is another difference from RL circuits. It will be recalled that the time constant in an RL circuit is  $L/R$ .) If  $R$  is in ohms and  $C$  in farads, or if  $R$  is in megohms and  $C$  in microfarads, then  $T$  will be in seconds. After one time constant has elapsed from  $T_1$  the voltage across  $C$  will have risen to 63.2% of its ultimate value (or, on discharge, will have dropped to 36.8% of its original value). After five time-constants have elapsed, the charge or discharge can be assumed complete for practical purposes.

In Fig. 8,  $C$  is  $3\frac{1}{3} \mu\text{fd}$ , and  $R$  is .001 megohm; their time constant is, accordingly,  $3\frac{1}{3} \times .001$  seconds, or  $3\frac{1}{3}$  milliseconds. At that time after  $T_1$  the voltage across  $C$  has risen to 6.32 volts, which is 63.2% of 10 volts. After five time constants (about 17 milliseconds) the charge is nearly complete.

Again, let us assume that the charge is complete at 15 milliseconds, and throw the switch back to position 1. Call that time  $T_2$ . Now the only voltage source in the circuit is the charged

capacitor, and it is charged with the polarity shown. Immediately current begins again. The initial current is limited again only by  $R$ ; it will be of the same value at  $T_2$  as it was at  $T_1$ , but of opposite direction. As the capacitor discharges, its voltage decreases and the current decays more and more slowly toward zero; as the current decays, so does the rate of discharge. Again, the discharge is 63.2% accomplished after one time constant, and almost complete after five time constants.

A corresponding chart of current during these time periods is given in Fig. 10. Current in the clockwise direction is considered to be positive here, and is plotted above the zero line. Current in the opposite direction is assumed to be negative, so it is plotted below the zero line. These are quite arbitrary choices, of course; they could just as well have been reversed.

Consideration of Figs. 8, 9, and 10, together with Figs. 3 and 4 in the previous chapter, should make clear the fundamental difference between an inductor and a capacitor: an inductor, because it stores energy in an electromagnetic field, tends to oppose rapid changes in current through it; a capacitor, because it stores energy in an electrostatic field, tends to oppose rapid changes in voltage across it.

Fig. 9. Voltage across a capacitor can change gradually but not instantaneously.

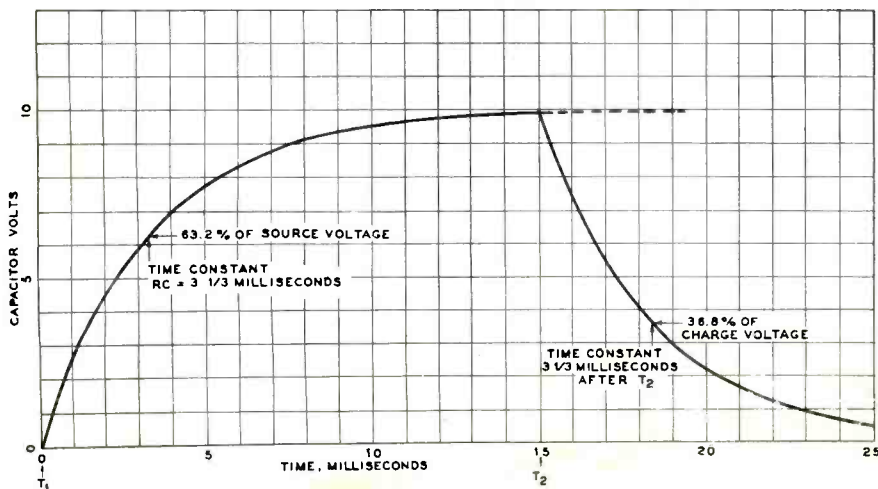

## TAPE RECORDER

*Continued from page 35*

the 2% harmonic distortion level on the Dubbings tape, it is then necessary to observe the machine's own indicator during such recording. If the indicator is a neon lamp, it should light. If it is a magic-eye tube, the eye should be fully closed. If it is a VU meter, it should read 0 VU\*.

\*Except in the case of Ampex, which has a specified distortion of 1% at 0 VU. Accordingly, the 2% distortion point should be 3 or 4 VU.—ED.



If the 400-cps tone, which has been recorded at what should be the 2% distortion level, does not sound as clean as the test tape when played back, insufficient ultrasonic bias current may be the cause or the tape itself may be at fault. In the better home tape recorders the user can vary the bias current.

It should be borne in mind that the recording level which produces 2% distortion on one brand of tape may produce more on another brand. This is so because the optimum bias and the 2% distortion points differ among tapes and because, after the 2% distortion point has been reached, slight increases in recording level produce large increases in distortion. Thus the home recordist is well advised to allow a margin of safety against overrecording. This can be done during actual recording by setting gain somewhat below the point at which peak passages produce an indication of maximum permissible recording level. Avoiding a large amount of distortion is well worth a small sacrifice in signal-to-noise ratio.

### Signal-to-Noise Ratio

For high fidelity purposes the dividing line between acceptable and unacceptable signal-to-noise ratios varies radically according to the type of noise and other factors; for tape recorders it may be assumed to be about 45 db. A ratio of 50 db is excellent, while one below 40 db is unsuitable.

The principle sources of noise (including hum) are encountered in playback rather than in recording. The playback head delivers a signal of only a few millivolts, and considerable amplification is therefore required. Along with the signal, there is also amplification of tube noise, thermal noise in resistors, and hum picked up by the head. Since playback noise is the dominant factor, a test of the playback section's signal-to-noise ratio usually provides a good indication of the machine's over-all performance in this respect. At the least, it tells whether the playback ratio is satisfactory. The Dubbings test tape provides such a check.

The signal-to-noise ratio indicates how far the maximum recorded signal lies above the noise level of the machine itself. In the Dubbings tape, the 400-cps tone that produces 2% harmonic distortion is considered to be the maximum recorded signal. In order to determine how far the noise level lies below the maximum signal, the tape contains a series of 400-cps tones decreasing in 5-db steps, the first recorded at 15 db below maximum. As the Dubbings tape is played, when one of these successively lower tones equals the tape recorder's noise level, then the machine's signal-to-noise ratio is defined. A voice announcement precedes each tone, stating

how many db it lies below maximum.

In order to determine when the machine's noise level has been reached, the level indicator is used. As the first 400-cps tone is played back, tape recorder or sound system gain is set to produce a clear reading on the indicator. When the tone ceases, the reading should drop, because the first tone indicates a signal-to-noise ratio of only 15 db. In other words, the signal rather than the machine's noise level should primarily actuate the indicator. On the second tone, which is 5 db lower (20 db below maximum), gain is advanced so that the same reading as before appears on the level indicator. Again the reading should drop when the tone ceases. Eventually a point is reached at which the reading does not drop when the tone stops. Evidently the tape machine's noise level is then as great as the tone just played. The voice announcement preceding this tone states the signal-to-noise ratio in playback.

### Frequency Response

Discussion of frequency response has purposely been left until last, as a means of de-emphasizing somewhat the im-

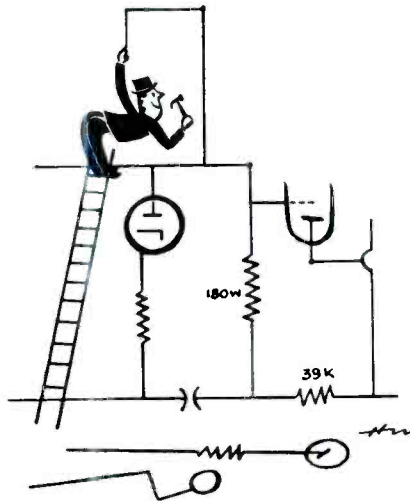

portance attributed to this measure of tape recorder performance. Not that wide, flat response is unimportant—but it is no more important than low distortion, high signal-to-noise ratio, and good performance of the transport mechanism.

Response flat within 3 db over the range of 50 to 10,000 cps can produce satisfactory results. Listening pleasure can be more adversely affected by excessive peaks than by somewhat restricted frequency range. Some machines, in order to maintain response out to 10,000 cps or beyond (especially at 7.5 ips), have equalization that results in a peak well above 3 db in the region of 3 Kc to 8 Kc. Such peaks produce definite treble coloration.

Frequency response of a tape recorder is determined by the adequacy of bass and treble boost circuits incorporated

in the record and playback preamplifiers, by the width of the playback head gap, by the amount of bias current fed to the record head, and, of course, by the tape speed. A test of the machine's over-all response can be made in the following manner.

Using a frequency record, tones covering the 50 to 10,000-cps range or more are played through a sound system, and the relative level of each frequency is measured with the level indicator. As each frequency is played and its relative level measured, this measurement should be noted on paper, with the 1,000-cps tone referred to as zero db.

The next step is to record these same frequencies on a fresh tape, at least 15 db (preferably 20 db) below maximum level. The tape is then played back through the same sound system and, once again, the relative level of each frequency is measured and noted, with 1,000 cps referred to as zero db. The differences between the two sets of measurements represent the extent to which the tape recorder's record-playback performance deviates from flat response.

Test tapes make possible a further significant test with respect to frequency response. This is to determine whether playback response is in accordance with the NARTB standard, which is observed by virtually all manufacturers of 15-ips machines and by many manufacturers of 7.5-ips recorders. Most 7.5-ips pre-recorded tapes conform to the NARTB standard for 15-ips playback.

Playback of a test tape with a series of frequencies recorded in keeping with the NARTB standard should give flat response within 2 or 3 db if the machine is properly equalized. This response may be determined by means of the level indicator. If playback response is flat but an over-all record-playback performance check fails to produce flat response, then a defect apparently exists in the record circuit. On the other hand, if over-all response is flat but playback response is not, then the machine probably does not conform to the NARTB standard.

An important determinant of a tape recorder's frequency response is azimuth alignment—that is, orientation of the head gaps with respect to the tape. The gaps must be exactly perpendicular to the direction of tape travel. Otherwise, there is attenuation of the output, increasing with frequency, when playing pre-recorded tapes. Slight azimuth deviations can play havoc with high-frequency response. For example, if a half-track playback head is misaligned only 30 minutes of arc (half a degree), its output at 7.5 Kc is reduced about 17 db.

*Continued on next page*

## TAPE RECORDER

*Continued from preceding page*

If a machine has a single record-playback head, azimuth error in record is compensated by the same error in playback. However, when it comes to playing tapes made on other machines, a misaligned single head obviously provides very poor high-frequency response.

To permit easy azimuth alignment, test tapes generally provide a steady high-frequency tone, such as 5,000 cps at 7.5 ips or 10,000 cps at 15 ips. As the tape is played the playback head is alternately tilted slightly to the left and right, so as to change the angle of the gap with respect to the tape. The position of the head which yields maximum output is the correct one. Maximum output can be measured by the level indicator or it can even be gauged by ear, because the correct azimuth setting is quite critical and the ear is sufficiently sensitive.

If the tape machine has a separate record head, the next step is to align this head. The procedure, using a fresh roll of tape, is to record a high-frequency tone and adjust the record head to give maximum output when played back through the already aligned playback head. This tone can be furnished by the phonograph test record.

## BALSA TONE ARM

*Continued from page 27*

lacquer. To assemble, force-fit the pivot shaft to the yoke, and the ball bearings in the bearing case. Then complete the base assembly as shown in Fig. 9.

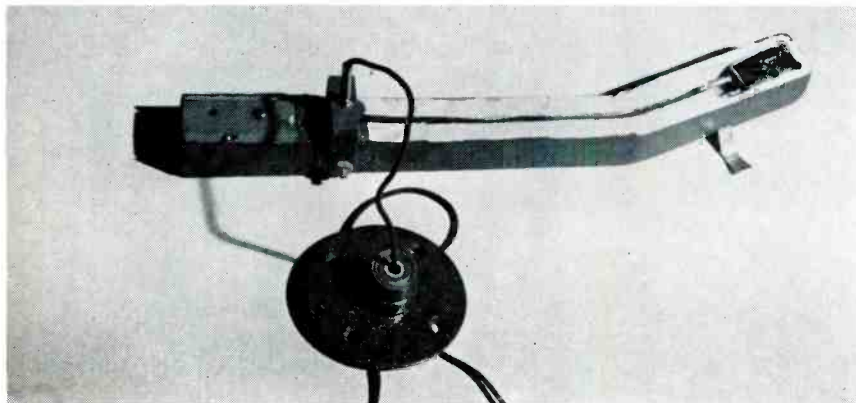

Fig. 10. Cable is run from cartridge through channel in arm and base assembly.

### Final Assembly

The arm is now ready for final adjustment and assembly. Install the cartridge, using self-tapping screws, and run the shielded cable in the cable slot, gluing or stapling it to the arm (Fig. 10). Mount the arm to the base by inserting the  $\frac{3}{8}$ -inch drilled rod in the arm between the needle bearings. The lead counterweights are lightly screwed into

place, using enough weight to give approximately the correct stylus pressure; final adjustments will be made when the arm is mounted. An armrest can be made from balsa or a 3-inch piece of  $\frac{1}{4}$ -inch Lucite rod.

Properly mounting this arm, as with any other, is most important. The amount of time spent in doing this correctly will be more than compensated for in better over-all performance and reduction of tracking error. There are three basic considerations in mounting the arm. First, the cartridge stylus must overhang the turntable spindle by a critical distance. Second, the arm must be horizontally parallel with the turntable when playing a record. Third, the stylus pressure must be correct.

Height adjustment is done simply by changing the height of the arm, moving the bearing case up or down in the base. Tighten the set screw in the base to hold the correct position. Proper overhang, the distance that the stylus extends beyond the turntable spindle, is determined by drilling a 1-inch hole for seating the bearing case in the mounting board; this is drilled at any desired point on the circumference of a circle of 9 in. radius having its center at the turntable spindle. The overhang should be exactly .048 in. With the bearing case in the 1-inch hole, move the arm so that the stylus is this distance past the center of the turntable spindle. The 1-inch mounting hole will permit movement of the arm for this minor adjustment. When overhang is correct, fasten the arm base to the mounting board with flat-head screws.

Stylus pressure is set according to the cartridge manufacturer's specifications,

using a stylus-pressure gauge. Changes in stylus pressure are made by changing the size and number of the lead counterweights.

If reasonable care has been taken in the construction, painting, and mounting of the arm, you now have a pickup that looks and performs with the best. Mine has been in use for over a year. It has been extremely satisfactory and sufficiently durable.

## AMPLIFIER DESIGN

*Continued from page 23*

each plate output swing to drive it, so as to give an output equal to that of the first tube. If both plates had exactly equal swing in plate current, there would be no swing across  $R_2$ ; the swing at this junction point automatically adjusts itself so that the plate currents are out of balance by a fraction sufficient to provide the grid swing for the second tube. By adjusting the values of plate resistors  $R_2$  and  $R_3$ , which are responsible for developing the actual output voltages, one stage can be arranged to have a gain larger than the other by this fraction.

Assuming that the gain of each stage can be 12, the voltage appearing at the junction must be  $1/12$  the voltage appearing at each plate. If  $R_1$  is equal to  $R_2$  and  $R_3$  (approx.) then the plate-current swings will have to be in the ratio of 12:11. This means that, to give equal plate-voltage swings,  $R_2$  and  $R_3$  must be in the ratio 11:12. Thus we can obtain equal outputs by altering the plate-load resistances only a fraction. Error due to variation in individual tube gain is reduced to a smaller fraction. This is a form of feedback, and we can expect the improvement to be about equivalent to the working gain of each tube.

Here is the rub: the series resistance  $R_1$  drops some of the available  $B+$  voltage, so that the load line starts from a lower point. Otherwise viewed, it could be said that only part of the active plate load is used. This has the effect of restricting the maximum available output in comparison with the straightforward paraphase circuit. Of course, the circuit must be tailored to the desired swing; if a swing of 25 to 30 volts RMS is adequate for each output tube the arrangement can serve as is. Otherwise, higher  $B+$  is needed.

This circuit provides distortion cancellation in the same way as the straight paraphase, and frequency response is calculated in the same way. A special case of floating paraphase inverter with feedback will be considered in detail in a later article.

### Cathode-Coupled Inverter

Another circuit that works almost the same way is called the long-tailed or cathode-coupled phase inverter. Instead of putting the common resistance in the plate lead, we put it in the common cathode return, as shown in Fig. 11. The total voltage for driving the inverter half is developed across this common resistance; the direction of the voltage drive is reversed by having the second-stage grid effectively connected to ground through a large capacitor. Bias for both tubes is taken from a



suitable point on the cathode resistor.

Apart from this, the circuit's operation and the available swing that it can give are quite similar to the floating paraphase. There is, however, the following difference: the voltage for the second grid is developed across  $R_3$ , which is a cathode load for the first half also. This being so, the input to the second grid is linearized by feedback, which does not occur with the floating paraphase. Accordingly the second-harmonic cancellation stands a chance of being a little better when this circuit is used as an inverter, although the gain is reduced.

### Output Impedances

It is essential that the impedance presented to the output-tube grids by the drive stage not be very high. Voltage-amplifier tubes can have grid-circuit

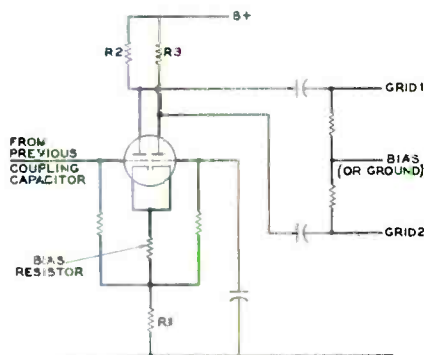

Fig. 11. Similar to the floating paraphase is the cathode-coupled or long-tailed inverter. This is one variation.

resistances on the order of a megohm, with an impedance or AC resistance of 100 K or 200 K. But output tubes must have much lower grid resistance than this, because of the bigger physical size of the tube and the fact that the grid current, although minute, is larger than in the voltage-amplifier tube.

So long as the grids of the output tubes are always operated in the negative region, and large grid currents do not begin to flow, a grid resistance in the range of 100 K to 250 K, but never greater than 500 K, is acceptable for stabilizing the bias. The driving impedance should be in the region of perhaps 20 K, as simplified by the inverter circuits we have discussed.

We shall find that in push-pull power-output stages, high power can be obtained much more easily if we "drive" the grids, making them go positive during part of the wave form. This means that we have to supply a current to the grid, as well as maintain the potential swing required to get the right output wave form.

Otherwise stated, the stage driving the output must be capable of supplying power for grid current to avoid the kind of distortion that occurs when

such power is not available. As soon as the drive reaches zero grid voltage, conduction of the grid in conjunction with the high source resistance prevents the voltage from swinging any further positive, and the wave form becomes "clipped".

Source resistances and impedances for drive stages have to be very much lower than when the same output tubes are operated without going into the positive-grid region. But the design of a drive stage to supply power for the output grids is somewhat more complicated than the design of a simple power-output stage. We will reserve discussion of this until after we have covered the design of the push-pull power stage itself. Sometimes, also, to get sufficient swing for a large power-output stage, even without positive grid drive, a push-pull stage is used between the phase inverter and the output. This is also called a drive stage, although not called on to handle power.

### HI-FI MILESTONE

Continued from page 25

This was proved when, just before the finish of the program, the indicator lights were extinguished and Mr. Hilliar left the console unobserved by the audience. It was startling to see him standing by the exit door as the closing chords sounded, since the last indication of the lights had been "live". The experiment was an unqualified success.

Joint promoters of the demonstration were The Audio League, The Harmonic Hill Radio League, and Saint Mark's Church; Richard W. Burden was director. The program consisted of *O Gott, Du frommer Gott* and *Tocatta*, Flor Peeters; *Gigue* from *Concerto No. V*, Handel; and *Concerto in C*, J. S. Bach.

### BASS WITH BUSTER

Continued from p. ge 31

ing them at the apex of the triangular speaker arrangement also increases greatly the depth of perspective.

The middle-range speaker, a Super 12 Wharfedale, lies in a horizontal position pointing upward toward a foot-high curved reflector. This reflector is formed over wooden knees by several sheets of cardboard cemented together and covered with vibration-proof rubber floor matting. This is not, strictly speaking, a simple direct radiator; the curved reflector, combined with the corner walls, provide a considerable front-loading factor. The rear of the cone is totally enclosed in about 10 cu. ft. of air. The corner structure is heavily constructed and insulated, and is larger than it appears in Fig. 5, because it connects with a former wood-box re-

Continued on next page



"Atlantic

"The AR-1W woofer gives the cleanest bass response I ever have heard."

AUDIO (Eduard Tatnall Canby)

"... the highs impressed me immediately as very lovely, smooth, unprepossessing, musical (for music) and unusually natural. No super-hi-fi screech and scratch... As to the lows... I was no end impressed, from the first time I ran my finger over a pickup stylus and got that hearty, wall-shaking thump that betokens real bottom bass to the time when I had played records and tapes on the speaker for some months on end."

THE NATION (B. H. Haggin)

"... achieves the seemingly impossible; a real and clearly defined bass in a cabinet only 14 by 11 3/8 by 25 inches in size."

RADIO - ELECTRONICS (J. M. Krech)

"... reproduced the full range of bass, even the pedal tones of the organ, cleanly and spectacularly... shook the concrete reinforced floors of the Hotel New Yorker..."

The Saturday Review (R. S. Lanier)

"... goes down into the low, low bass with exemplary smoothness and low distortion. It is startling to hear the fundamentals of low organ notes come out, pure and undefiled, from a box that is two feet long and about a foot high."

High Fidelity (Roy Allison)

"... a woofer that works exceptionally well because of its small size, not in spite of it... I have heard clean extended bass like this only from enclosures that were at least six or seven times its size."

### THE AUDIO LEAGUE REPORT

(Oct., '55) Pleasantville, N. Y.

"Speaker systems that will develop much less than 30% distortion at 30 cycles are few and far between. Our standard reference speaker system,\* the best we've ever seen, has about 5% distortion at 30 cycles."

\*The AR-1W

The AR-1 speaker system, in mahogany or birch, is \$185. Suggested driving power, at least 30 watts. Literature on request from Dept. U.

### ACOUSTIC RESEARCH, INC.

25 Thorndike St., Cambridge 41, Mass.

# Completely New! DYNAKIT MARK II



An amplifier kit which provides the finest sound at low cost. The listening quality of the Dynakit is unequalled by any amplifier, regardless of price; and this kit can be readily assembled in about three hours.

The Dynakit uses a new bug-free circuit, designed by David Hafler. Complete reproducibility of operating characteristics is guaranteed by the use of a factory-wired printed circuit board. The Dynakit comes complete with all components including the super-fidelity Dynaco A-430 transformer.

#### Specifications:

Power Output: 50 watts continuous rating, 100 watts peak. Distortion: under 1% at 50 watts, less than 1% harmonic distortion at any frequency 20 cps to 20 kc within 1 db of maximum. Response: Plus or minus 5 db 6 cps to 60 kc. Plus or minus .1 db 20 cps to 20 kc. Square Wave Response: Essentially undistorted 20 cps to 20 kc. Sensitivity: 5 volts in for 50 watts out. Damping Factor: 15. Output Impedances: 8 and 16ohms. Tubes: 6CA7/EL-34 (2) (6550's can also be used) 6AN8, 5U4GB. Size: 9" x 9" 65/8" high.

**69.75**  
net

# Dynaco Output Transformers



Featuring para-coupled windings, a new design principle (patents pending). These transformers use advanced pulse techniques to insure superior square wave performance and undistorted reproduction of transients. Dynaco transformers handle full rated power over the entire audio spectrum from 20 cps to 20 kc, without sharp rise in distortion at the ends of the band which characterizes most transformers. Conservatively rated and guaranteed to handle double nominal power from 30 cps to 15 kc without loss of performance capabilities.

entire audio spectrum from 20 cps to 20 kc, without sharp rise in distortion at the ends of the band which characterizes most transformers. Conservatively rated and guaranteed to handle double nominal power from 30 cps to 15 kc without loss of performance capabilities.

#### Specifications:

Response: Plus or minus 1 db 6 cps to 60 kc. Power Curve: Within 1 db 20 cps to 20 kc. Square Wave Response: No ringing or distortion from 20 cps to 20 kc. Permissible Feedback: 30 db.

#### MODELS

A-410	10 watts	6V6, EL-84	14.95
A-420	25 watts	KT-66, 5881, EL-34	19.95
A-430	50 watts	6550, EL-34 (6CA7)	29.95
A-440	100 watts	6550	39.95

(all with tapped primaries except A-440 which has tertiary for screen or cathode feedback)

Additional data on Dynakit and Dynaco components available on request including circuit data for modernization of Williamson-type amplifiers to 50 watts of output and other applications of Dynaco transformers.

## DYNA COMPANY

5142 Master St.  
Phila. 31, Pa.

## BASS WITH BUSTER

Continued from preceding page

cessed into the wall. The resulting sound is room-filling and without cabinet coloration. These qualities, plus comparatively low efficiency, make it an excellent match for the tweeter mounted above it.

This is the Janszen electrostatic. So much has been published about this speaker that it is not necessary to describe all its virtues. It must be remarked, however, that it withstands the most violent transient attacks with no trace of breakup. It is a genuine advance and well worth its price.

The Janszen has a built-in high-pass filter and is usually used with a woofer. But since the all-purpose Wharfedale has a higher range than a woofer, it has been wired with a 700-cps low pass filter, in order to secure the unmixed blessing of the electrostatic speaker at the high end.

The Janszen has been veneered to match the corner enclosure and provided with a phasing switch, a power switch, and a pilot light (since it requires an AC power supply).

These two speakers are driven by a 14-watt Hallmark Williamson amplifier. The sum of 14, 50, and 60 is 124; hence, "124 Watts in a 24-Foot Room". And 110 of them below 110 cps! The power allotted to the low frequencies would seem to be disproportionate, and it is—deliberately so, and fully justified by the results. For the key to a large part of the over-all excellence of a music system and the satisfying feeling of effortless latent power, perspective, and caliber lies in the quality and dimensions of the bass. A diagram of the speaker-amplifier system connections is given in Fig. 6.

The other system components are: a D&R turntable, an ESL Professional arm and cartridge, a Fairchild arm and cartridge as alternate, a Staticmaster system, and a Scott 121 equalizer-pre-amplifier.

We are told that the day is not far off when transistors will make amplifiers pocket-size; some form of magnetic record will supersede the crackling disc; and full-range, distortion-free electrostatic speakers will be almost as flat as the paper on the wall. While waiting, I shall have to try to get along with what I have. Barring, of course, the substitution of any little improvements in turntables, cartridges, arms, pre-amplifiers, or speakers which might come along in the meantime.

#### AUDIO AIDS

We'll pay \$5.00 or more for usable Audio Aids. See page 33 for details.

## WOODCRAFTER

Continued from page 9

desired since the wood can be darkened with stain. When the bleaching is completed, flush the surface with a solution of 1 ounce of borax to 1 quart of water (or whatever rinse the manufacturer recommends). This alkalizing action removes any trace of acid remaining on the wood.

After sanding the surface with 4-0 or 5-0 sandpaper apply the color tone desired by using one of the commercial blond stains or a homemade variety using white lead thinned with turpentine, white firzite, or white enamel. To achieve a different tone, these may be tinted with oil colors. Brush on the color coat and wait a few minutes until it starts to set. Wipe off as much as necessary to leave the desired tone. When dry, apply a wash coat of shellac and proceed as outlined previously for any standard finishing job.

With maple and pine finishes an anti-aging effect adds considerable charm to the piece. It is a shading process in which a portion of the finish is lighter in color than the edges and corners. This is accomplished by applying the stain in a normal manner uniformly over the entire work. Then with a clean, lintless cloth lightly wipe some of the stain from the flat, middle surfaces—leaving it untouched on the edges, in the corners, and in carvings. If the effect is not satisfactory, sponge off the surface with benzine and start over again. If you're satisfied with the shading effect, let it dry and continue with the normal finishing routine.

As I mentioned earlier, the subject of finishing is a large one and we have only scratched the surface. Scratched the surface? That calls for refinishing and that's another story for another time.

## IMPEDANCES

Continued from page 17

smoothest of many tweeters tested. The fact that production speaker systems have been compared A-B with live sound—the artists alternating with the recorded playback—and the playback can be indistinguishable from the original sound, attests that the accumulated refinements, mismatches, and second-order corrections have achieved a close approach to fidelity—in a minority of systems, that is.

## Multi-Speaker Systems

The "Ortho 15" system was developed by K'ipsch and Associates and applied to Shorthorns, Rebels, and other enclosures. In a sense this is a "four-way" system; the woofer is corner-horn back-



loaded up to about 150 cps, where an acoustic crossover transfers the cone function to direct radiation; then, at 1,000 and 5,000 cps, the squawker and tweeter drivers become involved. There are other "four-way" systems involving only three diaphragms, and some true four-way systems, of course, in which the audio spectrum is divided into four frequency ranges, each produced acoustically by an appropriate and individual transducer. (This is by way of admission that the Ortho drive as applied to the Shorthorn is an economic expedient.)

Experience, rather than science, suggests that the higher the frequency, the narrower the pass band in octaves a speaker unit should be asked to handle. For example: 15 years of accumulated mistakes applied to the Klipschorn system indicate a practical set of limits for comparative reproduction<sup>1</sup>.

The woofer can cover from 30 to 500 cps (roughly 4 octaves), the squawker from 500 to 5,000 cps (about 3.3 octaves), and the tweeter from 5,000 to 16,000, or very roughly 1.5 octaves. Some broader claims appear to need substantiation. There are admittedly some ground-plane reflections, some

<sup>1</sup>Where "comparative reproduction" is here defined as recording the original sound, repeating the original sound, and comparing the reproduction with the original.



# MELLOTONE

## HI-FI SARAN GRILLE FABRICS

... announces this special "FREE" SAMPLE OFFER!

- Write for MELLOTONE sample advising color requirements.
- When you receive your free sample, take it to your local dealer to buy yardage needed, and see his complete line.

Remember, MELLOTONE FABRICS are HI-FI FABRICS for all color tones.

Offer limited, write today!

**WENDELL PLASTIC FABRICS CORP.**  
17 West 17th St., New York 11, Dept. G

imperfections, that it would be desirable to eliminate. A proposal to eliminate a dip at 350 cps, though, by putting the first crossover at 300 cps merely aggravates the effect; a ground-plane reflection becomes involved with short low-middle-range systems.

What has this to do with impedance mismatching? Consider the power requirements, the amplifier capabilities, and the permissible variations. In the woofer range the power requirements are maximum, and a 2:1 average mismatch should not be exceeded<sup>2</sup>. In the squawker range the power demands are not as great, but accuracy of response is paramount. It is safer not to equivo-



cate. The tweeter will receive and deliver less than 5% of the total spectral power, and a mismatch of 2:1 is demonstrably tolerable.

### Pads and Attenuators

Any speaker drive unit works best from a low-impedance source. In the case of direct radiators without horn loading, especially, a low-impedance amplifier provides damping which may be otherwise lacking, with a resultant smoothing of response and reduction in distortion. The insertion of controls, attenuators, or "pads" between the power amplifier and the speaker voice coil can only deteriorate the quality by increasing the distortion and increasing the peaks and troughs of response.

If controls are necessary, they should be applied ahead of the final amplifier; in a preamplifier, for instance. As a matter of fact, most phono preamps have enough superfluous controls to offer speaker as well as record compensation.

### Conclusion

In constructing a home audio system, it would be well to adhere to the simpler loading systems like the bass reflex and the back-loading corner horn, using driver units selected from recommendations offered by the makers of the loading systems, baffles, or horns. The matching is then taken care of; the manufacturer has already made the mistakes. If, however, an existing driver from a former system or a spur-of-the-moment purchase must be used, the foregoing material may provide the applicable solution.

Home constructors should avoid trying to build the complex corner-horn systems. The pitfalls are many, and

*Continued on next page*

<sup>2</sup>Infrasonic and low bass power response in the amplifier is essential. A good 10-watt amplifier would suffice if it offered the full 10 watts down to 15 cps, and at least 5 watts at 10 cps.

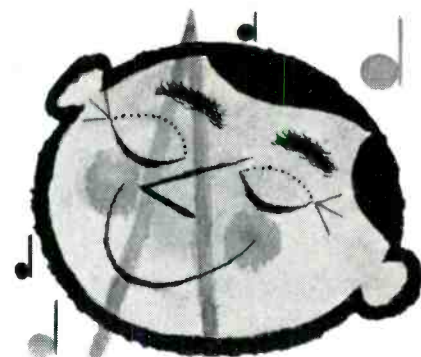

how "fi" is your hi-fi?

**ENJOY ALL THAT HIGH-FIDELITY CAN GIVE YOU — WITH CENTRALAB COMPENTROL®**

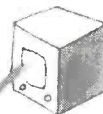

You bought your hi-fi to enjoy concert-hall realism. Are you actually getting it? You are for sure, if you use a Centralab Compentrol.

When an ordinary volume control is turned down, it not only lowers the sound—but cuts down both the high and low frequencies, leaving only the uninteresting middle range.

That's when you need a special control that bolsters frequencies otherwise lost.

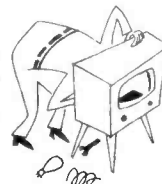

**THAT'S WHERE COMPENTROL COMES IN**

*with do-it-yourself fun!*

Compentrol is a COMPensated CONTROL that provides tonal balance of the lows and highs — and does it automatically at any volume level. You hear the pleasing full range of the orchestral score.

It's easy to replace an ordinary volume control with Centralab Compentrol — in amplifiers, preamplifiers, radios, TV, tuners, tape recorders, and record players.

Buy a Compentrol from your Centralab distributor today.

Remember, only Centralab makes Compentrol

**6 models from \$2.50**  
suggested net price



Send for Compentrol booklet. Write Centralab, Dept. 9281, Milwaukee 1, Wis.

**Centralab**

# AUDIOCRAFT Sound Sales Directory

Following is a list of dealers who state that they carry the products specified.

## KEY TO PRODUCTS HANDLED

- 1 Audio system components
- 2 Speakers and enclosures
- 3 Records and record accessories
- 4 Tape recorders
- 5 Pre-recorded tape
- 6 Radio hardware
- 7 Tools, wood
- 8 Audio parts
- 9 Microphones
- 10 Books
- 11 Test equipment

## CALIFORNIA

### Culver City

Bar-Shel's Hi-Fi Supply  
5512 S. Sepulveda Blvd.  
EX. 8-6747 1, 2, 4-6, 8-11

### Hollywood

Hollywood Electronics  
7460 Melrose Ave.  
Webster 3-8208 1, 2, 4, 5

### Los Angeles

Crenshaw Hi-Fi Center  
107 Santa Barbara Plaza  
Axminster 3-8201 1-5, 9

### Mentlo Park

Science in Sound  
777 Santa Cruz Ave.  
DA. 2-1611 1-11

### Santa Barbara

Pacific Audio Supply  
2919 De La Vina St.  
Woodland 5-6422 1-5, 9

## CONNECTICUT

### West Hartford

Audio Workshop, Inc.  
1 South Main St.  
Adams 3-5041 1-5, 9, 10

## DELAWARE

### Newark

Delaware Music House  
20 Academy St.  
Endicott 8-3258 1-5, 8, 9

## GEORGIA

### Atlanta

High Fidelity Sight & Sound Sys.  
606 Peachtree St., N. E.  
Vernon 6534 1-10

## ILLINOIS

### Champaign

The New Sound  
35 E. Springfield Ave.  
6-9119 1-5, 8-11

### Chicago

Allied Radio Corp.  
100 N. Western Ave.  
Haymarket 1-6800 1-11

Allied Radio Corp.  
2025 W. 95th St.  
Beverly 8-1067 1-11

Voice and Vision, Inc.  
Rush and Walton Place  
Whithall 3-1166 1-6, 8-10

### Evanston

Allied Radio Corp.  
602 Davis Street  
Davis 8-8822 1-11

## MISSISSIPPI

### Pass Christian

The Music Box  
121 Davis Ave.  
185 or 301W 1-5, 8, 9

## MISSOURI

### Kansas City

David Beotty Hi Fi Sound & TV  
1616 West 43rd (Westport Rd.)  
Jefferson 1-3110 1-10

## NEW YORK

### Albany

Hi-Fidelity Center, Inc.  
324 Central Avenue  
3-1167 1-5, 8-10

### Buffalo

Frontier Electronics, Inc.  
1507 Main Street  
GA. 5727 1-5, 8-10

### New York City

Arrow Audio Center  
65 Cortlandt Street  
Digby 9-4730 1, 2, 4-6, 8-11

### Yonkers

Westlab Electronics, Inc.  
2475 Central Avenue  
SP. 9-6400 1-6, 8-10

## OHIO

### Dayton

Custom Electronics, Inc.  
1000 S. Main Street  
AD. 3158 1-11

## PENNSYLVANIA

### Allentown

Baker Communications  
9 South 12th Street  
Hemloch 3-3326 1-11

### Philadelphia

Danby Radio Corp.  
19 South 21st Street  
Rittenhouse 6-5686 1-5, 8-10

Ten Cate Associates  
6128 Morton Street  
Germantown 8-5448 1-5, 8-10

## VERMONT

### Rutland

Fleetwood Sound Studio  
285 S. Main Street (Rt. 7)  
Prospect 3-2312 1-5, 8, 9

## VIRGINIA

### Arlington

Audio Services  
3131 N. 10th Street  
Jackson 7-2552 1, 2, 4, 5, 8, 9

## WEST VIRGINIA

### Huntington

Singer Electronics  
1555 Third Avenue  
3-7439 1-5, 8-10

## WISCONSIN

### Milwaukee

The Hi-Fi Center, Inc.  
4236 N. Capitol Drive  
Woodruff 4-3344 1-5, 9, 10

## CANADA

### Toronto

Electro Voice Sound Systems  
141 Dundas Street, W.  
EM. 3-7750-8301-8302 1-11

## IMPEDANCES

Continued from preceding page

any deviation from design center in any component will unbalance the entire system. Even when copying exactly, home constructors may get fouled on details.

Frankly, this is written for the owner of a Shorthorn, or one of the Cabinart Rebel series, but it is applicable to other enclosures as well as the lower-priced corner horns. Regardless of the type of necessary evil—the "box", "cabinet", "enclosure", or "horn"—remember these essentials:

1) Keep the middle range at as high a quality level as possible, with straight-axis, horn-loaded compression drivers, and without mismatch.

2) A woofer may be mismatched 2:1, but not 1:2. That is, an 8-ohm woofer may be used in a 16-ohm system; but a 16-ohm woofer should not be used in an 8-ohm system.

3) Tweeters may be mismatched 2:1 and may be so mismatched deliberately to achieve some desired result.

4) Attenuation pads, fixed or variable, are taboo. Keep the voice coils looking back into the amplifier without any more dissipation than the irreducible minimum necessary in the crossover network.

## GROUNDING EAR

Continued from page 5

although it is true that *most* speakers with a good low-frequency response have big cones, it does not necessarily follow that a small speaker needs to be inferior. On the contrary, some of the speakers with the finest bass response have been small. That includes the Hartleys and the Voigt and other drivers of bass horns. I trust manufacturers of 12- and 16-inch woofers and speakers will not misunderstand me as recommending the small cone. I am not a speaker designer and I know little of the problems involved. But as a critical listener I do know that good bass response is as you hear it, not as you see it. It is obtainable from big, small, and medium cones. I do not like to see prejudice become so established in high fidelity that it makes us follow narrower streets and alleys than we need to. For all we know, the very manufacturer committed today to 15-inch speakers may tomorrow develop a 6-inch speaker with a superior bass; it would be a shame to have that development suppressed by mere prejudice.

There is only one safe rule to follow when designing or buying speakers. Choose the one that produces the best sound, whether it conforms to current conventions or not. It is not size or



bass resonance point or magnet weight you are going to live with—but the invisible sound produced by them.

### Fairchild Elliptical Stylus

A couple of months ago I discussed the 1/2-mil stylus for LP records, and I mentioned then that Ferranti achieves much the same effect at 78 rpm with an elliptical stylus. I had presumed that, because of the small size, the problem of producing an elliptical stylus for microgroove records was so great that there was no need for me to mention it as a possibility. But along came Fairchild, offering the elliptical stylus in its new 220X cartridge! I have yet to try it, but if it works as well as the Ferranti does at 78 rpm (and I see no reason why it shouldn't) I think this will provide one of the best answers to the problem of obtaining better high-frequency response without increasing record wear. Except for the fact that an elliptical playback needle necessarily has rounded edges, its general shape parallels that of the chisel-shaped cutting stylus; it should, therefore, follow the finer undulations much more faithfully. An elliptical stylus should work better in the normal spade groove than a 1/2-mil stylus, and at least as well in a V-groove. I congratulate Fairchild and whoever ground the needle for them, and look forward impatiently to trying it.

### What Makes a Pickup

And that reminds me that Sherman Fairchild, president of Fairchild, took exception to my piece a few months ago on the principle of the Angel pickup, pointing out that, while theoretically the mass of a moving-coil pickup stylus is greater, the compliance is not entirely a function of mass; a moving-coil pickup is not necessarily handicapped by having to move a coil as well as a stylus. This is true, of course, and I hasten to make clear that it is not my intention in these discussions to make categorical judgments that this or that idea, circuit, or principle is the best possible. The intention in this column is to discuss new developments in terms of their implications and possibilities. Being human, with a normal human's propensity for enjoying prejudices, I may occasionally betray a preference for one thing over another and sometimes express a judgment which is positive or negative. But one thing I hope I have not done, and will not do: namely, suggest that there is any *best way* to achieve the high fidelity we all strive for. I said that loudspeakers are products of artists; in a real sense, that's true of all high fidelity audio. The most encouraging

thing about it is that so many people manage to find so many different ways of achieving the same end.

Specifically, as to pickups: they are an even more severe problem than loudspeakers. I stressed the advantage of the moving-needle movement used in the Angel from the standpoint of compliance, and it does have that advantage. But Pickering, for example, has managed to come up with a variable-reluctance movement which as far as I can see offers just about as great latitude in compliance. And Fairchild has managed in its pickups to attain very fine compliance despite the theoretical limitations of the moving-coil movement. Again, in the end, it isn't principles that win medals or demerits, but behavior.

### TAPE NEWS

*Continued from page 13*

that both record level indications and over-all frequency response suffer.

Ideal headphones for recorder monitoring are available from British Industries Corporation, the Brush Development Company, and Permoflux Corporation. The Brush phones, which are the only high-impedance quality units I know of, are marketed in two models: the standard series, and the bass-boost model which has its lower end tipped up to give a close approximation of loudspeaker balance. Very smooth top, too.

The Permoflux and British Industries phones are low-impedance units with a somewhat brighter-sounding high end than the Brush bass-boost model. The high-frequency response is still quite smooth, and distortion seems lower than from the Brush crystal types. Output is also significantly higher, for a given signal amplitude.

Low-impedance phones must either be used with a transformer-fed low-impedance output (as from a professional recorder), or connected to a high-impedance output through a special matching transformer. Permoflux has a few phone models with 8-ohm impedance which can be matched directly to a loudspeaker output, for tape monitoring or for late-hour listening to a hi-fi set.

Some professional recorders, such as the Ampex 300 and 400 series machines, have the 600-ohm output for direct connection of 600-ohm phones. There is a line-terminating resistor built into these recorders, however, that is switched across the line when there is no external termination, and this should be switched out when monitoring with 600-ohm phones. Failure to do this will create serious inaccuracies in the VU-meter indications, particularly at low frequencies, with resulting tape overload.

*Continued on page 48*



**KLIPSCH**  
SHORTHORN  
LOUDSPEAKER SYSTEM

Designed and manufactured by the originator of the KLIPSCHORN\* speaker system, the SHORTHORN\* is second only to the KLIPSCHORN\* system in performance. Using coordinated acoustic elements, including filters, it offers exceptionally smooth response, free from distortion. Back loading horn extends bass range without resonance.

Available in handsomely finished enclosures, in stripped down utility models (as illustrated) or separate components for assembly. Write for literature.

\*TRADEMARKS

**KLIPSCH & ASSOCIATES**  
HOPE, ARKANSAS

**THIS IS THE BOOK FOR EVERYONE INTERESTED IN TAPE RECORDING**

**"Tape Recorders—How They Work"**  
by Charles G. Westcott

**All the important facts in one book**  
Now you can have an expert understanding of tape recording. Explains magnetic recording theory; describes characteristics of tape. Tells how a recorder operates; discusses motorboard mechanism, drive motors, volume indicators, bias oscillators, equalization circuits, amplifiers and magnetic heads—includes diagrams, photographs and schematics. Tells you how to get best frequency response with lowest noise, how to avoid tape overload, how to obtain best bias settings; includes procedures for testing tape recorders and tape. The comprehensive book about Tape Recorders. 176 pages; 5 1/2 x 8 1/2"; over 150 illustrations. Use coupon below to order your copy today.

Postpaid, only . . . . \$2.75

**HOWARD W. SAMS & CO., INC.**  
2201 E. 46th St., Dept. 16-D6  
Indianapolis 5, Ind.

Send me your book: "Tape Recorders" (\$2.75)

Name . . . . .  
Address . . . . .  
City . . . . . Zone . . . . . State . . . . .  
(priced slightly higher outside U. S. A.)

<sup>4</sup>But the high-frequency resonance is a function of the effective stylus mass and the record material compliance.—ED

High Fidelity Magic...



from  
**EICO®**

**KIT \$49.95**  
**Factory Wired \$79.95**

**NEW! 20-WATT  
HIGH FIDELITY AMPLIFIER #HF20**

Due to its Ultra-Linear output stage with its conservatively-rated Ultra-Linear output transformer, the #20 features negligible distortion & increased power-handling capacity at both extremes of the audio spectrum. Costliest, complete equalization facilities—plus low-distortion, wide-range tone controls & Centralab Compentrol loudness control—create a preamplifier and control section unsurpassed even in units ticketed at much higher prices.

- Power Response (20W): ± 0.5 db 20-20,000 cps; ± 1.5 db 10-40,000 cps.
- Frequency Response (1/2 W): ± 0.5 db 13-35,000 cps; ± 1.5 db 7-50,000 cps.
- Rated Power Output: 20 w (34 w peak).
- IM Distortion: (60 cps: 6 kc/4:1) at rated power: 1.3%.
- Mid-Band Harmonic Distortion at rated power: 0.3%.
- Maximum Harmonic Distortion (between 20 & 20,000 cps at 1 db under rated power): approx 1%.
- Speaker Connection Taps: 4, 8 & 16 ohms.
- High quality preamp-equalizer & control section plus complete 20-watt Ultra-Linear Williamson-type power amplifier. Output transformer in compound-filled seamless steel case.

See and HEAR it at your neighborhood distributor. Write for FREE Catalog A-5.

**EICO** 84 Withers St., Brooklyn 11, N. Y.  
Prices 5% higher on West coast © 56

**RECORDING TAPES ...  
NEW LOW PRICES!**

ALL BRANDS, 1200 ft. plastic, now list, 3.50, our net 2.28. NEW.

ALL BRANDS, 1800 ft. 1 mil Mylar long playing tapes now list, 6.50, our net 3.89. NEW.

All H.O. tapes now list 5.50, our net 3.30. NEW. New 1/2 mil tape list 12.50, our net 7.45. NEW. (Above are all name brands and are not "super bargains" having no manufacturer's name.)

COMPLETE PRICE SHEET AVAILABLE

**USED RECORDING TAPE (Plastic Base)**

ATTENTION Industrial users: We have the New "Mylar" tapes from 1/2 mil to 3 mil thickness by Scotch, Encore, Reeves Audio and Irish. We will buy your present tapes provided there is not more than 1 splice per reel.

- 1.49 for 7" — 1200 ft.
- .74 for 5" — 600 ft.
- .45 for 4" — 300 ft.
- .25 for 3" — 150 ft.

★ ★ ★ ★ ★ ★ ★ ★ ★ ★ ★ ★ ★ ★ ★ ★

**USED "MYLAR" TAPE (1 mil)**

- 300 feet (3" reel) ..... .53
- 900 feet (5" reel) ..... 1.34
- 1800 feet (7" reel) ..... 2.69



New empty plastic reels in boxes. 3" 10c; 4" 22c; 5" 24c; 7" 27c ea. 10 1/2" fiberglass Reel \$1.49. EMPTY BOXES: 3" 3c; 4", 5", 7" 5c ea.; 10 1/2", 25c ea.

"Tape Recording" magazine, 35c (back issues available). Audio Devices 1956 TAPE RECORDING DIRECTORY free.

Please Include Sufficient Postage

**COMMISSIONED ELECTRONICS, INC.**  
2503 Champlain St. N.W. Washington 9, D. C.

**Abbreviations**

Following is a list of terms commonly used in this magazine, and their abbreviations. The list is arranged in alphabetical order.

- alternating current ..... AC
- ampere, amperes ..... amp, amps
- amplitude modulation ..... AM
- audio frequency ..... AF
- automatic frequency control ..... AFC
- automatic gain control ..... AGC
- automatic volume control ..... AVC
- capacitance ..... C
- cathode ray tube ..... CRT
- characteristic impedance ..... Z<sub>0</sub>
- current ..... I
- cycles per second ..... cps
- decibel ..... db
- decibels referred to 1 milliwatt ..... dbm
- decibels referred to 1 volt ..... dbv
- decibels referred to 1 watt ..... dbw
- direct current ..... DC
- foot, feet ..... ft.
- frequency ..... f
- frequency modulation ..... FM
- henry ..... h
- high frequency ..... HF
- impedance ..... Z
- inch, inches ..... in.
- inches per second ..... ips
- inductance ..... L
- inductance-capacitance ..... LC
- intermediate frequency ..... IF
- intermodulation ..... IM

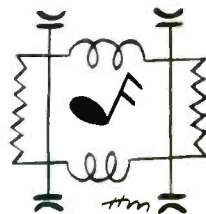

- kilocycles (thousands of cycles) per second ..... Kc
- kilohms (thousands of ohms) ..... K
- kilovolts (thousands of volts) ..... KV
- kilowatts (thousands of watts) ..... KW
- low frequency ..... LF
- medium frequency ..... MF
- megacycles (millions of cycles) per second ..... Mc
- megohms (millions of ohms) ..... MΩ
- microampere (millionth of an ampere) ..... μa
- microfarad (millionth of a farad) ..... μfd
- microhenry (millionth of a henry) ..... μh
- micromicrofarad ..... μμfd
- microvolt (millionth of a volt) ..... μv
- microwatt (millionth of a watt) ..... μw
- milliamperere (thousandth of an ampere) ..... ma
- millihenry (thousandth of a henry) ..... m
- millivolt (thousandth of a volt) ..... mv
- milliwatt (thousandth of a watt) ..... mw
- ohm ..... Ω

**PROFESSIONAL  
DIRECTORY**

**Artisan  
Build-It-Yourself  
ELECTRONIC ORGANS**

Send \$1.00 for "Organ Builders Manual"  
**ELECTRONIC ORGAN ARTS**  
4878 Eagle Rock Blvd.  
Los Angeles 41, Calif.

**HIGH-FIDELITY HOUSE**

Most complete stock of Audio components in the West

Phone: RYan 1-8171  
536 S. Fair Oaks, Pasadena 1, Calif.

**GIBSON GIRL TAPE SPLICERS**

splices in a wink!

NO SCISSORS!  
NO RAZOR BLADES!  
Diagonal cuts tape ends  
and forms splice edges



At Your Dealers

ROBINS INDUSTRIES CORP. Bayside 61, N. Y.

**AUTOMATIC CHANGER NEEDLE BRUSH**

**KLeeNeedLE**

KLeeNeedLE automatically keeps record changer needles clean. It is designed to remove the familiar "dust-blob" from under the needle point. At Your Dealer

ROBINS INDUSTRIES CORP. Bayside 61, N. Y.

**ATOMIC JEWEL RADIOACTIVE  
STATIC ELIMINATOR**



- Reduces Record Wear
- Reduces Needle Wear
- Improves Fidelity

At Your Dealer

ROBINS INDUSTRIES CORP. Bayside 61, N. Y.

- permanent magnet ..... PM
- potentiometer ..... pot
- radio frequency ..... RF
- resistance ..... R
- resistance-capacitance ..... RC
- resistance-inductance ..... RL
- revolutions per minute ..... rpm
- root-mean-square; effective value ..... RMS
- synchronous, synchronizing ..... sync
- television ..... TV
- ultra high frequency (radio) ..... UHF
- vacuum-tube voltmeter (multipurpose) ..... VTVM
- vacuum-tube voltmeter for AC measurements only ..... AC VTVM
- variable reluctance ..... VR
- very high frequency (radio) ..... VHF
- volt ..... v
- volt-ampere ..... va
- voltage, or potentiometer ..... E
- volts, center-tapped ..... vct
- watt ..... w



# Audiophile's Bookshelf

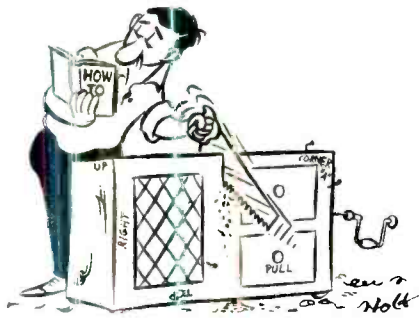

Order your audio and do-it-yourself books directly from us, using the convenient order blank. We make every attempt to take care of your order by return mail.

JUST FILL IN THE COUPON BELOW

## EQUIPMENT

**YOUR TAPE RECORDER**, Robert and Mary Marshall. The first book, for nonprofessionals, devoted exclusively to the tape recorder. Gives the complete story of what it consists of and how to use it. Based on more than 2500 experiments. Amply illustrated.

No. 202 ..... \$4.95

**MICROPHONES**, by Engineering Staff of BBC. 114 pages, cloth, covering theory, design and character of all standard microphone types. Not a new, but still a basic, book.

No. 73 ..... \$3.25

## DO-IT-YOURSELF

**BUILD IT YOURSELF** — 25 furniture designs. Specifically prepared working drawings. Clear and easy-to-follow instructions for making colonial, modern and contemporary furniture. 64 pp. illustrated.

No. 158 ..... \$2.15

**IMPROVE YOUR HOME WITH BUILT-INS**, Robert Schraft. How to make scores of built-ins for rewarding, low-cost home improvements. Over 200 plans for easy-to-build, space-saving units for every room in the house. The book takes you every step of the way.

No. 159 ..... \$4.95

**POWER TOOLS FOR THE HOME CRAFTSMAN**, Edwin G. Hamilton. Helps you do more kinds of jobs . . . produce better results — faster — easier. Start right with new tools, save time, money. Home craftsmen, planning to build their own speaker cabinets, will benefit from this handy, practical manual.

No. 160 ..... \$4.95

**BASIC TOOLS FOR WOODWORKING**, (2nd edition) Graphic illustrations and brief explanatory text indicate the right and wrong ways of using all carpentry tools. Basic, reliable information and guidance. 136 pp. illus.

No. 161 ..... \$3.25

## BINDERS FOR AUDIOCRAFT

Now available — for only \$3.50 each. Attractive, protective blue leatherette, to hold 14 issues of AUDIOCRAFT. Use coupon below to order.

## MISCELLANEOUS

**The New HIGH FIDELITY HANDBOOK**, Irving Greene and James Radcliffe.

Introduction by Deems Taylor. A complete, practical guide for purchase, assembly, installation, maintenance and enjoyment of high fidelity music systems. 250 illustrations, diagrams and plans.

No. 200 ..... \$4.95

**HOW TO INSTALL TV ANTENNAS**, Samuel L. Marshall. A completely practical, illustrated "Antenna Bible". Tells you everything you need to know about installing TV antennas: safety precautions, putting up masts and towers, getting the best reception in fringe areas, etc. In short—how to do the job RIGHT . . . quickly, safely, economically.

No. 162 ..... \$2.50

**HOME MUSIC SYSTEMS** (Revised Edition) Edward Tatnall Canby. 302 pages, illus. This popular guide to high fidelity has been completely revised. Explains the operation of a radio-phonograph, where to buy separate parts, and how to house them. One chapter devoted to suggested combinations of equipment.

No. 151 ..... \$3.95

**THE HIGH FIDELITY READER**, edited by Roy H. Hoopes, Jr. Introduction by John M. Conly. An anthology of outstanding articles originally appearing in HIGH FIDELITY Magazine covering various aspects of the high fidelity phenomenon.

No. 155 ..... \$3.50

**HIGH FIDELITY RECORD ANNUAL** — A first volume of record reviews—classical music and the spoken word—from HIGH FIDELITY Magazine. Edited by Roland Gelatt.

No. 201 ..... \$4.95

Book Department  
AUDIOCRAFT Magazine  
Great Barrington, Mass.

I enclose \$\_\_\_\_\_ for which please send me, postpaid, the books indicated by the circled numbers below. (No C.O.D.'s or charge orders, please.)

Foreign orders sent at buyer's risk. Add 50¢ for postage on foreign orders.

Binder #1 (14 issues)

73      151      154      155      158      159      160      161      162      200      201      202

NAME \_\_\_\_\_

ADDRESS \_\_\_\_\_

City \_\_\_\_\_ ZONE \_\_\_\_\_ STATE \_\_\_\_\_

**Do YOU Like  
To Waste Money?  
Can You AFFORD  
To Throw Money  
Away??**

If not, *there are some things you should know* before buying any high fidelity equipment, regardless of where you plan to purchase.

After three years in the audio field, during which time we have become one of the largest distributors in the nation, High-Fidelity House has published Bulletin G.

This bulletin contains some startling information, much of which has never before been put into print. It can help you to prevent costly mistakes, and you will find it most fascinating reading. We suggest you write for your copy at once. Bulletin G is absolutely free.

**HIGH-FIDELITY HOUSE**

Dept. AC605

536 South Fair Oaks, Pasadena, California

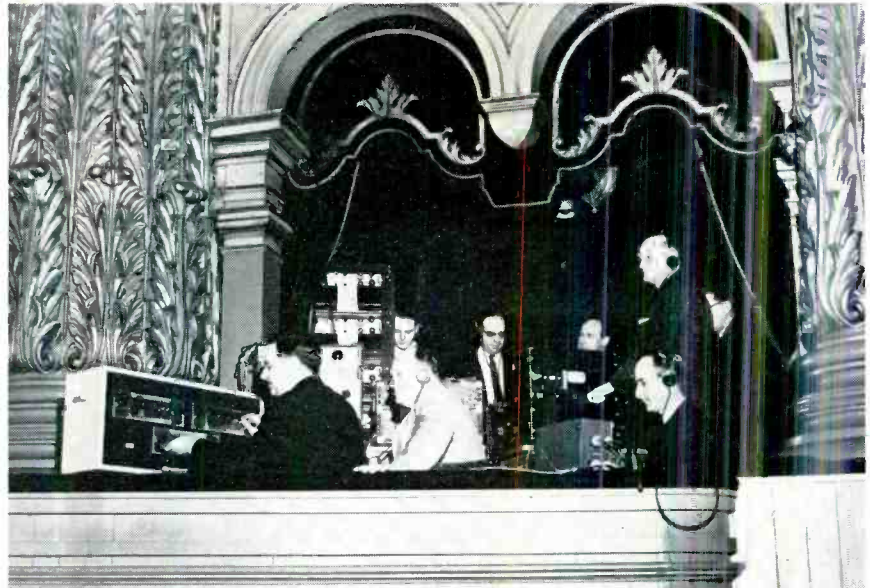

View of the audio control box at the Soundorama concert, held in Philadelphia at the Academy of Music. Ampex recorders, Fisher control units and amplifiers drove Jensen Imperial speakers on stage. See editorial on page 15 for more information.

**TAPE NEWS**

*Continued from page 45*

Regardless of the type of phones selected, it is an excellent idea to use them with foam-rubber ear pads—both to cut down extraneous noises when listening, and to prevent cauliflower ears from long sessions of ear-lobe compression. These foam rubber pads are made with very small center holes to pass the sound from the phones. If better bass response is desired it is recommended that the holes be enlarged to about an inch in diameter. Further enlargement might help, as long as the holes don't get big enough for the phones to fall through. They are quite inexpensive and well worth the money.

For anyone who is going to do a goodly amount of live recording the extra expense of a *good* pair of phones is well worth the extravagance, if only because they allow undisturbed (and undisturbing) program monitoring. Not everyone's mike cable will reach to a sound-proof room backstage, so speaker monitoring is likely to be difficult when an audience is trying to listen to the program rather than to a tape recorder.

**TRADERS' MARKETPLACE**

Here's the place to buy, swap, or sell audio equipment. Rates are only 20¢ a word (including address) and your advertisement will reach 20,000 to 35,000 readers. Remittance must accompany copy and insertion instructions.

**FM BROADBAND YAGI** for fringe and long distance reception. High gain design for maximum sensitivity to 72 or 300 ohm tuner input. Apparatus Development Co., Wethersfield, Conn.

**THREE WHARFEDALE W12/CS WOOFERS** in perfect condition, used less than 5 hours, \$30 each. Finished mahogany RAM Portraitist system, better than new, \$170. Box C, AUDIOCRAFT Magazine, Gt. Barrington, Mass.

**ADVERTISING  
INDEX**

Acoustic Research, Inc.	41
Allied Radio Corp.	13
Audio Exchange	48
Audio League	11
Audiophile's Bookshelf	47
Bozak, R. T., Co.	9
British Industries Corp.	Inside Front Cover
Centralab	43
Commissioned Electronics Co.	46
Components Corp.	5
Dyna Company	42
Eico	46
Electronic Organ Arts	46
Electro-Voice, Inc.	Back Cover
Fairchild Recording Equipment Company	11
Heath Co.	Inside Back Cover
High-Fidelity House	46, 48
Jensen Manufacturing Co.	2
Klipsch & Associates	45
Lansing, James B., Sound, Inc.	1
Music Box	14
Professional Directory	46
Robins Industries Corp.	46
Sams, Howard W. & Co., Inc.	45
Sound Sales Directory	44
Traders' Marketplace	48
Wendell Plastic Fabrics Corp.	43

**TRADE-INS**

**LABORATORY SERVICES**

**NEW COMPONENTS  
USED COMPONENTS**  
Fully Guaranteed

**audio  
exchange**

THE TRADING ORGANIZATION OF THE HI-FI FIELD  
159-19 Hillside Ave. | 367 Mamaroneck Ave.  
Jamaica 32, N. Y. | White Plains, N. Y.  
OL 8-0445 | WH 8-3380  
Tues. till 9 P.M. | CLOSED MONDAYS | Thurs. till 9 P.M.

Free catalog  
AC56 on request



Free parking  
at both stores

the audio exchange exchanges audio.



"BUILD-IT-YOURSELF" AND ENJOY . . . .

*high fidelity at its finest*

**IN KIT FORM**

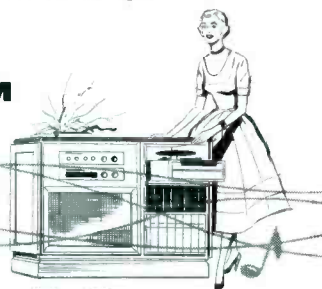

**1 Heathkit FM TUNER KIT**

Features brand new circuit and physical design. Matches WA-P2 Preamplifier. Modern tube line-up provides better than 10 uv. sensitivity for 20 db of quieting. Built-in power supply. Incorporates automatic gain control—highly stabilized oscillator—illuminated tuning dial—pre-aligned IF and ratio transformers and front end tuning unit. Uses 6BQ7A Cascade RF stage, 6U8 oscillator—mixer, two 6CB6 IF amplifiers, 6AL5 ratio detector, 6C4 audio amplifier, and 6X4 rectifier. **MODEL FM-3 \$24.50** Shpg. Wt. 7 Lbs.

**2 Heathkit 25-Watt HIGH FIDELITY AMPLIFIER KIT**

Features a new design Peerless output transformer and KT66 output tubes. Frequency response within  $\pm 1$  db from 5 cps to 160 Kc at 1 watt. Harmonic distortion only 1% at 25 watts, 20-20,000 cps. IM distortion only 1% at 20 watts, 4, 8, or 16 ohms output. Hum and noise, 99 db below rated output. Uses 2-12AU7's, 2-KT66's and 5R4GY. Attractive physical appearance harmonizes with WA-P2 Preamplifier. Kit combinations:  
**W-5M AMPLIFIER KIT:** Consists of main amplifier and power supply, all on one chassis. Shpg. Wt. 31 Lbs. Express only. **\$59.75**  
**W-5 COMBINATION AMPLIFIER KIT:** Consists of W-5M amplifier kit plus Heathkit Model WA-P2 Preamplifier kit. Shpg. Wt. 38 Lbs. Express only. **\$79.50**

**3 Heathkit HIGH FIDELITY PREAMPLIFIER KIT**

Designed specifically for use with the Williamson Type Amplifiers, the WA-P2 features 5 separate switch-selected input channels, each with its own input control—full record equalization with turnover and rolloff controls—separate bass and treble tone controls—and many other desirable features. Frequency response is within  $\pm 1$  db from 25 to 30,000 cps. Beautiful satin-gold finish. Power requirements from the Heathkit Williamson Type Amplifier. **MODEL WA-P2 \$19.75** Shpg. Wt. 7 Lbs.

**4 Heathkit Williamson Type HIGH FIDELITY AMPLIFIER KIT**

This amplifier employs the famous Acrosound TO-300 "Ultra Linear" output transformer, and has a frequency response within  $\pm 1$  db from 6 cps to 150 Kc at 1 watt. Harmonic distortion only 1% at 21 watts. IM distortion at 20 watts only 1.3%. Power output 20 watts, 4, 8, or 16 ohms output. Hum and noise, 88 db below 20 watts. Uses 2-6SN7's, 2-5881's and 5V4G. Kit combinations:  
**W-3M AMPLIFIER KIT:** Consists of main amplifier and power supply for separate chassis construction. Shpg. Wt. 29 lbs. Express only. **\$49.75**  
**W-3 COMBINATION AMPLIFIER KIT:** Consists of W-3M amplifier kit plus Heathkit Model WA-P2 Preamplifier kit. Shpg. Wt. 37 lbs. Express only. **\$69.50**

**5 Heathkit Williamson Type HIGH FIDELITY AMPLIFIER KIT**

This is the lowest price Williamson type amplifier ever offered in kit form, and yet it retains all the usual Williamson features. Employs Chicago output transformer. Frequency response, within  $\pm 1$  db from 10 cps to 100 Kc at 1 watt. Harmonic distortion only 1.5% at 20 watts. IM distortion at rated output 2.7%. Power output 20 watts, 4, 8, or 16 ohms output. Hum and noise, 95 db below 20 watts, uses 2-6SN7's, 2-5881's, and 5V4G. An exceptional dollar value by any standard. Kit combinations:  
**W-4AM AMPLIFIER KIT:** Consists of main amplifier and power supply for single chassis construction. Shpg. Wt. 28 lbs. Express only. **\$39.75**  
**W-4A COMBINATION AMPLIFIER KIT:** Consists of W-4AM amplifier kit plus Heathkit Model WA-P2 Preamplifier kit. Shpg. Wt. 35 lbs. Express only. **\$59.50**

**6 Heathkit 20-Watt HIGH FIDELITY AMPLIFIER KIT**

This model represents the least expensive route to high fidelity performance. Frequency response is  $\pm 1$  db from 20-20,000 cps. Features full 20 watt output using push-pull 6L6's and has separate bass and treble tone controls. Preamplifier and main amplifier on same chassis. Four switch-selected inputs, and separate bass and treble tone controls provided. Employs miniature tube types for low hum and noise. Excellent for home or PA applications. **MODEL A-9B \$35.50** Shpg. Wt. 23 Lbs.

**Heathkits**®

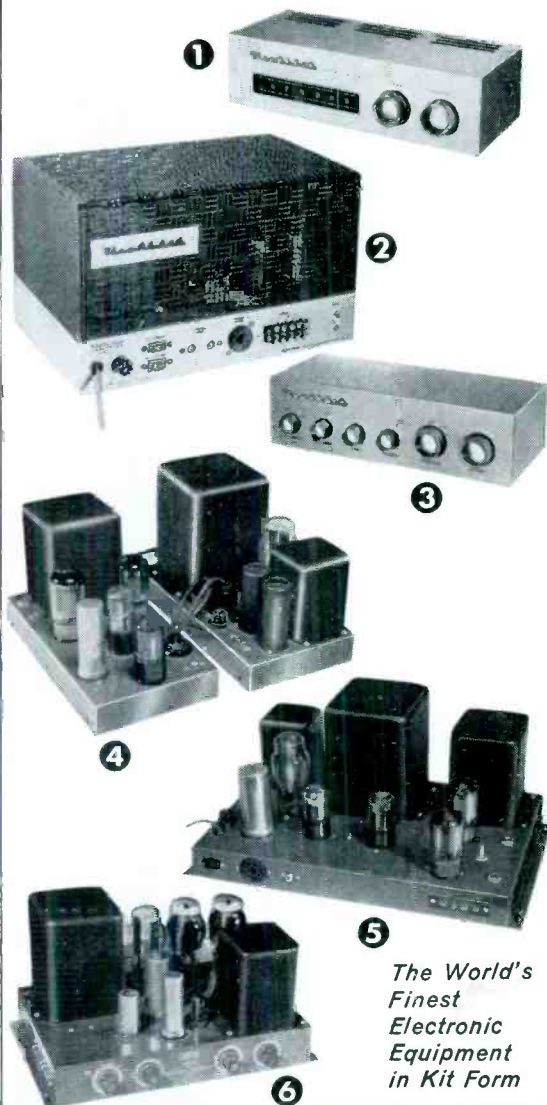

*The World's Finest Electronic Equipment in Kit Form*

*Heathkits are easy to build..*

Heathkit construction manuals are full of big, clear pictorial diagrams that show the placement of each lead and part in the circuit. In addition, the step-by-step procedure describes each phase of the construction very carefully, and supplies all the information you need to assemble the kit properly. Includes information on resistor color-codes, tips on soldering, and information on the tools you need. Even a beginner can build high quality Heathkits and enjoy their wonderful performance.

**HEATH COMPANY**

A Subsidiary of Daystrom Inc.

**BENTON HARBOR 18, MICHIGAN . . . . .**



Your next step to

# Perfection

## IN HIGH FIDELITY



### CIRCLOTROTON AMPLIFIERS

### and MUSIC CONTROL CENTERS



**Model A20CL Music Control Center and 20-watt Power Amplifier.** Features unique, exclusive "Presence" control. Response 20-20,000 cps.  $\pm 1.0$  db at rated 20 watts, 40 watts peak. Controls include Playing Selector, Loudness, Bass, Treble, Volume and Power, Phono-Selector. Power Amplifier utilizes Circlotron Circuit and Variable Damping Control. Low-boy style. **Net, \$124.50**

**Model A15CL Music Control Center and 15-watt Power Amplifier.** Similar to Model A20CL above except Power Output 15 watts rated, 30 watts peak. Controls include Power, Bass, Treble, Volume, Playing Selector and Phono-Selector. **Net, \$99.50**

**Model PC1 Music Control Center.** Serves as control for line amplifiers. Has self-contained, shielded, low-noise power supply. Features exclusive E-V "Presence" control. Other controls include Playing Selector, Loudness, Bass, Treble, Volume, Power and Phono-Selector. **Net, \$99.50**

**Model PC2 Music Control Center.** Serves as control for line amplifiers. Controls include Playing Selector, Bass, Treble, Phono-Selector, Volume and Power. Self-contained, shielded, low-noise power supply. **Net, \$67.00**

**Model A15 Circlotron Amplifier.** Power output: 15 watts rated, 30 watts on peak. Response:  $\pm .5$  db 20-50,000 cps. **Net, \$69.50**

**Model A20 Circlotron Amplifier.** Power Output: 20 watts rated, 40 watts on peak. Response:  $\pm .5$  db 20-60,000 cps. **Net, \$85.00**

**Model A30 Circlotron Amplifier.** Power Output: 30 watts rated, 60 watts on peak. Response:  $\pm .5$  db 20-75,000 cps. **Net, \$108.00**

**Model A50 Circlotron Amplifier.** Power Output: 50 watts rated, 100 watts on peak. Response:  $\pm .5$  db 20-75,000 cps. **Net, \$169.00**

**Model A100 Circlotron Amplifier.** Power Output: 100 watts rated, 200 watts on peak. Response:  $\pm .5$  db 20-50,000 cps. **Net, \$261.00**

Prices slightly higher west of the Rockies.

### Featuring the new, vital PRESENCE CONTROL

With the thrilling new PRESENCE CONTROL, you take the leader's baton and conduct the orchestra to suit your own listening pleasure in the ELECTRO-VOICE MUSIC CONTROL CENTER. Balances vocals to orchestra and room acoustics for true high fidelity. Just like the network and recording studios, the PRESENCE CONTROL gives mid-range program equalization never before available in home systems. Low-boy styling is skillfully blended with mocha, satin brown, and brushed brass trim for a beautiful appearance that matches blonde or mahogany cabinets.

With ELECTRO-VOICE CIRCLOTROTON AMPLIFIERS, you come closer than ever to perfection in high-fidelity reproduction. The famous Circlotron Circuit provides unity coupling between output tubes; eliminates switching transients and removes DC from output transformer. The exclusive Variable Damping Control greatly reduces loudspeaker low-frequency distortion and voice-coil override. Permits matching amplifier, speaker and enclosure to room...for the closest approach to reality of reproduction.

See your E-V High Fidelity Distributor or write for Bulletin 222-B65.

# Electro-Voice®

Producers of famous E-V High-Fidelity  
Speaker Enclosures and Systems

ELECTRO-VOICE, INC. • BUCHANAN, MICHIGAN