

April 1956

Volume 1 Number 6

audiocraft

THE HOW-TO-DO-IT MAGAZINE OF HOME SOUND REPRODUCTION

Authors new in this issue, in order as they appear at the right:

Paul Penfield, Jr. is a resident of Birmingham, Michigan, who points out that he has no connection with any manufacturer and can, accordingly, discuss transistors without bias. A consulting engineer, Mr. Penfield has certainly given a distortion-free analysis of the present and future status of transistors in audio; we hope readers will learn as much from it as we did.

Ronald R. Lowdermilk, who describes his extraordinary home sound system in detail, was one of the pioneer boosters of high-quality sound for everyone's home. He is with the Radio and Television Section of the Department of Health, Education, and Welfare, and was Chairman of the National Council of the Society of Music Enthusiasts.

Howard M. Van Sickle says he doesn't believe everything he's told about hi-fi speakers, equipment, and so on; if he has an idea that just might work out he tries it. The speaker system he describes in his article is, he says, an idea that worked out very well indeed. Mr. Van Sickle teaches music at State Teachers College in Mankato, Minnesota.

Mannie Horowitz, upon recovering his breath after doing battle with decibels, powers of 10, and logarithms, told us he is an electrical engineer for the Electronic Instrument Company, Inc., in Brooklyn, New York. He came there from the Mark Simpson Company, Inc.

CHARLES FOWLER, *Publisher*

ROY F. ALLISON, *Editor*

FRANK R. WRIGHT, *Managing Editor*

FRANCES A. NEWBURY, *Editorial Assistant*

ROY LINDSTROM, *Art Director*

ELEANOR GILCHRIST, *Art Assistant*

LUCIEN AIGNER, *Photography*

Contributing Editors

R. D. DARRELL

J. GORDON HOLT

JOSEPH MARSHALL

WARREN B. SYER, *Business Manager*

SEAVER B. BUCK, JR., *Circulation Director*

The Grounded Ear, by Joseph Marshall	4
<i>What's new and significant in sound reproduction.</i>	
Audionews	6
Tips for the Woodcrafter, by George Bowe	8
<i>This issue: Regular lumber.</i>	
Sound Servicing, by Irving M. Fried	10
<i>This issue: Distortion testing.</i>	
Tape News and Views, by J. Gordon Holt	12
<i>This issue: Tape-storage problems.</i>	
Readers' Forum	14
Editorial	15
Transistors in Transition, by Paul Penfield, Jr.	16
<i>Applications and limitations of transistors in audio.</i>	
The Dynakit Mark II Amplifier	19
<i>An AUDIOCRAFT kit report.</i>	
More Multi than Most, by Ronald R. Lowdermilk	22
<i>A How-They-Did-It feature.</i>	
Designing Your Own Amplifier, by Norman H. Crowhurst ...	25
<i>Part II: The power stage.</i>	
Stereo-Monaural Speaker System, by Howard M. Van Sickle	28
<i>A speaker system for stereo or single-channel reproduction.</i>	
The DB in Hi-Fi, by Mannie Horowitz	33
<i>The decibel, tracked down and subdued.</i>	
Audio Aids	35
Basic Electronics, by Roy F. Allison	36
<i>Chapter VI: Induction.</i>	
Rumble Seat	40
Professional Directory	47
Trader's Marketplace	47
Symbols and Abbreviations	48
Advertising Index	48

Branch Offices (Advertising only)—New York: Room 600, 6 East 39th Street. Telephone: Murray Hill 5-6332. Fred C. Michalove, Eastern Manager. - Chicago: John R. Rutherford and Associates, 230 East Ohio St., Chicago, Ill. Telephone: Whitehall 4-6715.-Los Angeles: 1052 West 6th Street. Telephone: Madison 6-1371. Edward Brand, West Coast Manager.

Audiocraft Magazine is published monthly by Audiocom, Inc., at Great Barrington, Mass. Telephone: Great Barrington 1300. Editorial, publication, and circulation offices at: The Publishing House, Great Barrington, Mass. Subscriptions: \$3.50 per year in the United States and Canada. Single copies: 35 cents each. Editorial contributions will be welcomed by the editor. Payment for articles accepted will be arranged prior to publication. Unsolicited manuscripts should be accompanied by return postage. Entered as second-class matter October 1, 1955, at the post office, Great Barrington, Mass. under the act of March 3, 1879. Additional entry at the post office, Pittsfield, Mass. Printed in the U. S. A. by the Ben Franklin Press, Pittsfield, Mass. Copyright 1956 by Audiocom, Inc. The cover design and contents of Audiocraft Magazine are fully protected by copyrights and must not be reproduced in any manner.

More and more discriminating people are discovering this unique

COMPLETE RECORD MAIL ORDER SERVICE

Quick, intelligent service. We can supply you
with anything currently available on disc.

Complete catalog of the famous WESTMINSTER W-LAB SERIES.	SINGLE	12 inch records	\$ 7.50
Westminster Test record TRC . . . Check and Double Check.		12 inch	\$10.00
Victor LM 1802. "An Adventure in High Fidelity"		12 inch	\$ 4.98
Victor LM 1922. The Sounds and Music of the RCA Electronic Synthesizer.		12 inch	\$ 3.98
Capitol SAL 9020. A Study in High Fidelity.		12 inch	\$ 6.95
Capitol SAL 9027. Further Studies in High Fidelity.		12 inch	\$ 6.95
Vox DL 130. This is High Fidelity.		12 inch	\$ 6.95
Vox DL 180. Spotlight on Percussion.		12 inch	\$ 6.95
Full line of Cook Laboratories remarkable records, including Voices of the Sea . . . Earthquake . . . Steel Band . . . Mariachi.			
		10 inch	\$ 3.98
Audio Fidelity AFLP 1801. The Brave Bulls. Music of the bullfight ring		12 inch	\$ 4.98
AFLP 1803. Drum Rhythms of Cuba, Haiti and Brazil.		12 inch	\$ 5.95
AFLP 901. Merry-go-round music.		10 inch	\$ 5.95
AFLP 902. Drums of the Caribbean.		10 inch	\$ 4.00
AFLP 904. Circus and Calliope Music.		10 inch	\$ 4.00
AFLP 906. Bawdy Songs and Backroom Ballads.		10 inch	\$ 4.00
Superb realisation of the full sound of the cathedral organ of Grace Cathedral, San Francisco, played by Richard Purvis.			
Hi-Fi Records R 703 and R 704.		12 inch	\$ 4.95
The sound of the mighty Wurlitzer organ, played by George Wright, realistically captured on Hi-Fi Records R 701, R 702		12 inch	\$ 4.95
Richard Dyer-Bennet 1. At last, a brand new high fidelity recording by this famous folk singer, of English and American folk songs. A true presentation of his superb artistry.		12 inch	\$ 4.95
Sounds of nature . . . Birdsongs . . . Frogs etc. on Ficker and Cornell University Records. Ficker 12 inch \$7.95 Cornell 12 inch \$6.75		10 inch	\$ 5.00
THE SPOKEN WORD. Caedmon's unique catalog of plays, poetry, prose, stories . . . High fidelity recordings of great literature by Poe, Whitman, Chaucer, Faulkner, Millay, Dylan Thomas, O'Casey, Tennessee Williams, Ogden Nash, Colette Macleish, Auden, Sirwell. Some read by the authors, others by famous actors.		All 12 inch	\$ 5.95
McIntosh MM 105. Breaking the Sound Barrier.		12 inch	\$ 4.98
Music Minus One. Fine recordings of great chamber music, with missing instrumental parts, permitting you to play your own instrument with the recorded ensemble. Wonderful for the amateur and professional chamber music player. Catalog on request. All LP records, complete with score.			

- ★ Every order over \$6.00 is mailed POSTAGE FREE anywhere in the U.S.A. On orders of less than \$6.00, please add 40¢ to cover mailing charges.
- ★ Our service is fast, prompt and courteous. All records are sold at the manufacturer's suggested list price only.
- ★ THE MUSIC BOX is devoted to mail orders exclusively. The general public does not have any access to our stock, which is handled only by two people.
- ★ When ordering, simply list the records needed, plus your check or money order to cover their cost. To avoid delay, list substitutions, since we will never make substitutions without your written permission. Sorry . . . no C.O.D.'s.

The Music Box

BOX 637, GREAT BARRINGTON, MASS.



Jensen *Authentic*
HIGH FIDELITY
LOUDSPEAKER KITS

High Fidelity Installation For the Home by John and Jean Wehrheim, Architects.

If you are planning to build-in your high fidelity system, you'll find a JENSEN Authentic High Fidelity Loudspeaker Kit not only gives superb performance but adds convenience and a note of simplicity to the whole project. Your builder or cabinet maker can easily follow the basic selected enclosure plan for the system you choose, (or do-it-yourself). New Manual 1060 tells all you need to know in simple terms, describes the eight JENSEN Loudspeaker Kits, and helps you make an intelligent choice of degree-of-performance.

Of course you can build your own free-standing speaker system if that is the arrangement you prefer. Again, Manual 1060 tells all. Why not order a copy today for only 50 cents.

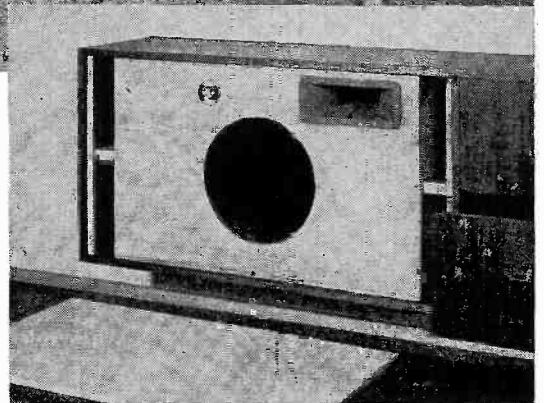

Installation of Jensen Speaker System Kits is easy — No Technical Skill Required.

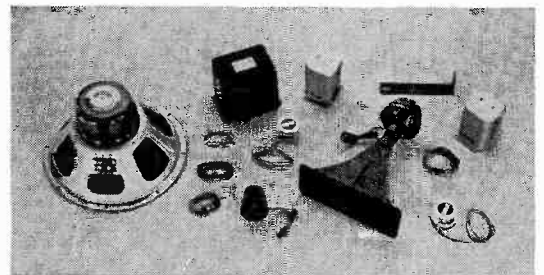

Components For the Jensen KT-32 Triplex 3-way System Loudspeaker Kit.

Jensen MANUFACTURING COMPANY
 Dept. N, 6601 S. Laramie, Chicago 38, Illinois
 Division of the Muter Co. • In Canada, Copper Wire Products, Ltd. Licensee
WORLD'S QUALITY STANDARD FOR MORE THAN A QUARTER CENTURY

SEND FOR BIG 36 PAGE MANUAL FOR BUILDING YOUR OWN ENCLOSURES

Select the Kit and Cabinet you want from this complete manual of do-it-yourself designs. Simplified drawings, parts lists, speaker data—all planned to help you. Send 50¢ in coin for Manual 1060 today!



The Grounded Ear

by Joseph Marshall

Goodbye, Hi-Fi Records

The past year has been significant to me for its evidence that high fidelity is leaving its adolescence behind and growing up. One bit of this evidence is the diminution of the output of special "hi-fi" records. I do not mean to say that records have lower fidelity than they did; on the contrary, the present trend is toward much more realistic fidelity to the sound one would hear if he were sitting in any of the really good seats in an auditorium, concert hall, or night club. I mean that there are fewer records with hi-fi jinks.

Two years ago some outstanding recordings sounded as if they had been made in a barn adjoining a blacksmith shop. In others, the double-bass choir was seemingly enlarged from its usual 4 or 6 to 18 or 20. In still others, a flute, oboe, or harp would seem to leap off the stage into the listener's lap when it received its brief moment of solo glory. Perhaps the *reductio ad absurdum* of these hi-fi jinks was represented by a recording of *Gaite Parisienne* which was so popular at the audio fairs of 1954. I don't believe there were any consecutive 30 seconds of this recording that did not have some example of high-frequency tinkling, jangling, or crashing. Furthermore, both the ears of the engineers and the mikes were seemingly deaf to the wonderful bass beat which underlies most of this work, particularly the cancons. The final effect was precisely what one would expect if he played a recording without play-back equalization and, to be truthful, the first time I heard it I wasted an hour checking my sound system to discover what had happened to the equalizers.

There was, admittedly, an engaging quality to these recordings. They permitted dealers to demonstrate their hi-fi wares without any necessity for turning the treble control full on—though many dealers did so anyway, and the effect in such cases was guaranteed to produce a headache in 5 minutes. Many of these recordings had, and still have, considerable value for testing. But the semblance to live sound was a

good deal less than a reasonable facsimile.

In the past year and, particularly, the past 6 months, there has been a firm movement toward a balance of tone more closely resembling what you might hear in the orchestra seats at Carnegie Hall. The triangles, chimes, and cymbals are still audible; the bass is still awesome; but neither is permitted to overpower the music, and the effect more nearly approaches that intended in the score.

Moreover, there has been steady and sometimes sensational improvement in the more subtle aspects of reproduction. For example, in the last few records E. D. Nunn has issued on his Audiophile label, the barrelhouse piano is outstanding for the absence of the slight touch of wow which somehow or other even the best recordists had previously been unable to eliminate. Result: the sound



is almost startling in its realism. Again, in this and other labels, the reproduction of transients and transient-like musical sounds is vastly sharper and cleaner. Vanguard, to give another example, has been sacrificing amplitude, both in its tapes and its master discs, at the cost of some additional background noise, but with a most worth-while reduction of distortion and needle chatter, and an improvement in definition.

There are still many records issued whose appeal is primarily to the hi-fi ear and only secondarily to musical tastes. And this, too, is as it should be. Every listener should have the privilege

of enjoying his high fidelity outfit as his taste and personality dictate. But where previously there was a choice of either a "hi-fi" record with gorgeous sound (at the expense of the emotions the composer intended to communicate), or another which was reasonably faithful to the musical intent but so dull in sound quality that only a serious musician could like it, today we are getting records which give fairly faithful renditions of both the composers' intentions and the live sound of the works as played by good orchestras in good auditoriums. This trend should please all factions.

How Much Power?

For some months now I have been monitoring my sound system with a power-output meter. I have not actually kept a systematic log, but I have kept the meter where I could see it easily. Whenever an unusual dynamic condition was audible I observed the meter reading. I was surprised to discover how little amplifier power the meter indicated even on very loud peaks. For example, when the volume was set for good listening volume, sufficient to provide appreciation of the music but not loud enough to annoy the family seriously, the average meter reading was less than 10 mw and the peaks somewhere between 200 and 500 mw at the outside. And when the volume was set for the sort of concert-hall level that brings a more complete illusion of presence but is really too loud to be tolerated by those who are not consciously listening to the music, the peak readings almost never exceeded 1 or 2 watts.

Now, before taking these figures at face value, some qualifications are necessary. For one thing, the background noise level of my home is very low; therefore it is possible to hear passages of very low intensity. If the background noise level were higher, it would be necessary to raise the volume level to overcome the background noise, if the softest passages were to be heard, and in that case the same recording would require greater power on the peaks.

Second, the power-output meter is calibrated for RMS sine waves and an adjustment is needed to translate its readings for peak complex waves. Roughly speaking we could say that when the RMS meter reads 1 watt, the complex-wave peak output is possibly 2.5 watts. Finally, the meter is too highly damped to provide full readings of transient peaks and some adjustment is necessary there, too. A reading of 1 watt on a transient peak might well represent as much as 4 watts peak complex-wave output. On the other hand, an amplifier capable of, say, 10 watts RMS is capable of nearly 20 watts peak, so this portion of the qualification does not have as much point as it might. Still taking all this into account, it appears superficially that in my home, for more than 99% of my listening, a 5-watt amplifier would be adequate.

To try to verify this I designed and constructed an amplifier which delivered about 4 watts just before the clipping point, with relatively low distortion (1.4% IM) at this point and a fraction of 1% below 1 watt. Significantly, this amplifier used in my home was never driven into the clipping point (as indicated on a scope) even at levels which were beyond polite tolerance by the rest of the family. Tried in a city home, with average city background noise, the little amplifier just barely sufficed; it had to be driven to higher levels, but the occasions it was driven to, or close to, the clipping point were infrequent enough to be relatively unimportant. However, when taken out on the lawn where sound dissipation was more complete and rapid, and I suppose background noise was also higher, it had to be driven into the clipping point fairly often on loud passages.

Of course, this sort of test proves very little besides the ability of my ears to be satisfied with relatively low volume and/or their tolerance for distortion. Mere theoretical calculations won't suffice either, for this question involves a subjective experience and no amount of mathematics can substitute for it. I wonder if any of our readers would like to try similar experiments in their own situations? All it takes is some kind of power meter or voltmeter across the voice coil of the speaker or speakers. If you use the power output meter you can multiply the RMS reading by about 2½ to obtain an approximation of peak complex wave. If you have a voltmeter you can calculate the peak complex power output with the formula:

$$\text{Power} = \frac{2.5 V^2}{R_L}$$

where V is the voltage and R_L is the nominal voice-coil impedance of the

Continued on page 40

Famous knight Hi-Fi Components

THE VERY FINEST FOR LESS:



Knight Custom components are built to ALLIED's own special high standards to deliver outstanding musical quality with distinguished appearance at money-saving minimum cost. Each unit is unconditionally guaranteed for one full year.

**ALLIED
EXCLUSIVES**

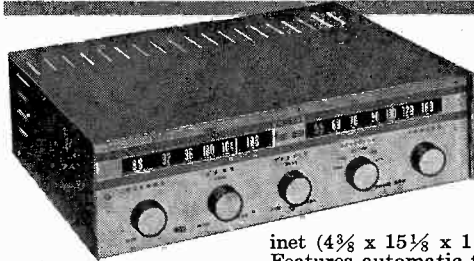

only
\$99⁹⁵
(less cabinet)
F. O. B. CHICAGO

Low Cost knight "Uni-Fi" Tuner-Amplifier Combination
The high quality complete ensemble for limited-space applications, exclusive with ALLIED at very low cost. Features single chassis construction including Hi-Fi FM-AM tuner, preamplifier and amplifier complete. Extremely compact cabinet (4¾ x 15½ x 11⅛") fits anywhere; simple to install. Features automatic frequency control; crystal or magnetic phono input; 3-position record equalizer; separate bass, treble controls; volume-loudness control; output and input for tape playback and recording; built-in antennas, etc. Available in cabinet illustrated or in chassis form (4¾ x 15 x 10½").

94 SX 730. Chassis only. Shpg. wt., 17 lbs. NET **\$99⁹⁵**
94 SZ 731. As above, in cork-grain finish metal cabinet. Shpg. wt., 19 lbs. NET **\$105.50**

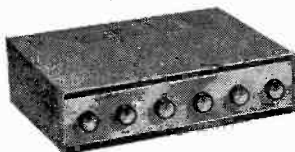

only
\$94²⁵
F. O. B. Chicago

knight Deluxe 24-Watt Amplifier

Superb amplifier compactly housed in beautiful "space-saver" metal cabinet finished in handsome cork-grain with gold-tone control panel. Custom quality featuring: frequency response, ± 0.75 db, 20 to 40,000 cps; 16 positions of record compensation; variable damping control; continuously variable loudness control; rumble filter; separate tone controls; hum balance adjustments, etc. Custom designed to satisfy the most discriminating audio expert—available at amazingly moderate cost. Size: 4 x 15½ x 11". Shpg. wt., 30 lbs.

94 SZ 701. NET only **\$94²⁵**



only
\$94⁵⁰
F. O. B. Chicago

knight Deluxe Basic FM-AM Tuner

Matches the Deluxe Amplifier; same attractive cork-grain finished metal case with gold-tone control panel. Outstanding features: "Lock-in" FM tuning (AFC); tuning meter for FM and AM; tuned RF stages on FM and AM; sensitivity: 5 mv for 30 db quieting on FM—5 mv for 1.5 volts on AM; FM discriminator with double limiter; 2 cathode follower outputs—detector and tape recorder, etc. Circuit includes 11 tubes plus rectifier. An exclusive ALLIED Hi-Fi tuner value. Size: 4 x 13¾ x 10". Shpg. wt., 17 lbs.

94 SX 702. NET only **\$94⁵⁰**



only
\$61⁹⁵
F. O. B. Chicago

knight "Bantam" 12-Watt Amplifier

Maximum value in a versatile, top-quality amplifier. Features include: 3-position record compensation; variable damping control; loudness control; frequency response of ± 0.5 db, 20-20,000 cps; six inputs; built-in preamplifier; separate bass, treble tone controls. In handsome metal case, with smart cork-grained finish. "Space-saver" design, only 3½ x 13 x 10½". An exceptional value. Shpg. wt., 14 lbs.

94 SX 700. NET only **\$61⁹⁵**

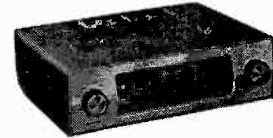

only
\$62⁹⁵
F. O. B. Chicago

knight "Bantam" Basic FM-AM Tuner

The perfect companion for the "Bantam" amplifier, in the same beautiful cork-grain finish metal case, only 3½ x 11½ x 9¾". Features: "Lock-in" FM tuning (AFC); latest 7-tube circuit; temperature-compensated oscillator to prevent "warm-up" drift; output level control; high sensitivity and exceptional frequency response: FM limiter and discriminator; built-in AM and FM antennas, etc. Shpg. wt., 10 lbs.

94 SX 703. NET only **\$62⁹⁵**

Order today from



free
ALLIED'S 100-page
HI-FI CATALOG

Shows you how to select Hi-Fi systems and components at lowest cost; offers the world's largest selection of Hi-Fi equipment. Send for your FREE copy of this valuable book today.

ALLIED RADIO

America's Hi-Fi Center

OUR
35th
YEAR

ALLIED RADIO CORP., Dept. 89-D-6
100 N. Western Ave., Chicago 80, Ill.

Ship the following KNIGHT Hi-Fi components: _____
\$ _____ enclosed

Send FREE 100-page ALLIED Hi-Fi Catalog

Name _____

Address _____

City _____ Zone _____ State _____



Audionews

RAULAND-BORG LINE

The Rauland-Borg Corporation has announced the addition of 4 new units to its line of high fidelity equipment.

The *Golden Chief* Model 1512 is a 12-watt amplifier in the moderate price

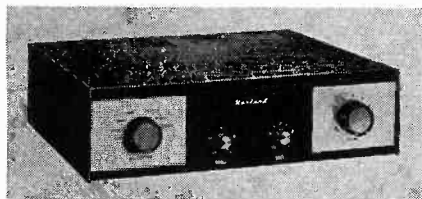

The Golden Chief 12-watt amplifier.

class. It has 4 equalization curves: EUR, frr, RIAA, and Quiet (scratch reduction). Bass and treble controls are separate; bass response is stated to be from +16 to -16 db at 40 cps, and treble response from +16 to -16 db at 10,000 cps. The unit has 5 inputs: MAGNETIC PICKUP, AUX. (ceramic pickup), TUNER, TAPE, and MICROPHONE. Variable damping control permits adjustment of the 1512 for best results with the particular speaker used. The manufacturer states that the frequency response of the amplifier is ± 0.5 db from 20 to 20,000 cps; harmonic distortion is not more than 0.6% measured in the secondary (16 ohms) of the output transformer, properly loaded; IM distortion is not more than 2% measured at 60 and 7,000 cps with a 4 to 1 ratio.

The *Golden Crest* Model 1520 is a 20-watt amplifier with a frequency response of ± 0.5 db from 20 to 40,000 cps, according to the manufacturer. Harmonic distortion is stated as no more than 0.5% measured in the secondary (16 ohms) of the output transformer, properly loaded. IM distortion is said to be less than 0.5% at normal listening level, and less than 2% at rated output. There are 6 equalization curves available: EUR, AES, frr, RIAA, 78 (Pop),

The 20-watt Golden Crest amplifier.



and Quiet (scratch reduction). A contour control varies the compensation from zero to full Fletcher-Munson equalization. Variable damping adjusts the amplifier to the speaker load used with it. The unit has 5 inputs: MAGNETIC PICKUP, AUX. (ceramic pickup), TUNER, TAPE, and MICROPHONE.

The *Golden Star* Model HF255 is an AM-FM tuner. The FM section has a discriminator with one limiter, and includes AFC with defeat on function switch, drift-compensated circuits, and has a 300-ohm balanced antenna input. A dipole antenna is supplied. The AM section incorporates a ferrite loop.

According to the manufacturer, sensitivity on FM is 5 microvolts for 20 db quieting, and 8 microvolts for 30 db quieting; sensitivity on AM is 20 microvolts for 1 volt output. FM frequency

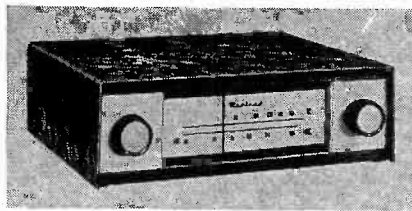

Golden Star HF255 AM-FM tuner.

response is stated as ± 0.5 db, 20 to 20,000 cps; AM response is ± 4 db, 20 to 5,000 cps. Distortion is said to be less than 2.5% at 1 volt output. The unit has 2 controls: one is a 4-position selector for POWER-OFF, AM, FM (AFC), and FM; the second control is for tuning.

The Model TV55 *Television Sound*

FOR MORE INFORMATION

For more information about any of the products mentioned in *Audionews*, we suggest that you make use of the Product Information Cards bound in at the back of the magazine. Simply fill out the card, giving the name of the product in which you're interested, the manufacturer's name, and the page reference. Be sure to put down your name and address too. Send the cards to us and we'll send them along to the manufacturers. Use this service; save postage and the trouble of making individual inquiries to a number of different addresses.

Tuner is for use exclusively with the Rauland HF155 AM-FM tuner or the Model HF355 tuner-amplifier combination. The *Sound Tuner* simply plugs in and tunes the TV sound for high fidelity

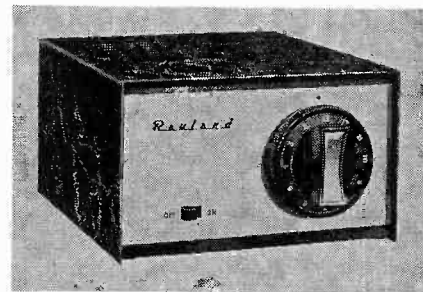

Sound Tuner tunes TV for hi-fi sound.

reproduction or for quality tape recording of TV programs.

The TV55 uses the IF strip, discriminator, and audio stage of the Rauland tuners, and also takes its operating voltage from the tuner. It operates independently of the TV set. This method of use is simply to locate the TV55 near the tuner. The selector switch is set on the tuner (HF155 or HF355) at the TV position; the slide switch on the TV55 is set to the ON position; the channel selector of the TV55 is set to the channel being viewed (it covers all 12 VHF channels); and the fine-tuning control on the TV55 is tuned for the best audio reception.

Additional information about any of the Rauland-Borg products mentioned here can be obtained by writing to the Rauland-Borg Corporation, 3515 West Addison St., Chicago 18, Ill.

MAGI-CLIP

Magi-Clip, a device to keep recording tape from unreeling by accident, has been introduced recently by Niblack Thorne Company. The *Magi-Clip* is made of brass and clips directly to the *Magi-Clip* holds tape tightly on reel.

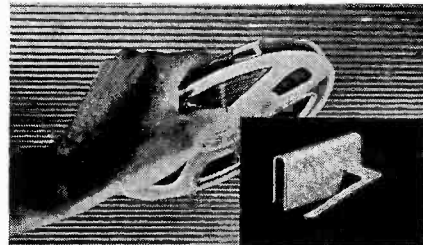

tape reel. It is said to hold tape securely on the reel to permit handling or storage without fear of having the tape unwind.

The clip is made to fit any size reel. It snaps on and off, eliminating the need for masking tape or rubber bands. Magi-Clip can be used on full or nearly full reels.

Magi-Clip is priced at 4 for \$1.00, 10 for \$2.00, and 30 for \$5.00.

ADDITIONS TO KNIGHT LINE

Three new pieces of Knight equipment have been announced by Allied Radio Corp. of Chicago.

The Knight *Uni-Fi* is a low-cost tuner-amplifier combination with a full set of controls. It combines FM-AM tuner,

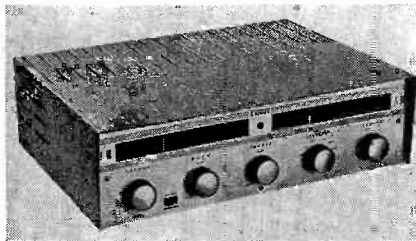

Knight tuner-amplifier combination.

magnetic preamplifier, and 10-watt amplifier on a single chassis. The unit is housed in a cork-grained metal cabinet measuring 4 $\frac{3}{8}$ in. in height.

The Uni-Fi tuner-amplifier needs only a hi-fi speaker to become a matched FM-AM system. For record reproduction, it can be used with any record player having either a magnetic or a crystal phono cartridge. In addition to an input for the record player, an auxiliary input is provided, permitting either a TV set or a tape recorder to be played through the Uni-Fi.

The unit requires an 8- μ v FM signal for 30 db quieting, according to the manufacturer. AM loopstick and FM loop antennas are supplied. The amplifier section is said to have a frequency response of ± 0.5 db from 20 to 20,000 cps. The circuit uses 10 tubes plus rectifier and germanium diode detector.

The Uni-Fi is equipped with separate bass and treble adjustments, a loudness



Space Spanner short-wave receiver kit.

control, and a 3-position compensation control.

The Uni-Fi tuner-amplifier is priced at \$105.50, complete with cabinet. With-

out cabinet, the unit is priced at \$99.95.

Also new in the Knight line is the *Space Spanner* 2-band receiver kit. This short-wave and broadcast receiver kit is said to be easy to build. It provides standard-broadcast coverage and short-wave coverage from 6 to 18 Mc.

The Space Spanner comes complete with a 4-inch, permanent-magnet speaker. Six controls are provided: BANDSPREAD, MAIN TUNING, ANTENNA TRIMMER, BANDSWITCH, REGENERATION, and VOLUME.

As a special bonus feature, the kit includes a new 24-page booklet written and illustrated by Allied's technical staff especially for the beginning kit builder. Twelve pages of the booklet cover basic radio theory, and the other 12 pages are devoted to instructions, including the "stop-and-check" building method, schematic diagrams, and large pictorial diagrams.

The Knight-Kit Space Spanner is priced at \$13.95 net, f.o.b. Chicago. A gray pyroxylin-covered wooden cabinet for the Space Spanner is available at \$2.85 net, f.o.b. Chicago.

Another new kit, the Knight-Kit *Transistor Radio*, is said to deliver clear headphone reception of the entire standard-broadcast band.

This unit features a printed-circuit component mounting board that eliminates all wiring and reduces soldering to

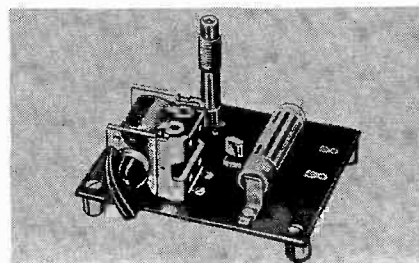

Knight transistor radio is easily built.

a few connections. It is said that the kit can be assembled in a matter of minutes by even the most inexperienced beginner. Operating power for the set is supplied by a single penlite-type dry cell.

The transistor-radio kit includes all parts, transistor, hardware, battery, and easy-to-follow instructions. The price is only \$3.95.

Further information about the Knight Uni-Fi tuner-amplifier, the Knight-Kit Space Spanner, and the Knight-Kit transistor radio is available on request.

SCREW-HOLDING SCREW DRIVER

A new *Midget* series of screw-holding screw drivers has been announced by the Kedman Company, manufacturers of Quick Wedge screw-holding screw drivers. The Quick Wedge Midget series will hold, start, and drive No. 0 to No. 4 wood screws and bolts, and No. 3 to No. 4 sheet-metal screws.

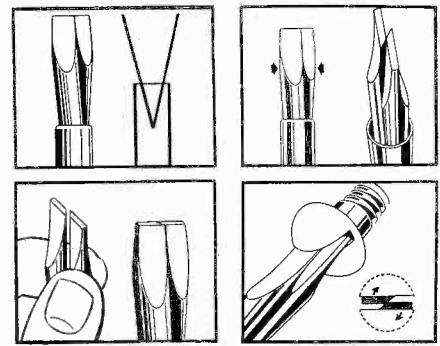

How the Kedman screw driver works.

Two half-round spring steel blades are welded, flat sides together, and molded into a plastic handle. At the bit end, these blades flare outward in a V shape. They are enclosed in a straight metal tube.

As the metal tube is pushed forward, its straight shape forces the V-shaped blades together. The inside edge of each blade slides up the diagonal cut and each blade rides up on the other. The hollow-ground blade tips grip the screw slot flush from top to bottom, with the force applied against the turning edge of the screw slot. The screw is thus held securely.

The screw is released by sliding the tube back toward the handle.

The Quick Wedge Midget comes in 2 sizes: No. 1253 with a 3-inch blade, retailing for \$1.25; and No. 1258 with an 8-inch blade, retailing for \$1.50. Other Kedman Quick Wedge screw drivers range in size from the No. 1732 with a 2-inch blade to No. 23514 with a 14-inch blade.

COMBINATION TUBE AND TRANSISTOR TESTER

A new combination tube and transistor tester was announced recently by Radio City Products Co. Known as the RCP *Model 325*, the new instrument tests N-P-N and P-N-P type transistors as well as all radio and television tubes,

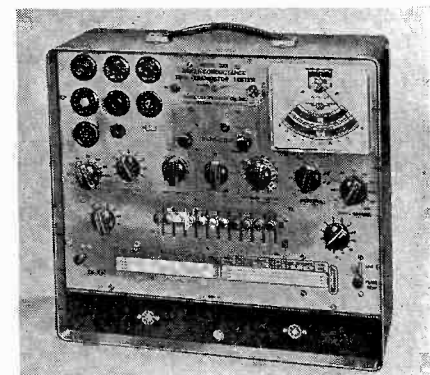

RCP combined tube and transistor tester.

including magnetically deflected black-and-white and color picture tubes, and all series-string heater types.

Continued on page 45

TIPS FOR THE WOODCRAFTER

by George Bowe

Regular Lumber

Just in case you're ever in the isolation booth and the \$64,000 question is: "What was the first major industry established in what is now the United States?", the golden answer is "lumber manufacturing". It started in the early 1600's and it might be interesting to note that more native timber has been

we'll discuss some lumber fundamentals that will add to your knowledge of what you're doing. Just as last month we examined the plywood picture, this time we'll explore the 2 x 4 and 1 x 10 — the wood we know as "regular lumber".

In general, lumber is classified in 2 divisions:

cone-bearing trees and are usually referred to as "conifers". These trees remain green throughout the year. Hardwoods, with few exceptions, are deciduous or broadleaf trees which shed their leaves at the end of the annual growing season, or trees of the fruit- and nut-bearing species. Unlike the conifers, hardwoods do not contain resin.

Lumber is graded according to its size, purity, color, texture, defects, or other characteristics. Pine, for instance, runs the gamut in grading from *clear*, which is free of all defects, to *select*, with only small imperfections, and on down the line from *grade 1* to *grade 5*, which is lowest quality with open knot-holes and other defects. Hardwoods have their own system of grading established by the National Hardwood Association. These grading rules are recognized as official throughout the United States and in many foreign countries. This standardization of grading is important because there are hundreds of different species of trees, each with its own natural peculiarities and defects caused in growth by storms, floods, forest fires, insects, and so on.

The most important and difficult process in the manufacture of lumber is proper seasoning. Seasoning, or drying of the wood, prevents warping, twisting, checking, and shrinkage after construction is completed; the danger of decay is lessened and thus the durability of the wood is increased; and the lumber is strengthened and its weight lowered for more economical transportation.

Green wood, when cut from the log, contains free water or sap constituting from one-third to more than one-half its total weight. A large percentage of this

Lumber described as nominal—	Actual dimensions when surfaced shall not be less than—		Actual dimensions when rough dry ¹ shall not be less than—	
	Inches	Inches	Inches	
Thickness	1	25/32	29/32	
	1 1/4	1 1/16	1 5/32	
	1 1/2	1 5/16	1 13/32	
	1 3/4	1 7/16	1 9/16	
	2	1 5/8	1 3/4	
	2 1/2	2 1/8	2 1/4	
	3	2 5/8	2 3/4	
	4	3 5/8	3 3/4	
	3	2 5/8	2 3/4	
	4	3 1/2	3 5/8	
	5	4 1/2	4 5/8	
	6	5 1/2	5 5/8	
Width of finish	7	6 1/2	6 5/8	
	8	7 1/4	7 3/8	
	9	8 1/4	8 3/8	
	10	9 1/4	9 3/8	
	11	10 1/4	10 3/8	
	12	11 1/4	11 3/8	
	Width of boards and dimension	3	2 5/8	2 3/4
		4	3 5/8	3 3/4
		5	4 5/8	4 3/4
		6	5 5/8	5 3/4
		7	6 5/8	6 3/4
		8	7 1/2	7 5/8
9		8 1/2	8 5/8	
10		9 1/2	9 5/8	
11		10 1/2	10 5/8	
12		11 1/2	11 5/8	

¹In a shipment of rough dry lumber 20 percent may be not more than one-thirty-second of an inch under the thicknesses shown.

Standard widths and thicknesses of rough and surfaced yard lumber.

used or destroyed since that time than existed here in the first place. New growth in our forests has made up the difference.

Since neither of the above facts will be of the least help when you start planning your next bit of hi-fi cabinet work,

1) Softwoods — for building and construction use, and some cabinet work.

2) Hardwoods — for architectural woodwork, furniture and cabinet making.

Softwoods, with few exceptions, are

PHOTO COURTESY APPALACHIAN HARDWOOD MANUFACTURERS, INC.

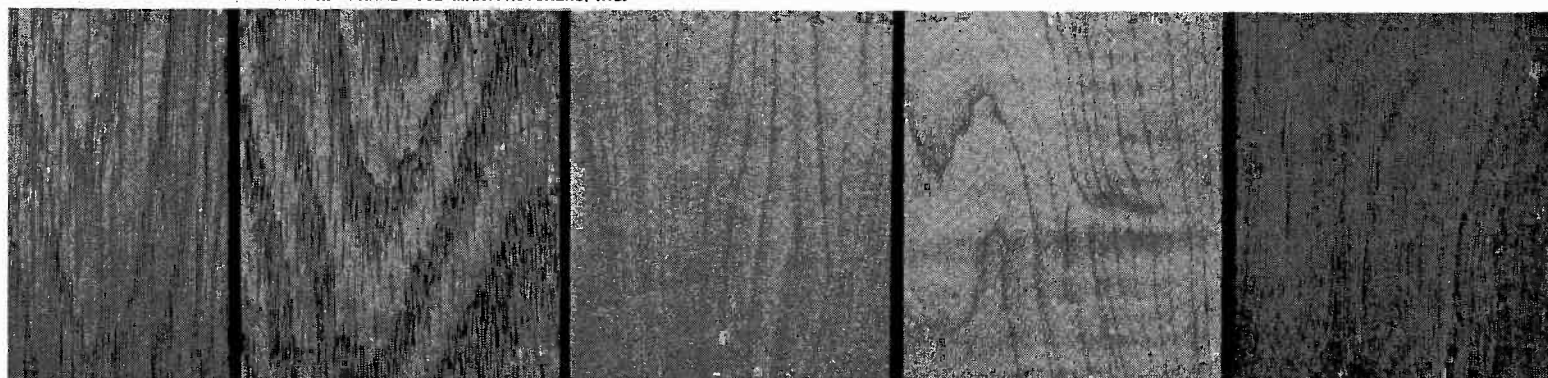

White Oak

Red Oak

Yellow Poplar

Hard Maple

Birch

moisture can be removed by an air-drying process which reduces the content to from 15 to 20%. However, for cabinet work and furniture, moisture content must be lowered still more by means of artificial heat; this is known as kiln-drying. Through the use of gauges and instruments, the humidity, circulation, and temperature are controlled without damage to the lumber. The reduction of moisture is a gradual process until its content is reduced to between 5 and 8%. Lumber containing more than 9 or 10% moisture cannot maintain a glue joint. A good glue joint in properly seasoned lumber is usually stronger than the grain of the wood paralleling the joint. It's a good idea to purchase the lumber for your cabinet work several weeks in advance and store it during that period in the same atmosphere in which it will be used.

Lumber comes in standard lengths of 8, 10, 12, 14, and 16 ft. Longer lengths, however, can be obtained if needed. Much of the eastern pine lumber is limited to 12 ft. in length by limited growth of the trees. Western lumber rarely exceeds 16 ft., yet lengths for framing can be had as long as 24 ft. at additional cost. Hardwoods seldom come wider than 12 in. while western pine runs as wide as 30 in. The home craftsman can profit by emulating the professional home builder who plans his building to accommodate the standard sizes of lumber and thus eliminates wastage.

Another important point to keep in mind when purchasing lumber is never to take the stated sizes literally. Although a length of lumber starts out as 2 in. thick and 4 in. wide, by the time it's dried and milled it arrives at your local lumber yard measuring nearer to 1 5/8 in. by 3 5/8 in. Other cuts of lumber are similarly affected. If you're planning on building bookshelves to house equipment as well as books, and your plan calls for shelves exactly 10 in. wide, don't buy 1-by-10 inch lumber or you will find it is only 9 1/2 in. wide. In this case buy boards of a 12-inch width and cut them down. Even the 1-inch thickness is actually only 25/32 in. Usually this size suffices for home cabinet work. Some lumber is available smooth on one side and rough on the other. The symbol "S2" means "surfaced on 2 sides" and "S4S" indicates "surfaced on 4 sides".

The term "lumber" is applied generally to all wood that is stocked by a lumber yard or cabinet shop. *Strip* is lumber under 4 in. in width, such as molding, furring strips, etc., and is sold by the linear foot. Plywood is sold by the square foot, the price varying with the thickness. The price of regular

Continued on page 38

Exciting News!

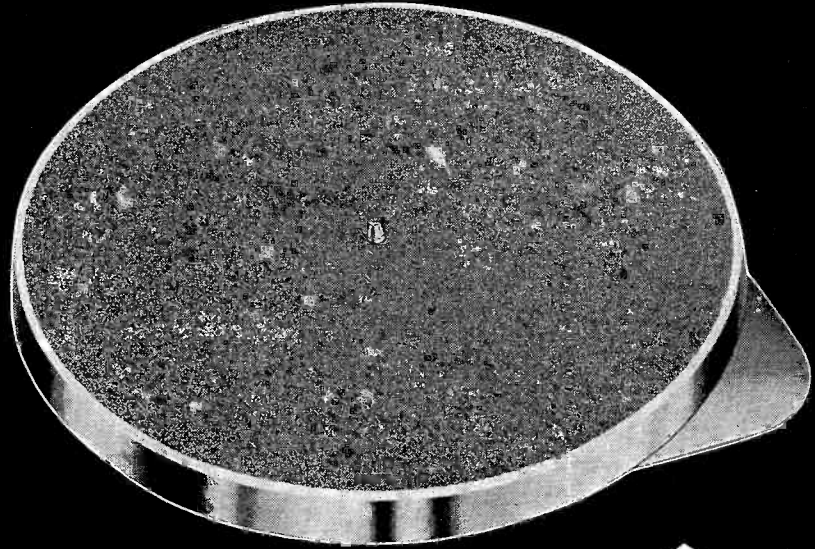

ONLY
\$39.50

A HEAVY WEIGHT BELT-DRIVEN TURNTABLE

THE "PROFESSIONAL" "Junior" by Components

Small, compact, precisely engineered — and packed with the distinctive features usually found in much more expensive turntables.

- Belt-Driven 12" Weighted turntable of non-magnetic polished aluminum
- Plays 4 speeds*
- Non-slip Cork Pad
- No noisy rubber idlers
- Negligible rumble, flutter and wow

Finished plywood mounting base 13 1/2" x 13 1/2" x 3" \$10

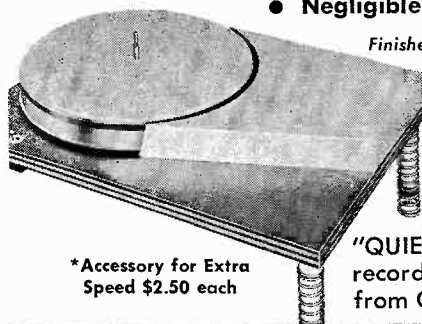

*Accessory for Extra Speed \$2.50 each

The PROFESSIONAL Junior is a worthy companion to Component's distinguished PROFESSIONAL, a complete turntable unit, ready to play, with 25 pound belt-driven turntable.

\$99.50

"QUIET, PLEASE" — Microgroove rumble test records 89c at your dealer, or \$1.00 postpaid from Components.



Components Corporation

DENVILLE, NEW JERSEY



SOUND SERVICING

by Irving M. Fried

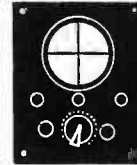

Checking Out Your Amplifier

There seems to be some confusion among earnest audiophiles concerning the kinds of tests and services that are important for high fidelity amplifiers. Many are the times I have seen someone entering a service shop carrying a bag of tubes to be tested, the bearer believing that the only trouble with his unit was a defective tube. And many times I have received calls and letters saying something like "I checked the voltage at pin 5, and it agrees with the factory manual"; or "I checked the voltage at pin 5, and it is 50% off from that given in the manual. How can this amplifier you sent me be running properly?"

In the past several months this column has discussed various tests for amplifier transient performance, and methods to improve it. Now I will take up a matter somewhat more elementary: what can go wrong with an amplifier, and how you can test for performance in terms of distortion.

You can't, in practice, expect to service your amplifier completely if all the equipment you have available is a tube tester or a voltmeter. Let me give an example: in a new amplifier kit currently becoming popular (the Dyna-

kit Mark II), the manufacturer specifically cautions against accepting voltage measurements as the ultimate criterion of performance in servicing and testing. The absence of any voltage reading at a certain check point where there should be a reading is significant; variance of more than 10% or 15% at certain other check points can be significant. On the other hand, variances of 50% or more at certain other points are interesting — *but not significant*. To know which are not particularly important requires a thorough knowledge of circuits, and the person who can predict them is probably enough of an engineer not to worry about voltage readings first, in any case.

As for tubes — a tube (say a 6SN7) can register "Good" on a tester yet, in a balanced Williamson stage, throw the whole thing so far off balance that distortion is 4 to 6 times what it should be. Or, if the "balanced" stages in an amplifier are actually unbalanced, because the resistors or capacitors have never been accurate or have wandered off value, then a tube unbalanced in the opposite direction will actually give better performance than a perfectly balanced one!

Therefore, the only convenient method of determining amplifier performance, assuming that the unit is actually operating, is by laboratory tests of distortion. For this you must have either a harmonic distortion analyzer or an intermodulation analyzer, preferably the latter. An IM analyzer can be used to detect immediately what is wrong with an amplifier.

I prefer intermodulation equipment because 1) it reveals distortion that harmonic analysis may not (0.1% harmonic distortion is 0.4% IM, generally); 2) it gives a much faster over-all check of low- and high-frequency performance; and 3) kit units are available, at very moderate prices, for the home experimenter.

Let us say that an amplifier is suspect, and is brought in for test. The owner has already had the tubes checked (OK), and he has had his radio serviceman make voltage measurements (they are within limits). Yet he brings it in because it just doesn't sound right. On the workbench, preliminary tests show it has 7% distortion at 20 watts, and 2% residual, while it is supposed to have less than 1% at 20 watts. Very often, by leaving the amplifier connected to the IM analyzer and substituting tubes, I have found the IM distortion suddenly drop way down, output power zoom up, and the wave trace become cleaner, just because a tube that tested well didn't perform well. Moral: tube testers aren't much use in the matter of distortion.

When tube substitution didn't help, or improved things only slightly, I have found that the IM analyzer (left in the circuit as I bridged this or that plate-load resistor, or changed this capacitor between stages) can give the most rapid indication of what is causing the trouble. I would not be without one.

If you aren't sure that your newly assembled kit, or your older kit or commercial unit are meeting specs, I can only tell you to check it on a reliable IM analyzer. Your local audio specialist, for a fee, should be willing to check it for you. If not, and if you are interested in consistently high quality, it might pay you to buy and build one yourself. Don't be thrown off track by tube testers and voltage measurements; they are fine to discover why your amplifier isn't operating, but they can't tell you much beyond that point.

This audio analyzer includes an IM section that generates both test frequencies.

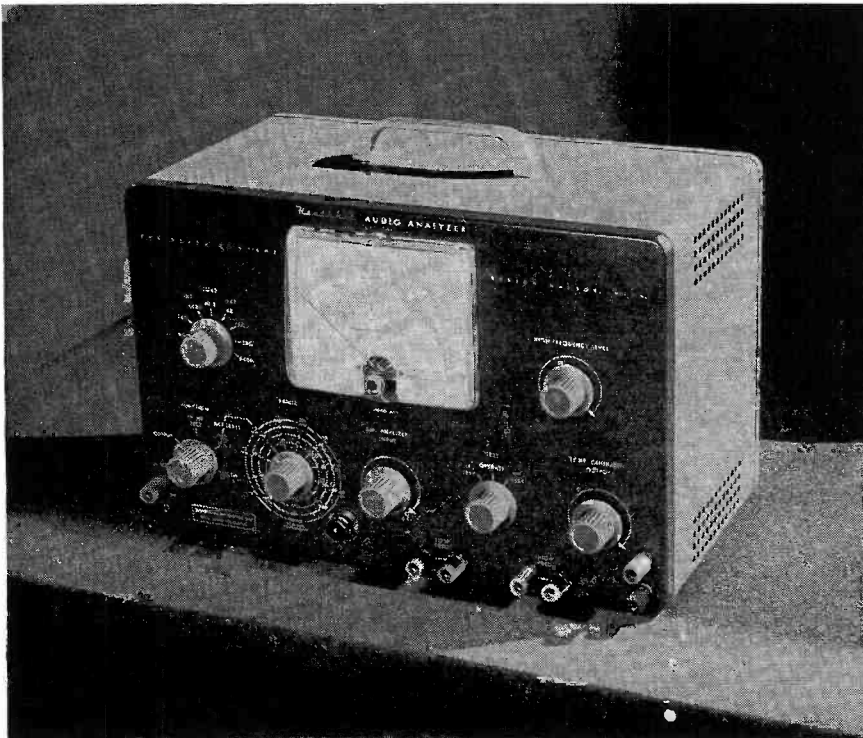
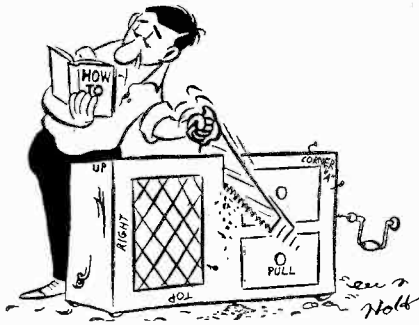

PHOTO COURTESY HEATH CO.

Audiophile's Bookshelf



EQUIPMENT

YOUR TAPE RECORDER, Robert and Mary Marshall. The first book, for nonprofessionals, devoted exclusively to the tape recorder. Gives the complete story of what it consists of and how to use it. Based on more than 2500 experiments. Amply illustrated.

No. 202 \$4.95

MICROPHONES, by Engineering Staff of BBC. 114 pages, cloth, covering theory, design and character of all standard microphone types. Not a new, but still a basic, book.

No. 73 \$3.25

DO-IT-YOURSELF

BUILD IT YOURSELF — 25 furniture designs. Specifically prepared working drawings. Clear and easy-to-follow instructions for making colonial, modern and contemporary furniture. 64 pp. illustrated.

No. 158 \$2.15

IMPROVE YOUR HOME WITH BUILT-INS, Robert Scharff. How to make scores of Built-Ins for rewarding, low-cost home improvements. Over 200 plans for easy-to-build, space-saving units for every room in the house. The book takes you every step of the way.

No. 159 \$4.95

POWER TOOLS FOR THE HOME CRAFTSMAN, Edwin G. Hamilton. Helps you do more kinds of jobs . . . produce better results — faster — easier. Start right with new tools, save time, money. Home craftsmen, planning to build their own speaker cabinets, will benefit from this handy, practical manual.

No. 160 \$4.95

BASIC TOOLS FOR WOODWORKING, (2nd edition) Graphic illustrations and brief explanatory text indicate the right and wrong ways of using all carpentry tools. Basic, reliable information and guidance. 136 pp. illus.

No. 161 \$3.25

MISCELLANEOUS

The New **HIGH FIDELITY HANDBOOK**, Irving Greene and James Radcliffe.

Introduction by Deems Taylor. A complete, practical guide for purchase, assembly, installation, maintenance and enjoyment of high fidelity music systems. 250 illustrations, diagrams and plans.

No. 200 \$4.95

THE FABULOUS PHONOGRAPH, Roland Gelatt.

The fascinating story of the interesting road from tin foil to high fidelity, starting with Edison's invention of the cylinder machine. Written by **HIGH FIDELITY Magazine's** N. Y. editor after many months of intensive research.

No. 154 \$4.95

HOW TO INSTALL TV ANTENNAS, Samuel L. Marshall.

A completely practical, illustrated "Antenna Bible". Tells you everything you need to know about installing TV antennas: safety precautions, putting up masts and towers, getting the best reception in fringe areas, etc. In short—how to do the job **RIGHT** . . . quickly, safely, economically.

No. 162 \$2.50

HOME MUSIC SYSTEMS (Revised Edition) Edward Tatnall Canby. 302 pages, illus. This popular guide to high fidelity has been completely revised. Explains the operation of a radio-phonograph, where to buy separate parts, and how to house them. One chapter devoted to suggested combinations of equipment.

No. 151 \$3.95

THE HIGH FIDELITY READER, edited by Roy H. Hoopes, Jr. Introduction by John M. Conly. An anthology of outstanding articles originally appearing in **HIGH FIDELITY Magazine** covering various aspects of the high fidelity phenomenon.

No. 155 \$3.50

HIGH FIDELITY RECORD ANNUAL — A first volume of record reviews — classical music and the spoken word — from **HIGH FIDELITY Magazine**. Edited by Roland Gelatt.

No. 201 \$4.95

Book Department
AUDIOCRAFT Magazine
Great Barrington, Mass.

I enclose \$..... for which please send me, postpaid, the books indicated by the circled numbers below. (No C.O.D.'s or charge orders, please.)

Foreign orders sent at buyer's risk. Add 55¢ for postage on foreign orders.

73 151 154 155 158 159 160 161 162 200 201 202

NAME

ADDRESS

City ZONE STATE

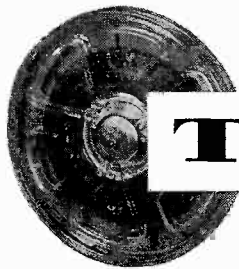

Tape News and Views

by J. GORDON HOLT

Tape-Storage Problems

It is still poor taste, in some circles, to admit that tapes can be as easily damaged or ruined as the discs they are supposed to replace. After all, the primary justification for paying premium prices for pre-recorded tapes is that they will never wear out the way records will.

Perfectly true — they *won't* wear out the way records will. Tapes have their own unique ways of becoming worn, mutilated, or otherwise decreasingly useful if they aren't cared for.

We all know, for instance, that acetate-base tape subjected to violence will break, crumple, warp, curl, cup, crinkle, or twist. We also know that a program so easily transcribed onto tape can be just as easily eradicated by depressing the RECORD button, intentionally or otherwise.

It is also commonly realized that a magnetized playback head can permanently raise the hiss level on a recorded tape, and can even begin to erase high frequencies after a few plays.

These are all misfortunes that an ill-fated tape can meet while actually in use and, as is true of discs, it simply requires a little additional care on the part of the user to minimize such threats to tape life.

But the big difference between tapes and discs is that a disc stored is a disc saved, whereas a tape stored may deteriorate in a remarkably short time unless a few simple precautions are taken.

Recent record-industry adoption of the RIAA playback characteristic brought this tape mortality business to the attention of a number of major recording companies who started digging their early tapes out of the files for re-mastering with the new curve. They found that many of their best tapes were totally unusable, even though they hadn't been played since the first masters were made from them. The passing of just a few years was enough to produce serious echo preceding and following each loud passage in the music, and to dry out some of the tapes so much that they wouldn't hug the playback heads properly and had an annoying tendency to break every time they were subjected

to the normal stresses of high-speed re-wind and quick-stop braking.

It is a discomfoting fact that most tape deterioration over a period of time takes place while it is stored, untouched by human hands. The most common trouble, as long-time tape users have discovered, is drying of the acetate backing. In this respect, acetate-base tape has just as definite a shelf-life as movie film, and when it dries out it becomes brittle, stiff, and cupped.

If there is any way to restore a desiccated tape to its original condition, I've yet to hear of it. Apparently it is possible to *prevent* drying, though, by storing all valuable tapes in metal reel cans, of the type that photographers use for holding 8-millimeter movie reels. These cans will do much to retard the drying process. If they are kept sealed with a strip of plastic insulating tape wrapped around them, the useful life of a tape could probably be ex-



tended to well over 20 years, as opposed to the 5 years or so for tapes stored in their original boxes or in the open air.

Another, more obvious, solution is to use a tape that doesn't dry out: Mylar polyester-base tape. I don't know of a single reel of this tape that has suffered physically from either extreme dryness or humidity. Even so, it pays to keep Mylar-base tapes sealed in metal cans also, to minimize the second threat to perfection.

Print-through, which causes the oft-heard pre- and post-echo before and after a loudly recorded passage, is caused by transfer of the magnetic field from one layer of tape to the adjacent ones. Groove pre-echo on some discs is customarily blamed on over-cutting, in-

correct stylus pressure, or a bad stylus, but it is usually nothing more than print-through which was present on the master tape and was transferred to the disc along with the rest of the program.

With the advent of thin-base extra-play and double-play tapes, print-through can become a major problem for home recordists, since the thinner tape backing brings the oxide layers closer to one another on the reels. Audio Devices, Inc., manufacturers of Audiotape, report that the *maximum* signal-to-print-through ratio on typical extra-play tapes is on the order of 51 db, with 47 db being a typical figure for double-play tape. These should be compared to 55 db for standard-thickness tape. It is emphasized also that these are maximum ratios, measured just after recordings are made. The print-through is very likely to increase during storage, raising the interference level above the tape hiss on most good recorders, particularly if the tapes are stored under adverse conditions.

A reel of tape can be erased by passing it through a powerful alternating magnetic field. On the other hand, passing it through a moderately strong field will produce print-through of truly monumental proportions, making the pre- and post-echo almost as intense as the original signals on the tape. This means that as innocent an act as laying a recorded tape near a power transformer can completely ruin it. And minor degrees of print-through can be caused by a soldering iron or a 2-pole phono motor. A soldering gun, in particular, develops a rather potent AC field around its U-shaped tip, and the DC magnetic field around a loudspeaker, dynamic microphone, or a pair of headphones can wreak its own share of damage if given the opportunity.

Finally, to complete this list of potential tape-spoilers, there are extremes of heat and humidity. High temperature and high humidity encourage layer-to-layer transfer. Also, a tightly wound tape is likely to print more readily than one loosely wound; a drastic reduction in temperature may have the same effect, as longitudinal contraction of the tape builds up pressure on the inner layers of the reel.

DYNAKIT

Mark II

50 WATT POWER AMPLIFIER KIT

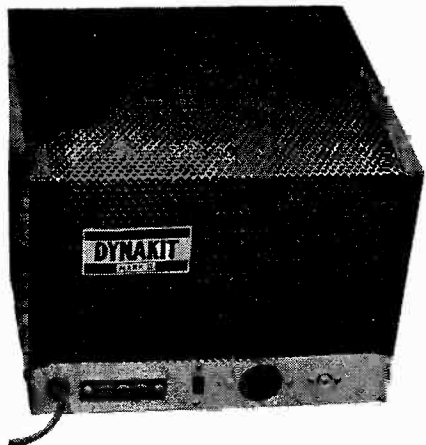

BEST IN EVERY WAY

✓ FINEST QUALITY

New circuit designed by David Hafler using the Dynaco A-430 output transformer, sets new performance standards both on the test bench and in listening.

✓ BEST SOUNDING

Smooth translucent highs and clean unmuddled bass characterize the Dynakit's sound. Listening superiority is due to highly stable circuit with outstanding transient response and distortion reduced to vanishing point.

✓ HIGHEST POWER

50 watts at less than 1% IM for listening ease. 100 watts peak. Frequency response ± 1 db 6cps to 60 kc. Full power available 20 cps to 20 kc within 1 db of 50 watts without exceeding 1% harmonic distortion over this range.

✓ EASIEST TO ASSEMBLE

Uses pre-assembled printed circuit board and simple physical arrangement. Only 9" x 9" x 6 1/2" high without sacrifice of performance, and can be assembled in 3 hours.

✓ GREATEST VALUE

\$69.75 complete with all top quality components, included pre-wired printed circuit board, pre-punched chassis, protective cover, and detailed assembly instructions.

Complete specifications and circuitry on this new amplifier kit are available. See your Audio jobber, Electronic Parts Dealer, or write direct.

DYNA COMPANY

Dept. AC, 5142 Master St., Phila. 31, Pa.

This is why a metal container isn't such a bad idea for Mylar-base as well as acetate tapes. The atmospheric changes won't hurt Mylar, but they can spoil the recording.

Other recommended ways of minimizing print-through are to record at as low a level as possible, consistent with low tape hiss; to rewind the tape a few times before each playing (so as to obtain uniform tension among the layers of tape); and to store boxed and canned tapes at a temperature of 60 to 70° F. and a relative humidity of 40 to 60%. In the average home, particularly during the winter when the furnace is working full time, these recommendations are rather difficult to comply with. Still, extremes should be avoided; don't pile tapes on radiators or on a shelf over the hi-fi equipment.

For single-track tapes, or half-track tapes recorded on only one side, further reduction in print-through can be effected by storing tapes on the take-up reel, rewinding them (a few times) only immediately before playing. This procedure doesn't do much to reduce the print-through; it simply puts the more powerful of the printed signals after the original loud passage, so that the echo will be more post- than pre-, and therefore less annoying.

Actually, the audible annoyance of print-through is likely to be greater at slow tape speeds than at 15 ips. At slower reel rotations there is a greater time lag between the original and the prints but, on the other hand, there is likely to be a lower tape hiss level from professional-type high-speed recorders, so smaller amounts of print-through can become audible. Either way, it pays to minimize print-through as much as possible.

One of the things that can cause tapes to deteriorate when played is head magnetization. This is, incidentally, a condition that is almost impossible for the amateur user to detect until after the damage has been done. Residual magnetization of the record and/or playback head in a tape recorder raises the hiss level, gradually removes the high frequencies from recorded tapes, and slightly increases distortion. It is altogether as insidious a condition as a worn phono stylus, since it is likely to become very gradually worse over a long period of time; quality deterioration isn't noticed until it has become quite bad.

A record head operates from the rapid reversals of induced magnetism created at the pole pieces by alternating voltages being fed to it. The steel used in the head is susceptible to permanent magnetization, and the only thing that prevents it from becoming strongly magnetized as soon as a signal is fed

Continued on page 43

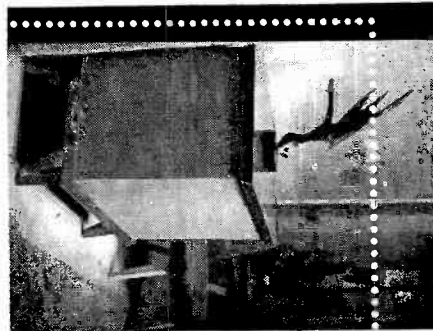

.....Systematic GROWTH into the Elegant... BOZAK B-305

In a living room of average size, the music-lover of above-average taste in decor and audio quality will delight in the quiet elegance and restful fidelity of the Bozak B-305 — in its class the purest voice for a fine music system. With 30 clean Watts, performance from 35 cycles to beyond 16 kc is phenomenal for subtlety of detail and effortless handling of dynamics. Transient response is outstanding; distortions vanish-

the ingly-low, listening ease and realism un- approached by any speaker system near its price. The infinite-baffle cabinet is in walnut, birch, or mahogany veneers. If you wish, grow from a single B-207A Coaxial to the full three-way B-305 with two coaxials and a mid-range—without capantry, tuning the enclosure, or balancing the speakers. From the lowest orchestral tones to the ultra-

sonic shimmerings of the triangle, it's all there in its proper values—and it's all yours, with a Bozak B-305. Write for full information on

Systematic Growth with Bozak

The Very Best in Sound

Export Office: Electronics Manufacturers' Export Co., Hicksville, N. Y.
The R. T. BOZAK SALES Co. • Box 966 • Darien • Conn.

1. E-305 Enclosure with B-207A Coaxial: 20 Watts; 40 cycles to beyond 16 kc.
2. E-305 Enclosure with two B-207A's: 30 Watts; 35 cycles to beyond 16 kc.
3. The full B-305: two B-207A's, one B-209 Mid-range, N-102 Network; 30 Watts; 35 cycles to beyond 16 kc with superb clarity of the "midrange".

Bozaks start at \$83.85



READERS' FORUM

Gentlemen:

I'd like to comment on a couple of articles in the January issue: Hafler's modernization of the W-3, and Mullings' on using the VTVM. This latter is a really fine one.

As a long-time hi-fi fan, ham and commercial radio operator; yes, even hi-fi serviceman—I object to Hafler's insinuation that the Acrosound TO-300 he developed and sold us a couple of years ago is now already passe and must be junked in favor of modern high-horse-power jet propulsion. At the same time I sympathize with anyone just going into business for himself, and I wish Mr. Hafler success in his new Dyna enterprise.

My own rig uses a W-3 Heath amplifier, and it was rather unstable at first, I'll admit. But the answer to my instability problem appears on page 28 of the same January issue: A diagram of the Heath W-4 amplifier. After my W-3 was changed to include the little "tweeter-saver" network across the speaker terminals, the delay network across the 47K in the first 6SN7 stage, coupling condensers to 0.25, and a 1,500-ohm resistor with another 20 μ fd filter as shown, my output cleaned



up fine. And it puts out 18 watts before showing overload on the 'scope, too—plenty; more than plenty for my little 12 \times 18 living room.

Maybe Hafler's Dyna circuit would be great stuff into a Stan White 4-D or E-V Patrician in some baronial hall, but my modest Aristocrat II system thrives nicely on the output of the TO-300 and, unless Mr. Hafler will allow me a good trade-in allowance, I intend to keep it. Transformers don't wear out, nor do they become obsolete in 2 years. My dad installed some 40 KV jobs in 1906 that I understand are still running efficiently after 50 years of continuous service.

So instead of tossing out a perfectly good \$25 transformer, just add a few inexpensive small parts as shown in Mullings' "typical" diagram on page 28. I might even try Hafler's 100- μ fd hi-frequency stabilizing condenser in my W-3 next time the bottom plate is off. But I'm keeping that TO-300 output transformer!

D. L. Devendorf, W8EGI
Lansing, Mich.

Continued on page 44

TUNING METER FOR BOTH AM AND FM
Now you can tune distant stations perfectly. Helps you adjust your antenna for best reception.

PLANETARY DRIVE TUNING
Edge lighted lucite tuning dials with separate logging scales. Big easy to read numbers. Quick or vernier tuning on both FM and AM sections.

FM RF SECTION
Highly sensitive cascode front end and heavy copper plated chassis gives 3 microvolts sensitivity for 20 db quieting.

SUPER SELECTIVE FM IF'S
Such sharp tuning that you can separate stations so close together ordinary tuners would pass them by.

WIDE BAND FM DETECTOR
Radically new design makes drift a thing of the past. Stations stay in tune. Strong and weak signals can be tuned with equal ease.

NEW AM DETECTOR
Exclusive H. H. Scott design means distortionless reception even if stations modulate to 100%. High frequencies come through perfectly. Conventional detectors distort AM above moderate modulation percentages, and distort high frequencies.

BINAURAL OUTPUT JACKS
from the completely separate FM and AM sections. Monaural output also provided.

WIDE-RANGE AM
3 position adjustable bandwidth including 'Ultra-Wide-Range' position for receiving the full 10 kc frequency range broadcast by the better AM stations. Perfect reception under any signal conditions.

Inside story on the

MOST ADVANCED AM-FM TUNER EVER DEVELOPED

Engineered by the same H. H. Scott team that has won every important High Fidelity award, this sensational tuner not only looks different . . . it sounds different — better than any tuner you've ever heard.

The AM side features radically new detector design . . . it's the first really wide-range AM tuner on the market . . . you actually get fine AM sound to 10 KC! The FM side has 3 microvolt sensitivity . . . you pull in stations you've never heard before.

"The Professional"
Model 330 AM-FM
(Binaural) Tuner

Styling and dimensions provide a perfect match to the 99-B and 210-D complete amplifiers. **\$199.95***

*Slightly higher west of Rockies

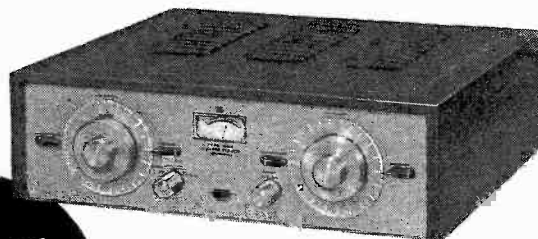

FREE!

New H. H. Scott Catalog and Hi-Fi Guide. Just off the press. Write for your free copy.



H. H. Scott, Inc., Dept. C-4 385 Putnam Ave., Cambridge, Mass. Export Dept.: Telesco International Corp. 270 Park Ave., N. Y. 17

H. H. SCOTT'S . . . A SOUND INVESTMENT

EDITORIAL

**Fight
cancer**

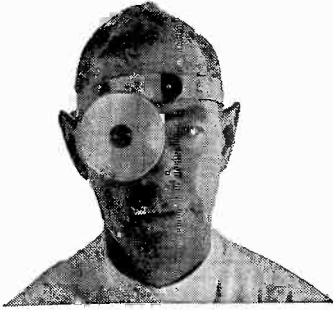

**with a
checkup**



**and a
check!**



**American
Cancer
Society**

PROBABLY everyone has heard vague rumors of the current struggles in the television broadcast industry and within the Federal Communications Commission, its governmental regulatory body. At the bottom of all this turmoil is the FCC's Sixth Report and Order, which has been in effect since mid-summer of 1952; this established a national city-by-city allocations plan for TV channels and ended the "freeze" on new station grants that had existed for some years before that. Better than 600 TV station construction permits have been granted under the Sixth Report and Order. Now a great many provisions of this plan are under fire.

The plan was prepared on the assumption that, with increased transmitted power, UHF stations could give as good service and as wide coverage as VHF stations and would, therefore, be fairly competitive with them. UHF and VHF channel allocations were intermixed freely; there was no effort to provide for areas that would be served by one type of station only. As it has turned out, UHF stations in general have been quite unable to compete with VHF's in the same area. At the present state of technology it appears unlikely that they will ever be on completely equal terms economically: with the same plant investment a VHF station can furnish wider and more reliable area coverage. For that reason (among others less obvious) VHF stations are almost invariably prospering, and UHF stations are losing money and going out of business.

Such a state of affairs is agreeable only to present owners of VHF stations. It is definitely *not* to the liking of UHF station operators, losing money because they're in the wrong business; to those who'd like to be TV station owners but can't get VHF assignments; to the public, which isn't getting the wide choice of program services it was promised; to the Congress, which is receiving complaints from constituents and entreaties to do something about it; and to the FCC, which is catching it from all sides.

There have been several courses of action proposed to alleviate these troubles. Some, depending on the sources, are selfishly inspired; others are not. One suggestion, for instance, is to put *all* television stations on UHF channels, freeing the VHF channels for use by industrial, common carrier (telephone and telegraph) and government agencies, and putting all TV stations on a more truly competitive basis. This makes most sense to us. Another pro-

posal is to "de-intermix" VHF and UHF television services by reallocation; in any given area, the service would all be of one type and therefore mutually competitive. A third proposal (one that has been made ever since the Sixth Report and Order was released) is to redistribute for commercial stations the VHF channels reserved for educational use. Along similar lines, it has often been suggested that 6, 12, or 18 megacycles of the 20-Mc FM band be removed and distributed as new VHF television channels.

Several other tentative solutions have been discussed at one point or another. All these cures have one thing in common: they involve a substantial amount of inconvenience and expense to one group or another. Some might reasonably be expected to solve the problem, though, while others cannot. The proposal to reallocate the FM band, which is what concerns us primarily, cannot be expected to do more than furnish slight temporary relief for TV's headache even if it is adopted. Each television channel consumes 6 entire megacycles; if 1, 2, or 3 TV channels were gained they would be insignificant to video with its ravenous appetite—and their removal would destroy FM broadcasting.

So far, the FCC has resisted the interests demanding surgery to the FM band—for which we can be thankful. But this is no time for complacency. The pressure is increasing rapidly to the explosion point, and something has to give soon. Recently Benedict Gimbel, an influential Philadelphia broadcaster, proposed personally to each FCC member that a TV channel (to be called 6-A) be chopped from the FM band; he said it could be used in 50 cities besides his own. A. Earl Cullum, Dallas consulting engineer, filed a comment in the latest FCC allocations proceedings recommending that 3 additional TV channels be obtained from the FM band. The Senate Interstate and Foreign Commerce Committee, irritated by the FCC's inactivity in the face of the Committee's frequent requests to solve the TV problem, has asked its own *ad hoc* committee to prepare a new national TV allocations plan that would be technically and economically sound. This plan will probably be examined and modified by the Commerce Committee, and presented to the FCC as a "suggestion"; such a suggestion would have the force of an order.

Now, more than ever before, is the time to write your Senator about this, expressing your views clearly and in no uncertain terms.—R. A.



TRANSISTORS

IN TRANSITION

by Paul Penfield, Jr.

IN the summer of 1948 there was made an announcement of significance to the whole electronics field: a report on the invention of the transistor. And in less than 8 years "transistor" has become a household word; so remarkable has been the progress of transistor development that many commercial products, including a number of consumer items, now use transistors. The questions might logically be (and have been) asked, "Why aren't transistors used in high fidelity equipment? Is there something inherently disadvantageous about the transistor that prevents its use in the best equipment?" The answers to these questions are given in this article.

To clear up one point of confusion, the original transistor was made by pressing 2 sharp points of metal into a block of germanium; hence, it was called a *point-contact* transistor. Since then another type, known as the *junction* transistor, has come into prominence. Characteristics of the junction transistor are much superior for audio applications than those of the point-contact transistor. Much of the present misunderstanding about the true place of transistors in audio equipment arises from a lack of appreciation of the wide differences between the 2 types.

Noise

Noise was originally considered to be the worst fault transistors, as a class, had. That, however, was back in the point-contact days. Modern junction

transistors can have very low noise figures, comparable to those of the best tubes available. So-called "low-noise" transistors are available costing only a trifle extra. Of course, the comparison doesn't mean too much, because of the widely different circumstances under which transistors and vacuum tubes are used. Whether vacuum tubes or transistors will be noisier in any *particular* application is sometimes hard to say; however, in audio applications either can, under normal circumstances, provide amplification with inaudible noise.

Noise in most transistors is predominantly at the low-frequency end of the band, and so the audible noise sounds less like hiss than a small roar. But the best transistors have noise spread fairly evenly over the audio range; it resembles the familiar vacuum-tube noise more closely.

Noise is not a deterrent, then, to the use of transistors in high fidelity equipment, since good modern transistors equal or surpass the best tubes available. Transistors not selected for low-noise characteristics have been used with mixed success in broadcast remote amplifiers for some time, and modern low-noise transistors are now being used in broadcast preamps with notable success.

Impedance

We know that a vacuum-tube grid presents almost infinite impedance to the drive source. This is not true with transistors. Transistor input circuits in

general operate at rather low impedances, and so do the output circuits. Is this an advantage or a disadvantage for audio work?

Well, it all depends on what you're trying to do. On the input side, certain drive circuits and transducers have high internal impedances; naturally, they work best feeding a high-impedance vacuum-tube amplifier. Crystal microphones and crystal cartridges are of this type. When loaded down by typical transistor circuits their performance is definitely inferior. Input transformers are required for best results.

But the shoe is on the other foot when we think of input devices like dynamic microphones, magnetic or variable reluctance cartridges, magnetic contact microphones, and so on. Excellent results are obtained by coupling a medium-impedance, broadcast-quality microphone directly into a transistor stage, bypassing the usual transformer altogether, at a considerable saving in cost. And unexpected bonuses are obtained by feeding the output of a magnetic cartridge to a low-impedance transistor amplifier. It is found that the normal 6-db per octave equalization in the bass range is obtained automatically to some extent, and all that is necessary for proper equalization is some treble attenuation. It isn't necessary for the preamp to have an extra gain of 25 db or so to be used in providing bass boost.

Bass equalization is not required because, while a vacuum tube ampli-

fies the *voltage* wave form appearing at its grid, the transistor amplifies the *current* through its input terminals, which often resemble a short circuit. The open-circuit voltage wave form and the short-circuit current wave form from a magnetic cartridge are not the same, because of the inductive, or magnetic, nature of the cartridge itself. If the internal resistance of the cartridge plus the input resistance of the transistor stage is low enough, compared to the inductance of the cartridge, bass boost at the rate of 6 db per octave is accomplished automatically over the entire audio range. In practical cases the boost stops at some frequency in the audio region, but what boost is obtained still helps considerably. This significant effect has not yet been adequately exploited. In the future, however, expect to see considerably simpler preamps, made with transistors instead of vacuum tubes.

Biasing

A vacuum tube, to operate correctly, must have the proper filament voltage applied, and, in addition, must have the correct plate voltage and grid bias. This is not very difficult to do, and people seldom give a second thought to the problem.

You have to think twice, though, about such matters with transistors. Why? Because transistors don't behave themselves very well in maintaining previously set bias conditions. If we set up a transistor with some given operating parameters, it will not remain at that particular emitter current and that particular collector voltage unless trouble is taken in designing the circuit so that it is quite stable. Normally, small changes of temperature change the operating bias—even changes of temperature brought about by increased dissipation within the transistor sometimes cause still more dissipation, causing another temperature rise; eventually, this process leads to thermal runaway in extreme cases. Designing stable transistor bias circuits is an often-neglected subject; it requires entirely different concepts than those useful with vacuum-tube circuits. Most of the so-called "temperature unreliability" in transistor circuits is caused by instability of the operating points. Although no filament power is required in transistor circuits, other difficulties are sometimes hard to overcome.

These difficulties are not, even so, a serious limitation in home audio applications so long as prudent circuit design is employed.

Frequency Limitations

One common opinion is that transistors are limited in high-frequency or low-frequency response, and for this reason

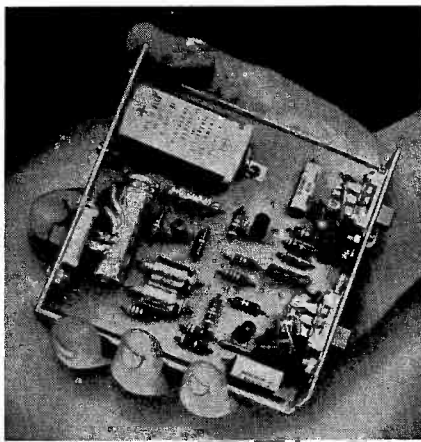

PHOTO COURTESY FISHER RADIO CORP.

*Just as this issue was going to press, Fisher Radio Corporation announced an all-transistor preamp-equalizer, model TR-1. It uses 3 transistors and has a self-contained battery, a volume control, mike-*phone* & input impedance switches.*

will never be used in high fidelity systems. This is only partly true of present-day models.

Low-frequency response of transistors is excellent. Bass response of transistor amplifiers is limited only by the size of the capacitors and transformers used.

High-frequency response, however, is not so good. The "alpha-cutoff frequencies" listed in transistor specification sheets for typical units go from 500 Kc to 3 Mc or more. Thus, on the surface, the outlook for adequate audio response would seem to be good. When operated in normal grounded-emitter fashion, however, transistor response tends to drop off 50 to 100 times below the alpha-cutoff frequency. A transistor with a cutoff frequency of 1 Mc might begin losing response above 15 Kc, and would introduce significant phase shift lower than that. High-feedback amplifiers (such as the Williamson) which depend on a rather extended high-frequency response will probably not be adapted for transistor circuits until better transistors are available.

Fortunately the Williamson is not the only high fidelity amplifier. Single-stage feedback amplifiers, which employ negative feedback around each individual stage, can utilize transistors to advantage. The frequency limitations of present-day transistors do not prevent their use in amplifiers of extremely high quality.

Power Output

High-power transistors are not yet cheap enough to compete with high-power vacuum tubes. The greatest transistor power dissipation rating now applies to the P-11, produced by Minneapolis-Honeywell: 60 watts. That's 60 watts collector dissipation under ideal conditions, not 60 watts output. The next highest ratings are for the 2N57: 20

watts. Power outputs up to the maximum power dissipation can sometimes be achieved using 2 transistors in Class B, under ideal circumstances. But, in general, power outputs will be less than 1/5 the peak power dissipation rating, for normal amplifiers—and even in these cases, distortion will be severe. Transistors at present are not capable of high-power, high fidelity operation.

Since audiophiles seem to enjoy having 50 watts available for peaks (while using only a fraction of a watt normally), transistors are clearly not capable of filling the role of power amplifier. Of course, the future is a different matter. Engineering developments now under way are directed toward bigger, more powerful, and better transistors tomorrow. Future power transistors will be made of silicon, or an alloy of silicon and germanium, or, in the far-away future, of some as-yet-undiscovered semiconductor. They will have special geometric shapes that not only enable them to dissipate heat rapidly, but also give them linear characteristics for low distortion. Then and only then will we be able to have high-quality, high-power, transistor audio amplifiers.

Distortion

Distortion in transistor amplifiers as well as in vacuum-tube amplifiers is caused by non-linearity of the voltage/current characteristics. In small-signal transistors, the variation is often exceedingly slight compared to the incoming signal. The non-linearities encountered depend mostly on the operating point, being greater at smaller current biases. Considerable effort is sometimes necessary to obtain the bias on a transistor which gives it the least distortion. Small-signal distortion usually is smaller than that occurring in vacuum-tube circuits, but not by a great amount. Each device has roughly the same low-distortion possibilities at present.

In power stages, as mentioned before, there is no comparison. Transistors exhibit extreme non-linearities at high currents, and also produce "crossover" distortion when operated Class B. Present vacuum-tube power amplifiers are head and shoulders above corresponding transistor power amplifiers as far as distortion is concerned. In medium-power

PHOTO COURTESY GENERAL ELECTRIC

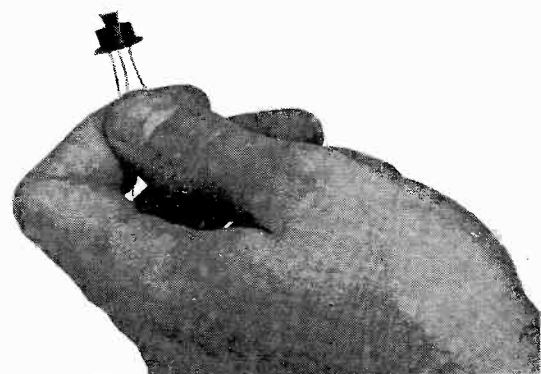

applications, such as for small radio output stages and the like, vacuum-tube circuits now used are so full of distortion that even present-day medium-power transistors are an improvement. Still, their operation can hardly be called "high fidelity".

Distortion performance looks brighter for the future. The fact that small-signal transistors are now roughly on a par with small-signal tubes means that future improvements in the art will reduce the non-linearities still further. Soon medium-power transistors with no drop-off in amplification at increasing collector currents will be released to the industry. The field of power transistors, and the distortion produced by them, is rightfully receiving considerable study at present.

Miscellaneous Difficulties

Two other factors at present work against the use of transistors. One of them is cost, and the other is inertia.

Cost of transistors has tumbled rapidly within the past 3 or 4 years. Even so, the best transistors are still priced at more than \$2.50 net, which is much more than normal vacuum tubes. Until the mass-produced cost can be reduced to about 25¢ or less, and the net price drops below \$1.00 for the best low-noise transistors, many circuits will remain non-transistorized. This factor does not influence high fidelity manufacturers very much, however, since their stress is on quality, not price (at least with most leading manufacturers). So the cost restriction does not apply presently to quality sound equipment as much as to other consumer products.

The inertia that works against greater use of transistors is of 2 types. First, it takes time to develop new circuits, new concepts, new methods of thinking about electronic designs, and new uses to put new components to. Engineers must be retrained, often throwing out much that they learned in vacuum-tube practice. Of course the better engineers readjust more quickly; still, some time is required.

Second, it takes time for the buying public to accept a new device. This will not be especially important, though, in the case of the transistor. The public (especially the audiophile public) already knows about transistors from Bell Labs institutional advertising and the advertisements of hearing-aid manufacturers. Further, the audiophile public is a little more receptive to new ideas than the public at large. Since a chronic ailment of hi-fi fans is a compulsion to tear their rigs apart and put them back together again, I expect transistorized high fidelity equipment will find a ready market as soon as it makes its appearance — for experimentation, if for nothing else.

The main cause for inertia, then, in the application of transistors to audio equipment is on the design level. This is rapidly being overcome now. Look for a number of transistorized pieces of equipment to be announced within the next year.

Transistor Advantages

After going this far the reader probably wonders, why bother with transistorized equipment at all? In every category mentioned, transistors have either fallen short of vacuum tubes or, at best, equaled them. Why start to use transistors, when vacuum tubes do everything as well or better?

The answer is, of course, that the peculiarities of the transistor offer many great advantages. Transistors need no filament power, and are normally as reliable as a common resistor — that is, they last as long. Transistors can be extremely efficient, approaching the theoretical limits of efficiency. Transistors can be made very small. They normally throw off no heat, so a transistor amplifier can be built in a sealed box no larger than necessary to hold the controls. Transistor preamps can be

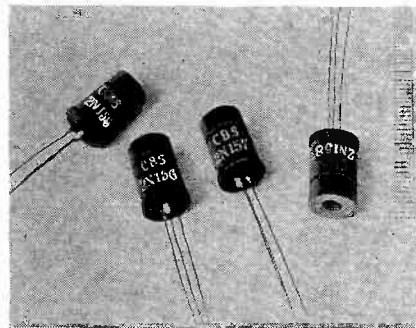

PHOTO COURTESY CBS-HYTRON
Some new CBS-Hytron power transistors; two 2N156's can deliver 8.5 watts.

mounted right in the phonograph arm, eliminating the long cartridge leads that are too often a source of hum. Long-range cost is less, both because of the lower replacement rate and because, by transistorizing a certain equipment, the associated circuitry is usually simplified. Power operating costs are less. And portable, battery-operated units are vastly more practical. Houses, hunting lodges, and boats without power-line service can have transistorized hi-fi rigs operated by a single battery that is replaced every year or so!

The possibilities of transistors in audio work are indeed unlimited, and in the very near future transistor devices will make serious bids for recognition.

The first applications will probably be in radio stations, recording studios, sound stages, and the like. These people can afford to invest in equipment which, in the long run, will save them money — transistorized equipment. A few remote amplifiers are now transistorized,

and soon more will be. Motion-picture sound men will be pleased to be able to take their transistorized, portable, *light-weight* equipment on location without having to lug heavy, cumbersome power supplies.

Soon microphone preamps will be mounted inside, or very close to, each studio microphone. This way, the long lengths of cable connecting the mike to the main preamp can be ordinary zip cord, instead of expensive mike cable. Less expensive cable connectors can be used. The hum problem will be reduced, since no low-level signal will be conducted for more than a few inches. And expensive input transformers will be eliminated.

Hard-to-manage television pickups can benefit from transistor-operated wireless mikes which can be made quite small, to be concealed on the person or in small props. It requires little imagination to think of many applications of transistor amplifiers in broadcasting and recording.

Home high fidelity systems will benefit soon from transistors, also. The first element to be transistorized will, naturally, be the preamplifier. Some transistor preamps have already been described in technical literature, but none is available commercially at this writing. After this, the first few stages of the ordinary power amplifier can be transistorized.

Tape-recording amplifiers for the public will soon be transistorized. The recording amplifier does not need much power, and present transistors can do the job adequately. The tape head, being a magnetic transducer, can be connected directly to a transistor preamp, eliminating the transformer that is often required.

More compact recording amplifiers, much more versatile, will result from intelligent use of transistors in this equipment. The amplifier will, almost literally, be just the size necessary to hold the controls and the connectors. With no heat problem, a sealed box may be used. And the weight will be considerably less — a real boon to serious audiophiles who like to carry their tape recorders all over with them.

Unfortunately, no high-quality transistor-operated power amplifier will appear for a while, at least 2 or 3 years. Until then the audiophile will have to contend with the awkward, fragile, hot, impossible device known as the vacuum tube. That is, he will unless some other type of amplifying device, such as a magnetic or dielectric amplifier, is developed into a workable unit suitable for high fidelity purposes. But the reader should by now know what to look for in transistorized equipment at this year's audio shows, and in a few years to come.

The Dynakit Mark II Amplifier

An AUDIOCRAFT kit report



DAVID Hafler's name achieved its present prominence among audiophiles by his development of the ultra-linear or tapped-screen output stage in collaboration with Herbert Keroes, and the design of a suitable output transformer for use in this circuit. The ultra-linear connection effectively doubled the maximum power output of the "standard" Williamson circuit, retaining its low-distortion performance capabilities. Subsequently he was one of the first to emphasize the importance of stability in heavy-feedback amplifiers, and of increased power requirements for the full dynamic range of present-day program sources. Further, he proceeded to demonstrate how both could be achieved.

Recently he set out to design an amplifier that would have the following characteristics:

- 1) Adequate power for modern dynamic requirements, even when driving low-efficiency speakers.
- 2) Extremely low distortion at any frequency up to its rated power level (and, of course, flat frequency response to well beyond the audio range at both extremes).
- 3) Stability at both ends of the range as nearly perfect as is practicable, with both resistive and reactive loads.
- 4) Low output impedance.

5) A simple, non-critical, and reliable circuit.

6) Very low cost.

The results were so encouraging that he formed the Dyna Company to market the amplifier as a kit, the Dynakit Mark II. We've just built one, and we must say that—surprising as it may

the output tubes have high power sensitivity, the output stage can be driven directly by the inverter even with 20 db over-all feedback. Coupling network components between the inverter and output stage have a very long time constant (25 milliseconds); this and the output transformer are the only

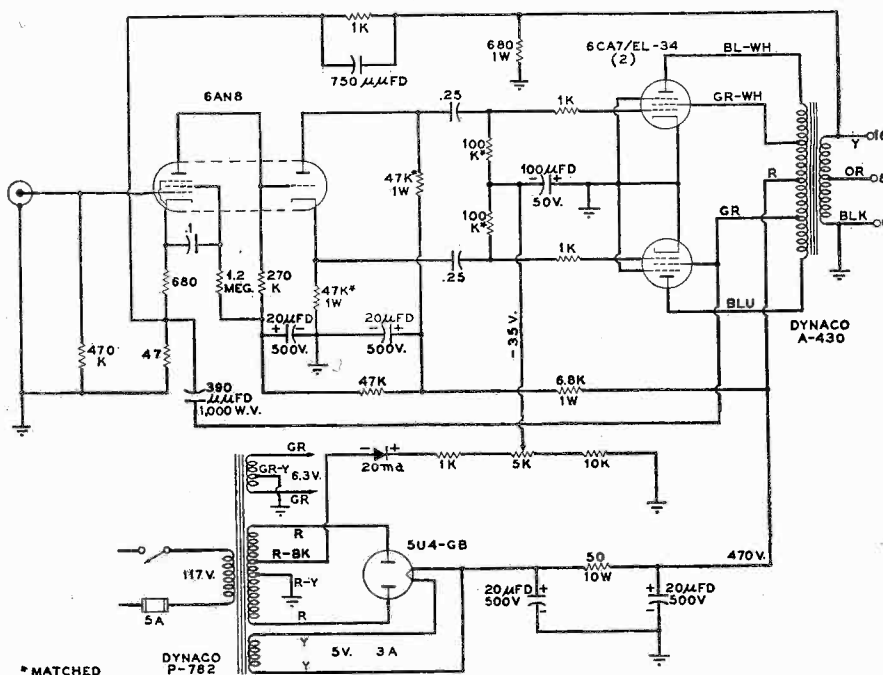

Fig. 1. Circuit of Dynakit Mark II. Note RC filtering of bias and power supplies.

seem—the objectives have been met fully. The price (\$69.75 net for all components, including punched chassis) is particularly remarkable, in view of performance.

A circuit diagram, shown in Fig. 1, reveals the unique simplicity of the Dynakit. Only 4 tubes, one of them a rectifier, are involved. The input stage is the pentode section of a 6AN8 triode-pentode, with the plate directly coupled to the grid of the triode section. This is arranged as a cathodyne or split-load phase inverter; signals of equal amplitude but opposite polarity are developed simultaneously at the plate and cathode of this stage. Because the gain of the pentode is so high, and

sources of low-frequency phase shift within the main feedback loop. Low-frequency stability is made virtually perfect by the phase correcting step circuit, consisting simply of a 0.1-µfd capacitor, between the screen grid and cathode of the input stage. Because this bypasses the screen circuit incompletely, it reduces response within the loop but doesn't produce phase shift at very low frequencies.

The 6CA7/EL-34 tubes used in the power stage have exceptional linearity and power sensitivity. Only a small amount of screen loading is employed—just enough to reduce the output impedance of the stage far below that of the straight pentode connection.

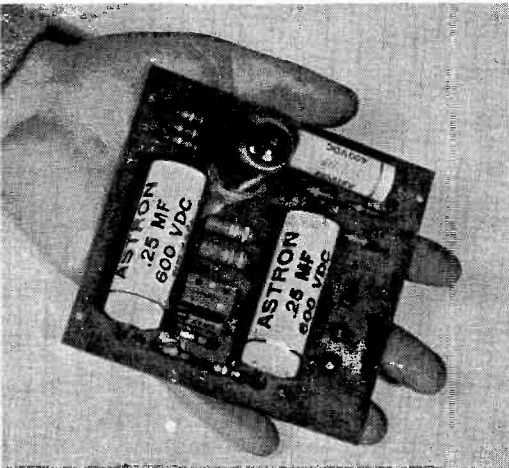

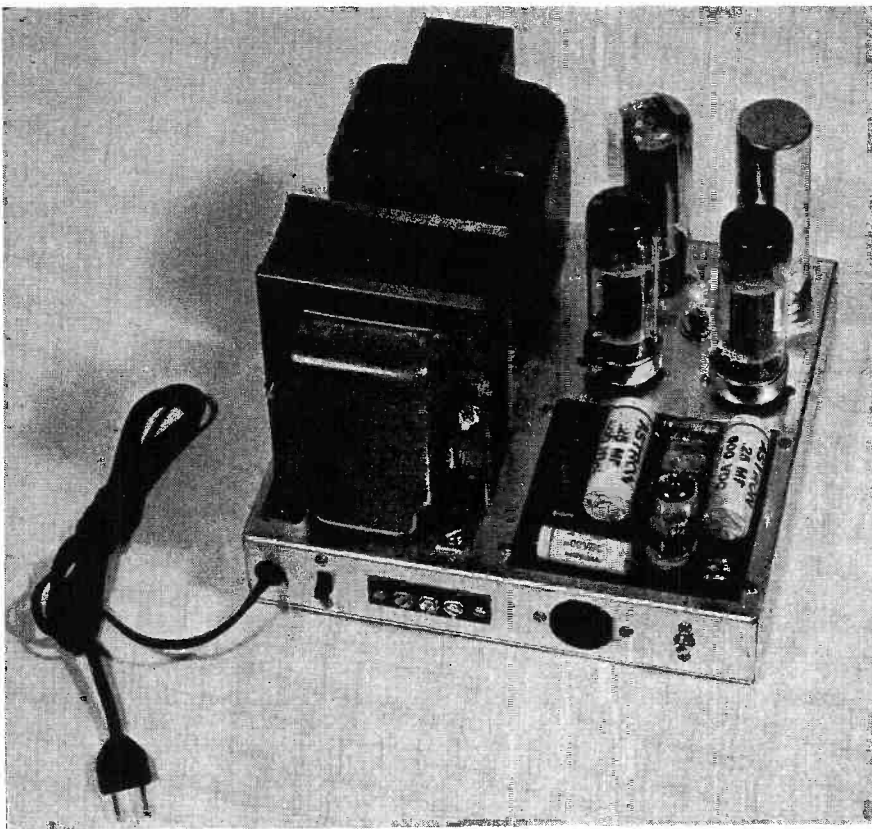

Fig. 3. Finished amplifier without cage. Connections, controls are all on one end.

With the simple fixed-bias supply furnished, and 470 volts on the plates and screens, the stage will deliver 50 watts at low distortion. An output transformer had to be designed specifically for this application: the Dynaco A-430. It is available separately, by the way, at \$29.95. The Acro TO-330 is claimed to be suitable for this circuit also.

Three factors account for the high-frequency stability: first, and most important, the fine output transformer; second, the capacitor bypassing the feedback resistor in the main loop, which increases feedback at extremely high frequencies; and finally, an auxiliary feedback loop effective at high frequencies only. This is the 390- μmfd capacitor from one of the output tube screens to the input stage cathode. It compensates for the unbalance of the phase inverter at frequencies well above the hearing range. Then, too, there is one less stage in this circuit than in most amplifiers, which makes the high-frequency phase shift problem less acute. All together, these factors result in performance at the high-frequency end that must be seen (and heard) to be believed.

Only 4 components in the circuit require matching: the plate and cathode loads of the phase inverter, and the grid resistors of the output stage; these establish the initial balance. (Matched parts are furnished.) It is worthy of note that the only other circuit components that could affect balance are the

coupling capacitors, which are high in quality and conservatively rated, and the output stage itself. Further, there

Fig. 4. Bottom of chassis is uncluttered because most small parts are on PC board.

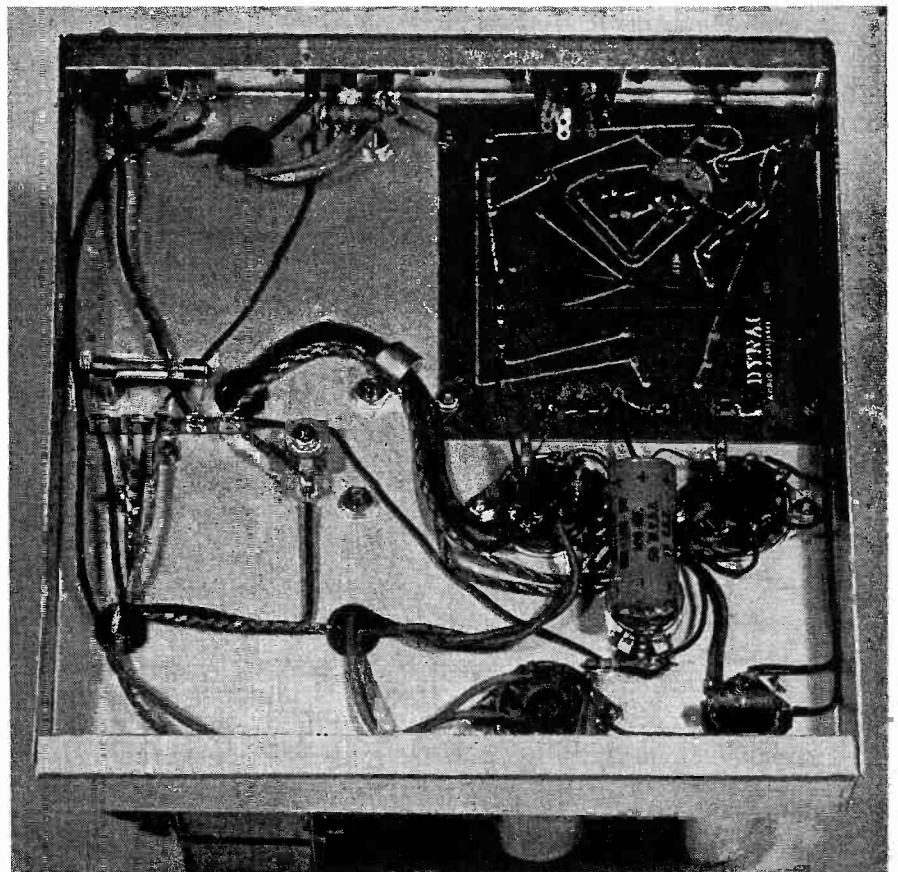

is only one adjustment that need be made: that for power stage bias. If the builder doesn't have a voltmeter that will measure in the range from 30 to 50 volts, he must borrow one or have a radio serviceman make the adjustment for him.

This is one of the easiest kits to build that we have even seen; it took us just 2 $\frac{3}{4}$ hours for the entire job. Everything is furnished, of course, down to nuts and bolts and hookup wire; all you need are tools and solder. Step-by-step instructions are given, and they are complete to the point of giving the color code for each resistor as it is wired in place. A large pictorial diagram is furnished that shows the proper orientation of all parts; each connection is pictured clearly. The instructions indicate when to solder each connection.

All of the first 2 stages and most of the other small components are already mounted and soldered on a printed-circuit board supplied with the kit. This is shown in Figs. 2, 3, and 4. The amplifier has an AC on-off switch and an outlet socket that can supply operating voltages for a preamplifier, tuner, or other small piece of auxiliary equipment; directions for wiring this socket are given. An AC receptacle, to furnish switched AC power, will fit the same chassis hole. Directions are supplied also for using 6550 tubes rather than 6CA7's (only difference: bias is ad-

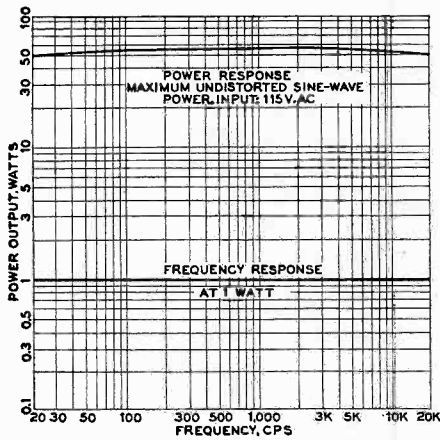

Fig. 5. Frequency and power response.

justed to — 48 rather than — 35 volts).

Size of the amplifier is surprisingly small, but don't expect to pick it up without a struggle—it's heavy! It will fit in places that many another won't, which is convenient. Still, it generates a lot of heat. It's best to use it in the open air, and the lacquered cage cover makes it attractive enough (and supplies protection for the tubes) so that it can be left on an open shelf. If you do enclose it leave plenty of ventilation.

The power supply makes use of another Dynaco transformer, the P-782. Aside from the unusually high voltage for the output stage, its most unique feature is a special tap on the high-voltage secondary winding for the bias supply. This is fed to a small selenium rectifier, rated at 20 ma, whose load is a series resistor string containing a potentiometer. The bias voltage is controlled within a fairly wide range by the pot. A single electrolytic capacitor is sufficient for filtering the bias voltage. It will be noted that there is no choke in the high-voltage supply either; the RC filtering has several advantages over conventional LC filters, particularly in cost.

Advertised specifications for the Mark II follow:

Power output: 50 watts continuous, 100 watts peak.

Distortion: less than 1% IM at 50 watts; less than 1% harmonic distortion at any frequency from 20 to 20,000 cps within 1 db of 50 watts.

Frequency response: ± 0.5 db, 6 to 60,000 cps; ± 0.1 db, 20 to 20,000 cps at any level from 1 mw to 50 watts.

Transient response: Essentially undistorted square waves from 20 to 20,000 cps.

Sensitivity: 1.5 volts input for 50 watts output.

Damping factor: 15.

Output impedances: 8 and 16 ohms.

Size: 9 in. wide by 9 in. deep by $6\frac{5}{8}$ in. high.

These are impressive specifications for any amplifier, to say nothing of one

that costs less than \$70. Our Dynakit has been in heavy use for better than a month now, and might reasonably be assumed to be well broken in. (The tests in the following section were performed after about 80 hours of use.) During this time we have listened as carefully as possible to all sorts of program material, on a variety of speakers, and have made several A-B comparisons with amplifiers in all price classes. Some amplifiers we liked as well as the Dynakit at the high end, and others as well at the low end; but the Mark II was outstanding for crisp yet velvety highs and rigidly articulated lows, together with adequate reserve power.

AUDIOCRAFT Test Results

The results of our instrument tests are shown in the accompanying charts. Frequency response and maximum-power response curves appear in Fig. 5. Little comment is required here, since the curves speak for themselves very well indeed. There is no falling off in power-handling ability at either end of the range. Although the curves are for frequencies from 20 to 20,000 cps only, tests were actually made out much further; it was found that frequency

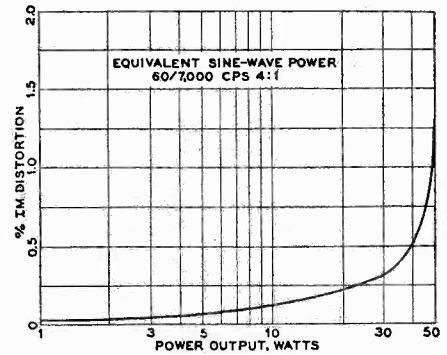

Fig. 6. The Dynakit's distortion curve.

response is flat out to about 48 Kc, at which point there is a 0.2-db rise followed by a very slow rolloff. This confirms the audible impression of exceptional high-frequency stability.

When the amplifier is subjected to a sharp overload pulse the recovery is rapid but flutterless. With a loudspeaker connected during the pulse, the cone returns to center position with insignificant overshoot. Obviously, the design emphasis on stability was successful at low frequencies also.

Fig. 6 shows an IM distortion curve on our test amplifier. It can be seen

Continued on page 43

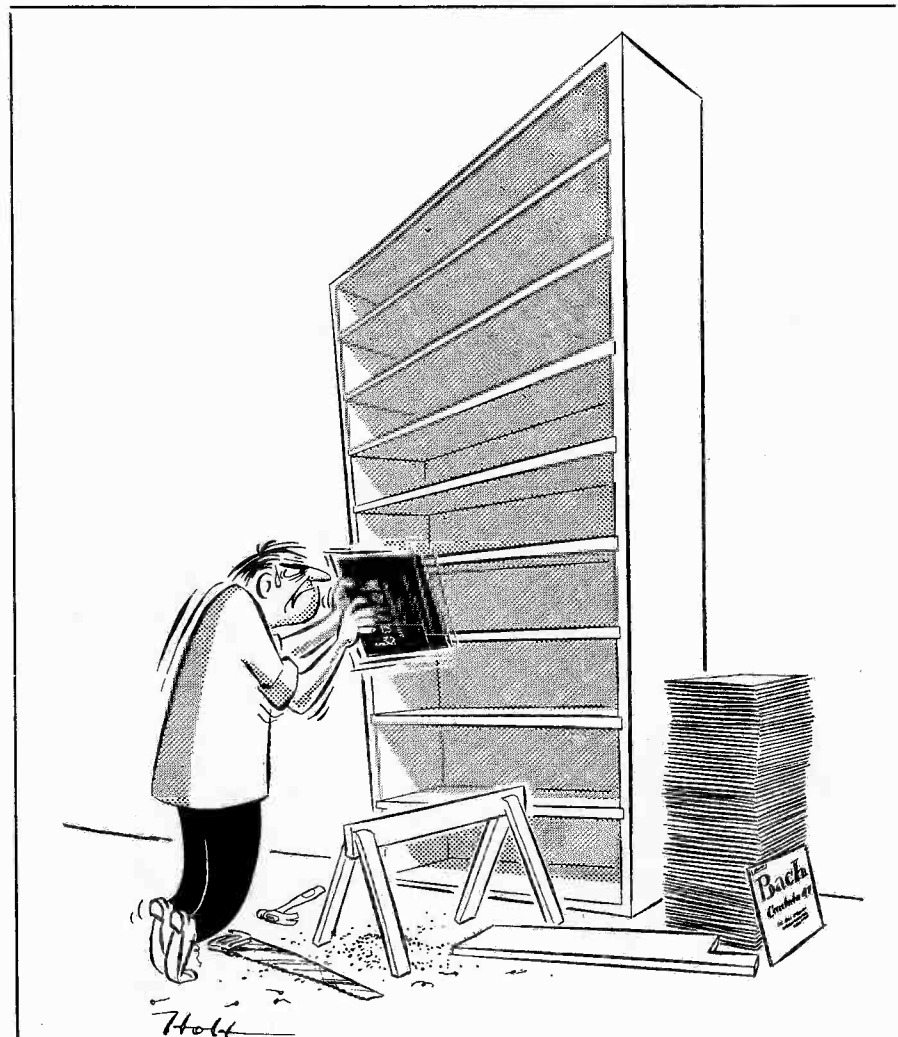

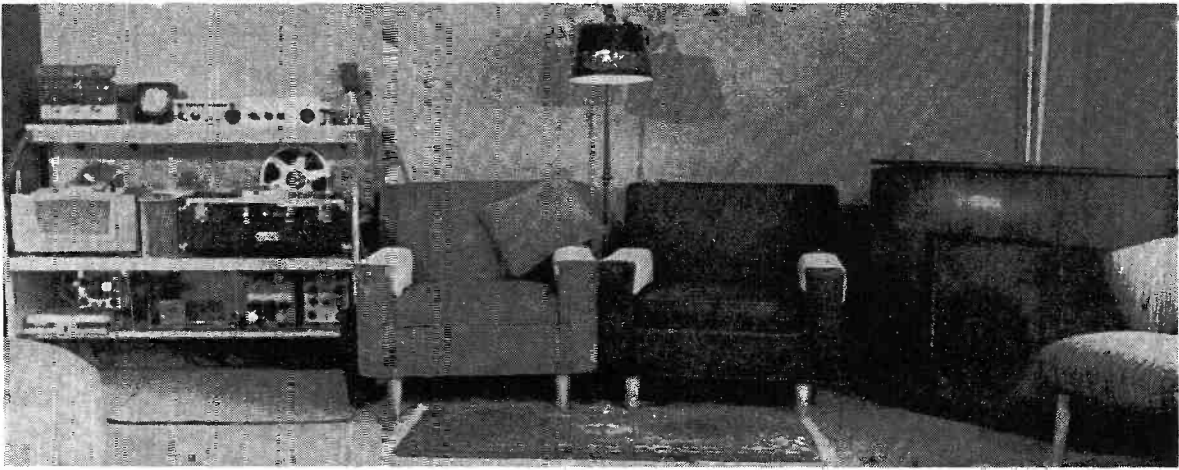

The listening room seen from the fireplace end. Most of the equipment is on shelves of an open-frame rack to permit ready heat dissipation. Rack is 1 x 1 welded steel angle stock. Plywood back conceals connecting cables and AC outlets, some switched by timer.

More Multi Than Most

by RONALD R. LOWDERMILK

These pictures and the diagram that follows are of a home sound system that has more flexibility, uses, components, channels, elaborate interconnections, and unique ideas than just about any we've heard of. There must be at least one good idea here for every reader, and many will find several they can use themselves.

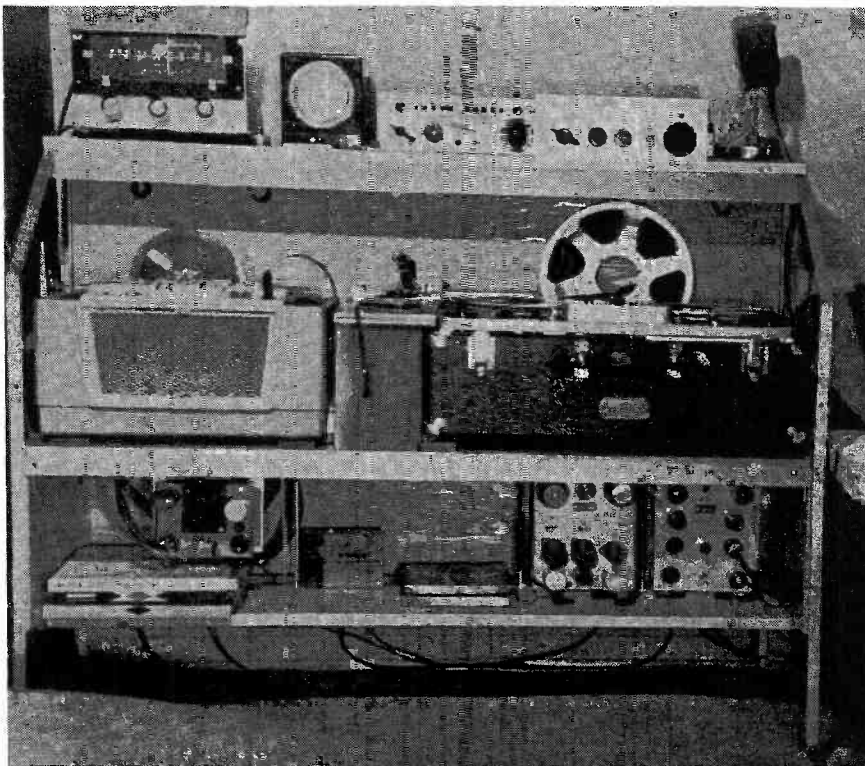

Closer view of the rack. Note screw-in feet for leveling. A box between tape recorders contains small tools, splicing tape, and alcohol for head cleaning. Amplifier and power supplies on the bottom shelf are shock-mounted. The tuner, clock timer, and the 2 preamplifiers are on top shelf for easy access to the controls.

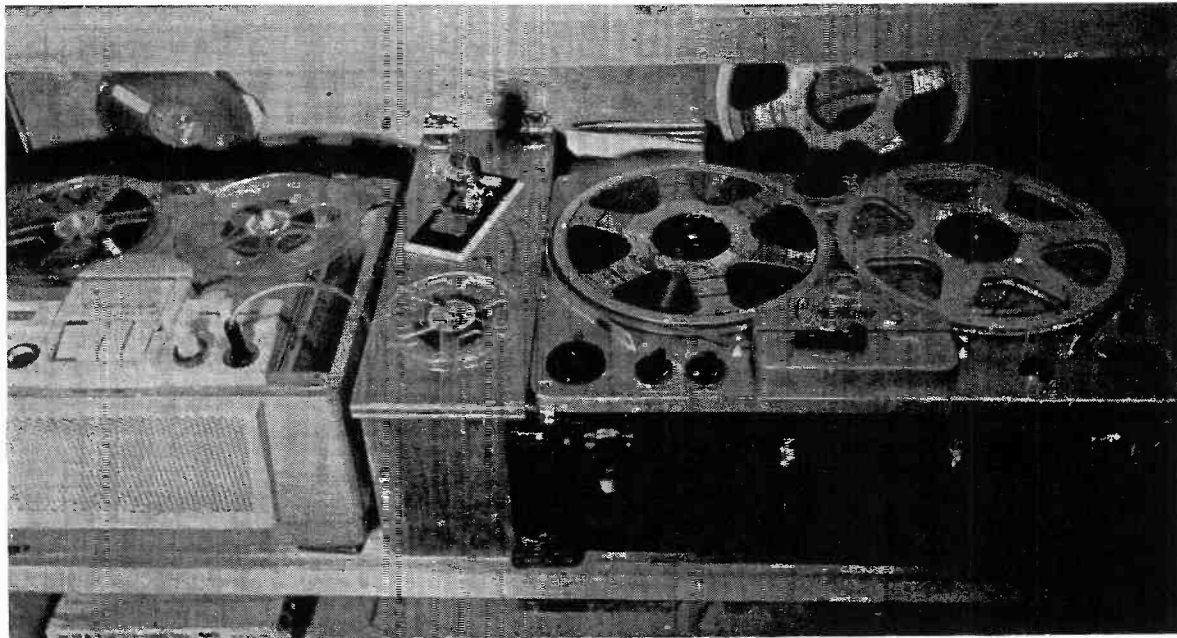

An expanded view of some equipment in the rack. Standard control knobs of the preamp-control units have been replaced with others varying in shape and color according to function. Level controls are set to give identical sound levels for equivalent settings of calibrated main volume controls. Note selection-identifying marks on the tape reels.

Base for the turntable and arm is mounted on foam rubber to isolate it from vibrations of the speaker system in lower section of this cabinet, which is at right in first picture. The amplifier to drive this speaker group hangs from floor joists below. All amplifier-speaker connections go through jack panel at rear of cabinet.

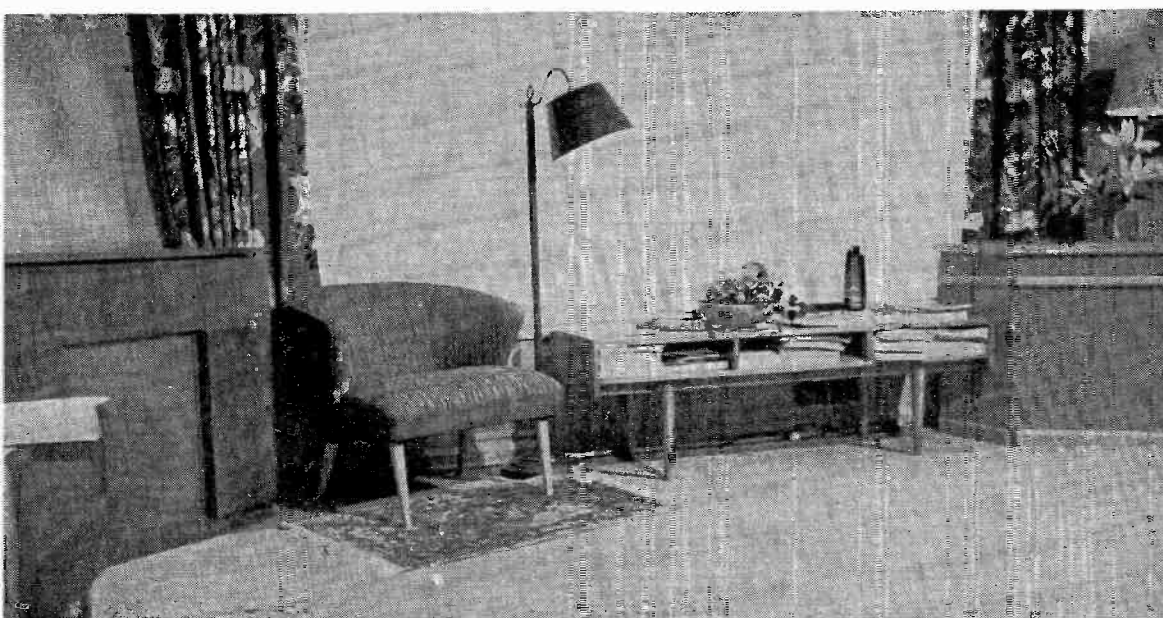
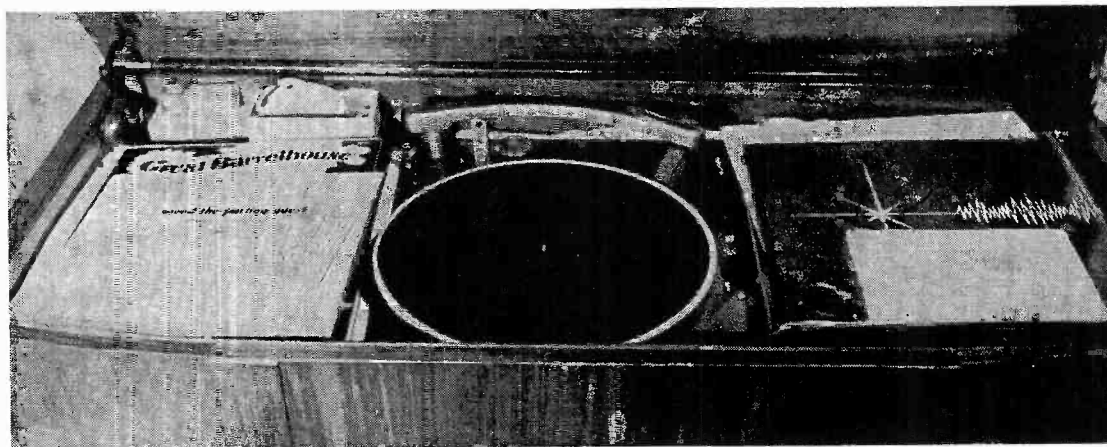

Relative positions of left-ear and right-ear speaker systems. Note that neither is located in a corner; inner edges of both are against window wall, and outer edges are about 3 ft. from end walls. Seating is arranged to take advantage of window view, so speakers were placed unconventionally to achieve stereo sound.

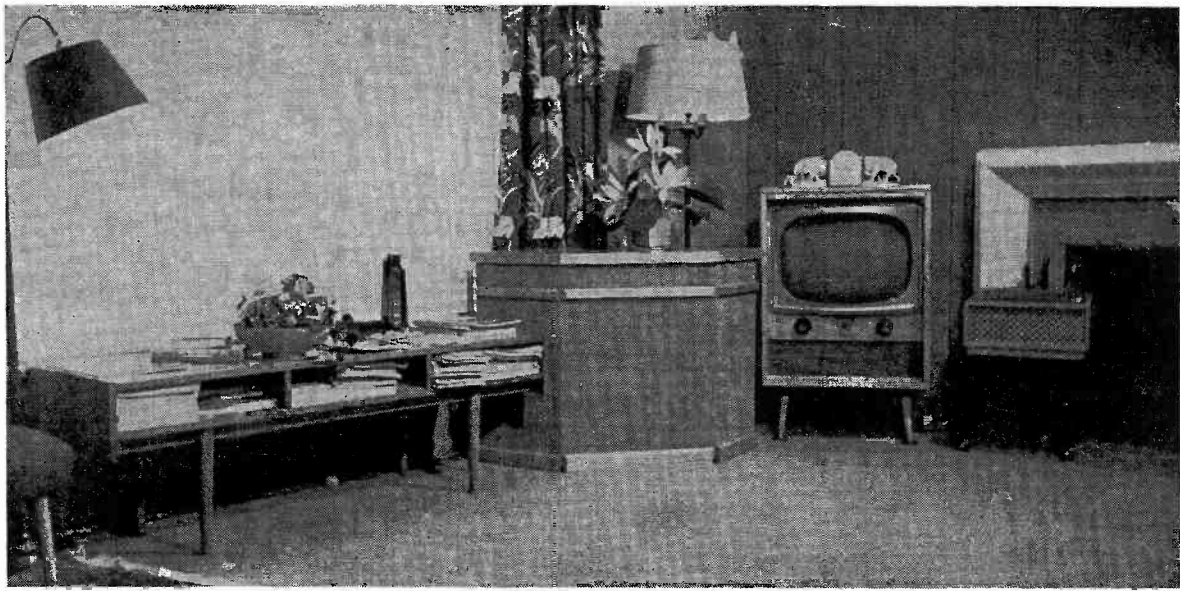

Right end of the speaker area. Paneled wall is opposite from that in first picture. Tape recorder and TV audio lines are interconnected with rest of system by means of shielded cables to opposite corner and to jack panel. Delay lines at the jack panel can furnish phase shift for pseudo-stereo effects from right and left speaker groups.

The block diagram shows how the coordinated 2-channel system pictured on the preceding pages is actually connected. The system is capable of performing a great many different functions. Here's how it works:

For maximum-fidelity (attended) off-the-air recording of an FM program, output from the RV-10A Tuner is fed directly into the 1502-D Recorder at a tape speed of 15 ips. Coincidentally with this, tape-playback output may be fed from the 1502-D Recorder 1) through the C-108 Control Unit into the T-10 Recorder (for copying at 7.5 ips); or 2) through the C-4 Control Unit into the 757 Recorder (for copying at 7.5 or 3.75 ips); or 3) through both 1 and 2 simultaneously.

For unattended, automatic off-the-air recording of an FM program 1) the RV-10A Tuner, the C-108 Control Unit, and the T-10 Recorder are switched to clock-timed operation, and output of the RV-10A Tuner is fed through the C-108 Control Unit into the T-10 Recorder; or 2) the RV-10A Tuner, the C-4 Control Unit, and the 757 Recorder are switched to clock-timed operation, and output of the RV-10A Tuner is fed through the C-4 Control Unit into the 757 Recorder; or 3) operations 1 and 2 are done simultaneously. (This type of operation is made possible and practicable by reason of the fact that, in both the Revere T-10 and the Ampro 757, tape drive is actuated by a solenoid which "drops out" when power to the recorder is interrupted, and remains disengaged

until power is restored. The signal is normaled through the 1502-D when it isn't recording.)

An FM program can be fed from the RV-10A Tuner either 1) through the C-108 Control Unit into the 30-watt amplifier and, thence, into the speakers; or 2) through the 1502-D Recorder through the C-4 Control Unit into the 50-W2 amplifier and, thence, into the 3-way speaker system.

An FM program can be fed simultaneously 1) through the C-108 Control Unit into the 30-watt amplifier and, thence, into the speakers; and 2) into the 1502-D Recorder onto tape at 15 ips, the playback output of which is fed

through the C-4 Control Unit into the 50-W2 Amplifier and, thence, into the 3-way speaker system. (Phase difference of the 2 channels simulates the reverberation of a large auditorium.)

An FM program can be fed either into the 1502-D Recorder and recorded, or through the 1502-D, but *not* recorded, and the output from the recorder fed, in phase (identical signals) 1) through the C-108 Control Unit into the 30-watt amplifier and, thence, into the speakers; and 2) through the C-4 Control Unit into the 50-W2 Amplifier and, thence, into the 3-way speaker system. (The chief advantage of this

Continued on page 43

Here is how the equipment is normally connected. Changes can be made readily.

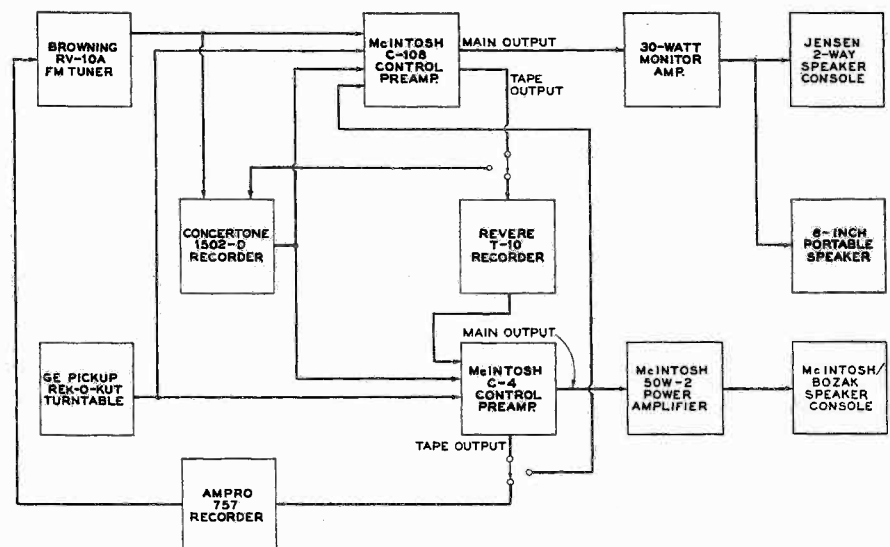

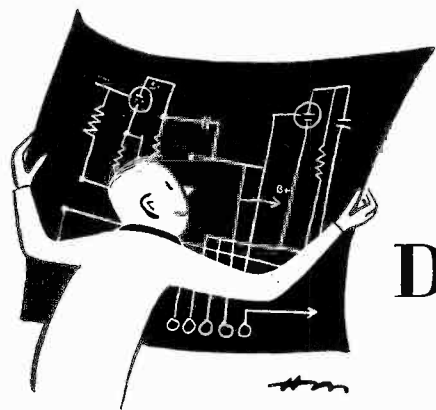

Designing Your Own Amplifier

by Norman H. Crowhurst

Part II: The Power Stage

IN the preceding article, on the design of voltage-amplifying stages, the job was simplified by the fact that we had only to consider the *voltage* swing that a certain load line produced when applied to a tube's characteristic curves. So far, we have not discussed how the maximum ratings impose limits on what we can "get out" of a given tube. Maximum ratings do limit the performance of voltage-amplifier tubes as well as the power types, but usually it's much easier to stay within the ratings of the former. We avoided mentioning it, because it might have been confusing at that point. But for power tubes, the ratings assume a primary importance. When we come to consider the design of a complete amplifier, we shall take all these points into consideration, including the ratings of voltage-amplifier tubes.

There are several ways to go about designing a power stage, depending to some extent on the information available. The tube characteristics — as we have used for voltage amplifiers — provide the most informative approach, but other useful data are published from

which it is also possible to make up quite accurate designs.

The tube characteristics on which we draw load lines are the ones that plot plate current against plate voltage for various values of fixed grid voltage. Fig. 1 shows such a set of characteristics for a triode-connected KT66 tube. A pentode tube connected as a triode will give characteristics similar to this. Each of the curves represents all the possible combinations of plate voltage and current that can occur when the particular voltage specified is applied to the grid.

When, in addition to a bias voltage, an audio voltage is applied to the grid, the plate voltage and current must vary in the manner of a line crossing these curves at some angle. The angle of the line will depend upon the value of resistance used as a load for the tube.

Suppose the value of load is 10,000 ohms: increasing the plate current by 1 ma will cause the plate voltage to drop by 10 volts. Increasing plate current by 2 ma will cause the plate voltage to drop by 20 volts, and so on. A straight line drawn across the curve at an angle representing 10 volts for each milliampere will be a load line representing 10,000 ohms. If we want to put a load line across the curves representing 4,000 ohms we make a change of 1 ma correspond with 4 volts, or 10 ma with 40 volts, and so on. The slope of the line, then, represents the resistance value of the load.

This tells us how to set up the angle of the load line; now, how do we know exactly where to draw it? That will be determined by our operating conditions — what steady-state plate voltage and current we choose, and the DC grid voltage that will have to be used as a bias to obtain this working voltage and current. In a power-output stage we have various limits to our choice.

First, we must not exceed the plate dissipation rating of the tube, otherwise the plate will get too hot and the tube will probably become gassy. Second,

we must not exceed the maximum plate voltage specified by the tube manufacturer.

These maximum ratings set a limit on how much we can "push" the tube in our endeavor to get more watts. We have

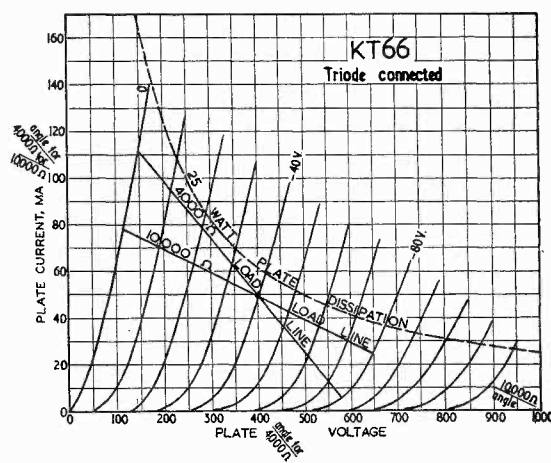

Fig. 2. The curves of Fig. 1, with the maximum dissipation curve drawn in (dotted). Two possible load lines are shown, using operating voltages of 400 on the plate and -40 on the grid. Small construction lines show a convenient way of getting the correct angle for a specific load value: for 4,000 ohms, 100 ma on the current axis is aligned with 400 volts on the voltage axis. Any values of voltage and current whose ratio corresponds with the required impedance value could be used as easily.

conflicting requirements: getting the most output power, yet allowing the tube a good safety margin so as to ensure long tube life. But whether we want to emphasize the safety aspect or to get as much output power as possible, we want to operate the tube under conditions that will show the cleanest output for the type of tube used. This means that distortion as well as power output must be considered.

Plate Dissipation

When using the tube curves the first thing to do is set up boundaries or

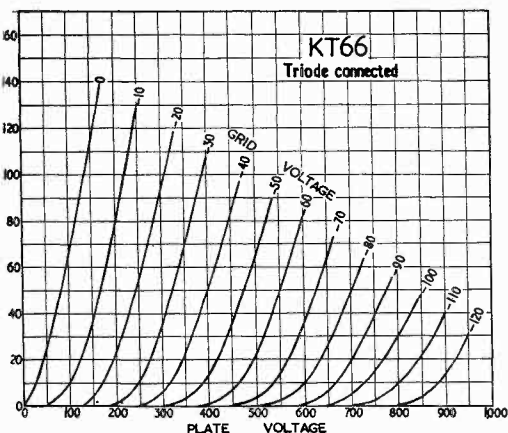

Fig. 1. Plate-current/plate-voltage characteristics for triode-connected KT66 tube. Each curve represents the variation of plate current with plate voltage when the grid voltage is fixed at the value for which the curve is labeled.

limits within which we can draw a load line. The manufacturer establishes a maximum dissipation rating for the tube. For instance, the KT66 tube, whose triode-connected characteristics

Let us assume 400 volts as the maximum.

Power Output

The next step in figuring out the optimal position of a load line is to realize that the grid-voltage excursions, positive and negative, from the working point will be equal. Thus, if the bias is chosen as -40 volts, and the maximum audio swing in the positive direction is taken as being up to 0 grid volts, the corresponding negative swing will be to the -80 -volt characteristic.

Assuming a grid bias of -40 volts as a starting point, we put a ruler across the chart so that it passes through the point where the -40 -volt bias curve crosses the 400-volt plate-voltage line. Then the ruler can be rocked about this point, and the way it crosses the other curves examined. Notice how the linearity of the output varies, represented by the evenness of spacing of the bias curves between the 0 and -80 -volt lines. If the load line is made too steep, representing too low a load impedance, the spacing between the grid-voltage curves toward the 0 end of the line will be wider than it is toward the -80 -volt end. To achieve the lowest distortion, which means maximum uniformity of spacing between curves along the load line, the line has to be more nearly horizontal, representing a higher impedance.

We shall find, though, when we come to calculate the power, that this reduces the available watts output. A better output can be obtained by working nearer the maximum dissipation curve. To keep within the 400-volt maximum plate-voltage requirement, this would require about -38 volts bias. That, in turn, gives approximately 60 ma steady-state current, and the audio swing is now limited from 0 to -76 volts on the grid. Refer to Fig. 3. Moving up in this way has resulted in 2 gains, compared with the -40 -volt point.

It has enabled us to work with a lesser audio grid-voltage swing which, apart from the slight increase in stage gain this represents, makes it easier to keep the distortion down.

It has also enabled us to use a steeper angle for the load line, representing a lower resistance, which probably means that a greater output power will be available.

The only way to be sure whether a change increases available power or not is to calculate it. It can be estimated roughly by gauging the relative area of the triangle formed by the load line, between the extremes of grid voltage used, with the horizontal and vertical lines making a right-angle triangle, as shown in Fig. 4. The load line that gives the triangle of greatest area will produce the greatest power output.

Maximum power represented by a load line, with a sinusoidal audio wave form, can be calculated by subtracting the lower plate voltage from the higher value, and the lower current from the higher value, then multiplying these quantities together and dividing by 8,000 to get the answer in watts. In Fig. 3 the values are 580 volts and 160 volts, and 14 ma and 120 ma. These represent changes of 420 volts and 106 ma. Multiplying them and dividing by 8,000 gives just over 5.5 watts, which is about the power output this tube will furnish working single-ended as a triode.

Distortion

Now to check distortion. The maximum positive excursion from the 400-volt midpoint to the 580-volt maximum is 180 volts; the negative excursion goes down to 160 volts, which is a drop of 240 volts. For symmetry the midpoint between 160 and 580 volts should be $\frac{160 + 580}{2}$ or 370 volts. The actual

400-volt operating point is 30 volts from the middle of the wave form. So the peak-to-peak ratio of second-harmonic distortion to the fundamental frequency, at 5.5 watts, is 30 to 420, or about 7.1%.

Because it is second harmonic, however, it can be considerably reduced by using a push-pull output arrangement. This neutralizes second- and even-order harmonics in a way which will be explained subsequently. Push-pull operation also permits the output to be more than doubled, by utilizing a greater length of the load line for each tube during its negative excursion. This too will be explained.

Notice that the load line we have drawn cuts across the 25-watt dissipation curve slightly. Is this permissible? The operating point is on the edge of the curve, and any plate excursions occur equally on either side of the center

Fig. 4. Relative power output can be estimated as the load line is changed: the solid-line triangle obviously has a larger area than the dotted-line one, which means increased power output.

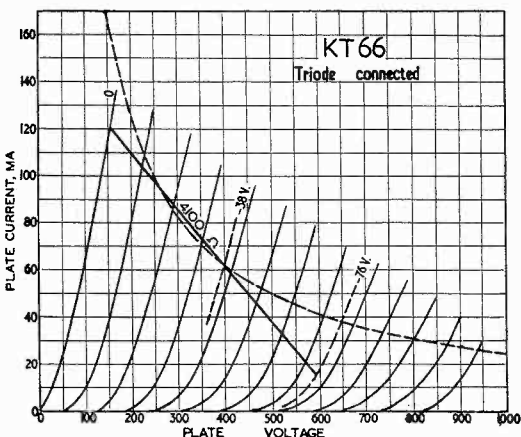
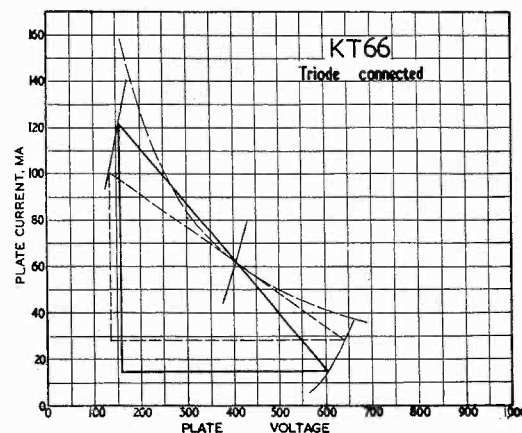

Fig. 3. Slight adjustment to the operating conditions of Fig. 2 produces improved results, both in higher power and decreased distortion (see text).

are shown in Fig. 1, has a maximum plate dissipation rating of 25 watts. This boundary can be plotted by determining various points on the chart that represent 25 watts, and then drawing a dotted line across the characteristic curves.

For illustration: 500 volts at 50 ma is one pair of values that represents 25 watts; 625 volts at 40 ma, 400 volts at 62.5 ma, 250 volts at 100 ma, and 1,000 volts at 25 ma are some other values that can be used to plot the maximum-dissipation line shown in Fig. 2.

The other maximum limit specified for triode tubes is the plate voltage. This is specified in one of 2 ways: the real limitation is the maximum positive excursion, because the danger is that of flash-over from a high potential difference between the plate and grid; but most circuit designers prefer to have a maximum working-voltage figure, which is the highest supply voltage that can be connected to the plate circuit.

In any output stage the plate-supply voltage is connected to the end or the center tap of the output-transformer primary, the plate being connected to the other end. In the quiescent or no-signal condition the plate voltage is almost equal to the supply voltage, being reduced only by the small DC drop in the winding. When the plate voltage changes because of an applied audio signal, the fluctuations will go positive as well as negative from this supply voltage. If the figure given by the tube manufacturer for any particular tube is the maximum supply voltage, this should be limited to the value stated. Then there is no need to bother about the positive-excursion limit because the specification given takes care of this.

operating point. Therefore, at all signal levels, the average dissipation throughout a cycle will always be within the 25-watt rating of the tube.

The important matter in dissipation ratings of tubes is that the *average* dissipation over the cycle must be within the rated value. Practically all heated-cathode tubes will take considerably more than their maximum plate dissipation for short intervals. This is the principle exploited to an extreme in pulse-amplifier technique; a tube may be operated up to 10 times its maximum average dissipation during the pulse.

So the load line shown in Fig. 3 is quite legitimate.

Although the KT66 is not designed as a triode, it is fairly representative, when so connected, of good triode tubes. This tube is not particularly efficient as a single-ended output stage: we only get 5½ watts output with about 7% distortion, for a plate dissipation of 25 watts. To get 50 watts output at this rate, we should need a tube or tubes with plate dissipation of 250 watts.

Tetrodes and Pentodes

It was the desire for bigger outputs at less power expenditure that led to the development of pentode and tetrode output tubes. These have characteristics similar to those shown in Fig. 5, which are for the 5881 with a fixed screen voltage of 250 volts. Fig. 6 shows curves for the same tube taken with a screen voltage of 325 volts, and the curves in Fig. 7 are for the same tube with a screen voltage of 400.

These sets of curves are all quite similar; one has to look at the numbers to see the differences. We find that the plate currents are successively higher as the screen voltage is raised. A high-

er screen voltage makes it possible to get a greater output from the tube, because a larger plate-current swing can be obtained with the same plate-voltage swing. Limitations to consider in selecting the operating characteristics for a tetrode or pentode tube are plate dissipation, screen dissipation, and maximum operating voltages.

A curve for maximum plate dissipation can be drawn on these charts by the method already shown for triodes; a dotted line is drawn on each of the sets in Figs. 5, 6, and 7 to indicate the rated maximum plate dissipation of 25 watts. Screen dissipation is not shown, but is limited to 6 watts for this tube.

Sometimes screen current is indicated on the same diagram as the plate-current curves, as shown at Fig. 8. These curves do not help as much as one might expect and for this reason they are usually omitted. The voltage applied to the screen as these curves are plotted is constant. It is the plate voltage that is varied for different values of grid voltage, and the screen is held to the same constant voltage value for the whole family of curves. The maximum screen dissipation is, accordingly, represented by a horizontal line across the curves, Fig. 8.

As in the case of plate dissipation, the screen dissipation condition is satisfied provided the average dissipation throughout the audio wave-form cycle is always kept within the specified limit. It does not matter if one peak of the screen-current wave form does exceed the maximum dissipation momentarily.

This being the case, the more direct method of determining that the screen dissipation is kept within bounds is to take the tube manufacturer's recommended operating voltage. If this is used, the dissipation will not be exceeded. A lower voltage may be used if desired, with consequent economy in both screen and plate dissipations.

In most pentode-type tubes there is a plate-voltage limit, because of the high impedance or plate resistance of the tube. Too high a load impedance would result in excessively high positive plate-voltage swings, corresponding to negative grid swings, that might cause flashover damage to the tube. The particular tube represented in Figs. 5, 6, and 7 is designed for push-pull operation, so the dissipation in each tube only occupies about half the time for a full-length load line.

With the pentode-type tube, minimizing distortion is a little more difficult than with the triode arrangement, because the triode tends to introduce primarily *second*-harmonic distortion, indicated by closing up of the intersections between the load line and the different grid-voltage curves toward one end and opening out at the other. In the case

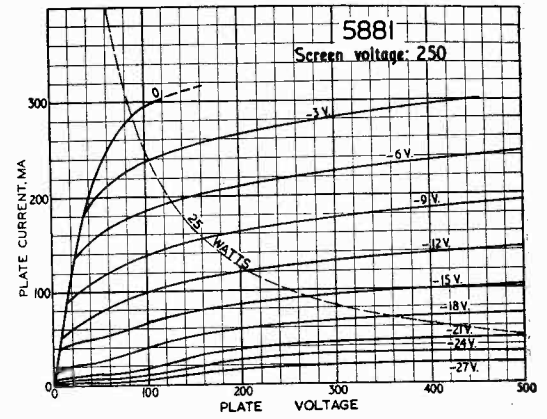

Fig. 5. Plate-current/plate-voltage characteristics for type 5881 tube working as a pentode, with 250 volts on the screen. Numbers on the curves represent grid voltage at which they were taken.

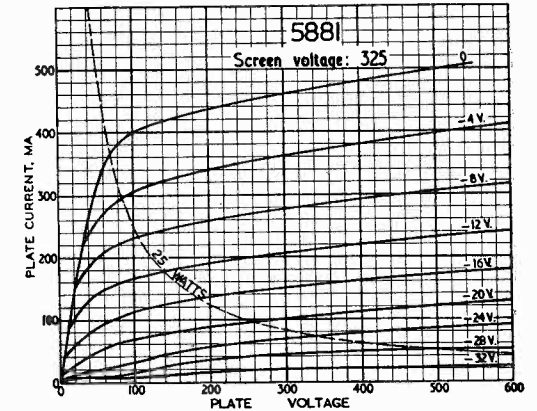

Fig. 6. Characteristics similar to those of Fig. 5, but with the screen voltage at 325. Notice the increased scales; the raised screen voltage produces larger plate currents for same plate voltages.

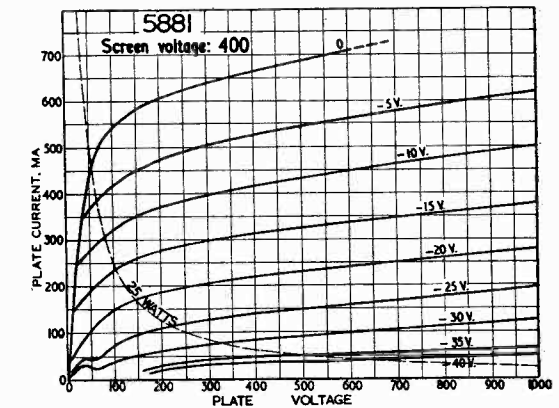

Fig. 7. Raising the screen voltage to the limit of 400 volts. Most of the curves are now above the specified maximum dissipation curve. This is because the tube is designed for push-pull operation.

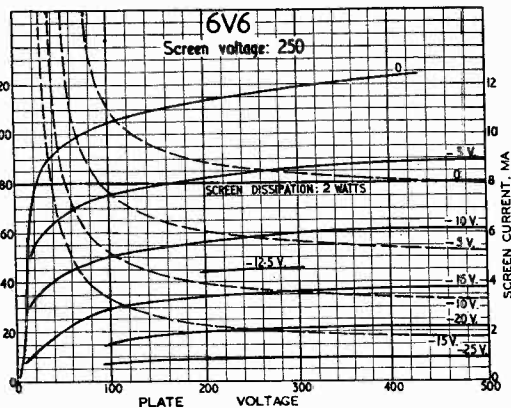

Fig. 8. A pentode characteristic chart with screen currents as well as plate currents plotted. Solid-line curves are for plate current and voltage. The dashed curves are for screen current, the screen being fixed at a voltage of 250 for all these curves. Obviously, plate voltage effects screen current markedly. Maximum screen dissipation of 2 watts is a horizontal straight line on the chart.

A Stereo-Monaural Speaker System

by Howard M. Van Sickle

A DESIRE to design a speaker system that would give a sensation of extensity to the sound of a reproduced symphony orchestra, pipe organ, or concert band prompted a rather unusual combination of speaker and enclosure ideas. The system described in this article was built for use in a public school whose superintendent *cared* what sort of sound his staff and students heard¹. Durability, attractiveness, and flexibility (with an eye to the increased use of stereophonic sound) were considered in the design.

Extensity is an attribute of sound that gets lost in some commercial speaker units. As Seashore comments, "Volume is often confused with loudness²." Many speaker systems fail to distribute sound in a pattern that simulates the massiveness that is so characteristic of the original sound produced by large ensembles. The large frontal projection of the higher strings in the symphony orchestral tone and the divided ranks of the large pipe organ are associated with a realistic perception of the sound of these complex instruments.

Several very simple adjustments or rearrangements of the parts making up the system developed provide a quick variation of the sound pattern from high directivity to wide dispersion. Since the higher sound frequencies are known to travel in increasingly straighter paths the adjustments for dispersion of sound or the division of the sound paths for stereophonic reproduction are most

practical for the middle and upper ranges. The woofer range is cared for through a combination of bass production techniques: namely, an expanding horn and a tapered air coupler. The air coupling is particularly advantageous for approaching fundamental bass tones at low volume. As the volume of the bass increases the horn tends to take over more of the projection.

This unique speaker system comprises 3 interdependent units. The bass chest provides support for 2 cubes, each of which contains middle- and upper-range speakers. These cubes are placed side by side on the chest and can be so arranged that the speakers radiate directly into the room. The units are all padded, so there is no need of fastening the cubes down to prevent buzzing. When each cube is given a quarter turn the sound, then radiating from opposite sides, can be directed with varying degrees of concentration by changing the angle of the cabinet doors. The doors act as reflectors and diffusers for the middle and upper frequency ranges. Wiring of the cubes is such that they can be fed separate sound tracks for stereophonic effects. With a single signal, however, a convincing pseudo-stereophonic effect can be obtained by proper orientation of the cubes.

All 3 unit shells are made of $\frac{3}{4}$ -inch plywood. All exposed surfaces of the plywood are covered with a cloth-textured vinyl fabric, stretched over upholsterer's padding. The base of the unit shown in Figs. 1 and 2 is tobacco brown, and the cubes are shrimp-colored; the light brown grille cloth

with a gold metallic thread to catch the light and the warm brown-stained, satin-finished, solid walnut doors add an artistic touch. Each of the cubes contains an 8-inch speaker for middle-range service. The highs in each cube are handled by two 4-inch tweeters.

The Bass Assembly

A 12-inch woofer is used in the bass chest, which is the more complicated unit to build. This section is 42 in. long, 21 in. wide, and 14 $\frac{1}{4}$ in. high. It is supported by 6-inch bent iron legs; these are easily obtained, ready for use, from hardware, furniture, or do-it-yourself stores. The chest construction, Fig. 3, resembles the assembly of a club sandwich. Three plywood panels are stacked vertically with a filling of edge-mounted asphalt expansion strips to form the sound reinforcing channels.

The bottom panel of the bass chest is 21 by 42 in. A leg is attached at each corner of this panel. A slot, 4 by 10 $\frac{3}{4}$ in., is cut 12 in. from one end and centered between the sides. On this platform 2 tapered air-coupler channels are constructed, as shown in the layout diagram (Fig. 4). The partitions are formed of expansion strips so that the channels have slightly different tapers and are of different lengths. Outside walls of the channels are formed by the plywood sides of the cabinet. The details of the design are best understood by consulting the accompanying diagrams.

Asphalt expansion strips can be purchased at lumber yards or concrete products service concerns. This material

¹Public Schools, Tracy, Minnesota.

²Seashore, Carl E., *Psychology of Music*, McGraw-Hill, New York, N. Y., 1938, pp. 134-5.

Fig. 1. Upper-range reproducers oriented for wide dispersion.

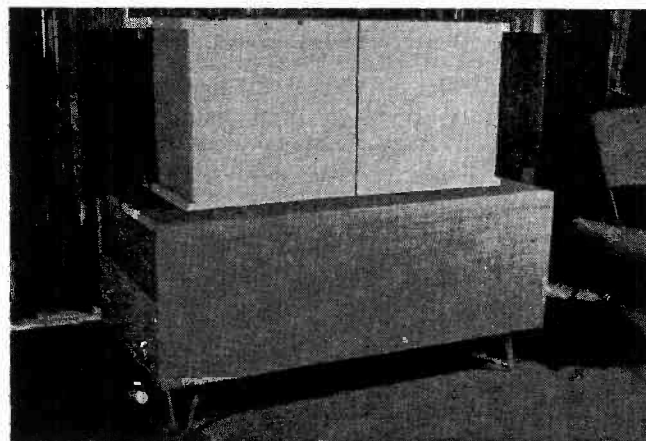
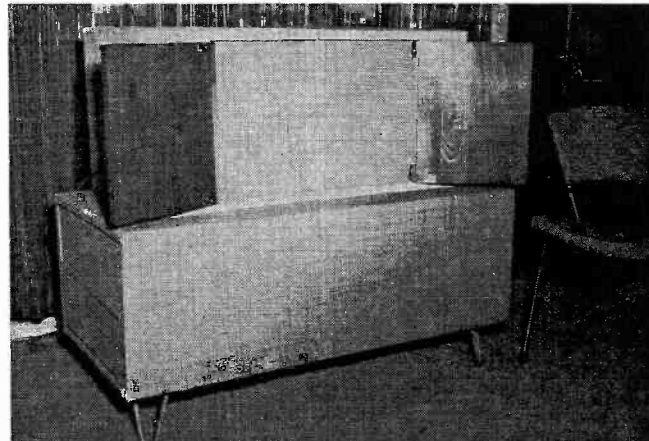

Fig. 2. Cube arrangement that provides a point-source effect.



is obtainable in many sizes, but lengths greater than 5 ft. may be hard to manage. For this use the strips should be $\frac{1}{2}$ in. thick and 6 in. wide. The core is of asphalt and rope fibers; on each side of the core is a heavy asphalt-impregnated paper, so the material has very little resonance.

The channels are formed by these strips set on the $\frac{1}{2}$ -inch edges. Stability of the walls is increased because they are curved. It is advisable, for a smoothly formed curve, to cut into the side of the strip on the inner edge of the curve. Quarter-inch cuts spaced about an inch apart work well. (You will find that the saw teeth have to be cleaned often. Rub the teeth with a block of wood to loosen the accumulated asphalt, or clean with white gasoline.) After these cuts are made, the bending process is comparatively easy: the section can be warmed with a heat lamp until it is soft enough to bend. Old gloves are recommended for handling the heated material. The process can be speeded by putting the part to be bent in a heated oven; aluminum foil in the kitchen oven will prevent damage or extra cleaning. It is wise not to heat the asphalt strips any more than necessary, since they can be reheated if additional adjustments need be made. After obtaining the desired curvature hold each strip in position until it cools and it will remain stable. If the path of the channels is drawn on the bottom panel or cleats are tacked temporarily on each side of the channel the strips can be easily and accurately fitted.

Channel forms can be fastened permanently and sealed to the lower panel by using linoleum paste or asphalt cement. When the paste or cement is dry, additional sealing material can be added to insure that all contacts are air tight. Non-drying rope putty, available at hardware stores, is excellent for this purpose. Be sure to press this putty tightly into the angles formed by the asphalt strips and the lower panel.

Before putting the middle panel in place, a speaker hole should be cut in its exact center. The hole should be about 10 in. in diameter. Plywood sidewall panels for the bass chest should then be added. These should be 42 in. long and $12\frac{3}{4}$ in. high. Be sure to check the height of these side panels carefully, because any variation of the asphalt expansion strip width may change the dimension a fraction of an inch. The actual height is equal to 2 widths of expansion strip plus $\frac{3}{4}$ in. for the middle plywood panel. These plywood walls should be fastened by screws into the base panel. A cleat approximately 1 by $\frac{3}{4}$ in., the full length of each side panel, should be screwed into place so that its top is at the same height from the bottom panel as the

top of the asphalt strips. These cleats will support the middle panel. Addition of non-drying putty rope on top of the cleats eliminates the possibility of panel vibration. Large corner blocks can be positioned at this time 1 in. from each end of the sidewall; they should be the same height as the asphalt strips. The 1-inch inset is allowance for the end panel plus 2 thicknesses of the covering fabric. As a precaution it might be wise to tack a piece of plastic screen wire over the slot in the lower panel to discourage any mice interested in hi-fi nest building.

Before setting the middle panel in place be sure to apply paste or cement generously to the top edges of the

The middle panel now becomes the lower side of an expanding horn. The design as shown in the sketch can be interpreted as providing 2 long horns or one horn split down the middle.

Walls for the horn channels are formed by the plywood sides of the bass chest and the expansion strips, which are bent and fastened to the middle panel in the same manner as for the air-coupler unit. When the expansion strips are in place they should be the same height as the plywood sidewalls, and above the pot of the speaker. A woofer deeper than 6 in. will not fit. Care should be used in forming the horn section sidewalls to be sure there is a gradual increase in the cross section

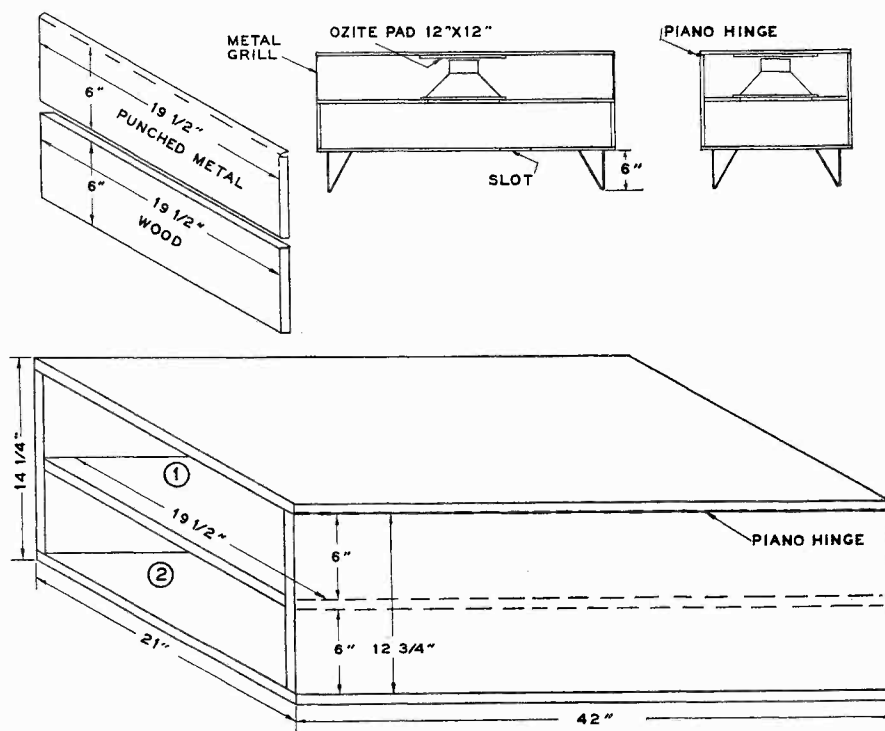

Fig. 3. Bass chest is a combination of 2 low-frequency baffles in club sandwich form.

expansion strips. Check the angles of the plywood sidewalls with a square and then fit the middle panel on the top of the air-coupler channels. When the paste or cement binding the asphalt strips to the middle panel is dry, seal with rope putty as much of the channel as you can reach through the speaker hole and the open ends. Screw the middle panel down tightly to the side-panel cleats. Panels to enclose the ends of the air-coupler unit can now be cut to size. Additional trimming might be made later to allow for the thickness of the covering fabric. When these panels are finally fastened into place, strips of non-drying putty should be so placed on the end blocks that they will seal the ends of the air-coupler section.

After the middle panel is installed, the speaker is mounted face down. Seal around the speaker frame with putty.

from the speaker to the horn exit. Any adjustment of the design for smoothing out the turns should be considered.

Connector sockets should be mounted at this time. A 4-pin socket should be mounted near the end of the back side of the bass chest so that short connections can be made to the section of the crossover network that is mounted in one side of the horn section. The additional 2-pin sockets should be placed on the back of the bass chest where they will be centered in relation to the backs of the cube enclosures. Two wires can be soldered to the speaker tabs and brought through one horn channel leading to the speaker clips of the crossover network assembly.

The top panel is fastened to the front sidewall with a full-length piano hinge. Ask a local piano dealer where he junks his old pianos before going out on the

market for a hinge. A cleat should be screwed to the top panel near the back side in such a way that screws through the back side panel can hold the top panel down snugly. Before closing the top it may be desirable to cover the floor of the horn section with Ozite undercarpeting. A patch of the same material should be tacked or cemented to cushion the top panel just above the speaker to eliminate any chance of mechanically caused buzzing.

It will be necessary to complete the installation of the crossover network and wire it to the external connectors before sealing the top panel. Punched steel grilles to protect the horn exits should be measured, formed, and fitted at this time. There are many interesting designs of punched-metal or expanded-metal grilles available from heating contractors or other steel fabricators. The grille panel should have 1-inch tabs on all edges, and the tabs should be held in place with screws to the middle panel and to the plywood sidewalls of the horn section. Rubber grommets between the metal and the wood will help prevent buzzing, or several thicknesses of rubber tape can be used to provide cushioning. Allowance should be made for the thickness of the covering fabric when used on the end pieces of the air-coupler section. If the covering fabric is carried over the back edge of the top as well as over the top edge of the back panel, some reduction of the panel height may be desirable to insure that the top panel fits down tightly on the expansion strips. Putty rope placed on top of the expansion strips will effect a seal with the top panel.

Cube Enclosures

The 17-inch cubes holding the middle-range and tweeter speakers are mirror images of each other. Top and bottom pieces of each cube are of $\frac{3}{4}$ -inch plywood cut exactly 17 in. square. One side piece is 17 by $15\frac{1}{2}$ in. This makes it possible for the solid walnut doors to extend to the edges of the cabinet, so that the doors of the 2 cubes will meet when closed. The plywood panels should be screwed and glued together and further braced with angle blocks. Cut the back panel slightly smaller than $15\frac{1}{2}$ in. square to allow for a double thickness of the heavy covering material. Bracing blocks in the angles should come within $\frac{3}{4}$ in. from the back of the top and side panels so that the back, which is the last panel added to the cubes, can be screwed into the ends of the bracing blocks.

Front panels of the cubes are the most complicated. A plywood speaker-mounting panel is cut to fit the front end of each cube. The 8-inch speaker is positioned near the lower corner of the mounting panel with the tweeter

speakers side-by-side a little above it. A piece of plastic screening should be tacked over the front of the mounting board to protect the speaker cones. The mounting panel is set back within the cube to allow for the grille cloth frame, which is of $\frac{1}{4}$ -inch plywood. It has the same outer dimensions as the speaker panel but is cut out in front of the speakers, as Fig. 5 shows. This frame is added to separate the grille cloth from the mounting board. It and the mounting board should be painted grey or dead black to match the color of the speaker cones, so that the speaker holes will not show through the grille cloth. Be sure also to paint the edges of the speaker holes in the plywood. The interior of each cube is lined with about a 2-inch thickness of insulating material, except in the area where it might flake into the mechanism of the speakers.

The solid walnut doors are $15\frac{1}{2}$ by 12 in. Brass hinges are mounted on the grille cloth mounting strips. The

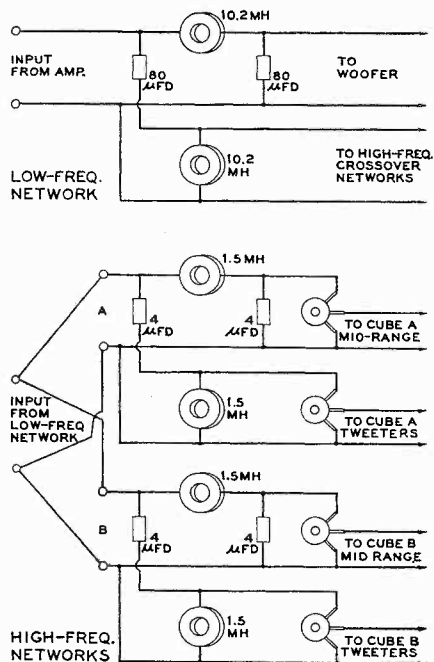

Fig. 6. Each enclosure has its own network. Connections depend on the source.

entire front section is held in place by screws through angle bracing blocks inside the cube. Strap iron angles can be used for the same purpose.

An opening of about 3 by 5 in. is made in the side panel of each cube to expose the controls for adjustment of speaker balance. These cut-outs should be on the outside panels of the cubes when the speakers are in direct-radiation position, and when the quarter turn is made for side dispersion the cut-outs should then appear on the rear panel. Balance controls and the upper sections of the crossover network are mounted on hardboard panels

slightly larger than the cutouts. The control shafts and input connectors are brought through these panels, and the panels are covered with whatever fabric is used on the cubes. Then the panels are screwed into place from the insides of the cubes with the control shafts and input connectors centered in the side panel cut-outs.

Many decorative schemes could be used for this speaker unit. Vinyl fused to fabric (made by the L. E. Carpenter Company and called *Vicrtex*) is available in many textures and in an excellent choice of colors. Similarly, a wide choice of grille cloth colors and materials is available from the Wendell Plastic Fabrics Corporation.

Underneath the fabric should be fastened some upholsterer's padding. It can be tacked into place with a wire paper stapler. A black rubber adhesive made by 3M (Minnesota Mining and Manufacturing Company) is excellent for fastening down the plastic fabric. This adhesive holds on contact. Although rather expensive, it comes in tubes and is easy to use. Since the fabric can be stretched slightly, it is desirable to seal the edges completely to the plywood.

All exposed screws used to fasten the cube back panels, and the top and ends of the bass chest, are brass and have brass washers. The iron legs and the metal grille are painted to match the fabric. Your local paint store will be glad to mix the paint to the color of a swatch.

All crossover network units are built on hardboard panels. In the bass chest the coils and capacitors for a 175-cps crossover frequency between the bass speaker and the middle-range speakers are mounted. Two coils of 10.2 mh, and two 80- μ fd condensers, are required for this part of the crossover network; the diagram is given in Fig. 6. The panel with its coils and condensers mounted is screwed to the floor of the rear-loaded horn section nearest the amplifier connecting socket.

Identical crossover network units, with potentiometers of 25 ohms for level control of the middle-range and upper-range speakers, are mounted in the cubes. The upper division frequency is around 3,000 cps. Four coils of about 1.5 mh are used in these networks with four 4- μ fd capacitors. The length of wire in the inductance coils was determined by weight. Practical information on the exact values of the coils and capacitors for the speakers

Continued on page 40

Fig. 4, upper right: Layout diagrams for the horn and air coupler channel partitions. Fig. 5, lower right: How the 2 cube enclosures are assembled.

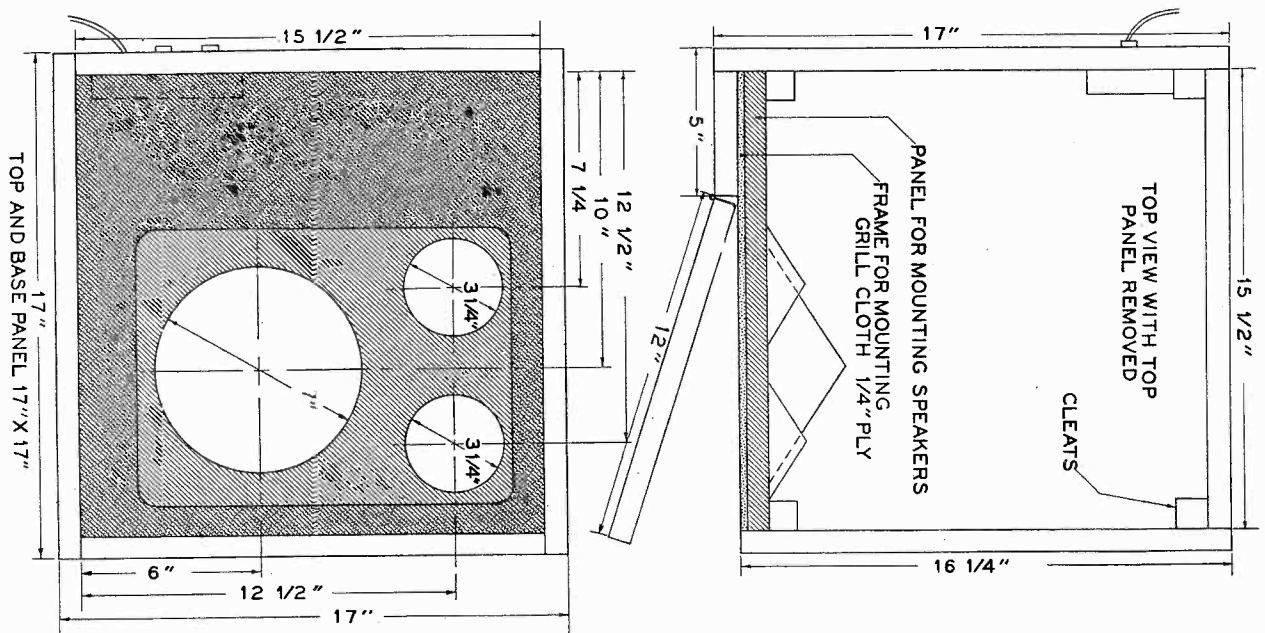
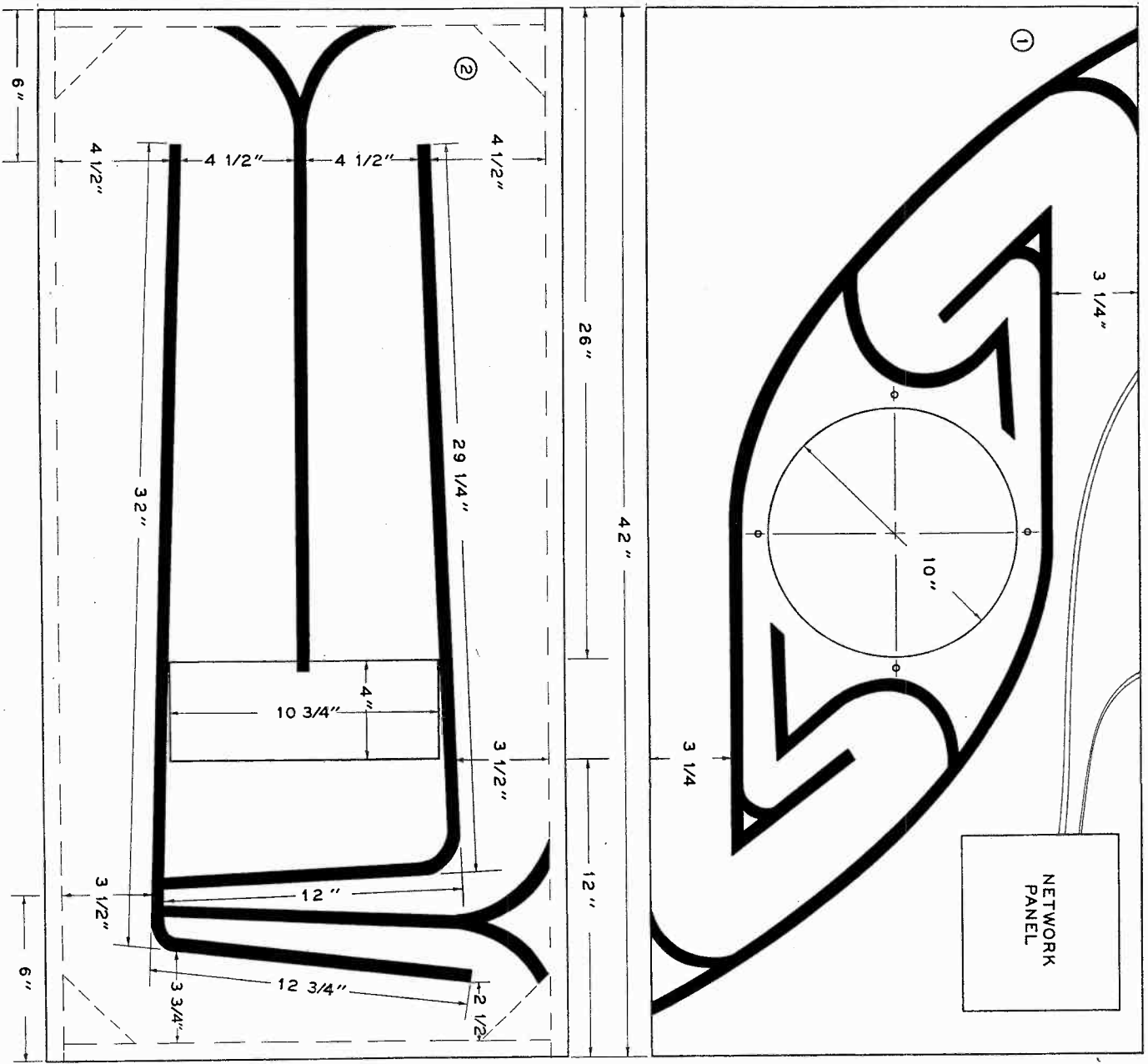

"BUILD-IT-YOURSELF" AND ENJOY

high fidelity at its finest

IN KIT FORM

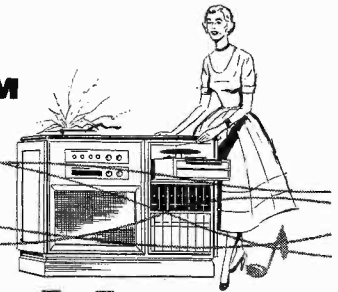

① Heathkit FM TUNER KIT

Features brand new circuit and physical design. Matches WA-P2 Preamplifier. Modern tube line-up provides better than 10 uv. sensitivity for 20 db of quieting. Built-in power supply.

Incorporates automatic gain control—highly stabilized oscillator—illuminated tuning dial—pre-aligned IF and ratio transformers and front end tuning unit. Uses 6BQ7A Cascode RF stage, 6U8 oscillator—mixer, two 6CB6 IF amplifiers, 6AL5 ratio detector, 6C4 audio amplifier, and 6X4 rectifier. Shpg. Wt. 7 Lbs.

MODEL FM-3

\$2450

② Heathkit 25-Watt HIGH FIDELITY AMPLIFIER KIT

Features a new-design Peerless output transformer and KT66 output tubes. Frequency response within ± 1 db from 5 cps to 160 Kc at 1 watt. Harmonic distortion only 1% at 25 watts, 20-20,000 cps. IM distortion only 1% at 20 watts, 4, 8, or 16 ohms output. Hum and noise, 99 db below rated output. Uses 2-12AU7's, 2-KT66's and 5R4GY. Attractive physical appearance harmonizes with WA-P2 Preamplifier. Kit combinations:

W-5M AMPLIFIER KIT: Consists of main amplifier and power supply, all on one chassis. Shpg. Wt. 31 Lbs. Express only.

\$5975

W-5 COMBINATION AMPLIFIER KIT: Consists of W-5M amplifier kit plus Heathkit Model WA-P2 Preamplifier kit. Shpg. \$7950 wt. 38 Lbs. Express only.

\$7950

③ Heathkit HIGH FIDELITY PREAMPLIFIER KIT

Designed specifically for use with the Williamson Type Amplifiers, the WA-P2 features 5 separate switch-selected input channels, each with its own input control—full record equalization with turnover and rolloff controls—separate bass and treble tone controls—and many other desirable features. Frequency response is within ± 1 db from 25 to 30,000 cps. Beautiful satin-gold finish. Power requirements from the Heathkit Williamson Type Amplifier. Shpg. Wt. 7 Lbs.

MODEL WA-P2

\$1975

④ Heathkit Williamson Type HIGH FIDELITY AMPLIFIER KIT

This amplifier employs the famous Acrosound TO-300 "Ultra Linear" output transformer, and has a frequency response within ± 1 db from 6 cps to 150 Kc at 1 watt. Harmonic distortion only 1% at 21 watts. IM distortion at 20 watts only 1.3%. Power output 20 watts, 4, 8, or 16 ohms output. Hum and noise, 88 db below 20 watts. Uses 2-6SN7's, 2-5881's and 5V4G. Kit combinations:

W-3M AMPLIFIER KIT: Consists of main amplifier and power supply for separate chassis construction. Shpg. Wt. 29 lbs. Express only.

\$4975

W-3 COMBINATION AMPLIFIER KIT: Consists of W-3M amplifier kit plus Heathkit Model WA-P2 Preamplifier kit. Shpg. \$6950 Wt. 37 lbs. Express only.

\$6950

⑤ Heathkit Williamson Type HIGH FIDELITY AMPLIFIER KIT

This is the lowest price Williamson type amplifier ever offered in kit form, and yet it retains all the usual Williamson features. Employs Chicago output transformer. Frequency response, within ± 1 db from 10 cps to 100 Kc at 1 watt. Harmonic distortion only 1.5% at 20 watts. IM distortion at rated output 2.7%. Power output 20 watts, 4, 8, or 16 ohms output. Hum and noise, 95 db below 20 watts, uses 2-6SN7's, 2-5881's, and 5V4G. An exceptional dollar value by any standard. Kit combinations:

W-4AM AMPLIFIER KIT: Consists of main amplifier and power supply for single chassis construction. Shpg. Wt. 28 lbs. Express only.

\$3975

W-4A COMBINATION AMPLIFIER KIT: Consists of W-4AM amplifier kit plus Heathkit Model WA-P2 Preamplifier kit. Shpg. \$5950 Wt. 35 lbs. Express only.

\$5950

⑥ Heathkit 20-Watt HIGH FIDELITY AMPLIFIER KIT

This model represents the least expensive route to high fidelity performance. Frequency response is ± 1 db from 20-20,000 cps. Features full 20 watt output using push-pull 6L6's and has separate bass and treble tone controls. Preamplifier and main amplifier on same chassis. Four switch-selected inputs, and separate bass and treble tone controls provided. Employs miniature tube types for low hum and noise. Excellent for home or PA applications. Shpg. Wt. 23 Lbs.

MODEL A-9B

\$3550

Heathkits®

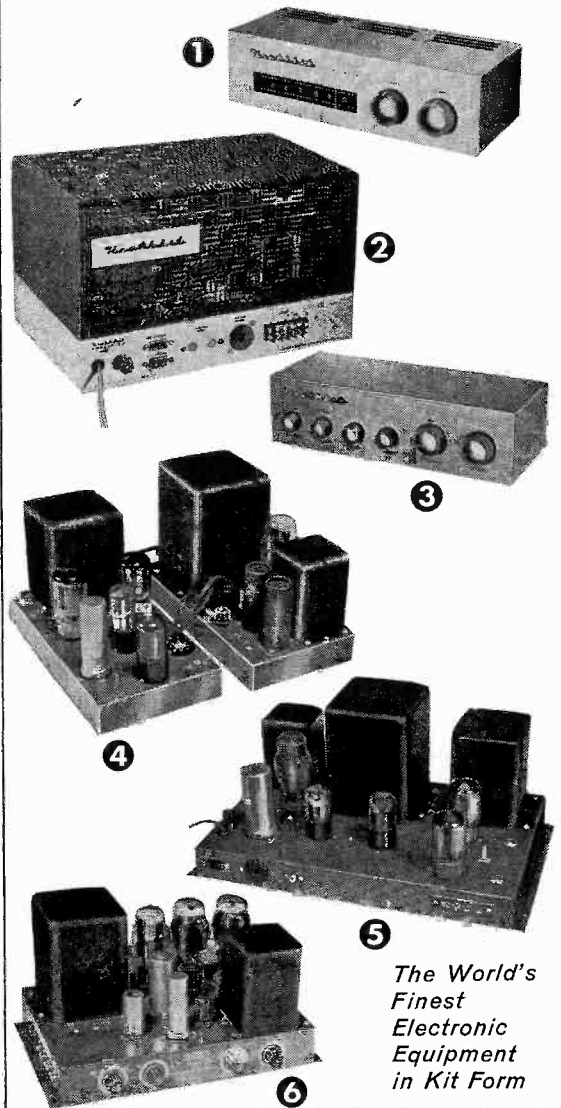

The World's Finest Electronic Equipment in Kit Form

Heathkits are easy to build..

Heathkit construction manuals are full of big, clear pictorial diagrams that show the placement of each lead and part in the circuit. In addition, the step-by-step procedure describes each phase of the construction very carefully, and supplies all the information you need to assemble the kit properly. Includes information on resistor color-codes, tips on soldering, and information on the tools you need. Even a beginner can build high quality Heathkits and enjoy their wonderful performance.

HEATH COMPANY

A Subsidiary of Daystrom Inc.

**BENTON HARBOR 18,
MICHIGAN**

The DB in HI-FI by Mannie Horowitz

THE decibel may be defined by the simple equation

$$\text{decibels} = 10 \log_{10} \frac{P_1}{P_2},$$

where P_1 is one power figure and P_2 is another power figure—either smaller or larger than P_1 . That is, a decibel figure expresses a mathematical relationship between one power figure and another.

From this equation it is obvious that the decibel is a *ratio* of 2 power values and not an absolute value of power. Suppose, for example, that an amplifier delivers 2 watts power to a speaker. If someone turned up the volume so that the amplifier delivered 5 watts power, the ratio of the 2 levels of power would be 5:2. This ratio can be expressed in terms of the decibel (abbreviated db). To do this, one would simply substitute this ratio in the equation $\text{db} = 10 \log_{10} \frac{5}{2}$.

Many mathematical purists and theoretical physicists claim that the decibel has no other meaning than that of a ratio expressed as a mathematical relationship. However, the practical engineer and technician have found much physical significance in this term. They have found that 1 db change of power is the minimum variation of sound intensity that the human ear can perceive when a single note is played. It has been experimentally determined also that for complex sounds, such as that of an orchestra, the minimum perceptible variation in sound intensity is 3 db. Note that the ear judges intensity differences not according to the absolute differences in sound power but by the percentage of change, or the ratio between 2 power values. Therefore, although the decibel is basically a mathematical relationship, it represents actual variation in physical sensation.

From this it becomes obvious why the standard chosen was the decibel rather than the bel. The bel is 10 times the size of the decibel, equal to the $\log_{10} P_1/P_2$. To use the bel would mean constant use of fractions. For example, 1 db change of sound intensity is the same as 1/10 bel change. Inconvenience in using fractions or their decimal equivalents thus made the smaller term, the decibel, more useful than the bel.

The actual equation to determine the decibel is simple mathematics, once the meaning of the logarithm is fully under-

stood. For the definition and application of the logarithm, the reader is referred to any good algebra text. However, a brief review of logarithms is presented here with the decibel in mind.

The Logarithm

When a number is multiplied by itself, such as 5×5 , it can be noted mathematically as 5^2 . The "2" (read "squared") is known as the *exponent* of 5. It then follows that $5 \times 5 \times 5$ is noted as 5^3 (read "5 cubed", or "5 to the third power"). Five to the fourth power is written 5^4 ; this represents $5 \times 5 \times 5 \times 5$.

In mathematical calculations, large numbers are expressed in powers of 10. Thus:

$$\begin{aligned} 10^0 &= 1 \\ 10^1 &= 10 \\ 10^2 &= 10 \times 10 = 100 \\ 10^3 &= 10 \times 10 \times 10 = 1,000 \\ 10^4 &= 10 \times 10 \times 10 \times 10 = 10,000 \\ 10^5 &= 10 \times 10 \times 10 \times 10 \times 10 = 100,000, \text{ etc.} \end{aligned}$$

Similarly, it can be written that

$$\begin{aligned} 10^{-1} &= 1/10 = 0.1 \\ 10^{-2} &= 1/100 = .01 \\ 10^{-3} &= 1/1,000 = .001 \\ 10^{-4} &= 1/10,000 = .0001, \text{ etc.} \end{aligned}$$

If a number is written 5×10^2 , it actually means $5 \times (10 \times 10) = 500$.

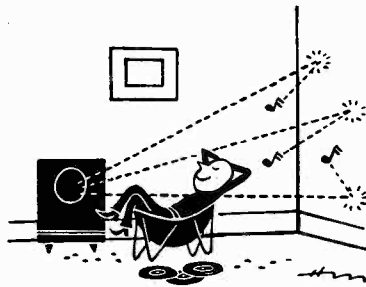

To write a number such as 5,300 in exponential notation, 53 is multiplied by 100 (53×10^2) or 5.3 is multiplied by 1,000 and written exponentially as 5.3×10^3 .

When numbers with exponents are multiplied, the exponents are added. Thus $(5 \times 10^2) \times (3 \times 10^3) = 500 \times 3,000 = 1,500,000 = 15 \times 10^5$. Similarly, when numbers written in exponential form are divided, the exponents are subtracted. If, for example, 10^3 is divided by 10^2 , the result is $10^{3-2} = 10^1$, since $10^3 \div 10^2 = 10^3/10^2 = 1,000/100 = 10 = 10^1$.

The exponential form of writing

numbers as powers of 10 can be expressed algebraically as $10^n = a$. Thus, if $n = 2$, $a = 100$ because, by substitution in the equation, $10^2 = 100$.

This same expression can be noted in another way. It can be written equally well as $\log_{10} a = n$, and is usually abbreviated simply as $\log a = n$, with the 10 (known as the base) being understood. *The logarithm of any number is the power of 10 that is equal to the number.*

Using the expression $\log a = n$, several exponents can readily be written down in logarithmic form.

Thus

$$\begin{aligned} 10^0 &= 1 && \text{becomes } \log 1 = 0 \\ 10^1 &= 10 && \text{becomes } \log 10 = 1 \\ 10^2 &= 100 && \text{becomes } \log 100 = 2 \\ 10^3 &= 1,000 && \text{becomes } \log 1,000 = 3, \end{aligned}$$

etc.

In each case, the base "10" is understood.

For values between $\log 1$ and $\log 10$, or for values between $\log 10$ and $\log 100$, logarithm tables can be consulted and used in accordance with the rules found in algebra textbooks.

From the exponential definition of the logarithm, several mathematical manipulations become obvious:

$$\begin{aligned} \text{Since } 10^n \times 10^m &= 10^{n+m}; && \log n + \log m = \log mn. \\ 10^n \div 10^m &= 10^{n-m}; && \log n - \log m = \log n/m. \\ (10^n)^c &= 10^{nc}; && \log (n^c) = c \log n. \end{aligned}$$

The second of these mathematical manipulations ($\log a/b$) is the basic form of the decibel.

The Decibel

Mathematically, the bel has no other meaning than the log of the ratio P_1/P_2 . It is more convenient to use the decibel than the straight power ratio. For example: a power gain of 10,000 (P_1/P_2) can be expressed as a small number, 40 db ($10 \log P_1/P_2 = 10 \log 10,000 = 10 \times 4 = 40$). The decibel is then, the most practical and concise way of expressing power ratios.

To calculate the power ratio of any 2 values in terms of db, the mathematical manipulation is quite simple. The log of this ratio is found in the logarithm tables, and this figure is multiplied by 10. If several of these power ratios were looked up in tables, the following easy-to-remember relationships between power ratios and their decibel equivalents would be noted:

Power ratio	decibels
2:1	= 3 db
5:1	= 7 db
8:1	= 9 db
10:1	= 10 db

Using these relationships, practically any power ratio can be translated into terms of db.

Db figures are logarithmic or exponential relationships, and power ratios are arithmetic relationships. Thus, when the power ratios are multiplied, the db figures are added. Using the power-ratio tables above, $16:1 = 2:1 \times 8:1 = 3 \text{ db} + 9 \text{ db} = 12 \text{ db}$; or $80:1 = 8:1 \times 10:1 = 9 \text{ db} + 10 \text{ db} = 19 \text{ db}$. Computations can be made in the reverse direction as well. For example, if an amplifier manufacturer claims a hum of 66 db below his full power output, his ratio of full power output to hum power output is $66 \text{ db} = 6 (10 \text{ db}) + 2 (3 \text{ db}) = (10:1)^6 \times (2:1)^2 = 10^6:1 \times 4:1 = 4 \times 10^6:1 = 4,000,000:1$.

$$\frac{\text{Max. power}}{\text{Hum power}} = \frac{4,000,000}{1} = \frac{4 \times 10^6}{1} = 66 \text{ db}$$

In most amplifiers, the input impedance is different from the output impedance. To measure the gain of an amplifier in terms of db, the actual ratio of output power to input power must be used.

Power is defined as the square of the voltage impressed across a resistor divided by the value of that resistor. Mathematically, this is written:

$$P = \frac{V^2}{R}$$

If, in a particular hi-fi amplifier, the input power, input voltage, and input resistance are specified as P_i , V_i , and R_i respectively; and similarly, the output power, output voltage, and output resistance are specified as P_o , V_o , and R_o , the following relationship is derived from the initial definition of the decibel:

$$\text{db gain} = 10 \log \frac{P_o}{P_i} = 10 \log \frac{V_o^2/R_o}{V_i^2/R_i}$$

In the particular case where the input and output impedances are equal ($R_i = R_o = R$),

$$\text{db gain} = 10 \log \frac{V_o^2/R}{V_i^2/R} = 10 \log \frac{V_o^2}{V_i^2}$$

$$\begin{aligned} V_o^2/V_i^2 &= 10 \log (V_o/V_i)^2 \\ &= 20 \log V_o/V_i \end{aligned}$$

Thus, in terms of *voltage*, the definition of the decibel is

$$\text{db} = 20 \log V_o/V_i$$

when $R_i = R_o = R$.

A table of easy-to-remember relationships can be written for the voltage ratios similar to the one for power ratios:

Voltage ratio	decibels
2:1	= 6 db
5:1	= 14 db
8:1	= 18 db
10:1	= 20 db

Just as in the case of the power ratios, when the voltage ratios are multiplied, the db figures representing them are added. A voltage ratio of $16:1 = 2:1 \times 8:1 = 6 \text{ db} + 18 \text{ db} = 24 \text{ db}$. In the reverse direction, hum 66 db below full output indicates a voltage ratio of $3 (20 \text{ db}) + 6 \text{ db} = (10:1)^3 \times 2:1 = 2 \times 10^3:1 = 2,000:1$.

At first the 2 ratio tables might seem confusing because different ratios indicate the same number of db. However, it should be remembered that the tables are solutions of 2 different equations— $10 \log P_o/P_i$ and $20 \log V_o/V_i$, for power and voltage ratios respectively. It will be noted that 66 db indicates a voltage ratio of 2,000 and a power ratio of 4,000,000. These are actually the same, of course, since power is equal to the square of voltage when the impedance remains constant, and 4,000,000 is 2,000 squared.

When *voltage* measurements are made (to determine power from the term V^2/R) across load resistors of equal value, the voltage ratio is used with the corresponding db numbers. If *power* measurements are made across the same or different resistors, the power ratio is used. There is no difference in the actual number of db in any one situation. There is, however, a difference in the ratio (either voltage or power) used to find the number of db from the tables.

As an example of the use of these ratios, assume that an amplifier delivers 100 volts across a 1-ohm resistor at 1,000 cps, and 1 volt across this 1-ohm resistor at 50,000 cps. The voltage ratio at these 2 frequencies is then



100:1, while the power ratio (V^2/R) is 10,000:1. Thus the voltage db reading is $100:1 = 10:1 \times 10:1 = 20 \text{ db} + 20 \text{ db} = 40 \text{ db}$, while the power db reading is $10,000:1 = 10:1 \times 10:1 \times 10:1 \times 10:1 = 10 \text{ db} + 10 \text{ db} + 10 \text{ db} + 10 \text{ db} = 40 \text{ db}$. The power db rating is identical with the voltage db rating under identical conditions. It bears repetition, though, that db figures calculated from voltage ratios are valid only when the voltages are across the same or identical impedances, but for power ratios the impedances do not matter.

The Dbm

A standard reference level of 1 milliwatt (.001 watt) is frequently used in audio work. With 1 mw understood as P_2 in the initial defining equation, the db reading is referred to as *dbm*. Note that 1 mw is power, not voltage, neces-

sitating the use of the equation $10 \log P_1/P_2$ rather than $20 \log V_1/V_2$.

Any power level can be expressed with reference to 1 mw in the dbm scale. To convert 1 watt to dbm, calculate the ratio of 1 watt to 1 mw (1000:1) in terms of db—namely, 30 db ($10 \log 1,000/1 = 3 \times 10 \text{ db}$). Thus 1 watt = 30 dbm, with 1 mw as the reference level being understood.

The term dbm, as well as the term db, refers to a power ratio. However, the term dbm is an absolute value of power. This is true since P_2 in the defining equation is given a value of power: 1 mw. When referring to db, P_2 can have any value. When referring to dbm, P_2 can have only its assigned value.

To express any value of power in dbm, the following simple steps should be used:

- 1) Find the ratio of the power value to 1 mw.
- 2) Find the logarithm of this number from a log table.
- 3) Multiply the log by 10.

Amplifier Measurements

The gain of an amplifier indicates the ratio of the amount of power that must be delivered into the unit in order to get another amount of power out of it. If, for example, 3 mv across an input resistance of 9,000 ohms drives an amplifier to 10 watts output, the ratio of power output to power input can be computed as follows:

1) 3 millivolts across 9,000 ohms is the same as 3×10^{-3} volts (3 mv = $3 \times 1/1000$ volts) across 9,000 ohms, or $(3 \times 10^{-3})^2/9,000$ watts. (Power = V^2/R .) Thus the input power is $9 \times 10^{-6}/9 \times 10^3 = 10^{-9}$ watts.

2) With an output power of 10 watts, the ratio of power output to power input is $10/10^{-9} = 10^{10}:1$.

Since, from the tables, the power ratio of 10:1 is 10 db, and $10^{10}:1$ is the ratio 10:1 multiplied by itself 10 times, the number of db representing this ratio is $10 \times 10 \text{ db}$ or 100 db.

An amplifier working under these conditions, then, has a gain of 100 db.

Hum and noise are undesirable characteristics in an amplifier because they interfere with program material. The less hum generated by an amplifier, the better the unit is considered to be.

Hum is generated within the amplifier itself. Thus, to measure hum, all signal is removed from the input to the unit. The remaining measurable voltage is hum. This hum is noted as a certain number of db below the rated power of an amplifier.

The laboratory procedure for measuring the power delivered by an amplifier is as follows:

- 1) Connect a resistive load across

Continued on page 42



Volume Compensator for Turnover Cartridges

Here's an idea that may be useful to people who like to play LP and 78-rpm records interchangeably, using a magnetic turnover cartridge and a standard preamplifier.

A variation in output level is usually encountered between the 2 sides of the cartridge. A slide switch on the record player can be linked mechanically to the



Fig. 1. Arrangement to get equal output of pickup cartridge on 78's and LP's.

motor speed control lever to cut down the excess volume of the 78's. A small amount of mechanical ingenuity is required to do this, of course.

First, determine the percentage of the volume of the 78's wanted to match the output of your LP's. Choose a potentiometer or a set of fixed resistors so that the total resistance, Fig. 1, will equal the recommended cartridge load. The terminating resistor inside the preamp should then be removed. Hook up as shown; then, by playing records of varying types at both speeds, determine the setting of the control which gives the same volume from 78's, with the switch down, as it does from LP's with the switch up.

Once this point has been determined, 1/4-watt resistors or a midget semi-variable control may be installed permanently. The remaining problem is mechanical: to engineer the co-ordinated operation of the SPDT switch and your

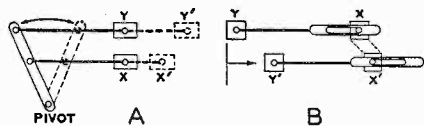

Fig. 2. Two automatic switching devices.

motor speed control lever, the former to be mounted out of sight under the panel and operated by the latter. If the travel of the 2 switches is identical this is easy. More likely, however, one of the 2 ar-

rangements shown in Fig. 2 will have to be used to adapt one device to the travel of the other. Fig. 2A shows a pivoted arm which accomplishes this by operating the 2 switches at different radii. Fig. 2B is simpler, showing how the excess travel may be taken up by using an elongated slot, so that device X does not move in either direction until device Y has nearly completed its motion. The length of the slot just equals the difference in travel.

Harry L. Wynn
Derry, Pa.

Construction Material

A construction material which should be brought to the attention of the "audio-crafter" is the do-it-yourself aluminum alloy offered by several manufacturers. This material is invaluable for the hobbyist with limited facilities and grandiose ideas. It possesses the advantages of an attractive, non-ferrous metal, plus the fact that it can be worked with common hand tools intended for wood.

Of particular use is the right-angle channel that comes in 6-foot lengths for about \$2.00. It makes perfect members for rack mounting of components. Short pieces of it can be cut and drilled for right-angle braces for cabinet work. Also, longer sections can be used to brace large plywood panels—it takes up much less space inside a speaker cabinet than do 2-by-4's.

The material also comes in rod, tube, and sheet forms, and may be used for everything from chassis to tube shields.

David S. Mayo
Belmont, Calif.

Rumble Trouble

Audiophiles having rumble trouble, but not enough ready cash for a filter, may find a 100-K power rheostat a good substitute. The rheostat can be connected across the output of the preamplifier. Varying the resistance from high to low causes a subsequent loss in bass, starting at subsonic frequencies and continuing up to about 100 cps as the resistance is decreased.

John Montgomery
Eldorado, Ill.

Soldering Wire to Phono or Octal Plug

The method described here will give a good solid connection between the prong of a phono plug or an octal power plug and the connecting wire.

1) Cut a length of solder wire (about 1/2 in.) and insert it into the prong of the phono or octal plug as shown in Fig. 1.

2) Bare the connecting wire for a length of about 1/2 in. and twist the strands to make it reasonably stiff.

3) Clamp the soldering iron so that its tip points upward. Then place the tip of the plug's prong against the tip

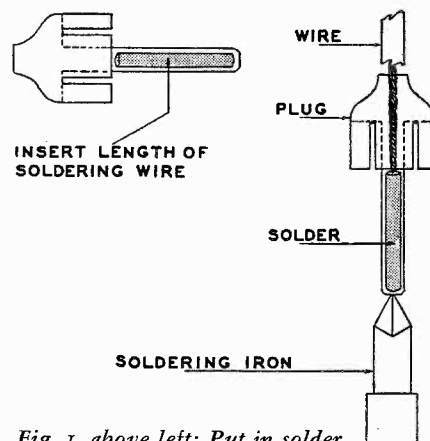

Fig. 1, above left: Put in solder first. Fig. 2, right: Perfect connection.

of the iron as shown in Fig. 2. At the same time, gently push the wire into the prong from the back of this plug. As the solder melts inside the prong, the wire can be pushed all the way in. This way a good soldered connection of about 1/2 in. long is formed inside the prong of the plug. The connection can sustain tension up to the strength of the wire itself.

There is no chance of the solder running out from the plug and down the soldering iron, because the surface tension of the melted solder inside the prong holds it there. This surface tension is what makes it difficult to form a joint when the solder is applied from the outside.

Y. C. Ho
Detroit, Mich.

BASIC ELECTRONICS

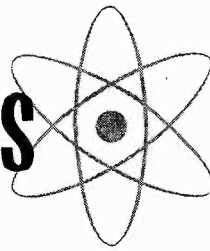

VI: Induction.

by Roy F. Allison

PERMANENT magnets and electro-magnets were discussed in Chapter V. It was pointed out that lines of magnetic force common to both types were identical in their effects, and that each exhibited polarity. Lines of force (magnetic flux) always accompany an electric current, and the field intensity near a current-carrying conductor is proportional to the magnitude of current. In a coil through which a current flows, the field intensity at the center is proportional to the current magnitude and the number of turns in the coil; if the coil is of some material other than air or a vacuum, the flux density is proportional also to the permeability of the core.

Very well: a magnetic field is always formed by current flow. Can a magnetic field, conversely, induce a current in a conductor? Suppose we wind a coil and connect its free ends to a current-measuring device such as a milliammeter, Fig. 1A. Now a bar magnet is brought close to the coil. As the magnet approaches the coil 2 effects are noted—first, a deflection in the milliam-

is increased, and are zero when the relative motion is zero. Obviously, current in a conductor can be induced by a magnetic field only when the intensity of the field is *changing*. This process of current induction was first noticed by Michael Faraday.

One turn of the coil is shown in Fig. 1B, with the magnet approaching it. If the south pole of the magnet is nearest the coil, the magnet's field will have the direction indicated. The flux lines in this field, cut by the conductor, induce a voltage in the coil that produces current having the direction shown by arrows next to the coil leads. This current (by the left-hand rule) in turn generates its own field around the coil whose flux lines go downward within the coil and upward outside it. Polarity of the electro-magnet thus formed is south at the top of the coil, north at the bottom; this is of such polarity as to repulse the south pole of the bar magnet. When the bar magnet is stationary the coil does not cut any of the permanent-magnet flux lines; no voltage is induced in the coil, therefore no

resisted by the field it would set up around the coil. This simple fact is stated in Lenz's Law (after H. F. E. Lenz): *The direction of a current caused by a change of magnetic flux will be such as to oppose the act that caused it.*

This is only logical, after all. Whenever a current exists some work is done; the energy to do the work must come from somewhere. It originates with the force that is required to overcome the opposition and which moves through a certain distance.

The voltage induced in a circuit by changing values of magnetic flux is, as we have seen, proportional to the *rate of change* of flux. This is expressed basically as

$$e = - \frac{d\Phi}{dt}$$

where Φ indicates flux in maxwells, and t is time in seconds. The expression d , appearing in both numerator and denominator, indicates loosely a *change in value*. Thus, assuming a uniform rate of change in flux lines, the voltage could be found by subtracting the smaller value of flux from the larger, and dividing this by the time interval in seconds during which the change occurred. The result will be in *abvolts*, whose value is defined by the equation above: *1 abvolt is the voltage induced in a circuit when the flux that is linked with it changes at the rate of 1 maxwell per second.* Because the volt is 10^8 (100 million) times as great as the abvolt, it follows that there must be 10^8 flux-linkage changes per second in order for 1 volt to be induced. The minus sign is used in this and other similar equations to show that the induced voltage is in opposition to its cause, following Lenz's Law.

If the circuit in question consists of several turns of wire, wound tightly enough together that each is affected by the same flux, then equal voltages are induced in each turn and they are additive. Calling the number of turns N , and incorporating the conversion factor to yield an answer in volts E , the total voltage induced in a coil by changing magnetic flux is

$$E = - \frac{Nd\Phi \times 10^{-8}}{dt}$$

We have been considering, up to this

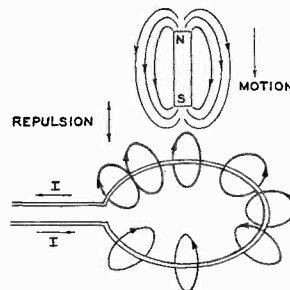
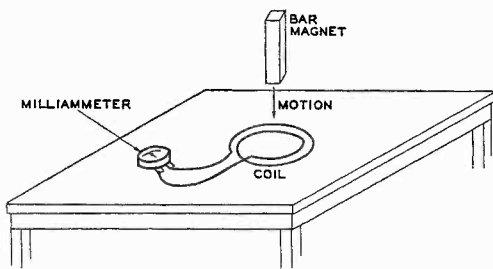

Fig. 1A, left, and 1B, right. How a voltage is induced in a coil by changing flux.

meter, indicating current flow in the coil; second, a slight resistance to the motion of the magnet. If the magnet is stopped and simply held over the coil, the current stops also, and there is no further force exerted on the magnet. When the magnet is withdrawn it is found that current again is indicated in the coil, but in the opposite direction. Again the motion of the magnet is resisted: indeed, if it is withdrawn rapidly enough, the coil can be lifted off the table! It will be found that the magnitude of attraction or repulsion between the magnet and the coil, and the magnitude of the current in the coil, both increase as the speed of relative motion

current flows; there is no opposing field formed; and accordingly, the magnet is neither attracted nor repulsed by the coil. It is important to note these and the following facts:

1) When the bar magnet is pulled away from the coil the conducting turns of the coil cut the flux lines of a decreasing magnetic field; this causes current in the opposite direction and the formation of a north pole at the top of the coil, which attracts the bar magnet—resisting its motion again.

2) If the north pole of the bar magnet were used, current directions in the coil would again be reversed; again, any motion of the bar magnet would be

point, a coil affected by the field of a permanent magnet. There is no reason why the permanent magnet could not be replaced by an electromagnet; the results would be identical. Nor would there be any difference in results if a magnet of either type were held stationary and the coil moved in its field. A voltage is induced in a circuit whenever it is subjected to a changing value of magnetic flux, or—another way of saying the same thing—whenever its conductors “cut” lines of flux. The manner in which this is accomplished has no bearing on the results. With this in mind, we can proceed to the concepts of mutual and self-induction.

Mutual Induction

Fig. 2 is a diagram of 2 coils of wire, one outside the other, separated by a layer of insulating material. Coil A (inside) is connected to the terminals of a battery through a slide-wire potentiometer—that is, a length of wire having high resistance, and a sliding contact by means of which any desired length of wire can be used. The total resistance of the circuit is determined by the length of this wire used in the circuit; accordingly, the current in coil A can be varied by changing the position of the sliding contact. Coil B is connected to a milliammeter.

As would be expected, the milliammeter shows no deflection when the slider is left in any fixed position. Some value of current exists in coil A, and because of this there is an electromagnetic field around it. Coil B is certainly within the field. But the field is constant; the coils are assumed to be fixed in position relative to one another, and since the flux around coil B does not change there is no induced voltage. What happens, though, when the slider is moved? *While it is moving*, the current in coil A is changing; therefore the strength of the electromagnetic field is changing (remember that field intensity around a conductor or coil is directly proportional to current magnitude). And because the field intensity around coil B is *changing*, a voltage is induced in the coil, creating current in the circuit of coil B and a deflection of the milliammeter needle.

It is important to realize that the absolute values of current in coil A before and after the slider is moved have no bearing on the magnitude of the voltage induced in coil B. That is determined by the difference in the 2 values—the amount by which coil A current changes—and the time in which the change is accomplished. If the slider is moved faster, the *rate of change* of flux is increased, and the induced voltage is greater. If the battery is replaced by one of greater voltage, so that the difference in coil A current is greater at similar slide

positions than it was before, the rate of change in flux is again greater and the voltage induced in coil B is increased.

Suppose now that we separated the coils and fixed them several inches apart. The field intensity from the current in coil A would now be less at coil B's new location than it was before, since it is inversely proportional to the distance from the source. Therefore, for a given rate of change of current in coil A, the rate of change of flux at coil B would be less than before, and the induced voltage would be less. (The percentage of change in flux would not be less, but the difference in terms of lines per second would be decreased, and it is the latter that determines the induced voltage.) Voltage induced in coil B would still be proportional to the time rate of change of current in coil A, but its magnitude would be decreased because of decreased *coupling* between the coils. If all the force lines of coil A engaged coil B, the coupling would be perfect. This closeness of coupling can only be approached in practical units; ordinarily there is some appreciable leakage. The degree of coupling is expressed as a part of a coefficient of mutual induction, whose symbol is M . The unit of mutual inductance is the *henry*, for Joseph Henry; if a change in current at the rate of 1 amp per second in one coil

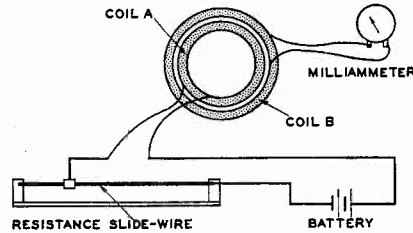

Fig. 2. Mutual induction demonstrator.

induces 1 volt in another coil, the coils have a mutual inductance of 1 henry. Thus,

$$E = \frac{M di}{dt}$$

where di is the change of current (in amps) in the first coil during the time dt (in seconds); E is the voltage induced in the second coil; and M is, of course, the mutual inductance in henries (h).

It is obvious that the mutual inductance would be increased substantially by winding the coils on a magnetic core, since the total flux and the closeness of coupling would both be increased. Increasing the total flux for any given value of current in coil A would make for greater *changes* in flux with the same changes in current.

We could go on to discuss transformers, since a transformer is nothing more than coils coupled together, but that will come more appropriately later

on. Now we shall only point out, as a matter of interest, that the requirement for changing values of current in coil A (the primary winding) in order to obtain a voltage in coil B (the secondary winding) is the reason why transformers don't work on DC.

Self-Induction

We have been considering the effect of current in one coil on another coil that is in the resulting electromagnetic field. So far nothing has been said about the effect on the first coil—but there must be an effect, because it too is in its own field. The flux that its current sets up surrounds the coil itself; when the current changes, the coil is subjected to a magnetic field whose intensity is changing, and accordingly a voltage must be induced in it. This voltage is, as before, proportional to the rate of change of current in the coil, and *it is in opposition* to the voltage causing the original current flow. Therefore the coil resists any *change* in current through it, and the opposition to a change in current is proportional in strength to the rate at which the current is changed. This property is called self-induction.

The magnitude of the effect depends on several factors. First is the number of turns in the coil; each turn increases the number of flux linkages to develop the opposing voltage, and also increases the total flux. Thus self-induction varies as the square of the number of turns. The diameter of the coil and the cross-section area have their effects. A magnetic core increases self-induction remarkably provided the current is kept below a certain value (above that value the core becomes *saturated* and will carry no additional flux). In general, the process of determining the exact self-inductance of a coil under any given circumstances, without actually measuring it, is a complicated matter.

The henry is used to express the magnitude of self-induction, as it is for mutual induction: 1 henry is that inductance which will have 1 volt induced in it when the current changes at the rate of 1 amp per second. L is the symbol for inductance. Thus,

$$E = - \frac{L di}{dt}$$

where E is the voltage induced in a coil in opposition to that voltage which causes the change in current; di is change in current occurring during the time dt ; and L is the inductance in henries. The minus sign indicates, as noted before, that the induced voltage opposes the applied voltage.

Now, what is a henry, precisely? It will be noted that the equation above can be rearranged to yield

$$L = - \frac{Edt}{di}$$

and that the same E was expressed previously as

$$E = - \frac{Nd\Phi \times 10^{-8}}{dt}$$

Substituting the latter in the former, and assuming a linear relationship between current and flux, the following expression is obtained for L :

$$L = \frac{N\Phi \times 10^{-8}}{i}$$

The henry, then, is that magnitude of induction for which there occur 100,000,000 flux linkages per ampere of current.

If a large inductor (or *choke*, as it is often called) is wired in series with a resistor, a battery, a switch, and a milliammeter, as in Fig. 3, the effect of inductance can be examined in a practical manner. The schematic diagram of an air-core choke is as shown; 3 parallel lines are added next to the coil to represent an iron core.

Suppose an initial condition is assumed with the switch in position 1. Then, at a time T_1 , the switch is turned to position 2. The circuit is completed through the battery and current immediately begins to flow. As it does, the inductance of the choke causes a reverse voltage which opposes the current. This can never be as large as the source voltage, however, so the current rises gradually, building up the field around the choke in spite of the opposing voltage. As the rate of current increase slows, less and less reverse voltage is induced; eventually, the current reaches a value determined by the series resistor (this is assumed to be large enough that other circuit resistances can be neglected) and the battery voltage. The milliammeter needle, registering the circuit current, rises from zero at T_1 rapidly to begin with, then less and less rapidly, and finally registers the limiting current value, which is E/R .

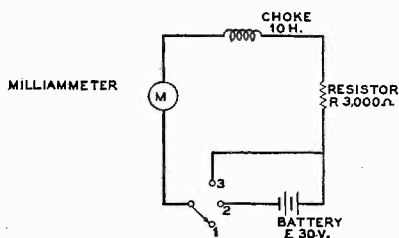

Fig. 3. Measuring a choke's inductance.

Fig. 4 is a chart of this action. Current in ma is read along the vertical (ordinate) scale, beginning from zero at the base line (abscissa scale). Elapsed time in milliseconds is read along the abscissa scale, beginning from zero where it joins the ordinate scale. If we begin the time scale at the moment the switch is moved to position 2, then $T_1 = 0$. The current then rises according to the formula

$$i = \frac{E}{R} \left(1 - e^{-\frac{Rt}{L}} \right)$$

where i is instantaneous current value; E is the source voltage; R is the resistance in the circuit; e is the Napierian base of logarithms ($e \approx 2.718$); t is the elapsed time in seconds; and L is the inductance of the choke in henries. The current follows an exponential curve, obviously, and theoretically never quite reaches the limiting value E/R (in this case, E/R is 10 ma). Practically, it does reach this value after a time that is about 5 times the ratio L/R . When L is in henries and R is in ohms, their ratio in seconds is the *time constant* of the circuit; at that elapsed time the current has risen to 63.2% of its limiting value. This is true of any RL circuit to which a DC voltage or a transient pulse is applied. It furnishes a convenient means to estimate the charge time. In the circuit under discussion now, the time constant is $10/3,000$, or $3\frac{1}{3}$ milliseconds. A glance at the chart in Fig. 4 will show that the current has indeed reached 63.2% of its maximum value at $3\frac{1}{3}$ milliseconds, and has virtually reached the limiting value at 17 milliseconds.

Let us assume that the current has reached 10 ma at 15 milliseconds (to conserve graph space), and that the switch in Fig. 3 is then turned to position 3. The source voltage is eliminated from the circuit and by-passed; but current was flowing in the circuit when the switch was thrown, and the magnetic field around the choke was completely built up. It took work to create the field, and there is energy stored in it. When the field begins to collapse about the coil it becomes a *changing* field again, and induces a voltage in the coil that tends to keep current flowing in the same direction. Remember that a choke opposes any change in current through it. The result is that the current in the circuit does not stop instantaneously, but dies away gradually in the same

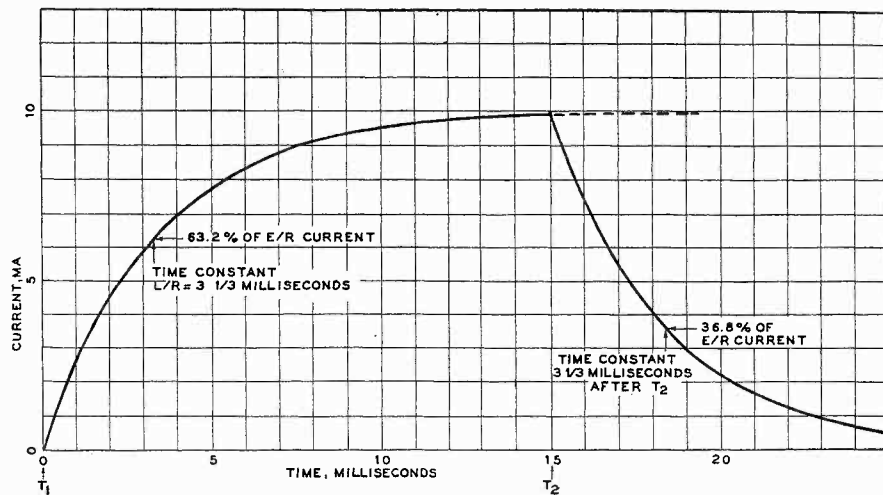

Fig. 4. How current rises and decays gradually in an RL circuit with DC inputs.

way it built up. Current decays according to the formula

$$i = \frac{E}{R} \left(e^{-\frac{Rt}{L}} \right)$$

This is plotted on the chart in Fig. 4. Current decay is rapid at first and then tapers off. The time constant L/R again furnishes a simplified way to calculate the decay time; after one time constant has elapsed, 63.2% of the decay has occurred (current is reduced to 36.8% of its value at the start of the decay); after 5 time constants have elapsed, the decay can be assumed to be complete.

WOODCRAFTER

Continued from page 9

lumber is usually figured by the board foot which is the amount of lumber in a piece 1 in. thick, 1 ft. wide, and 1 ft. long. Thus, to obtain the amount of board feet in a length of lumber, multiply the thickness in inches times the width in feet times the length in feet. However, keep in mind that any thickness under 1 in. is usually figured as 1 in. regardless of whether it is $3/8$ in., $5/8$ in., or $3/4$ in. For example, let's determine the cost of 3 boards, each measuring 1 in. by 12 in. by 16 ft. at a price of 50¢ per board foot. The formula would be as follows: Number of pieces \times thickness in inches \times width in feet \times length in feet. 3×1 in. $\times 1$ ft. $\times 16$ ft. = 48 board feet; 48 board feet at \$.50 per bd. ft. . . . \$24.00.

It is always wise to select a lumber dealer with a sound reputation. When you visit his yard, have a written list of your lumber needs. Tell the salesman something of your project so that he can use his knowledge and experience to help you.

To help in the selection of the proper wood for the job at hand, the table on the facing page lists data on 10 of the most popular woods available at most lumber dealers.

Name	Location	Description	Uses	Characteristics
Bass-wood	Grows best on lowlands along the rivers east of the Mississippi.	The fruit is a cluster of round, hard, green nutlets attached to the middle of a long leafy wing. Light in weight and color. Grows 50-70 ft. and has a trunk diameter of 2-3 ft. A soft wood.	Toys, paper pulp, furniture, boxes, baskets.	Easily worked by machines and hand tools. Glues well and takes nails well. It is well adapted to paint and enamel finishes.
Birch	Grows best in the northern part of United States and Canada.	The fruit is a cone-shaped spike, containing small, flat, brown, winged seeds. Attains a height of 60-70 ft. and has a trunk diameter of 2-3 ft. A hard, elastic, tough wood.	Furniture, interior trim, butcher blocks, toys, and flooring.	Difficult to work with because of its irregular grain. Excellent finishing characteristics. Responds well to red and brown stains for all shades of walnut and mahogany.
Maple	Grows best in the northeastern part of United States.	Fruit is a double-winged seed frequently called a "key". Hard, stiff, heavy, and has exceptional strength and shock resisting properties. Accidental forms with abnormal grain, known as <i>curly</i> and <i>bird-eye</i> maple. Has a height of 60-70 ft. and a trunk diameter of 2-3 ft.	Furniture making, interior trim, flooring, musical instruments.	Difficult to work with. Takes an excellent polish and a beautiful stained or natural finish. Hard surface provides an exceptional base for high-gloss finishes.
Cherry	Florida to Nova Scotia: west to Texas and Kansas.	Fruit is black in color, about the size of a pea, and is borne in long hanging clusters. A hard wood growing from 30-50 ft. with a trunk diameter 6-20 in.	Furniture, cabinets, tool handles.	Practically free from checking and warping. Works well with hand tools. Finishes should be of medium gloss to dull types and should be light enough to permit the natural satin luster of the wood to appear through the finish.
Red Cedar	Eastern United States and westward to Mississippi River.	Grows in all kinds of soil from swamps to rocky ridges. A small tree, the leaves are usually about 1/2 in. long and sharp pointed. Seldom exceeds 25-30 ft. in height with trunk of 8-15 in.	Telephone poles and posts, linen closets and chests.	Due to numerous knots it is difficult to plane. Its light, soft, fine grain and its pleasant aroma make it very attractive. Normally left unfinished, should be vanished if a finish is desired, to avoid undesirable gray undertones.
Philippine Mahogany	Philippine Islands.	Resembles genuine mahogany. Tree has straight, clean trunk with virtually no knots, crooks, or other defects common to most hardwoods. Grows to immense size, often reaching 150 ft. in height and 6-12 ft. in diameter.	Furniture, cabinet work, interior trim, and boats.	Easy to work with, takes a fine finish. It is equally attractive bleached, stained, or left in its natural state. Simplest finish for natural coloring consists of shel-lacking and waxing and then rubbing to desired luster.
American Black Walnut	A scattered forest tree. It is found widely distributed throughout the eastern and central states.	The fruit is a nut, borne singly or in pairs, enclosed in a solid green husk. Frequently reaches a height of 100 ft. with a straight trunk 2-4 ft. in diameter, clear of branches for half of its height.	Furniture, cabinet making, paneling, gun stocks, art objects, novelties.	Base of working with tools, high strength, responsiveness to finishes and polish. It should be filled, and requires relatively heavy finishing coats capable of being cut to a level, semi-gloss surface to bring out the inherent beauty of this foremost American cabinet wood.
White Oak	Eastern part of the United States.	Normally grows 60-100 ft. with trunk diameter of 2-3 ft. However, some trees have been found that grow to 150 ft. with a trunk diameter of 6-8 ft. Very strong, stiff, heavy, and is very durable when exposed to weather.	Originally desired for strength and durability. Now valued for its beauty in furniture, interior trim, and floors.	Rather difficult to work with; however its durability makes its finished products practically indestructible. Particularly adapted to modern bleached and limed finishes.
Cypress	Grows best in the swamps of southern United States.	Often called "the eternal wood" because of its decay- and insect-resisting properties. A slow-growing tree that attains a height of 150 ft. and 3-6 ft. in diameter. Its cones are globular about 1 in. in diameter and have hard scales.	Used principally where the wood comes in contact with elements. Used for exterior trim, garden furniture, trellises, fences, and boats. Also used for interior trim, paneling, chests, furniture, and fine cabinet work.	Planes and works easily: takes and holds paint well. A soft, dull, natural finish produces splendid results on interior trim and paneling.
Sugar Pine	Grows from southwestern Oregon to southern California.	Tallest of all pines. Wood is light colored, soft, smooth, and straight grained. Remarkably free from warp and twist. Grows as high as 250 ft. with a trunk diameter of 12-18 ft. Pine cones are 10-20 in.	Interior trim, doors, window frames, furniture, cabinets.	Oil stains and shellac finishes are very popular. Also noted for its excellence as a base for paints and enamels. A very easy wood to work with.

speaker load. If you have a calibrated 'scope, you can read the peak voltage directly and obtain the peak output again by the above formula. Take 2 sets of readings: 1) with the volume at which you normally listen to music; and 2) at the volume you can get away with when you raise it to the point which renders some degree of real presence but is still listenable for musical enjoyment. If you like you can add a third series for

those occasions when you're showing off. If you will report these to me, with a brief description of your speaker system, perhaps we can get more representative figures than are provided merely by my own experience. I don't pretend that we can substitute for carefully controlled experiments involving a representative cross section of the population. But no one appears to be making that kind of study, and perhaps our disorganized experiment might stimulate a really valid one. In any case, all of us would have an opportunity to determine just how typical our individual experiences are.

you use is available from an early issue of *High Fidelity Magazine*³, Walter M. Jones Apparatus Company, University Loudspeakers, Inc., and other sources.

The network was divided in sections so that, if it was desired to operate the cubes individually and without the bass chest (for stereo reproduction), 8-inch speakers used in the cubes would not then be limited at the low end by anything other than the characteristics of the speakers themselves and the enclosures. No level control is needed on the 12-inch woofer unit. Commercially available networks can be used, of course, provided the crossover frequencies are correct.

The diagram in Fig. 6 is for single-channel program sources. Output of the amplifier is connected to the low-frequency network input. This feeds the woofer and the 2 high-frequency dividing networks, both of which are connected to the high-frequency channel of the first network. For stereo applications, on the other hand, cube A's network input is connected directly to one stereo amplifier, and cube B's network input to the other amplifier.

To balance the speakers, play one of your favorite monaural recordings through the system. Turn the general volume up far enough for the bass to sound reasonably strong, and cut out the middle- and upper-range sound with the controls at the sides of the cubes. Then turn the tweeter controls up until you have brightness to balance the bass. Add just enough of the middle range to bring the extreme highs and lows into focus. When you have found the balance proper for your room, recheck to see that both sides of the middle and upper ranges are in proper relationship. A recording of a soloist is most convenient for determining this. While listening directly in front of the cabinet alter the adjustments until the solo part seems to come directly from the front of the cabinet. This balance is perhaps best obtained when the cubes are in side-radiating positions (be sure the doors are matched in angle during this operation). If the speaker phasing is off, a correction can be made quickly by reversing wires either in the cubes or in the bass chest. If your woofer speaker seems to produce a high-pitched harmonic it can be reduced by adding a limited amount of insulating material in the channels of the rear-loaded horn. This will act as an acoustical filter for the highs, and will not disturb the lows.

The cable from the amplifier to the speaker unit can be either 2 rubber-

The RUMBLE Seat

Gentlemen:

I would like to point out some errors in Joseph Marshall's article "The Grounded Ear" (*Audiocraft*, November 1955). I doubt if most authorities agree that the cathode-coupled inverter is superior to the split-load type. The split-load inverter is both theoretically and practically balanced. It is the only inverter circuit which does not depend on the characteristics of a tube as well as the characteristics of other parts in the circuit. This is all pointed out by Jones in *Audio Engineering*, December 1951. Incidentally, in the April 1950 issue of *Audio Engineering* Mr. Marshall indicated that the cathode-coupled inverter is not capable of as good balance as a transformer.

I agree that the Williamson amplifier is much more popular than it intrinsically merits. However, it is not the phase inverter which makes it less than optimum. The long-tailed pair does give a good bit of gain but the same 2 triode sections, one employed as an amplifier and the other as a split-load inverter, will give more gain. A disadvantage of the circuit shown in Fig. 1 is that at very low frequencies the 2 halves of the 12AU7 become excited in parallel; thus, one tube section is causing the over-all feedback network to contribute positive feedback.

The *RCA Tube Handbook* says that 6V6's will put out more power with less distortion than will 6K6's. In general, pentodes have high third-harmonic distortion which is not reduced by the push-pull connection, while beam tetrodes have more second-harmonic distortion which is greatly reduced by the push-pull connection.

As for low-drive tubes, the 6BK5 gives full output for 5 volts drive. Four of these tubes in push-pull parallel will give about 14 watts, but like

most pentodes the distortion is high. It is well worth while to produce the extra drive for 6L6's. As pointed out in my article in *Radio News* for January 1955, a very simple driver system will drive the 6L6 grids to the clipping level with less than 1% intermodulation distortion—which should correspond to about 1/4% harmonic.

W. B. Bernard
U. S. Navy Electronics Lab.
San Diego 52, Cal.

Reply:

As you know, arguments about the inverter are endless and indecisive. I said "most authorities agree that the cathode-coupled inverter is superior to the split-load type." Mr. Bernard says he doubts it; I presume only a tabulation of all the authorities and their points of view would settle the issue. He quoted me clearly on my 1950 statement about the cathode-coupled inverter but, as I recall, I also said I didn't think any vacuum-tube inverter was as good as a good transformer. I am still inclined to think so. As you know, there are many good reasons for not using transformers.

As for whether 6V6's produce less distortion than 6K6's, I can only repeat what I said in November, and still believe is right: many engineers have found that amplifiers built with 6K6's produce less distortion than 6V6's.

Joseph Marshall

Gentlemen:

Concerning Mr. Marshall's reply: the only comment I can make is that he quoted no authorities to back his views. In the matter of the split-load phase inverter I refer you to the *Radioiron Designers' Handbook* and, on 6V6's vs. 6K6's, I refer you to the *RCA Tube Handbook*.

W. B. Bernard

³September-October, 1952.

covered AC lines or, if it is desired to run a wire under a rug, a section of flat 4-conductor cable of the type used for antenna rotators. When only one amplifier is used the wires can be paired; if 2 amplifiers are employed, all 4 wires will be used. It is recommended that this system be driven by a single amplifier of at least 20 watts output, or by two 10-watt amplifiers.

AMPLIFIER DESIGN

Continued from page 27

at the top end of the line than at the bottom, then there will be a combination of third-harmonic and second-harmonic distortion, the second harmonic being in

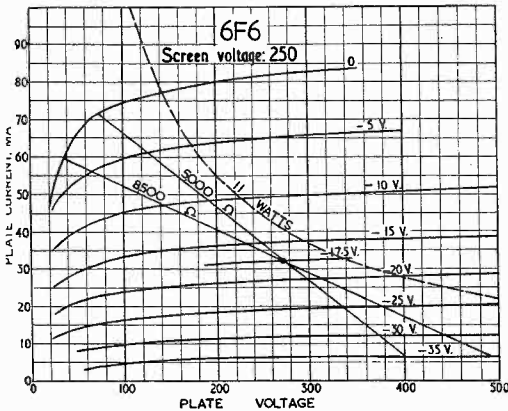

Fig. 9. How changing the value of a load affects output when applied to pentode curves. The 5,000-ohm line manifests mostly second-harmonic distortion, indicated by wider spacing toward the top end, and closer spacing toward the bottom. The 8,500-ohm line manifests mostly third-harmonic distortion, indicated by closing up of the spacing toward both ends of the line.

opposite phase to that produced by the triode tube. Use of some lower value of load will result in practically uniform closing up at both ends, while a still lower value causes more pronounced closing up at the bottom end of the line.

When these results are analyzed in terms of distortion *vs.* load impedance for the same amount of drive, the result appears as at Fig. 10. Third-harmonic distortion becomes progressively less as the load value is reduced. Second-harmonic distortion, on the other hand, passes through a null point, at which the closing-up effect at both ends of the load line is balanced. In practice, minimum over-all distortion is achieved by using a value of load slightly lower than that which gives minimum second harmonic.

Determination of operating bias point from the working plate current and plate voltage, together with the amount of grid swing necessary to give full output, is calculated in just the same way as was described for the triode tube. Choice

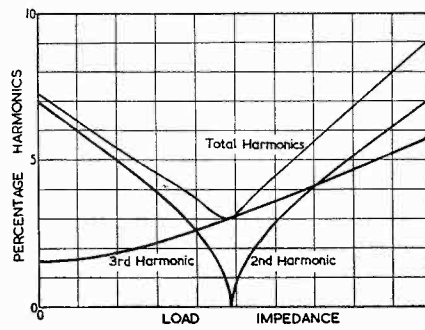

Fig. 10. Typical variation of harmonic content in a pentode output stage as load value is varied. Curves are for constant grid swing and plate voltage.

of load line for maximum output and minimum distortion is assessed in much the same way too.

Impedance Loads

This way of using a load line, while very convenient for making calculations, overlooks one thing in the practical performance of the amplifier. This is the fact that the load line represents a *pure resistance* load. Most amplifiers are used to feed loudspeaker loads, which have considerable reactance at various frequencies.

The relation between voltage and current in reactance, when plotted on graph paper or presented on an oscillo-

scope screen, is an ellipse. This means that the load line applied to tube-characteristic curves for a reactive load, or for a load that is a combination of reactance and resistance (an impedance) will be an ellipse, the horizontal and vertical dimensions of which will be in a proportion representing the impedance value.

If the reactance is pure — that is, with no resistance included — the major and minor axes of the ellipse will be horizontal and vertical, as shown in Fig. 11. In practice, of course, there

Continued on next page

Fig. 11. Comparison between load lines representing pure resistance (straight line) and pure reactance (ellipse) of same magnitude and at the same values of plate voltage and plate current.

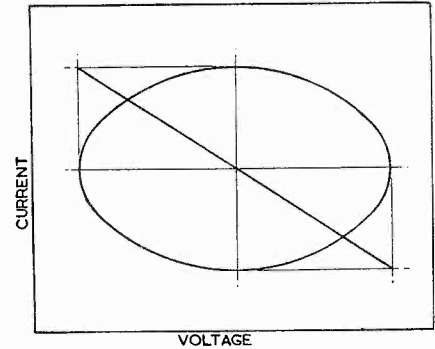

NOW! BUILD-IT-YOURSELF

THE FAMOUS MARK II DYNA-KIT 50 WATT AMPLIFIER

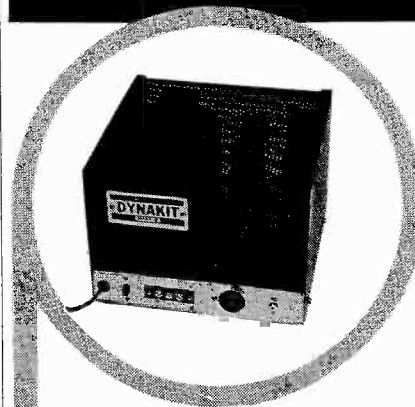

Unsurpassed in—

- STABILITY • LOW DISTORTION
- BAND PASS • POWER OUTPUT

Specifications—

Power—50 Watts, continuous at less than 1% I.M.
 Power Curve—+1 db—20c—20 kc.
 Frequency Response—.5 db—6 c to 60 kc; Size 9" x 9" x 6 1/4" h.

Complete kit, including detailed instructions and diagrams. **\$69⁷⁵**
 ALSO AVAILABLE COMPLETELY BUILT

ELECTRONICS CITY LINE CENTER PHILADELPHIA 31, PA.

Those who demand the finest in
"living reproduction" always choose Bell

NOW...
enjoy the ultimate in
sight and sound

Bell

"Capri" Hi-Fi
Amplifiers

The new Capri amplifiers are actually the renowned Bell high fidelity amplifiers in striking golden-hued covers. You can enjoy the finest in reproduction without the necessity of custom cabinetry... the Capri styling blends with any decor.

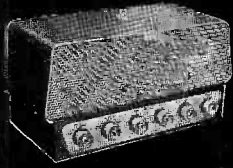

Model 2200-CG
20-watts with less than 3/10 of 1% distortion. 35-watt peak. 20 to 20,000 cps $\pm .2$ db.

Model 2199-BG
12-watts



See and hear these truly fine instruments at your high fidelity dealer's. Or, write for catalog 542A for complete technical details on the entire Bell high fidelity line.

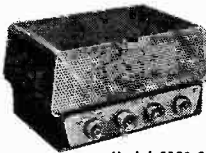

Model 2122-CG
10-watts

Bell
Sound Systems, Inc.

569 Marion Road, Columbus 7, Ohio

A subsidiary of Thompson Products, Inc.



Export Office: 401 Broadway, New York City 13
In Canada:

Charles W. Pointon, Ltd., 6 Alcina Ave., Toronto 10, Ont.

AMPLIFIER DESIGN

Continued from preceding page

is always some resistance present, otherwise there would be no power output. So the practical form of ellipse, representing impedance, is shown in Fig. 12.

It may be possible to get a very nice, large output and low distortion using a straight load line, but is the uniformity

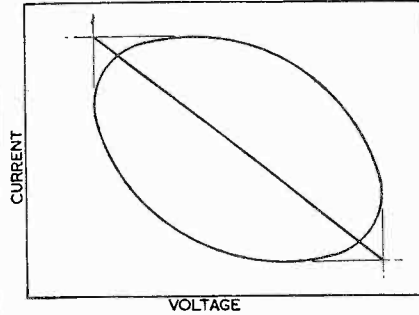

Fig. 12. Comparison between load lines representing pure resistance (straight line) and combination of resistance and reactance as impedance (ellipse) having the same magnitude and at the same values of plate voltage and current.

of the characteristic curves good enough to allow the load line to spread out into an ellipse? This will depend upon the type of tube and the operating conditions chosen. Triode and pentode tubes both introduce distortion when reactance is added, but under different conditions and degrees as the combination of resistance and reactance is varied.

These problems are the reasons push-pull operation has become used almost universally. This we shall go into in detail in a subsequent article. There are other special circuits, such as the ultra-linear, unity coupling, and several more, that we shall discuss later on as well.

THE DB IN HI-FI

Continued from page 34

the output transformer of the amplifier, to represent the impedance of the loud-speaker. This load must be the one which the manufacturer of the amplifier or output transformer specifies as the correct value for proper output impedance matching under the conditions used.

2) Feed a sine-wave audio signal into the input of the amplifier.

3) Turn up the gain of the amplifier and signal source until the maximum undistorted signal is reached. This can be observed on a 'scope which is connected across the output load resistor.

4) Measure the voltage across the load resistor.

5) Compute the power from the formula V^2/R .

To check the hum, remove the signal and measure the voltage using the voltmeter across the same load resistor. The power-output voltage is known (step 4 above) from previous measurement. Multiplying by 20 the log of the ratio of the power-output voltage to the hum-output voltage will indicate the hum in db inherent in this amplifier. An alternate way of computing the hum in db is the use of the voltage ratio table above.

If, for example, the voltage output due to the power delivered were 16 volts across the load resistor, and the hum voltage were 1 volt, the voltage ratio would be 16:1. (Note the use of voltage ratio here since the measurements are both made across one load resistor). Thus the amplifier would have $16:1 = 8:1 \times 2:1 = 18 \text{ db} + 6 \text{ db} = 24 \text{ db}$ hum below full power output.

Frequency response is also measured with respect to the voltage across a load resistor. This is done by varying the input frequency to the amplifier (keeping this input voltage constant) and noting the voltage output variation with frequency. From these voltage changes, the db variation with frequency can be calculated as above.

The frequency response of an amplifier with various tone-control settings can be checked in a like manner. The tone controls are set at any desired position. The input frequency to the amplifier is varied while the input voltage is kept constant. Variations observed on the VTVM can again be calculated in terms of db.

To avoid much of this calculation, many voltmeters are calibrated in terms of db as well as in volts. When such a meter is connected across a load resistor, and all db measurements are

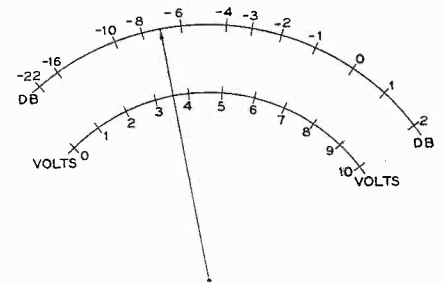

Fig. 1. Meter with voltage and db scales.

made only across this one resistor, the meter's reading in db has meaning.

These meters are based on the formula previously noted,

$$\text{db} = 20 \log V_o/V_i$$

A voltage ratio of 2:1 would be indicated on the meter directly as a 6-db difference.

If in the tone-control test, for example, 1,000 cycles read 9 db on the meter, and 10,000 cycles indicated 3

db, the treble cut would be 9 db—3 db, or 6 db. Whatever value 9 db represented in terms of absolute voltage (which is unimportant) 3 db would be equal to just $\frac{1}{2}$ this voltage, since there was a 6 db difference between the 2; this is indicated on the dial scale shown in Fig. 1.

On the scale, 0 db was chosen to be 8 volts, so —6 db represents 4 volts. Therefore a voltage change by $\frac{1}{2}$ is represented as 6-db difference in reading. Any voltage that is half or twice another voltage would be shown as a 6-db change on any part of the decibel scale.

DYNAKIT

Continued from page 21

that the residual distortion, which is most important at normal listening levels, is well below 0.1%. The 1% IM point is reached at 48 watts; this is equivalent sine-wave power for the test frequencies of 60 and 7,000 cps mixed in a 4-to-1 ratio. Thus, the distortion specification is missed by less than 0.2 db. Before quibbling about this, we should point out that if the performance of an amplifier is going to deteriorate during use it will do so within 10 to 20 hours. Comparatively, then, our amplifier had been in use for a long while, and no significant further deterioration could be expected until the tube life expectancy were approached. No care was taken in matching output tubes, either—the balance was not even checked. Finally, reports from other sources indicate that our Mark II was slightly below average in performance: if this was below average, we wonder what an above-average Dynakit would sound like!

MORE MULTI

Continued from page 24

arrangement is *area* source, rather than *point* source, for music. Eventually the 1502-D will be replaced with a Berlant SBX-4 Recorder for stereophonic operation.)

A disc recording from the pickup-turntable unit can be played 1) through the C-108 Control Unit into the 30-watt amplifier and, thence, into the speakers; or 2) through the C-4 Control Unit into the 50-W2 Amplifier and, thence, into the 3-way speaker system; or 3) through 1 and 2 simultaneously.

Concurrently with 1, 2, and 3 above, or independently, as a separate operation, a disc recording from the pickup-turntable unit may be taped by feeding it 1) through the C-108 Control Unit into the 1502-D Recorder; or 2) through the C-108 Control Unit into the T-10 Recorder; or 3) through the C-4

Control Unit into the 757 Recorder; or 4) through 1, 2, and 3 simultaneously. Tape-recorded copies of previously recorded tapes can be made 1) by playing the original tape on the 1502-D Recorder and feeding its output *a*) through the C-108 Control Unit into the T-10 Recorder, or *b*) through the C-108 Control Unit into the 757 Recorder, or *c*) through both *a* and *b* simultaneously; or 2) by playing the original tape on the T-10 Recorder and feeding its output through the C-4 Control Unit into the 757 Recorder; or 3) by playing the original tape on the 757 Recorder and feeding its output *a*) through the RV-10A Tuner into the 1502-D Recorder, or *b*) through the RV-10A Tuner through the C-108 Control Unit into the T-10 Recorder, or *c*) through *a* and *b* simultaneously.

Pre-recorded tapes can be played from the 1502-D Recorder 1) through the C-108 Control Unit into the 30-watt amplifier and, thence, into the speakers; or 2) through the C-4 Control Unit into the 50-W2 Amplifier and, thence, into the 3-way speaker system; or 3) through both 1 and 2 simultaneously.

Pre-recorded tapes can be played from the T-10 Recorder 1) through C-4 Control Unit into the 50-W2 Amplifier and, thence, into the 3-way speaker system; or 2) through the C-4 Control Unit through the C-108 Control Unit into the 30 watt amplifier and, thence, into the speakers; or 3) through both 1 and 2 simultaneously.

Pre-recorded tapes can be played from the 757 Recorder through the RV-10A Tuner 1) through the C-108 Control Unit into the 30-watt amplifier and, thence, into the speakers; or 2) through the 1502-D Recorder through the C-4 Control Unit into the 50-W2 Amplifier and, thence, into the 3-way speaker system; or 3) through both 1 and 2 simultaneously.

TAPE NEWS

Continued from page 13

to it is the structure of sound itself.

No natural sound ever cuts off instantly after it has occurred. There is, rather, a brief period of decay following it, during which the vibration of the sound-producer dies away. Also, a large positive pulse created by a sound is as likely as not followed closely by a negative pulse of similar magnitude, and these 2 characteristics prevent a record head from becoming magnetized as rapidly as we might expect it to.

A single large pulse fed to a recording head will cause a state of permanent head magnetization. A second pulse of about the same magnitude but of opposite polarity will bring it back to its

Continued on next page

EXTENDED RANGE
HIGH-FIDELITY

3-WAY TRX

INTEGRATED TRIAXIAL

12 and 15-inch REPRODUCERS

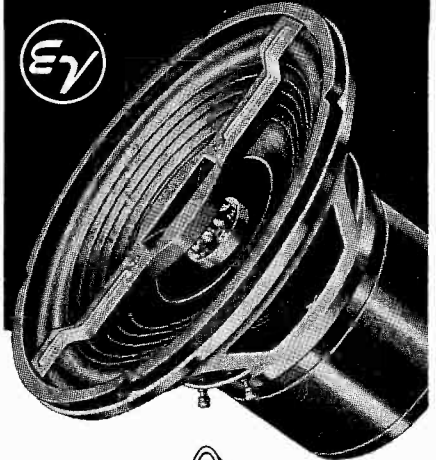

Concentrically
Combines E-V
Super-Sonax,
Radax Propagator,
and Bass Cone

Brings advantage of distortion-free
wider range found in E-V separate
3-way systems, in one compact speaker

E-V concentric triaxial design gets the most from specialized driving media for each portion of the audio spectrum. Augmented bass response, full bodied mid-range and silky-smooth upper octaves to the highest audible frequencies provide excellent musical balance without masking effects or imposed distortions.

Model 12TRXB. 12 $\frac{1}{4}$ -in. diameter.
Magnet wt. 1 lb. 2 oz. Net, \$59.70

Model 12TRX. 12 $\frac{1}{4}$ -in. diameter.
Magnet wt. 3 $\frac{1}{2}$ lb. Net, \$114.00

Model 15TRXB. 15 $\frac{1}{8}$ -in. diameter.
Magnet wt. 1 lb. 2 oz. Net, \$78.00

Model 15TRX. 15 $\frac{1}{8}$ -in. diameter.
Magnet wt. 5 $\frac{3}{4}$ lb. Net, \$135.00

Each speaker includes brilliance control

- Exclusive E-V Concentric Mounting Insures Smooth, Full Range, Complete Room Coverage
- Balanced Response Characteristic Provides Realism and Presence
- Adjustable Brilliance Control for Remote Mounting. Allows Matching to Room Acoustics
- Edgewise Wound Voice Coil Design Affords 18% More Efficiency and Lower Distortion

Send 25c for Catalog and Guide No. 117-B64

Electro-Voice[®]
BUCHANAN, MICHIGAN

IMMEDIATE DELIVERY!

DYNAKIT

Mark II

50 WATT POWER AMPLIFIER KIT

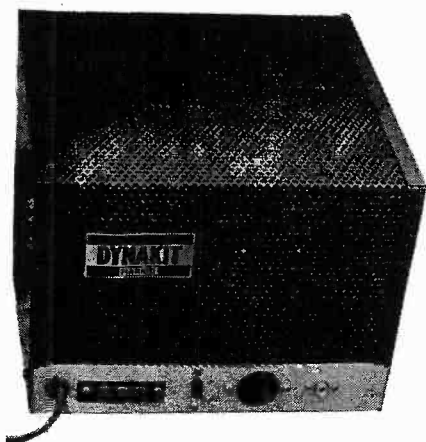

\$69⁷⁵ complete
when ordered by mail

DOUBLE the power and quality on your present Williamson type amplifier with DYNACO A-430 transformer.

\$29⁹⁵
when ordered by mail

HI-FI COMPONENTS EXCLUSIVELY

HOLLYWOOD ELECTRONICS

7460 MELROSE AVE.
HOLLYWOOD 46
CALIFORNIA
WEBSTER 3-8208

HOLLYWOOD ELECTRONICS

7460 Melrose Ave., Hollywood 46, Calif.

Please ship the following:

- DYNAKIT Mark II — \$69.75
 DYNACO A-430 Transformer — \$29.95

___ Check, ___ Money Order for \$ ___ enclosed.
In California add 3% sales tax — Shipping charges C.O.D.

Name _____

Address _____

City _____ Zone _____ State _____

TAPE NEWS

Continued from preceding page

neutral, unmagnetized condition, and this is what happens when recording. The alternating currents through the record head swing it back and forth through phases of opposite polarity, but always after a series of large impulses (from a loud signal), there are those few cycles of diminishing intensity which restore the head to its neutral state. The impulses, then, tend to average out over a period of time.

An "average" being what it is in nature, though, it is inevitable that occasionally a majority of the largest impulses that occur during a series of recordings will be, say, of positive polarity. Or a little non-linearity in one of the recorder's amplifying stages may make all the positive half-cycles in the signal a little larger than the negative ones. Then again, the recorder may be switched off the RECORD function right on the positive half of a bias-current cycle for a few times in a row, or the coupling condenser from the output stage to the record head may leak a little bit, just to help things along even more. So the head will gradually build up a small amount of residual magnetization.

Anyone who owns a recorder with a rated signal-to-noise ratio of 50 db or better should also own a head demagnetizer, and should get into the habit of using it every month or so. At least 2 companies I know of make these handy little gadgets: Ampex and Audio Devices. They are similar in construction and operation; each consists of a fat coil of wire with 2 long pole pieces protruding from it and a cord to plug into the 110-volt AC mains.

The energized demagnetizer's pole pieces are brought close to the pole pieces on the head in question, without touching them, and are slowly moved up and down across the width of the head. They are then gradually pulled away from the head, leaving it demagnetized. A hand-held bulk tape eraser may also be used to demagnetize recorder heads, but it is only effective when the heads are not concealed under or behind a thick mu-metal shield. Also, watch out for DB meters when using a bulk eraser on heads—recently I heard from an unfortunate individual who degaussed his record head along with the magnet in the recorder's VU meter, which was located just below the head assembly.

Note on Control Units

A few more commercially available control units which permit monitoring from the playback of 3-headed tape recorders have been brought to my

attention since last month's TN&V listing. These are the Harman-Kardon D-1100 "Festival", a combined AM-FM tuner, control unit, and power amplifier; and the following units from H. H. Scott, Inc.: Models 121-B, 120-A, 120-B, and 120-C preamplifier-control units, Models 210-C, 99-B, 99-A, and 210-B complete amplifiers, and 214-A and 214-B 2-unit amplifiers. All current Scott control units are being built with tape monitoring facilities.

READERS' FORUM

Continued from page 14

Gentlemen:

I would like to see a construction article on the Villchur Acoustic Research AR-1. AUDIO magazine had an article about a year ago on how to change the suspension of a cone speaker to make it more compliant. Such a speaker in a closed box should approach the low speaker in the AR-1 enclosure.

Charles L. Kerstein
Charleston, W. Va.

The AR-1 system is just that—a system that is designed as a unit. The speaker must be used with its perfectly matching enclosure, and the enclosure is good only for that specific speaker. Since Acoustic Research does not sell the speaker separately, there would be little point to an article on the enclosure construction. — Ed.

Gentlemen:

Last August I secured the plans for the Classic enclosure from University Loudspeakers. The plans at that time did not include the location dimensions for the compression chamber housing the 15-inch woofer. Making use of the University of Tennessee's sound room, Hewlett-Packard generator and voltmeter, and Shure microphone, we found

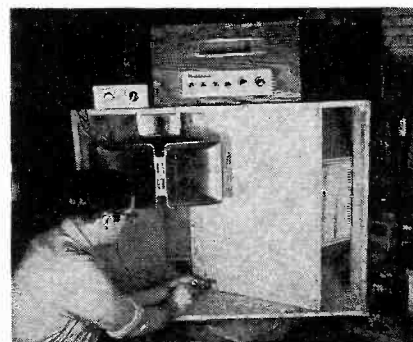

Mr. Eckel with his home-built Classic.

that the smoothest low-frequency response was produced when the chamber was moved as far as possible toward the front edge of the outer shell but still held in contact with the right end. The chamber was then rigidly fixed in position.

The total cost of the $\frac{3}{4}$ " plywood was \$30. This included 45° cuts for the 4 right-angle miter joints of the outer shell and the 65° cuts for the woofer chamber, but did not include any cutting on the 3 pieces making up the "boomerang" sound deflection assembly between the woofer chamber and the right end. I preferred to cut these myself. Each joint is held together with $\frac{3}{4} \times \frac{3}{4}$ strips and 1 $\frac{1}{4}$ -inch No. 10 flat-head wood screws. One gross was needed for the complete enclosure. The best grade wood glue was liberally applied at each joint.

The only difficulty encountered was in the assembly of the boomerang. The odd-sized angles and dimensions make this a tedious process. The plans at this late date still do not specify the exact location of the middle piece of the boomerang. Its inner edge *apparently* should coincide with the edge of the rectangular speaker cut-out.

This enclosure is used with the recommended University speakers. A Harman-Kardon Model A 300 "Theme" AM-FM tuner, Heath preamp and Williamson amplifier, and Garrard RC-90 changer are the other items in the present system and are now housed in an equipment cabinet matching the speaker enclosure. The results produced by this enclosure are well worth the few hours spent in the assembly.

James R. Eckel, Jr.
Knoxville, Tenn.

Gentlemen:

I am getting a great deal out of your articles on Basic Electronics. They seem to be easily understood so far.

However, there is something I might have missed. How do you determine the source resistance for power transfer? You assume the 10-volt battery has a 10-ohm resistance. How do you find the resistance of the battery? And/or the Z of the amplifier output to match the speaker? If that's coming up later I can wait. Just thought I'd ask.

Ernest E. Bien
Sharon Hill, Pa.

The source resistance of a battery begins at a low value when the battery is new, and increases steadily with age. Charts of source resistance versus discharge (in terms of ampere-hours) can be obtained from the battery manufacturer. In most batteries, though, discharge at a current load heavy enough that the source resistance must be considered will result in appreciably shortened battery life.

Output impedance of an amplifier will indeed be discussed at some future time in the Basic Electronics series. Briefly, it is the plate resistance of the output stage divided by the turns ratio of the output transformer, and may be modified by feedback.—ED.

AUDIONEWS

Continued from page 7

Tubes can quickly be tested for grid conductance, plate conductance, and shorts. Most important is the dynamic mutual conductance test which measures the effect of the control grid on plate-current flow. Signal and bias voltages are applied to the tube grid. Proper separate high voltages are applied through separate loads to plate and screen. Potentially weak, gassy, or low-gain tubes can be spotted by this test. As an added safety feature, the meter always indicates line voltage until one of the 2 test switches is pressed.

The RCP Model 325 tests all commercially used transistors under actual operating conditions. Current amplification is measured using a constant-current bridge and low-impedance power supply. A diode limiting circuit protects the 50- μ a meter against burn-outs due to shorted transistors.

The entire instrument is housed in a portable case measuring 15 $\frac{1}{8}$ in. by 14 $\frac{1}{4}$ in. by 5 $\frac{1}{2}$ in., complete with probe compartment and built-in pin straighteners for 7- and 9-pin tubes. The front panel is etched aluminum with red and black markings.

The price of the Model 325 is \$129.50 net through local radio parts jobbers. Full specifications on this unit will be furnished on request.

FISHER FM TUNER

A new FM tuner, the *Model FM-40*, was announced recently by the Fisher Radio Corporation. The new unit is self-powered and features a meter for accurate tuning.



Low-cost FM-40 Fisher tuner.

The FM-40 has 2 controls; an AC Power/Volume Control, and a Station Selector. The chassis is completely shielded and shock-mounted. The unit contains 7 tubes plus rectifier, and a 3-gang variable condenser. Sensitivity, according to the manufacturer, is 3 μ v for 20 db of quieting, and response is said to be uniform, ± 1 db, from 20 to 20,000 cps.

The price of the FM-40 tuner is \$99.50 (slightly higher west of the Rockies) and a cabinet (mahogany

Continued on next page

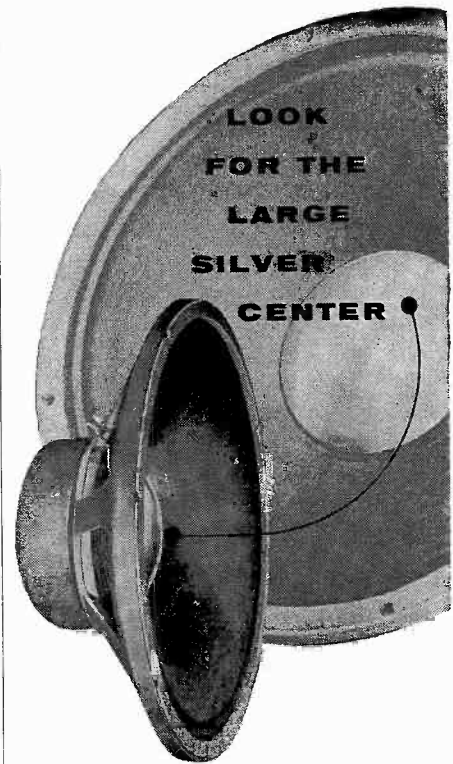

In your audio dealer's demonstration room where loudspeakers are lined up all in a military row . . . look for the speaker with the large, silvery dural dome in the center. Ear-test it with special care. This is the Jim Lansing Signature D130—the 15" Extended Range Speaker with 4" voice coil of edge-wound aluminum ribbon. The coil is attached directly to the 4" dural dome. Together they give the piston assembly exceptional rigidity. This is one reason why bass tones sound so crisp and clean . . . why the highs so smooth . . . the mid-range so well-defined. You will find the D130 to be as distinguished to your ear as it is to your eye.

THE SIGNATURE D130 (shown above) IS YOUR BASIC SPEAKER

Use it alone when you first begin your high fidelity system. Perfectly balanced with other Signature units, it later serves as a low frequency unit in your divided network system.

Additional Signature Precision Transducers with large domes and voice coils:



SIGNATURE D131 . . .
the finest 12" speaker made
O.D.—12 $\frac{1}{8}$ "
4" voice coil of edge-wound
aluminum ribbon
Depth—5"
Power input—20 watts
Impedance—16 ohms



SIGNATURE D123 . . .
an innovation in speaker design
Depth—only 3 $\frac{5}{8}$ "
O.D.—12 $\frac{1}{8}$ "
3" voice coil of edge-wound
aluminum ribbon
Power input—20 watts
Impedance—16 ohms



SIGNATURE D208 . . .
an 8" precision transducer
O.D.—8 $\frac{1}{4}$ "
2" voice coil of edge-wound
aluminum ribbon
Power input—12 watts
Impedance—D208—8 ohms
D216—16 ohms

See your audio dealer for complete catalog

precision that speaks for itself
JIM LANSING *Signature*

JAMES B. LANSING SOUND, INC.

2439 Fletcher Drive • Los Angeles 39, Calif.

High Fidelity Magic...



KIT \$49.95

Factory Wired \$79.95

NEW! 20-WATT

HIGH FIDELITY AMPLIFIER #HF20

Due to its Ultra-Linear output stage with its conservatively-rated Ultra-Linear output transformer, the #20 features negligible distortion & increased power-handling capacity at both extremes of the audio spectrum. Costliest, complete equalization facilities—plus low-distortion, wide-range tone controls & Centralab Compentrol loudness control—create a preamplifier and control section unsurpassed even in units ticketed at much higher prices.

- Power Response (20W): ± 0.5 db 20-20,000 cps; ± 1.5 db 10-40,000 cps.
- Frequency Response ($\frac{1}{2}$ W): ± 0.5 db 13-35,000 cps; ± 1.5 db 7-50,000 cps.
- Rated Power Output: 20 w (34 w peak).
- IM Distortion: (60 cps: 6 kc/4:1) at rated power: 1.3%.
- Mid-Band Harmonic Distortion at rated power: 0.3%.
- Maximum Harmonic Distortion (between 20 & 20,000 cps at 1 db under rated power): approx 1%.
- Speaker Connection Taps: 4, 8 & 16 ohms.
- High quality preamp-equalizer & control section plus complete 20-watt Ultra-Linear Williamson-type power amplifier. Output transformer in compound-filled seamless steel case.

See and HEAR it at your neighborhood distributor. Write for FREE Catalog A-4.

EICO 84 Withers St., Brooklyn 11, N. Y. Prices 5% higher on West coast © 56

RECORDING TAPES...

NEW LOW PRICES!

ALL BRANDS, 1200 ft. plastic, now list, 3.50, our net 2.28. NEW.

ALL BRANDS, 1800 ft. 1 mil Mylar long playing tapes now list, 6.50, our net 3.89. NEW.

All H.O. tapes now list 5.50, our net 3.30. NEW. New $\frac{1}{2}$ mil tape list 12.50, our net 7.45. NEW. (Above are all name brands and are not "super bargains" having no manufacturer's name.)

COMPLETE PRICE SHEET AVAILABLE

USED RECORDING TAPE (Plastic Base)

ATTENTION Industrial users: We have the New "Mylar" tapes from $\frac{1}{2}$ mil to 3 mil thickness by Scotch, Encore, Reeves Audio and Irish. We will buy your present tapes provided there is not more than 1 splice per reel.

1.49 for 7" — 1200 ft.
.74 for 5" — 600 ft.
.45 for 4" — 300 ft.
.25 for 3" — 150 ft.

★ ★ ★ ★ ★ ★ ★ ★ ★ ★ ★ ★ ★ ★
USED "MYLAR" TAPE (1 mil)

300 feet (3" reel)53
900 feet (5" reel)	1.34
1800 feet (7" reel)	2.69

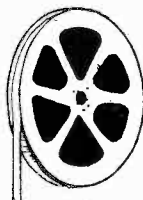

New empty plastic reels in boxes. 3" 10c; 4" 22c; 5" 24c; 7" 27c ea. 10 1/2" fiberglass Reel \$1.49. EMPTY BOXES: 3" 3c; 4", 5", 7" 5c ea.; 10 1/2", 25c ea.

"Tape Recording" magazine, 35c (back issues available). Audio Devices 1956 TAPE RECORDING DIRECTORY free.

Please Include Sufficient Postage

COMMISSIONED ELECTRONICS, INC.
2503 Champion St. N.W. Washington 9, D. C.

AUDIONEWS

Continued from preceding page

or blond finish) is available for \$14.95. Complete information will be furnished on request.

SELF-FOCUSING CATHODE RAY TUBE

The Cossor 1CP1, a new flat-face, 1-in., self-focusing cathode ray tube, said to be ideal for monitoring purposes in a variety of electronic circuits, has been announced by Beam Instruments Corporation.

The new Cossor 1CP1 features automatic self-focusing at low anode voltage from 500 to 1,500 v and has 250-volt heater-cathode insulation. Also featured



Tiny CRT for monitor circuits.

are newly designed electrodes and a structure utilizing precision ceramic tubular spacers exclusively, and new screen material which is said to provide longer life for continuous operation. Screen color is green, short persistence. Base is a standard loctal type.

Literature and detailed specifications are available upon request.

HAND-SIZE MICROPHONE

A new hand-size microphone, designed especially for use by the hi-fi enthusiast, has been developed by American Microphone Company, electronics affiliate of Elgin National Watch Company.

The new microphone is equipped with a built-in transformer to give the high impedance required in modern high fidelity equipment. The frequency range of the unit is said to be from 40 to 15,000 cps. Weight is 6. oz.

One of the D-300 Series, the microphone, according to the manufacturer,

AUDIO AIDS

We'll pay \$5.00 for usable Audio Aids. See page 48 for details.

is the first to be equipped with the Cannon XLR "quiet" connector to eliminate annoying clicks and crackles when the instrument is carried.

D-300 Series microphones are also available with 50 to 250 ohms impedance, and in a choice of satin black alumilite or polished silver and black alumilite finishes. A miniature desk stand is available with this series.

NEW HARMAN-KARDON CATALOGUE

Harman-Kardon, Inc. have recently announced a new 17-page, full-color catalogue containing information on their complete line of high fidelity instruments. Copies are available from high fidelity dealers or by writing directly to Harman-Kardon, Inc., 520 Main St., Westbury, N. Y.

BREADBOARD OCTAL SOCKET

Pomona Electronics Co., Inc., have added to their breadboard socket line with the XS-8 standard octal socket. Together with the XS-7 seven-pin miniature and XS-9 nine-pin miniature, this makes a complete kit of surface mounted breadboard sockets suitable for many electronic and experimental projects.

These sockets feature an insulated base to prevent connections from short-

TRADE-INS

LABORATORY SERVICES

NEW COMPONENTS USED COMPONENTS
Fully Guaranteed

audio exchange

THE TRADING ORGANIZATION OF THE HI-FI FIELD

159-19 Hillside Ave. | 367 Mamaroneck Ave.
Jamaica 32, N. Y. | White Plains, N. Y.
OL 8-0445 | WH 8-3380

Tues. till 9 P.M. | CLOSED MONDAYS | Thurs. till 9 P.M.

Free catalog AC3 on request

Free parking at both stores

the audio exchange exchanges audio

PROFESSIONAL DIRECTORY

Artisan Build-It-Yourself ELECTRONIC ORGANS

Send \$1.00 for "Organ Builders Manual"
ELECTRONIC ORGAN ARTS
4878 Eagle Rock Blvd.
Los Angeles 41, Calif.

HIGH-FIDELITY HOUSE

Most complete stock of Audio
components in the West

Phone: RYan 1-8171

536 S. Fair Oaks, Pasadena 1, Calif.

VOICE AND VISION HI-FI SPECIALISTS



- COMPONENTS
- CUSTOM DESIGNING
- INSTALLATIONS
- SERVICING

RUSH & WALTON CHICAGO 11, ILL.
Whitehall 3-1166

GIBSON GIRL TAPE SPLICERS

splices in a wink!

NO SCISSORS!
NO RAZOR BLADES!
Diagonal cuts tape ends
and trims splice edges

At Your Dealers

ROBINS INDUSTRIES CORP.

Boyside 51, N. Y.

AUTOMATIC CHANGER NEEDLE BRUSH

KLeeNeedLE

KLeeNeedLE automatically keeps
record changer needles clean.
It is designed to remove the
familiar "dust-blob" from under
the needle point. At Your
Dealer

ROBINS INDUSTRIES CORP. Boyside 61, N. Y.

ATOMIC JEWEL RADIOACTIVE STATIC ELIMINATOR

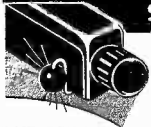

- Reduces Record Wear
 - Reduces Needle Wear
 - Improves Fidelity
- At Your Dealer

ROBINS INDUSTRIES CORP. Boyside 61, N. Y.

TRADER'S MARKETPLACE

Here's the place to buy, swap, or sell
audio equipment. Rates are only 20¢ a
word (including address) and your ad-
vertisement will reach 20,000 to 35,000
readers. Remittance must accompany
copy and insertion instructions.

RECORDS FROM YOUR TAPES. PROFESSIONAL QUALITY
TAPE OR DISC TRANSFERS AND REPRODUCTIONS.
ALL SPEEDS. LOWEST PRICES. Patmor Sound Systems,
92 Pinehurst Ave. 3K, N. Y. 33.

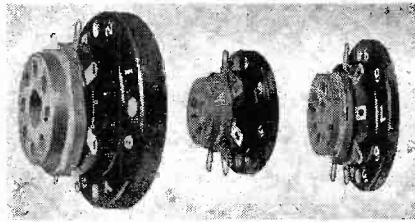

Surface-mounted tube sockets.

ing to chassis, numbered base connections for ease of identification, and silver-plated phosphor bronze contacts. For ease of installation, the 7- and 9-pin miniatures may be mounted either in the center or on the sides: the octal is mounted on the sides only.

For further information about Pomona products, write to Pomona Electronics Co., Inc., 1126 West Fifth Ave., Pomona, Calif.

EMPIRE SPEAKER ENCLOSURE AND SYSTEMS

The *Empire* low-boy speaker enclosure, *Empire* separate 2- and 3-way systems, and *Empire* factory-installed reproducers were announced recently by Electro-Voice, Inc.

Designed with a built-in corner for use in a corner or flat against one wall, the *Empire* enclosure permits the use of 15-inch coaxial or triaxial loudspeaker, or separate 15-inch, 2- or 3-way speaker system.

The enclosure employs 2 vertical, parallel porting slots. Hardwood veneers are hand-rubbed on all exposed surfaces. The cabinet is strongly braced to eliminate resonances. Dimensions of the *Empire* enclosure are 29 3/8 in. high, 32 in. wide, and 16 in. deep.

Price of the enclosure in mahogany is \$79.00, and in korina \$85.00. The *Empire* is also available complete with factory-installed 15-inch separate 2- and 3-way speaker systems from \$198.70 to \$317.20. For easy do-it-yourself, *Empire* separate 2- and 3-way speaker systems are available from \$119.70 to \$232.20, without enclosure. The enclosure kit only is \$48.00.

Complete information about the *Empire* speaker enclosure and systems will be furnished on request.

E-V "Empire" speaker system.

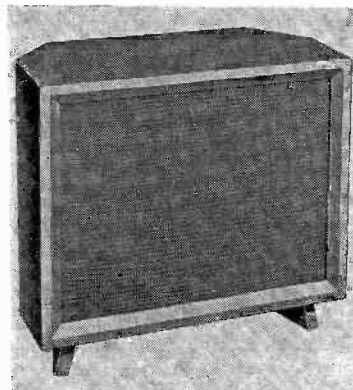

KLIPSCH



SHORTHORN assembly kit



Designed and manufactured by the originator of the KLIPSCHORN* speaker system, the SHORTHORN* is second only to the KLIPSCHORN* system in performance. Using coordinated acoustic elements, including filters, it offers exceptionally smooth response, free from distortion. Back loading horn extends bass range without resonance.

Available in kit form, with or without drive system. Prices from \$39 for the do-it-yourself horn kit to \$209 for assembled horn with Klipsch ORTHO* 3-way drive system installed. Write for literature.

*TRADEMARKS

KLIPSCH
& ASSOCIATES
HOPE, ARKANSAS



MELLOTONE HI-FI SARAN GRILLE FABRICS

... announces this special
"FREE" SAMPLE OFFER!

● Write for MELLOTONE sample advising color requirements.

● When you receive your free sample, take it to your local dealer to buy yardage needed, and see his complete line.

Remember, MELLOTONE FABRICS are HI-FI FABRICS for all color tones.

Offer limited, write today!



WENDELL PLASTIC
FABRICS CORP.

17 West 17th St., New York 11, Dept. G

Abbreviations

Following is a list of terms commonly used in this magazine, and their abbreviations. The list is arranged in alphabetical order.

alternating current	AC
ampere, amperes	amp, amps
amplitude modulation	AM
audio frequency	AF
automatic frequency control	AFC
automatic gain control	AGC
automatic volume control	AVC
capacitance	C
cathode ray tube	CRT
characteristic impedance	Z ₀
current	I
cycles per second	cps
decibel	db
decibels referred to 1 milliwatt	dbm
decibels referred to 1 volt	dbv
decibels referred to 1 watt	dbw
direct current	DC
foot, feet	ft.
frequency	f
frequency modulation	FM
henry	h
high frequency	HF
impedance	Z
inch, inches	in.
inches per second	ips
inductance	L
inductance-capacitance	LC
intermediate frequency	IF
intermodulation	IM

kilocycles (thousands of cycles) per second	Kc
kilohms (thousands of ohms)	K
kilovolts (thousands of volts)	KV
kilowatts (thousands of watts)	KW
low frequency	LF
medium frequency	MF
megacycles (millions of cycles) per second	Mc
megohms (millions of ohms)	MΩ
microampere (millionth of an ampere)	μa
microfarad (millionth of a farad)	μfd
microhenry (millionth of a henry)	μh
micromicrofarad	μμfd
microvolt (millionth of a volt)	μv
microwatt (millionth of a watt)	μw
milliampere (thousandth of an ampere)	ma
millihenry (thousandth of a henry)	mh
millivolt (thousandth of a volt)	mv
milliwatt (thousandth of a watt)	mw
ohm	Ω
permanent magnet	PM
potentiometer	pot
radio frequency	RF
resistance	R
resistance-capacitance	RC

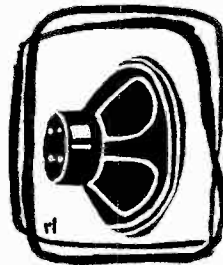

resistance-inductance	RL
revolutions per minute	rpm
root-mean-square; effective value	RMS
synchronous, synchronizing	sync
television	TV
ultra high frequency (radio)	UHF
vacuum-tube voltmeter (multipurpose)	VTVM
vacuum-tube voltmeter for AC measurements only	AC VTVM
variable reluctance	VR
very high frequency (radio)	VHF
volt	v
volt-ampere	va
voltage, or potential difference	E
volts, center-tapped	vct
watt	w

AUDIO AIDS WANTED

That's right—we'll pay \$5.00 or more for any shortcut, suggestion, or new idea that may make life easier for other AUDIOCRAFT readers, and which gets published in our Audio Aids department. Entries should be at least 75 words in length, and addressed to Audio Aids editor. No limit on the number of entries.

ADVERTISING INDEX

American Cancer Society	15
Allied Radio Corp.	5
Audio Exchange	46
Bell Sound Systems, Inc.	42
Bozak, R. T., Co.	13
Commissioned Electronics, Inc.	46
Components Corporation	9
Dyna Company	13
Eico	46
Electronic Organ Arts	47
Electro-Voice, Inc.	43
Gray Research & Development Company, Inc.	Back Cover
Heath Co.	32
High-Fidelity House	47, 48
Hollywood Electronics	44
Jensen Manufacturing Co.	2
Klipsch & Associates	47
Lansing, James B., Sound, Inc.	45
Lectronics, Inc.	41
Music Box	1
Professional Directory	47
Radio Craftsmen, Inc.	Inside Front Cover
Robins Industries Corp.	47
Scott, H. H., Inc.	14
Stephens Manufacturing Corp.	Inside Back Cover
Trader's Marketplace	47
Voice & Vision, Inc.	47
Wendell Plastic Fabrics Corp.	47

Do YOU Like To Waste Money? Can You AFFORD To Throw Money Away? ?

If not, *there are some things you should know* before buying any high fidelity equipment, regardless of where you plan to purchase.

After three years in the audio field, during which time we have become one of the largest distributors in the nation, High-Fidelity House has published Bulletin G.

This bulletin contains some startling information, much of which has never before been put into print. It can help you to prevent costly mistakes, and you will find it most fascinating reading. We suggest you write for your copy at once. Bulletin G is absolutely free.

HIGH-FIDELITY HOUSE

Dept. AC604

536 South Fair Oaks, Pasadena, California