

MAKING THE MOST OF DVD-AUDIO

AUDIO[®]

THE EQUIPMENT AUTHORITY

APRIL 1998

AUDIO INTERVIEW
KRELL'S DAN D'AGOSTINO

TESTED

**A TOWER OF POWER
FROM KLIPSCH**

**PARADIGM'S SUPER
SUBWOOFER**

ALSO TESTED

**Philips CD Recorder,
Z-Systems Digital
Preamp, and **MORE!****

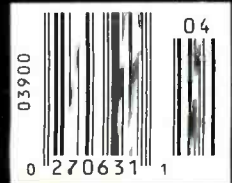

US \$3.99
UK £2.50
CAN \$4.99

#BXHBBY***** 3-DIGIT 600
#BLK0769S091 68 90088 06
MAY 98
BARBY J BULK
769 ST JOHNS
HIGHLAND PARK IL 60035-4657





DVX8000 MULTIMEDIA HOME THEATER

Experience DVD movies, DVD-ROM gaming, even the Internet with intense sound and graphics. **DVX8000** manages and enhances your entire home theater set-up. Video line doubler, 3-D graphics accelerator and audio technology

Dolby Digital is a trademark of Dolby Laboratories Licensing Corp.

P R E P A R E

D V X 8 0 0 0

F O R

YOU

I M P A C T

by Marantz® (including Dolby Digital™). All integrated with powerful multimedia PC functionality. It's entertainment to the extreme. Available at select dealers. For more info on Philips Extreme Home Entertainment call 1-888-486-6272 or visit us at www.mmhometheater.com

©1997 Philips Electronics North America Corp.



PHILIPS

Let's make things better.

AUDIO

THE EQUIPMENT AUTHORITY

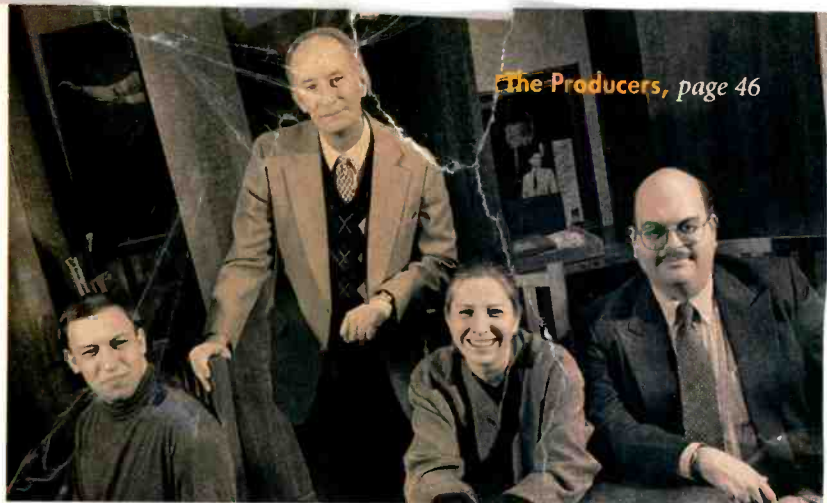

The Producers, page 46

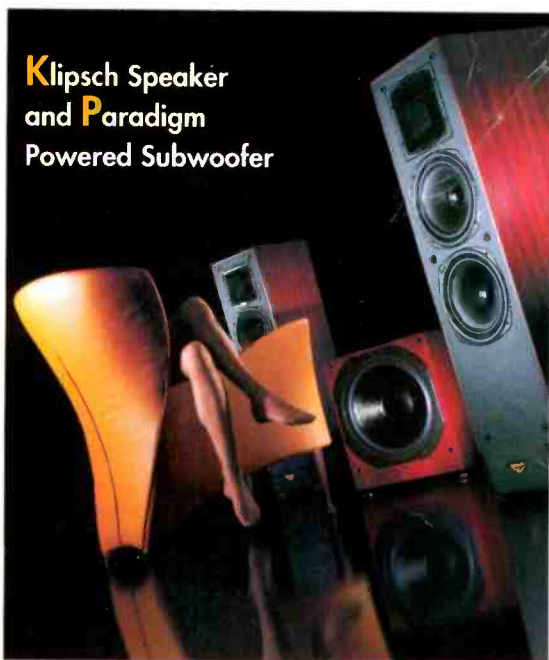

Klipsch Speaker and Paradigm Powered Subwoofer

FEATURES

- DIGITAL AUDIO FOR THE FUTURE, PART 2 J. Robert Stuart . . . 30
- THE AUDIO INTERVIEW:
 - DAN D'AGOSTINO OF KRELL Steve Guttenberg 40
- RESURRECTION: THE NEW YORK PHILHARMONIC
 - HISTORIC BROADCAST RECORDINGS Susan Elliott 46

EQUIPMENT PROFILES

- KLIPSCH KSF 10.5 SPEAKER D. B. Keele, Jr. 52
- PHILIPS CDR 870 CD-R/RW RECORDER Edward J. Foster 58
- Z-SYSTEMS RDP-1 DIGITAL PREAMP Bascom H. King 64
- PARADIGM REFERENCE SERVO-15
 - POWERED SUBWOOFER D. B. Keele, Jr. 68

AURICLES

- THETA DIGITAL MILES CD PLAYER Anthony H. Cordesman. 72
- VIENNA ACOUSTICS BEETHOVEN MK. II, MOZART,
 - AND MAESTRO SPEAKERS Anthony H. Cordesman 76

DEPARTMENTS

- FAST FORE-WORD Michael Riggs 4
- LETTERS. 6
- WHAT'S NEW 8
- AUDIOCLINIC Joseph Giovanelli. 12
- SPECTRUM Ivan Berger 16
- MONDO AUDIO Ken Kessler 20
- FRONT ROW Corey Greenberg. 24

RECORDINGS

- CLASSICAL 80
- ROCK/POP. 84
- JAZZ & BLUES 86

Cover Photographer: Bill Kouirinis Studio
Cover Equipment: Klipsch KSF 10.5 speaker and Paradigm Reference Servo-15 powered subwoofer

Audio Publishing, Editorial, and Advertising Offices,
1633 Broadway, New York, N.Y. 10019
Editorial E-Mail: audiomag@aol.com

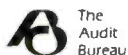

Subscription Inquiries:
Phone, 303/604-1464; fax, 303/604-7455;
e-mail, hachette@neodata.com (must include
magazine title, your name, and old and new addresses)

PLAYBACK

- PRO DIGITAL SDIOC PORTABLE
 - DAT COAXIAL IN/OUT CABLE,
 - KOSS QUIET ZONE 2000
 - HEADPHONES, AND FOSTEX COP-1
 - DIGITAL SIGNAL CONVERTER 96

Fostex Converter, page 96

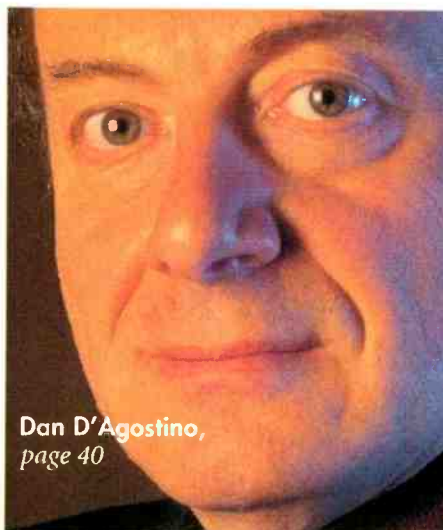

Dan D'Agostino, page 40



Digital Audio, page 30

SONY



RECORDABLE PORTABLE DIGITAL VIRTUALLY UNSHOCKABLE MINIDISC YOU KNOW YOU WANT IT... MAKE IT WITH MD.



TYRA ON THE MAKE.

In our January issue, John Gatski reported on where things stand in the effort to establish a digital radio standard for the United States. Since then, the Consumer Electronics Manufacturers Association (CEMA) has filed its final report on the subject with the Federal Communications Commission (FCC). The report is based on a six-year evaluation in which nine proposed digital radio technologies were subjected to extensive laboratory and field testing. And its conclusions are discouraging.

The report states that of the systems tested, only Eureka-147 could be expected to deliver satisfactory performance in actual use. That shouldn't be a problem—Eureka-147 is the system that has been adopted by almost every other country contemplating digital radio, including our neighbor Canada—but it is. The sticking point is that Eureka-147 operates in a block of the radio-frequency spectrum known as the L band, which in this country is owned by the military. They use it, *very* occasionally, for telemetry in weapons testing. Given that the L band is dead more than 99% of the time, one would think the Pentagon could just move the little bit of work it does there someplace else in the spectrum, thereby clearing the way for a more productive application. But it won't, so Eureka-147, the de facto world standard for digital radio, is effectively locked out of the U.S.

The proposed alternatives are IBOC (in-band, on-channel), IBAC (in-band, adjacent-channel), and S-band satellite transmission. The first two are schemes for terrestrial broadcasting of digital radio within the existing AM and FM radio bands, either inside or alongside analog transmissions. Unfortunately, CEMA has concluded that existing IBOC systems have a number of performance deficiencies with respect to both reception and audio quality and that IBAC systems cause unacceptable interference with conventional FM transmissions. And S-band transmission, it says, suffers from signal blockages for which there may be no practical remedy.

Work has not stopped on these alternatives, particularly IBOC and S-band, but many observers are skeptical that anything other than the L-band-dependent Eureka-147 will ever prove good enough to deploy. If you would like more detail, the CEMA report, *Technical Evaluations of Digital Audio Radio Systems: Laboratory and Field Test Results, System Performance, Conclusions*, is available from the FCC and is posted on the Internet at CEMA's Web site (www.cemacity.org/works/pubs/dar.htm).

On a brighter note, I recently spent a couple of days at the NAMM Show, the convention of the National Association of Music Merchants, which proved remarkably interesting. Today's music stores range from shops that sell nothing but band instruments and sheet music to large chains that carry everything from traditional musical instruments to sophisticated pro audio electronics and loudspeakers.

Over the last few years, progress in digital audio and computer technology has fostered a revolution in music-making. It is now possible to perform recording and editing feats at home or in a small studio, using just a few thousand dollars' worth of equipment and software, that not long ago would have required the services of a full-blown professional recording studio. I was particularly amazed at the bang for the buck provided by a lot of the electronics, right down to things as simple as stand-alone A/D and D/A converters. Look for coverage of some of this gear in future issues.

Meanwhile, if you have a serious interest in recording of any type, you owe it to yourself to locate a well-stocked music or pro audio store and kick a few tires. You might be as surprised as I was at what's available to hobbyists these days.



AUDIO

EDITOR-IN-CHIEF

Michael Riggs

ART DIRECTOR

Cathy Cacchione

ASSOCIATE ART DIRECTOR

Linda Zerella

TECHNICAL EDITOR

Ivan Berger

SENIOR EDITOR

Alan Lofft

MANAGING EDITOR

Kay Blumenthal

MUSIC EDITOR

Douglas Hyde

ASSOCIATE MANAGING EDITOR

Scott Van Camp

ASSISTANT EDITOR/DIRECTORY

Gerald F. McCarthy

EDITOR-AT-LARGE

Corey Greenberg

SENIOR CONTRIBUTING EDITORS

Edward J. Foster, D. B. Keele, Jr., Bascom H. King, Edward M. Long

CONTRIBUTING EDITORS/ARTISTS

Rad Bennett, David L. Clark, Anthony H. Cordesman, Ted Costa, John Diliberto, John Eargle, D. W. Fostle, John Gatski, Joseph Giovanelli, Dawn Joniec, Ken Kessler, Daniel Kumin, Robert Long, Paul Moor, John Sunier, Michael Tearson, Jon & Sally Tiven

V.P./GROUP PUBLISHER

Tony Catalano 212/767-6061

V.P./ASSOCIATE PUBLISHER

Scott Constantine 212/767-6346

GENERAL MANAGER *Greg Roperti*
BUSINESS MANAGER *Jonathan J. Bigham*
ASSISTANT BUSINESS MANAGER *Nicolas Black*
PRODUCTION DIRECTOR *Michael Esposito*
PRODUCTION MANAGER *Lynn O. Scaglione*
PROMOTION MANAGER *Adele Ferraioli-Kalters*
OFFICE MANAGER *Aline J. Pulley*
OPERATIONS MANAGER/AD COORDINATOR
Linda Neuweiler

ADVERTISING

REGIONAL V.P./AD DIRECTOR, EAST COAST
Charles L. P. Watson 212/767-6038
REGIONAL ACCOUNT MANAGER
Christine B. Ead 212/767-6025
ACCOUNT EXECUTIVE *Paul C. Smith 212/767-6077*
MIDWEST ADVERTISING MANAGER
Jerry Stoeckigt 312/923-4804
REGIONAL V.P./AD DIRECTOR, WEST COAST
Bob Meth 213/954-4831
WESTERN MANAGER *Paula Mayeri 213/954-4830*
NATIONAL RECORD LABEL SALES
MAG Inc. Mitch Herskowitz 212/490-1715
CLASSIFIED ADVERTISING
800/445-6066



CHAIRMAN *Daniel Filipacchi*
PRESIDENT AND CEO *David J. Pecker*
EXEC. V.P. AND EDITORIAL DIRECTOR
Jean-Louis Ginibre
SENIOR VICE PRESIDENT, COO *John Fennell*
PRESIDENT, NEW MEDIA *James P. Docherty*
SR. V.P./DIR., CORP. SALES *Nicholas J. Matarazzo*
SR. V.P./CFO & TREASURER *John T. O'Connor*
SR. V.P./MFG. & DISTRIBUTION
Anthony R. Romano
SR. V.P./GENERAL COUNSEL AND SECRETARY
Catherine Flickinger
V.P., CIRCULATION *David W. Leckey*
V.P., COMMUNICATIONS & SPECIAL PROJECTS
Keith Estabrook
V.P./DIR., MARKETING & SALES DEVELOPMENT
Lynn Chaiken
V.P., CORPORATE COMPLIANCE *Carlo A. Boccia*
V.P., BUSINESS DEVELOPMENT *Raymond Dreyfus*

Work for a living. Play for a life.

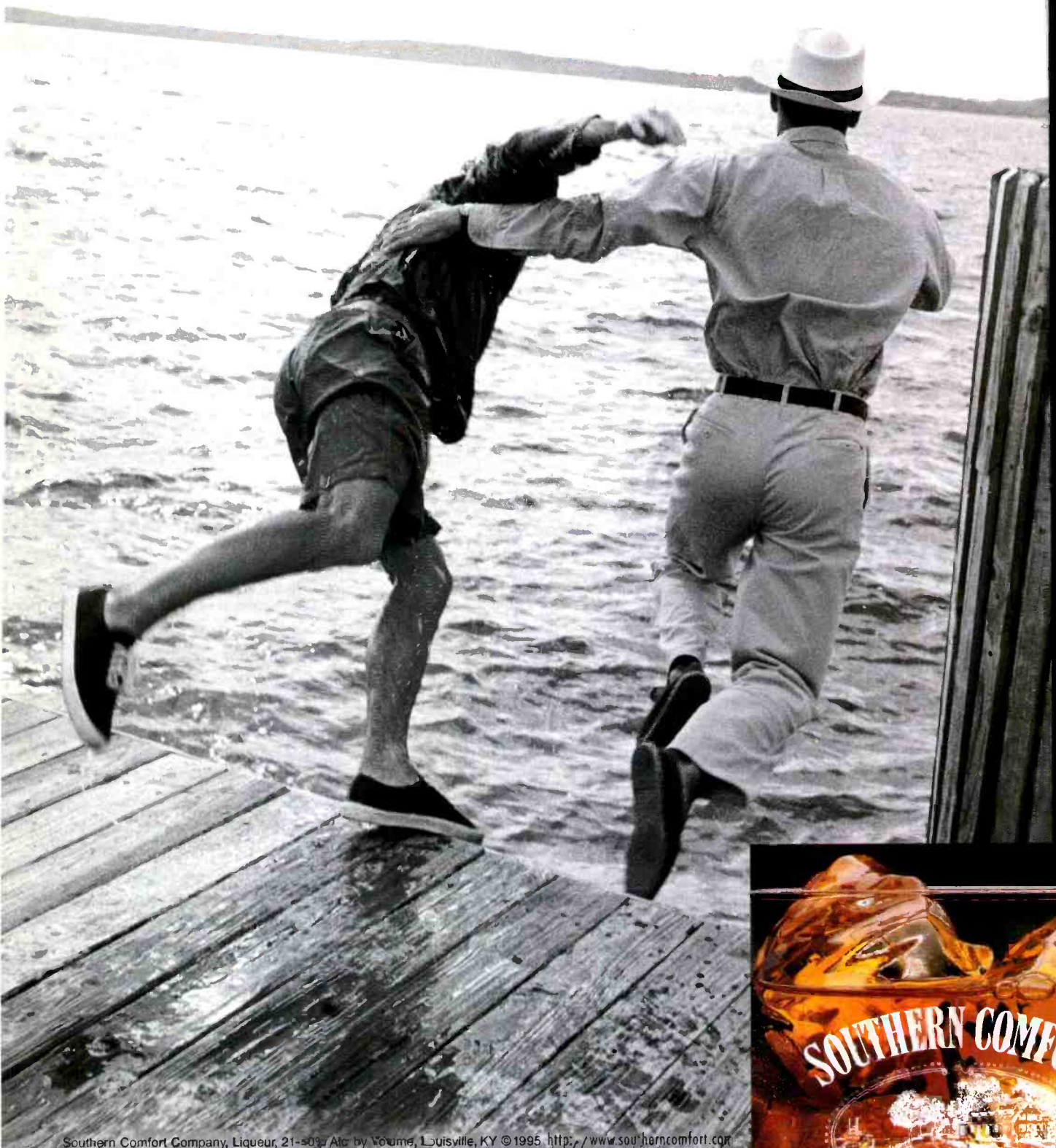

Southern Comfort Company, Liqueur, 21-50% Alc by Volume, Louisville, KY ©1995 <http://www.southerncomfort.com>

Take it easy.

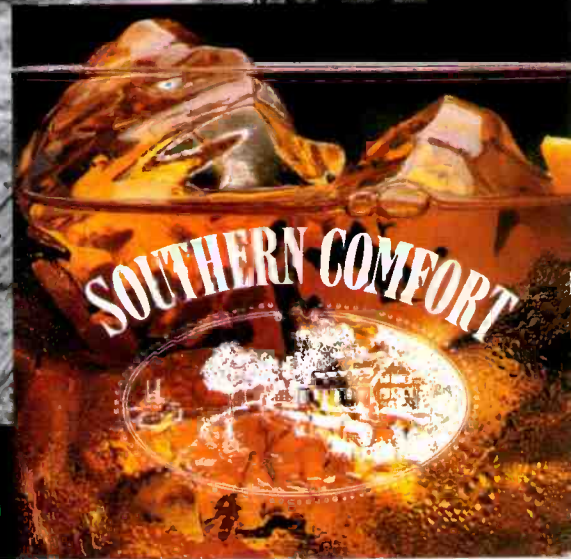

Quibbles and Bits

Dear Editor:

In Anthony H. Cordesman's review of the Krell Audio + Video Standard (December 1997), he stated that "only Theta Digital's Casablanca currently offers 20-bit DACs for the surround and subwoofer outputs—as an option."

This isn't correct. The Proceed PAV/PDSD uses identical 20-bit DACs for all channels (six standard, eight optional). It also uses the next-generation Motorola DSP chips and already features a 96-kHz digital input receiver.

The advanced technology of Proceed's PAV/PDSD comes at a price approximately \$3,000 less than for the Krell.

Seth Bradley
via e-mail

Burning Issue

Dear Editor:

Regarding Robert Long's "Living with CD-R" (February), I take issue with his total dismissal of using a computer CD-R "burner" for audio recording. Many of his comparisons are valid. However, his weighting of the comparisons are quite opinionated. I suspect that Long is not computer-literate.

I have a computer CD-R recorder and find the control I get over the resulting disc is the best reason to use a computer over a dedicated audio CD recorder. I copy cuts from my audio CDs to WAV files on my hard drive. I have editing software that enables me to edit the WAV files for length and level. Once I have everything as I like it, I burn the CD-R.

I hear very large differences in recording level from commercial CD to CD. Using a straight digital copy from an audio CD player to an audio recorder provides *no* means for level matching. The resulting "compilations" have vastly different levels between cuts from different source CDs. I can match levels on the computer hard disk before burning. The software I use (Goldwave, a \$15 shareware program) allows me to edit the WAV files down to the bit level. I have even "cut and pasted" from one WAV

file to another. This level of control is simply impossible using an audio recorder—just try standing at your equipment, hands on the pause and level controls (when using analog inputs), hoping you can press buttons and turn dials while recording.

Another reason to use computer CD-R is cost. Initial startup costs may be similar, but I'm paying no more than \$1 per blank CD-R disc (after rebates). The computer solution also has no copy protection, unlike digital audio recorders. I can make copy after copy of any disc I record, which is prohibited with audio CD-R recorders.

I had no trouble at all installing my SCSI HP4020I CD recorder in my PC, and now most computer recorders are EIDE, making installation a snap. I strongly urge everyone to seriously consider the computer CD-R over the audio CD-R. The results will be much better (and cheaper).

George Kerber
Golden, Colo.

Author's Reply: Well, you're entitled to your opinion. I thought I'd made plain that the fundamental assumption most readers are likely to make is that burning CDs is best left to a computer CD-R drive and that, therefore, it was up to me to present the contrary case—for the free-standing, consumer-grade, music-component-style CD recorder.

As a matter of fact, I'm trying to set up a computer-based system so it, working from analog originals, will let me use Cool Edit Pro to do editing that I think is best handled in the digital domain. But I want my DAT recorder to do the A/D conversion for two reasons: Any reasonably priced sound card I can find seems to have a vastly inferior ADC to begin with, and the extremely noisy computer environment is one to which I don't want to subject my analog signals.

Then there's the question of FireWire technology, which may be just around the corner to replace the multichannelly-challenged S/P DIF and AES/EBU connections that are presently the standard digital interconnects. I know, I know: You gotta go ahead and *do* it, because there's always

change just around the corner and you can't afford to wait for it. But that still leaves the other consideration.

I've already picked out the CD-R drive (no, I don't plan to go with CD-RW—maybe eventually with DVD-RAM), the added hard disk, and the SCSI card (don't ask—it's too complicated to explain). So once I've decided on the S/P DIF sound card. . . Maybe when I get it all working Ye Olde Editore will let me do another article called "Living with a CD-R Setup in a Musical Household."

You're right that if you lift recordings off existing CDs you're much better off doing it with a computer-based system. I just don't happen to cotton to that idea. As an *Audio* CD reviewer, I have too much respect for the integrity of a well-produced CD and too little interest in one that is badly produced. I prefer playing the originals, therefore. My homemade CDs are derived from LPs, 78s, and private recordings of various sorts, all of which are unavailable on commercial CDs. I suppose I could also raise the issue of copyright, but as a Usenet junkie I'm sick of the whole subject.

Anyway, enjoy your setup. I've certainly been enjoying mine.—Robert Long

Fantastic Fogerty

Dear Editor:

Daniel Levitin's interview with John Fogerty, in the January issue, was great! This is just the kind of article I've always wanted to read but have never been able to find. *Rolling Stone* and *Spin* focus too much on musicians' personalities, and *Musician* talks too much about gear and the fuzzy ideas of songwriting inspiration. In Levitin's interview, I felt like I was overhearing Fogerty talk with a fellow musician about his work.

I have long thought of Fogerty as one of the great creative forces in rock music, but I had no idea how much influence he had on the sound and music of CCR. Levitin was able to get just the right information out of him, too. I would like to see more articles like this—maybe with other self-producers, such as Paul Simon, Stevie Wonder, or Steely Dan. The focus on how recordings are made is just as important as the equipment we use to play them back. After all, when we listen, we have to be listening to *something*.

Larry Spencer
North Hollywood, Cal.

Now hear this.



The 3.3
Loudspeaker System

Design:
Ultimate expression
of NHT philosophy.
System accuracy:
Acoustical accuracy
rivaling finest audio
electronics.
Resolution:
Spatial/spectral
soundfield fully
responsive to
recording.
Enclosure:
Radical enclosure
optimizes radiation
over full audio
frequency range.
Componentry:
Individually matched
components assure
laboratory precision
within 0.3dB

Patrick Smith.
Music Mixer, The Tonight
Show with Jay Leno.
Berklee College of Music
grad. Husband. Formula 1
racing fan. Big proponent
of NHT 3.3s and the rather
sizeable hand-wrapped
Dominican torpedo.

Knows a pure note when he hears it.

Everything you hear is true. Audio: SuperZero • SuperOne • 1.5 • 2.5 I • 2.9 • 3.3 Home Theater: VT-2 • VS-2a • VT-1.2 • VS-1.2a

WHAT'S NEW

AudioQuest FLAT SPEAKER CABLES

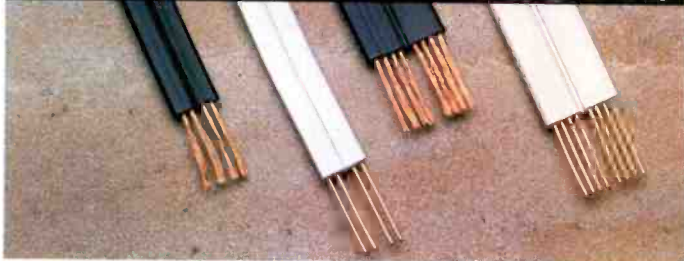

Hiding conventional speaker cable under a carpet is futile, because a bump is always visible. However, the F (solid-conductor, Hyperlitz) or FF (stranded, flexible) series of flat cables, just 2 millimeters thick, should solve the problem. The F-14 and FF-4 have four,

17-gauge, long-grain copper (LGC) conductors per cable; the F-18 and FF-8 have eight, 14-gauge LGC conductors. The FF type is available in white or black; the F, in white, brown, or blue. Prices: F-14 or FF-4, 95¢ per foot; F-18 or FF-8, \$1.95 per foot. (AudioQuest, 714/498-2770)



Panasonic Portable DVD Player

You can watch DVD movies anywhere you want on the 5½-inch, high-resolution LCD display of the DVD-L10, the world's first portable DVD player. A touch of a button will select the aspect ratio (4:3 for standard-width TV screen or 16:9 for widescreen), and there's an optical

output for the Dolby Digital (AC-3) surround sound bitstream, so you can plug the DVD-L10 into your home theater. Other features include a rechargeable two-hour battery, a 96-kHz, 24-bit audio D/A converter, 10-bit video DAC, and composite- and S-video jacks. Price: \$1,299. (Panasonic, 800/222-4213)

The ED-301 uses a Motorola 56009 processor and 20-bit D/A conversion to decode an AC-3 bitstream into 5.1 discrete analog channels. Outputs include a multipin DB-25 and six RCA jacks, and there are optical and coaxial digital inputs and six discrete RCA inputs, the latter for

Onkyo Dolby Digital Decoder



future upgrading (e.g., DVD-Audio). A six-way test signal aids system balancing and subwoofer level adjustment. The ED-301 has Home THX Cinema Re-EQ to tame strident soundtracks and a Midnight Theater compression mode. Price: \$450. (Onkyo, 201/825-7950)

SVETLANA TUBES



Intended for high-end audio components or guitar amps, the SV572 series of triode tubes have directly heated tungsten filaments and graphite anodes rated for 125 watts of dissipation. These attributes are

said to help produce excellent power output and rich sound. The SV572 tubes are available in four types for different modes of operation. Price: \$57 each. (Svetlana Electron Devices, 650/233-0429)

AMC INTEGRATED AMP

Rated at 20 watts per channel into 8 ohms, the Model 3020 has an unusual feature that lets you blend computer and audio sources (CD, tuner, and so on) by adjusting source input level controls. The mixed signal is available at the tape output jacks, enabling you to record

mixed-down recordings from your computer and audio systems. The 3020 is said to produce peak output current of 17 amperes into 1-ohm loads. Total harmonic distortion is specified at 0.03% or less, from 20 Hz to 20 kHz. Price: \$249. (AMC, c/o Weltronics, 818/799-6396)



GFA

5802



Before you buy an expensive power amplifier, read the fine print.

Adcom's dedication to uncompromising sonic reproduction, innovative circuit design, and the highest quality electronic parts guarantee that, dollar for dollar, you're getting the best value in the audio world. At 300 watts per channel into 8 ohms and 450 watts per channel into 4 ohms*, our new GFA-5802 combines innovative all MOSFET circuitry with a tremendous power supply to out perform the so-called 'super amps' retailing for two to three times the price.

To produce this remarkable amplifier, Adcom started with an enormous toroidal power transformer. Totally separate secondary windings and independent ground connections assure each channel is completely isolated from crosstalk and AC line interference. Lots of clean power for lots of clear and powerful sound. Even the neighbors will enjoy it.

In addition to the GFA-5802's main toroidal transformer, a separate front end transformer is also used. This additional device isolates the front end input stages from the main output section so any peak demands from the output stages will not decrease the operating voltages for the input sections. This design also contributes to improved separation at the inputs for precise soundstaging and imaging.

Adcom's new GFA-5802 power amplifier also has exceptionally large capacitors to store large amounts of DC current for supply to the speakers. This large storage capacity means that the amp won't be starved for power when you're driving low impedance and/or inefficient speaker systems. Now your speakers and your music can sound the way you expect them to. All the time.

The well organized and simple design of the GFA-5802's glass epoxy circuit boards assures outstanding and reliable operation. Class 'A' circuitry in the front end, the Adcom GFA-5802 delivers the pure sound that other amplifiers can only talk about. All devices are precision matched for maximum performance, negligible distortion, and higher output currents.

We use only International Rectifier Hexfets transistors in the signal path of the Adcom GFA-5802. These Hexfet circuits are reference grade, hybrid MOSFET transistors which reproduce all the punch and muscle of bipolar devices but with the musical sound of tube amps. And since the GFA-5802 has only three gain stages it out performs comparable amps which usually have five stages or more. The shorter the path of power resistance, the better the sound.

The GFA-5802 comes with versatile binding posts for easy speaker hook-ups. Accepting either standard stripped or 'tinned' wires, single or dual banana plugs or spade lug connectors, the GFA-5802 is a great match for any system. And since it can drive virtually any speaker system regardless of its impedance, even the most demanding speakers will sing beautiful music. Additionally, the GFA-5802 also comes equipped with two sets of binding posts for each channel. These extra binding posts allow the GFA-5802 to accommodate speaker systems that have 'bi-wire' capability.

Adcom makes sure that the sound created by your other components can be flawlessly transferred to the GFA-5802's balanced power and optimum circuit technology. The GFA-5802 is equipped with two types of input connectors for complete compatibility, high quality gold-plated RCA jacks and XLR jacks. The GFA-5802's professional grade three pin XLR jacks provide both positive, negative and shield properties. The result is a balanced line connection between the GFA-5802 and your other components. This connection is essentially immune to electromagnetic and radio frequency interference and provides a significant reduction in 'common mode noise'.

Dependable technology and efficient use of the highest quality parts make the GFA-5802 one of the most sought after audiophile products in recent years. And because it's an Adcom component it will benefit from a high resale value and an outstanding dealer service network. After you hear the GFA-5802 you'll agree that it's an incredible value in high end audio.

The most important detail to look for before you buy your next amplifier is the Adcom name. Adcom audio and audio/video components are designed to be second to none. It's this driving passion for accurate, musical sound and performance that has made Adcom components sought after by the discriminating audiophile. Through a combination of technology and innovative engineering techniques, the Adcom GFA-5802 is quite possibly the best amplifier you may ever hear. From its toroidal transformer and giant capacitors to its reference grade Hexfet circuitry, the Adcom GFA-5802 is built to be the best amplifier money can buy.

Your ears will thank you.
And so will what's between them.

ADCOM®
Designed for your ears.
And what's between them.

11 Elkins Road • East Brunswick, N.J. 08816 • U.S.A.
Tel: 732-390-1130 • Fax 732-390-5657 • Web: <http://www.adcom.com>

WHAT'S NEW

VELODYNE POWERED SUBWOOFER

Using a high-gain servo system that measures woofer cone movements 3,500 times per second and corrects distortion-creating errors, the FSR-18 is said to deliver clean, accurate sound from 15 to 120 Hz. THD is specified at less than 1%. A built-in Class-D amplifier, which is rated at 1,250 watts continuous output, powers the magnetically shielded

18-inch driver. Other features include signal-sensing on/off circuitry, remote control with volume presets, adjustable low-pass filter (40 to 120 Hz), high-pass outputs (80 and 100 Hz), and a switch to bypass the internal crossover. Price: \$2,399 in black vinyl, \$2,499 in high-gloss black or rosewood. (Velodyne, 800/835-6396)



AUDES SPEAKER

Built in Estonia, the Model 75AC-105 is a two-way, bass-reflex system with a frequency range specified at 50 Hz to 20 kHz. The front-ported cabinet, internally braced for stiffness, is 13½ inches tall and 9¾ inches wide.

The nominally 8-ohm system has a 6½-inch woofer and a ¾-inch tweeter. Sensitivity is specified at 86 dB (1 watt/1 meter) and power handling at 100 watts. Price: \$400 per pair. (Audes, c/o Savva Group, 212/938-9283)



ACOUSTIC RESEARCH SPEAKER ▲

Inside each P315 HO floor-standing speaker is a Bob Carver-designed, 500-watt Sunfire amplifier that drives a servo-controlled 15-inch woofer, side-mounted to improve bass coupling to the room. The woofer/amp combo is said to be capable of dramatic bass output levels down to 20 Hz. A three-way, acoustic-suspension system, the P315 HO has two midrange drivers and a diamond-coated, 1-inch titanium-dome tweeter. Frequency response is specified at 20 Hz to 20 kHz, ±3 dB. Price: \$1,199.50 each. (Acoustic Research, c/o Recoton Home Audio, 800/648-9993)

JAMO THX HOME THEATER SYSTEM

With all signals digitized, including analog inputs, the Digital Cinemaster system is said to provide unprecedented clarity, low distortion, and ease of use. Additionally, crossovers, active equalization for each speaker driver, automatic calibration to the listening room, and even THX surround decorrelation are done digitally. The

three front speakers, two surround speakers, and the sub are self-powered. Total continuous power output is said to be 1,900 watts; peaks of 4,000 watts are possible. The motion-feedback subwoofer has two back-to-back 15-inch drivers and a 750-watt, Class-D amp. Price: \$30,000. (Jamo Hi-Fi, 847/465-0005)





F-1800R11

World's Best Subwoofer Technology...

Patented *True Accelerometer-Based High Gain Servo Control*

- Low distortion, clean, accurate sound that Velodyne is famous for.
- Smoothest frequency response of any subwoofer.

Revolutionary New *Energy Recovery Switching Amplifier Design*

- Transformerless direct-line power switching creates the most powerful amplifier in any subwoofer: (1000 watts RMS/3000 peak).
- Patent pending design eliminates shoot-thru current for the highest amplifier efficiency ever achieved.

Tandem Voice Coil in Push-Pull Motor Structure

- High linear excursion capability
1 1/4" peak to peak, 2" max.
- Four times the heat dissipation for high power handling and long life.
- Less than 1/2 the distortion of conventional motor designs.

"The Velodyne's performance here was breathtaking. In fact, it may very well have threatened the room's structural integrity had we not backed off the volume a bit..."

Al Griffin, *Home Theater*, December '96

"This is bass that doesn't end, in frequency or in level! It is bass that is literally felt as much as heard - on occasion, more felt than heard."

Edward J. Foster, *Audio*, March '97

"Bring on the challengers. They won't have an easy job... the Velodyne F-1800R11 is the best subwoofer I have yet had in my home theater."

Thomas J. Norton,
Stereophile Guide to Home Theater, Fall '97

New! ... ULTRA SMALL PACKAGE

All of the best features of the world famous F-1800R11 have been put into a smaller cabinet. Response down to 20 Hz for audiophiles with output levels to satisfy all home theater systems. Now you don't have to sacrifice sound quality for a compact, easy to place subwoofer.



HGS-10

(actual size: 11.25"H x 11"W x 11"D)

Velodyne®

Velodyne Acoustics, Inc., 1070 Commercial Street, Suite 101, San Jose, CA 95112

Phone: 408-436-7270 • Fax: 408-436-7276 • Web Site: www.velodyne.com • E-mail: velodyne@earthlink.net • Literature Requests: 1-800-VELODYNE

Fixing Scratched CDs

Here's an easy method to fix scratched CDs, one I used years ago to polish a scratched watch crystal. Use a bit of toothpaste and a soft cotton cloth, like an old T-shirt. Wrap a small part of the cloth around your index finger, but make sure it doesn't bunch up when you polish the disc's surface. Apply a tiny amount of toothpaste, rubbing it back and forth radially in a straight line across the disc, and then buff off the residue in the same manner. I practiced this on an unwanted CD until I perfected my technique. It works very well!—Richard Lester, Raleigh, N.C.

Taking a Stand

Q What would happen if I used cinder blocks, filled with sand or lead shot, as speaker supports in place of traditional steel stands? I assume I wouldn't need to use the spikes that screw into the bottom of steel stands, because the cinder blocks would be very solid.—Robert Yu, Flushing, N.Y.

A I have to think that cinder blocks filled with sand or lead shot would work well as speaker stands. The purpose of the stand (if you accept the premise of one audiophile faction) is to provide a support that does *not* transmit vibration from the speaker enclosure to the floor; in other words, it isolates the speaker. This is best achieved by means of some sort of resilient shock mounting. However, if you examine the physics of sound propagation, it is evident that no stand can ever provide total isolation of any speaker. The reason? Because it's the *acoustical* energy radiated by the woofer, and the standing waves triggered by that energy (and by the interaction of the room's dimensions and the speaker's location), that ultimately stimulate the vibrations and resonances of various objects and room surfaces. Other audio enthusiasts endorse using spikes to couple a speaker to the floor, thereby encouraging the transmission of vibration to the listener's feet.

In my view, the arguments pro and con are greatly overshadowed by the aforementioned effects of acoustical propagation. For

most listeners, the principal acoustical benefit of speaker stands (of whatever type) is to raise the speaker's tweeter to ear level and move the woofer far enough above the floor to eliminate or reduce woofer/floor interactions that might otherwise color bass reproduction. Incidentally, most experts agree that the layering of dissimilar materials—e.g., rubber, cinder blocks, sand, and so on—will discourage the transmission of vibration.

CB Interference

Q On summer nights and on weekends, the highway 50 feet from my house turns into a haven for high school kids cruising in their cars. They use CB radios to communicate with each other, and if someone is transmitting as he passes my house, I hear that transmission over my speakers. I have three identical receivers located in various rooms. Their power is on with no audio source plugged in. Volume is turned down, and it does not matter which program source is selected. Under these conditions, I still receive 3-second bursts of CB interference about 15 times a week. I have tried other receivers and some integrated amplifiers; all receive the interference. I haven't tried components with balanced inputs. No speaker cable is longer than 10 feet. One of the engineers at a local radio station suggested putting 0.01-microfarad capacitors across the speaker output terminals. I have wound a part of the power cord around a ferrite choke, placed very close to the receiver. What else can I do?—Dave Popovich, West Allis, Wisc.

A You should determine if the capacitors or the ferrite will help. Often it is necessary to add even more ferrite to the power cord. Ferrite increases impedance to the flow of RF into the equipment via the power cord.

As for using bypass capacitors, well, they're almost a good idea. Try connecting a bypass capacitor of perhaps 0.01 microfarad from each speaker output terminal on the back of the receiver to a screw on the chassis. Do this even if the common side of the speaker is connected to chassis ground.

Inductance can make what should be a ground virtually useless. Use the shortest possible leads on these capacitors.

You may find that the speaker cable should be wound onto ferrite, if this is physically possible. Keep this as close to the chassis as you can.

You should also consider using shielded speaker wire, with the shield connected directly to the chassis rather than to the common ground usually employed. Leave the shield unconnected at the speaker ends. Of course, connect the two inner conductors as you would any speaker cable.

Dolby Digital Connections

Q I'd like to connect a Dolby Digital (AC-3) decoder to my five-channel power amp, but my preamp doesn't have inputs that can be fed directly from the decoder. Therefore, I think I should hook up the decoder between my preamp and the inputs to the amp. Will this suffice? And, for the surround and center-channel speakers, must I use the same expensive speaker cable that I use for the front speakers?—Name withheld

A You need not use identical cable. The main criterion for speaker cable is that the gauge of the wire be thick enough for the distance required, in order to keep resistance low. You must also take into account the impedance of the speakers; if it dips below 4 ohms and the cable run is 30 or 40 feet, use AWG No. 8 or 10 cable. Otherwise, 12-gauge cable should be more than ample for most cable runs in domestic settings.

I see no problem with your planned wiring; it's what I would do. As you indicate, the various outputs from the processor are connected to their appropriate power amplifier inputs. The two preamplifier output channels are connected to the inputs on the processor. However, coaxial or optical digital sources that carry the AC-3 bit-stream must be routed directly to the appropriate digital inputs on the Dolby Digital decoder.

If you have a problem or question about audio, write to Mr. Joseph Giovanelli at AUDIO Magazine, 1633 Broadway, New York, N.Y. 10019, or via e-mail at JOEGIO@delphi.com. All letters are answered. In the event that your letter is chosen by Mr. Giovanelli to appear in Audioclinic, please indicate if your name or address should be withheld. Please enclose a stamped, self-addressed envelope.

The Krell® Full Power Balanced 600 power amplifier and the Krell® KAV-300i integrated amplifier establish new standards for performance and design. Both amplifiers are among the few products holding the distinguished Class A rating from *Stereophile*.

A fully regulated output stage in the Full Power Balanced 600 enables the amplifier to produce up to *2400 watts per channel* of clean power for open, effortless sound.



Complementary, discrete circuitry in the KAV-300i delivers *300 watts per channel* of pure Krell-quality sound.

The robust designs of all Krell® Full Power Balanced and KAV-Series amplifiers feature proprietary output devices that are yet another hallmark of Krell® design.

Distinguished Quality

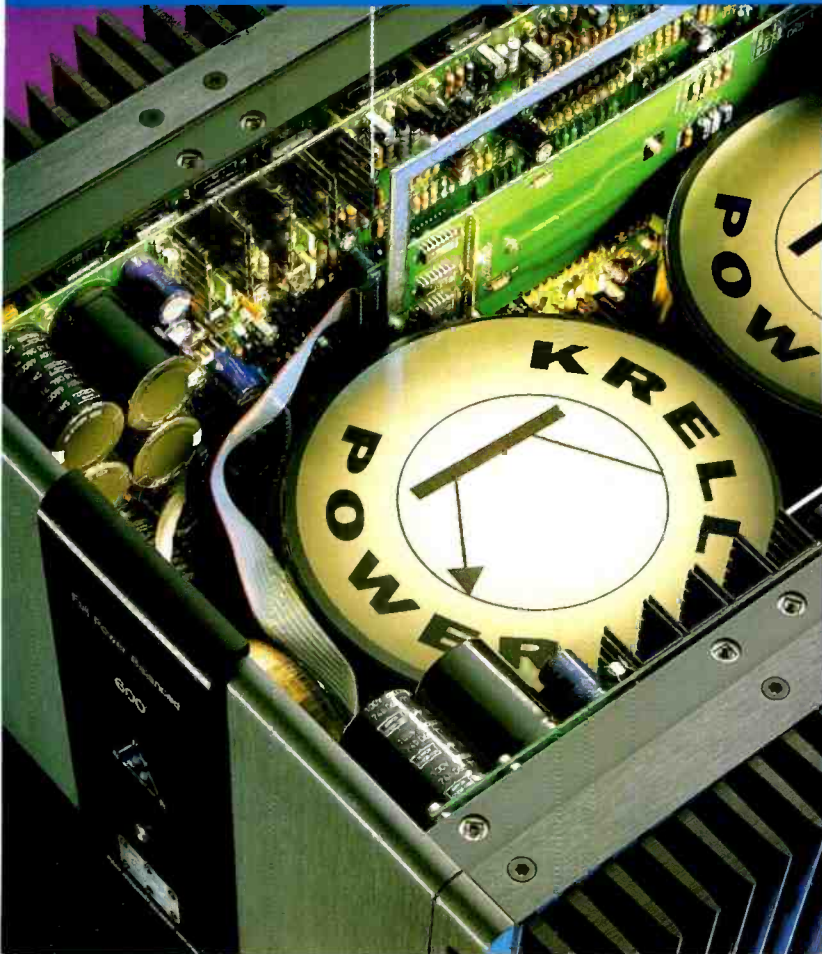

*powerful
traits*



The Leader in Audio Engineering

Krell® Industries, Inc.
45 Connair Road
Orange, CT 06477 USA
TEL 203-799-9954
FAX 203-799-9796
<http://www.krellonline.com/~krell>

Klipsch AUTHORIZED DEALERS

Alabama	Madison Caldwell Soundworks Crown Audio TV DJ's Stereo Video The Good Guys Hammaker's Ken Crider Sound Advice Video and Audio Center Zip Audio	Arkansas Crown Dorrel Audio Video Full Drive All Louisiana locations Tombala Los Angeles Eureka Torrance Santa Monica Fullerton All Colorado locations Newark All Connecticut locations Burr Pensacola Jacksonville Beach All Florida locations Gainesville All Georgia locations Toccoa Bokarboraville West Dundee Galesburg Glenwood Villa Park Sterling Springfield All Illinois locations Akron Fort Wayne Crown Audio Huntington All Indiana locations Des Moines, Cedar Rapids Levellington, Lawrenceville Lake Charles Scarborough Luzon Greenfield Worcester All Massachusetts locations Dearborn, Farmington Hills Royal Oak Grand Rapids, Kalamazoo Flint Muskegon Lansing Rochester Hills All Minnesota locations Bozeman Billings All Nevada locations All Nevada locations Bedford All New Hampshire locations All New Jersey locations Northfield Albuquerque Albuquerque Boonville New York All New York locations Syracuse Rochester Amherst New York Rocky Mount All North Carolina locations Conover Canal Winchester All Ohio locations Tulsa All Oregon locations All Oregon locations Greensburg Pittsburg Warwick Sioux Falls Nashville All Tennessee locations Cordova San Antonio Odessa Dallas All Texas locations All Utah locations Burlington Virginia Beach Northfield, Roanoke Richmond All Washington locations All Washington locations All West Virginia locations New Berlin, Brookfield Appleton, Onalaska Casper
Arizona	Ultimate Electronics Stereo Entertainment Center Century Audio Video Luscik Electronics The Eddie Gurs Simply Stereo Sterling Electronics Sundown Audio/Video Grand Audio Center	California Audio King Classic Stereo Crown Electronics Lectern Electronics Orlando Audio King Orlando Lake Charles Music Hi Music Audio Video Solutions The Music Store Peter's Tweeter Etc. Almas Hi-Fi Stereo
California	Ultimate Electronics Stereo Entertainment Center Century Audio Video Luscik Electronics The Eddie Gurs Simply Stereo Sterling Electronics Sundown Audio/Video Grand Audio Center	California Audio King Classic Stereo Crown Electronics Lectern Electronics Orlando Audio King Orlando Lake Charles Music Hi Music Audio Video Solutions The Music Store Peter's Tweeter Etc. Almas Hi-Fi Stereo
Colorado	Ultimate Electronics Stereo Entertainment Center Century Audio Video Luscik Electronics The Eddie Gurs Simply Stereo Sterling Electronics Sundown Audio/Video Grand Audio Center	California Audio King Classic Stereo Crown Electronics Lectern Electronics Orlando Audio King Orlando Lake Charles Music Hi Music Audio Video Solutions The Music Store Peter's Tweeter Etc. Almas Hi-Fi Stereo
Connecticut	Ultimate Electronics Stereo Entertainment Center Century Audio Video Luscik Electronics The Eddie Gurs Simply Stereo Sterling Electronics Sundown Audio/Video Grand Audio Center	California Audio King Classic Stereo Crown Electronics Lectern Electronics Orlando Audio King Orlando Lake Charles Music Hi Music Audio Video Solutions The Music Store Peter's Tweeter Etc. Almas Hi-Fi Stereo
Delaware	Ultimate Electronics Stereo Entertainment Center Century Audio Video Luscik Electronics The Eddie Gurs Simply Stereo Sterling Electronics Sundown Audio/Video Grand Audio Center	California Audio King Classic Stereo Crown Electronics Lectern Electronics Orlando Audio King Orlando Lake Charles Music Hi Music Audio Video Solutions The Music Store Peter's Tweeter Etc. Almas Hi-Fi Stereo
Florida	Ultimate Electronics Stereo Entertainment Center Century Audio Video Luscik Electronics The Eddie Gurs Simply Stereo Sterling Electronics Sundown Audio/Video Grand Audio Center	California Audio King Classic Stereo Crown Electronics Lectern Electronics Orlando Audio King Orlando Lake Charles Music Hi Music Audio Video Solutions The Music Store Peter's Tweeter Etc. Almas Hi-Fi Stereo
Georgia	Ultimate Electronics Stereo Entertainment Center Century Audio Video Luscik Electronics The Eddie Gurs Simply Stereo Sterling Electronics Sundown Audio/Video Grand Audio Center	California Audio King Classic Stereo Crown Electronics Lectern Electronics Orlando Audio King Orlando Lake Charles Music Hi Music Audio Video Solutions The Music Store Peter's Tweeter Etc. Almas Hi-Fi Stereo
Illinois	Ultimate Electronics Stereo Entertainment Center Century Audio Video Luscik Electronics The Eddie Gurs Simply Stereo Sterling Electronics Sundown Audio/Video Grand Audio Center	California Audio King Classic Stereo Crown Electronics Lectern Electronics Orlando Audio King Orlando Lake Charles Music Hi Music Audio Video Solutions The Music Store Peter's Tweeter Etc. Almas Hi-Fi Stereo
Indiana	Ultimate Electronics Stereo Entertainment Center Century Audio Video Luscik Electronics The Eddie Gurs Simply Stereo Sterling Electronics Sundown Audio/Video Grand Audio Center	California Audio King Classic Stereo Crown Electronics Lectern Electronics Orlando Audio King Orlando Lake Charles Music Hi Music Audio Video Solutions The Music Store Peter's Tweeter Etc. Almas Hi-Fi Stereo
Iowa	Ultimate Electronics Stereo Entertainment Center Century Audio Video Luscik Electronics The Eddie Gurs Simply Stereo Sterling Electronics Sundown Audio/Video Grand Audio Center	California Audio King Classic Stereo Crown Electronics Lectern Electronics Orlando Audio King Orlando Lake Charles Music Hi Music Audio Video Solutions The Music Store Peter's Tweeter Etc. Almas Hi-Fi Stereo
Kansas	Ultimate Electronics Stereo Entertainment Center Century Audio Video Luscik Electronics The Eddie Gurs Simply Stereo Sterling Electronics Sundown Audio/Video Grand Audio Center	California Audio King Classic Stereo Crown Electronics Lectern Electronics Orlando Audio King Orlando Lake Charles Music Hi Music Audio Video Solutions The Music Store Peter's Tweeter Etc. Almas Hi-Fi Stereo
Kentucky	Ultimate Electronics Stereo Entertainment Center Century Audio Video Luscik Electronics The Eddie Gurs Simply Stereo Sterling Electronics Sundown Audio/Video Grand Audio Center	California Audio King Classic Stereo Crown Electronics Lectern Electronics Orlando Audio King Orlando Lake Charles Music Hi Music Audio Video Solutions The Music Store Peter's Tweeter Etc. Almas Hi-Fi Stereo
Louisiana	Ultimate Electronics Stereo Entertainment Center Century Audio Video Luscik Electronics The Eddie Gurs Simply Stereo Sterling Electronics Sundown Audio/Video Grand Audio Center	California Audio King Classic Stereo Crown Electronics Lectern Electronics Orlando Audio King Orlando Lake Charles Music Hi Music Audio Video Solutions The Music Store Peter's Tweeter Etc. Almas Hi-Fi Stereo
Maine	Ultimate Electronics Stereo Entertainment Center Century Audio Video Luscik Electronics The Eddie Gurs Simply Stereo Sterling Electronics Sundown Audio/Video Grand Audio Center	California Audio King Classic Stereo Crown Electronics Lectern Electronics Orlando Audio King Orlando Lake Charles Music Hi Music Audio Video Solutions The Music Store Peter's Tweeter Etc. Almas Hi-Fi Stereo
Maryland	Ultimate Electronics Stereo Entertainment Center Century Audio Video Luscik Electronics The Eddie Gurs Simply Stereo Sterling Electronics Sundown Audio/Video Grand Audio Center	California Audio King Classic Stereo Crown Electronics Lectern Electronics Orlando Audio King Orlando Lake Charles Music Hi Music Audio Video Solutions The Music Store Peter's Tweeter Etc. Almas Hi-Fi Stereo
Massachusetts	Ultimate Electronics Stereo Entertainment Center Century Audio Video Luscik Electronics The Eddie Gurs Simply Stereo Sterling Electronics Sundown Audio/Video Grand Audio Center	California Audio King Classic Stereo Crown Electronics Lectern Electronics Orlando Audio King Orlando Lake Charles Music Hi Music Audio Video Solutions The Music Store Peter's Tweeter Etc. Almas Hi-Fi Stereo
Michigan	Ultimate Electronics Stereo Entertainment Center Century Audio Video Luscik Electronics The Eddie Gurs Simply Stereo Sterling Electronics Sundown Audio/Video Grand Audio Center	California Audio King Classic Stereo Crown Electronics Lectern Electronics Orlando Audio King Orlando Lake Charles Music Hi Music Audio Video Solutions The Music Store Peter's Tweeter Etc. Almas Hi-Fi Stereo
Minnesota	Ultimate Electronics Stereo Entertainment Center Century Audio Video Luscik Electronics The Eddie Gurs Simply Stereo Sterling Electronics Sundown Audio/Video Grand Audio Center	California Audio King Classic Stereo Crown Electronics Lectern Electronics Orlando Audio King Orlando Lake Charles Music Hi Music Audio Video Solutions The Music Store Peter's Tweeter Etc. Almas Hi-Fi Stereo
Mississippi	Ultimate Electronics Stereo Entertainment Center Century Audio Video Luscik Electronics The Eddie Gurs Simply Stereo Sterling Electronics Sundown Audio/Video Grand Audio Center	California Audio King Classic Stereo Crown Electronics Lectern Electronics Orlando Audio King Orlando Lake Charles Music Hi Music Audio Video Solutions The Music Store Peter's Tweeter Etc. Almas Hi-Fi Stereo
Missouri	Ultimate Electronics Stereo Entertainment Center Century Audio Video Luscik Electronics The Eddie Gurs Simply Stereo Sterling Electronics Sundown Audio/Video Grand Audio Center	California Audio King Classic Stereo Crown Electronics Lectern Electronics Orlando Audio King Orlando Lake Charles Music Hi Music Audio Video Solutions The Music Store Peter's Tweeter Etc. Almas Hi-Fi Stereo
Montana	Ultimate Electronics Stereo Entertainment Center Century Audio Video Luscik Electronics The Eddie Gurs Simply Stereo Sterling Electronics Sundown Audio/Video Grand Audio Center	California Audio King Classic Stereo Crown Electronics Lectern Electronics Orlando Audio King Orlando Lake Charles Music Hi Music Audio Video Solutions The Music Store Peter's Tweeter Etc. Almas Hi-Fi Stereo
Nebraska	Ultimate Electronics Stereo Entertainment Center Century Audio Video Luscik Electronics The Eddie Gurs Simply Stereo Sterling Electronics Sundown Audio/Video Grand Audio Center	California Audio King Classic Stereo Crown Electronics Lectern Electronics Orlando Audio King Orlando Lake Charles Music Hi Music Audio Video Solutions The Music Store Peter's Tweeter Etc. Almas Hi-Fi Stereo
Nevada	Ultimate Electronics Stereo Entertainment Center Century Audio Video Luscik Electronics The Eddie Gurs Simply Stereo Sterling Electronics Sundown Audio/Video Grand Audio Center	California Audio King Classic Stereo Crown Electronics Lectern Electronics Orlando Audio King Orlando Lake Charles Music Hi Music Audio Video Solutions The Music Store Peter's Tweeter Etc. Almas Hi-Fi Stereo
New Hampshire	Ultimate Electronics Stereo Entertainment Center Century Audio Video Luscik Electronics The Eddie Gurs Simply Stereo Sterling Electronics Sundown Audio/Video Grand Audio Center	California Audio King Classic Stereo Crown Electronics Lectern Electronics Orlando Audio King Orlando Lake Charles Music Hi Music Audio Video Solutions The Music Store Peter's Tweeter Etc. Almas Hi-Fi Stereo
New Jersey	Ultimate Electronics Stereo Entertainment Center Century Audio Video Luscik Electronics The Eddie Gurs Simply Stereo Sterling Electronics Sundown Audio/Video Grand Audio Center	California Audio King Classic Stereo Crown Electronics Lectern Electronics Orlando Audio King Orlando Lake Charles Music Hi Music Audio Video Solutions The Music Store Peter's Tweeter Etc. Almas Hi-Fi Stereo
New Mexico	Ultimate Electronics Stereo Entertainment Center Century Audio Video Luscik Electronics The Eddie Gurs Simply Stereo Sterling Electronics Sundown Audio/Video Grand Audio Center	California Audio King Classic Stereo Crown Electronics Lectern Electronics Orlando Audio King Orlando Lake Charles Music Hi Music Audio Video Solutions The Music Store Peter's Tweeter Etc. Almas Hi-Fi Stereo
New York	Ultimate Electronics Stereo Entertainment Center Century Audio Video Luscik Electronics The Eddie Gurs Simply Stereo Sterling Electronics Sundown Audio/Video Grand Audio Center	California Audio King Classic Stereo Crown Electronics Lectern Electronics Orlando Audio King Orlando Lake Charles Music Hi Music Audio Video Solutions The Music Store Peter's Tweeter Etc. Almas Hi-Fi Stereo
North Carolina	Ultimate Electronics Stereo Entertainment Center Century Audio Video Luscik Electronics The Eddie Gurs Simply Stereo Sterling Electronics Sundown Audio/Video Grand Audio Center	California Audio King Classic Stereo Crown Electronics Lectern Electronics Orlando Audio King Orlando Lake Charles Music Hi Music Audio Video Solutions The Music Store Peter's Tweeter Etc. Almas Hi-Fi Stereo
Ohio	Ultimate Electronics Stereo Entertainment Center Century Audio Video Luscik Electronics The Eddie Gurs Simply Stereo Sterling Electronics Sundown Audio/Video Grand Audio Center	California Audio King Classic Stereo Crown Electronics Lectern Electronics Orlando Audio King Orlando Lake Charles Music Hi Music Audio Video Solutions The Music Store Peter's Tweeter Etc. Almas Hi-Fi Stereo
Oklahoma	Ultimate Electronics Stereo Entertainment Center Century Audio Video Luscik Electronics The Eddie Gurs Simply Stereo Sterling Electronics Sundown Audio/Video Grand Audio Center	California Audio King Classic Stereo Crown Electronics Lectern Electronics Orlando Audio King Orlando Lake Charles Music Hi Music Audio Video Solutions The Music Store Peter's Tweeter Etc. Almas Hi-Fi Stereo
Oregon	Ultimate Electronics Stereo Entertainment Center Century Audio Video Luscik Electronics The Eddie Gurs Simply Stereo Sterling Electronics Sundown Audio/Video Grand Audio Center	California Audio King Classic Stereo Crown Electronics Lectern Electronics Orlando Audio King Orlando Lake Charles Music Hi Music Audio Video Solutions The Music Store Peter's Tweeter Etc. Almas Hi-Fi Stereo
Pennsylvania	Ultimate Electronics Stereo Entertainment Center Century Audio Video Luscik Electronics The Eddie Gurs Simply Stereo Sterling Electronics Sundown Audio/Video Grand Audio Center	California Audio King Classic Stereo Crown Electronics Lectern Electronics Orlando Audio King Orlando Lake Charles Music Hi Music Audio Video Solutions The Music Store Peter's Tweeter Etc. Almas Hi-Fi Stereo
Rhode Island	Ultimate Electronics Stereo Entertainment Center Century Audio Video Luscik Electronics The Eddie Gurs Simply Stereo Sterling Electronics Sundown Audio/Video Grand Audio Center	California Audio King Classic Stereo Crown Electronics Lectern Electronics Orlando Audio King Orlando Lake Charles Music Hi Music Audio Video Solutions The Music Store Peter's Tweeter Etc. Almas Hi-Fi Stereo
South Carolina	Ultimate Electronics Stereo Entertainment Center Century Audio Video Luscik Electronics The Eddie Gurs Simply Stereo Sterling Electronics Sundown Audio/Video Grand Audio Center	California Audio King Classic Stereo Crown Electronics Lectern Electronics Orlando Audio King Orlando Lake Charles Music Hi Music Audio Video Solutions The Music Store Peter's Tweeter Etc. Almas Hi-Fi Stereo
Tennessee	Ultimate Electronics Stereo Entertainment Center Century Audio Video Luscik Electronics The Eddie Gurs Simply Stereo Sterling Electronics Sundown Audio/Video Grand Audio Center	California Audio King Classic Stereo Crown Electronics Lectern Electronics Orlando Audio King Orlando Lake Charles Music Hi Music Audio Video Solutions The Music Store Peter's Tweeter Etc. Almas Hi-Fi Stereo
Texas	Ultimate Electronics Stereo Entertainment Center Century Audio Video Luscik Electronics The Eddie Gurs Simply Stereo Sterling Electronics Sundown Audio/Video Grand Audio Center	California Audio King Classic Stereo Crown Electronics Lectern Electronics Orlando Audio King Orlando Lake Charles Music Hi Music Audio Video Solutions The Music Store Peter's Tweeter Etc. Almas Hi-Fi Stereo
Utah	Ultimate Electronics Stereo Entertainment Center Century Audio Video Luscik Electronics The Eddie Gurs Simply Stereo Sterling Electronics Sundown Audio/Video Grand Audio Center	California Audio King Classic Stereo Crown Electronics Lectern Electronics Orlando Audio King Orlando Lake Charles Music Hi Music Audio Video Solutions The Music Store Peter's Tweeter Etc. Almas Hi-Fi Stereo
Vermont	Ultimate Electronics Stereo Entertainment Center Century Audio Video Luscik Electronics The Eddie Gurs Simply Stereo Sterling Electronics Sundown Audio/Video Grand Audio Center	California Audio King Classic Stereo Crown Electronics Lectern Electronics Orlando Audio King Orlando Lake Charles Music Hi Music Audio Video Solutions The Music Store Peter's Tweeter Etc. Almas Hi-Fi Stereo
Virginia	Ultimate Electronics Stereo Entertainment Center Century Audio Video Luscik Electronics The Eddie Gurs Simply Stereo Sterling Electronics Sundown Audio/Video Grand Audio Center	California Audio King Classic Stereo Crown Electronics Lectern Electronics Orlando Audio King Orlando Lake Charles Music Hi Music Audio Video Solutions The Music Store Peter's Tweeter Etc. Almas Hi-Fi Stereo
Washington	Ultimate Electronics Stereo Entertainment Center Century Audio Video Luscik Electronics The Eddie Gurs Simply Stereo Sterling Electronics Sundown Audio/Video Grand Audio Center	California Audio King Classic Stereo Crown Electronics Lectern Electronics Orlando Audio King Orlando Lake Charles Music Hi Music Audio Video Solutions The Music Store Peter's Tweeter Etc. Almas Hi-Fi Stereo
West Virginia	Ultimate Electronics Stereo Entertainment Center Century Audio Video Luscik Electronics The Eddie Gurs Simply Stereo Sterling Electronics Sundown Audio/Video Grand Audio Center	California Audio King Classic Stereo Crown Electronics Lectern Electronics Orlando Audio King Orlando Lake Charles Music Hi Music Audio Video Solutions The Music Store Peter's Tweeter Etc. Almas Hi-Fi Stereo
Wisconsin	Ultimate Electronics Stereo Entertainment Center Century Audio Video Luscik Electronics The Eddie Gurs Simply Stereo Sterling Electronics Sundown Audio/Video Grand Audio Center	California Audio King Classic Stereo Crown Electronics Lectern Electronics Orlando Audio King Orlando Lake Charles Music Hi Music Audio Video Solutions The Music Store Peter's Tweeter Etc. Almas Hi-Fi Stereo
Wyoming	Ultimate Electronics Stereo Entertainment Center Century Audio Video Luscik Electronics The Eddie Gurs Simply Stereo Sterling Electronics Sundown Audio/Video Grand Audio Center	California Audio King Classic Stereo Crown Electronics Lectern Electronics Orlando Audio King Orlando Lake Charles Music Hi Music Audio Video Solutions The Music Store Peter's Tweeter Etc. Almas Hi-Fi Stereo

Call 1-800-KLIPSCH for the location of your nearest Klipsch audio retailer.

Klipsch
A LEGEND IN SOUND

Your preamp must have enough inputs to accommodate all the audio sources you plan to use. This applies even when some of these sources will not present encoded signals for processing, i.e., when you want to listen to plain stereo. Use the bypass switch on the decoder to circumvent the decoding circuits.

If your preamplifier has tone controls, do not use them when feeding analog signals to the processor for Dolby Pro Logic decoding; otherwise, the decoding will be degraded.

VHS Hi-Fi Incompatibility

Q Tapes that I record on my VHS Hi-Fi VCR will play back only in mono on other Hi-Fi VCRs. Rental movie videos play back fine on my machine. However, I have recorded many TV broadcasts and fear that when this VCR wears out, my tape library will be virtually worthless.—Donna S. Cofield, Katy, Tex.

A I have worked with VHS Hi-Fi VCRs since they first appeared. Assuming that all machines are properly adjusted, there is no tape incompatibility problem. Were this not the case, it would not be possible to sell commercially prerecorded movie videos, because they wouldn't play on the millions of different Hi-Fi VCRs made over the years.

The fact that your VCR plays standard movie videos okay (which normally play on any Hi-Fi VCR), as well as playing back your own tapes, is odd. It prompts a question: What is different about your recorded tapes that renders them unplayable on other machines yet playable on yours? It means that something about your recordings is different from most other tapes.

I think that the audio record current is too low; have a technician set it to the proper level. When it's too low, your tapes will fail to play on most other machines. I suspect your machine can play them because its playback sensitivity is also misadjusted and compensates for the deficiencies in your recorded tapes.

Next, see if the Hi-Fi tracks on your tapes, at least those made with the higher current, play back properly on other Hi-Fi VCRs. You may wish to buy another machine, but it must have the means by which you can adjust its playback sensitivity. Make these adjustments to the point where your

tapes play properly. In the worst case, you may want to consider borrowing or buying a second Hi-Fi VCR and copying your library to it.

Buzzing Amplifiers

Q Each of my power amps (same brand, different models) produces a loud and distracting buzz from the transformer whenever I turn on a halogen light. The lights are in a different room and on a different circuit from the amplifiers. The larger amp produces a louder buzzing, presumably because of its larger transformer. The noise is just from the transformer and is not reproduced through loudspeakers. Why do halogen lights cause this interference? Is there any way to eliminate it? And will the buzzing shorten the life of the transformer or the amplifier? I checked my house's AC wiring, tried different halogen bulbs, and installed an AC noise filter to remove RF and electromagnetic interference.—Name withheld

A Noise of this kind is usually a sign of loose laminations in the core of an amp's transformer. The core of a power transformer is made up of very thin sheets of soft iron, insulated from one another by varnish. These laminations are supposed to be dipped into varnish and then tightened securely with bolts. Although it is not possible for you to add more varnish, you might be able to tighten any bolts that are holding the transformers together (I am not referring to the mounting hardware).

In any case, you should consult the amplifier's manufacturer. Have the serial numbers of your two amplifiers handy when you call, because the factory may have received a supply of defective transformers, and the serial numbers of the affected amplifiers would be on record. I can scarcely believe that your amps were the only ones that were affected.

I have not had problems with lights making transformer cores mechanically vibrate or buzz. One possibility is that the power transformers may be on the verge of buzzing, and turning on the halogen lights makes the waveform on the AC line very dirty. Maybe, and only maybe, the asymmetry of these waves jogs the laminations more than when the waveforms are sinusoidal.

I don't believe the buzzing will influence the longevity of your equipment. **A**

The
ROAR.

The
Rumble.
Ringside
seats to every
resounding
punch
since 1946.

The
POWER
of
KLIPSCH.



PRODUCT
OF THE
YEAR

WINNER
of the
HI-FI
GRAND PRIX
AWARD

from
AudioVideo
The professional magazine
of U.S. home electronics

It's Alive.

And, stunningly real. Klipsch first stepped into the ring of big theater sound in 1946 with the unveiling of the patented Klipschorn® and the introduction of horn technology. This technology continues today as the hallmark of Klipsch speaker design, delivering the most authentic sound reproduction possible. It's no contest—for theater sound that ranks as the perennial heavy-weight favorite, choose Klipsch. With the Klipsch Synergy 3.1 Home Theater System™ in your corner, you're ringside for all the action. Thunderous power. Devastating punch. Auditory dynamite wrapped up in a solid, compact package. Visit your Klipsch audio retailer to hear, feel and experience the distinctive Klipsch difference. It's Alive.

Learn more about the heart and science of the Klipsch sound by calling 1-800-KLIPSCH,
or for the surfing savvy, visit us online at www.klipsch.com.

 **Klipsch**®
A LEGEND IN SOUND.

©1997 Klipsch, Inc. All rights reserved.

IVAN BERGER

SELF-CRANKING STEREOS



When your car's speed goes up, so does road noise—and the volume, on this JVC and certain other car stereos.

The greater a car stereo's dynamic range, and the greater the dynamic range of the music we play on it, the more we have to crank the volume up and down to cope with varying road noise. Compressors, which reduce dynamic range, can help—but they also reduce the life and excitement of music. What's needed is something that changes the audio signal in response to road noise.

For years, I've been suggesting a complex solution that would raise

volume, boost bass, and boost low-level passages in response to road noise. Chevrolet Corvettes have long had stereos that simply boost volume as your speed goes up. I've recently been using two stereos that also do this, the factory head unit in my '96 Saab 900SE and a JVC KD-GS929 in my '88 Scorpio. And although I'm confident that some speed-dependent bass boost and a wee touch of compression might improve things further, this simpler approach turns out to work quite well.

The three systems I've mentioned actually monitor speed, not ambient noise. The Corvette system is linked to the car's speedometer. I don't know how the Saab's system (which was built by Clarion) gets

its speed information. And the JVC's Audio Cruise mode senses the frequency generated by the car's alternator, which varies with engine speed. (Audio Cruise was surprisingly accurate, once I got it calibrated to my Scorpio. But that took a while, what with two operating modes and 15 boost levels to play with.)

The JVC 929 also has Voice Support System (VSS), which announces what button you've pushed. (It also says "See you," in a girlish singsong, when you switch the JVC off.) Until I learned the 929's control layout, VSS proved handy in thick traffic and on twisty roads, since I didn't have to take my eyes off the road to find out what I was doing to the stereo. Once my fingers no longer needed training wheels, I switched VSS off. But I wished for an intermediate setting that would announce functions I rarely use and let me know when I've pressed the "Sound" button the right number of times to bring up the balance control. JVC's KD-GS939, which replaces the 929, has Audio Cruise but not Voice Support. Sony, however, will have Voice Confirmation on a few '98 car stereos.

Illustration: Bob Scott

CAR STEREO SYNERGY?

Some Pioneer car stereos now combine two systems for identifying radio stations ("Spectrum," September 1997). If you tune in an FM station that transmits RDS-encoded signals, the radio will read and display its call letters. For any other station, it will check a built-in ID Logic database to find what call letters are assigned to nearby stations on its frequency. But the ID Logic system works only if the radio knows rough-

SORRY ABOUT THIS

Q. What happens when you play a blank tape at full volume?

A. Every mime in the neighborhood complains about the noise.



DTS Ready

Beyond

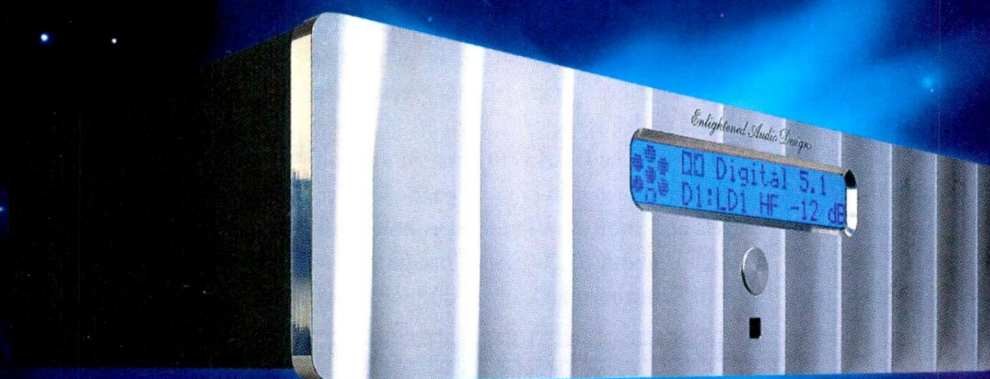

*Limitations Dissolve. All Possibilities Emerge.
The New TheaterMaster Line.*

TheaterMaster[®]

Encore, Ovation and Signature

The New Era: As the first company to introduce high-end multi-channel decoders, EAD is proud to announce the next generation: TheaterMaster Encore, Ovation and Signature. Consider:

3rd Generation: TheaterMaster now offers 3rd generation technology. Up to 12 previously separate circuits have been integrated onto cutting-edge IC's, enhancing performance, upgradability, and reliability. Flawless decoding of Dolby Digital,[®] DTS,[™] HDCD,[®] Dolby Pro-Logic[®] and audiophile stereo is now possible at prices that will amaze you. You, the consumer, benefit most from this price/performance revolution.

Sound: *Extraordinary.* The original TheaterMaster was used by Hollywood to produce over 200 AC-3 movie releases. New enhancements in EAD's award-winning AccuLinear[®] and Digital Flywheel[™] circuitry achieve even greater levels of sonic realism and emotional involvement. Purity that establishes a new standard.

Ergonomics: With a back-lit, touch-screen programmable remote and front-panel LCD screen, TheaterMaster offers the slickest, most comprehensive user interface in the industry. Set-up, volume control, and audio/video switching are accomplished effortlessly. Controls all components in your system.



Enlightened Audio Designs

402 NORTH B STREET • FAIRFIELD, IOWA 52556 • 515-472-4312 • WWW.EADCORP.COM

ly where it is, and Pioneer's system for updating location data isn't always accurate. So, pleased as I am to find car stereos that combine both systems, I think the combination could be more synergistic.

The updating system could be greatly improved by using RDS to check the ID Logic system's sense of location. For example, if RDS identifies the FM station coming in at 93.9 MHz as WNYC when ID Logic was expecting WKYS, then the system should be able to figure out that the car is somewhere in the New York City area

So why do commercials sound louder? Many commercials use audio compression, boosting quiet passages to make the ads consistently loud. Some also use filtering to divide the audio spectrum into bands, then compress the sound within each band to make sure every part of the spectrum is packed with energy.

In Britain, at least, a cure may be at hand. A meter that registers both peak electrical levels and subjective loudness is now available, for about \$5,000. And though no law limits commercials' aural intrusiveness,

ear membranes. But the secret of its stereo hearing may have less to do with that spacing than with a pivoted bridge of cuticle connecting the two membranes, say researchers studying the phenomenon (Ron Hoy of Cornell, Ron Miles of Binghamton University, and Daniel Robert of the University of Zürich). When one membrane picks up a sound, the bridge transmits it to the other, with a tiny delay. The bridge also sets up complex vibrations, which build up at the membrane that receives the sound first. This concept, it is hoped, could be adapted for an in-ear hearing-aid microphone that will emphasize frontal sounds.

LIRPA HITS HOME THEATER

For some home theater fans, big-screen TVs and neighbor-shaking surround sound aren't theatrical enough; even installing genuine movie seats doesn't quite suffice.

Now Lirpa Laboratories has the missing link, the Lirpa Home Theater Authentication Kit.

The basic kit has two-sided sticky tape to simulate soda on the floor and

simulated chewing gum to place under the seats. (Unlike genuine gum, it will maintain its stickiness for at least a year.) An upgrade option randomly fires popcorn from a simulated balcony, but only when you play westerns on Saturday afternoons.



Illustration: Bob Scott

HELMHOLTZ REFRIGERATOR

Today's loudspeakers often have bass drivers in vented enclosures, commonly described as Helmholtz resonators. Tomorrow's refrigerators could also have speaker drivers and Helmholtz resonators (albeit with external drivers)—but to preserve the ozone layer, not sound quality.

Freon or similar chlorofluorocarbon (CFC) refrigerants that leak into the atmosphere attack the ozone layer. Most industrial countries have therefore stopped producing CFCs and switched to other, less efficient, refrigerants. But developing countries, such as China, still make CFCs—and make or buy a rapidly growing number of refrigerators.

Luc Mongeau and other researchers at Purdue's School of Engineering have therefore developed a refrigeration system that uses sound waves for heat extraction. At the heart of things is a tube with a speaker and a heat exchanger at one end and a Helmholtz resonator at the other. The speaker fires 300-Hz sound waves down the tube, where they're reflected by the resonator. The sound waves compress and decompress the gas in the tube (a mixture of helium and neon); compression heats the gas, while decompression cools it. Excess heat is segregated by a honeycomb-like "stack," placed near the speaker. Heat exchangers at the cool end of the stack suck heat out of the refrigerator, and exchangers at the hot end dump it outside the fridge.

The sound levels within the tube and resonator can reach 180 dB SPL. Tight sealing and good insulation, however, keep the sound—and the cold—inside the fridge. A

rather than near Washington, D.C. And if the radio also picks up a signal at 101.5 MHz with RDS-encoded call letters of WKXW, the system should be able to figure out that you're somewhere between New York City and Trenton, N.J., rather than in Long Island or Connecticut (where WNYC comes in but WKXW doesn't). An "Update" button on the radio could automatically scan for RDS stations, then calculate your car's position from that—within a county or two, anyway.

British TV networks have begun using this meter to identify offensively loud ads.

A FLEA IN YOUR EAR?

With our two ears, several inches apart, we can localize sounds, tuning into those in front of us while ignoring others. But how does *Ormia ochracea* do it?

O. ochracea is a small parasitic fly whose ears are virtually adjacent to each other. Yet it tracks crickets, its prey, by homing in on their chirps. Scientists hope to use its auditory secrets to produce small, efficient hearing aids that not only amplify high frequencies (the major area of human hearing loss) but also preserve stereo information.

O. ochracea's ears are only half a millimeter apart, about five times the size of its

SPEAK UP! A COMMERCIAL'S ON!

Laws limit how heavily broadcasters can modulate their signals. That puts absolute limits on maximum audio levels, for programs and commercials alike.

A Revelation In High-End Sound!

"I was floored by the Paradigm Active/20 ...this is hands down the best sounding two-way 6-incher I've heard at any price...highly recommended!"

- Corey Greenberg, Audio Magazine

"this particular system is...ten leaps forward in terms of performance ...destined to become a legend."

- Tom Nousaine, Video Magazine



Paradigm Reference fully powered speakers are highly advanced Integrated Active Systems designed to deliver breathtaking high-end sound!

At the heart of these incredible speakers are highly sophisticated electronic crossover/amplifiers. These are matched to high precision drive units in a closed system that utilizes both active frequency and phase optimization. The result is unprecedented spectral and phase coherent accuracy.

We invite you to visit your nearest Authorized Paradigm Reference Dealer and experience these stunning Reference Active speaker systems for yourself!



PARADIGM® REFERENCE

Active

THE ULTIMATE IN HIGH-END PERFORMANCE FOR MUSIC AND HOME THEATER™

For more information visit your nearest Authorized Paradigm Reference Dealer or write: AudioStream, MPO Box 2410, Niagara Falls, NY 14302 (905) 632-0180 In Canada: Paradigm, 101 Hanlan Rd., Woodbridge, ON L4L 3P5 (905) 850-2889

© Paradigm Electronics Inc. + Bavian Corp.

website: www.paradigm.ca



Active/450-LR • Active/450-C



Active/20



Active/450-ADP

GEAR AND LOATHING IN LAS VEGAS



Necessary evils in hi-fi are numerous—cables, reviewers, retailers, CD jewel boxes—but none is quite so irritating, exhausting, and yet potentially “curable” as a Consumer Electronics Show. Readers who do not work in the hi-fi industry and therefore are precluded from attending these trade-only events might think that they must be *the* place to see it all, schmooze with buddies, and overindulge in a four-day audiofest. But the reality is often quite different. A typical CES is a hustle on a scale unmatched by any other electronics trade show on earth, not even the physically larger (yet infinitely more civilized) Berlin show. And CES remains the single most important event on the hi-fi calendar—that is not open for argument.

Just look what’s at stake if you are a manufacturer. You exhibit at the show so that you may seduce the press into publicizing your new models. At the same time, you are wooing retailers and foreign distributors so they will pre-order for the following year. You get one shot, one 96-hour attempt to impress upon all observers that you have one of the hottest lines around—for the next 12 months, at least.

All of this should take place for the benefit of the entire industry (the vendors, the makers, and the critics) and, eventually, for the consumer’s

benefit, but the nature of the hi-fi beast is such that priorities are skewed and maturity is at a premium. And so overwhelming is the CES, held in Las Vegas every January, that no visitor can escape without the nagging feeling that he missed something important or wasted time on something unimportant. Worse, the CES—or, more specifically, the specialty audio segment, which matters most to us—no longer knows why it exists. Is it for the visitors or the exhibitors?

Before you read any further, I swear that this diatribe is not entirely a self-serving kvetch written in the hope that next year’s event will be more visitor-friendly; it’s much too late for that. Rather, my purpose here is to convince each and every non-trade reader who would kill to visit a CES that such a desire should be squelched. Frankly, you’re better off reading about hi-fi than schlepping around the Hotel from Hell.

But let’s backtrack for a moment. Editor Michael Riggs recently wrote about the aforementioned Funk-austellung show in Berlin (“Fast Fore-Word,” January), an event that never fails to attract about 500,000 public visitors—the trade be damned. Every country in Europe and many in Asia host shows open to the public, not just the trade. Why can *they* do it, while the United States has to make do with regional events?

Simple: The United States is too large to host a single event that would be open to the public. Many members of the trade can afford

to travel anywhere for a show if they have to, because the costs are tax-deductible. But how many audiophiles in Tampa, for example, could make a trip to Boston, let alone one to Seattle or San Diego? In most European or Asian countries, the distances are relatively manage-

**YOU’RE BETTER OFF
READING ABOUT HI-FI
THAN SCHLEPPING AROUND
THE HOTEL FROM HELL
AT A TRADE SHOW.**

Illustration: Courtney Grammer

ASTONISHING!

"...smooth...refined...I've heard highly regarded \$2,000 2-way 6-inchers that could not keep up with the Mini Monitor." - Corey Greenberg, Audio Magazine

As a world leader in speaker design, PARADIGM knows what it takes to make great sounding speakers – from superb best-value budget audiophile speakers, right through to sensational PARADIGM® REFERENCE high-end systems. And now PARADIGM brings it's comprehensive design expertise to an all new generation of the most affordable high-performance speakers the market has ever seen. Introducing the exceptional new MONITOR SERIES.

High-frequency drivers use our remarkable new PTD™ pure-titanium dome along with our exclusive controlled waveguide to provide outstanding, and utterly natural, high-frequency response.

Bass/midrange drivers utilize high-pressure diecast chassis' and our unique ICP™ injection-moulded copolymer polypropylene cones. This advanced cone design effectively eliminates unwanted resonances and standing waves.

Add minimum diffraction grills, solid braced enclosures, phase coherent crossovers, gold input terminals and what you have is the pure, clear and uncolored sound of PARADIGM's astonishing new MONITOR SERIES.

We invite you to visit your nearest AUTHORIZED PARADIGM DEALER and experience any of our high-performance speakers today. The difference is... simply better sound!



Micro/CC-50/Micro/SB-90
\$626



Atom/CC-50/Micro/PDR-10
\$816



Titan/CC-150/ADP-100/PDR-10
\$1,096



Mini Monitor/CC-350/ADP-150/PS-1000
\$1,596



Monitor 7/CC-350/ADP-350/PS-1200
\$2,256



Monitor 90P/CC-350/ADP-350
\$2,727



For more information visit your nearest AUTHORIZED PARADIGM DEALER or contact:
AUDIOSTREAM, MPO Box 2410 Niagara Falls, NY 14302 (905) 632-0180
In Canada: PARADIGM, 101 Henlan Rd. Woodbridge, ON L4L 3P5 (905) 850-2889
© Paradigm Electronics Inc. + Bowers Corp. Prices are manufacturer's EMV retail.
website: www.paradigm.ca

Paradigm®

THE ULTIMATE IN HIGH-PERFORMANCE SOUND™



able, so some hi-fi-lovin' consumer in Rome *might* make the trip to Milan.

Given that the public, if allowed to attend, would be unlikely to turn out in droves for a CES anyway, it's up to the press to visit the show, scope out new products, and report about them to its readers. So what does the CES management do? It seems to run the show solely to meet the needs of the exhibitors, ignoring the visitors' needs.

So unfocused and ill-conceived is the way that CES deals with high-end audio that it has forced a situation where major brands—not just insignificant little malcontents—now practice what is known as outboarding. This happens when a show is so expensive or the designated hotels so sonically challenged, disgusting, or inhospitable that certain brands choose to hold their own little unofficial shows. They must then pray that their market clout is strong enough to induce the various elements of the trade to visit them, even if they set up shop in a hotel on the other side of town.

However much I detest the official hotel, I refuse to visit outboarders. Whether it's a maker of world-class amps or some lone lunatic who thinks he's reinvented the 300B, I do not believe that outboarders deserve any coverage. The term "a free ride" isn't exactly appropriate, even given the lower costs of exhibiting unofficially, but these companies attract traffic at the expense of those who play by the rules. Any sneaking admiration I might hold for an outboarder rapidly disappears once I remember that the round trip from the busy end of the Strip to, say, the Golden Nugget can eat up an hour of precious time, time that could be spent at the booths of "official" brands.

Adding insult to injury, especially for those companies that *do* try to support the CES, is the choice of venue for high-end audio. (It's why the outboarders laugh at the official exhibitors.) The Alexis Park may serve perfectly well in its capacity as a motel ("hotel" seems far too grand a word for two floors of rooms built around mini-courtyards with no linking corri-

dors), but it has few, if any, qualities that make it suitable for a hi-fi show. One can only guess at the politics that led CES organizers to choose a site that is (1) not near any of the other venues and (2) a rabbit warren so badly laid out for show purposes that it takes 40% longer to cover than it

**IMERSA SHOWED THAT
YOU REALLY CAN HAVE
OUT-OF-THE HEAD,
DISCRETE SURROUND
VIA HEADPHONES.**

would if the near-200 exhibitors were on five or six floors of a real hotel.

God bless the weather: It actually rained in Las Vegas during CES this year, so those who find the Alexis Park less than a delight have even more ammunition against the place. Nobody could visit more than a couple of rooms without getting soaked in between. I was also reminded of an unpleasant hypocrisy in the American character. The United States purports to be the guid-

ing light when it comes to matters Politically Correct, especially on issues involving the handicapped. So why did CES opt for a hotel whose design precludes the wheelchair-bound from visiting its upper level?

Aah, what's the use; I'm peeing up a tree. And to show that I'm not a total (post-Xmas) Scrooge, I must tell you about some outrageous new toys on display at CES. The most impressive demonstration I attended was for a product that isn't yet on the market: It embodies a new technology, Imersa, that I hope will find its way into every system having a headphone socket. Lake DSP, an Australian chip manufacturer, showed that you really *can* have out-of-the-head, discrete surround sound via headphones. Its demonstration was clever in the extreme. The listener sat in a chair in the middle of the room and wore headphones, even though the sound was coming from speakers. With the lightweight and open-backed 'phones, I could hear the system exactly as expected; the sound was fully encompassing, despite the fact that cans were in place. Then, at an undisclosed point, the speakers were switched off and the headphones activated. (It was impossible to tell when the changeover occurred.) So convincing was the out-of-head experience, so all-enveloping the surround, that it more than compensated for all of the previous compromises and false starts down this path, from binaural to holophonic sound to whatever other gimmick passed for surround sound from cans. And the reason why I felt confident that the Imersa demo wasn't a ruse? A well-known producer and studio habitué with a low boredom threshold was in the room with me, and he was blown away, too.

Equally unobtainable (but not because it doesn't exist) is Krell's new Master Reference amplifier [see the interview with Dan



D'Agostino in this issue]. It's a monoblock good for a kilowatt into 8 ohms but doubles its power every time the impedance is halved, down to 0.5 ohm. Weight? Said to be 600 pounds each. Size? Like a small refrigerator on its back. Price? About \$80,000 per pair. Which is why it's as likely to be *chez Kessler* this year as *Imersa*.

Cable skeptics should note that although prices continue to skyrocket, Tara Labs has come up with a new approach to system grounding, via external devices called Ground Stations. If you thought tri-wiring was complicated, wait 'til you get a load of these black boxes. Classic Records, in cahoots with Chesky and a bunch of hardware guys, announced a new two-channel, 24-bit/96-kHz format using DVDs—and it abides by the existing DVD-Video standard. Nagra showed a stunning prototype tube amp to match its acclaimed PL-P preamp, and Sonic Frontiers made good on its promise to deliver a CD transport with a hatch that opens up like an iris. I saw some working NXT flat-panel speakers hither and yon, which probably caused investors to issue a sigh of relief, while Quad reappeared with new electrostatics—totally unexpected but indicative of plans announced by the new Managing Director (and described in this column last month) to restore the brand to its former glory.

Voce Divina of Utah gave Italian speaker makers plenty to worry about, and Evett & Shaw showed that small speakers flanking a computer monitor needn't be plastic lumps with the fidelity of a kid's walkie-talkie. Speaking of the Italians, Unison Research turned up with a neat preamp/power amp combination that has the preamp driven by the amp's overkill power supply, and GRAAF offered a multichannel amplifier for tube devotees who want to enter the world of home theater. Jeff Rowland, too, debuted a multichannel amp (are there any high-end majors still resistant to multichannel?), and Meridian introduced what must be the world's costliest high-end DVD player, in its 800-series chassis.

Acurus returned to CES, abandoning outboarder status, with the impressively feature-laden ACT3 surround processor (my choice for Bargain of the Year). Martin-Logan finished its flagship Statement speaker and still found time to produce a new hybrid electrostatic center-channel

model, the Cinema. B&W entered the home-automation field with Casa; Lexicon added DTS to its DC-1 preamp/processor; TACT showed a digital amplifier, the Millennium; WBT now offers the world's most expensive screwdriver (with adjustable torque, of course); Western Electric announced a whole new range of tubes to accompany the reborn 300B; LAMM has a new amp using Russki military bottles; Z-Systems has a multichannel digital preamp in the wings; Arcam joined forces with dCS to produce an affordable 24-bit CD player

called the Alpha 9; Corey Greenberg wore a suit; the smutmeisters were isolated from the audiophiles; and everyone who attended the otherwise delightful DTS party at the Harley-Davidson Club now has impaired hearing (which, to some observers, already described most reviewers).

With all of the above going on, I suppose the indignity of visiting the Alexis Park pales to insignificance. CES is still the greatest show on earth; I just wish someone would sweep up the elephant droppings now and then. A



P a r a g o n



FACTORY DIRECT

**25% off Retail Prices
& Free Delivery to your Door.**

*14 Day In-Home Audition
Money Back Guarantee*

We Accept Master Card, Visa, Discover, Certified Checks,
Money Orders and Wire Transfers as payment.

5 Year Limited Warranty

Our US Dealer showrooms:

<p>Audio Center Deerfield Beach, FL (954) 574-9200</p>	<p>Audio Image Chicago, IL (773) 334-2400</p>	<p>Audio Perfection Minneapolis, MN (612) 866-0083</p>
<p>Stereo Exchange Manhattan, NY (800) 833-0071</p>	<p>Audiophile Systems Honolulu, HI (808) 487-8252</p>	<p>Our Showroom 2966 N. Cleveland St. Paul, MN 55113</p>

(800) 224-7599

Webpage: www.paragonacoustics.com
Email: highend@paragonacoustics.com

The Sweet Spot

*Model Shown: The Jubilee/JEM
Finish: Red Walnut
See us in Audio's Annual Equipment Directory

ELVIS HAS RE-ENTERED THE BUILDING

Steve Hoffman, DCC's master remasterer

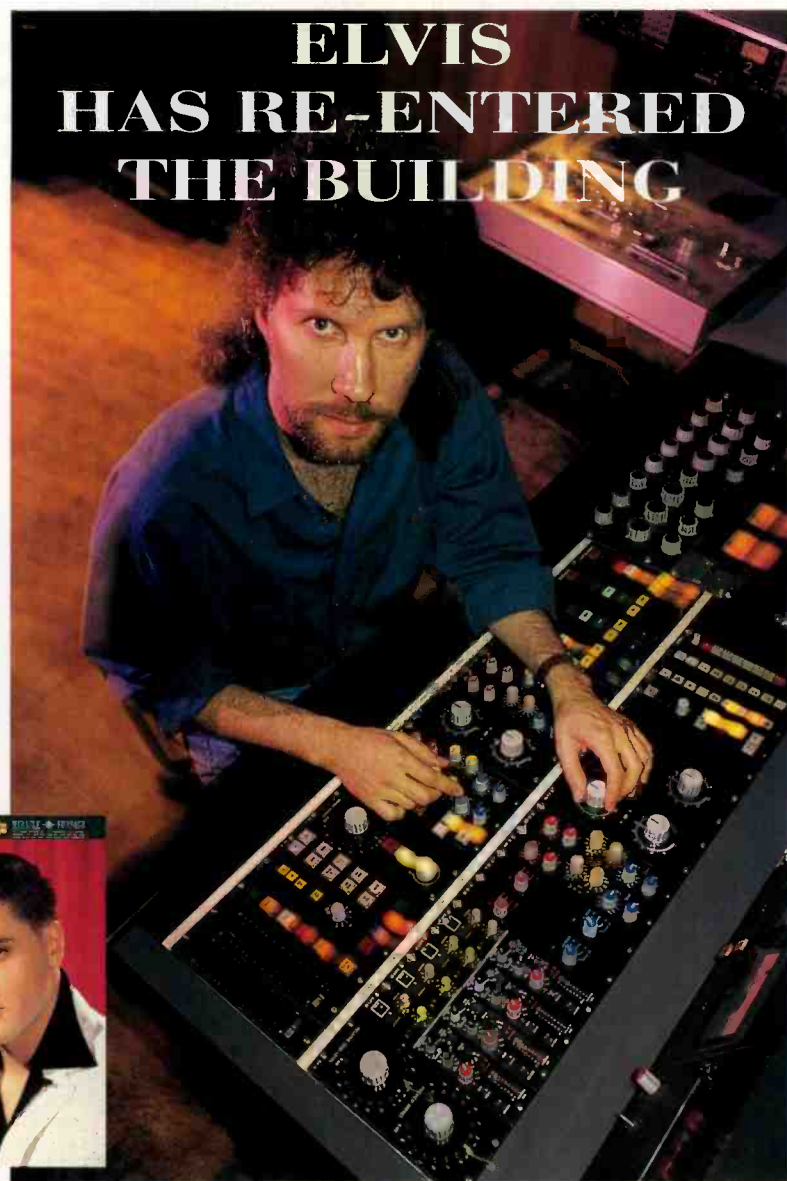

Listen, I know I've always said that it doesn't matter how crappy your favorite records and CDs sound, they're still the best test discs to take along when you're trying to judge new gear because you're only going to notice sonic differences that are right and wrong if you care about the music in the first place.

But I have a confession to make: Even though I worship Elvis's '50s recordings on Sun and RCA, I've never used them when I've auditioned equipment. They just don't sound good enough to judge hi-fi gear with; they sound like—well, like

crap! There, I said it! They're cloudy and muffled, they've got no bass, The Jordanaires all sound like they're overloading the same cheap microphone, and not one of the instruments sounds anywhere near as clear and natural as in the best recordings of the era. You put on the best Sinatra from the same period, and his voice rings like a bell. But even my cleanest Elvis records and

THIS ELVIS DISC IS THE MOST MIRACULOUS REMASTERING JOB I'VE EVER HEARD, BAR NONE.

RCA/BMG CD reissues sound like bad cassette dubs.

So it was with a mixture of shock and joy that I first heard a new CD from Dunhill Compact Classics (DCC, 800/301-6874), *Elvis: 24 Karat Hits!* (DCC GZS-1117). I'm telling you, I've never had an experience with an audiophile remastered CD like this one. Mobile Fidelity's CD reissue of *Muddy Waters, Folk Singer* shook me to my core a few years ago, but then the original LP sounded very good to begin with. DCC's own reissue of Dylan's *Highway 61 Revisited* was incredible, but again, the original LP was pretty good, too. Even the latest Jimi Hendrix reissues on MCA, as amazing as they are, are just the latest in a series of remastered versions that start with something good and make it just that much better.

But this DCC Elvis CD is something entirely different. Here's a case where the old CDs and LPs sound like garbage, and the remastered disc actually sounds sweeter and cleaner than most of Tower Records' Top 100! I can't believe how good this thing sounds! You have no idea what it's like for me to finally hear Elvis's voice in pure, lifelike clarity—with full, warm, natural-sounding bass and clear, open highs—and where the stereo mixes finally sound like true, wide *stereo*. It's just too much.

I'd always chalked up the lousy sound quality of Elvis recordings to the myth of the King bursting through the doors of a recording studio full of squares and sidemen and shouting, "Awright, man, lez GO!" before launching into the only take the frenzied engineers would have the chance to cut before Elvis hopped on his Harley and tore ass out

of there with Sonny and Red in search of cheeseburgers, danger, and blank prescription pads. But I was wrong. These recordings sounded

Photos: Chris Jurgenson

CARVER

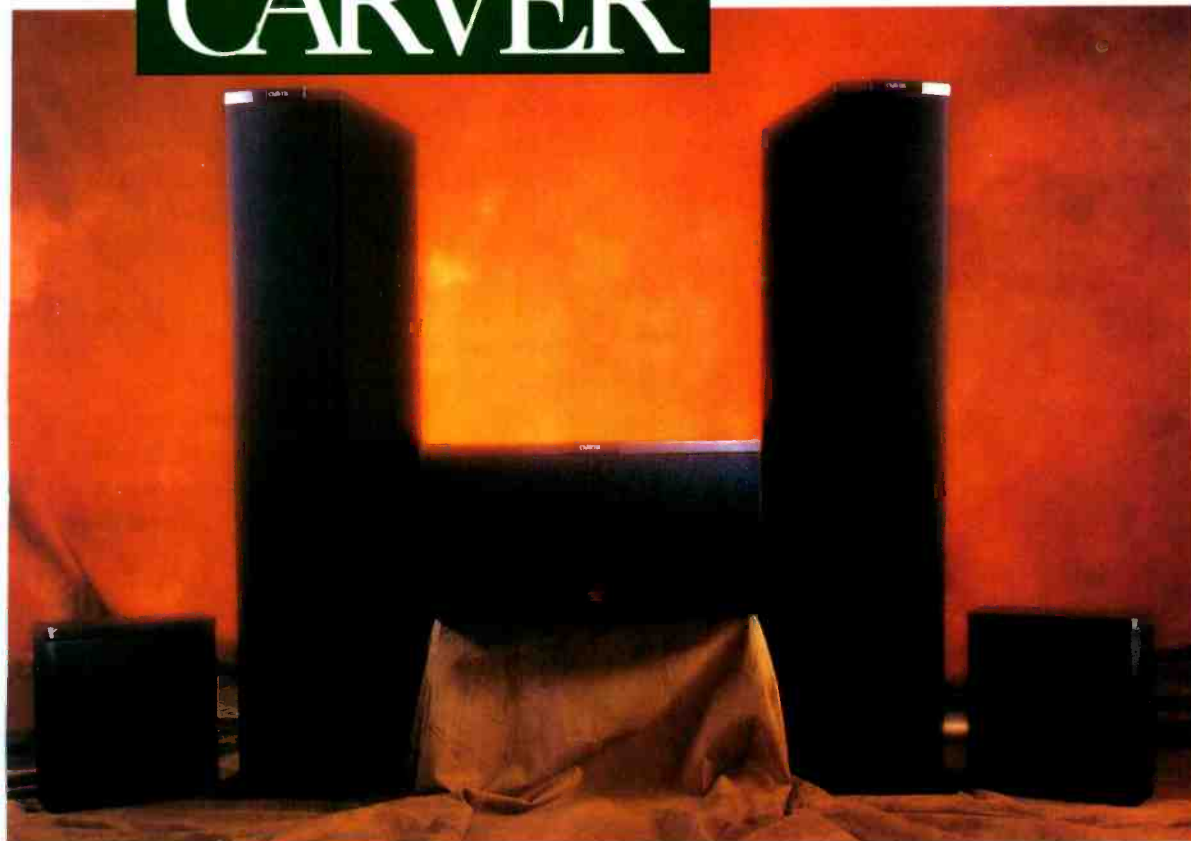

Get serenaded by violins or trampled by dinosaurs.

Introducing the new Cinema Systems from Carver, each with powered subwoofers utilizing Carver amplifier technology.

During the past decade, there has been tremendous interest in adapting new theories, technologies and materials to loudspeaker designs of every type. As a result, "stereo" two-channel systems have been improved in accuracy and imaging, while multi-channel "home theater" systems have progressed in dynamics and clarity. However, the final evolutionary stage – where spectral, spatial and power aspects achieve perfect balance in a single design – had yet to be realized. This is the concept behind Carver's new Cinema System series – speaker systems ideal for every form of recorded sound.

Carver's own amplifier research program provides the electronic muscle for the subwoofers. Extreme bass presentation is further ensured by the use of either one, two or four extended-excursion 10-inch woofers, depending on the system.

Each system element – drivers, crossovers and enclosures – was evaluated and ultimately selected from the realm of "audiophile" quality speaker components, to create systems that let you have it all – superb music reproduction combined with the power and dynamic range demanded by home theater.

Audition these new systems today – before the stampede.

P.O. Box 137, Woodinville, WA 98072-0137
Phone (425) 482-3400 • Fax (425) 482-3401
For authorized dealer locations, call 1-800-521-4333
www.carver.com

For the Cinema Systems project, Carver engineers investigated, tested and evaluated every meaningful technical and material innovation

CINEMA SYSTEM 5.4x

- THX Certified
- 500 Watt Lightstar-powered Dual Diversity subwoofer system utilizing four Large-Displacement woofers
- Focussed Vertical array with center operating in line source mode
- Dipolar surrounds
- Constant Directivity tweeters
- Nominal impedance 4 Ohms
- Freq. response 19Hz-23kHz

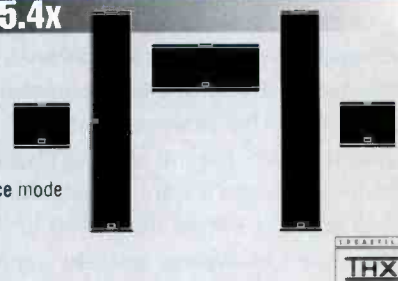

CINEMA SYSTEM 5.2

- 300 Watt Lightstar-powered dual tower subwoofers with two Large-Displacement woofers
- Progressive Directivity array
- Dipolar Surrounds
- Constant Directivity tweeters
- Nominal impedance 4 Ohms
- Freq. response 24Hz-22kHz



CINEMA SYSTEM 5.1

- 150 Watt powered Large-Displacement subwoofer
- Progressive Directivity array
- Dipolar Surrounds
- Constant Directivity tweeters
- Nominal impedance 4 Ohms
- Freq. response 27Hz-22kHz

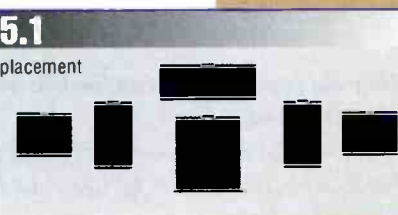

great all along; they just never got transferred properly.

DCC's *Elvis: 24 Karat Hits!* is an all-new compilation of two dozen of the King's greatest RCA hits, featuring all-new cover art and liner notes by legendary engineer

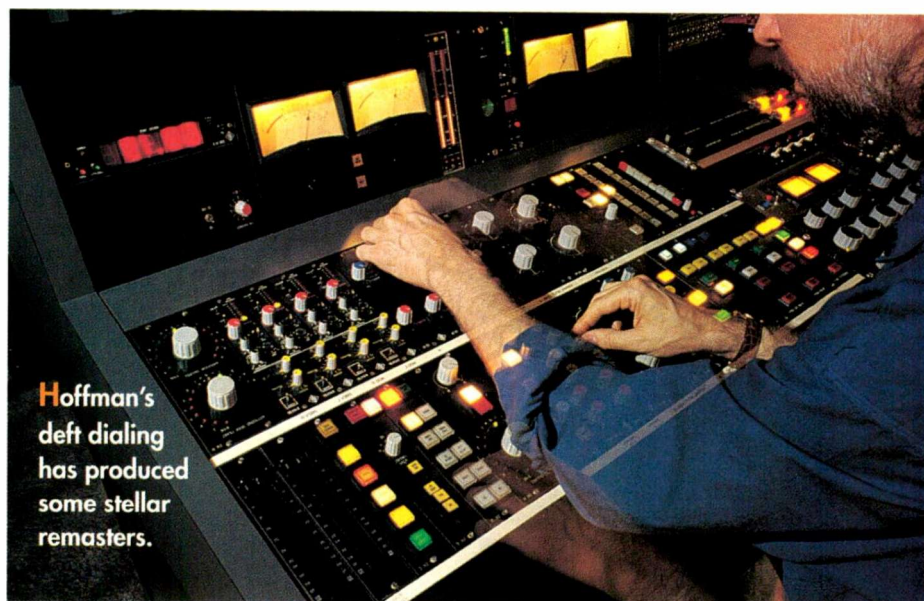

Hoffman's
deft dialing
has produced
some stellar
remasters.

Bill Porter. With this new disc, DCC has restored some of the greatest pop music of all time to a level of sound quality that is astounding, far exceeding any previous version of this music you may have heard, even the original records. This isn't merely a better-sounding version of an already decent recording. All it took was a track-by-track comparison between RCA/BMG's best-sounding Elvis on CD, 1992's five-disc *The Complete 50's Masters* (RCA 07863), and this new DCC disc to convince me that this is the most miraculous remastering job I've ever heard, bar none. If you like Elvis even peripherally, you'll want to own this CD. And if you're one of the 50,000 LP Fans Who Can't Be Wrong, you'll be happy to know that DCC also did an analog-mastered two-disc LP version.

Steve Hoffman, DCC's Vice President of A&R/Engineering, is the man responsible for this and so many other extraordinary remastering jobs the label has produced over the past several years. I've admired his work for years, and the release of *24 Karat Hits!* seemed the perfect reason to finally sit down and interview him.

How did you get into the audiophile remastering business?

Well, I started out in broadcasting and then I went to work for MCA Records' historical

department, and that's where I learned about all the old songs, the old masters—who Bing Crosby was, things like that. Eventually I became an expert in the old stuff, the musicology *and* the technology. Because they really do go hand in hand. If

Basically, most of these people are audiophiles who like the old gear, but immediately they start modifying it. They don't use the original circuit; they change it, upgrade the parts. They make it sound like a modern vacuum tube unit. But what I like to do is to take an old piece of gear and restore it exactly to the original specification. Then you can begin to get a glimmer of what they heard in the old days and why they got the sounds they did.

While you were still at MCA, you were responsible for 1985's Buddy Holly: From the Original Master Tapes (MCAD-5540), one of the best-sounding reissues ever from a major label. Were you already leaning in an audiophile direction back then?

Well, I tried there to release things that sounded as lifelike as possible. It was hard, because if you take a song like "That'll Be the Day," there might be 50 versions of it in the vault, and they're all on old tape. It was just a matter of patience. You have to sit there and listen to every single version in order to find the actual master, because none of the tapes were marked.

So how could you tell which version was the master? Just by sound?

By the sound and also by the certain type of recording tape used. I knew that Buddy Holly's producer, Norman Petty, used Audiotape brand. So I weeded out all the Scotch and all the Irish, and when I finally got down to just the Audiotape reels, the master tape wound up being in a box marked "Do Not Use"! It's almost an axiom: If it's in the box marked "Do Not Use," it's probably the master!

Shortly thereafter, you left MCA to go work for the new audiophile reissue label, Dunhill Compact Classics. What was the biggest difference between working for one of the largest record companies in the world and working for a small upstart?

DCC's owner, Marshall Blonstein, gave me absolute carte blanche to do whatever I had to do in the mastering and compiling to make things sound *the best*. And that's very rare in the music industry. Usually it's the producers and artists who get spoiled, but in this case, I was the one who got all the leeway and toys I needed to make it happen. *Some reissue labels, like Rhino, tend to apply a pretty heavy hand to the EQ on their releases, sometimes even going as far as re-mixing the original instrument levels. What*

**"I BECAME AN EXPERT
IN THE OLD MUSICOLOGY
AND TECHNOLOGY,
BECAUSE THEY REALLY DO
GO HAND IN HAND."**

you have a master that was recorded before magnetic tape was used in 1948 but you don't know how to properly transcribe it back so you can hear it to its fullest, then you're cheating the public out of the great joy of hearing something old that still sounds musical. So I had to learn how to do it, because no one could tell me; all the old-timers were long gone. And all these tapes were sitting around decomposing.

How good was the mastering gear you had to work with at MCA?

Oh, it was state of the art for the 1980s, but when you use modern gear, it doesn't sound as good as when you hear an old recording played back on machines of the same era. So I started collecting and restoring old acetate players and tape recorders, just so if I ever came across a certain type of recording, I could reproduce it correctly.

There's a big market today for vintage Ampex tape machines with upgraded circuitry.

Experience *a* higher expression of Power *and* Precision.



Perfection, some say, is merely the fleeting glimpse of a vague ideal. But to those who listen it is the absolute expression of deep, accurate and dynamic sound. To them, perfection is the achievement of life-like sonic reproduction.

The High Output Series P315 HO Powered Speaker is a defining testament to that philosophy. Everything about the P315 HO – from the crystal-clear accuracy of its diamond-coated titanium tweeter to its thunderous 500-watt RMS Bob Carver/Sunfire™

driven 15" side-firing subwoofer, the P315 HO is the ultimate expression of sonic perfection. In fact, the P315 HO delivers a level of deep, highly accurate and dynamic sound never before heard in the realm of home audio loudspeakers.

So, close your eyes and think for a moment about your favorite film or concert performance. Imagine yourself right in the action. Experience the Power and Precision of the sound around you. Then open your eyes to the High Output Series from Acoustic Research.



For additional information or your nearest dealer call 1-800-969-AR4U.
Acoustic Research is a registered trademark of Recoton Corporation, 527 Stone Road, Benicia, California 94510
© 1998 Recoton Corporation. All rights reserved. All specifications and prices subject to change without notice.

Before you buy stereo for your home, get this catalog!

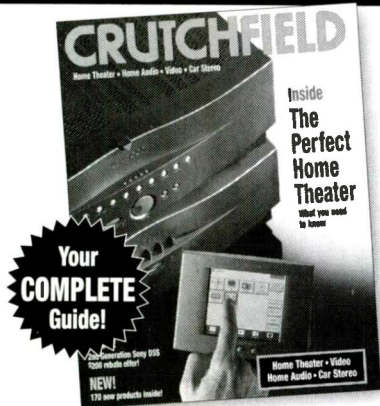

FREE Stereo Catalog

Looking for the latest in audio/video components?

The Crutchfield catalog brings you hundreds of top, brand-name components and makes it easy to compare them feature for feature. Informative articles, helpful tips and exclusive comparison charts guide you through the maze of buzzwords. You'll find exactly what you need without paying for more than you want!

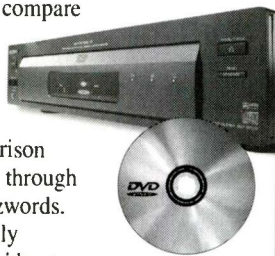

New! See why DVD means movies at home will never be the same!

Discover the convenience of shopping from home

Part catalog, part shopper's guide, the Crutchfield catalog makes it a pleasure to shop from home. You can call our well-informed sales advisors toll-free, 7 days a week with any of your product questions. Plus, you'll get your order in 2 days or less!



Sony, Kenwood, Pioneer, JVC, Bose, Harman Kardon, Infinity, Technics, Polk, Carver, Yamaha, and more!

So what are you waiting for? Get your copy on its way today!

Call now for your free copy!

1-800-955-9009

8 a.m. to Midnight (Eastern time), 7 days a week

or visit our Web site at

<http://www.crutchfield.com>

CRUTCHFIELD

1 Crutchfield Park, Dept. AU, Charlottesville, VA 22906

is your philosophy on remastering old recordings for new release?

I want to restore the breath of life. If it's there on the tape, I want the listener to hear it on the CD or LP that we put out. By breath of life, I mean the illusion that this performance could actually be happening. I mean, it's never going to *really* sound like it's happening; they can argue about this in audiophile magazines from here to eternity. But if you listen to, say, one of the Nat King Cole reissues we did last year, and it sounds like it's *possible* that he's right there with you, then that's the breath of life.

Do you use the same setup for all of your remastering projects at DCC?

No. It changes for every project. You can't just master The Eagles' *Hotel*

California and The Doors and Roy Orbison on the same gear; it would all start to sound a little homogenized. I always try to use the same kind of tape machine, equalizer, and other gear that was used in the original mastering sessions. And I never use any kind of Sonic Solutions-type noise-reduction processing. I always stay straight in the analog mode until the very last second, when it has to go into bits.

Given that RCA/BMG has already remastered and reissued the Elvis catalog on CD several times over, what was their response when you came along and told them you wanted to do another remastering?

They were very enthusiastic. Elvis for audiophiles, that was how we pitched it, and they were overjoyed to do it. RCA/BMG was very cooperative, and they made it extremely easy for me. We got to use the original non-EQ'd, uncompressed master tapes—which, incidentally, were the same masters they'd used for the RCA/BMG CDs.

I can't believe the same masters were used for the DCC and the RCA CDs. They just couldn't sound more different.

It's true; we all used the same exact tapes. The RCA/BMG people were the ones who actually went through the RCA vault and found all the original tapes. If it hadn't been for them, I would never have been able to do this disc.

If you both used the same master tapes, how

can there be such a night-and-day sonic difference between your reissue and theirs? The differences I heard go way beyond a little EQ and running the signal through tubes. The RCA discs have layers of distortion and compression, and a lot of the stereo stuff is collapsed to mono. I always attributed these characteristics to the original recordings, but they just aren't there at all on the DCC disc.

For one thing, a lot of engineers and people in the music industry don't like wide stereo. They don't want to hear that; they want to

hear things practically collapsed into mono. That's their problem. I know audiophiles and I know music lovers, and they want to hear what was on the tapes. They don't want to hear some truncated, EQ'd version. Fortu-

nately, Elvis's engineer, Bill Porter, and I—thanks to Michael Fremer's introduction—corresponded back and forth, and he explained to me exactly how he engineered the sessions, exactly how he wanted them to sound, and exactly what kind of EQ he used. That helped me immensely to re-create what he was looking for.

What kinds of things did you learn from Porter about how he wanted the Elvis recordings to sound?

I remember reading an interview he did years ago where he was complaining about the sound of the Roy Orbison reissues on CD. Bill was the original engineer on those recordings, and he complained that the CD versions shaved off all the upper bass and had no warmth. So I remembered that and wanted to make sure I asked him what he was trying to achieve on the Elvis recordings. I always try to ask the original engineer, if he's still alive, "What was your idea here?" I don't ever want to change someone's vision; I just want it to sound good.

You know, I read that interview too, and I have to tell you, it wasn't until I heard the DCC Elvis CD that any of the "Bill Porter's a genius" stuff made sense to me. The DCC reissue is such a revelation, because I can finally hear what all the fuss was about. You really expose his sonic expertise on this disc. Well, that was the idea. I worked long and hard on Elvis. It took many weeks, and

"I TRY TO USE THE SAME TAPE MACHINE AND OTHER GEAR USED IN THE ORIGINAL MASTERING SESSIONS."

some of the songs took four or five days alone to remaster. A lot of it was just removing certain equalization things that Bill had added on there; he told me exactly what kind of equalizer he used, so I went out and found the same model, a special old Universal Audio tube EQ that boosted the high end in 5-dB steps at 12 kHz and the bass at 50 Hz. I used it to remove the added EQ, because Bill had EQ'd extra *everything* on those tapes, and when you do that, everything starts to overload.

Why was he adding so much EQ?

He was boosting the frequency extremes, so when it finally ended up on LP, there would be some high end and some low end. That was his idea. But now that we don't have to worry about that anymore and things can be cut and mastered fairly accurately, I asked him if I could please remove some of that added EQ. He said yes, by all means. And when you remove it, everything else falls into place: The hiss goes down, the distortion goes away, and it starts to sound like it actually sounded when they were doing it straight.

Did you ever get to play Bill Porter your Elvis CD?

Oh, yeah. He teaches a college class in engineering, and he's been using my Elvis and

Orbison reissues of his original recordings as a comparison to all the other ones that are out there. He's extremely happy with them.

Are there any plans for more Elvis on the DCC label?

Yes. We're working on *Elvis: 24 Karat Hits, Volume II*.

Will you please put "Don't" on there? It was such a knife in the gut that it wasn't on the first disc.

[Laughing.] It's on the list. You know, I pondered those songs for so long, and I thought, oh boy, I gotta put this song or that song on there, but no, I can't, because I know that audiophiles love stereo—mono scares them. So I put one more stereo song on the disc than mono, even though most of Elvis's hits were in mono.

Speaking of which, are you going to include any of the legendary Sun Sessions recordings on Volume II?

Yep! "That's Allright, Mama," "Mystery Train," and—what's that one—"Baby, baby, baby, b-b-baby"?

"Baby, Let's Play House!"

And that other one, "Waitaminute, fellas, that don' *move* me! Lez get real, real *gawn* for a change."

You're putting "Milkcow Blues Boogie" on there, too? My god, RCA's actually letting you Hoffmanize The Sun Sessions?

Sure! Why not? You know, most of the fan mail we've received from the first Elvis reissue has been from regular people, non-audiophiles. And the Elvis fan clubs and collectors have really responded to it, too. They even sell both the CD and the LP at Graceland. Hey, it's a new compilation, with never-before-seen artwork, and it sounds great. Who wouldn't want that?

I can't believe this. The Sun Sessions is one of my favorite records of all time, but this is so wacky—it's like we're reaching the absurdist extreme of audiophile remastered versions of the most primitive, mono roots music. What's next, DCC reissuing Robert Johnson?

[Laughing.] I'd love to! Those original metal parts sound so good. I heard one at Columbia back in 1985, and I almost fell on the floor. It

sounded so wonderful—so much dynamic range, so much ambience coming from that little hotel room in San Antonio. But when the CD was finally released, it just sounded like an old, filtered 78. I was extremely disappointed.

See, here's what happens: There's a little bit of surface noise, so that's filtered off. Then it's compressed, and the dynamic range goes down. Then there's a lot of rumble down there, so the bass is filtered off. And after all that, it starts to sound like an old record.

But I know those original metal parts sound wonderful. They sound as lifelike and dynamic as anything I have ever heard in any other era. I remember listening to "Hellhound on My Trail" and thinking, my god, I'd never heard anything like this on the LP. So we'll see. I would love to do a reissue of Robert Johnson for DCC. You bet. A

**"IF IT'S THERE
ON THE TAPE,
I WANT THE LISTENER
TO HEAR IT ON THE CD."**

precision audio interconnect

HERO

The Hero interconnects
utilize many advanced
KIMBER KABLE
technologies. Proven

VariStrand™ conductor
geometry, new

GyroQuadratic field
geometry, and Teflon™
based dielectrics, all
combine in a cable that

welcomes the listener into
the performance.

Featuring

WBT
The art of connection

KIMBER KABLE

2752 S 1900 W - Ogden UT 84401

Phone 801-621-5530 - Fax 801-627-6980

www.kimber.com

PART 2

Digital Audio *for*

Photograph: David Hamsley

by J. Robert Stuart

the Future

Last month, Part 1 of this article examined in detail what is required for digital audio coding that can be guaranteed transparent for all listeners with all types of signals. This month, we turn our attention to how most effectively to code such audio for distribution.

In its analysis of this question, the Acoustic Renaissance for Audio (ARA) concluded that uniform, linear, multibit pulse-code modulation (PCM) offers the following overwhelming benefits, against which other contenders should be judged: (1) Its uniform sampling and quantization gives the option of scalability. (2) Optimal dither offers effectively infinite time and amplitude resolution and is *demonstrably* linear, both mathematically and in practice. (3) Psychoacoustically based pre-emphasis schemes are easily incorporated. (4) Stationary, psychoacoustically based noise shaping can be applied as a straightforward optimization technique. (5) Transparent data compression is an option to save bandwidth or storage capacity.

A distribution channel need not carry raw PCM. In fact, the choices currently available include: (1) PCM at sampling rates between 32 and 192 kHz and with word lengths from 8 to 24 bits. (2) Pre-emphasized PCM with complementary de-emphasis on playback. (3) PCM using psychoacoustically optimized noise shaping to deliver higher resolution for a given word length. (4) PCM combining the techniques of options 2 and 3.

(5) Losslessly compressed PCM (what the ARA has called "packed PCM"). (6) PCM with losslessly cascadable lossy encoding. (7) PCM compressed using a lossy method (psychoacoustically based variants of which include Dolby Digital, DTS, and MPEG). (8) Bitstream coding.

We in the ARA have contended that current technology can guarantee transparency in a channel *only* if lossy perceptual coding (option 7 above) is not used. Underlying this point is an extremely important observation: With the exception of bitstream coding (option 8 above), all the systems start and end with linear PCM. Linear PCM, when used correctly, provides an infinite-resolution (but noise-limited) representation of the output of a microphone. We in the ARA take the purist view that we want to convey as nearly as possible the acoustic waveform of the original performance. By coding that waveform, we can attempt to replay the audio by reversing the process—the traditional goal of high-fidelity sound reproduction. This does not exclude certain legitimate concessions to psychoacoustics: bal-

J. ROBERT STUART IS CHAIRMAN AND TECHNICAL DIRECTOR OF MERIDIAN AUDIO AND CHAIRMAN OF THE ACOUSTIC RENAISSANCE FOR AUDIO, AN ORGANIZATION FOUNDED TO CAMPAIGN FOR ESTABLISHMENT OF A DVD-AUDIO STANDARD THAT WOULD ASSURE THE HIGHEST POSSIBLE QUALITY OF SOUND REPRODUCTION.

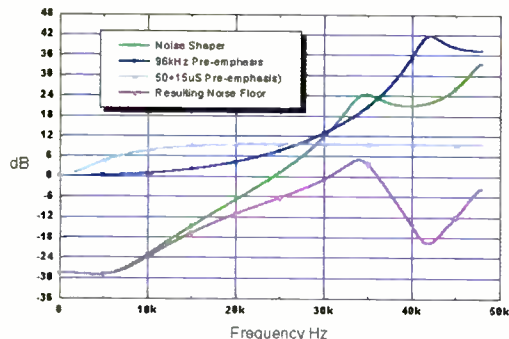

.....
Fig. 1—The current standard pre-emphasis curve for digital audio compared with a pre-emphasis characteristic optimized for high sampling rates, such as 96 kHz. Also shown are a noise-shaping curve matched to the proposed pre-emphasis as well as the spectrum of the noise floor produced by this noise shaper.

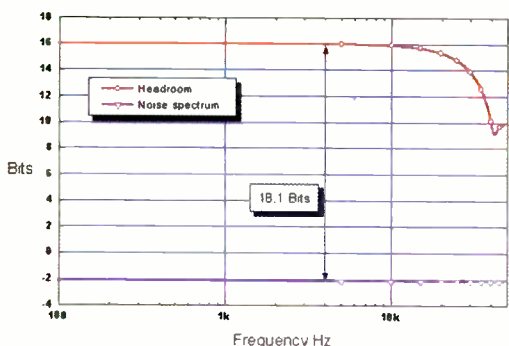

.....
Fig. 2—Output noise spectrum and headroom after application of the proposed pre- and de-emphasis. The graph expresses dynamic range in bits. This example illustrates a capacity of 18.1 bits at 1 kHz for a 16-bit channel, a perceptual gain of 2.1 bits.

anced limitation of bandwidth and dynamic range and enhancement of perceived resolution by means of pre-emphasis or psychoacoustically optimized noise shaping (processes that can be considered effectively linear).

96-kHz) signal or (2) as a combination of a half-bandwidth version suitable for reproduction at the channel sample rate (e.g., 48 kHz) and a high-frequency touch-up signal for highest-quality playback, either of which may use lossless or lossy encoding.

Among the other coding methods, *lossless* compression, or packing, of PCM data is simply a method of delivering a bit-accurate output while reducing the quantity of data stored or the data rate transmitted in the channel. This is no different in concept from the well-known methods, such as Zip files, used in computers for storing data in less space than occupied by the original files, although the techniques for packing audio are quite different from those used to compress text and pictures. Such lossless compression is an important tool in the quest to optimize resolution and deliverable sound quality.

The ARA has strongly supported the use of lossless packing, not only because it enables much more efficient data storage and transmission but also because such compression lowers the correlation between bit patterns and audio data. This, in turn, can lead to reduced levels of correlated jitter, which is a critical factor in high-resolution digital audio systems.

For sampling rates of 96 kHz and above, designers of both lossy and lossless compression schemes have considered reducing the fundamental word rate in the distribution channel, principally to enable easy transmission through existing carriers or interfaces. A lossless processor, for example, can offer at least 2:1 compression on most 96-kHz audio material, effectively allowing the distribution sample rate to be halved as one expression of the reduced data rate. In principle, this lowered rate can be treated in two ways: (1) as a single, compressed, high-rate (e.g.,

MULTIBIT PCM

I have argued that if a well-executed PCM channel is to *guarantee* transparency to a human listener, it will require more than 16 bits and a sampling rate higher than 48 kHz. I have also pointed out that normal practice still does not exploit the full potential of the current 44.1-kHz, 16-bit Red Book CD channel.

If we were to change the parameters purely according to audio considerations, we might well propose 20 bits at 66.15 kHz. Such a channel would require a data rate of 1.4 megabits per second, which is twice the rate required by the current 44.1-kHz, 16-bit channel. In fact, however, there are very strong practical reasons for maintaining 2:1 relationships with the Red Book release format, with the current archive, or with video-related formats (48-kHz sampling). Realistically, therefore, the next useful sampling rates for pure audio are 88.2 and 96 kHz.

It should be clear that increasing the bandwidth in this way will double the required data rate. In conventional audio engineering terms, that could look like a bad deal, depending on one's views concerning the value of audio content above 20 kHz and the desirability of setting standards defensively (using more data to cover up bad implementations). With that in mind, let's examine the options for reducing the data requirements of channels that run rather too fast (at 96 kHz, for example).

NOISE SHAPING AND PRE-EMPHASIS

There are two linear and psychoacoustically correct coding methods for improving the performance of linear PCM channels, particularly if the distribution channel uses a word length shorter than that of the original. These methods are: (1) noise shaping during a word-length reduction process to maintain a high effective dynamic range in a channel of fewer bits and (2) pre- and de-emphasis to better match channel capacity to the energy spectrum of music and to human hearing. Noise shaping can also be combined very effectively with pre-emphasis/de-emphasis, particularly if the noise shaper is designed to exploit the pre-emphasis curve.

Because the use of a high sampling rate (such as 96 kHz) allows the bandwidth of the channel comfortably to exceed the

high-frequency cutoff of human hearing, there are new options for noise shapers that have low coloration in the mid-band but also redistribute channel capacity in a more useful way. We have come up with examples of noise shapers that can provide perceptual gains of as much as 6 bits in a 96-kHz channel!

The unique advantage of using noise shaping alone as a method of minimizing data rate or maximizing the perceptual performance of a channel is that it requires

***a* significant advantage of noise shaping is that it requires neither equipment changes for playback nor a special decoder.**

neither equipment changes for replay nor a decoder. It is fairly easy to design noise shapers that will provide the required dynamic range in a 96-kHz, 16-bit channel.

The use of pre- and de-emphasis to improve the perceived dynamic range of analog channels is quite familiar to audio engineers. The method has been used with particular success in systems where the analog noise level increases with frequency, such as with magnetic tape, shellac or vinyl records, and FM broadcast. In each case, a well-documented property of music and speech is exploited: When material of acoustic origin is microphoned at normal listening positions, the average and peak spectrum levels decline with frequency above a few kilohertz. It is therefore efficient to boost (pre-emphasize) high-fre-

quency signals enough to make it more likely that they will fully occupy the channel's capacity. De-emphasis is applied on replay or reception, restoring correct frequency response while reducing both noise and distortion from the preceding chain.

Although pre-emphasis followed by de-emphasis was first implemented in analog systems, it can very usefully be applied to digital channels. When a link in the transmission chain requires a shorter word length (for example, when a 20-bit recording is transferred to CD), very real benefit can be obtained by performing pre-emphasis in the digital domain, quantizing with a noise shaper designed to exploit the pre-emphasis curve, and performing de-emphasis in the analog domain (or in the digital domain to a digital channel using a larger word size).

So far, all standards for digital audio have permitted the use of pre- and de-emphasis. The universal characteristic is currently 50/15 microseconds, as shown in Fig. 1. This pre-emphasis characteristic makes an increase in subjective dynamic range possible by boosting audio frequencies above 3 kHz in the transmission channel and attenuating them (and channel noise) on replay. It has not been overwhelmingly popular with the recording industry, mainly because some close-miked material does not offer in-band high-frequency headroom and because pre-emphasis brings on a mastering management issue, as its use has to be flagged. (Once again, a great potential squandered by poor practice.)

The ARA committee has proposed a new pre- and de-emphasis scheme to the DVD Forum for material recorded at sampling rates higher than 88.2 kHz. It combines a very suitable pre-emphasis characteristic with a matched noise shaper (Fig. 1 again). Figure 2 shows the output noise spectrum after application of the proposed pre- and de-emphasis. This scheme has several attractions. It substantially improves high-audio-frequency headroom (reducing it by only 2 dB at 15 kHz, compared to 9 dB

in the current standard). The pre-emphasis method involves a noise shaper that gives a 2.2-bit increase in overall dynamic range when used as a word-length-reduction device. In essence, channel capacity is moved from the extreme high-frequency range, where it is not required, to the mid-band, where it is incredibly useful. Because the noise shaper has the same shape as the pre-emphasis curve, the output (i.e., de-emphasized) noise spectrum is "white." And analog playback devices can match the de-emphasis curve very closely.

Figure 3 clarifies the way in which the suggested pre-emphasis combines with a noise shaper to provide increased dynamic range. The headroom curves at the top show de-emphasized response normalized for 16-, 20-, and 24-bit channels. The bottom curve represents the noise spectrum of the shaper used, *after correction* to allow for the 2.2-bit gain achieved by the pre-emphasis scheme. You can see from the figure how a 16-bit channel operating at a 96-kHz sampling rate can have an effective dynamic range of 23 bits in the critical 4-kHz region; note also that the channel is still offer-

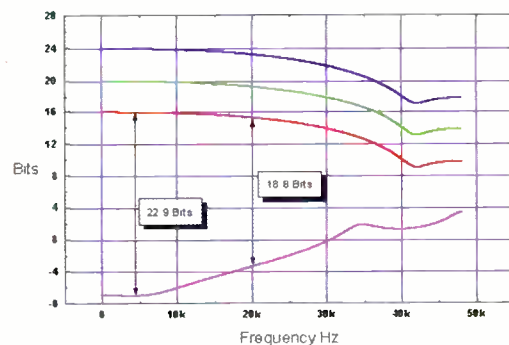

.....
Fig. 3—Output noise spectrum and headroom for 16-, 20-, and 24-bit channels after application of the proposed pre- and de-emphasis and noise shaping. The graph expresses dynamic range in bits. The example illustrates a capacity of almost 25 bits at 4 kHz for a 16-bit channel. a perceptual gain of 7 bits.

Table I—Coding benefits of pre-emphasis, noise shaping, and a combination using both of the described schemes.

METHOD	SAMPLING RATE	
	48 kHz	96 kHz
Pre-Emphasis	3 dB	12 dB
	(0.5-bit)	(2-bit)
Noise Shaping	16 dB	30 dB
	(2.7-bit)	(5-bit)
Pre-Emphasis – Noise Shaping	21 dB	42 dB
	(3.5-bit)	(7-bit)

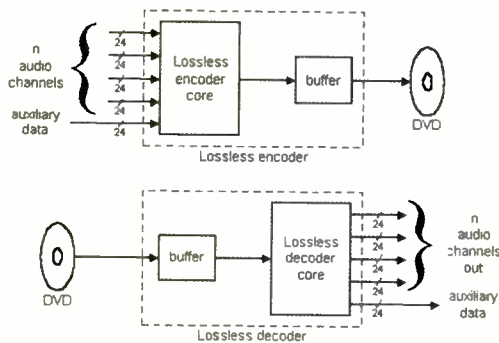

Fig. 4—Proposed lossless encoder and decoder for DVD-Audio, each consisting of the core algorithm followed (in the encoder) or preceded (in the decoder) by a smoothing buffer.

ing 19-bit performance at 20 kHz. Table I summarizes the benefits noise shaping and pre-emphasis can offer.

LOSSLESS COMPRESSION OF PCM

Any stream of digital data representing coded audio information is in principle compressible, for two basic reasons. First, the full capacity of a rectangular channel is not occupied continuously by audio that conveys meaning. This leaves room for simple techniques like noise shaping and pre-/de-emphasis to work successfully. Second, material of interest to human listeners contains some structure that can in part be predicted. It is therefore possible to design a coding and decoding scheme that reduces

the quantity of data transmitted or stored.

Doubling the data rate from 48 to 96 kHz to convey any less than twice the information is inefficient. One elegant solution is to use lossless compression in the channel. There are many methods of implementing lossless compression; most are based on the use of prediction, which reduces the quantity of data to be conveyed. An appropriate lossless compressor should: (1) return the original data intact, bit-for-bit; (2) be robust in dealing with errors in the channel; (3) be effective in reducing the data rate at high sampling rates (i.e., recognize ultrasonic content); and (4) control the peak data rate (a factor of importance in DVD replay).

The ARA has strongly recommended that high-quality audio channels be losslessly compressed (packed). Signal processing has advanced to such a level that the data-reduction benefits of this sort of coding are too good to pass by. Unlike perceptual coding or other forms of lossy data reduction, lossless compression does not alter the final, decoded signal in any way; it merely packs the audio data more efficiently into a lower data rate.

Existing lossless audio data-compression systems are optimized for reducing the *average data rate* but not for reducing the *peak data rate* or for obtaining good results at high sampling rates, such as 88.2 or 96 kHz. The process of packing PCM becomes more efficient as the sampling rate is increased. For example, packed 96-kHz audio does not double the data rate of packed 48-kHz audio, as you might expect; the increase is more like 30%.

Lossless compression can also allow the record producer to choose what trade-offs should be made between playing time, frequency range, number of active channels, and precision. The packed channel can convey this choice implicitly in its control data, and the system's operation will be transparent to the user. This arrangement has the

following benefits: (1) A producer mastering at 48 kHz can control the incoming precision of each channel and trade playing time or channels for noise floor. (2) A producer mastering at 96 kHz can also trade bandwidth for playing time, active channels, and precision. Playing time or precision can be extended, for example, by pre-filtering information above 30 kHz or supplying only a two-, three-, or four-channel mix. (3) Lossless packing offers an opportunity to make a much better product, in that more precision and more channels can be provided.

LOSSLESS COMPRESSION FOR DVD

It should be apparent that any lossless compression scheme will, of its nature, be more successful in some passages than in others, so that the compressor's output data rate will not be constant. Recently,

Lossless
compression
delivers a bit-
accurate output
while reducing
the quantity
of data.

however, a lossless compression scheme has been developed that is optimized for (but not exclusive to) DVD, in that it delivers a constant data rate in the packed domain. With this scheme, 16-bit, 96-kHz-sampled audio signals can almost always be losslessly compressed to 8 bits (and 16-bit, 48-kHz-sampled signals to 12 bits), with exact reconstruction of the original on playback.

The properties of the lossless coding scheme proposed for DVD audio are as follows: (1) output data filled out to a constant data rate to meet disc constraints; (2) output data rate typically lower than that of PCM input at 48 kHz; (3) output data rate significantly lower than that of PCM input at 96 kHz; (4) input word length continuously adjustable between 16 and 24 bits; (5) bandwidth continuously adjustable between 22 and 48 kHz, with efficient coding for these options; (6) good compression; (7) seamless transition from lossless to lossy operation (if necessary); (8) extremely simple decoder; and (9) auxiliary data stream exactly synchronized to the audio. This scheme, which uses a simple hardware or software decoder that takes instructions from the bit stream, enables great flexibility at the mastering stage. And the option remains open of substituting a more sophisticated encoder at some future time to achieve better compression.

Figure 4 shows the lossless encode/decode process. Low-frequency effects channels do not require special handling, as the encoder automatically makes bit-rate savings according to signal bandwidth. The encoder core produces a data rate that varies with the audio signal, being greatest during peaks of high treble energy. Because the peak data rate is a limiting factor in DVD, the complete encoder includes a buffer that smooths the peaks in the data rate. A corresponding buffer on the playback side allows peak data rates higher than the DVD can handle to be delivered to the decoder core. Table II shows the reductions in peak and average data rates achieved by the proposed lossless compression scheme. These levels of compression very comfortably exceed the tentative projections put forward by Gerzon in the original ARA proposal.

In DVD applications, the peak data rate is the important parameter, whereas for hard-disc storage, the average rate would be the one to examine. At 44.1 or 48 kHz, the proposed scheme can almost always reduce the peak data rate by at least 4 bits/sample in lossless mode—i.e., 16-bit audio can be losslessly compressed so that it fits into a 12-bit channel. At 96 kHz, this scheme can reduce the peak data rate by 8 bits/sample in lossless mode, which means that 24-bit audio can be compressed to 16

bits and 16-bit, 96-kHz audio can be losslessly compressed so that it fits into an 8-bit channel.

These numbers indicate that lossless compression enables more audio channels to be transmitted on a given carrier. For example, the following intriguing arrangements are possible: (1) three channels of 16-bit, 44.1-kHz audio in a Red Book CD data stream (allowing, for instance, Ambisonic B format to be issued on CD); (2) two channels of 16-bit, 88.2-kHz audio in a Red Book CD data stream; (3) four channels of 24-bit, 96-kHz audio in a DVD stream of 6.144 megabits/second (currently only two channels fit); (4) 5.1 channels of 20-bit, 96-kHz audio in a DVD stream; and (5) eight channels of 20-bit, 48-kHz audio in a DVD audio stream.

PCM WITH LOSSY COMPRESSION

Lossy compression schemes attempt to evaluate the component of the microphone output that is irrelevant to human listeners (either because it falls below the hearing threshold or because it will be masked by adjacent content) and to convey the essence of the sound rather than the waveform. Now, perceptual coding is not a ridiculous idea: After all, that is exactly what happens in our hearing system, and such techniques have been shown to be capable of excellent performance. However, no one in the ARA believes that any existing lossy coding system can be said absolutely to have passed the test of time with respect to complete sonic transparency. Furthermore, our current understanding of human psychoacoustics is such that it would take a very brave (or foolish) person to suggest we understand all we need to design a lossy compression coding scheme that meets all the ARA requirements.

This is not to say at all that lossy compression is wrong; it is very useful in appropriate contexts. However, if we are to be confident that we are conveying the original music event with complete transparency, then our current understanding can offer nothing beyond passing all the

captured data, bit-accurate, to the playback system. That may well change in the future, but for now, I don't feel that lossy compression can be advocated for audio of the highest resolution.

BITSTREAM CODING

It has been suggested that a suitable distribution format might be the single-bit, perhaps 64-times-oversampled, data streams produced by many modern-day A/D converters (see Fig. 5) or even hybrid bit streams, such as eight-times oversampled 8-bit. The argument for the 1-bit scheme is that simple DACs complete the chain, allowing the stages of digital filtering in the A/D and D/A converters to be bypassed, and that the bitstream signal represents a superior archive. The data rate of such a channel is high (around 3.1 Mb/S), and even with lossless compression, a bitstream channel requires nearly three times the data required by a losslessly compressed PCM equivalent.

While it is not appropriate here to go too deeply into the arguments for and against bitstream coding, there are some very pow-

Table II—Reduction in data rates, in bits per sample per channel, when the proposed lossless compression scheme is used.

Sampling Rate	DATA-RATE REDUCTION	
	Peak	Average
48 kHz	4 Bits	5-11 Bits
96 kHz	8 Bits	9-11 Bits

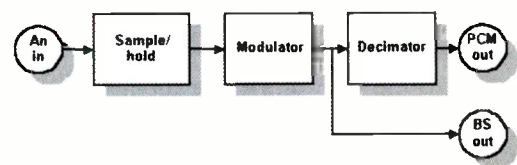

Fig. 5—Block diagram of a delta-sigma A/D converter, showing both PCM and bitstream outputs.

Table III—Data rates per channel, relative efficiencies, and jitter susceptibility of a number of coding options. Also shown are the number of whole channels that can fit into a DVD data stream of 6.144 megabits/second (Mb/S).

CODING EXAMPLES

	f_s , kHz	Precision, Bits	Noise Shaping?	Pre- Emphasis?	Lossless Compression?	Data Rate, Mb/S	Efficiency	Number of Channels at 6.144 Mb/S	Jitter Sensitivity
1	58	14	Yes	No	No	0.81	100%	7	Medium
2	48	21	No	No	No	1.01	81%	6	Medium
3	48	18	Yes	Yes	No	0.86	94%	7	Medium
4	48	20	No	No	Yes	0.77	106%	8	Low
5	96	20	No	No	No	1.92	42%	3	Medium
6	96	16	Yes	No	No	1.54	53%	4	Medium
7	96	14	Yes	Yes	No	1.34	60%	4	Medium
8	96	18	No	Yes	No	1.73	47%	3	Medium
9	96	24	No	No	No	2.30	35%	2	Medium
10	96	20	No	No	Yes	1.15	70%	5	Low
11	96	20	No	No	Band- Limited	0.92	88%	6	Low
12	96	18	No	Yes	Yes	0.96	85%	6	Low
13	96	24	Yes	No	Adaptive	1.10	74%	5	Low
14	96	18	No	Yes	Yes	0.96	85%	6	Low
15	3072	1	No	No	No	3.07	26%	2	High
16	384	8	No	No	No	3.07	26%	2	High

erful negatives, beginning with the fact that we should be aiming substantially higher for the future than accepting a 1-bit, 64-times modulator. The best current-day converters use 4- or 8-bit modulators. Furthermore, most recordings are multibit and originate in a multibit DSP environment (for example, as a result of performing a mixing or editing function). So, if the capturing A/D converter uses a different modulator architecture (such as 4-bit, $128f_s$) or the recording is multibit as an original, it makes no sense to convert the signal to bitstream—especially as the conversion process is inherently lossy and nonlinear. I believe that it would be a very great mistake to try to standardize the archive format, particularly to anything of such questionable audio promise as $64f_s$, 1-bit code.

In addition, any attempt to introduce a low-bit distribution format would face a

significant difficulty because the industry has no interfaces, DSP methods, or machinery that would permit the change to be effected gradually. In fact, the inherent simplicity of bitstream coding rapidly disappears when any subsequent operations on the data are required, such as in normal editing.

Bitstream coding might be appropriate to very simple two-channel systems, but its data-rate requirement becomes unacceptable when the needs of multichannel are taken into account. It is also difficult to guarantee perfect linearity when bitstream coders based on delta-sigma modulation are used. That is because, unlike a multilevel quantizer with dither, a two-level quantizer, even with dither, is not linear. Linearity is improved by negative feedback, but performance cannot be guaranteed for all signals.

BIT-BUDGET COMPARISONS

Thus far, we have reviewed a number of important features of the eight coding methods listed at the beginning of this article. Because we are interested here only in the highest-quality sound, I have set aside lossy compression schemes. All the remaining options on the list can be engineered to provide equivalent resolution. In the context of real applications, such as DVD, a crucial comparison is the quantity of data used by each method. Channel coding that requires more data to convey the same sound quality uses up bandwidth that could otherwise be used to convey more channels or higher-quality associated video information.

Table III offers a useful comparison. The base data rate is taken to be a 14-bit, 58-kHz channel with noise shaping, suggested last month in Part 1. If the sampling rates are

..... FURTHER READING

Acoustic Renaissance for Audio, "DVD: Application of Hierarchically Encoded Surround Sound—Including Ambisonics," private publication, November 1996; available for download at www.meridian-audio.com/ara.

Acoustic Renaissance for Audio, "High-Quality Audio Application of DVD (Draft 0.5)," private publication, November 1996; available for download at www.meridian-audio.com/ara.

Acoustic Renaissance for Audio, "A Proposal for High-Quality Application of High-Density CD Carriers," private publication, April 1995; available for download at www.meridian-audio.com/ara (reprinted in Japanese in the *Journal of the Japan Audio Society*, Vol. 35, October 1995).

Acoustic Renaissance for Audio, "DVD: Pre-Emphasis for Use at 96 kHz or 88.2 kHz," private publication, November 1996; available for download at www.meridian-audio.com/ara.

Akune, M., R. M. Heddle, and K. Akagiri, "Super Bit Mapping: Psychoacoustically Optimized Digital Recording," 93rd Convention of the Audio Engineering Society (AES), San Francisco, 1992; AES Preprint No. 3371.

Craven, P. G. and M. A. Gerzon, "Compatible Improvement of 16-Bit Systems Using Subtractive Dither," 93rd Convention of the AES, San Francisco, 1992; AES Preprint No. 3356.

Craven, P. G. and M. A. Gerzon, "Lossless Coding for Audio Discs," *Journal of the Audio Engineering Society (JAES)*, September 1996 (Vol. 44, No. 9; pp. 706-720).

Craven, P. G., M. J. Law, and J. R. Stuart, "Lossless Compression Using IIR Prediction Filters," *JAES (Abstracts)*, March 1996 (Vol. 44, No. 3, pg. 404), and AES Preprint No. 4415.

Craven, P. G. and M. A. Gerzon, "Lossless Coding Method for Waveform Data," International Patent Application No. PCT/GB96/01164 (May 1996).

Dadson, R. S. and J. H. King, "A Determination of the Normal Threshold of Hearing and Its Relation to the Standardisation of Audiometers," *Journal of Laryngology and Otology*, Vol. 66 (1952; pp. 366-378).

Hawksford, M. O. J. and C. Dunn, "Is the AES/EBU/SPDIF Digital Audio Interface Flawed?," 93rd Convention of the AES, San Francisco, 1992; AES Preprint No. 3360.

Hawksford, M. O. J., "Bitstream vs. PCM Debate for High-Density Compact Disc," private publication, April 1995; available for download at www.meridian-audio.com/ara.

Gerzon, M. A. and P. G. Craven, "Optimal Noise Shaping and Dither of Digital Signals," 87th Convention of the AES, New York, 1989; AES Preprint No. 2822.

Gerzon, M. A., P. G. Craven, J. R. Stuart, and R. J. Wilson, "Psychoacoustic Noise Shaped Improvements in CD and

Other Linear Digital Media," 94th Convention of the AES, Berlin, 1993; AES Preprint No. 3501.

Katz, B., "96-kHz Listening Test," thread on Internet newsgroup rec.audio.pro (July 1997).

Komamura, M., "Wideband and Wide Dynamic-Range Recording and Reproduction of Digital Audio," 96th Convention of the AES, Amsterdam, 1994; AES Preprint No. 3844.

Meridian Audio, Ltd., "Lossless Compression for DVD: Summary of Features," private publication, July 1997; available for download at www.meridian-audio.com/dvd.

Meridian Audio, Ltd., "Lossless Compression for DVD: Technical Proposal," private publication, July 1997; available for download at www.meridian-audio.com/dvd.

Ohashi, T., E. Nishina, N. Kawai, Y. Fuwamoto, and H. Imai, "High Frequency Sound Above the Audible Range Affects Brain Electrical Activity and Sound Perception," 91st Convention of the AES, New York, 1991; AES Preprint No. 3207.

Ohashi, T., E. Nishina, Y. Fuwamoto, and N. Kawai, "On the Mechanism of Hypersonic Effect," *Proceedings of the International Computer Music Conference*, Tokyo, 1993 (pp. 432-434).

Oomen, A. W. J., R. G. Groenwegen, R. G. van der Waal, and R. N. J. Veldhuis, "A Variable-Bit-Rate Buried-Data Channel for Compact Disc," *JAES*, January/February 1995 (Vol. 43, No. 1/2; pp. 23-28).

Robinson, D. W. and R. S. Dadson, in International Standards Organization ISO131-1959.

Robinson, D. W. and R. S. Dadson, "A Redetermination of the Equal-Loudness Relations for Pure Tones," *British Journal of Applied Physics*, May 1956 (Vol. 7; pp. 166-181).

Stuart, J. R. and R. J. Wilson, "A Search for Efficient Dither for DSP Applications," 92nd Convention of the AES, Vienna, 1992; AES Preprint No. 3334.

Stuart, J. R., "Noise: Methods for Estimating Detectability and Threshold," *JAES*, March 1994 (Vol. 42, No. 3; pp. 124-140).

Stuart, J. R. and R. J. Wilson, "Dynamic Range Enhancement Using Noise-Shaped Dither Applied to Signals With and Without Pre-Emphasis," 96th Convention of the AES, Amsterdam, 1994; AES Preprint No. 3871.

Stuart, J. R. and R. J. Wilson, "Dynamic Range Enhancement Using Noise-Shaped Dither at 44.1, 48 and 96 kHz," 100th Convention of the AES, Copenhagen, 1996.

Stuart, J. R., "Auditory Modelling Related to the Bit Budget," *Proceedings of AES U.K. Conference: Managing the Bit Budget*, 1994 (pp. 167-178).

Vanderkooy, J. and S. P. Lipshitz, "Digital Dither: Signal Processing with Resolution Far Below the Least Significant Bit," *Proceedings of the AES 7th International Conference: Audio in Digital Times*, Toronto, 1989 (pp. 87-96).

limited to multiples of 48 kHz, then a simple rectangular PCM channel using 20 bits at 96 kHz (example 5 in the table) can meet the target performance.

When sampling is at 48 kHz, the perceptually equivalent 21-bit channel (example 2 in the table) uses 24% more data to convey less bandwidth than may be needed. Noise shaping with pre-emphasis (example 3) is close to 100% efficient, and its losslessly compressed version, at 106% efficiency, is very effective indeed, enabling eight nearly transparent channels to fit into a DVD audio stream.

Moving up to 96-kHz sampling guarantees adequate bandwidth. Examples 5 and 9 in Table III show that raw 20- and 24-bit

(88%) is achieved with 30-kHz band-limited lossless compression (example 11). The losslessly compressed examples exhibit low jitter sensitivity.

The bitstream options (examples 15 and 16) have the lowest efficiency of all, at 26%. They are also highly susceptible to jitter and manage to fit only two channels into the data stream. With bitstream coding, it is very difficult to offer multichannel audio or high-quality associated video.

SUMMING UP

In Part I of this article, I reviewed the issues surrounding the transmission of high-resolution digital audio. The conclusion was that audible transparency can be guaranteed by a channel equivalent to one that uses PCM coding at a 58-kHz sampling rate with either 14-bit representation and appropriate noise shaping or 20-bit representation and a flat noise floor (i.e., a “rectangular” channel). This implies that the current CD channel standard—44.1-kHz, 16-bit coding—may not always be adequate (even with noise shaping to extend the resolution) and that raising the sampling rate to 48 kHz is still not quite enough.

Sampling at 88.2 or 96 kHz is too high, on the other hand, and therefore wasteful of storage capacity or transmission bandwidth. The use of sampling rates above 96 kHz to convey a wider audio bandwidth cannot currently be justified at all. But on the assumption that practical considerations of downsampling will lead the industry to choose sampling rates for DVD-Audio that are integral multiples of 44.1 or 48 kHz (i.e., 88.2 and 96 kHz), we have looked in this installment at options for improving coding efficiency at these rates.

Noise shaping combined with a new pre-emphasis/de-emphasis characteristic for 96-kHz (or 88.2-kHz) applications can result in an effective increase of 2 to 7 bits' worth of dynamic range to the channel. At these sampling rates, in other words, a 16-bit channel should be sufficient. (Actually, a 14-bit channel can be made to yield a 21-bit dynamic range via these techniques, but the examples given are based on 16-bit channels because that is the smallest option in the current DVD standard.) This coding scheme compares very favorably with other methods of reducing the data rate, in that it offers a very low implementation cost, as-

sure transparency, and is compatible with existing systems. I and the other members of the ARA strongly urge its adoption as a standard.

And though we consider bitstream coding and lossy compression schemes inappropriate for an audio system intended to deliver the highest possible resolution and transparency, we see considerable advantages to well-implemented lossless compression. Consequently, I have also presented here a lossless compression method that provides significant savings in peak data rate at both 48- and 96-kHz sampling rates. The savings made in the high-rate channels are sufficient to allow more than five channels to be carried in a 6.144-Mb/S DVD audio stream or to leave room for video on a DVD-Audio carrier. A

ACKNOWLEDGMENTS

This article is based on papers I have presented to the Audio Engineering Society. Inevitably, it draws on the work of others. Many points emerged from discussions between members of the Technical Subcommittee of the Acoustic Renaissance for Audio (Tony Griffiths, Professor Malcolm Hawksford, David Meares, and me) and our advisors (Peter Craven, Michael Gerzon, Hiro Negishi, Francis Rumsey, and Chris Travis). The assistance of Takeo Yamamoto, Bike Suzuki, Malcolm Law, and Adrian Farmer has also been particularly valuable.

Those who wish to contact the Acoustic Renaissance for Audio (ARA) may write (c/o Meridian Audio, Stonehill, Stukeley Meadows, Huntingdon PE18 6ED, England), call (+44 1480 52144), send a fax (+44 1480 451587), send e-mail (ara@meridian-audio.com), or visit the group's Web site (www.meridian-audio.com/ara).

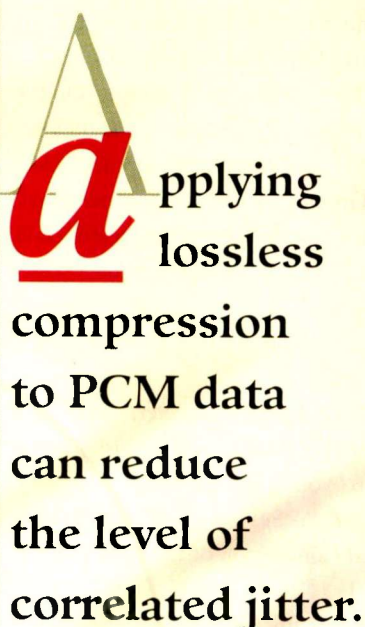

pplying
lossless
compression
to PCM data
can reduce
the level of
correlated jitter.

channels use up to three times the base data rate and restrict a 6.144-Mb/S stream to two or three channels. Example 8 indicates how using the new pre-emphasis scheme alone increases efficiency, and when noise shaping is added (example 7), we see 60% efficiency, with four channels accommodated. The PCM options have medium jitter susceptibility.

When lossless compression is added (example 10 in the table), efficiency rises to 70% and five channels fit into the data stream. The highest efficiency in this group

We've got rhythm. We've got music.

"Rotel's products, at all prices, are so impressive that it is safe to think of Rotel as a gold standard against which we can confidently measure the industry's performance as a whole."

Audio
Adventure
Magazine

Thanks Gershwin.

George and Ira Gershwin were a prolific team who wrote some of America's best loved music. Lady be Good, Rhapsody in Blue, and I've Got Rhythm among countless others. Inspired, provocative music that became repertoire standards due to their beautiful melodies and unforgettable lyrics.

At Rotel, we also know about establishing standards. For nearly forty years our engineers have worked to develop hi-fi components to bring your favorite artists to life. We do it by manufacturing our own custom transformers and shopping the world for premium components from world-class manufacturers. We assemble them in our own ISO9002 certified factory, and finally, we listen. If it moves our feet, we know it will move yours.



Rotel's RTC940 Stereo FM Tuner/Preamp with Remote and RB981 130watt/Channel Power Amplifier

Rhythm and music. Who could ask for anything more?
Rotel. Real hi-fi.

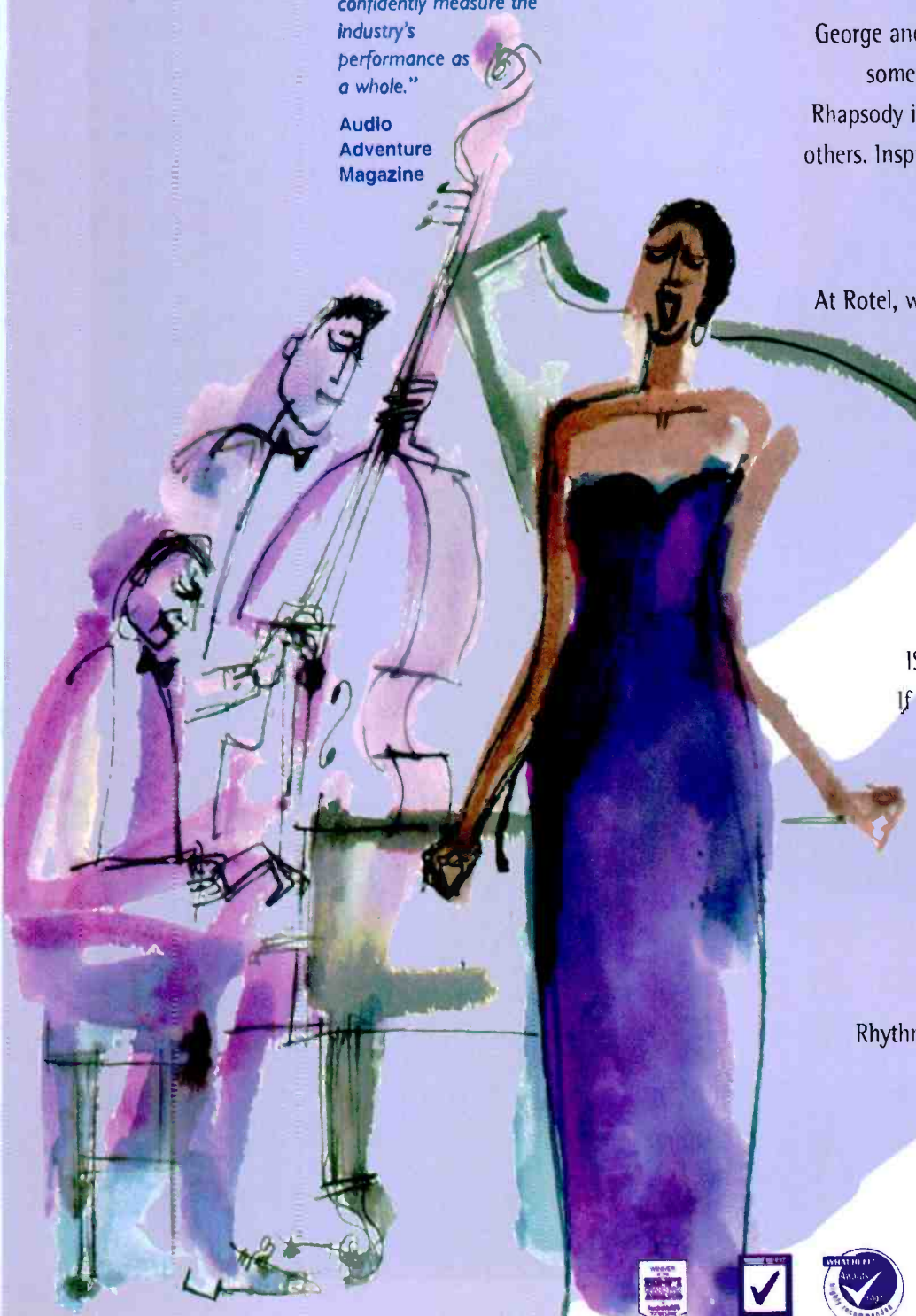

AUDIO ADVENTURE'S MANUFACTURER OF THE YEAR

ROTEL

54 Concord Street
N. Reading, MA 01864-2699
Phone: 978.664.3820
Fax: 978.664.4109



Photography: ©1998, Dave King

Dan D'Agostino

OF KRELL

FROM SCI-FI TO HI-FI

Dan D'Agostino is a driven man: His all-consuming passions for sound, technology, and music have made his company, Krell Industries, the Lamborghini of high-end audio. Indeed, the name Krell is now synonymous with American high-end virtues (state-of-the-art construction wrapped around powerfully transparent sound), but D'Agostino plucked the appellation from an old sci-fi flick, *Forbidden Planet*. It surely was the portentous line from Dr. Morbius (played by Walter Pidgeon) that caught D'Agostino's imagination—"In times long past, this planet was the home of a mighty and noble race of beings, which called themselves the Krell"—because those qualities describe his design goals so perfectly. Having chosen a marque, Dan and his wife, Rondi, launched the company in 1980 with just one product, the KSA100 power amplifier.

Dan D'Agostino's entree to audio began at age 11, when he started putting together more than his share of Heath and Eico kits. At the same time, his father was building Klipsch corner-horn speakers from plans straight out of *Wireless World*. By 14, Dan had graduated to a Marantz 7C preamp, a Marantz 8B power amp, and AR-1 speakers with Janszen electrostatic tweeters, all bought with money he earned "polishing the tubes and

Steve Guttenberg is a freelance writer and a producer for Chesky Records. He sold Krell gear, along with many other products, during his 16-year stint working at New York City retailer Sound By Singer.

sweeping up the floors" at his hometown hi-fi shop, the Audio Center, in Niagara Falls, N.Y. He went on to receive his degree in electrical engineering at the University of California, Berkeley.

Though Krell Industries currently has nearly 100 employees, D'Agostino remains involved in nearly every aspect of his company. He conceives products, designs the cosmetics, and specifies production methods. Even the engraving tools for the faceplates and back panels of Krell components have his original stamp on them. During the course of this interview, conducted in Dan's small office, we were interrupted by a nearly constant stream of questions from various staff members, all of whom needed decisions from him. **S.G.**

How did you two meet?

Rondi: At a Consumer Electronics Show. Lord knows which one.

Dan: I'd been working on this little head amp [low-output moving-coil cartridge preamp] for myself. This was in the days of Mitch Cotter and all that business.

Rondi: For whom I worked at the time!

Dan: I told Rondi, "That guy you work for is a snake-oil salesman, 'cause the stuff he's making is really expensive and it doesn't sound that good." I'd listened to the Cotter transformer at a place called Stereo Emporium [in Buffalo, N.Y.] and thought, jeez, there's something wrong with this thing. I have a really keen set of ears for vinyl, and when I listened I thought there was some filtering going on. Something was not right. What Cotter's transformer had was an incredibly low noise floor—it had a moving-magnet

by Steve Guttenberg

T H E A U D I O
I N T E R V I E W

noise floor—with moving-coil gain. And no RF interference. So I thought if I could build an active moving-coil stage that didn't do any filtering, was immune to RF, and was extremely quiet, then I would have something better than the Cotter transformer, and it would certainly be a lot cheaper. I built perhaps 30 or 40 versions until I was happy, and then I sent one to Rondi. And when she listened to it at home and compared it to the Cotter, of course it sounded a lot better. Then she didn't think I was as crazy as I came off.

Rondi: He was so arrogant. . . .

Dan: I was arrogant, but when you're 30 years old and in the business for 11 years, you have to be really arrogant or you're not in audio anymore. If you're not arrogant, you're going to get your teeth kicked in a lot before someone says, "Yeah, that's pretty good." You have to start off from a really high place to get knocked down to where you're a normal person again.

Rondi: I had a tube amp that blew up, and Dan romanced me with a Class-A, solid-state amplifier. [Laughs.] It was 25 watts, and it was great!

Dan: Back in the late '70s, early '80s, there was a shakeout in the high-end audio industry, and I looked around and I saw that there were only two high-end companies left making big solid-state amplifiers—Threshold, which had already abandoned the audiophile, and Mark Levinson Audio Systems, which embraced the audiophile. Their stuff really didn't sound that good and was really expensive; their only Class-A amp was 25 watts, but it was \$5,000 or \$6,000. So I realized that what the world needed was a 100-watt, stereo Class-A amplifier of reasonable size, with big power supplies, that didn't cost a fortune. I figured the only way to do that was with fan cooling and discrete mono power supplies. I threw the book at it, but the KSA100 retailed for just \$2,200. It had a lot more power than the Levinson Class-A amp and delivered more into some speaker loads. It also was a lot cheaper than the 200-watt Levinson ML-3 Class-AB amp. I think the first amps we delivered all went to Levinson dealers. The Mark Levinson company got really paranoid, because our product came out of nowhere, from someone with no reputation in the industry. Their dealers were saying our amp was really good, that Levinson should take a look at it, and they did. Then Levinson's president, Sandy Berlin, sent out a directive to the dealers: No one can have Krell and Levinson. So we got thrown out of all those stores, and we started going around to other dealers. Then we picked up foreign distributors.

You were on your way.

Dan: Rondi and I started Krell on a shoestring in October 1980, and we showed the first product at the 1981 CES. It was just two of us: Rondi built the first 80 amplifiers, I tested them, and together we boxed them. It was hand-to-mouth. We'd build two amplifiers, put them in our car, drive them to a dealer, get a check, and then



Dan and Rondi D'Agostino with the Krell KSA100, the amplifier with which they launched the company in 1980.

build two more and do the same thing. So if that took 22 hours a day, then that's what we did.

That's how we lived; today I think it would be impossible for a company that small to survive. I think it would be really difficult to do now what we did back then. Even some of the more established names in our industry are starting to fall behind because they haven't addressed market trends. I think two-channel audio is shrinking at such a rate that most of the dealers who would have taken on a product like our original amplifier are now gone.

Which brings us to home theater.

Dan: Home theater is growing because it's a family thing. Audio is a hermit's hobby, let's face it. It's one guy sitting between two speakers playing music he likes. Typically his wife can't even turn on his system because it's so complicated. What I like about home theater is that that doesn't happen. Their kid is going to watch a cartoon, or at night they might make popcorn and put on a movie. Yeah, it's going to shake the house, but the whole family is going to love the fact that the audio makes the movie more exciting. Everybody is going to use it. We're not losing the two-channel audiophile, we're just gaining the approval of his wife and family.

Rondi: I have another thought about home theater. Now that there's more of a focus on it, the guys with the really nice sound systems are adding home theaters to those systems. They still have their two-channel audio, but they also have their home theater.

Dan: I've had home theaters in various forms for 10 or 12 years, and I've hated the sound. So when I designed the Audio + Video Standard [reviewed in *Audio*, December 1997], I made it an audiophile-quality processor. It was a huge undertaking; we probably have invested a couple of hundred thousand dollars in engineering in it and a year and a half of time. It uses six DSPs, and it works exactly like a computer. If you ask it to load DTS or





Dolby Digital, it loads it like a computer. It was a monster project. We're also making more affordable home theater components that won't leave performance in the wastebasket.

Ah, yes, but Krell built its reputation by pushing the limits. . . . We think there's going to be one more really good play on ultra-high-end two-channel audio, and we're just about ready to introduce something for that market: the Master Reference monaural power amplifier. It's going to be expensive to do that.

How expensive?

I wouldn't be surprised if the amps will cost \$70,000 or \$80,000 or even \$100,000 per pair. I don't care. I'm building the Master Reference as a statement of what I can do, and I don't want any limitations. There are no compromises with this amp, except the wall voltage, and we took care of that too. This amp draws more juice than a clothes dryer, and you wouldn't hook up a clothes dryer yourself,

would you? You'll have to hire an electrician to do it. It's a 220-volt appliance, but with a smart power supply. It will operate on one 117-volt, 20-ampere line or two 117-volt, 20-ampere lines, or on a single 220-volt or two 220-volt lines per amplifier! But if you want to get 24,500 watts of output power into 1 ohm, you need to run two 220-volt, 60-ampere lines. And you

can do that; this amplifier has that capability. I believe there are dynamic resonances and impedances that may, in fact, go as low as 0.5 ohm, and if you're playing your speakers really loud, you may need that much power. If the speaker can't handle it, that's the speaker designer's problem. The amp will put out huge amounts of power.

I pity the poor speakers! Do you ever sit down with speaker designers to find out what they need?

You know what? I don't; we have different design objectives. They're trying to make speakers that can be driven by most of the popular amplifiers on the market and still sound good. If I were making a speaker, it would be very, very difficult to drive, because I know, in my heart of hearts, that I could make better speakers if I didn't pay attention to impedances. The bottom line: If you don't mind paralleling six identical drivers, you could make better speakers. But remember, out there in the world there are lots of single-ended tube amplifiers, push-pull tube amps, and solid-state amplifiers that are less capable and less powerful. Speaker designers have to devise speakers that work with those amps. And, by the way,

the Master Reference amp also plays extremely well at low levels. Its low-level linearity is a quantum leap better than anything I've ever made before.

Speaking of low output levels, what do you think about the vogue for single-ended triode tube amps?

I lived this stuff before most of the guys doing single-ended amps were around. And back then there were great tubes that are no longer available. I remember single-ended amps and Williamson push-pull amplifiers with Klipschorn speakers, and I want to say, I would never pick the single-ended tube amplifier. The single-ended tubes were nice, but when you turned that Williamson on, the sound bloomed and it got big; there was dimensionality. When I see single-ended stuff coming back, I think we're going backwards. You're not going to pull the wool over my eyes and tell me that something that looks like that, measures that way, and sounds that way is good. I've eaten my spinach, and I'm sorry to say, it does not sound good. In the final analysis, there is a reason that circuits got more complicated. They did more things. They got a little bit better in one area, maybe at the expense of another, and then the engineers did more work, and they kept building on the research. Listen, I think if you took a

panel of people, even nonaudiophiles, put them in a room, played music for them with a big amplifier, and compared that to a little single-ended amplifier, they would never pick the small amp. No one would pick it. It's amazing to me that the industry embraced this. We've lost those people.

Your company has built its reputation on the strength of stratospherically priced gear, but in recent years, with the KAV line, you've introduced fairly reasonably priced components.

I never wanted to do that. But I was talking to my French distributor, and he said that integrated amplifiers were selling really well and suggested that Krell make a \$2,000 integrated amp. I thought it was feasible, but I wasn't so sure I wanted to do it. I started batting it around, and in its first iteration, it couldn't sell for less than \$4,500 to \$5,000. But then I came up with a front end and output stage that embraced all of the things we do in the big stuff, but it wasn't really expensive to build. We started using extrusions for front panels instead of solid billets. That was the KAV-300i, which came out at \$2,350. As it turned out, the French distributor probably sold five pieces. But the rest of Europe got on board, the Far East got on board, and our U.S. dealers did as well. Now we're selling 250 to 300 units a month and have been for more than two years. We'll be adding a Day Sequerra-designed tuner to the KAV-300i. . . .

The Krell receiver!



A pair of husky Krell FPB-250M Class-A mono amps, each rated at 250 watts into 8 ohms

T H E A U D I O
I N T E R V I E W

It's kind of full circle, eh? There'll be a 150-watt/channel receiver, the KAV-300r.

You've done some outside consulting over the years.

We designed the output stage for the Day Sequerra Reference tuner, the original Aragon 2004 and 4004 power amplifiers, and Aragon's first preamp. We've also designed electronic crossovers for Martin-Logan, JBL, and B&W, and we built the amplifier and power supplies for the Apogee Grand loudspeakers.

When you're working on a design, how do you "know" what it sounds like? What's the process?

It does take a fair amount of time to hear that, usually weeks and weeks. I start by listening with Etymotic Research ER4 headphones that were specially adjusted to compensate for the frequency response of my hearing. Later, I'll do more listening on the Wilson Audio X-1 speaker or something like that. For the Master Reference power amplifier, I probably put in close to a year of listening to different stages during its development.

It's amazing that you're known for designing massive amplifiers, but the bulk of your critical judgments are made listening over headphones.

Let's take as a given that I know how to drive speakers. Now, if I have that part figured out, then the only thing I'm interested in is the tonality. By using headphones, I'm eliminating the room and all sorts of variables; I'm just listening to tonality. And I'm also looking for low-level information, 'cause I know what the big stuff is supposed to look like. I'm looking very, very closely at the low-level stuff, the dirt—the stuff that's way down there around -110 dB, where all the dirt lives. That's why I really need headphones to tell me how an amplifier sounds. It's interesting. Seven or eight years ago big amplifiers had to be driven to a certain level before they began to sound decent; at lower levels they didn't do so well. That's something we worked on. I think the secret to making really good solid-state amplifiers is paying attention to their low-level resolution. So when our customers are listening at very low levels over speakers, the amps sound great. And when they turn them up, they'll still sound great. They shouldn't shift gears.

What is it, exactly, that you're listening for?

I like the sound to be big and robust. I don't want it to be bright or hard, but I do like definition. I don't want to leave the detail on the floor. I like it to be there, but I don't want it to be aggressive.

High-end companies like yours do substantial export business.



The Krell
FPB-650M
power amplifier



A section of the massive output stage for the Krell Master Reference power amplifier, Dan D'Agostino's newest design

It represents around 50% of our production. We were the first American high-end company to crack the U.K.; until that point American product was labeled "agricultural." [Rondi laughs.] Hong Kong is one of our top markets, followed by Germany, Japan, Korea, and the rest of Europe. I dedicate 50% of my output to the U.S. market, though I sometimes have foreign distributors screaming for more product. There are some high-end companies whose sales are 80% to 90% export.

You're still driven; what keeps you going?

My mission won't be complete until I make Krell the largest single-proprietor high-end audio company ever. I'm a driven person; I don't like failing at anything, so I just work at it until I make it right. I'm still doing it. It's still never good enough for me, so I just keep making my designs a little better and then a little better still. But it's never good enough. I look at the stuff—I do—and I say, that's great, but I think I can do better.

Let's do it over. I talk to customers on the phone. I want to know how they've been treated by the receptionist and how the salespeople treated them. I want to make improvements. And you know what? There's a niche market for people who want the best, and everything we do is based on quality first. Everything else is secondary.

TIME TESTED

A true test of any company is endurance in it's field. At Legacy Audio we've not only endured but excelled. For 15 years Legacy craftsmanship has been at the forefront of innovation and technology in the audio field. With such standards as the Classic, Focus and Whisper you can be confident that each Legacy product will withstand the test of time.

For more information and a free catalog, call 1-800-AUDIO-HI or visit us on the web at www.legacy-audio.com

LEGACY[®]
A U D I O

1-800-283-4644 • 217-544-3178 • Fax: 217-544-1486 • www.legacy-audio.com

ON THE ROAD '98

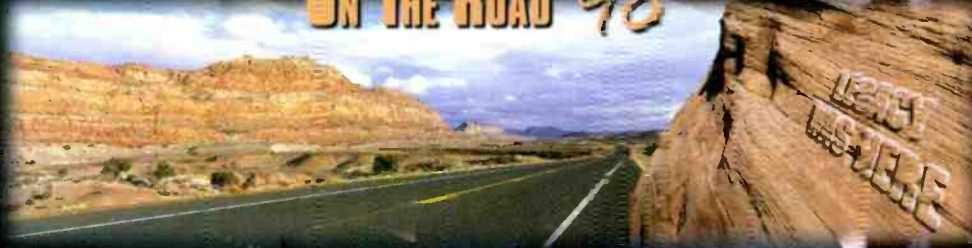

- Orlando, FloridaSight & Sound • Buena Vista Palace, Disney Village • March 21st & 22nd
- Houston, Texas11011 Brooklet Suite 360 • March 28th & 29th
- Grand Rapids, Michigan533 32nd St. SE • April 25th & 26th
- Dallas, Texas1610 North I-35, Suite 2024 (Carrollton, TX) • May 16th & 17th
- Los Angeles, CaliforniaHi-Fi '98 • The Westin-LAX • June 10th - 14th
- Seattle, Washington18422 103rd Ave. NE (Bothell, WA) • Cox Music Co. • July 17th & 18th
- Vancouver, B.C.7283 Cambie St. • July 25 & 26th
- New Orleans, LouisianaCEDIA, Ernest N. Morial Convention Center • September 9th - 13th
- Newport Beach, CaliforniaHome Theater Expo • Hyatt Newport (Ocean Floor) • October 9th - 12th
- Oakland, California4231 Park Blvd. (Oakland Hills) • J. Nelson & Co. • October 17th & 18th
- Atlanta, Georgia3315 Chamblee-Dunwoody Rd. • Alcor Organ Studio of Atlanta • November 14th & 15th

All show times are Saturday 12 pm - 6pm, Sunday 11 am - 4pm unless otherwise noted

resurrection

THE RESTORATION *of the* NEW YORK PHILHARMONIC

BY SUSAN ELLIOTT

Photos Courtesy of the New York Philharmonic Archives

When the New York Philharmonic issued its 10-CD set of historic broadcasts (1923 to 1987) late last fall, even the crustiest critics hastened to sing the collection's praises. Among the most significant orchestral compilations ever to see the light of day, the set's artistry is as much in the music-making as in the technology that serves it.

Having made the savvy decision not to go with a commercial label and issue the disc independently, the orchestra—the players as well as the administration—had a hand in everything, from repertoire and soloists to producers and packaging.

Given the immense amount of material—12+ hours of music comprising 32

"THE WHOLE IDEA IS TO PRESENT THE VIRTUOSITY OF THIS ORCHESTRA OVER 64 YEARS," SAYS SEDGWICK CLARK.

performances, 21 conductors, and 18 soloists—and the ragged shape that much of it was in, it's surprising that it took less than 10 months to compile and issue this set. Especially surprising given that the pro-

ducer, historic recordings buff Sedgwick Clark, likes to polish things endlessly before letting them go, that every selection had to be approved by both the orchestra and music director Kurt Masur, and that engineer Seth Winner moved his studio in the middle of the project.

Before commencing his hundreds of hours of listening, Clark—a writer whose credits include editing the late, great *Keynote*—asked for a list of all the orchestra's broadcasts, from 1923 to 1987. (In 1922, the Philharmonic was the first major orchestra to broadcast a live concert.) "The first thing I looked for was whether the conductors had recorded these pieces commercially or not. I also looked for rare combinations of artists," for instance, Artur Rubin-



LECTION

MONIC'S HISTORIC BROADCAST RECORDINGS

stein and Bruno Walter performing Chopin's First Piano Concerto. This collaboration never saw the light of day on a commercial record, since the artists were under contract to different labels.

The set abounds with such heretofore unissued rarities: Walter conducting Richard Strauss's underappreciated tone poem *Symphonia Domestica*, Nadia Boulanger in a rare stint on the podium with Fauré's Requiem, Arturo Toscanini conducting Henry Wood's delightfully bloated orchestration of Bach's Toccata and Fugue in D Minor. Clark's goal was to showcase the orchestra in as broad a context as possible, balancing historical significance with, heaven forbid, audience appeal. "The whole idea of this set is to present



THE CREATIVE TEAM:
ION SAMUELS,
SEDGWICE CLARK,
BARBARA HAWS, AND
SETH WINNER

Photo: Robert Lewis



the virtuosity of this orchestra over 64 years," he says.

After a couple of months of listening, Clark brought his wish list to Masur, who checked off those performances he liked. The music director's input was by no means token. Consider the case of the 1960 broadcast of Brahms's Symphony No. 2; it was led by Fritz Reiner, who never recorded the work commercially. "I told Masur I thought it was a good, solid performance but that I found it lacking in energy," says Clark. "And he said, 'Well, you know, sometimes Americans like fast performances, and those are the kind they find the most exciting. But a slower performance might just appeal to me—I might like that.' And I said, 'Great, it's in.'"

Clark auditioned material over a five-month period, usually in his living room in East Hampton, Long Island. "Sedge was in heaven," reports the set's other engineer, Jon Samuels. "He used to say, 'And I'm actually getting paid to do this!'"

"And then," interjects Winner with droll humor, "he roped us in."

Winner and Samuels, friends and colleagues for more than 20 years, have their own studios and are collectors in their own right. Winner, a sound-preservation engineer for the Rodgers and Hammerstein Archive at Lincoln Center (from which



AARON COPLAND,
VIRGIL THOMSON, AND
NADIA BOULANGER

much of the early source material came) worked on both the Heifetz and Toscanini collections for BMG, among other projects. Samuels, a freelancer at BMG studios, was also involved in those projects and served as producer for a recent nine-CD William Kappell reissue set.

"The input from both of these guys was invaluable," says Clark. "While I was the one who chose the performances, they're the ones who knew where the bodies were buried. It's one of the major reasons I chose them, because their knowledge of historical recordings is second to none."

The later material, from 1963 to 1988, came from the orchestra's own archives, stored at Lincoln Center and in Iron Mountain, N.Y.; earlier broadcasts were culled from the R&H Archive and, significantly, from private collections. As word of the project spread, collectors, in turn, suggested other sources; Clark, ever vigilant, had to hear them all. "If it had been up to Sedge," laughs Samuels, "we never would have finished."

"And if it hadn't been for [Philharmonic archivist and the set's executive producer] Barbara Haws telling me we have to get this out," says Clark, "I'd still be listening."

The two engineers divided up the project: Samuels, working on his own, did most of the tape material—the last three CDs; Winner worked with Clark on the rest.

THE ARTISTRY HERE
IS AS MUCH IN
THE MUSIC-MAKING
AS IT IS IN
THE TECHNOLOGY
THAT SERVES IT.

"Since I have a full-blown CEDAR system with a digital editor, it was logical I should get all the lacquer material," says Winner. "I also did the final remastering and assembling of the package. Sedge and I sat there and discussed things like audience noise, fade in, fade out on the applause, level corrections, and so forth."

While Samuels had professionally-made original tape recordings from which to work, Winner was dealing with far dicier sources—usually air checks made by amateurs. "Just the collector sitting there with his tuner and tape recorder putting on a reel of tape [or, earlier, a disc] and letting it fly," he says.

"In a way," says Samuels, "I had too much, Seth too little. And either way, there wasn't a single source in the entire collection that was easy to reproduce."

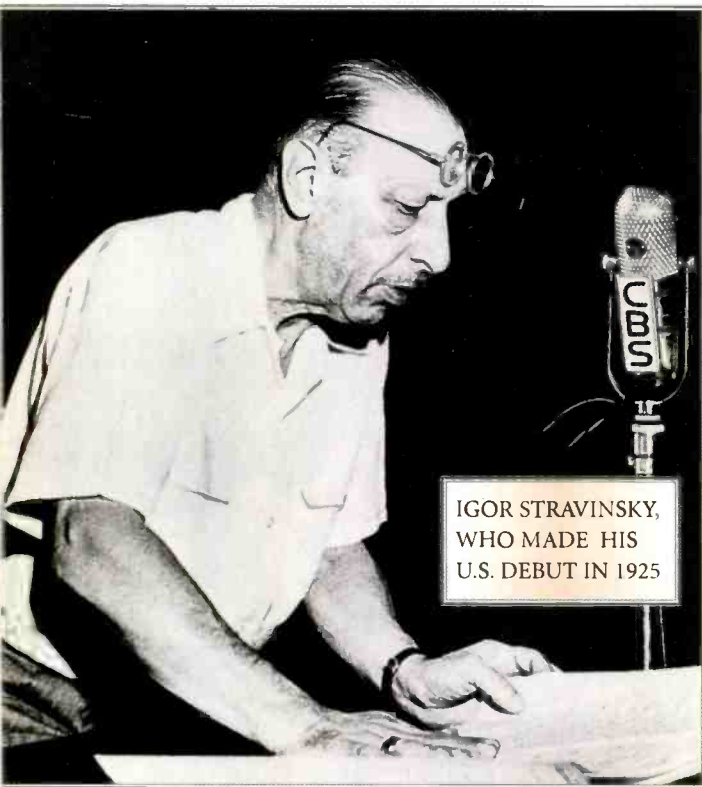

IGOR STRAVINSKY,
WHO MADE HIS
U.S. DEBUT IN 1925

NEW YORK PHILHARMONIC

THE ORCHESTRA
EMBARKS ON ITS
1930 EUROPEAN TOUR



Samuels' biggest problem was documentation. Determined to reconstruct the original master tapes rather than simply use one of the copies sent to the radio stations, he started from scratch. "Sedge and Barbara would send me every single tape they could find for a particular series of concerts. There would be about 10 different tapes, all unlabeled." In one instance, he spent 18 hours just searching for the right takes—before beginning any editing or processing. Fortunately for the Philharmonic, the producer and engineers agreed to work for a flat fee rather than charging by the hour.

"One wonderful thing I did for Jon was to find him six different sources of the Brahms Second with Reiner," recalls Clark. "Yeah, after I had finished it twice," retorts Samuels. "Sure, but better sources kept turning up," says Clark with a big grin. "Michael Gray at the Voice of America sent me copies that had been sitting in his office since 1987, and they were better than anything else we'd heard."

Other sources were farther afield. Determined to include Bruno Walter's 1945 broadcast of the *Symphonia Domestica*, Clark hopped on an airplane to Columbus, Ohio, to borrow a recording from 83-year-old collector Robert Buchsbaum of Coronet Recordings. "The discs at Lincoln Center had two gaps in them, at the turnover points," Clark reports, "and we wanted to plug the holes. Buchsbaum's source turned

out to be better than what we had, so we used his for most of it. But one of his discs was cracked."

"I had never seen one like it," Winner remarks. "During the War, they used glass-based discs, but this was the strangest one I'd ever seen. It was cracked only on one side; the other side was intact."

"Of course, the side we wanted was cracked," continues Clark. "There were two 16-inch discs and a 12-inch, which was the one giving us problems. After three minutes into the side, it would not track."

"It was a bit frustrating," says Winner, "but I finally got it, then cut back into the library source, then back again to Buchsbaum's."

"Now, you might ask, why did we go through all this?" says Clark rhetorically. "Richard Strauss's *Symphonia Domestica* is generally considered his least successful tone poem. Everyone says to me, 'Oh, I hate that piece.' But I felt it was very important that people hear what can be done with it. Walter never recorded it, this is the best performance I've ever heard, and the orchestra plays fabulously."

But Clark did not always get his way; he has maintained from the beginning that both the orchestra's and the music director's contributions were key to the project's success. "The thing that makes me the happiest about this set is that the players seem to love it. That means we did our jobs well, which pleases me no end."

He and Winner had two two-hour listening sessions with the orchestra. The players were welcome to attend, and in at least one case they rejected a performance. Clark had chosen a 1948 broadcast of Charles Munch conducting Chabrier's "Marche Joyeuse." "It was a little three-minute piece, a lot of fun," he recalls. "I put it at the beginning of the disc; it would have been a great curtain raiser. But one of the musicians commented, 'They're not playing very well.'"

"Masur said, 'This is sloppy; they're not together,'" recalls Winner. "To me, it was a devil-may-care performance, very boisterous," continues Clark. "Sure, it was loose, but there was a great deal of verve and excitement and fun. However, they thought it was sloppy, so out it went."

The musicians were also on the lookout for technology overkill. When Winner

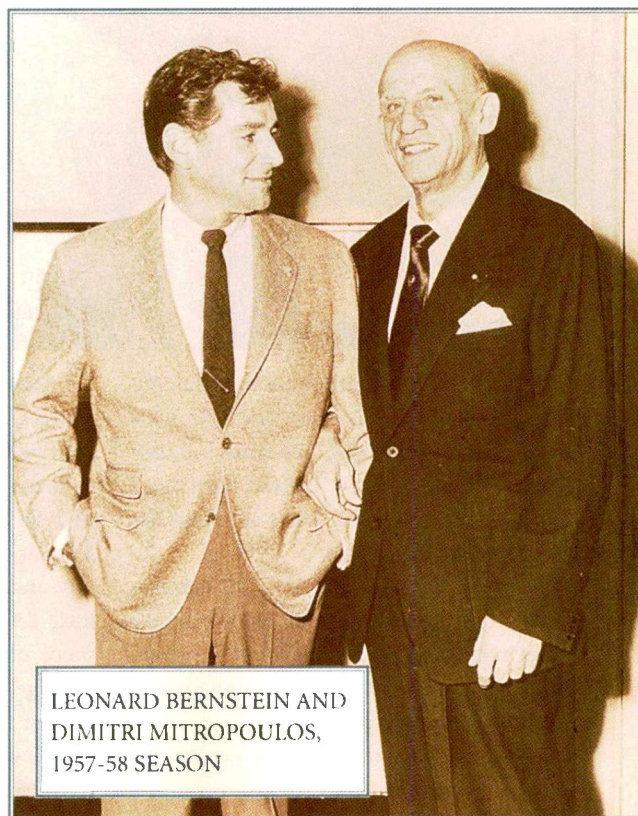

LEONARD BERNSTEIN AND
DIMITRI MITROPOULOS,
1957-58 SEASON

NEW YORK PHILHARMONIC

played the 1940 broadcast of Stravinsky conducting Tchaikovsky's "Little Russian" Symphony in its pre- and post-processing versions, the orchestra raised a red flag. Recalls Clark, "Masur said, 'Sometimes you can do too much, and it takes the music out.' They suggested that we go back and do a different mix. We did, and they liked it very much."

To be sure, the performance is the thing on this set, for this is a case where technology—in the form of CEDAR and Sonic Solutions' NoNoise—has been applied artfully. So aural smog and snow are still in evidence. Says Clark, "I think a lot of producers and engineers go overboard in historical releases; in trying to get detail, they lose tone quality. There were times when I'd say

ing, poor storage, stone-age technique, or all of the above. Samuels recalls how the channels were reversed on the 1977 premiere broadcast of John Corigliano's Clarinet Concerto, conducted by Leonard Bernstein; Winner remembers that his primary source for the third movement of Shostakovich's Violin Concerto with David Oistrakh (1956—the American premiere) muted for 30 seconds and that a 1952 broadcast of Kirsten Flagstad singing the "Immolation Scene" from Wagner's *Götterdämmerung* sounded like there had been "a trained orangutan at the controls.

"The broadcast engineer had no clue of how big her voice was," Winner explains. "When she opened her mouth, the sound not only came at you, it went around you, underneath you, and totally enveloped you—no matter where you sat in the hall. Well, she's standing in front of the mike, or at least one of two for that broadcast, and every time it gets loud, you hear them bring the level down. Then, when they think it's safe, they bring it back up. Then, of course, another wild cry out of her, and down it goes.

"Actually, I worked with two different sources," Winner continues. "In the major source I used, the guy started the tape recorder too late; he missed the opening bar or two. So I literally taped the beginning from another tape, EQ'd it, pitched it properly, and then dubbed it in. Then there were little dropouts that had to be fixed, a little piece of oxide missing on the tape, curl damage, and so forth.

"But the most fun, before I even did any level correction, was that this was a very bass-deficient broadcast. I tried some of the wackiest digital curves I have ever come

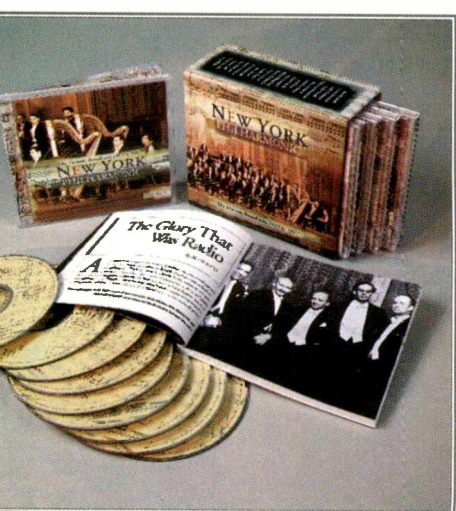

up with to get the bass back in." In fact, throughout that alternate source, the recording level was too low. "About two minutes in," continues Winner, warming to the subject, "the guy suddenly realizes that his levels are too low and jumps it about 10 dB, so I had to do a level correction and then create a cross-fade." All told, Winner estimates he performed about 100 level corrections on approximately 16½ minutes' worth of music. By the time Clark approved the final mix,

GIVEN THE AMOUNT OF MATERIAL, IT'S SURPRISING THAT THIS SET WAS PRODUCED IN LESS THAN 10 MONTHS.

admits Winner, "I never wanted to hear the thing again."

He may get another chance to relive the experience, however—if not with *Götterdämmerung*, then perhaps, as rumor has it, with Mahler or Bernstein. The success of this set, despite its hefty price tag of \$185, has prompted the Philharmonic to consider doing another archival project. Whatever that may be, if the same tender loving care is applied by the same team, it's sure to be another triumph for the artful cohabitation of historic recording and modern technology. A

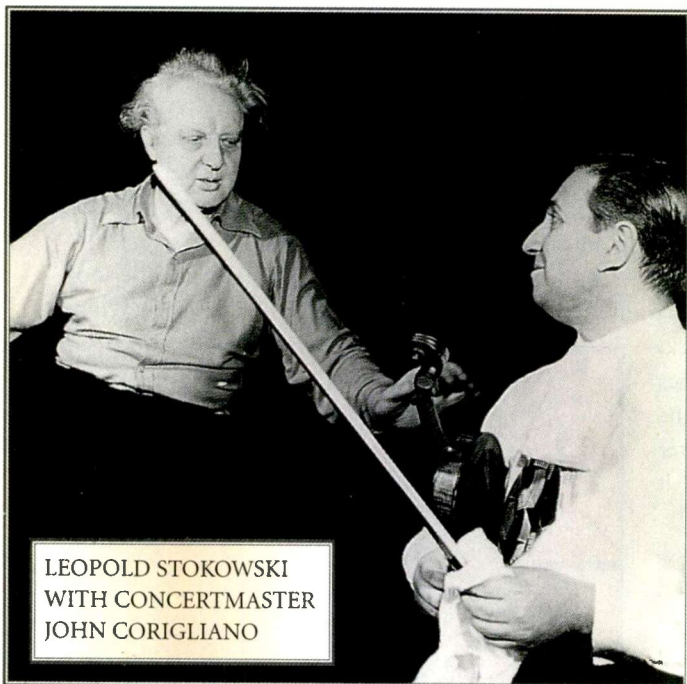

LEOPOLD STOKOWSKI
WITH CONCERTMASTER
JOHN CORIGLIANO

to Seth, 'Yes, you're getting more detail, but the tone doesn't strike me right.' So we'd work on it, and he'd say, 'Yes, okay, but now you're losing this detail.' He was right, but I felt we had to go with what sounded the most musical to my ears."

"Actually," inserts Samuels, "it's extraordinary that Seth didn't kill Sedge. On the other hand, it's an extraordinary product. And, to be fair, you only get one chance, so you may as well do it right."

Virtually all of the source material had problems, whether from the pickup in the hall, the broadcast signal, the actual record-

Vienna Acoustics™



The Bridge

S U M I K O

"Everyone who heard the Vienna Acoustics speakers — including the snobbiest listener in our office — loved the sound, loved the looks, and wanted to take them home."

[Home Theater]

Vienna Acoustics loudspeakers are precision-engineered by European craftsmen to bring to life the thrill of music and film in your living room. Your eye is drawn to their slender, elegant cabinets lovingly finished in warm beech, dramatic rosewood, and formal black, welcoming their owners home at the end of a long day. If they look like fine furniture, it's because they are.

Less obvious is the intensely technical approach present in all Vienna Acoustics designs. Only a few know that each cabinet has been designed with computerized finite element analysis. Or that, after carefully studying all of the commonly used cone materials, we selected an all-new transparent material called XPP™ that is both stiffer than polypropylene

and much quieter. One brief listen and you'll be stunned by their richness, depth, and impact.

You might not know that we make exclusive use of the finest Scandinavian silk dome tweeters in all our models because their extreme power handling provides for effortless, soaring highs.

Or that our crossovers use precision-wound coils tolerated to an incredible .7% for better imaging. You won't have to think about it because we have.

And isn't that really the point? We invite you to kick off your shoes, sit back and enjoy Europe's most compelling new range of luxury loudspeakers.

D. B. KEELE, JR.

KLIPSCH KSF 10.5 SPEAKER



Paul Klipsch, who founded his speaker company in 1946 (when I was just six years old!), has always been a maverick. He was a vociferous advocate of horn-loaded speakers—so much so that he named his first conventional box speaker the Heresy. During the '60s, '70s, and '80s, he wrote a series of consumer-oriented monographs on speakers and related technical topics (no longer available, alas) and, since the company was in Hope, Ark., named that series "Dope from Hope." The company, now

owned and operated by Paul's second cousin, Fred Klipsch, still has its manufacturing and engineering facilities in Hope, but its head office is in Indianapolis.

Unlike the original Klipschorn (which is still available, for \$5,798 per pair), the Model KSF 10.5 uses a bass-reflex woofer rather than a horn-loaded one; its tweeter, however, is a horn. Poorly designed horns can color sound, but well-designed horns offer many advantages. For one thing, they match the speaker diaphragm's mechanical impedance to the acoustical impedance of

the air. This improves dynamic range by increasing power handling, output, and efficiency and by reducing distortion. Because efficiency reduces heat buildup, horn speakers can be more reliable. Horns can also offer precisely controlled horizontal and vertical coverage patterns.

The KSF 10.5 is the larger of two tower speakers in Klipsch's 18-model Synergy line (which includes bookshelf, center-channel, and surround speakers as well as powered

**KLIPSCH HAS BEEN
TRUMPETING
THE ADVANTAGES
OF HORN SPEAKERS
SINCE 1946.**

subwoofers). Its vented enclosure holds two 8-inch, long-throw woofers, coupled with a medium-sized constant-directivity horn tweeter; these drivers are all designed and manufactured by Klipsch. Although the horn is square (6¾ x 6¾ inches), it provides 90° horizontal and 60° vertical coverage. The enclosure's vent tube has a large, 2¾-inch, diameter and is 7 inches long. Its exit, near the bottom of the rear panel, is generously flared to reduce air turbulence.

To minimize diffraction, the KSF 10.5's woofers and horn are flush-mounted on the front panel, which is about 7/8 inch thick. The rest of the cabinet (made of medium-density fiberboard) comprises ¾-inch pan-

Rated Frequency Response: 36 Hz to 20 kHz, ±3 dB.

Rated Sensitivity: 95 dB at 1 meter, 2.83 V rms applied.

Rated Impedance: 8 ohms, nominal.

Rated Power Handling: 100 watts (400 watts, peak).

Dimensions: 38 in. H x 10¼ in. W x 12½ in. D (96.5 cm x 26 cm x 31.8 cm).

Weight: 55 lbs. (25 kg) each.

Price: \$800 per pair; available in black ash or rosewood vinyl veneer.

Company Address: 8900 Keystone Crossing, Suite 1220, Indianapolis, Ind. 46240; 800/KLIPSCH (800/554-7724).

Photos: Michael Groen

els, stiffened by a brace, 2 inches x 3/4 inch in cross section, between the sides. The mold- ed-plastic grille frame plugs into six rubber bushings on the front panel. On the bottom are large, molded-plastic feet, 2 inches in diameter x 1 inch thick. Spikes are not provided, but you can unscrew the supplied feet and replace them with spikes if you prefer.

The tweeter's molded-plastic horn flares out in a complex curve called a tractrix, whose properties were described by Klipsch engineers in the March 1991 issue of *Audio*. The horn emerges from a small compression driver, so-called because sound waves from the tweeter's diaphragm are compressed as they travel through the horn's much smaller throat (which is actually inside the driver); the area of the entrance to the throat is usually just 10% to 20% that of the driver's radiating diaphragm. The tweeter has a large ceramic magnet, 2 3/4 inches in diameter x 3/8 inch thick. An identical magnet attached to the rear of the driver, in reverse magnetic polarity, acts as a bucking magnet to cancel or reduce external magnetic fields. This, and similar bucking magnets

on the woofers, enable the speaker to be used near a TV screen.

The woofers have mica-filled polypropylene cones, butyl rubber surrounds, and high-temperature Kapton voice-coil formers. Their ceramic magnets are 4 inches in diameter x 1/2 inch thick.

The crossover feeds the parallel-connected woofers through a fourth-order (24-dB/octave) low-pass filter, while the tweeter is driven by a third-order (18-dB/octave) high-pass filter; the nominal crossover frequency is 2.2 kHz. The crossover's 11 components (three resistors, four iron-core inductors, and four nonpolarized electrolytic capacitors) are mounted on a small circuit board behind the input terminal cup, which is just above the port on the rear panel. The speaker's input is a single pair of

gold-plated, five-way binding posts spaced 3/4-inch apart, enabling use of double-banana plugs. The crossover is connected to the drivers by 16-gauge stranded wire and clips.

Measurements

Figure 1 shows the KSF 10.5's anechoic frequency response; the curves combine ground-plane bass measurements with midrange and treble measurements taken in a large anechoic chamber. Response is quite smooth and flat below 1 kHz but rises and becomes bumpy above that frequency, then rolls off above 13 kHz; this is more evident in the unsmoothed curve (taken with the grille on) than in the smoothed (grille-off) curve. Overall, the curve taken without the grille fits a loose, 9.5-dB, window between 49 Hz and 20 kHz (+5, -4.5 dB, referenced to 1 kHz) and fits a much tighter, 2.5-dB, window between 66 Hz and 1.4 kHz. Between 2 and 7 kHz, the grille causes significant response deviations. Averaged from 250 Hz to 4 kHz, the KSF 10.5's sensitivity measured a high 92.5 dB.

Figure 2 shows the KSF 10.5's phase and group-delay responses, referenced to the tweeter's arrival time. The phase response of direct-radiator speakers typically slopes off at a roughly constant rate. But in this case, the phase response has nonlinear characteristics, with distinctly different slopes in the region below 400 Hz, from 400 to 800 Hz, from 800 Hz to 4 kHz, and above 4 kHz. This is reflected in the group-delay curve, which exhibits peaks and dips in these regions. In addition, this curve indicates that there is significant delay through the crossover region, reaching a maximum of 0.4 millisecond at 2.5 kHz. To

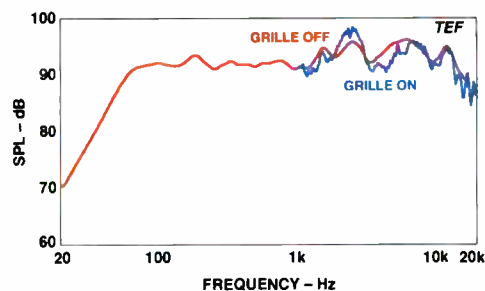

Fig. 1—Frequency response.

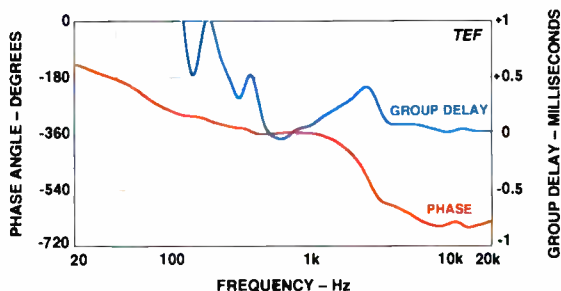

Fig. 2—Phase response and group delay.

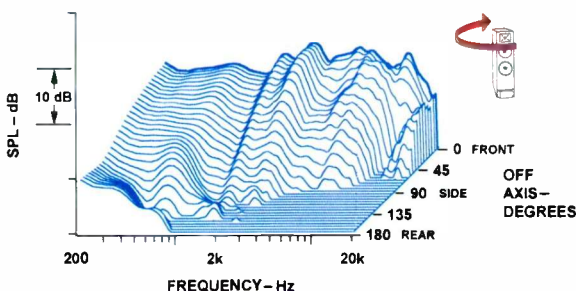

Fig. 3—Horizontal off-axis frequency responses.

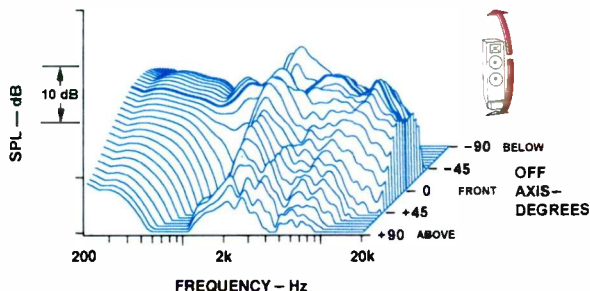
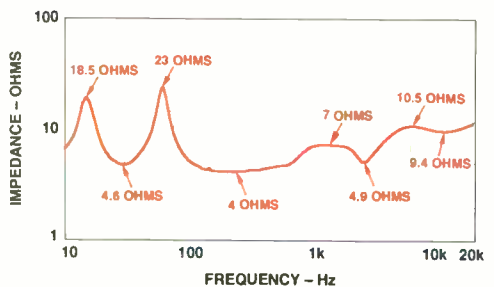
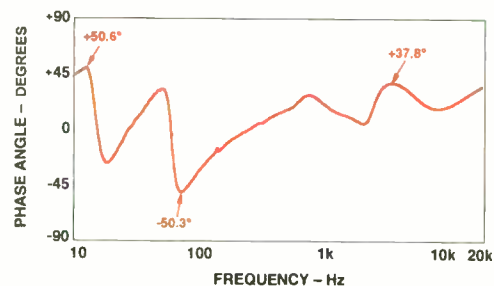

Fig. 4—Vertical off-axis frequency responses.



A



B

Fig. 5—Impedance magnitude (A) and phase (B).

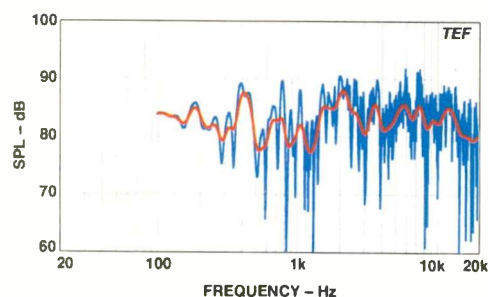

Fig. 6—Three-meter room response.

minimize waveform distortion, a device must have linear phase response (which would be visible if the graph had a linear frequency scale rather than the log scale I use in order to cover the entire audio band) and constant group delay. And its phase curve must pass through 0° (or a multiple of $\pm 360^\circ$) when extended to 0 Hz, the phase intercept. The curve of waveform phase that I sometimes present in my reviews displays the phase-intercept angle as a function of frequency. The KSF 10.5's waveform phase (not shown) is near zero only between 500 Hz and 1 kHz, so this speaker will preserve wave shapes only in that frequency range. In general, however, the only speakers that do preserve wave shapes are those specifically designed to do so, which are few in number. So the Klipsch is actually fairly

typical, or even a bit better than usual, in this respect.

To investigate the phase relationship between the tweeter and woofers at crossover, I measured on-axis frequency response with the tweeter connections reversed. Reversing the tweeter's phase caused an octave-wide response dip between 1.2 and 2.3 kHz, reaching 13 dB at 1.9 kHz, and a rise in response between 2.3 and 4.6 kHz, which reached a 7-dB peak at 3.2 kHz. This indicates that the tweeter and woofers are mostly in phase around 2 kHz and somewhat out of phase above 2.3 kHz. Lobing (which makes a speaker's output higher above or below the axis than on it) will therefore be minimal around 2 kHz but significant above 2.3 kHz.

The KSF 10.5's horizontal off-axis responses (Fig. 3) are extremely uniform all the way to 20 kHz within the main, $\pm 15^\circ$, listening window. As you move farther off axis, the coverage above 12 kHz narrows. The vertical on- and off-axis responses of the KSF 10.5 (Fig. 4) are quite uniform except in the crossover region, between 1 and 4 kHz, where response is flat only within $\pm 5^\circ$ of the axis. Farther off axis, significant peaks and dips emerge. Although you can't see it clearly, the upward and downward responses are not symmetrical, because of lobing.

The KSF 10.5's impedance magnitude (Fig. 5A) exhibits the classic twin peaks of a vented-box enclosure. The frequency of the dip between the peaks indicates that the enclosure's tuning frequency, where the woofer's excursion and distortion are at a minimum, is approximately 30 Hz. The 23-ohm impedance at 61 Hz is rather high, but overall the Klipsch is closer to being a 4-ohm load than its rated 8 ohms. From 20 Hz to 20 kHz, the impedance range is a moderate 5.8 to 1. As a result, cable series resistance of 0.05 ohm or less should keep cable-drop effects from caus-

The horn tweeter's coverage is 90° in the horizontal plane and 60° vertically.



ing response peaks and dips greater than 0.1 dB. For a typical run of about 10 feet, that would correspond to 14-gauge (or larger), low-inductance cable. The maximum impedance phase (Fig. 5B) within the audio range is about $+38^\circ$, and the minimum is about -50° , so a single KSF 10.5 should be a relatively easy load for any amp.

A high-level sine-wave sweep revealed that the cabinet was fairly rigid, though its back panel did vibrate at 148 Hz. The slight buzz I heard with this test signal seemed to come from inside the bottom rear of the cabinet, so it may have been caused by vibration of the crossover board or input terminal cup.

The 8-inch woofers had a generous 0.55-inch excursion, peak to peak, and

KLIPSCH'S CLAIMS OF HIGH SENSITIVITY AND HIGH EFFICIENCY ARE JUSTIFIED FOR THE KSF 10.5.

didn't make harsh sounds when overdriven. Excursion reached its minimum at 31 Hz, the vented enclosure's resonant frequency. Only a slight amount of dynamic offset distortion was evident.

To measure raw and smoothed 3-meter room responses (Fig. 6), I placed the KSF 10.5 in the right-hand stereo position and aimed it toward a test microphone placed at ear height (36 inches) at the listening position. The smoothed curve fits within a fair-

ly tight, 10.6-dB, window overall and with-in a much tighter, 5-dB, window between 2.3 and 15 kHz. No significant peaks or dips are evident.

The KSF 10.5's E_1 (41.2-Hz) harmonic distortion is shown in Fig. 7. At a maximum power of 50 watts (20 volts rms into the 8-ohm rated impedance), the speaker sounded fairly clean, as implied by the moderate second and third harmonic distortion levels of 13.5% and 13.6% and the very low, 1%, levels of higher harmonics. At 41 Hz, the KSF 10.5 generated a fairly healthy 100 dB SPL at 1 meter in a free field from a 50-watt input.

At A_2 (110 Hz), the only significant harmonic is the second, at a moderate 17.2% (Fig. 8). The level of the third harmonic is just 1%, and higher harmonics are essentially below the floor of the display. At 110 Hz, a 50-watt input generated a loud 109 dB SPL at 1 meter in a free field.

Figure 9 shows the KSF 10.5's intermodulation (IM) distortion versus power, created by 440-Hz (A_4) and 41.2-Hz (E_1) tones of equal power. The IM distortion increases gradually, reaching a moderate but quite audible 13.9% at 50 watts.

**THE KLIPSCH KSF 10.5s
SOUNDED VERY DYNAMIC,
PLAYING LOUD
AND CLEAN.**

Short-term peak power input and output are shown in Fig. 10. Peak input power starts out fairly strong, 55 watts at 20 Hz, and rises quickly to 360 watts at 35 Hz. It then swings between 230 and 620 watts to about 250 Hz before falling into a trough of about 230 watts between 500 Hz and 1.5 kHz. At higher frequencies, in the tweeter's range, the power-handling capability rises rapidly, reaching 4 kilowatts above 6.5 kHz.

Why the trough at 500 Hz? Most two-way speakers I've tested have significantly greater power handling (and acoustic output) in this range, but the Klipsch sounded harsh and distorted at higher levels. Suspecting crossover-inductor overload, I disconnected the woofers from the crossover and drove them directly from my test am-

plifier. As I suspected, the maximum power I could feed to the woofers was dramatically higher, reaching about 4.5 kilowatts at 1 kHz (see Fig. 10, "Direct to Woofers" curve), an increase of nearly 13 dB! Driven directly, the KSF 10.5's output at 1 kHz was very loud and clean. Driven through the crossover (at a level just below the point where distortion was objectionable), the speaker sounded rather anemic.

Not surprisingly, the same trough can be seen in Fig. 10's curve for peak acoustic output. At 20 Hz, peak output starts quite strong at 96 dB SPL and rises rapidly through 100 dB at 24 Hz, 110 dB at 32 Hz, and 120 dB at 148 Hz. After staying around 120 dB SPL to about 300 Hz, the output then decreases, reaching about 115 dB between 500 Hz and 1 kHz. At higher frequencies, the maximum output rises rapidly to around 130 dB, which is very loud. Judged by the frequency at which its acoustic output reaches 110 dB SPL, the KSF 10.5's bass response is in the top third of the speakers I've tested, a very good ranking for its size.

Use and Listening Tests

It was refreshing to handle a tower speaker that's not a hundred-pound behemoth. The 55-pound Klipsch KSF 10.5 was significantly easier to unpack, move around, and set up than other speakers I'd reviewed recently.

I was quite impressed by the Klipsch's overall look and by its build quality. The speakers supplied to me had a rosewood finish except for the grille and front panel, which were black. The "rosewood" is a vinyl veneer rather than real wood, but it's so well done that only close inspection by an experienced eye is likely to reveal this. The cabinet's good looks are greatly enhanced by the bezel, carrying the distinctive Klipsch logo, that runs across

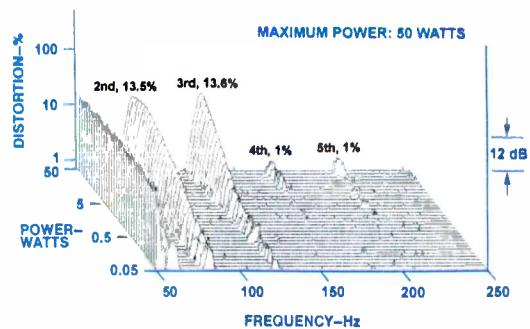

Fig. 7—Harmonic distortion for E_1 (41.2 Hz).

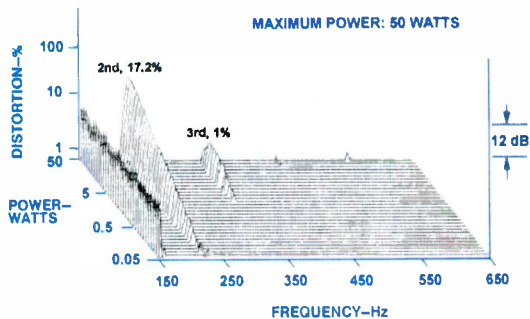

Fig. 8—Harmonic distortion for A_2 (110 Hz).

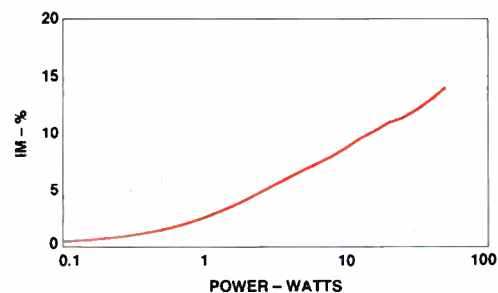

Fig. 9—IM distortion for A_4 (440 Hz) and E_1 (41.2 Hz).

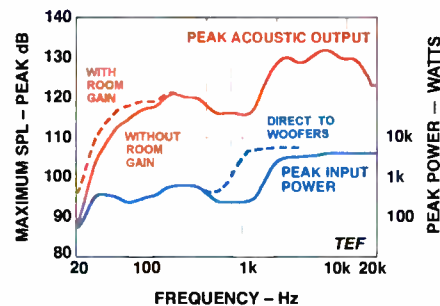
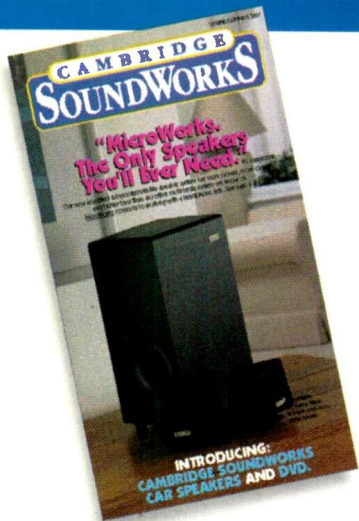

Fig. 10—Maximum peak input power and sound output.



FREE Audio Catalog

At Cambridge SoundWorks we make unique, critically-acclaimed speakers and music systems designed by Henry Kloss (founder of AR, KLH & Advent). We sell them—and components from companies like Sony, Harman Kardon, Carver and others—factory-direct, with no expensive middlemen. Call today and find out why *Audio* magazine said we may have “the best value in the world.”

- Call toll-free – 8AM-Midnight (ET), 365 days a year—even holidays.
- Save hundreds on components and systems from Cambridge SoundWorks, Sony, Aiwa, Harman Kardon, Panasonic, JVC and more.
- Audio experts will answer your questions before and after you buy.
- 30-Day Total Satisfaction Guarantee on all products.

“MovieWorks 5.1 Definitely Delivers The Goods.”

Stereo Review

MovieWorks™ 5.1 by Henry Kloss. A no-compromise surround sound speaker system with awesome powered sub and MultiPole™ surround speakers—able to switch from dipole



to bipole operation. *Stereo Review* says, “genuinely full-range, legitimately cinematic home theater surround sound...open, detailed, up front sound with an unexpectedly sumptuous bottom end.”

\$1,799⁹⁹

1-800-FOR-HIFI
CAMBRIDGE
SOUNDWORKS
Critically Acclaimed. Factory-Direct.

311 Needham Street, Suite 104, Newton MA 02164
Tel: 1-800-367-4434 Fax: 617-332-9229
Canada: 1-800-525-4434 Outside U.S. or Canada: 617-332-5936
World Wide Web Address: www.hifi.com

©1998 Cambridge SoundWorks, Inc.
MovieWorks & MultiPole are trademarks of Cambridge SoundWorks, Inc.

the bottom of the front panel. By most outward appearances, the KSF 10.5 could be a high-end speaker costing much more than its modest \$800 per pair.

The KSF 10.5's owner's manual covers the whole Klipsch Synergy series, including the KSF-C5 center channel and the KSF-S5 surround. It goes into moderate detail about speaker placement, connections, warranty, and general setup of your stereo or home theater system. But if you're in the market for a Klipsch speaker, I suggest you ask your dealer for a chance to read his copy of the company's 30-page *New Product Training Manual*. I was quite impressed by this tutorial, which even includes lists of CDs and specific tracks that demonstrate certain features of these speakers.

The KSF 10.5's readily accessible input connections made the speakers easy to hook

up. The system I used them with included an Onkyo CD player, a Krell KRC preamp, a Crown Macro Reference power amplifier, Straight Wire Maestro cabling, and a pair of B&W 801 Matrix Series 3 speakers for comparisons.

The first thing I noticed when I listened to the Klipsch KSF 10.5s was their high sensitivity. They were significantly louder than the B&W 801s when driven by identical signal levels. For direct comparisons, these Klipsch speakers needed to be attenuated by 7 dB (using a passive line-level attenuator in the tape loop of the preamplifier) to make them approximately equal in loudness to the B&Ws. For speakers of equal impedance, that would translate to an input power requirement only one-fifth as great for identical output levels. Two main virtues Klipsch claims for its speakers are high efficiency and sensitivity, and this claim is certainly justified for the KSF 10.5.

The 10.5s sounded quite dynamic. They could play loud and clean, particularly on rock, big-band jazz, symphonies, and sound effects. Bass was smooth and extended, and the impressive reproduction of pipe-organ pedal notes is unsurpassed by all but a few speakers of the 10.5s' size.

When listening to female vocals, I could hear that the Klipsch's upper midrange and

treble were not as smooth as the B&W's. The KSF 10.5's imaging and soundstaging, however, were first-rate; center images were very stable, even when the frequency content of the centered image changed.

The KSF 10.5s superbly re-created the near-live excitement and impact of Dave Younger's *Western Hero* (Clarity Recordings CCD-1011) at realistic levels. (I highly recommend this CD, which was made with two microphones and no editing or processing. It is one of the very few audiophile country recordings around.) Younger's vocals sounded slightly more up-front through the KSF 10.5s than through the 801s,

and I noticed a slight harshness on his voice through the 10.5s that I did not hear through the 801s.

On the low-frequency, third-octave, band-limited pink-noise test, the KSF 10.5 generated some us-

able output at 20 Hz, good usable output in the 25-Hz band, and strong output (equal to the 801's) from 32 Hz up. Wind noise from the 10.5's port was quite low.

The Klipsch KSF 10.5 was only average in its ability to maintain the same tonal balance for seated and standing listeners; the tone of the upper midrange changed noticeably when I changed positions. The octave-to-octave spectral balance on pink noise was quite acceptable, although there was some upper-midrange and treble tonality. The 10.5's voicing was tilted somewhat toward the high end, providing slightly less low bass and more treble than the 801.

When I tried the Klipsch KSF 10.5s in the main channels of my home theater setup, they performed faultlessly. They were particularly good in reproducing loud effects, such as explosions and gunshots, yet also capable of delivering depth and realism on symphonic soundtracks.

I give the Klipsch KSF 10.5s a solid thumbs-up, with only minor reservations—particularly considering their modest price. Their high sensitivity is a refreshing change compared to other speakers of equal or higher price. And their fine looks and overall performance will make them a good addition to any stereo or home theater setup. **A**

**SOUNDSTAGING
AND IMAGING
WERE FIRST-RATE,
WITH VERY STABLE
CENTER IMAGES.**

The Equipment Authority sold at these specialty dealers

AUDIO

The following are just some of the fine audio/video dealers that sell Audio Magazine:

Esoteric Audio
4120 N. Marshall Way
Scottsdale, AZ 85251

Pacific Audio & Alarm
2370 E. Orange Thorpe Ave.
Anaheim, CA 92806

Sound Tech/Los Gatos
15330 Los Gatos Blvd.
Los Gatos, CA 95032

Stereo Plus
2201 Market Street
San Francisco, CA 94114

Jack Hanna Audio/Video
6130 Pacific Ave.
Stockton, CA 95207

Sound Eye
1317 Sartori Ave.
Torrance, CA 90501

Westside Int'l News Inc.
11949 Wilshire Blvd.
W. Los Angeles, CA 90025

Durango Music Co.
902 Main Ave.
Durango, CO 81301

Video 7 West
22 Kneen Street
Shelton, CT 06494

Sounds Exclusive/Hanks
757 N. Montrose Street
Clermont, FL 34712

Bob's News & Books
1515 Andrews Ave.
Fort Lauderdale, FL 33316

Audiomasters
102 Lafayette Street
Anma, IL 62906

Sounds Designs
808 Coldwater Road
Murray, KY 42071

Goodwins Audio
870 Commonwealth Ave.
Boston, MA 02210

New Horizon Books
20757 13 Mile Road
Roseville, MI 48066

Audio-Video Alternatives
4526 N. Woodward Avenue
Royal Oak, MI 48073

Sound Advice Inc.
3348 Niles Road
St. Joseph, MI 49085

Matlack Communications
2866 Foxwood Drive
Marylane Hts, MO 63043

Harvey's Stereo
2646 South Glenstone Ave.
Springfield, MO 65804

Pro Audio
1630 Country Club Plaza
St. Charles, MO 63303

Audio Visions
136 Main Street
Kalispell, MT 59901

Sound System
3201 State Route 27
Franklin Park, NJ 08823

Mario's Sound Room
176 Franklin Ave.
Franklin Square, NY 11010

Sound Concept Inc.
264 East Route 59
Nanuet, NY 10954

Dalbec Audio Lab
51 King Street
Troy, NY 12180

Audio Encounters
4271 W. Dublin Granvill
Dublin, OH 43017

Sound Station
601 SE Frank Phillips Blvd.
Bartlesville, OK 74003

Sound Service
621 North Main Street
Guymon, OK 73942

David Lewis Audio
9010 Bustleton Ave
Philadelphia, PA 19152

Stereo Shoppe
900 Washington Blvd.
Williamsport, PA 17701

Sound Decision
3727 Franklin Road
Roanoke, VA 24014

Sound Stage
5900 N. Point Washington Rd.
Milwaukee, WI 53217

Dealers, call: 1-800-221-3148 if you are interested in selling Audio...The Equipment Authority

EDWARD J. FOSTER

PHILIPS CDR 870 CD-R/RW RECORDER

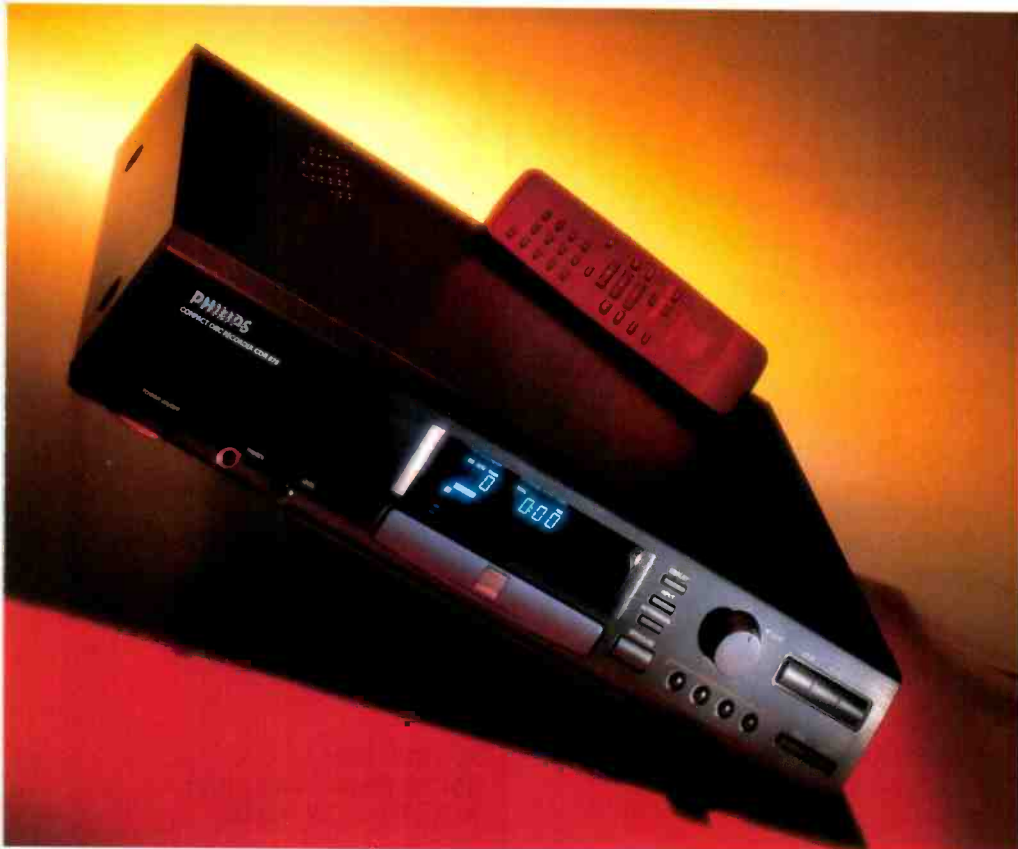

Although the Philips CDR 870 isn't the first CD recorder on the consumer market, it's currently the least expensive, by a wide margin. Even more exciting, it is the first stand-alone unit that records CD-RWs (rewritable CDs) as well as CD-Rs (record-once CDs).

The CDR 870 can use only "consumer-audio" CD-Rs and CD-RWs, on which a royalty has been paid to compensate musi-

cians, composers, and lyricists for the possibility that their works might be copied. This makes consumer-audio CD-Rs five to ten times more expensive than computer/professional CD-Rs, which are identical except for the royalty code that home audio recorders check for.

Needless to say, the CDR 870 checks the Serial Copy Management System (SCMS, known as "scums") flag before permitting digital dubbing. With SCMS, you're allowed to make digital copies of original material but you can't digitally dub a dub, even though you've paid a royalty on the recordable disc. (Bootleggers, of course, know how to get around

this nonsense, and professional recording gear doesn't use SCMS. Therefore, the law doesn't really protect artists; it just gets in the way of consumers enjoying their hobby.) The CDR 870 also encodes a 97-bit Recorder Unique Identifier code on all discs it records, so that any unauthorized recordings you do make can be traced back to you.

Rewritable CDs, i.e., CD-RWs, cost more than CD-Rs, but you can erase and rerecord them a thousand times or more. (I doubt you could do that to a cassette without wearing it out.) However, there are limits on CD-RW rerecordability. You can delete the last track if the disc hasn't yet been "finalized" (which involves copying the disc's temporary table of contents, or TOC, to the area on the disc where CD players look for it). You can also wipe the entire disc clean, before or after finalization. But you can't cherry-pick tracks for erasure.

Being able to erase the last track on a CD-RW means that you can fix mistakes and recoup the recording space that otherwise would be wasted. This isn't possible with CD-R, although some CD recorders (but not this one) permit you to "edit" CD-Rs by "deleting" tracks prior to finalization. This doesn't erase the "deleted" tracks; it just removes them from the disc's TOC. Some players may then skip over that portion of the disc, but you don't get the recording time back.

Ordinary CD players cannot read unfinalized CD-Rs and can't read CD-RWs at all. (Recorders, of course, can read unfinalized discs.) We can expect the ability to read finalized CD-RWs to be included in many future CD players, however. Also, DVD

players that use one multifocus laser instead of dual lasers usually don't recognize CD-Rs. (See "Giving Proper Recognition.")

Except for a few more buttons and knobs on its front

and a few extra jacks on its rear panel, the Philips CDR 870 looks very much like an ordinary CD player. Its disc tray is under the display, the on/off switch and the headphone jack and level control are at the far left, and the transport controls are off to the far right.

**REWITABLE CDs
COST MORE
THAN RECORDABLE CDs,
BUT YOU CAN ERASE
AND RERECORD THEM.**

Dimensions: 17½ in. W x 3 in. H x 12¼ in. D (43.5 cm x 7.6 cm x 31.1 cm).

Weight: 8.8 lbs. (4 kg).

Price: \$649.

Company Address: 64 Perimeter Center East, Atlanta, Ga. 30346; 770/821-2400.

From here on, things are different, as indicated by the recording level knob and the four buttons with red legends ("REC," "Finalize," "Erase," and "CD Sync") below it. The level knob affects both channels; there's no channel-balance adjustment. The display incorporates nine-segment recording level indicators for each channel, calibrated from "-50" to "0" and then "Over."



**I'M QUITE PLEASED
THAT THE CDR 870'S
ANALOG ELECTRONICS
ARE SO QUIET.**

In digital dubbing, of course, the level control is disabled and the level indicators are merely informative, as the source's channel levels are copied exactly.

As with many cassette decks, pressing "REC" puts the CDR 870 into record/pause mode, and recording begins when you then press "Play"; if the disc has already been partially recorded, the laser will move just past the last recorded track. If you're recording a CD-RW, pressing "Erase" once removes the last track and pressing it twice in quick succession wipes the entire disc, but erasure begins only when you follow these commands by pressing "REC." It takes several seconds to erase the disc.

The fourth button, "CD Sync," is used to synchronize digital dubbing from CD, DCC, DAT, or MD, starting and stopping the CDR 870 when the source player starts and stops. You press the button once to copy a single track, twice to copy the complete source disc or tape (but only if you play that source's tracks in their original order). The display flashes a warning ("DIG") if no digital carrier is present and shows the current track number and elapsed record-

ing time; you can check how much time remains on the disc by pressing the "Display" button.

The recording input (analog, coaxial digital, or Toslink optical) is selected by pressing a bar just to the right of the display window. Legends in the display indicate which input has been selected.

The "Auto/Manual" bar just beneath "Input" controls track numbering. In "Auto" mode, the CDR 870 automatically increments the track number when it detects a 3-second pause in an analog input signal or, with a digital signal, when the source's track number changes. In "Manual" mode, you increment track numbers by pressing "REC" (or the "Track INCR" pad on the remote), whether you're recording from an analog or digital source.

The CDR 870 automatically stops recording when it detects a 20-second pause in the source material (again, whether the source is analog or digital) or, of course, whenever you press "Stop." Every time the Philips stops recording, it updates the temporary TOC, locking the controls and displaying "Update" for the few seconds this takes.

The controls also lock during the several minutes it takes to finalize the disc by writing its permanent TOC. The display indicates the time required. During this period, it is imperative that the CDR 870 not be turned off. If you lose power while finalizing a CD-R, you're likely to scramble the TOC irreparably, since the disc can't be erased. (However, the CDR 870 may be able to repair the damage in some cases.) A CD-RW, on the other hand, can be erased even after finalization. To finalize a disc, you press "Finalize" and "REC."

On the back of the CDR 870 are a Toslink optical input and output, as well as base-metal RCA jacks for coaxial digital and analog input and output. The Toslink sockets are protected with plugs when not in use. A removable two-wire IEC line cord supplies power.

The Philips CDR 870 comes with a 27-button remote that replicates basic trans-

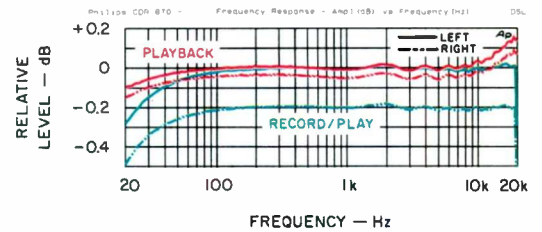

Fig. 1—Frequency response.

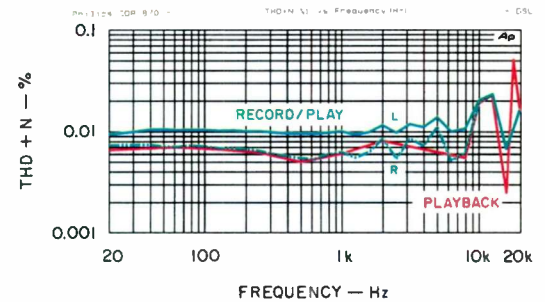

Fig. 2—THD + N vs. frequency.

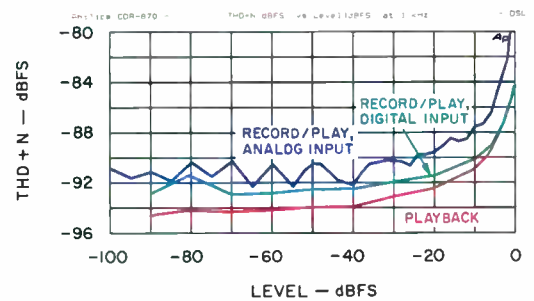

Fig. 3—THD + N vs. level.

port and recording functions, opens and closes the disc drawer, and provides direct track access via a 10-key numeric pad. The remote enables you to fast-search through discs at two- or eight-times normal speed, to program playback of as many as 20 tracks in any order, and to repeat playback of an individual track, the full disc, or the contents of the program memory. You can also set up synchronized or normal recording from the remote and initiate the finalization process.

Measurements

I bench-tested the Philips CDR 870 as a conventional player and as a recorder for digital and analog sources. I used the CBS CD-1 test disc for playback and digital dubbing and used signals from my Audio Preci-

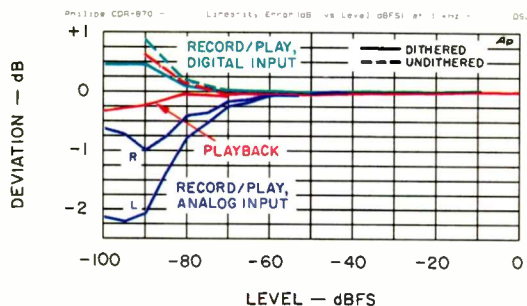

Fig. 4—Linearity error.

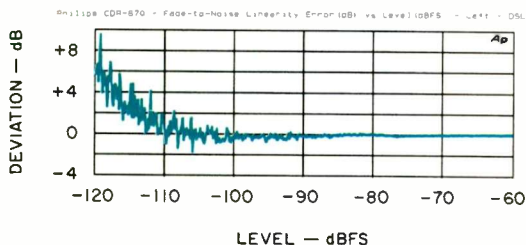

Fig. 5—Fade-to-noise test.

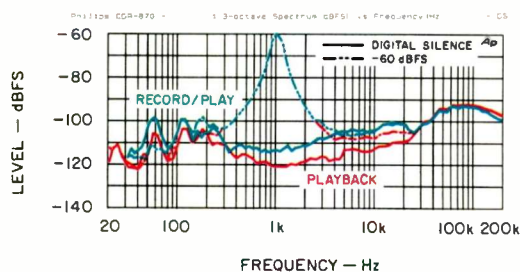

Fig. 6—Noise spectra.

The remote handles recording as well as playback functions.

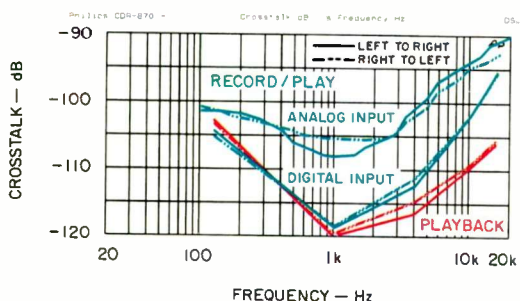

Fig. 7—Crosstalk.

sion System One's generators for recording via the analog input. Except for a few instances, I've plotted playback and record/play data on the same graph, for easy comparison, and have included record/play curves for the analog and digital inputs wherever they differed significantly. In some cases, only the worse channel is presented, for clarity.

In playback, the channels were balanced within ± 0.02 dB, which I consider excellent. There was plenty of drive for both high- and low-impedance headsets, and the output impedances of the line and headphone jacks were well chosen.

Figure 1 shows frequency response, plotted at 0.1 dB per division to reveal even minor deviations. The playback response has a trace of filter ripple and a rising treble characteristic, but performance is really very good, within $+0.17$, -0.1 dB from 20 Hz to 20 kHz. Interestingly, the response curves for record/play via the analog inputs do not exhibit the same treble rise as the playback curves; there seems to be fortuitous compensatory rolloff in the analog-to-digital (A/D) converter. The filter ripple is essentially the same for playback or record/play, which means that the A/D converter's anti-aliasing filter doesn't damage the signal. Although it's hard to see in Fig. 1, the record/play response starts to drop just below 20 kHz as that filter kicks in. There is a bit more bass rolloff when recording from the analog input, but overall, record/play response is within $+0.03$, -0.28 dB from 20 Hz to 20 kHz. That's very fine indeed! The digital dub I made was virtually identical to the CD-1 test disc I copied, so I omitted these results from Fig. 1. In this (and many other) respects, the CDR 870 proved capable of making perfect digital dubs. But for some strange reason, it would not recognize the emphasis flag if it was present in a digital source's subcodes. This means that

GIVING PROPER RECOGNITION

The reason that some players can't recognize certain types of discs is that the information layers of CD-Rs, CD-RWs, and prerecorded CDs differ in reflectivity. Old CD players expect a greater contrast between the recorded zeroes and ones than rewritable media provide. Commercially recorded CDs have three-dimensional pits and lands pressed into their recording layers. The deformable dye that carries a CD-R's information is lower-contrast. And CD-RWs, whose recording layer changes its physical state from amorphous to crystalline and back again under the recording laser, provide even lower contrast between the zeroes and ones—in fact, only about a third as much as CD-Rs. That's why many players that recognize regular CDs and CD-Rs can't read a CD-RW. E.J.F.

pre-emphasized recordings will have an excruciatingly hot high end; luckily, few modern CDs are pre-emphasized, so you'll probably not be affected by the problem.

When recording via the analog input, I initially set the level control for 0 dBFS from a 2-volt, 1-kHz signal. However, the distortion at 0 dBFS was substantially greater than when I was recording from the digital jacks. That's why, in "Measured Data," I've listed total harmonic distortion plus noise (THD + N) at -1 dBFS instead of 0 dBFS. Higher distortion at 0 dBFS when recording from analog inputs is quite common in digital recorders; at 0 dBFS, their A/D converters are almost clipping.

In Fig. 2, THD + N versus frequency, record/play curves taken via the analog inputs are a little higher across most of the band (especially on the left channel), even though I measured them at -1 dBFS. However, the figures in "Measured Data" seem to indicate the contrary because the recording from the analog input did not have the 18-kHz distortion peak that was present in the other recording (not shown) or in playback. This is a clear example of why curves are sometimes more meaningful than tabulated data.

**NOBODY'S HARDER ON CARS THAN
PEOPLE WHO DON'T DRIVE THEIR OWN.**

8H69

Broadway Taxi Company, New York, NY.



Lowell Police Department, Lowell, MA.

STUDENT DRIVER

California Driving School, Southern California



It takes a tough motor oil to stand up to tough drivers. That's why the Broadway Taxi Company, the Lowell Police Department, and the California Driving School all use Castrol GTX 10W-30. It's the only leading motor oil that provides maximum protection against both viscosity and thermal breakdown. Making it harder for people who are tough on their engines, to be tough on their engines.

DRIVE HARD.

www.castrolauto.com



MEASURED DATA

In Fig. 3, THD + N versus level at 1 kHz for the worse (left) channel, the curves for record/play via the analog input lie above the others, but by a relatively small amount until the level approaches 0 dBFS and the A/D converter starts to act up. Overall, these results are very respectable.

Linearity error (Fig. 4) is quite modest for playback or digital dubbing, but it tops 2 dB at -90 dBFS for record/play from the analog input. It's questionable how significant this is, since most analog source material is likely to bottom out on noise before it gets down to -90 dBFS, but I've seen better performance. The record/play curves taken from the analog input also indicate that there's a fair amount of nonlinearity in the A/D converter below -70 dBFS. (There are, of course, no "undithered" curves for analog input; digital recordings of analog signals tend to be dithered by the signals' inherent noise.)

The fade-to-noise linearity test (Fig. 5) is for playback only. I could not run this test for record/play, because the CDR 870 assumes that recordings at the levels used for this test represent silence. It therefore stopped after 20 seconds, long before the test sweep ended. (I checked the level below which the CDR 870 considers the source to be "silent"; it was -54 dBFS.) Based on the linearity error seen in Fig. 4, I expect that the digital dub would have been fine but that the analog-source recording (had it been possible to make one) would have contained substantial error at low levels. Consumer digital recorders commonly shut themselves off this way, to keep you from wasting tape or disc space by recording silence. As long as they don't shut off during a long *pi-anis-si-mo*, I guess that's beneficial, but I wish I could have defeated this feature for my tests.

In the spectrum analysis of residual noise (Fig. 6), the noise floor for the recording via the analog input lies about 9 dB above the playback curve for digital silence, but that's to be expected. In fact, I'm quite pleased that the CDR 870's analog electronics are as quiet as they are. And there's little hum; all power-line-related components lie at or below -100 dBFS. The difference of approximately 9 dB between the playback and the analog record/play curves carried over fairly consistently when I tested S/N with A-weighting (see "Measured Data").

Channel Balance: Playback, ± 0.02 dB.

Frequency Response, 20 Hz to 20 kHz: Playback, +0.17, -0.1 dB; record/play via analog input, +0.03, -0.28 dB (at -1 dBFS); record/play via digital input, +0.15, -0.12 dB.

THD + N at 0 dBFS, 20 Hz to 20 kHz: Playback, less than 0.0517%; record/play via analog input, less than 0.0237% (at -1 dBFS); record/play via digital input, less than 0.051%.

THD + N at 1 kHz: Playback, below -84.3 dBFS from 0 to -90 dBFS and below -93.2 dBFS from -30 to -90 dBFS; record/play via analog input, below -79.9 dBFS from -1 to -90 dBFS and below -90.2 dBFS from -30 to -90 dBFS; record/play via digital input, below -84.3 dBFS from 0 to -90 dBFS and below -91.5 dBFS from -30 to -90 dBFS.

Maximum Linearity Error: Playback, 0.63 dB to -90 dBFS with undithered recording and 0.33 dB to -100 dBFS with dithered recording; record/play via analog input, 2.1 dB to -90 dBFS and 2.2 dB to -100 dBFS; record/play via digital input, 1 dB to -90 dBFS with undithered recording and 0.47 dB to -100 dBFS with dithered recording.

S/N Ratio: Playback, 104 dB, A-weighted, and 96.5 dB, CCIR-weighted; record/play via analog input, 94.6 dB, A-weighted, and 85.4 dB,

CCIR-weighted; record/play via digital input, 103.1 dB, A-weighted, and 96 dB, CCIR-weighted.

Quantization Noise: Playback, -85 dBFS; record/play via analog input, -84.4 dBFS; record/play via digital input, -85 dBFS.

Dynamic Range: Playback, 94.6 dB, unweighted (99 dB, A-weighted, and 89.4 dB, CCIR-weighted); record/play via analog input, 90.7 dB, unweighted (94.6 dB, A-weighted, and 85.9 dB, CCIR-weighted); record/play via digital input, 92.7 dB, unweighted (96.7 dB, A-weighted, and 87 dB, CCIR-weighted).

Channel Separation: Playback, greater than 103 dB from 125 Hz to 16 kHz; record/play via analog input, greater than 90.9 dB from 100 Hz to 17 kHz; record/play via digital input, greater than 95.6 dB from 125 Hz to 16 kHz.

Analog Input Characteristics: Sensitivity, 0.81 V for 0-dBFS recording level; overload, 8 V; impedance, 49 kilohms.

Line Output Characteristics: Level, 1.92 V for 0-dBFS recorded level; impedance, 200 ohms.

Headphone Output Characteristics: Maximum output voltage, 5.91 V at clipping; maximum power, 43.3 mW into 600 ohms and 63.6 mW into 50 ohms; impedance, 120 ohms.

The curves in Fig. 6 for 1-kHz signals at -60 dBFS are closer together than those for digital silence (and are identical above -100 dBFS). Dynamic range, which is based on measurements using the same test signals, was also quite similar for playback and record/play of a digital dub. The fact that the results in "Measured Data" correspond so well with the curves suggests that the A/D converter is pretty clean at this recording level (and reinforces what we learned from Fig. 3). Quantization noise was essentially the same for playback and for record/play via either input.

Channel separation (Fig. 7) is more than adequate, even with analog input.

All of these results are gratifying and signify that the Philips CDR 870 is a product to be reckoned with. It's also nice to see analog inputs that combine good sensitivity and high input impedance with a virtually bulletproof overload point of 8 volts!

Use and Listening Tests

I was impressed with how easy the CDR 870 is to use. Pop a disc in, and the Philips automatically checks to see what kind of CD it is. If it's a commercial disc or a finalized CD-R or CD-RW, the 870 informs you that it's "Reading" the TOC and displays the number of tracks. If it's an unfinalized recordable CD, it tells you the type of disc

(CD-R or CD-RW), after which it goes through a brief Optimal Power Calibration procedure.

That calibration is needed because a number of different materials can be used for the recording layer of a CD-R or CD-RW, and optimum recording power depends on the specific material used. As a result, CD recorders must calibrate themselves for each disc. The 870 does this automatically, trying various power levels and evaluating the results. (CD-Rs and CD-RWs have a special area for this test.) During calibration, "OPC" appears in the display. If you've calibrated the power so many times that there's no room left in the test area, "Final" appears in the display to request that you finalize the disc. If the disc is defective or calibration fails, you're told "OPC Fail." If there's no recordable space left on the disc (but the disc hasn't yet been finalized), the display reads "CD Full."

It's pretty hard to goof up with the CDR 870. This is especially true when you're making a digital dub of a CD, DAT, or similar source; level setting is a nonissue in this

case. The owner's manual doesn't mention it, but I discovered that the 870 converts signals sampled at 48 kHz (the "professional" rate usually used by DAT recorders) to the CD sampling rate of 44.1 kHz. (In fact, as I later learned from a brochure, it also



**RECORD/PLAY
VIA DIGITAL INPUTS
OFTEN YIELDED
THE SAME PERFORMANCE
AS PLAYBACK ALONE.**

converts signals sampled at 32 kHz.) Copies of 48-kHz DATs sounded pretty good—perhaps not quite so transparent as the original, but pretty darned close. Sampling-rate converters can have audible side effects, and good ones tend to be quite expensive.

So considering the price of this Philips recorder, I was impressed with the sound quality that its converter delivered.

However, the CDR 870's facilities for recording analog signals could be better. Proper level setting is important to avoid overloading the A/D converter, so better recording level indicators (and a way to adjust channel balance) would be highly desirable. As it is, if either of the top two indicator segments ("0" and "Over") lights up, you're into clipping, leaving only seven useful indicator segments. (Cassette recorders get away with such crude metering, but they overload far more gracefully than digital recorders do.) Fortunately, this does not affect digital dubbing, which is probably what most people would use the 870 for.

Sound-wise, I rate the CDR 870 on the high end of average. It's not the equivalent of the finest CD players I've used, but it's competent, quiet, and reasonably transparent. Considering the price and all that this recorder can do, it's definitely a winner. If you thought that CD recorders were forever out of reach, think again. Try the Philips CDR 870—highly recommended! **A**

PERFECTION HAS ITS PRICE... OUR PRICE HAPPENS TO BE LESS!



Amplifier Technologies, Inc.

<http://www.ati-amp.com> EMAIL: amptech@ix.netcom.com

Distributed in Canada by Artech Electronics Ltd., 514-631-6448

Value without compromise.

At \$1,695, the 73-pound AT1505 5-channel power amplifier has no equal. FTC power output is 150 watts per channel into 8 ohms from 20Hz to 20kHz at no more than 0.03% THD with all channels driven simultaneously! ATI engineers have been designing and manufacturing power amplifiers for over 30 years. All ATI amplifiers are built with the finest parts available...we invite you to compare our amplifiers to any other makes, no matter what the price! ATI power amplifiers have received critical acclaim from reviewers and from audio enthusiasts worldwide.

All ATI amplifiers are backed by a seven-year warranty and are made in the USA. For more information on the AT1505 or our other models, or to order, please call 1-888-777-8507.

Z-SYSTEMS RDP-1 DIGITAL PREAMP



For me, the main attraction of this component, which Z-Systems calls a Reference Digital Preamp, was its built-in equalizer. I needed a good equalizer to help iron out some in-room response anomalies I was getting with a pair of electrostatic speakers, and the RDP-1 looked like it would fill the bill nicely.

Analog equalizers have gotten a bad reputation for introducing distortion, noise, and colorations, which digital equalizers can avoid. But, says designer Glenn Zelniker, "finding the right 'recipe' for implementing a digital filter is a brutal task." As the co-author of *Advanced Digital Signal Processing: Theory and Applications* (Marcel Dekker, New York, 1994) and designer of digital processors used in CD mastering, he speaks from experience. According to Zelniker, the proprietary filter architectures in the RDP-1 avoid problems of coefficient quantization, round-off noise, and low-level

nonlinearity that often occur in textbook designs. Although phase linearity has been cited as an advantage of digital filtering, the RDP-1's filters are not quite linear-phase designs; Zelniker says true linear-phase filters sound less natural.

Like its six-band parametric equalizer section, which Z-Systems calls a Transparent Tone Control, the RDP-1's volume control and source selector operate in the digital domain. All six inputs are digital, of course, but Z-Systems offers an accessory, the RADC-2 (\$650), which adds two stereo analog inputs and an A/D converter. Because it has no analog outputs, the RDP-1 must be used with an external D/A converter. A remote control is supplied.

The Transparent Tone Control (TTC) is one of the RDP-1's most significant features. (It will soon be available separately, as the RDQ-1 equalizer, for \$3,000.) Said to have no sonic character of its own, the TTC incorporates bass and treble shelving filters

and four bell-shaped peak/dip filters, which can be used simultaneously. The turnover frequencies of the shelving filters and the center frequencies of the bell filters can be set from 28 Hz to 18 kHz at intervals of one-sixth of an octave, and each filter can provide up to 12 dB of boost or 95 dB of attenuation. The bell filters' relative sharpness, or Q, can be adjusted, too. However, Z-Systems calls this adjustment "slope," because it's actually a number by which the filter's base Q is multiplied. The RDP-1 has a slope adjustment because the Q of its filters rises at frequencies from 8 kHz up—e.g., the base Q is 0.4 below 8 kHz, 0.44 at 8 kHz, 0.48 at 9 kHz, and so on. The adjustment range runs from 1 (corresponding to a broad Q, 0.4 at 1 kHz) to 12 (a quite sharp Q, 8 at 1 kHz). Each filter's gain can be set from +12 to -95 dB. These controls enable a broad range of equalization for program material and are useful for speaker and room equalization.

The RDP-1 accepts data words up to 24 bits long. Its output word lengths can be set to 16, 20, or 24 bits, with defeatable dither for 16- and 20-bit output and fixed dither for 24-bit output.

The three large control knobs on the RDP-1's refreshingly modern-looking front panel aren't labeled, because their functions change according to operating mode. The display window shows their functions and settings. Operating modes are usually set with the three buttons to the left of the knobs ("Input," "Presets," and "Bypass") and the "Volume" button to the knobs' right.

When you press "Input," the first knob becomes the input selector, the second selects output word length (16, 20, or 24 bits) and dithering, and the third sets the controls to affect the left channel, the right channel, or both.

Pushing "Presets" once enables you to retrieve any of 100 combinations of tone-

Dimensions: 17 in. W x 4½ in. H x 10 in. D (43.2 cm x 11.4 cm x 25.4 cm).

Weight: 14 lbs. (6.4 kg).

Price: \$5,000.

Company Address: 4641-F N.W. 6th St., Gainesville, Fla. 32609; 352/371-0990; z-sys@z-sys.com; www.z-sys.com.

control setting, volume level, input selection, and output mode and to make instant comparisons between any two presets. In this mode, you select presets by using the six-button array to the right of the control knobs. To save settings, press "Presets" twice; you then use the left-hand control knob to select which preset you'll store your selections in and the lower left button of the six-button array to store them. The presets are numbered from 0 to 99. Preset 99 is active whenever you turn the RDP-1 on, which makes it a good place for the settings you use most often. Preset 0, whose settings cannot be changed, disengages all filters, sets the output to 24 bits, and leaves your current input selection unchanged.

The "Bypass" button defeats all controls and sets all of the TTC's filters for flat response. However, it retains current input and volume settings, to help you evaluate the impact of the filter settings.

Pressing the "Volume" button and turning the left-hand control knob enables you to boost volume by up to 12 dB or to cut it by up to 95 dB. In this mode, the volume setting is displayed in dBFS (dB relative to digital full scale), preceded by "L," "R," or "S" to remind you whether the control

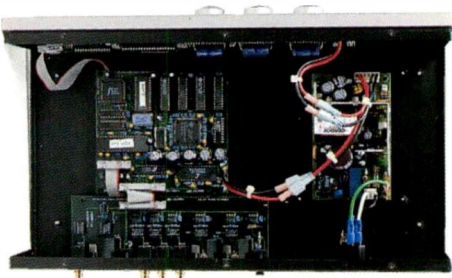

IT WOULD APPEAR THAT Z-SYSTEMS' CLAIM OF SUPERIOR FILTER ARCHITECTURES IS JUSTIFIED.

mode is set to left, right, or stereo. The adjustment steps for volume (and filter amplitude) are quite gradual from +12 to -12 dB, broadening from 0.2 dB until they reach 5 dB for 70 to 95 dB of attenuation.

To set equalization, you select the filter you want by means of the six-button array

at the right. After that, you adjust the selected filter's parameters with the three control knobs.

The rear panel carries the six digital inputs—two XLR jacks, three coaxial jacks, and one Toslink optical connector—and the digital outputs—one XLR, one coaxial, and one Toslink. (The Toslink input and output can be replaced with ST glass-fiber connections at extra cost.) A Crystal Semiconductor CS8412 digital receiver and CS8402 digital transmitter are used for input and output, coupled to the outside world through high-quality Scientific Conversion transformers.

Lacking a schematic, I could not analyze the circuitry to the extent that I usually do. I was able to ascertain that a Texas Instruments TMS320C31 floating-point digital signal processor is used for generating the filter functions and for overall system control. Further, the power supply includes a potted toroidal power transformer.

Measurements

I made the bench tests with Audio Precision dual-domain System One instrumentation. I obtained the filter-response curves by feeding in test signals at -10 dBFS and setting the RDP-1's volume control for 0 dB of gain; this allowed me to set the filters for up to 10 dB of boost without exceeding digital full scale (0 dBFS).

When I measured the frequency response of the RDP-1's filters, it quickly became obvious that their cut and boost curves were not the usual mirror images. This is readily apparent in Fig. 1, which shows the response of one bell filter set for 10 dB of boost or cut at 1 kHz with various slope settings. The curves for cut are noticeably sharper than the corresponding boost curves.

The response curves in Fig. 2, for varying degrees of boost and cut at 1 kHz, look symmetrical at first glance, but that's because I used different slopes for boost and cut (the specific settings were 4 and 1, respectively). Here, even though the curves at +10 and -10 dB look the same, they differ more and more as the amount of boost and

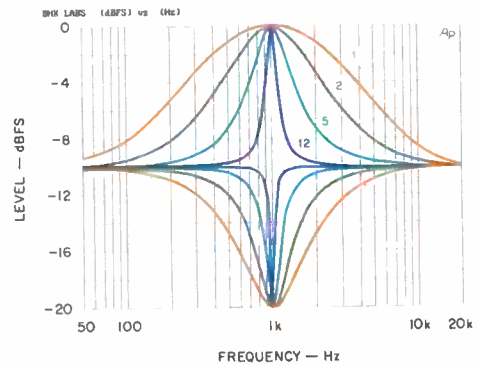

Fig. 1—Bell-filter response curves for 10 dB of boost and cut at 1 kHz and slopes of 1, 2, 5, and 12. Note the asymmetry; see text.

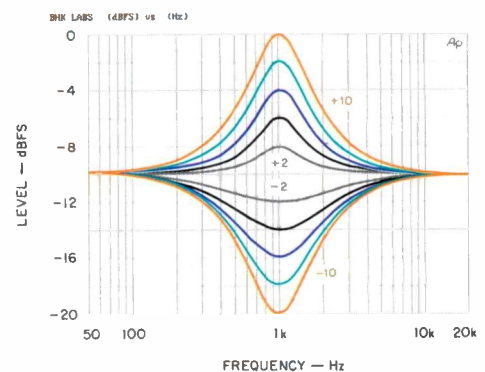

Fig. 2—Bell-filter response curves at 1 kHz with boost and cut settings of 10, 8, 6, 4, and 2 dB. Apparent symmetry was achieved by using different slopes for boost and cut.

cut is reduced. I could usually find a mirror image for any particular boost or cut curve, but doing so was hardly intuitive. For example, the response curves for the low-frequency shelving filter (Fig. 3) look symmetrical only because I did not use identical frequency settings for boost and cut. The boost curves have a constant turnover frequency, 28 Hz. But to make the other curves match them, I had to change turnover frequency each time I changed the filter's gain. (For 2, 4, 6, 8, and 10 dB of cut, I used turnover frequencies of 35, 45, 56, 70, and 90 Hz, respectively.) Using this technique, I was also able to generate complementary cut and boost curves with the high-frequency shelving filter.

Next I turned my attention to a more common phenomenon. Many synthesis

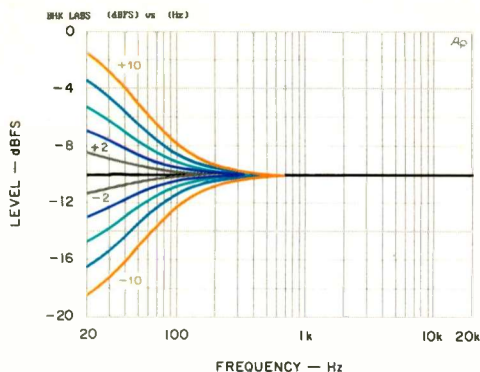

Fig. 3—Bass shelving filter's response curves for boost and cut settings of 10 to 2 dB, with frequency of cut settings varied to match 28-Hz boost curves.

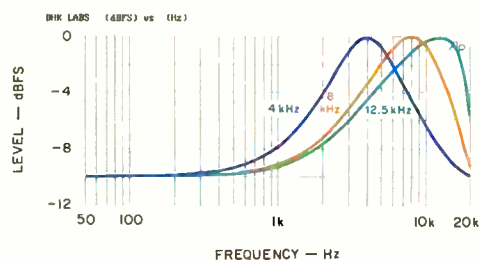

Fig. 4—Low-Q boost curves (slope of 3); note altered curve shape at higher frequencies.

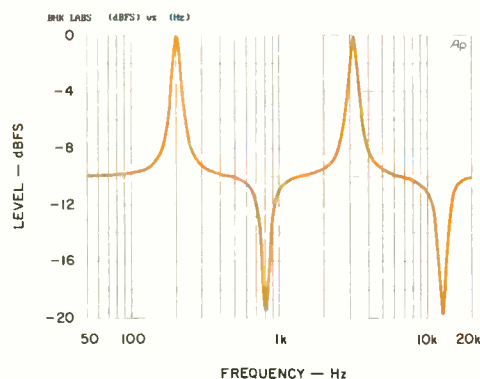

Fig. 5—Complex response curve using four bell filters. Because Q is higher than for the curves of Fig. 4, high-frequency curve shape is relatively unchanged.



techniques for generating digital filters are based on the mathematics of analog filter design. When the center or cutoff frequencies for such digital filters approach one-half the sampling frequency (the high-frequency end of the audio bandwidth), their curve shapes deviate from their analog prototypes, making them lean to the right. I believe that this accounts for the behavior of the curves in Fig. 4, response for 10-dB boost with center frequencies of 4, 8, and 12.5 kHz. (The slope was 3, which equals a Q of 1 at 4 kHz but a slightly higher Q above that frequency.)

The RDP-1 can generate some very complex curves. In Fig. 5 is a response curve that has alternating 10-dB peaks and dips for frequencies of 200 Hz, 800 Hz, 3.15 kHz, and 12.5 kHz; the slopes are 12 (a Q of 8 or higher) for the peaks and 8 (a Q of 4 or higher) for the dips. Note that the last dip, which has the same center frequency as the lopsided peak in Fig. 4, does not lean appreciably to the right. Its high Q makes the curve rise back to its origin so quickly that the deviation caused by the approaching high-frequency cutoff has little effect.

To assess total harmonic distortion plus noise (THD + N), I fed the RDP-1 a 16-bit signal with triangular dither and set it for 0 dB of gain and 16-bit, undithered output. Under these conditions, THD + N was essentially constant, at -93.4 dBFS, across the audio band and, for 1-kHz signals, at all levels. Distortion also remained basically unchanged for filter settings from full boost to full cut, as seen in Fig. 6 for a combination of high-frequency rolloff from the shelving filter and four bell-filter dips at octave intervals. It would appear that Z-Systems' claim of superior filter architectures is justified.

I got roughly the same results for signal-to-noise ratio, quantization noise, and dynamic range as I did for THD + N. With the exception of S/N for digital silence, all of these were about 93.4 dB for 16-bit undithered signals, about 114 to 118 dB for un-

dithered 20-bit signals, and about 122 to 128 dB for 24-bit signals (which the RDP-1 automatically dithers). Predictably, adding dither lowered the 16- and 20-bit results by about 3 to 4 dB, again except for S/N with digital silence.

With digital silence, S/N for undithered signals improved by about 30 dB for 16-bit signals and by nearly 20 dB for word lengths of 20 bits. For dithered signals, it improved by about 3 to 4 dB for both word lengths.

THIS PREAMP CHANGED THE SOUND ONLY IN THE WAYS I WANTED, WHICH IS COMMENDABLE BUT RARE.

Most of my measurements of THD + N, signal-to-noise ratio, quantization noise, and dynamic range were virtually identical for the two channels, usually differing by no more than 0.3 dB. The notable exceptions were for 24-bit signals, where results for S/N with digital silence and for dynamic range were about 3 dB worse in the right channel than the left.

To find out what effect the RDP-1's volume control has on low-level linearity, I set my Audio Precision test system to generate a 500-Hz tone whose level was swept from -60 to -120 dBFS, passed that signal through the RDP-1, bandpass-filtered the output to eliminate noise effects, and plotted the filtered output's level against the input's. I repeated this test procedure for several settings of the RDP-1's volume control, 10 dB apart. With the preamp's word length set to 24 bits, the full-volume curve looked good but linearity looked poor at volume settings lower than -10 dB. However, as you can see in Fig. 7A, there is little linearity error for low-level signals with dithered 16-bit output. With dithered 20-bit output (Fig. 7B), linearity is, predictably, even better.

Interchannel crosstalk for 16-bit dithered input and output was better than -110 dB up to 8 kHz, increasing to about -105 dB at 20 kHz. This held true whether I was examining crosstalk from the left channel to the right or vice versa.

Use and Listening Tests

For my initial listening tests, I connected my CD transport to a digital input of the DGX DDP-1 preamp (which provides digital equalization specifically designed for the B&W 801 speakers I used), fed the DGX's output to a Genesis anti-jitter device, and connected the Z-Systems RDP-1 between the output of the jitter reducer and the input of my D/A converter.

I set the RDP-1's volume control to 0 dB and all of its filters for flat response. I then disconnected the RDP-1 from my system and reconnected it many times, to see if I could hear any change. This preamp was almost completely transparent! On some recordings, I thought a minuscule amount of air and space may have been taken away, but I was never really sure about this.

ASSOCIATED EQUIPMENT USED

Equipment used in the listening tests for this review consisted of:

CD Equipment: PS Audio Lambda Two Special CD transport, Genesis Technologies Digital Lens anti-jitter device, and Classé Audio DAC-1 and Sonic Frontiers Processor 3 D/A converters

Phono Equipment: Kenwood KD-500 turntable, Infinity Black Widow arm, Win Research SMC-10 moving-coil cartridge, and Vendetta Research SCP2-C phono preamp

Additional Signal Sources: Nakamichi ST-7 FM tuner, Nakamichi DR-3 cassette deck, Technics 1500 open-reel recorder, and Denon DMD1300 MiniDisc recorder

Preamplifiers: DGX Audio DDP-1, Sonic Frontiers Line-3, and Ayre Acoustics K-1

Amplifiers: Crown Macro Reference, Ayre Acoustics V-3, and Audio Note Ongaku single-ended tube amp

Loudspeakers: B&W 801 Matrix Series 3s

Cables: Digital interconnects, Illuminati DX-50 (AES/EBU balanced); analog interconnects, Transparent Cable MusicLink Reference (balanced) and Tara Labs Master and Music and Sound (unbalanced); speaker cables, Transparent Cable MusicWave Reference and Tara Labs RSC Master Generation 2

I found the RDP-1's equalizer section very useful for taming bright-sounding CDs; setting the high-frequency shelving filter to 3.5 kHz with 2 dB (or a bit more) of attenuation defanged the sound nicely. And setting one of the bell filters to 100 Hz, with a few dB of cut and a slope of 3 (a Q of 1), tamed my system's tendency to sound a little thick around that frequency on some recordings. I also used the equalizer to tame weak midbass and lower midrange from a pair of electrostatic speakers, in this case using a few dB of boost and a broader slope setting. I really appreciated being able to save and recall the different filter settings that I devised, and it was most handy to be able to switch back and forth between any two filter settings for instant comparisons. I was also pleased that saving settings, recalling them, and making instant comparisons could be done from the front panel or by using the remote control.

After listening to CDs, I connected an Ayre preamp's tape output to an analog input of the DGX digital preamp and fed my analog sources into the Ayre. In this setup, I used the Ayre as the analog source selector, the Z-Systems for system volume and tone control, and the DGX as an A/D converter and speaker equalizer and for switching between CD and the analog sources. Once again, even though the RDP-1's equalization was superimposed on the speaker equalization provided by the DDP-1, the RDP-1 did not change the sound in any way other than performing the volume and tone changes I set it for. That's a most unusual and commendable state of affairs!

I had three small complaints about the RDP-1's operation. When I turned its knobs quickly, the display didn't change fast enough to register what I was doing. Furthermore, I sometimes had to turn a knob to the left before turning it to the right would have any effect. And I sometimes had to turn the RDP-1 off and on again to get any output from it. (This wouldn't have happened, however, if I had left the unit on. And doing so wouldn't have

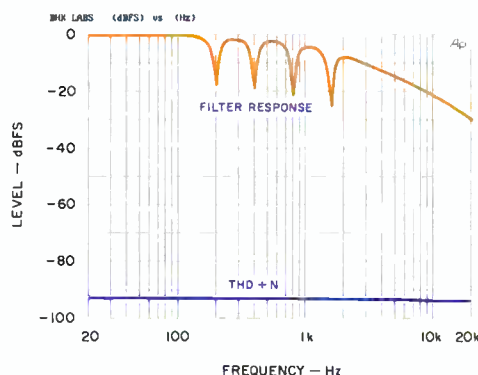

Fig. 6—Filter response and THD + N with four bell filters and high-frequency shelving filter engaged.

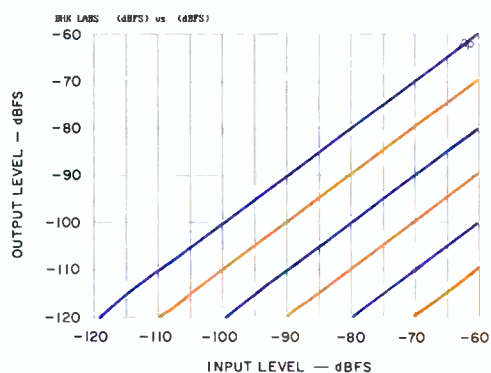
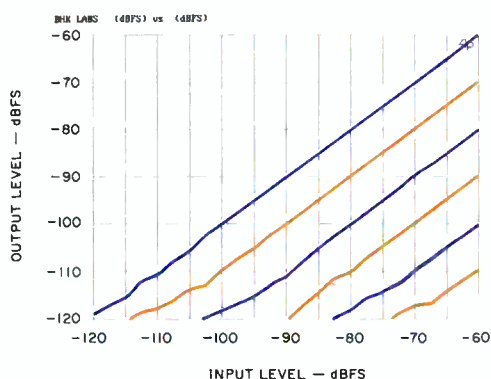

Fig. 7—Input/output linearity vs. volume setting for dithered signals with word lengths of 16 bits (A) and 20 bits (B).

been a problem, since its power consumption is very low.)

Nitpicking aside, I think the RDP-1 is a terrific device. I found it useful for equalizing room acoustics and other response anomalies and for making some recordings more enjoyable. Every audiophile should have tone controls, but few do. The RDP-1 gave them back to me, and I love it.

D. B. KEELE, JR.

PARADIGM REFERENCE SERVO-15 POWERED SUBWOOFER



The Servo-15, Paradigm's top subwoofer, is part of the company's Paradigm Reference line, which includes the Eclipse/BP, Studio/100, and Active/20 speakers (reviewed in the August 1995, July 1996, and September 1997 issues, respectively), along with other models. The Servo-15 is one of five powered systems comprising the Active subgroup of the line.

The Servo-15's beefy 15-inch woofer is housed in a solidly constructed, sealed enclosure and driven by a built-in 400-watt amplifier. The amp incorporates a servo circuit that monitors the woofer's activity via

an instrumentation-grade piezoelectric accelerometer on the driver. The subwoofer comes with an electronic controller that provides crossover functions and phase adjustment for the subwoofer and line-level high-pass filtering for the wide-band signal driving the rest of your audio system. Two versions of this unit are available: the X-20, which has speaker-level inputs, and the X-30, with line-level inputs, that I reviewed. (Each is also sold separately, for \$159.)

The Servo-15's nearly cubical enclosure has a grille on its front that covers the driver; the power amp's controls, input jack, and power cord are on the rear. The con-

trols are minimal, consisting of a level knob and a tiny three-position power switch ("Always Off," "Auto On/Off," and "On"). There is a line-level RCA jack, but no speaker-level input, because the Servo-15 is intended to be driven from its controller or directly from a low-pass-filtered subwoofer output on a surround processor, preamp, or receiver.

Although the Servo-15's driver is nominally a 15-inch unit, it is actually 16 to 17 $\frac{3}{4}$ inches, depending on where you measure the diameter of the heavy-duty, die-cast aluminum frame. The cone is a Kevlar-fiber reinforced composite (whose high internal damping and stiffness are said to significantly reduce unwanted resonances and distortion) and has a multilayer surround. Rated excursion is a healthy 1 inch, peak to peak.

The driver's large motor assembly has three ceramic magnets, each 6 inches in diameter and $\frac{3}{4}$ inch thick: Two power the woofer, and the remaining one is a bucking magnet that reduces external magnetic fields. The magnet assembly, computer-optimized for low distortion and high field strength, has a low-turbulence center vent that exits to the rear. Two aluminum shorting rings around the pole piece are intended to improve heat transfer and lower distortion. The voice coil has bifilar windings on an aluminum/Nomex former that's 2.1 inches in diameter and 1.4 inches long. The accelerometer is bonded to the front of the voice coil, under the woofer's dust cap. Three leads connect it to the built-in amplifier.

Rated Frequency Response: 17 to 80 Hz, ± 2 dB.

Rated THD + N: Less than 0.3% at 50 Hz and 90 dB SPL.

Dimensions: Speaker, 20 in. H x 18 in. W x 21 $\frac{3}{4}$ in. D (50.8 cm x 45.7 cm x 55.2 cm); controller, 1 $\frac{7}{8}$ in. H x 7 $\frac{1}{4}$ in. W x 5 in. D (4.8 cm x 18.4 cm x 12.7 cm).

Weight: Speaker, 78 lbs. (35.5 kg); controller, 2.7 lbs. (1.2 kg).

Price: Speaker, \$1,500 in black ash laminate or \$1,750 in light cherry or rosenut wood veneer (price includes controller).

Company Address: c/o AudioStream, M.P.O. Box 2410, Niagara Falls, N.Y. 14302; 905/632-0180.

Photos: Michael Groen

The Servo-15's power amplifier is a purely linear design, using no switching output or power-supply circuitry. It is mounted to a removable rear subpanel that includes a large heat sink. The amp's circuitry is on a large glass-epoxy board that is at right angles to the rear panel; its eight output transistors are attached to that panel, just behind the heat sink. The amp's large toroidal power transformer is on the bottom of the cabinet.

The accelerometer and the amp's servo circuits form a closed-loop system that compares the accelerometer's output to the audio input signal and then corrects any discrepancies in the driver's motion. The amp also has limiting circuitry to prevent clipping and guard against excessive cone excursion.



I FOUND IT IMPOSSIBLE TO MAKE THE SERVO-15 SOUND BAD BY OVERLOADING IT.

Paradigm's patented automatic circuitry turns the subwoofer on quickly whenever there is an input signal and turns it off about 15 to 20 minutes after the signal stops. Paradigm says the amp consumes less than 1.5 watts while it's waiting for a signal, which is said to be significantly less than competing designs draw.

The Servo-15's cabinet is made of 1-inch medium-density fiberboard (MDF) and is heavily braced. Front and rear baffles use self-locking joints for additional rigidity. The enclosure is strengthened by two full-

perimeter vertical braces of 3/4-inch MDF. One brace connects the top and bottom to the two sides, while the other connects them to the front and rear; Paradigm calls this a Cascade design. A removable grille with a 3/4-inch MDF frame plugs into the front of the cabinet. Large feet are provided, and gold-plated feet with adjustable spikes are available.

The X-30 and X-20 electronic-crossover/controllers are recommended for use in audio systems that lack appropriately filtered subwoofer outputs. The X-30 is small and intended to be placed near your system's other electronics. An audiophile-grade RCA-to-RCA cable is provided for connection to the subwoofer. This cable is 23 feet long, which should be enough to extend from a controller stacked with your other components to a Servo-15 at the opposite end of your listening room. Paradigm sent me the X-30 for review; it has controls for subwoofer level, low-pass cutoff (which is variable from 35 to 150 Hz), and subwoofer phase (which affects only one of the two mono subwoofer output jacks on the rear panel). The latter two controls enable the Paradigm Servo-15 to be used with virtually any main speaker system, located at any distance from the subwoofer. The X-30 also has 18-dB/octave high-pass filters, with separate line-level stereo output jacks for 50-, 80-, and 120-Hz cutoff frequencies.

Measurements

The Servo-15's on-axis anechoic frequency response (Fig. 1) is quite flat and well behaved, with a bandwidth of about 20 to 150 Hz at the 3-dB-down points and a maximum output at about 60 Hz. These are ground-plane measurements, made with the subwoofer's level control at its middle position and an input of 0.1 volt rms.

Figure 2 shows response at the X-30 controller's subwoofer outputs for various low-pass frequency settings. (The input was again 0.1 volt rms, the X-30's subwoofer level control was in its mid position, and

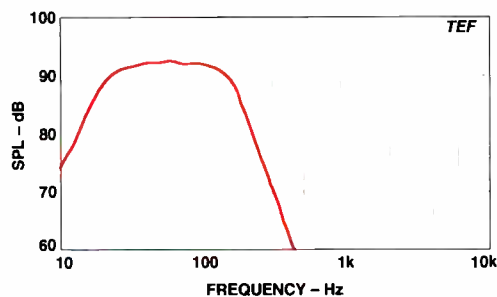

Fig. 1—Frequency response of Servo-15 subwoofer.

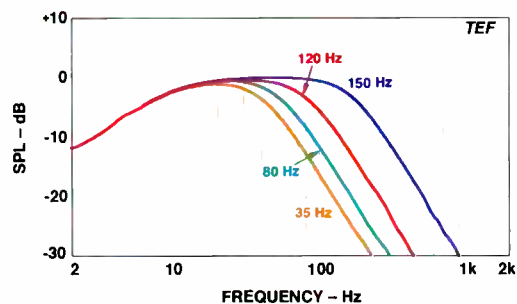

Fig. 2—Frequency response of X-30 controller's subwoofer outputs.

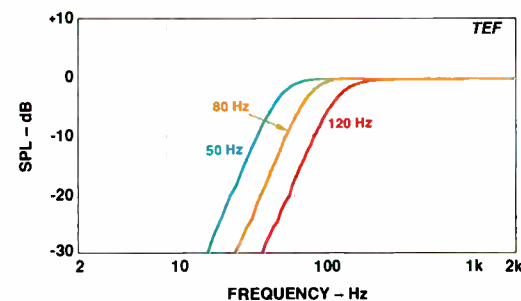

Fig. 3—Frequency response of X-30's high-pass outputs.

the test load was 1 megohm. With these settings and the cutoff control at 150 Hz, the X-30's gain was +2 dB at 50 Hz.) Infra-sonic frequencies are rolled off at 6 dB/octave below about 8 Hz, while the high-frequency cutoff, specified as 18 dB/octave, actually has a 12-dB/octave slope. As can be seen, a relatively large gap exists between the 150- and 120-Hz positions. (In this and the following graph, note that the frequency scale extends down to 2 Hz.)

Figure 3 shows the frequency response of the X-30's high-pass outputs. (Response above the graph's 2-kHz limit was perfectly flat to 20 kHz.) Each curve exhibits a classic third-order, 18-dB/octave, high-pass response, as specified. The measured cutoff

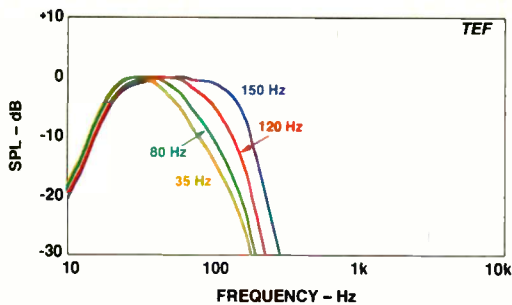

Fig. 4—Combined response of Servo-15 and X-30.

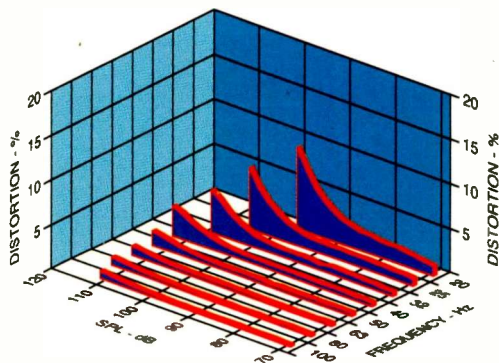

Fig. 5—Harmonic distortion of Servo-15 vs. SPL and frequency.

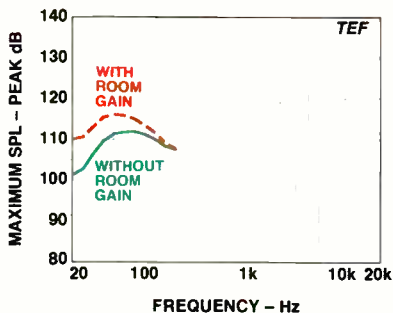

Fig. 6—Maximum peak sound output.

Table 1—Low-pass frequencies of Servo-15 subwoofer when driven by X-30 controller.

Low-Pass Setting	-3 dB Cutoff	-6 dB Cutoff
150 Hz	135 Hz	156 Hz
120 Hz	85 Hz	105 Hz
80 Hz	62 Hz	75 Hz
35 Hz	51 Hz	63 Hz

(-3 dB) frequencies are quite close to those indicated on the jacks: 48 Hz at the 50-Hz output, 75 Hz at the 80-Hz output, and 119 Hz at the 120-Hz output.

Figure 4 shows the combined frequency response of the Servo-15 and X-30 controller. The frequencies indicated on the X-30 are significantly different from the measured -3 dB points, instead corresponding roughly to the -6 dB points. The exact cutoff frequencies are listed in Table 1.

I was quite impressed with the Servo-15's low-frequency output and general sonic cleanliness at high levels. I found it impossible to make this subwoofer sound bad by overloading it, no matter what the input frequency or level. Furthermore, the cabinet was essentially vibration-free. The woofer's maximum excursion was about 0.8 inch, peak to peak, and occurred at 20 Hz. By removing the woofer from the cabinet and driving it directly from my amplifier, I found that it could easily reach excursions of 1 inch, peak to peak, with fairly low distortion. No dynamic offset distortion was evident. I would suspect that even without the accelerometer servo feedback, distortion would be quite acceptably low.

Figure 5 shows the Servo-15's harmonic distortion versus frequency and SPL (and includes the effects of room gain). The distortion presented is the sum of the first 10 harmonics, expressed as a percentage of the power in the fundamental. (This method yields essentially the same results as measuring total harmonic distortion, which includes all harmonics—even those above the tenth—and excludes noise.) The second and third harmonics predominate at most frequencies and levels.

At each test frequency, the Servo-15's limiter put a cap on the maximum sound pressure level; beyond a certain point, increasing the input level produced no further increase in output level or distortion. The limiter allowed the subwoofer to generate 113 dB SPL at 40 Hz but only about 98 dB at 20 Hz. At all the test frequencies, the Paradigm Reference sub sounded quite effortless and clean, and its

distortion was less than 10%. In fact, as you can see in Fig. 5, it rose to only 9% at 20 Hz, was just 6.8% at 25 Hz, stayed below 5% at 32 and 40 Hz, and was less than 2% from 50 Hz on up.

Figure 6 shows the Servo-15's short-term peak sound output versus frequency. The subwoofer was driven directly, without the X-30 controller. The maximum peak SPL at each frequency was constrained by the subwoofer's limiter. The tone-burst test signal sounded quite clean and powerful at all levels up to the limit. However, if I turned up

**THE SERVO-15
WAS A CLEAN AND
POWERFUL PERFORMER,
WITH PARTICULARLY
GOOD LOW BASS.**

the input level well past the limiting point, the signal changed its tonal characteristics (though it still seemed undistorted). Observing the output on an oscilloscope, I saw that the shape of the tone burst changed significantly: Levels were highest near the start of each burst instead of in the middle. Although the tone burst's envelope changed significantly at high overload levels, the sine waves making up each burst were still essentially sinusoidal. The sound was thus fairly clean.

With room gain, the maximum peak output in Fig. 6 starts quite strongly, at 110 dB SPL at 20 Hz, and then rises quickly to a peak of 115 dB SPL at 50 Hz. At higher frequencies, the maximum SPL drops smoothly to a still strong 108 dB at 200 Hz, passing through 113 dB at 100 Hz. The Servo-15's low-frequency output is very nearly the highest of all subwoofers I have tested.

Use and Listening Tests

The Paradigm Reference Servo-15 weighs nearly 80 pounds and is 23 inches deep with its grille on, making it somewhat of a chore to move around and reposition. The large plastic feet, which look like hockey pucks, make it easier to move the speaker and provide convenient handholds for lifting it. My review sample, supplied in the black ash finish, was quite attractive. (I found it a lot more attractive than my wife did. Any

speaker that can generate lots of clean, powerful bass must be attractive, right?)

With its grille removed, the woofer looks more like a heavy-duty 18-incher than a 15-incher. Hookup was simple and easy, thanks to the Servo-15's single RCA input jack and the facilities of the X-30 controller. I used this subwoofer primarily in my home theater and judged it with stereo music CDs and laserdiscs. The Servo-15 was driven by the X-30, which provided a convenient bass volume control.

The Servo-15's manual is short but informative and detailed. It covers, among other things, placement, controls, and operation with an X-series controller (which is covered in greater detail in the X-30's own manual).

For comparisons, I used two other powered subwoofers. One was the Velodyne F-1500B, a servo-controlled sealed system with a 15-inch woofer, which is similar to the Servo-15. (The F-1500B is an upgraded version of the F-1500 I tested in the November 1992 issue.) The other sub was a Boston Acoustics VR2000, whose 12-inch woofer is in a vented enclosure and whose built-in amplifier has no servo-feedback or limiter/compressor circuitry (*Audio*, January 1997).

I positioned the Servo-15 to the left of my right front speaker (a KEF Reference Four) and faced it into the room. For A/B comparisons with the other subwoofers, I placed the Velodyne on top of the Paradigm Reference and the Boston on the floor in front of the right front speaker, facing across the room. This kept the woofers as close together as was reasonably possible.

All three subwoofers were driven by the X-30 controller through a line-level A/B switcher. I set the Velodyne and Boston subwoofers' low-pass cutoff controls to their highest frequencies. I set the X-30's cutoff control to its middle position (halfway between the 80- and 120-Hz markings), which actually channeled all the bass below about 65 Hz to the subwoofers. When playing pink noise in the octave around 31 Hz, I used the subwoofers' level controls to match output levels.

The Servo-15 proved to be an excellent all-around performer, clean and powerful with particularly good output in the very low bass. It played significantly louder than the Velodyne at all frequencies and easily dusted off the Boston at 40 Hz and below.

(The Boston was a very able performer above 40 Hz, however.) On loud rock music, such as heavy metal with strong kick drum (whose energy is mostly above 40 Hz), I slightly preferred the Boston to the Paradigm, while both the Paradigm and the Boston were significantly more dynamic than the Velodyne, with bass that rivaled a live concert's.

On recordings having high levels of low bass, such as the organ pedal notes on the Jean Guillou CD of Mussorgsky's *Pictures at an Exhibition* (Dorian Recordings DOR-90117, one of my favorite bass demos), the Servo-15 was the clear and decisive winner. On other pipe-organ recordings that had bass below 20 Hz, this sub was an outstanding performer.

On the bass drum on track 1 (at 1:08 and 1:10) of *Winds of War and Peace* (Wilson Audio WCD-8823, another favorite bass demo), the Paradigm blew off the Velodyne and Boston Acoustics subs, playing much louder and cleaner. Compared to the Paradigm, the Velodyne wimped out: Its limiter acted so aggressively that its output was anemic compared to the Servo-15's,

**IN THE SERVO-15,
PARADIGM HAS STRUCK
A GOOD BALANCE
BETWEEN HIGH OUTPUT
AND LOW DISTORTION.**

and low notes accompanying bass-drum whacks were considerably modulated.

A particularly useful test signal for subwoofer output is the 6.5-cycle, third-octave tone bursts that I use for my peak power tests (available on Syn-Aud-Con's Sound Reinforcement test CD). Like music, but unlike such test signals as sine waves, the signal is quite transitory in nature yet also very restricted in frequency content. By design, its energy is concentrated in a fairly narrow bandwidth. Just by listening, it's relatively easy to detect the onset of nonlinearities and distortion when the signal level is raised and to compare the outputs of different speakers.

As I pointed out in my review of the Boston VR2000, the Syn-Aud-Con test CD provides bursts at the rate of one per sec-

ond in one channel and one every 2 seconds in the other channel. Summing the two channels into a monophonic signal yields a train of bursts that alternate in level by 6 dB. This is also a very useful test signal for comparing speakers by ear. Just turn the level up until the higher burst is distorted or, in the case of systems that have limiters or compressors, until the alternating bursts sound about equally loud. When this point is reached, compare the loudness of the two speakers. On this signal, the Paradigm could play much louder than the Velodyne and still preserve the tone burst's alternating high-and-low volumes, though it did not sound as clean as the Velodyne. The Velodyne's output sounded very pure and distortion-free, but all the tone bursts were equally loud instead of alternating in level. (During this test, I noticed that the Servo-15's woofer motions were significantly greater in amplitude than the Velodyne's on the high-level burst. Apparently, the Velodyne's limiter was holding back its excursion and therefore restricting its acoustic output. The Velodyne's limiter is set so that distortion does not rise above a very low 1%, greatly reducing the speaker's potential maximum output.) Below 40 Hz, the Paradigm could also play much louder than the Boston, which distorted quite badly on the higher-level bursts.

The Paradigm was also an excellent performer with movies. The sound effects and bass stood out, especially on *The Mask* and *Terminator 2: Judgment Day*. The Servo-15's solid bass underpinning added a high degree of realism to both movies. Particularly memorable were the "Future War" sequence in *Terminator 2* (just preceding the intro credits), where the explosions and other special effects were outstanding, and the '40s nightclub sequence in *The Mask*, where the acoustic bass and live drum sounds were quite notable.

The Paradigm Reference Servo-15 powered subwoofer proved to be a very strong and extremely capable performer. Paradigm has struck a very good balance between the Servo-15's maximum output and its maximum distortion. Its distortion, although not super-low (it seldom is in subwoofers), nevertheless sounded quite acceptable. The Servo-15 should be seriously considered for any situation where the highest caliber of bass performance is required. **A**

AURICLE

ANTHONY H. CORDESMAN

THETA DIGITAL MILES CD PLAYER



Someday there will be audio discs that use DVD's huge data capacity to bring us higher sampling rates, longer data words, and multiple channels. Meanwhile, DVD sound is mostly mediocre, in my opinion, and nobody knows what the DVD-Audio standard will be or how many years it will take to achieve full acceptance—which leaves CD as *the* format for serious music listening. It offers an immense library of performances and can deliver sound that's musical, if not the absolute state of the art. So buying a good CD player makes as much sense now as it did before DVD loomed on the horizon.

Company Address: 5330 Derry Ave., Suite R, Agoura Hills, Cal. 91301; 818/597-9195.

At \$2,195, Theta Digital's Miles CD player is at the affordable end of the high-end price spectrum. (The transport section of the Miles is available separately as the Pearl, which costs \$1,235.) The Miles may not have all of the technology or the sound quality that Theta's DS Pro Generation V-a D/A converter and Data III transport have, but it comes surprisingly close. More important, it takes you out of the "ho-hum" level of CD sound, giving you music with real dynamics, excellent soundstaging, and the transparency and sweetness you need for serious long-term listening.

**CIRCUIT AFTER CIRCUIT
USES TECHNOLOGY
THETA FIRST DEVELOPED
FOR STATE-OF-THE-ART
COMPONENTS.**

The Miles comes with a coaxial digital output. An AES/EBU balanced output is \$50 extra; I strongly recommend getting it if your D/A converter has AES/EBU inputs, because it will almost invariably improve low-level resolution and transparency. Theta also offers AT&T (ST) and single-mode glass-fiber outputs, at \$250 and \$800, respectively. However, I think the time of glass optical fiber connections is over; in practice, a coaxial connection is generally better. As for Toslink, which has several technical limitations, Theta doesn't even offer it.

The Miles is available with single-ended analog outputs and, for an additional \$400, with balanced analog outputs. Both versions use the high-grade K version of Burr-Brown's PCM67P stereo DAC chip but otherwise differ noticeably. The single-ended version uses one PCM67P. Separate high-speed devices for each channel convert the DAC's analog current output into discrete voltage steps. (This stage uses Vishay bulk foil resistors and Wima polypropylene capacitors.) The balanced version uses two of the Burr-Brown stereo DACs in a dual differential configuration, each DAC converting both the positive and negative phases for its channel. Separate high-speed op-amps for each phase convert the DACs' current output into discrete

voltage steps. The balanced version offers lower noise, slightly better low-level resolution, as well as more refinement of upper-octave har-

monics and soundstage detail. In both versions, digital filtering and interpolation are performed at an eight-times oversampling rate, using the same proprietary algorithm as Theta's far more expensive DS Pro Generation V-a D/A converter.

The Miles has an analog volume control that is bypassed entirely

Photo: Michael Groen

JVC is proud to introduce
the first two pop titles
available on **xrcd**.

Listen and compare.

the steve miller band the joker JVCXR-0043-2

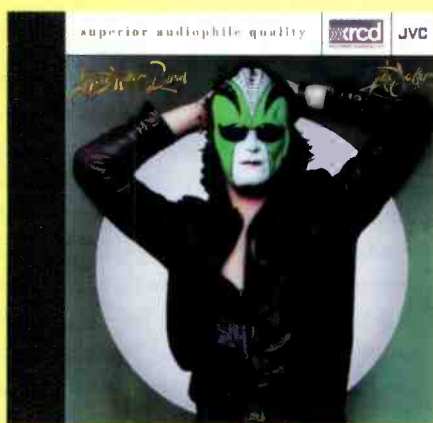

When you hear the name Steve Miller, the first thing that comes to mind is *The Joker*. Miller's classic 1973 album features the title track, which was his first huge #1 single, as well as "Sugar Babe" and "Something to Believe In." During rehabilitation following a car accident that put the artist out of commission for a year and a half, Miller began to reinvent his style. Leaving behind a more blues based rock style to compose compact, catchy and melodic pop songs, Miller created *The Joker*. It was this turning point recording that set the stage for Miller's exquisitely crafted material that would follow in the mid and late seventies. This historical rock recording is available for the first time as an audiophile disc. The critically acclaimed XRC technology reveals nuances previously unheard and presents this platinum-selling disc the way it was originally intended.

tina turner private dancer JVCXR-0044-2

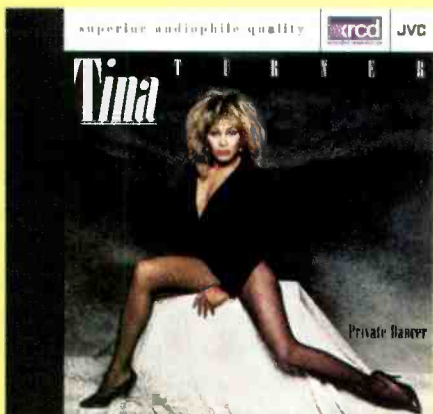

It has been said that Tina Turner is "the woman who taught the world to dance in heels." From the early days to the present, the fabulous Tina has managed to captivate listeners with her electrifying vocals and mesmerizing presence. Perhaps nowhere is her unique musical personality more completely captured than on her solo breakthrough *Private Dancer*. Few artists can claim to have had two distinct careers, however, Tina Turner can claim just that as *Private Dancer* exposed this compelling artist to an entirely new generation. Containing the title track as well as "What's Love Got to Do With It," "Better Be Good to Me" and "Let's Stay Together," *Private Dancer* is practically a greatest hits collection itself. Recorded with a variety of producers, this disc also features a blistering Jeff Beck solo on the track "Steel Claw." Now this multi-award winning disc is brought to new life utilizing the critically-acclaimed XRC technology...listen and compare.

To find out more about XRC visit our web site at: xrcd@jvcmusic.com

To order by phone with a major credit card, call toll free 1-800-JVC-1386

JVC Music 3800 Barham Blvd., Suite 305, Los Angeles, CA 90068



when you set it for zero attenuation. Theta, like most manufacturers, has found that digital volume controls degrade sound quality. The analog outputs have high-speed buffers to drive even very long interconnects, circuitry Theta first developed for its Casablanca A/V preamp.

For the transport section of the player, Theta used Pioneer's Stable Platter mechanism and made major improvements to its power supply and digital circuitry. The clock circuitry, taken from Theta's top-of-the-line Data III transport, has a

custom-manufactured low-jitter oscillator. The clock/digital-output section has its own highly regulated power supply that uses a custom-made low-flux transformer. This power supply's very high isolation, together with extensive use of ground planes, is said to suppress AC line noise and help keep digital noise and hash from corrupting the purity of the clock signal.

The control and audio circuits are also well isolated, with extensive shielding to keep the comparatively noisy transport clocks from polluting the clock signals that

drive the DACs. Three additional low-flux transformers are in the power supply, feeding six separate regulation stages on the DSP and analog boards. These power supplies are similar to those used in Theta's highest priced transports and D/A converters. High-quality Nichicon Muse capacitors are used in the power-supply, clock, DSP, and analog sections.

In short, the Miles has much of the technology you'd pay more than \$8,000 for if you bought a Data III transport and DS Pro Generation V-a converter. As you might expect, this shows up in sound quality, especially in dynamics, transparency, low-level resolution, and deep bass.

I found the dynamics of the Miles to be far more musically natural than those in most players in its price range. There are good-sounding CD players at much lower prices, but those I've heard have had restricted dynamics; some even sounded compressed. (I suspect that this lack of natural dynamic energy and transient response is one reason many audiophiles prefer the dynamics of LPs; I believe that CD recordings often get the blame for this technical limitation of CD players.) The dynamics of the Miles approached those of some really fine CD transport and D/A converter combinations I've auditioned.

On the Miles, chamber music did not have the peculiar flatness often heard from CD, and strings and woodwinds took on more life. Jazz bass lines were clear, without the beat compression that makes some listeners think that CD players lack proper musical tempo. The Miles also opened up the dynamics of full orchestral music and big-band jazz—and not just on "audiophile" CDs.

Transparency and low-level resolution are clichés in audio reviewing, but words cannot properly convey these qualities. The best I can say is that for transparency and low-level resolution, the Miles scores an 8 out of 10 (where 10 would be top-of-the-line Krell, Mark Levinson, Theta, and Wadia Digital equipment); I'd give most of the competition in its price range a 5 or a 6. (If you find such rankings as suspect as I do, I suggest you to go to a dealer and do some comparative listening—a good idea, in any case.)

When auditioning CD components, I often use string quartets or trios and Bach

LET'S LAUNCH A NEW PRESIDENTIAL CAMPAIGN.

Plant a historic tree from the home of your favorite President and vote to help preserve America's great trees.

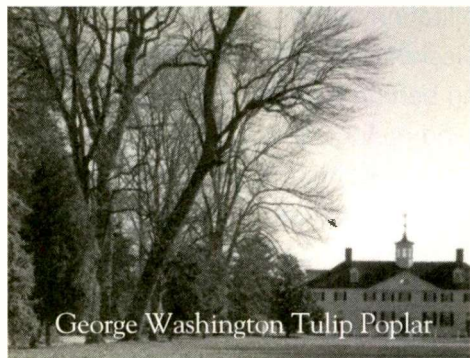

George Washington Tulip Poplar

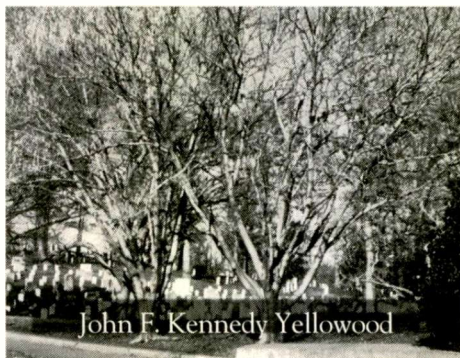

John F. Kennedy Yellowwood

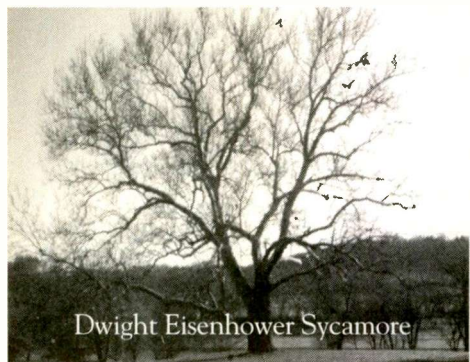

Dwight Eisenhower Sycamore

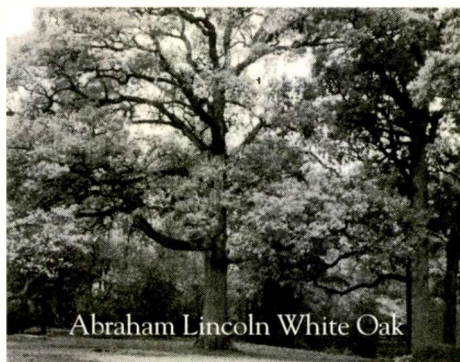

Abraham Lincoln White Oak

Small trees have been grown from seed hand-picked from trees that stand at the birthplaces and homes of America's presidents. Each tree planted supports AMERICAN FORESTS, our nation's oldest non-profit citizens' conservation organization, founded in 1875.

Choose the tulip poplar tree that George Washington planted in 1785 or the white oak that marked the boundary of Sinking Springs Farm where Lincoln was born.

Each tree comes in a complete planting kit and is guaranteed to grow. Cast your vote and plant a tree.

Call for a full color booklet that is yours at no cost.

**AMERICAN
FORESTS**

or write to: AMERICAN FORESTS Famous & Historic Trees
8555 Plummer Road
Jacksonville, Florida 32219
904-765-0727



harpichord music to test transparency and resolving power. For some reason, both types of music seem to expose the limits of CD gear more quickly than most orchestral music, jazz, or rock. In fact, many CD players and D/A converters miss a significant portion of the "air" and sweetness of the strings and harpichord on good recordings. The Miles may not have had quite enough transparency and low-level resolution to challenge the very best transport and converter combinations, but it did reproduce enough of that "air" to give strings and woodwinds the sweetness and harmonic integrity they deserve. Bach's harpichord music sounded like real music on the Miles, not an atonal exercise in mathematics (though I have yet to hear *any* CD playback equipment reproduce harpichord in a

**FOR ITS PRICE,
THE MILES DELIVERS
OUTSTANDING
BASS EXCITEMENT,
NOT JUST BASS POWER.**

way I find totally convincing). Considering its price range, the Miles also did an exceptional job of providing the low-level details of hall ambience and of musicians at work; these are things that help you forget you're listening to a sound system and get involved in the music.

As for low frequencies, the Miles had both dynamics and deep bass punch. Here again, top-of-the-line Krell and Theta CD gear can provide more resolution, dynamics, and deep bass extension, but the margin of superiority is small. The Miles provided outstanding bass excitement, not just bass power, for its price. It helped give ordinary CDs far more natural musical realism than run-of-the-mill players could.

Theta Digital's Miles shows what happens when a manufacturer takes technology from ne-plus-ultra equipment, with ne-plus-ultra prices, and makes it more affordable. Far too many high-end manufacturers seem obsessed with raising the ante and pursuing the ultimate design at the ultimate price. It's nice to see one devote a major design effort to a product in a more reasonable price range.

SOUND YOU CAN



ALMOST SEE

**Virtual Reality
In Home Entertainment**

It's a jungle out there in home-theater land!

Let Phase Technology be your guide to movies, music and more with critically acclaimed home theater, audiophile and in-wall speaker systems.

Now presenting our latest crowning achievement—the user-adjustable Model PC-3 multi-purpose speaker. It's ideal for front, rear and center use in any multi-channel system.

Your hunt is over. Audition the Model PC-3 and experience sound so real, you can almost see it.



**PHASE
TECHNOLOGY**

1-888-PHASE TK
www.phase-tech.com

© Phase Technology Corp.

**“WOW, I can't
believe you have
that CD!”**

1-800-EVERY-CD is a wholesale music club. Members receive a 950 page catalog offering virtually every CD in print. All CD's are offered at wholesale, which is guaranteed to be the lowest price you can find. We do not send unsolicited CD's, and there is no minimum required to order. Call today or search our catalog now online at <http://www.everycd.com>. Whatever CD you last bought, chances are we'll have it, too, for less. We'll also have the items you've been wanting to buy but couldn't find.

Good music selection is hard to find. We're not.

800 EVERY CD



music for the serious collector™

Outside the U.S., please call (203) 972-1752 or fax (203) 972-1129

VIENNA ACOUSTICS BEETHOVEN MK. II, MOZART, AND MAESTRO SPEAKERS



The Vienna Acoustics Beethoven Mk. II, Mozart, and Maestro

Choosing a speaker is like choosing a partner for a love affair: You can never find perfection, merely maximize delight. And the choice isn't easy, because speakers have more individual character than anything else in your audio system and have the greatest influence on its overall sound character. The selec-

tion is further complicated by the fact that there are thousands to choose from (*Audio's* most recent Annual Equipment Directory lists more than 3,000 models).

Luckily, some companies' speakers really do stand out from the rest. Take Vienna Acoustics, whose speakers offer exceptional bass and dynamic range for their size, embody a

musically convincing mix of design trade-offs, deliver excellent sound-staging, and are equally good for stereo and home theater listening. What's more, these speakers are unusually small and quite stylish. For this review, I auditioned two pairs of floor-standing systems from Vienna Acoustics, its largest, the Beethoven Mk. II (\$3,990 per pair), and the smaller Mozart (\$2,500 per pair). I also tried the Maestro center-channel speaker (\$995).

The Beethoven Mk. II, Vienna Acoustics' flagship, is relatively compact for a floor-standing speaker: Although it's 40 inches high, it's only 7½ inches wide and 14½ inches deep. Even so, it weighs 54 pounds, perhaps because its cabinet has five

**THESE SPEAKERS
SOUND SWEET,
BUT THERE'S NO LACK
OF HIGH-FREQUENCY
DETAIL OR "AIR."**

internal braces. This extensive bracing, and the quality of the cabinet, keep the enclosure's walls exceptionally inert during loud passages. The finish is very attractive; the Beethoven looks even better in real life than it does in photographs.

The Beethoven II's two 7-inch woofers operate in a quasi-Butterworth, bass-reflex enclosure. Its other drivers are a pair of 5½-inch midranges and a 1½-inch tweeter. The three-way crossover, a Bessel-filter design with 9- and 12-dB/octave slopes, uses such high-quality components as air-core coils and noninductive metal-film resistors. The midranges are said to cross over to the woofer at a relatively low 110 Hz and to the tweeter at 3 kHz, so they can cover most of the human vocal

**Company Address: c/o Sumiko,
2431 Fifth St., Berkeley, Cal.
94710; 510/843-4500.**

Photo: Michael Groen

CABINETS THAT ADD, SUBTRACT, MULTIPLY AND DIVIDE.™



If you've ever changed your mind, these are the cabinets for you. The first high quality, expandable system that you customize to meet all your audio, video and computer needs. Make it vertical or horizontal. The Encase™ look is built-in without the built-in cost.

ENCASE LTD.
BLOCK & QUOIN SYSTEMS™



Drawer
High quality, side mount, full extension drawer guides



Cord Channel
With hook and loop fasteners, hides, holds, separates cables



Quoins
Add, subtract, multiply and divide units without tools



Desk Bridge
Easy addition for desk, computer or TV stand

Encase Ltd. • P.O. Box C • Lawrence, KS 66044 • **Telephone: 785 / 331-3400** • **Fax: 785 / 331-3443**

©1997 Encase Block & Quoin Systems • TM Trademark of Encase Block & Quoin Systems

range seamlessly. The Beethoven's rated frequency range is 30 Hz to 22 kHz, its rated sensitivity is 91 dB, and its nominal impedance is 4 ohms.

The reason Peter Gansterer, Vienna Acoustics' chief designer, gave the Beethoven II a pair of smallish woofers rather than one large woofer was to keep the front baffle narrow, for good imaging, while still providing bass down to about 35 Hz in most listening rooms. (Such low bass response is far rarer in the real world than most speaker specifications imply.) The woofer cones are made of a medium-weight, silicone-based polymer called XPP, which the company says is stiffer and better

damped than polypropylene. The individually cast cones are further stiffened by spider-web-shaped molded ribs, said to make them even stiffer than metal cones. The midrange cones are also of XPP,

but Gansterer left off the spider-web ribbing to make them less stiff, for speed and delicacy. The tweeter is the highly regarded ScanSpeak D29. It has a silk dome, which some audiophiles believe produces a smoother and sweeter treble than metal or plastic tweeter domes.

The Mozart, which shares many features with the Beethoven II, is 37 inches high, 6¾ inches wide, and 11⅝ inches deep and weighs 44 pounds. It has two 5½-inch XPP woofers (in separate enclosures of different sizes) and a ScanSpeak D29 1⅞-inch tweeter. Like the Beethoven II, the Mozart is a quasi-Butterworth bass-reflex system, and it has a Bessel crossover with 9- and 12-dB/octave slopes. Frequency range is rated at 35 Hz to 22 kHz, sensitivity at 90 dB, and nominal impedance at 6 ohms.

Each speaker's midrange and treble blended exceptionally well; I heard no discontinuities, response peaks, or harshness. These systems sounded slightly warm, and their upper-octave balance was sweeter than the high-frequency energy balance some other manufacturers define as "flat." (Even so, no one will criticize these speakers for a lack of high-frequency detail or "air.") That sweetness worked very well with many CDs, laserdiscs, and DVDs that had a bit

too much upper-midrange energy. The Vienna Acoustics speakers produced a more musically natural balance with them, yet there was still enough high-frequency detail to keep LPs and more natural digital recordings from sounding soft.

The Beethovens and Mozarts proved particularly good in reproducing the tonal differences of different models of guitars, violins, and pianos, and they reproduced all the character of brass and woodwinds. They did a lovely job of reproducing solo voices and choruses without favoring one gender over the other and could handle all types of music well, from the grittiest blues to the most delicate soprano arias.

THE VIENNA SPEAKERS
SING IN VIRTUALLY
THE SAME VOICE,
WHICH IS EXCELLENT
FOR HOME THEATER.

I was struck by the unusually good job these did of maintaining instrumental timbres over a very wide dynamic range. The Beethoven II performed better in this regard. Don't let its size fool you, for this is one speaker that lets you glory in Mahler's excesses at full tilt without compressing the sound or losing detail.

The Beethoven's bass was unusually deep and powerful for a speaker its size, as long as I spiked it to the floor and followed the manufacturer's placement instructions. It does need an amplifier that provides a lot of control and bass power, however, and I found it to be sensitive to cables. (It worked better with the Wire World Atlantis II and the Kimber KS 3033 than it did with my MIT and Alpha-Core Goertz cables.) Amplifier and cable interactions are a fact of life with almost all speakers, but the Beethoven II required more attention in this area than most.

The Mozart did not have the deep bass extension and dynamic range of the Beethoven II, but the differences were smaller than I'd expected and mattered only on recordings having true deep bass or extreme musical dynamics. The Mozart was less sensitive than the Beethoven to room placement and to amplifier and cable interactions—but then, the price of deep bass response is often greater difficulty with room interactions and cables.

The Beethoven II produced a very wide, deep, and stable three-dimensional sound-

stage over a broad listening area. Definition was unusually good, with no blurring or smearing. This speaker spread the instruments evenly and provided exceptional center fill. Its superior dynamics also ensured that the soundstage and imaging did not change when volume did, even when played at loud orchestral levels. These qualities came through clearly on grand opera, large 19th- and 20th-century orchestral pieces, and big-band jazz. They also showed up on several rock recordings that happen to deliver an actual soundstage rather than random, console-mixed effects.

The Mozart's soundstage was also very good. However, this speaker didn't quite match the Beethoven II's outstanding detail in really loud passages or its precision in reproducing complex choral and orchestral passages.

The Beethoven II and Mozart were at their best when driven by high-quality, high-powered solid-state amplifiers. With several medium-powered tube amplifiers, the sound was warm and the bass lacked proper tightness and definition, though this was less noticeable with Audio Research's VT200 tube amp. The Vienna speakers performed very well with moderately priced but powerful solid-state amplifiers, such as the Adcom GFA5802 and GFA5500 and the Classé Audio CA-400. The solid-state Krell KSA-300S provided even more bass control and definition, as, to a lesser extent, did the Pass Laboratories Aleph 1.2.

After stereo music listening, I put the Vienna Acoustics speakers into a home theater system, using the Beethoven IIs for the main channels and the Mozarts for the surrounds. For the center channel, I used the Maestro, a shielded speaker that has the same driver complement as the Mozart but is much smaller.

I was very impressed by this combination. The Viennas could handle the dynamics of the most demanding Dolby Digital (AC-3) or DTS soundtracks, and the sound field was large and stable. Dynamics and transient definition were very good, even when I drove the Viennas to levels best suited to reproducing World War II.

The speakers had virtually the same overall sound, or "voice," making them an excellent choice for use together in a home theater system. The timbre and dynamics of the Beethoven II and the Maestro were

much better matched than those of many competing speakers whose makers specifically claim good matching. The Beethoven II had enough deep bass power and definition to match an outstanding subwoofer like the REL Stentor II (which I reviewed in the April 1997 issue) and to deal with Dolby Digital and DTS soundtracks. The Mozarts did surprisingly well as surround speakers, projecting a broad sound field despite having just one tweeter apiece. For really good home theater, you need full-range surround speakers like the Mozarts, with response to well below 40 Hz and excellent dynamics throughout their frequency range. Using main and surround speakers that can reproduce deep bass well makes the sound far more exciting and natural than using smaller speakers that force you to funnel every channel's deep bass through a common subwoofer.

I greatly appreciated the Vienna speakers' superior dynamic performance. Many speakers can play loud, but few can play loud, fast, and accurately. You can hear far more soundtrack detail with speakers whose timbre and definition don't change when the level does. I was impressed with how well the Vienna Acoustics setup did relative to the Polk Audio Signature Reference Theater setup I compared it to. (I reviewed the SRT system in the September 1996 issue.) I was also struck by how well

**MANY SPEAKERS
CAN PLAY LOUD,
BUT FEW CAN PLAY
LOUD, FAST,
AND ACCURATELY.**

the Viennas reproduced different types of music and how well they blended into different listening rooms.

In the price ranges where the Vienna Beethoven Mk. II and Mozart compete, there are no world beaters. Instead of searching vainly for perfection, you must listen at length to find which speakers' design trade-offs are ones you can accept. I think you'll find that, although the Viennas may not sound exciting or different at first listening, they do sound right—and should sound increasingly right over time. **A**



The World's Most Popular Internet Online Service.

America Online. Easy to use. Friendly menus.

E-mail. News. Sports.

The entire Internet at your fingertips.

Call 1-800-827-6364



So easy to use, no wonder it's #1

Availability may be limited, especially during peak times.

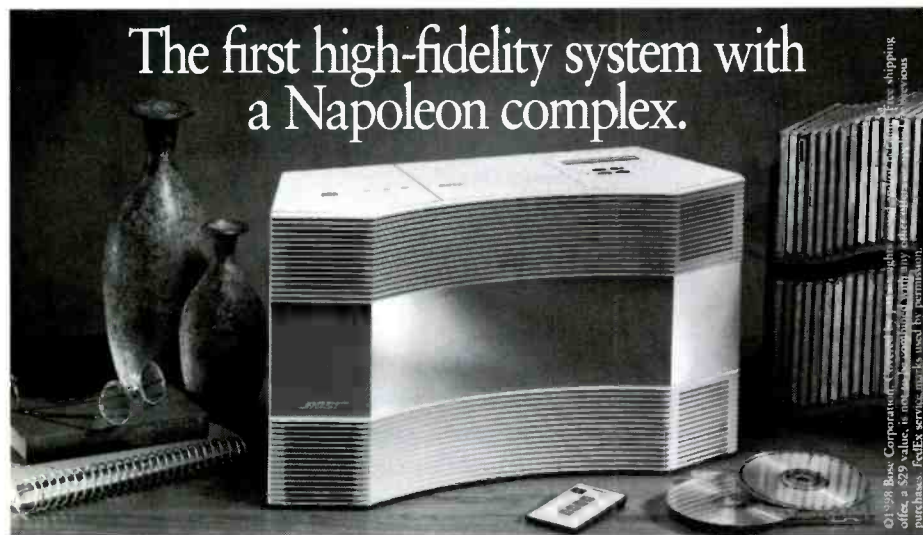

The first high-fidelity system with a Napoleon complex.

It may be small. But the Bose® Acoustic Wave® music system is definitely an overachiever. The unit features a compact disc player, an AM/FM radio, a handy remote control, and our patented acoustic waveguide speaker technology. And it produces a rich, natural sound quality comparable to audio systems costing thousands of dollars. We know that's hard to believe. So we're ready to prove it. Call or write now for our complimentary guide to this award-winning system. Because, like the system itself, it's available directly from Bose.

Call today. 1-800-897-BOSE, ext. A2782.

Mz/Mrs./Ms. _____ Telephone _____
Name (Please Print) _____
Address _____
City _____ State _____ Zip _____
Or mail to: Bose Corporation, Dept. CDD-A2782, The Mountain, Framingham, MA 01701-9168.
Ask about FedEx® delivery service.

For FREE
shipping, order by
June 30, 1998.

BOSE
Better sound through research®

©1998 Bose Corporation. Bose and Acoustic Wave are registered trademarks of Bose Corporation. Free shipping offer, a \$29 value, is not available with any other offers. Offer good on purchases. FedEx service mark used by permission.

CLASSICAL RECORDINGS

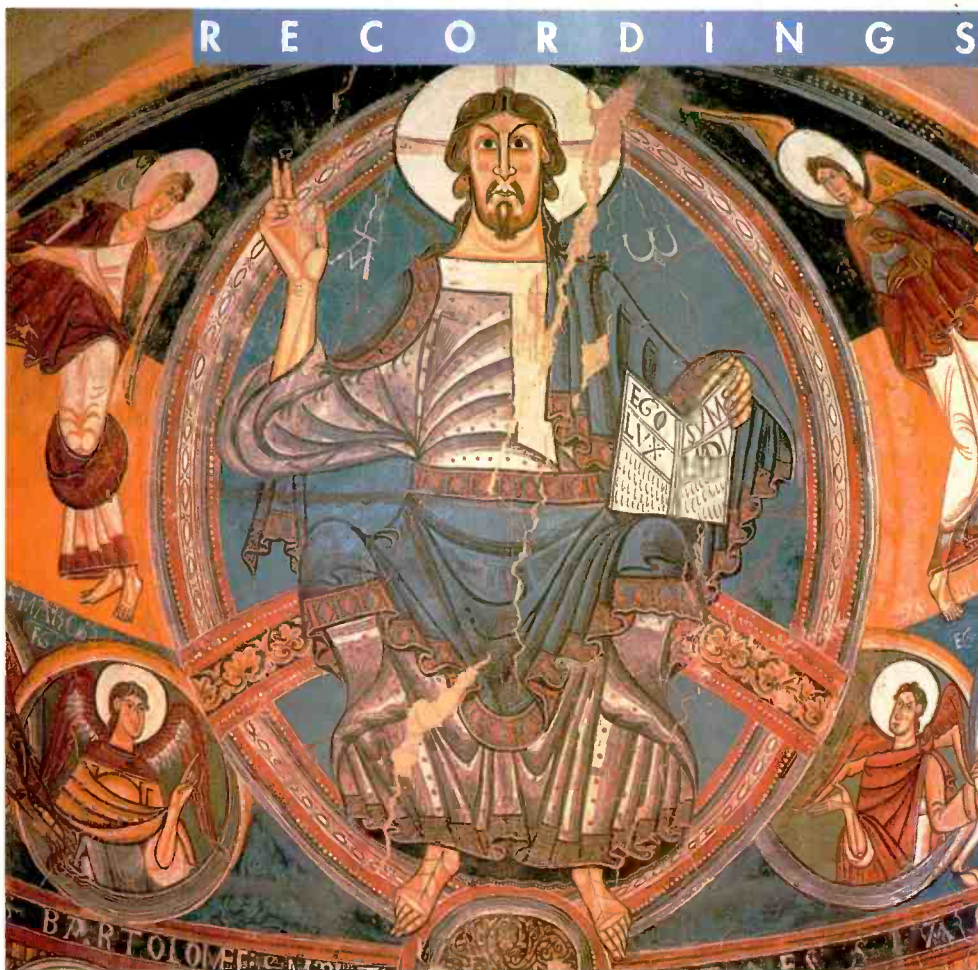

Photo: © Museo de Arte de Catalunya, Barcelona, Spain/SuperStock



Handel: *Messiah*

Dorothea Röschmann and Susan Gritton, sopranos; Bernarda Fink, contralto; Charles Daniels, tenor; Neal Davies, bass; Gabrieli Consort & Players, Paul McCreesh ARCHIVE 453 464; DDD; 2:12:19
Sound: A, Performance: A



Charles Jennens (1700-1773), the librettist for *Messiah*, was a devout Christian and, moreover, a fundamentalist who feared that church reforms of his day would eat away at basic Christian doctrine. It is no wonder, then, that in choosing texts for the oratorio to be composed by George Frideric Handel, he came up with words of affirmation and unhampered faith. These texts inspired Handel to compose some of his most emotional music.

Messiah does not exist in any one authentic version; Handel kept re-writing sections, often to accommodate a particular soloist or set of

soloists, sometimes in an apparent effort to improve them. (Here, Paul McCreesh basically uses the Foundling Hospital version of 1754.) After Handel's death, other changes were perpetrated by greater and lesser arrangers. Mozart provided a version better suited to the instrumentation of the classical period. More recently, an even larger-scaled version was credited to Eugene Goossens that obviously had some contribution from Thomas Beecham as well.

It became standard to assay Handel's masterpiece with choirs of 100+ singers and gigantic orchestras (including trombones and even percussion). In the mid-1960s, the English scholar Watkins Shaw came out with an edition that went back to Handel's original manuscripts, restoring much of his more modest intent. This was recorded, with modern instruments, by Robert Shaw for RCA and by Colin Davis for Philips, and

the race for the "authentic" *Messiah* began. Christopher Hogwood's baroque original-instrument version opened the floodgates, and in the two decades since, we've had notable original-instrument, baroque-scaled recordings from Andrew Parrott, Martin Pearlman, Trevor Pinnock, and William Christie.

As good as these have been, most have missed the dramatic element of *Messiah*. This piece is unusual in Handel's opera-inspired oratorio output because it doesn't have a specific plot or characters; it would be foolish to think that a composer of dramatic music would suddenly turn his back on the devices he had developed to convey human emotion and action.

Paul McCreesh's recording is proper in the same way as that of the other baroque forces. It uses a small chorus of about two dozen singers and an orchestra of just under 40 players that employs original instruments or facsimiles thereof. McCreesh also observes the period pen-

JOHANNES BRAHMS

Songs Ring Out to the Heavens: Choral Works by Brahms

Kansas City Chorale, Charles Bruffy
NIMBUS RECORDS NI 5524
DDD; 65:16
Sound: A, Performance: A

Topping the list of choral compositions by Johannes Brahms is his imposing German Requiem. But many of his other choral pieces show a great diversity of style and text. Compare the sophistication of the *Liebeslieder Waltzes* to the religious fervor of the *Two Motets*, Opus 29, or to the delicate texture of the *Four Songs*, Opus 17, which is scored for a choir of two sopranos and one alto accompanied by two horns and a harp. All of these delightful pieces are excellently performed by the Kansas City Chorale. Using a vocal ensemble of only 25 singers, conductor Charles Bruffy shapes a versatile sound that ranges from intimate to massive. At times you can imagine a cathedral setting, a concert hall setting, or even a sing-along party setting; all are achieved with precision and finesse. *Patrick Kavanaugh*

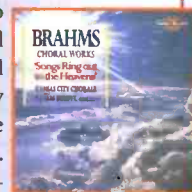

J&R MUSIC WORLD®

Receivers

JVC **75% OFF**
Mfr. Sug. Retail of \$799.95



JVC RX-880VBK
A/V Receiver
•120w x 2 or 100w x 4 •Dolby Pro Logic Surround •Multi-color on-screen display •Multi-brand A/V remote

\$199.99 (JVC RX880VBK)

Technics SA-EX110
•100 watts/channel, 30-AM/FM presets, A/V remote **\$149.99**

Technics SA-EX310
•Home Theater, 70w x 2 or 70w x 4, Dolby Pro Logic, 30-AM/30-FM presets, remote **\$179.99**

TEAC AG-V8600
•130w x 2 or 100w x 3 + 50w x 2, Dolby Pro Logic, 30-AM/30-FM presets, remote **\$249.99**

Harman Kardon AVR20 MKII
•A/V, 60w x 2 or 50w x 3 + 20w rear, low-impedance drive, Dolby Pro Logic **\$299.99**

HOME THEATER A/V COMPONENT SUPER SPECIALS

45% OFF
Mfr. Sug. Retail



Harman Kardon PA5800
5-Channel Home Theater Power Amplifier
•High-current design with 80 watts x 5 at 8 ohms (20Hz-20kHz); 110 watts x 5 at 4 ohms (20Hz-20kHz) •All-discrete output circuitry

\$549.99 Mfr. Sug. Retail \$999.00
(HK PA5800)

37% OFF
Mfr. Sug. Retail



Harman Kardon PT2500
Home Theater A/V Tuner-Controller
•Audio/video control center with Dolby Pro Logic, Dolby 3 Stereo, Theater & Hall modes •30-AM/FM presets •Harman Kardon system remote control

\$299.99 Mfr. Sug. Retail \$479.00
(HK PT2500)

Audiophile

PHILIPS CD RECORDER!



Philips CDR870
Compact Disc Recorder
•Record your own digital audio CDs •Use as a standard CD player •Will also record audio CD Re-Writable discs •Remote control

\$599.99 (PHI CDR870)

AudioSource AMP Two
•Power Amp, 80 watts/channel, switchable to 200 watts mono **\$299.99**

AudioSource AMP Three
•Power Amp, 150 watts/channel, switchable to 400 watts mono **\$399.99**

Dynaco PAS-4
•Vacuum Tube Preamp, MM phono preamp, 50% OFF Mfr. Sug. Retail (\$999) **\$499.99**

TEAC V-8030S
•3-heads, Dolby B/C/HX-Pro, quartz lock direct drive dual capstan drive, remote, 110/220v **\$699.99**

CD Players/Changers

JVC **69% OFF**
Mfr. Sug. Retail



JVC XLMC301
100 + 1 CD Auto Changer
•Rack-size controller with Plus One tray & CD playback/storage unit •Remote control

Mfr. Sug. Retail \$899.00

\$279.99 (JVC XLMC301)

TEAC CD-P1120
•16-track programming, headphone jack with volume control, remote control, 110/220v **\$99.99**

Sony CDP-CE215
•5-disc changer, play 1, exchange 4 feature jog dial, 32-track programming **\$139.99**

JVC XL-V282
•32-track programming, disc stabilizer, remote control **\$149.99**

Dynaco CDV-PRO
•HiDC Player with Vacuum tube output stage, 20-track programming, remote control **\$799.99**

Cassette Decks

TEAC



TEAC V-377
Stereo Cassette Deck
•Center-mounted transport •Dolby B noise reduction •1-touch recording •3-position tape selector •Peak-level meter •110/220 volts

\$69.99 (TEA V377)

JVC TDR462
•Auto-reverse, Dolby B & C, Dolby HX-Pro, fine bias control, cassette stabilizer **\$179.99**

JVC TD-W354
•Dual auto-reverse, Dolby B/C/HX-Pro, pitch control **\$179.99**

TEAC V-1050
•3-heads, Dolby B/C/HX-Pro, fine bias control, electronic tape counter **\$279.99**

TEAC W-6000R
•Dual auto-reverse record & play, Dolby B/C/HX-Pro, pitch control, remote **\$429.99**

Mini Systems

SONY **69% OFF**
Mfr. Sug. Retail of \$1299.95



Sony PMC-M2
MiniDisc/CD/AM/FM Micro Component Stereo System
•1-touch CD to MD duplication •AM/FM digital tuner •Digital bass boost •25 watts per channel •2-way speakers •Remote

\$499.99 (SON PMCM2)

Aiwa NSX-A22
•20 watts/channel, 3-disc CD changer, dual cassette, AM/FM, remote **\$199.99**

Panasonic SC-AK20
•30 watts/channel, 5-disc CD changer, dual auto-rev. cassette, AM/FM, remote **\$229.99**

Aiwa XR-MT100
•100w x 2 + 20w ch. & 20w rear, Dolby Pro Logic, 3-CD changer, dual A/R cassette **\$599.99**

Bose® Lifestyle® 3-II
•AM/FM, CD player, 2 tiny cube speakers + Acoustimass® bass module, remote **\$799.99**

Speakers

JBL **61% OFF**
Mfr. Sug. Retail of \$638.00



JBL LX500
3-Way Speakers
•8" woofer •5" midrange •1" titanium dome tweeter •10-150 watts suggested power range •8 ohms •Black cabinet

\$249.98/pr. (JBL LX500)

Bose® 201®-IV
•Direct/Reflecting®, 6" woofer, black or rosewood color cabinet pr. **\$198.00**

Advent JADE™
•Floorstanding, 2-way, 8" polypropylene woofer, dome tweeter, 10-125 watts, 8Ω, pr. **\$249.99**

JBL 4312BK
•Direct/Reflecting®, 8" woofer, black or rosewood grained cabinet pr. **\$499.99**

Bose® Acoustimass® 7
•Home Theater Speakers, Acoustimass® bass module + 3 cube arrays **\$599.00**

Sony Digital Technology

SONY



Sony INT-W200
WebTV™ Internet Terminal
•Integrates Internet & TV programming with built-in cable-compatible tuner •High-speed 56Kbps modem •Remote control

\$199.99 (SON INTW200)

Sony MDS-JE510
•MiniDisc Home Recorder, up to 10-sec. shock-resistant memory, remote **\$299.99**

Sony MDS-S38
•MiniDisc Recorder, 10-sec. shock resistant memory jog dial, 25-track programming **\$299.99**

Sony SAS-AD3
•Digital Satellite System, compact 18" design, 10-event timer, joystick remote **CALL**

Sony MDBUNDLE4
•Home MiniDisc Recorder & a portable player, includes 2 blank discs **CALL**

Turntables/Cartridge

THORENS **3 SPEEDS**



Thorens TD180
3-Speed Belt Drive Turntable
•33, 45, 78 r.p.m. •Automatic shut-off & auto-retract •Synchronous motor •External power supply •Includes phono cartridge

\$299.99 (THN 180)

Aiwa PX-E850
•Mini Size Turntable, built-in phono preamp, belt-drive, includes cartridge **\$119.99**

Thorens TD280 MK IV
•Turntable, belt-drive, 33/45, auto shut-off, includes Stanton cartridge **\$369.99**

Technics SL-1200II
•Turntable, Professional Manual, direct-drive, quartz clock, pitch control **\$479.99**

Audio Technica AT-ML150
•Audiophile Phono Cartridge, standard-mount, MicroLine® stylus **\$229.99**

Audio/Video Add-Ons

TERK



Terk AM-FMQ
Powered FM Indoor/Outdoor Antenna
•Selectable modes •Wideband enhances all radio broadcasts •Narrow band locks in on precise frequencies to minimize noise & interference

\$79.99 (TRK AMFMQ)

Standesign SSB
•Omnidirectional Speaker Brackets, for wall or ceiling-mount speakers (to 13 lbs. each) pr. **\$29.99**

One-For-All URC-8090
•Universal IR/RF Remote, replaces 8 devices, works through walls **\$79.99**

Terk TV25
•Amplified TV Antenna, local/distant mode switch, adjustable gain **\$69.99**

Plateau Z4A
•Audio Rack, high-tech ergonomic design, 4 shelves, all metal, black **\$159.99**

Hi-Fi Stereo VCRs

JVC



JVC HM-DSR100
D-VHS Digital Satellite Recorder
•Records an image of identical quality to digital satellite broadcasts •MPEG2 •Dolby Digital output •Plays/records standard VHS tapes •18" satellite dish

CALL (JVC HMDSR100DU)

Samsung VR8607
•4 heads, Quick start mechanism, digital auto tracking, real-time counter, remote control **\$149.99**

Panasonic PV-8450
•4 heads, trilingual on-screen display, auto clock set, TV/cable box universal remote **\$169.99**

JVC HRJ640
•Precision 19 micron heads, Shuttle Plus, VHS Digital Line Circuitry, Shuttle Plus on remote **\$199.99**

JVC HR-VP638
•VHS Hi-Fi Stereo, 4-heads, VCR Plus+ with cable box controller, jog/shuttle control **\$259.99**

DVD

Panasonic



Panasonic DVD-A300
Deluxe DVD Player with Built-in Dolby Digital Decoder (AC-3) & Karaoke Functions
•Plays DVDs, video CDs, & audio CDs •Joystick universal remote

\$549.99 (PAN DVD A300)

Panasonic DVD-A100
•Plays DVDs, video & audio CDs, includes remote control **\$429.99**

JVC XV-1000BK
•Plays DVDs, video & audio CDs, on-screen Graphical User Interface, remote **\$449.99**

JVC XV-D2000BK
•Plays DVDs, video & audio CDs, Dolby Digital (AC-3) decoder built-in, remote control **\$599.99**

Toshiba SD-3107
•Plays DVDs, video & audio CDs, 5.1 ch. Dolby Digital Surround Sound, Specializer™ 3D **\$599.99**

Music

RCA VICTOR



James Galway
Greatest Hits, vol. 3
\$12.99 CD

Yo-Yo Ma:
Bach: The Cello Suites 2-Cds **\$23.98**
SDN 63203

Renee Fleming: The Beautiful Voice
LON 458858 CD **\$11.99**

Gidon Kremer: From My Home
TLD 14654 CD **\$11.99**

Sarah Chang: Sibelius & Mendelssohn Violin Concertos
ANG 56418 CD **\$11.99**

CALL TO ORDER MUSIC REVIEWED IN THIS ISSUE!

CALL US TOLL FREE FOR ITEMS NOT LISTED IN THIS AD **SE HABLA ESPANOL**

SEND MONEY ORDER, CERTIFIED OR CASHIER'S CHECK, MASTERCARD, VISA, AMERICAN EXPRESS OR DISCOVER CARD (include Interbank No., expiration date & signature) To: J&R Music World, 59-50 Queens Midtown Expwy, Maspeth, Queens, NY 11378. Personal & business checks must clear our Authorization Center before processing. Shipping, handling & Insurance Charge (Continental US) is 5% of the total order with a \$4.95 minimum for orders up to \$500; 4% for orders over \$500 to \$1000; 3% for orders over \$1000 to \$1500; 2% for orders over \$1500 to \$2000; 1% for orders over \$2000. For heavyweight/over-sized items, shipment by air, or to Canada, Hawaii, Alaska, Virgin Islands & Puerto Rico please call for information. DO NOT SEND CASH. Sorry, no C.O.D.'s. NY residents please add sales tax. ORDERS SUBJECT TO VERIFICATION & ACCEPTANCE. NOT RESPONSIBLE FOR TYPOGRAPHICAL OR PICTORIAL ERRORS. ALL MERCHANDISE SHIPPED BRAND NEW, FACTORY FRESH & 100% GUARANTEED. Some quantities may be limited. Copyright 1998 J&R Music World.
City of N.Y. Dept. of Consumer Affairs License Nos. 0900310/0900615/0900616/0900617

Visit **J&R MUSIC WORLD** at 31 Park Row, NY, NY
Shop By Phone or to order a FREE CATALOGUE
24 Hours A Day, 7 Days A Week
1-800-221-8180

Order Code AU804 

chant for large numbers of double reeds, with four oboes balancing 14 violins and four bassoons enriching the sound of three cellos and two double basses during tuttis. He employs horns doubling trumpets and gives the tympani a lot to do in the "Hallelujah" and "Worthy Is the Lamb" choruses. Interpreted ornamentation is correctly and amply applied, and tempos are brisk and incisive but never rushed. Going a step further, McCreesh and his forces set forth the text in a dramatic manner that sometimes made me feel like I was hearing the piece for the first time.

Neal Davies, the best bass singer I've ever heard in this work, displays a ghostly tone at the beginning of "The People Who Walked in Darkness" and produces resplendent open tones as the text dictates "upon them the Light hath shined." The chorus adopts a derisive "crowd" tone for "He trusted in God," the tenor really "dashes" those disbelievers, the contralto holds Christ to the most vile spitting ever from those smiters, the final "amens" peal as church bells, and so forth. At every turn there seems to be deeper meaning or color applied to a familiar text often taken for granted.

Davies is not the only stellar soloist in the lineup. McCreesh uses an alternative soprano version of "But Who May Abide," which gives Susan Gritton an opportunity to bring "Queen of the Night" virtuosity and presence to the proceedings. Who, indeed, would dare? The other soloists have wonderful moments as well, although soprano Dorothea Röschmann seems a bit over her head in "Rejoice Greatly."

The recorded sound is detailed yet warm, tending to a bit of congestion only in the very loudest moments.

All in all, this is not just a magnificent performance of the familiar work but a new insight and statement. *Rad Bennett*

Wind Visions:

The Music of Samuel Adler

Keystone Wind Ensemble, Jack Stamp
CITADEL/KLAVIER 88120; DDD; 69:41
Sound: A-, Performance: B

Klavier, one of the few companies since Mercury to have an ongoing commitment to band and wind ensemble repertory, boasts not one, but two wind ensemble series. One, conducted by Eugene Corporon, is on its own label, and the other, helmed by bandmaster Jack Stamp, is on Citadel, which Klavier distributes. This CD, from the latter distinguished series, is devoted entirely to the prolific American composer Samuel Adler. The music is diverse, ranging from the folk-tinged "Southwestern Sketches" to the driving Stravinskian dissonance of the latter portion of "A Little Night and Day Music." *The Force of Credulity* is an arrangement for bands from the first

CLAUDE DEBUSSY

Debussy: Études

Louis-Philippe Pelletier, piano
MUSICA VIVA MVCD1107; DDD; 72:02
Sound: A, Performance: A+

B



esides being a superb composer, Claude Debussy was an outstanding pianist. But he never quite accepted the fact that a piano's sound is made by hammers striking tightly stretched metal strings and sought a more fluid, less percussive sound. Yet his innovative style created an interesting problem: In his own public performances, his audiences could barely hear him.

Debussy's novel compositional talent produced some very difficult and esoteric music for later generations of keyboard artists. His well-known Études are prominent examples. Although he wrote the two books of Études in 1915, as he endured both the heartache of World War I and the physical pain of spreading cancer, they display a great deal of joy, exhilaration, and, at times, even humor (the

opening movement, for instance, cleverly mocks the infamous exercises of Carl Czerny). These Études may occasionally allude to Chopin's (Debussy dedicated his to the Polish composer), but a mature impressionistic stamp is heard in every movement.

Perhaps because of the somewhat pedagogical title, too many pianists look upon the Études as technical showpieces. Fortunately, Louis-Philippe Pelletier approaches them as music, playing them with the same emotional enthusiasm as he does the other works here. Indeed, his interpretation of "L'isle Joyeuse" has an almost reckless abandon that is electrifying.

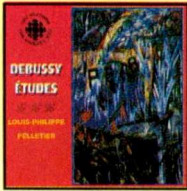
The Musica Viva recording perfectly captures delicate *pppp* passages without allowing low-register fortissimos to overwhelm us. A good example is the opening movement of Estampes ("Pagodes"), which is so convincing that one imagines a Javanese gamelan ensemble rather than a piano. This recording brings out the true nature of Debussy's piano works, in all their diverse shades of color. *Patrick Kavanaugh*

American opera, written in 1767. Its thoroughly consonant harmonies seem to catch the players of the professional-sounding Keystone Wind Ensemble by surprise. Throughout the more recent works, the ensemble plays with great assurance. The recorded sound is revealing and awesome; the percussion section is captured with uncanny realism, and all the woodwind and brass balances seem just right. *Rad Bennett*

The Art of the Toy Piano

Margaret Leng Tan,
toy piano and other instruments
POINT MUSIC 456 345; 48:47
Sound: A+, Performance: A

John Cage's Suite for Toy Piano, written in 1948, was the first serious composition for the toy piano. This instrument's gamelan-like bell sonorities intrigued him, as later they did pianist Margaret Leng Tan—dubbed "the diva of avant-garde pianism" by *The New Yorker*. She searched out a high-quality toy piano on which to demonstrate in recital what she calls the "off-key poignancy" of the instrument's unique sound. (She now owns nine of them.)

Leng Tan's composer friends, fascinated with this "new" sound, began writing pieces for the toy piano. Soon there were enough for her to record an entire album. The Cage suite is not among the dozen tracks here, but the delightfully varied fare includes originals by Toby Twining, David Lang, Julia Wolfe, Stephen Montague, and accordionist Guy Klucevsek. There are also a few unexpected transcriptions, such as the Adagio from the "Moonlight" Sonata, a Gymnopédie by Satie, and The Beatles' "Eleanor Rigby."

What you won't find is a maddening sameness of sound. The use of the toy piano as well as a number of other melodic/harmonic instruments (including standard piano, toy accordion, and melodica), the addition of various noisemakers on some tracks (whistles, cap guns, and percussion), and the selection of wildly contrasting pieces contribute to this fascinating and satisfying program.

The direct-to-two-track recording nicely captures the extreme high frequencies, preserving the delicate overtones generated by plastic hammers striking tiny metal bars. It makes a fine and welcome contrast to bass demo material. *John Sunier*

George® AND UNIVERSAL PICTURES

INVITE YOU AND A GUEST TO A SPECIAL ADVANCE SCREENING

Pick up your
tickets by
March 16, 1998
at the following
locations*:

BOSTON

Filene's
426 Washington Street
Extreme Polo Sport
Ralph Lauren
The New Men's
Fragrance

PHILADELPHIA

Boyd's Philadelphia
1818 Chestnut Street
Canali Department

Louis Vuitton
King of Prussia Plaza
King of Prussia

LOS ANGELES

Robinson's - May
Glendale Galleria
Glendale
Extreme Polo Sport
Ralph Lauren
The New Men's Fragrance

JOHN TRAVOLTA
EMMA THOMPSON

A MIKE NICHOLS FILM

**PRIMARY
COLORS**

BILLY BOB THORNTON ADRIAN LESTER MAURA TIERNEY PAUL GUILFOYLE LARRY HAGMAN KATHY BATES

UNIVERSAL PICTURES AND MUTUAL FILM COMPANY PRESENT AN ICARUS PRODUCTION JOHN TRAVOLTA EMMA THOMPSON "PRIMARY COLORS" BILLY BOB THORNTON
ADRIAN LESTER MAURA TIERNEY PAUL GUILFOYLE LARRY HAGMAN AND KATHY BATES MUSIC BY COOPER COSTUME DESIGNER ANN ROTH EDITOR ARTHUR SCHMIDT PRODUCTION DESIGNER BO WELCH
EXECUTIVE PRODUCERS NEIL MACHLIS JONATHAN KRANE BASED ON THE NOVEL BY ANONYMOUS SCREENPLAY BY ELAINE MAY
DIRECTOR OF PHOTOGRAPHY MICHAEL BALLHAUS, A.S.C. PRODUCED AND DIRECTED BY MIKE NICHOLS A UNIVERSAL RELEASE

R RESTRICTED
UNDER 17 REQUIRES ACCOMPANYING
PARENT OR ADULT GUARDIAN

COMING IN MARCH

www.primary-colors.com

* Offer available
February 24, 1998.
While supplies last.

ROCK ~ POP RECORDINGS

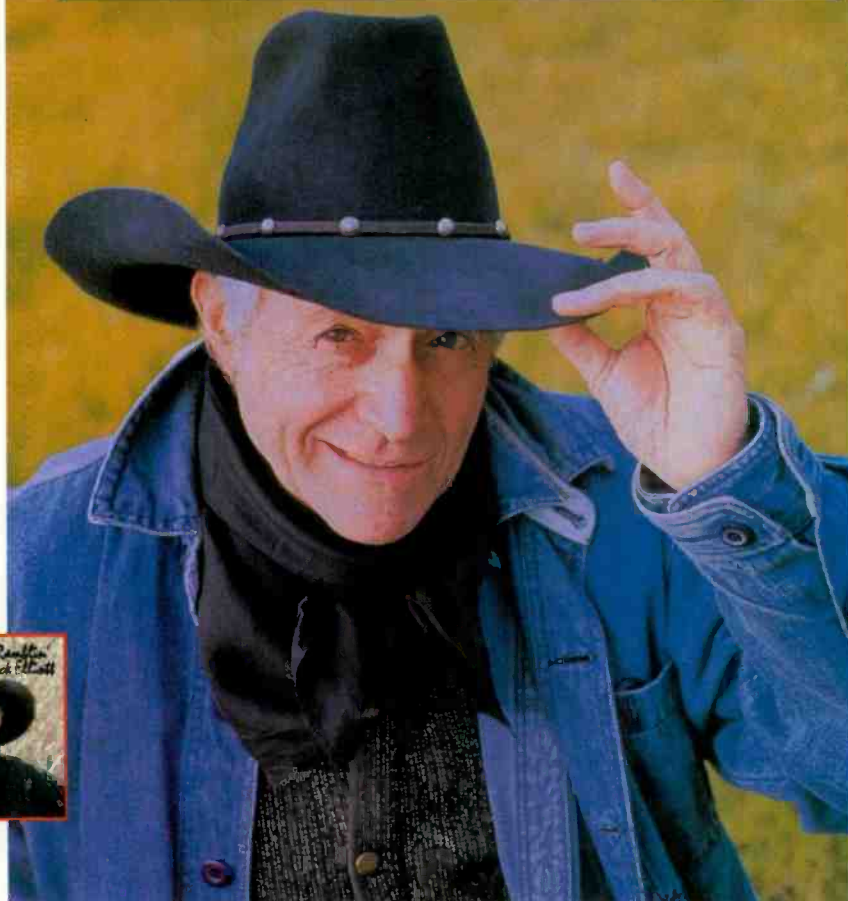

Photo: Chris Felver



Friends of Mine
Ramblin' Jack Elliott
 HIGHTONE RECORDS
 HCD 8089, 48:50
 Sound: B, Performance: A-

In the rusty chain of folk singers linking Woody Guthrie to Bob Dylan, Ramblin' Jack Elliott lies about midway, not early enough to be anointed an "influence," not late enough to steal much wind from Dylan's sail. Having played folk, cowboy country, and acoustic blues since the '40s—he even helped popularize Guthrie himself in the '60s with an album of Woody's songs—Elliott's main claim to folk music fame has been his eye-bulging longevity. Today, at 67, one of the best storytellers around continues his search for a way to stay faithful to the folk foundations he helped lay yet be relevant to the world of contemporary acoustic music.

One way to straddle that fence is to invite some well-known friends over to your place for a recording session. Heck, you amble through the tumbleweed-strewn folk and country scenes for nearly five decades, and you're bound to find a friend or two, right? So Elliott made a few phone calls, and cronies like Tom Waits, Guy Clark, Emmylou Harris, Bob Weir, John Prine, Arlo Guthrie, Peter Rowan, Rosalie Sorrels, Jerry Jeff Walker, and Nanci Griffith moseyed on down to his place. Set that talent to songs by Joe Ely ("Me & Billy the Kid"), Tim Hardin ("Reason To Believe"), Merle Travis ("Dark As a Dungeon"), and Gene Autry ("Ridin' Down the Canyon"), among others, and you've got the stuff for a mythical folk album.

Of the baker's dozen tunes here, only two are new. In "Louise," written by Waits specifically for this album, he and Elliott sidle up to a

grand folk ballad dotted with an accordion and slide guitar. And "Bleeker Street Blues" is a spoken-word thing Elliott wrote for Dylan after hearing about his friend's recent life-threatening illness.

No, you couldn't build a new folk movement around Elliott's rickety henhouse of a voice, nor could you hang one on the aging timbres of Clark or Walker. But there's a great deal of charm in the oaken rasp of these performers, and the esprit de corps spills from each song. Alongside angelic warblers Harris and Griffith, Elliott sounds thuggish crooning Townes Van Zandt's soul-stirring ballad "Rex's Blues." And, of course, beside the steely throated Prine on Dylan's "Walls of Red Wing," Elliott sounds like an old bleater whose best time has already past. But if *Friends of Mine* doesn't exactly shine in terms of pure performance, it will most certainly live on in the folk album pantheon as a passionate gathering of some of our generation's greatest folk and roots talents.

Bob Gulla

CELTIC CRYSTAL

Dean Shostak, glass armonica;
Jacqueline Schwab, piano;
Sue Richards, Celtic harp;
Ulysses Kirksey, cello
 DEAN SHOSTAK DS-0121
 DDD, 48:28
 Sound: A, Performance: A

Benjamin Franklin believed that the glass armonica (his invention) was the ideal instrument on which to play Scottish folk tunes. Dean Shostak and friends prove his judgment correct, offering Scottish traditional tunes as well as many Celtic favorites on this enchanting album. The eerie, somewhat ghostly sound of the glass armonica, punctuated by harp and piano, creates a timeless sound that gently transports you to a peaceful past. (Available from Dean Shostak, P.O. Box 465, Williamsburg, Va. 23187; phone, 800/588-3326; fax, 804/642-1452.)

Rad Bennett



• Buena Vista Social Club •

Buena Vista Social Club
WORLD CIRCUIT/
NONESUCH 79478, 60:09
Sound: A-, Performance: A+

Perhaps no other nation in the world has as rich a musical heritage as Cuba. From rumba to danzón to trova, the island air is saturated with danceable, singable sounds. American guitarist Ry Cooder knew all that when he ferried over to play and record with Buena Vista Social Club, a loose agglomeration of musicians of modest reknown, which has, in a quiet way, helped preserve the deeply funky music known as *son de Cuba*.

Because of its casual approach, every moment of *Buena Vista Social Club* comes across as pure musical pleasure. Cooder is joined by a long list of prominent island players, including major Cuban composers and musicians Ibrahim Ferrer, Compay



Segundo, and Rubén González. The album feels like a Folkways historical document, but it sounds more like a good-time fiesta.

This is a trove of sparkling Cuban jewels. "Chan Chan," the opening peasant ode, features guitar giant Eliades Ochoa on lead. His half-jubilant, half-melancholy guitar (bolstered by Cooder's) is wide-open and sounds positively heart-warming. "El Cuarto de Tula," an extended Cuban-style jam, also features Ochoa, this time flanked by Ferrer and "Puntillita" Licea on vocals. "Dos Gardenias," a prototype of the bolero style, hinges on Ferrer's passionate voice and "Guajiro" Mirabal's devastating trumpet.

No matter where your laser lands on this disc, you'll hear a brilliant example of energetic and passionate Cubanismo. Because of that passion and Cooder's open-mindedness, *Buena Vista Social Club* is, hands-down, one of the best World Music discs of recent memory. *Bob Gulla*

So Much for the Afterglow

Everclear

CAPITOL CDP 72438 36503, 48:49
Sound: B, Performance: B+

Songwriter Art Alexakis has been called an opportunist, a mimic, a martyr, and a hero; more than anything else, however, Everclear's frontman is a realist. After the band's grungy *Sparkle and Fade* rocketed up the pop charts in 1995, Alexakis was showered with praise, cash, and fan mail, but, through it all, his cynical nature remained intact. On this new album, *So Much for the Afterglow*, that may be changing. Much of the distorted fury of *Sparkle and Fade* is absent from *Afterglow*, to attain a listener-friendly sheen that some have associated with Alexakis's pre-punk hero Tom Petty. Everclear also makes its music more dynamic by experimenting with a variety of sounds, including alt-country banjo twang, layered samples, braying horns, and clanging cowbell.



Whether Everclear churns up a storm of noise or unravels strings of sticky pop confection, it does so with joyous abandon. As a result, songs about abandonment ("Father of Mine"), shameless ass-kissing ("Everyone to Everyone"), and mental illness ("Normal Like You") are ultimately uplifting instead of bleak or enervating. Yet even when the

music sounds triumphant, a bit of underlying angst seeps through, thanks largely to Alexakis's raw, raspy drawl.

So Much for the Afterglow may not be the mainstream hit that *Sparkle and Fade* was for Everclear, but it's far more eclectic and satisfying. It's also more confessional, exposing the machinations of an artist who's proud to be passionate, pain-stricken, and iconoclastic. *Jon Weiderhorn*

FAST TRACKS

Those Were the Days: Cream (Polydor/Chronicles 31453 9000, four CDs, 5:05:48). This package contains all of Cream's studio work, live albums, and unreleased demos. The original power trio's blues material and "hits" stand the test of time, while much of the rest is dated art rock. Peaks and valleys, with the earliest album, *Fresh Cream*, still the strongest. *Jon Tiven*

Roni Size/Reprazent: *New Forms* (Mercury 136, two CDs, 2:13:52). Last year, Roni Size snatched England's coveted Mercury Music Prize from commercial favorites Prodigy and The Chemical Brothers. Now the Bristol sensation is poised to break live drums and upright bass to the masses in music that fuses electronic and hip-hop with jazz and soul. It's as funky as classic James Brown and destined to be a cornerstone of the next decade's music. *Chris Gill*

STOP!

Before you buy any pro gear, call for our

FREE 84 page catalog!



Looking For the Latest in DJ, Recording or Lighting Gear?

The Pro Sound & Stage Lighting catalog brings you all the hottest gear and makes it easy to compare the equipment feature for feature. You'll



find what you're looking for at the guaranteed lowest price. Even better, you can call our

friendly pro staff 7 days a week with any of your questions. Plus, you'll usually get your order shipped within 24 hours. So what are you waiting for? Call to get you free copy in the mail today!



PRO SOUND & STAGE LIGHTING™

1-800-672-4268

Outside the U.S.A. 1-714-891-5914

Mon.- Fri. 6am - 8pm

Sat. & Sun. 8am - 5pm (PST Call Times)

Online Catalog - www.pssl.com

Fax Toll Free 1-888-PSSL-FAX (777-5329)

11711 Monarch St.,
Garden Grove, California 92841

JAZZ ~ BLUES

RECORDINGS



Illustration: Marina Sagona



Sanctuary

Dave Douglas

AVANT 066, two CDs; 1:52:45

Sound: A, Performance: A+

Stargazer

Dave Douglas

ARABESQUE JAZZ AJ0132, 60:31

Sound: A, Performance: A



Since making his first recording in 1986 at the age of 22, trumpeter Dave Douglas has received a lot of attention. He's been playing in various avant-garde jazz ensembles in New York, leading some of them, but he's best known for his work in saxophonist John Zorn's Masada. Last fall saw the release of two Douglas studio recordings, *Sanctuary* and *Stargazer*. They are vastly different in concept: *Sanctuary*, according to Douglas's notes, was inspired by the music of John Coltrane, Ornette Coleman, Pierre Boulez, and Arnold

Schoenberg as well as pre-Renaissance Florentine literature and architecture; *Stargazer* is a tribute to saxophonist/composer Wayne Shorter.

Sanctuary consists of two hour-long parts that progress with the development and abandonment of composed themes, tempos, and solo space. The ensemble is a variation on Ornette Coleman's double quartet, and Douglas also enlists a pair of sampler manipulators, Yuka Honda and Anthony Coleman. In the album's mix, these two trios are split-channelled—one issuing from the left speaker, the other from the right. Mixed in the center are Dougie Bowne (drums) and Chris Speed (tenor saxophone and clarinet).

Sanctuary develops as if following a dramatic storyline, with the musicians improvising through aleatoric sections to predetermined moments. These moments are often marked by the introduction of themes or sampled beats and textures. Take the way "Part one" negotiates one of its first turns: Douglas's dynamic solo ex-

hausts itself into a soft bleating and is then overcome by Coleman violently churning out a rhythmic sucking sound. Coleman's plunger serves as a noisy transition into a hard-hitting hip-hop backbeat sequenced by Honda. The beat is given some time to establish its dominance before Cuong Vu and Douglas loosely tag a noirish series of long, contoured phrases over it. The trumpets then suddenly drop out to reveal Speed's demure tenor—sometimes flowing freely, sometimes intentionally struggling—naked over the programmed beat.

Music of the moment, *Sanctuary* could not have existed 30, 10, or even five years ago. Less momentous, but

CANTO

Charles Lloyd

ECM 1635 78118-21635, 65:18

Sound: A, Performance: A-

Hardly a review is ever written about saxophonist Charles Lloyd without mentioning his kinship to John Coltrane—both sonic and spiritual. But whereas Coltrane's sound became more brittle and strident with time, Lloyd's has become exceedingly lush and haunting. His tenor is engagingly warm yet thoroughly expressive, boasting one of the most colorful timbres in jazz today.

On *Canto*, Lloyd is joined by pianist Bobo Stensen, bassist Anders Jormin, and drummer Billy Hart, and the rhythm section's interplay creates a feeling of utter buoyancy, easily accessed by the lilting saxophonist. Lloyd gravitates toward more assertive Eastern-sounding fare on several cuts and even performs on Tibetan oboe with positive results, but ethereal lyricism is the quartet's strongest attribute. The high level of musicianship, combined with a beautifully recorded concert hall ambience, find Lloyd's fifth ECM release a truly introspective listening experience.

James Rozzi



still an excellent jazz record, is *Stargazer*. Joined by Speed, trombonist Joshua Roseman, pianist Uri Caine, bassist James Genus, and drummer Joey Baron, Douglas plays three Wayne Shorter compositions from different eras—"Pug Nose" (1959), "Diana" (1974), and "On the Milky Way Express" (1995)—and six compositions he wrote in tribute to the saxophonist. Although Douglas occasionally mimics Shorter's phrasing and tone, the main idea is to evoke Shorter through composition: his strongly accented bass ostinato that propels "Spring Ahead," the horns drifting through open space on "Stargazer," the sense of beauty gently awakening. How appropriate that one of two recordings moving Dave Douglas from behind John Zorn's shadow pays tribute to a musician many still think of as a sideman.

R. Dante Sawyer

The Heart of Things

John McLaughlin

VERVE 314 539 153, 47:20

Sound: B, Performance: A

In "Acid Jazz," the opening track of the fine album *The Heart of Things*, John McLaughlin manipulates mood through metric superimposition. It's become something of a trademark for McLaughlin, who, as far back as Mahavishnu Orchestra's 1972 *Birds of Fire*, arranged odd meters with the dazzle of a fleet-fingered Indian tabla player. And although the Indian influence in his mind-boggling guitar solos can still be heard, his music has become airier and more refined, if no less passionate. *The Heart of Things* finds McLaughlin back in blistering fusion form with a band capable of pushing him to soaring, if brief, heights of improvisation.

One of only six songs on the album, "Acid Jazz" begins with jazz-lite meandering, then sinks into a funky, furious groove courtesy of drummer Dennis Chambers. The odd-metered pulse boils over a darting be-boppish melody, then suddenly drops back into a slower, humid feel as tenorman Gary Thomas unfurls a concise solo. The song careens between these two time feels, eventually climaxing in a thunderous duel between McLaughlin and Chambers. *The Heart of Things'* best moments come from such involved metric sleights of hand and from McLaughlin's dizzying guitar explosions.

"Seven Sisters" is another tongue twister in time, over which McLaughlin and Thomas engage each other like battling warlords. "Mr. D.C." refers to Chambers, of course, and is a showcase for the drummer's astounding chops, which embellish his bedrock feel for any rhythm McLaughlin throws his way. The wist-

ful "When Love Is Far Away" closes the album. McLaughlin is on acoustic guitar, his notes ringing with remarkable grace and power.

The Heart of Things seems a throwaway title, but the music proves John McLaughlin hasn't lost his touch. With his crack band and expressive tunes, fusion is no longer a dirty word.

Ken Micallef

Thoughts of Dar Es Salaam

Horace Tapscott

ARABESQUE JAZZ AJ 0128, 59:48

Sound: A, Performance: A

Pianist Horace Tapscott has a long-standing penchant for changing time signatures and textures within a single song or theme. On *Thoughts of Dar Es Salaam*, however, he explores only one time signature per tune, while his love of textures—of creating feeling where none would have been discovered by lesser pianists—remains very much intact.

On his original "Bibi Mkuu: The Great Black Lady," Tapscott teases the supporting line, weaving his solos in and out of Ray Drummond's jumping, blues-heavy bass line and drummer Billy Hart's ferocious time-keeping. On "Willetta's Walk," it is the conversation between piano and bass that drives the tune forward, while Hart answers Tapscott's deceptively simple melody with an equally soulful and lighthearted solo.

Tapscott takes the familiar melodies of standards like Gigi Gryce's "Social Call" and Charlie Parker's "Now's the Time" and reinterprets them with a fluid subtlety that may take one by surprise. On the title track, Tapscott lets his fingers imagine the secrets yet unearthed in the Tanzanian port city; one can feel his absorption in the riches of a still mysterious continent.



Marie Elsie St. Léger

FAST TRACK

Cuba: I Am Time: Various Artists (Blue Jackyl BJAC 5010, four CDs, 4:31:29). Here's a comprehensive box (cigar box, no less) of CDs that examine the history of Afro-Cuban music as it evolved on Cuba (as opposed to other Caribbean islands on which slavery existed). Included are examples of Afro-Cuban music's roots, from rumba and son styles that evolved after slavery was abolished through the current, jazz-influenced progenitors of Afro-Cuban. Spread across four CDs, *Cuba: I Am Time* is a fascinating and quite enjoyable study. (Available from Blue Jackyl, 322 Hicksville Rd., Bethpage, N.Y. 11714.)

Mike Bieber

come see us on the

IMALL

SHOP SOUND CITY ON-LINE

www.soundcity.com

Shop for the best names in audio, video, car stereo and home theater on the web! Pages and pages of information and hundreds of products to order directly on-line. It's safe and easy from your home or office 24 hours a day, 7 days a week! If you don't see what you're looking for on-line, call us at 1-800-542-7283

CD STORAGE CONNECTION

For advertising information call

1-800-445-6066
(9am-5pm EST)

or Fax 1-212-767-5624

For subscriptions inquiries call

1-303-604-1464

Modular		Tabletop
stackable		Rail Rack
oak units		Component Rack
hold all		Drawers
recording		Dolly
formats & components		

America's best disc, tape and component storage system

Free mail-order brochure
(please mention Audio)

Per Madsen Design (415) 822-4883
P.O. Box 88246+, San Francisco, CA 94188

The Shelving Shaped By Your Needs.

Archetype System® features modular elements that you combine and, as needs change, reconfigure. Shelves are rigid, neoprene isolators damp vibration, and solid steel threaded support posts provide infinite vertical adjustability. Options include acoustic mounting spikes, large-capacity drawer, bookends and section-bridging shelves. In solid hardwood or fiberboard. Call or fax for our free color brochure.

Salamander Designs Ltd.

800.206.5658 Fax: 860.313.0526

Visit our web site: www.mander.com

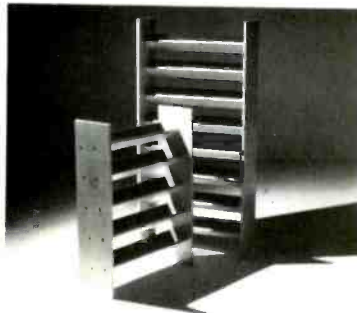
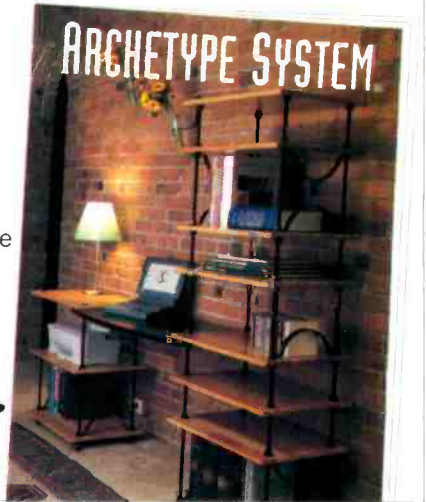

STORADISC™ - See why CD Review picked our Library Series as their "top choice". Fine-furniture quality in a variety of finishes and sizes. Call or write DAVIDSON-WHITEHALL, 555 Whitehall Street, Atlanta, GA 30303. 1-800-848-9811.

Classified Advertisers...

Millions of your prime prospects can be found in the industry leading titles of *Hachette Filipacchi Magazines, Inc.*

To place a classified ad, simply call *toll-free* and reserve your space today!

1-800-445-6066

(9am - 5pm EST)

or

Fax your order to 212-767-5624

BILLY BAGS

AUDIO/VIDEO FURNITURE DESIGN

"We'll even design a piece to your exact specifications!"

TOP QUALITY



ANY SIZE • ANY PLACE



#BB 4803
2-Bay Component Center



HOLDS 1000 CD's
500 or 2000



#Media Raxx
Entertainment Center/Waves
Holds up to a 40" TV



#PRO-34
Custom Audio Racks

Our **CUSTOM** design department is fast and affordable. We also offer over 100 stock designs of unequalled quality. And contact us today for a copy of our detailed newsletter **THE BAGS REPORT**, now **IN COLOR**.

And for your local dealer
805/644-2185

4147-A Transport St. Ventura, California 93003
Fax: 805/644-0434
E-mail: billy@billybags.com
www.billybags.com

The Ultimate STORAGE CABINET



Made in U.S.A. Stores 306 CD's or any combination of CD's, DVD's, CD-ROM, VHS, Cassettes, etc.

The Cube
by Lorentz Design

- Featuring our patented ALLSTOP STORAGE SYSTEM, no slots, no plastic molds, no wasted space • Full-extension drawer slides • From high quality oak veneers and hardwood
- 23" H x 19 1/2" W x 17 1/2" D • Fully assembled • Stackable •

to order or for a free, color brochure
Call **800-933-0403**

LDI, Inc. • P.O. Box 277 • Lanesboro, MN 55949
Fax: 507-467-2468 • Or e-mail us your brochure request at lorentz@polaristel.net

The AUDIO CD STORAGE CONNECTION

puts manufacturers of CD storage units in touch with the ideal audience... CD purchasers unsurpassed in size, buying activity & the need for storage of their ever-growing CD collections!

For advertising information call:
1-800-445-6066
(Monday-Friday, 9-5 EST)
or Fax 212-767-5624

NEW SERIES B

MODULAR HARDWOOD CABINET SYSTEM



PROVIDES UNLIMITED STORAGE FOR CDs, DVDs, VIDEOS, LPS, LASERDISCS, CASSETTES & COMPONENTS.

DOESN'T YOUR COLLECTION DESERVE THE BEST? FIND OUT JUST HOW AFFORDABLE TOP QUALITY IS. REQUEST INFO KIT 1 & GET ALL THE FACTS...

CALL: 800-432-8005
FAX: 973-667-8688
E-MAIL: SORICEAV@AOL.COM

SORICÉ
PO BOX 747-1A, NUTLEY, NJ 07110
[HTTP://WWW.SORICE.COM](http://www.SORICE.COM)

DEALER SHOWCASE

CALIFORNIA

Components that
define the
PRESENT

Systems that
anticipate the
Future

Reference

AudioVideo

(800) 947-4434
(310) 517-1700 so. cal.
(310) 517-1732 fax

Expert Advice
Courteous Service
Competitive Prices

18214 Dalton Ave., Dept. A
Gardena, CA 90248
e-mail: rav2000@aol.com

Visit our web site:
www.reference-av.com

ADA	CITATION	MAGNUM DYNALAB	SONANCE
ATLANTIC TECH.	CREEK	MERIDIAN	SONY
AUDIOEASE	DCM	MIRAGE	SPECTRON
AUDIBLE ILLUSIONS	DENON	MITSUBISHI	STRAIGHTWIRE
AUDIO CONTROL	FANFARE	NAD	TARGET
AUDIO POWER	GRADO	NESTOROVIC	THORENS
AUDIOQUEST	HAFLER	NILES	TICE
BAG END	HARMAN KARDON	NISSA	TOSHIBA
BALANCED AUDIO	INFINITY	ONKYO	TOWNSHEND
BRISTON	JAMO	PIONEER ELITE	TRIAD
CAL AUDIO LABS	JBL SYNTHESIS	PROAC	VON SCHWEIKERT
CARDAS	KEF	PSB	VPI
CARVER	KIMBER KABLE	ROOMTUNE	WIREWORLD
CARY	LINN	SHARP	XLO
CELESTION	LUTRON	SME	... and more

ILLINOIS

ELECTRIFY
YOUR LISTENING EXPERIENCE

FOR YOUR FREE CATALOG
CALL 1-800
AUDIO-HI
(1-800-283-4644)

LEGACY
A·U·D·I·O

3021 SANGAMON AVE.
SPRINGFIELD, IL 62702

NEW JERSEY

Avalon Audio Video

Reasonable, High-End Equipment for
Music, Home Theater, Surround Systems

Robert Trollinger, Jr.
Rt. 541, Medford, New Jersey

Personalized Service & In-Home Setup

Acurus	Millennium
Amfi	Mirage M Series
Angstrom	MSB
Aragon	N.E.A.R.
Aragon Palladium	Parasound
B&K	Seleco
Bryston	StraightWire
Chiro & Kinergetics	Sunfire
Da-Lite	Target
Hologram	Toshiba
Lexicon	Tributaries
Meadowlark	Velodyne

And More...

Tel/Fax: 609-654-7752 www.avalonav.com

ILLINOIS

HOLM AUDIO

HOME OF THE BITT
Audio - Video - Products

SERVING THE CHICAGOLAND AUDIOPHILE

AcousTech Phono	Electrocomplanet	Monitor Audio	Sovtek
Alon	Ensemble	Montana Speakers	Spectron
Apogee	G&D Transforms	M&A	Sunfire
ATI	Gold Aero	Muse	Synergistic Research
Audio Alchemy	Golden String	NAD	Tannoy
Audio Magic	Golden Tube	Nordost Flatline	Target
Audio Note	Gradient	Pink Triangle	TDL
Audio Prism	Grado	Pope Music	Thor Audio
Audioquest	Jolida	PS Audio	Thorens
Bedini	Joseph Audio	QED	Timbre
Black Diamond Racing	Joule Electro	Reference Recordings	Toshiba
By-Beel/Curl	JPS	Rego	Townshend
Comelot	JVC Discs	Rogers	TPC
Cory	Kusma	Roomtunes	Unity Audio
CEC	Lightspeed	Salamander Designs	Ultech Audio
Chesky	Lovan	Sanus	Ultrasystems
Chiro	Magnum	Sennheiser	Unison
Classic Records	May Audio	Sheffield	Vampire
Contour	MBL	Shure	van den Hul
Discovery	McCormack	Signature Audio	Von Schweikert Spkrs
Dadson Audio	Melos	Solid Steel	VPI
Dynadiao	Meridian	Sonic Integrity	VTL
Ear Max	Mesa Baron	Sonoran Cables	Wilson Benesch
Elac	Mobile Fidelity	Soto	

TRADE INS WELCOME

Ask About Our 1-Year/100% Trade Up Policy!

450 Ogden Avenue

Uster, IL 60532

Phone: (630) 663-1298

Fax: (630) 663-1198

CUSTOM HOME INSTALLATION AVAILABLE!!!

IOWA

hawkeye audio video

www.hawkeyeaudio.com

Acurus	Marantz
Audioquest	McCormack
B & K	Mitsubishi
Balanced Audio Tech.	Niles
Black Diamond Racing	Onkyo
Carver	Paradigm
Chang Lightspeed	Paradigm Reference
Conrad Johnson	Rega
Definitive Technology	Sanus
Grado	Snell
Jolida	Sumiko
JMLab	Tara Labs
Lovan	Yamaha

(319) 337-4878

401 S. Gilbert St. Iowa City, IA 52240

6322 University Ave. Cedar Falls, IA 50613

NEW YORK

AUDIO VIDEO CREATIONS

"HOOKED ON SONICS"

AMPRO	MITSUBISHI
ANGSTROM	NHT
ANTHEM	NILES
APOGEE	ONKYO
BASIS	PIONEER ELITE
B&K	PSB
BELL'OGGETTI	SONANCE
CONRAD JOHNSON	SONY
DWIN	SONIC FRONTIERS
FAROUDJA	STRAIGHTWIRE
HARMON/KARDON	STEWART
JBL	SUNFIRE
KRELL	TRANSPARENT
MARTIN-LOGAN	TRIAD
MAGNUM DYNALAB	VPI
MIRAGE	XLO

AND MORE:

999 NORTHERN BLVD.
MANHASSET, NY 11030

Phone 516-365-4434 • Fax 516-365-6285

MASSACHUSETTS

The Best Values In Hi End Hi-Fi.

audio studio

Authorized sales and service for:
Audible Illusions, Audioquest, B&K,
Beyerdynamic, Counterpoint, Dual,
Klyne, Maplenoll, Marantz, Mirage,
Mission, Monster Cable, Morel,
NAD, Nakamichi, Oideion Products,
Ortofon, Project, Proton, QUAD,
Renaissance Audio, Revox,
Sennheiser, SME, Shure, Stax,
Straight Wire, Sumiko, Thorens,
Velodyne, VPI, and many more.

414 Harvard St., Brookline, MA 02146

(617) 277-0111

FAX (617) 277-2415

INTERNATIONAL BUSINESS ACCEPTED

NEW YORK

SHOP US LAST

FACTORY AUTHORIZED DEALERS

HOME THEATER

SINCE 1979
ADS • ALPINE • ATLANTIC TECH
BOSE • CARVER • DENON • INFINITY
KENWOOD • NAKAMICHI
ONKYO • SONANCE • SONY ES
VELODYNE • YAMAHA
and many we can't print!

CAR STEREO

The Sound Approach

6067 Jericho Tpke., Commack, NY 11725

800-368-2344

FULL FACTORY WARRANTY

*IN-STORE WARRANTY

DEALER SHOWCASE

PENNSYLVANIA

AUDIOLAB STEREO CENTER

492 Lincoln Highway Fairless Hills, Pa 19030

800-513-8555 We are conveniently located just minutes from Philadelphia and NJ.

Factory Authorized

Celebrating 40 YEARS

We now proudly offer Lovan

Get the point

M-F 10-9
Sat 11-7
Sun 12-5

*No Mail Orders on these items.

ADCOM
ARCAM
AUDIOLAB
AUDIOQUEST
AUDIOTRUTH
AYRE
B&K
B&W*
BOSTON
CARVER
CREEK
EPOS
FRIED
FAROUDJA
HK
INFINITY
JAMO
JBL
JM LAB
JOLIDA
LEXICON

M&K
MARANTZ
MONSTER "M"
NAD
NAKAMICHI
NHT
ONKYO
ORTOFON
PANAMAX
PARASOUND
PLATEAU
POLK
PSB
ROTEL*
SHARPVISION
SOLID*
SPENDOR
SUNFIRE*
TANNOY
VANDERSTEEN
YAMAHA*

PENNSYLVANIA

VIDEO PLUS AUDIO

490 2nd Street Pike, Southampton, PA 18966

If you don't see what you're looking for, please call

SPEAKERS & SUBS **AUDIO COMPONENTS**



HOME THEATER PACKAGES

Acoustic Research
Atlantic Technology
Bose, Canon
harman/kardon
Jamo, JBL,
JVC, Kenwood,
Monster Cable, NAD
Sony, Toshiba, Infinity
and much more!

or call us for door to door delivery

800-226-6784

http://www.videoplusaudio.com
email: DTLVPA@aol.com

PLEASE NOTE: It is impossible for us to verify all of the claims of advertisers, including product availability and existence of warranties. To confirm that an advertiser is authorized to sell a product, we suggest you contact the manufacturer directly. Please review our *Tips for Mail Order Purchasers* in this section.

FOR SALE

AUTHORIZED

AUDIO UNLIMITED

Authorized dealer for: ACCUPHASE, Acoustic Energy, Acrotec, Aesthotix, AIR TIGHT, Audio Artistry, AudioCraft, AudioNote, Avalon, Basis, Benz-Micro, Cary, Chang, Charlo, CODA, Continuum, DaySequerra, Dynavector, Ensemble, Graaf, Graham, High Wire, Kuzma, Magnum Dynalab, Merel, Micro-Seiki, Morch, MUSE, Musical Design, Music Metre, Odeon, Onix, Oracle, Rega, Samahdi Acoustics, Spondor, Symphonic Line, Systemdek, TANNOY, Totem Transfiguration, VanDenHul, Wheaton, YBA, XLO, Zoethecus, and more.....Call, Write or Fax for more information. John Barnes @ Audio Unlimited, 2341 Weest Yale Ave Englewood, Co, 80110. Phone/Fax 303-691-3407. Visa and Mastercard Accepted.

TEXAS

AUDIO BY DESIGN

MAKE US AN OFFER... WE DELIVER!

- | | |
|--------------|-----------------|
| Acurus | Onkyo |
| Aragon | Paradigm |
| AudioQuest | Platinum Audio |
| Bryston | Quicksilver |
| CAL Audio | Rega |
| Citation | Ruark |
| CLASSE Audio | Synergistics |
| Condor | Sonic Frontiers |
| Creek | Stand Design |
| Denon | Threshold |
| Epos | Von Schweikert |
| Jolida | VPI |
| Kimber | Wharfedale |
| Mirage | |
| Niles | |

FACTORY AUTHORIZED
3-DAY FEDEX SHIPPING

(800) 285-5884

911 W. Anderson Ln. #116
Austin, TX 78757

WISCONSIN

the Happy Medium

www.HappyMedium.com

- | | |
|-----------------------|-----------------------|
| • ARCHITECTURAL AUDIO | • FIELD RECORDERS |
| • DAT | • DSS |
| • MINIDISC | • SONY DST |
| • WORLD BAND RADIO | • CUSTOM INSTALLATION |
| • PRO WALKMAN | • HOME THEATER |
| • CABLES | • ACCESSORIES |
-
- | | |
|-----------------------|-----------------|
| • ADS | • NAD |
| • AMC | • NAKAMICHI |
| • ATLANTIC TECHNOLOGY | • NILES AUDIO |
| • BANG & OLUFSEN | • ONKYO |
| • CARVER | • PANAMAX |
| • CELESTION | • POLK AUDIO |
| • GRADO | • PSB SPEAKERS |
| • HARMAN KARDON | • SANUS SYSTEMS |
| • JVC | • SUNFIRE |
| • KEF | • SONY ES |
| • LEXICON | • TARGET |
| • MONSTER CABLE | • THORENS |

430 State Street • Madison, WI 53703 • FAX 1(608) 255-4425

1-800-906 HI-FI (4434)

VIRGINIA

THE BEST IN HOME GROWN AUDIO

With over 20 years of experience in hi-end audio equipment, we proudly inventory the following products:

- | | |
|------------------|-----------|
| ◆ Quad | ◆ Spondor |
| ◆ Accuphase | ◆ Kora |
| ◆ OCM | ◆ Kimber |
| ◆ Magnum Dynalab | ◆ B&K |
| ◆ Cardas | ◆ Acrotec |
| ◆ Clayton | ◆ YBA |
| ◆ Von Schweikert | ◆ Alon |
| ◆ Joule Electra | ◆ Creek |

We have a huge assortment of accessories and many more brands to choose from. We also offer a large inventory of used equipment.

Call For Information Toll Free:

1-800-752-4018



Hi-Fi Farm

616 Plaza, Suite 5, Moneta, VA, 24121

Or Order On Line At:

<http://www.hififarm.com>

AV ELECTRONICS
HOME THEATER - DVD

800-359-8200
AUTHORIZED DEALER
FOR EVERY COMPONENT SOLD!

1585 ROUTE 46 EAST, LITTLE FALLS, NJ 07424
TEL: 973 256-1122 • FAX: 973 256-5388
www.avielectronics.com

OUR 22ND YEAR! CALL 1 (800) 826-0520. ★
NAD ★ SONY ES ★ ONKYO ★ CARVER ★
KEF ★ HARMAN KARDON ★ LEXICON ★ AD-
COM ★ NAKAMICHI ★ AMC ★ POLK AUDIO
★ SUNFIRE ★ ATLANTIC TECHNOLOGY ★
PROAC ★ TARGET ★ VELODYNE ★ PSB ★
PANAMAX ★ MONSTER CABLE ★ JAMO ★
GRADO ★ AUDIOCONTROL ★ CELESTION
★ THORENS ★ SANUS SYSTEMS ★ NILES
AUDIO ★ OMNIMOUNT ★ SOUNDSTREAM
★ ROCKFORD FOSGATE ★ SOUND SELLER,
BOX 224, 2808 CAHILL, MARINETTE, WI
54143-0224.

AUDIOPHILE & SCHOLAR

UNIVERSITY AUDIO SHOP, MADISON, WI
AUDIO RESEARCH, KRELL, Linn, YBA, Aragon, Acurus,
B&K, MARTIN LOGAN, VANDERSTEEN, NHT, PARA-
DIGM, Spica, Hales, Totem, Von Schweikert, Aniel, Creek,
EAD, Micromega, CAL, Golden Tube, Tara, Lexicon & Thiel.
(608) 284-0001.

FOR SALE

ENJOY JITTER-FREE MUSIC! The UTP-1 and the UCD-1 combine improved sound with new cosmetic appeal. Our Basic Player and the Reference One transport have made BOUND FOR SOUND'S Components of Merit list. Low jitter kits still available. G&D TRANSFORMS, (602) 650-1155. E-mail: Transforms@aol.com

SATURDAY AUDIO EXCHANGE—
Chicago's source for discontinued,
demo, used & new home audio equip-
ment for 15 years. For information call
773-935-U-S-E-D or see our online cata-
log at <http://saturdayaudio.com>

AUDIO/VIDEO DEALS

www.leshoppe.com

1-800-988-7929

We bring our shop and expertise to your door.

TIPS FOR MAIL ORDER PURCHASERS

It is impossible for us to verify all of the claims of advertisers, including product availability and existence of warranties. Therefore, the following information is provided for your protection.

1. Confirm price and merchandise information with the seller, including brand, model, color or finish, accessories and rebates included in the price.
2. Understand the seller's return and refund-policy, including the allowable return period, who pays the postage for returned merchandise, and whether there is any "restocking" charge.
3. Understand the product's warranty. Is there a manufacturer's warranty, and if so, is it from a U.S. or foreign manufacturer? Note that many manufacturers assert that, even if the product comes with a U.S. manufacturer's warranty card, if you purchase from an unauthorized dealer, you are not covered by the manufacturer's warranty. If in doubt, contact the manufacturer directly. In addition to, or instead of, the manufacturer's warranty, the seller may offer its own warranty. In either case, what is covered by warranty, how long is the warranty period, where will the product be serviced, what do you have to do, and will the product be repaired or replaced? You may want to receive a copy of the written warranty before placing your order.
4. Keep a copy of all transactions, including cancelled checks, receipts and correspondence. If you pay by credit card, you may have a greater recourse in the event the advertiser does not perform. (Check the complaint procedures of your credit card companies). For phone orders, make a note of the order including merchandise ordered, price, order date, expected delivery date and salesperson's name.
5. If the merchandise is not shipped within the promised time or if no time was promised, 30 days of receipt of the order, you generally have the right to cancel the order and get a refund.
6. Merchandise substitution without your express prior consent is not allowed.
7. If you have a problem with your order or the merchandise, write a letter to the seller with all the pertinent information and keep a copy.
8. If you are unable to obtain satisfaction from the seller, contact the consumer protection agency in the seller's state or your local Post Office.

If, after following the above guidelines, you experience a problem with a mail order advertiser that you are unable to resolve, please let us know. WRITE to Susan Ross, Special Marketing, 45th floor, Hachette Filipacchi Magazines, 1633 Broadway, NY, NY 10019. Be sure to include copies of all correspondence.

FOR SALE

FRIENDLY PEOPLE, EXPERT ADVICE, AND THE LOWEST PRICES!

ABC
American Buyer's Club Int.
1-800-354-1324
FAX your order: 908-294-7480
VISIT OUR WEBSITE
WWW.ABCSTEREO.COM

RECEIVERS		SPEAKERS	
YAMAHA		KRUX	
RX-V992	AC-3	EQUINOX	AWARD WINNER
RX-V1092	CALL	APEX	TOWER
HARMONIKARDON		PSB	
AVR85 MK II	CALL	STRATUS GOLD	CALL
AVR25 MK II	439	STRATUS MINI	NEW
DENON		CAMBER	
AVR3200	CALL	LASER and T1 SERIES	CALL
AVR3600	AC-3	ATLANTIC TECHNOLOGY	
AVR5600	THX	SYSTEM 350 THX	IN STOCK
SEPARATES		BOSE	
NAD		AM 10	
218 THX	AMP	AM 7 II	LOWEST PRICE
PARASOUND		MIRAGE	
P/SP-1000	PRO-LOGIC	MANY MODELS	CALL
HCA 1206	AMP	BIC	
CINEPRO		TOP RATED	
3K6	350W x 6	BIG SCREEN	
600x2	849	AUTHORIZED	
CARVER		TOSHIBA	
AV-705X	CALL	DEALER	
DVD PLAYERS		SONY	
PIONEER		MITSUBISHI	
DVL700	CALL	CALL	
SONY		SUBWOOFERS	
DVP-S7000	AC-3	VELODYNE	
SDJ006	CALL	FSR-12	LOWEST
BOSE		KLIPSCH	
SONY		KSW 200	
DYNACO		MIRAGE	
YAMAHA		BPS 150	
PIONEER		IN STOCK	
Velodyne		For info & customer service call	
		908-780-6600	

MILLION DOLLAR INVENTORY
5 YEAR WARRANTIES AVAILABLE ON ALL PRODUCTS
ABC 130 Highway 33 • Englishtown, NJ 07726
All products are new, USA merchandise covered by the manufacturer's warranty or ABC's exclusive limited warranty. MEMBER OF THE BETTER BUSINESS BUREAU

STEVE'S CONSIGNMENT SHOP
HI FI FARM AND STEVE'S AUDIO ADVICE NOW OFFERS CONSIGNMENT OPPORTUNITIES FOR THE USED AUDIO MARKET. TOP DOLLAR OFFERED. CALL FOR INFORMATION. NEW EQUIPMENT ALSO. CALL 1-800-752-4018.

Buy-Sell-Trade

All brands of
High End Audio Since 1979
AUDIO CLASSICS

Limited
FREE condensed catalog!
8AM-5PM ET Monday-Friday
Phone/Fax
607-766-3501
www.audioclassics.com
3501 Old Vestal Rd.
Vestal, NY 13850

HI FI EXCHANGE. Large selection of quality USED highend components at huge discounts. We buy, sell & trade. Call for inventory list. (718) 423-0400 or visit our showrooms at 251-11 Northern Blvd, Little Neck, NY 11363.

HIGH END SUBWOOFER AMPS, ALUMINUM-CONE DRIVERS, MORE for DIYers, OEMS, dealers. Free info. Burnett Associates. (603) 924-2383. FDTF77B@prodigy.com.

FOR TWENTY-FIVE YEARS WE HAVE BEEN THE SOURCE FOR ALL OF YOUR BLANK AUDIO/VIDEO TAPES AND ACCESSORIES, EVEN REEL-TO-REEL TAPES FOR STUDIOS, AT DISCOUNTED PRICES. CATALOG AVAILABLE. SOUND INVESTMENT CORPORATION, 3586 PIERCE DRIVE, CHAMBLEE, GA 30341. (800) 659-TAPE (8273), IN GA (770) 458-1679. FAX: (770) 458-0276.

FOR SALE

MUSICAL CONCEPTS SIGNATURE
Signatures mods have arrived with HyperFast diodes, BlackGate caps. Add HyperFasts and BlackGates to any component! Signature updates available for previous mods! Specialized mods for Adcom, Audio Alchemy, B&K, Dyna (tubes too!) and Hafler! NEW!!! Single-Ended PA-3 front end board for Hafler amps—unbelievable sound! Signature CD Players are ready! Highly regarded CDT-4 Transport \$795. Marantz, Rotel, Pioneer CD mods. Musical Concepts, 5749 Westwood Dr., St. Charles, MO 63304. 314-447-0040.

USED & DEMO HIGH-END & HOME THEATER EQUIPMENT AT UNBELIEVABLE SAVINGS! CALL OR E-MAIL OR FAX FOR YOUR FREE CATALOG—VOICE/FAX: 609-799-9664. E-MAIL: Savant@SavantAudio.com WWW.SavantAudio.com

FREE SHIPPING!
FRIENDLY ADVICE! MIRAGE, KEF, PARASOUND, KINERGETICS, NAD, AUDIOQUEST, KIMBER, STRAIGHTWIRE, MORE!! READ BROTHERS, 593 KING, CHARLESTON, SC 29403. (803) 723-7276. RBScharleston.net

AUDIO CONNECTION
NEW JERSEY'S BEST SELECTION
BEST SOUND AT THE SHOW FOR LESS THAN \$50,000!
• Vandersteen • Rotel • Wadia
• B and W • Sonic Frontiers • Cary
• Proac • Audible Illusions • Arcam
• Kimber Kable • AudioQuest • Audiolab
• Cardas • Quicksilver • Ayre
* No mailorder: B&W, Rotel
615 Bloomfield Avenue, Verona New Jersey 07044
Phone (973) 239-1799 • Fax: (973) 239-1725
<http://www.audiocconnect.com>

ATTENTION: S.A.E.—G.A.S.—SUMO OWNERS! Original designer is now offering a Modernization Program. Why pay today's megabuck prices? Consider the alternative. **JAMES BONGIORNO: (805) 963-1122.**

FINALLY... A software package developed for the audio/video enthusiast to design, organize and account for the complete home entertainment investment. **Introducing Home entertainment Organization and Management System—HOMeS!** (W 95 CD). Profile home theater & music systems, movie & music libraries, computer/game systems & software, vehicle after-market audio systems and much more. Includes hardware and software databases. Creates wiring diagrams to help organize and add to your existing systems or to assist with designing a system from the ground up. Data import capabilities and many standard reports. Order HOMeS today at 1-888-554-HOMS(4667). Introductory priced at \$149.95 + S/H. Major credit cards accepted For more information check out our web site at **www.g-fakt.com**

FOR ADVERTISING INFORMATION CALL 1-800-445-6066, 9AM-5PM EST. CLASSIFIED ADVERTISING

FOR SALE

WHOLESALE CONNECTION

To order call: **1-800-226-2800**
www.wholesaleconnection.com

Receivers	Mini Systems
JVC RX662.....CALL RX882.....CALL RX992.....CALL	AIWA NSXA30.....CALL NSXA50.....CALL NSXA75.....CALL NSXA92.....CALL NSXMT70.....CALL NSXMT90.....CALL XRMT0.....CALL XRMT30A.....CALL XRMT100.....CALL ZVM27.....CALL
TECHNICS SAAX710.....CALL SAAX910.....CALL SHAC300.....CALL	JVC FS1000.....CALL FS2000.....CALL EXT05.....CALL EXT07.....CALL RX0761.....CALL
PIONEER VXK49.....CALL VXK0506.....CALL VXK59.....CALL VXK0606.....CALL VXK79.....CALL VXK0906.....CALL	PANASONIC SCAK20.....CALL SCAK90.....CALL
KENWOOD 1070VR.....CALL 1080VR.....CALL 1090VR.....CALL KR9900.....CALL	Dat Recorders Portable & Home.....Call
HARMAN/KARDON AVR40.....CALL AVR55.....CALL AVR75.....CALL AVR85.....CALL	Mini Disc Recorders Portable & Home.....Call
ONKYO TXSV535.....CALL TXDS838.....CALL TXSV636.....CALL TXDS939.....CALL	Home Speakers
CARVER HTR880.....CALL AV705X.....CALL	JBL HLS810.....CALL HLS810.....CALL HLS820.....CALL ESC550.....CALL SCS15.....CALL SCS120.....CALL
CD Players	INFINITY RS2000.1.....CALL SM65.....CALL RS2000.2.....CALL SM85.....CALL RS2000.3.....CALL SM105.....CALL RS2000.4.....CALL SM115.....CALL RS2000.5.....CALL SM125.....CALL RS2000.6.....CALL SM155.....CALL MINUETTE.....CALL DUTRIGGER.....CALL
PIONEER PDF79.....CALL PDF908.....CALL PDF59.....CALL PDF908.....CALL	BIC V504.....CALL V5231.....CALL V509.....CALL V5231.....CALL V802.....CALL ADATTO.....CALL
KENWOOD 1070CD.....CALL 1060CD.....CALL ONKYO DXC330.....CALL DXC530.....CALL	BOSE 201.....CALL 151BK.....CALL 301.....CALL 100.....CALL
HARMAN/KARDON FL8300.....CALL FL8450.....CALL	Powered Subwoofers
TECHNICS SLP887.....CALL SLMC400.....CALL	INFINITY BU1.....CALL BU2.....CALL INFINITY VIC.....CALL V1000R.....CALL VIC.....CALL V1200R.....CALL
SONY CDPCX200.....CALL CDPCX250.....CALL	MTX PS12.....CALL PS15.....CALL SONY SAW101.....CALL TSW40.....CALL AIWA TSW50.....CALL
Tape Decks	Center Channels
JVC TDV562.....CALL TDV562.....CALL JVC TDW718.....CALL TDW718.....CALL HARMAN/KARDON...DC520.....CALL PIONEER...CTW606.....CALL PIONEER...CTW616.....CALL TECHNICS...RSTR575.....CALL SONY...TWE605.....CALL SONY...TWE605.....CALL ONKYO...TARW909.....CALL	INFINITY VIDE01.....CALL INFINITY SMVIDE0.....CALL BIC V52CLR.....CALL BIC V62CLR.....CALL
DVD Players	Car Stereo
PIONEER...DV500.....CALL PIONEER...DVL700.....CALL TOSHIBA...SD2107.....CALL TOSHIBA...SD3107.....CALL PANASONIC...DVA100.....CALL PANASONIC...DVA300.....CALL PIONEER LASER...CLDD406.....CALL PIONEER LASER...CLD59.....CALL	PIONEER KEHP414.....CALL DEHS8.....CALL KEHP515.....CALL DEH68.....CALL KEHP818.....CALL DEHS90H.....CALL COXFM629.....CALL DEHP85.....CALL COXFM1227.....CALL DEHP85.....CALL DPS900.....CALL COXFP925.....CALL
DSS All Brands-Call	PANASONIC CDDP6550.....CALL CDDP995.....CALL
Camcorders	SONY XRC450.....CALL COXC460.....CALL XRC550.....CALL COXC860.....CALL COX50RF.....CALL MOXC670.....CALL COX705.....CALL
JVC GRAXM25.....CALL GRAX920.....CALL GROVM1.....CALL	JVC KSRT420.....CALL KOGS720.....CALL KSRT520.....CALL KOGS920.....CALL KDMK68RF.....CALL KDMK88.....CALL
PANASONIC PVL857.....CALL PVL657.....CALL PVDV710.....CALL	KENWOOD KRC703.....CALL KDC6005.....CALL KRC903.....CALL KDC7005.....CALL KOCC604.....CALL KDC8005.....CALL
CANON ES4000.....CALL ES6000.....CALL OPTURA.....CALL	Radar Detectors
Portable CD'S	BEL 9451.....CALL 850ST1.....CALL 855ST1.....CALL
SONY D368.....CALL D465.....CALL D368.....CALL D307CK.....CALL	WHISTLER 1565WH.....CALL 1575WH.....CALL
KENWOOD DPC671.....CALL DPC971.....CALL	UNIDEN LRD6499.....CALL LRD6599.....CALL LRD2200.....CALL
PANASONIC SLS321C.....CALL SLS651C.....CALL	Telephones
	SONY SPPH910.....CALL SPPM920.....CALL SPPS960.....CALL
	PANASONIC KKTCC902.....CALL KKTCC912.....CALL KKTCC942.....CALL KKTCC942.....CALL KKTCS970.....CALL KKTCS940.....CALL FT986.....CALL TOSHIBA FT8006.....CALL

Call for Brands & Models Not Listed
 24 HR. Fax (516)564-9593 PO's Welcome
 We accept MC, Visa, Amex, Discover & COD We ship FEDEX
 WHOLESALE CONNECTION 361 Charles St. West Hempstead, NY 11552

AUDIO CABLES & MORE



DON'T PAY EXORBITANT PRICES ! FOR TOP QUALITY !

We have equated the high priced brands. Sonic equivalents at a fraction of their cost. We demystify wire technology. Ask for literature.

AND MORE: Audio/Video Components, DDS and other Home Theater Components, Speakers (Component stands, Accessories - & MORE

Call 800 321 2108 24 hrs/day for free catalog

L A T INTERNATIONAL
 Dept. A 317 Provincetown Road
 Cherry Hill, NJ 08034

FOR SALE

SAVE 40% ON HIGH-END home speakers, subwoofers, amplifiers. FREE CATALOG, 3023 E. Sangamon Ave., Springfield, IL 62702. 1-800-283-4644.

AUDIO BY VAN ALSTINE FET-VALVE hybrid tube and Omega III active feedback preamplifiers, amplifiers, DACs, inverters, more, achieve dynamic liquidity, stunning clarity, rugged durability through precision engineering. Plus economical AVA kit or wired circuits for classic Dynaco and Hafler chasis attain ultimate musical faithfulness. Free illustrated catalog! Audio by Van Alstine, 2202 River Hills Drive, Burnsville, MN 55337. (612)890-3517. Fax: (612) 894-3657. info@avahifi.com http://www.avahifi.com/

LOUDSPEAKERS

Read about the famous NEWFOAM™ D.I.Y. Speaker Repair process in "Stereo Review" June 1996

Standard and Deluxe NEWFOAM™ kits available • www.NEWFOAM.com

1-800-NEW-FOAM

Satisfaction Guaranteed or your money back • Worldwide Speaker Repair since 1979

NEWFOAM™ • 3047 West Henrietta Road • Rochester, NY 14623-9531 USA
 voice (716) 424-3680 fax (716) 427-9337 video (716) 427-9277

"New Foam's price was half of what I had paid previously. I recommend the company highly." David Adler, "Audio Magazine" February 1997
 "It (NEW FOAM™) looks like a good value and a darn good idea." Dr. Allan Powell, Host "Tech Talk" radio program KAMU FM Texas A & M University

Phone Toll Free 1-800-NEW-FOAM 1-800-639-3626	FAX Toll Free 1-800-2FX-FOAM 1-800-239-3626
---	---

Global 800 Phone
+ 800 4NEW-FOAM
+ 800 463 9-3626

Se Habla Español
e mail NEWFOAM@msn.com



\$499/PR JBL 4312C(BK), \$799/PR JBL 4312MKII
 MONITORS NEW! USED BY 70% OF RECORDING STUDIOS FOR MIXING AND EVALUATION. 12db X-OVER NETWORK, 3-WAY WITH 12" WOOFER, 5" MIDRANGE & DOME TWEETER, 100 WATT CAPACITY. MFC.LIST \$899 WALNUT, PARAGONS \$13,999 DELIVERED. HARTSFIELD 085s \$6,999(REPRO)-\$17,999(ORIG)/PR. OLYMPUS S8-R \$3,999/PR-L200 \$1,999/PR. W.E. 300Bb \$350/EACH(NEW) CATALOG \$10. SHIPPED WORLDWIDE (UK-\$297, EUROPE-\$325, JAPAN-\$350). VISA/MC. HAL COX, INCENT 1947. (415) 388-5711, FAX: (415) 388-3359. 164 TAMALPAIS AVENUE, MILL VALLEY, CA 94941. SAN FRANCISCO AREA.

ROTTEN SPEAKER FOAM?
 Toll Free 1-800-767-4041 SIMPLY SPEAKERS, 11203 49th St. N., Clearwater, FL 33762. www.simply-speakers.com. D.I.Y. NEW FOAM KITS FOR ANY SPEAKER. FACTORY SERVICE—ALL BRANDS. SATISFACTION GUARANTEED!! VISA/MC/DISC/AMEX.

ONLY ONE BRAND

Ohm

www.OhmSpeaker.com

Service, upgrades, trades and new speakers. Factory direct from Ohm Acoustics, 241 Taaffe Place, Brooklyn NY 11205 (718) 783-1555; FAX (718) 857-2472; email OhmSpeaker@AOL.com

SOLEN

EUROPEAN SPEAKER DRIVER UNITS CATALOG



LA PASSION DU HAUT-PARLEUR
AUDAX



SOLEN CROSSOVER COMPONENTS CATALOG

HEPTA-LITZ INDUCTORS PERFECT LAY HEXAGONAL WINDING

STANDARD INDUCTORS PERFECT LAY HEXAGONAL WINDING

FAST CAPACITORS METALLIZED POLYPROPYLENE

SOLEN CROSSOVER & SPEAKER PARTS

SOLEN INC.
 4470 Ave. Thibault
 St-Hubert, QC J3Y 7T9
 Canada

Tél.: 514-656-2759
 Fax: 514-443-4949
 E-mail : solen@quebec.net
 WWW : http://www.quebec.net/solen/

Catalog US\$8.00 Refundable

MDY-4 Dynaudio Speaker Kit

Audio enthusiasts have long known that a **Dynaudio** two way system is an effective way to create quality sound without creating significant debt. In comparison with any system at any price, the combination of the **Dynaudio** 17cm woofer with the incomparable 28mm tweeter is exceptional in all of these areas:

- **Dynamic range**
- **Smooth response**
- **Phase and frequency fidelity**
- **Transient attack**
- **Reproduction of the human voice**
- **Lack of compression.**

To be fair, these modest drive units cannot produce infrabass (those frequencies below 50 Hz), but in the other 99.75% of recorded material, they equal products that cost up to 10 times as much.

Madisound is proud to introduce a further refinement of this combination, the **MDY-4**. This quality kit uses high order filters to eliminate sweet spots in the off-axis response. The imaging is exceptional, a result of precise phase and time delay, refined in a sophisticated 14 ele-

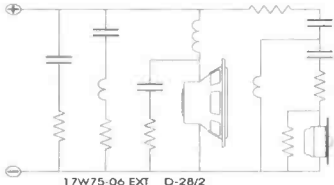

ment filter. Every part is of the highest quality; every detail is the culmination of three years of careful analysis.

Best of all, the **MDY-4** is modestly priced. The complete system with oak veneer cabinets in either a clear finish or black stained finish, is **\$650**. Cabinets are finished, and the system can be assembled in one evening. Hundreds of satisfied music lovers have built and cherish the earlier **Image Systems**, and now **Dynaudio** and **Madisound** have taken another step toward **Audio Perfection**. Isn't it time for you to build a standard to evaluate your success as a **Speaker Builder**?

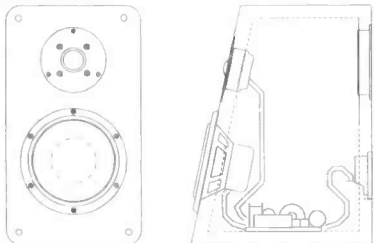

16" tall x 9" wide x 12" deep on bottom / 8.5" deep on top.

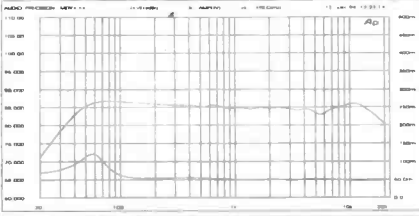

Madisound Speaker Components
(8608 University Green)
P.O. Box 44283
Madison, WI 53711 U.S.A.
Tel: 608-831-3433
Fax: 608-831-3771

LOUDSPEAKERS

TRUE SUBWOOFERS

With phenomenal *true* deep bass extending below 20Hz with low distortion at a very affordable price.



Hsu Research HRSW12V

New **HSU TRU SUBS** will extend the bass of your stereo or video system for that "air shaking all around you" effect.

Here's what experts are saying about **HSU TRU SUBS**:

"The TN1225HO plays louder (over 110 dB with program material) and goes deeper (a true 25Hz extension) than an of the competitive subs I have tested in its price or size class" Tom Nousseine, *Stereo Review*, November 1997

"This product (TN825) sets new standards for subwoofer performance at \$400. "106 dB at 30 Hz, 100 dB at 25 Hz" Richard Hardesty, *Widescreen Review*, Vol. 6, No. 4

150W TN1225HO: "111dB at 35 & 30 Hz, 106 dB at 25 Hz. These are very impressive figures for a single 12 driver, but even more significant is the low distortion and clarity achieved at these high output levels" Richard Hardesty, *Widescreen Review*, Vol. 6, No. 4

"The Hsu had no problems with the incredible bass of anything I threw at it. It blends as well with music as it does with movies - one of the best deals on the market." Stacey Spears, *Secrets of Home Theatre and High Fidelity* Volume 4 No. 2, May 1997. (http://www.sdinfo.com/volume_4_2hsu12va.html)

"To my even greater surprise, it integrated splendidly with the Sound Lab A-2X. Thanks Hsu Research for coming up with this sonic bargain." Rome Castellanes, *Audio Shopper*, Vol. 3 No. 3, April 1997 (<http://www.cdrome.com/hsu.html>)

"...output to rival many 18 inch subs along with the rare ability to homogenize almost perfectly with high-performance main speakers. ...rated flat way down to 20 Hz but in my room it went even lower, and could get stomach-churning loud if you asked it." Dan Sweeney, *Audio/Video Shopper*, December 1996

Send for full details on the vastly improved new 12Va, the 10V, and our new TN series. Write or call:

HSU RESEARCH
14946 Shoemaker Ave. Unit L, Santa Fe Springs, CA 90670
1-800-554-0150 (Voice)
1-562-404-3848 (Voice-Fax)
E-mail: hsures@earthlink.net
Website: <http://www.hsuresearch.com/>
Sold factory direct with a 30 day trial - money back guarantee - 5 year manufacturer's defect warranty.

REPAIR FOAM ROT YOURSELF!

- Save \$\$\$ with original kit!
- Kits to fit any speaker—Advent, AR, JBL, Bose, Infinity, EV, etc.
- Surrounds, adhesive & instructions
- MC/VISA/Discover—no CODs
- Call with make & model for best price
- Phone 24 hrs. 704-697-9001



STAPP
AUDIO TECHNOLOGIES

or Toll Free 800-747-3692
P.O. Box 1088 • Flat Rock, NC 28731

CUSTOM ACTIVE ELECTRONIC CROSS-OVERS, 6 to 36 dB/Oct. Also Snell, Magnepan versions. DB SYSTEMS, POB 460, RINDGE, NH 03461. (603) 899-5121.

SERVICES

Audio Equipment Built, Repaired, Modified and Restored by Richard Modafferi, independent consultant to Audio Classics, Ltd., inventor, and former Senior Engineer at McIntosh. **AUDIO CLASSICS, LTD.** 3501 Old Vestal Rd., Vestal, NY 13850. Phone: 607-766-3501, 8am-5pm EST Mon-Fri.

RECORDS

NEEDLES/CARTRIDGES & Belts—Expert Consultations, All Major Brands, One of Largest Stocks in Country including Old/Obsolete Models. NEEDLE EXPRESS. 1-800-982-2620. www.needleexpress.com

LV/CD/RECORD COLLECTOR'S SUPPLIES. Jewel boxes, jackets, sleeves, etc. CABCO-641, BOX 8212, COLUMBUS, OH 43201. (614) 267-8468. JProto1@aol.com

HALF MILE VINYL. Large Inventory Quality Preowned LP's cleaned and graded. Send SASE for catalog to Box 98, East Wareham, MA 02538. Call 508-295-2508.

RECORDS

KAB ELECTRO-ACOUSTICS
Preserve + Enhance + Restore™
"Serving The Record Collector and Sound Enthusiast" FREE CATALOG • 908-754-1479 • www.KABusa.com • P.O. Box 2922 • Plainfield • NJ 07062-0922 Visa/MC/AmEx.

PARTS AND ACCESSORIES

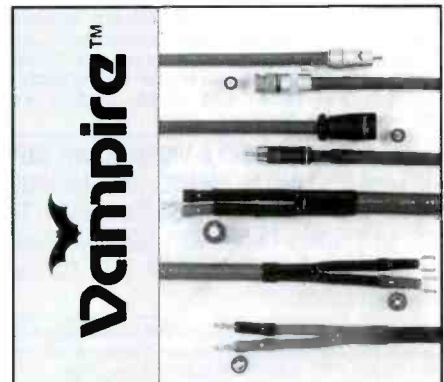

...audible results with the finest in connecting components!

SOUND CONNECTIONS INTERNATIONAL, INC.
203 Flagship Dr.—Lutz, FL USA 33549
PH: 813-948-2707 Fax: 813-948-2907

Hi-Fi for the Masses

Super High Fidelity Audio Equipment
Made in the U.S.A.

Our components feature state of the art designs and the best quality parts...we leave no stone unturned in the pursuit of sonic perfection!

Single-ended and push-pull tube amps, linestages, phono stages, active crossovers & ac line conditioners fully assembled or sold as kits. Affordable to cost-no-object models available. Plus we offer the largest assortment of parts & circuit modules for the hobbyist.

Our 200 page catalog is just \$12 U.S. & Canada \$18 International (refund w/order). Call 303.470.6585 Fax: 303.791.5783 or E-Mail: wlab@ix.netcom.com

WELBORNE LABS
P.O. Box 260198, Littleton, CO 80126-0198
Visit our Website for info: <http://www.welborne.com>

Premium Grade Parts

Don't Pay More!

Excellent selection of audiophile parts at fair prices & prompt shipping! Extensive in stock inventory featuring these vendors and many more. **Free** catalog! INFINICAP, HOVLAND, MIT MULTICAP, SOLEN, SCR, RH-CAP, NICHICON MUSE, BLACK GATE, CADDOCK, VISHAY, MILLS, HOLCO, RESISTA, TKD, ALPS, NOBLE, EAR, DEFLEX PANELS, CARDAS, KIMBER, ACROTECH, & pure silver chassis wires, HEMFRED diodes, SOLO foil inductors, all types of audio connectors, silver contact toggle & rotary switches, stepped attenuator kits, hospital grade plugs, tubes, tools, IC's, super selection of damping materials & feet. International/overseas orders are especially welcome! Phone (415) 669-7181 or fax (415) 669-7558 for a catalog. **Michael Percy, Box 526, Inverness, CA 94937**

BLANK TAPES

1-800-TAPE WORLD or 1-800-245-6000
We'll beat any price! 5.95 SHIPPING • FREE CAT.

SONY	MAXELL	TDK	FUJI
DAT-120 5.79	XLII-90 1.49	GDR-74 1.99	SVHS-T120 6.49
DAT-124 PRO 8.99	XLII-S 90 1.99	D-90 79	Hi 8 120 5.99
T-120V 1.69	T 120 HGX 2.39	SA-90 1.49	DR-190 .69
L-750BT 3.49	ST 120 6.99	SAX-90 1.99	T-120 SHG 2.29
ST-160 7.99	DAT-124 PRO 6.99	SAX-100 2.09	JVC ST 120 5.79
MDW-74 5.99	UD35-90 8.99	T 120 EHG 2.49	CDRXG-74 6.99
TKDVC60 10.99	UR-90 79	DAT-120 6.49	GDR-D-74 1.89

TAPE WORLD 220 SPRING ST, BUTLER PA 16003 FAX 800-322-8273
OVER 500 DIFFERENT. SAME DAY SHIPPING. M-F 8-5

WANTED TO BUY

MARANTZ & ALL VINTAGE EQUIPMENT, HIGH-END. No one pays MORE, working or not! N.Y.S.I. (718) 377-7282, 2-6pm, WEEKDAYS.

AUDIO CLASSICS BUYS-SELLS-TRADES-REPAIRS High End Audio Components. CALL for a quote. See our ad at the beginning of the classifieds. **AUDIO CLASSICS, LTD.**, 3501 Old Vestal Rd., Vestal, NY 13850. Phone: 607-766-3501 8am-5pm EST Mon-Fri.

ALWAYS PAYING TOP FOR: Tube Marantz, McIntosh, Western Electric equipment. Vintage speakers, units, from Tannoy, JBL, Altec, Jensen, EV, Garrard 301. Thorens TD-124. P.O. BOX 80371, San Marino, CA 91118-8371. Telephone: (626) 441-3942. **DAVID YO** (My word's like a signature.)

CASH for USED AUDIO & VIDEO EQUIP. BUY-ING and SELLING by PHONE. CALL for HIGHEST QUOTE. (215) 886-1650 Since 1984. The Stereo Trading Outlet, 320 Old York Road, Jenkintown, PA 19046. WEB SITE Catalog: www.tsto.com

WANTED: TUBE HI FI, CORNER/HORN SPEAKERS! Altec, Jensen, Marantz, Leak, Quad, McIntosh, Western Electric, EV, JBL, Tannoy ETC. Sonny (405)737-3312. Fax 3355.

CABLE TV

FREE TV Cable catalog Products & Pricing on Revolutionary Full Viewing Boxes with Dealership 800/676-6342.

Why Rent?

WORLDWIDE ELECTRONICS

CABLE TV CONVERTERS & DESCRAMBLERS

1 YEAR WARRANTY!

SAVE SAVE

ABSOLUTELY LOWEST WHOLESALE/RETAIL PRICES!

30 DAY MONEY BACK GUARANTEE!

MASTERCARD • VISA • DISCOVER • AMEX • CDD NO FL SALES

1-888-430-4301
http://www.wwcableboxes.com

CABLE TV EQUIPMENT & ACCESSORIES. Quality products at affordable prices. 30 day money back guarantee. 1-year warranty. Quantity discount. Dealers welcome. 1-888-828-7712.

SAVE \$100s

CABLE TV CONVERTERS / EQUIPMENT

WE WILL BEAT ANY ADVERTISED PRICE

Dealers Welcome

QUANTITY DISCOUNTS

1 Year Warranty
30 day money back guarantee

Visa MC Disc CDD

T.C.V. Call Us Last!
1-800-582-0989

CABLE DESCRAMBLER KIT. Only \$14.95! See all premium and pay-per-view channels. Why pay hundreds more? For more information, call 1-800-752-1389.

CABLE TV CONVERTERS, DESCRAMBLERS. Great Price and Quality Service. Satisfaction Guaranteed. **EAGLE ELECTRONICS INC:** 1-800-259-1187. Visa/MC/Amex/Disc accepted.

CABLE TV CONVERTERS: ALL MAJOR MAKES & MODELS WITH REMOTE. ALSO UNIVERSAL CABLE BOX. 30 DAY MONEY BACK GUARANTEE. DEALERS WELCOME. CALL 1-800-538-CABLE

CALL 1(800)-72-BOXES(26937) FOR UNBEATABLE PRICES ON ALL YOUR CABLE EQUIPMENT. MONEY-BACK GUARANTEE. DEALERS WELCOME. VISA/MASTERCARD/DISCOVER/C.O.D. QUALITY ENTERTAINMENT. WE WILL NOT BE UNDERSOLD!!

CABLE TV

IP-TV™

- Link your TV-Descrambler-Computer into one system.
- Experience the possibilities of surfing the NET using your cable box remote.
- Financing available.
- **FREE** cable TV decoder included with every purchase.

800-835-2330

SATELLITE TV

SATELLITE DESCRAMBLER. PROGRAMMING PACKAGE AUTHORIZES ANY SATELLITE TO RECEIVE ALL CHANNELS AVAILABLE, INCLUDING PREMIUMS & PAY-PER-VIEWS. \$99.95. 800-333-6150. www.satellite2000.net

FREE DSS TEST CARD information package. Works with new system. Write **SIGNAL SOLUTIONS**, 2711 Buford Rd., Suite 180, Richmond, VA 23235.

HELP WANTED

Recording Engineer Broadcasting Radio/TV/Sports/News/DJ/Talk Show Multimedia/Digital/Video/Film No Experience Required. On-The-Job Training. In-Major Local Recording Studios & Radio/TV Stations. Great 2nd Career Part-time, Nights, Weekends. Call recorded line for free video 1-800-295-4433

HOME THEATER

INTERNET SHOPPING! All Brands Electronics, Inc. 20 page Electronic Catalog— http://www.AVHTS.com/ALLBRANDS or call TOLL FREE 1-888-312-7283. Check our Monthly Specials!

LCD VIDEO PROJECTORS- GIANT 5' - 25' ULTRA-BRIGHT HIGH RESOLUTION PICTURES!!! SEAMLESS SCREENS TO 25'!!!"DEPIXELATION PROCESSORS". UNBEATABLE PRICES!!! FREE CATALOG!!! POLI-VISION (717) 489-3292.

FOR SALE

NEW WORLD AUDIO
WHOLESALE PRICES

STOP PAYING RETAIL

(800) 311-0392

Products come with manufacturers warranty or NWA warranty

- ADS
- ALPINE
- ATL TECH.
- B & O
- BOSE
- CARVER
- DENON
- HK
- INFINITY
- KENWOOD
- M & K
- MB QUART
- MARANTZ
- NAK
- NILES
- NHT
- ONKYO
- SONANCE
- SONY ES
- VELODYNE
- YAMAHA
- AND MORE

Millions of your prime prospects can be found in the industry leading titles of *Hachette Filipacchi Magazines, Inc.*

To place a classified ad, simply call toll-free and reserve your space today!

1-800-445-6066 (9am - 5pm EST) or Fax your order to 212-767-5624

Let Us Entertain You!



Photo created and produced by Media Group Marketing, Inc. ©

PARA Home Theater Specialists

When you're buying audio and video components, it's important to understand that it's not enough to buy a good TV and VCR. Components must also be chosen for how they sound together. PARA is a professional association of independent specialty audio/video stores who are committed to the highest standards in retailing.

- ▶ PARA stores will take the time to ask about what you already own and suggest home theater components that will integrate into your current system.
- ▶ PARA home entertainment professionals are educated to explain the newest technologies clear, friendly language, helping you get the best value for your money.
- ▶ Let us help you choose the system that's just right for you.

CALL 1-800 4-PARA 94 to find the PARA dealer nearest you!



PAGE	ADVERTISER	WEB SITE/E-MAIL	TELEPHONE
27, C III	Acoustic Research		707-748-5930
9	Adcom	www.adcom.com	732-390-1130
63	Amplifier Technologies, Inc.	www.ati-amp.com/ amptech@ix.netcom.com	514-631-6448
79	Bose/Wave Radio	www.bose.com	800-897-BOSE ext. A 2782
56	Cambridge SoundWorks	www.hifi.com	800-367-4434
25	Carver	www.carver.com	425-482-3400
C IV	Chevy Camaro		
28	Crutchfield	www.crutchfield.com	800-955-9009
77	Encase		785-331-3400
17	Enlightened	www.eadcorp.com	515-472-4312
81	J&R Music World	www.JandR.com	800-221-8180
73	JVC Musical Industries	xrcd@jvcmusic.com	800-JVC-1386
29	Kimber Kable	www.kimber.com	801-621-5530
14, 15	Klipsch	www.klipsch.com	800-KLIPSCH
13	Krell	www.krellonline.com/-krell	203-799-9954
45	Legacy	www.legacy-audio.com	800-283-4644
7	Now Hear This (NHT)	www.nhthifi.com	800-NHT-9993
19, 21	Paradigm	www.paradigm.ca	905-632-0180
23	Paragon	www.paragonacoustic.com/ highend@paragonacoustics.com	800-224-7599
77	Parliament		
75	Phase Technology	www.phasetech.com	888-PHASE TK
C II, 1	Philips/Maganvox	www.mmhometheater.com	888-486-6272
85	Pro Sound Stage and Lighting	www.pssl.com	800-672-4268
39	Rotel		978-664-3820
75	Seneca Media	www.everycd.com	800-EVERY CD
3	SONY	www.sony.com/minidisc	
87	Sound City	www.soundcity.com	800-542-7283
5	Southern Comfort		
11	Velodyne	www.velodyne.com	408-436-7270
51	Vienna Acoustics		510-843-4500

AUDIO, April 1998, Volume 82, Number 4. **AUDIO** (ISSN 0004-752X, Dewey Decimal Number 621.381 or 778.5) is published monthly by Hachette Filipacchi Magazines, Inc., a wholly owned subsidiary of Hachette Filipacchi USA, Inc., at 1633 Broadway, New York, N.Y. 10019. Printed in U.S.A. at Dyersburg, Tenn. Distributed by Warner Publisher Services Inc. Periodicals postage paid at New York, N.Y. 10019 and additional mailing offices. One-year subscription rates (12 issues) for U.S. and possessions, \$24.00; Canada, \$33.68 (Canadian Business Number 126018209 RT, IPN Sales Agreement Number 929344); and foreign, \$32.00.

AUDIO® is a registered trademark of Hachette Filipacchi Magazines, Inc. ©1998, Hachette Filipacchi Magazines, Inc. All rights reserved. The Editor assumes no responsibility for manuscripts, photos, or artwork. The Publisher, at his sole discretion, reserves the right to reject any ad copy he deems inappropriate.

Subscription Service: Postmaster, please send change of address to **AUDIO**, P.O. Box 52548, Boulder, Colo. 80321-2548. Allow eight weeks for change of address. Include both old and new address and a recent address label. If you have a subscription problem, please write to the above address or call 303/604-1464; fax, 303/604-7455.

Back Issues: Available for \$6.95 each (\$8.25 Canada; \$13.25 other foreign) in U.S. funds. Please add \$1.00 for the Annual Equipment Directory (October issue). Send a check or money order to ISI/AUDIO Magazine, 30 Montgomery St., Jersey City, N.J. 07302, or call 201/451-9420.

AUDIO

SUBSCRIBER SERVICE

PLACE LABEL HERE

MOVING? Please give us 8 weeks advance notice. Attach label with your old address, and write in new address below.

NAME _____

ADDRESS _____

CITY _____

STATE _____

ZIP _____

1 (303) 604-1464
FAX 1 (303) 604-7455

AUDIO
P.O. Box 52548, Boulder CO 80322

PlayBack

PRO DIGITAL SDIOC PORTABLE DAT COAXIAL IN/OUT CABLE

Thousands of Sony TCD-D7 and -D8 palm-sized DAT recorders are now in the hands of audiophiles and recording pros. But these recorders' digital inputs and outputs use a proprietary seven-pin plug, so connecting them to other digital devices requires accessory cables or interface boxes.

One of the best accessory cables I have found for this purpose is the SDIOC from Pro Digital. Priced at \$115, it has a seven-pin plug at one end for connection to the Sony recorders and two RCA male plugs for connection to an S/P DIF coaxial input and output at the other. The cable and S/P DIF connectors are of professional quality and made by Canare.

Sony, of course, also makes cables for connection to its pocket DAT recorders and SBM-1 Super Bit Mapping A/D converter. But its RK-DA10 coaxial cable (\$65) is for input only, and the RMD-3K interface,



which provides coaxial digital and Toslink input and output, will set you back about \$200. You could also use Sony's Toslink input/output cable, the POC-DA12, with one of the Toslink-to-coaxial interface boxes made by other companies. But the DA12 costs \$85 and the interface boxes cost \$75 to \$95, which adds up to more than the Pro Digital cable. And the extra connection between cable and interface box increases the potential for interface-induced jitter. The SDIOC's price still seems a bit high, but Pro Digital has to

GRADE: A-

buy fully assembled RK-DA10 cables from Sony to get the seven-pin connectors. Highly recommended. (Pro Digital: 700B Parkway Blvd., Broomall, Pa. 19008; 610/353-2400.)

John Gatski

Koss Quiet Zone 2000 Headphones

I have several noise-cancelling headphones to choose from. The one I usually take along on trips is the Koss Quiet Zone 2000 (\$200). It's ideally configured for travelling, because its headset folds and the anti-noise electronics package (built for Koss by Andrea Electronics) just fits within the folded headset. The electronics box has a multipin jack for connection to the headset and a stereo mini-jack for an audio connecting cord. That cord has right-angled stereo mini-plugs at each end; adaptors for quarter-inch jacks and the double mini-plugs used in some airplanes are included, as is a soft zippered pouch to keep everything together.

The 2000's headset, like that of Koss's other folding models, has no top padding but does have foam pads that press against your temples to relieve pressure on your ears; I've found the 2000 comfortable enough to wear continuously while crossing the country or the Atlantic.

Because the frequency extremes roll off a bit, the sound is neither as

GRADE: A-

rich nor as clear and open as that of my Grado SR325, but that's not very noticeable under the noisy conditions I carry the Koss 2000 for. If the two AA batteries go dead or if I turn the electronics off, volume drops and the frequency response tilts more toward the bass, but I don't lose the signal entirely—which I do with some other noise-cancelling 'phones. (Koss: 4129 North Port Washington Rd., Milwaukee, Wisc. 53212; 414/964-5000; www.koss.com.)

Ivan Berger

Fostex COP-1 Digital Signal Converter

When I reviewed the Bir6 t2, an inexpensive Toslink-to-coaxial S/P DIF converter (November 1996), my sole complaint was that it didn't also convert electrical digital signals to optical. The Fostex COP-1 (\$95) converts in both directions.

Many of today's consumer digital audio components have only Toslink optical connections, which makes it impossible to use them with gear having only coaxial digital connectors. The COP-1, a product Fostex developed for its professional line, allows separate, even simultaneous, Toslink-to-coaxial and coaxial-to-Toslink conversions. This box is a snap to use: Just plug in its 9-volt DC adaptor, connect your signal source's output to the appropriate input jack, and connect the appropriate COP-1 output jack to the next digital component in your system. The device accepts sampling rates from 32 to 48 kHz. It

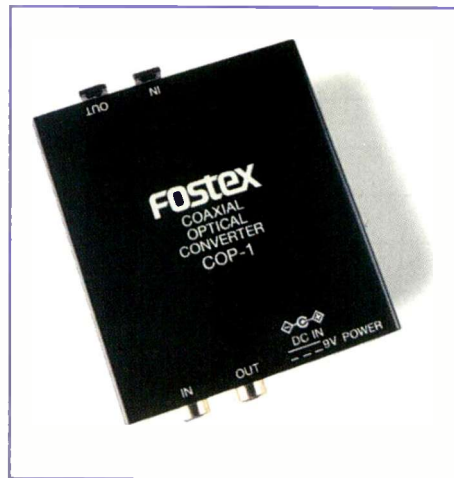

also lets Serial Copy Management System (SCMS) anti-copying subcodes pass through.

I used the COP-1 to link my DVD player's

GRADE: A+

Toslink output to my Dolby Digital preamp, whose only unused digital input was coaxial. The Fostex also enabled me to link a DAT recorder's coaxial digital output to my Pioneer PDR-04 CD recorder's Toslink input.

I am a sucker for interface boxes like this, and the Fostex is a great one. (Fostex: 15431 Blackburn Ave., Norwalk, Cal. 90650; 562/921-1112.)

John Gatski



Photos: Len LaGrana

INCREDIBLE PERFORMANCE. Inside And Out.

Looking for proof that big features come in small packages? Welcome to **The Edge**, the all-purpose, all-terrain speaker from Acoustic Research, the worldwide leader in loudspeaker innovation since 1954.

The Edge delivers an amazing frequency response and ultra high sensitivity*, thanks to our exclusive time-aligned, acoustic wave-controlled driver design. In addition, magnetic shielding makes The Edge perfect for home theater applications, while the molded enclosure



and built-in swivel mount allow unlimited installation options, inside and out.

Spacious sound, high efficiency, weather resistance, and AR's long-standing commitment to value all add up to **The Edge**—your best choice for high-quality satellite speakers that fit anywhere...especially your budget. To learn more, call 707-748-5930 for the name of your nearest authorized AR dealer. **The Edge** from Acoustic Research. Enjoy the performance.

*91dB @ 2.83 volts per meter

AR
Higher Fidelity

**You could buy a more practical car,
but then you'd have to drive it.**



New Camaro Z28. Genuine Chevrolet

Okay, we admit, with 305 hp, a six-speed transmission and the top down, it's anything but practical. But can you think of a better way to get your hair all messed up? Well... besides that.

Call 1-800-950-2438 or visit www.chevrolet.com *No-cost option. Camaro Z28 is a registered trademark of the GM Corp. ©1997 GM Corp. Buckle up, America!

