

# Audio

TEST REPORT  
**SPECIAL!**

AUGUST 1990 • US \$2.75 • UK £2.00 • CAN \$2.95

**GOLDMUND**  
**ST4 TURNTABLE**  
**GOLD CARTRIDGE**  
LONG-PLAYING  
LUXURY



**RECORDING**  
**THE BOSTON**

**TESTED**

DAHLQUIST M907  
LOUDSPEAKER  
VTL COMPACT 100 AMP  
& DELUXE PREAMP  
FISHER RS-Z1 RECEIVER



#5001\*\*\*\*\*5-DIGIT 22306  
#MXW7736F096#  
710272 MXW 7736F095 04 6 FEB93  
MR F B MAXWELL JR  
7736 FRANCES DR  
ALEXANDRIA VA 22306  
08#J5

## *The Spirit Captured*



In the AR tradition, another milestone.  
AR's designers and engineers achieve the ideal:  
European Elegance... Exquisite Sound... Affordable  
Prices. The quintessence of both sight and sound.  
Premiered in Europe - now available in America.



**TIMELESS INNOVATION**

Enter No. 1 on Reader Service Card



## Unfortunately, most CD changers change more than the discs.

Typically, a CD changer's complex transport mechanism doesn't isolate the playing disc enough to prevent vibration interference.

Something that can turn a perfectly good performance into a rather shaky one.

Fortunately there's a CD



changer that won't add any additional shake, rattle or roll to your music.

The new CDC-805 from Yamaha. The first CD

changer with a vibration-free transport system.

A remarkable accomplishment which isolates and clamps the playing disc, just like a single-disc player, so your music won't suffer from any vibes of the bad variety.

But there's much more to it than merely a superior changing mechanism.

Due to Yamaha's Single-Bit Technology, the CDC-805 sounds far better than most single-disc CD players on the market.

There's also something we call PlayXchange.

A creature comfort that provides uninterrupted music, permitting you to load up to four CDs without interrupting the disc playing.

The CDC-805 is also the only changer with a built-in equalizer.



*The CDC-805. The only CD changer with a five-mode digital equalizer*

Five digital presets designed to give every

type of music even more musical presence — even a flat setting so you can bypass the EQ altogether.

The CDC-805 is the only five-disc changer that can provide 10-disc relay play by patching two CDC-805s together — something definitely worth considering for custom installations.

Here's yet another point well worth considering.

Instead of your typical belt drive, Yamaha's CDC-805 uses long-lasting gears for added reliability. A small, yet significant reason why Yamaha can confidently back every CDC-805 with a two-year limited warranty.

Stop by your Yamaha dealer's showroom for an earful of Yamaha's remarkable new CDC-805.

The first CD changer capable of changing even the most ardent audiophile's mind about buying a CD changer.

**YAMAHA**



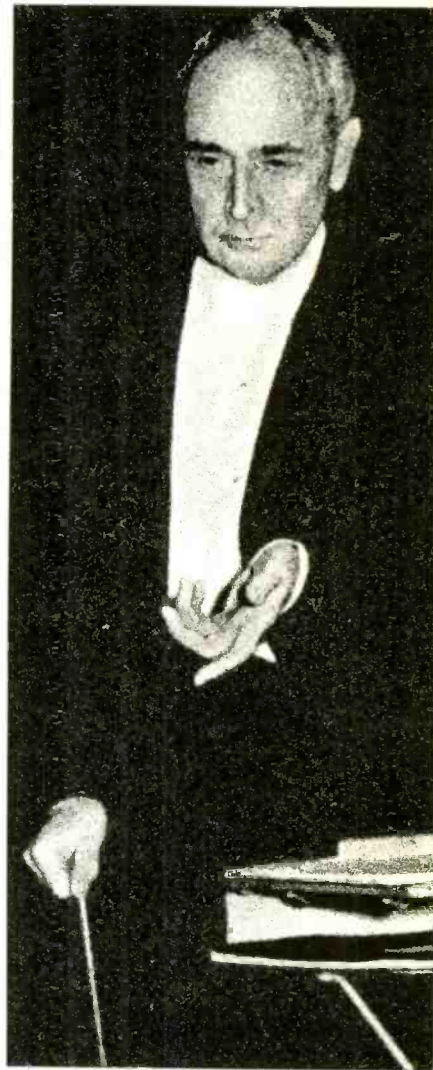
# Audio

AUGUST 1990

VOL. 74, NO. 8



Goldmund, page 40



Koussevitsky, page 36

## FEATURES

<b>BUILD AN AUXILIARY SWITCHBOX</b> .....	Richard J. Kaufman .....	34
<b>ENGINEERING THE BOSTON</b> .....	John Alvin Pierce .....	36

## EQUIPMENT PROFILES

<b>GOLDMUND ST4 TURNTABLE &amp; GOLD CARTRIDGE</b> .....	Edward M. Long .....	40
<b>FISHER RS-Z1 RECEIVER</b> .....	Leonard Feldman .....	60
<b>VTL COMPACT 100 MONO AMP AND DELUXE PREAMP</b> .....	Bascom H. King .....	74
<b>DAHLQUIST M907i SPEAKER</b> .....	D. B. Keele, Jr. ....	88

## MUSIC REVIEWS

<b>CLASSICAL RECORDINGS</b> .....	100
<b>ROCK/POP RECORDINGS</b> .....	106
<b>JAZZ &amp; BLUES</b> .....	110

## DEPARTMENTS

<b>SIGNALS &amp; NOISE</b> .....	6	
<b>AUDIOCLINIC</b> .....	Joseph Giovanelli .....	16
<b>TAPE GUIDE</b> .....	Herman Burstein .....	20
<b>ROADSIGNS</b> .....	Ivan Berger .....	24
<b>CURRENTS</b> .....	John Eargle .....	26

The Cover Equipment: Goldmund ST4 turntable and Gold cartridge  
 The Cover Photographer: Robert Lewis

Audio Publishing, Editorial, and Advertising Offices,  
 1633 Broadway, New York, N.Y. 10019.

Subscription Inquiries, (800) 274-8808;  
 in Canada or other foreign countries, (303) 447-9330.



Currents, page 26

GET ON WITH IT.



**The Proceed CD.** An original expression of how technology can fulfill your desire for musical fidelity. Two years of research into the sonic possibilities of the compact disc medium have resulted in a component worth waiting for.

The Proceed CD. The world's most well understood CD player.

 **PROCEED**

Proceed® products are designed and manufactured by **MADRIGAL AUDIO LABORATORIES**  
P.O. Box 781, Middletown, CT 06457 INTL TLX 4942158

# Just Say No!

It's as  
good as a  
Kicker!



Don't listen to sly salesmen who don't do their homework! Get the facts on automotive speakers. As the final link between a system and your ears, speakers are the most important component you will buy.

There are many features, design options and performance parameters to consider. Make your speaker investment an informed decision.

Stillwater Designs has written an easy to read booklet called "The Speaker Buyer's Handbook." It's objective. It's informative. It will tell you what you need to know about speakers and it's free! We are confident that the more you know about speakers, the more you will appreciate the outstanding value and awesome sound of

**KICKER! Call Toll-Free 1-800-256-5425**

for your complimentary copy of the "Speaker Buyer's Handbook."

# KICKER®

AUTOMOTIVE SPEAKERS BY STILLWATER

5021 N. Perkins Rd., Stillwater, OK 74075

Designs

Enter No. 29 on Reader Service Card

## Audio

Editor: Eugene Pitts III

Art Director: Cathy Cacchione  
Associate Art Director: Linda Zerella

Technical Editor: Ivan Berger  
Managing Editor: Kay Blumenthal  
Associate Managing Editor: Teresa A. Carriero  
Associate Managing Editor: Douglas Hyde  
Assistant Editor: Joe Wiesenfelder  
Editorial Assistant: Michael Bieber

Associate Editors:  
Edward Tatnall Canby, Bert Whyte, B. V. Pisha  
Senior Editors:  
Leonard Feldman, Howard A. Roberson  
Senior Editor/Loudspeakers: D. B. Keele, Jr.  
Editor-At-Large: David Lander

Contributing Editors/Artist:  
Michael Aldred, Herman Burstein, David L. Clark,  
Anthony H. Cordesman, Ted Costa, John Diibertc,  
Frank Driggs, John M. Eargle, Susan Elliott,  
Joseph Giovaneli, Bascom H. King,  
Hector G. La Torre, Edward M. Long,  
Frank Lovece, Jon W. Poses, Jon R. Sank,  
Susan Borey Sherman, Donald Spoto,  
Michael Tearson, Jon & Sally Tiven,  
Michael Wright

Business Services Director: Greg Roperi  
Circulation Director: Leon Rosenfield  
Production Director: Patti Burns  
Production Manager: Nancy Potts  
Research Director: Vicki Bimblich  
Office Manager: Phyllis K. Brady  
Ad Coordinator: Sylvia Correa  
Sales Secretary: Liz Dedivanovic

V.P./Publisher: Stephen Goldberg

### ADVERTISING

Advertising Director: R. Scott Constantine  
(212) 767-6346  
Account Managers: Barry Singer  
(212) 767-6291  
Carol A. Berman  
(212) 767-6292  
Western Manager: Bob Meth  
Regional Manager: Paula Mayeri  
(213) 739-5130  
Automotive Manager: James Main  
(313) 643-8800

### DCI EXECUTIVE STAFF

President and CEO: Peter G. Diamandis  
Executive V.P.: Robert F. Spillane  
Sr. V.P., Finance, and CFO: Arthur Sukel  
Sr. V.P., Mfg. & Distribution: Murray M. Romer  
Sr. V.P., Operations: Robert J. Granata  
V.P., Controller: David Pecker  
V.P., General Counsel: Catherine Flickinger

**AUDIO**, August 1990, Volume 74, Number 8  
AUDIO (ISSN 0004-752X, Dewey Decimal Number  
621.381 or 778.5) is published monthly by DCI, a  
wholly owned subsidiary of Hachette Publications, Inc.,  
at 1633 Broadway, New York, N.Y. 10019. Printed in  
U.S.A. at Dyersburg, Tenn. Distributed by Warner  
Publisher Services Inc. Second class postage paid at  
New York, N.Y. 10001 and additional mailing offices.  
Subscriptions in the U.S., \$21.94 for one year, \$39.94  
for two years, \$53.94 for three years; other countries  
add \$6.00 per year. **AUDIO** is a registered trademark  
of DCI. ©1990, Diamandis Communications Inc. All  
rights reserved. **Editorial contributions** should  
include return postage. Submissions will be handled  
with reasonable care, but the Editor assumes no  
responsibility for safety or return of manuscripts,  
photographs, or artwork. The Publisher, in his sole  
discretion, reserves the right to reject any ad copy he  
deems inappropriate. **Subscription Service:** Forms  
3579 and all subscription correspondence must be  
addressed to AUDIO, P.O. Box 52548, Boulder, Colo  
80321-2548. Please allow at least eight weeks for the  
change of address to become effective. Include both  
your old and your new address and enclose, if  
possible, an address label from a recent issue. If you  
have a subscription problem, please write to the above  
address or call (800) 274-8808; in Canada or other  
foreign countries, (303) 447-9330.



Signature II—The tower speaker that's been six years in the making.

The Monitors — Accuracy unbounded by dimension.



# Legacy Loudspeaker Systems

3021 Sangamon Ave.  
Springfield, IL 62702

- Factory Direct
- Home Auditions
- Ten Year Warranty

**1-800-283-4644**

**IMAGERY • TRANSPARENCY • DYNAMICS**

*Call or write for complete literature!*

Enter No. 22 on Reader Service Card

## Thou Shalt Not Digitize

Dear Editor:

Music has always been a very important part of my daily life. As an audiophile, I have purchased the best equipment I can afford in order to get good sound to enjoy that music.

I own a pretty good turntable and CD player. After much listening, I prefer the sound of an LP over a CD in most cases. It just sounds more like real music. Over a year's time, I probably buy between 30 and 50 albums—mostly country, with some jazz and pop vocals.

The rapid demise of vinyl has me very unhappy. The 45-rpm record is no longer being made, and the selection of LPs is getting smaller all the time (some stores don't carry them at all).

I'd like to say to record companies, if you stop producing LPs, you have lost a customer. I refuse to pay artificially high prices for CDs that have a sound I don't prefer anyway. If it's CDs with high prices or nothing, it will be nothing.

I'll stick with my current library of music or listen to FM. Should the cost of CDs ever come down to where it should be, under \$10, we'll talk.

It is a sad time for music lovers. Selection, affordable prices, and, to my ears, good sound are no more. Somebody has fashioned a little round golden calf, and greed has triumphed once again.

Stan Davis  
Buena Park, Cal.

## Tape Test: A+

Dear Editor:

Just a note to say what a fantastic job Howard A. Roberson did on the cassette report in the March 1990 issue ("Greatest Tape Test Ever: 88 Cassettes Tested"). As a person who has done reports like this, I can appreciate the amount of work that he must have put into it. His report beats any I have done. Absolutely incredible!

Edward M. Long  
Oakland, Cal.

## Optical Optimism

Dear Editor:

I have just now read Bert Whyte's "Behind the Scenes" column in the March 1990 issue. In the second to last paragraph, he says, "The advent of fiber-optic interconnects should finally put an end to the often fanciful performance claims made for audiophile cables." Mr. Whyte is not only a leader in the audio field, he is also a starry-eyed optimist. There is no limit to the gullibility of some members of the public or to the reality of the placebo effect.

When fiber optics replace copper conductors, and the problems we've come to associate with interconnects are done away with, I fully expect to see fiber-optic static shields being profitably marketed by such outfits as the one that sells weighting rings for Compact Discs and subjectivist reviewers praising the "improvement" the shields make.

Kenneth H. Fleischer  
Los Angeles, Cal.

## "The M-200 power amplifier is a smashing success by any standard, and an absolute steal at the price."

Kent Bransford

*Hi-Fi Heretic*, Autumn 1989

### Highlights of the review:

Over the years, B & K Components, Ltd. has become one of America's leading manufacturers of affordable, high-quality audio electronics. B & K has done an admirable job of providing musical, reliable preamplifiers and power amplifiers within the budget of virtually any music lover.

The M-200 can drive virtually any loudspeaker load in existence. Rated at 200 watts into 8 ohms and 400 watts into 4 ohms, the M-200 can drive loads as low as .75 ohms and still pump out its rated 200 watts! Rated peak current output of the M-200 is an incredible 150 amperes.

### "I was floored by the M-200's sense of pace and drive."

Internal construction is most impressive—a massive, shielded toroidal transformer centrally sited within the steel chassis. Four filter capacitors offer nearly 70,000 mfd of

storage capacitance. The input and driver circuits are carried on a single glassfibre board that sits atop the power supply caps. A gold-plated premium input jack is included, with gold-plated 5-way binding posts handling speaker cable connection.

### "I was bowled over by its combination of smoothness (a B & K hallmark) and detail."

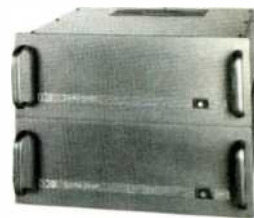
All too often extremely powerful amps excel on bombastic symphony works, but fall down when it comes to conveying the subtlety and nuance of "smaller" music. The M-200 proved to be a glorious exception. Yes, the massed brass and great whomping bass drum shots in "Uranus, the Magician" were appropriately startling, but equally satisfying were the quiet flute and violin passages. Delicate instrumental shadings and nuances that are so important in communicating the emotion of the music were never glossed over or homogenized. The M-200 had that essential

ability to draw me further and further into the music, rather than hurling it in my face. Equally impressive was the M-200's soundstage width and depth.

While offering the tonal naturalness that characterizes all B & K products, the M-200 goes far beyond previous B & K amps in its outstanding bass quickness and definition, as well as its excellent retrieval of low-level detail and recording acoustic.

The M-200 power amplifier is a smashing success by any standard, and an absolute steal at the price.

Reprinted by permission of *Hi-Fi Heretic*. Annual (four issue) subscriptions are \$15 (\$18 outside U.S.), available from: *Hi-Fi Heretic*, P.O. Box 2019, Yorba Linda, CA 92686.



**B & K** Sonata Series



# THE END OF HYSTERESIS

"A generation later, transistor designs by such companies as Levinson, Krell, and Threshold have gained my respect as being eminently musical despite their silicon hearts. To this list I can now add Kinergetics Research."

**Dick Olshe**  
**Stereophile Vol. 13, No. 1.**

"Those audio fanatics who want to be bombarded by jet planes, earthquakes, thunderstorms, and even atomic bombs would probably not like the Kinergetics sound, but if they're searching for music, here is an oasis."

**Lewis Lipnick**  
**Stereophile Vol. 10, No. 5.**

"...Kinergetics offers its purchaser more than a glimpse of what the best CD sound is all about."

**John Atkinson**  
**Stereophile Vol. 13, No. 1.**

"...Kinergetics KCD-40 has become an integral part of my playback system. I recommend it very highly, especially to those who have had monumental difficulty coming to any terms with the CD format."

**Neil Levenson**  
**Fanfare, Jan/Feb 1990.**

"Kinergetics's KCD-20... the first CD player to crack the Class 1 Sound barrier"

**Peter Montcriaff**  
**"International Audio Review",  
Hotline #43-45.**

**We will continue to create  
improvements in areas of  
psychoacoustic that others  
have yet to discover.**

 **KINERGETICS  
RESEARCH**

6029 Reseda Blvd., Tarzana, CA 91356  
818/345-5339 • Fax 818/609-8576

# IF GOD EVER SPEAKS TO YOU, THIS IS THE TAPE TO RECORD IT ON.

**T**here are some things you want to record with absolute accuracy. Which is why Maxell has created Metal Vertex — the most precise audio cassette ever.

52% LESS MODULATION NOISE.

And that's compared to our top-of-the-line MX tape. Thanks to a sturdier, fiberglass-reinforced guideblock, steel pins, wider pressure pad, and high precision crown-shaped rollers, Metal Vertex virtually eliminates tape fluctuation. Plus our proprietary Techno-Silver backcoating reduces friction and further improves tape-running stability. All of which makes for a tape with the lowest modulation noise level available. Anywhere.

A REVOLUTIONARY  
NEW CASSETTE SHELL.

To better absorb outside vibrations, our new three-piece shell is made of a highly visco-elastic, super composite material with almost twice the specific gravity of that found in most cassettes. Yet what

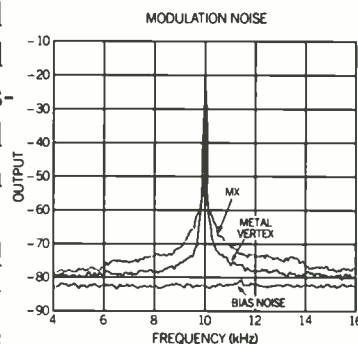
makes this mechanism truly unusual is the golden emblem center, which is not simply decorative but serves to dampen external vibrations even further. Bad vibes aside, our new Metal Vertex cassette shell also provides unmatched durability and heat resistance.

WIDER DYNAMIC RANGE AND  
THE HIGHEST MOL IN EXISTENCE.

The Metal Vertex magnetic coating consists of extremely fine (.3 micron) metal particles, packed together with high density through a process called parallel bundling. That not only increases dynamic range, it pushes the Maximum Output Level 1db to 2db higher than our MX tape (depending on frequency). That, in turn, allows for a substantial improvement in sensitivity and an astonishing 40% reduction in distortion.

If you're surprised by all these incredible specs, don't be. Remember, Maxell has always been at the forefront of creating magnetic tape for the world's most sophisticated equipment. So if what you're recording demands superior reproduction, look to Metal

Vertex from Maxell. Anything less and you don't have a prayer.





0004520

**Metal Vertex 90**

**maxell**

ANTI-MODULATION NOISE CASSETTE MECHANISM  
THREE-PIECE CONSTRUCTION

**Techno-Silver Back Coat**

**A**



**McIntosh® C35**  
**SYSTEM CONTROL CENTER**

Handcrafted with pride in the United States

# SUPERIOR SOUND McIntosh® QUALITY



The C35 System Control Center is an outstanding expression of McIntosh research into user desires consistent with high quality music reproduction.

- Engineering that is aggressively inquisitive in the search for better ways to bring these user dictated requirements to a technologically superior, innovative and clearly useful result.
- Appearance design that has long life, complements the living style, is complimentary to the owner, and is made of materials, whose characteristics permit 'a like new always' appearance.
- Easy to operate; The unique McIntosh designed panels are always easily readable in your choice of home

lighting. They are obviously designed by human beings for human beings.

- Manufactured of carefully specified and selected component parts that have high quality and long predicted life.
- Assembled by highly trained craftspeople who are dedicated to quality, accuracy and perfection.
- Thorough verification of the desired capabilities and quality of performance by constant and complete testing throughout the entire manufacturing process.

The McIntosh C35, above all others, will satisfy these requirements while it gives you the best sound, the most flexibility, and the greatest ease of use.

The C35 has many useful features to enhance your listening and video enjoyment. They include: High level inputs to accommodate the traditional as well as all the latest audio sources. Any one of nine input sources can be selected from the front panel or by the handheld IR remote. Electronic tape monitor switches for two audio tape recorders, or the audio from two video recorders, or one audio recorder and the audio from one video recorder, allow either recorder to be heard from the main output.

Volume is adjusted by a motor driven precision potentiometer. Left/right tracking accuracy is controlled to a fraction of a dB. Volume is displayed on the front panel by LED's which display the percentage of rotation of the volume control.

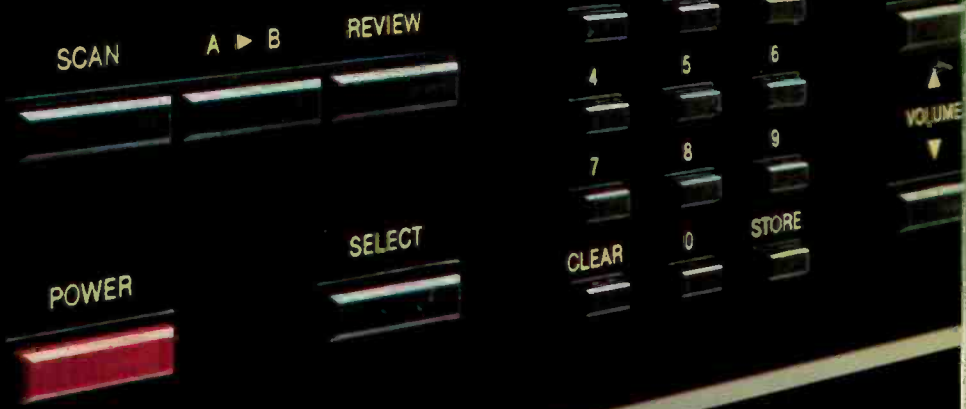
A five-band program equalizer permits the adjustment and improvement of the loudness contrast of five important frequency ranges. Musical balance of source material can be adjusted to compensate for room recording differences or listener preferences.

McIntosh Engineering has carefully and expertly merged the many contributing elements into a superior quality, versatile and outstanding value, the McIntosh C35 System Control Center.

For information on McIntosh products and product reviews please send your name, address and phone number to:

McIntosh Laboratory Inc.  
Department A904A  
PO Box 96 East Side Station  
Binghamton, NY 13904-0096

by dedicated, highly trained craftspeople.



PANLOC

**McIntosh® MCD 7007  
COMPACT DISC PLAYER**

**Handcrafted with pride in the United States**

# SUPERIOR SOUND

# McIntosh®

# QUALITY



The McIntosh MCD 7007 Compact Disc Player moves performance to a new pinnacle of technological achievement producing the highest quality music reproduction. Every aspect of performance is improved: focusing and tracking, decoding, error correction, digital filtering, digital to analog conversion. Even with dirty or damaged discs, even when the player is bumped or knocked, the music retains its surpassing purity. The full integrity of the sound is preserved from the first readout of the compact disc straight through to the gold-plated connectors on the output.

"The unit's broad dynamic range, very low inter-modulation, and excellent transitory response enhances each of the orchestra's instruments in superbly-colored sounds."\*

The value of all-integrated electronics is already well recognized. The advanced integration techniques in the MCD 7007 provide virtually all digital functions within the integrated circuits. Even the self-regulating and reference circuits are designed in the new VLS (very large scale) integrated circuit. You gain value because the VLS eliminates the need for factory adjustment. There is nothing to adjust so nothing can go out of adjustment assuring constant highest quality sound. You get very high standards of performance, consistency and reliability.

Demodulation, full-performance, error detection and correction and basic concealment of uncorrectable audio data are all performed in the VLS chip. This highly-advanced concept takes performance closer than ever to the theoretical maximum.

"Tone transcription, melodies, and accompaniments have a "spontaneous" beauty. Refined, transparent, and sumptuous are words that reflect the MCD 7007. --- interwoven throughout is the famous "McIntosh" sound, which can be described as synonymous with power, dynamism, and flawlessness."\*

"Truly, the McIntosh MCD 7007 Compact Disc player sets superlative new standards for musical purity and enjoyment. The massive effort of McIntosh engineers --- allows us to discover a universe of sound in which the least subtleties of harmonic tonal structure and the smallest of range changes are heard in just the right places."\*

For information on McIntosh products and product reviews please send your name, address and phone number to:

McIntosh Laboratory Inc.  
Department A904C  
PO Box 96 East Side Station  
Binghamton, NY 13904-0096

\**Revue Du Son*

by dedicated, highly trained craftspeople.

Enter No. 16 on Reader Service Card



**McIntosh® MC 7270**

**DIGITAL DYNAMIC STEREO POWER AMPLIFIER**

**Handcrafted with pride in the United States**



# SUPERIOR SOUND McIntosh® QUALITY



The McIntosh MC 7270 power amplifier is designed to fulfill Digital Dynamic Range demands. It outperforms all competitors when listening to sound derived from digitally recorded tapes and compact discs.

"That a manufacturer can remain faithful to a certain listening style, to a "sound signature" recognizable by all through electronics even so different always astonishes. Such is the case of McIntosh where, in spite of the

change from tubes to transistors and from medium to high power, the basic McIntosh quality has not changed with the added benefit of an enormous reserve of power. Witness the MC 7270 for which this reserve of power sensation reaches almost the "colossal".\*

The compact disc is capable of **real life dynamic range** while noise generated from compact discs is inaudible. With the noise restraint removed it is both easier and dramatically more enjoyable to listen to music at much louder levels. To fully enjoy this new capability your amplifier must be able to receive three to ten decibels of overstress from music, and it must do this without severely distorting the sound! This is the real world of Digital Dynamics demand. How to achieve the performance demanded, which often lasts from minutes to only a few thousandths of a second, and to achieve the goal economically, is a real achievement. Power Guard is that achievement.

"The Power Guard system is most effective in making it impossible to hardclip the output of the amplifier. Regardless of how hard it is driven, it simply cannot develop an audible amount of distortion on musical program material - - - . This feature should also mean a greatly reduced likelihood of blowing out a speaker, since clipping is a common cause of tweeter damage."\*\*

McIntosh leadership in engineering has developed the Power Guard circuit which—(1) dynamically prevents power amplifiers from being overdriven into hard clipping—(2) assures that the amplifier will produce its maximum output without increased distortion—(3) protects your speaker from excessive heating. Power Guard is a patented McIntosh design (U.S. patent #4,048,573).

"The feeling of power is never refuted and instead of stunning the listener, the 7270 recreates an audio environment of a majesty that no other transistor amplifier is capable of reproducing as well."\*

For information on McIntosh products and product reviews please send your name, address and phone number to:

McIntosh Laboratory Inc.  
Department A904B  
PO Box 96 East Side Station  
Binghamton, NY 13904-0096

\**Revue Du Son*  
\*\**Stereo Review*

by dedicated, highly trained craftspeople.

Enter No. 16 on Reader Service Card

AK - ANCHORAGE: PYRAMID AUDIO  
 AL - HUNTSVILLE: PALM AUDIO  
 AL - FAYETVILLE: STEREO ONE • FT. SMITH: STEREO ONE • JONESBORO: PRO AUDIO  
 SOUND • LITTLE ROCK: CUSTOM AUDIO  
 AZ - PHOENIX: BUZZ JENSEN'S SOUND ADVICE • TUSCON: WILSON AUDIO  
 CA - AUBURN: WOODEN SHIP STEREO • BERKLEY: HONKERS • BURLINGAME: KUSTOM  
 HI FI • CAMPBELL: SOUND GOODS • CARLSBAD: SHELLEY STEREO • CHICO: CHICO  
 SOUNDS BY DAVE • DAVIS: STEREO IMAGE • DUBLIN: STEREO DOCTOR • EUREKA:  
 SOUND ADVICE • FRESNO: VALLEY STEREO • MODESTO: PARADYME •  
 MOUNTAINVIEW: SOUND GOODS • REDDING: CLYDE'S HOME ENT. • REDONDO  
 BEACH: SYSTEMS DESIGN GROUP • RIVERSIDE: SPEAKERSRAT • SACRAMENTO:  
 PARADYME • SAN CARLOS: HERIMARY'S • SAN DIEGO: SOUND COMPANY • SAN  
 FRANCISCO: MARYBURNS PERFORMANCE AUDIO • SAN MARCOS: SOUND COMPANY  
 • SANTA MONICA: CA • SANTA CRUZ: WATER ST. STEREO • SANTA  
 ROSA: GOLDEN EAR • WALNUT CREEK: AUDIO DISTRIBUTION  
 CO - BOULDER: THE STEREOHOLE • COLORADO SPRINGS: THE SOUND SHOP • DENVER:  
 PIETOLS STEREO • FORT COLLINS: AUDIO JUNCTION  
 CT - NEW CANAAN: AUDIO IMAGE  
 DE - PINE CREEK (WILMINGTON): HI FI HOUSE  
 FL - BOCA RATON: VERN'S ELECTRONICS • BRADENTON: AUDIO WORKSHOP •  
 JACKSONVILLE: BEHRENS AUDIO • LAKELAND: SOUND FACTORY • LAKE WORTH:  
 AUDIO ADVISORS • LEESBERG: NIGHTMING • MIAMI: CLOVER AUDIO • ORLANDO:  
 ELECTRONIC SHOP • PENSACOLA: AUDIO DISTRICTIONS • PORT ST. LUCIE: SOUTHERN  
 AUDIO • TAMPA: AND VISORS  
 GA - ATLANTA: STEREO VIDEO DESIGNS  
 IA - DAVENPORT: AUDIO ODYSSEY • DES MOINES: AUDIO LABS • IOWA CITY: HW/WKEYE  
 AUDIO  
 ID - BOISE: STEREO SHOPPE • BURLEY: SOUND COMPANY • TWIN FALLS: SOUND  
 COMPANY  
 IL - ALGONQUIN: TEAM ELECTRONICS • AURORA: STEREO SYSTEMS • BLOOMINGDALE:  
 AUDIO VISIONS • BURBANK: DIGITAL TV/AUDIO • CHAMPAIGN: GLEN POOR'S •  
 CHICAGO: AUDIO ENTERPRISES, MILLS RECORDING, PRO MUSICA • CHICAGO  
 HEIGHTS: AUDIO ENTERPRISES • CLARENDON: SOUNDS DELUXE • FAIRVIEW: HI FI FO  
 FUN • GURNEE: OPTI RECORDING • KENOSHA: OPTI SYSTEMS • KANKAKEE: BARRIETS  
 • MORFON GROVE: MEDIA ROOM • MURPHYSBORO: SABIN AUDIO • NAPEEVILLE:  
 STEREO SYSTEMS • NORMAL: GLEN POOR'S • PEORIA: SOUND OF PEORIA •  
 ROCKFORD: ABSOLUTE AUDIO STORE • STERLING: STERLING ELECTRONICS  
 KY - WICHITA: CUSTOM SOUND  
 KS - LOUISVILLE: AUDIO VIDEO BY DESIGN  
 LA - BATON ROUGE: ART COLLEY AUDIO • LAKE CHARLES: CLASSIC AUDIO • NEW  
 ORLEANS: WILSON AUDIO • SHREVEPORT: AUDIO FIDELITY  
 MA - CAMBRIDGE: G. AUDIO • NORTH DARTMOUTH: SOUND II • NORTHAMPTON:  
 SOUND & MUSIC • WELLESLEY: MUSIC BOX • WORCESTER: OCEANS  
 MD - BALTIMORE: SOUNDScape  
 ME - FALMOUTH: HI FI EXCHANGE  
 MI - DETROIT: PECAR ELECTRONICS • ELANSING: JEMSTONE AUDIO • GRAND RAPIDS:  
 ELECTRONIC SOUND • JACKSON: SOUNDS PERFECT • NOV: PECAR ELECTRONICS  
 MN - MINNEAPOLIS: STEREO LAND • ROCHESTER: AMALGAMATED AUDIO • ST. PAUL:  
 HOUSE OF HIGH FIDELITY  
 MO - ST. LOUIS: HI FIDELITY FUM  
 MS - JACKSON: CUSTOM AUDIO • STARKVILLE: IDEAL ACUSTICS  
 MT - BOZEMAN: THIRSTY EAR • MISSOULA: ELECTRONIC PARTS  
 NC - CONOVER: AUDIO HAUS • DURHAM: AUDIO VISIONS • GREENVILLE: TODD'S  
 STEREO  
 ND - FARGO: TODAY ELECTRONICS  
 NH - KEENE: INTERFACE • NASHUA: TECH HI FI • NEW LONDON: NORTH STAR  
 ELECTRONICS • WEST LEBANON: AUDIO ARTS  
 NJ - CHERRY HILL: HI FI SALES • DEPTFORD: HI FI CONNECTION • EATONTOWN: HI TECH  
 STEREO • KINNELON: SOUND CITY • MARLTON: HI FI CONNECTION • MORRISTOWN:  
 SOUTH HORIZON  
 NM - ALBUQUERQUE: ABSOLUTE AUDIO STORE • CLOVIS: TOWN CRIER  
 NV - RENO: WILD WEST STEREO  
 NY - ALBANY: MOM'S STEREO • ALLEGANY: SOUNDTRACK • BINGHAMTON: HART  
 ELECTRONICS • BUFFALO: SPEAKER SHOP • HUDSON FALLS: VIDEO VISIONS AUDIO  
 TOOLS • LAKE GROVE: AUDIO DEN • NEW YORK CITY: AUDIO SALON, PARK PLACE  
 AUDIO • ONEONTA: ANDRITRACIA ELECTRONICS • WEST BABYLON: AUDIO VISIONS  
 AUDIO EXCELLENCE • ROCHESTER: ROWE PHOTO/AUDIO • SALAMANCA:  
 SOUNDTRACK • SYRACUSE: GORDON ELECTRONICS • WAPPINGERS FALLS: SOUND  
 COMPANY • WATERBURY: GORDON ELECTRONICS • WEST BABYLON: AUDIO VISIONS  
 OH - AKRON: OHIO SOUND • CINCINNATI: STEREO STORE • AND MORE • DAYTON:  
 AUDIO ETC. • NILES: SOUND CHOICE • SANDUSKY: AUDIOWORKS • TOLEDO:  
 JAMESON'S STEREO • YOUNGSTOWN: SOUND CHOICE  
 OK - MUSKOGEE: SOUND STATION • LAWTON: AUDIO TECH • OKLAHOMA CITY:  
 AUDIO MIXER • STILLWATER: AUDIO SOUND • TULSA: WIPRTRAC SOUND  
 OR - BEND: STEREO PLANT • CARVALLAS: NORTHWEST AUDIO • LAKE OSWEGO: POSH  
 AUDIO • PORTLAND: HAWTHORNE STEREO • SALEM: HEAR NO EVIL  
 PA - BROOMALL: HI FI HOUSE • DOYLESTOWN: SOUND ADVICE • ERIE: CUSTO AUDIO  
 • GREENSBURG: THE BEECH • HUNTER: EAR STEREO • MILTON: LAMPSON'S  
 • MONROEVILLE: AUDIO COMMUNICATIONS • PHILIPSBURG: ROSSSELL'S • PITTSBURGH:  
 AUDIO GALLERY • STATE COLLEGE: PAUL & TONY'S • SCRANTON: HART ELECTRONICS  
 • WILKES BARRE: HART ELECTRONICS • WEXFORD: AUDIO INSIGHT • YORK: AUDIO  
 CLARK  
 RI - PROVIDENCE: STEREO CENTER  
 SC - CHARLESTON: INTERNATIONAL HI FI • COLUMBIA: AUDIO ALTERNATIVES •  
 GREENVILLE: AMERICAN AUDIO • MILTON HEAD: SOUND IDEAS  
 TN - JOHNSON CITY: MR. TOADS • KNOXVILLE: HI FI AUDIO • NASHVILLE: TENZEL'S  
 AUDIO  
 TX - ABILENE: SOUND EFFECTS • AUSTIN: MARCIUM ELECTRONICS, AUDIO  
 CONNECTIONS • BEAUMONT: SALMAD AUDIO • BRYAN/COLLEGE STATION: SOUND  
 WAVES • CORPUS CHRISTI: TAPE TOWN AUDIO VIDEO • DALLAS: HILLCREST FIDELITY  
 • HOUSTON: ALLSTAR AUDIO, ESOTERIC EAR • LARDO: JETT AUDIO • MIDLAND:  
 MIDLAND SOUND • NACOGDOCHES: SPINEL MUSIC • ODESSA: SOUND CONNECTION  
 • SAN ANTONIO: AUDIO CONNECTIONS • SAN ANGELO: SOUND BOX • TEXARKANA:  
 SOUND TOWNE • WICHITA FALLS: AUDIO TECH  
 UT - SALT LAKE CITY: AUDIOWORKS  
 VT - S. BURLINGTON: CITY STEREO • MIDDLEBURY: SOUND SOURCE  
 WA - BELLEVUE: HAWTHORNE STEREO • RICHLAND: QUICKSILVER AUDIO • SILVERDALE:  
 EVERGREEN AUDIO • SPOKANE: HAI S STEREO  
 WI - APPLETON: SUESS AUDIO • FOND DU LAC: PRO AUDIO VIDEO • MADISON: HIGH  
 PERFORMANCE AUDIO • MILWAUKEE: GENERAL ELECTRONICS  
 WY - MORGANTOWN: SOUND INVESTMENTS  
 WY - LARAMIE: MUSIC BOX

CANADA  
 AB - CALGARY: K&W AUDIO • EDMONTON: AUDIO AID • RED DEER: AUDIOVIDEO  
 BC - CHILLIWACK: SOUND AROUND • CRANBROOK: ALL STAR AUDIO • KELOWNA:  
 KELOWNA SIGHT & SOUND • NANAIMO: SOUND ATTRACTIONS • POWELL RIVER:  
 SOUND ATTRACTIONS • PRINCE GEORGE: J&A STEREO • QUEENSLAND: QUEENSLAND  
 ELECTRONICS • RICHMOND: SIGHT & SOUND STEREO HEAVEN • TRAIL: ROCK ISLAND  
 TAPE CENTRE • VANCOUVER: SIGHT & SOUND (BROADWAY), SIGHT & SOUND  
 (CENTRAL), ON 4TH AUDIO • VICTORIA: EDGEWATER SOUND • WILLIAMS LAKE: HI FI  
 EXPRESS  
 SK - REGINA: KRAZY KLEY • SASKATOON: KRAZY KLEY  
 MB - WINNIPEG: CREATIVE AUDIO, GILLAM SOUND  
 NB - FREDERICTON: MAGIC FOREST MUSIC STORE • MONCTON: HI FI EXPRESS • ST.  
 JOHN: WADSWORTH HI FI • WOODSTOCK: DICKENSON'S STEREO  
 NF - GRAND FALLS: DEAN'S RADIO  
 NS - BRIDGEWATER: SHORE SOUND • NEW GLASCO: BACKMAN VIDEO.COM, KELLYS  
 ELECTRONIC WORLD MUSICSTOP • HULLIFORD: C.P. SMITH • NEW MINAS:  
 LYRIC AUDIO • SYDNEY: SOUNDAREX  
 ON - AJAX: HI FI PHOTO AUDIO • BARRIE: JERRY'S RADIO • BELLEVILLE: DECEBEL AUDIO  
 • BRACEBRIDGE: BRACEBRIDGE TAPES • BRANTFORD: BRANT STEREO • BROCKVILLE:  
 1000 ISLANDS ELECTRONICS • BURLINGTON: FAIRVIEW HI FI • CHATHAM: CAPRI  
 STEREO • COBOURG: UNIV. TV • CORNWALL: THE RALLI ELECTRONICS • DRYDEN:  
 SOUND OF MUSIC • FORT FRANCES: GIFT & SOUND • GUELPH: MICRO TONE  
 • HAMILTON: GLOE AUDIO • KINGSTON: JERN NAPPERS • KITCHENER: NATURAL  
 SOUND • LONDON: POWER STATION • MIDLAND: AUDIO SHOPPE • MISSISSAUGA:  
 FAIRVIEW ELECTRONICS • NEWMARKET: LITTON'S ELECTRONICS • NIAGARA FALLS:  
 SELECT AUDIO • NORTH BAY: POPULAR AUDIO • ORILLIA: AUDIO PLUS • ORLEANS:  
 SOUND ADVICE • OSHAWA: CONABYS STEREO • OTTAWA: SOUND ADVICE  
 (MURRAY) SOUND ADVICE (RANK) • OWEN SOUND: PALLS AUDIO • PEMBROKE:  
 SOUND SOUND • PENROBROUGH: AUDIO ROOM • SARINIA: ST. CLAIR STEREO •  
 SCARBOROUGH: FAIRVIEW ELECTRONICS • ST. CATHARINES: ELECTRONIC SERVICE  
 CENTRE • STRATFORD: MUSIC • SUBURRY: TOTAL SOUND & SOUND • THORNHILL: STEREO  
 FACTORY • THUNDER BAY: POWER CENTRE AUDIO • TORONTO: FAIRVIEW  
 ELECTRONICS (ALBION), FAIRVIEW ELECTRONICS (YONGE) STEREO FACTORY •  
 WATERLOO: NATURAL SOUND • WINDSOR: LIVE WIRE AUDIO  
 PQ - ANJOUI: SON-OR • HATFIELD: BOURJOIS LTD. • LAVAL: MUSIQUELITE • LONGUEUIL:  
 PARADYME AUDIO • MONTREAL: TELTRON, LOUVERNE SOUND STUDIO •  
 QUEBEC CITY: CORA • ROUYIN: TELEVISION JLT • SEPT ILES: SEPT ILES  
 SHERBROOKE: BOURGET STEREO • SOREL: LA BOUTIQUE DU SON • ST. AGATHE DES  
 MONTS: DEMONSTRATION • ST. ANACLET: ARCHIVES SONORES • ST. HUBERT: ATTELER  
 ELECTRO ACUSTIQUE • ST. JEAN RICHIEL: PANGIN AUDIO • ST. HYACINTHE:  
 MICHEL ST. PIERRE AUDIO • TROIS-RIVIERES: LE DOMAINE DU SON • VAL D'OR: BN  
 ELECTRONIQUE • VICTORIAVILLE: MAYRAND FRERES  
 YK - WHITEHORSE: KELLYS ELECTRONIC WORLD

# AUDIOCLINIC

JOSEPH GIOVANELLI

## FM Antenna Length

Q. I am cutting wire to construct an indoor FM antenna. Is there a formula by which to calculate the optimum length of an antenna used for FM reception for the carrier frequency of a given station? I am mainly interested in receiving stations between 88.5 and 91.1 MHz.—Name withheld

A. I don't think that getting too serious with math will help you very much. The Q of a typical FM dipole antenna is rather low. This will mean that the length can be off quite a bit and the strength of the received signals will not drop off very much. If the antenna is to be used indoors, it is not in the clear, as it should be if it is to operate according to theory.

To give you a flavor for wavelength calculations, the speed at which radio waves at any frequency travel in space is about 186,000 miles per second—or 300,000,000 meters per second.

This speed is constant regardless of the wave's frequency. If the frequency is low, the number of such waves passing you each second is small, and the length of each wave will be large. As the frequency goes up, the wavelength goes down—you can calculate it by dividing the wave's speed by its frequency. A frequency of 100 MHz, roughly in the middle of the FM band, will have a wavelength of about 3 meters (300 million meters per second divided by 100 million Hz), or about 9 feet, 10 inches. Most antennas are half the wavelength (some are a quarter wavelength), so you can divide the wavelength by two and be close.

Now that you have the idea, here's a shortcut as long as you keep your frequency in MHz. To obtain a half wavelength for an antenna in feet, divide 468 by the frequency in MHz. Thus, the length of the antenna for 100 MHz is 4.68 feet. The length of an antenna for 88.5 MHz is 5.29 feet. The length needed for proper resonance at a frequency of 91.1 MHz is 5.14 feet.

If your antenna is a form of "rabbit ears," you'll end up adjusting the length of the two elements for maximum signal strength and make no calculations at all!

## MM Cartridge Considerations

Q. I own two moving-magnet cartridges. The cheaper cartridge has

more output than the more expensive one, 4.6 mV as opposed to 3 mV; I like the sound of its high end better than that of the more costly cartridge. Which unit is really better, and what specs can I use to determine the best cartridge, whether the "best" is what I already own or not?—Gusztav Marokity, Van Nuys, Cal.

A. The cartridge which sounds best to you is the one you should use, regardless of its price or other considerations. Wanting to be sure we have the best is fine up to a point. Yet because of the subjective nature of the way we perceive what we hear, there is no absolute best cartridge or other audio product. In fact, even my own thoughts on this matter are subjective.

You might also find that the more pleasing high end you hear from your less expensive cartridge is not just a function of the cartridge's own performance but of other factors in your system which affect its response, such as the load resistance and load capacitance into which the cartridge works. For flattest frequency response, the proper capacitance must be provided by a combination of the phono cable's capacitance and that of the preamplifier's input. The load resistance should also be correct; for the most part, this is standardized at 47 kilohms for moving-magnet cartridges, and most phono inputs have this resistance value.

It is best if your equipment's phono input sensitivity specification is lower than your cartridge's output voltage spec. This insures sufficient output from your system and also results in the best possible signal-to-noise ratio for your system. If your system produces more than sufficient output and its signal-to-noise ratio is greater than the background noise of the records themselves, you will probably be able to use a cartridge having less output than is expected by your phono inputs.

The mass of your tonearm may also be important when attempting to find the "best" cartridge. The maker of the tonearm will usually offer guidelines as to cartridge requirements.

If you have a problem or question about audio, write to Mr. Joseph Giovanelli at AUDIO Magazine, 1633 Broadway, New York, N.Y. 10019. All letters are answered. Please enclose a stamped, self-addressed envelope.

# THE SHOCKING TRUTH!

Speakers are *the most important part* of your stereo system. It is the speaker that turns amplifier signal into sound and so ultimately determines what you hear. If your speakers do not perform well, your stereo system will simply not sound like music.

The search for musically satisfying speakers, however, can lead to some very expensive products. And if you have already bought those high priced speakers, then you better not listen to Paradigms. But if you haven't, better not miss them. Why? Because from the time they were first introduced, Paradigm's sheer musical ability utterly amazed listeners.... but what caused even more amazement was the *unprecedented low price*.

The shocking truth is, you no longer have to amass a small fortune to buy speakers that will satisfy your love of music. Simply visit your authorized Paradigm dealer.... *and listen*.

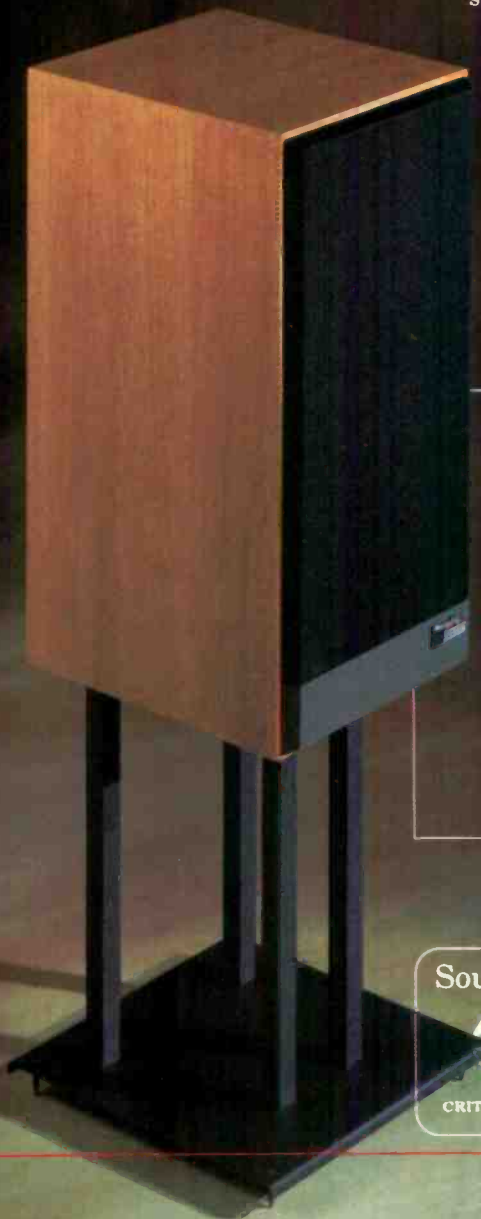
#### *The critics agree:*

"... natural, open and clear...excellent depth... lots of hall sound... big, expansive soundstage... well defined... a rare achievement for any loudspeaker, but when price is taken into account the Paradigm's performance must be considered as nothing short of remarkable."

- *Sound & Vision Magazine*

"... we can't think of another speaker at or below this price that manages to match the Paradigm's overall sense of balance and competence... exceptional value."

- *Hi Fi Heretic Magazine*



## Paradigm<sup>®</sup>

*music . . . above all.*

In the U.S.: AudioStream, MPO Box 2410, Niagara Falls, New York 14302  
In Canada: Paradigm Electronics Inc., 457 Fenmar Drive, Weston, Ontario M9L 2R6

Enter No. 6 on Reader Service Card

# DoAsThe

If you share the beliefs of the most serious audiophiles, *Audio* magazine is something you live by. And if you saw the March 1990 issue, you must surely see the wisdom of TDK.

But in case you missed it, allow us to enlighten you.

In that issue, *Audio* revealed the results of a massive test it conducted among 88 blank audio cassettes. And all it could do was praise TDK.

**AUDIO MAGAZINE RATED  
TDK AR-X #1 OVERALL AMONG ALL  
NORMAL BIAS CASSETTES.**

The test began with *Audio* evaluating and comparing normal bias Type I cassettes from virtually every conceivable manufacturer.

After the data was polled, *Audio* concluded TDK AR-X was not only the best Type I tape, but "... close to the best for Type II as well." A finding that isn't all that surprising considering the technology that goes into AR-X, which results in the



highest high-frequency SOL.

**AUDIO MAGAZINE RATED TDK SA-X  
THE #1 HIGH BIAS CASSETTE IN TERMS  
OF DYNAMIC RANGE (S/N RATIO).**

The next area for review was the high bias Type II segment. And in this highly

competitive arena, the engineer *Audio* used found the performance of TDK no less impressive: TDK SA-X, with its dual coating of Super Avilyn particles, has the

# Bible Says.

example of which is the MA-XG. And by the end of the test, it was the chosen tape of *Audio*.

After a close and exhaustive scrutiny of Type IV tapes, based on several parameters, TDK MA-XG was not only the choice as the best Type IV tape, but also the best tape on the market. Period.

So why not write to TDK Reprints, P.O. Box 166, 70A Greenwich Ave., New York, NY 10014, for a condensed reprint of the ultimate tape test from the ultimate authority.

If you're serious about your sound, you'll practice what *Audio* preaches, and use TDK.



widest dynamic range of any high bias tape. Which perhaps explains why serious audiophiles have always found CD recordings made on TDK SA-X to be so incred-

ibly faithful to the original.

**AUDIO MAGAZINE RATED TDK METAL MA-XG #1 OF ALL 88 TAPES TESTED.**

TDK has a long history of innovation in metal tape technology, the most recent

As Serious  
As You Can Get.

# TAPE GUIDE

HERMAN BURSTEIN

## Setting Record Level

*Q. What is the proper way to set record level? Should I set it once and use the same setting throughout the tape, or should I reset it for each cut? I usually set the level at the beginning of recording, but on playback my deck's meters go up to maximum on some cuts and down to -5 or -7 dB on others.—John DeRosa, Mattapan, Mass.*

A. I am not sure what you mean by "cuts." Do you mean sections of a phono record or CD? If these sections are related, such as movements of a symphony or parts of a song cycle, then it is best to set record level at the beginning and leave it alone throughout taping. However, if the cuts are unrelated, such as a collection of popular songs originally recorded at various times and places by one person, it would be appropriate to set the record level individually for each selection, if you wish. Still, this isn't really necessary, because tape decks today provide such a high S/N ratio that it isn't important to get the last iota of recording level on the tape in order to maximize S/N. Wasting a few dB of S/N isn't likely to interfere with listening pleasure.

Back in the days before noise reduction, when the best S/N ratios you could get from tape decks were relatively low—around 50 dB and sometimes even lower—recordists would sometimes "ride gain" when taping. That is, they would keep the record level quite high to maximize S/N, and they would temporarily reduce gain during crescendos (assuming they knew loud passages were coming) to avoid tape saturation, with consequent distortion and treble loss. This resulted in a loss of dynamic range, but such a loss was often considered preferable to the insistent hiss and hum of tape recording when the state of the art was less developed. Today, though, S/N is generally high enough that one can afford to underrecord.


## Transplanting Heads

*Q. I am considering transplanting the heads from one cassette deck to another. The donor is a deceased three-head deck, and the recipient is a two-head model. A four-pole double-throw switch would be added to alternate the head between record and*

*playback. Aside from mounting and alignment problems, might this work? Should I expect irregularities in frequency response?—Mark Slagell, Madison, Wisc.*

A. Assuming that you can satisfactorily mount and align the replacement heads—not an easy task—I think they have a good chance of working adequately, provided that you use the former playback head as the new record/playback head. The playback head has a much narrower gap than the record head—roughly one-fifth as wide—and this is essential to preserve high-frequency response in playback.

On the other hand, the playback head may have too narrow a gap for good recording, which would increase distortion and reduce response in the lower audio range. The narrow gap tends to act as a short-circuit, preventing the magnetic field from penetrating the tape as deeply as it should. For this reason, heads designed for combination record/playback use have somewhat wider gaps than those intended solely for playback. (To illustrate, a record/playback head might have a gap 1.2 microns wide, whereas a playback-only head might have a gap of 1 micron or less. The narrower the gap, the better the high-frequency response in playback. The difference between gaps of 1.2 microns and of 1 micron or less is of consequence.)

Bias employed in recording will probably have to be changed to obtain suitably low distortion along with suitable high-frequency performance. It may be more difficult to drive the required amount of bias current through the new (formerly playback-only) head than through the old record/playback head, requiring an increase in current supplied by the oscillator—or it may be the other way around. Also, it may be necessary to adjust calibration of the record level indicators so that they will adequately indicate maximum permissible recording level. This is because the strength of the magnetic field applied by the head to the tape will vary with the head that is used. 

If you have a problem or question on tape recording, write to Mr. Herman Burstein at AUDIO, 1633 Broadway, New York, N.Y. 10019. All letters are answered. Please enclose a stamped, self-addressed envelope.

## PARTICIPATING LOCATIONS

- ALASKA**  
PYRAMID AUDIO, ANCHORAGE
- ARIZONA**  
HASSLER'S, PHOENIX—HI FI SALES, MESA—WILSON'S AUDIO, TUCSON
- ARKANSAS**  
AUDIO WORLD, LITTLE ROCK—NO LITTLE ROCK—HI FI HOUSE, BATESVILLE—STEREO JUNCTION, PINE BLUFF—STEREO ONE, FAYETTEVILLE
- CALIFORNIA**  
ATLANTIC STEREO, COSTA MESA—AUDIO ECSTASY, SAN LUIS OBISPO—AUDIO VIDEO CITY, CULVER CITY—BOOTS CAMERA, VIDEO, AUDIO, FRESNO—CLYDES TV, REDDING—CREATIVE STEREO, CARPENTERIA—GOLETA SANTA BARBARA—SANTA MARIA, THOUSAND OAKS—VENTURA—DAVID RUTLEDGE AUDIO, PALM SPRINGS—DB AUDIO, BERKELEY—DIGITAL EAR, TUSTIN—DOW STEREO, CHULLA VISTA—EL CAJON, ESCONDIDO—SAN DIEGO—VISTA—EBER ELECTRONICS, MENLO PARK—SAN FRANCISCO—EUREKA AUDIO/VIDEO, EUREKA—FUTURVISION, NAPA—GLUSKINS, STARKTON—THE GOLDEN EAR, CHICO—MARCONI RADIO, GLENDALE—PARIS AUDIO, WEST LOS ANGELES—WOODLAND HILLS—ROGERSOUND LABS, CANOGA PARK—EL TORO PASADENA—SANTA MONICA—TORRANCE—VAN NUYS—WESTMINSTER—ROYAL SOUND, LOS ANGELES—SHERMAN OAKS CAMERA & SOUND, SHERMAN OAKS—SOUND GOODS, CAMPBELL—MOUNTAIN VIEW—STEREO UNLIMITED, CONCORD—FAIRFIELD—TURNTABLES UNLIMITED, SACRAMENTO—WATER STREET STEREO, SANTA CRUZ—WESTCHESTER TV, BAKERSFIELD—WILSHIRE TV, LOS ANGELES
- COLORADO**  
AUDIO JUNCTION, FT COLLINS—LISTEN UP, BOULDER—DENVER—COLORADO SPRINGS—SOUND SHOP, COLORADO SPRINGS
- CONNECTICUT**  
AUDIO ETC., NEW HAVEN—COUNTY AUDIO, STAMFORD—HI FI CONSULTANTS, DANBURY—SOUND I, NORWICH—SOUND UNLIMITED, BRISTOL
- DELAWARE**  
HI FI HOUSE OF DELAWARE, WILMINGTON
- FLORIDA**  
AUTO AUDIO & STEREO STORE, TALLAHASSEE—CONSUMER CENTER, TAMPA—ELECTRONICS CREATIONS, ALTAMONTE SPRINGS—ELECTRONICS ENVIRONMENTS, ORMOND BEACH—HOUSE OF HIGH FIDELITY, NAPLES—HOYT HI FIDELITY, JACKSONVILLE—ISLAND AUDIO/VIDEO, MERITT ISLAND—SALON OF MUSIC, WEST PALM BEACH—SOUND ADVICE, ALTAMONTE SPRINGS—BOCA RATON—CLEARWATER, CORAL GABLES—DANIA—FT LAUDERDALE—HIALEAH—HOLLYWOOD—MIAMI—NORTH MIAMI BEACH—ORLANDO—SARASOTA—ST PETERSBURG—SUNRISE—TAMPA—WEST PALM BEACH—SOUND IDEAS STEREO, GAINESVILLE—SUNCOAST SIGHT & SOUND, DUNEDIN—T.V.C., TEQUESTA—TV & MUSIC CENTER, ST PETERSBURG
- GEORGIA**  
AUDIO WAREHOUSE, SAVANNAH—G.A. MUSIC, MACON—HI FI BUYS, ATHENS—ATLANTA—DULUTH—KENNESHAW—MORROW—NORCROSS—RIVERDALE—SMYRNA—TUCKER—HI FI SALES & SERVICE, THOMASVILLE—MELTONS PRO SOUND, ATLANTA—DORALVILLE
- IDAHOW**  
GOOD EAR AUDIO, BOISE—INFINITE AUDIO, KETCHUM—SOUND COMPANY, BURLEY, TWIN FALLS
- ILLINOIS**  
CENTURY AUDIO VIDEO, CRYSTAL LAKE—GOOD VIBES SOUND, INC., CHAMPAIGN—MILLS RECORDING, CHICAGO—SABIN AUDIO VIDEO, MURPHYSBORO—STEREO SYSTEMS, AURORA—JOLIET—NAPERVILLE—SUNDOWN ONE, NORMAL—SPRINGFIELD—TEAM ELECTRONICS OF PEORIA, PEORIA—UNITED AUDIO CENTER, AURORA—CHICAGO—NILES—NORTHBROOK—SCHAMBERG—VERNON HILLS—VILLAGE TV, WILMETTE
- INDIANA**  
GOOD VIBES SOUND, LAFAYETTE—HJS SOUND, NEW HAVEN—TOM DOHERTY AUDIO, CARMEL
- IOWA**  
AUDIO ODYSSEY, DAVENPORT—IOWA CITY—GRIGGS MUSIC, DAVENPORT—STEREO SOUND STUDIOS, DES MOINES
- KANSAS**  
BRANDS MART, OVERLAND—RED BARON, WICHITA
- KENTUCKY**  
THE STEREO SHOPPE, LEXINGTON—LOUISVILLE—WILDER ELECTRONICS, LOUISVILLE
- LOUISIANA**  
ALTERMAN AUDIO, METAIRIE—NEW ORLEANS—KADAI'S SIGHT & SOUND, BATON ROUGE—SIMPSON ELECTRONICS, ALEXANDRIA
- MAINE**  
NEW ENGLAND MUSIC, SCARBOROUGH
- MARYLAND**  
AUDIO BUYS, GAITHERSBURG—GRAMOPHONE LTD, ELLICOTT CITY—LUTHERVILLE—PROFESSIONAL PRODUCTS, BETHESDA—SOUNDSCAPE, BALTIMORE
- MASSACHUSETTS**  
AUDIO STUDIO STEREO LAB, BOSTON—BROOKLINE—HIGH FIDELITY HOUSE, WORCESTER—NATURAL SOUND, FRAMINGHAM—Q AUDIO, CAMBRIDGE—SERVICE BENCH, NORWOOD—SOUND & MUSIC, NORTHAMPTON
- MICHIGAN**  
AUDIO DIMENSIONS, ROYAL OAK—AUDIOVISION, WEST BLOOMFIELD—POINTE ELECTRONICS, GROSSE POINTE WOODS—STEREO CENTER, FLINT—STEREO SHOPPE, ANN ARBOR—EAST LANSING—LANSING—SAGINAW—TRAVERSE CITY
- MINNESOTA**  
AUDIO KING, BROOKLYN CENTER—BURNSVILLE—EDINA—MANKATO—MINNEAPOLIS—MINNETONKA—ROCHESTER—ROSEVILLE—ST CLOUD—SIOUX FALLS—ST PAUL
- MISSISSIPPI**  
AUTOMOTIVE AUDIO, RIDGELAND—McLELLAND TV, HATTISBURG

# AUDIO INFORMATION MAGAZINE

TECHNOLOGY UPDATE #10

**MISSOURI**  
BRANDS MART, KANSAS CITY—SOUND CENTRAL LTD.,  
ST LOUIS—SPEAKER & STEREO STORE, KIRKWOOD—  
STEREO ONE, CAPE GIRARDEAU

**MONTANA**  
ASPEN SOUND, MISSOULA—ROCKY MTN HI FI, GREAT  
FALLS

**NEBRASKA**  
NEBRASKA APPLIANCE CENTER, NORFOLK—STEREO  
WEST, LINCOLN, OMAHA—U.S. TECH, GRAND ISLAND

**NEW HAMPSHIRE**  
CUOMO'S, SALEM—MELODY SHOP, KEENE—TECH HI FI,  
NASHUA

**NEW JERSEY**  
ABINGTON AUDIO & VIDEO, BURLINGTON—ATLANTIC  
STEREO, E. BRUNSWICK—AUDIO NEXUS, SUMMIT—  
COMTEL CORPORATION, WEST CALDWELL—HARVEY  
ELECTRONICS, PARAMUS—LANDES AUDIO, CHESTER—  
MONMOUTH STEREO, FARMINGDALE—SHREWSBURY—  
RECORD SHOP, CHERRY HILL—ROUTE ELECTRONICS  
17, PARAMUS—ROUTE ELECTRONICS 46, TOTOWA—  
SOUTH STREET STEREO, MORRISTOWN

**NEW MEXICO**  
HUDSON'S AUDIO CENTER, ALBUQUERQUE—THE  
CANDY MAN, LTD., SANTA FE

**NEW YORK**  
ALTAIR AUDIO, ALBANY—AUDIO EXCELLENCE,  
PLEASANTVILLE—AUDIO NOUVEAU, CANANDAIGUA—  
CHEMUNG ELECTRONICS, CORNING—ELMIRA—ITHACA—  
CONTINENTAL SOUND, REGO PARK—DEFINITE HI FI,  
MAMARONECK—GRAND CENTRAL RADIO, NEW YORK—  
HARVEY ELECTRONICS, NEW YORK, WESTBURY—WHITE  
PLAINS—LISTENING ROOM, SCARSDALE—LYRIC HI FI,  
NEW YORK—LYRIC HI FI NORTH, WHITE PLAINS—PARK  
AVENUE AUDIO, NEW YORK—PERFORMANCE  
AUDIO VIDEO, HUNTINGTON—RABSONS AUDIO/VIDEO,  
BROOKLYN—GARDEN CITY, NEW YORK—SPEAKER SHOP,  
INC., AMHERST—SQUARE DEAL RADIO & TV,  
PATCHOGUE—STEREO CHAMBER, ORCHARD PARK—  
STEREO EXCHANGE, NEW YORK

**NORTH CAROLINA**  
AUDIO BUYS, RALEIGH—AUDIO VIDEO SYSTEMS,  
CHARLOTTE—VIDEO-AUDIO CONNECTION, LENOIR

**OHIO**  
ALAMO TV, CINCINNATI—AUDIO CORNER INC., CANTON  
—AUDIO ETC., FAIRBORN—B & B APPLIANCE, EUCLID,  
MIDDLEBURGH HEIGHTS—JAMESONS INC., TOLEDO—  
NEWCOME SOUND, WORTHINGTON—STEREO LAB,  
CINCINNATI—COLUMBUS—THRESHOLD AUDIO, HEATH

**OKLAHOMA**  
AUDIO ADVICE, TULSA—AUDIO ASSOCIATES, INC.,  
OKLAHOMA CITY

**OREGON**  
BRADFORD'S HI FIDELITY, EUGENE—FRED'S SOUND  
OF MUSIC, GRESHAM, PORTLAND—HEAR NO EVIL,  
SALEM—MAGNOLIA HI FI, BEAVERTON—CLACKAMAS

**PENNSYLVANIA**  
ABINGTON AUDIO & VIDEO, ABINGTON—AUDIO  
INSIGHT, WEXFORD—AUTO COMMUNICATIONS,  
MONROEVILLE—BUTCH'S SOUND SHACK, NATRONA  
HEIGHTS—HIGH FIDELITY HOUSE, BROOMALL—PAUL &  
TONY'S STEREO, STATE COLLEGE—SASSAFRAS AUDIO,  
INC., BRYN MAWR, FEASTERTVILLE—MONTGOMERYVILLE,  
PHILADELPHIA, WHITEHALL—STEREO BARN, EPHRATA,  
LANCASTER, WYOMISSING—STEREO CONNECTION,  
SCRANTON

**RHODE ISLAND**  
STEREO DISCOUNT CENTER, PROVIDENCE

**SOUTH CAROLINA**  
READ BROS., CHARLESTON—SOUND ADVICE,  
COLUMBIA—STEREO VIDEO, GREENVILLE

**TENNESSEE**  
HI FI BUYS, NASHVILLE—SOUND CONCEPTS, JOHNSON  
CITY—NEW WAVE ELECTRONICS, MEMPHIS

**TEXAS**  
BEAUMONT SOUND, BEAUMONT—BJORN'S  
AUDIO/VIDEO, SAN ANTONIO—DIGITAL CENTER, INC.,  
DALLAS—THE ESOTERIC EAR, HOUSTON—GROOVE  
AUDIO VIDEO, HOUSTON—HAROLD'S ELECTRONICS,  
MIDLAND—ODESSA—HI FI INC., AUSTIN—METEX  
INTERNATIONAL, LAREDO, McALLEN—OMNI SOUND,  
DALLAS—SOUND IDEA, ARLINGTON, FORT WORTH—  
SOUND SYSTEMS, LTD., AMARILLO—SOUTHWEST  
RECORDS & TAPES, HOUSTON—STEREO  
SUPERCENTER, LUBBOCK—STEREO & VIDEO  
CENTER, TYLER

**UTAH**  
HI FI SHOP, OGDEN—STANDARD AUDIO & HI FI, SALT  
LAKE CITY

**VERMONT**  
GREAT NORTHERN STEREO, SO. BURLINGTON

**VIRGINIA**  
AUDIOTRONICS, ROANOKE—AUDIO ART, RICHMOND—  
AUDIO BUYS, BAILEYS CROSSROADS, MANASSAS—DAN  
JONES ELECTRONICS, WILLIAMSBURG—DIGITAL  
SOUND, VIRGINIA BEACH—EVERGREEN AUDIO,  
LEESBURG—SASSAFRAS AUDIO, INC., ALEXANDRIA

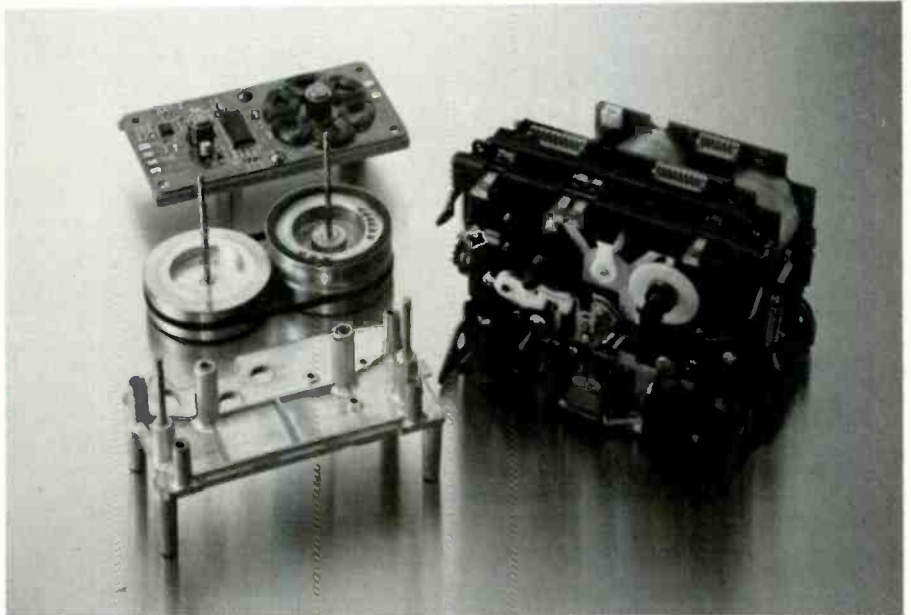
**WASHINGTON**  
ADVANCED AUDIO, TACOMA—DEFINITE AUDIO,  
SEATTLE—HUPPINS HI FI, SPOKANE—MAGNOLIA HI FI &  
VIDEO, BELLVUE, LYNNWOOD, SEATTLE, TACOMA—QC  
STEREO CENTER, BELLINGHAM, OAK HARBOR

**WEST VIRGINIA**  
MACK & DAVE'S, HUNTINGTON—SODARO'S,  
CHARLESTOWN—SOUND INVESTMENTS, MORGANTOWN

**WISCONSIN**  
AUDIO PLUS, OSHKOSH—FORWARD ELECTRONICS,  
WAUSAU—GENE'S, SHEBOYGAN—HAPPY MEDIUM,  
MADISON—HI FI HEAVEN, GREEN BAY—SALON 1 AUDIO,  
LTD., WISCONSIN RAPIDS—SOUND STAGE,  
MILWAUKEE—SUESS TV, APPLETON

**WYOMING**  
MUSIC BOX, LARAMIE

Recent improvements in cassette deck technology have brought significant improvements in convenience and performance. For example, die-cast construction reduces vibration and offers extended life. High torque, brushless, slotless motors assure accurate speed and reduce wow and flutter. Closed-loop dual capstan drive keeps tape in correct relationship to heads and provides extended frequency response. A third motor enables power assisted loading and unloading.



3 motor, 3 head transport (as in the Sony TCM200D)

There are more advances you should get to know about. Audio Magazine and Sony have teamed to bring you updates in Audio Information Magazine (AIM). Written in plain, concise language, AIM is yours ABSOLUTELY FREE. Look for it in the special AIM display at the quality dealer listed in the two columns to the left.



## FREE!

New Cassette Deck  
Technology Improves  
Convenience & Performance

For More Information



Call 1-800-553-4355

# Audio



# SONY

THE LEADER IN DIGITAL AUDIO™



Imagine a DiscJockey that's professional, accommodating and ready to play hour after hour of your favorite music. That's the guiding principle behind Sony DiscJockey® CD changers—inspiring Sony to create more ways than anyone to enjoy the fabulous sound of Compact Disc in your car.

Of course, today's DiscJockey changers are just the latest in a string of Sony hits that began with the world's first Compact Disc player. And Sony was first to take our act on the road with the world's first car CD player. We also invented the car CD Changer, opening up remarkable new possibilities. The trunk-mounted



ONE OF MANY REMOTE POSSIBILITIES TO CONTROL 10 DISCS.

mechanism lets you load ten discs at a time while the remote control switches from Be-Bop to Beethoven at the touch of a button.



THIS IN-DASH OPERATES AM, FM, CASSETTE AND 10 CDs—AND COMES WITH WIRELESS REMOTE.



So it's only natural that only Sony gives you the widest choice of CD changers and controls, starting with the affordable, sensational-sounding CDX-A30. This changer even connects to car stereos without provision for CD; all you need is your FM radio and our CDX-A30RF system. Next comes the Sony



# Sony presents the only DiscJockey that takes all your requests.

Introducing the 1990 DiscJockey® CD changers.  
The most comprehensive line of car CD changers in CD history.

CDX-A100, combining a superlative new suspension with an 8x oversampling digital filter to take automotive high fidelity even higher. And for the fortunate few, there's the incomparable CDX-A2001. With such esoteric circuitry as a 45-bit digital filter and four staggered D/A



SOMETIMES,  
REMOTE CONTROL  
IS NO BIG DEAL.

converters, its musical abilities border on the magical.

While a DiscJockey changer mounts out of sight, it's never out of touch. You can operate it with any of three Remote Commander® units. Or choose one of the many Sony in-dash cassette/receivers that give you effortless



WITH SONY 10-DISC MAGAZINES, YOU CAN  
BRING IT ALL BACK HOME.

command over radio, tape and disc. Whatever your need, chances are there's a DiscJockey controller that fills it perfectly.

DiscJockey grants you one other request. Its ten-disc magazine—used by more car stereo companies than any other design—is also compatible with Sony home DiscJockey ten-disc changers. Which means the same library of CD magazines that transport you in the car will be equally at home—at home.

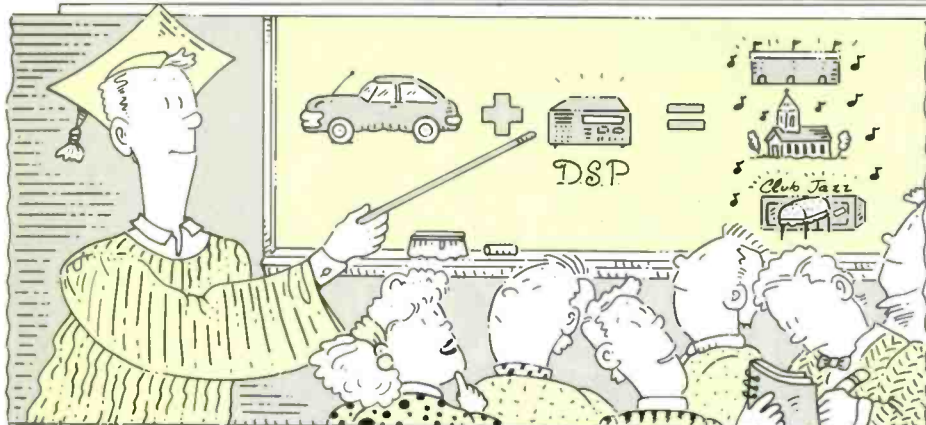
So if you want a car Compact Disc changer that will carry all of your favorite tunes, listen closely. Sony has dedicated a DiscJockey just for you.

**SONY**

THE LEADER IN DIGITAL AUDIO™

IVAN BERGER

## QED: DSP



**D**igital technology may wind up doing more for car stereo than for sound in the home. It's already brought us two small, super-fidelity sound media, CD and DAT. It will encourage the use of digital fiber-optic interconnections between components, ending forever the problems of ground-loop hum and interference pickup in long signal runs. And now it's starting to bring us digital signal processing—DSP.

Home systems have been able to include DSP ever since Yamaha's DSP-1 came out in 1986, but it didn't hit car stereo until last fall, when Eclipse announced its Model EQS-1000 stand-alone processor. Since then, Alpine, Clarion, JVC, Kenwood, Pioneer, Technics, and Yamaha have shown prototype car DSP gear here or in Japan, or have announced plans to do so. It looks like DSP's progress in car audio will more than make up for its late start. It wasn't conceived with automotive use in mind, but DSP is proving to be a natural for the car, posing answers for almost every basic problem of car stereo.

The most obvious problem is dimensionality. If a living room needs help to make you feel like you're listening in a concert hall or a cathedral, think how much more help a car's interior needs. And one chief barrier to adding dimensional enhancers to home systems—the need to add extra speakers and amps for the surround channels—is not an issue in the car, where those speakers and amps are already in place. Fosgate-Audionics has had analog surround processors for several years (first the Gavotte and now the \$499 Gavotte ProPlus), and Audio

Control has just introduced two (the Model ESP-2 for \$189 and the ESP-3 for \$299), but the future belongs to digital, which can do more complex processing without introducing distortion and noise.

The first DSP unit out, Eclipse's \$999.95 in-dash processor, offers four sound environments: "Concert Hall," "Live Music House" (jazz club), "Church," and "Stadium," with adjustable early- and late-reflection timings. Sanyo has shown a similar prototype but says production versions will be trunk-mounted and controlled from the dashboard.

These systems, analog and digital, use center-front speakers to help focus the image. Since front center speakers are hard to install neatly (the reason my car doesn't yet have one), Eclipse offers a self-amplified speaker, the Model ESG-3000 (\$159.95), to hook over a car's rear-view mirror support. The mirror may become a standard center-speaker mounting point; Sanyo's DSP showcase installation (in an Infiniti Q45) had tweeters built into the front of the mirror, as do some nonsurround custom installations I've heard of recently.

Technics and Orion have already shown trunk-mounted DSP prototypes. Both also have digital inputs, a sign that more car stereo components with digital outputs must be on the way. (Trunk-mounted CD changers with digital outputs are already here. In addition to the Nakamichi system reviewed in the May issue, there are two such models from Sony.) Pioneer has taken the idea of direct digital linkage even further by integrating DSP with a CD/tuner head unit; they say that pro-

duction versions will sell for about \$800, which is less than Eclipse's processor alone.

Orion, Pioneer, and Technics have taken DSP one more logical step, by adding equalization to its functions. Orion's unit, a modular mainframe system, had a five-band fully parametric system available. The Technics unit had a seven-band equalizer whose 60-Hz and 15-kHz bands were graphic but whose middle five bands had adjustable center frequencies. Pioneer's DSP prototype could be used as either a seven-band graphic equalizer or a pair of three-band parametric equalizers, the latter providing independent equalization for the front and rear speakers. To help one use EQ wisely, Technics included warble-tone and pink-noise generators plus an automatic equalizing function, while Orion had a spectrum analyzer module that could go beyond the usual dancing-light display to make fast Fourier transform (FFT) measurements of the system's signals or of sound and ambient noise picked up by a mike.

There's a threefold logic here. Equalization makes much more sense in the context of a car's weird acoustics, frequency-skewed noise, and constricted speaker placements and enclosures. Using the same DSP chips for equalization as for dimensionality helps lower noise and distortion (every analog stage adds these). It also helps keep the system within car audio's cost and space constraints.

With DSP, more complex equalization functions will also become available. Nearly a decade ago, Acoustic Research showed a digital home equalizer that separately assessed the response of a system's speakers and the acoustics of the room, then separately corrected the two. (The system pre-equalized the signal to complement the speakers' problems, then issued delayed signal modifications to counteract frequency skewing in the room's reflected sound.) It all worked, but at an impractically high cost. In a car, where the space is small and the listener positions fixed, it should work better. It should also cost a lot less now that DSP is available on chips, especially if the analyzer part is not built into the car but stays with the installer who adjusts the system for you.

Illustration: Teresa Anderko

The International Preview Society

HOROWITZ AT HOME

3 COMPACT DISCS OR CASSETTES \$1 FOR JUST

plus shipping and handling with Club membership

With No Obligation To Buy Anything ... Ever!



Horowitz At Home DG 25211

Viennese Bonbons • Vienna Phil./Maazel. DG 15287\*

Bernstein: Brahms, Symphony No. 1 Vienna Phil. DG 25224\*

Ton Koopman: Bach, Organ Works, V. 1 Novalis 01137

Bartók, Concerto For Orchestra; more Montreal Sym./Dutoit. London 25303

Ashkenazy: Rachmaninov, Sym. No. 2 Concertgebouw Orch. London 15189

Pinnock: Vivaldi, The Four Seasons Archiv 15356

Colin Davis: Mahler, Sym. No. 1 • Bavarian Radio Sym. Novalis 73745

Bychkov: Shostakovich, Sym. No. 5 • Berlin Phil. Philips 15454

Rubinstein: Rachmaninoff, Piano Conc. No. 2 • RCA 70232

Zimerman: Chopin, Ballades; Barcarolle; more • DG 15332

Levine: Mozart, Sym. Nos. 30-32 • Vienna Phil. DG 25341

Solti: Dvořák, Sym. No. 9 ("New World") • Chicago Sym. London 15168\*

Ravel, Piano Concertos Argerich, Beroff. Abbado cond. DG 15462

Cilburn: My Favorite Chopin • "Minute" Waltz, more. RCA 10998

Arrau: Beethoven, Piano Sonatas 3 & 8 ("Pathétique") • Philips 15355

Reich, Sextet; 6 Marimbas • Steve Reich & Musicians, etc. Nonesuch 00520

Norrington: Beethoven, Symphony No. 9 ("Choral") • Angel 00467

Fritz Reiner: Strauss, Also sprach Zarathustra; more • RCA 63627\*

Bylisma: Bach: The Violoncello Piccolo Brilliant! DHM 63749

J.R. Baker: Everybody's Favorite Synthesizer Pieces • Newport Classic 44611

Classic Marches • Triumphal March, more. Slatkin cond. RCA 00996

Andrés Segovia Plays Bach • Chaconne, 3 Pieces For Lute, Siciliano, many more. MCA 63600

Mussorgsky, Pictures At An Exhibition; Russian Easter Overture; more • Montreal Sym./Dutoit. London 25314

Copland, Billy The Kid; Rodeo (Complete Ballets) • St. Louis Symphony led by Leonard Slatkin, RCA 41491

Poulenc, Gloria; more • Kathleen Battle, soprano. Boston Symphony Orchestra/Seiji Ozawa. DG 05576\*

Ashkenazy Mozart, Piano Conc. 11 & 14 "Masterly playing."—Gramophone London 25424

O Cleo Mondo—The Italian Lauda Ensemble Huelgas/Nevel, DHM 53753

Pinnock: Handel, Water Music • The English Concert. "Strong."—Stereo Review Archiv 15306

Corelli, Concerti Grossi, Op. 6 • Tafelmusik Baroque Orch. "Clear...Strong."—Gramophone CHM 73751

Fauré, Requiem; more • Te Kanawa, Milnes. Montreal Symphony Orchestra/Dutoit. London 15321

Heifetz: The Decca Masters, Vol. 1 Humoreske, Habañera, Golliwog's Cakewalk, more. MCA 00604

Empire Brass: A Bach Festival • Jesu, Joy Of Man's Desiring; Sleeper's Wake; more. Angel 64211

Dvořák, Slavonic Dances; Carnival Overture • Houston Symphony/Commissioner. Pro Arte 14884\*

Irish Harp Songs • Emily Mitchell plays & sings The Last Rose of Summer, many more, RCA 00812

Mozart, Haffner Serenade; Symphony No. 32 • Bavarian Radio Symphony/Davis. Novalis 83748

Berlioz, Symphonie Fantastique • Philadelphia Orchestra/Muti. Angel 54244

Itzhak Perlman: Brahms, Violin Concerto Chicago Symphony Orchestra/Carlo Maria Giulini. Angel 63343

Samuel Ramey Sings Rodgers and Hammerstein • Some Enchanted Evening, more. Angel 43820\*

Respighi, Pines Of Rome; Fountains Of Rome; Roman Festivals • Phila. Orch./Muti. Angel 34443

Koopman: Bach, Organ Works Vol. 2 • Prelude & Fugue in C Minor, more. Novalis 54634

On The Boardwalk Paragon Ragtime Orch. Chatterbox Rag, Memphis Blues, more. Newport Classic 24699

Andrés Segovia Plays Rodrigo, Ponce & Torroba • Fantasia para un Gentilhombre, more. MCA 63579

Holst, The Planets • Montreal Symphony Orchestra led by Charles Dutoit. London 15448\*

Ute Lemper Sings Kurt Weill • Speak Low, I'm A Stranger Here Myself, more. London 15163

Dvořák, Serenade in E; Sextet in A. Camerata Bern. "Superb."—CD Yearbook Novalis 63639

Bylisma: Boccherini, Cello Concertos • Plus 2 Symphonies, Tafelmusik. "Demonic."—NY Times DHM 83676

Kazuhito Yamashita: Rimsky-Korsakov, Scheherazade • Plus Debussy, others all in guitar! RCA 64251

Vladimir Horowitz Plays Liszt • Sonata in B Minor, Consolation No. 2, Ballade No. 2, more. RCA 00511\*

Fête à la Française • Sorcerer's Apprentice, more. Montreal/Dutoit. London 25235



Cilburn: Liszt & Grieg Piano Concertos 00606

Baroque Trumpet Music • Trompeten Consort/Immer. Bach, more. DHM 80082

Flamenco • Pepe Romero, guitar, with Chano Lobato and dancers. Spanish favorites. Philips 15478

Madison Avenue Goes To The Opera • Great opera themes featured in TV commercials. Angel 24825\*

Itzhak Perlman: Mozart: Violin Concertos Nos. 2 & 4 • Vienna Philharmonic Orchestra/James Levine. DG 25021\*

Newman: Beethoven, 4 Sonatas For Fortepiano • An unbelievable "Moonlight", etc. Newport 00784

Kathleen Battle Sings Mozart • Exsultate, Jubilate, more. "A joy."—Ovation Angel 44625



Salerno-Sonnenberg: Mendelssohn, Violin Concerto; more Angel 34670

COMPLETE AND MAIL THIS CARD TODAY!

The International Preview Society

YES! Please accept my membership in The International Preview Society and send me, for 10 days' FREE examination, the 3 selections I have indicated below, under the terms of this offer. I may return them after 10 days and owe nothing, or keep them and pay only \$1 (shipping and handling added to each shipment). I understand that I'm not obligated to buy anything...ever!

Please send selections on:  Compact Disc  Cassette \*

Write Selection Numbers Here: \_\_\_\_\_

Mr.  Mrs.  Miss \_\_\_\_\_ First Name Initial Last Name (PLEASE PRINT)

Address \_\_\_\_\_ Apt. \_\_\_\_\_

City \_\_\_\_\_ State \_\_\_\_\_ Zip \_\_\_\_\_

Telephone (Area Code) \_\_\_\_\_

Signature \_\_\_\_\_

Members who choose CDs will be serviced by the BMG Compact Disc Club and will receive CD Discovery 19 times a year (about every 3 weeks). Full membership details will follow with the same 10-Day, no-obligation, no-minimum purchase privilege. Current BMG CD Club members not eligible for this offer.

Limited to new members; continental U.S.A. only, one membership per family. We reserve the right to request additional information or reject any application. Local taxes, if any, will be added.

PLR (BF) ZHPLR (PJ)

IPS 543 \*Note: Selections marked (\*) are available on CD only.

IPS/6550 E. 30th St./Indianapolis, IN 46219

50% OFF BONUS PLAN

Unlike other clubs, you get bonus certificates good for 50%-off Bonus Savings with every album you buy at regular prices, effective with your first full-price purchase!

*The International Preview Society*

# 3 COMPACT DISCS OR CASSETTES \$1 FOR JUST 1

plus shipping and handling with Club membership

**With No Obligation To Buy Anything ... Ever!**



**Adams, Fearful Symmetries; The Wound Dresser** • Sylvan; Orchestra of St. Luke's/Adams. Nonesuch 54396\*

**Pops In Space** • John Williams & The Boston Pops. Star Wars, Superman, more. Philips 05392

**Musicians For Armenia** Galway, Previn, Rostropovich, others. Gala Concert! RCA 00928

**The Pearl Fishers** • Jussi Bjöerling with Merrill, Milanov, others in classic duets. RCA 00992

**Kiri Te Kanawa Sings Gershwin** • The Man I Love, I Got Rhythm, more. McGlinn cond. Angel 70258

**Reiner: Strauss, Don Quixote** Janigro, cello; Janis, piano. Chicago Symphony. RCA 63643\*

**The Digital Fox** • organist Virgil Fox plays Bach, Widor, Vierne, Franck, many others. Balnbridge 62889

**Son Of Movies Go To The Opera** • Operatic moments from "Prizzi's Honor", more. Angel 33664

**Cilburn: Rachmaninoff, Sonata No. 2, Prelude in D; Prokofiev, Sonata No. 6; more.** RCA 00607

**Jeffrey Reid Baker: Rhapsody In Electric Blue** • Gershwin synthesized! Title piece, more. Newport Classic 34647

**Horowitz in Moscow** • The historic return! Mozart, Liszt, Chopin, more. A Grammy Award Winner! DG 25264\*

**Ashkenazy: Mozart, Piano Concertos Nos. 8 ("Lutzow") & 9 ("Jeunehomme")** London 15418

**Leontyne Price & William Warfield: Porgy & Bess Highlights** • Summertime, many more. RCA 00994

**Vivaldi, The 4 Seasons** • Amsterdam Guitar Trio. "Amiable."—*Billboard* 44583

**Horowitz Plays Mozart** • Concerto No. 23; Sonata K. 333. La Scala/Gullini. DG 15436\*

**Canadian Brass: Greatest Hits** • Pachelbel Canon, Carnival Of Venice, etc. RCA 73493



**Haydn, 3 Symphonies** Orpheus Chamber Orchestra DG 15112\*

**Sound The Trumpet** • English Ceremonial Music by Purcell, others. Newport Classic 00990

**Salerno-Sonnenberg: Franck, Violin Sonata** • More by Brahms. Cecile Licad, piano. Angel 34674

**Emanuel Ax: Beethoven, Piano Concertos Nos. 1 & 2** • Previn conducts. RCA 83469

**Bernstein: Mahler, Symphony No. 4** Helmut Wittek, boy soprano • Concertgebouw Orchestra, Amsterdam. DG 15526\*

**Galway: Serenade** • With Marisa Robles, harp & Kazuhito Yamashita, guitar. RCA 63424\*

**Accardo: Bach, Violin Concertos** Philips 25162

**Kern, Overtures, & "Swing Time"** • New Princess Theater Orchestra/John McGlinn. Angel 83605\*

**Itzhak Perlman: French Violin Showpieces** • Havaïnaise, Tzigane, more. Mehta cond. DG 15457

**Mozart, The Piano Quartets - The Beaux Arts Trio**; Bruno Giuranna, viola. Philips 15271\*

**Ashkenazy: Rachmaninov, Piano Concerto No. 3** • Concertgebouw Orchestra, London 25157

**Rattle: The Jazz Album** • Rhapsody In Blue, more. Angel 72226

**Prokofiev, Cinderella (Suite)** • St. Louis Symphony led by Leonard Slatkin. RCA 43298

**Kronos Quartet: White Man Sleeps** • Plus Bartók, etc. Nonesuch 40256

**Pavarotti At Carnegie Hall** • Schubert, Verdi, Scarlatti, more. London 15311

**The Academy—By Request** • Neville Marriner conducts Sheep May Safely Graze, more. Angel 54094

**Claudio Arrau: Beethoven, Piano Sonatas Nos. 21 ("Waldstein") & 30; Andante Favori** DG 15366

**Heifetz: The Decca Masters, Vol. 2** • Lullaby (with Bing Crosby). Summertime, many more. MCA 00605

**Mozart, Clarinet Concerto; Horn Concertos 1 & 4** • Neidich, Jolley Orpheus Chamber Orch. DG 15481

**Norrington: Beethoven, Symphonies Nos 1 & 6 ("Pastorale")** • London Classical Players. Angel 60068

**Barry Douglas: Brahms, Piano Concerto No. 1** • London Symphony. RCA 00732

**Jeffrey Reid Baker: Orff, Carmina Burana** Synthesized with chorus. Newport Classic 64605

**HALF-PRICE BONUS PLAN**

**SAVE 50%** Unlike other clubs, you get bonus certificates good for 50%-off Bonus Savings with every album you buy at regular prices, effective with your first full-price purchase!

IPS £43



**BUSINESS REPLY MAIL**  
FIRST CLASS PERMIT NO. 5071 INDIANAPOLIS, IN

POSTAGE WILL BE PAID BY ADDRESSEE

*The International Preview Society*  
P.O. BOX 91406  
INDIANAPOLIS IN 46209-9755

NO POSTAGE NECESSARY IF MAILED IN THE UNITED STATES



**This remarkable \$1 offer is being made to introduce you to an outstanding classical music membership—with never any obligation to buy.**

You'll find hundreds of outstanding albums in each issue of the Society's magazine, which will be sent to you approximately every 4 weeks. That gives you 13 convenient, shop-at-home opportunities a year, but there is no obligation to accept any offering at any time.

**You choose only the music you want!** If you'd like to accept the Main Selection, you need not do a thing. It will be sent automatically. If you'd prefer an alternate selection or none at all, just mail back the Notification Card by the specified date. You'll always have at least 10 days to decide. But if you don't, you may return your Main Selection at our expense. You may cancel your membership whenever you wish, simply by writing to us. Or, remain a member and take advantage of future money-saving bargains.

**3 Compact Discs or Cassettes for just \$1!**

Begin your membership now by choosing any 3 albums shown here for just \$1, plus shipping and handling. Send no money now. We want you to judge for yourself before you decide to buy. If not delighted, return your 3 albums at the end of 10 days without obligation. (Shipping and handling added to each shipment.)



Today DSP can make cars sound like concert halls. Tomorrow it could combat road noise, too.

While we're at it, let's also make the crossovers digital (Orion already plans to) and have the system fine-tune the crossover frequencies and slopes to optimize them for the drivers and enclosures being used. And let's have the system cut back on any boosted frequencies when they reach volumes that might damage the speaker drivers. This may not be the path digital car equalization takes, but it gives some idea of what is possible.


Digital systems can also help keep the sound clear and audible at high road speeds. As the car's speed goes up, so does the noise level, especially in the bass. Over the years, some car stereo components from Philips, Pioneer, Yamaha, and other companies have incorporated systems that sense the ambient noise and raise the sound level accordingly. Since raising the quiet passages above the noise can make loud passages ear-shattering, Delco, Philips, Sony, and Yamaha have offered CD players with compres-

sors to fit music of wide dynamic range into the limited range between a moving car's elevated noise floor and OSHA noise-hazard levels.

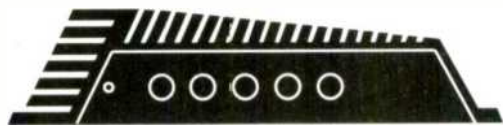
Neither solution covers all the bases. A few years back, I suggested a range-compensation system that would respond to road noise in three ways, raising overall level a bit, compressing dynamic range a bit, and adding a touch of bass boost. That may be impractical for analog, but it's not too big a stretch for digital. And if you don't want to add circuitry to sense ambient noise directly, you could tie the range-compensator to a digital speedometer and calculate the presumed noise level from the speed, as the 1990 Corvette does. This wouldn't account for such variables as differences in tire tread, road surface, and traffic conditions (15 mph between two buses in a tunnel is probably noisier than 60 mph on a smooth, deserted road), but it's close enough for jazz. Orion's spectrum analyzer module

could handle the noise analysis required, but so could a simpler circuit.

The ultimate solution might be to cancel ambient sounds before they can interfere with the music, by using anti-noise systems that duplicate the noise with opposite polarity ("Road-signs," March 1989). This is already being done by analog means, but as long as DSP is in the car, it could be given this additional task. Both Lotus and Fujitsu Ten (Eclipse's parent company) have already discussed precisely this application.

None of the car DSP units I've seen has as many control functions as some home DSP units do, to reduce the chance that you'll get so distracted chasing sonic nirvana that you'll drive into a tree. Even so, digital technology gives each of them more functions than one would probably be comfortable fiddling with in traffic. Therefore, all use another digital facility, memories that hold clusters of user-selected settings, to simplify control. 

# Hafler MSE



## Shaping the Future

The MSE from Hafler. A new line of multi-channel, mosfet amplifiers designed inside and out for improved mobile audio performance. From the thermally efficient, sculpted heat sink to the "Dielectric Isolation" (DI) integrated circuitry, the Hafler engineering team is shaping the future of mobile audio. For more information on these new 2, 4 and 6 channel amplifiers and the dealer nearest you call 1-800-366-1619.

Hafler, shaping the mobile environment with sonic excellence and inherent value.

**Hafler.** "The Affordable High-End"

For More Information



Call 1-800-553-4355



Enter No. 13 on Reader Service Card

## HAUTE CUISINE

**W**hen the young William Walton was asked to compose a work for the Leeds Festival in 1931, he considered taking advantage of the large orchestral and choral resources which were to be amassed for the Berlioz "Requiem." Before he composed for these large ensembles, however, he sought the advice of conductor Sir Thomas Beecham, who said in effect, "Why not? You'll never hear the work again!" History has been far kinder to "Belshazzar's Feast" than Beecham presumed, for it may be the best-known English oratorio of the first half of the 20th century.

Since the 78-rpm era, there have always been "Belshazzars" in the record catalog. My first hearing of the work was in 1948, by way of the old recording on RCA Victor with Walton conducting the Liverpool Philharmonic and the Huddersfield Choral Society. During the age of the LP, many more recordings were made by such conductors as Adrian Boult, William Walton (a 1959 remake), André Previn (two versions), Eugene Ormandy, Georg Solti, Maurice Abravanel, Roger Wagner (the best of the lot), Alexander Gibson, and James Loughran. So far in the CD era, six versions have been released, impressive enough, I feel, to call for critical comparison.

The work, based on biblical texts set by Sir Osbert Sitwell, chronicles the suffering of the Israelites in bondage under King Belshazzar of Babylon and the ultimate demise of Belshazzar after the mysterious handwriting on the wall appears during a great feast: *Mene mene tekel upharsin* (thou art weighed in the balance and found wanting). The work is richly scored with lots of percussion, requires a large double chorus, and has a demanding baritone role. It has not always fared well in recording, essentially because too many things can go wrong either in planning or execution. Some of these problems are detailed here.

Virtuoso choral performance is required, but many recordings have been made using collegiate choruses or those consisting of too many amateur singers. What is required is an ensemble of first-rate singers who can tone down their individual characteristics and blend into a homogeneous whole. Under these conditions, a large

chorus may not be needed. Another contributor to poor vocal performances is that many fine orchestral conductors simply do not know how to get the best out of a chorus.

Although the score calls for organ and two ancillary brass bands, several recordings have been made without these. Walton included extra cues in the score, enabling smaller groups to perform the work, but for recording, nothing less than the full instrumental complement should be considered.

The differences between the dramatic demands of oratorio and opera must be emphasized by the soloist. "Belshazzar" broke new ground in the oratorio field, and few good baritones truly understand how the work should be sung. Outside the opening *cantante* for the voice, the role is essentially a declamatory one, providing continuity from one section to another.

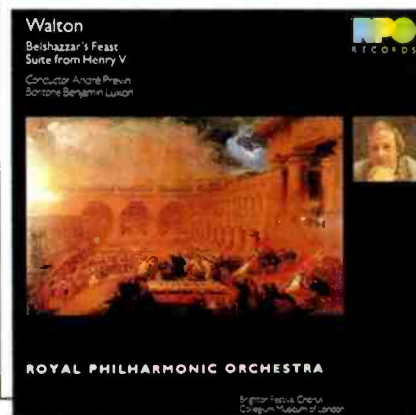
The work needs to be recorded with a good sense of space and ambience while illuminating all of the inner details. The double chorus and brass bands provide natural stereo advan-

tages, and the rich percussion detail must be clear. It is a definite case for multi-miking—but without excess.

When everything comes together the right way, the work is truly stunning. Let us see how well the current crop of CDs has made out. We'll take them in order of the recording date.

Sir Adrian Boult, London Philharmonic Choir and Orchestra. Dennis Noble, baritone. This is the only pre-stereo version of the lot. It is a reissue of the 1954 mono recording produced as a joint venture between Westminster Records and the British Nixa company and is available in two versions. One is a 1986 transfer from the original source tapes (Precision Records and Tapes PVCD 8394). The other is a 1988 transfer in which "Belshazzar" is coupled with the Walton First Symphony (NIXA NIXCD 6012) and has had stereo reverberation added to it, to the detriment of the music. As for the performance, it is an early LP landmark. The Huddersfield Choral Society is not always as precise as we take for granted in today's recordings, but the spirit is there. Both Noble and the orchestra are up to the task, and Boult's tempos are in keeping with the composer's indications. All the drama is there, but the creaky sonics often get in the way. Despite the favorable coupling with the symphony, I cannot recommend the 1988 release of the Boult version because the added reverberation is completely out of context. The 1986 release is preferred, despite its playing time of about 35 minutes.

André Previn, London Symphony Orchestra and Chorus. John Shirley-Quirk, baritone. EMI CDC 7 47624 2. In the mid-'60s, Previn proved himself a superb Walton interpreter. While his zeal may have cooled in recent years, this 1972 recording shows him at his best. When the LP was originally released, it had little serious competition. In its CD form, it is coupled with Walton's "Portsmouth Point" and "Scapino" overtures, as well as "Improvisations on an Impromptu of Benjamin Britten," and is thus a real bargain. "Belshazzar" was recorded with Walton present, and the tempos are just what the composer ordered. Shirley-Quirk's dark baritone complements the music, and the LSO Chorus is excellent. The 1972 sonics stand up well.





## THE CLS II

The CLS II. A marvel of electrostatic design that dispenses prismatic beams of musical energy throughout your environment with unmatched precision, clarity and power.

With full-range purity, the CLS II reproduces the entire musical spectrum with a single curvilinear electrostatic transducer. Pure, clear performance made to satisfy the most critical ear.

The flawless, total dispersion is achieved without delay lines, lenses or protective devices. Purity flows in passages of silence as well as crescendo... and provides the absolute truth in musical reproduction.

The challenge now is for you to determine the sound purity for yourself. Go, hear, experience the CLS II.

MARTIN·LOGAN, LTD.

The electrostatic loudspeaker technology company

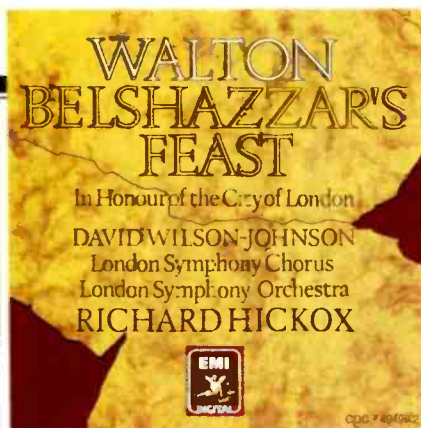
913-749-0133 · lawrence, kansas 66044



"Belshazzar" is richly scored with percussion, needs a large double chorus, and makes great demands on the baritone.

Sir Georg Solti, London Philharmonic Orchestra and Choir. Benjamin Luxon, baritone. London CD 425 154-2. This 1977 recording has undergone thoughtful treatment via Decca's ADRM process, which cleans up whatever residual noise might have been in the original tapes. (By 1977, Dolby noise reduction was so well entrenched at Decca that little treatment, outside of cleaning up sticky splices, would have been needed.) As with the original LP release, "Belshazzar's Feast" is coupled with the "Coronation Te Deum" Walton wrote for the crowning of Elizabeth II in 1953. Solti's high-pressure approach to these works is often less than satisfactory. Little is held in reserve, and we get overblown chorus and brass from the onset. Luxon's splaying vibrato detracts from the declamatory role which the part calls for, and Solti allows the chorus to rise nearly a half-tone during a critical unaccompanied section at the start of the "Praise ye" section—something any competent choral conductor would never let happen. On the positive side, the recording is vintage Decca, with Kenneth Wilkinson and James Lock at the controls. Of the two works on this CD, the "Coronation Te Deum" comes off best.

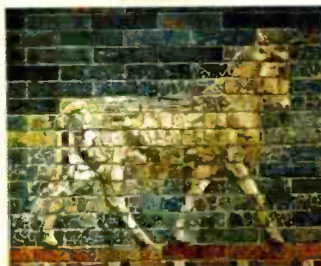
André Previn, Royal Philharmonic Orchestra. Benjamin Luxon, baritone; Brighton Festival Chorus and Collegium Musicum of London. MCA, MCAD6187. During 1986, the Royal Philharmonic Orchestra established its own record label, and this was the initial release. I am not sure what has become of the orchestra's label activities as such, but this item is now distributed in the United States by MCA. It was the first digital "Belshazzar," and as I noted in the pages of *Audio* at the time, the "see-through" quality of the new recording technology allowed us to hear far more detail in the score than we had heard before. This recording is Previn's second "Belshazzar," following his earlier one by 14 years. It shares both Luxon and the aforementioned choral pitch problem with the Solti recording; otherwise, it is excellent. It presents no additional insights which are not to be found in Previn's earlier recording, and it is coupled with the "Henry V Suite" from the Laurence Olivier film.



SIR WILLIAM WALTON  
**BELSHAZZAR'S FEAST**

Impressions on an Impression of Benjamin Britten  
Revised with Philip Sulzberger

John Shirley Quirk  
London Symphony Chorus & Chorus  
London Symphony Orchestra  
**ANDRÉ PREVIN**



Richard Hickox, London Symphony Orchestra and Chorus. David Wilson-Johnson, baritone. EMI CDC 7 49496-2. The strong point of this 1988 recording is its superb choral work, which we would expect of Hickox. The weak point is Wilson-Johnson, whose tremulous vibrato exceeds that of Luxon. The coupling is the choral/orchestral work "In Honour of the City of London," written for the 1937 Leeds Festival and given its first recording here.

Robert Shaw, Atlanta Symphony Orchestra and Chorus. William Stone, baritone. Telarc CD-80181. This 1989 recording has a lot going for it. Foremost are Shaw's integration of superb choral singing with orchestral resources and baritone William Stone's intelligence and intensity. Telarc has recorded so many choral/orchestral works in the Atlanta hall that it is all down to a predictable science. Balance between the double chorus and orchestra is excellent, as is the ratio of direct to reverberant sound. I for one wish that the soloist had been slightly more forward, but this is a very small point. The inner orchestral details are superbly delineated, the organ well balanced with its subterranean pedal line, and the brass bands limned out at hard left and right. The suave Shaw choral sound may strike some as a touch too refined for the Old Testament brimstone of the work. I thought so, too, on first hearing, but subsequent listening convinces me that it is fine as it stands.

Of the "Belshazzars" available, the Boulton release (without added reverberation) is an important link to the past and should not be overlooked. The 1972 Previn slightly outranks his 1986 remake, in spite of the latter's better sonics, mainly because of the superb singing of Shirley-Quirk. Telarc and Shaw walk away with the prize here, at least until EMI reissues, on CD, its mid-'60s Roger Wagner version with the Royal Philharmonic Orchestra and baritone John Cameron. (I don't find it surprising that the two best recordings of this complex work are at the hands of two of the best choral conductors of our time, Wagner and Shaw.) A bonus on this Telarc issue is Bernstein's "Chichester Psalms" and the first recording of his "Missa Brevis."

Good listening!







**P**anasonic brings you the **CQ-ID90. It finds your favorite type of music automatically — no matter where you are.**

When you're driving, searching for your favorite music on the radio can drive you crazy. Especially if you're in unfamiliar territory.

But our new car radio has ID Logic\* circuitry. A computer chip that stores information covering over 10,000 stations in over 4,300 cities in the U.S. as well as parts of Mexico and Canada. You program it to know where your home town is. Then, the CQ-ID90 will not only pick up all the local stations, it will find them by format. And if you drive out of town, just indicate the direction you're heading in (N, S, E, W every 30 miles or so), and the ID Logic tuner will automatically look for the desired stations along the way. And that means, whatever you want to listen to (classical, country, rock, jazz, easy listening or talk), you won't have to fumble up and down the dial for it.

The unit also includes a full logic tape deck with Tape Program Search (TPS), Dolby\*\* B and C noise reduction, and a microprocessor to ensure smooth tape operation. Instead of protruding knobs and buttons, a smooth, touch-sensitive display serves as the control panel for most functions.

The new Panasonic car stereo with ID Logic. You always knew there was a way to make car audio more convenient. Now, you can put your finger on it. ■

\*ID LOGIC is a trademark of and is manufactured under license from PRS Corporation. N.Y. & H.K. All Rights Reserved.

\*\*Dolby and the double D symbol are registered trademarks of Dolby Laboratories Licensing Corporation.



**INTRODUCING  
THE FIRST CAR RADIO  
IN HISTORY  
THAT TAKES REQUESTS.**

**Panasonic**  
just slightly ahead of our time

Enter No. 33 on Reader Service Card

# PSYCHIC USES MYSTERIOUS DEVICE TO ASSEMBLE SIX DEAD COMPOSERS, BRINGS THEM TO LIFE FOR DINNER PARTY.

It's almost eerie. Who would have thought that raising people's spirits for hours could be so simple.

With the Pioneer CD Changer, you load a magazine cartridge with six CDs for six hours of divine listening. The multi-play system, created by Pioneer, makes it possible to store and catalog CDs so you can unite your favorite artists for crystal-clear performances

at home, or on the road with a Pioneer Car CD Changer. And the CD Synchro feature lets you record six CDs onto six cassettes with the touch of a button when you're connected to a Pioneer Multi-Play Cassette Changer. When it comes to channeling music into your life, there's just no other medium like the Pioneer Multi-Play CD Changer.



 **PIONEER**

Call 1-800-421-1404 for the dealer nearest you.



© 1990 Pioneer Electronics (USA) Inc., Long Beach, CA

Enter No. 20 on Reader Service Card

# the *Soundcraftsmen* STORY



## SECTION OF PRODUCTION AREA IN MAIN PLANT



One hundred percent quality control is seen on EVERY unit manufactured. EVERY completed unit is electronically tested for specification accuracy and then EVERY unit is connected to a high fidelity system and listened to—just like you would at home. If your unit meets or exceeds the critical standards set forth on these tests, it is then packaged for shipment.

## INDIVIDUAL CERTIFICATE OF PERFORMANCE WITH EVERY AMPLIFIER



Soundcraftsmen celebrates its 20th year of manufacturing audio components for the discriminating audiophile.

Soundcraftsmen engineers are highly respected in audio design circles as being very forward thinking, yet practical, when engineering new products, by using proven design principles from the past with tomorrow's technology.



From the finest equalizers, the most accurate analyzers, to the unique preamps, to the revolutionary Class H and Power MOSFET amplifiers, you cannot purchase finer audio components.

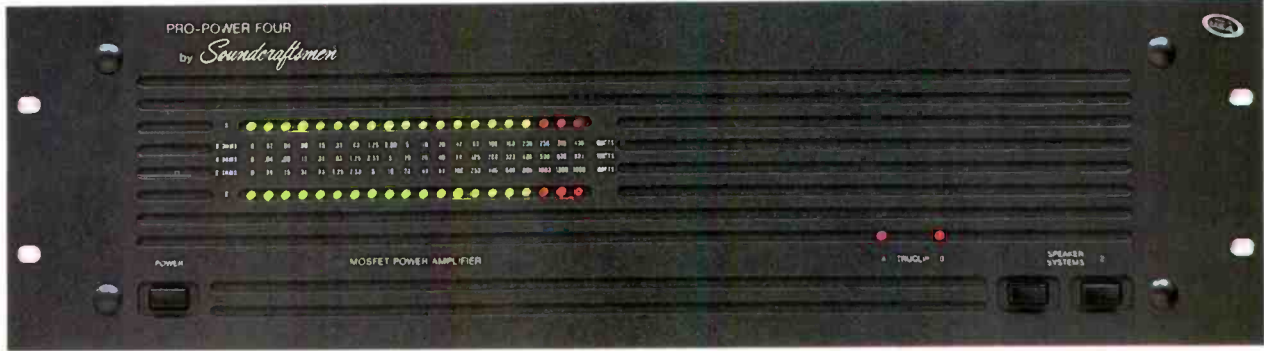
The next few pages will answer many of your questions. If you have more, our customer service department will be pleased to assist you by telephone or letter. We invite your questions and appreciate your interest.





# Soundcraftsmen Power Amplifiers...

**Not only the Most Watts for your Dollar,  
but also the Superb Musicality of Mosfets...**



## PRO-POWER FOUR

Says Leonard Feldman in his Test Report in AUDIO Magazine, Vol. 71, No.9:

"...it brought out the best in all of the loud speaker systems with which I tried it. I sensed an effortlessness about the musical crescendos reproduced from some of my CD spectaculars..."

"In my view, you can spend five times as much as what this amp costs, but you won't get a better, more reliable, or more musical unit."

**DESCRIPTION:** The New PRO-POWER amplifiers are especially designed for the extended Dynamic Range requirements of today's Compact Disc players and Hi Fi VCRs. The ULTRA HIGH CURRENT design offers you incredibly high power without sacrificing distortion-free performance, superb reliability, and the utmost in sonic purity. These new amplifiers operate flawlessly under all operating conditions. It is well known that most of today's highly regarded loudspeakers exhibit impedance curves which drop to 1 or 2 ohms at some frequencies, and in conventional amplifiers this results in severe clipping and the triggering of protective circuitry. However, our new PRO-POWER Phase Control amplifiers continue to operate even under those

extremely low impedance conditions. Current limiting had been eliminated entirely by the use of the latest POWER MOSFET technology, thus avoiding the sonic degradation typically found when limiting circuitry is employed.

**FEATURES:** MOSFET amplification stages provide the utmost in sonic purity, rivaling that of vacuum tube amplifiers... Precision-Calibrated LED power meters (0-400 watts at 8 ohms)... Speaker switching for two pair of stereo speakers...

**SPECIFICATIONS:** CONTINUOUS RMS POWER: 205 watts per channel @ 8 ohms, 20Hz-20kHz, 300 watts per channel @ 4 ohms, 20Hz-20kHz, 450 watts per channel @ 2 ohms, 1kHz... THD—less than 0.05%.

## PCR800

The new PCR800 offers the most Power, the Lowest Distortion, the Best Signal-to-Noise ratio, and the highest Current capability for your amplifier dollar. Coupled to your existing system or receiver, your speakers will come to life and you will experience all the Dynamics you expected from your Compact Discs.

\*PC-1 Power Coupler is only \$39.00 and enables quick and easy, no-loss connection of any of our power amplifiers to your Receiver. (Not necessary if your receiver has preamp outputs.)



PCR800 SHOWN MOUNTED IN OPTIONAL 19" RACK-MOUNT PANEL

**300 watts per channel**  
@ 4 ohms, 20Hz-20kHz, less than 0.05% THD...

**205 watts per channel**  
@ 8 ohms, 20Hz-20kHz, less than 0.05% THD...

**\$499.00**

Enter No. 30 on Reader Service Card

**FREE System/Analysis Test Recording,  
Now available on 5" COMPACT DISC!**

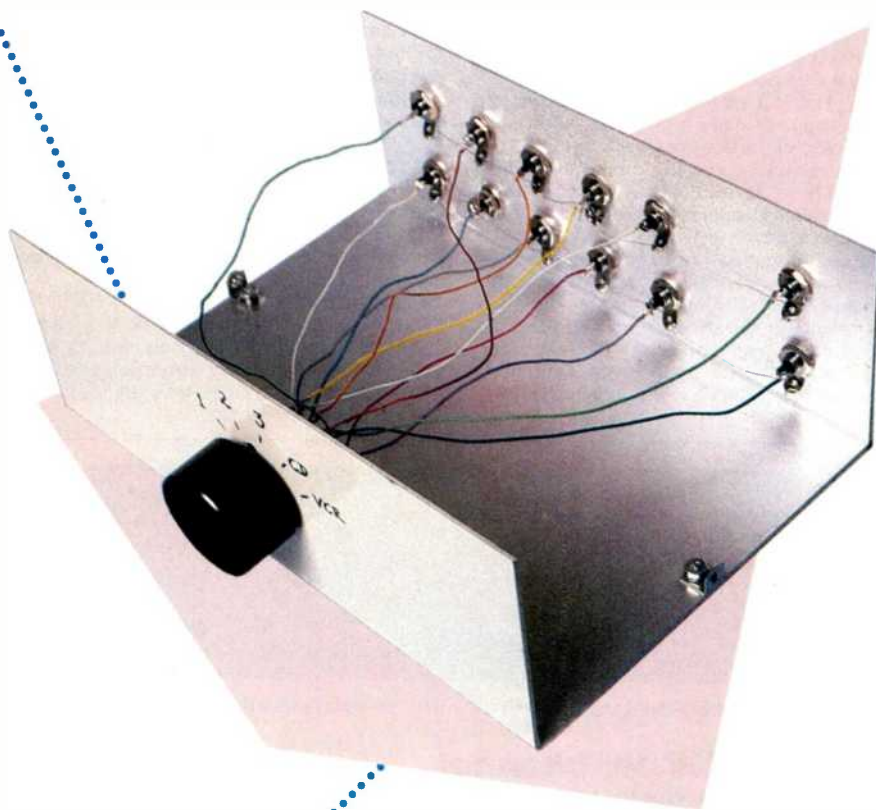
# Soundcraftsmen

**FREE!**

\$19.95 SYSTEM EVALUATION KIT, includes your choice of 5" Instructional Test/Analysis COMPACT DISC, or 12" LP, plus 2-sets of Computer Charts, 1-Connector Cable for comparison test, 1-Instruction folder. WRITE TO US FOR FAST ACTION, OR CIRCLE READER CARD, and we'll send you FREE SPECIAL OFFER DETAILS, and 16 page COLOR BROCHURE.



# BUILD AN AUXILIARY



**F**or those of you who share my fascination with audio and my pleasure in tinkering, I'd like to suggest a simple, low-tech project. Although it can be completed in a few weekend hours, the results will add a noticeable degree of convenience to your system. This project requires no unusual level of skill; you needn't have an advanced degree in engineering or be especially handy.

I have one auxiliary input on my preamplifier. To plug in a CD player, a Hi-Fi VCR, and a digital recorder resulted in a chaotic tangle of wires that I had to

unsort before I could plug in the correct one and listen. It would be possible to use the tape monitor inputs for these sources, but I have two cassette decks plugged into them.

A perfectly good preamp without enough inputs must be a widespread problem since so many new high-fidelity products are becoming available. The solution is obvious too. If you don't want to trade in your preamp or receiver, you need an outboard switchbox. This sounds simple, but try to find one. It's not easy.

It seemed that the only solution was to build one. This project is a Radio Shack special. They sell a six-position, two-pole rotary switch (catalog #275-1386), which should be more than adequate. Although the switch has six positions, I only used five. A sufficiently roomy box (such as their #270-253), some phono jacks (#274-346), a knob, and some 22-gauge wire (or larger) are all the parts needed. By using a metal box, which provides adequate shielding, it is possible to use single-strand wire instead of shielded cable.

Drilling holes in the box must be done with care, as it will affect the look of the finished project. Use a ruler and felt-tip pen to lay out the locations of the jacks

**I used to have a chaotic tangle of wires that had to be unsorted before I could plug in the correct one and listen.**

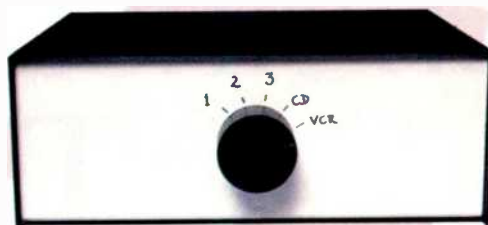
# SWITCHBOX

and the switch (a water-soluble ink will wash off with a damp sponge). Then use a metal punch, or a hammer and nail, to dimple the site of the intended hole. This makes it easier to drill accurately. Start drilling  $\frac{1}{8}$ -inch holes and work up to  $\frac{1}{4}$ -inch for the jacks. You will need a  $\frac{3}{8}$ -inch bit for the switch. Remove metal burrs from the holes with a rattail file. You will need a second hole, approximately  $\frac{1}{8}$  inch, for the stop tab that prevents the switch from rotating. Mount the switch and the phono jacks.

You are now ready to wire the unit. The two input jacks go to the two inner solder tabs on the switch. Examination of the switch structure will show which pairs of tabs to use for an output, and in what order to connect them. If the rotating wipers aren't visible, use a continuity tester or an ohmmeter to determine this information. Note: The ground lugs of all the phono jacks for each single channel should be wired together, to ensure a good ground connection. The two channels' grounds needn't be cross-connected. Only the inner or "hot" leads from the jacks need to be connected to the switch.

To improve the appearance, you will probably want to shorten the switch's shaft with a hacksaw. A professional look can be had by labelling the switch positions and the inputs and outputs with dry transfers (catalog #270-201), but I found it more convenient to write the labels by hand with a permanent, fine-point felt-tip pen.

All in all, for a small investment in time and money, this project can add considerable flexibility and convenience to a good preamp or receiver which would otherwise be rendered limited by the multiple-input demands of today's systems. A little extra effort will yield a switchbox as attractive as it is useful. **A**



## PARTS LIST

**Metal box, approximately 3 × 5¼ × 5⅞ inches (Radio Shack #270-253 or equivalent); one required**

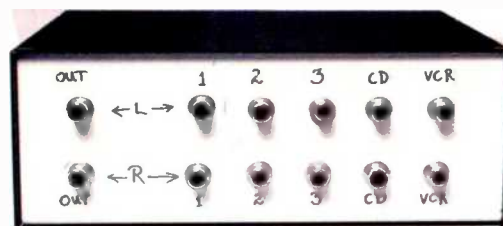
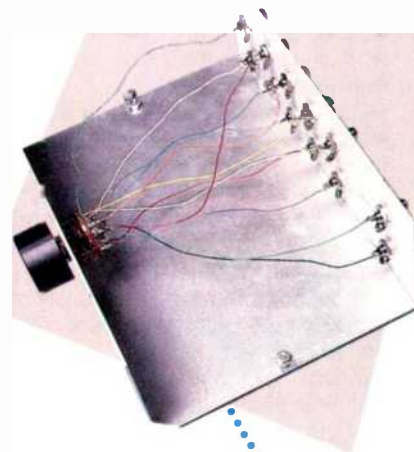
**Six-position, two-pole rotary switch (Radio Shack #275-1386, Mouser 10WA125, or equivalent); one required. Mouser version is sealed, with silvered contacts; for ordering information, call (800) 546-6873.**

**Panel-mount phono jacks (Radio Shack #274-346 or equivalent); 12 required**

**One knob**

**Dry-transfer project labels (Radio Shack #270-201 or equivalent); one set required**

**Hookup wire (#18 to #22 gauge); 8 feet required**



In an era before I settled into my "defense" or wartime activities, I held a most interesting consulting role. This was passed on to me by Ted Hunt, who was sureiy already preparing for his very important work as director of the Underwater Sound Laboratory at Harvard. The Boston Symphony Orchestra had been encountering great difficulties in its efforts to avoid signing a contract with the Musicians' Union. The latest, and ultimately conclusive, difficulty was the success of the union in forbidding RCA Victor to make any more recordings of the orchestra. It could easily be predicted that, without a continuing supply of newly recorded performances, the royalties from records would soon decrease. In a last-minute effort to offset this financial threat, the orchestra trustees adopted the idea that they might well record, manufacture, and sell their own recordings.

I was introduced to this proposition by George E. Judd, a charming man who was then the manager of the BSO. Under his guidance, a man from New York who understood the manufacturing aspects was found, and I became a consultant on the recording end. Between us we selected, and the orchestra bought, all the necessary equipment. Whenever possible (and without compromising the quality of the product), the purchases were made in the secondhand market. A little room overlooking the stage in Symphony Hall was fitted with first-rate amplifiers and cutting turntables, and part of the basement was filled with electroplating tanks and presses for the actual manufacturing of records.

My primary duties in this enterprise were in the supervision of the cutting of the wax master records. Today, in the era of high-quality magnetic tape, making masters is relatively easy. The performance is recorded from as many as 16 or 24 microphones in strategic locations and on as many separate tape tracks. These, sometimes after as

much as a year of study and experimentation, are blended together to produce the desired artistic results. The same original material can then be remastered to meet a variety of recording needs.

In 1941 and 1942, this experimentation and flexibility were not possible. It was necessary for the original recording to satisfy all the requirements for a finished commercial release. This involved much attention to the placement of mikes and the proper mixing of their outputs in proportions that usually varied during a performance.

Recording engineer in several ways. It was recognized that at times the audience noise would ruin a recording, but because any important work would be presented many times, it was hoped that at least one recording would be satisfactory.

The greatest problem in making a record was the compression of the volume range of the orchestra into a compass that did not exceed the limitations of the recording medium. Should the level be too low, surface noise on a record (in the absence of either the Compact Disc or Digital Audio Tape) could overcome the signal and become intolerable; too high a level leads to distortion. Even if the recording mechanism employed could follow the whole range of loudness possible to a symphony orchestra, the resulting music could never be played in a small room without very unpleasant results.

To avoid this, it was necessary to increase the gain of the recording amplifiers for pianissimo passages and to reduce it

when the orchestra played fortissimo. If this compression process should be carried to the extreme, so that the record played everything at a constant loudness, the music would lose much of its emotional content. This would certainly disgust a listener with any musical taste at all.

In order to maintain dynamic realism, the recording engineer needed to foresee all changes in volume. When he knew that a crescendo was coming, he inconspicuously and gradually reduced the gain so that the increase in loudness came forth with as much as possible of its full glory. Similarly, he prepared for a soft passage by bringing up the gain enough so that none of the reproduced music was lost in the background noise of an ordinary room.

Our solution to this problem, as it must be for any other engineer, was to rehearse the operation of the recording gain control as though it were another musical instrument. We learned to fol-

# Engineering The Boston



*Serge Koussevitsky insisted that BSO's records be cut during actual performances. The performance was better, but harder for the engineer.*

One policy decision, probably made by the music director and conductor, the great Serge Koussevitsky, was that the records should be cut during actual performances. Although this ensured a higher quality, as there was no doubt that the orchestra played better before a sympathetic audience than in a "cold" hall containing only microphones, it was harder for the re-

**JOHN ALVIN PIERCE**



low the printed score well enough so that we could annotate it with numbered settings for the gain control. We used whatever musical taste we had to make the necessary adjustments as inaudible as possible—or perhaps I should say to preserve as much as possible of the artistic values of the performance. We tried, through many rehearsals and performances, to have music students and other artists carry out this function, almost always with discouraging results. I am sorry to have to say that the least satisfactory results were those with Arthur Fiedler, the famous late composer of the Boston Pops, at the controls. It was clear that Fiedler was too devoted to the music itself and could not simultaneously maintain the necessary concentration on the recording process. The only alternative seemed to be to employ an engineer who had a modicum of musical taste but who could keep the technical problem uppermost in his mind. I am sorry that we did not identify a better compromise candidate than me. Consequently, I am sure that I "rode gain" on more trials and records than anyone else. Curiously, I was never introduced to Koussevitsky in the year I spent on this effort, but I still treasure a letter from Judd in which he described the conductor's satisfaction with some of our results.

Koussevitsky's personal habits complicated my recording problem. He felt that his orchestra could keep time, so he devoted his gestures, whether of the baton arm or the other, almost entirely to matters of inflection. It was commonplace for the orchestra to begin playing with no preliminary signal that I could see from the poor vantage point of the very small window overlooking the stage from the side. This was a great trial, because it was necessary, in those days that did not permit re-recording, to start the cutting turntable soon enough so that the record would have only three or four silent grooves. All too often I found the orchestra playing while I was still eagerly watching for a cue. From my point of view, the per-



Serge Koussevitsky

formance was reduced to the status of another rehearsal.

I was sternly assured that Koussevitsky could not be troubled to give a starting signal for my benefit because, in the last seconds before beginning a composition, he was entirely occupied in mental preparations and could not be disturbed. After watching this ritual many times, I came to the conclusion that an errant cough in the last row of the audience could interrupt the conductor's concentration and considerably extend the time it took him to prepare himself. I did learn to start the recorder at nearly the right time on some occasions, but I failed much too often. I was delighted at one rehearsal when a violinist, new to the orchestra, had the temerity to inquire how the musicians were supposed to know when to begin. Koussevitsky looked at him in what seemed to be total amazement. "Why, why," he said, "When ze baton touches ze air, you play."

By the end of the year, when it was too late for the information to do me much good, one of the musicians who had become accustomed to seeing me around finally provided the answer to the question. This was not given without an oath of secrecy, as the musicians seemed to feel that they were in deadly peril if the conductor heard of their betrayal. I was informed that when the first oboe saw Koussevitsky's baton gently descend to the level of the third button on his vest, the musician would give an inconspicuous nod which the orchestra would take for its starting time. This confession may have been akin to sending me for a left-handed monkey wrench, but it comforted me to believe that I was not alone in my trouble.

When introducing a new composition for rehearsal, Koussevitsky had the habit of giving the orchestra little 5- or 10-minute lectures, discussing the composer and explaining the conductor's beliefs about what the composer was trying to accomplish. These talks were invariably delightful and I tried very hard to get permission to record

*The orchestra would often start playing with no visible cue I could see; their performance became, to me, just another rehearsal.*

Roman Szulc (left) and Everett J. Firth



some of them, thinking they would be of great interest and importance to music students everywhere. I am still disappointed that Koussevitsky never agreed to this suggestion, especially because such a series of records might have gone far toward justifying the amount of time and energy, if not of money, that was spent on the recording project.

One of our great difficulties was the strength of the timpanist, Roman Szulc (pronounced, as it seemed to me, "Schultz"). He had muscles that I never saw equalled. He enjoyed baring his arm, with a drumstick between his fingers, and letting all comers feel his forearm; it felt as though it were carved out of seasoned maple. His power was a trial to us in the recording room. We would often think that we were ready for a passage rising to fortissimo when Szulc would join in with his kettle-drums and send sound levels above our distortion threshold. Those of us bothered by his skill, or strength, in-

vented all sorts of hypothetical schemes to limit his acoustical output. Probably the most polite of these was the suggestion that we bore holes at appropriate points in the ceiling and drip water onto his drums during the performance.

After suffering from Szulc's ministrations for some time, there came a cheering day when the orchestra was rehearsing Shostakovich's Sixth. At a moment when, to me, all seemed to be going beautifully, Koussevitsky's baton went "tap, tap, tap" and the music came to a quick stop. Turning toward the timpanists' corner, extending his

arms toward Szulc and then bringing his hands over his heart, the maestro, Koussevitsky, then exclaimed, "Ah, Szulc, Szulc, you play be-yooo-tiful—but too loud!"

Koussevitsky's instructions to the orchestra were, to one with no musical experience except as a listener, often unintelligible. My favorite occasion was during a rehearsal of something by Beethoven, when again the baton tapped three times. As the orchestra stopped playing, Koussevitsky extended his arms in a gesture somewhere between beckoning and beseeking and cried, "Zhentlemen, zhentlemen, I moost haif more go-o-old all over ze orchestra!" When the music resumed, I could detect no difference, but the tone must have been more golden because the conductor made no further comment.

The year in which I spent a fraction of my time in this enterprise of the Boston Symphony Orchestra was full of discovery and excitement. It had all of the fascination of any work that requires stretching one's ability and energy to the utmost. The satisfaction that should have ensued was, unfortunately, absent because the management of the BSO found it financially impossible to continue without signing a contract with the union. I never found out whether the few symphonies I had successfully recorded could have withstood commercial competition. I had, however, had a memorable experience in a world that was new to me. **A**

# All this jazz

## ANY 8 CDs FOR ONLY 1¢

with membership in the Club. See details below.

PLUS A CHANCE TO GET ONE MORE CD—FREE!



Basia—London Warsaw  
New York (Epic) 401-552

Kenny G Live (Arista)  
401-505

Chick Corea Electric  
Band—Inside Out (GRP)  
404-574

### POPULAR HITS

- Rush—Presto (Atlantic) 401-695
- Chicago—Greatest Hits 1982-1989 (Reprise) 401-166
- Eric Clapton—Journeyman (Warner Bros.) 400-457
- Linda Ronstadt—Cry Like A Rainstorm, Howl Like The Wind (Elektra) 389-874
- Aerosmith—Pump (Geffen) 388-009
- Billy Joel—Storm Front (Columbia) 387-902
- Don Henley—The End Of The Innocence (Geffen) 383-802
- Michael Bolton—Soul Provider (Columbia) 383-083
- Tom Petty—Full Moon Fever (MCA) 382-184
- Bonnie Raitt—Nick of Time (Capitol) 381-087

- Joey DeFrancesco—Where Were You? (Columbia) 404-939
- Dianne Reeves—Never Too Far (EMI) 404-517
- Mike Stern—Jigsaw (Atlantic Jazz) 403-493
- Eddie Gomez—Street Smart (Columbia) 403-360
- Ahmad Jamal—Pittsburgh (Atlantic) 403-279
- George Benson—The Best Of George Benson Original CTI Recordings (CBS Associated) 403-246
- Dave Grusin—The Fabulous Baker Boys Soundtrack (GRP) 402-958
- Dizzy Gillespie—The Symphony Sessions August 25, 1989 (Pro Jazz) 401-943
- Jon Faddis—Into The Faddisphere (Epic) 401-927
- David Benoit—Waiting For Spring (GRP) 401-901
- Happy Anniversary, Charlie Brown—Various Artists (GRP) 400-846
- Original Sound Track—Strait No Chaser Music from the Motion Picture Thelonus Monk (Columbia) 400-614
- Lee Ritenour—Color Rit (GRP) 400-051
- Dave Grusin—Migration (GRP) 400-044
- Michel Camilo—On Fire (Epic) 389-999
- Earl Klugh—Solo Guitar (Warner Bros.) 389-932
- Nancy Wilson—Lady With A Song (Columbia) 389-692
- Miles Davis—Aura (Columbia) 389-312
- Yellowjackets—The Spin (MCA) 388-173
- Lou Rawls—At Last (Blue Note) 387-589
- David Newman—Fire! Live at the Village Vanguard (Atlantic Jazz) 387-563
- Randy Crawford—Rich And Poor (Warner Bros.) 401-950

- Don Cherry—Art Deco (A&M) 387-548
- Elaine Elias—So Far So Close (Blue Note) 387-530
- Victor Bailey—Bottom's Up (Atlantic Jazz) 387-464
- Freddie Hubbard—Times are Changing (Blue Note) 387-449
- Stanley Turrentine—La Place (Blue Note) 387-159
- Harry Connick, Jr.—When Harry Met Sally—Music From The Motion Picture (Columbia) 386-821
- McCoy Tyner—Revelations (Blue Note) 386-763
- New York Voices (GRP) 386-292
- Janis Siegel and Fred Hersch—Short Stories (Atlantic) 386-029
- Rippingtons—Tourist In Paradise (GRP) 385-658
- David Murray—Ming's Samba (Portrait) 384-875
- David Benoit—Urban Day Dreams (GRP) 384-628
- Chet Baker—The Best Thing For You (A&M) 384-594
- George Benson—Tenderly (Warner Bros.) 384-214
- Dr. John—In A Sentimental Mood (Warner Bros.) 384-040
- Diane Schuur—Collection (GRP) 383-919
- Pat Metheny Group—Letter From Home (Geffen) 383-901
- Spyro Gyra—Point Of View (MCA) 383-737

- Larry Carlton—On Solid Ground (MCA) 383-661
- Grover Washington, Jr.—Time Out Of Mind (Columbia) 383-539
- Jean Luc Ponty—Storytelling (Columbia) 383-521
- Branford Marsalis—Trio Jeeps (Columbia) 381-830
- Miles Davis—Amandia (Warner Bros.) 381-756
- Steps Ahead—N.Y.C. (Intuition) 381-681
- Kirk Whalum—The Promise (Columbia) 380-436
- Wynton Marsalis—The Majesty Of The Blues (Columbia) 380-394
- George Duke—Night After Night (Elektra) 379-719
- Hiroshima—East (Epic) 379-321

- Dave Grusin Collection (GRP) 378-398
- Joe Sample—Spellbound (Warner Bros.) 378-224
- Gerard Albright—Bermuda Nights (Atlantic) 377-903
- Al Jarreau—Heart's Horizon (Reprise) 376-186
- Michael Brecker—Don't Try This At Home (MCA/Impulse) 374-769
- Stanley Jordan—Flying Home (EMI) 373-860
- Bird—Original Motion Picture Soundtrack (Columbia) 373-332
- Bob James—Ivory Coast (Warner Bros.) 372-789
- Ornette Coleman—Virgin Beauty (Portrait) 372-722
- Take 6 (Reprise) 372-680

- Najee—Day By Day (EMI) 371-856
- Stanley Clarke—If This Bass Could Only Talk (Portrait) 371-823
- Kenny G—Silhouette (Arista) 371-559
- David Sanborn—Close Up (Warner Bros.) 370-304
- Bobby McFerrin—Simple Pleasures (EMI) 369-306
- Basia—Time And Tide (Epic) 368-043
- Oscar Peterson—The Trio (Pablo) 367-268
- The Manhattan Transfer—Brasil (Atlantic) 363-648
- Duke Ellington Orch.—Digital Duke (GRP) 357-350
- Chuck Mangione—The Best Of Chuck Mangione (A&M) 340-547

### LEGENDARY JAZZ PERFORMANCES

- Thelonious Monk—The Composer (CL Jazz Masterpieces) 377-770
- Great Moments In Jazz—Various Artists (Atlantic) 376-582/396-580
- Charles Mingus—Mingus Ah Um (Cl Jazz Masterpieces) 354-795
- Bill Evans—Waltz for Debby (Riverside) 376-335
- Ornette Coleman—The Shape of Jazz to Come (Atlantic) 371-641
- John Coltrane—Giant Steps (Atlantic) 371-591
- The Gil Evans Orchestra—Out Of The Cool (MCA/Impulse) 370-072
- The Best Of Chess Jazz—Various Artists (Chess) 363-937
- Billie Holiday—From The Orig. Decca Masters (MCA) 354-985
- Charlie Parker—Bird/The Savoy Recordings, Vol. 1 (Savoy Jazz) 383-950
- Benny Goodman—Sextet-Slipped Disc 1945-46 (CL Jazz Masterpieces) 377-531
- Miles Davis—Kind of Blue (CL Jazz Masterpieces) 353-045
- The Dave Brubeck Quartet—Time Out (CL Jazz Masterpieces) 353-060

From Charlie Parker to the Pat Metheny Group—and all the jazz in between—now all available on CD! As your introduction to the Club, you can choose any 8 CDs listed in this ad for 1¢. Fill in and mail the application—we'll send your 8 CDs and bill you for a penny, plus shipping and handling. You simply agree to buy 6 more CDs (at regular Club prices) in the next three years—and you may then cancel your membership anytime after doing so.

**How the Club works.** About every four weeks (13 times a year) you'll receive the Club's music magazine, which describes the Selection of the Month... plus new hits and old favorites from every field of music. In addition, up to six times a year, you may receive offers of Special Selections, usually at a discount off regular Club prices, for a total of up to 19 buying opportunities.

If you wish to receive the Selection of the Month, you need do nothing—it will be shipped automatically. If you prefer an alternate selection, or none at all, fill in the response card always provided and mail it by the date specified. You will always have at least 10 days in which to make your decision. If you ever receive any Selection

without having 10 days to decide, you may return it at our expense.

The CDs you order during your membership will be billed at regular Club prices, which currently are \$12.98 to \$15.98—plus shipping and handling. (Multiple-unit sets may be somewhat higher.) After completing your enrollment agreement you may cancel membership at any time; if you decide to continue as a member, you'll be eligible for our money-saving bonus plan. It lets you buy one CD at half price for each CD you buy at regular Club prices.

**10-Day Free Trial:** We'll send details of the Club's operation with your introductory shipment. If you are not satisfied for any reason whatsoever, just return everything within 10 days and you will have no further obligation. So why not choose 8 CDs for 1¢ right now?

**Extra Bonus Offer:** As a special offer to new members, take one additional CD right now for only \$6.95. This discount purchase entitles you to choose an extra CD as a bonus FREE. Just indicate your choices in the coupon, and you'll receive your discounted CD and your bonus CD with your 8 introductory CDs—a total of 10 in all!

COLUMBIA HOUSE, 1400 N. Fruitridge Ave. 234/F90  
P.O. Box 1129, Terre Haute, Indiana 47811-1129

Please accept my membership application under the terms outlined in this advertisement. Send me the 8 Compact Discs listed here and bill me 1¢ plus shipping and handling for all eight. I agree to buy six more selections at regular Club prices in the coming three years—and may cancel my membership at any time after doing so.

SEND ME THESE 8 CDs FOR 1¢ (write in numbers below):


My main musical interest is (check one): (But I may always choose from any category)

- Jazz  
Wynton Marsalis, Spyro Gyra
- Classical  
Vladimir Horowitz, Kathleen Battle
- Soft Rock  
Michael Bolton, Fleetwood Mac

Mr. \_\_\_\_\_  
Mrs. \_\_\_\_\_  
Miss \_\_\_\_\_  
First Name Initial Last Name

Address \_\_\_\_\_ Apt. \_\_\_\_\_

City \_\_\_\_\_

State \_\_\_\_\_ Zip \_\_\_\_\_

Do you have a VCR? (04)  Yes  No  
Do you have a credit card? (03)  Yes  No

**Extra Bonus Offer:** also send me this CD for which I will be billed an additional \$6.95.

...and I'm entitled to this extra CD FREE!

JZQ/F6 JZR/59 JZS/ZX JZT/18

Note: We reserve the right to reject any application or cancel any membership. These offers not available in APO, FPO, Alaska, Hawaii, Puerto Rico, write for details of alternative offer. Canadian residents serviced from Toronto. Applicable sales tax added to all orders.

# 1

## GOLDMUND ST4 TURNTABLE & GOLD CARTRIDGE

### Manufacturer's Specifications

#### Turntable

**Drive System:** Direct, with quartz-regulated speed control.

**Speeds:** 33 $\frac{1}{3}$  and 45 rpm.

**Resonance Frequency of Suspension:** 3 Hz.

**Platter Construction:** Methacrylate with peripheral lead inserts.

**Platter Weight:** 7 lbs (3.2 kg).

**Weight:** 46 lbs. (20.9 kg), including tonearm.

**Dimensions:** 20 in. W x 8 $\frac{3}{8}$  in. H x 20 in. D (51 cm x 22 cm x 51 cm).

#### Tonearm

**Type:** Linear-tracking, servo.

**Tracking Error:** Maintained within  $\pm 0.1^\circ$  by servo and infrared sensor.

**Effective Length:** 8 $\frac{1}{16}$  in. (20.5 cm).

**Damping:** Adjustable, fluid.

**Main Resonance:** 10 to 14 Hz, depending on cartridge.

**Vertical Tracking Angle:** Adjustable.

**Cartridge Weight Range:** 4 to 20 grams.

**Headshell:** Detachable, with adjustable overhang.

#### Cartridge

**Type:** Moving coils, on cantilever axis.

**Stylus:** Trigon parabolic line contact, 7 x 35  $\mu$ m.

**Estimated Stylus Life:** 1,500 hours.

**Cantilever:** Boron pipe.

**Tracking Force:** 2 grams,  $\pm 0.2$  gram.

**Vertical and Lateral Compliance:** 7 mm/N.

**Mass:** 6.4 grams.

**Trackability:** 80  $\mu$ m at 315 Hz.

**Vertical Tracking Angle:** 23 $^\circ$ .

**Output Level:** 0.7 mV for 5-cm/S recorded velocity at 1 kHz.

**Balance:** Within 0.1 dB at 1 kHz.

**Channel Separation:** 35 dB at 1 kHz.

**Output Impedance:** 50 ohms.

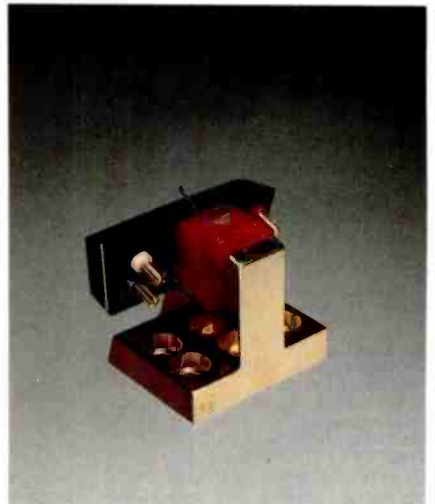
**Optimal Load Impedance:** 50 ohms,  $\pm 1$  ohm.

#### General Specifications

**Prices:** Turntable and tonearm, \$5,690; cartridge, \$1,950.

**Company Address:** c/o International Audio Technologies, 1387 Willard Rd., Suite J, Chantilly, Va. 22021.

For literature, circle No. 90



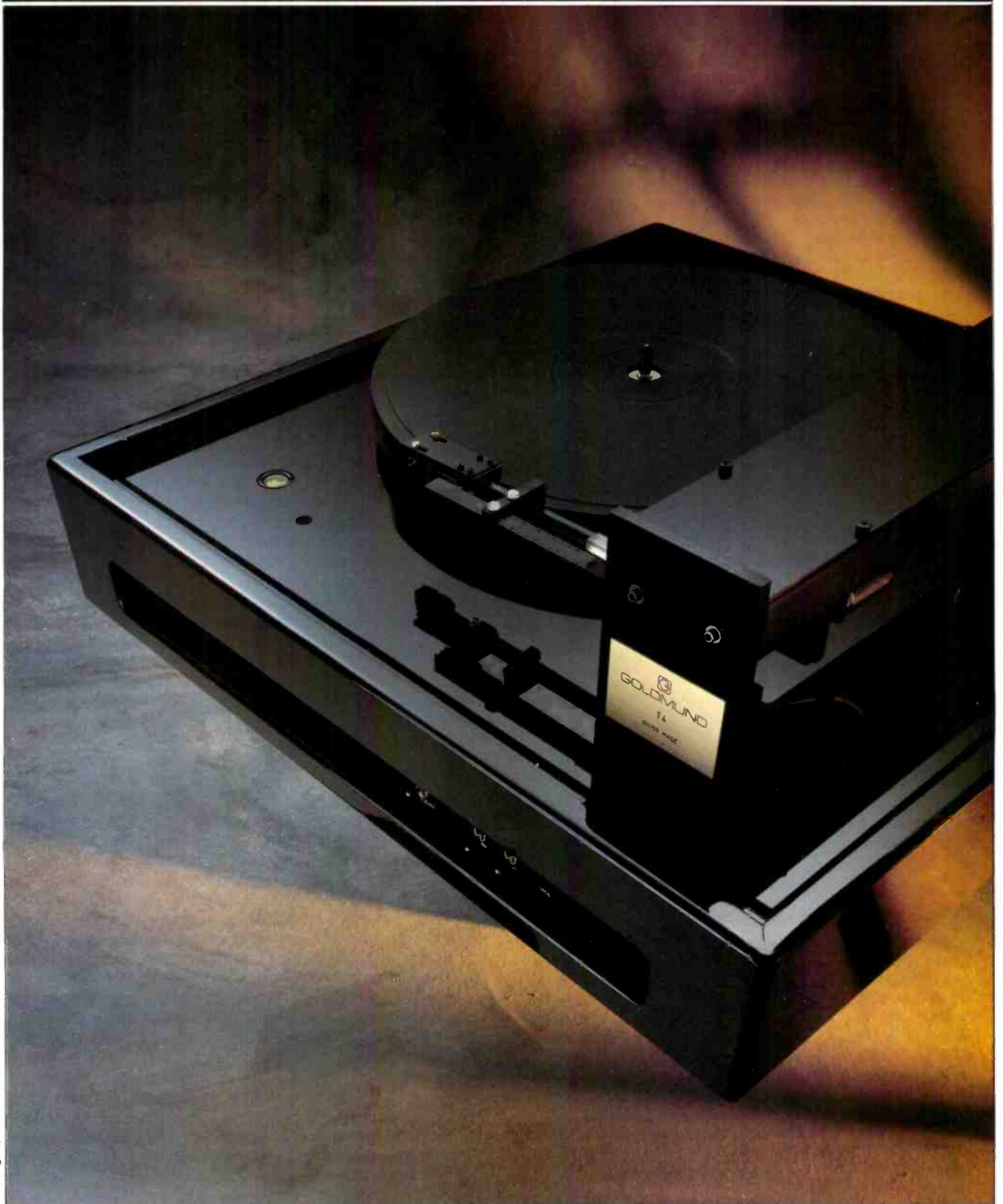
Goldmund is a Swiss firm that has earned an enviable reputation in audiophile circles as a producer of excellent turntables. The company began by making a servo-controlled linear-tracking arm, which has gone through several revisions to become the T3F (now available for \$4,990). Two years later, in 1979, they introduced the Studio turntable (\$3,590). This was followed in 1983 by the Reference, designed to be the ultimate turntable, with no cost restrictions whatever; it is still available by special order at a cost of \$27,400. The Studietto, also released in 1983, was more affordable at \$2,195.

The ST4 reviewed here is Goldmund's first turntable to be sold complete with tonearm, and is intended to approach the sonic attributes of their original products at a much more reasonable price. It uses the drive and base from the Studio Mk. IV turntable, and the motors and design principles of the T3F arm, together with servo electronics. While the servo

electronics of the T3F are in a separate, rack-mountable box, the simplified servo circuits for the arm used in the ST4 are mounted within the turntable base.

To complete the package, Goldmund has arranged with Peter Suchy of Clearaudio to provide a special cartridge that they have designated the Goldmund Gold. I tested the Goldmund ST4 turntable and tonearm with the Goldmund Gold cartridge.

The glossy finish of the ST4 is very striking, but after working on the initial setup adjustments, I realized how clearly fingerprints stand out on its mirror-like surface. These are easy to remove, however, and I was able to restore everything to original pristine appearance by merely wiping the surfaces with my pocket handkerchief. The turntable platter surface and the tonearm tube and sensor rail are finished in dull black, providing an interesting contrast. I noticed that Goldmund has added a nice touch by mounting



Photograph: Robert Lewis

The arm assembly is sturdy, with no detectable play in its bearings, and the armtube's damping is extraordinary.

## MEASURED DATA

### ST4 Tonearm

Pivot-to-Stylus Distance: 7.87 in. (200 mm).  
 Pivot-to-Rear-of-Arm Distance: 1.25 in. (32 mm).  
 Overall Height Adjustment: 1.0 in. (25.4 mm).  
 Tracking-Force Adjustment: Sliding counterweight.  
 Tracking-Force Calibration: None; separate gauge required.  
 Cartridge Weight Range: 2 to 10 grams.  
 Counterweights: 145.5 and 181.5 grams.  
 Counterweight Mounting: Direct to armtube.  
 Sidethrust Correction: None required.  
 Pivot Damping: Fluid in trough.  
 Lifting Device: Motorized, controlled by toggle switch.  
 Headshell Offset: None required.  
 Overhang Adjustment: Slotted cartridge mounting holes.  
 Bearing Alignment: Excellent.  
 Bearing Friction: Extremely low.  
 Pivot Bearing Type: Two vertical and two horizontal jewelled pivots in gimballed arrangement.  
 Track Bearing Type: Eight roller bearings, four for horizontal movement and four for side-to-side stability.  
 Lead Torque: Negligible.  
 Arm Lead Capacitance: Left, 90 pF; right, 84 pF.  
 Arm Lead Resistance: Left, 0.9 ohm; right, 1.1 ohms.  
 External Lead: None supplied.  
 Base Mounting: Directly to ST4 turntable base.

### Gold Cartridge

Coil Inductance: Less than 100  $\mu$ H, left and right.  
 Coil Resistance: Left, 49.0 ohms; right, 48.6 ohms.  
 Output Voltage: Left, 0.160 mV/cm/S; right, 0.158 mV/cm/S.  
 Tracking Force: 2.1 grams.  
 Cartridge Mass: 5.1 grams.  
 Microphony: Extremely low.  
 Hum Rejection: Very high.  
 Rise-Time: 12  $\mu$ S.  
 High-Frequency Resonance: 25.1 kHz.  
 Low-Frequency Resonance: 8.0 Hz, in ST4 tonearm.  
 Low Frequency Q: 2.87, in ST4 tonearm.  
 Recommended Load Resistance: 47 kilohms to 50 ohms.  
 Recommended Load Capacitance: Unaffected by 500 pF or less.

PARAMETER	MEASURED	COMMENT
Speed Accuracy	0.16% fast	Excellent
Speed Stability	0.317%	Good
Wow, DIN Unwtd.	0.18%	Very good
Wow, DIN Wtd.	0.12%	Very good
Flutter, DIN Unwtd.	0.20%	Good
Flutter, DIN Wtd.	0.08%	Good
Wow & Flutter, Unwtd.	0.21%	Good
Long-Term Drift	0.05%	Excellent
Rumble, Unwtd.	-58.9 dB	Good
Rumble, Wtd.	-73.7 dB	Excellent
Suspension Resonance	6.67 Hz	High

a bubble level in the top of the turntable's suspended main platform, which makes the balancing adjustments quite easy. The operating controls for speed change (33 $\frac{1}{3}$  and 45 rpm), power, and tonearm lift are located on a recessed panel in the front of the turntable base. Unless you mount the ST4 high up on a shelf, you will have difficulty reading the labels on the switches.

I was surprised at the tonearm position. I am used to seeing linear-tracking tonearms mounted with their horizontal tracks behind the platter, but the ST4's arm is mounted with its track on the right side of the platter, running from front to rear. Since the arm then comes to its rest in front of the platter, you must lift a record over the arm and its tracking-sensor tube to place the record on the platter. This position also makes it harder to find the desired groove on a record before lowering the arm. During the testing and auditioning, I operated the ST4 from what would normally be its left side, having previously memorized the functions of the three switches. Unfortunately, only after my testing was complete did Goldmund's importer mention that the top plate can also be mounted with the arm track behind the platter.

The arm assembly seemed very sturdy. I could detect no play in the bearings when I tried to elicit movement between the armtube and the pivot bearings by holding the gimballed steady in one hand while I tried to pull, push, and twist the armtube. This is as it should be. The friction of the tonearm in the traverse mode was also extremely low.

When I performed my usual "tap" test on the armtube, I was surprised that the "tick" sound was very uniform all the way from the headshell to a point just forward of the gimballed bearings; most armtubes exhibit some change in the character of the sound when tapped at various points along their length. This indicates to me that the damping of mechanical energy in the ST4 armtube is quite extraordinary. I was also very impressed by the level of finish and apparent precision of the parts and assembly.

### Features

The ST4 turntable uses a direct-drive motor with a speed-servo system controlled by a quartz reference oscillator and associated electronic drive circuitry. The motor is fastened directly to the main platform, which is about 0.3 inch thick, while the servo system's circuit board is mounted directly beneath the tonearm. The methyl methacrylate platter is 12 $\frac{3}{16}$  inches in diameter and  $\frac{3}{4}$  inch thick, and it weighs 6 pounds on my scale. Ten counterweights, each 1 $\frac{3}{8}$  inches in diameter, are mounted in holes around the platter's bottom periphery to increase inertia and ensure rotational stability.

Goldmund has placed much emphasis on the unidirectional transmission of energy through the various parts of the ST4 tonearm and turntable to the structure on which it rests. The objective, which the company calls mechanical grounding, is to provide a "mechanical diode" design that allows energy to be transmitted in one direction only—that is, from the tonearm and turntable, through the three Delrin feet on the turntable base, to the platform or shelf beneath—without allowing energy to be transmitted back from the outside. Goldmund also makes cones that can be used in place of the feet; the company states that these cones

**Make your next move to Velodyne.  
It's guaranteed to put new life  
into your system!**



**For sound performance, a Velodyne subwoofer is the single most dramatic addition you can make to any system. Experience the true power of bass without harmonic distortion. Experience all the music. Experience Velodyne.**

**Velodyne**

For More Information



Call 1-800-553-4355

Enter No. 28 on Reader Service Card

1746 Junction Ave., San Jose, CA 95112 408/436.0688 800/VELODYNE In Canada: 416/671.8990

The Goldmund's suspension is designed as a "mechanical diode," transmitting energy only one way—down and out.



"improve vibration evacuation efficiency" and "provide the last mechanical diode link in the Goldmund Mechanical Grounding chain."

The platter is isolated from the motor except at the chrome-plated spindle, which is tapered at the top, and the tops of three hex-head bolts. These bolts pass through a disc, made from the same acrylic resin as most of the turntable's other major components, which isolates the rotating outer part of the direct-drive motor. The mechanical energy is transmitted through the bolts from the platter to the motor, which is in turn fastened to the main platform. The center of the platter is not directly coupled to the motor because a precision-machined Teflon sleeve, with an outer diameter of 0.89 inch, is between the spindle and the platter's 0.9-inch center hole. This may sound a little complicated, but the intention is to provide energy isolation except where energy transfer is desired—that is, from the platter, through the three bolts, to the motor, and then to the main platform. The main platform also acts as an energy sink for the tonearm, because the tonearm's two side supports are fastened directly to it. The main platform, the tonearm horizontal structure, and the turntable base are also made from methyl methacrylate, which should aid in keeping undesired mechanical energy away from the stylus/groove interface, where it can color the sound. At the bottom center of the platter is a recessed area,  $5\frac{3}{16}$  inches in diameter, to allow clearance for the  $4\frac{3}{8}$ -inch diameter plastic disc fastened to the rotating outer part of the motor.

The top of the platter is also recessed at the center and the edge to allow clearance for the center label area and outer rim of a record; this ensures a close contact between the bottom surface of the record and the turntable platter. Because the platter and the record are made of similar materials, most of the mechanical energy in the record, caused by stylus vibrations in the disc's groove, will be absorbed into the platter instead of making its way back to the stylus, where it would be picked up again as delayed vibration that could color the sound.

The main platform is a little over 0.3 inch thick and is supported by three coiled springs. One spring is situated directly under the tonearm, in the middle of the right side; the other two are under the left side of the main platform, at the front and rear. All of the springs are  $2\frac{1}{2}$  inches long (when uncompressed) and  $2\frac{1}{4}$  inches in diameter, but each is wound with a different number of turns and is therefore color coded so it can be placed in its proper position. There are felt rings between the springs and the underside of the main platform.

Additional felt rings are inside the plastic cups that form part of the turntable's levelling system. The cups are mounted on long bolts fastened to the turntable base. To adjust the height of the main suspension platform, one turns these bolts, usually while watching the bubble level, using a tool inserted from above through holes in the platform. The long bolts pass through the bottom of the turntable base, where rubber feet are threaded onto them. Turning these feet allows the outer base to be levelled. One of the feet is tapered to allow easier transfer of energy from the turntable base to the platform on which it rests. The feet add about 1 inch to the height of the turntable base and cover assembly, which is about  $7\frac{3}{4}$  inches, making the total height  $8\frac{5}{8}$  inches with the cover closed. The turntable base measured  $19\frac{3}{4}$  inches square, which gives you some idea of the space required for the ST4—especially when you allow for raising the lid to change records. The cover is made from  $\frac{1}{8}$ -inch clear acrylic plastic and has a rounded top at its front and back.

The tonearm's horizontal tracking assembly is  $12\frac{3}{16}$  inches long and  $2\frac{3}{16}$  inches wide, including the two end supports that mount to the turntable platform. After height adjustment, the traverse assembly can be locked in place with horizontal screws that pass through inch-long vertical slots on each support. The arm's height is adjustable to suit cartridges of different sizes and to fine-tune the vertical tracking angle. The traverse assembly is raised or lowered by adjusting four vertical screws located under the polished top cover (which can be lifted off after removing the four screws securing it). Once the correct height has been determined visually and aurally, the four horizontal screws on the side posts are tightened to lock this correct setting. Then, in order to provide a single transmission path for unwanted mechanical energy, three of the vertical screws are backed off until the transverse part of the arm rests on a single screw.

The round armtube's diameter changes gradually, from 0.375 inch at the front to 0.395 inch just before the pivots. The pivots consist of a gimbal arrangement of two horizontal and two vertical jewelled bearings. Because the ST4's pivot-to-stylus distance is about 8 inches, comparable to that of normal, pivoted tonearms, vertical motion caused by record warp has much less effect on tracking than it does on other linear-tracking tonearms, which have short armtubes.

The headshell is securely attached by four Allen-head screws to a block at the end of the armtube. The left- and right-channel signal leads, each a very thin, twisted pair, exit from the horizontal traverse part of the tonearm, as do the seven leads for tonearm servo control. All these leads are fed through a slot in the turntable's main platform, where



# MAXIMUM

Reduce vibration and achieve maximum sonic performance from your audio components with Allsop's new Sonic Enhancement Series.

Allsop CD Plus Protective Stabilizers reduce CD jitter for the ultimate sound reproduction from your CD player.

# SONIC

NAVCOM™ Audio Isolators are ultra thin, NAVCOM™ component feet that isolate your sensitive audio equipment from sound degrading vibration. They're specifically engineered to reduce the transmission of unwanted vibration throughout the entire sonic spectrum. Allowing your components to process more pure signals rather than distorted ones. Resulting in tighter bass,



Allsop CD Plus Protective Stabilizers are unique bands that conform to the outer edge of your compact disc. They're made of NAVCOM™, a specially formulated material that absorbs unwanted vibration, helping to stabilize your disc. This stability allows your CD player's laser

clearer sound and greater overall sonic quality. Achieve maximum sonic performance from your equipment with Allsop's Sonic Enhancement Series...  
... Music in its purest form.

# Performance

to read musical data with greater accuracy for tighter bass, smoother highs, improved separation and soundstage.

- NAVCOM™ Audio Isolators
- reduce the transmission of
- unwanted vibration in sensitive
- audio components for unsur-
- passed clarity and greater
- overall sound quality.

Enter No. 3 on Reader Service Card



## ALLSOP 3

P.O. Box 23  
Bellingham, WA 98227 U.S.A.  
(206) 734-9090  
1-800-426-4303  
FAX: (206) 734-9858

© 1990 Allsop Inc.

# Breathtaking



# the new Polk RTA 15t

The breathtaking performance of Polk Audio's new RTA 15t loudspeaker system is the result of the rare combination of state-of-the-art technology and superior design.

Incorporating technology from Polk Audio's limited production SRS (Signature Reference Loudspeaker System), the RTA 15t uses advanced components and design technologies to achieve outstanding musicality, detail and imaging. The heart of this design is a line source array that achieves an openness and spaciousness permitting a wide range of optimum listening positions. At the center of this line source is Polk's SL3000 tri-laminate tweeter, an engineering triumph in high frequency smoothness and dispersion.

Outstanding bass impact and dynamic range is realized by using two 10" sub-bass radiators (one front mounted and one rear mounted). This dual bass radiator technology achieves deeper, flatter, more accurate bass than conventional designs.

The new Polk RTA 15t  
...one listen will take your  
breath away.

The RTA 15t is available  
in natural oak, natural  
walnut and black oak  
wood veneer finishes.



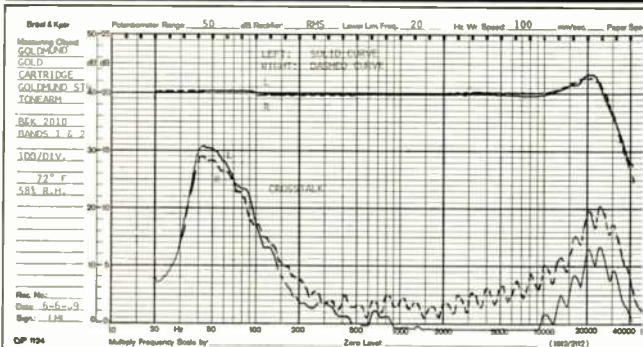
**polk audio**  
The Speaker Specialists

5601 Metro Drive, Baltimore, MD 21215 (301) 358-3600

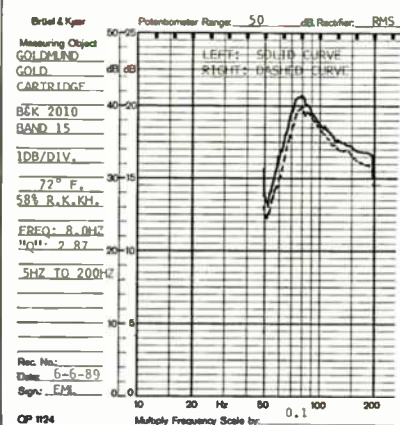
**Where to buy Polk Speakers?**  
**For your nearest dealer, see page 114**

Enter No. 21 on Reader Service Card

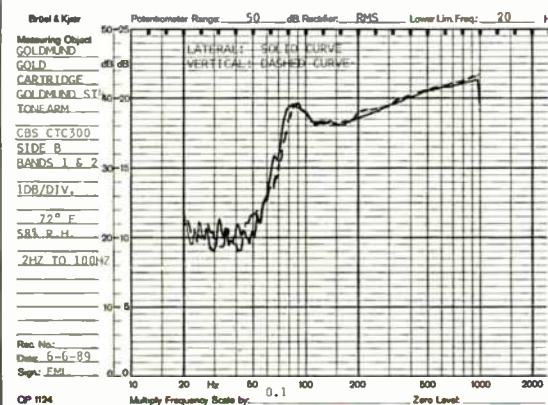
Because this linear-tracking arm is as long as a pivoted one, vertical motion caused by record warp has little effect on the sound.



**Fig. 1—Frequency response and crosstalk of Goldmund Gold cartridge in tonearm of Goldmund ST4, using B & K 2010 test record.**



**Fig. 2—Low-frequency tonearm/cartridge resonance is at 8.0 Hz with a Q of 2.87.**



**Fig. 3—Response to vertical and horizontal modulation from 2 to 100 Hz (slow sweep).**

**Note that the response is virtually identical in either plane.**

The seven control leads connect to the servo-control circuit board located under the tonearm. The signal leads are brought through a hole in the turntable base near the rear of the horizontal part of the tonearm. These leads are soldered to a pair of gold WBT phono connectors mounted on the vertical support of the tonearm. Leads are not normally supplied with the ST4, but Goldmund strongly recommends the use of MIT cables. I used a pair of 1-meter MIT cables while testing and auditioning the ST4.

A sliding counterweight is used to set the tracking force; after it is adjusted, it is locked in place by an Allen-head setscrew. Various weights are available for cartridges of different mass so that the correct position will always be near the pivots; this ensures that the effective mass, at the stylus tip, will be as low as possible.

The horizontal traverse portion of the ST4 arm consists of a set of four roller bearings. Two of these bearings are on a felt track; the other two are in direct contact with the aluminum rail and are slightly larger in diameter to make up for the absence of the felt. This system allows a direct path from the tonearm to the base for unwanted mechanical energy. There are also four more bearings, on the front and back of the carriage, for stability; these bear against the side surfaces of felt-covered tracks. The upper part of the carriage is an epoxy/glass printed circuit board that carries the control signal leads to the arm lift motor, located on the underside of the traverse system, and to the servo-control motor at the end of the arm's horizontal structure. This latter motor drives the traverse carriage by means of a 10½-inch-long rubber belt that passes around a ⅜-inch pulley on the drive shaft and around a similar pulley at the other end of the horizontal structure.

The lift motor operates a cam that raises the armtube when the sensing system is actuated by the lead-out groove of a record. When this happens, a claw (which normally grips the belt that slowly drives the horizontal carriage toward the center of the record) opens up, freeing the belt from the drive system.

Horizontal movement is determined by the action of a photocell, mounted on a fixed sensing arm that is parallel to the armtube, and a vane that is attached to the armtube just behind the headshell. Normal, small movements caused by the slow spiral of the record grooves cause the tonearm's horizontal drive motor to move the belt by slight amounts. When the lead-out groove is sensed, the horizontal drive system is disengaged and the lift motor operates to raise the stylus out of the record groove. By using separate motors for each operation, Goldmund can optimize each motor's design and location.

Tonearm damping is provided by a paddle, or vane, attached to the tonearm near the pivot and riding in a fixed trough. Viscous fluid in the trough impedes quick movements of the vane, thereby damping the armtube.

Power for the turntable and tonearm motors and for the control electronics is provided by an external 12-V d.c. supply. It can deliver 300 mA and measures 4⅜ × 2⅜ × 1¼ inches. This supply is connected to the turntable by a thin cable with a locking plug that mates to a socket in the left rear of the turntable base. A thin ground wire is also provided to connect the metal parts of the turntable to an



# DETROIT'S NIGHTMARE. MUSIC LOVER'S DREAM.

**MTX Music Modules have features you won't find in a conventional "off-the-shelf" plate-style loudspeaker or sound you won't find in a factory system.** We use the same molding machines utilized by luxury automakers to build each MTX Music Module to the exact dimensions of your car.

**We've made installation easy.** All models require only small holes behind the woofer unit and these are usually the standard factory holes. Pop off the door panel, secure with provided hardware, and replace the door panel and grille. You're done.

To color-match the car's interior the entire unit can be sprayed with vinyl dye available at any retail automotive supply store. The pay-off is a factory OEM look with audiophile sound not available in factory systems.

MTX Music Modules are built to last and to make a lasting impression. The door panel versions and the rear deck models are tough, high quality audio components featuring die-cast baskets, mid-bass drivers, and ferrofluid soft dome tweeters, coupled with a sophisticated L/C cross-

over network and over-power protection circuitry. Musicality, sharp definition, great frontal staging, solid bass. It's the sound you've been listening for.

**You know MTX. We're the only company that warranties every loudspeaker we make for a full ten years.** That's commitment. At MTX, we don't make it because it's different, we make it because it's better.

For the MTX dealer nearest you, call 1-800-223-5266 or write us at One Mitek Plaza, Winslow, IL 61089. When calling, please refer to ad number 27265.

Find out more about Music Modules and MTX, the company that's serious about sound. Because you are.



**MTX**<sup>®</sup>

Serious about sound

This moving-coil cartridge has enough output to drive moving-magnet phono inputs and is unfazed by their 47-kilohm impedances.

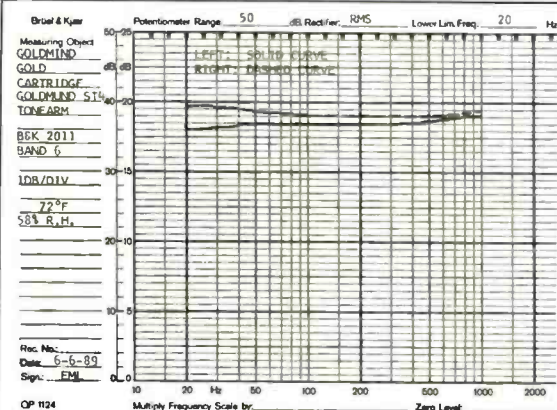


Fig. 4—Slow sweep from 20 to 1,000 Hz to check for structural resonances in the arm.

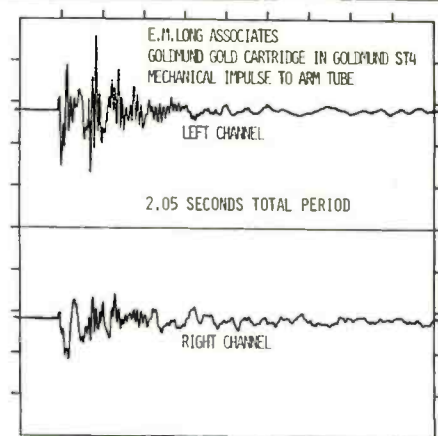


Fig. 5—Output vs. time of arm/cartridge when mechanical impulse was applied to armtube, with arm lifted.

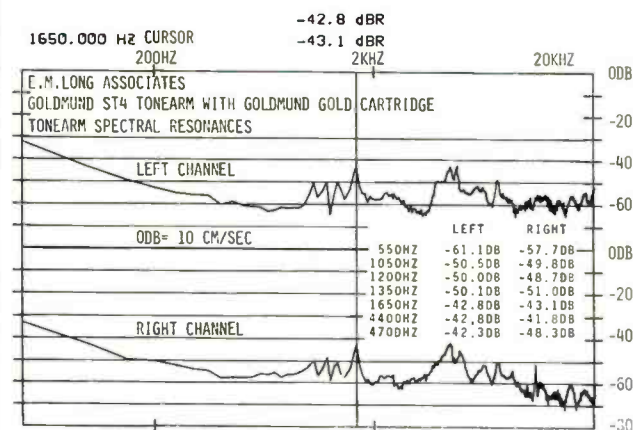


Fig. 6—Spectral output (averaged) of arm/cartridge for sixteen mechanical impulses applied to armtube.

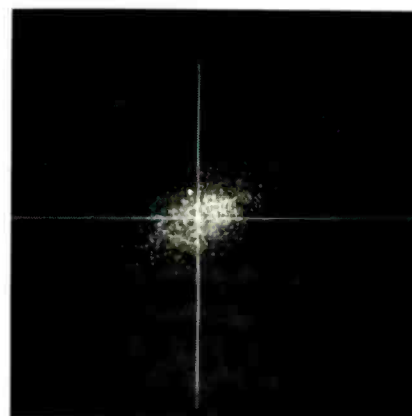


Fig. 7—Interchannel phase of cartridge, using pink noise from B & K 2011, band 7.

appropriate ground point on a preamplifier. Three tiny access holes in the turntable base, near the tonearm, allow adjustment of the servo system for vertical cueing speed, delay between horizontal corrections, and the speed of those corrections.

The manufacturer recommends the use of their optional Relief Clamp, which can be placed on a record over the label area and tightened with a knurled knob. This ensures

good contact between the bottom surface of the record and the top of the turntable platter, allowing any delayed mechanical energy in the record to be conducted away from the stylus and dissipated so it cannot reappear and color the sound.

The total weight of the Goldmund ST4 turntable system is about 46 pounds. This is quite reasonable for a turntable of its size.

The cartridge's response is excellent for its smoothness as well as the close match between channels.

The cartridge used during the measurements and listening sessions was the Goldmund Gold, a special high-output moving-coil design made especially for Goldmund by the German company Clearaudio. The body of the Gold is wide at the front and the output pins are at the rear of this wide section, which is quite unusual. The cartridge is so wide, in fact, that the plastic stylus protector, which should be in place when the system is not in use, must be slipped on from the rear of the cartridge body. The Goldmund Gold has an unusual method of holding the stylus cantilever in the magnetic field, in that it employs no damping materials; however, I do not have any further details at this writing. I did notice, during the initial setup checks, that there was little or no internal damping applied to the stylus system.

Because the cartridge's high output allows its use in moving-magnet as well as moving-coil inputs, I tried output loads that ranged all the way from the recommended 50 ohms to the 47 kilohms typical of moving-magnet input circuits. Changing the load did not change the cartridge's frequency response or damping; only its output level changed. I found this most interesting.

### Measurements and Listening Tests

The usual procedures were employed in evaluating the Goldmund ST4 turntable and tonearm and Gold cartridge. The technical measurements preceded the listening sessions to ensure that everything was set up and adjusted for optimum performance. This proved to be very worthwhile, because during the setup I could hear definite improvements in the sound as I brought the system into optimum adjustment. For example, the VTA adjustment proved to be rather critical, as did the amount of viscous fluid in the trough of the damping system.

After the setup and technical measurements, the members of the listening panel auditioned the Goldmund ST4 turntable tonearm and Goldmund Gold cartridge versus my reference system. Twelve different recordings were used to evaluate the quality of the sound of various instruments and types of music and singing. The panel members were asked to rate the systems, which were designated "A" and "B," from 0 to -5 for each category of music and instrumental sound characteristics. They were also encouraged to write down comments and cautioned not to talk or visually convey their feelings during the session.

Figure 1 shows the frequency response and interchannel crosstalk of the Goldmund Gold cartridge in the ST4 tonearm. The rise in crosstalk in the low-frequency range is an artifact of the B & K 2010 test record, but the rest of the range indicates excellent separation between the channels. The response is also excellent because of its smoothness and the close channel matching through the critical mid-range; there is no indication of the sagging response in this range that is so prevalent with other cartridges. Comments by some panel members that certain instruments sounded "slightly forward" compared to the reference system might be correlated with this smooth response. The slight rise at around 20 kHz could not be directly correlated with any comments, at least any negative ones.

Figure 2 shows that the low-frequency resonance of the tonearm mass and cartridge compliance, for the left and

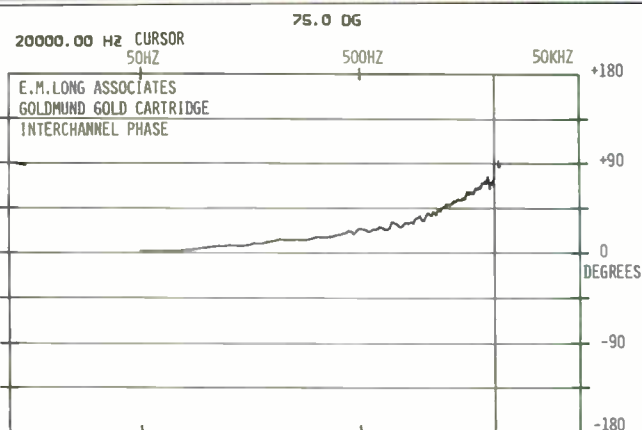


Fig. 8—Interchannel phase difference vs. frequency. Phase difference at 20 kHz is 75.0° (10.4 μS).

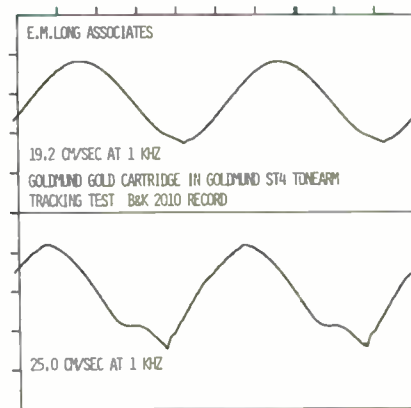


Fig. 9—Tracking of arm/cartridge with 1-kHz test tones at 19.2 cm/S (top) and 25.0 cm/S (bottom), using B & K 2010. Some asymmetry is apparent at the higher level.

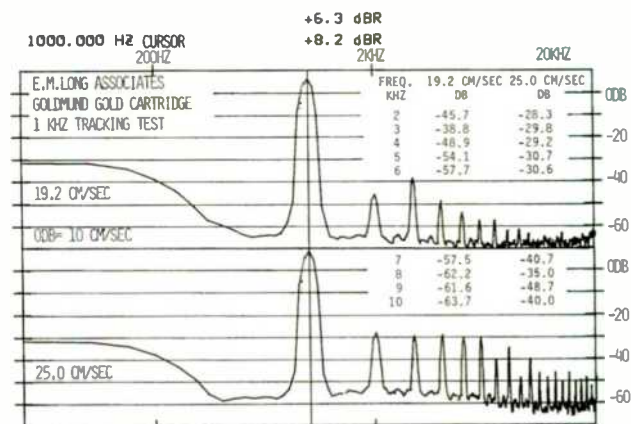
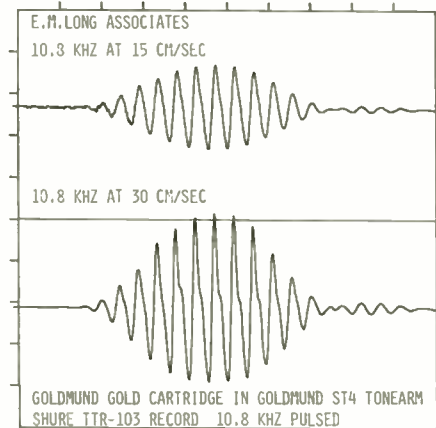
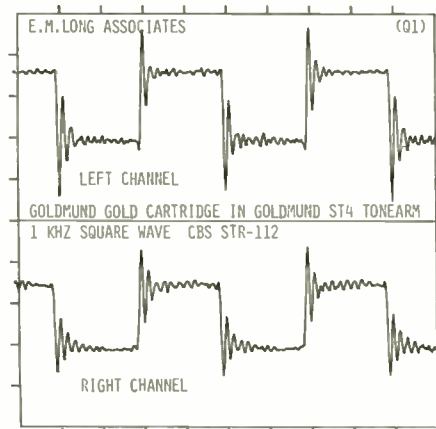


Fig. 10—Spectral analysis of the cartridge output when reproducing the signals of Fig. 9. The third harmonic is 0.7% (-45.1 dB) at 19.2 cm/S and 1.2% (-38.0 dB) at 25.0 cm/S.

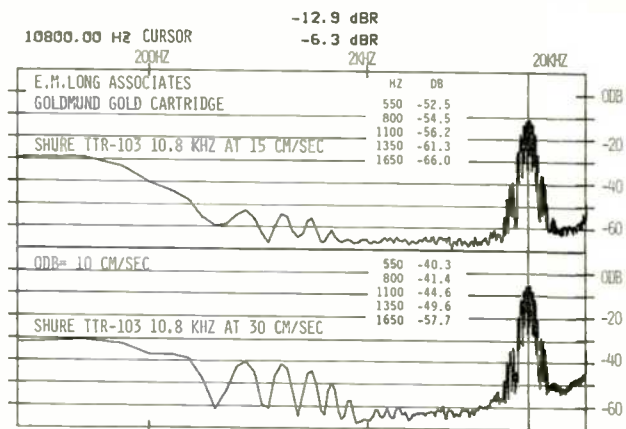
The listening panel felt that the Goldmund system sounded smooth, rich, and tart, and it beat my reference system at resolving space and details.



**Fig. 11—Output for 10.8-kHz pulse test at levels of 15 and 30 cm/S, using Shure TTR-103 test record, bands 1 and 4. Notice the step in the negative-going portion of the wave.**

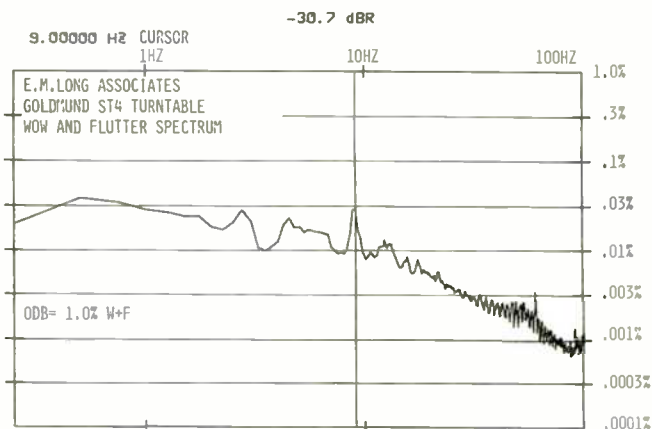


**Fig. 13—Output from 1-kHz square wave, using CBS STR-112 test record.**



**Fig. 12—Spectral analysis of distortion from signals shown in Fig. 11 (average of 16 samples at each level). The highest level tone burst at 30 cm/S results in less than 1.0% distortion, but the**

**components are in the low to middle frequency range, which can be perceived quite easily.**



**Fig. 14—Wow and flutter spectrum, from 0 to 100 Hz, of ST4 turntable. The peak at about 9.0 Hz is due to the arm/cartridge resonance.**

right channels, is at 8.0 Hz and is reasonably well controlled. This rise did not seem to have caused any deleterious effects on the reproduced sound—at least I wasn't able to correlate it with any comments by the listening panel.

Figure 3 is very interesting because it shows that the ST4 tonearm exhibits the same effective mass in the vertical and horizontal planes, which is not the case for most linear-tracking arms. The effective mass, i.e., the mass as it ap-

pears at the stylus tip, interacts with the cartridge cantilever's compliance to produce a mechanical resonance; it is this resonance that causes the rise in output at 8 or 9 Hz seen in Figs. 2 and 3. If severe, this resonance can make the bass sound boomy or even make the stylus mistrack when the record contains strong bass signals. Usually most of the mass of a linear-tracking tonearm is in the horizontal plane, but the Goldmund ST4, by the use of a relatively





## A NAIM FOR MUSIC

At Naim Audio we believe in a basic truth. You deserve a hi-fi system worth coming home to. And there are sound reasons why proud Naim owners have been coming home to us for twenty years.

We never settle for less than the very best in musical reproduction and we don't expect you to either. From the start of the design process to the last detail of production, rigorous care goes into every piece of Naim equipment.

We utilize a unique combination of high technology and skilled craftsmanship. Our robot loads the circuit boards, then every item of our equipment is hand-built with justifiable pride. If you haven't seen the inside of a Naim amplifier, send for our brochure or better yet,

see your nearest Naim dealer. This is our art and we are proud of it.

We test our equipment in our factory, not in your home. We measure distortion, stability, bias, noise levels and over a dozen other parameters, to ensure they fall well within our, and your, demanding specifications. Finally each piece of Naim equipment has to pass the ultimate test - we listen to it. Think about that, thousands of components every year, each auditioned prior to shipment.

Most importantly, Naim is about music. We have behind us a twenty year tradition of excellence, craftsmanship and innovation.

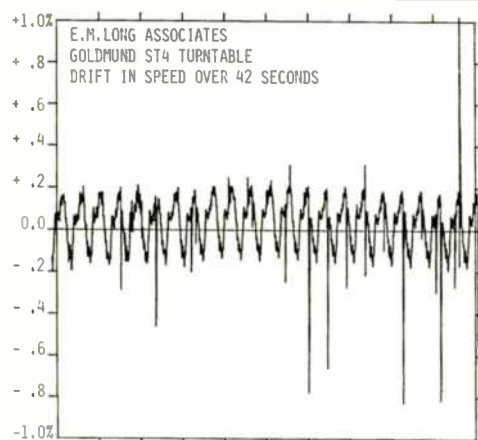
Visit your Naim dealer and audition our full range of electronics and speakers.

NAIM AUDIO NORTH AMERICA  
1748 NORTH SEDGWICK STREET  
CHICAGO  
IL 60614  
U.S.A.  
TEL (312) 9440217

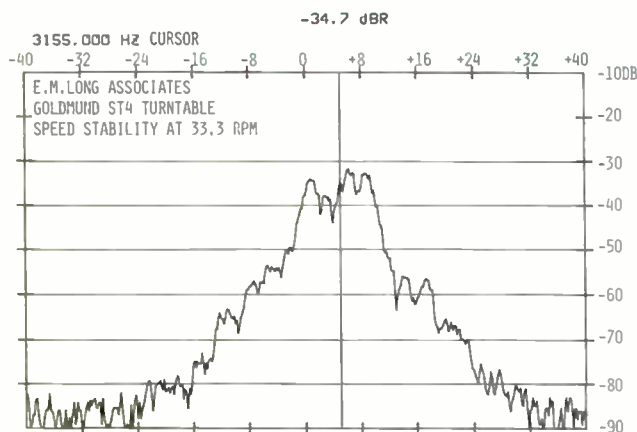


ALCYON ELECTRONIQUE  
6818 ST DENIS  
MONTREAL  
HUS 252  
CANADA  
TEL (514) 276 4004

Square waves from cartridges without damping have ripples, which some call ringing, but which I think of as a sign of delayed energy.



**Fig. 15—Speed drift over 42-S period. Cyclic variations at 1.8 S, or 0.56 Hz, are related to the rotational speed of 33½ rpm.**



**Fig. 16—Speed accuracy and stability, for 3,150-Hz tone on B & K 2010, band 8. Drift is 0.317%.**

long armtube, has both planes of motion well matched and under control.

A slow sweep from 20 to 1,000 Hz was performed to see if there were any mechanical resonances (Fig. 4). The left channel has two small steps below 40 Hz and a slight step at about 450 Hz, but these are so minute that the mechanical integrity of the cartridge, its mounting, and the tonearm structure and bearings have to be considered of the highest quality—especially when one considers the complexity of

the system and the large number of items that could cause problems if the design were not as good as it proved to be.

The result of the mechanical impulse test is shown as an output versus time plot in Fig. 5. The rapid undulations indicate that most of the energy is in the mid or upper frequency range. This also is a technical verification of the subjectively perceived "tick" sound I mentioned earlier when I performed the tap test. Figure 6 shows the average of the spectra from 16 mechanical impulses applied to the arm. There is an output peak at 1,650 Hz as well as a large amount of energy in the range from 4,400 to 4,700 Hz. All of the members of the listening panel made comments about the "sharp," "bright" quality of sound from the ST4, which might very well be correlated to this characteristic of the tonearm and Gold cartridge combination.

Figure 7 shows interchannel phase relationship as a left-versus-right 'scope display. Perfect interchannel phase correlation would produce a single 45° line. Figure 8 shows the interchannel phase correlation as a function of frequency. At 20 kHz it is 75°, which can be converted into a time delay between the left and right channels of 10.4 μs. Some people may argue that this is too small an amount to matter, but I am not prepared to do so. The fact that the random character of the pink noise displayed in Fig. 8 is very similar to that of a stereo recording with good spatial effects causes me to withhold judgment. While I always rely on the comments of the listening panel when I write reports for *Audio*, I must admit that I do listen to the sound produced by test records, such as the B & K 2011 pink-noise test, when I am setting up and measuring the system. Don't laugh; I find out some very interesting things that I can later correlate to comments made by the panel members during the listening sessions. In fact, their positive comments about the spatial characteristics of the ST4/Gold combination, which I think some reviewers call "soundstage," may be due, at least in part, to the lack of precise interchannel phase correlation.

I divide spatial characteristics into two separate categories, width and depth. The width of the sonic presentation can be enhanced by the reproducer beyond that actually present in the original recording. "Holographic" processors do this by manipulating phase and delay between channels; these techniques have been well known at least since the '50s. Depth is a function of the ratio between direct and reverberant sound, and it is not an exclusive feature of stereo reproduction since it is also present in mono recordings. The ST4 tonearm and Gold cartridge reproduced a very good sense of front-to-back depth, according to the comments made by some of the panel members.

Figure 9 shows the output of the Gold cartridge for the two highest signal levels on the B & K 2010 test record. A touch of distortion can be seen in the top trace, but it really becomes apparent in the bottom trace, where the cartridge is tracking the 25-cm/S signal. This would still be good performance for most cartridges, but at the price of the Gold it should be better. This lack of ability to track the highest recorded levels was demonstrated only once during the listening sessions. During that one particular passage, even the reference system exhibited slight mistracking, but with the ST4/Gold combination it was obvious.

The ST4's very small range of speed variation must be considered excellent, and its rumble is very low.

Figure 10, the spectra for the two signals of Fig. 9, also shows something I found to be interesting: The even-harmonic distortion components increase more than the odd ones at the higher level. This would account for the comments from the panel that, at higher levels of full orchestra, the sound was "smooth," "rich," and, believe it or not, "tart." Other comments regarding the sound of full orchestra indicate that the ST4/Gold combination was superior to the reference system in resolving details and giving a "good delineation of space."

Figure 11 also shows something that I have not seen often. Note the "step" in the waveform of the tone burst; it is reminiscent of the "crossover" distortion artifact in early transistor amplifiers, especially when they were operating near Class B. This might also correlate with the comment about tartness, since it is asymmetrical distortion that adds "brightness" without being considered annoying. The "brightness" comment was a consistent one by all panel members for most of the selections played during the listening sessions. Figure 12 shows the spectrum produced by the tone bursts of Fig. 11 and indicates that even though the waveform of Fig. 11 shows definite nonlinearity, it doesn't show any serious asymmetrical flattening of the waveform, which would produce increased output at the lower frequencies and cause the sound to be muddy. No comments of this type were made by any panel member for any of the selections played. Only one comment was made that could be correlated with Figs. 11 and 12, and that was regarding the sound of cymbals during one selection; the cymbals seemed "slightly spattered."

The square wave shown in Fig. 13 verifies that the Goldmund Gold's stylus cantilever has little or no damping. These square waves are reminiscent of those from the Decca cartridge, which also has no damping. My own personal taste leans in this direction, since I don't see the waveforms riding on the square wave as "ringing" but rather as the delay of energy which appears later than it should, due to time delay. A perfect square wave requires that all of the harmonic components remain in precise relationship with each other. When a square wave is run through a low-pass filter (which is another way of stating what a phono cartridge is), its higher frequencies are delayed. Figure 13 shows this, but it isn't as bad as it looks, especially when one considers what a "Band-Aid" damping can be when it is used in an attempt to fix a delay phenomenon.

Figure 14 shows the wow and flutter spectrum for the Goldmund ST4 turntable. If any components of this spectrum stood out, they would indicate mechanical problems. Here there are none, except at the tonearm/cartridge resonance, which always exaggerates the output. No comments were made by the listening panel, even during piano selections, that would indicate that the ST4 had any wow or flutter problems. I consider the information shown in Fig. 14 much more valuable than a single numerical reading from a meter, whose pointer is jumping back and forth in a manner similar to that shown in Fig. 15. I do take readings, and they appear in the "Measured Data" Table, but I don't trust them as I do the information in Fig. 14.

Variation in speed over a 42-S period is shown in Fig. 15. Except for some rapid spikes that I am at a loss to explain,

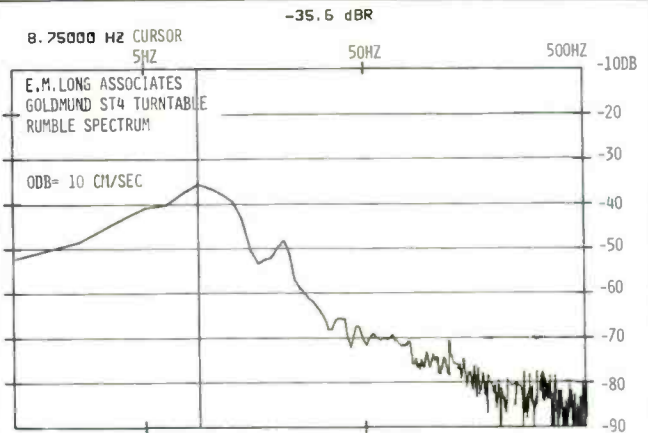


Fig. 17—Rumble spectrum. Most of the output is at the arm/cartridge resonance.

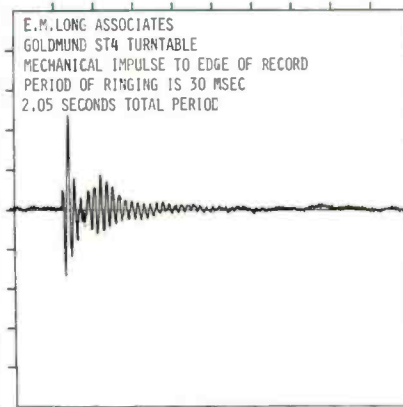


Fig. 18—Energy-absorption test, showing output vs. time for mechanical impulse applied to edge of a stationary record, with stylus resting in groove.

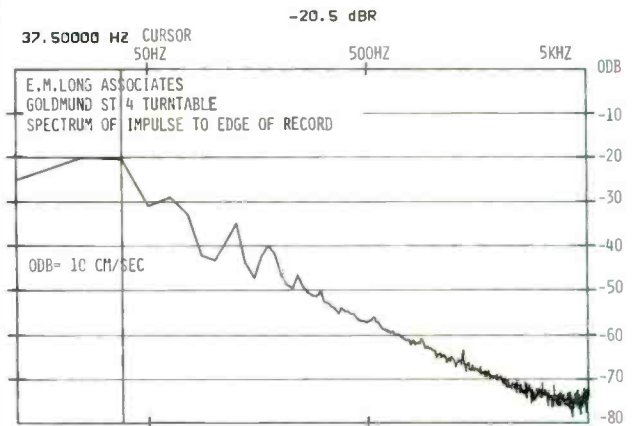
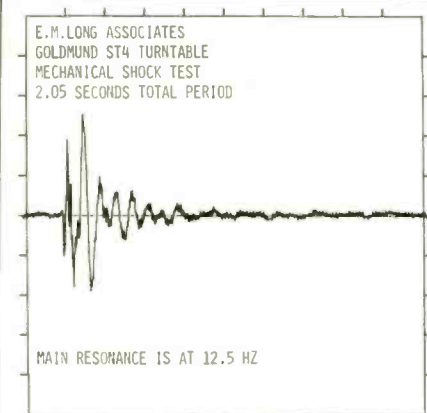


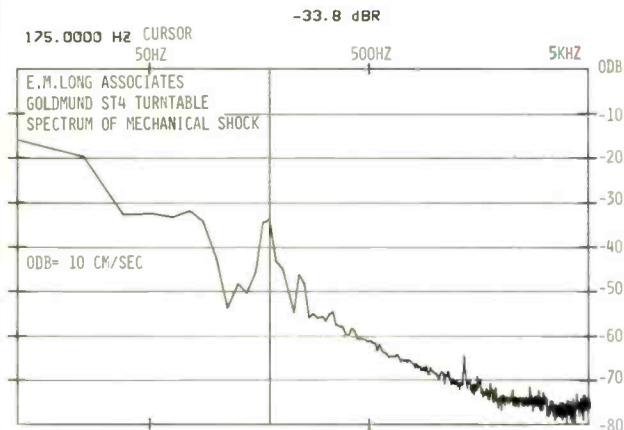
Fig. 19—Spectrum to 5 kHz of output from a series of 16 mechanical impulses (averaged)

applied to the edge of a stationary record, with stylus resting in groove.

These Goldmunds may convince you that they're a bargain at over \$7,000 altogether, and that CDs may be used for background music.

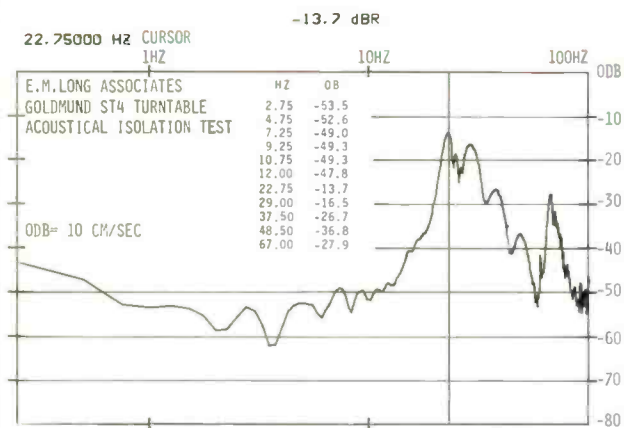


**Fig. 20—** Output vs. time for mechanical shock applied to platform on which the turntable rested.



**Fig. 21—** Spectrum to 5 kHz of the vibrations caused by mechanical

shocks to support platform (16 impulses, averaged).



**Fig. 22—** Spectrum of acoustical breakthrough from an acoustic field of 100 dB SPL at the

surface of a record. Stylus is resting in a groove near the middle of the record.

the speed stability was very good. The jaggedness of the waveform, due to cogging of the direct-drive servo system, can be seen but apparently not heard. Speed variation is also shown in Fig. 16, as a plot of frequency variation over time. The center frequency is 3,155 Hz, 5 Hz higher than the 3,150-Hz tone on the record; this shows that the ST4 is running 0.16% fast. The range of speed variation is very small and must be considered excellent.

Figure 17 shows the rumble spectrum. Rumble is very low except, as is always the case, at the tonearm/cartridge resonance. No comments were made about rumble by any panel members.

The ability of the Goldmund platter and clamp to dissipate energy from the record is indicated by Figs. 18 and 19. Figure 18 shows output versus time for a mechanical impulse applied to the record's edge while the Goldmund cartridge's stylus rested in a stationary groove. Figure 19, the spectral output for a series of applied mechanical shocks, shows that energy reduction is not only very good but also, except from about 100 to 300 Hz, very uniform. The output shown in Fig. 18 does indicate that some delayed energy is present that could enhance the spatial qualities of the reproduction.

Figure 20 shows the output versus time for a mechanical shock applied to the platform on which the Goldmund ST4 turntable base was resting. The results indicate that the main resonance of the whole system is at 12.5 Hz; the platform suspension resonance was checked separately and found to be at 6.67 Hz. The spectrum shown in Fig. 21 shows a rise at 175 Hz, the source of which I was not able to determine.

The spectrum of the acoustical breakthrough is shown in Fig. 22. The sound level was maintained at 100 dB SPL at the surface of the record while a tone was slowly swept from 20 to 100 Hz. The output is quite high, which indicates that the turntable system should not be located close to the loudspeakers.

### Conclusions

For the cost of the Goldmund ST4, one expects superb performance. While there are some things that could be improved, such as the suspension, the Goldmund ST4 turntable and tonearm and the Goldmund Gold cartridge do provide a very high level of performance. Because no sane person would buy a component this costly merely on the recommendation of a reviewer, my telling you to audition the ST4 before buying would be unnecessary. Nevertheless, I will caution you that, when you do listen to it, you should be aware of two things that I became convinced of during the number of months I have had the ST4. First, the ST4 and the Gold can complement certain loudspeaker systems in such a way as to provide exceptional results, while not necessarily being an optimum choice for use with others. Second, the ST4 must be set up and adjusted with great care to achieve the results described in this report. If there is any exaggerated brightness or harshness, then you are probably not hearing the sound the ST4 is capable of when properly adjusted. When you do, you may decide that the ST4 is actually a bargain and that Compact Discs are great for background music.

Edward M. Long



## A Reference Preamplifier for the 1990's

Counterpoint's finest preamplifier, the SA-5000 utilizes the "New Generation" technology of vacuum tubes, FETS, and bipolars, at last delivering the hybrid promise of tube performance, plus solid state reliability. The SA-5000 Preamplifier offers the world's only separate vacuum tube power supply, as well as a floating 3-point suspension, decoupling the audio circuitry from the acoustic environment. Provisions



for exact accommodation of **any** moving coil, and most moving magnet cartridges are standard. Mere talk about maximum musical performance will not suffice . . . the Counterpoint SA-5000 is an electrified object that embodies a strain of musical soul. We cordially

invite you to audition the reference Preamplifier for the 1990's as well as the SA-5000's companion, the powerful vacuum tube hybrid SA-220 Amplifier.



# COUNTERPOINT

NOTHING<sup>®</sup> BETWEEN THE MUSIC AND YOU

10 YEAR ANNIVERSARY 1979-1989

2610<sup>th</sup> COMMERCE DRIVE, VISTA, CA 92038 - CALL 800-2E6-3090

# Great Music Should Fill Your Senses.



Introducing Sonance in-wall speakers. ▪ The first speakers built on the theory that music should be heard, but not seen. ▪ Off the floor and out of sight, throughout your home, they satisfy your sense of aesthetics as well as the demands of high fidelity. ▪ With your choice of paint or fabric, Sonance blend perfectly, almost invisibly, with the decor. But more remarkable, these compact but powerful speakers reproduce music so accurately, even an audiophile's expectations are surpassed. ▪ See your

T H E • L E A D E R • I N • A R C

# Not Your Living Room.



nearest Sonance dealer. He's the one source for the speakers, switchers, wire, and accessories you need to add extraordinary ambience to the bedroom, library, bath, or kitchen. ■ Without ever intruding on your space. ■ For dealer locations, please call 1-800-582-7777. Outside the U.S.A., 714-492-7777, in Canada 604-873-4475. Or, write: Sonance, 961 Calle Negocio, San Clemente, CA 92672. Fax: 1-714-361-5151.



H I T E C T U R A L • A U D I O™

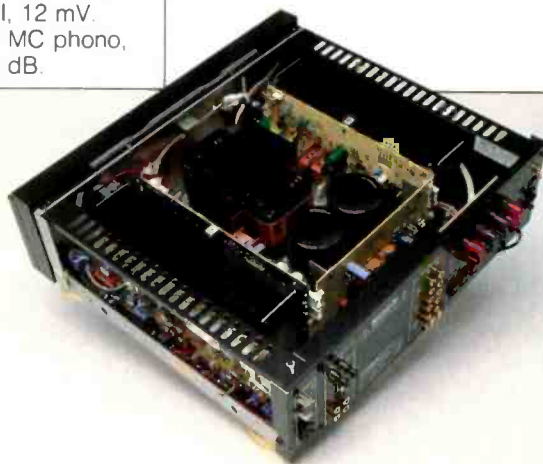
Enter No. 23 on Reader Service Card

## 2

FISHER  
RS-Z1  
RECEIVER**Manufacturer's Specifications**  
**FM Tuner Section****Usable Sensitivity:** Mono, 10.3 dBf; stereo, 19.17 dBf.**50-dB Quieting Sensitivity:** Mono, 16.07 dBf; stereo, 40 dBf.**Signal-Seeker Sensitivity:** 25.19 dBf.**S/N:** Mono, 85 dB; stereo, 80 dB.**THD at 50-dB Quieting:** Mono, 0.3%; stereo, 0.4%.**THD at 65 dBf in Wide Mode:** Mono, 0.05% at 100 Hz and 1 kHz, 0.1% at 6 kHz; stereo, 0.1% at 100 Hz, 1 kHz, and 6 kHz.**Frequency Response:** 20 Hz to 15 kHz,  $\pm 0.5$  dB.**Stereo Separation:** Wide mode, 50 dB at 100 Hz and 1 kHz, 45 dB at 10 kHz.**Capture Ratio:** Wide mode, 1.3 dB; narrow mode, 3.0 dB.**Selectivity:** Wide mode, 40 dB; narrow mode, 80 dB.**Image Rejection:** 120 dB.**Spurious-Response Rejection:** 120 dB.**I.f. Rejection:** 120 dB.**AM Suppression:** 60 dB.**Subcarrier Rejection:** 80 dB at 19 kHz, 90 dB at 38 kHz.**Stereo Threshold:** 19.17 dBf.**AM Tuner Section****Usable Sensitivity:** With supplied loop antenna, 400  $\mu$ V/m; with external antenna, 200  $\mu$ V.**Signal-Seeker Sensitivity:** 500  $\mu$ V/m.**S/N Ratio:** 55 dB.**Image Rejection:** 40 dB.**I.f. Rejection:** 65 dB.**Selectivity:** 50 dB,  $\pm 10$  kHz.**THD:** 0.3%.**Frequency Response:** 2.5 kHz, +0, -3 dB.**Amplifier Section****Power Output:** 150 watts/channel into 8 or 4 ohms, from 20 Hz to 20 kHz.**Rated THD:** 0.007% into 8 ohms, 0.015% into 4 ohms.**SMPTE IM:** 0.007% into 8 ohms, 0.015% into 4 ohms.**Damping Factor:** 50.**Dynamic Headroom:** 2.0 dB.**Slew Factor:** 3.**Frequency Response:** Phono (RIAA), 20 Hz to 20 kHz,  $\pm 1.0$  dB; high level, 20 Hz to 20 kHz,  $\pm 0.5$  dB.**Input Sensitivity, re: 1 Watt Output:** MM phono, 0.204 mV; MC phono, 20.4  $\mu$ V; high level, 12 mV.**S/N:** MM phono, 82 dB; MC phono, 70 dB; high level, 100 dB.**Phono Overload:** MM phono, 160 mV; MC phono, 16 mV.**Bass and Treble Control Range:**  $\pm 10$  dB.**Subsonic Filter:** -3 dB at 15 Hz, 12 dB/octave.**Loudness Contour:** +8 dB at 100 Hz and +4 dB at 10 kHz, for volume-control setting of -30 dB.**D/A Converter Section****Sampling Frequencies:** 32 kHz, 44.1 kHz, and 48 kHz.**D/A Conversion:** Full 18-bit linear, dual D/A converters.**Coaxial Input Level:** 500 mV peak to peak.**Filters:** Digital filter, eight-times oversampling; analog low-pass filter, third-order linear-phase.**Frequency Response:** 20 Hz to 20 kHz,  $\pm 0.3$  dB.**S/N:** 115 dB.**Dynamic Range:** 97 dB.**THD at 1 kHz:** 0.004%.**Channel Separation:** 90 dB.**General Specifications****Power Requirements:** 120 V a.c., 50/60 Hz, 400 watts.**Dimensions:** 18 $\frac{1}{8}$  in. W  $\times$  6 in. H  $\times$  17 in. D (48 cm  $\times$  15.2 cm  $\times$  43.2 cm).**Weight:** 46.2 lbs. (21 kg).**Price:** \$1,200.**Company Address:** 21350 Lassen St., Chatsworth, Cal. 91311.

For literature, circle No. 91

Just by examining its comprehensive list of specifications, you have to conclude that the Model RS-Z1 is not the run-of-the-mill, "me-too" kind of component you get from some giant Japanese companies which, in their own domestic market, don't sell receivers at all. I must confess that when the editors of *Audio* asked me to test and review a Fisher receiver, I had mixed feelings about the project. For one thing, I am an alumnus of the "original" Fisher Radio Corporation's Engineering Department, having worked there for a half-dozen years when its founder, Avery Fisher, was in charge. As many loyal readers know, Mr. Fisher sold the company in the late 1960s to the Emerson Electric Co. of St. Louis, which, after a short time, sold it to Sanyo Corp. While many Sanyo products certainly rank high in quality and sophistication, the early years of the Sanyo-Fisher relation-





ship saw a shift in emphasis from high-end, state-of-the-art audio components to everything from rack systems (at every price level) to video components. Nothing wrong with that, of course, except that it didn't really preserve the original Fisher image in the minds of old-time audiophiles (including me).

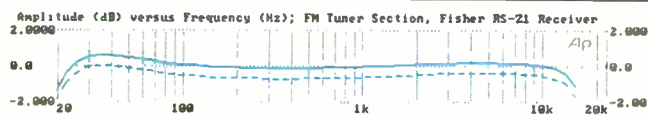
Well, it is now obvious that when they want to, Sanyo can design and make products under the Fisher name and trademark that are truly top-grade. The Fisher RS-Z1, introduced recently as part of what the company calls its Professional Digital Reference series, is a well-designed receiver that not only delivers high power levels with low distortion but is equipped with an excellent AM/FM tuner section and is designed to accommodate digital input signals at any of the three standard sampling frequencies that are currently in use worldwide.

The RS-Z1 AM/FM stereo receiver is the "flagship" of Fisher's Professional Digital Reference Series, which con-

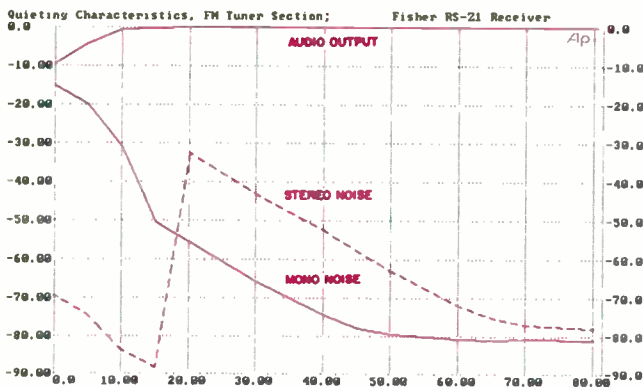
sists of seven audio and video products. The receiver incorporates Class A-2 amplifier circuitry that combines the low distortion of Class-A amplifier design with the higher efficiency of a Class-AB configuration. The power rating is 150 watts per channel into 8 ohms, from 20 Hz to 20 kHz, with no more than 0.007% THD. My sample didn't quite meet every single amplifier distortion spec and tuner spec in its owner's manual (it came very close to those that it missed), but I have absolutely no quarrel with the measured performance of this receiver. Furthermore, Fisher is to be commended for listing just about every performance specification that is currently required for conformance with the IHF/IEEE FM Tuner Measurement Standard and with the EIA Amplifier Measurement Standard. That's more than I can say about some of the other "major" manufacturers who, for reasons known only to themselves, omit certain fairly important specifications from their manuals and brochures more often than not.



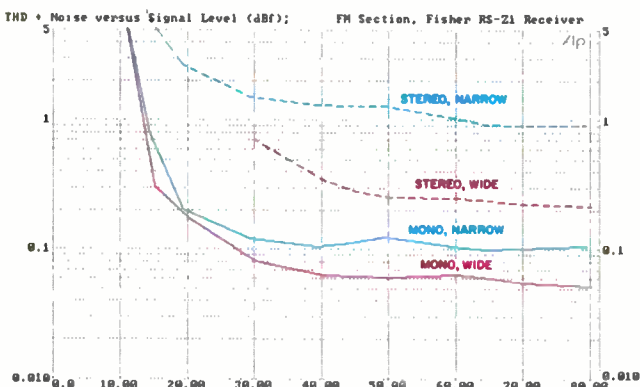
The RS-Z1 delivers high power levels with low distortion, has a fine tuner section, and can accommodate digital signals.



**Fig. 1—Frequency response, FM tuner section. Right-channel response (dashed curve) has been displaced downward slightly for clarity.**



**Fig. 2—FM quieting characteristics.**



**Fig. 3—THD + N vs. signal level.**

The most notable aspect of the RS-Z1 is that it has digital inputs and outputs for use with CD players, DAT recorders, and (possibly) digital satellite broadcast receivers in the future. Only two of those digital connections are the coaxial electronic type; the others are all optical fiber. Optical interfacing is said to reduce or eliminate the possibility of r.f. interference and other forms of signal degradation. In its digital circuitry, the RS-Z1 employs two linear, 18-bit D/A converters plus eight-times oversampling. The receiver is supplied with a Model RRS-Z1 remote control.

### Control Layout

The front panel of the RS-Z1 is three-dimensional in appearance, owing to the sloped metal pieces at either end. A large vertical "Stand By" switch on the left end-piece operates in conjunction with the main power switch below, on a sloping section of the main panel. On the right end-piece are the buttons for tuning up and down, which operate either in the station-seeking or the manual tuning mode.

The slightly sloped lower section of the panel contributes further to the three-dimensional look and also makes for better visibility of controls found on its surface. Besides the power switch, these include a 'phone jack, a timer switch (for 30- or 60-minute turn-off), a display dimmer switch, analog input selector buttons, six numbered station preset buttons, and FM and AM band-selector buttons. There are six memories per band, but because the "FM" button cycles through three FM "bands," a total of 18 FM stations can be memorized, as opposed to six AM stations. Further to the right, still on the sloped lower portion of the panel, are an "Antenna A/B" selector, a "Memory Scan" button, an auto/manual tuning button, an i.f. bandwidth selector (wide or narrow), and a high-blend selector for reduced separation and noise when listening to weak stereo FM signals. A "Rec Out Lock" button locks the tape outputs to the currently selected source, so you can continue recording from that source even after switching to another source for listening. This is a rather unusual way of selecting the record out, but it works just as well as having two selector switches and takes up a lot less front-panel space.

The main, central portion of the front panel has a massive, accurately calibrated master volume control at the extreme right. With power applied, an indicator light above the volume control illuminates. Below the rotary volume control are a phono MM/MC selector button, an audio muting button, and a loudness switch. The left end of this main control area houses rotary bass, treble, and balance controls, separate A and B speaker-selector buttons, a mono/stereo switch, a subsonic filter switch, and an "Adaptor EQ" switch, which controls the jacks on the rear panel for the external processor loop. An unusual feature is the coaxial digital input on the front panel, with a switch selecting between it and the rear-panel "Digital AUX" jacks.

A large display area at the center of the front panel shows both the signal source and the frequency of the currently tuned station in large characters. Smaller indicators on the display show whether the source is analog or digital (and whether a digital source is coaxial or optical), the sampling frequency of the digital input signal, and whether high blend, loudness, muting, and wide i.f. settings are in use.

Some of the best tuners I've measured recently don't suppress subcarrier components as well as this Fisher receiver does.

Other tuner information displayed includes the current band and preset number, which antenna is in use, signal strength (shown graphically), and center tuning. The display also shows if the sleep timer has been engaged and, if so, whether for 30 or 60 minutes.

Below the display are a "Source Direct" button, which bypasses the tone controls and filter, and three buttons for selecting the digital inputs. Green and red lights on the "Digital AUX" and "Digital CD" buttons show when the digital and analog record-out terminals are active. However, because the "Digital DAT" input doesn't feed the digital record-out jack, its button only has a red light.

The rear panel houses two 75-ohm coaxial antenna connectors for FM, plus a pair of AM antenna terminals to which either a supplied loop or any other external antenna can be connected. A 300-ohm/75-ohm transformer is supplied in case your FM antenna has a 300-ohm twin-lead transmission line. Phono and high-level analog inputs and a ground terminal are adjacent to the antenna terminals, while further inboard are two sets of tape record-out/monitor jacks and the "Adaptor EQ" jacks, normally interconnected by jumpers in the absence of any external signal processor. Large, color-coded speaker terminals are further to the right, and below them are three convenience a.c. outlets (two switched, one unswitched). Finally, at the extreme right, are a coaxial digital input, an optical digital input labelled for a CD player, and two more optical connectors labelled for the record-out and playback connections of a DAT recorder.

The supplied RRS-Z1 remote control not only has buttons for most of the functions of the receiver but can also be used to operate other components in Fisher's Professional Digital Reference series.

### Tuner Section Measurements

Figure 1 shows frequency response of the FM tuner section, measured at the speaker terminals, with the tone controls bypassed. Response was flat to within +0.4, -1 dB from 30 Hz to 15 kHz. (The dashed curve, representing right-channel output, was displaced for the sake of clarity; output levels were the same for both channels.)

The quieting characteristics of the FM tuner section are shown in Fig. 2. Fifty-dB quieting required a signal input of only 14.5 dBf in mono (as against 16.07 dBf stated by Fisher) and 37.5 dBf in stereo (against 40 dBf claimed by the manufacturer). Best signal-to-noise ratio for strong signals was 80 dB in mono and 76.5 dB in stereo. Both figures fall a bit short of the numbers claimed by Fisher but are certainly better than average for the FM tuner sections found in most receivers. Notice that below 20 dBf, the output is muted when the tuner is set to the stereo mode. This, then, constitutes the true stereo threshold, and it is almost precisely where Fisher claims it to be.

Figure 3 shows how distortion plus noise varied with increasing signal input. Using the wide i.f. mode, usable mono sensitivity (the amount of signal required to reduce THD + N to 3%) measured 11.8 dBf. In mono, THD + N at strong signal levels was 0.06%, while in stereo, THD + N measured 0.24% at 65 dBf. Switching to the narrow i.f. mode, THD + N increased, as you would expect. In mono, it was now about 0.1%, while in stereo it increased to 0.9%

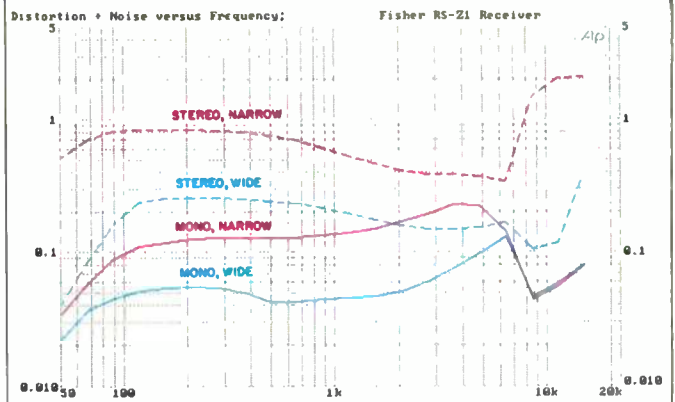


Fig. 4—THD + N vs. frequency.

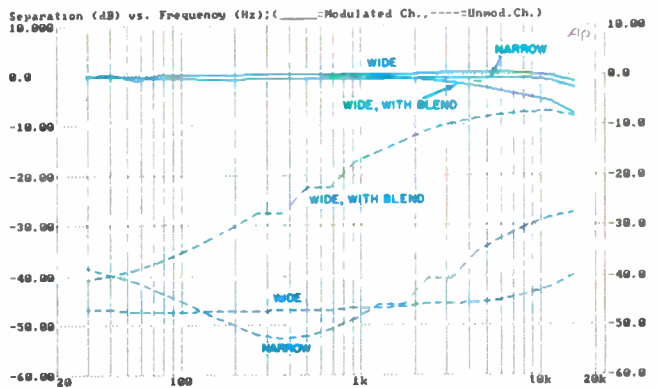


Fig. 5—FM frequency response and stereo separation.

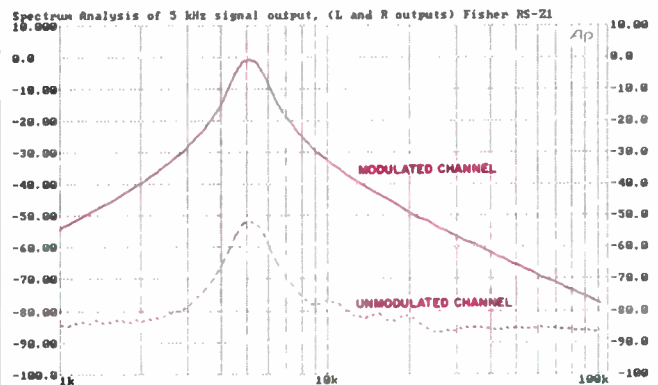


Fig. 6—Spectrum analysis showing crosstalk products for a 5-kHz signal.

ES

For Sony ES,  
redefining the  
Compact Disc Player  
means changing  
more than a bit.



Today, the entire focus of Compact Disc player development appears to have been reduced to a single bit. While this approach has some merit, to the engineers of Sony ES it is merely the starting point in redefining the CD player.

But then, the ES engineers have always charted their own course. These are the same people whose independent thinking created the world's first Compact Disc player. And their digital insights have enabled them to engineer proprietary advances in D/A conversion, digital filtering, data synchronization, error correction, laser optics and chassis rigidity—in short, all the elements necessary to establish an entirely new benchmark in Compact Disc performance.

### A converter with a pulse all its own.

Sony started with the High Density Linear Converter™ system. Based on an all-new integrated circuit, the CXD-2552, this pulse sys-



Not restricted to the deluxe CDP-X77ES shown opposite, Sony's new definition of the CD player extends to the affordable CDP-X33ES.

tem replaces the typical converter's sixteen or more switches with a simpler, more efficient design. With a single stroke, it eliminates non-linearity, glitches, and crossover problems. The HDLC system also operates at the unprecedented speed of 45 MHz—the world's fastest conversion rate—to help substantially reduce harmonic and inter-modulation distortion.

As a result, converter distortion measures an astonishing 0.001%. Dynamic range is 124 dB—exceeding the theoretical maximum of the CD itself. The audible benefits are equally impressive. You'll experience music that is warmer and less clinical, with a more spacious stereo soundstage.

### Nothing less than a total system approach.

We've matched the new HDLC system to our legendary CXD-1244 digital filter, a Sony design that overcomes requantization error through superlative calculating accuracy. And Sony overcomes a principal source of error in pulse converters: the time-base inaccuracies called "jitter." These errors cause modulation in the analog

signal, veiling the music and altering the sound stage. By integrating our Direct Digital Sync™ circuitry directly on the converter chip, the Sony HDLC system corrects jitter automatically and decisively.

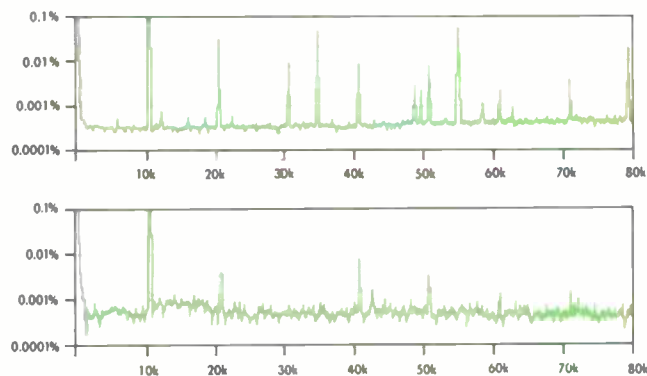
Similar inspiration led to other pivotal developments in rigid anti-resonant chassis design, linear motor transports, and low-noise servo stabilizer circuits. These developments motivated *Stereo Review*



Extended playback meets an extensive technical resume with the CDP-C85ES five-disc carousel changer.

to make this pronouncement: "Our test results leave no doubt that the Sony CDP-X55ES represents the current state of the art in CD players. Virtually every measurement surpassed those of the best players we have tested in the past."\*

Best of all, these landmark advancements are not reserved for one or two high-priced models. They grace every ES single-disc player and both ES five-disc changers. And each model is backed by a three-year limited parts and labor warranty. (See your authorized ES dealer for details.)



Spectrum analysis of a 10 kHz signal with a typical pulse converter (top) shows additional non-harmonic distortion. With the Sony HDLC system (bottom) this distortion is negligible.

So call 201-930-7156 (Monday-Friday, 9:00 am-5:00 pm EST) to locate an ES dealer. Then audition the ES Compact Disc players. Just don't be surprised if other players seem to fall a bit short.



# SONY®

THE LEADER IN DIGITAL AUDIO™

Testing the D/A section helped me appreciate the convenience of having a digital input on the unit's front panel.

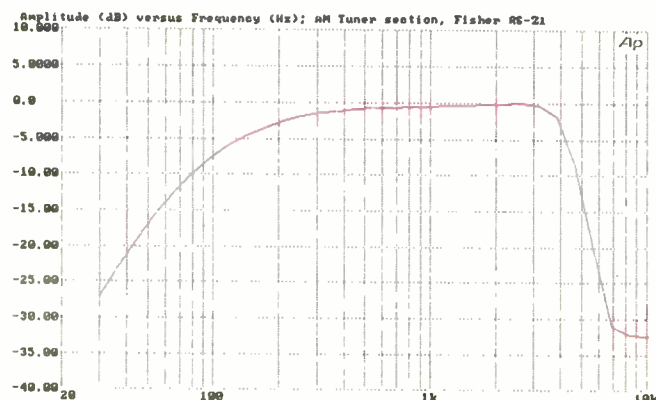


Fig. 7—AM frequency response.

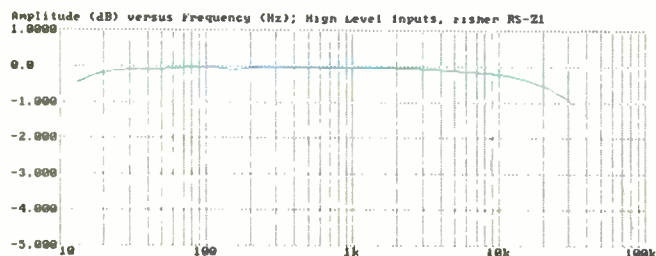


Fig. 8—Amplifier section frequency response, using high-level analog input.

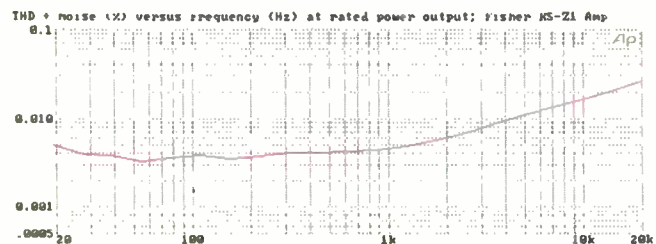


Fig. 9—Amplifier section THD + N vs. frequency at rated output of 150 watts per channel into 8 ohms.

at 65 dB. These results clearly illustrate why it is best to use the wide i.f. mode whenever no interference from adjacent- or alternate-channel signals is present. (In the plots of Fig. 3, a 1-kHz modulating signal was used.)

In Fig. 4, I plotted THD + N versus frequency for strong signals in mono and stereo, first using the wide i.f. mode and then the narrow mode. Of great interest was the fact that distortion varied only slightly with frequency. In fact, the THD + N figures for stereo at 6 kHz were actually lower in both i.f. modes than they were at 1 kHz.

I made three separate measurements of FM stereo separation (Fig. 5). First, I plotted separation versus frequency in the wide i.f. mode. This separation is represented by the almost horizontal dashed curve and the uppermost solid curve. Under these conditions, separation was 46.5 dB at 1 kHz, 47.5 dB at 100 Hz, and 42.6 dB at 10 kHz. Switching to the narrow i.f. mode actually resulted in a slightly higher separation figure at 1 kHz (48 dB) but lower figures at 100 Hz and 10 kHz (45.5 dB and 29 dB, respectively). Finally, reverting to the wide i.f. mode, I activated the high-blend circuit, which further reduced separation at 1 kHz to about 16.5 dB and to virtually nothing at 10 kHz. Frequency response for the modulated channel was also affected somewhat when the high-blend circuit was employed, as you can see from the lowest solid-line curve, which rolls off slightly at the treble end of the plot.

An examination of crosstalk for a 5-kHz modulating signal (Fig. 6) revealed excellent suppression of 19-kHz and 38-kHz subcarrier components; both were down more than 80 dB below 100% modulation levels in the unmodulated channel. Even some of the best tuners I have measured recently don't manage to suppress these unwanted components that far.

Capture ratio was measured only in the wide i.f. mode and was exactly 1.3 dB, as claimed. Selectivity was 42 dB in the wide mode and 80 dB in the narrow mode. Image, i.f., and spurious-response rejection were all in excess of 100 dB, the highest I can measure with my test equipment. The RS-Z1's AM suppression was 58 dB.

Figure 7 shows the frequency response of the AM tuner section. The treble -6 dB point occurred just above 4 kHz (better than most AM sections I've tested, and better than the 2.5 kHz claimed by Fisher). However, the bass rolled off rather quickly below 100 Hz, and I can't imagine why Fisher designed the AM section that way. Since the company published rather complete AM specifications, I took the trouble to check a few of them before going on to the amplifier section. Maximum signal-to-noise ratio was 55 dB, as claimed. THD measured 0.35%, a bit more than the 0.3% claimed by Fisher. Selectivity measured 45 dB. I suspect that the sensitivity figures given by Fisher contain a misprint. The specification for external AM antenna sensitivity was probably meant to read 20  $\mu$ V rather than 200  $\mu$ V, since I measured it at about 22  $\mu$ V.

#### Amplifier Section Measurements

Measured via one of the high-level analog inputs, overall frequency response for the amplifier section of the RS-Z1 was flat to within -0.5 dB from 20 Hz to 20 kHz, as shown in Fig. 8. The -3 dB point for the treble end of the spectrum

# WE CAN ALSO PUT \$18,000 FOR COLLEGE WITHIN YOUR SIGHTS.

Fact is, we offer over \$18,000 for college if you qualify for the Montgomery GI Bill and add that to your Reserve pay during a standard enlistment.

We can help you pay off some or all of a qualified student loan, too, through the Student Loan Repayment Program. And offer you the chance to train in a useful skill.

You serve part-time, usually one weekend a month plus two weeks a year at a nearby Army Reserve unit. So you can continue to pursue your education while participating in the Reserve, where your time can mean valuable college money.

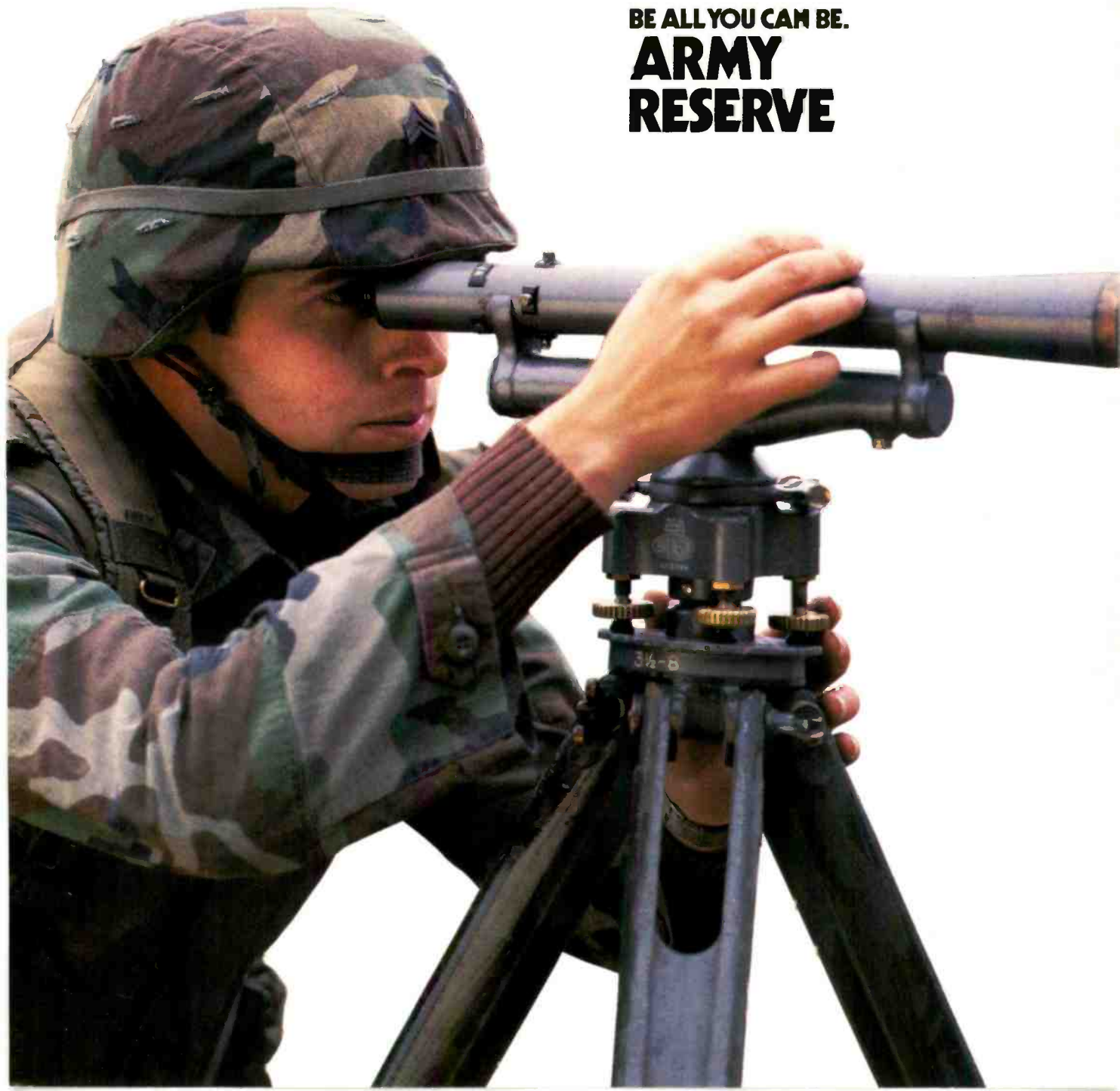
Think about it.

Then think about us.

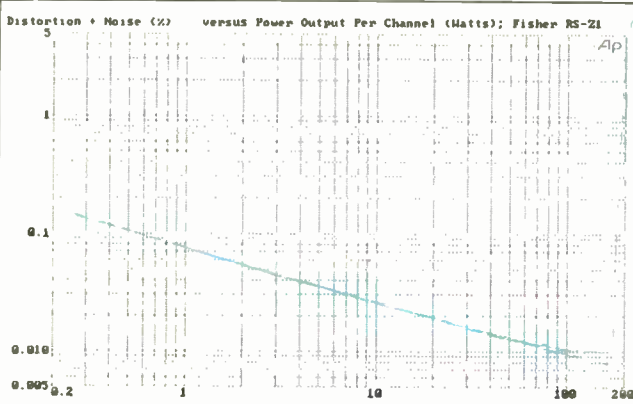
See your Army Reserve recruiter today. Or call 1-800-USA-ARMY.

**BE ALL YOU CAN BE.**

**ARMY  
RESERVE**



The D/A linearity was as close to perfect as I've seen from any CD player, and substantially better than the player I use!



A  
B

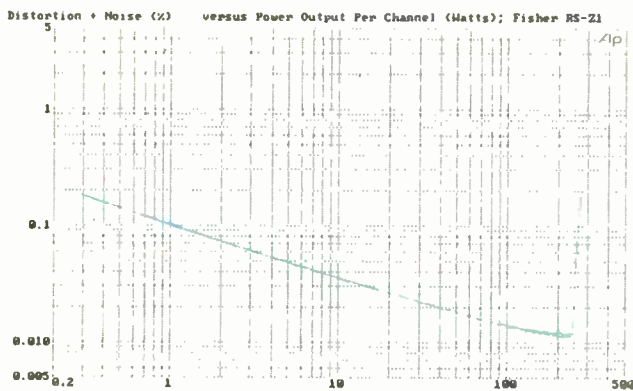


Fig. 10—THD + N vs. power output per channel into loads of 8 ohms (A) and 4 ohms (B), at frequencies of 20 Hz, 1 kHz, and 20 kHz. Note the unusual similarity of the three curves in each case.

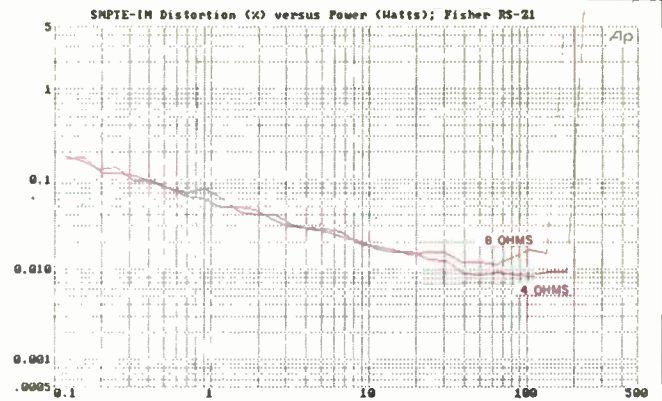


Fig. 11—SMPTE-IM distortion vs. power output.

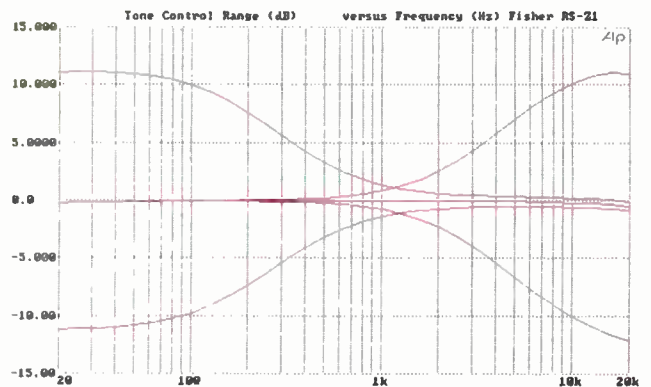


Fig. 12—Bass and treble control range.

occurred above 60 kHz. Fisher rates the power output of this amplifier as 150 watts per channel into both 8-ohm and 4-ohm load impedances. In Fig. 9, I plotted THD + N versus frequency while maintaining output of a constant, regulated 150 watts per channel. From 20 Hz to 3 kHz, THD + N was well below 0.01% (0.0045% at 1 kHz). At higher frequencies, THD rose a bit, reaching the altogether acceptable figure of 0.025% at 20 kHz. Although this doesn't quite correspond to the claimed 0.007%, it certainly didn't upset me. Fisher may want to rethink their published specs, however, if this excellent result is typical, since the FTC requires that the rated THD be met at all audio frequencies listed in the power rating.

Figures 10A and 10B are plots of THD + N versus power output for 8-ohm and 4-ohm loads. For 8-ohm loads, clipping did not occur until output levels in both channels reached more than 167 watts per channel. The curves for 1

kHz, 20 Hz, and 20 kHz were almost identical at all levels except near clipping, when the THD + N for a 20-kHz signal rose a bit before final overload. In the case of 4-ohm loads (Fig. 10B), results were also excellent; all three test frequencies resulted in similar plots, and clipping did not occur until about 263 watts per channel were being delivered to the 4-ohm loads! Figure 11 is a plot of SMPTE-IM distortion versus equivalent power output level. Plots were made for both 8-ohm and 4-ohm loads.

Damping factor for the amplifier section, referred to 8 ohms and with a test signal of 50 Hz, measured 70, which is considerably more than the 50 claimed by Fisher. Dynamic headroom was an impressive 2.12 dB, a bit higher than claimed. Signal-to-noise ratio, referred to 1-watt output and with 500 mV of input, measured 78.5 dB for the high-level inputs. I suspect that Fisher's published S/N figure of 100 dB, though referred to as an IHF measurement, is in fact





# The Marque of a Lifetime

The test of any great product comes with time, with years of use and years of reliably superb performance. When it passes the test, the marque carried by that product comes to signify something very special to thousands of owners, and to thousands more who hope to become owners. The name itself becomes a symbol of pride, of distinction.

In audio, no marque comes so close to this stature as Audio Research, which has been defining and redefining the state of the art for over two decades. Many of our products have become collectors' items, earning extraordinary resale values. Our first pre-amplifiers were seminal in the creation

of "high-end" audio. Today, the sophisticated hybrid technology of the SP15 continues that same passionate commitment to music. Most recently, the LS1 line-stage preamp and Classic 30 power amp have made leading-edge performance accessible to more music-lovers than any products in recent memory.

Excellence. Reliability. Integrity. Value. These are what come with every Audio Research product. To be enjoyed as long as you own the marque—for a lifetime.



classic years

1970 - 1990

**audio research**<sup>®</sup>  
HIGH DEFINITION<sup>®</sup>

6801 Shingle Creek Parkway / Minneapolis, Minnesota 55430 / Phone: 612-566-7570 FAX: 612-566-3402

Enter No. 5 on Reader Service Card

# “Model Eleven...Exquisite Sound...Dwarfs Any Portable Stereo...A High Tech Wonder...Thumbs Up”

Doug Simmons—*The Village Voice*

## MODEL ELEVEN

BY HENRY KLOSS

Cambridge SoundWorks' Model Eleven is the world's first *transportable* full-range, high performance component system. It consists of a powerful 3-channel amplifier and two “satellite” mid/high-frequency speakers—all packed in a rugged “BassCase”™ that, when empty, serves as the system's subwoofer. Model Eleven's performance, when coupled with your portable CD or tape player,\*\* rivals that of the most expensive component systems. And because we market it directly from our factory, it costs hundreds less than it would in stores.



The drivers used in Model Eleven's two-way satellite speakers are no-compromise, high-performance components—just like you'd expect to find in the finest home speaker systems.

Performance that rivals the best home component systems.

Until now portable music systems were, at best, a compromise. Even the most expensive ones lack the deep bass necessary for full, natural sound. But Model Eleven delivers the all-out performance previously found only in high quality home component systems. Its three speakers are designed to



Made In U.S.A.

work with a room's acoustics for optimum performance. Remove the satellite speakers, amplifier and your portable CD player from BassCase. Place the satellites where they create a musical “stage” near ear level. Put the BassCase where it reinforces low frequency output—on the floor, even behind furniture. The result is musically accurate



- Fits under airline seats—23 lbs.
- Can be checked as luggage.
- Works on all electrical systems.
- Delivers the full range of music.
- Is backed by a unique 5-year warranty.

The Ideal “Second Stereo” Use It 52 Weeks A Year

- Perfect for boating, camping & vacations anywhere in the world.

sound virtually identical to our acclaimed Ensemble® speaker system.

Model Eleven can be used virtually anywhere in the world—115- or 230-volt, 50 or 60 Hz AC or 12-volts DC. Because the entire system fits under an airline seat—or can be checked as baggage—you can take it just about anywhere. But Model Eleven's sound is so good, so “big,” you may want to keep it home. It's an ideal second (or first) music system for a study, bedroom or kitchen. At \$749† we don't know of any combination of components near its price (transportable or not) that approaches its sound quality.



Henry Kloss created the dominant speaker models of the '50s (AR), '60s (KLH) and '70s (Advent)—as well as our highly acclaimed Ensemble and Ambiance® speakers. While packing a stereo system into a suitcase before a vacation, he realized that an amplifier, a CD player and two small speakers take up the same space required for an acoustic suspension woofer to reproduce really deep bass. That was the inspiration for BassCase, Model Eleven's bass speaker enclosure which doubles as the entire system's carrying case.

# “We Know Of No Small Speaker That Surpasses The Overall Sound Of Ambiance” —Stereo Review

## Ambiance

BY HENRY KLOSS

Ambiance is an ultra-compact speaker that proves high performance, small size and low cost need not be mutually exclusive. Ambiance is ideal for bedrooms, dens, dorm rooms...or for use as an extension speaker or in surround sound systems. While no speaker of its size can provide the same low bass as our Ensemble and Model Eleven systems, Ambiance has more output in the

40Hz region than any “mini speaker” we've encountered. Stereo Review magazine described Ambiance as “...beautifully balanced, delivering a full-size sound image with not a hint of its origin in two small boxes...very few small speakers we have heard can match the overall sound of Ambiance, and we know of none that surpass it.” Available in Nextel or primed for painting for \$109 each†, or in solid oak for \$129 each†—backed by our 30-day money-back guarantee—direct from Cambridge SoundWorks.



Made In U.S.A.

Ambiance is an ultra-compact speaker that proves high performance, small size and low cost need not be mutually exclusive.

# "Cambridge SoundWorks May Have The Best Value In The World. A Winner."

David Clark—*Audio Magazine*

## Ensemble

BY HENRY KLOSS

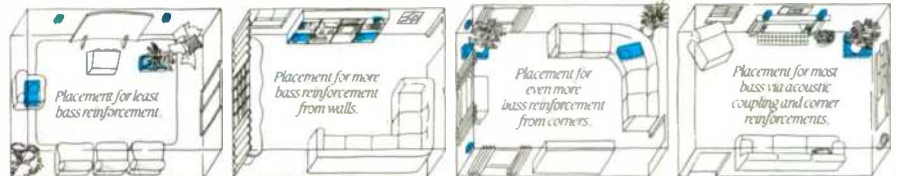
Ensemble is a speaker system that can provide the sound once reserved for the best speakers under laboratory conditions. It virtually disappears in your room. And because we market it directly, it costs hundreds less than it would in stores.

Ensemble consists of four speaker units. Two compact low-frequency speakers reproduce the deep bass, while two small satellite units reproduce the rest of the music, making it possible to reproduce just the right amount of energy in each part of the musical range without turning your listening room into a stereo showroom.

Your listening room works *with* Ensemble, not against it.

No matter how well a speaker performs, at home the listening room takes over. If you put a conventional speaker where the room can help the low bass, it may hinder the upper ranges, or *vice-versa*. Ensemble, on the other hand, *takes advantage* of your room's acoustics. The ear can't tell where bass comes from, which is why Ensemble's bass units can be tucked out of the way—on the floor, atop bookshelves, or under furni-

ture. The satellites can be hung directly on the wall, or placed on windowsills or shelves. No bulky speaker boxes dominate your living space, yet Ensemble reproduces the deep bass that *no* mini speakers can.



You can put Ensemble's low-frequency units exactly where they should go for superb bass. You can't do this with conventional speakers because you have to be concerned about the upper frequencies coming from the same enclosures as the low ones.

Not all the differences are as obvious as our *two* subwoofers.

Unlike seemingly similar systems, Ensemble uses premium quality components for maximum power handling, individual crossovers that allow several wiring options and cabinets ruggedly constructed for proper acoustic performance. We even gold-plate all the connectors to prevent corrosion.

*Unlike satellite systems which use a single large subwoofer, Ensemble features separate compact bass units for each stereo channel. They fit more gracefully into your living environment, and help minimize the effects of the listening room's standing waves.*

30-day money-back satisfaction guarantee.

At only \$499†—complete with all hardware and 100' of speaker cable,—Ensemble is *the* value on today's speaker market. *Esquire* magazine describes them by saying, "You get a month to play with the speakers before you either return them or keep them. But you'll keep them." *Stereo Review* said "It's hard to imagine going wrong with Ensemble." For literature, reviews or to order, write us at the address in the coupon, or call 1-800-AKA-HIFI.\*

New Ensemble System With Utility Woofer Cabinets. \$499†

Made in U.S.A.

Try Model Eleven...  
Or Ensemble...  
Or Ambiance...

Risk Free For 30 Days.  
Call 1-800-AKA-HIFI\*  
(800-252-4434)

All Cambridge SoundWorks products are sold only factory direct. This allows you to save hundreds of dollars and audition our products the *right* way—in your home for 30 days, with no risk, no sales person hovering nearby.

Our toll-free number connects you to a Cambridge SoundWorks audio expert. He or she will answer all your questions, send literature and reviews—or take your order (you can use Visa, MasterCard or American Express) and arrange shipment via UPS. Your Cambridge SoundWorks audio expert will continue as your personal contact with us.

\*9AM to midnight (ET), seven days a week. In Canada, call 1-800-525-4434. Fax: 617-332-9229. Outside the U.S. or Canada, 617-332-5936.

© 1990 Cambridge SoundWorks. ® Ensemble is a registered trademark of Cambridge SoundWorks. ™ BassCase, Ambiance, Model Eleven and Cambridge SoundWorks are trademarks of Cambridge SoundWorks, Inc. Ensemble review quote reprinted with permission of Audio Magazine. © 1989 Diamandis Communications.

\*\* CD player not included in Model Eleven system.

Enter No. 8 on Reader Service Card

## CAMBRIDGE SOUNDWORKS

Suite 104AU 154 California St., Newton, Massachusetts 02158

- Send more information and test reports.
- Send Ensemble (black-laminate woofers) \$599. †
- Send Ensemble (vinyl-clad woofers) \$499. †
- Send Model Eleven risk-free for 30 days, \$749. †
- Send \_\_\_\_\_ (qty.) Ambiance (Nextel), for \$109 ea. †
- Send \_\_\_\_\_ (qty.) Ambiance (Primed), for \$109 ea. †
- Send \_\_\_\_\_ (qty.) Ambiance (Oak), for \$129 ea. †

I'm paying by  Check  MC  Visa  AmEx

Acct. Number \_\_\_\_\_ Exp. \_\_\_\_\_

Signature \_\_\_\_\_

Name \_\_\_\_\_

Address \_\_\_\_\_

City \_\_\_\_\_ State \_\_\_\_\_ Zip \_\_\_\_\_

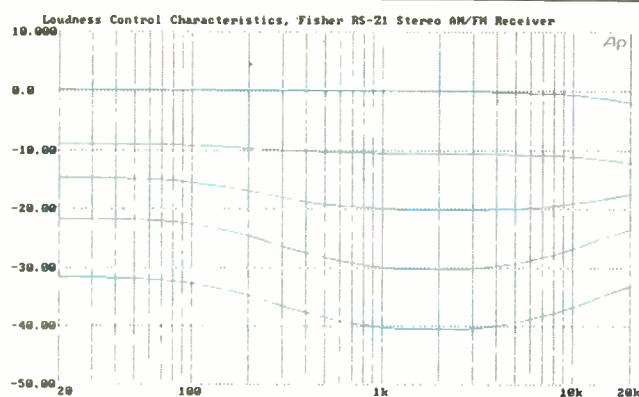
Phone (Area Code) \_\_\_\_\_ Number \_\_\_\_\_

FOR IMMEDIATE SERVICE: 1-800-AKA-HIFI.

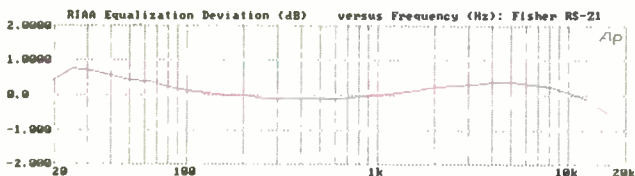
MA residents add 5% sales tax.

†Original black laminate bass cabinet version \$599. All prices plus freight (Ensemble \$8-\$27, Model Eleven \$6-\$16, Ambiance \$4-\$12). Delivery time usually, 2-7 days. We ship worldwide, including APO & FPO.

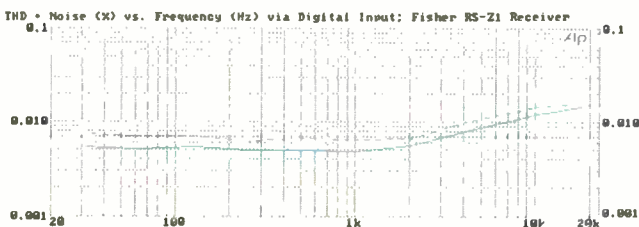
The ability to select wide or narrow i.f. helped the sensitive FM tuner section pull in 56 signals without intolerable interference.



**Fig. 13—Loudness characteristics for volume-control settings from 0 (full up) to -40 dB.**



**Fig. 14—RIAA equalization error.**



**Fig. 15—THD + N vs. frequency, using digital input, at 135 watts output. Note the similarity to Fig. 9; see text.**

referred to rated output rather than to 1 watt, as prescribed by the measurement standard. If I were to translate the 78.5-dB figure to rated output, I would have to add 21.8 dB to my reading, for a total S/N figure of 100.3 dB. Input sensitivity for the high-level analog inputs was 16.5 mV for 1-watt output.

Range of cut and boost for the bass and treble tone controls is shown in Fig. 12. Maximum boost and cut were almost precisely 10 dB at 100 Hz and at 10 kHz. I did feel that the tone control action extended a bit too far into the midrange region. The action of the loudness contour circuitry is shown in the graph of Fig. 13, for volume control levels from 0 dB (maximum setting) to -40 dB.

Next, I measured the performance of the phono section. The RIAA equalization was quite accurate, deviating from the prescribed playback curve by about +0.7 dB at 30 Hz and -1.0 dB at 20 kHz, as shown in Fig. 14. Phono input sensitivity for 1-watt output measured 0.2 mV for the MM inputs and 20  $\mu$ V for the MC inputs. Signal-to-noise ratio for the MM inputs, using an input signal of 5 mV and reducing the volume control setting to produce 1-watt output, measured 78 dB; for the MC inputs (using a 500- $\mu$ V signal and the same 1-watt output), the S/N was 68 dB.

### The Digital-Input Afterthought

Since Fisher went to all that trouble to provide this receiver with optical and digital inputs, I felt I had to check them out as well, even though most users are not likely to connect very many components to the digital inputs (coaxial or optical) of this receiver just yet. Be prepared for the future—that's my motto!

For the few remaining tests I wanted to make, I decided to set the "reference output level" at around 135 watts into 8-ohm loads. I connected the coaxial digital output of one of my reference CD players to the "Digital AUX" circuit's front-panel input jack (an unusual convenience that I now fully appreciated). Then, using my CD-1 standard test disc, I performed some of the tests that I usually make when evaluating a CD player—only this time, the entire D/A conversion system and analog amplification circuitry of the Fisher RS-Z1 were included in the measurement loop. It should be understood, therefore, that the THD, linearity, and noise readings that I obtained are not strictly confined to the D/A circuitry of the RS-Z1. When you stop to think of it, that's entirely fair, since this is the way a user would have to listen to the equipment even if he uses the digital inputs—at least until someone comes up with an all-digital signal chain, right up to the loudspeakers. That having been said, examine Fig. 15, which is a plot of THD + N versus frequency. Of course, it is quite similar to Fig. 9, except that THD levels are somewhat lower (especially at the treble end of the plot) simply because the power output level of 135 watts that I was using for reference was a bit below the receiver's rated output.

Referred to that same output level, A-weighted S/N measured 99.6 dB rather than the 115 dB claimed by Fisher. Obviously, since I had already established that the amplifier's high-level S/N ratio was around 100 dB, that had to be the limiting factor in this measurement (even though the D/A circuitry of the receiver may well be delivering its

I was pleased with what I heard—especially the tight bass, which made the Fisher seem more powerful than it measured.

claimed S/N ratio of 115 dB). The spectrum analysis of the noise, plotted from 30 Hz to 20 kHz (Fig. 16), shows that the major contributors to the overall S/N of the system in this test were the power-line component of 60 Hz and its third harmonic, 180 Hz.

My big surprise came when I checked linearity through the entire system (my CD player's digital output signals, fed to the digital input of the receiver, translated back to analog by the receiver's D/A circuitry, and amplified to a 135-watt level by the RS-Z1 amplifier section). For the results shown in Fig. 17, I used undithered test signals at levels from 0 to -90 dB. Linearity was as close to perfect as I've seen from any CD player, and substantially better than what I know my two-year-old reference CD player could have done had I extracted the signal from its analog outputs! Here, then, was a good justification for bypassing the D/A circuitry in all but the most linear of CD players. The same thing occurred to me when I plotted the deviation from linearity for low-level dithered signals (Fig. 18). Now, deviation at -100 dB was less than 2 dB for the right channel and less than 4 dB for the left channel.

Finally, using the EIAJ method for measuring dynamic range of the total system, I came up with a reading of 99.1 dB for the left channel and 101.0 dB for the right channel. One could hardly ask for more than that from any complete combination, let alone a CD player connected to an all-in-one receiver.

### Use and Listening Tests

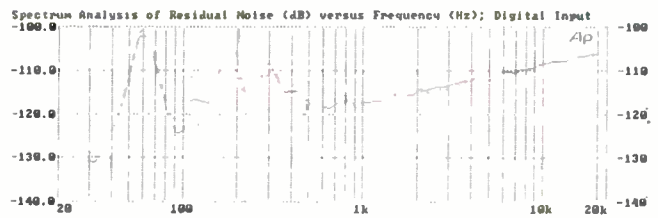
The Fisher RS-Z1 receiver is easy to hook up and easy to use. All controls and their functions are thoroughly described in the 23-page owner's manual. An excellent and complete hookup diagram shows you how and where to connect components, using either the analog or digital inputs or combinations of both.

The FM tuner section was quite sensitive, and being able to select wide or narrow i.f. mode increased the number of usable signals in my location to 56. Had I needed to remain in the wide mode all the time, some half dozen of these signals would have encountered intolerable amounts of adjacent-channel interference.

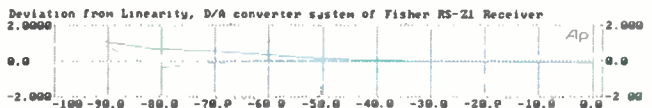
My first listening tests involving CDs and DAT recordings were all done with the analog outputs of those devices connected to the analog inputs of the receiver, and results were more than satisfactory. What little hum and noise there was could only be detected audibly when I turned up the volume control enough to yield ear-shattering listening levels during louder passages. As for the sound quality, it was, of course, a function of the analog amplification stages, but I was pleased with what I heard—especially the tight bass, which made the Fisher seem more powerful than its rating of 150 watts per channel would suggest, even on my low-efficiency reference speakers. The dynamic headroom helps here, no doubt, along with the ability of the receiver to deliver low-frequency signals at high power levels with no more distortion than it delivers at mid-frequencies.

When it came time to pack up the receiver and return it to the manufacturer, I couldn't help thinking that even the exacting Avery Fisher would be proud of this latest product to bear his name.

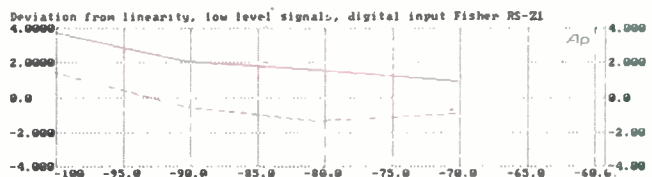
*Leonard Feldman*



**Fig. 16—Spectrum analysis of residual noise when playing “no signal” track of CD-1 test disc through digital input. The solid curve is for the left channel and the dashed curve is for the right.**



**Fig. 17—Deviation from perfect linearity using undithered signals; see text.**



**Fig. 18—Deviation from linearity using dithered, low-level signals.**

## 3

## VTL COMPACT 100 MONO AMP AND DELUXE PREAMP

### Manufacturer's Specifications

#### Amplifier

**Rated Power:** 100 watts into nominal 5-ohm load, 20 Hz to 20 kHz.

**Rated Distortion:** 1% at 100 watts.

**Input Sensitivity (for Full Output):** 775 mV.

**Input Impedance:** 137 kilohms.

**Dimensions:** 13½ in. W × 6½ in. H × 7 in. D (34.3 cm × 16.5 cm × 17.8 cm).

**Weight:** 35 lbs. (15.9 kg) each.

**Price:** \$2,650 per pair.

#### Preamplifier

**Phono Input Impedance:** MM version, 47 kilohms; MC version, 500 ohms.

**Input Sensitivity (for Full Output):** MM, 1 to 3 mV; MC, 0.33 to 1 mV.

**Line Amplifier Gain:** 8 (100 mV for 0.8 V).

**Output Impedance:** Low-impedance output, 600 ohms; high-impedance output, 10 kilohms; tape output, 100 kilohms.

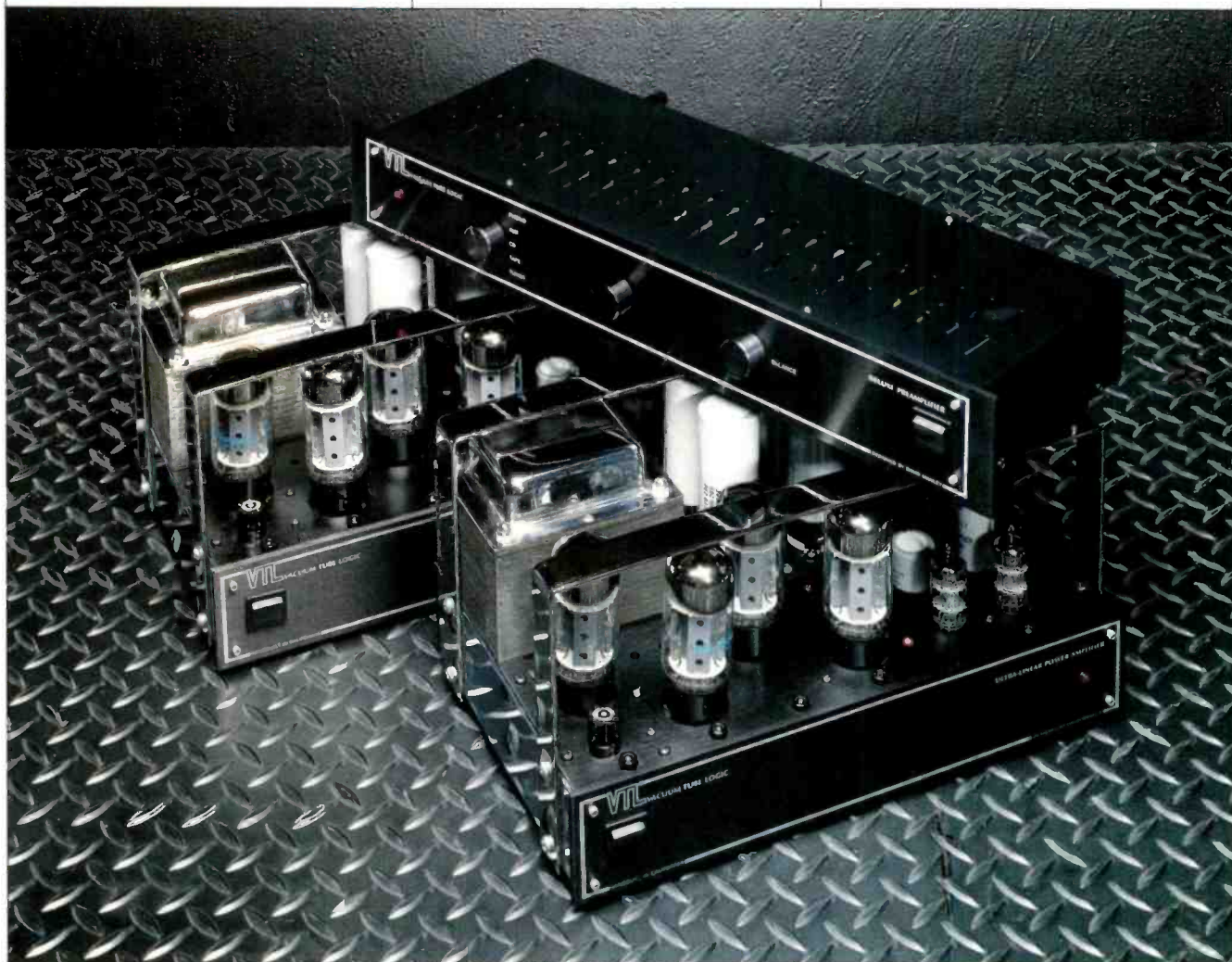
**Dimensions:** 19 in. W × 3 in. H × 6½ in. D (48.3 cm × 7.6 cm × 16.5 cm).

**Weight:** 10 lbs. (4.5 kg).

**Prices:** With moving-magnet phono input, \$1,050; with moving-coil phono input, \$1,350.

**Company Address:** 4774 Murietta St., Suite 9, Chino, Cal. 91710.

For literature, circle No. 92



I have followed the progress and success of Vacuum Tube Logic, or VTL, with interest more or less since the company's inception. Their line seems to include an almost excessive number of models, especially power amplifiers; VTL says they want to make available a wide range of tube "flavors." The Compact 100 monoblock amplifiers and the Deluxe preamp reviewed here are at or just below the middle of VTL's product line and are competitively priced.

I have had some prior experience with VTL gear, and while I recall some reliability problems with at least one earlier model, I also remember the sound of these units as being very good. So it was with pleasure and anticipation that I agreed to review some of their equipment.

The VTL amps' power tubes, transformers, and filter capacitors appear to be mounted to the top surface of the chassis, as they were in old-time tube amps. In fact, however, the tubes, tube sockets, and the smaller filter capacitors are mounted to a p.c. board beneath and parallel to the top of the chassis. The main filter capacitors are longer than they appear to be, as they extend inside the chassis, and are mounted with standard capacitor clamps.

Chassis construction is simple: A chrome-plated piece is bent to form the amp's front subpanel and the sides, two pieces are used for the top surface of the chassis, and the rearward piece is bent over to form the rear panel. A front panel and bottom cover complete the enclosure. Two protective bars cover the tubes and transformers. VTL emphatically says that these bars are not for handles, but I'm sure that is what everybody uses them for; I know I do.

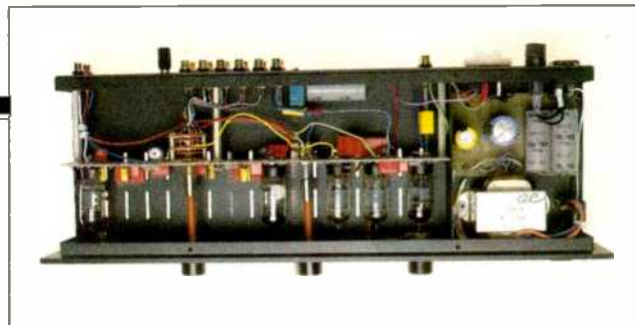
On the top, in front of the output tubes, are four tip jacks for measuring the individual plate currents of the output tubes. This is done as a voltage measurement in respect to ground, assessing the plate current as a voltage drop across 10-ohm cathode resistors. It would have been nice if there were a jack for ground as well. Behind the four output tubes are five access holes for adjusting the trimpots that control the individual plate currents and overall idling current. Another pair of tip jacks and a balance pot near the driver tube permit adjustment of the push-pull balance.

Underneath, the wiring and construction are reasonably neat, and parts of good quality are used. The p.c. board on my sample hadn't been cleaned of rosin from the soldering; I find this not as attractive and finished-looking as when the rosin is removed. A piece of VTL interconnect wire is used between the input signal jack and the p.c. board.

An LED pilot light and power on/off switch are all that is found on the amp's front panel. On the rear panel are a high-quality female RCA signal input jack; good gold-plated, five-way binding posts; the power cord, and a designation plate giving the model and serial numbers.

The Deluxe preamplifier is of the minimalist, straight-line school. It has inputs for phono and four high-level sources. The unit reviewed had a phono stage whose gain was set for moving-magnet cartridges, but a moving-coil version is also available.

The controls on the preamp's front panel are, from left to right, a rotary input selector switch, rotary volume and balance controls, and a rocker-type power switch. A red LED at the left side of the panel indicates power on/off. On the rear panel are the signal input/output connectors, which appear



to be Tiffany or Tiffany look-alikes, a binding post for ground connections, a three-pin socket for the line cord, the a.c. power fuse, and a TO-3 filament regulator protected by an appropriate insulating cover.

One unusual note is that the preamp has both low- and high-impedance line outputs. The high-impedance set is for driving an amplifier where the cable run is short. The low-impedance outputs come from a cathode follower driven by the high-impedance output point in the line amplifier.

Although this preamp doesn't have a tape monitor switch, one of its high-level input pairs is labelled for tape, and there is a tape-out jack pair for recording. Be careful with this arrangement, as it permits feedback between the tape output and input if "Tape" is selected as a signal source while the tape deck is recording. Also, be sure to disconnect the tape recorder from the record output jack when the deck is off, because the input impedances of some tape decks become very nonlinear when their circuitry is not powered. This possibly nonlinear tape recorder load could adversely affect the signal source selected for listening. Easy to miss, on the bottom of the unit near the right front corner, is a switch for setting line voltage to 120 or 240 V a.c.

Construction of the Deluxe preamp, like that of the power amps, is simple and straightforward. A main chassis piece is bent up into a U that forms the front subpanel, bottom, and rear panel. A separate front-panel piece and another U-shaped piece for the top cover complete the enclosure. The power supply, toward the right side of the unit, takes up approximately 25% of its internal volume. A vertical shield, oriented front to back, partitions off the power supply from the rest of the internal space. Within the power-supply area are the power transformer, a p.c. board that mounts the low- and high-voltage rectifiers, dropping resistors, filter capacitors, and the panel-mounted power switch and line cord socket. The rest of the internal space is taken up by the signal circuitry. A vertical p.c. board runs from left to right, the full internal height of the preamp, and is spaced about halfway back from the front panel. This board contains most of the parts, including the five tubes, selector switch, and volume control. Shaft extensions couple the selector switch and volume control to the front-panel knobs. Noticeable to a critical observer is that when the volume control knob is pushed, the middle p.c. board flexes. Perhaps more support would be in order. The balance control is mounted from behind the front panel. Another p.c. board, situated just inside the rear panel, mounts the signal input and output connectors and a final B+ decoupling capacitor.

#### Circuit Description

All of VTL's power amplifier circuits are basically like the ones shown in Figs. 1A, 1B, and 1C. (These Figures are reproduced, with the permission of VTL, from their neat little

Much of the low end's solid, socko quality may come from the 125 joules of energy storage in the amplifier's power supply.

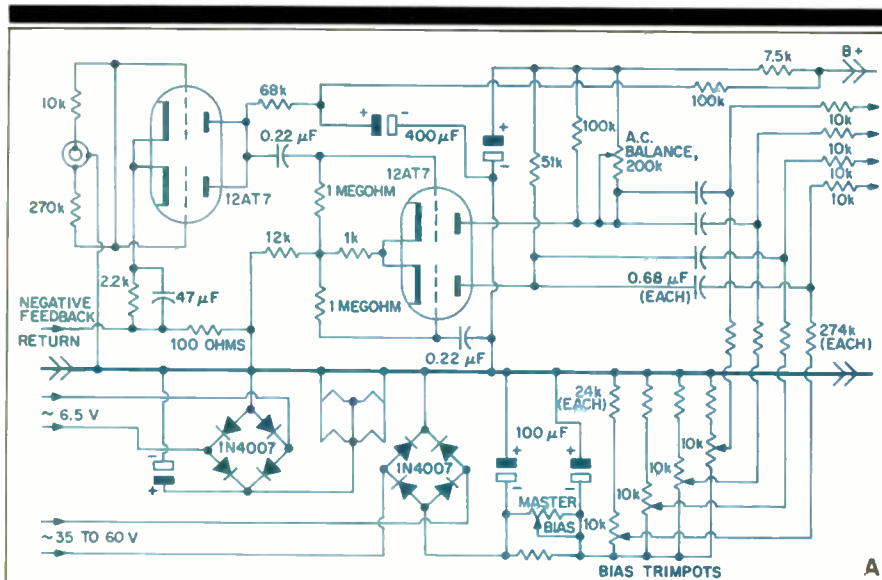
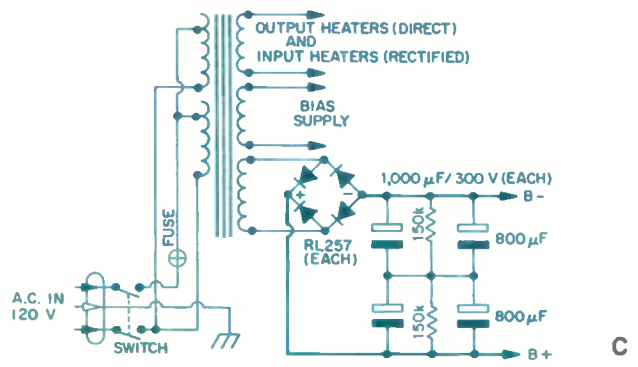
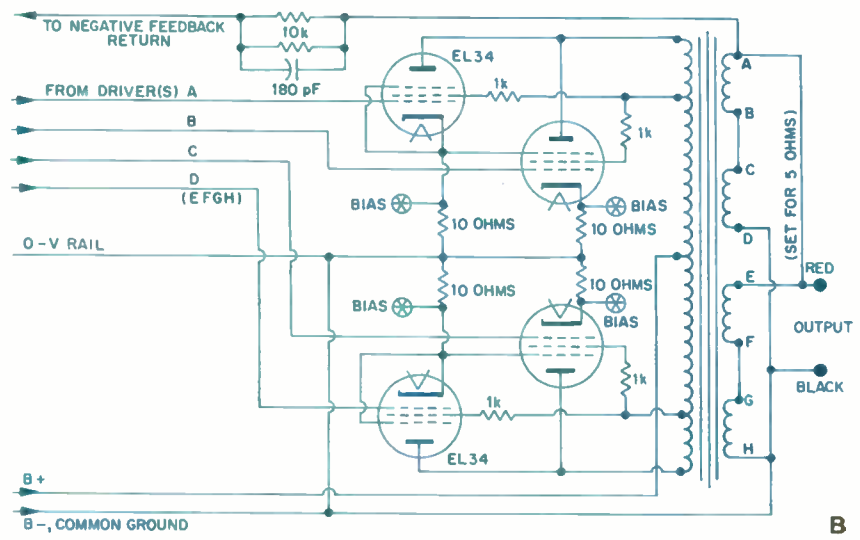


Fig. 1—Schematic diagram of VTL amplifiers' input and driver stage (A), output stage (B), and power supply (C).



publication, *The Vacuum Tube Logic Book*, which shows all of their schematics and loads of other interesting stuff. I would recommend that anyone interested in tube circuitry get a copy of this book, which is available from VTL for \$12 in the United States, \$18 for overseas orders.) The various VTL models differ in the kind and number of their output tubes, the number of paralleled driver tube elements (the larger amplifiers have more than two output tubes per push-pull side), and the capacity and sophistication of their power supplies.

As can be seen in Fig. 1, the circuitry of VTL's amplifiers is very straightforward. A common-cathode input stage, composed of two tube elements in parallel, is capacitor-coupled to a long-tailed pair (or differential-amplifier), phase-inverter driver stage. The a.c. balance is controlled by varying the



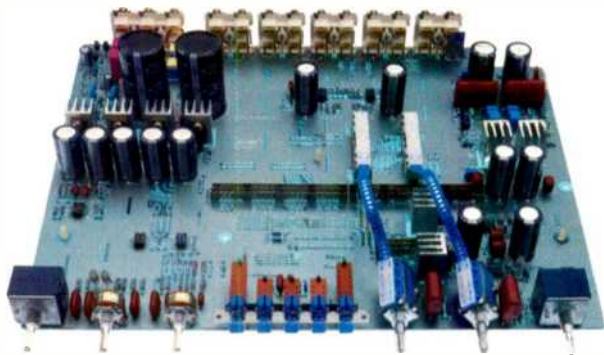
# Adcom's GFP-565 Preamp: Pure and Simple.



## In Search of Sonic Perfection, Adcom Took the Path of Least Resistance

The fewer circuits a musical signal encounters on its way to your loudspeaker system, the greater its musical purity will be. Now, through obsessive attention to detail and design ingenuity, Adcom has created the GFP-565 — the world's first affordable preamplifier with direct, linear gain path circuitry. By combining the GFP-565 with any of Adcom's power amplifiers, you can experience the exceptionally lifelike sound which has astonished even the most demanding critics.

From Input to Output,  
the Signal Path is  
as Direct, Pure and  
Simple as Possible



*By gold plating all input and output jacks, and then directly mounting all jacks, switches, potentiometers and other laboratory grade components on a double copper-plated, glass epoxy printed circuit board, signal losses and noise are dramatically reduced.*

## Three Sets of Outputs for the Perfect Balance of Performance and Flexibility

You can use one or more sets of outputs: 1) BYPASS - direct-coupled before tone controls, filters, etc. for the most direct path to your power amplifier while retaining control of volume and balance. 2) LAB - direct-coupled with no output-coupling capacitors yet with tone, filter and loudness controls. 3) NORMAL - same as LAB but with highest quality output capacitors for use with amplifiers needing the extra protection of ultra-low-frequency roll-off.

Bi-amped and tri-amped systems are easily accommodated by this flexible arrangement.

## Pure Convenience

The minimalist aesthetics of the GFP-565 are deceptive in their simplicity. Without being overly complicated to use, this preamplifier is able to integrate and control all of the components in the most sophisticated of music systems. There are five high-level inputs as well as a phono input. A separate front-panel switch allows the use of an external processor, only when needed, leaving both tape circuits free. And, of course, you may listen to one input while recording from another.

## More Sound, Less Money

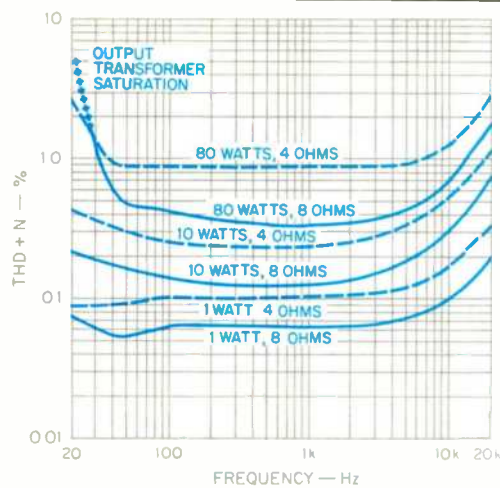
Adcom stereo components have a reputation for sounding superior to others costing two and three times more. Keeping faith with this tradition, Adcom took the path of least resistance. Why not do the same? Ask your authorized Adcom dealer for a demonstration of this remarkable stereo preamplifier. Please write or call for a fully detailed brochure. You'll discover the best value in high performance

preamplifiers.  
Pure and  
simple.

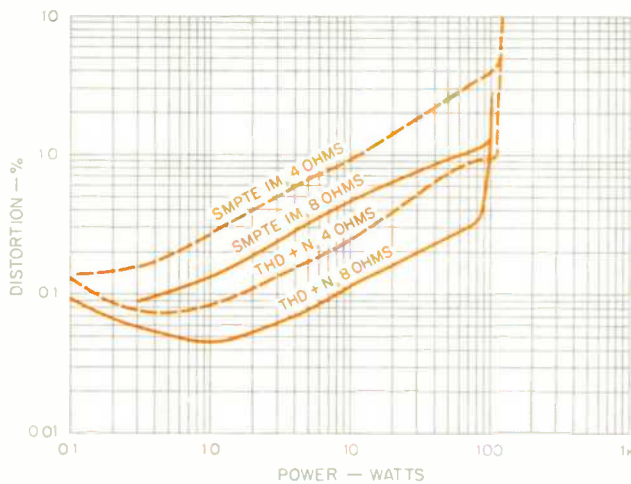
**ADCOM**<sup>®</sup>  
details you can hear

©1990 ADCOM

The amplifiers' relatively constant impedance over the audio range was noteworthy. Damping factor only fell off a bit at 20 Hz and 20 kHz.



**Fig. 2—THD + N of Compact 100 as a function of frequency and power output for 8- and 4-ohm loads; see text.**



**Fig. 3—SMPTE IM and THD + N vs. power and load. THD + N for a 1-kHz signal.**

value of one of the plate load resistors. Most of the output stages of VTL amplifiers are configured for ultralinear operation, with screen taps on the primary of the output transformer. Also common to VTL's power amps is the relatively low plate current per output tube, 26 to 32 mA, that is set at the factory. Usually, tube power amplifiers have plate currents on the order of 55 to 70 mA per tube. VTL believes that, although these levels of current do indeed result in reduced

measured distortion, the difference is not that audible and the reduction in tube life is not worth it.

Three full-wave diode bridges are used in the Compact 100 to provide the high-voltage, bias, and filament supplies. The input tubes' heaters are run on d.c. for lowest hum. The Compact 100 has a single control to adjust overall bias, a relatively recent addition to VTL's amplifier designs that is not present in all models. This makes it possible to run up the bias by turning one control, instead of commutating among the four individual bias pots, if one wishes to run up the bias current for "better sound" (which the company emphatically does not recommend) and is willing to accept the consequent reduction in output-tube longevity.

The main high-voltage filter-capacitor arrangement in the Compact 100 consists of four 1,000- $\mu$ F, 300-V units. These are connected in series-parallel for a composite rating of 1,000  $\mu$ F and 600 V. Suitable resistors wired across the paralleled units serve as bleeders and equalize the voltage across all of the capacitors. This is quite a lot of energy storage, some 125 joules, and probably accounts for a good part of the solid, socko quality of the Compact 100's low end.

One smart thing that designer David Manley does is to make full use of all of the copper in the output transformer secondary windings. In contrast to the usual arrangement of multiple output taps, some of which are not used with loads of various impedances, VTL uses a four-section secondary that is connected at the factory in series-parallel as an optimum match for a 5-ohm load. This will drive most of the speakers around very nicely. If one has a really difficult low-impedance load to drive, the dealer can connect the wires in parallel for a \*.25-ohm match.

Signal circuitry for the Deluxe preamp, like that of the power amps, is quite conventional; it reminds me of many preamp circuits of the '50s. The phono preamp section is a two-stage block, with feedback equalization to generate the RIAA response. Both tubes are connected in the common-cathode configuration; the second-stage cathode is bypassed with a capacitor for maximum loop gain. The output of the phono preamp stage goes to one input of the selector switch. The wiper of the selector switch goes to the record-out jack and into the top of the volume control. The volume control's output directly feeds the input of another two-stage amplifier. Connection of these two tubes is, again, a cascade of two common-cathode amplifiers.

A wideband, flat-feedback network from the second-stage output back to the first-stage cathode includes the balance control's resistor elements. This arrangement varies the gain between the two channels of the output amplifier in a manner similar to that of a silvered conventional balance control. The output of this two-stage feedback pair is connected through a suitable coupling capacitor to the high-impedance output jack. Calling this output "high impedance" is not strictly true, as negative feedback probably reduces the output impedance to a few thousand ohms. Through another coupling capacitor, this point feeds the input of the cathode-follower stage. If the cable connecting the preamp to the system power amp is short, the high-impedance output can be used without significant loss of highs and with the benefit of not going through another

# Introducing a novel concept in three-piece satellite systems.

To give you some idea of the bass output you can expect from most compact satellite systems, we'd like you to listen to something you already own.

A clock radio.

Because, quite frankly, while these satellite systems may be "marvels of space efficiency," they have very little bass efficiency.

In response to this, the engineers at Cerwin-Vega have designed a satellite system

with a subwoofer that takes bass response all the way down to 30 Hertz.

So while you may not be able to see our subwoofer (it's still small enough to hide), you'll hear it. And feel it. Now, it's only fair that we show you our competitor's low frequency specifications exactly as they're published. So, here they are:



Our 10" woofer gives new meaning to the term "low performance."

Amazing, isn't it? What do they



Our SAT-6 satellite system can make a room the size of, say, an outhouse, sound very much like an opera house.

think, that because the subwoofer is meant to be hidden, the specs should be hidden as well?

At Cerwin-Vega, we're proud, no, we're gushing over our SAT-6.

Not only is it quite compact, it's one of the best sounding speaker systems we've ever

made. If you'd like us to be more specific, we've got nothing to hide.

With sensitivity measured at 95 decibels, the SAT-6 can play

very loud on very little power.

If you appreciate a good high, the dome tweeters in our satellite speakers can take your music clear up to 20,000 Hertz.

What's more, at 6½", our mid-range speakers are the same size as the woofers in the Bose AM-5.®

Speaking of woofers, ours is a full 10" die-cast aluminum frame woofer with something no one else has.

The Cerwin-Vega logo. Which, for over thirty years, has been the equivalent of the Good Housekeeping® seal of approval.

For rock and roll.

Before we get to the finish, let's talk about the finish. Unlike most systems, where the subwoofer comes "nude," and is meant to be hidden, the SAT-6 is finely crafted and detailed for public viewing.

So, if you're at all intrigued by this, we suggest you take this simple bass test. And listen.

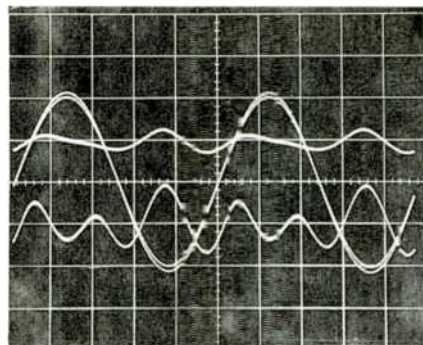
## A CRITIC'S RESPONSE TO OUR BASS RESPONSE.

*"When I fired up the SAT-6 system, and what sound! Good grief. Wide range, clean, smooth, and powerful . . . superlative sounding on rock, of course. On Mozart, the Cerwin-Vega SAT-6's sound was delicate, light, accurate, and spacious. This was one system I kept in place for a while, for daily listening in place of my usual loudspeakers."*

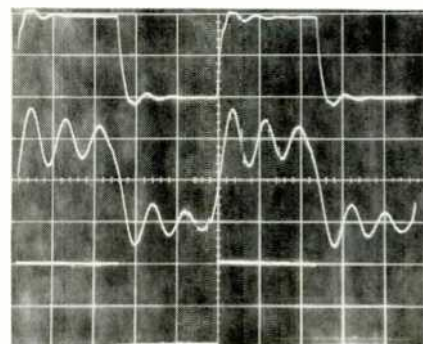
— David Moran, CD Review

 **Cerwin-Vega!**

Both response checks and square-wave tests show that the Compact 100 amps have excellent, extended low-frequency response.



**Fig. 4—Distortion residues and the original 1-kHz signal. For 10 watts into 8 ohms (top trace), distortion was 0.14%; for 20 watts into 4 ohms (bottom trace), distortion was 0.4%.**



**Fig. 5—Amplifier square-wave response. Top trace is 10 kHz with 8-ohm load, middle trace is 10 kHz with 2- $\mu$ F capacitance across the 8-ohm load, and bottom trace is 40 Hz into 8 ohms. (Scales: Vertical, 5 V/div.; horizontal, 20  $\mu$ S/div. for 10 kHz, 5 mS/div. for 40 Hz.)**

**Table 1—Output noise of VTL Compact 100 monoblock amplifiers with a source impedance of 1 kilohm. The IHF S/N ratios, with the same source impedance, were 76.5 dB for amplifier No. 229 and 77.0 dB for amplifier No. 230. The high wideband noise reading for Amp No. 230 was due to low-frequency surges.**

Bandwidth	Output Noise	
	Amp No. 229	Amp No. 230
Wideband	900 $\mu$ V	2 to 3 mV
20 Hz to 20 kHz	750 $\mu$ V	850 $\mu$ V
400 Hz to 20 kHz	450 $\mu$ V	400 $\mu$ V
A-Weighted	440 $\mu$ V	400 $\mu$ V

stage (the cathode follower). For longer cable runs or amplifiers with lower input impedances, the low-impedance output should be used.

Power-supply circuitry for the Deluxe preamp is quite simple and is without any fancy regulation except for the filament supply. The high-voltage secondary winding on the power transformer is rectified with a full-wave bridge and fed into a multi-section RC filter. A number of the filter capacitors have some 400  $\mu$ F of capacitance. Final B+ to the circuitry is about 250 V, and it appears that no decoupling is used between the output amplifier and the phono stage. Regulation for the heater supply for all the tubes, after full-wave rectification and capacitor filtering, is provided by a 7812 regulator.

### Measurements

Rather than referring to the left or right channel, which is not relevant to a pair of mono power amps, I will identify the two VTL units I tested by the last three digits of their serial numbers: 229 and 230. Voltage gain of both of the amplifiers was 36  $\times$ , or 31.3 dB, with 8-ohm loads. The IHF sensitivity was 80 mV for both units. Vacuum Tube Logic sets the gain of their power amplifiers, especially those of higher power, somewhat higher than the 26 dB typically seen in solid-state amplifiers. This gain is for some professional applications, where apparently full power output is desired to occur when the input level is 775 mV. This extra gain makes the amps easier to drive but can accentuate preamplifier line-amp noise. Such high gain is very nice in my situation, where I use no preamp line amplifier, and obviously would also be nice in other systems where a passive control center is used.

Total harmonic distortion plus noise is presented in Fig. 2 as a function of frequency, power, and loading. The data shown is for amp 229. Both of the units had similar distortion behavior, but amp 230 was noisier, having some subsonic noise that obscured distortion readings at low levels. With 8-ohm loading, it takes a higher output-transformer primary (and secondary) voltage to produce the 80 watts output that I show as the highest power in Fig. 2. The amplifier could not put out 80 watts into 8 ohms at 20 Hz, as its output transformer was saturating, with consequent bad waveform distortion. However, with 4-ohm loading, 80 watts at 20 Hz was attainable. I think the output transformer's core size is a bit too small for a 100-watt amplifier. Total harmonic distortion plus noise for a 1-kHz signal, and SMPTE-IM distortion, are shown in Fig. 3 as functions of power output and of loading. The distortion is generally low order (second and third harmonics) at low to medium levels, and some higher order odd harmonics come in at higher power levels with 8-ohm loading. With 4-ohm loading, the higher order odd harmonics come in sooner and have greater magnitude. Figure 4 shows distortion residues for a 1-kHz tone at 10 watts into 8 ohms and 20 watts into 4 ohms. Distortion is 0.14% in the 8-ohm case (top residual trace) and 0.4% for the 4-ohm load (bottom residual trace).

Damping factor as a function of frequency was virtually the same for both amplifiers—about 15.7 over most of the audio range, falling off slightly at the extremes of 20 Hz and 20 kHz to about 14.8. Magnitude of output impedance was

# ● THE AUDIO COLLECTION

AUDIO TECH WATCH



AUDIO TECH WATCH

Sleek, exotic and accurate, this elegant solid black chrome bracelet watch has a round black dial with gold-tone hands, sweeping second hand and precision quartz movement. It comes beautifully gift-boxed and warranted by Gruen Men's style #65WATTM Ladies style #65WATTL \$89.95 (\$3.00)

CD PLAYER BAG



CD PLAYER BAG

Made from the strongest 1000 Denier Cordura fabric, it measures a full 18" x 13" x 5" and features 1/4" foam padding for player protection, three pockets, shoulder and hand grip straps and fastex hardware.

Whether you use it to transport your player and discs or for business trips, this bag is the best. #65DISCB \$59.95 (\$3.00)

TIMELESS HITS



TIMELESS HITS

Now you can personalize your own CD with this unique timepiece. These clocks are the result of extensive design engineering. Each clock is individually handcrafted in the U.S., using only premium quality enamels and beveled glass. The fully electronic quartz movement is warranted for life. Just give us the name you would like to appear on the clock and we'll give you your greatest hits of all time. #65CLOCD \$36.00 (\$3.00)

POLO SHIRT



POLO SHIRT

100% pique knit cotton shirt with two-button front, knit collar and cuffs and hemmed back make this the standard. Available in black #65S01B, white #65S01W and red #65S01R \$26.95 (\$3.00)

CLASSICAL MUGS

These distinctive 12-ounce English Ironstone mugs with large grip handles boast the logo of your favorite magazine. Available in set of two (black and gray)

#65MUGS2  
\$16.95 (\$3.00)

CLASSICAL MUGS



# Audio

To order, call our TOLL FREE lines. We accept Visa, MasterCard and American Express, or send a check plus shipping and handling to AUDIO, P.O. Box #765, Holmes, PA 19043

ORDER TOLL FREE 800-345-8112

The amps' strengths include wide bandwidth, low power consumption (for long tube life), large energy storage, and low-order distortion.

**Table II**—Gain, IHF sensitivity, and approximate output impedances for VTL Deluxe preamp.

	Gain, dB			
	Left		Right	
	Instr. Load	IHF Load	Instr. Load	IHF Load
AUX to Main Outputs				
Low-Impedance Output	17.4	17.0	17.3	17.2
High-Impedance Output	17.5	16.7	17.4	16.4
AUX to Tape Output	0	0	0	0
Phono to Main Outputs				
Low-Impedance Output	52.5	52.1	52.4	52.3
High-Impedance Output	52.7	51.6	52.5	51.5
Phono to-Tape Out	35.0	34.2	35.1	34.2

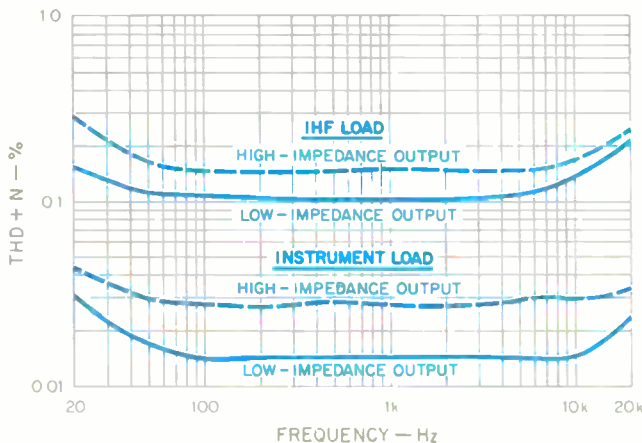
  

	IHF Sensitivity, mV	
	Left	Right
AUX to Main Outputs		
Low-Impedance Output	70.5	69.5
High-Impedance Output	76.0	76.0
AUX to Tape Output	500	500
Phono to Main Outputs		
Low-Impedance Output	1.24	1.22
High-Impedance Output	1.33	1.32
Phono to Tape Out	9.8	9.8

	Output Impedance at 1 kHz, Ohms	
	Left	Right
Phono Out	1,100	1,100
Line, High Impedance	1,300	1,200
Line, Low Impedance	403	370

Note: Output impedance at tape out is the same as that of the signal source. The output impedance of the phono section, measured at tape out, was 1,100 ohms in either channel.



**Fig. 6**—THD + N vs. frequency of Deluxe preamp's line section.

about 0.5 ohm, which is within the typical range for tube power amplifiers. Noteworthy was the relatively constant impedance over the audio range.

Rise- and fall-times at 10 V peak-to-peak amplitude were about 4  $\mu$ S with 4-ohm loading and 3.7  $\mu$ S with 8-ohm loading. At the 1-watt level, frequency response above the audio range varied somewhat with loading; this is usual with most power amplifiers. Low-frequency response was essentially flat down to 10 Hz. High-frequency response was flat out past 20 kHz, peaking slightly at about 60 kHz and rolling off some 6 to 8 dB at 100 kHz. The peaking at about 60 kHz was +0.5 and +0.1 dB for 4- and 8-ohm loading, respectively. Related to frequency response is square-wave response, some of which is displayed in Fig. 5. The top trace is for 10 kHz into an 8-ohm load at an output level of 10 V peak to peak. Some ringing is evident, and it isn't quite second-order damping (i.e., simple resonance). Investigation of frequency response beyond 100 kHz would no doubt show some multiple resonances. In the middle trace, an extra 2- $\mu$ F capacitive load was placed in parallel with the 8-ohm resistive load. Here, ringing is quite strong at an approximate frequency of 60 kHz, right where the response with resistive loading peaks slightly. A frequency of 40 Hz was used for the bottom trace, which exhibits an excellent, extended low-frequency response.

If one takes a flat 100 watts as the rated power of these amplifiers, then clipping headroom comes out to -0.6 and +0.09 dB for 8- and 4-ohm loads, respectively. Dynamic headroom was -0.44 and +0.5 dB for the same loading. With the tone-burst signal used for tests of dynamic headroom, a 1-ohm load could be driven to about  $\pm 11$  V, producing the same amount of peak current,  $\pm 11$  amperes. Amplifier output noise for various bandwidths is shown in Table I. The high reading of 2 to 3 mV for the wideband measurement of amp 230, which prevented accurate low-level distortion readings, was caused by a noisy tube.

Line draw at idle and at 120 V was about 1.2 amperes. Full power at visual onset of clipping drew 2.2 amperes for 80 watts into 8 ohms and 3.2 amperes for 102 watts into 4-ohm loads. I also checked bias current uniformity by checking the voltage drop across the tubes' cathode-sampling resistors. With a good warm-up, amplifier 229 had plate currents of 30.1, 30.3, 30.4, and 30.9 mA for its four output tubes, while the plate currents of amp 230's four tubes were 28.6, 28.9, 30.0, and 30.5 mA. This is pretty good uniformity. Power-supply regulation was also pretty good for a capacitive input filter system. The B+ at turn-on, before the tubes warmed up and started to conduct, was about 520 V. At idle, B+ was 50 V; at 100 watts into 4 ohms, it had dropped to 470 V.

The Deluxe preamplifier's gain and sensitivity measurements appear in Table II. Also shown in this Table are the approximate impedances of the various outputs.

Concentrating on the line section of the preamplifier first, THD + N was measured as a function of frequency, level, loading, and output (low or high impedance). Figure 6 shows THD + N for 1 V output. Loading either output with the 10 kilohms of the IHF load increases the distortion to about the same degree. This won't be a problem with any of VTL's power amplifiers because of their high input sensitivity

# RECORD YOUR CDs DIGITALLY



## On Equipment You Already Own!

### Isosonics has developed the World's Best Digital CD Recorder: *The PCM 44.1*

Just grab any VCR, a \$3 blank video tape, and the *PCM 44.1*. Then make a direct-to-digital copy of 6 hours of CDs by touching two buttons and walking away.



Unlike old-fashioned analog recording, there are no confusing adjustments to be made. No recording levels to set, no bias or equalization switches to fiddle with - no Dolby to remember.



The only thing stopping you from creating the perfect digital music mix is your own imagination.

### How It Works

The *PCM 44.1* works the same way that professional digital master tape recorders do: by transforming the digital signal from your CD player into a video signal that your VCR can record.

You just connect either the coaxial or optical digital output from your CD player into the *PCM 44.1*, and the *PCM 44.1* into your VCR. Then with the touch of a button, you can make a flawless digital recording of 6 CDs (or more) onto a single video cassette!

When you want to playback your digital masterpiece, use your VCR's address or index search system to go straight to any spot on the tape. You can access any of hundreds of songs using your VCR's remote control.

### The Highest Quality Sound

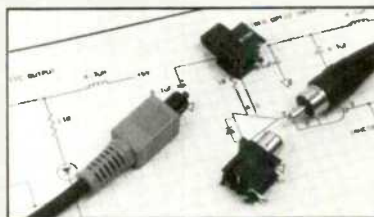
Upon playback, the video signal from your VCR passes back through the *PCM 44.1*. The *PCM 44.1* features IsoSonics' Enhanced Error Correction System, as well as the best Philips 4x oversampling D/A conversion available. The *PCM 44.1*'s output stage contains only the highest quality analog components and regulated power supplies.

The result is a professional studio master-quality digital recording.



The *PCM 44.1* features the Philips Special Select Grade TDA-1541A-51 -- the D/A converter widely regarded by engineers and audiophiles as the Premier DAC technology. It is the same chip found in Philips' \$4000 LHH 1000 Reference Series CD Player.

You can also use the *PCM 44.1* as an outboard D/A converter. Its superior digital and analog output sections will transform any CD player (with a digital output) into a *Reference-Quality* Component.



Optical and coaxial digital inputs & outputs lets you hook up your *PCM 44.1* to other digital components such as digital preamps, and digital tape recorders.

### Easy Addition To Your System

Hooking the *PCM 44.1* up to your existing audio/video system is a snap. Just plug your CD player and VCR into the *PCM 44.1*; and the *PCM 44.1* into your stereo receiver and TV set. When you're not using the *PCM 44.1*, your VCR records and plays back movies as usual.

### Made In The USA

Isosonics is a Cambridge, MA based company, founded by a team of audiophile engineers from the Massachusetts Institute of Technology. We are committed to producing innovative audio technology that maintains the highest quality and truest sound possible.

### 30-Day Money Back Guarantee

The *PCM 44.1* is the perfect answer to your home taping needs. It is convenient to hook up, easy to use, and creates hours of perfect-sounding digital recordings.

If you're not totally satisfied with your purchase, just send back the unit within 30 days for a full refund.

If you have any questions about the set up or operation of your *PCM 44.1*, you can reach us Monday through Friday between 9AM and 6PM Eastern Time.

### 5-Year Warranty

The *PCM 44.1* also comes with a full 5-year parts & labor warranty. And if we can't fix it within 5 working days, we'll send you a replacement unit immediately.

You can own a *PCM 44.1* CD Copier for only \$1495 including shipping.

(MA residents please add 5% sales tax)

To order your *PCM 44.1*  
(with our 30-day money-back guarantee)

**CALL TOLL FREE**

**(800) 969-3700**

Overseas & Canada Call:

(617) 354-8100

Or send a check to:

**ISOSONICS**

222 Third Street

Cambridge, MA 02142

Master Card/Visa/Amex Accepted

Enter No. 32 on Reader Service Card

Dolby and Philips are registered trademarks

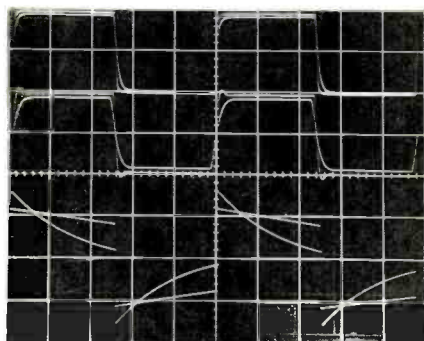
The amps have good tonal balance, plenty of apparent power, and fine revelation of detail, space, and depth.

**Table III**—Low-frequency response limits of Deluxe preamplifier's line output as a function of load.

	IHF Load (10 Kilohms)	50 Kilohms	Instrument Load (91 Kilohms)
Low-Impedance Output	-3 dB at 18 Hz	-0.1 dB at 20 Hz	0 dB at 20 Hz
High-Impedance Output	-3 dB at 20 Hz	0 dB at 20 Hz	+0.1 dB at 20 Hz

**Table IV**—Noise of Deluxe preamp, referred to input, with 1-kilohm input termination, and IHF S/N ratio. Measurements were taken at the low-impedance output. For the phono section's S/N measurements, the input was terminated by an IHF dummy MM load.

Bandwidth	Referred Input Noise, $\mu$ V	
	Left	Right
Phono Section		
Wideband	1.4	2.3
20 Hz to 20 kHz	1.0	1.6
400 Hz to 20 kHz	0.52	0.52
A-Weighted	0.53	0.55
Line Section		
Wideband	9 to 10	6.3
20 Hz to 20 kHz	3.7	3.5
400 Hz to 20 kHz	2.05	1.95
A-Weighted	1.95	1.90
	IHF S/N Ratio, dB	
	Left	Right
Phono Section	77.0	76.0
Line Section	89.5	88.8



**Fig. 7**—Preamp's response to square waves through line inputs for, top to bottom, 20 kHz through low-impedance output, 20 kHz through high-impedance output, and 40 Hz through high-

impedance output. In each case, responses with instrument and IHF loads are superimposed. (Scales: Vertical, 1 V/div.; horizontal, 10  $\mu$ S/div. for 20 kHz, 5 mS/div. for 40 Hz.)

and impedance. Measurements at higher output voltages with IHF loading yielded distortion levels somewhat higher than shown in the Figure, especially at the frequency extremes. The distortion behavior at the higher output voltages with instrument loading was much better and quite acceptable—in fact, either output could put out more than 20 V rms above 50 or 100 Hz.

Some specific information about the preamp's line-out low-frequency response appears in Table III. Since the 10-kilohm loading rolls off the low-frequency response too much, in my opinion, I would recommend that the Deluxe preamp not be used with amp input impedances lower than 47 kilohms.

Rise- and fall-times for the line amplifier at its two outputs was checked at two signal levels, 2 and 5 V peak to peak. At the lower level, rise- and fall-times were both about 0.6  $\mu$ S for the low-impedance output and about 1  $\mu$ S for the high-impedance output. The use of IHF loading increased the response times to 2.5 or 3  $\mu$ S for the high-impedance out and to 1 or 2  $\mu$ S for the low-impedance out. At the output level of 2 V peak to peak, and with IHF loading, one can see the beginnings of slewing occurring in the negative-going direction for the low-impedance output and in the positive-going direction for the high-impedance output. This shows up as longer response times in the aforementioned directions. With the volume control turned down 6 dB below maximum, rise- and fall-times were about the same as at maximum, although the edge shape developed more overshoot. At 5 V peak to peak, rise- and fall-times increased slightly with instrument loading. With IHF loading, slewing was evident on both outputs in the direction of tube cutoff—negative-going for the low-impedance output, which is fed by a cathode follower, and positive-going for the high-impedance output, which is fed by a common-cathode amplifier. Slew rate was on the order of 1 to 2 V/ $\mu$ S.

Square-wave responses for the output amplifier are shown in Fig. 7. The output level for all traces is about 2 V peak to peak. The top trace is for 20 kHz, taken at the low-impedance output, with instrument and IHF loads. (Instrument load is 91 kilohms paralleled with about 200 pF; IHF load is 10 kilohms paralleled with 1,000 pF). Response at the high-impedance output is shown in the middle trace. Low-frequency response and the effect of loading can be seen in the bottom trace, a 40-Hz square wave. The 40-Hz traces shown are for the high-impedance output; behavior of the low-impedance output was about the same.

Volume control tracking between channels was found to be within 0.6 dB at all levels down to -55 dB, increasing to a difference of 1 dB down to a level of -65 dB and to a 3-dB difference at -70 dB. When the balance control is turned toward either channel, that channel's gain is unaffected and the opposite channel's gain is attenuated up to a maximum of 8.5 dB.

Interchannel crosstalk, with the undriven input terminated in 1 kilohm, was measured and found to be asymmetrical in the two directions. In the worse (left-to-right) direction, overall crosstalk was greater than 80 dB down, from about 20 Hz to 1 kHz. At 10 Hz, the crosstalk came up a bit, to -75 dB. Above 1 kHz, it increased to -70 dB at 3 kHz, to -62.5 dB at 7 kHz, and to -53.5 dB at 20 kHz. Moving the balance



The VTL Deluxe preamp is a smooth-sounding unit, with reasonably neutral tone and good revelation of detail.

control over its range didn't make the high-frequency crosstalk get worse, but turning down the volume control 6 dB from maximum increased the crosstalk quite a bit, to about -30 dB at 20 kHz in the worse (right-to-left) direction. Crosstalk in the line amp was in phase.

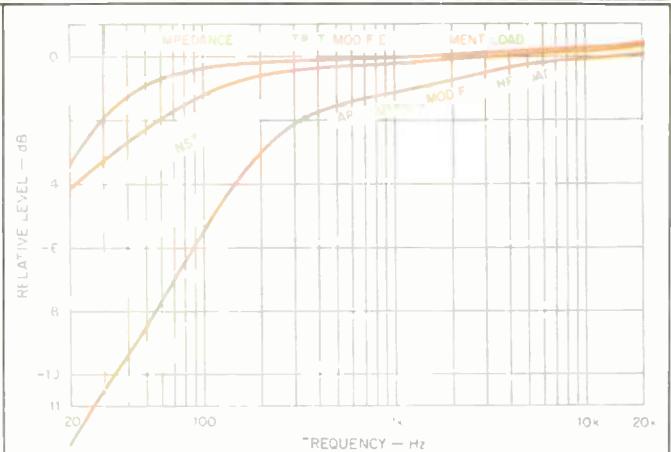
Referred input noise, along with IHF signal-to-noise ratio, is presented in Table IV for the line section as well as for the phono section. The tabulated results are for the low-impedance outputs, which were slightly noisier.

The phono section's RIAA equalization error is shown in Fig. 8 for several conditions. Note that the vertical scale is coarser than I usually use (2 dB per major division versus 1 dB per division). The middle curve is the equalization error at the tape out jacks with my normal instrument loading in parallel with the input impedance of my chart recorder. This makes for a combined load of about 32 kilohms, which is getting on the low side of desirable for tube equipment, but it is an impedance that one might easily find at the input of modern tape recorders. At 20 Hz, response is down about 4 dB, which in my opinion is too much. The top curve gives a better idea of the actual phono equalization error since the only load on the output of the phono preamp was then the volume control. This would represent the response when listening to records, providing the loading on the output of the preamp is high enough (see the discussion of line-amplifier low-frequency response, above). The bottom curve is for an IHF load in parallel with my chart recorder input, or about 8.33 kilohms, which is ridiculously low loading for tube gear, and the resultant low-frequency roll-off is completely unacceptable. Forget about taping records with this preamp, or get a recorder with an input impedance of 50 kilohms (or, preferably, higher). On the good side is the excellent uniformity of response between the left and right channels.

Figure 9 shows the phono section's response to pre-equalized square waves, measured at the tape output. Both instrument and IHF loads were used, and the waveforms showing the effects of each are overlaid; the traces with IHF loading have the lower amplitudes. The output level in the Figure is about 200 mV peak to peak. Some asymmetry can be seen at this level with the IHF loading on the 1- and 10-kHz waveforms. The bottom trace, for 40 Hz, indirectly shows the phono preamp's low-frequency response (which is detailed in Table III); note that IHF loading causes severe differentiation of the square wave.

The phono section's harmonic distortion was measured for a number of conditions. At 1 V out, distortion was about 0.1% in the midband and increased to 0.4% at 20 Hz and to 0.65% at 20 kHz. IHF loading increased distortion at 1 kHz to 1.6%. My lab notes say, "Forget IHF loading of the phono preamp!" Phono overload versus frequency is presented in Table V. As can be seen, input signal acceptance tends to level off above 3 to 5 kHz. This is probably due to the relatively high value of the plate load resistor in the phono circuit's second stage and the circuit's attendant inability to drive the RIAA feedback network at higher frequencies.

Related to phono overload with sine waves is the behavior of a phono preamp with increasing input levels of a pre-equalized, 1-kHz square wave. Figure 10 shows how the Deluxe phono preamp handles this admittedly difficult test.



**Fig. 8—RIAA equalization error for various output and load conditions; see text. Modified instrument load is 32 kilohms; modified IHF load is about 8.3 kilohms. The two channels' responses matched so closely that they could not be drawn as separate curves.**

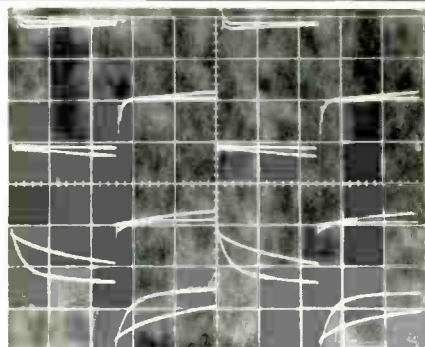
**Table V—Phono overload vs. frequency, for MM input, with instrument loading.**

Frequency, Hz	Left Channel		Right Channel	
	Input, mV	Output, V	Input, mV	Output, V
20	17.0	6.9	17.5	7.1
50	20.3	7.1	20.3	7.1
100	34.0	8.2	34.0	8.2
300	70.0	7.3	70.0	7.3
1k	102.0	5.8	102.0	5.8
3k	137.0	4.6	137.0	4.6
5k	140.0	3.2	140.0	3.2
7k	140.0	2.35	140.0	2.35
10k	140.0	1.72	140.0	1.72
20k	140.0	0.9	140.0	0.9

The way the waveform becomes asymmetrical is typical of many preamps, tube and solid-state alike. What I would consider a weakness in this circuit is the relatively low output level at which visible aberration occurs—on the order of 200 to 300 mV peak to peak.

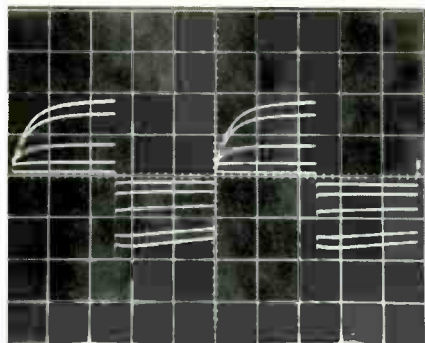
Crosstalk in the phono stage was quite symmetrical in both directions when the input of the undriven channel was terminated in a 1-kilohm resistor but became somewhat less so when the input termination was the IHF dummy moving-magnet load. In the worse (left-to-right) direction, crosstalk that was a constant -75 dB between 1 and 20 kHz with the 1-kilohm termination increased to -71 dB at 1 kHz, to -54 dB at 5 kHz, to -45 dB at 10 kHz (where the dummy load resonates), and to -52 dB at 20 kHz. In the better (right-to-

The VTL preamp and amps complement each other; their tonal balance is good, and they sound quite musical.



**Fig. 9—Response of phono section to pre-equalized square waves for 10 kHz, (top), 1 kHz (middle), and 40 Hz (bottom), all obtained via tape output. Both instrument and IHF loads**

were used and the results superimposed. (Scales: Vertical, 0.1 V/div.; horizontal, 20  $\mu$ S/div. for 10 kHz, 200  $\mu$ S/div. for 1 kHz, and 5 mS/div. for 40 Hz.)



**Fig. 10—Overload test of phono circuit, using pre-equalized, 1-kHz square waves at increasing input levels. (Scales: Vertical, 0.5 V/div.; horizontal, 200  $\mu$ S/div.)**

left) direction, the 10-kHz value was  $-64$  dB. Crosstalk in the phono section was in phase.

From a measurement point of view, the power amps' strengths include wide bandwidth, low distortion order (at lower power levels, where most information resides), low power consumption (resulting in long life for the output tubes), essentially constant output impedance with frequency, and large energy storage in the power supply. Not as good as some competing designs are what might be considered a slightly undersized output transformer, relatively high measured distortion at higher power levels, a relatively high output impedance, and more than usual high-frequency ringing with capacitive loads. The preamp has good high-frequency bandwidth and adequate low-frequency re-

sponse when loaded with VTL power amps. Loss of "weight" in the very low frequencies is likely to be the consequence of loading either tape or main outputs with less than 50 kilohms.

#### Use and Listening Tests

Equipment used to evaluate the VTL components included, as signal sources, an Oracle turntable fitted with a Well Tempered arm and Spectral Audio MCR-1 Select cartridge, a Magnavox 560 CD player feeding into a Wadia 2000 decoding computer, a Nakamichi 250 cassette player, and a Technics 1500 open-reel recorder. Other preamps used were my Cook/King reference phono-preamp/selector switch/stepped-attenuator unit and an Illusion No. 8 tube unit from Finland. A Head TX4 MC step-up transformer (from Esoteric Audio Research in Britain) was used with the VTL and the Cook/King phono preamps. Other power amps used were VTL 120s, a Counterpoint SA-20, and the EAR 519 100-watt mono tube units that I use for reference. Most of the listening was done on Siefert Research Magnum III speakers. Some of the listening was done with some new Martin-Logan Monolith III speakers, using the Counterpoint amp for the cone woofer and the various tube amps to drive the electrostatic part of the Monoliths.

The Compact 100 power amps have good tonal balance with excellent bass quality. Compared to some amps I like, including my reference EAR 519s, the 100s are a little on the bright side with both the Siefert and Martin-Logans. Revelation of detail is very good, as are space and depth. These amps have plenty of apparent power and can play most of the music I like bit louder than I usually want to play it.

The Deluxe preamp is a smooth-sounding unit. Tonal balance is reasonably neutral. Revelation of detail is good, although spatial depth is not as good as that of other units I have on hand or have previously reviewed. What is nice is that the music generally comes through with low amounts of irritation.

The preamp and power amps complement each other, especially with records, yielding a good tonal balance. I did feel that playing some of my musically favorite CDs through the combination sounded as if some detail and definition had been lost and that some irritation had crept in. However, many other CDs sounded stunningly musical and realistic. Most of the time, I was happily listening away to the combination and think that many people would be quite pleased with either or both of these VTL pieces.

The Compact 100 power amps operated without a glitch. The preamp had a mild switching transient when going to and from phono. It also had some r.f. sensitivity. In phono mode, I heard a radio station playing faintly—something that I had never heard in my setup before. Because of the power amplifiers' high gain, I could hear a faint hiss right at the speakers, probably the amplified input noise of the preamp's line amplifier or a combination of the line section's output noise and the power amplifiers' own input noise. This could be more audible with high-efficiency speakers.

Criticisms and nit-picking aside, these VTL pieces are quite musical and are very likely to satisfy the musical sensibilities of many of you out there. I recommend an audition.

*Bascom H. King*

# No lines. No hassles. Free parking.

Just call for the finest audio gear. We're fast. Friendly. We make it so easy.

## Magnavox CD Players

CD8605 Player no remote	**149.95
CD8610 Player w/remote	**199.95
CD8583 CD Changer	**279.95
CD8630 Player w/digital out	**329.95



## AUDIOPHILE HEADPHONES



<b>Beyer Dynamic</b>	
BDT 990 Pro	229.95
BDT990	189.95
BDT880	149.95
BDT550	129.95
Pipicmt ear cushions	22.95
<b>STAX</b>	
SR-34 Pro	179.95
SR-84 Pro	269.95
SRE-15N 5m extension cable	39.95
SRE-16 5m Pro cable	95.00
SRE-17 5m Sig cable	189.95
Pipicmt ear pads 34&84	19.95

**NEW FROM BEYER!**  
BOT-770 Pro 30-ohm headphone  
for Walkmans and portable stereos  
.....215.00

## ENERGY ABSORBING FEET

<b>AudioQuest Sorbothane Feet</b>		<b>Monster Footer w/ IsoTech</b>	
CD Feet (set of 4)	21.95	All Purpose (set of 4)	49.95
Large Feet (set of 4)	34.95	CD Footers (set of 4)	49.95
		Heavy Duty Footers (4)	95.00
		Air Footers (4)	119.95



**Navcom Silencers (Sims)**  
(pictured at left)  
Set of 4 .....35.00

## GRADO Cartridges

ZTE-1	19.95
Signature Brnz_MCZ TLZ	Call
XTZ	Call
Brnz stylus	89.95
MCZ stylus	135.00

## LAST Record Care

#1 Power Cleaner	19.95
#2 Preservative	19.95
#3 Rep. Cleaner	14.95
#4 Stylus Cleaner	12.95
#5 Stylus	21.95

## Niles Audio

Speaker Switching Boxes .....Call

## NEW! Audioquest Moving Coil Phono Cartridge Demagnetizer



Only \$79.95  
3 batteries included!

## RETIPTING MC Cartridges



YES! You can trade up when you trade in!

AudioQuest (AQ) Ruby	169.95
AQ MC-5 1.4mv or 5mv	159.00
AQ 404-1.4mv or 5mv	350.00
AQ Onyx 1.4mv or 5mv	499.95
AQ B-200 1.4mv or 5mv	550.00
AQ 7000 3mv	895.00
Monster AG 1000 MKII	450.00
Sumiko Blue Point	75.00
Blue Pt w/Gladius trade-in	85.00
Sumiko Taismaa R vdr	299.95
Sumiko Taismaa 118 vdr	385.00
Sumiko Virtuoso DTI	719.95

\*Replacements with used trade-in

## DB Protrac

Cartridge Alignment Gauge 29.95



## Monster X-Terminator

pair .....24.95

## ASC Tube Traps

TX6 Set \$869

## SONEX JRs

2"x2" SHEETS colors  
Box of (4) \$49.95

## FM Antennas

AudioPrism antenna HI-G APPA-1 49.95  
Terk PI Special 49.95  
Terk P2 79.95

## CD Stoplight

Green pain pen for CO treatment  
Only 14.95

Minimum order: 2 LPs or CDs

## Audiophile LPs/CDs

<b>Audiophile Samplers and Test CDs</b>	
Classics J237 Jazz Sampler/Test CD	(cd) 14.98
Dorand Sampler Disc	(cd) 12.95
H-F News Test CD 2 (UK)	(cd) 29.95
3-Blind Mice Jazz Samplers 1 2 3	(ea cd) 17.95
<b>Chessy NEW Jazz CDs:</b>	
J21 Johnny Frigo	(cd) 14.98
J22 Clark Terry	(cd) 14.98
J23 Phil Woods	(cd) 14.98
J28 Caram: Rio After Dark	(cd) 14.98
J29 Boris: Nonstop to Brazil	(cd) 14.98
J32 Earl Wind: Gershwin	(cd) 14.98
J33 David Chesley: Club de Sol	(cd) 14.98
J34 Paquito D Rivera: 'Tico 'Tico'	(cd) 14.98
<b>Reference Recordings LPs or CDs</b>	
RR-31 Tropic Affaire	(cd/tp) 15.98
RR-32 Farrell Rodgers&Hart	(cd/tp) 15.98
RR-33cd Fats Waller 'Lid Ed'	(cd) 29.95
Progmas: Camar6/Domingo	(cd/tp) 17.95
Jazz at Pawnshop	(2 b/s) 34.95 (cd) 16.95
Amphipon Blues Jazz	(cd) 17.95

<b>Mobile Fidelity UltraDiscs CDs</b>	(cds) 29.95
<b>MOBILE FIDELITY LPs</b>	
The Beatles	(b/s) 14.99 each
Sgt. Pepper's Please Please Me For Sale	
Hard Day's Night, Help, Revolver, Let It Be	
Miles Davis, Someday My Prince	(lp) 17.95
Frank Sinatra Collection	(16 lps) 299.95
Rolling Stones Collection	(11 lps) 299.95
Sheffield: Kodo	(cd) 14.99
Moscow Sessions set	(3 lp/cd) 39.95
Wilson Audio: Center Stage	(lp/cd) 15.98
Grace Cathedral Choir	(lp/cd) 15.98
S Wonderful Jazz	(lp/cd) 15.98
Winds of War and Peace	(lp/cd) 15.98
Opera 3 Test Records/CD	(cd) 23.95 (lp) 16.95
Deenan Classical CDs	(cd) 18.95
<b>Harmonia Mundi Recordings - Now on CD!</b>	
HMC379 G Panagiu	(lp) 12.95 (cd) 14.95
HMC1050 La Folia Sp	(lp) 12.95 (cd) 14.95
HMC7010 Walter Masch	(lp) 12.95 (cd) 14.95
Pathfinder: Natural Selection Jazz	(cd) 16.95
East Wind Jazz CDs	(cd) 18.95

## INTERCONNECT CABLES

Aural Cardas Distech Audioquest, MIT, Monster, van den Hul	Call
Custom length interconnects	Call

## SPEAKER CABLES

Cardas, Distech, Audioquest, Monster, Tara Labs Space & Time	Call
Tara Temporal Continuum Cable & Controllers (pictured at right)	
(8 ft) 450.00 pr (10 ft) 450.00 pr (12 ft) 595.00 pr	

## POWER STRIPS



<b>Triplite "ISOBAR" Line Filters</b>	
ISOBAR-4-220 4 outlet, 220/240v	79.95
ISOBAR-6 6 outlet, 3-stage filtering	89.95
ISOBAR-8 8 outlet, 4-stage filtering	99.95
<b>Triplite Power Regulators:</b>	
LC-1200-220 4 outlet, 2 stage, 1200 watt	**249.95
output 120v. **219.95 220v	
LC-1800 6 outlet, 3 stage, for audio and video	**299.00
1800 watt output	

## DELUXE POWERCORDS

Distech Powerbridge II (8 ft)	169.95
Cardas mudrino PC (8 ft)	169.95
Cardas Machine V PC (8 ft)	249.95
Tara Labs Phase II PC (5 ft)	99.95

## VIDEO CABLES

<b>Monster SYN'S Video Cable</b>	
1M 15.95 3M 24.95 6M 29.95	
<b>Monster Video 2 Cable</b>	
1M 14.95 3M 19.95 20 ft 29.95	
<b>Audioquest Video "X"</b>	1M 34.95 2M 34.95
<b>Audioquest Video "Z"</b>	1M 69.95 2M 89.95
<b>Tara Labs Video Cable</b>	3ft 34.95 6ft 34.95

## Target Racks and Stands



<b>RACKS</b>	#	Shelves	Ht	Price
TT2	2	20"		149.00
TT3	3	33"		219.95
PS3	3	33"		275.00
TT7	4	33"		259.00
TT5	5	33"		275.00
TT5T	5	40"		299.00

<b>HS STANDS</b>	
Target HJ	149.95
HJ20/2T	210.00
HJ24/2T	235.00



## Specialty Stands

<b>ARCICI Stands</b>	
B&M801M	389.95
ESL63	175.00
Old ESL	175.00
<b>Sound Anchors Stands</b>	
Vandersteen IIc	249.95
MagIIIa	299.95
B&W801M	449.95

## TIPTOES II



<b>Tiptoes (Original)</b>	
Short (5")	4.95
Tall (1 1/2")	6.50
Tall w/screw	9.95

<b>ToneCones (New)</b>	
Short	3.95
Medium w/screw	7.95
Large w/screw	14.95

## Reference Video Standard Laser Disc

<b>Reference Recordings LD-101</b>	
Video Calibration Laser Disc	59.95

## Audiophile Books

<b>The VTL Tube Book</b> Manley	12.95
<b>Good Sound</b> Laura Dearborn	12.95
<b>The Good CD Guide '89</b>	17.95
<b>The Wood Effect</b> RC Johnson	7.95

## RAM Vacuum Tubes



ARC 3P3a	85.00
SPE	65.00
SPB	89.95
SP	79.95
SP10	139.95
SP11	73.00
ARC Power Amps	Call
Audible Mod2	49.95
California Audio Labs	
Aria	49.95
Tempest	125.00
CAT 5L1	129.95
Conrad Johnson	
PV2 & 6	69.95
PV3	39.95
PV4	49.95
PV5	99.95
PV6	79.95
PV9	99.95
Premiert	149.95
SP16	149.95
MV50	169.95
MV75	199.95
NVAL Microcote	49.95
Silver	49.95
Minuet	49.95
Monocote 500	199.95
Monocote 150-300	89.95

## LEAD BALLOON

<b>Counterpoint</b>	
SA1000	45.00
SA3000	79.95
SA2	169.95
SA3	69.95
SAS	169.95
SAR	49.95
SA12	69.95
SA20	129.95
SA50	59.95
Dynaco Pas 3r	199.95
Stereo 70	199.95
Mark II	119.95
MFA Magus	65.00
Music Ref RM4	49.95
RMS	85.00
RMR	269.95
Quickstart Monos	p/269.95
VTL Maximal	49.95
Deluxe	59.95

## RAM PHONO TUBES

<b>Tablet</b> T2AK7s	
Low Noise	16.95
Prem	42.00
49.95	
<b>RAM POWER AMP TUBES</b>	
12AU7/12AT7	16.95ea
12BH7	16.95ea
5AR4	19.95ea
6X4 matched pair	69.95
6X5 matched pair	119.95
6X4 matched pair	49.95
8417 matched pair	77.50
5881/6L6 matched pair	77.50
<b>VTL POWER TUBES</b>	
855CA (US)	30.00
81-36 (US)	20.00
KT 66-5881 (USSR)	23.00
807 (USSR)	23.00
300B (US)	335.00



Turntable Stand 299.95

## Clean isn't clean until it's vacuum-cleaned.

## NIITY GRITTY Record Cleaning Machines

NG CD-1, CD cleaner	159.95
NG 1.5F	399.95
NG 2.5F	449.95
Mini-Pro	569.95
Hybrt 1	549.95

## VPI Record Cleaning Machines

VPI HW-16.5	**369.95
VPI HW-16.5 220v	**399.95
VPI HW-17	Call
VPI HW-17F (lan model)	Call
VPI HW-16/17 suction tubes	19.95

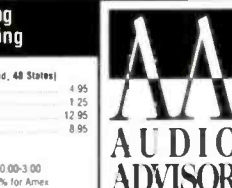


## RECORD DOCTOR Vacuum-powered record-cleaning machine

The Record Doctor cleans records just like the expensive machines with liquid application and vacuum suck-up but costs only \$169.95! Made by Nitty Gritty USA. Comes with cleaning fluid and applicator brush. 220V-240V version for Europe and Asian countries, \$189.95

## Record Cleaning Solutions

<b>Formula Tr-73H</b>	(16 oz)	14.95
<b>SuperCleaner</b>	(16 oz)	12.95
	(32 oz)	16.95 (1 gal) 24.95
<b>Nitty Gritty "First" Record Cleaner</b>	(6 oz)	14.95
	(16 oz)	24.95
<b>Nitty Gritty Purifier #2</b>	(16 oz)	11.95
	(1gal)**	39.95



**CHARGE IT!**  
Mastercard / Discover Visa / Amex  
**1-800-942-0220**  
225 Oakes SW, Grand Rapids, MI 49503  
FAX 616-451-0709 Service 616-451-3868

4

## DAHLQUIST M907i SPEAKER

### Manufacturer's Specifications

**System Type:** Box-style, three-way, acoustic suspension.

**Drivers:** 10-in. (254-mm) cone woofer, 5-in. (127-mm) cone midrange, and 1-in. (25.4-mm) dome tweeter.

**Frequency Range:** 30 Hz to 24 kHz.

**Sensitivity:** 88 dB SPL at 1 meter for 2.83 V rms at 1 kHz.

**Crossover Frequencies:** 400 Hz and 3.5 kHz.

**Impedance:** 8 ohms nominal, 6 ohms minimum.

**Recommended Amplifier Power:** 40 to 150 watts per channel.

**Dimensions:** 27 in. H x 13½ in. W x 10⅞ in. D (68.6 cm x 34.3 cm x 27.6 cm).

**Weight:** 40 lbs. (18.2 kg).

**Price:** \$1,000 per pair.

**Company Address:** 601 Old Willets Path, Hauppauge, N.Y. 11788.

For literature, circle No. 93



Dahlquist is best known for its series of Phased Array loudspeaker systems, which started with the Model DQ-10 in 1973. In designing these systems, Jon Dahlquist paid very close attention to loudspeaker time behavior and baffle diffraction effects. The result of these concerns was a very distinctive design with an open-air look, consisting of a rectangular grille frame in front of a broad, shallow woofer enclosure which was surmounted by a set of small, staggered baffles holding the other drivers.

Dahlquist was formed in 1973 by Saul Marantz, now retired, and Jon Dahlquist, who just recently sold the company to Carl Marchisotto, Michael Russo, and associates. Marchisotto, who currently is president, has been with the company since 1976 and has designed all of its current products.

The loudspeaker evaluated in this review is from Dahlquist's box-style "M series" monitor system line, which represents a major departure from the phased-array "DQ" line. The current line of monitors, launched in 1987, comprises four systems ranging from a small two way speaker with a 6½-inch woofer (M903) to a much larger, floor-standing, three-way design utilizing four drivers (M909).

The system reviewed here, the M907i, is Dahlquist's second largest monitor, a three-way design using a 10-inch woofer in a somewhat large bookshelf-sized enclosure of about 1½ cubic feet (42 liters). The manufacturer has placed great emphasis on minimizing the "boxy" sound of the system and calls its enclosure the "Un-Box." The company's stated goal is controlling diffraction by the use of a "unique combination of carefully selected materials, critical

panel bracing, and selective damping, all of which reduce coloration."

The 5-inch midrange is loaded by a cylindrical duct that Dahlquist says "provides an aperiodic termination combined with controlled dipole radiation." The tweeter is a standard-design, 1-inch, soft-dome direct radiator. Both units are manufactured by the Danish company VIFA. The 10-inch woofer is manufactured by Dahlquist.

The systems were delivered with Dahlquist's substantial Model ST-9 wood speaker stands. Due to its slanted top surface, the stand aims the system's axis upwards at an angle of about 3.5°. This built-in angle slants the main axis of the system (chosen here to be a point halfway between the tweeter and midrange) directly toward the ears of a listener seated 3 meters away. A standing listener, at the same distance, would be above this axis by about 13°.

The M907i systems I evaluated were finished in a very nice-looking white oak veneer, as were the stands and grille trim. Walnut veneer is also available as a standard finish. The handsome grille frames were made of 5/8-inch-thick wood with oak trim on the sides. The grille is attached to the front of the cabinet with plastic studs that protrude from the front panel and engage holes in the grille frame. The grille is held off the front panel by about 1/4 inch, presumably to reduce grille diffraction effects. The surface of the front panel is covered with a thin felt-like material composed of "thousands of black fibers electrostatically aligned on the baffle board." This was done, according to Dahlquist, to add absorption and reduce diffraction of sound on the cabinet's surface.

An examination of the inside of the box, with the woofer removed, revealed 3/4 × 2-inch, on-edge wood braces running up and down the sides of the enclosure. All box panel surfaces were 3/4-inch particleboard or plywood. Good workmanship was evident. Acoustic damping consisted of a large, 3-inch-thick fiberglass blanket running across the box and centered between the vertical braces.

Most of the exposed surfaces on the sides, top, and bottom of the cabinet were covered with 1/16-inch-thick sheets of an inert black material, which I assumed is a form of vibration damping. A call to Carl Marchisotto revealed that it is a proprietary vibration-damping material that he described as a "tangential extension damping pad." He stated that it is very "lossy" for motion that tends to compress or elongate the material, and small amounts of this material worked very well in damping the motion of the cabinet's side walls.

A large tube, 4 3/4 inches in diameter, connects the front and back panels of the cabinet, just behind the midrange driver. In addition to acting as a very rigid front/back brace, it also acts as a sub-enclosure for the midrange driver. A smaller tube, 4 inches long with a 1-inch inner diameter, vents this sub-enclosure outside through the back panel. Some fiberglass damping surrounds this tube in the sub-enclosure.

The rear panel contains the recessed input connectors (five-way binding posts spaced for double-banana plugs) along with fast-blow fuses for the woofer (3 amperes, equivalent to about 70 watts into 8 ohms) and for the tweeter (0.8 ampere, about 5 watts into 8 ohms). The crossover is fairly

complex, consisting of 15 components—four air-core inductors (one large and three medium), four capacitors, and seven 5-watt power resistors. No tweeter level control is provided. The crossover was hand-wired on a 1/4-inch piece of hardboard, 5 × 10 inches, attached to the rear panel. All connections to the drivers were soldered (no clips), using 18-gauge stranded wire.

### Measurements

The Techtron TEF System 12 Plus Time Delay Spectrometry (TDS) analyzer was used for most of the measurements in this review. The tests were performed at a number of locations, including my own listening room, Crown International's microphone test chamber, and outdoors on my driveway. The system was evaluated using elevated free-field, near-field, and ground-plane techniques.

The test of on-axis frequency response was conducted at a distance of 2 meters, on an axis halfway between the tweeter and the midrange driver, normal to the front baffle.

A first measurement made on the tweeter's axis was quite rough and depressed in the upper crossover region. The lower I moved the test microphone, the better the response was. I finally chose a point halfway between the midrange and the tweeter. The input level was 2.83 V rms, which corresponds to a level of 1 watt into the manufacturer's nominal 8-ohm rated impedance. The on-axis response was corrected to the standard distance of 1 meter for display of the data. A one-tenth octave filter was used to smooth the response.

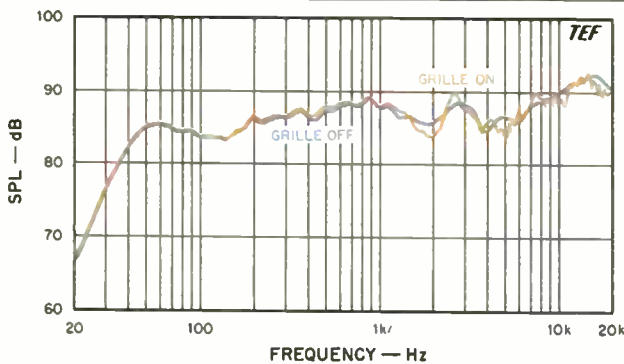
Figure 1 shows the on-axis frequency response of the M907i both with and without its grille, measured at 1 meter for a 1-watt input. Aside from the rise above 9 kHz, the response without the grille is moderately flat ( $\pm 3$  dB) from 42 Hz to 9 kHz, with some roughness in the middle and high frequencies between 1 and 8 kHz. The grille adds additional roughness to the response above 1 kHz. Averaging the axial response over the range of 250 Hz to 4 kHz yields a sensitivity of approximately 87 dB SPL, a reasonable match for the manufacturer's rating of 88 dB SPL at 1 kHz.

A separate test, comparing the axial response of both right and left speakers (not shown), yielded a moderately good match of about  $\pm 1$  dB over the frequency range from 100 Hz to 15 kHz. One woofer of the pair was about 1 dB hotter than its mate.

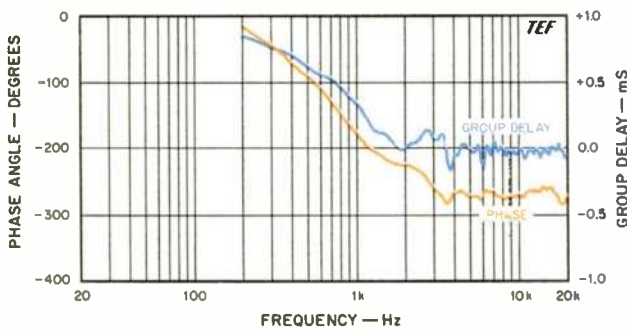
The woofer's excursion capability was assessed by sweeping with a constant-voltage, high-level sine wave covering the low-frequency range. The woofer did not exhibit any "dynamic offset" or "oil-canning" effects. (See the September 1989 issue, page 90, for more information on the "oil-can effect.") The maximum linear excursion capability of the woofer was about  $\pm 0.2$  to  $\pm 0.25$  inch (0.4 to 0.5 inch, peak to peak). The woofer has an effective radiating diameter of about 8 1/4 inches, and even though it is nominally a 10-inch unit, it is mounted in a 12-inch diameter frame. A hardboard reducer ring couples the frame to the smaller cone. Marchisotto stated that mounting the smaller cone in a larger basket makes it easier to assemble parts that would yield a quality, high-excursion driver.

The box was well sealed and had no leaks, even at high levels and low frequencies. The box side walls were quite

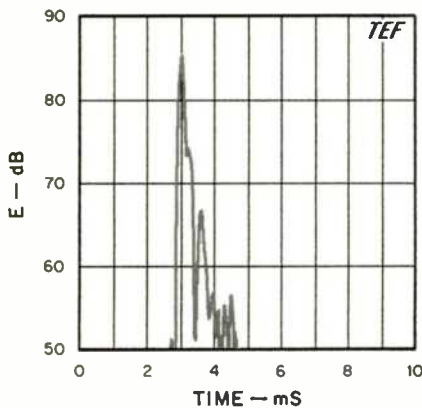
The driver Dahlquist uses as a midrange in the M907i has enough excursion capability to be used as a respectable woofer in a small two-way.



**Fig. 1—On-axis frequency response with input of 2.83 V rms, equivalent to 1 watt into the rated 8-ohm impedance.**



**Fig. 2—One-meter, on-axis phase response (left-hand scale) and group delay (right-hand scale), with the delay adjusted for the tweeter.**



**Fig. 3—One-meter, on-axis energy/time curve.**

rigid and displayed minimal vibration. At high levels, there was a slight buzz, in the range between 155 and 185 Hz, which seemed to come from inside the box.

Figure 2 shows the on-axis phase and group-delay responses of the system, corrected for the time arrival of the tweeter. The phase response exhibits a total phase rotation of only 110° between 1 and 20 kHz, a commendably low amount. The group delay indicates that the midrange trails the tweeter by about 0.13 mS (130  $\mu$ S), which corresponds to a distance of 1.8 inches (46 mm). At the 3.5-kHz cross-over point, this offset represents approximately 0.47 wavelength or 168°.

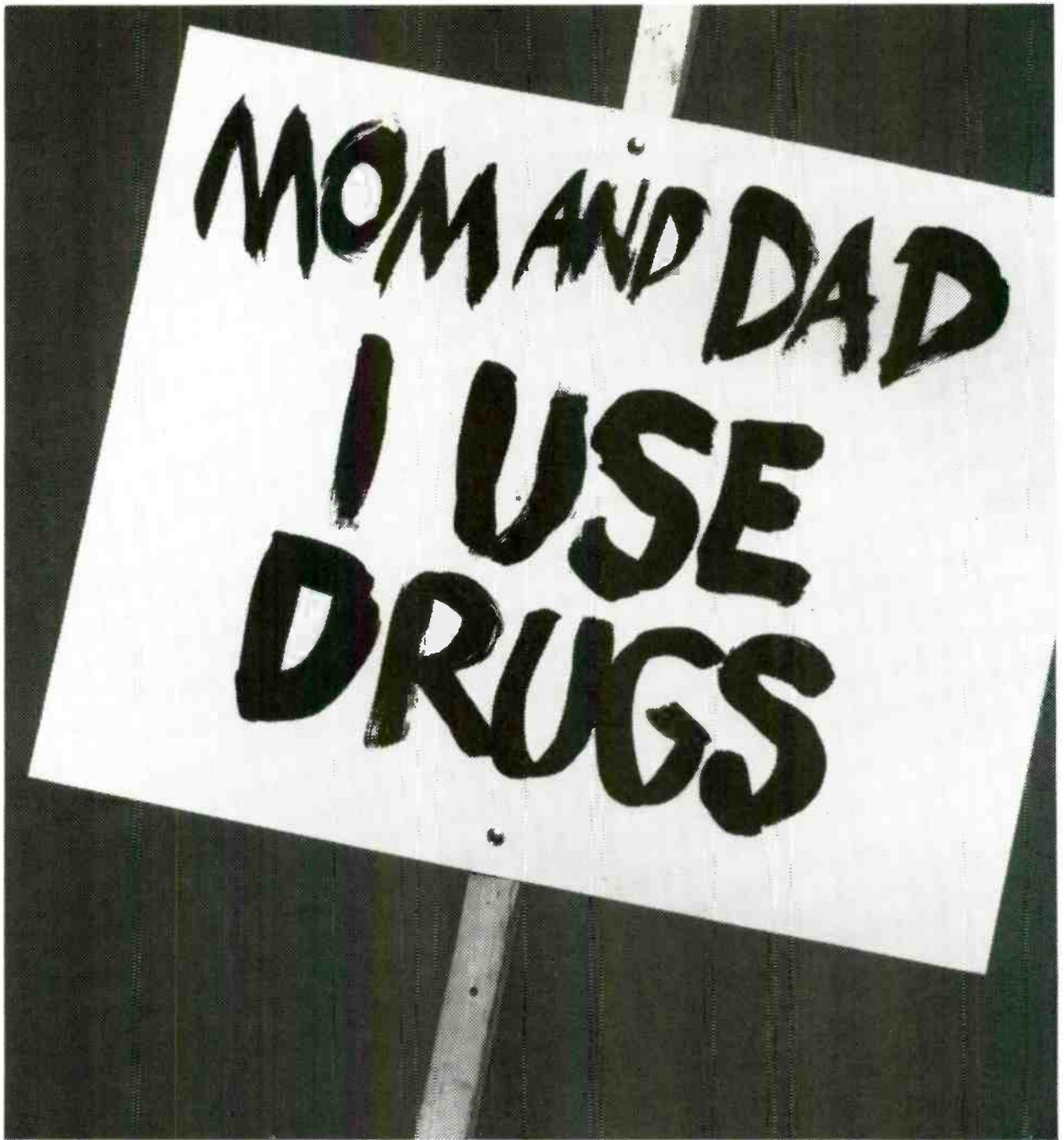
Figure 3 shows the 1-meter, on-axis, 1-watt, energy/time curve (ETC) for a test signal swept over the range from 200 Hz to 10 kHz. Be aware that this ETC represents essentially the midrange and tweeter's response only and emphasizes energy in the range of 2 to 9 kHz. The response is satisfactory except for a minor delayed peak, 20 dB down, about 0.56 mS after the main arrival (equivalent to a 7.6-inch difference in path length). This delayed peak may result from reflections or diffractions from the cutout hole for the midrange driver; the timing is correct for this possibility. Disconnecting the tweeter by removing the fuse (fuses make disconnecting drivers very easy!) revealed that the midrange output indeed lagged the tweeter by 128  $\mu$ S.

The off-axis response of the system was measured in two different ways. The first method displays the data in a "three-dimensional" TEF format, and the second method closely follows the way the on- and off-axis response curves are measured and derived at the Canadian National Research Council's test facilities (see the September 1989 issue, page 75, for more information).

Figures 4 and 5, respectively, show the "3-D" horizontal and vertical off-axis frequency response of the M907i. These curve sets were derived from response measurements made at 5° increments along the major horizontal and vertical planes of the system. No additional smoothing was done on these curves except for the fairly high-resolution smoothing by the constant 300-Hz bandwidth of the TDS data gathering process. Note that these plots have a logarithmic frequency scale and that all curves have been referenced (normalized) to the on-axis frequency response. As a result of this normalization, the on-axis response curve is shown as a straight line. Using the normalized format is beneficial because it clearly indicates the differences between the on- and off-axis curves, with the intrinsic response of the system eliminated.

The horizontal "3-D" off-axis curves in Fig. 4 indicate fairly smooth off-axis behavior, with high-frequency coverage up to 12.5 kHz out to about 50° off axis. This indicates that the M907i will have a large stereo imaging area and that pointing or aiming the speaker will not be needed.

The vertical off-axis curves in Fig. 5 clearly indicate the effects of the crossover in the range from 1.5 to 6 kHz. A deep off-axis depression zone exists in the crossover response region at angles between 5° and 25° above the axis. At corresponding angles below the axis, response is quite smooth in the same frequency range (not clearly shown in this plot). This indicates that Dahlquist's ST-9 stand ought to be used.



## **UNFORTUNATELY, SIGNS OF DRUG USE AREN'T THIS OBVIOUS.**

Fortunately, they're not invisible, either. That's why it's so important that parents know what these signs are.

The problem is that most parents don't know. And, as so often happens, their child's drug problem goes undetected.

It's senseless. Especially when the signs of drug use are right in front of the parent's eyes. Signs such as excessive secrecy, fewer visits home from college or a drop in school performance. Other signs are irritability,

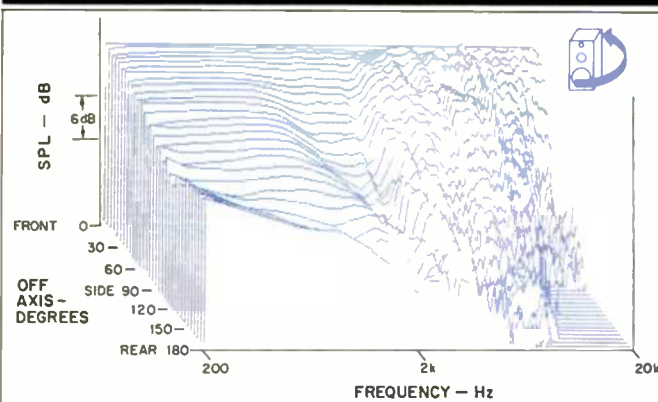
weight loss, pupil dilation, and heavy usage of eye drops or nasal sprays.

These are only a few. There are many others.

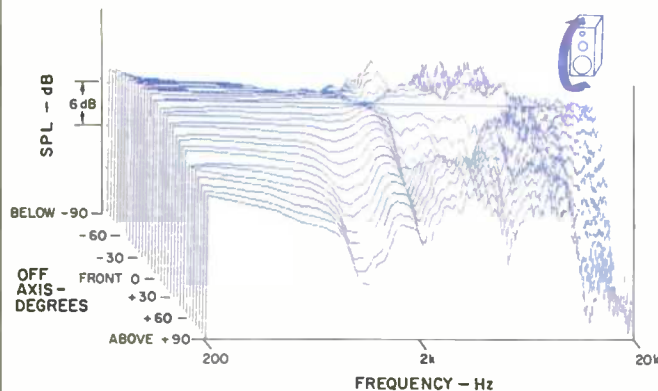
If you're a parent, you must get involved. You can learn more about the signs of drug use by contacting your local agency on drug abuse.

Knowing these signs isn't a cure. But at least it's a start.

For a system with a 10-inch woofer, overall distortion was quite low through most of my tests and was mainly low-order harmonic.



**Fig. 4—Horizontal off-axis responses taken from the rear, around the side, to the front of the system. Results have been normalized to the on-axis response; see text.**



**Fig. 5—Vertical off-axis responses taken from below, up the front, and to the top of the system. Lobing error is evident through the crossover region from 1.25 to 6 kHz, and there is a hole, centered at 3.5 kHz, in the region from 10° to 20° above axis; see text.**

The very asymmetrical behavior of the vertical frequency responses indicates that the woofer and tweeter are significantly out of phase acoustically in the crossover region. This denotes a high amount of lobing in the crossover frequency region. A separate measurement of tweeter and midrange individual magnitude/phase responses (not shown) revealed that the drivers were indeed quite out of phase, about 90° to 150° between 2.5 and 5 kHz. (This explained why measurements on the tweeter axis do not yield a reasonably smooth frequency response.) The phasing was such that the unavoidable crossover directional lobe is aimed downwards at about 15°, with the null aimed upwards at about the same angle. This amount of vertical lobing and its upwards orientation will cause a very irregular upper midrange response in the direct sound for listeners who are standing.

Electrical measurements of the crossover voltage drive (not shown) established that the tweeter was rolled off below 4 kHz at 6 dB per octave. The midrange was rolled off below 800 Hz at 6 dB per octave and above 4 kHz at 12 dB per octave. The woofer had a 6-dB octave roll-off above 400 Hz. Note that the total crossover response is the combination of both the crossover electrical drive and the drivers' acoustical response.

Figures 6 and 7, respectively, show the mean horizontal and vertical on- and off-axis response curves of the system, measured and derived in the manner of the NRC tests. These responses were derived from the previous "3-D" data by calculating response averages of several adjacent curves in specific on- and off-axis angular regions. This spatial averaging (rather than frequency averaging or smoothing) tends to suppress the effects of localized response aberrations due to diffractive effects without minimizing overall frequency response problems exhibited over broad angles. Mean axial responses were calculated separately for horizontal and vertical planes by averaging all the individual responses in a  $\pm 15^\circ$  window. The mean off-axis responses were computed separately in both the horizontal and vertical directions from the 30° to 45° and the 60° to 75° off-axis curves.

The mean horizontal response curves are shown in Fig. 6. The mean axial horizontal response curve is somewhat flat, although moderately rough, falling within a  $\pm 3.5$  dB envelope out to 20 kHz ( $\pm 2.5$  dB if the broad peak at 15 kHz is excluded). This curve represents the average frequency balance within  $\pm 15^\circ$  of the axis horizontally but on-axis vertically. The irregular 30° to 45° response fits in a tighter envelope of  $\pm 2$  dB out to 12 kHz. The 60° to 75° response fits in an envelope of  $\pm 2$  dB out to 8 kHz, where the level drops quite rapidly at higher frequencies. The fairly smooth wide-angle horizontal response indicates that the M9071 should maintain stable images over a fairly broad horizontal listening area.

The mean vertical responses are shown in Fig. 7. These curves are significantly rougher than the just-previous horizontal responses. The lobing or out-of-phase effects just above the axis, included in the  $\pm 15^\circ$  averaging, affect the mean axial vertical response (top curve) quite strongly. The mean off-axis responses (middle and bottom curves) are also significantly rougher than the horizontal curves and



America's **USED** Hi-End  
Largest Inventory

WE  
**BUY**  
&  
**SELL**  
BY  
**PHONE**

1-(800) 833-0071 • NYC 505-1111

- 30,000 sq. ft. on 3 Levels • 17 listening areas, including 9 sound rooms • Custom Installation
- Multi-Room Installations, Entertainment Centers • Audio/Video Consultants • In-House Repair
- Pick-up & Delivery Service • Extended warranty available on both new & used components

AMERICA'S LARGEST HI-END SPECIALTY STORE

**STEREO  
EXCHANGE**  
the **BLOCK-LONG** store

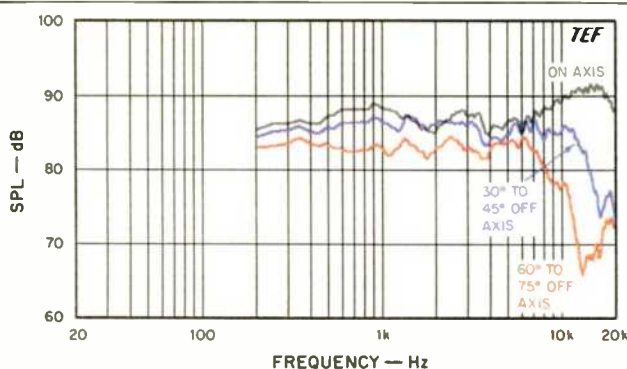
Authorized Dealerships:

Arcam (#1 U.S. Dealer), Ariston, Audioquest, Boston Acoustics, B&K (#1 N.Y.C. Dealer), B&W (#1 N.Y.C. Matrix Dealer), California Audio Labs, Carver, Celestion SL, conrad-johnson (#1 U.S. Dealer), Counterpoint (#1 U.S. Dealer), CWD, Duntech, Eminent Technology, Grado, Infinity, JSE, Kimber Kable, Kinergetics, Luxman, Magnum Dynalab (#1 E. Coast Dealer), Mod Squad (#1 E. Coast Dealer), MIT, NAD, Nitty-Gritty, ProAc, Revolver, Rogers (#1 U.S. Dealer), Roxsan, SME, Snell, Sonus Faber, Sony ES, Sota, Spica (#1 E. Coast Dealer), Stax, Straightwire, Sumiko, Sumo, Target (#1 U.S. Dealer), Threshold & Forte (#1 N.Y.C. Dealer), Tice (#1 U.S. Dealer), Van Den Hul, VPI (#1 U.S. Dealer), Velodyne, Vendetta, VTL, Wadia (#1 E. Coast Dealer), Well Tempered, Yamaha

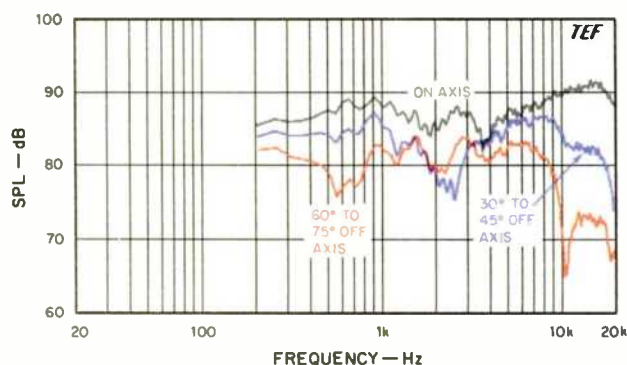
627 Broadway, Greenwich Village, NY 10012 • Open 7 days a week, Mon.-Fri. 11-7:30 pm, Sat., 10:30-7 pm, Sun. 12-7 pm  
212 505-1111 800 833-0071 outside NYC Fax 212 995-5524

our other location: 687-A Broadway, Greenwich Village, NY 10012 212 505-0433 *Most Major Credit Cards*

The M907i handles enough power to generate sound levels greater than 120 dB SPL in the upper bass and 110 dB SPL at frequencies above 48 Hz.



**Fig. 6—Mean horizontal responses, derived from data of Fig. 4.**



**Fig. 7—Mean vertical responses, derived from data of Fig. 5.**

include effects of both the woofer/midrange and midrange/tweeter crossovers. The lobing due to the upper crossover is quite apparent in the 30° to 45° response as an octave-wide hole centered at 2.3 kHz.

The effect of the cylindrical duct loading on the midrange was assessed by making separate near-field measurements on the midrange driver and the output of the tubular duct on the rear of the enclosure. An examination of the inside of the cylindrical sub-enclosure revealed that it is essentially a form of vented-box (bass-reflex) loading of the midrange. A direct hookup to the midrange, with a high-level sine-wave sweep, indicated that the box resonance frequency was about 85 Hz. This is the frequency where the tuning minimizes the excursion of the midrange. This tuning frequency is much too low to have any effect within the operating frequency range of the midrange driver. Near-field response sweeps of the midrange, conducted with the system's vent tube both covered and uncovered, showed absolutely no change in its output at frequencies above 200 Hz (not shown). The vent did affect the driver's output in the

range from 50 to 200 Hz, however, by a maximum of about 1 dB.

While the box tuning that resulted from the tube had no effect within the midrange's operating frequency, a near-field response measurement taken at the tube's outlet, behind the enclosure, showed that the tube itself did have appreciable resonant output within the driver's operating range. This took the form of a narrow, half-wave organ pipe resonance, with a high Q (about 9) at 1,360 Hz and a peak some 12 dB below the output of the midrange. The second and third overtones of the tube's resonance were also clearly evident. This is definitely not aperiodic (nonresonant), as claimed. On theoretical grounds, I suggest covering the tube or stuffing it so that it can't radiate into the room; however, I couldn't hear any difference from doing this.

This 5-inch driver, even though it is used here as a midrange, could be used as a very respectable bass speaker in a small two-way system due to its roughly 0.3-inch, peak-to-peak excursion capabilities. The driver is hardly being exercised in the M907i.

Figure 8 shows the input impedance of the M907i, plotted over the range from 20 Hz to 20 kHz and with a logarithmic vertical scale covering 1 to 100 ohms. A minimum impedance of 5.1 ohms at 80 Hz, and a maximum of 20 ohms at the low-frequency closed-box resonance of 43 Hz, were measured.

The complex phase (Nyquist) polar plot of the impedance, covering the range from 10 Hz to 30 kHz, is shown in Fig. 9. The polar curve is quite well behaved, with no minor loops. This indicates that there are no spurious higher order resonances in the cabinet or in the woofer's moving system. The flattened corners and sharp bends of the large, low-frequency resonance circle are caused not by the speaker system but by my measurements, which under-sampled the response data. I should have decreased the width of my analysis sweep to get higher resolution in this particular frequency area.

The maximum positive (inductive) phase angle of 32° was attained at 38 Hz. The maximum negative (capacitive) phase angle of -40° was reached at 51 Hz. These moderate maximum phase angles will present no problems to any reasonably well-designed amplifier. The impedance of the M907i is quite well behaved.

Figure 10 shows the 3-meter room curve of the system, located in the right-channel stereo position, with the test microphone placed at ear height, on the sofa, where the listener normally sits. The system was swept from 100 Hz to 20 kHz with a 2.83 V rms sine-wave signal (equivalent to 1 watt into 8 ohms). The resultant SPL can be read directly off the graph. Also shown is a sixth-octave, smoothed version of the curve. The parameters of the TDS sweep were chosen to include the direct sound plus 13 mS of the room's first reflections. This amount of room sound represents approximately the effective averaging of the human ear, with its emphasis on the direct sound plus early energy arrivals. In general, the curve is well behaved except for a rough upper midrange and a high-frequency rise between 8 and 20 kHz. The effect of the floor-bounce reflection is clearly seen at about 370 Hz; the height of the woofer heavily influences the frequency of this effect.

My early listening disclosed good control of the lateral soundstage and a top end whose forward sound made my reference system seem dull.

The distortion characteristics were measured in two different ways, by obtaining three spectra for single-frequency harmonic distortion versus power and by running an IM distortion versus power measurement.

Figures 11, 12, and 13, respectively, show the single-frequency harmonic distortion spectra versus power level for the musical notes of  $E_1$  (41.2 Hz),  $A_2$  (110 Hz), and  $A_4$  (440 Hz). These curves indicate the level of harmonic distortion generated by the system with the application of a single-frequency sine wave at power levels covering the range of 0.05 to 50 watts (-13 to 17 dBW, a 30-dB dynamic range). The power levels were computed assuming the rated impedance of 8 ohms. I choose to limit the maximum power to 50 watts, not because of excessive distortion but because the woofer is protected with a 3-ampere fuse. This theoretically limits the system to roughly 70 watts into 8 ohms. (By Ohm's Law, power equals  $I^2R$ , so 3 amperes squared times 8 ohms equals 72 watts.) Neither the woofer nor the tweeter fuses blew during these tests or the tests of IM and peak power.

The curves were run by successively increasing the sine-wave input level in 1-dB increments (each step about 26% higher in power than the previous level). At each power level, a swept spectrum analysis was done over a frequency range covering up to the fifth or sixth harmonic. Two precision 1-dB/step attenuators were used in the setup—one in the send path and one in the receive path—to ensure that the power level steps were accurate. The receive attenuator provides a constant fundamental level to the spectrum analyzer so that distortion percentages can be directly read off the plotted data scales.

Figure 11 shows the harmonic data for  $E_1$  (41.2 Hz). The nonharmonically related spikes at lower power levels are due to background noise in the test setup and were not generated by the speaker. The narrow, constant-height ridge at the left of the display, seen in Fig. 11 and in the following two Figures, is a test artifact and not due to the system under test. The ridge is due to spectrum residuals of the fundamental signal. At lower power levels, the second and third harmonics predominated. At higher levels, these were joined by the fourth, fifth, and sixth harmonics. The distortion levels shown are reasonable for a 10-inch driver at such power levels. Remember that an output of 50 watts generates SPLs in excess of 100 dB (that's loud!) in the low-frequency and mid-band ranges of this system.

The harmonic data for  $A_2$  (110 Hz) is shown in Fig. 12. The data shows that only the second and third harmonics were significant. The second harmonic increases gradually with power, reaching a level of 7.6% at 50 watts. The third harmonic is quite low over most of the range and reaches a level of only 1.3% at 50 watts.

Figure 13 shows harmonic measurements for  $A_4$  (440 Hz). Again, the predominant distortion is a low amount of second and third harmonics, with negligible amounts of higher order distortion.

Figure 14 shows the IM created when the Dahliques were fed a 440-Hz ( $A_4$ ) tone and a 41.2-Hz ( $E_1$ ) tone at equal power levels. The IM distortion gradually rises with power, reaching about 5% at 20 watts and 11% at 50 watts. The first-order ( $f_2 \pm f_1$ ) and second-order ( $f_2 \pm 2f_1$ ) side frequen-

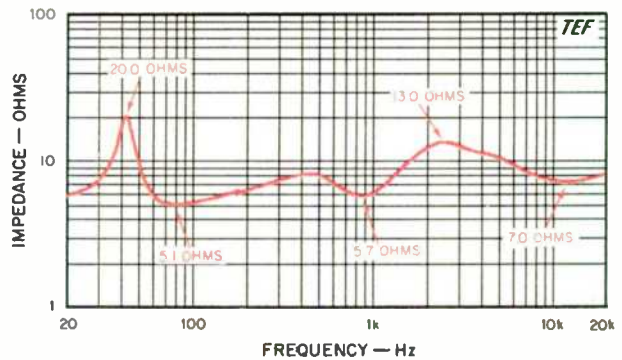


Fig. 8—Magnitude of impedance. Note the logarithmic impedance scale.

Fig. 9—Complex impedance.

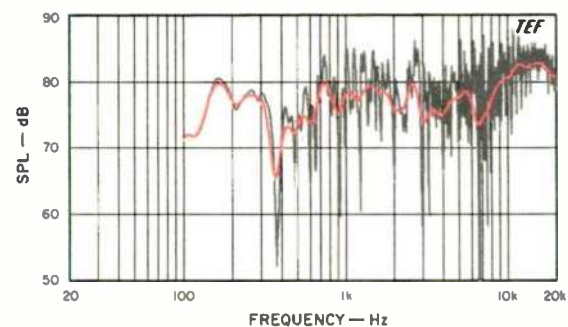
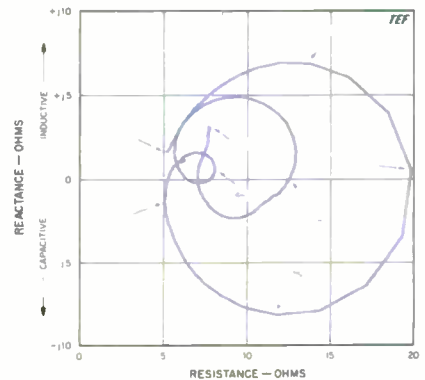
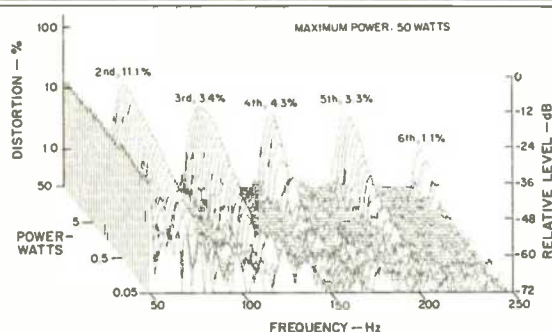
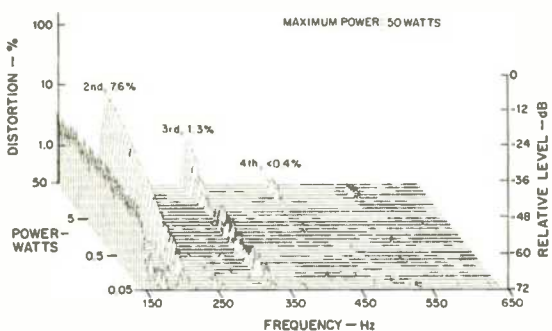


Fig. 10—Three-meter room response containing direct sound plus 13 mS of room reflections. Irregular curve is raw data, smooth curve is sixth-octave average; see text.

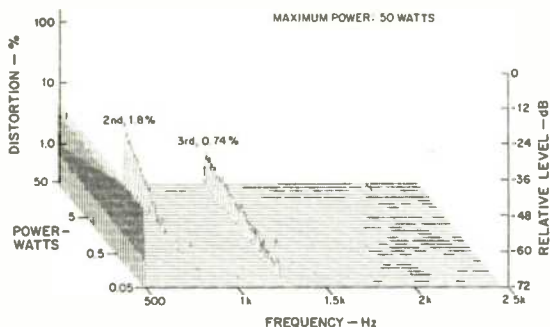
Except on loud, low organ notes that few systems can handle adequately, these speakers sounded clean at all playback levels.



**Fig. 11—Harmonic distortion products for the tone  $E_1$  (41.2 Hz).**



**Fig. 12—Harmonic distortion products for the tone  $A_2$  (110 Hz). Only the second and third harmonics were significant in this power range.**



**Fig. 13—Harmonic distortion products for the tone  $A_4$  (440 Hz). Only relatively low amounts of second and third harmonics are evident; other distortion products were below the 0.2% measurement floor.**

cies predominate in this power range. These levels of IM distortion are reasonable for a system having a woofer diameter of 10 inches.

Overall, the distortion measurements on the M907i are quite low and are reasonable for a three-way system with 10-inch woofer.

Figures 15 and 16 show the short-term, peak power input and output capabilities of the system, as a function of frequency. The tests were run by applying a shaped, third-octave tone-burst signal consisting of 6½ cycles of a sine wave shaped using a Hamming raised-cosine envelope. The resultant test signal covers a third-octave bandwidth and has a time duration that increases as the frequency goes down. The burst is presented at such a low duty cycle that the long-term thermal characteristics of the speaker under test are not exercised. The test consisted of evaluating the maximum peak input power-handling capacity and maximum output peak sound pressure levels at all the third-octave center frequencies between 20 Hz and 20 kHz. A very powerful amplifier, which can generate 5,500 watts peak (+37 dBW, ±210 V into an 8-ohm load), was used to drive the system. The peak input power was calculated by squaring the measured peak driving voltage and dividing by the rated 8-ohm impedance.

The test sequence consisted of determining how much of the special test signal could be handled by the speaker, at each frequency, before either the output sounded audibly distorted or the acoustic output waveform appeared distorted on a 'scope, whichever occurred first. At each frequency, I recorded the maximum peak input voltage and the corresponding generated peak output sound pressure level at 1 meter. At low frequencies, the 'scope waveform defined the power limit, while at higher frequencies the audible effects defined the limit. I found that I was aurally quite tolerant of rather high distortion levels (primarily second and third harmonic distortion) at low frequencies but was very critical of even slight audible distortion at mid and high frequencies.

Figure 15 shows the maximum peak electrical input power-handling capacity of the M907i. The peak input power-handling capacity is seen to rise with frequency until about 400 Hz, where it levels out at about 4.5 kW. Above 4 kHz, the power is limited to 5.5 kW due to clipping of the test amplifier! A slight depression at 2.5 kHz is noted, in the low end of the tweeter's range, presumably due to tweeter excursion limitations. The system cannot handle more than about 12 watts below 25 Hz for moderately clean output. It can actually handle more power than the curves show but at the expense of much greater distortion and possible risk of damage at higher frequencies.

Figure 16 illustrates the maximum peak sound pressure levels the system generated at a distance of 1 meter, on axis, for the levels shown in Fig. 15. Also shown is the "room gain" of a typical listening room at low frequencies. This adds about 3 dB to the response at 80 Hz and 6 dB at 30 Hz. (The room gain data was taken from a paper by Martin Colloms given at the Symposium on Perception of Reproduced Sound in Denmark in 1987. This and many other very informative papers are included in *Perception of Reproduced Sound*. This book, which was reviewed in the April

# Wisconsin Discount Stereo



or COD

# 1-800-356-9514

CALL: M-F 8 a.m. - 8 p.m. • Sat. 8 a.m. - 5:30 p.m. • Closed Sunday  
Some items closeouts. Some items limited quantities.



**Knowledgeable**  
Factory trained.

**Friendly and**  
**Helpful**

**Expert Repair**  
**Service**

Finest test  
equipment.  
Large inventory of  
replacement parts.

## HIFI VCR

- Quasar HiFi** ..... \$299  
155 Ch, MTS, On Screen  
Program, 31 Day
- JVC HRS5500U** ..... \$649  
Super VHS, LCD Remote,  
155 Ch, 8/14
- JVC HRS6600U** ..... \$749  
Super VHS, Jog Shuttle  
Advanced EDIT, 4-Head HiFi

## VCR

- Sharp VHS** ..... \$219  
111 Ch, 4/14, 2x Comb Filter,  
Auto Rewind
- Toshiba M220** ..... \$229  
181 Ch, 8/365 Day, Index, On-  
Screen Program, Tape Remain
- JVC VHS** ..... \$239  
181 Ch, Go-To, Index, Real  
Time Counter, All 4 HQ

## CAMCORDER

- Sony Camcorder** ..... \$679  
6x, 1 Page Digital Titler,  
Date/Time, Auto Focus
- RCA Super VHS** ..... \$799  
6x, High Speed Shutter, On  
Screen Auto Focus
- JVC GRA1** ..... \$629  
VHS Format, 6x Zoom,  
2.5 lbs., Auto Focus, Date/Time

## TV

- Sony AV2749S** ..... \$519  
27", 600 Lines, 180 Ch,  
Master Command Remote, S-VHS
- Quasar TV/VCR** ..... \$569  
Combination TV/VCR, OSP,  
155 Ch, 4/31 Day
- Panasonic 40"** ..... \$1499  
40" Projection, 155 Ch, S-VHS  
Input, Unified Remote

## CAR STEREO

- Clarion 8671RT** ..... \$169  
Din, Removeable, A/R, 18  
Presets, Bass/Treble
- Sherwood XR1604** ..... \$219  
Din, Removable, High Power,  
Dolby B/C, CD Input
- Clarion 9772RT** ..... \$225  
Din, Removable, Dolby, High  
Power, 18 Presets

## MISC SPECIALS

- Sony MDRV6** ..... \$67  
Best Buy Rated Headphones,  
Professional Quality
- Audiosource SS2** ..... \$159  
Dolby Surround Sound,  
Remote, 30 Wts/Ch
- Bearcat RD9XL** ..... SPECIAL  
Radar Detector, Best Buy
- BEL 944 3-Band** ..... CALL

## DISC PLAYER

- Harmon Kardon HD800** ... \$239  
Top-of-the-Line Close-out.  
Way below normal cost.
- Magnavox CDB586** ..... \$229  
6 Disc Changer, 4x, Dual D/A,  
Favorite Track
- TEAC PD700M** ..... \$189  
6 Disc Changer, 4x, Remote,  
Dual D/A

## PORTABLE CD

- Sony D2** ..... \$144  
Portable Discman, 16 bit, AMS,  
Shuffle, Carry Belt
- Sony D9** ..... \$189  
Dual 16 Bit D/A's, Mega Bass,  
22 Track Programming, Search
- JVC PCX200** ..... \$299  
Portable with CD, A/R  
Hyper Bass, 5-Band EQ

## RECEIVER

- Proton D940** ..... \$388  
Dynamic Power on Demand,  
Schotz Tuner, MC Phono
- Sherwood RA1240** ..... \$159  
70 Wt/Ch, Remote, Surround,  
5 Band EQ, 30 Presets
- TEAC AG75** ..... \$198  
75 Wt/Ch A/V, Matrix Surround,  
High Output Discrete Circuit

## CASSETTE

- TEAC W660** ..... \$199  
Double A/R Rec/Play, 3 Motor  
Dolby B/C, WAY BELOW COST
- TEAC V680** ..... \$239  
3 Head, 2 Motor, Fine Bias,  
Dolby B/C/HX Pro, Black
- Sherwood DS1630** ..... \$189  
Dolby B/C/HX Pro, A/R,  
AMS, Microphone Jacks



**Fast Delivery**  
\$30,000,000 Inventory

**Widest Selection**  
1000's of Models

**Consistently**  
**Low Price**  
Huge Volume  
Low Overhead

**200,000 sq. ft.**  
**Warehouse**  
6 football fields large

**Brand New**  
Full Manufacturer  
Warranty

**CALL FOR**  
**DEMO**  
**SPECIALS**

**BEST**  
**EXTENDED**  
**WARRANTY**



## MISC HIGH END

- Thorens TD318II** ..... \$299  
Audiophile Turntable, TP28 Tone-  
arm, Belt, 16 Pole
- TEAC V970X** ..... \$469  
Audiophile Cassette, dbx, 3 Head,  
Dolby B/C/HX Pro
- SAE A502** ..... \$439  
200 Wt/Ch Power Amp,  
Dual Speaker Switching

## MISC HIGH END

- SAE P102** ..... \$249  
Computer Direct Line Preamp, 3  
Tone Presets, MC/MM, Fading
- Dual CS5000** ..... \$325  
Audiophile Turntable, Belt, Hand  
Rubbed Walnut Base
- Soundcraftsman** ..... CALL  
Made and Designed in the USA,  
We Carry Most Models

\*10-Day Return Policy: Return items accepted within 10 days of purchase. (Must get prior authorization.) Original Condition. 10% restocking fee. Shipping and handling not refundable. 1-800-271-8889



**Fast Delivery**  
In stock orders  
shipped next day.

**10 Day Return\***

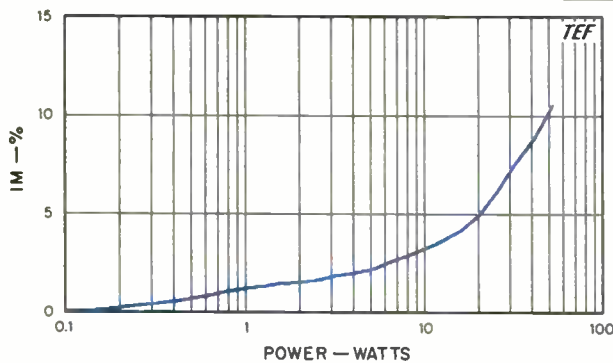
**30 Day No Lemon**

Any problem in the  
first 30 days will be  
repaired within 48  
hours or we will  
replace it with a  
brand new unit.

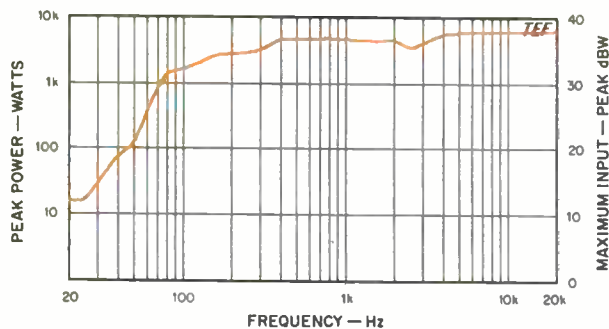
**WDS ★ Wisconsin Discount Stereo ★ WDS**  
**2417 W. Badger Rd., Madison, WI 53713**

- Consistently Low Price
- Fast Delivery
- 10-Day Return Policy
- 30-Day No Lemon
- Widest Selection
- Friendly Knowledgeable Staff

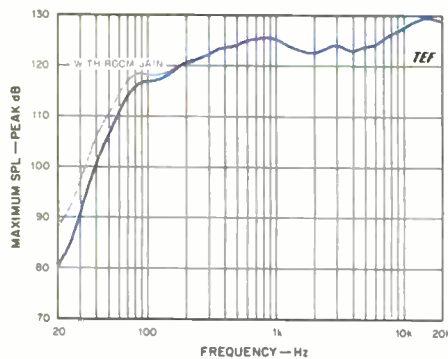
The M907i has good dynamics and lots of bite, along with a smooth bass and realistic presentation of everything from coughs to concertos.



**Fig. 14—IM distortion produced by mixing A<sub>4</sub> (440 Hz) and E<sub>1</sub> (41.2 Hz) in equal proportion; see text.**



**Fig. 15—Maximum peak input power for moderately clean output; see text.**



**Fig. 16—Maximum peak sound output, measured at 1 meter on axis, for the input levels shown in Fig. 15. The curve for room gain shows low-frequency augmentation by a typical**

**listening room. With room gain, the system can generate peak levels in excess of 120 dB SPL at frequencies above 180 Hz and 110 dB SPL above 48 Hz; see text.**

1989 issue of *Audio*, is available from Old Colony Sound Lab, P.O. Box 576, Peterborough, N.H. 03458. I highly recommend it for any serious student of loudspeakers and the subjective evaluation of reproduced sound.)

With room gain, a single system can generate very respectable peak levels, in excess of 120 dB SPL above 180 Hz and 110 dB SPL above 48 Hz. Of course, a pair of these systems, operating with mono bass, will be able to generate levels some 3 to 6 dB higher in the critical low-frequency range. (Read Bert Whyte's "Behind The Scenes" in the June 1990 issue for some very pertinent comments on bass reproduction and the significance of the low-frequency thresholds at 110 and 120 dB SPL.)

### Use and Listening Tests

Listening was conducted in my new listening room. It is fairly large, having a volume of about 3,400 cubic feet. The room is approximately 15½ feet wide, 8 feet high, and 27 feet long. Its floor is carpeted, and it has normal living-room furnishings. The short wall is filled with deep, floor-to-ceiling bookshelves and an equipment cabinet. Listening equipment consisted of an Onkyo Grand Integra DX-G10 CD player, a Krell KSP-7B preamp, a Krell KSA-200B power amplifier, and Straight Wire Maestro interconnects and speaker cables. Most of my listening evaluation was done before the measurements were made on the speakers.

In its two-page instruction guide, Dahlquist presents very general recommendations for positioning the systems. The instructions suggest that the speakers will "perform best with plenty of 'air' around them" and that one shouldn't place them less than 6 inches away from the wall or pack them tightly against furniture. All listening was done with the systems placed on the supplied Model ST-9 stands.

The speakers were placed well out in the room, 6 feet away from the short wall, and separated by about 8 feet. This left a space of about 4 feet from the side walls. The systems were aimed horizontally at my normal listening position so that I was on the midrange/tweeter axis of the enclosure. Most listening took place on the sofa, about 10 feet away.

My initial exposure to the systems disclosed a well-controlled lateral soundstage with good smoothness but with a forward-sounding top end that emphasized instruments having appreciable high-frequency content, such as cymbals or tambourines, and sibilant sounds in the human voice. The high-frequency emphasis bordered on spittiness on such selections as "Bird on a Wire" by Jennifer Warnes on the B & K Pro Audio sampler (CD-4090). However, the elevated high-frequency response of the systems was quite revealing on a number of the selections I auditioned. It was quite easy to become accustomed to the high-frequency lift; it made my reference systems sound dull in comparison!

The systems sounded very clean at all playback levels, with the exception of selections with very high-level, low-frequency content such as the organ version of *Pictures at an Exhibition* (Dorian DOR-90117); few systems can handle this disc adequately! Even with this CD, the systems did a very respectable job on the organ pedal notes at reasonable playback levels. With more contemporary source material—such as rock/pop with high-level, higher frequency bass—the systems did an extremely good job at high levels.

The Dahluists did very well in the areas of clarity, bass response, low distortion, high maximum output, and good time/phase response.

On Bob Mintzer's Big Band disc, *Incredible Journey* (dmp CD-451), the systems exhibited good dynamics, with lots of "bite" on the horns and a smooth bass line. The systems were quite revealing on the recording of Mozart's Piano Concerto No. 13 included in *Midsummer Mozart Festival Orchestra—Live* (Bainbridge BCD-6273). This disc, recorded live with the Colossus system, is very smooth, natural, and realistic sounding. The Dahluists reproduced the occasional live cough and the applause at the end of the last cut with quite good realism.

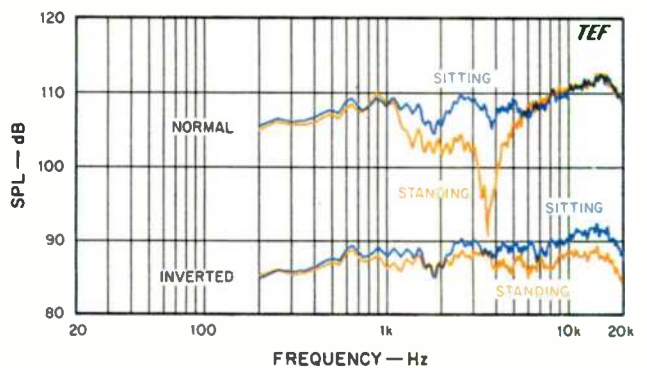
On pink noise, the systems barely passed the walk-around, stand-up, sit-down test to check evenness of coverage. The side-to-side coverage was quite good, but major changes in upper midrange timbre were heard when I moved up and down. In contrast, my reference systems' tonal quality changes very little with changes in listening height.

The measurements showed something that my earlier listening tests could not—that the system had a much smoother response at angles below its center axis than above. I then did a series of listening tests with the systems inverted rather than in the normal configuration, which greatly improved two areas of performance—the rough upper midrange and the boosted high frequencies. Though brighter than the reference when I listened seated, the Dahluist was quite close to the reference when I stood up, so that it easily passed the stand-up, sit-down test when inverted.

These lobing changes and their effects on frequency response are, paradoxically, due to Dahluist's long-standing emphasis on linear phase response. The M907i's curves for phase angle and group delay show far less phase rotation than do those of the NHT Model II reviewed in the July 1990 issue, for example. If you were to reverse the tweeter's polarity, you would get a good deal of improvement in the midrange/tweeter crossover region in an upward direction. This doesn't change the upper bass response, but the phase linearity would suffer. Unfortunately, in speaker design, it's not possible to optimize any one thing without adversely affecting others.

This will become clearer when you look at Fig. 17, which shows unsmoothed response of the system, both upright and inverted, taken at angles corresponding to listeners sitting and standing 3 meters away. (The top set is raised 20 dB for clarity.) These curves were derived from the previous off-axis curves, rather than being new measurements, but they do correspond to what I heard, which is that the speaker is much smoother when it is inverted. For sitting and standing, the regular curves correspond to vertical angles of 0° and +12.5°, respectively, while the inverted curves are for -5° and -15°.

Since woofer height changes when the system is inverted, the upper bass response will change as well, depending on room conditions. In my room, the systems' low end was affected primarily in the range from 80 Hz to 220 Hz by two third-octave-wide dips of 3 to 5 dB. However, this same configuration also yielded much better reproduction of the up and over illusions on the Listening Environment Diagnostic Recording test. (This test is track #51 of the Prosonus *Studio Reference Disc* and track #11 on Chesky Records'



**Fig. 17—Derived frequency response curves for seated and standing listeners with speakers in normal and inverted positions. The curves for the upright speaker position have been raised 20 dB for clarity. The response for standing listeners is considerably flatter with the system inverted; see text.**

*Jazz Sampler & Audiophile Test Compact Disc, Vol. 1, Chesky JD37*). To convincingly reproduce these effects of the LEDR test requires a system that has smooth upper midrange response, particularly in upward directions that contribute to ceiling reflections. With this arrangement, the Dahluist systems also did a particularly good job with the a cappella choir of the Cambridge Singers' disc, *A Portrait of the Cambridge Singers* (Collegium CSCD 500).

To sum up, I have mixed feelings about the Dahluist's M907i speakers. They made very good account of themselves in the areas of innovative enclosure design and cosmetics, bass response, clarity, low distortion, high maximum output, and well-behaved time and phase response but came up short in emphasis of high frequencies and poor vertical coverage. However, inverting the systems removed my objections to the vertical coverage and minimized the high-frequency emphasis somewhat. You definitely need to audition these systems for yourself to decide whether they fit your needs.

D. B. Keele, Jr.

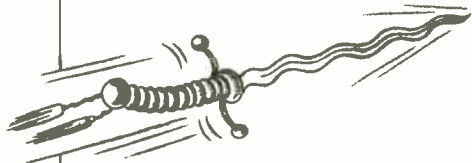
## MANDARIN MIRACLE

**Bartók: The Miraculous Mandarin;**  
**Kodály: Háry János and Dances of Galánta.** Seattle Symphony Orchestra; Gerard Schwarz, conductor.  
**Delos DE 3083, CD; DDD; 72:00.**

This new Delos CD features superbly recorded performances of Kodály's delightful suite from *Háry János* and "Dances of Galánta." Yet the centerpieces are Gerard Schwarz's highly dynamic, gripping, and involving performance of Bartók's controversial ballet *The Miraculous Mandarin* and the truly stunning sonic realism of engineer John Eargle's recording.

Bartók's bloodcurdling *Miraculous Mandarin* was composed in 1918 to 1919 but was not performed until 1926 in Cologne. This ballet takes its place alongside Stravinsky's *Rite of Spring* and Richard Strauss' *Salome* as extremely shocking affronts to the musical and moral sensibilities of the audiences who first heard these works.

In this ballet, thugs hire a prostitute to lure men to their sleazy apartment in order to rob them. The first two victims are penniless, but the third is a rich Chinese mandarin who lusts for the girl. The thugs rob him and then smother him with pillows, but the mandarin doesn't die. Enraged, they stab him repeatedly, but the wounds don't bleed. Then the thugs hang the mandarin from a light fixture, but still he does not die. Appalled by all this, the girl orders the thugs to remove the mandarin from the makeshift gallows and she cradles him in her arms. With



this act of compassion, the mandarin's wounds begin to bleed and he dies peacefully.

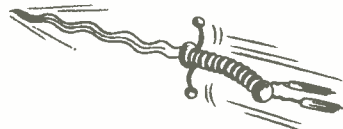
Pretty raw stuff—and violent, to say the least! This is reflected in the score, which fairly crackles with tension, fear-some energy, and awesome dynamic outbursts from the orchestra. The CD recording is indexed, making it easy to follow and access the ballet's episodic development.

It would be something of a cliché to state that the music is fiendishly diffi-



cult. It is that, and more, which makes the wonderful playing and execution of the Seattle Symphony Orchestra even more remarkable. Schwarz deserves great credit for the responsiveness of his orchestra as well as kudos for his unflagging, highly propulsive, and very exciting performance of the *Miraculous Mandarin*—and his fine readings of the Kodály works.

John Eargle's recording may well be his finest ever. The orchestra is strategically positioned in the Seattle Opera House to obtain a warm, natural ambience while allowing the clean orchestral definition so necessary for the complex scoring of Bartók's masterpiece. Instrumental localization is precise and stable. The perspectives of depth are perfectly presented. The often angular, clashing tonalities of the music are clearly delineated. Dynamic



expression is extreme and requires state-of-the-art audio components with great power-handling capabilities to fully appreciate them. There are massive outpourings from the orchestra and huge, brazen crescendos.

There is abundant percussion in the *Miraculous Mandarin*, with considerable emphasis on the bass drum. At index 6, "Mandarin Chases the Girl," fast scurrying figures in the lower strings are followed by more than a minute of repetitive, high-energy, 31-Hz bass drum strokes. At index 7, "Thugs Smother the Mandarin," Eargle has captured six mighty bass drum whacks with such accuracy that you can feel their wavefronts! Following this are a great brazen tam-tam, stentorian chords from trombones, and then organ pedals and bass drum rolls which contribute to a tumultuously terrifying outburst. More orchestral fireworks follow in subsequent sections until, at index 12, a wordless chorus enters to bring some surcease before the piece ends quietly.

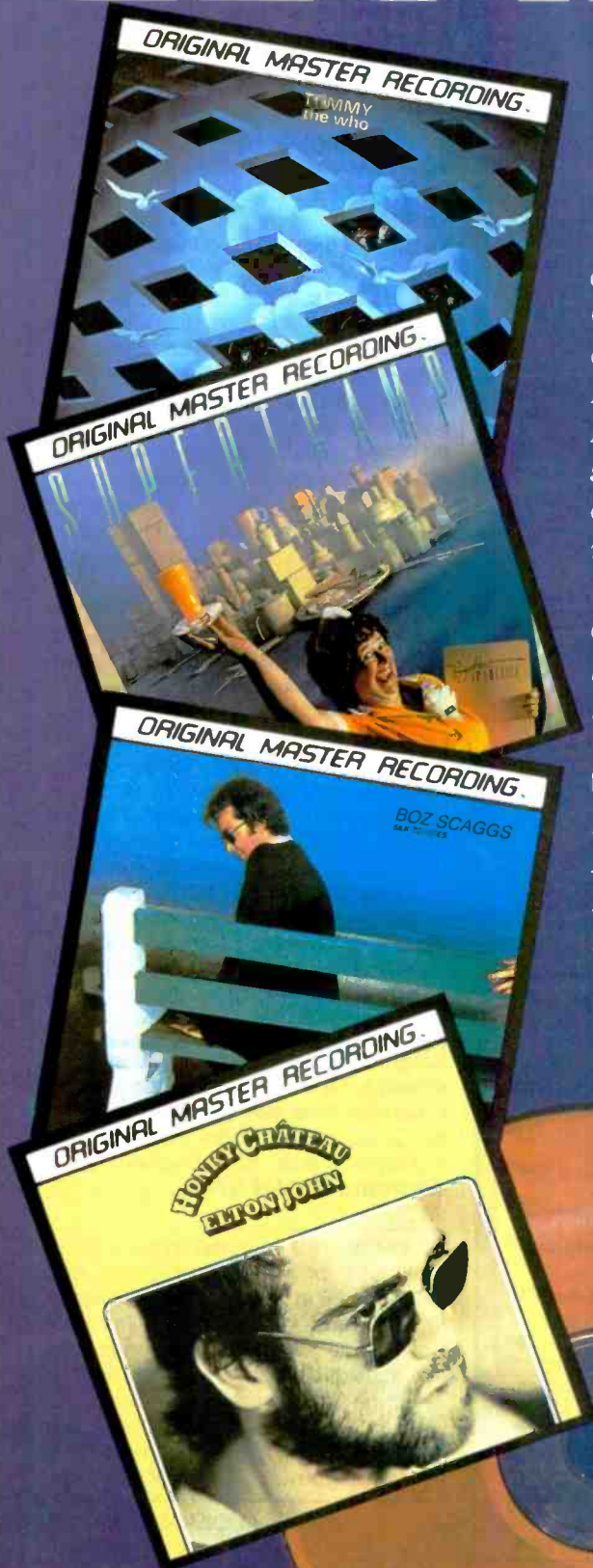
This is truly an amazing feat of recording and makes the *Miraculous Mandarin* an overwhelming musical experience. *Bert Whyte*

Illustration: Rick Tulka



ORIGINAL MASTER RECORDINGS™

# ULTRADISC™



## *The Sound with the Midas Touch.*

*The 24K gold answer in the quest for optimal compact disc reproduction. Original Master Recordings that demand Intelligent Engineering and Proprietary Mastering Technology. Exacting Technical Specifications satisfied by a process that offers a compact disc with the highest reflectivity and enhanced longevity. Current releases on **ULTRADISC**: Jeff Beck, Sting, Rod Stewart, Steely Dan and more. Upcoming releases on **ULTRADISC**: Pink Floyd, The Jefferson Airplane, Harry Nilsson and Miles Davis.*

*The **ULTRADISC**™ is protectively packaged in the "Lift-Lock" jewel box*



For a complete free Original Master Recordings catalog, call toll free: 800-423-5759, or write: Mobile Fidelity Sound Lab, 1260 Holm Road, Petaluma, CA 94954.

Enter No. 17 on Reader Service Card

Benjamin Luxon does so much with the drama and feeling of each song; few singers are so scrupulous in their characterizations.

**Schubert: Die Schöne Müllerin.** Benjamin Luxon, baritone; David Willison, piano.  
Chandos CHAN-8725, CD; DDD; 62:55.

Benjamin Luxon is an intelligent, sensitive, committed singer and a fine

musician. He also possesses a distinctively British voice—which may or may not be a good thing, depending on your taste. His sound is rather reedy and marked by neither steadiness nor opulence of tone, particularly at high output levels. Yet his understanding of, and dedication to, the material he

chooses can disarm any misgivings about his sound.

Whether it will disarm you depends in part on how familiar you are with this song cycle in its many recordings by the master singers of the German school: Hüsch, for example, or (inevitably) Fischer-Dieskau. Actually, there are times when Luxon sounds surprisingly like Fischer-Dieskau. There are far more, however, when he lacks the vocal aplomb that is almost taken for granted among the Germans.

The comparison is invidious because Luxon does so much with the drama and feeling of each song. Few singers of any nationality are so scrupulous in their characterizations. Some songs he sings with beauty by any standard: "Die liebe Farbe" and "Des Baches Wiegenlied" in particular.

The recording, which is perhaps a shade over-reverberant, was made in October 1988 in The Maltings, Snape. That venue naturally suggests Benjamin Britten and Peter Pears, whose many performances there are legendary. I mention this because Luxon reminds me more of Pears' penetrating musical sensibility and very individual projection than his contemporaries.

Very few of Pears' lieder performances were preserved for posterity, unfortunately. In Luxon—and Willison, whose abilities as an accompanist bear comparison to Britten's—we have not only a possible surrogate but a unique and vivid talent whose work deserves the care Chandos has provided. Texts and translations are provided, by the way. *Robert Long*

**Leighton: Concerto for Cello and Orchestra, Opus 31; Symphony No. 3 ("Laudes Musicae").** Scottish National Orchestra, Bryden Thomson; R. Wallfisch, cello; Neil Mackie, tenor.  
Chandos CHAN-8741, CD; DDD; 59:36.

Until this record, I had heard none of the music of Kenneth Leighton, who died in 1988 at the age of 58. I'm eager to hear more. His urgency—his passion—is as rare in modern music as the accessibility of the vocabulary in which he expressed it.

I want to discuss the symphony first because it is the more impressive work and is, moreover, the key to the con-

**STEREO RECEIVERS/TAPE DECKS/EQUALIZERS/HEADPHONES AMPLIFIERS/COMPACT VIDEO RECORDERS/PERSONAL COMPUTERS/SECURITY/VIDEO COMPONENTS/ASSETS/45'S/STEREOS/BLANK AUDIO CAMERAS/BLANK VIDEO CAMCORDERS/VIDEO/COMPUTER SOFTWARE/TELEPHONE BUSINESS MACHINES/TYPENRITERS/HEADPHONES/AMPLIFIERS/COLOR TELEVISIONS/COMPUTERS/BUSINESS**



**Teac X-2000M**  
Open Reel Mastering Deck  
•2-track record/play •4-track play  
•15/7.5 ips tape speeds •DBX noise reduction/expansion •Closed-loop dual capstan drive •Black finish  
Our Low Price **\$999<sup>95</sup>** (TEA X2000M)

**The Bose Acoustimass AM-5**  
Speaker System  
•2 cube speaker arrays provide direct & reflected sound •Acoustimass module gives deep bass •Choose black or white  
Our Low Price **\$749<sup>95</sup>** (BOS AM5 color)

**ADC SS-525X**  
Computerized Graphic Equalizer  
•Custom tailor your sound •Automatic analyzer equalizes room for precise flat response •12 bands/channel •Mic flat noise •Wireless remote  
Our Low Price **\$299<sup>95</sup>** (ADC SS525X)

**dbx 3BX-D5**  
Dynamic Range Expander  
•Increases dynamic range by as much as 50% •Reduces background noise by as much as 20% •Impact restoration adds punch to musical material  
Our Low Price **\$299<sup>95</sup>** (DBX 3BXDS)

**Teac V-670**  
3-Head Stereo Cassette Deck  
•Hear your actual recording as you are making it •2-motor logic transport •Dolby B & C plus HX Pro extension •Fine bias •Black finish  
Our Low Price **\$199<sup>95</sup>** (TEA V670)

**Shure V15 Type V-MRLE**  
Limited Edition Audiophile Cartridge  
•Hand-picked •Lighter specs •Micro ridge stylus •Dynamic stabilizer •Side guard stylus protection •Deluxe wood case & stylus gauge  
Our Low Price **\$189<sup>95</sup>** (SHU V15VMRLE)

**Audio Specials**

**Technics SL-PC33**  
•Compact Disc changer, 5-disc rotary, remote . . . . . **\$249<sup>95</sup>**

**Teac V-970X**  
•Cassette deck, 3-head, Dolby B/C, DBX . . . . . **\$479<sup>95</sup>**

**Beyer DT-880**  
•Headphones, semi-open design . . . . . **\$119<sup>95</sup>**

**Pinnacle PNS+ /Oak**  
•Diaduct-port bookshelf speakers . . . . . Pair **\$149<sup>95</sup>**

**dbx 18XDS**  
•Dynamic range expander . . . . . **\$179<sup>95</sup>**

**dbx 120XDS**  
•Subharmonic bass enhancer . . . . . **\$199<sup>95</sup>**

**dbx SNRI**  
•Noise reduction system . . . . . **\$199<sup>95</sup>**

**Audio Source EQ-10**  
•Equalizer/analyzer, remote . . . . . **\$349<sup>95</sup>**

**Koss JCK-200**  
•Cardless headphone system . . . . . **\$89<sup>95</sup>**

**Audio Specials**

**Audioquest Feet**  
•Sorbothane shock absorbers, set of 4 . . . . . 4-Pack **\$34<sup>95</sup>**

**Teac W-990RX**  
•Double cassette deck, Dolby B/C, DBX . . . . . **\$489<sup>95</sup>**

**Dual CS5000/X3MC**  
•Turntable with Ortolan MC cartridge . . . . . **\$449<sup>95</sup>**

**Celestion DL-1011**  
•Speakers, high-accuracy, 3-way . . . . . Pair **\$600**

**Sherwood AM-7040**  
•Power Amplifier, 200 watts/channel . . . . . **\$399<sup>95</sup>**

**Sherwood AP-7020**  
•Preamplifier, discrete components . . . . . **\$249<sup>95</sup>**

**Sherwood TD-7010R**  
•AM/FM Stereo Tuner, 30 station presets . . . . . **\$129<sup>95</sup>**

**Technics SL-P550**  
•Compact Disc player, 4X oversampling . . . . . **\$249<sup>95</sup>**

**Audioquest CD Feet**  
•4 Sorbothane feet for CD players . . . . . 4-Pack **\$22<sup>95</sup>**

**Audio Specials**

**Monster Cable Interlink Reference 2**  
•Interconnect cable, 1 meter . . . . . **\$89<sup>95</sup>**

**Monster Cable Heavy Duty Footers**  
•Vibration isolators, set of 4 . . . . . 4-Pack **\$79<sup>95</sup>**

**Monster Cable Discus Plus**  
•CD stabilizer disc . . . . . **\$19<sup>95</sup>**

**Pioneer CLD-3080**  
•CD/Laser disc player, remote . . . . . **CALL**

**Audioquest DM-1000**  
•Phono cartridge demagnetizer . . . . . **\$74<sup>95</sup>**

**Sony D2**  
•Portable Compact disc player . . . . . **\$149<sup>95</sup>**

**Panasonic RN-105D**  
•Microcassette portable recorder . . . . . **\$29<sup>95</sup>**

**Maxell MX-90**  
•Metal audio cassettes 10-Pack . . . . . **\$27<sup>50</sup>**

**Sony UX-Pro90**  
•High bias audio cassettes . . . . . 10-Pack **\$22<sup>50</sup>**

**Denon HD8-90**  
•Audiophile high bias audio cassettes . . . . . 10-Pack **\$29<sup>75</sup>**

Enter No. 14 on Reader Service Card

**ORDER TOLL-FREE 1-800-221-8180** Outside U.S.A. 1-718-417-3737  
Order By FAX 24 Hours A Day: 1-718-497-1791

Mail Order Hours: Monday To Friday 8 AM to 8 PM, Saturday 9 AM to 6 PM, Sunday 10 AM to 6 PM  
TO ORDER BY MAIL: SEND MONEY ORDER, CERTIFIED OR CASHIER'S CHECK, MASTERCARD, VISA, AMERICAN EXPRESS OR DISCOVER CARD (Please include interbank No., expiration date and signature.) TO: **J&R MUSIC WORLD, DEPT. AMO890, 59-50 QUEENS-MIDTOWN EXPRESSWAY, MASPETH, QUEENS, NY 11378** Personal and business checks must clear our Authorization Center before processing. Shipping, Handling & Insurance Charge is 5% of Total Order with a \$4.95 minimum. (Canadian Orders Add 15% Shipping, with a \$9.95 minimum charge.) For shipments by air, please double these charges. \$25 MINIMUM ORDER. DO NOT SEND CASH. SORRY, NO C.O.D.'s. NEW YORK RESIDENTS PLEASE ADD SALES TAX. ALL MERCHANDISE BRAND NEW, FACTORY FRESH, AND 100% GUARANTEED. Copyright 1990 J&R Music World

J&R Music World, Dept. AMO890, 59-50 Queens-Midtown Expressway, Maspeth, Queens, NY 11378



At 80, Monet was still gilding his lilies.  
 At 80, Denon is still making musical history.



At 80, Denon is proud of its heritage. Generations of musicians and researchers have contributed to making Denon a leader in the two worlds of recording and re-playing great music.

Eliahu Inbal.

"The music of Berlioz has always been part of my life... Playing the music of a composer in its entirety, making his music live again from A to Z, is a vast and thrilling undertaking. Relations between works that hitherto had remained hidden are discovered. The responsibility of obtaining a fundamental unity, a unity of spirit, is that of the conductor alone."

"You hear with your eyes as well as your ears. If I close my eyes, the instruments are blended and their colors change. In a recording, the microphone compensates for the eye. It 'sees' the stage for you."



## DENON RECORDS

Denon Records are marketed and distributed in the United States by A&M Records Inc.

For complete details (and entry blank) write to "Denon's 80th Birthday Sweepstakes," P.O. Box 118, Hollywood, CA 90078

No purchase necessary. Must be 18 years of age or older to enter.



## WIN A TRIP TO JAPAN!



- Win a 7-day trip for two to Tokyo and Kyoto!
- Win Denon's Deluxe Audio System!
- Share in over 40 additional Hi-Fi-Prizes!

Look for displays and entry boxes at participating record and audio retailers.



System includes infinity speakers.

Kenneth Leighton's passion is as rare in modern music as the accessibility of the vocabulary in which he expressed it.

certo that precedes it both in Leighton's output and on this record. It is a symphony about music, with a part for solo tenor—marvelously realized here by Neil Mackie—using texts by Shelley, Elizabeth Barrett Browning, Sir Thomas Browne, and Leighton. (All of the texts are supplied). Each, in its

way, celebrates music as an affirmation of life—even (as in the adagio finale's Shelley excerpt!) in death.

The centerpiece of the symphony is the Barrett Browning movement, a scherzo based on her poem, "A Musical Instrument." Literally a panegyric, it eulogizes Pan's act in blowing through

the reed to create the first music. Leighton's masterful deployment of harmony, orchestral color, and rhythm adds wonderful sonic dimensions to the verses. The rhythmic relationship between soloist and orchestra often is subtly complex. Though it emerges naturally as an intrinsic part of the expressive language, it could not have been easy to learn.

There are moments—particularly in the setting of Leighton's own poem in the adagio molto introduction—when the prosody is reminiscent of Benjamin Britten. Otherwise, Leighton sings with a voice that is distinctively his own. He doubtless has learned from Walton, Vaughan Williams, and many others, but each element is either assimilated into that unique voice or it is discarded. As his poem says, "O Yes, I must sing/And so must you sing also/For all music is singing/And in music there is praise of life."

Raphael Wallfisch, who seems to be making a career as soloist in modern British cello concertos, is the authoritative protagonist in this one. A vivid and exciting piece, it can match neither the beauty nor the directness of the symphony, and it isn't as distinctive of voice. This isn't surprising, since it dates from 1955-1956, almost 30 years before the symphony. It's a good piece, but the record will be cherished for the symphony's sake.

Bryden Thomson and the Scottish National Orchestra acquit themselves in fine style as usual. The playing is unstintingly committed, but also very accurate and generous of tone. The pickup is exceedingly clean and rather close, with just enough reverberation to keep the space open.

In fact, the only complaint I have about any aspect of the package centers on the art direction. Why choose for the cover that exquisitely silly neo-classical painting in which a morose cherub plays the panpipes? (The only possible connection with the music is Barrett Browning's ode to Pan, and a mighty tenuous one this is when the poem evidently envisions Pan as making something more like a fipple flute.) Further, the headline type is straight *art nouveau*. Viking runes would hardly have been less sensitive to the cultural and stylistic properties of this music.

Robert Long

## ZAPCHORD™

Speaker and Interconnect  
Interface Cables  
from MIT®



After nearly a decade of groundbreaking research and development, Music Interface Technologies now has neutral, noise-free audio cable that is within reach of any audio budget. MIT's new Zapchord speaker and interconnect interface cables "ZAP" the noise with "Zapline" networks and patented termination techniques. Because Zapchord interface cables remove the noise, audio components sound more powerful, dynamic, defined, and detailed than ever before.

HOME AUDITION PLAN  
Visit Your Authorized MIT Dealer

Music Interface Technologies MIT

Transparent Audio Marketing • Rt. 202 • Box 117  
Hollis ME 04042 • Tel • (207) 929-4553 • FAX (207) 929-4271

SPECIAL \$5.00 CD OFFER FROM WINDHAM HILL

# NEW VOICES. NEW VIEWS. NEW MUSIC.



Individually, they are Cliff Eberhardt, John Gorka, Barbara Higbie and Pierce Pettis, four singers & songwriters with debut albums on Windham Hill.

Collectively, they appear on "New Voices," a specially priced Compact Disc featuring selections from Cliff's "The Long Road," Barbara's "Signs of Life," John's "The Land of the Bottom Line" and Pierce's "While the Serpent Lies Sleeping."

New Voices. An eloquent introduction to four compelling, original new artists.

## Special \$5.00 CD Offer...New Voices from Windham Hill

Send a check or money order for \$5. (\$3.75 + \$1.25 shipping and handling) to Windham Hill Records, Box 9388, Stanford, CA 94309. CA, TX and NY residents add applicable sales tax. Allow four weeks for delivery.

Name

Address

City

State

Zip

Daytime phone

Please send complete catalog listing.

## ALL ABOUT ANDY

**Songs for Drella:** Lou Reed/John Cale  
Sire 26140-2, CD; ADD; 54:55.

Sound: B Performance: B+

As Lou Reed and John Cale's careers were launched by Andy Warhol via The Velvet Underground, it is not only fitting that these two pay tribute to him through their music, it is stylistically proper as well. Warhol's main contribution to The Velvet Underground was to provide a perspective on the combination of art and marketing, and Reed and Cale had a keen grasp on Warhol's work ethic. On *Songs for Drella*, these two men sing from Andy's perspective and about Andy from others' (one assumes their own), and the combination—chemistry, some would call it—is very effective on some songs. If the promise of the first five songs was realized or continued in the 10 that follow, this would be a likely contender for album of the year; instead, *Songs for Drella* is more of a curiosity piece.

On songs like "Smalltown" and "Work," one can hear that writing from a new and very specific point of view has benefited Lou Reed greatly. Both lyrically and musically he soars here, conquering fresh territory that is intriguing yet familiar. John Cale has always been musically interesting but lyrically inconsistent, and although all of the songs are credited to both men, one would hope he had something to do with the words on "Style It Takes" and "Trouble with Classicists" because they are two of the best songs he's ever sung. Not since his early '70s classic album, *Fear*, has Cale sounded so ferocious or so sure of his material. Of course, Warhol was quite a character, and as such he provides a perfect launching pad for this tour de force.

However, after the first five songs, the best from either of these two in years, Reed and Cale seem to have rushed through the rest without

the care and consideration given to their opening numbers. The episodic characterizations don't have nearly the interest or power of the songs in which Cale and Reed simply speak the gospel according to Andy Warhol. If this were a staged musical, which these songs would lend themselves well to, it would be praised for having a brilliant first act but nothing to follow it up. It's nice to know that these two rockers can work together so well after so many years apart. The music is presented in stripped-down, guitar/voice/piano form that serves the material well, but it would be so much more satisfying if *Songs for Drella* were solid throughout. It could have been a flawless EP.

Jon & Sally Tiven

**Heart of Uncle:** 3 Mustaphas 3  
Rykodisc RCD 20156, CD; ADD;  
60:03.

Sound: B Performance: A

If international music constitutes the next course of aesthetic experimenta-

tion for listeners who have lost their taste for the staples of the American pop music diet, 3 Mustaphas 3 can serve as the perfect entrée. Manic virtuosos of the weirdest amalgam of regional musics imaginable, the group has been for several years at the front of a movement that is revolutionizing our ideas about international music, demolishing the notion that it is defined by elderly men who stumble through polkas on accordions in VFW halls. *Heart of Uncle* is a high-energy collection that includes music composed for a Hindi film soundtrack, a Nigerian juju pop song, a Balkan shepherd's ballad, a Greek drinking song. . . .

The 14 songs aren't really museum pieces that merely exemplify the traditions they embrace. Nor are they simply a hodgepodge of cultures and instruments tossed in a blender at high speed. The clever manipulation of such disparate ingredients from song to song produces in each case a unique creation to savor like a post-Impressionistic collage. Listen to

"Sitna Lisa," for example, a spritely tune that is accompanied by electric bass, tambura (an Asian string instrument resembling a fretless lute), dumbek (a Middle Eastern drum), and conga (a Caribbean drum that originated in Africa). In the midst of this already eclectic treatment of an Eastern European folk song, a string trio suddenly breaks in to restate the melody in the style of the 18th century. Another traditional song, "Vi Bist Du Geveyzn Far Prohibish'n," arranged with bouzouk, banjo, piano, woodwinds, and tabla (a small drum often heard in Indian ragas), comes across like a score for a chase scene in a surreal, futuristic cowboy movie.

It doesn't much matter that most of the lyrics are in languages we may not understand (Kiswahili, Macedonian, Hindi, Greek, French, and Spanish); all the emotions are there—



# AUDIO ON-SALE AT THESE FINE STORES

## AUDIO DEALER LISTING

### ALABAMA

Huntsville  
Audio Video Lab.  
2801 Newby Rd.

### ARIZONA

Douglas  
DM Electronics  
929 G. Ave.

### ARKANSAS

Paragould  
Sound Choice  
1605 W. Kings Hwy

### CALIFORNIA

Salinas  
Bay Video & Stereo  
1168 S. Main

Pomona  
Dr of Audio  
575 7th Ave

Calexico  
Seiki Stereo  
700 Imperial Ave.

Modesto  
CD Exchange  
435 McHenry

Los Angeles  
Henry Audio  
2050 S. Bundy Drive

Mountain View  
Sound Goods  
391 S. San Antonio Road

San Diego  
Stereo Design  
9353 Clairmont Mesa Blvd.

### COLORADO

Grand Junction  
The Sound Shop  
528 South Tejon  
636-1684

Boulder  
Listen Up Inc.  
2034 Avapahoe Street

### CONNECTICUT

Waterbury  
Zinno Music Inc.  
195 Meriden Rd.

Hartford  
New York Sounds  
624 Wethersfield Ave.

### FLORIDA

Tampa  
Audio Visions  
14306 Dale Mabry Hwy. N.

Altamonte  
Sound Advice Orlando-Two  
455 W. State Road 436

Sound Advice Coral Gables  
1222 S. Dixie Hwy.

Dania  
Sound Advice  
1901 Tigertail Blvd.

Hialeah  
Sound Advice Hialeah  
6490 W. 20th Avenue

N. Miami Beach  
Sound Advice Miami Beach  
1595. N.E. 163rd Street

Sunrise  
Sound Advice Sunrise  
2200 N. University Drive

Boca Raton  
Sound Advice Boca Raton  
444 N. Federal Hwy.

Tampa  
Sound Advice Tampa One  
625 N. Dale Mabry

Sound Advice Tampa Two  
1102 E. Fowler Ave.

Sarasota  
Sound Advice Sarasota  
6307 S. Tamiami Trail

Orlando  
Sound Advice Orlando One  
4835 E. Colonial

Ft. Lauderdale  
Sound Advice Ft. Lauderdale  
4008 N. Federal Hwy.

Hollywood  
Sound Advice Hollywood  
5951 Hollywood

Miami  
Sound Advice Kendall  
13915 S. Dixie Hwy.

W. Palm Beach  
Sound Advice W. Palm Beach  
2275 Palm Beach Lakes Blvd.

Clearwater  
Sound Advice Clearwater  
1451 US Hwy 19 South

St. Petersburg  
Sound Advice St. Petersburg  
2925 Tyrone Blvd.

### GEORGIA

Atlanta  
Stereo & Video Designs Inc.  
6300 Powers Ferry

### ILLINOIS

Rockford  
Absolute Audio  
4227 Maray Dr.

Bloomington  
Lasers Edge  
512 IAA Dr.

### INDIANA

Bloomington  
Campus Audio  
413 E. Kirkwood Ave.

Portage  
Who's Your Entertainment  
P.O. Box 22

Huntingburg  
Audiosource Electronics  
322 W. 4th

### KANSAS

Wichita  
Advance Audio  
5507 E. Kellogg

### LOUISIANA

Baton Rouge  
Art Colley's Audio Specialists  
711 Jefferson Hwy

### MARYLAND

Lutherville  
Gramophone Ltd.  
1081 Tony Drive

### MASSACHUSETTS

Northhampton  
Sound & Music Inc.  
Millbank Place 351  
Pleasant Street

Plymouth  
PM Systems  
20 Court St.

### MICHIGAN

Grand Rapids  
Electronic Sound Equip Co.  
2249 Division S

Dearborn  
Little Professor  
22174 Michigan Ave.

Rochester  
Rochester Book Center  
1410 Walton Blvd.  
Rochester Hills Plaza

### NORTH CAROLINA

Greenville  
Todd's Stereo Center  
105 Trade

Durham  
CD Superstore  
5410 N. Highway 55

### NEW HAMPSHIRE

Concord  
Audio of New England  
31A S. Main

### NEW JERSEY

Vincetown  
Sound Waves  
RD 10 RT 206

Bloomfield  
Sound Reproduction  
237 Bloomfield Ave.

Verona  
Audio Connection  
615 Bloomfield Ave.

North Plainfield  
Stereo City  
950 US Hwy 22

Livingston  
Metro Media Design Inc.  
15 Tarlton Dr.

Morris Plains  
J.S. Audio  
643 Speedwell

Plainsboro  
Sound Ideas  
Princeton Meadows  
Shopping Center

### NEW YORK

Liverpool  
Audio Excellence  
4974 Alexis Drive

Hartsdale  
Stereo Depot  
155 S. Central Ave.

Montauk  
Montauk TV Service  
Main Street

Orchard Park  
Stereo Chamber Inc.  
Union & Orchard Pk. Rds

Roslyn  
The Discriminating Bar  
at the Harborview Shoppes  
1518 Old Northern Blvd.

New York  
Stereo Exchange Inc.  
194 Mercer Street

Merrick  
Performance Audio Svc.  
2064 Sunrise Hwy

Lake Grove  
Audio Den Ltd.  
Smith Haven Plaza  
2021 Nesconset Hwy

Hicksville  
Avtronics Ltd.  
260 Old Country Road

Rochester  
Paul Heath Audio  
217 Alexander Street

### OKLAHOMA

Oklahoma City  
Contemporary Sounds  
10327 North May Ave.

### OHIO

Westerville  
Audio Horizons  
20 Westview Dr.

Warrensville Hts.  
Hoffmans House of Stereo  
23031 Emery Road

### PENNSYLVANIA

Fairless Hills  
Audiolab Stereo Center  
500 Lincoln Hwy.

Hermitage  
Sounds Good To Me  
2481 E. State

### SOUTH CAROLINA

Columbia  
Sound Advice  
2821 Ashland Rd.

### TEXAS

Dallas  
Omni Sound  
4833 Keller Springs

Houston  
Soundscape  
2304 Portsmouth

Home Entertainment  
2617 Bissonnet

San Antonio  
Auto Sec & Sound Systems  
6893-2 Bandera Rd.

Corpus Christi  
Audio Video Designs  
4904 S. Staples

Laredo  
Audio Systems Inc.  
4500 San Bernardo

McAllen  
Showery Stereo  
320 S. 10th

### VIRGINIA

Danville  
Aeolian Svcs.  
215 Main Street

Newport News  
Go-Ho Auto Audio  
10817 Warwick Blvd.

### WASHINGTON

Seattle  
Definitive Audio  
6017 Roosevelt Way N.E.

San Diego  
Stereo Design  
9353 Clairmont Mesa Blvd.

### WISCONSIN

Greenbay  
HI-FI Heaven  
1917 S. Webster Ave.

Dealers interested in Audio should call 1-800-221-3148

3 Mustaphas 3 have acquired an impressive grasp of many musical styles and a facility for authenticity.



nuances of longing, joy, idealism. Vocalist Lavra Mustapha has a powerful voice that can be plaintive or playful; she is equally at home portraying a mournful Macedonian peasant or a sassy, streetwise seductress.

The more you try to find out about the band from liner notes and press

releases, the less anything about them is certain. The photograph of the group on the CD booklet makes them resemble some forgotten cast of *Saturday Night Live*. Are they really a family group? Why do they claim to hail from the mythical town of Szegehely? Did they actually defect from somewhere by smuggling themselves into England in refrigerators? One should not be tormented by the contrived mysteries of 3 Mustaphas 3, however, as they serve an important purpose. Obscuring facts about the group, their backgrounds, and their process of creation keeps us from pigeonholing them. It should be enough to know that the core members have acquired a grasp of many styles of music and a facility for authenticity that contains a ton of enthusiasm for whatever they make with it.

Susan Borey Sherman

# WHAT MAKES The Absolute Sound UNIQUE?

*Some Things You Can't Get  
from Any Other Magazine*

**How To Get** the Most out of Your Stereo System (whether it costs two or twenty thousand) ... How To Find (new or used) Analogue Recordings ... Understanding component interactions and how to minimize them ... The effects of room acoustics on your speakers and how to finesse the problems ... Who today's brilliant maverick designers are and how they are tackling audio's most persistent distortions ... The very best sounding super discs, analogue and digital ... Equipment reviews written by people who love music ... A sonic survey of the best Living Presence and Living Stereo discs ... and today's CD re-issues ... The scoop on oldie goldie components from the Classic Era of American audio (the late '50s and early '60s) ... What's wrong, in theory and in fact, with contemporary digital encoding ... Can digital ever be made as accurate and as musically truthful as analogue? ... How loud music is destroying our hearing ... Who's making excellent LPs today—and why ... The only great rock-and-roll reviews in any audio magazine (and we tell you how they sound and why they sound that way) ... The magicians behind the old Mercury, RCA, and Decca/London recordings and how they made their magic ... And a constant reminder: The meaning of music and how to listen to it ... **HP himself ... and, of course, the truth.**

**Subscribe now** for six issues for just \$34.95, using our toll-free number. We'll bill you. If you're not completely satisfied, just write "cancel" on your invoice and return it to us. You keep your first issue and owe nothing! Yes, we are that sure that if you start reading *The Absolute Sound*, you won't ever want to stop.

Offer good only in North America and for new subscribers

## the absolute sound®

Call 9am-6pm ET, Mon-Fri, at 800-222-3201 or 516-671-6342. Or mail this ad with your name and shipping and billing address to P.O. Box L, Sea Cliff, NY 11579

Enter No. 27 on Reader Service Card

DIAAUO

**Ah Via Musicom:** Eric Johnson  
Capitol CDP 7 90517 2, CD; ADD;  
40:49.

Sound: A Performance: A

Like some distant star traveller landing his ship before a crowd of highly expectant illuminati, "Ah Via Musicom" slowly descends into aural range, accompanied by the hum of hyperdrive engines, the bleeps of controls, a choir of synthetic angels. From out of the mix of backward tape effects and resonances of Jimi Hendrix emerges a solo guitar line which transforms into a jumping, soaring, almost country-jazz instrumental ensemble romp. Welcome back, Eric Johnson.

*Ah Via Musicom* is a tour de force of both guitar playing and studio patience (a year and a half to produce). On this, his second album, Johnson, from Austin, Tex., plays a mix of instrumentals and vocals (he needs a singer if he's going to continue with these) that range from straight-ahead country rock ("Steve's Boogie") and distorted ZZ/Texas Boogie ("Righteous") to gentle ballads ("Forty Mile Town") and solo acoustic fingerpicking à la John Renbourn ("Song for George"). On "East Wes," Johnson shows off Montgomery-style octaves and jazz chords. Hendrix is everywhere, in phrases, in effects, in the soul.

While Johnson can rock hard and blow off the sure-fingered runs with the





Eric Johnson can rock hard and blow off sure-fingered runs with the best of them, but this isn't heavy metal.

Black Crowes use keys, provided here by Chuck Leavell, who toured last year with The Stones. However, The Black Crowes are no mere clone. What elevates them is how very well they play, the excellent songwriting of the Robinson brothers, and the spirit of raw fun all through the album.

Only partly joking, a close friend of mine called *Shake Your Money Maker* the best Rolling Stones album The Rolling Stones never played on. I'll buy that. And I'll add my strong endorsement as well.

Play this sucker loud!

Michael Tearson

best of them, this isn't heavy metal. The feeling here is softer, with an emphasis on tasteful playing and balanced composition, on exceptional concern for tonal variety and control. Johnson uses some excellent backing musicians, but mostly—as producer, writer, guitarist, and singer—this is his show.

Perhaps no other guitarist has achieved such an enormous reputation with so little recorded output and almost no touring. Speak to an aficionado, and Johnson's name will be hallowed. Whether that's justified or not, *Ah Via Musicom* is not his *Electric Ladyland*. Still, it is a mighty pleasing record; keep your eyes and ears on Eric Johnson.

Michael Wright

**Shake Your Money Maker:** The Black Crowes

**Def American 24278-2**, CD; AAD, 45:10.

Sound: B Performance: B+

This is one terrific rock 'n' roll album. Nothing real progressive or strange. Just some damn fine, down-the-line, bluesy rock.

The Black Crowes' lineup is Chris Robinson singing, Young Rich Robinson and Jeff Cease on guitars, Steve Gorman on drums, and Johnny Colt on bass. That makes two guitars plus bass, drums, and a frontman—the same as The Rolling Stones. And like The Stones, to flesh out the record The

**HPC**  
HELICAL PLANAR COPPER

**CPC**  
CO-PLANAR COPPER

Over two years ago the staff at Madrigal Audio Laboratories began accumulating convincing evidence that solid conductors of rectangular cross-section would do a better job of carrying musical signals. Years of listening and engineering tests making use of ribbons of specially processed, high-purity copper with teflon insulation and the highest quality terminations, have resulted in the new Madrigal HPC and CPC cables.

Visit your Madrigal dealer and hear what these original designs can do to improve your music system.

HPC and CPC cables are designed by, and manufactured exclusively for  
**Madrigal Audio Laboratories**, P.O. Box 781, Middletown, CT 06457 ITT TLX 4942158

## MIDNIGHT JOURNEY



**Round Midnight:** Sir Roland Hanna  
**Town Crier TCD 513**, CD; DDD; 51:16.

Sound: A- Performance: A

I tend to think of Roland Hanna in like context to Randy Weston: They're both extremely versatile pianists who project an enormously stately, almost intimidating presence. This date, *Round Midnight*, preserved more than two years ago but not issued until recently, captures Hanna at his best—solo, incorporating myriad styles which range from the European impressionistic tradition to turn-of-the-century ragtime, from blues to bop.

This is an exquisite undertaking, a majestic journey through time. Pacing, delivery, and finely and atypically delivered passages abound. The album's title track, under many circumstances these days, often arrives hackneyed, rushed, and in taken-for-granted fashion. Not so here, where Hanna spends as much energy delicately veering off the beaten path as he does presenting the haunting but evocative melody.

Hanna's "big piano" sound commands attention. Full-bodied, properly nourished, and carefully tended to originals, such as his far-reaching "Let Me Try" and the slightly Hancockian "A Story Often Told, Seldom Heard," ooze with texture and feeling. You can't help but be drawn in. The same for his "Astral Essence."

While much of Hanna's strength lies in his ability to create, harness, develop, and successfully express the need for pensive solitude, he is not without a sense of the raucous or a sense of wit and humor. Such is the temperament in the freewheeling "Blues," another original that, with its stride-like orientation, recalls the days of James P. Johnson and touches on boogie-woogie and the likes of Meade Lux Lewis and Albert Ammons. Further testimony to this is his properly embellished and exaggerated Fellini-esque "Century



Rag" and his "Mediterranean Seascape," with its march-like tendencies.

It's worth noting, for it underscores this pianist's great but understated—and perhaps underestimated—diversity, that in addition to writing seven pieces, Hanna chose to interpret four works. These are the aforementioned title track; an adaptation of "Prelude," which is a piece originally conceived for solo cello; a crisp, boisterous, three-minute reading of Sonny Rollins' "Oleo," and finally, Duke Ellington's "In a Mellow Tone," which closes out the set. Roland Hanna's ability to improvise comfortably within each of these varied expositions only emphasizes his depth as composer and musician.

Jon W. Poses

**Jumpworld:** Cassandra Wilson  
**JMT 834 434-2**, CD; ADD; 50:29.

Sound: A Performance: A-

The balance between the arty and the popular, between precious inaccessibility and pandering accessibility, is precarious. On her fourth album, vocalist Cassandra Wilson has managed to produce music that's warm and sensuous, generous in its optimism yet bleak in its social critique, without exclusivist or vacuous pretense—a feat in itself. *Jumpworld* combines the genteel romanticism of Wilson's acclaimed renditions of standards on *Blue Skies* with that of the more streetwise sci-fi funk of the M-Base group, of which she is an important figure. In plain terms, Wilson comfortably swings from Betty Carter-like love songs and deep, throaty scatting reminiscent of Aminata Moseka (Abbey Lincoln) to the odd meters of intricately layered vamps. Her voice exudes a bittersweet edge that contrasts rudely with the ethereal quality of the music.

Yet it's conflict that gives *Jumpworld* its sometimes ominous momentum, as on the caustic blues "Domination Switch," where Wilson growls out a condemnation of such public relations piffle as "a thousand points of light." Wilson rejects the fruits of the fat cats for a melody that sounds like a smoother, funkier arrangement of Muddy Waters' "I Just Want To Make Love To You." Joined by numerous guest composers and/or soloists, such as saxophonists Steve Coleman, Greg Osby,

# ELEKTRIFYING!



Available on  
Compact Disc,  
HQ Cassette  
and Records  
©1990 GRP Records

THE  
DIGITAL MASTER  
COMPANY

A virtuoso performance and artistic  
explosion from the Chick Corea Elektric Band.  
Dave Weckl, John Patitucci, Eric Marientho,  
and Frank Gambale.

Also available on GRP Music Video and Pioneer VideoDisc

Enter No. 12 on Reader Service Card

# AKG's K280 Headphones for the Digital Era

Now that you've upgraded your system to include CD technology, your headphones must meet a higher standard.

That's why you need AKG's high output, parabolic stereo headphones.

The K280 features a computer-positioned pair of matched transducers in each ear cup to provide transparent, interference-free sound at the center of your ear.

AKG headphones are world-renowned in the professional digital recording industry, as backed by a recent *Billboard* survey\* rating AKG headphones the most widely used in U.S. professional recording studios.

AKG's K280 headphones. The standard of quality for the digital era.



Focusing on new technology.  
1525 Avenida St., San Leandro, CA 94577  
[415] 351-3500

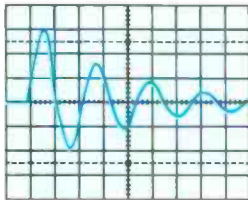
\*Billboard's 1990 International Recording Equipment & Studio Directory, Oct. 1989  
© AKG 1990 © Akustische und Kino-Geräte GmbH, Austria

## Introducing the MultiCap™ High Performance Capacitor

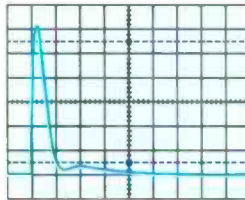
Few people know capacitors as well as Richard Marsh. He has now patented a new design uniquely suited to the demands of high definition audio and produced it with the help of Music Interface Technologies.

The MIT MultiCap eliminates the need for additional bypass capacitors, and, as the following graphs show, has considerably less oscillation than conventional designs.

Uncontrolled impulse response of typical film capacitor.



Controlled impulse response of the MIT MultiCap.



The result is more focused sound throughout the critical midrange and fewer compression effects at frequency extremes.

**Music Interface Technologies** 

For more information, including a detailed white paper, please contact:

**TRANSPARENT AUDIO MARKETING**  
Rt. 202, Box 117, Hollis, Maine 04042 (207) 596-7151

and Gary Thomas, trombonist Robin Eubanks, and trumpeter Graham Haynes, Wilson and her quartet weave sinuous jams that are filled with squirming solos and percussive comping. Nonetheless, songs like "Jump World," which is a celebration of unity in rhythm with rap breakdown, are still light and airy despite the detail. Actually, much of the album is a lot like trying to touch a cloud. There's a great deal of beauty and many pleas for compassion, but it's not tangible, at least in the sense that Wilson fails to offer concrete solutions to the problems she addresses. Both lyrically and musically, *Jump-world* implies more than it states, which makes the album all the more tempting for the fleeting impressions it leaves.

Don Palmer

**Blues on the Range:** Roy Rogers  
**Blind Pig BP73589**, CD, AAD, 43:04.

Sound: A Performance: B+

Aficionados of that particularly human-sounding whine of a slide guitar might want to check out California maestro Roy Rogers. His third album, *Blues on the Range*, takes you through a set of mostly original instrumental and vocal tunes, stopping here and there to drop a classic cover.

Rogers, an unassuming man with a self-deprecating grin, is quite accomplished in the slide area, specializing primarily in blues- and roots-oriented music. His playing is clean and expressive, at times reminiscent of Ry Cooder. Perhaps the songs best demonstrating his technique are the acoustic cover of Muddy Waters' "Baby, Please Don't Go" and his own electric "Dreamin' at the Juke." For a taste of Delta, try the cover of Robert Johnson's "Hellhound on my Trail." Rogers steps out of the blues mode slightly on the very fine "Spanish Blues," the album's highlight. Although his voice probably isn't the best suited for blues, he sings with feeling, so it's not objectionable. Those of you with long memories might want to note that piano and accordion are played by Mark Naftalin, a veteran of the original Paul Butterfield Blues Band.

Roy Rogers' *Blues on the Range* is a swinging set of slide guitar and blues 'n' roots.

Michael Wright

# BREAK AWAY FROM HIGH PRICES

A Tradition of Trust and Service



**Ace of Harps:** Charlie Musselwhite  
Alligator ALCD 4781, CD; AAD; 44:19.

Sound: B+ Performance: B+

Once upon a time, blues harp-blower Charles Musselwhite III was a screaming force of nature, an heir apparent to the legendary little Walter Jacobs. Few rivals could approach his dizzying solos of the late '60s. One day, the albums became disappointing, the live dates were worse still, and he sank with barely a ripple into the nether world of soon-to-be has-beens. He's back—thinner, looking healthy, and with the bad times seemingly behind him. The best news? He's as good as ever.

*Ace of Harps* (no point in false modesty) is mostly vintage Musselwhite. His group is a harp-player's band, unapologetically modelled after the small units that burned behind Little Walter. Rhythm and drive are everything, lyrics a quick afterthought. No tricky changes or stop-time breaks for these guys. The band plays as if it's two hours late for a pressing appointment, while Musselwhite nimbly manages to stay in control with soaring, full-bodied solos. His fluid technique is consistently dazzling, built around signature figures that inspired Magic Dick, James Harman, and a generation of harp players. If his casual singing remains only passable at best, give him credit for long ago accepting his voice's limitations.

When faced with a song structured around a definite rhythm and tune, such as Brook Benton's "Kiddeo," he is at his best. His solo stretches over several choruses, each one a unique variation on the melody, but every one pure Musselwhite.

Even though Musselwhite has been supported in the past by such stellar guitarists as Robben Ford and Tim Kaihatsu, his interplay with Andrew Jones, Jr. has the makings of a timeless partnership. Jones' rhythm work on "Mean Ole Frisco" is more intricate and effective than most players' solos, while his leads seamlessly incorporate modern ideas into a traditional framework.

*Ace of Harps* proves that "legendary" is not always a euphemism for over the hill. Charlie, we missed you. Welcome back.

Roy Greenberg

## PROTON

Clearly the Best

AA1150  
Stereo Power Amplifier  
•50 watt/ch  
•Protection Circuitry  
•Dynamic Power on Demand  
•Dual Mono Construction

NEARLY  
1/2 PRICE  
ONLY  
**\$299**

## VCR Super Savings

•JVC HRS-6600U HRD850U  
•Hitachi VT-F430A HIFI with P-N-P  
•Toshiba SV-F990 CALL FOR BRANDS  
•Philips VR6995A NOT LISTED

## BBE

**\$179**



"...The most hearable advanced in Audio Technology since HI FIDELITY ITSELF!"

Laurence Henry, Music Connection Magazine

a/d/s/

•CM5, CM6, CM7  
"Specials"  
•"The Atelier System Components"  
are on sale L9E, L8E, L7E, M12  
R4, PA4, CC4, CD4, C4 and C2/3



PROTON  
VT-331  
Product of  
the Year



Hitachi  
800 Lines of  
Resolution  
IN STOCK  
MITSUBISHI



Audio-Dynamics  
CD-2000E  
•Remote Control  
•4X Over Sampling  
•3 Laser Beam  
as they last **\$199**



dbx 500XR  
Audio/Video  
Program Route Selector  
• Full function remote  
**\$399**

## BIGGEST SELECTION OF IN-WALL SPEAKERS CALL FOR BRAND NAMES

★ TERK FM Antennas as low as  
**\$1995**

## HAFLER

DH100 Preamp **\$149**  
DH120 Amp **\$275**  
DH500 Amp **\$499**  
DH110 Preamp **\$324**  
DH330 Tuner **\$289**



Other Models Available

## PHILIPS CD/VIDEO PLAYER

OTHER PHILIPS MODELS  
CD80, CD60, CD840, CDC875, CD50 and CD40



CDV 487  
BELOW ORIGINAL COST GIVEAWAY

## dbx Package

BX3MKII, CX3MKII, TX3MKII  
800 watt amplifier with digital dolby pre-amp and schortz tuner

**\$1995**

## SAE

A502 Amplifier  
P102 Preamp  
T102 Tuner  
C102 Cassette  
D102 CD Player  
**LOW PRICE**

## SUPER SYSTEM SPECIAL

200 Watts FROM THE MAKERS OF dbx  
• 200 watts Integrated amplifier  
• Remote control  
• Schortz tuner  
• CD Player

**\$699**

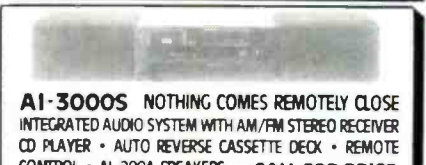
100 Watt System W/ 5 Disc Carousel  
• 28-Key A/V unified remote control unit w/ volume control  
• Top loading rotary compact disc changer

**\$499**

## Audio Source

•EQ10  
Computerized Graphic Equalizer  
Spectrum analyzer with auto control EQ and remote control  
**\$299**

•LLC1  
Compact Disc Lens Cleaner  
A must for every CD player  
**\$2495**



AI-3000S NOTHING COMES REMOTELY CLOSE  
INTEGRATED AUDIO SYSTEM WITH AM/FM STEREO RECEIVER  
CD PLAYER • AUTO REVERSE CASSETTE DECK • REMOTE CONTROL • AL-200A SPEAKERS CALL FOR PRICE

## dbx Dynamic Savings

SX10 Video Sound Impact Restoration **\$50**  
SX20 Video Sound Dynamic expander **\$50**  
1 BXDS Dynamics Range Expander  
3 BXDS 3-Band Expander  
120XDS Subharmonic Synthesiser  
Other Models: 224, 228, SNR1

CALL FOR PRICE

Nobody was ever sorry for buying the best!

Not responsible for typographical errors

Pictures are for demonstration only

SoundCITY INC.  
**201-838-3444**  
-the only number you'll ever need!

Meadow Shopping Center  
Route 23  
Kinnelon, NJ 07405  
Hours Mon-Fri 10-9/Sat 10-6

Ship UPS and Federal Express

Visa / MC / Amex  
Diners / Discover

Naked City is a collection of jazz and rock renegades who, in the slice-and-dice Ginsu music of John Zorn, are really in their element.



**Naked City: John Zorn**  
Elektra/Nonesuch 979238-2, CD;  
AAD; 55:14.

Sound: B — Performance: A

Naked City has been John Zorn's principal live performance unit for the last two years. It's a collection of jazz

and rock renegades who bend the forms of their own genres, but in the slice-and-dice Ginsu music of John Zorn, they are really in their element. This CD doesn't quite capture the power and the sheer exhilaration of never knowing where the music will turn, which this group brings to a live concert, but it comes close.

Zorn is a musical eclectic. He'll never stay in one genre or mood for long, jumping maniacally from jazz to country & western, free-form or hard-core within seconds.

Zorn continues his love affair with film music, covering Ennio Morricone's "The Sicilian Clan," Jerry Goldsmith's "Chinatown," and a supercharged version of John Barry's "The James Bond Theme." In many ways, Zorn is like a film composer, establishing mood and atmosphere with his music. Only he needs just 10 seconds to do it.

He also pays homage to Ornette Coleman, with a rock reading of his "Lonely Woman." The rock comes from Fred Frith, who plays the bassline to Roy Orbison's "Pretty Woman" instead.

Zorn's originals are a mix and match, from the opening fury of "Batman," which steals the bassline to the TV theme, to the '50s-style dance rock of "Latin Quarter" interpolated with waltzes, C & W breakdowns, and total blow-outs. He loves violence in his music, and if the sound isn't enough, the grotesque images on the cover will push most of us over the edge.

Keyboardist Wayne Horvitz seems to find the right sound and backing at a moment's notice. Joey Baron is a well of rhythmic invention who careers around the solid bass playing of Frith. And Bill Frisell redefines the electric guitar every time he plays a note. Vocalist Yamatsuka Eye, who shrieks and gurgles on several of the seconds-long tracks on the record, is like another sound that Frisell or Horvitz might twist out of their instruments.

Like his previous album, *Spy Vs. Spy*, Zorn has opted for a simple open-miked sound that would have worked well in the energy of a concert, but in the studio he could have done even more to realize *Naked City's* assaulting power. Nevertheless, *Naked City* is a potent, electrifying document.

John Diliberto

## Where to buy Polk Speakers

### AUTHORIZED HOME DEALERS

CANADA Call Evolution Technology, Toronto for nearest dealer 1-416-847-8888  
**AK Anchorage:** Magnum Electronics • Fairbanks: Hoff's  
**AL Birmingham:** Audition • Huntsville: Sound Distributors • Mobile: Hi Fi Zone • Montgomery: The Record Shop • Tuscaloosa: Kincaid Stereo & TV  
**AR Ft. Smith:** Stereo One • Little Rock: Leisure Electronics • Searcy: Softmart  
**AZ Phoenix/Yuma:** Hi Fi Sales • Tucson: Audio Emporium • Mesa: Warehouse Stereo  
**CA Bakersfield:** Casa Moore • Campbell: Sound Goods • Canoga Park: Shelley's • Chico: Sounds By Dave • Corona Del Mar: Pacific Coast Audio Video • El Toro: Genesis Audio • Escondido: Sound Company • Eureka: Eureka Audio Video • Lancaster: California Soundworks • Long Beach: Audio Concepts • Mountain View: Sound Goods • Napa: Futurvision • Pannogrove: California Stereo • Redondo: Systems Design • Riverside: Signalcraft • Sacramento: Good Guys • San Diego: Sound Company • San Francisco & Suburbs: Good Guys • San Gabriel: Audio Concepts • San Jose: Good Guys • San Luis Obispo: Audio Ecstasy • Santa Barbara: Creative Stereo • Santa Cruz: Sound Wave • Santa Maria: Creative Stereo • Santa Monica: Shelley's Stereo • Stockton: Gluskins • Thousand Oaks: Creative Stereo • Upland: Audio Haven • Ventura: Creative Stereo • Visalia: Metro Stereo • Westminster: Videotek Stereo  
**CO Boulder:** Soundtrack • Colorado Springs: Sunshine Audio • Denver & Suburbs: Soundtrack • Glenwood Springs: Stereo Unlimited • Grand Junction: Sound Company • Minturn: Custom Audio Video • Pueblo: Sunshine Audio  
**CT Danbury:** Carlson's • Fairfield: Audio Design • Greenwich: Al Franklin's • Hartford: Al Franklin's • New Haven: Audio Etc. • Newington: Hi Fi Stereo House • New London: Robert's • Waterbury: Zimmo Music  
**DE Wilmington:** Bryn Mawr Stereo  
**FL Daytona Beach:** Stereotypes • Ft. Lauderdale: Sound Advice • Ft. Pierce: Sound Shack • Gainesville: Electronics World • Jacksonville: Audio Tech. Spectrum Home Theater • Key West: Audio International • Lakeland: Sound Factory • Mary Esther: Palm Audio Video • Merritt Island: Southern Audio • Miami: Sound Advice • Naples: Stereo Garage • Panama City: Watsound Stereo • Pensacola: All Pro Sound • Sunrise: Sound Advice • St. Petersburg: Sound Advice • Tallahassee: Stereo Store • Tampa: Sound Advice • W. Palm Beach: Electronic Connection, Sound Advice  
**GA Athens:** Hi Fi Buys • Atlanta & Suburbs: Hi Fi Buys • Augusta: Stereo City • Brunswick: H&H Service Store • Columbus: Merit TV • Gainesville: Audio Dimensions • Macon: Georgia Music • Savannah: Audio Warehouse • Valdosta: Stereo Connection  
**HI Honolulu:** Honolulu Audio Video  
**IA Davenport:** Grigg's Music • Des Moines: Audio Labs • Dubuque: Reniers • Ft. Dodge: Sound World of Ft. Dodge • Iowa City: Hawkeye Audio • Mason City: Sound World • Sioux City: Audio Visions  
**ID Boise:** Stereo Shoppe • Idaho Falls: Video & Electronics Shoppe • Ketchum: Infinite Audio • Moscow: Stereo Shoppe • Twin Falls: Audio Warehouse  
**IL Alton:** Reliable Stereo • Aurora: Stereo Systems • Carbondale: Southern Stereo • Champaign: Good Vibes • Chicago & Suburbs: United Audio • Decatur: Team Electronics • DeKalb: Classic Hi Fi • Fox Valley/Aurora: United Audio • Highland Park: Columbia • Joliet: Stereo Systems • Kankakee: Barrett's Entertainment • Lansing: Unitek Electronics • Naperville: Stereo Systems • Niles: United Audio • Normal: Sundown One • Northbrook/Oakbrook: United Audio • Peoria: Team Electronics • Rockford: Columbia • Schaumburg: United Audio • Springfield: Sundown One • Spring Valley: Audio Labs • Sterling: Sterling Electronics • Vernon Hills: United Audio  
**IN Bloomington:** Campus Audio • Bluffton: Eley TV & Appliance • Evansville: Riskey's • Ft. Wayne: Lehmans • Indianapolis: Ovalion • Jasper: Riskey's • Lafayette: Good Vibes • Michigan

City: Audio Connection • Terre Haute: Stereo Crafters • Vincennes: Riskey's  
**KS Junction City:** Audio Junction • Kansas City: Brands Mart • Overland Park: Audio Electronics, Brands Mart • Wichita: Audio Visions • Topeka: Nelson's  
**KY Bowling Green:** Poston's • Campbellsville: Coppock's • Lexington: Ovalion Audio • Louisville: Audio Video Buy Design, Ovalion • Madisonville: Riskey Electronics • Owensboro: Paducah: Riskey's • Pikeville: Mayo Inc.  
**LA Alexandria:** Simpson Electronics • Lafayette: Stereo Electronics • Metairie & New Orleans: Alternam Audio • Shreveport: Wrights Sound Gallery  
**MA Boston:** Goodwins, Waltham Camera & Stereo • Fitchburg: Fitchburg Music • N. Dartmouth: Sound II • Pittsfield: H.B.S. Stereo • Wallham: Waltham Camera & Stereo • Worcester: O'Colts  
**ME Bangor:** Sound Source  
**MD Baltimore:** Soundscape • Galthersburg: Audio Buys • Hagerstown: Sunrise Electronics  
**MI Ann Arbor:** Hi Fi Buys • Birmingham: Almas Hi Fi • Dearborn: Almas Hi Fi • Farmington Hills: Almas Hi Fi • Flint: Stereo Center • Grand Rapids: Classic Stereo • Iron Mountain: Sound North • Kalamazoo: Classic Stereo • Lansing: Midland: Hi Fi Buys • Petoskey: Kurtz Music • Rochester: Sound Choice • Saginaw: Court St. Listening Room • Traverse City: Kurtz Music  
**MN Alexandria:** Sound Shop • Duluth: Mel's TV & Audio • Grand Rapids: Audio Files of Grand Rapids • Marquette: Audio King • Minneapolis & Suburbs: Audio King • Rochester: Audio King • St. Paul: Audio King • Winona: Audio Design  
**MO Cape Girardeau:** Stereo One • Columbia: Johnston Audio • Jefferson City: The Entertainer • Kansas City: Brands Mart • Springfield: Harvey's Stereo • St. Louis: Sound Central  
**MS Columbus:** Hooper's • Gulfport: Hooper's • Hattisburg: McLelland TV • Jackson: Hooper's • Pascagoula: Empress • Hooper's  
**MT Billings:** Video Sat & Sound Bozeman: Thrifty Ear • Great Falls: Rocky Mountain Hi Fi • Kalispell: Audio Visions • Missoula: Aspen Sound  
**NC Asheville:** Pro Sound • Boone: Highland Audio • Chapel Hill: Stereo Sound • Charlotte: Audio Video Systems • Conover: Tri-City • Greensboro: Stereo Sound • Hendersonville: Stereo King • Kinston: Stereo Concepts • Moorehead City: Anderson Audio • New Bern: Anderson Audio • Raleigh: Audio Buys, Stereo Sound • Rocky Mount: Microwave Audio • Wilmington: Atlantic Audio • Wilson: Modern Stereo • Winston-Salem: Stereo Sound  
**ND Bismarck:** Pacific Sound • Fargo: Today Electronics  
**NE Kearney:** Midwest Audio • Lincoln: Stereo West • Norfolk: Mid City Stereo • Omaha: Stereo West • York: Midwest Audio  
**NH Concord:** Audio of New England • Laconia: Greenleafs Music • North Hampton: The New Audiophile • Salem: Cuomo's  
**NJ East Brunswick:** Atlantic Stereo • Maple Shade: Bryn Mawr Stereo • Paramus: Harvey Electronics • Raritan: AC Audio • Ridgewood: Sounding Board • Shrewsbury: Monmouth Stereo • Toms River: Rands Camera • Trenton: Hals Stereo Sound Center • Wall Twp.: Monmouth Stereo • Westfield: Stuarts Audio Video  
**NM Alamogordo:** DBK Electronics • Albuquerque: West Coast Sound • Carlsbad: Beason's • Clovis: Towne Crier • Santa Fe: West Coast Sound  
**NV Reno:** Elko Audio • Las Vegas: Upper Ear • Reno: Good Guys  
**NY Albany:** Clark Music • Amherst: Speaker Shop • Batavia: Unicorn Audio • Bedford Hills: The Sound Concept • Buffalo: Speaker Shop • Corning: Chemung • Elmira: Chemung • Forest Hills: Continental Sound • Fredonia: Studio One • Glens Falls: Audio Genesis • Goshen: Longplayers Stereo • Harriman: The Sound Concept • Rhineclaire: Sound Image • Jamestown: Studio One • Maxana: Hi Fi Shop • Manlius: The Sound Concept • Newburgh: Audio Expressions • New Hartford: Adirondack Audio • New York City: Electronic Workshop, Harvey Electronics •

## polkaudio

The Speaker Specialists®

**Pittsburgh:** Alpha Stereo • Queensbury: Audio Genesis • Rochester: JB Sound • Syracuse: Clark Music • Vestal: Hart Electronics • Westbury: Harvey Electronics • White Plains: Harvey Electronics  
**OH Akron:** Audio Craft • Canton: Belden Audio • Cleveland & Suburbs: Audio Craft • Cincinnati: Stereo Lab • Columbus: Stereo Lab • Dayton: Stereo Showcase • Findlay: Audio Craft • Lima: Classic Stereo • Toledo: Audio Craft • Wooster: Far East Audio  
**OK Lawton:** Hi Fi Shop • Oklahoma City: Audio Dimensions • Tulsa: Audio Advice  
**OR Eugene:** University Hi Fi • Grants Pass: Sheekel's • Medford: Sheekel's • Portland: Magnolia • Salem: Kelly's Home Center  
**PA Allentown:** Bryn Mawr Stereo • Blakely: Hart Electronics • Bryn Mawr: Bryn Mawr Stereo • Camp Hill: Bryn Mawr Stereo • Chambersburg: Sunrise Electronics • Erie: Studio One • Harrisburg: Bryn Mawr Stereo • Jeannette: Audio Communications • Johnstown: Gary's Entertainment • Kingston: Langhorn Stereo • Lancaster: G'n'T Stereo • Longhorne: Bryn Mawr • Montgomeryville: Bryn Mawr Stereo • Natrona Heights: Stereo Land • Philadelphia & Suburbs: Bryn Mawr Stereo • Pittsburgh: Audio Communications, Audio Junction • Quakertown: Bryn Mawr Stereo • Reading: G'n'T Stereo • Selinsgrove: Stereo Shoppe • State College: Paul & Tony's Stereo • Stroudsburg: Main St. Audio Video • Williamsport: Robert M. Sides  
**PUERTO RICO Rio Piedras:** Precision Audio  
**RI Middleton:** Flint Audio • N. Providence: East-em Audio  
**SC Anderson:** Music Machine • Charleston: Audio Warehouse • Columbia: Music Machine, Sound Advice • Greenville: American Audio • Greenwood: Stereo Shop • Spartansburg: Stereo Shop SD Aberdeen: Engel Music • Rapid City: Team Electronics • Sioux Falls: Audio King  
**TN Chattanooga:** R&R TV • Cookeville: Lindsey Ward • Jackson: New Wave Electronics • Kingsport: Audition • Knoxville: Lindsey Ward • McMinnville: Lindsey Ward • Memphis: New Wave Electronics • Nashville: Hi Fi Buys  
**TX Amarillo:** Sound Systems Ltd. • Arlington: Sound Idea • Austin: Marcum Electronics • Beaumont: John Goodyear Audio • College Station: Audio Video • Corpus Christi: Tape Town • Dallas: Americell • Denton: Bell Audio Video • El Paso: Soundquicks • Ft. Worth: Sound Idea • Garland: MJM Audio • Houston: Sheffield Audio • Hurst: Sound Idea • Laredo: Metex International • Longview: Audio Techniques • Lubbock: Electronics Supercenter • McAllen: Metex • Memphis: Modern Music • San Angelo: Sound Box • San Antonio: Mobile HiFi • San Marcos: Discovery Audio Video • Sherman: Worldwide Stereo • Temple: Audio Tech • Texarkana: Sound Town • Victoria: Dyer Electronics • Waco: Audio Tech  
**UT Logan:** Consumer Technologies • Salt Lake City: Broadway Music • St. George: Boulevard Home Furnishings  
**VA Charlottesville:** Holdrens • Collinsville: Holdrens • Falls Church/Manassas: Audio Buys • Harrisonburg: Ace Music • N. Electronics • Radford: Holdrens • Richmond: Gary's Stereo • Roanoke: Holdrens • Virginia Beach: Digital Sound  
**VT Essex Junction:** Creative Sound  
**WA Bellingham:** DC Stereo • Chehalis: Music Store • Oak Harbor: DC Stereo Center • Seattle/Bellview/Lynnwood: Magnolia • Spokane: Electracrat (Hals) • Tacoma: Magnolia  
**WI Appleton:** Sound World • Fond Du Lac: Audio Plus • Green Bay: Sound World • Lacrosse: Sound World • Madison: Happy Medium • Milwaukee: Audio Emporium • Oshkosh: Audio Plus • Ripon: Audio Plus • Sheboygan: Genes Sound & Camera • Wausau: Sound World  
**WV Barboursville:** Beckley, Charleston: Piel Piper • Clarksburg: Audio Visual Concepts • Huntington: Piel Piper • Parkersburg: Video Warehouse • Piedmont: Sound Gallery • Wheeling: Look 'N' Listen  
**WY Cheyenne:** Electronics Unlimited • Gillette/Sheridan: Star Video Library

**LOS ANGELES**



**Beverly Hills Audio**  
EXCITEMENT IN SOUND

**Surround Sound Specialists  
Custom Installation**

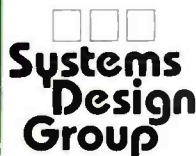
- |           |               |
|-----------|---------------|
| McIntosh  | Lexicon       |
| Nakamichi | B+K           |
| Linn      | Naim          |
| Mirage    | Stax          |
| Denon     | Pioneer Elite |

8950 West Olympic Boulevard, Suite 202  
Beverly Hills, CA 90211, (213) 276-2001

**VALUEable**

Products, Service and Consultation  
designed to give you the maximum  
performance for your dollar.

- Adcom • B&W • Polk • NAD • Celestion  
Carver • PS Audio • Counterpoint • M&K  
Denon • Terk • Proton • Sota • ADS  
Optonica • Canon Video • Tera • Stax  
Magnum • Ambria • Mod Squad • Thorens  
Lexicon • Grado • Signet • Klipsch  
Nitty Gritty • Tara Labs • AudioQuest  
Paradigm • Talisman • Sumiko  
Sharp Vision • Sonance • SME



(213) 370-8575  
1310 Kingsdale Ave.  
Redondo Beach, CA 90278  
Mon-Fri 11am-7pm  
Sat 11am-6pm

**THE DAT STORE**

**DIGITAL AUDIO TAPE RECORDERS**

MONDAY THRU FRIDAY: 9:00-6:00 WEEKENDS: 1:00-4:00

OVER 25 MAKES & MODELS--IN STOCK NOW!

**PANASONIC SONY JVC AKAI  
CASIO PIONEER NAKAMICHI  
NEC TASCAM SHARP FOSTEX**

& Introducing the smallest DAT to date:

**THE AIWA HD-X1**

DIRECT DIGITAL RECORDING MASH FILTERS  
DIGITAL IN & OUT RECHARGEABLE BATTERY  
256X OVERSAMPLING SUB-CODE EDITING  
A/D CONVERTER W/WIRED REMOTE & CASE INC.

2624 WILSHIRE BOULEVARD  
SANTA MONICA, CA 90403  
(213) 828-6487 / FAX (213) 470-6176

**SERIOUS AUDIOPHILES  
DESERVE SERIOUS SERVICE.**

- Acou-tat • Advent • AKG • Audible Illusions •  
Audi Pro • Audiophile • Audioquest •  
Beyer Dynamic • Blaupunkt • Bose • Canon •  
Cardas • Celestion • Counterpoint • Crest • CWD •  
Dahlquist • dbx • DCM • Dual • Fosgate •  
Grado Signature • Hafler • Harman Kardon •  
Jamo • JBL • JSE • JVC • Lexicon •  
Magnum Dynalab • MFA • Mod Squad • NEC •  
Niles Audio • Nitty Gritty • Ohm Acoustics •  
Onkyo • Ortofon • Philips • Precise • Proton •  
PS Audio • Revox • SAE • SME • Sonance • Sony •  
Sumiko • Stax • Straightwire • Superphon •  
Talisman • Tannoy • TDK • Teac • Thorens •  
Ungo Box • Velodyne • VPI • Wharfedale



Call Us ... (213) 517-1700  
1821 1/2 Dalton Ave., Dept. A8, Gardena, CA 90248

**THE SOUNDS OF MUSIC  
IN THEIR PUREST FORM**

Exclusive South Florida Tara Labs  
Temporal Continuum Dealer and  
Leading Distributor of ..

- |                          |                |                           |
|--------------------------|----------------|---------------------------|
| 3A                       | Infinite Slope | Sumiko SME                |
| Ariston                  | J.S.E.         | Sumo                      |
| ASC Tube Traps           | JVC            | Tara Labs Space &<br>Time |
| Audioquest               | Mission        | Temporal                  |
| Beyerdynamic             | Mod Squad      | Continuum                 |
| California Audio<br>Labs | Pioneer        | Triad                     |
| Carver                   | Proton Audio   | Tice                      |
| Celestion                | Proton Video   | VPI                       |
| Chesky                   | Sonex          |                           |
| Clear Image              |                |                           |
| Conrad-Johnson           |                |                           |
| Cyrus                    |                |                           |
| Dorian                   |                |                           |
| Energy                   |                |                           |
| Epicure                  |                |                           |
| Fosgate Surround         |                |                           |
| Hafler                   |                |                           |



**In Florida  
stereo  
shoppe**

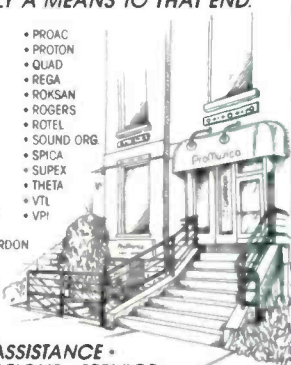
1650 North Federal Highway  
Pompano Beach, FL 33062  
Phone: (305) 942-7074

Free Shipping Nationwide

**ProMusica**  
AUDIO SPECIALISTS

**WE SELL MUSIC: AUDIO EQUIPMENT  
IS SIMPLY A MEANS TO THAT END.**

- ACCUSTAT
- AD-20M
- ARAGON
- ARCAM
- ARDICI
- AUDIOTECH
- BEYER
- CRE-K
- CWE
- DUAL
- ENE-GY
- GOLDRING
- GOODMAN'S
- GRADO
- HARMAN/KARDON
- JANS
- LIMP
- MOD SQUAD
- NAIF
- PAR-DIGM



**EXPERT ASSISTANCE •  
INSTALLATIONS • SERVICE**

2236 N. CLARK • CHICAGO, IL 60614 • 312-883-9500

**ADVERTISERS!**

Think of the sales your  
ad can generate from the  
**October Equipment  
Directory and Audio's  
Guide to Surround  
Sound.** Space closing is  
August 6th.

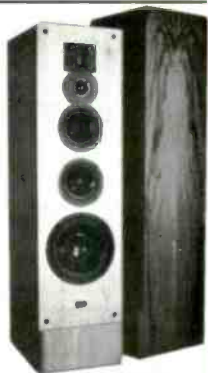


For details call  
Carol Berman at  
(212) 767-6292

Visit our **SPEAKER FACTORY SHOWROOM**  
at 3021 Sangamon Ave., Springfield, IL 62702

Authorized Dealer:

- B&K/Sonata
- Thorens
- Sumo
- Soundcraftsmen
- Parasound
- Belles
- Fosgate
- Audio Dynamics
- Audioquest



LEGACY  
SIGNATURE II

800-283-4644  
call for literature

**Reel to Real Designs**

**Look Here For The Finest  
Lines and Sound Advice.**

- |                |           |
|----------------|-----------|
| Apogee         | Mirage    |
| Bang & Olufsen | NAD       |
| Canton         | Optonica  |
| Celestion      | Sonance   |
| Esoteric       | Threshold |
| Lexicon        | Vidikron  |
| Meridian       |           |

Call us when you need a high-  
performance, integrated sight  
and sound system installed.



31 Schoosett St., Pembroke, MA  
(617) 826-4422

# DEALER SHOWCASE

O'Coin's

SERVING CENTRAL NEW ENGLAND WITH VALUED PRODUCTS FOR OVER 30 YEARS

ACOUSTAT, AKG, APATURE, ARAGON, ARISTON, ASC, AUDIO CONTROL, AUDIOQUEST, BEYERDYNAMIC, BOULDER, CAMBER, CARVER, DUAL, ESOTERIC, FORTE, HAFLER, HARMAN, KARDON, KEF, LEXICON, NAD, NITTY GRITTY, ONKYO, ONKYO GRAND INTEGRA, ORTOFON, PARADIGM, PARASOUND, POLK AUDIO, REVOX, SONY, TECHNICS ... AND MANY MORE AT PRICES THAT SOUND RIGHT.

O'COIN'S

239 Mill Street Worcester, MA 01602  
508-791-3411 x 315  
M-F 10-9pm, Sat 9-6pm  
DISCOVER, MASTERCARD, VISA ...  
FINANCING AVAILABLE

W. New England's Best!

Acoustat • Adcom • Apogee • Aragon • AudioQuest • B&W • Celestion • CWD • Dahlquist • Denon • Dual • Hafler • Infinity • JVC Video • Krell • Krell Digital • Lexicon • Magnum • MIT • Mod Squad • Monster • NAD • NHT • Onkyo • Ortofon • Proceed • Proton • Shure • SME • Snell • Sony ES • Sota • Stax • Sumiko • Tera • Vandersteen • Velodyne • VPI

**Sound & Music**

Sales & Service • 351 Pleasant Street  
Northampton, MA 01060 • (413) 584-9547

Aragon ... Apogee ... Audible Illusions ... Audioquest ... Audio Research ... Bryston ... Canon ... Compact Discs ... Counterpoint ... Creek ... CWD ... Denon ... Dynavector ... Grado ... Jamo ... Lexicon ... Livewire ... Magneplaner ... Magnum Dynalab ... Mariah ... Mark Levinson ... Mission ... NAD ... Nova ... Pinnacle ... Revolver ... SME ... Sota ... Sumiko ... Sumo ... Stax ... Symdex ... Vandersteen ... VPI ...  
And Much More!

**Hi Fi Exchange**

FORESIDE MALL • ROUTE ONE  
FALMOUTH, ME 04105  
(207) 781-2326

1(800)274-0644

LARGEST SELECTION & LOWEST PRICES in the Country! Call! Call! the Needle Doctor HAS IT ALL !!



50% OFF cartridges

The needle doctor sells all major lines of needles and cartridges. Great variety! He stocks old styluses, accessories, and turntables, too.

Free Turntable Clinics  
M-Th 10-7 Fri-Sat 10-6  
419 14th Avenue SE  
Minneapolis, MN 55414

Jerry Raskin's  
Needle Doctor

(612)378-0543 or 1(800) 274-0644

We've moved!

HIGHER FIDELITY

704-889-5440

THREE NEW LISTENING ROOMS

605-F Polk Street  
Pineville (Charlotte), NC 28134

Authorized Dealer For: AKG • ARAGON • BEYER • B&W • CAMBRIDGE • CELESTION • CHICAGO • COUNTERPOINT • GRAMOLIN • DAHLQUIST • GRADO • KOSS • MAGNUM DYNALAB • MAY AUDIO • MEITNER • MOD SQUAD • MORDAUNT SHORT • NILES • RATA • ROTEL • SENNHEISER • SHURE • SONRISER • SUMIKO • SUMO • SUMO ARIA • SYSTEMDEK • TERK • TWEED • VAN DEN HUL • VAMPIRE • VPI • WBT • ZETA AND MORE.

ASK ABOUT OUR PROFESSIONAL AUDIO DIVISION. HUGE SELECTION OF AUDIOPHILE RECORDINGS AND COMPACT DISCS.

DAT—We have legal DAT with full warranty.

CSA Audio announces the arrival of the incredible Duntech Black Knight

featuring

- Wall to wall soundstage
- Liquid midrange
- Awesome bass performance
- 92 dB efficiency
- 72" tall, 152 lbs. each
- The summation of over 20 years of leading edge technology.
- Uniquely affordable at under \$4000. per pair.
- A truly best buy.

Save Big By Trading In Your Current Speakers

**CSA AUDIO**

Upper Montclair, NJ Bernardsville, NJ

201-744-0600

Metro NY & NJ Readers Call or Write for Free Catalog

**JS A**

J S AUDIO

Our own line of handcrafted speakers

Speaker parts • Repair • Complete audio & video systems featuring:

LUXMAN HAFLER  
AUDIO DYNAMICS PROTON  
HARMAN KARDON NEC  
MAGNAVOX ONKYO  
PARASOUND ORTOFON  
PICKERING AKG  
MONSTER CABLE KOSS

and more ...

643 Speedwell Ave,  
Morris Plains, NJ 07950  
201-292-2799

Music & Video Systems for the Novice & Connoisseur

Savant  
Audio & Video

Consultancy - Custom Systems - Acoustic Treatment  
Installation - Retail

Apogee • Arcici • Audio Prism • AudioQuest Basis • Benz • Cardas • Chesky  
Chicago Speaker Stand • Classé • Clearaudio Cogan Hall • Creek • Delos • Distech • Dorian  
Electron Kinetics • Eminent Technology  
First Sound • Garth • Garrott • Harmonia Mundi  
Klyne • Lantana • Last • Lectron • Magnon  
Merrill • Mod Squad • Mogami • Morch  
Nestorovic • Neutrik • Opus3 • Pro Ac • Q E D  
Rega • Reference Recordings • Sequerra  
Sheffield Lab • Sims • Sumiko • Superphon  
Tara Labs • Target • Tice Audio  
Vendetta Research • V M P S • Wadia  
Water Lily • W B T • and More

(800) 628-0627  
Princeton Jct., N.J. 08550



**ALPHA STEREO**

Quality Components. Professional Installation & Service



"We are known for the companies we keep"

Adcom, NAD, Rotel, Onkyo, Denon, Dual, Mission, Celestion, Coustic, Soundstream, Audioquest, Paradigm, Monster Cable, Ortofon, AKG, Stax, Polk Audio, Alpine, Sharp Vision

Northern NY's oldest & most renowned dealer.

345 Cornelia St., Plattsburgh, NY 12901

518-561-2822

Fax: 518-561-2961

Monday-Friday 10am-8pm, Saturday 10am-6pm  
Mastercard, Visa, Discover, Amex



Visit these specialty retailers  
for professional consultation

# DEALER SHOWCASE

## Hear it all!

Apalure • Arcam • ASC Tube Traps • Audio Control • Audio Research • Audioquest • B&W • Dual • Entec • Grace • Grado • Krell • Krell Digital • Kiseki • L.A. ST. Products • Lazarus • Magnum-Dynalab • Martin-Lagan • Mirage • MIT • Monster Products • Premier Tonearms • Premier Stands • Niles Audio • NAD • Ortofon • RPG Diffusers • Sansui/Vintage • Sharp/Optonica • Shure HTS • Signet • Simply Physics • SME • Sonrise Furniture • Sony ES • Sony AV Laser • Soundstream • Stax • Sumiko • Talisman • Target Stands • TDK • TDL • Terk • That's Tape • Theta Digital • van den Hul • VPI • WBT Connectors • Well-Tempered • Wilson Audio • Yamaha, etc.

**Altair**  
AUDIO

1980 Central Ave.  
Albany, NY 12205  
518-452-3525

## audio experts

### WESTCHESTER'S FOREMOST CUSTOM DESIGN AND INSTALLATION SERVICES

Adcom	Grado	Rotel
Audio Access	Lexicon	Signet
Bang & Olufsen	MB Quart	Sonance
B&W	MKO	Sony Projection
Carver	Niles	Soundstream
Dahlgust	Ortofon	Sumo
Denon	Philips	Target
Energy	Proton	Triad
		Wharfedale

Call us . . . or come in, and find out  
why "The experts choose the experts."

(914) 698-4444

875 Mamaroneck Ave.,  
Mamaroneck, NY 10543

**para**

## Any Recording By Phone or Mail

Now you can order any CD, Tape, or LP in print from our 200-page catalog. We carry all major labels plus independents like Chandos, Harmonia Mundi, Sheffield, and many more.

**BOSE**  
**EXPRESS**  
**MUSIC**  
**CATALOG**

Send \$6.00 (refundable on your first order from the catalog) for our 45,000 title catalog with \$50 in merchandise credits. Subscribers get our Annual Catalog


+ 1 year of FREE updates covering new releases & specials. Absolutely no obligation or unrequested shipments.

Call ☎ 1-800-233-6357 or send to

Bose Express Music, A5, 50 W. 17th St NYC, NY 10011

March, Music Reference, Musical Concepts, PSB, Raven, Solostat Audio, Dorian, Dacote, Eminent Tech, Grant, Kinetics, Lantson, Magnum Dynalab, Marantz, Merrill, Mod Squad

"Let's talk about the real reason why you want to buy a stereo. Music!" -MG



**MG Audio** (216) 339-4918  
202 Second Street, SW-New Philadelphia, OH 44663

Denon, Sonata, Sound Lab, Superphom, Tara Lab, Venedino, and VPI

## Vermont's Audio Leader!

DUAL  
ARISTON  
TARA LABS  
PARADIGM • A&R CAMBRIDGE  
DENON • SUPERPHON • KLIPSCH  
B&K • ADVENT • ADS • ROTEL  
MARANTZ • REGA • AUDIOQUEST  
PROTON • AUDIO CONTROL • AKG  
SENNHEISER • CREEK • GRADD  
TARGET • GOLDRING • AUDIOLAB  
BRETTFORD • SPICA • KIMBER  
AIWA • PRO-AC • VPI • MAGNUM

"INTELLIGENT AUDIO AT  
REASONABLE PRICES"  
802-863-4372

**city  
stereo**

207 College St • Burlington, VT 05401

## SENSIBLE, PERSONAL HIFI ADVICE, TOLL-FREE

HERE IN VERMONT, PEOPLE DEMAND VALUE.

WE DON'T WASTE CUSTOMERS' MONEY,

AND NEITHER DO THESE FOLKS:

ARISTON AUDIOQUEST B&W CELESTION  
DUAL GRADO GRAHAM HAFLER  
LUXMAN MAGNAVOX CD MAGNUM DYNALAB  
MOD SQUAD MONSTER CABLE ORACLE  
POLK ROTEL WHARFEDALE

5-YEAR WARRANTIES ON ALL NEW EQUIPMENT,  
INCLUDING CD PLAYERS, TURNTABLES, TAPE DECKS.

NO CHARGE FOR DELIVERY.

**SCIENTIFIC STEREO**

128 MAIN ST BRATTLEBORO VT 05301

1-800-456-HIFI

Be as selective  
in where you  
buy as you  
are in what  
you buy.

We know they're hard to resist. Guaranteed lowest prices in the universe. Every day's a sale day. Big, bigger, biggest.

But, buying a serious audio or video component isn't the same as buying a dishwasher or microwave. And that's why AUDIO recommends you visit an independent A/V specialty retailer when shopping for equipment.

A/V product is the heart of his business, not a "profitable or trendy" sideline. That means the independent dealer will always be more concerned in helping you select the proper equipment than he will be helping himself to a commission.

So, be as selective in where you buy as you are in what you buy. Support your independent specialty dealer.

**Audio** The Equipment Authority

## CLASSIFIED ADVERTISING LINE ADVERTISING

CLASSIFIED LINE ADS ARE PAYABLE IN ADVANCE BY CHECK OR MONEY ORDER ONLY. (Sorry, we cannot accept credit cards or bill for line advertising.) ALL LINE ORDERS should be mailed to:

AUDIO MAGAZINE, P.O. Box 9125  
Dept. 346-01, Stamford, CT 06925

ORDERS WILL NOT BE PROCESSED WITHOUT ACCOMPANYING PAYMENT FOR FULL AMOUNT. Agency discounts do not apply to line advertising.

**CLOSING DATE**—First of month two months preceding the cover date. If the first of the month falls on a weekend or holiday, the closing date is the last business day preceding the first. ADS RECEIVED AFTER THE CLOSING DATE WILL BE HELD FOR THE NEXT ISSUE UNLESS OTHERWISE STATED.

**GENERAL INFORMATION**—Ad copy must be type-written or printed legibly. The publisher in his sole discretion reserves the right to reject any ad copy he deems inappropriate. **ALL ADVERTISERS MUST SUPPLY:** Complete name, Company Name, Full street address (P.O. Box numbers are insufficient) and telephone number. Classified ads do not carry Reader Service Card Numbers. Frequency Discounts not fulfilled will be short rated accordingly.

## DISPLAY ADVERTISING

DISPLAY ADVERTISERS should make space reservation on or before the closing date. Ad material (film or velox) may follow by the tenth. DISPLAY ADVERTISERS MUST SUPPLY CAMERA READY ART. PRODUCTION CHARGES WILL BE ASSESSED ON ANY AD REQUIRING ADDITIONAL PREPARATION.

ALL DISPLAY CORRESPONDENCE should be sent to:

Carol A. Berman, AUDIO MAGAZINE  
1633 Broadway, New York, NY 10019

**FOR RATES & ADDITIONAL INFORMATION:**  
DISPLAY ADS: Carol Berman (212) 767-6292  
CLASSIFIED LINE ADS: 800-445-6066

We buy and sell  
**LP vinyl records**  
Over 100,000 titles in stock  
139 West 72nd Street  
New York, NY 10023  
**Rare Records Ltd. 212 877-5020**

## ANNOUNCEMENTS

Aaaannouncingggg!! Aaaannouncingggg!!

### MOSCODE HYBRID HAFLER

POWER AMPS—Enjoy the Benefits of Moscode™ Tube Technology with a Moscode™ Conversion for Hallers. Call/Write: CLASSIC AUDIO, 238 Liberty Ave., New Rochelle, NY 10805. (914) 633-3039.

**Audio Repairs and Restorations** by Cliff Ramsey of Audio Classics, former Senior Service Technician at McIntosh. **Tuner Modifications** by Richard Modafferi, Independent consultant to Audio Classics, inventor, and former Senior Engineer at McIntosh. Over 55 years combined experience. **AUDIO CLASSICS**, 8AM-5PM EST Mon.-Fri. United States Post Office Building, POB 176AAR, Walton, NY 13856 607-865-7200.

—Audio Advertiser for over a Decade—

**AUDIO RESOURCE HAS MOVED** to its new 4400 sq. ft. store at 3133 EDENBORN AVENUE, METAIRIE, LOUISIANA 70002. We now have five private listening rooms where you can audition one of the LARGEST SELECTIONS of HIGH END AUDIO EQUIPMENT in the country. **AUDIO RESOURCE** continues to offer precision-matched tubes, plus sales, service, and restoration of vintage components. Call or write for information on our products and services **AUDIO RESOURCE**, 3133 EDENBORN AVE., METAIRIE, LA 70002. (504) 885-6988.

## ANNOUNCEMENTS

### AUDIO CLASSICS

Precision Stereo Components Bought-Sold-Traded-Repaired-Modified. **AMPLIFIERS:** Acoustat T1200 \$600; Carver 1.5 \$300; Conrad-Johnson Premier 1B (\$5950) \$3000; Counterpoint, Denon POA6600 \$750; Electrocompaniet Amp II AS IS \$300; Hafler SE120 Demo \$299, XL280 Demo \$575; Krell KSA80B (\$3950) \$2700, KMA100 II \$3400, KSA100II \$2400, KSA200B \$4500; McIntosh MC225 \$6-800, MC240 \$1200, MC250 \$450, MC502 \$675, MC752 \$675, MC754 \$750, MC2100 \$500, MC2105 \$500, MC2120 \$600, MC2150 \$900, MC2200 \$700, MC2205 \$1400, MC2250 \$1560, MC2300 \$1400, MC2500 \$2700, MC7200 \$2075, MC7270 \$1750; Nlko Alpha 230 \$200. **CD PLAYERS:** Denon DCD3300 \$600; Hafler Iris \$549; Mod Squad CDB650 \$600; Philips CD40 (\$279) \$225, CD50 (\$329) \$299, CD60 (\$429) \$375, CD80 (\$799) \$675, LHH1000 (\$4000) \$3500; Sonograph SD1 \$300. **CROSS-OVERS:** Levinson LNC2 \$1100. **EQUALIZERS:** Audio Control C101 \$399, Richter Scale \$349, Ten Plus \$295; McIntosh MQ101 \$175, MQ104 \$99-285, MQ107 \$400. **HEAD AMPS:** Conrad-Johnson HV1A \$300; Step-up Transformers. Call. **INTEGRATED AMPLIFIERS:** McIntosh MA230 \$399; MA5100 \$400, MA6100 \$500-600, MA6200 \$1200; Philips DFA980 (\$749) \$699. **PREAMPLIFIERS:** Audio Research SP4 \$600; Conrad-Johnson PV1 \$300, PV3 \$175, PV5 \$850; Counterpoint; Crown IC150 \$300; Hafler Iris Demo \$679; HK Citation 11 \$150; Krell KSP7B (\$2700) \$2250; PAM 7 \$1200; McIntosh C11 \$700, C20 \$600, C24 \$300, C26 \$400, C28 \$450, C30 \$1100, C31V \$1200, C32 \$850, C34V \$1700; Mod Squad Line Drive \$250; Philips DAC960 (\$999) \$749; SAE XXX \$75. **PROCESSORS:** Quad & Surrond Sound, Call. Audio Control Phase Coupled Activator \$149; Carver C9 \$175; Lexicon CP1 (\$1295) \$1150, CP2 (\$895) \$699; SAE 5000 \$125, SCI 100 \$99; Sansui DS77 \$199; Shure HTS5200 \$449. **RECEIVERS:** McIntosh MAC1700 \$450, MAC1900 \$500, MAC4300V \$2200. **SPEAKERS:** Acoustat Spectra 11 \$899, 33 \$1799; B&W 808 \$4000, DM100 \$1800; Celestion SL600SI (\$2000) \$1463; Duntech Marquis \$3000; JSE Infinite Slope Used 2 \$1400; McIntosh MLIC \$500, XL1W \$375, XR19 \$3000; Velodyne 1200 \$795, ULD12 \$1095, ULD15II \$1669. **TAPE DECKS:** Astrocom 407 \$400; Crown SS824 \$750; Philips FC40 (\$299) \$259, FC50 (\$379) \$329, FC60 (\$549) \$499. **TEST EQUIPMENT:** Audio Control SA3050A \$877; McIntosh MP14 \$1400; Sound Technology 1000A \$1200, 1200 \$1200. **TONE ARMS:** Denneson ABLT1 \$1000; Eminent Technology \$300; many more. **TUBES:** Many major brands. **TUNERS:** Magnum Dynalab FT11 Demo \$399, 205 Demo \$199, Etude Demo \$995; McIntosh MR65B \$200-500, MR67 \$399, MR71 \$600, MR78 \$1400, MR500 \$800, MR510 \$900, MR7082 (\$1499) \$1200. **TUNER PREAMPS:** McIntosh MX110 \$250-500, MX112 \$500, MX113 \$550, MX117 \$1200. **TURNABLES:** Dual CS5000 \$359; Thorens TD124 \$125, TD125 \$200, TD126 \$400. **VD PLAYERS:** Magnavox CDV474 \$400, Philips CDV487 (\$949) \$869; Yamaha CDV1000 \$400. **FREE Catalogue.** Layaway Program. Major Credit Cards accepted. 8AM-5PM EST Mon.-Fri., **AUDIO CLASSICS**, United States Post Office Building, POB 176AAA Walton, NY, 13856. Call Mike.

**607-865-7200**

—Audio Advertiser for over a Decade—

High-end and hard-to-find audio components. New and used. Foreign and domestic. Low, low prices! **AUDIO AMERICA** (Virginia). Call 1-703-745-2223.

**Michigan Audiophiles! AUDIO ILLUSIONS** of East Detroit, Michigan presents these fine products: 3A Loudspeakers, Audible Illusions, Aragon, Audioquest, British Built, Cogan-Hall, Chicago Stands, Creek, Dahlquist, Edison-Price, Hafler, Heybrook, Musical Concepts, Onix, Ryan, Revolver, Straightwire, Sumo, Wadia & much more!!! Call (313) 772-8822 for more information.

**MINNESOTA, Bedini, Kinergetics, Well Tempered, Rega, LAST, MIT, Shahinian, Audio Prism (CD Stoplight), Sumo, Arcici, Sumiko & more. AUDITION AUDIO, (612) 331-3861.**

# NEW!

## Soft Shoes Advanced Component Damping Feet

The Mod Squad, manufacturer of Tiptoes, introduces a new type of damping feet designed to lift the vibrational veil from your music. Soft Shoes' superior damping profile combines three important factors. Stiffness limits lateral vibrations. Nonreactivity eliminates vibration amplification at their own resonant frequency. Self-damping prevents vibration propagation in both structural and environmental domains. This unique blend of low reactance and resistive loss replaces smearing and grundginess with lucidity and transparency.

So slip some Soft Shoes under your components and enjoy cleaner, clearer music. A convenient center hole lets you attach them permanently. Audition them at your local Mod Squad Dealer, or contact

*The Mod Squad*

542 N. Hwy. 101 • Leucadia, CA 92024 • (619) 436-7666



## ANNOUNCEMENTS

**MOSCODES, FUTTERMANS, AUDIO RESEARCH SP3, 6 & 8'S MODIFIED & SERVICED BY GEORGE KAYE.** Moscode Designer—Tremendous improvement. Protect your investment. CLASSIC AUDIO, 238 Liberty Avenue, New Rochelle, NY 10805. (914) 633-3039.

**Old Colony Sound Lab offers a free catalog for the asking.** Twenty-four pages of amplifiers, preamps, cross-overs, audio accessories, parts, boards, resistors, capacitors, etc. Everything you need for that do-it-yourself project to improve the sound of your audio system. Write Old Colony Sound, PO Box 243A, Peterborough, NH 03458, or call (603) 924-6371.

**A TRANSDUCER FOR THE PERFECTIONIST AUDIOPHILE ONLY.** THIS STATE OF THE ART SPEAKER (PAT. PEND.) UTILIZES NO WOOFERS, MIDRANGES, TWEETERS, RIBBONS, ELECTROSTATICS OR CONVENTIONAL PLANAR DRIVES. ABOUT THE ONLY THING OURS HAS IN COMMON WITH OTHER HIGH-END TRANSDUCERS, IS THAT IT RECREATES A NEAR PERFECT SOUND STAGE. FOR FREE INFORMATION ON OUR PRODUCT LINE, WRITE TO: A.W.H., P.O. BOX 591, BELLPORT, NY 11713.

## FOR SALE

**"AAAMPSTRAVAGANZA!! NAKAMICHI PA7II, WARRANTY"** - \$1450; BRYSTON 4B - \$695; BKEX442 - \$650; CROWN PSA2 - \$695; KINERGETICS KBA200 - \$695; COUNTERPOINT SA20 - \$1395; TANDBERG 3006A - \$495; GAS THAEDRA, MINT CLASSIC - \$395; CARVER C4000T - \$495; CARVER C2TX11 - \$450pr.; NAKAMICHI RX202 - \$475. MUST MAN BE BORN AGAIN? JOHN 3:1-18. (313) 949-4567.

### AAA—AUDIO ELITE IN WISCONSIN!!!

HAFLER, PS AUDIO, B&K, JSE, NAKAMICHI, PROTON, CARVER, ONKYO, ADS, VPI, DCM, SONOGRAPH, FRIED, NITTY GRITTY, SUMIKO, THORENS, SUPERPHON, SNELL, M&K, LUXMAN, BOSE, PHILLIPS, VELODYNE and any others you desire. (414) 725-4431.

### CALL US WE CARE!!!

**AAA-CALL US NOW! Luxman, Carver, ADS, Nakamichi, Denon, Boston Acoustics, NAD, Celestion, B&W, Adcom, PS Audio, HK, Hafler, AR, B&K, Onkyo, KEF, Proton, Snell, DCM, Infinity, JBL, Counterpoint, JSE, Spica, M&K, Bose, VPI, Sonograph, Sumiko, Thorens, Velodyne. WHY CALL US NOW? 414-727-0071. WE HAVE THE LOWEST PRICES!!!**

### AAA—LOW PRICES—HIGH END EQUIPMENT!!!

PS AUDIO, HAFLER, B&K, CARVER, NAKAMICHI, SUPERPHON, LUXMAN, THORENS, M&K, SNELL, INFINITY, ONKYO, PROTON, SONOGRAPH, FRIED, NITTY GRITTY, SUMIKO, BOSE, PHILLIPS, DCM, VELODYNE, ADS, VPI, JSE and any others you desire. AUDIO ELITE, (414) 725-4431, Menasha, Wisconsin.

### OUR PRICES CAN'T BE BEAT!!!

**AAA! NAKAMICHI, LUXMAN, CARVER, BOSTON ACOUSTICS, DENON, NAD, CELESTION, B&W, AR, AD-COM, PS AUDIO, HAFLER, ADS, COUNTERPOINT, B&K, ONKYO, KEF, PROTON, JBL, SNELL, DCM, INFINITY, HK, VELODYNE, JSE, SPICA, M&K, PHILIPS, VPI, BOSE, SONOGRAPH, (414) 727-0071.**

## AA/SOUND ADVICE

**LOW PRICES FAST DELIVERY! DENON, NAD, CELESTION, B&W, HARMON KARDON, JBL, CARVER, NAKAMICHI, BOSTON ACOUSTICS, LUXMAN, PS AUDIO, HAFLER, ADS, M&K, ONKYO, B&K, PROTON, DCM, SNELL, BOSE, VELODYNE, PHILIPS, SPICA, COUNTERPOINT, AND MUCH MORE! 414-727-0071.**

## CALL US!!

**ACCENT ON MUSIC WESTCHESTER NY. LINN, NAIM, REGA, ARCAM, CREEK, EPOS, ROTEL, REVOLVER, NITTY GRITTY, TARGET & SOUND ORG.** Interesting LP's & CD's; practical, honest advice; free delivery and installation; & single speaker demo rooms. Hear the difference. 175 Main St., Mount Kisco, NY 10549 (914) 242-0747.

## ATTENTION AUDIO BUYERS!!!

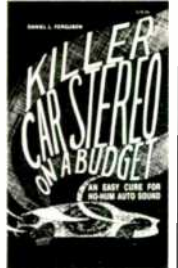
**AUTHORIZED DEALER FOR...ADS, ALPHASONIK, BOSTON ACOUSTICS, CARVER, DENON, DUAL, HAFLER, INFINITY, KENWOOD, KICKER, MONSTER CABLE, ORTOFON & YAMAHA! THE SOUND APPROACH, 6067 JERICHO TPKE, COMMACK, NY 11725 (516) 499-7680.**



## FOR SALE; SUPERB SOUND

With *The Loudspeaker Design Cookbook* for home and *Killer Car Stereo* for the road, there's no excuse for less than the best in loudspeaker sound! Fun to read, easy to understand and use. **\$19.95 each, \$30 for both.** Please add \$1.75 S/H for one book, \$2 for two. MC/Visa welcome. Dealer inquiries invited.

**OLD COLONY SOUND LAB**  
PO Box 243, Dept. A97, Peterborough, NH 03458  
(603) 924-6371/924-6526 FAX: (603) 924-9467



*we relish good musicke*

## Everyday Compact Disc Prices

- all TELARC & DMP \$11.49/cd
- all CHESKY \$10.99/cd
- all SHEFFIELD & REFERENCE \$11.99/cd

We've been in business more than 4 years providing *quality* mail-order service & *low* prices. Self-addressed stamped envelope gets you a catalog of above labels, or simply send your order for speedy turnaround. VISA-MC-Discover + \$3 shipping. Only from . . .

**The Acme Compact Disc Company**  
P.O. Box 7004 Evanston, IL 60204

## IT'S TIME YOU CLEANED UP YOUR IMAGE

Without Missing Link™, you're audibly missing a newly discovered refinement not available with any electronic manufacturers original power cable. A refinement of sound being reproduced from component to component, clearly audible as increased transparency of wider and deeper soundstage, spatial coherence around instruments and voices, recovery of hidden nuances, increased clarity across the audio band, low frequencies that are cleaner and have more authority, a delicate intimacy of high, seamless tonal balance and holographic musical images. Hearing is believing what Missing-Link can recover and enhance in your audio system.



distributed by  
**UNIVOCAL CORPORATION**

*Aural Symphonics*

2016 FLINTBURY CT. SAN JOSE, CALIFORNIA 95148  
408-270-6033 FAX 408-270-6039  
IN CANADA, INTERLINEAR, 416-479-1893

## AUDIO CLASSICS<sup>SM</sup>

### NEW & PRE-OWNED PRECISION STEREO COMPONENTS



- STATE-OF-THE-ART REFERENCE STANDARD DUAL-CHASSIS CD PLAYER SYSTEM WITH USA BIPASSED PERFORMANCE
- DEDICATED BROADCAST QUALITY CDM-1 RADIALBEAR TRANSPORT MECHANISM
- DIGITAL-TO-ANALOG CONVERTER SECTION USES HIGHEST GRADE D/A CONVERTER CHIPS AND DIGITAL FILTER WITH FOUR TIMES OVERSAMPLING
- PHILIPS JITTER ELIMINATION CIRCUITRY
- AUDIOPHILE ATTENTION TO DETAIL ON ALL DIGITAL AND ANALOG CIRCUITRY
- EXTENSIVE INPUT AND OUTPUT CAPABILITIES
- LCD/LEARN REMOTE CAN COMMAND UP TO 10 DIFFERENT COMPONENTS

Buy · Sell · Trade  
Repair · Modify · Update

FREE CATALOG

**607-865-7200**  
FAX # 607-865-7586

8 AM-5 PM MON-FRI EST  
UNITED STATES POST OFFICE BLDG. P.O.B. 176, WALTON, N.Y. 13856

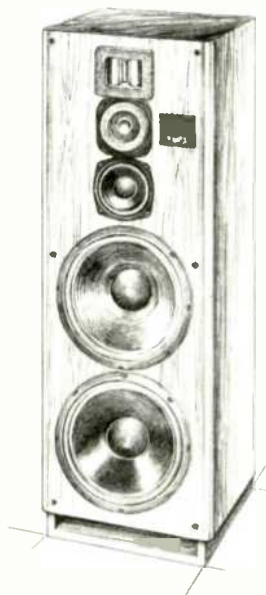


**PHILIPS**

LHM1000 Reference Series  
Compact Disc  
Player System

00011111

# LOWER LOUDSPEAKER DISTORTION



The VMPS Tower II Special Edition, \$1376/pr kit, \$1776/pr assem. in light or dark oak 45x15x16", 100 #

The new Special Edition of the VMPS Tower II, one of the most highly reviewed speakers of the decade (both a "Recommended Component" of **Stereophile** magazine and a "Best Buy" in **Audio**'s full review Jun 89), combines luxury features and updated cabinetry into a convenient, low-cost system of outstanding musicality, lowbass extension, and dynamic range.

A flushmounted ribbon supertweeter, Focal "Superdome" inverted haddome tweeter, and polycone ferrofluid midrange (like the three 12" woofers designed and built by VMPS in the USA) form a vertical array in a stunningly finished, rounded cabinet treated with **Soundcoat** for 10-15dB broadband reduction in spurious panel vibration. All Wondercap/polypropylene crossovers, silverplate Teflon solidcore/large gauge stranded internal wiring, biamp/biwing capability, and user adjustable bass damping guarantee maximum performance and flexibility in any environment and with a wide variety of associated equipment.

Hear VMPS at the dealers listed below, or write for brochures and test reports on the floorstanding **MiniTower IIa** (\$369ea kit, \$479ea assem), the standard **Tower II** (\$479ea kit, \$649ea assem), the **SuperTower R** (\$749ea kit, \$998ea assem), the all-out **Super Tower III** (\$3895/pr kit, \$4795/pr assem), our three **Subwoofers**, two **QSO Series** bookshelf speakers, and John Curl's breakthrough **SCP2B** phono preamp (\$2495).

## VMPS AUDIO PRODUCTS

div Itone Audio

3412 Eric Ct. El Sobrante Ca 94803  
(415) 222-4276

Hear VMPS at The Listening Studio, Boston Par Troy Sound Parsippany NJ Dynamic Sound Washington DC, Essential Audio Winchester Va American Audio Greenville SC Sound Audio Charlotte NC Audio by Caruso Miami Fl Arthur Morgan Ft Myers Fl Stereoland Natrona Hts Pa Shadow Creek Ltd Minneapolis Mn Audio Specialists South Bend In Concert Sound San Antonio Tx Mike Parker Garland Tx Stereoworks Houston Tx Encore Audio Lees Summit Mo Hifi Farm Beckley WV Lookout Electronics, Longview Wa Sound Room Vancouver BC Can, Exclusively Entertainment, San Diego Ca, Audio Haven Upland Ca Sounds Unique, San Jose Ca Private Line Home Entertainment, Stockton Ca Ultimate Sound San Francisco Ca Itone Audio El Sobrante Ca



## The mark of a true Denon.

This sticker tells you who is an authorized Denon dealer and who isn't.

Some people who offer Denon products are not authorized dealers. That can lead to problems.

First, *only* authorized dealers offer you the protection of a Denon warranty with your purchase: at other dealers, you may have no warranty at all.

Authorized Denon dealers stock only components designed for the U.S., and have the training to help you select the one right for you.

Authorized dealers know Denon technology inside and out and stock factory parts for your Denon to preserve true Denon sound.

So before you buy your Denon, look for this Denon Authorized Dealer Sticker.

It assures you of the authentic Denon technology and support you expect. And nothing less.

To find your nearest AUTHORIZED Denon Dealer call:  
1-201-575-7810  
(9:00 am-5:00 pm EST)

# DENON

### TIPS FOR MAIL ORDER PURCHASERS

It is impossible for us to verify all of the claims of advertisers, including product availability and existence of warranties. Therefore, the following information is provided for your protection.

1. Confirm price and merchandise information with the seller, including brand, model, color or finish, accessories and rebates included in the price.
2. Understand the seller's return and refund policy, including the allowable return period and who pays the postage for returned merchandise.
3. Understand the product's warranty. Is there a manufacturer's warranty, and if so, is it from a U.S. or foreign manufacturer? Does the seller itself offer a warranty? In either case, what is covered by warranty, how long is the warranty period, where will the product be serviced, what do you have to do, and will the product be repaired or replaced? You may want to receive a copy of the written warranty before placing your order.
4. Keep a copy of all transactions, including cancelled checks, receipts and correspondence. For phone orders, make a note of the order including merchandise ordered, price, order date, expected delivery date and salesperson's name.
5. If the merchandise is not shipped within the promised time or if no time was promised, 30 days of receipt of the order, you generally have the right to cancel the order and get a refund.
6. Merchandise substitution without your express prior consent is not allowed.
7. If you have a problem with your order or the merchandise, write a letter to the seller with all the pertinent information and keep a copy.
8. If you are unable to obtain satisfaction from the seller, contact the consumer protection agency in the seller's state or your local U.S. Postal Service.

If, after following the above guidelines, you experience a problem with a mail order advertiser that you are unable to resolve, please let us know. Write to Scott Constantine, Advertising Director, at AUDIO Magazine. Be sure to include copies of all correspondence.

## FOR SALE

ACOUSTIC ENERGY, AUDIBLE ILLUSIONS, AUDIOQUEST, ARCICI, ASC TUBE TRAPS, B&K SONATA, CELESTION, CLASSE' AUDIO, CARDAS, ENTEC, EPOS, KEF CUSTOM, KIMBER KABLE, KRELL DIGITAL, LEXICON, MAGNUM DYNALAB, MERLIN, MISSION CYRUS, THE MOD SQUAD, NILES, PHILIPS AUDIO VIDEO, REGA PLANAR, SONRISE CABINETS, STAX, SONUS FABER, SOUND ANCHOR, TARGET STANDS, TERRA LABS, TEMPORAL CONTINUUM, TERRA VIDEO, VELODYNE, WBT, FOR FREE LITERATURE CALL 301-890-3232 J S AUDIO ONE CHILDRESS COURT, BURTONSVILLE, MARYLAND 20866, AUDITION BY APPOINTMENT, MONDAY THRU FRIDAY 10am TO 7pm, SATURDAY 11 TO 5, WE HONOR VISA, MASTERCARD, AMERICAN EXPRESS, DISCOVER, FAX 301-890-3819.

### ADCOM, PHILIPS MODS.

OUR F.E.T. CIRCUITS MAKE THE MIRACLE DIFFERENCE! GFA AMPLIFIERS 269.00 INSTALLED. DISCRETE F.E.T. OUTPUT BOARDS FOR MAGNAVOX PHILIPS PLAYERS 179.00 KIT; 229.00 INSTALLED. COMPLETE CD-50 PLAYERS 679.00 AND 399.00. TEFLON & SILVER IS WHAT MAKES OUR NEW INTERCONNECT SO REVEALING! 139.00 MTR/PR. ALL ABOVE WITH OUR MONEY-BACK GUARANTEE! DEALER INQUIRIES INVITED.

#### SUPERMODS

2375 WEST 21ST. AVE., EUGENE, OR 97405.  
(503) 344-3696.

#### WAVETRACE TECH

4215 EAST BAY DR., #1205C,  
CLEARWATER, FL 34624.  
(813) 392-6423.

ADS, NAKAMICHI, CARVER, BANG OLUFSEN, REVOX, B&W, KEF, HARMON/KARDON, N.A.D., LUXMAN, HAF-LER, TANDBERG, ADCOM, DENON, KLIPSCH, YAMAHA, D.B.X., INFINITY, J.B.L. AND OTHER QUALITY COMPONENTS. BEST PRICES—LIVE PROFESSIONAL CONSULTATION WEEKDAYS—AUTOMATED PRICING AND INFORMATION AVAILABLE 24 HOURS. ALL PRODUCTS COVERED BY MANUFACTURER'S U.S.A. WARRANTY. AMERISOUND SALES INC., EAST: (904) 262-4000 WEST: (818) 243-1168.

**AFFORDABLE HIGH-END, NEW AND PCO UNITS:** B&K, Musical Concepts, Angstrom, Merlin, Kinergetics, Straight Wire, Musical Fidelity, Pro Ac & more. ARIEL, Carmel, IN 46032. Visa MC. (317) 846-9766 or (317) 841-7154, 5-10 pm.

**ALEX BUYS-SELLS USED CELLO, ARC, LEVINSON, KRELL, THRESHOLD, C.J. SPECTRAL, MIT, ETC. SHIP UPS-COD.** (CA) (415) 769-7891 OR FAX (415) 521-3080.

**ATTENTION HAFLER, DYNA, MAGNAVOX OWNERS!** Audio by Van Alstine builds complete new higher performance circuits for you. Not "modifications," but original new engineering designs that eliminate transient distortion, have no on or off thumps, are durable and rugged, and sound closer to live than anything else at a rational price. Our complete do-it-yourself rebuild kits start at \$200, including all new PC cards. Complete wonderfully-musical factory wired amplifiers, preamplifiers, tuners, CD players, and a great \$99 phono cartridge. Write or call for our new illustrated catalog. Audio by Van Alstine, 2202 River Hills Drive, Burnsville, MN 55337. (612) 890-3517.

**AUDIO BEST: LA, ORANGE, SAN BERNADINO, CALIFORNIA. HOT COMPONENTS:** CELESTION SL-3000, COUNTERPOINT, TARALAB, PS DIGITLINK; MIT: AUDIBLE ILLUSIONS; MODSQUAD; ACOUSTAT SPECTRA 11+; SPICA ANGELA; KINERGETICS; MAGNUM; FOSGATE; B&K SUPERPHON, MUSIC REFERENCE, RAUNA, SOUNDLAB, VPI, MAPLENOLL, SYSTEMDEK, GRADO, GARROTT, MONSTER, STRAIGHTWIRE, MUSIC CONCEPTS, (714) 861-5413, APPOINTMENT.

**AUDIO DEN Authorized Sales and Service.** ADCOM, ARAGON, ARCAM, B&K, CAL, CELESTION, CONRAD-JOHNSON, HAFLER, KLIPSCH, MAGNEPAN, MIRAGE, MIT, MONSTER CABLE, NAD, NAKAMICHI, PARADIGM, ROGERS, SHURE ULTRA, SONOGRAPHIE, SOTA, STAX, THETA DIGITAL, VELODYNE, VTL & YAMAHA. Audio Den, 2021 Smith Haven Plaza, Lake Grove, N.Y. 11755 (516) 360-1990.

**THE BEST IN AFFORDABLE HIGH-END! AUDIOQUEST \* B&K \* BOSE \* CELESTION \* GRADO SIGNATURE \* HARMAN KARDON \* JBL \* MONSTER \* NITTY GRITTY \* PREMIER \* SONY \* SOTA \* STAX \* STRAIGHTWIRE \* SUMIKO \* PLUS MANY ACCESSORIES. CALL FOR PRICES & ORDERING INFORMATION. GOLDEN EAR/HCM AUDIO 1-800-222-3465. 1-916-345-1341.**

## FOR SALE

### AUDIO NEXUS = QUALITY

Featuring legendary VANDERSTEEN loudspeakers & COUNTERPOINT electronics

Apogee • Arison • Audioquest • Bel • B&K • British Fidelity • Counterpoint • Eminent Technology • Forte • Fried • Jamo • JSE • Kimber Cable • Klyne • Magnum Dynalab • Melos • MIT • Monster Cable • Musical Concepts • Nitty Gritty • Premier • PS Audio • Precise • Rotel • Rowland Research • SME • Sonographe • Sony ES • Sota • Stax • Systemdek • Talisman • Alchemist • Vandersteen • Vendetta **SUMMIT, NJ. (201) 277-0333.**

**AUDIOQUEST PRODUCTS!** WE CARRY THE ENTIRE LINE OF AUDIOQUEST CABLES, CARTRIDGES, TONEARMS, & ACCESSORIES. CALL FOR PRICES & ORDERING INFORMATION. GOLDEN EAR/HCM AUDIO, 1-800-222-3465, 1-916-345-1341.

**AUDIO TEST EQUIPMENT** by Bruel & Kjaer, GenRad, Hewlett Packard, Rockland, Sound Technology, Spectral Dynamics, Tektronix, Wavetek, and others. Used, guaranteed, low prices. Call for complete list. (401) 421-7430.

**B&K AMPLIFIERS & PREAMPS** REPRESENT THE FINEST VALUE IN AMERICAN MADE ELECTRONICS! WE HAVE ON DISPLAY THE ENTIRE LINE OF B&K ELECTRONICS INCLUDING THE SONATA SERIES. FOR MORE INFORMATION OR AUDITIONING CALL GOLDEN EAR/HCM AUDIO 1-800-222-3465. 1-916-345-1341.

**BEST TRADES OFFERED.** We buy sell, trade, consign most high-end products. Audio Doctor, 1518 W. Commercial, Buffalo, MO 65622. 417-345-7245. COD-VISA-MC. Newsletter.

### BOUND FOR SOUND

The only monthly publication emphasizing affordable "Blue Collar Audio" over high-end haughtiness. Recent reviews include Revolver turntable, Dynavector pickup, Dana Audio loudspeaker, amplifiers from Muse, B&K (EX-442) and AVA. Coming agenda offers products from CODA Technologies, NEAR, 3a, Amrita, Bryston, Linn, Rush Sound, Reel to Reel and more. "Hot Wires" tells the truth about an interconnect that may blow you away for mere pennies; explore earth grounding. THIS IS THE MEAT OF AUDIO. 12 months, 12 issues, 12 dollars. 220 N. Main, Kewanee, IL 61443.

**BUY/SELL/TRADE IN THE AUDIO/VIDEO TRADER!** Published monthly. FREE ADS! \$15/yr. sample \$1.00-S.A.S.E. 330 SQ. MAIN STREET, DEPT. A, WAKE FOREST, NC 27587.

**CABLE TV CONVERTERS/DECODERS. WE HAVE ALL MAKES AND MODELS. WILL BEAT ALL PRICES.** 1-800-677-3335.

**CABLE TV CONVERTERS AND DESCRAMBLERS BARGAIN HEADQUARTERS.** JERROLD, ZENITH, TOCOM, HAMLIN, SCIENTIFIC ATLANTA, OAK. FREE CATALOG! GCN, 1032 IRVING #109, SF, CA 94122. ORDER NOW. VISAMC/COD (800) 327-8544.

**CABLE TV WIRELESS REMOTE CONVERTERS/DESCRAMBLERS.** SALE/USE REGULATED BY FEDERAL LAW. T.J. SERVICES. (313) 979-8356.

**CALL TOLL FREE! 1-800-826-0520 FOR: ACOUSTAT, Audio Control, Lexicon, JBL, Nitty Gritty, M&K, Oracle, Proac, Proton, Stax, Thorens, Dahlquist, Halfer, Monster Cable, Belles, CWD, dbx, Fried, Harman Kardon, Onkyo, Grado, Celestion, DCM, Duntech, Niles, Citation, Kinergetics.** Sound Seller, 1706 Main St., Marinette, WI 54143. (715) 735-9002.

**CASH for USED AUDIO EQUIP. BUYING and SELLING by PHONE. CALL for HIGHEST QUOTE.** (215) 886-1650. The Stereo Trading Outlet, 320 Old York Road, Jenkintown, PA 19046.

**Cost-effective vibration damping discs.** Newly designed and developed by a small Southern California company. Ideal for use in CDs, turntables, speakers, and VCRs. Available directly from the manufacturer. Set of four \$14, plus \$2 shipping/handling. California residents, please add 6% sales tax. Send check or money order to: ADB Laboratories, 2973 Harbor Boulevard, Suite #458, Costa Mesa, CA 92626-3989.

**HOME ALARM SYSTEM!** All Components "PREWIRED" for easy installation, including MICROWAVE Motion Sensor, high SPL SIREN, 110v. Supply with Backup Battery, Test Switch & L.E.D., Case. All concealed when Installed. Simple to operate - Affordable - Practical. \$299.95 + \$6.00 U.P.S. Intrusion Technologies Group, 2925 South Memorial Drive, Racine WI53403. VISA, MC, (414) 633-1240.

## FOR SALE

ADS., NAKAMICHI, CARVER, BANG OLUFSEN, REVOX, B&W, KEF, HARMON/KARDON, N.A.D., LUXMAN, HAFER, TANDBERG, ADCOM, DENON, KLIPSCH, YAMAHA, D.B.X., INFINITY, J.B.L. AND OTHER QUALITY COMPONENTS. BEST PRICES—LIVE PROFESSIONAL CONSULTATION WEEKDAYS—AUTOMATED PRICING AND INFORMATION AVAILABLE 24 HOURS. ALL PRODUCTS COVERED BY MANUFACTURER'S U.S.A. WARRANTY. AMERISOUND SALES INC., EAST: (904) 262-4000 WEST: (818) 243-1168.

### MUSICAL DESIGN D-140

THE MUSICAL DESIGN D-140 IS FINALLY AVAILABLE: •140 W/CH MOSFET AMPLIFIER, LINEAR MOSFET DRIVERS •DUAL-MONO POWER SUPPLY, 100,000 MFD STORAGE •ALL ALUMINUM CONSTRUCTION, HI-QUALITY GOLD CONNECTORS •THE MUSICALITY OF A "CLASSIC" WITH "WORKHORSE" RELIABILITY •DESIGNED BY MUSICAL CONCEPTS. MUSICAL DESIGN •ONE PATTERSON PLAZA • ST. LOUIS, MO 63031 • 314-831-5802 • SEND FOR DETAILS • DEALER INQUIRIES INVITED

**DYNACO ST70 UPGRADES.** Gold EL34 Sockets. 1215 Microfarad on-board solid state B+, triode output, more. Complete service. DoReTech Audio Services, Box 6054, South Hackensack, NJ 07606-4354. (201) 843-0488.

**ELECTRONIC CROSSOVERS, SUBSONIC FILTERS** for mono/stereo subwoofers, bi-amp, tri-amp. Free flyer: ACE AUDIO, #532 5th STREET, EAST NORTHPORT, NY 11731-2399.

"FREE CATALOG NEWSLETTER." CD's DAT, Cassettes, Reel. Write to DIRECT-TO-TAPE RECORDINGS, 14-R Station Ave., Haddon Heights, NJ 08035.

# A JANIS BASS SYSTEM

IT'S THE CHOICE  
WHEN ONLY THE BEST WILL DO

- Perfect coherence with all speakers
- Flat, calibrated low bass response
- No exaggerated, equalized bass response
- High speed transient response
- Up to four times more amplifier response
- Up to four times more speaker response

John Marovskis Audio Systems, Inc.  
2889 Roebling Avenue  
Bronx, New York 10461 (212) 892-7419

## HOW TO THINK BIG ON A SMALL BUDGET.



Introducing the VTL Integrator Line Stage Preamp. It's made for CD-based systems, but you can plug in your tape deck and tuner, too. It's compact, but filled with some remarkable circuitry. Like high quality precision parts, gold RCAs, and tape output.

But what's most impressive about the VTL Integrator is the *sound*. It's fantastic! Brilliant highs. Liquid midrange. Great bass. It's the sound every music lover dreams about, but thought he or she couldn't afford. That is, until now.

How do we do it? We keep things simple. VTL builds each one like a tank. Then Audio Advisor sells it direct, by mail order. And that simple formula keeps cost way down, but quality way, way up.

So call and order your Integrator today. If you don't agree it's a lot of pre-amp for a little money, return it within 30 days and we'll give you your money back with no hassle (we promise).

VTL Integrator Line Stage Preamp  
\$399.95. Add \$6.95 shipping in US.

CALL  
**1-800-942-0220**  
T O D A Y

Use your charge card (AMEX, Discover, MC or VISA). Many other fine products from VTL are also available. Ask for our complete catalog.



Not a store. More.

225 Oakes SW., Grand Rapids  
MI 49503 616-451-3868  
FAX #1-616-451-0709

# ONE OF THE TEN BEST BUYS IN AUDIO.



Revelation II Preamp—\$749.95

"With the Superphon equipment, the sound is smooth and detailed, and seemingly effortless. Music has a sense of clarity and openness that is utterly believable, never sounding strident or harsh... the Superphon dazzles... with an unrelenting music rightness..." —*Hi Fi Heretic*, Issue #10, "The Best Buys In Audio."



Call or write: Superphon Products Inc.  
1035 Conger #3, Eugene, OR 97402  
503-345-4226 FAX 503-345-0704  
Dealer Inquiries Invited

**SUPER  
PHON**

## FOR SALE

**LINN NAIM GOLDRING BLOWOUT.** Some new, some demo with new warranty. Many other items too numerous to mention. Write for details. MUSIC SYSTEMS, 3149 Shenandoah, St. Louis, MO 63104 (314) 773-1222.

**McINTOSH AND MARANTZ VINTAGE GEAR NOW IN STOCK AT REASONABLE PRICES! SATISFACTION GUARANTEED! EXPERT SERVICE! HI-FI CLASSICS.** NOVATO, CA. (415) 898-HIFI (415) 898-4434.

**McINTOSH Bought-Sold-Traded-Repaired. FREE Catalogue.** See our ad at the beginning of the classifieds. **AUDIO CLASSICS**, POB 176MB, Walton, NY 13856. 607-865-7200. 8AM-5PM EST Mon.-Fri.  
—Audio Advertiser for over a Decade—

**MIT, MAS MasterLink, OCOS, VdHul, Cardas cables, custom terminations, Camacs, XLR balanced, hi-flexibility tone-arm sets; Atma-Sphere OTL, Vendetta Research, custom Shallcross volume controls; Wonder Caps-solder-wire; all types of audio connectors, tonearm and chassis wires; NAV-COM; Tone Cones, many accessories-mod parts. \$1 catalog (\$3 overseas); Michael Percy, Box 526, Inverness, CA 94937; (415) 669-7181.**

**MONSTER CABLE! WE CARRY THE MONSTERS FINEST PRODUCTS. "M" SERIES, POWERLINE, ALPHA GENESIS, MORE! CALL FOR PRICES & ORDERING INFORMATION.** GOLDEN EAR HCM AUDIO, 1-800-222-3465. 1-916-345-1341.

## MUSICAL CONCEPTS

Offers the finest sounding modifications for Adcom, B&K, Hafler (including CD), Philips/Magnavox CD. With 11 years experience providing "classic" sound quality and high reliability, we have the products to beat! Don't settle for unknowns! The best is affordable! **NEW!** PA-1 circuit boards for Hafler amps, P-555 front-end, I/O assembly for Adcom GFA-555, Epoch II, Era II and Enigma II CD players, untouched in their price classes! Send for brochure of outstanding Adcom, B&K, Hafler modifications, plus Teflon® MC-21, SuperConnect III, mods for your CD player. Musical Concepts One Patter-son Plaza • St. Louis, Mo 63031 • 314-831-1822

**NITTY GRITTY RECORD CLEANING MACHINES & SUPPLIES.** IF YOU STILL BELIEVE IN VINYL THE NITTY GRITTY IS A MUST! CALL FOR PRICES & ORDERING INFORMATION. GOLDEN EAR HCM AUDIO. 1-800-222-3465. 1-916-345-1341

**PROTON D1200 AMPLIFIER, NAKAMICHI 482 CASSETTE, ADS-10 ACOUSTIC SYNTHESIZER, \$399 EA, NUMARK EC-2800 CROSS-OVER \$129. ERNIE (916) 922-2391 OR (916) 324-7118.**

## PS AUDIO & WADIA.

THESE INCREDIBLE OUTBOARD D.A.C. PROCESSORS ARE NOW AVAILABLE. CALL OR WRITE TODAY! AUTHORIZED DEALER. WAVETRACE TECHNOLOGIES, 4215 EAST BAY DR., #1205C, CLEARWATER, FL 34624. (813) 392-6423.

## PS AUDIO—SUPERB!

FAST, FREE SHIPPING! KNOWLEDGEABLE, FRIENDLY SERVICE! AUDIOQUEST, AUDIRE, CHESKY, CWD, FRIED, GRADO, KINERGETICS, LEXICON, MIRAGE, MONSTER CABLE, QUAD, SOTA, SPICA, STAX, STRAIGHTWIRE, THORENS, MORE. READ BROTHERS-STEREO, 593 KING STREET, CHARLESTON, SOUTH CAROLINA 29403. (803) 723-7276.

**QUADROUSOUND MUSICPRODUCTION** has released the first new quadrophonic recordings, of course also for the fans in the USA. Actual obtainable on analog discrete 4-channel open reel tape and compact cassette, digital if possible. Ask for more information by P.O. Box 6104 11, 2000 Hamburg 61, West-Germany.

**RANE, SENNHEISER, AKG, A-T, dbx, Fostex, SONY TAPE, LOFTECH, TRIPP-LITE, ELMO TeleCines, LOWEL, Chinon, BOGEN, Hi8 CARPENTER/GHP, BOX 1321, MEADVILLE, PA 16335-0821.**

**SAVE 40% ON HIGH-END home speakers, subwoofers, amplifiers. FREE CATALOG! CATALOG, 3021 Sangamon Ave., Springfield, IL 62702. 1-800-283-4644.**

## FOR SALE

FOR SALE McINTOSH, JBL (ALNICO), KRELL, M. LEVINSON AND OTHER HIGH END AUDIO COMPONENTS. LET ME FIND YOUR HARD TO GET ITEMS. JOHN WOLFF, 313-229-5191 24HR MACH. 6-11PM EST BEST.

**GAS EQUIPMENT OWNERS:** From repairs to complete rebuilds, we are the GAS specialists. Since 1977. Call or write: **GASWORKS** 8675 NORTHVIEW STREET, BOISE, IDAHO 83704 (208) 323 0861.

**HAFLER, TEXAS BIGGEST DEALER, TOBY CORPORATION.** Also ROTEL, TOBY HI-TECH HOME, CAR SPEAKERS, SATELLITE, SUBWOOFER SYSTEMS. 817-732-6301. 2060 Montgomery; Fort Worth 76107.

## ACTIVE ELECTRONIC CROSSOVERS

MODEL 120 CABINET & NEW 120-R "RACK AND PANEL" DESIGNS

Made to order in Butterworth bi-amp, tri-amp, or quad-amp configurations with optional level controls, subsonic filters, or summers. Filters, regulated power supplies, equalizers, are also available.

New catalog and price sheet. Free!

*DeCoursey* Eng. Lab.

11828 Jefferson Bl. Culver City, CA 90230  
PHONE (213) 397-9668

# SPEAKER COMPONENTS

## CROSSOVER COMPONENTS

**DYNAUDIO**

**ETON**

**FOCAL**



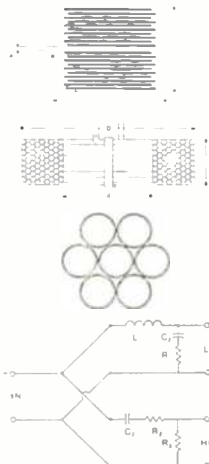
**more!**

**Peerless**

**scan:speak**

**scas**

**vifa**



### FAST CAPACITORS

Metallized Polypropylene (Non-Polarized)  
Values from 1.0 mfd to 200 mfd.  
Voltage Rating 250 VDC / 150 VAC

### SOLENI INDUCTORS

Perfect Lay Hexagonal Winding Air Cored  
Values from 10 mH to 30 mH,  
Wire Sizes from #20 AWG to #10 AWG

### HEPTA-LITZ INDUCTORS

Seven Strands Litz-Wire Constructions  
Values from 10 mH to 30 mH  
Wire sizes from #16 AWG to #12 AWG

### SOLENI CROSSOVERS

Custom Computer Design  
Passive Crossover for Professional, Hi-Fi and Car Hi-Fi, Power up to 1000 Watt

### CROSSOVER, SPEAKER PARTS

Gold Speaker Terminals, Gold Banana Plugs  
Gold Binding Posts, Crossover Terminals,  
Power Resistors, Mylar Capacitors,  
Plastic Grill Fasteners, Nylon Ty-Wraps  
Grill Cloth, Car Speaker Grills, Misc. Parts



**SOLENI INC.**  
4470 Thibault Ave  
St-Hubert QC J3Y 7T9  
Canada  
Tel.: (514) 656-2759  
Fax: (514) 443-4949

**COMPUTER AIDED DESIGN FOR ENCLOSURE AND CROSSOVER AVAILABLE TO CUSTOMER**

Product specifications and prices available upon request

## FOR SALE

Serious Audio/Videophiles demand Tripp Lite protection. Tripp Lite Power Conditioners automatically adjust varying input voltages to provide full voltage support. In addition, Isobar spike and line noise suppression is built in. CABLE CONCEPTS for the best in Audio/Video cables and equipment protection. (614) 761-8933. Fax (614) 761-8955.

**60 YEARS IN BUSINESS...WE MUST BE DOING SOMETHING RIGHT!** If it's a much-in-demand audiophile product, we're likely to have it for immediate shipment. Consult with one of our quiet experts or just order U.S.—warranted components directly. VISA/MC. Ask for Steve K. or Dan W. **SQUARE DEAL**, 456 Waverly Ave., Patchogue, N.Y. 11772. (516) 475-1857; (800) 332-5369.

## "SOUND YOU CAN TOUCH"

CLASSE • PROAC • SUPERPHON • BARCLAY • RYAN ACOUSTICS • WELL TEMPERED • KOETSU. **AUDIO EXCELLENCE**. LIVERPOOL, NY (315) 451-2707. VISA/MC/AMEX.

**STAX HEADPHONES ARE THE FINEST AVAILABLE!** WE ARE AN AUTHORIZED U.S. DEALER. CALL FOR PRICES & ORDERING INFORMATION. GOLDEN EAR/HCM AUDIO 1-800-222-3465. 1-916-345-1341.

**STRAIGHTWIRE CABLES!** WE STOCK MAESTRO & RHAPSODY. CALL FOR PRICES & ORDERING INFORMATION. GOLDEN EAR/HCM AUDIO, 1-800-222-3465. 1-916-345-1341

**SUBWOOFER. BUILD IT YOURSELF.** Add clean low base to your system. Easy to follow plans. Send \$5, R.T. AUDIO, Box 3588, Merrifield, VA 22116 "KITS AVAILABLE."

**TRANSCENDENCE THREE—Finally musical reality!** Announcing the stunning original new hybrid Fet-Valve designs from Audio by Van Alstine. The Fet-Valve Amplifiers, the Fet-Valve Preamplifiers, and the Fet-Valve CD Players. A perfect combination of tubes for voltage gain and power lets for current gain, each used ideally! The result is musical reality—the closest approach to live music in your home short of bringing in the musicians. One listen and you will be satisfied with nothing less. Now ultimate musical enjoyment is much less expensive. Write or call for our illustrated catalog. Audio by Van Alstine, 2202 River Hills Drive, Burnsville, MN 55337. (612) 890-3517.

**USED AND DEMO EQUIPMENT:** Audio Research SP-15, SP-9 Mark II, M-300 and CL-30. Counterpoint SA-11, Infinity IRS Gama, Celestion SL 700, Theta DS PRO, Mark Levinson 20.5, B&W 801 Matrix & Kimber Cable silver speaker cable and interconnects. Call **AUDITION AUDIO** for pricing and details at (801) 467-5918. Visa, MC, Amex accepted.

## LOUDSPEAKERS

**A&S SPEAKERS** imports the world's finest speaker components, crossovers, and kits: Dynaudio, Scan Speak, Focal, Morel, MB Electronics, Peerless, Polydax, SEAS, LPG, Eton. We also ship VMPS systems and kits and Parasound Amplifiers. Free literature. 3170 23rd Street, San Francisco, CA 94110. (415) 641-4573; Fax (415) 648-5306.

**ABSOLUTE SATISFACTION.** Save 50-75% on AUDIO CONCEPTS, INC. speaker kits. Sixteen models from \$139. (also assembled). Thirty day money back guarantee if not 100% satisfied. Free catalog 1-800-346-9183. Audio Concepts, Inc. 901 South 4th Street, La Crosse, WI 54601.

**ADS., NAKAMICHI, CARVER, BANG OLUFSEN, REVOX, B&W, KEF, HARMONKARDON, N.A.D., LUXMAN, HAF-LER, TANDBERG, ADCOM, DENON, KLIPSCH, YAMAHA, D.B.X., INFINITY, J.B.L. AND OTHER QUALITY COMPONENTS. BEST PRICES—LIVE PROFESSIONAL CONSULTATION WEEKDAYS—AUTOMATED PRICING AND INFORMATION AVAILABLE 24 HOURS. ALL PRODUCTS COVERED BY MANUFACTURER'S U.S.A. WARRANTY. AMERISOUND SALES INC., EAST: (904) 262-4000 WEST: (818) 243-1168.**

**AFFORDABLE HIGH-END SATELLITE SPEAKERS** designed to place on stand or bookshelves, velodyne style subwoofer, reproducing remarkable soundstage and bass. High power with low distortion. Audio Reference, 3301 Spring Mountain Road, Suite 11, Las Vegas, NV 89103. (702) 791-6968.

## DIMENSIONAL PURITY

## VANDERSTEEN AUDIO



MODEL 2C

Vandersteen Audio was founded in 1977 with the commitment to offer always the finest in music reproduction for the dollar. Toward this goal there will always be a high degree of pride, love, and personal satisfaction involved in each piece before it leaves our facilities. Your Vandersteen dealer shares in this commitment, and has been carefully selected for his ability to deal with the complex task of assembling a musically satisfying system. Although sometimes hard to find, he is well worth seeking out.

Write or call for a brochure and the name of your nearest dealer.

VANDERSTEEN AUDIO  
116 WEST FOURTH STREET  
HANTFORD, CALIFORNIA 93230 USA  
(209) 582-0324

*"The Quick Connection"*  
**B.J. AUDIO**  
991 Beechmeadow  
Cincinnati, OH 45238  
(513) 451-0112

**HOME**

- NAKAMICHI • HIK • ONKYO • CHICAGO SPEAKER STAND
- CARVER • AIWA • DESIGN ACOUSTICS • DENON • POLK
- CELESTION • ADCOM • YAMAHA • NAD • PARADIGM

**CAR**

- ALPINE
- BOSTON ACOUSTICS
- AUDIO CONTROL
- POLK AUDIO
- ROCKFORD FOSGATE
- KENWOOD
- CARVER
- SOUNDSTREAM
- NAKAMICHI
- PYRAMID

- ADS
- COUSTIC
- BAZOOKA
- INFINITY
- PRECISION POWER
- MB QUART
- DENON
- SONY
- YAMAHA
- PYLE

MC Visa or COD



Your search for refinement will end here.

**Brown Electronic Labs**  
2530 Berryessa Rd., Suite 126, San Jose, CA 95132

## Your Records will sound better and last longer.

### Audio Advisor's New "Record Doctor" vacuum cleans records... spotless! Only \$169.95

You don't have to spend \$300 or more to clean your records right—liquid application and vacuum suck-up. New "Record Doctor" exclusively from Audio Advisor cleans records right for only \$169.95.

#### Get serious

Serious audiophiles ALWAYS vacuum-clean their records—for less surface noise and fewer ticks and pops. Sound is clearer, cleaner... the music more natural. Your amplifier doesn't have to amplify noise!

#### Longer record life

Records LAST LONGER because your stylus no longer pushes particles of dust into soft vinyl grooves. You protect irreplaceable, priceless LPs for years to come. The "Record Doctor" pays for itself!

#### Sucks up debris

Record Doctor's powerful vacuum sucks up fluid, safely removing dirt, dust, grease and fingerprints. Debris is sucked up, NOT picked from one part of the record and left on another.

"I can't believe how good my records sound. Record Doctor gets rid of the grunge that was getting between me and the music," says D.P.G., Brooklyn, NY.

"You are right. Record Doctor does the job just as well as an expensive machine," writes D.K. from LA. "And I'd rather rotate the records myself anyway!" (Expensive machines have an extra motor to rotate records. Rotate them yourself and save!)



The Record Doctor™

You get the complete package: vacuum machine, professional applicator brush, and cleaning fluid—all for only \$169.95 (220v version \$189.95) plus \$8.95 shipping & handling in US. Satisfaction guaranteed—no other machine near this price cleans records better.

Charge It! Amex / Discover / MC/ Visa

1-800-669-4434

audio  
advisor, inc.

225 Oakes SW • Grand Rapids, MI 49503  
616-451-3868 • FAX 616-451-0709

## LOUDSPEAKERS

**ATC LOUDSPEAKER TECHNOLOGY, LTD.** drive units for professional monitoring and esoteric speakerbuilding. Uncompromised design and build quality. Short voice coil woofers, 3" soft dome midrange drivers, and a 24db/oct 3-way stereo electronic crossover with adjustable everything. Grover Preston, Audio Ecstasy, 231 Elwood Dr., Rochester, NY 14616 (716)865-9938 7-10PM EST.

**BEST SELECTION—50 HOME, SUBWOOFER, CAR & PRO SPEAKERKITS.** JBL, AUDAX, MOREL, SEAS, VIFA, ELECTRONIC CROSS-OVER, 64p CATALOG, \$2. GOLD SOUND, BOX 141A, ENGLEWOOD, CO 80151.

**CABINETS AND STANDS.** Large selection of high quality Speaker Cabinets and Stands. Available in Oak and Walnut. Sanded smooth, ready to finish and reasonably priced. Call or write: Grenier Cabinets, 5901 Jennings Road, Horseheads, NY 14845. (607) 594-3838.

**ELECTROSTATIC SPEAKERS OUR SPECIALTY!** Factory direct pricing! Full warranty and money back guarantee. Factory sealed. Enjoy the finest at the lowest possible price! DAVID LUCAS, INC., DEPT. A, 924 HULTON RD., OAKMONT, PA., 15139, (412)828-9049.

## FRIED SPEAKERS & KITS

STATE-OF-THE-ART! AMAZING PERFORMANCE PRICE! FREE SHIPPING. KNOWLEDGEABLE, FRIENDLY SERVICE! AUDIRE, CWD, GRADO, KINERGETICS, LEXICON, MONSTER, PS, QUAD, SPICA, STAX, THORENS, MORE. READ BROTHERS STEREO, 593 KING STREET, CHARLESTON, SOUTH CAROLINA 29403. (803) 723-7276.

**KITS, CABINETS & ASSEMBLED SPEAKER SYSTEMS.** 14" X 20" CATALOG OF HANDCRAFTED SPEAKERS. \$5.00 (REFUNDABLE WITH ANY SYSTEM ORDER). ADVANCED SOUND, DEPT. A, 711 E. MAGNOLIA AVENUE, KNOXVILLE, TN 37917. (615) 637-6694.

**LEGACY SIGNATURE II—IMAGINE THE IDEAL DIMINISHING LINE SOURCE.** BEGIN AT THE TOP OF THE TOWER WITH A SAMARIUM COBALT RIBBON FOR THE ABSOLUTE IN TRACING SPEED AND 'AIRINESS'. HAND-OFF TO A METALLIZED DOME WITH NEARLY 5 LBS. OF MAGNET STRUCTURE TO DETAIL THE PRESENCE BAND. PROVIDE THE SWEETEST VOCALS POSSIBLE WITH TWIN SEAS 6.5" MIDBASS DRIVERS. PUNCTUATE THE SUBTERRANEAN WITH THREE CARBON/POLY SUBWOOFERS. INCLUDE CARDAS LITZ, TIFFANY BIAMP INPUTS AND A TEN YEAR WARRANTY. \$2696/PR SHIPPED REFUNDABLE. OAK, WALNUT, MAHOGANY, BLACK LACQUER. HOME AUDITIONS. RTRD, 3021 SANGAMON AVENUE, SPRINGFIELD, IL 62702. (800) 283-4644.

**LOUDSPEAKER COMPONENTS-KITS.** Dynaudio, Morel, Eclipse, Focal, Peerless, Eton, Vifa, more! Crossover parts—design books also. Catalog \$1. Meniscus, 2442 28th St. S.W., Wyoming, Michigan 49509. (616) 534-9121.

## 1990 DYNAUDIO SpeakerKits

We believe SUPERIOR SOUND QUALITY promotes itself, and invite you to DISCOVER for yourself. ADVANCED AKUSTIC, 4555 PERSHING, SUITE 33•184, STOCKTON, CALIFORNIA 95207. Catalog \$1.00. • 1-209-477-5045.

**PARASOUND:** The entire line of PARASOUND pre-amps, power amplifiers and tuners is available nationally through A & S SPEAKERS, a leader in mail order sales since 1980. 3170 23rd Street, San Francisco, CA 94110. (415) 641-4573; FAX: (415) 648-5306.

## SOUND ANCHORS

### Specialty Audio Stands

**SOUND ANCHORS** stands come PREFILLED with special materials to dampen resonances and add mass, you don't have to fool with sand or shot. **SOUND ANCHORS** stands are engineered to interlace with your specific components and speakers so they sound their best...period. Special stands are available for these speakers. **Vandersteen 2-C, B&W 801 Matrix, Spica TC-50, Sota Panarama** and now **Magnepan** models MG 2C/2.5 and MG 3A. For information and the name of your nearest dealer please call (407) 724-1237.

# ABSORB YOURSELF



Sorbothane® has an incredible ability to absorb energy. This allows AudioQuest Sorbothane products to effectively damp and isolate all vibration sensitive equipment — CD/laser players and audio and video electronics.

P.O. Box 3060  
San Clemente, CA 92672 USA  
Tel: 714-498-2770 Fax: 714-498-5112



## THE FINEST IN HOME AUDIO, CAR STEREO & VIDEO EQUIPMENT

### AUTHORIZED DEALER FOR

- ADS
- ADVENT
- AIWA
- AKG
- ALTEC LANSING
- AUDIO CONTROL
- AUDIO SOURCE
- CERWIN-VEGA
- CITIZEN
- CWD
- dbx
- DCM
- DENON
- HAFLENER
- INFINITY (car)
- KENWOOD
- KICKER
- MITSUBISHI
- MONSTER CABLE
- MISSION
- ONKYO
- ORION CAR AMPS
- PHILIPS
- PINNACLE AUDIO
- POLK AUDIO (car)
- PROTON
- SAE
- SANSUI
- SONANCE
- SONY
- SOUND CRAFTSMEN
- STAX
- TOSHIBA
- TRIAD
- YAMAHA

**Sound CITY**  
Meadown Shopping Center  
Route 23 South  
Kinneton, N.J. (201) **838-3444**

MASTERCARD • VISA • AMEX • DINERS • DISCOVER

# DAT

## AUDIO GALLERY

AMERICA'S BEST PLACE TO BUY  
DIGITAL AUDIO TAPE RECORDERS

*Don't be deceived by imitators. We are  
the original DAT stereo store in the USA!  
We're the 1st and we're still the best.*

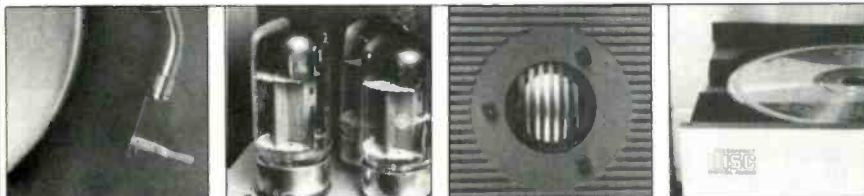
## AUDIO GALLERY

*"the friendly store"*

**213 • 829 3429**

2716 Wilshire Blvd, Santa Monica,  
CA 90403. FAX: 213 • 829 0304  
Hours: Mon-Fri 10am-6pm  
Saturday 12pm-5pm

Ask about the DATMAX 60,  
an attractive solid  
state DAT tape  
unit.



# THERE'S MORE TO HEAR AT LYRIC.

At Lyric, you'll find more great components to choose from. And along with all the brands and models on display, more knowledge and experience. More service, too. Which explains why more people around the world make Lyric their choice for high-quality audio.

Let us help improve your system with state-of-the-art models from more than 50 manufacturers. We supply 220 volt equipment, and most speaker models are available for export.

Accuphase • Ariston • Audio Research • B & W • Bryston • Cal. Labs • Carnegie • Carver • Celestion • Classe conrad-johnson • Dynavector • Entec • Goldmund • Infinity (including IRS) • JVC • JSE Infinite Slope • Koetsu Magneplanar • M & K • Manley • Mark Levinson • Mirage • MIT • Mod Squad • Mondial • Monster Cable • Motif NAD • Nakamichi • Oracle • Pioneer • Proton • Quad • Rega • Revox • Rogers • Shure • SME • Sonance Sonographic • Sony ES • Sota • Spectral • Stax • Vandersteen • Velodyne • VPI • VTL • Well Tempered and other fine brands



1221 Lexington Ave.  
New York, NY 10028  
212-439-1900  
800-848-4981

2005 Broadway  
New York, NY 10023  
212-769-4600

146 East Post Road  
White Plains, NY 10601  
914-949-7500



## LOUDSPEAKERS

**Speaker Box Builders Program for the IBM PC XT/AT and Commodore 64 computers.** Very easy to use, even for beginners. Calculates ported boxes, closed boxes, port sizes & speaker tests. Includes manual and book. ONLY \$25.00 Jordan Century P.O. Box 1347 Odessa Texas 79761.

## COMPACT DISC PLAYERS

### COMPACT DISC PLAYERS

Knowledgeable, friendly service! Finest brands. **FREE** shipping. **READ BROTHERS STEREO**, 593 King Street, Charleston, South Carolina 29403. (803) 723-7276.

**PHILIPS REFERENCE CD PLAYERS NEW CD-80 W/S1 CROWN CHIP SET, NEW BITSTREAM CD-840, LHH-1000 STEREOPHILE RECOMMENDED COMPONENTS CLASS A [VOL. 12 NO. 6], CD-60, CD-50, NEW CD-40, CDV VIDEO PLAYERS CDV-488, CDV-487, FOR FREE LITERATURE CALL 301-890-3232, J S AUDIO, ONE CHILDRESS COURT BURTONSVILLE, MARYLAND 20866, WE HONOR VISA, MASTERCARD, AMERICAN EXPRESS, DISCOVER.**

## COMPACT DISCS

**CUSTOM ELECTRONIC CROSSOVERS.** 6 to 36 dB/Oct. Also Snell, Magnepan versions. DB Systems, POB 460, Rindge, NH 03461. (603) 899-5121.

**FREE CD/RECORD OFFER! FREE CATALOG!** "Worlds Best Brass Catalog" (Fanfare) Outstanding Brass, Woodwinds, Strings, Orchestra. CRYSTAL RECORDS, Sedro-Wooley, WA 98284.

**WHICH ONE GOT THE RAVES?** Catalog of Award-Winning Classical CDs. Your handiest guide to outstanding recordings \$10.00. (Sample pages available) KEN'S KOMPENDIUM, 2400 Hawthorne Dr., Atlanta, GA 30345.

## RECORDS

**RECORD COLLECTORS SUPPLIES.** REPLACEMENT JACKETS, INNER SLEEVES, 78 RPM SLEEVES, OPERA BOXES, LASER DISK BOXES, ETC. FREE CATALOG. CABCO PRODUCTS, BOX 8212, ROOM 662, COLUMBUS, OHIO 43201.

**WANT LISTS WANTED.** Over 100,000 Rock, Soul & Country LPs. Over 10,000 cassette titles also available. ALL NEW. Send us your want lists or call Toll Free: 1-800-847-5008 or FAX 207-285-7359. MAINE RECORD SALES, P.O. BOX 1054, BANGOR, ME 04401.

## WANTED TO BUY

**AAAWAYS PAYING TOP \$\$ FOR TUBE OR S.S. McINTOSH, TUBE MARANTZ AND FISHER, SEQUERRA, M. LEVINSON, KRELL, C.J., ARC, ALL JBL PRE-1975 PARTS AND SYSTEMS, EV PATRICIANS, GEORGIANS, EARLY ALTEC AND??? MFSL, NAUTALUS AND OTHER 1/2 SPD. MASTERS, 24HR ANS. MACH. 1-800-628-0266, 6-11PM EST BEST.**

**Always Paying Best For: Studer, CAL, CJ, Levinson, McIntosh, Marantz, Audio Research, Quad, Leak, Sequerra. Vintage speakers, units, from Western Electric, Tannoy, JBL, Altec, Jensen, EV. Tel: 818/701-5633 David Yo, P.O. Box 802, Northridge, Ca. 91328-0802.**

**GET OFFERS FIRST, THEN CALL! MARANTZ, MCINTOSH, ALL TUBE COMPONENTS, VINTAGE SPEAKERS, HI-END. OUTBIDDING EVERYONE ON CERTAIN ITEMS. N.Y.S.I. (718) 377-7282 WEEKDAY AFTERNOONS.**

**HI-FI SUPPLIES—PAYS CASH FOR LEVINSON, ARC, C.J., KRELL, SPECTRAL, ROWLAND & THRESHOLD. (212) 219-3352. 7 DAYS 10AM-6PM (NY)**

# TRADE IN AND TRADE UP



Convert your old AudioQuest cartridge to one of our current state-of-the-art models. Our very liberal trade in policy allows you from 35% to 125% of the value of your cartridge towards a new AQ cartridge. Any AudioQuest MC cartridge ever made qualifies!

P.O. Box 3060  
San Clemente, CA 92672 USA  
Tel: 714-498-2770 Fax: 714-498-5112

**aq**  
audioquest

## What price Performance?

Modular speaker systems that offer high accuracy and flexibility!

Prices start at \$450.00

# Lantana

P.O. Box 1958 • Garden Grove, CA 92642  
(800) 234-TADS (8237)

## WANTED TO BUY

I WILL PAY RETAIL for all tube MARANTZ or used McINTOSH tube or solid state. Need not work. (504) 885-8988 days.

**audio-technica** *Track*

**YOUR SEARCH IS OVER!**

We specialize in hard to find phono cartridges and original replacement styli only!!

**(800) 221-0906**

CALL TOLL-FREE FOR FREE PRICE QUOTES AND VISA/MC ORDERS N.Y. STATE (516) 599-1112

SEND SELF ADDRESSED STAMPED ENVELOPE FOR OUR FREE CATALOG.

**LYLE CARTRIDGES**  
Dept. A, Box 158  
Valley Stream, N.Y. 11582

Phones Open Mon-Sat 9 am-8 pm

**SHURE** **STANTON**

TIPTOES  
CRADLE  
LASC  
UNSTEPPABLE  
ortofon

Dynavector  
Bang & Olufsen  
PICKERING

## Does your system sometimes sound different for no apparent reason?

The reason could be your power. A refrigerator or air conditioner, even in another part of the house, may cause voltage to vary whenever they kick on or off. Or you may be getting line noise—electrical interference that your preamplifier and amplifier amplify and send on to your speakers.

Solution? Tripplite LC-1800. It regulates voltage so it's constant—not too low, not too high. Full voltage—even in brownouts. LEDs show you what Tripplite is doing!

Tripplite's patented ISOBAR circuits provide three "banks" of isolation, two receptacles per bank. You can eliminate interference between critical components. It's like putting your CD player, preamp, and power amp all on separate lines. Sonic benefits may be subtle... but real.

### Protection, too

And Tripplite prevents spikes and power from damaging your equipment. This protection is absolutely essential if you leave any of your gear on all of the time.

### Take a Power Tripple—No Risk!

Try the Tripplite LC-1800 for 30 days. If not satisfied with the performance (and protection), return it for a full refund of your purchase price. Made in USA by Tripple Manufacturing Co., Est. 1922. Only \$299.00 plus \$9.95 shipping in the US. If you want a clean musical signal, start with clean, consistent power. Order now.



Charge It! Amex / Discover / MC / Visa  
**1-800-942-0220**

**audio advisor, inc.**

225 Oakes SW • Grand Rapids, MI 49503  
616-451-3868 • FAX 616-451-0709



# FREE AUDIO CATALOG

- Cambridge SoundWorks speakers & music systems by Henry Kloss, Audio Hall of Fame member, and founder of AR, KLH & Advent.
- Special prices on Philips And Cambridge Soundworks component music systems.
- Toll-free expert advice, service & ordering 7 days a week.

## 1-800-AKA-HIFI CAMBRIDGE SOUNDWORKS

Suite 104JUL, 154 California St., Newton, MA 02158

\* 9AM to midnight (ET), seven days a week. In Canada, call 1-800-525-4434. Fax: 617-332-9229. Outside the U.S., Canada, 617-332-5936.



### SINGERS! REMOVE VOCALS FROM RECORDS AND CDs!

**SING WITH THE WORLD'S BEST BANDS!**  
An Unlimited supply of Backgrounds from standard stereo records! Record with your voice or perform live with the backgrounds. Used in Professional Performance; yet connects easily to a home component stereo. This unique product is manufactured and sold Exclusively by LT Sound - Not sold through dealers. Call or write for a Free Brochure and Demo Record.

**LT Sound**, Dept. AU-3, 7980 LT Parkway  
Lithonia, GA 30058 (404) 482-4724  
Manufactured and Sold Exclusively by LT Sound  
**24 HOUR PHONE DEMO LINE: (404) 482-2485**

### WANTED TO BUY

IT'S WORTH IT CALLING ME! MCINTOSH, MARANTZ TUBE AMP, MCINTOSH SOLID STATE, WESTERN, JBL HARTSFIELD, EV PATRICIAN, JENSEN, TANNY, ALTEC, TRUSONIC, SPEAKER & HORN, OLD EQUIPMENT. WILL PAY TOP CASH. HENRY CHANG, 115 S. NICHOLSON AVENUE, MONTEREY PARK, CA 91754. (818) 307-7372. FAX: (818) 288-1471 L.A.

TOP PAYING FOR MCINTOSH, MARANTZ TUBE AMP McIntosh Solid State, Western, JBL, Altec, Tannoy, EV, Jensen, Speakers & Horn, EMT Turntable, Ortofon Arm. Temma—(516) 935-2605, (516) 496-2973.

WANTED: ELECTRONIC CROSSOVERS, PIONEER SF-850, D-23. SPEC-4 AMPLIFIER. AL (916) 920-8339. 1415 OAK NOB WAY, SACRAMENTO, CA. 95833.

WANTED: MCINTOSH, MARANTZ (TUBE), KRELL, ARC, MARK LEVINSON & OTHER HIGH-END EQUIPMENT. TRADE ALSO POSSIBLE. YANG (201) 935-4026 (NJ)

### WANTED TO BUY

WANTED: KRELL, LEVINSON AMPS, PRE-AMPS, KOVERS, AUDIO RESEARCH, CONRAD-JOHNSON, BAND & OLUFSEN, MCINTOSH, VINTAGE MARANTZ, TANNY. (718) 387-7316 OR (718) 384-4667.

WANTED: WESTERN ELECTRIC, JBL, MARANTZ OLD EQUIPMENT. SUNLIGHT ENGINEERING COMPANY: 213-320-7020, 22130 SOUTH VERMONT AVENUE, #A, TORRANCE, CA 90502.

WANT—JBL Hartsfield, EV Patrician, Brociner Transcendent, Singles OK, McIntosh, Marantz & other tube equipment. Larry Dupon, 2638 W. Alblon, Chicago, IL 60645. (312) 338-1042 evenings.

### AUDIOPHILE RECORDS

#### AUDIOPHILE LP'S AND CD'S

##### IN PRINT

Mobile Fidelity, Reference Recording, Sheffield Labs, Chesky, Wilson, M & K, American Gramophone, Proprius, OPUS 3, Gemini, Super Analogue, Concord, ATR Mastercut, Harmonia Mundi, Linn Re-cut, EMI, Waterlily, North Star, Odlin, BIS, Hungaroton, Chandos, CMP, Hyperion, Japanese and British Imports (lps). Many TAS recommended LP's!

##### OUT OF PRINTS

Nautilus, Super Disks, Nimbus, UHQ, Lyrita, MFSL, Stones, Sinatra Boxes, Direct to Disc by Crystal Clear, Umbrella, EMI, RCA LSC, Mercury SR, Casino Royal, CBS Mastersounds, Etc.

##### AUDIOPHILE CD'S

MFSL Gold "Ultra Disk", Bainbridge "Colossus", Elite "Stereo play", Three Blind Mice, East Wind, DMP, Dorian, Delos, plus the above labels.

##### ACCESSORIES BY:

Nitty Gritty, LAST, Audio Quest

For latest, most descriptive catalog send \$3.00 for U.S. or \$5.00 for Canada/overseas. Includes \$4.00 U.S. or \$6.00 Canadian/overseas DISCOUNT CERTIFICATE on next purchase.

##### Call for catalog

Acoustic Sounds

P.O. Box 2043, Salina, Kansas 67402  
913-825-8609/FAX 913-825-0156

ORDER DESK: 1-800-525-1630

**AUDIOPHILE RECORD WAREHOUSE!** Out-Of-Print Direct-To-Disc, Halfspeed, Quix II & Import Pressings. Great selection of In-Print Records & CD's. Quantity Discounts! Call for Free Catalog. Elusive Disc, 5346 N. Gullford Ave. Indianapolis, IN. 46220. (317) 255-3446.

# REVAMP YOUR AMP.



### We make good amps great.

At Professional Mod Service, we take your Adcom, B&K, or Hafler amp and make the bass more powerful and the mids and highs clearer. By the time we're through, your amp will sound as good as amps costing *twice as much*.

How do we do it? We make real improvements, developed with factory engineers. We use nothing but premium materials. And our technicians are real pros with years of experience.

#### Pickup service.

Call us and we'll pick up your amp. Or send it to us with \$199.95 plus \$14.95 shipping. We'll revamp your amp, spec it out, and return it insured.

**1-800-334-0295**

Amex/Visa/MC/Discover

#### Professional Mod Service, Inc.

225 Oakes SW  
Grand Rapids, MI 49503  
616-451-3527 FAX 616-451-0709



MY COST, PLUS ONE DOLLAR!

MUST SELL MY EXCESS INVENTORY OF  
ACOUSTAT CELESTION DL  
ADCOM CONRAD-JOHNSON  
AR DAHLQUIST M-900  
ARISTON E.S.B.  
B&W ROTEL  
B&W STANDS SONOGRAPHIE

CALL NOW 1 / TOLL-FREE - 800-438-6040

## We're Esoteric because . . .

We prefer to part from the mainstream to bring our customers components that reveal more of the music *naturally!* "Product name value" does not guarantee musical accuracy: therefore, we choose components designed and manufactured by people dedicated to "high fidelity" instead of "high profile". Our premier speakers are the Diapason by Shabinian, the TDL Monitors, the Apogee Diva & the Altec BIAS 550.

ALTEC LANSING • APOGEE • BARCLAY • BEDINI • COUNTERPOINT • LEXICON  
MARANTZ • PRECISE • ROTEL • JEFF ROWLAND • SHAHINIAN • TDL • WADIA • AND MORE  
ESOTERIC SOUND, COVENTRY COMMONS RTE 347, STONY BROOK, N.Y. 11790 516-689-7444

## AUDIOPHILE RECORDS

**THE BINAURAL SOURCE**—Exclusive one-stop source of true binaural recordings for startling headphone listening (also speaker-compatible). Classical/jazz/drama/sound environment albums; 43 recordings, in all three formats, from U.S. & Germany. Free catalog: Box 1727A, Ross, CA 94957. (415) 457-9052

## BUSINESS OPPORTUNITIES

**READ BOOKS for pay!** Call 1-900-847-7700 (\$0.99/min) or Write: PASE — RQ2, 161 Lincolnway, North Aurora, IL 60542

## BLANK TAPES

4.95 SHIPPING ANY SIZE ORDER UPS 1-800-245-6000

+	TDK	DENON	OCTAVE	FUJI	SONY	MAXELL	+		
SAK 90	2.00	MDR-100	1.50	SE-40	98	PLA P100	1.50	MAXELL 90	1.50
SAK 90	2.00	MDR-100	2.00	SE-40	98	PLA P100	1.50	MAXELL 90	1.50
SAK 90	2.75	MDR-100	2.75	SE-40	115	SONY METAL 90	2.00	MAXELL 90	2.00
ADFC	2.00	MDR-100	2.00	SE-40	1.00	SONY METAL 90	2.00	MAXELL 90	2.00
SA 90	1.50	MDR-100	2.15	SE-40	1.70	SONY METAL 90	2.20	MAXELL 90	2.20
SA 90	1.50	MDR-100	1.20	SE-40	1.00	SONY METAL 90	2.00	MAXELL 90	2.00
SA 90	1.75	MDR-100	1.20	SE-40	1.00	SONY METAL 90	2.00	MAXELL 90	2.00
MAX 100	1.50	MDR-100	1.50	SE-40	1.00	SONY METAL 90	2.00	MAXELL 90	2.00
ADFC	1.50	MDR-100	1.50	SE-40	1.00	SONY METAL 90	2.00	MAXELL 90	2.00
ADFC	1.50	MDR-100	1.50	SE-40	1.00	SONY METAL 90	2.00	MAXELL 90	2.00
D-90	98	MDR-100	1.50	SE-40	1.00	SONY METAL 90	2.00	MAXELL 90	2.00
D-90	98	MDR-100	1.50	SE-40	1.00	SONY METAL 90	2.00	MAXELL 90	2.00
MAX 100	1.50	MDR-100	1.50	SE-40	1.00	SONY METAL 90	2.00	MAXELL 90	2.00
MAX 100	1.50	MDR-100	1.50	SE-40	1.00	SONY METAL 90	2.00	MAXELL 90	2.00

ALL WOOD 1.20  
T120 2.00  
HFC 2.00  
HFC 2.00  
EY100 2.00  
8809720 2.00

1-800-245-6000  
112 263 8071  
800 245 6000

we will Beat Any Price of the Total Order Including All Shipping & Handling Charges by 1% + \$5 Shipping Any Size Order, COD Add \$3.00  
All Tapes Home U.S. Warehouse Please Print Serial Call  
TAPE WORLD 220 SPRING ST. BUTLER, PA 16001  
DEALER PROGRAMS ON DENON, TDK AND OCTAVE

1800' OR 2400' AMPEX REELS USED ONCE-SAMPLE: \$3.00. NEW MAXELL REELS/CASSETTES. SPECIAL: TDK SA90 \$1.79. AR100: \$1.55. FREE FLYER. AUDIO TAPES, BOX 9584-A, ALEXANDRIA, VA 22304. (703) 370-5555. VISA/MC.

## DAT

Custom DAT tapes. Classic and theatre pipe organ digital master recordings: Brochure 50¢ & SASE. T-V RECORDING, BOX 70021, SUNNYVALE, CA 94086.

## CAR STEREO

"STEREO WORLD" is your discount sound source with super deals on the following car and home stereo lines: Technics, Panasonic, JVC, Sony, Pyle, Pioneer, Sherwood, Hi-Fonics, Blaupunkt, Kenwood, Harmon Kardon, Autotek, and many others. Also full line of installation kits. Please call or write for free catalog. Free UPS in 48 states. 10AM-6PM Mon-Fri. Visa/MC; COD accepted. "Our 4th year." P.O. Box 596, Monroe, NY 10950 (914) 782-6044.

W.E.D.—Super deals on Car Stereo. ADS \* ALPINE \* AUDIO CONTROL \* AUTOTEK \* BAZOOKA \* BLAUPUNKT \* BOSTON \* CARVER \* COUSTIC \* EARTHQUAKE \* H/K \* HIFONICS \* INFINITY \* JBL \* KENWOOD \* KICKER \* MB QUART \* MPX \* NAKAMICHI \* ORION \* PHASE LINEAR \* PIONEER \* POLK \* PYLE \* PRECISION POWER \* ROCKFORD-FOSGATE \* SONY \* SOUNDSTREAM \* SHERWOOD \* SANSUI \* TECHNICS \* YAMAHA. Monday-Friday 10AM-6PM (718) 370-1303, 43 Racial Court, Staten Island, NY 10314.



## THE ULTIMATE DYNAMIC RANGE CONTROLLER

5-BAND STEREO EXPANDER CPU MICROCOMPUTER CONTROL  
5-BAND STEREO COMPRESSOR 5 MEMORY SETTINGS & BACKUP  
5-BAND TRANSIENT RECOVERY 106 dB PEAK-A-WEIGHTED NOISE  
INDIVIDUAL BAND PRESETS FULL-FUNCTION WIRELESS REMOTE  
LINEAR & NON-LINEAR MODES MULTI-VOLTAGE POWER SUPPLY  
EXCLUSIVE DOWNWARD EXPANSION EIA RACK MOUNTING & MORE

- Add impact and crispness to any material **ORIG. \$1400.00**
- Reduce hiss from analog-mastered CDs **NOW**
- Restore lost dynamics on FM, TV, LPs, etc. **\$799.00**
- Compress digital recordings with no side effects
- Ultra high-end specs w/latest dbx VCA technology

Limited availability. Exclusive Distributor: Audio Marketing  
P.O. Box 886, Culver City, CA 90232 (213) 839-2000  
24-month factory warranty Free shipping on prepaid orders

## INVENTIONS WANTED

A NEW IDEA? Call NATIONAL IDEA CENTER of Washington D.C. FREE INFORMATION--1(800) 247-6600 EXT.155. Come see THE INVENTION STORE!!

INVENTIONS/NEW PRODUCTS/IDEAS WANTED: Call TLCI for free information 1-800-468-7200, 24 hours/day—USA/CANADA.



CD & LP

◆ **1ST RATE RECORDINGS & PERFORMANCES**

◆ **MUSIC OF OUR CENTURY & THE PAST**

◆ **SOMETHING DIFFERENT AND WORTH LISTENING TO**

◆ **RECORDED MAGIC**  
distributed by

**UNIVOCAL CORPORATION**

2016 FLINTBURY CT. • SAN JOSE, CA 95148  
(408) 270-6033 • FAX (408) 270-6039  
IN CANADA INTERLINEAR  
105 RIVIERA DR., #3 • MARKHAM, ONTARIO, L3R5J7  
(416) 479-1893

## Say "G'day" to Greencorp's family of Australian tapes.

**THE GOOD STUFF**—our great XDS tape that the big recording companies (Philips, EMI, & overseas divisions of RCA) buy from Greencorp for their music cassettes.

**THE BETTER STUFF**—Music-PLUS, the best-sounding tape you ever heard, short of genuine chrome. Its custom formulation produces a higher frequency response and lower noise level than the heavily advertised brands.

**THE BEST STUFF**—genuine chrome tape coated with Dupont's chromium dioxide powder. CD-grade, delivering much quieter output than so-called "chrome-bias" ferric oxide products.

Greencorp tape is the right stuff at the right price. . . order your blanks today!

	QUANTITY	25	100	500
<b>XDS Music Grade</b>	C12	.39	.28	.26
	The C32	.46	.35	.32
	Good C47	.51	.39	.35
	Stuff! C62	.58	.45	.42
	C92	.68	.55	.52
<b>Music-PLUS</b>	C12	.44	.32	.30
	The C32	.54	.42	.39
	Better C47	.58	.45	.41
	Stuff! C62	.66	.52	.47
	C92	.77	.64	.57
<b>Genuine Chrome</b>	C12	.53	.41	.39
	The C32	.63	.51	.48
	Best C47	.68	.55	.51
	Stuff! C62	.75	.61	.57
	C92	.98	.85	.80
	C100	1.04	.88	.82

Norelco-type clear plastic boxes, sturdy commercial grade .18 .16 .15  
Self-adhesive, white cassette labels and blank inserts \$3.00 per 100

VHS Video Cassettes: prices each in quantity

QUANTITY	20	60	120
Premium T-015	1.70	1.55	1.45
Grade by T-030	1.80	1.65	1.55
length T-060	2.10	2.00	1.90
T-120	2.80	2.70	2.60

**TELEPHONE ORDERS:**  
**TOLL FREE: 1(800) 972-0707**  
Local: (305) 429-9225  
**FAX ORDERS: (305) 429-9214**

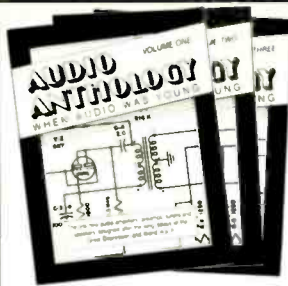
- \* F.O.B. Deerfield Beach, FL. Taxes (if any) plus shipping extra. CALL FOR SHIPPING CHARGES & LARGER QUANTITY PRICES.
  - \* Minimum quantities are 25 per size (audio), and may be mixed to get larger quantity discounts.
  - \* Orders of 6,000+ shipped road freight at cost.
  - \* We accept company or personal checks, or charges to VISA, MASTERCARD, and AMERICAN EXPRESS. (possible surcharge)
  - \* Prices subject to change without notice.
- SATISFACTION GUARANTEED!** If not satisfied for any reason, return the cassettes within 30 days for a full refund of the unused portion.

**GREENCORP USA INC.**



The Right Stuff from Down Under

Suite 105, 1015 W. Newport Center Drive,  
Deerfield Beach, Florida 33442



## AUDIO ANTHOLOGIES from the '40s and '50s!

In these volumes of *Audio Engineering's* best articles from 1947-55, the exciting world of that golden era comes to life on every page. Vol. 1: 38 articles; Vol. 2: 45; Vol. 3: 43. Complete with many classic photos and diagrams. **\$16.95 each; set of 3, \$42.** Please add \$1.75 S/H for one book, 50¢ each additional. MC/Visa welcome. Dealer inquiries invited.

### OLD COLONY SOUND LAB

PO Box 243, Dept. A96, Peterborough, NH 03458-0243  
(603) 924-6371 / 924-6526 FAX: (603) 924-9467

### RETAIL MART

**HIGH-END AUDIO IN SALT LAKE CITY:** Audition Audio features speaker systems by Magneplanar, Vandersteen, Martin Logan, Celestion, Spica, Infinity IRS, Electronics by Audio Research (new Classic 30 & 60 in stock), Mark Levinson, Aragon, Counterpoint, NAD, Adcom, Luxman, Front ends by Versa Dynamics, VPI, Well-Tempered, SME AR, Accuphase CD players. Also Sumiko, MIT, Audioquest, etc. Three hard-wired sound rooms including a new room built for the Infinity IRS. **2144 Highland Dr., Suite 125, SLC, UT 84109. (801) 467-5918.** Visa, MC, Amex accepted.

**WE HAVE THE FINEST SHOWROOM** in our area with the best selection of audio/video components available. We represent Adcom, Infinity, Thorens, NAD, Polk, Yamaha, Canton, Luxman, Klipsch, SONY ES, and more. **CONTINENTAL SOUND, 98-77 Queens Blvd., Forest Hills, NY 11375. (718) 459-7507.**

### DECALS/EMBLEMS

**CUSTOM EMBROIDERED EMBLEMS, PINS, DECALS.** Free catalog quotes. Rush sketch. **STADRI, 61AU JANE STREET, NEW YORK, NY 10014. (212) 929-2293.**

### PARTS AND ACCESSORIES

**AUDIOPHILE QUALITY PARTS:** BOURNS VOLUME CONTROLS, GRAYHILL ROTARY SWITCHES, RESISTA 1% RESISTORS, ALCO TOGGLE SWITCHES, WONDER CAPS-WIRE-SOLDER, RAM LABS TUBES, HITACHI MOSFETS, WBT AND MONSTER RCA CONNECTORS, MIT WIRE, TEC-200 FILM, GRAMOLIN 2% CONTACT SPRAY, TOROIDS, ALUMINUM ENCLOSURES AND KNOBS, PASSIVE PREAMP AND POWER SUPPLY KITS, PLUS MUCH MORE! SEND \$2 FOR CATALOG (REFUNDED WITH FIRST ORDER) TO: **WELBORNE LABS, 6836 SO. UNIVERSITY BLVD., #70, LITTLETON, CO 80122.**

### MISCELLANEOUS

**TERMPAPER** assistance, 15,278 papers available! 306-page catalog—rush \$2.00. Research, 11322 Idaho #206AD, Los Angeles 90025. TOLL FREE HOTLINE: (800) 351-0222 (California: (213) 477-8226).



**HI-FI HEAVEN**

**BRANDS AND MODELS ON DISPLAY**

- KRELL KSA-250B & KSA-150B
- WADIA X-32 D/A & WT-2000 TRANSPORT
- APOGEE DIVA
- CAL ARIA MK III
- MAUGHANBOX EQ FOR B&W 801 & 802 MATRIX
- ACOUSTAT SPECTRA 11
- MAGNUM FF-101A TUNER

1917 S. WEBSTER  
GREEN BAY, WI 54301  
(414) 437-8727

### PUBLICATIONS

**MOVIESOUND NEWSLETTER.** The state of film audio tracks in theaters and at home. Send \$2 for two sample issues. PO Box 7304, Suite 269A, No. Hollywood, CA 91603.

### SERVICES

**Audio Repairs and Restorations** by Cliff Ramsey of Audio Classics, former Senior Service Technician at McIntosh. **Tuner Modifications** by Richard Modalleri, independent consultant to Audio Classics, inventor, and former Senior Engineer at McIntosh. Over 55 years combined experience. **AUDIO CLASSICS, 8AM-5PM EST Mon.-Fri. United States Post Office Building, POB 176SAR, Walton, NY 13856 607-865-7200.**

—Audio Advertiser for over a Decade—

### MAIL ORDER

**A BARGAIN: STAX SIGN/LAMBDA \$1,395.** PRO/LAMBDA (#3) \$799, PRO/LAMBDA (#1) \$499, SIGN/SRM1MK2 \$998, SIGN SRD7 \$675, 220V AVAILABLE. GRACE 747, F9E (Super) #109, F9ERUBY \$175, DENON 103D \$149, FR1MK3F \$235, ZEISS BINOCULARS: ALL UNUSED. (212) 966-1355.

**ADS., NAKAMICHI, CARVER, BANG OLUFSEN, REVOX, B&W, KEF, HARMON KARDON, N.A.D., LUXMAN, HAF-LER, TANDBERG, ADCOM, DENON, KLIPSCH, YAMAHA, D.B.X., INFINITY, J.B.L. AND OTHER QUALITY COMPONENTS. BEST PRICES—LIVE PROFESSIONAL CONSULTATION WEEKDAYS—AUTOMATED PRICING AND INFORMATION AVAILABLE 24 HOURS. ALL PRODUCTS COVERED BY MANUFACTURER'S U.S.A. WARRANTY. AMERISOUND SALES INC., EAST: (904) 262-4000 WEST: (818) 243-1168.**

**THE BEST RECORD RACK IN AMERICA.** Stackable, portable, oak units hold LP's, CD's and tapes. Free Mailorder Brochure. (please mention Audio). Per Madsen Design: (415) 928-4509. P.O. Box 330101, San Francisco, CA 94133.

High-end and hard-to-find audio components. New and used. Foreign and domestic. Low, low prices! **AUDIO AMERICA** (Virginia). Call 1-703-745-2223.

**CALL US  
FOR QUALITY AUDIO  
AT THE LOWEST PRICES  
WITH FAST SERVICE,  
EVEN ON ESOTERIC ITEMS**

**SOUND ADVICE . . . without the price**



**AUDIO** (914) 666-0550

**OUTLET** P.O. Box 673  
Bedford Hills, New York 10507-0673

### Firm (Reader Service No.) Page

Acoustic Research (1)	Cover II
Adcom (2)	77
AKG Acoustics	112
Allsop (3)	45
Audio Advisor (4)	87
Audio Research (5)	69
Audiostream (6)	17
B & K (7)	6
BMG	24 a&b
Cambridge Soundworks (8)	70 & 71
Cerwin-Vega (9)	79
Columbia House	39
Counterpoint (10)	57
Denon/A&M Records (11)	103
GRP (12)	111
Hafler (13)	25
Isononics (32)	83
J & R Music World (14)	102
Kinergetics Research	7
Levinson	Cover IV
Madrigal	109
Martin-Logan	27
Maxell (15)	8 & 9
McIntosh (16)	10-15
Mobile Fidelity (17)	101
MTX (18)	49
Music Interface Technology (19, 31)	104, 112
Naim Audio	53
Onkyo	Cover III
Panasonic (33)	29
Pioneer (20)	30 & 31
Polk (21)	46 & 47
Proceed	3
Reel to Real (22)	5
Sonance (23)	58 & 59
Sony	22 & 23, 64 & 65
Sound City (24)	113
Soundcraftsmen (30)	32 & 33
Stereo Exchange (25)	93
Stillwater (29)	4
TDK (26)	18 & 19
The Absolute Sound (27)	108
U.S. Army	67
Velodyne (28)	43
Windham Hill	105
Wisconsin Discount Stereo	97
Yamaha	1
Touch Tone Participant	

# How to make an Onkyo CD player as good as its competition.

Eliminate independent power supplies

Remove fiber optic modules from signal path

Disconnect Accubit calibration circuit

Replace die cast metal tray with cheap plastic

If we wanted to make an Onkyo CD player as good as our competition, it wouldn't be too hard.

We'd have to remove our isolated transformer with its three independent power supplies for the transport, digital and analog circuits. As a result, tracking stability suffers, while signal interference measurably increases (turning music peaks into music mounds).

There'd be no need for Onkyo's proprietary Accubit calibration circuit. Which means there'd be no low level dynamics—no sense of depth or dimension to the music. So Carnegie Hall sounds like Carnegie's closet.

Taking out Onkyo's Opto-Coupling fiber optic

For More Information

41244

Call 1-800-553-4355

modules and using conventional circuit wiring would insure that a little harsh digital noise mixes in with the music. Perfect for "grate audio."

Gone would be the die cast aluminum tray Onkyo uses, replaced by a plastic version that leads to further diminished sound quality and a wear, tear, it's-due-for-repair syndrome.

Now, we could do all these things to an Onkyo CD player. But then we wouldn't have a component as masterful as our new DX-5700 with Dual Linear 18 Bit D/A Converters and Accubit<sup>2</sup> Calibration.

At Onkyo, all our CD players are built to be better. That's a difference you can hear—and see.

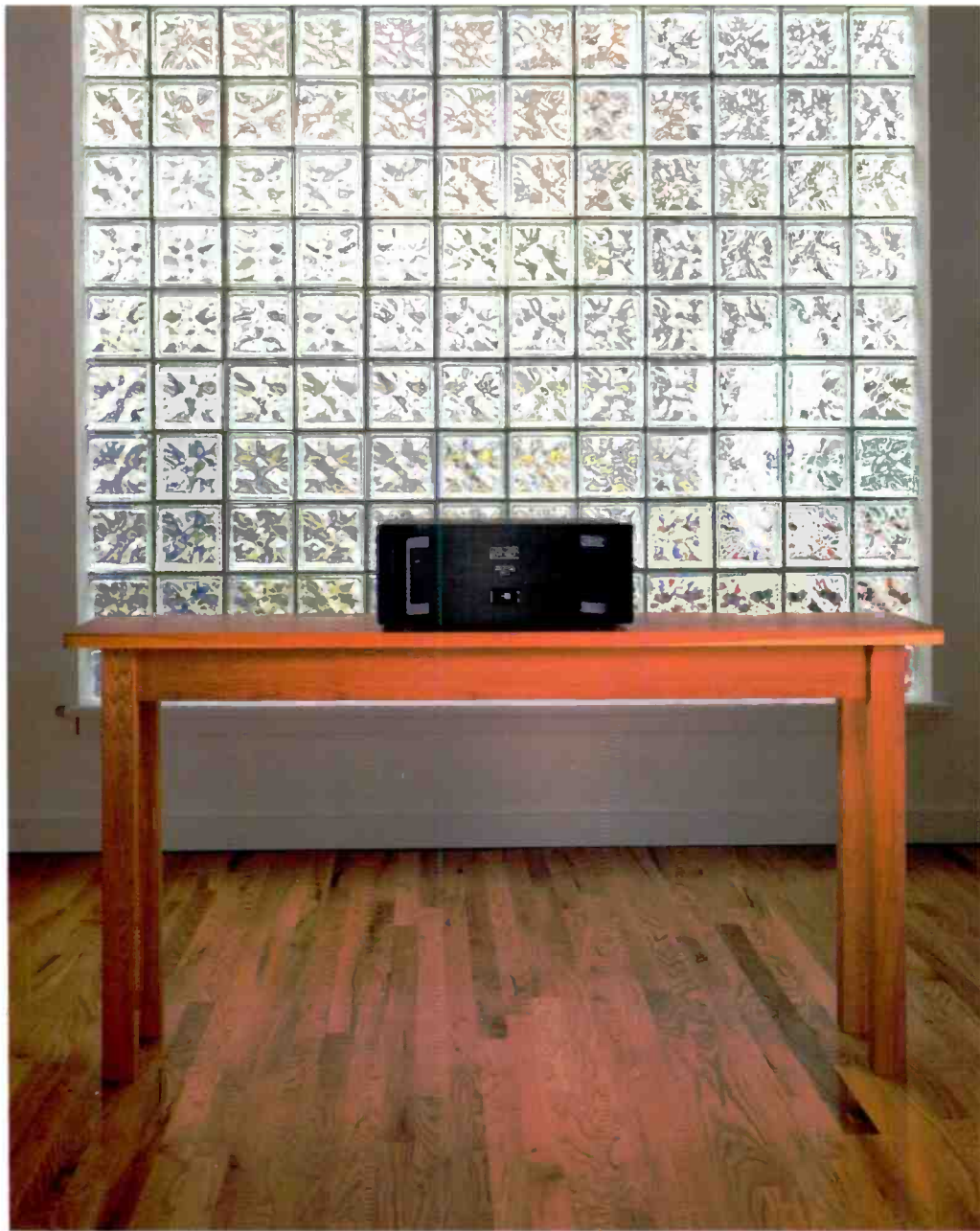


## ONKYO

200 Williams Drive, Ramsey, N.J. 07448 201-825-7950

T H E M A X I M U M M I N I M U M

NO 29



**Musical enjoyment,  
performance,  
reliability, durability,  
beauty, stability,  
compatibility, value,  
pride of ownership.**

Size, weight, heat,  
distortion, downtime,  
coloration, veiling,  
listening fatigue,  
consumer regret.

mark  
levinson

Mark Levinson® products are designed and manufactured by **MADRIGAL AUDIO LABORATORIES**  
P.O. Box 781, Middletown, CT 06457 FAX (203) 346-1540

Table courtesy of Fairhaven Woodworks.