

Audio

MARCH 1988 • \$2.50

TANDBERG 3001 A FM TUNER

SETS NEW STANDARDS
OF PERFORMANCE

INTERVIEW

GRUSIN & FOSEN OF GRP,
THE MUSICIANS LABEL



TESTED NEC AVD-700E SURROUND PROCESSOR

GOOD VALUE

LUXMAN R-117 RECEIVER

FIRST-RATE ELECTRONICS



The love of music taken to Infinity



Two decades ago, a small group of music-obsessed physicists and engineers working on advanced aerospace problems discovered they shared an absolute dissatisfaction with existing speaker technology. They decided to put their knowledge of electronics, audio and music to the task: Could they expand existing technological boundaries to create the kind of speaker *they* could live with?

The result was the Infinity Servo Statik I, immediately acclaimed by leading audio critics as the State of the Art in the reproduction of music.

In the ensuing years, this absolute obsession with music, this passion for perfection has continued to drive us. And to please equally fanatic music lovers and audiophiles throughout the world.

Today the benchmark 7½ foot tall \$45,000 Infinity Reference Standard V is the embodiment of Infinity's obsession. It is also the source of much of the state-of-the-art technology used throughout the entire Infinity product line.

Every Infinity speaker at every price point—our IRS V, our IRS Beta, Gamma and Delta, our Kappa Series, our RS Series, our Studio



Infinity Reference Standard V IRS Beta

Monitor Series and Kappa Automotive Series—shares a 20-year tradition of technological innovation.

This Infinity dedication to developing some of the most demanding and expensive high-end products has enabled us to offer the audiophile speakers of unprecedented value and musicality.

The rich velvet timbre of a French horn with all its overtones; the crisp, gutty attack of a Fender bass; the clean, delicate swish of a brush on a Ziljian cymbal; nowhere but through an Infinity speaker will you hear them with such warmth and lifelike presence.

Unless you're at the live concert.

Which, as we've been saying all along, is what it's all about.



Kappa 9

Kappa 6
(optional pedestal)



RS 4000
RS 62k 2-way driver
RS 693k 3-way driver
CS-1 component system



20 years of technological innovation in the love of music.

Enter No. 38 on Reader Service Card

All of our advances in speaker technology are compiled into a brief presentation booklet called "The Creative Technology of Infinity Speakers, Vol. II." Ask your Infinity dealer for your copy.

Audio

MARCH 1988

VOL. 72, NO. 3



Deciding on DAT, page 40



Dave Grusin and Larry Rosen, page 34

FEATURES

THE AUDIO INTERVIEW:		
DAVE GRUSIN AND LARRY ROSEN	David Lander	34
DECIDING ON DAT:		
WITNESS OF THE PERSECUTION	Barry Fox	40
THE MOSCOW SESSIONS:		
FROM RUSSIA WITH LOVE	Bert Whyte and Lisa Sonne	45

EQUIPMENT PROFILES

TANDBERG 3001 A FM TUNER	Leonard Feldman	48
LUXMAN R-117 RECEIVER	Leonard Feldman	56
PARASOUND D/HX-600 CASSETTE DECK	Howard A. Roberson	68
NEC AVD-700E DIGITAL SURROUND PROCESSOR	Howard A. Roberson	78

MUSIC REVIEWS

ROCK/POP RECORDINGS	94
JAZZ & BLUES	102

DEPARTMENTS

SIGNALS & NOISE		6
AUDIOCLINIC	Joseph Giovanelli	8
TAPE GUIDE	Herman Burstein	10
WHAT'S NEW		12
AUDIO ETC	Edward Tainail Canby	14
SPECTRUM	Ivan Berger	20
ROADSIGNS	Ivan Berger	22
BEHIND THE SCENES	Bert Whyte	24

The Cover Equipment: Tandberg 3001 A FM tuner.
The Cover Photographer: Mark Weiss.

Audio Publishing, Editorial, and Advertising Offices,
1515 Broadway, New York, N.Y. 10036.

Subscription Inquiries, (800) 525-0643,
in Colorado, (303) 447-9330.



Moscow Sessions, page 45



Behind the Scenes, page 24

O N E F O R T H E A G E S



THE NO 23 DUAL MONAURAL POWER AMPLIFIER

The No 23 announces a new generation of technical refinement in dual monaural amplifiers. The No 23 amplifier has a power output of two hundred watts per channel at eight ohms, allowing you to realize the full potential of your system at all times.

Experience a level of craftsmanship that sets the standard for technical artistry and stands the test of time.

mark
levinson

Stop wasting digital sound on analog components.



When all your source material was analog, you had no choice but to use analog components. And no option but to endure the resulting signal loss, interference, hum and noise.

With push/pull Super Linear Converters (two per channel), optical and coaxial digital inputs, digital tape monitor loop, and three sampling rates, the Denon DAP-5500 Preamplifier establishes digital — not analog — as the primary signal format.

So addition the Denon DAP-5500. You have nothing to lose but noise.

DENON

DESIGN INTEGRITY

Denon America, Inc., 222 New Road, Parsippany, NJ 07054 (201) 575-7810
Denon Canada, Inc., 17 Denison Street, Mississauga, Ont. L3R 1B5 Canada

Enter No. 16 on Reader Service Card

Headphones that work with your ears, not against them.

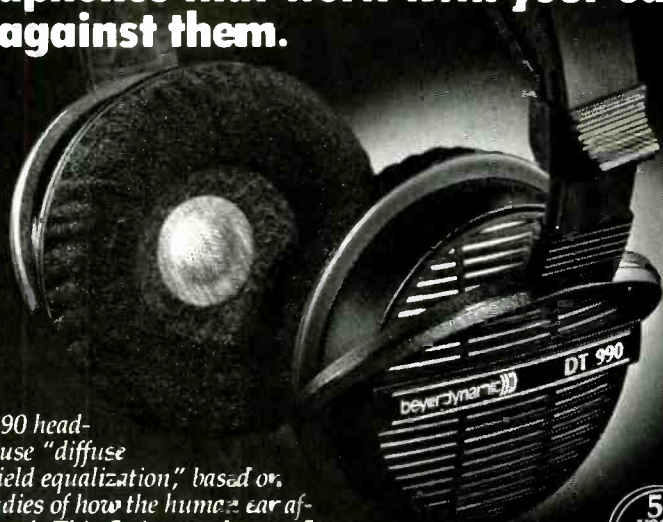

DT 990 headphones use "diffuse sound field equalization," based on new studies of how the human ear affects sound. This design produces a flat frequency response, accurately recreating the experience of the listening environment.

Hostaphan™ diaphragms and Neodyme™ magnets are two more reasons DT 990s have won technical and critical acclaim in Europe and America. They "... delivered a superb sound" and were "... remarkably comfortable to wear" according to Stereo Review.

So if you enjoy losing yourself in the music, start by finding the Beyer dealer in your area. Call the reader response number below, or write — **beyerdynamic US, 5-05 Burns Avenue, Hicksville, NY 11801.**



ACCURACY IN AUDIO

beyerdynamic

Canada: ELNOVA 4190 rue Sere, St. Laurent, Quebec H4T1A6 Tel. (514) 341-6933 Telex: 5824086

Enter No. 5 on Reader Service Card

AmericanRadioHistory.Com

Audio

Eugene Pitts III
Editor

Art Director: Cathy Cacchione

Technical Editor: Ivan Berger
Managing Editor: Kay Blumenthal
Copy Chief: Elise J. Marton
Associate Art Director: Linda Zerella
Assistant Editor: Karen Clark

Associate Editors:

Edward Tatnall Canby, Bert Whyte, B. V. Pisha

Senior Editors:

Leonard Feldman, Howard A. Roberson
Senior Editor/Music Features: Ted Fox
Editor-At-Large: David Lander

Contributing Editors/Artist:

Susan Borey, Herman Burstein, David L. Clark,
Anthony H. Cordesman, Ted Costa, John Diliberto,
Frank Driggs, John M. Eargle, Joseph Giovanelli,
Bascom H. King, Gary Krakow, Hector G. La Torre,
Edward M. Long, Ken Pohlmann, Jon R. Sank,
George Shellenberger, Donald Spoto,
Michael Tearson, Jon & Sally Tiven, Paulette Weiss,
Michael Wright

Business Services Director: Greg Roperti

Circulation Director: Leon Rosenfield

Production Director: David Rose

Production Manager: Michele Lee

Research Manager: Neil Karlin

Special Projects Coordinator: Phyllis K. Brady

Ad Coordinator: Susan Oppenheimer

Stephen Goldberg
Publisher

ADVERTISING

Associate Publisher: Stephen W. Witthoft
(212) 719-6335

Sales Manager: Nick Matarazzo
(212) 719-6291

Account Manager: R. Scott Constantine
(212) 719-6346

Western Manager: William J. Curtis
Regional Manager: Bob Meth
(818) 784-0700

Classified Manager: Carol A. Berman
(212) 719-6338

DCI EXECUTIVE STAFF

President and CEO: Peter G. Diamandis
Executive V.P.: Robert F. Spillane
Sr. V.P., Finance, and CFO: Arthur Sukul
Sr. V.P., Operations: Robert J. Granata
Sr. V.P., Mfg. & Distribution: Murray M. Romer
V.P., Controller: David Pecker
Pres., DCI Magazine Marketing: Carl Kopf

AUDIO (ISSN 0004-752X, Dewey Decimal Number 621.381 or 778.5) is published monthly by DCI at 1515 Broadway, New York, N.Y. 10036. Printed in U.S.A. at Dyersburg, Tenn. Distributed by DCI Magazine Marketing. Second class postage paid at New York, N.Y. 10001 and additional mailing offices. Subscriptions in the U.S., \$19.94 for one year. \$35.94 for two years, \$49.94 for three years; other countries, add \$6.00 per year.

AUDIO is a registered trademark of DCI. ©1988. Diamandis Communications Inc. All rights reserved.

Editorial contributions are welcomed but should be accompanied by return postage. Submissions will be handled with reasonable care, but the Editor assumes no responsibility for safety or return of manuscripts, photographs, or artwork. The Publisher, in his sole discretion, reserves the right to reject any ad copy he deems inappropriate.

Subscription Service: Forms 3579 and all subscription correspondence must be addressed to AUDIO, P.O. Box 5316, Boulder, Colo. 80302. Please allow at least eight weeks for the change of address to become effective. Include both your old and your new address and enclose, if possible, an address label from a recent issue. If you have a subscription problem, please write to the above address or call (800) 525-0643; in Colorado, (303) 447-9330.

YOU'LL NEVER HAVE TO SIT THROUGH ANOTHER AMATEUR NIGHT AGAIN.

How can you really enjoy professional entertainment when your equipment isn't professional?

You can't. And dbx can prove it to you. Here and now. And with a dbx dealer demo later.

For over 15 years, the greatest moments in entertainment have come through us. Today, you'll find dbx professional equipment at work at most every important recording studio, broadcast facility and live performance in the world.

With 75 patents and a recent Emmy

for co-developing stereo TV, our list of firsts and onlies puts us in a class all our own.

The results are ready for you to take home now. Professional equipment with all the clarity, impact, nuance and range you couldn't get before. Even in the most expensive amateur systems.

The differences you'll see and hear are audible, visible and phenomenal.

For example, our Soundfield psychoacoustic-imaging speaker systems sound spectacular in any room. Anywhere you sit in that room.

Our audio/video preamplifier incorporates Dolby® Pro Logic surround sound using dbx proprietary technology. For the most thrilling home-theater performance you can get.

Our incomparable configurable 2/3/4-channel amplifier provides over 800 watts per channel in actual use. With a flatter response than amateur amps costing twice as much.

Add to these one-of-a-kind components our FM/AM tuner with Schotz® noise reduction, uncanny clarity and a noise floor way below what you're probably listening to now.

And a CD player that's so good, *Stereo Review's* Julian Hirsch wrote: "Even without its special circuits [proprietary sonic enhancements], the dbx DX5 would rank as one of the best available."

Complete your home studio/theater with our superlative digital-processing VCR with VHS Hi-Fi and our own MTS stereo TV sound. And bring your video enjoyment up to where it should be.

A visit to your dbx dealer will convince you that your amateur days, and nights, are over.

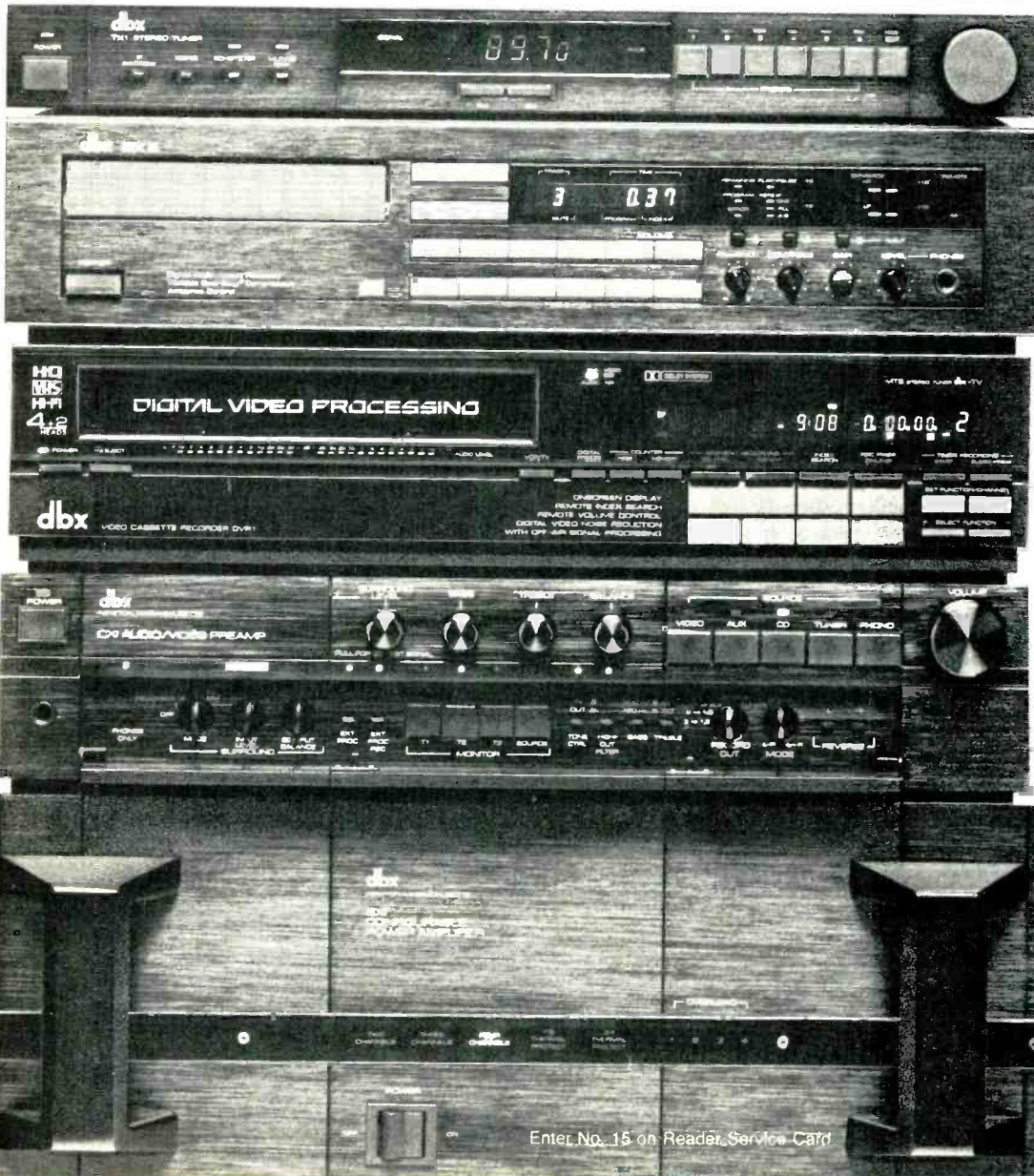

dbx
Audio and Video
at its professional best.

Enter No. 15 on Reader Service Card

Back to The Beatles

Dear Editor:

I am moved to comment on the five letters pertaining to the Beatles CDs that were released in mono ("Signals & Noise," October 1987). The letters were extremely entertaining (and somewhat humorous). How so? These readers imply that they know more about these records than the man who produced them.

Although I cannot prove this, many popular records of the late '50s to mid-'60s were probably intended to be released in mono but, because of the growing demand for stereo, were either remixed or electronically reprocessed for stereo. There were double inventories of most albums through about 1967. I know; I've got all the Beatle albums in mono through *Sgt. Pepper*. I could have gotten *Mystery Tour* in mono too, but the record store I usually went to said they'd have to make a special order as they were no longer carrying this double inventory. There are differences in the mixes that made me glad I had the mono as well as the stereo versions. I also have many other albums from this period with a mix of real and fake stereo on the same record—The Who's *Magic Bus*, for instance.

Being an engineer at a 24-track facility has allowed me to more fully understand the processes a record goes through on its way to becoming a finished product. As you pointed out, just because there is more than one track used on a master doesn't mean the intended release was stereo.

I, too, wondered about the mono CDs, but after reading George Martin's interviews in *Mix* and *Audio*, I came to the conclusion that Mr. Martin knows what he's doing. Anyone who doesn't agree is missing out on some great music on perhaps the finest storage medium available, the CD.

Nuff said!

Ron Carlson
Ogden, Iowa

One for the Rhoads

Dear Editor:

I really enjoyed the CD review of *Tribute* by Ozzy Osbourne and Randy Rhoads that appeared in the November 1987 issue. It really did justice to a great guitarist, and I hope to see more

reviews like that one. A lot of reviews I have seen seem to cut down heavy metal. Please continue to do justice to this type of music and do more CD reviews on heavy-metal bands.

Thank you, and keep up the good work.

Tony Velasco
Crystal, Minn.

Signs of the Times

Dear Editor:

I've enjoyed reading your magazine for many years. The product reviews offer instructive information with complete accuracy and truth. But since the digital craze has hit our society, and especially now with DAT starting to break onto the audio scene, I wonder if this is a sign that your magazine is going to cut out turntable reviews completely. Just remember, it wasn't too many years ago that basically the only way for us to get sound reproduction was through the sweet, beautiful sound of the turntable, which I feel is still sonically superior to the Compact Disc of today.

Mike Hunter
Virginia Beach, Va.

Editor's Note: The answer to your question is no.—E.P.

Honoring the Old

Dear Editor:

Have you ever considered a column on reliable older equipment? I have a 1965 Knight-Kit AM/FM tuner that has been realigned once, and it still works every day for eight hours a day. I also have an Ampex reel-to-reel with new belts and bushings, and my AR 4a speakers still sound good to me. There are a lot of old McIntoshes around too. Just a thought.

Robert W. Gamage
Snohomish, Wash.

The Anti-CD Snowball

Dear Editor:

In the January 1988 "Signals & Noise," Gilbert A. Johnson says, in connection with the issue of copy protection, "I can't imagine spending good money for a recording with a hole in the middle of the treble." I'd like to add my own comments. The destructive copy-protection threat will take away from the CD the quality that is its

reason for being. I hope the lawyers and money men will decide to abandon that threat without another day's delay, so as to bring to a halt the snowballing public disenchantment with the idea of buying CD players.

It really seems incredible that organizations with lots of marketing talent can be so obtuse as to seriously adopt a policy that cannot help but cause the public to have second thoughts about buying their most promising product. Had CD makers been threatening to deliberately diminish the quality of their product in May 1983, when I acquired my first CD player, I would not have bought it. I'd have gotten a cassette player instead.

Edgar R. Jones
Englewood, Fla.

A \$3,000 Dragonfly?

Dear Editor:

Having read your test report of the \$3,250 Klyne SK-5A preamplifier (January 1988), I confess to some bewilderment at the philosophy that inclines one to purchase such a product. I own a Kenwood Basic-C1 preamplifier whose value I estimate at around \$240 (I bought it along with two other Kenwood separates for only \$448). And while high-end *doyens* may snicker at my choices, I cannot imagine the Klyne delivering discernibly better *sonic* performance, either in measurable terms or in double-blind A/B/X comparator testing, than my prosaic little Kenwood.

One real advantage the Klyne preamp may have is durability. Let's say the Klyne gives faithful service for 40 years or so. If I can squeeze just 10 years out of my Kenwood, and if I replace it with another preamp of comparable value every 10 years, I figure that for the price of the Klyne I can be immersed in music for the next 140 years.

Another way to look at it: With the \$3,000 difference (and that's for the preamp *alone*), I can get this great-looking p.c. board with a dragonfly logo imprinted on it, or I can purchase close to 250 Compact Discs or roughly 400 LPs. Oh well, chalk it up to my being an irreconcilable software junkie. I guess I'm just funny that way. . . .

Gordon M. Brown
San Diego, Cal.

Brain vs. Bulk.

FOR UNDER \$625 YOU CAN OWN AN AMPLIFIER JUDGED TO HAVE THE EXACT SOUND CHARACTERISTICS OF AN ESOTERIC \$3000 MODEL.

Bob Carver recently shocked the staid audiophile world by winning a challenge that no other amplifier designer could ever consider.

The new M-1.0t was judged, in extensive listening tests by one of America's most respected audiophile publications, to be the sonic equivalent of a PAIR of legendary, esoteric mono amplifiers which retail for \$3000 each!

CARVER'S GREAT AMPLIFIER CHALLENGE. Bob Carver made an audacious offer to the editors of *Stereophile Magazine*, one of America's exacting and critical audio publications. He would make his forthcoming amplifier design sound exactly like ANY high-priced, esoteric, perfectionist amplifier (or amplifiers) the editors could choose. In just 48 hours. In a hotel room near *Stereophile's* offices in New Mexico! As the magazine put it, "If it were possible, wouldn't it already have been done? Bob's claim was something we just couldn't pass up unchallenged."

What transpired is now high fidelity history. From the start, the *Stereophile* evaluation team was skeptical ("We wanted Bob to fail. We wanted to bear a difference.") They drove the product of Bob's round-the-clock modifications and their nominees for "best power amplifier" with some of the finest components in the world. Ultimately, after exhaustive listening tests with carefully selected music ranging from chamber to symphonic to high-impact pop that led them to write, "... each time we'd put the other amplifier in and listen to the same musical passage again, and hear exactly the same thing. On the second day of listening to his final design, we threw in the towel and conceded Bob the bout. According to the rules... Bob had won."

BRAIN vs. BULK. Pictured is a photo of the 20-pound, cool-running M-1.0t. Above it are the outlines of the pair of legendary mono amplifiers used in the *Stereophile* challenge. Even individually, they can hardly be lifted and demand stringent ventilation requirements. And yet, according to some of the most

discriminating audiophiles in the world, Bob's new design is their sonic equal.

The M-1.0t's secret is its patented Magnetic Field Coil. Instead of increasing cost, size and heat output with huge storage circuits, Magnetic Field Amplification delivers its awesome output from this small but powerful component. The result is a design with the dynamic power to reproduce the leading edge attacks of musical notes which form the keen edge of musical reality.

A DESIGN FOR THE CHALLENGES OF MODERN MUSICAL REPRODUCTION. The M-1.0t's astonishingly high voltage/high current output and exclusive operation features make it perfect for the demands of compact digital discs, video hi-fi and other wide dynamic range playback media. The M-1.0t:

Has a continuous FTC sine-wave output conservatively rated at 200 watts per channel into 8 ohms 20 Hz to 20 kHz with no more than 0.15% THD.

Produces 350-500 watts per channel of RMS power and 800-1100 watts momentary peak power (depending on impedance).

Delivers 1000 watts continuous sine wave output at 8 ohms in bridging mode without modification.

Is capable of handling unintended 1-ohm speaker loads.

Includes elaborate safeguards including DC Offset and Short Circuit Power Interrupt protection.

SHARE THE RESULTS OF VICTORY. We invite you to compare the new M-1.0t against any and all competition. Including the very expensive amplifiers that have been deemed the M-1.0t's sonic equivalent. You'll discover that the real winner of Bob's remarkable challenge is you. Because world class, superlative electronics are now available at reasonable prices simply by visiting your nearest Carver dealer.

Specifications: Power, 200 watts/channel into 8 ohms 20Hz to 20kHz, both channels driven with no more than 0.15% THD. Long Term Sustained RMS power, 500 watts into 4 ohms, 350 watts into 8 ohms. Bridged Mono power, 1000 watts into 8 ohms. Noise, -110dB IHF A-weighted. Weight, 20 lbs.

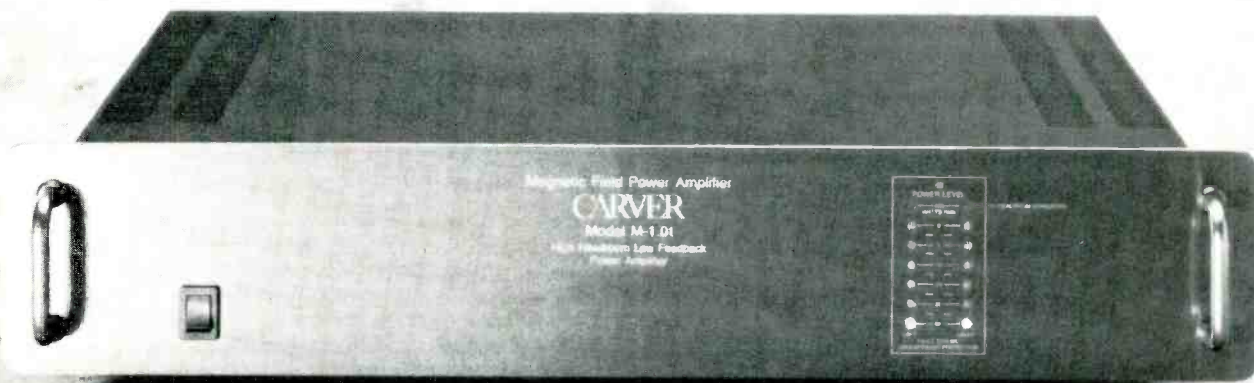
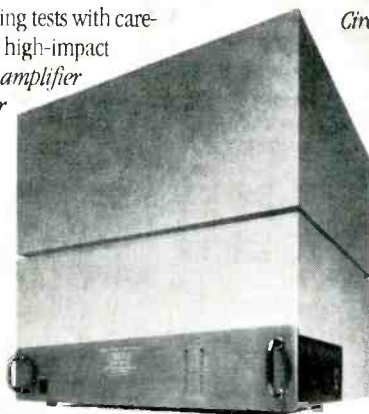

CARVER

POWERFUL

MUSICAL

ACCURATE

P.O. Box 1237, Lynnwood, WA 98046

Distributed in Canada by: evolution technology

Enter No. 9 on Reader Service Card

AmericanRadioHistory.Com

Which Switch?

Q. I have found a need to switch loudspeaker polarity under some conditions. How does one go about selecting toggle switches of the proper current ratings? Are there any dangers or shortcomings involved in inserting switches in the relatively high-current wiring in a loudspeaker line?—David M. Schneider, Marion, Iowa

A. Any reasonable toggle switch will be suitable for your application. Most of the switches used for a.c. power switching can handle 10 amperes, and this should be fine. If need be, you can certainly use an industrial-grade switch capable of handling 20 amperes or more. You can check all of this with Ohm's Law power formulas; the power which you should consider is that which will be supplied to your speakers.

I have done quite a bit of polarity switching at high volume and have not had problems. Even so, I recommend that you keep the volume low during switching, to avoid gradual arcing and damage to the contacts.

As for disadvantages, I suppose there are those who will be concerned about some loss in damping to the woofer cone. This is about the only drawback I can think of, assuming that we are talking about solid-state equipment. Tube equipment might be damaged because of high voltages developed within the output transformers during switching.

Outdoor Antenna Troubles

Q. My favorite FM stereo stations are located some 50 miles from me. In an attempt to dispose of a small amount of noise, I have installed an FM antenna atop the chimney on my two-story house. The signals, however, are accompanied by even more noise when using the outdoor antenna than when using the indoor antenna. I have tried rotating the outdoor antenna, as well as using a shielded lead-in—with no improvement.

I am puzzled by this because it runs counter to what I might reasonably expect. I would, therefore, appreciate any advice you may offer.—Name withheld, Arlington, Va.

A. If there is a signal-strength meter on your tuner, check it to see if you have more signal when the external

antenna is used than when using the indoor antenna. There should be a marked increase in meter readings with the outdoor antenna. If there is no such increase, check the antenna connections very carefully. There may be cracked insulators associated with the antenna which would render it useless. Check, too, to be sure that you have installed the various pieces of the antenna properly.

Assuming that you do get the expected increase in signal with the outdoor antenna, it may be that some of the stations you are listening to are broadcasting SCA signals, and that your tuner is sensitive to this background music service. It may require either an SCA filter or perhaps an alignment of the existing filter. SCA can produce noise when it is combined with the stereo information present on the same FM station.

Differences in Power Mains

Q. I have not seen any articles concerning differences between a.c. voltage and frequency in different parts of the world. How do these differences affect various components? I have heard that only components having motors (turntables, cassette decks, CD players, etc.) are affected, while those without motors (amplifiers, tuners, and the like) are not. I know that one can change voltage by means of suitable transformers, but if the frequency is important as well, can one similarly change frequencies as needed in different countries?—G. Papadorfos, New York, N.Y.

A. If you travel in countries other than the United States, Canada, and a few others whose power mains supply 117-V, 60-Hz a.c., you need to take the local power system into account for any mains-powered devices you take along.

If the device in question is designed to operate only at 117 V a.c., running it at 220 V will destroy it. If the device is designed to operate at 220 V and it is run at 117 V, damage will usually not be done, but the device won't run correctly, in any event. As you pointed out, there are transformers designed to change the mains voltage to whatever the device needs. Such transformers are interposed between the mains and the device.

Some motors are affected by the frequency of the a.c. voltage supplied to them. Frequency directly determines the speed of such motors' rotation, especially if they are of the hysteresis-synchronous or induction type. However, I know of no means by which you can easily convert the mains frequency to suit the needs of your equipment. You may need to change pulleys or other mechanical parts to accommodate the different motor speeds which will result from the change in line frequencies. Check with the manufacturer of your motorized equipment as to the availability of such parts.

In today's equipment, we are seeing more of a different sort of motor, one that operates from d.c. (which has no frequency). The power mains does supply a.c. to the equipment, but by the time the voltage reaches the motor, it has been converted to d.c. Motors of this kind are electronically servo-controlled.

Purely electronic components and motorized components with electronic speed control employ transformers. Such transformers must be operated from a.c. so that voltage can be produced in their secondary windings. The frequency of the a.c. is not critical except where there is insufficient iron in the transformer core. The amount of iron affects the inductance of the winding and, as a consequence, the reactance. In order to save a long explanation, let me just say that if the reactance is really low (as it will be at lower frequencies), the transformer will run hotter than it will if its reactance is higher. If the transformer runs hot when operated at 60 Hz, it may overheat and burn out when operated at 50 Hz—where its reactance has dropped.

Electrical systems which operate at 220 V a.c. usually also operate at a frequency of 50 Hz, and manufacturers of 220-V equipment must take this into account. As a result, when a piece of equipment has been fitted with a power transformer that can be adjusted for either 117 V or 220 V, it will have no problem with 50-Hz power mains. **A**

If you have a problem or question about audio, write to Mr. Joseph Giovanelli at AUDIO Magazine, 1515 Broadway, New York, N.Y. 10036. All letters are answered. Please enclose a stamped, self-addressed envelope.

“If you’ve never heard truly great audio reproduction before, slip into a pair of Stax”

Ken Pohlmann
Digital Audio & Compact Disc Review
February 1987



“We rarely state unequivocally that a product is ‘the best’ of its type, principally because it’s usually impossible to define ‘best’ in universally meaningful terms. The Stax SR-Lambda Professional and its companion driver are an exception.”

Julian Hirsch
Stereo Review
April 1986

“The Stax Lambda Pro system is one of the few products unique enough to rise above the issue of its particular technology (of which it is an outstanding example) and be compared on a no-holds-barred basis with the best high-end components around.”

Anthony H. Cordesman
Audio Magazine
January 1985

“If you want the ultimate in sound quality, just hook up the output of a CD player to the input on the rear of the SRM-1/Mk2 Professional amplifier, put on the Lambda Professional earspeakers, and play a well recorded CD.”

Burt White
Audio Magazine
November 1983

Recommended by Stereophile Magazine in the March and May 1987 issues as “Class A: Best attainable sound, without any practical considerations; “State-of-the-art.”

Recipient of International Audio Review Engineering Achievement Award.

Winner of Audio Video International Hi Fi Grand Prix Product of the Year Award for 1986 & 1987.

STAX

electrostatic audio products

Imported by: STAX KOGYO, INC. • 940 E. Dominguez St. • Carson, California 90746

Enter No. 33 on Reader Service Card

AmericanRadioHistory.Com

TAPE GUIDE

HERMAN BURSTEIN

Improper Winding

Q. In record or playback mode, my cassette deck initially does not wind the tape squarely on the cassette's take-up reel; part of the tape extends over the edge of the reel. After about three minutes, the tape begins winding correctly. When the deck is put into fast forward or fast rewind, there is no problem. What causes the faulty winding? How can I correct it?—Albert C. Ososky, Philadelphia, Pa.

A. Some decks have separate motors for the supply and take-up reels. If this is true in your case, it could be that the take-up motor is defective.

Alternatively, it may be that the take-up reel does not exert sufficient tension. There is an internal adjustment for this, but it will vary from one make of deck to another, so I cannot advise you more specifically. To know exactly what to do, you will need to consult the service manual for your deck, and you will probably need a gauge to measure torque; otherwise, you may do more harm than good. Unless you are expert in this sort of thing, the adjustment is best left in the hands of a qualified service technician.

Cleaning Frequency

Q. I used to clean my deck after every two hours of operation, using isopropyl alcohol. Even with such frequent cleaning, an oxide "track" was developing on the pinch roller. I considered this normal and ignored it. About a year ago, at a friend's suggestion, I tried a "rubber rejuvenator," which completely removed the oxide and improved the roller's traction. But when I used it for regular, frequent cleaning, traction became very poor for a while. Therefore, I went back to isopropyl alcohol. Subsequently I tried a professional aerosol cleaner that is a blend of freon TF and isopropyl alcohol. This completely removes the oxide track, and traction remains great. Am I overcleaning? Is there supposed to be an oxide track on the roller?—Scott Eric Packard, Los Alamitos, Cal.

A. Yes, I think that you are cleaning too frequently. The usual rule is to clean the heads, capstan, and pressure roller after approximately eight hours of use. And yes, it is normal for a small amount of oxide to accumulate on the roller, though this will vary with

the brand, type, and quality of tape, and perhaps with the deck.

Isopropyl alcohol usually works well and is suitable for cleaning. However, you might want to check with the deck manufacturer as to his recommendation. After cleaning, be sure to allow adequate drying time—at least five minutes, to be safe.

Print-Through Prevention

Q. How can I best prevent or reduce print-through on my tapes?—Roberta Lindenberg, New York, N.Y.

A. Storing tapes in cool, dry places and keeping them away from magnetic fields help prevent print-through. Fast-winding a tape just before playback also helps, because print-through signals are transient, and their level drops when they are removed from the imprinting field. This is one of the reasons why studio tapes (which are recorded in only one direction) are not rewound after recording, but are left "tail out" on the reel and rewound just before playback. Home tapes, which are recorded both ways, can be wound forward and back before they are played.

It is also probably wise to play or fast-wind each of your tapes at least once or twice a year. This is because taped signals become increasingly difficult to erase with the passage of time. Presumably, this would apply to the printed-through signal as well as to the desired one; "exercising" the tape periodically might well reduce the printed signal before it has time to "set."

Mechanical Malfunctions

Q. My problem concerns a cassette deck purchased in 1984 but used for only about 20 hours. When I play or record a Type I tape, everything is fine; when I play or record a Type II, I have major problems. The tape gradually speeds up until it is going so fast that you can't hear anything but "chip-munk" sounds, and eventually the tape gets tangled around the capstan.

The authorized service center in my area wants \$75 as a bench charge just to look at the deck, which cost me only \$140 originally. For sentimental reasons, I would rather not replace the deck.—Bobby Fox, Rockville, Md.

A. I can't come up with any reason why your deck should exhibit its strange mechanical behavior solely

with tapes other than Type I. When switching types, only electronic changes occur in the deck, not mechanical ones. Perhaps some reader can offer counsel.

It appears ridiculous to spend \$75—at minimum—to salvage a deck that cost \$140. Today, for not much more than \$100 at discount stores, you can buy a new cassette deck that is probably at least as good as your present model. I suggest that you save your money by using your deck only with Type I cassettes, and when it eventually goes bad altogether, put your \$75 (or more) toward a new deck.

Superior Tape, Reduced Output

Q. When I make a cassette recording with my usual tape, it plays back at the same level that I used in recording, as shown by the deck's meters. But when I use a superior tape made by the same company, with everything else remaining the same, the playback level is below the recording level. I have tried cleaning the heads, demagnetizing them, and using other cassettes of the superior formulation, but I still get reduced output. What could be the explanation?—Jeffrey Nachson, Brooklyn, N.Y.

A. Tapes differ in their sensitivity—that is, in the amount of signal output for a given amount of signal input. That is why you get different playback readings with different tapes.

There are a number of electromagnetic and physical factors that add up to a good tape. Sensitivity is only one of these factors; others include extended frequency response, low distortion, low modulation noise, high maximum output level for a given amount of distortion (and therefore high signal-to-noise ratio), smoothness of the magnetic coating, immunity to oxide shedding, accuracy of dimensions, immunity to cupping or other warping, and immunity to skewing and squeal. It is quite possible for a superior tape to have lower sensitivity than an inferior tape but to excel in all or most other respects. 

If you have a problem or question on tape recording, write to Mr. Herman Burstein at AUDIO, 1515 Broadway, New York, N.Y. 10036. All letters are answered. Please enclose a stamped, self-addressed envelope.

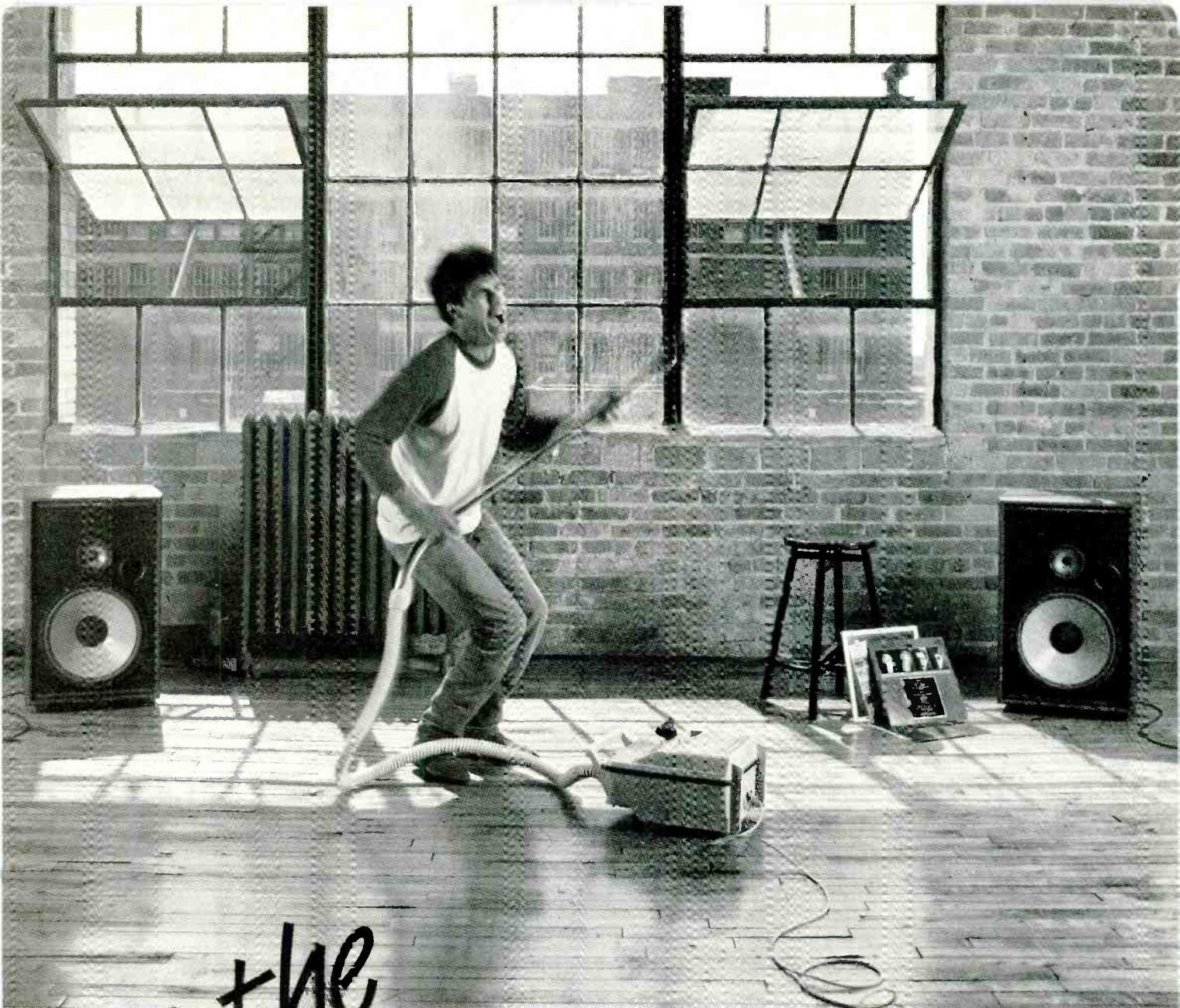

Be the BOSS

Whatever "instrument" you play, you'll be the Boss with American Acoustics Generation III loudspeakers. You can really feel the music! But watch out ... when you crank up American Acoustics, you'll have the power to shake the room.

Get caught up in the experience with Generation III loudspeakers. You'll get excellent depth and sound separation, plus extraordinary wide dynamic range... a *must* for CDs. American

Acoustics are among the top rated loudspeakers across the country according to the Audio Video International poll.

Listen to the Experts:

"Acoustic SPL (Sound Pressure Level) impressively high; octave-to-octave frequency balance exceptionally uniform and smooth"—**Stereo Review.**

"Low-frequency reproduction quite smooth and tight and extends well into the deep bass; imaging very good, wide dynamic range"

—**High Fidelity.**

"Unusually high sensitivity; orchestral sound 'big' with a good sense of space; can play loud without any audible distress"—**Digital Audio.**

All this and an outstanding 10-year warranty... and built in the U.S.A.

For more information, contact your nearest authorized American Acoustics dealer. Or call us at (815) 367-3000.

GENERATION III

Digital Loudspeakers



American Acoustics

A Mitek Group Product

One Mitek Plaza
Winslow, IL 61089
815-367-3000
FAX: 815-367-3851
TELEX: 989 790 MTX INC UD

Enter No. 2 on Reader Service Card

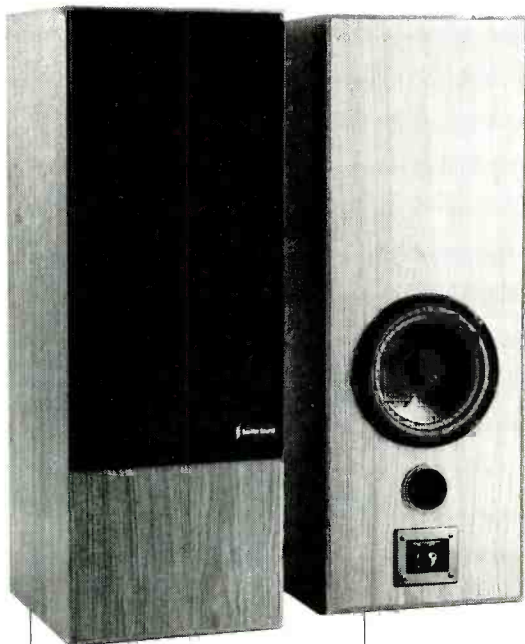

Seattle Sound Loudspeaker

Obviously, the grille on this speaker can't cover the port and the 8-inch subwoofer shown. It doesn't have to: The subwoofer and port are on the back of Seattle Sound's M5 speaker system, and the front grille conceals a 6½-inch woofer and a 1-inch tweeter. All drivers are polypropylene, and the fourth-order tuned-port enclosure has a narrow front to improve imaging. Rated frequency response is 34 Hz to 21 kHz, ±3 dB. All six surfaces of the cabinet are finished in scratch-resistant, walnut-grain vinyl. Price: \$359 each. For literature, circle No. 100

Shure Cartridge

The VST V phono cartridge uses several design elements of Shure's V15 Type V MR. Its stylus has a Micro-Ridge tip and a low-mass, telescoped beryllium tube. The stylus assembly includes Shure's Side-Guard protection against damage from accidental side thrusts as well as the company's Dynamic Stabilizer shock absorber and static eliminator. All internal elements are solidly

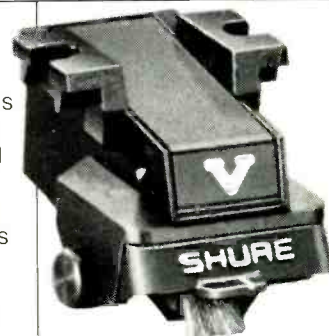

encapsulated in plastic to reduce spurious resonances. Price: \$170. For literature, circle No. 101

Video Link Remote Command Center

The Cockpit II turns three audio or video remotes into one by allowing them to be gathered in one convenient tray. A solid-state circuit in the unit picks up infrared signals from the remotes in the tray, amplifies them, and feeds them through two rotatable turrets. The system is more convenient, if perhaps bulkier, than programmable universal remote controls. Price: \$49.95. For literature, circle No. 102



Tandberg Receiver

Unlike most receivers, the TPR 3080A is FM only and uses discrete components in its r.f. and audio circuits. It does,

however, use digital ICs for control functions to simplify operation and minimize front-panel clutter. Hence, i.f. bandwidth is selected by a microprocessor

presets are accessed sequentially by two buttons rather than by 16 separate controls. The amplifier section, which uses high-current, zero-feedback circuitry, delivers 80 watts per channel into 8 ohms. The tuner section's 50-dB quieting sensitivity is 17.2 dBf in mono and 37.2 dBf in stereo. The receiver can be operated by the RC 3000 system remote control, which also operates other Tandberg components. Price: \$2,500. For literature, circle No. 103

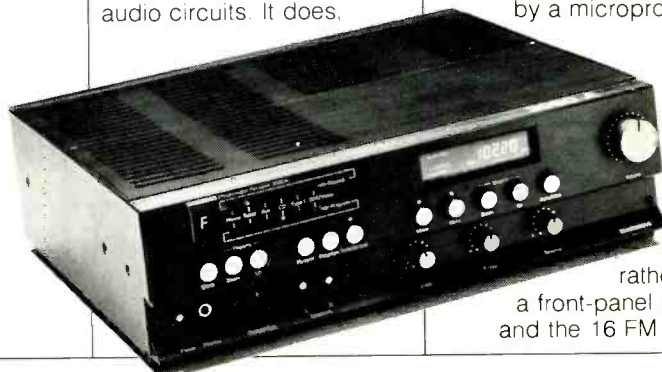

rather than a front-panel switch, and the 16 FM station

THE CBS COMPACT DISC CLUB HAS THE MUSIC YOU WANT TAKE ANY 6 FOR \$1

plus shipping/handling with membership



- 345751. Paul Simon—Graceland. (Warner Bros.)
- 356279. Gloria Estefan And Miami Sound Machine—Let It Loose. (Epic)
- 356576. John Adams—The Chairman Dances—DeWorst, San Fran. Sym. (Digital—Nonesuch)
- 356287. Suzanne Vega—Solitude Standing. (A&M)
- 359901. Mick Jagger—Primitive Cool. (Columbia)
- 357889. Copland: Billy The Kid; Appalachian Spring; etc.—Bernstein, NY Phil. (Digitally Remastered—CBS Masterworks)
- 361022. Tchaikovsky: Symphony No. 6—Claudio Abbado, Chicago Symp. Orch. (Digital—CBS Masterworks)
- 358127. Kronos Quartet—White Man Sleeps. Volans; Ives; Bartok; etc. (Digital—Nonesuch)
- 361139. R.E.M.—Document. (I.R.S.)
- 359521. The Cars—Door To Door. (Elektra)
- 358507. Who's That Girl—Orig. Soundtrack. (Sire)
- 357087. Grateful Dead—In The Dark. (Arista)
- 349571. Boston—Third Stage (MCA)
- 359208. Loverboy—Wildside. (Columbia)
- 346478. Madonna—True Blue. (Sire)
- 350736. Rolling Stones—Rewind. (Rolling Stones Records)
- 347955. Huey Lewis & The News—Fore! (Chrysalis)
- 287003. Eagle's Greatest Hits 1971-1975 (Asylum)
- 346957. Steve Winwood—Back In The High Life. (Island)
- 344622. Anita Baker—Rapture. (Elektra)
- 319996-399998. Motown's 25 #1 Hits From 25 Years. (Motown)
- 291278. The Doobie Brothers—Best of the Doobies. (Warner Bros.)
- 345777. Peter Gabriel—So. (Geffen)
- 246868. Jim Croce—Photographs And Memories—His Greatest Hits. (Sajal)
- 348979. Tina Turner—Break Every Rule (Capitol)
- 308049. Creedence Clearwater Revival Featuring John Fogerty/Chronicle. 20 greatest hits. (Fantasy)
- 342097. Barbra Streisand—The Broadway Album. (Columbia)
- 219477. Simon & Garfunkel's Greatest Hits. (Columbia)
- 360974. Squeeze—Babylon And On. (A&M)
- 360016. Spyro Gyra—Stories Without Words. (Digital—MCA)
- 357640. Wynton Marsalis—Marsalis Standard Time. (Columbia)
- 356667. Heart—Bad Animals. (Capitol)
- 355115-395111. Prince—Sign 'O' The Times. (Paisley Park)
- 348318. The Police—Every Breath You Take—The Singles (A&M)
- 336222. Dire Straits—Brothers In Arms. (Warner Bros.)
- 346544. Kenny G—Duotones. (Arista)
- 344721. Lionel Richie—Dancing On the Ceiling. (Motown)
- 314997-394999. Stevie Wonder's Original Musiquarium 1. (Tama)
- 357657. Beethoven: Piano Concerto No. 5—Murray Perohia. (Digital—CBS Masterworks)
- 361279. World's Greatest Overtures—Strauss, Suppe, more. (Digital—Pro-Arte)
- 349373. Beethoven: Symphony No. 9 (Choral) Bernstein, NY. Phil. (Digitally Remastered—CBS Masterworks)
- 355156. Vladimir Horowitz Plays Favorite Chopin (Digitally Remastered—CBS Masterworks)
- 352948. Wynton Marsalis—Carnaval. Hunsberger, Eastman Wind Ensemble (Digital—CBS Masterworks)
- 353946. Bryan Adams—Into The Fire. (A&M)
- 353771. Bolling/Rampal: Suite #2 for Flute & Jazz Piano Trio (Digital—CBS)
- 354951. Mozart: Flute Quartets—Rampal, Stern, Accardo, Rostropovich. (Digital—CBS Masterworks)
- 357616-397612. The Best Of The Doors. (Digitally Remastered—Elektra)
- 355362. Whitesnake. (Geffen)
- 354829. Lisa—Lisa And Cult Jam With Full Force—Spanish Fly. (Columbia)
- 362210. Earth, Wind & Fire—Touch The World. (Columbia)
- 361147. Rodgers And Hammerstein's Carousel. Barbara Cook; Samuel Ramey. (Digital—MCA Classics)
- 359612. Elton John's Greatest Hits, Vol. III 1979-1987. (Geffen)
- 359018. Pat Metheny Group—Still Life (Talking). (Geffen)
- 357939. Original Soundtrack—"La Bamba". (Slush/Warner Bros.)
- 357350. The Duke Ellington Orchestra—Digital Duke. (Digital—GRP)
- 356741. Bach: Preludes And Fugues For Organ, Vol. 1. (Digital—Newport Classic)
- 356501. Benson/Klugh—Collaboration. (Warner Bros.)



361170. Yes—Big Generator



359075. Aerosmith—"Permanent Vacation"



354449. U2—The Joshua Tree



356154. Whitney Houston—Whitney



354902. Fleetwood Mac—Tango In The Night



361017. Billy Idol—Vital Idol

The age of CD sound is here—and you have a practical new way to find the CDs you want. As your introduction to the CBS Compact Disc Club, you can choose any 6 CDs listed in this ad for \$1.00. Fill in and mail the application—we'll send your CDs and bill you for \$1 plus shipping and handling. You simply agree to buy 4 more CDs (at regular Club prices) in the next two years—and you may then cancel your membership anytime after doing so.

How the Club works. About every four weeks (13 times a year) you'll receive the Club's music magazine, which describes the Selection of the Month... plus new hits and old favorites from every field of music. In addition, up to six times a year, you may receive offers of Special Selections, usually at a discount off regular Club prices, for a total of up to 19 buying opportunities.

If you wish to receive the Selection of the Month, you need do nothing—it will be shipped automatically. If you prefer an alternate selection, or none at all, fill in the response card always provided and mail it by the date specified. You will always have

at least 10 days in which to make your decision. If you ever receive any Selection without having 10 days to decide, you may return it at our expense.

The CDs you order during your membership will be billed at regular Club prices, which currently are \$14.98 to \$15.98—plus shipping and handling. (Multiple-unit sets may be somewhat higher.) After completing your enrollment agreement you may cancel membership at any time; if you decide to continue as a member, you'll be eligible for our money-saving bonus plan. It lets you buy one CD at half price for each CD you buy at regular Club prices.

10-Day Free Trial: We'll send details of the Clubs operation with your introductory shipment. If you are not satisfied for any reason whatsoever, just return everything within 10 days and you will have no further obligation. So why not choose 6 CDs for \$1 right now? **ADVANCE BONUS OFFER:** As a special offer to new members, take one additional Compact Disc right now and pay only \$6.95. It's a chance to get a seventh selection at a super low price!

CBS COMPACT DISC CLUB, 1400 N. Fruitridge P.O. Box 1129, Terre Haute, Indiana 47811-1129

Please accept my membership application under the terms outlined in this advertisement. Send me the 6 Compact Discs listed here and bill me \$1.00, plus shipping and handling for all six. I agree to buy four more selections at regular Club prices in the coming two years—and may cancel my membership at any time after doing so.

SEND ME THESE 6 CDs FOR \$1.00

My main musical interest is (check one): (But I may always choose from any category.)

HARD ROCK SOFT ROCK JAZZ CLASSICAL

Mr. _____
Mrs. _____
Miss _____
Prim First Name Initial Last Name

Address _____ Apt. _____

City _____

State _____ Zip _____

Do you have a VCR? (Check one.) Yes No 810/588

Do you have a credit card? (Check one.) Yes No G13/RX G14/RV

ADVANCE BONUS OFFER: Also send me one more CD right now at the super low price of just \$6.95, which will be billed to me.

Note: we reserve the right to reject any application or cancel any membership. Offers not available in APO, FPO, Alaska, Hawaii, Puerto Rico, please write for details of alternative offer. Canadian residents serviced from Toronto. Applicable sales tax added to all orders. *Classical members serviced by the CBS Classical Club.

Selections with two numbers contain 2 CDs and count as 2—so write in both numbers. © 1988 Columbia House A Division of CBS Records Inc.
CBS COMPACT DISC CLUB: Terre Haute, IN 47811

DECLARATION OF INTERDEPENDENCE



What is the biggest upcoming development in consumer audio—speaking strictly quantitatively? The sound of video, of course. But I ask you, what is the most *unexplored* (and hence the newest) kind of consumer audio? Also the sound of video—specifically, the sound associated with the now fast-multiplying camcorder, updated version of the old home movie camera. We haven't even begun to learn how to use that sound. But it is *there*, which is what matters.

I've been especially interested in the rebirth of the home movie because I was in on its very beginning, a couple of generations ago, with my 1933 Ciné Kodak Eight, spring-wound and short in the breath, so to speak, but one of the most ingenious and satisfactory little machines I have ever used. It buzzed away for some 15 years before I slid off into color stereo slides, and it works perfectly to this day—though there is no film for it. In that camera, by the way, originated the bidirectional tape-travel format used much later for our reel-to-reel half-track tape and for a billion or so audio cassettes.

The sound in the revived home movie is, of course, what prompts me to write these words. It is indeed audio, if not always "hi" in the "fi." When we

finally learn to use it, there's no reason why this sound too may not be "high end" in quality. The more camcorders we acquire, the more important it will be, in audio interest and in sales.

With all this in mind, I jumped enthusiastically onto the new video track a number of years ago—much too soon. As some may remember, my first efforts at video were a mess, out of a roomful of malfunctioning monstrosity, snarled cables, hundreds of pounds of incidental equipment, including a large, separate VCR and a big camera that specialized in purple skies and coffee-colored human faces. Not surprising, at that stage. There has been enormous progress in the few short years since, including the very idea of the camcorder, a unit with just about everything built in. But my next venture in personal movies has had to wait. Instead, as you may also recall, I have been snooping on other people's pictures.

It's been by invitation, of course, just like old times. Today, people invite you to a home-movie party to show off their new camcorder, whereas it used to be films or color slides. Everything, picture-wise, is just as it always was. Dad takes hour after hour of family shots and picks out "the best" of them for the

party: Family in back yard, getting into car, jumping into swimming pool, ogling Niagara Falls or the Eiffel Tower or maybe the big game in Timbuktu, baby drooling in crib. Mama beaming all out of focus. Gorgeous mountains (a vague, thin line on the wavy horizon), glowing mountain lakes (a featureless blue screen with a smudge), and so on, ad infinitum, or anyway for too long. Still, everyone enjoys the show, and there are bits of real beauty here and there. The only thing missing is the sound.

This kind of home show, I say, is a lot better than a mere pile of color prints on a table. A true captive audience! Isn't that what we all want? Everybody sees the pictures together, too, a much better kind of sociability.

The sound is there, from start to finish, but nobody listens. That's because it is 90% zilch, a vague sonic mush with bits of unintelligible voices here and there, thumps, clicks, bangs unexplained—about as interesting as a roomful of office machinery. Very simply, this is because, though the mikes are operating, the camera wielders simply ignore them. The picture's the thing.

Left to their own devices, microphones are really stupid. They don't have automated brains; they pick up huge volumes of sonic mishmash signifying nothing whatsoever, and if they *do* catch anything useful, it is by sheer accident. That can happen, rarely, but you can't count on it. You must work at your sound, just as you work at your pictures.

Which reminds me of just such a sonic accident I heard in 1972, in a small Austrian mountain-lake town. A walking race, of all things, was taking place. If you haven't seen one of these, you should. One or the other of the racer's feet must always be on the ground, like the contact shoes on the power rail of a subway line. So they make haste by an extraordinary huffing and puffing and violent pumping of the arms, with chest out, head back, knees flying high, all spasms and shudders. This bizarre race ended at a white ribbon at the town center, with judges, a grandstand, and a public-address system to carry the speeches and announce the winners. At the far edge of the little crowd, I held my fingers in my

Illustration: Michael A. Donato

THERE ARE OVER 600 CD PLAYERS
ON THE MARKET TODAY.

HERE'S THE
ONE WAY TO TELL
THEM APART.

Today's compact disc players produce a sound so precise, that differences between models are very subtle. • Hearing those differences requires audio equipment that's every bit as sophisticated as the CD players themselves. Like the new Koss SST-10 professional stereophone. Its advanced element design provides a full frequency response, outstanding dynamic range, ultra-low distortion, and optimal sensitivity. • In short, this flagship of Super Sonic Technology™ has all the characteristics necessary to fully appreciate every nuance of today's digital recordings. • And that can make a big difference in your listening enjoyment. No matter which CD player you own.

 **KOSS**
stereophones

Included with the SST: The Koss Hold-A-Fone II Storage Hook that attaches to a shelf or a rack system to store your phones when they're not in use.

Koss Stereophones, 4129 North Port Washington Road, Milwaukee, WI 53212. Koss Limited, 4112 South Service Road, Burlington, Ontario L7L 4X5. Koss-Europe: CH-6855, Stabio-Switzerland. For more information call 1-800-USA-KOSS.

Enter No. 23 on Reader Service Card

AmericanRadioHistory.Com

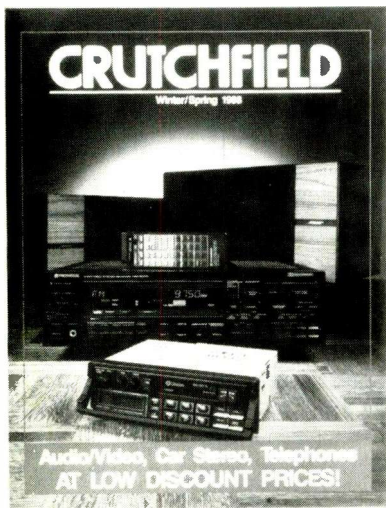

You'll find the most helpful shopping information in the 108 page Crutchfield catalog.

FREE Stereo Catalog

Refer to the Crutchfield catalog before buying your next car stereo, home stereo, or video product:

- 108 pages of helpful articles, consumer tips, charts, and installation guides.
- Color photos, complete descriptions and technical specifications on hundreds of the finest brand name products.

You get more value shopping Crutchfield:

- Toll-free product advice, ordering, and customer service.
- 24 hour shipping.
- Absolute satisfaction guaranteed.
- Full 30-day return privileges.
- Discount prices on Sony, Pioneer, JVC, Teac, Proton, Advent, Jensen, Clarion, Concord, Sherwood, Canon, Bose, and many more!

Call or send this coupon now for your FREE Catalog

800-336-5566

Be sure to mention *Audio* when calling

Name _____

Address _____

Apt. # _____

City _____

State _____ Zip _____

CRUTCHFIELD

1 Crutchfield Park, Dept. AU, Charlottesville, VA 22906

Pictures are much easier than sound, admittedly. So we continue to take pictures and forget about the rest.

ears—those speakers, high up on street poles, were *loud*. People a mile away could have heard the winners' names—and probably did.

When it was over, some of the crowd hung around to chat and kibitz, as might be expected. Meanwhile, I had moved along the lake shore a considerable distance. There was not a soul in sight anywhere near me. But I began to hear quiet conversations going on a few feet away, intimately. It took me some minutes to realize that it was the P.A. system, a mile away. Somebody had left it on; the people next to the mikes could not hear the speakers far overhead (and so no feedback). They were "broadcasting" acoustically, unknown to themselves, over a vast territory. I could have understood every word if German had been my language. Then, *clunk*, the P.A. went off, and I was alone. A quite astonishing freak pickup.

We all know perfectly well that, in our active daily life, sound is just as important as sight. Why, then, do camcorder owners who now have that sound along with their pictures seem to go out of their way to ignore it? No doubt it's a holdover from the old home-movie days, but they probably also ignore it because they are at a complete loss as to what to do with it. Pictures are much easier than sound, admittedly. So we continue to take pictures and forget about the rest. And yet, there are simple things to do with sound, things that are easy enough for anybody. Above all, though, it means paying attention to what you hear as well as what you see.

You may remember my snooping reports of a while back; these included an account of my own video picture (complete with bright-green bald head, bloated body, and bilious face—thanks to fluorescent lights near the camera) and a description of the little man who made a long speech in an unintelligible whisper of a voice (he'd zoomed the lens but could not zoom the mike). Or perhaps you recall how the same little man dashed madly around the room like a lunatic on the loose (four-head fast forward), which was the hit of that show. I have two more recent video snoopings to report, one involving a camping weekend (I was there) and the other a fancy,

cruise-ship tour. Both videotapes were played back at parties, and both were instructive to me.

A camping weekend out of New York City, you understand, is not like others. A large collection of people travel to a convenient nearby wilderness, ours being in the Pennsylvania mountains, where, in the midst of unbroken forests and fields with cows, there is a resort with swimming pool, sundecks, beach umbrellas, easy chairs, air mattresses, a bar, wide green lawns, and disco music. Yes, there are tents. But in other respects we might as well have been in the heart of the metropolis. Reassuring, at least to city dwellers, who never go near the dangerous forests, anyhow. Poison ivy.

To keep 150 such folks from boredom, there must be endless activities, nature being out-of-bounds. Pure camcorder stuff, sights and sounds! At most of our activities, the camcorders duly appeared. Piles of bodies tangled in hilarious human chains. Volleyball, tag, three-legged races, setting-up exercises (pardon me—aerobics), meditation, and contests for best this and best that, with prizes. A fine, noisy scene as well as a photogenic one—could there be a better opportunity for video?

Came the playback, months later in the city. At a big party, of course, with the usual disco music, colored lights, dancing, and a loud roar of conversation. Mostly young people. The video equipment was late; as it was being set up, the party went on, with lights, music, and the roar of happy voices.

I became aware of a faint, pinkish image on the curved projection screen. Wedging myself in closer, I discovered two loudspeakers in the middle of the crowd: Stereo! But they were 30 feet apart and inaudible from more than a couple of feet away. Their sound blended into the general noise. The lights never went off at all. A TV-watching habit, no doubt. The music finally was stopped and the live voices gradually died away, leaving the loud-speaker sound, which was almost exactly the same as the live sound, a genial sonic mush.

The pictures were good (if washed out). Everything was there—games, sports (neatly zoomed in upon), and the prize presentations, which brought

True Story

KLIPSCH® speakers weren't the first I owned. Fact is, I had another 'highly touted' brand and thought they were wonderful. Those speakers were almost new when a friend came to live with me for a few days between apartments.

He'd put all his furniture in storage, but he brought his KLIPSCH FORTÉS® with him and hooked 'em up next to my speakers. I was ready for the duel and confident my speakers would win.

On the very first CD, the FORTÉS made it clear that I'd been missing a lot in my music. They delivered so much more detail and articulation. So much more dynamic range. The sound was alive. There was no contest.

As soon as my friend moved on, I sold my speakers and bought a new pair of FORTÉS. I was pleasantly surprised at the price. I could have bought them to begin with and saved some money.

I think the FORTÉS are just great. No component in my system, not even my CD player, ever made such a vivid difference. Music never sounded so good to me.

For your nearest KLIPSCH dealer, look in the Yellow Pages or call toll free, 1-800-223-3527.

 **klipsch**[®]
A LEGEND IN SOUND.™

P.O. BOX 688 • HOPE, ARKANSAS USA 71801

Enter No. 13 on Reader Service Card



GET 4 COMPACT DISCS FOR THE PRICE OF 1

...WITH NOTHING MORE TO BUY EVER!

WHITNEY HOUSTON
"WHITNEY"
152854

BARRY MANILOW
Swing Street
170250

Itzhak Perlman MOZART
Violin Concertos Nos. 3 & 5
James Levine, Conductor
115146

TCHAIKOVSKY
1812 Overture
Romeo & Juliet
Nutcracker Suite
Chicago Symphony
SOLTI
125179

Sting
Nothing Like The Sun
273965

James Galway Kazuhito Yamashita
Italian Serenade
173824

PRETENDERS
THE SINGLES
133248

HOROWITZ
In Moscow
125264

Bon Jovi: Slippery When Wet • You Give Love A Bad Name, etc. Mercury 143465

Pops In Space • Boston Pops/Williams. Music from Star Wars, Close Encounters, others. Philips DIGITAL 105392

Genesis: Invisible Touch • Land Of Confusion, title song, etc. Atlantic 153740

The Glenn Miller Orch.: In The Digital Mood In The Mood, etc. GRP DIGITAL 143293

Whitesnake • Here I Go Again, Still Of The Night, Give Me All Your Love, Crying In The Rain, Bad Boys, more. Geffen 163629

Pat Metheny/Ornette Coleman: Song X Fusion guitar master and legendary saxophonist. Geffen DIGITAL 151992

Alabama: Greatest Hits • She And I, Why Lady Why, Feels So Right, etc. RCA 120247

Kitaro: The Light Of The Spirit • Sundance, Mysterious Encounter, The Field, In The Beginning, etc. Geffen DIGITAL 164228

Bryan Ferry: Bête Noire • The Right Stuff, Limbo, Kiss And Tell, Zamba, more. Reprise 144543

Vivaldi, The Four Seasons • Pinnock/English Concert. Archiv DIGITAL 115356

Heart: Bad Animals • Alone, Who Will You Run To, There's The Girl, Wait For An Answer, others. Capitol 153552

Bach, Brandenburg Concertos Nos. 1-3 The English Concert/Pinnock. Archiv DIGITAL 115541

Randy Travis: Always And Forever • Forever And Ever Amen, Too Gone Too Long, more. Warner Bros. 163917

Previn: Gershwin • Rhapsody In Blue, Concerto In F, more. Philips DIGITAL 115437

Brahms, Symphony No 1 • Vienna Philharmonic Orchestra/Bernstein. DG DIGITAL 125224

Crosby, Stills, Nash & Young: So Far • Our House, Teach Your Children, Suite: Judy Blue Eyes, etc. Atlantic 130230

Huey Lewis & The News: Fore! Hip To Be Square, Stuck With You, Jacob's Ladder, more. Chrysalis 154570

Mozart, Symphonies Nos. 40 & 41 (Jupiter) Chicago Symphony Orchestra led by James Levine. RCA DIGITAL 104810

The Judds: HeartLand • Don't Be Cruel, Cow Cow Boogie, etc. RCA 160363

The Cars: Door To Door • You Are The Girl, Strap Me In, others. Elektra 161593

Kenny Rogers: I Prefer The Moonlight One More Day, etc. RCA 162743

The Legendary Enrico Caruso • Vesti la giubba, Celeste Aida, Cielo e mar. La donna è mobile, 17 more. RCA 134274

Mozart, Serenade No. 3 in D, K. 185 Academy Of Ancient Music/Hogwood. L'Oiseau-Lyre DIGITAL 115000

Aerosmith: Permanent Vacation • Dude (Looks Like A Lady), Magic Touch, Rag Doll, etc. Geffen 143960

Elvis Presley: The Sun CD • That's All Right, Mystery Train. RCA 272289

Dire Straits: Brothers In Arms • Money For Nothing, etc. Warner Bros. DIGITAL 114734

Robbie Robertson • Showdown At Big Sky, Sweet Fire Of Love, etc. Geffen 144460

Fleetwood Mac • Rhiannon, Monday Morning, Over My Head, Say You Love Me, more. Warner Bros. 104897

Toscanini: Beethoven, Symphonies Nos. 2 & 7 • NBC Symphony Orchestra. RCA 154202

John Cougar Mellencamp
The Lonesome Jubilee
134420

FOREIGNER
Inside Information
143330

Led Zeppelin IV (Runes) • Stairway To Heaven, Rock & Roll, Black Dog, Misty Mountain Hop, others. Atlantic 112014

Linda Ronstadt: Canciones De Mi Padre (Songs Of My Father) • Por Un Amor, Los Laureles, etc. Asylum 163509

Ciuburn: Tchaikovsky, Piano Concerto No. 1; Rachmaninoff, Piano Concerto No. 2 Running time: 68 minutes. RCA 163527

Starship: No Protection • Nothing's Gonna Stop Us Now, It's Not Over ('Til It's Over), others. Grunt 163827

Fritz Reiner: Strauss, Also sprach Zarathustra • Plus Der Rosenkavalier Waltzes, more. Chicago Symphony Orchestra. RCA 163627

Steve Winwood
CHRONICLES
GREATEST HITS
134501

Holst
THE PLANETS
Montreal Symphony Orchestra
DUROIT
115448

Stevie Wonder
Characters
133966

JAZZ CD SAMPLER
JAZZ LIKE YOU NEVER HEARD IT BEFORE
OVER 67 MINUTES OF MUSIC
173406

Madonna
You Can Dance
134536

Handel
WATER MUSIC
The English Concert
PINNOCK
115306

START NOW WITH 3 COMPACT DISCS!

Yes, pick any 3 Compact Discs shown here. You need buy just one selection at regular Club prices (usually \$14.98-\$15.98)...and take up to one full year to do it. That's 4 great compact discs for the price of 1 and there's *nothing more to buy...ever!* A shipping and handling charge is added to each shipment.

HOW THE CLUB OPERATES

You select from hundreds of exciting Compact Discs described in the Club's magazine mailed to you approximately every 3 weeks (19 times a year). Each issue highlights a Featured Selection in your preferred musical division plus alternate selections. If you'd like the Featured Selection, do nothing, it will be sent to you automatically. If you'd prefer an alternate selection, or none at all, just return the card enclosed with each issue of your magazine by the date specified on the card. You will have at least 10 days to decide, or you may return your Featured Selection at our expense. Cancel your membership at any time after completing your membership agreement, simply by writing to us.

FREE 10-DAY TRIAL

Listen to your 3 introductory selections for a full 10 days. If not satisfied, return them with no further obligation. You send no money now, so complete the coupon and mail it today.

CD615 Compact Disc Club, 6550 E. 30th St., Indianapolis, IN 46219-1194

SAVE 50% INSTANT HALF-PRICE BONUS PLAN
Unlike other clubs that make you first buy one, two, or more CDs, the Compact Disc Club gives you a 50%-off Bonus Certificate with the very first CD you buy at regular Club prices!



YOUR SAVINGS START HERE
Mail to: Compact Disc Club
P.O. Box 91412 • Indianapolis, IN 46291

YES, please accept my membership in the Compact Disc Club and send me the three Compact Discs I've indicated below and bill me for just shipping and handling, under the terms in this ad. I need buy just 1 CD at regular Club prices during the next year. That's 4 for the price of 1...with *nothing more to buy ever!* (Shipping & handling added to each shipment.)

RUSH ME THESE 3 SELECTIONS (Indicate By Number):

D D D

I am most interested in the following type of music—but am always free to choose from both categories (check one only) } 1 CLASSICAL
2 POP/SOFT ROCK

MR.
 MRS.
 MISS First Name Initial Last Name (PLEASE PRINT)
Address Apt.
City State Zip

Telephone () Area Code
Signature

Limited to new members; continental U.S.A. only; one membership per family. We reserve the right to request additional information or reject any application. Local taxes, if any, will be added.

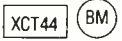

BARS AND STRIPES FOREVER

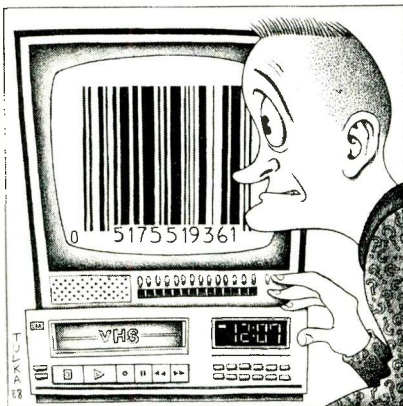

Bar None

The bar codes on products like this magazine are for the convenience of distributors and stores, but bar-code readers have already started infiltrating homes. Some new VCRs, for instance, have wands that read bar-coded programming instructions in the accompanying owner's manuals, and a few TV program listings have begun to carry the codes as well. This is a boon to people who make mistakes when programming their VCRs—which, I suspect, is almost everybody. (I confess to having taped the odd half-hour of cable classified ads or hair-restorer promos myself.)

Soon, we may have CD players that read bar-codes too. This may well be a fallout from CD-V, since it involves a format jointly developed by Sony for CD players and Pioneer for videodisc machines and which is now being proposed as an industry-wide standard. This application of bar codes is intended not so much to solve existing user problems as to open up new programming possibilities; Sony and Pioneer both plan to produce textbooks keyed by code to specific spots on educational CDs or videodiscs.

I suspect that there may be an additional, hidden motivation behind all this activity: If people have to keep their manuals around for bar-code wands to read, they won't toss out those manuals the instant their equipment is up and running. And that means fewer silly calls to manufacturers' service departments asking questions that the manual answered in the first place.

International CD Scene

The most comprehensive directory of nonclassical CDs I've seen is *CD International*, a West German publication. The premier edition of *CDI*, which is to be published six times a year, has 215 pages of listings which show the issuing companies and the record numbers each album bears in the U.S., Britain, West Germany, and Japan. The value of this international info to record collectors who travel is obvious, but stay-at-home collectors will find it useful too. If you know what's available, you can ask your travelling friends to keep an eye out for the discs you want or you can order them from overseas. (The publishers of *CDI* sell a list of international mail-order record sources.) Or you can simply keep on the lookout in this country—CDs available abroad frequently do come to the U.S. later, and some discs not officially available here turn out to be on sale in the better American record shops.

So now I'm on the lookout for some CDs I did not know of previously—and will be doubly on the lookout if I travel overseas. For instance, there's a Bessie Smith CD available only in Germany (*Jazz Classics*, IRS 970.477), and my favorite Charles Mingus album, *Mingus Presents Mingus*, is available only in Japan (Tokuma 32JCD-101).

I found *CDI* pretty accurate when I cross-checked some of its entries against the *Schwann CD Catalog*—no errors of commission, and the very few omissions were par for the course in an enterprise this size. One English-language comedy album (*The Three Faces of Al*, by Firesign Theater) was listed as available only in Germany, not in the U.S. or U.K., a weirdness the Firesigns themselves would appreciate.

Keeping up with the Joneses, I checked to see how the number of albums by people named Jones varies from country to country. I noted that George Jones is best represented in the U.S. (nine albums here, none in Britain, one in Germany, and none in Japan), Grace does better in Europe (four in the U.S., five in Britain, seven in Germany, two in Japan), Hank Jones CDs are most available in Japan (the count is one, zero, one, and four), Quincy is a hair better represented here than in Japan (19, four, six, and 18), and Rickie Lee has three albums available in each of the four listed countries.

Elvis Presley, of all people, is better represented on CDs abroad than in America (15 in the U.S., 17 in Britain, 36 in Germany, 24 in Japan). Old rock 'n' roll, in general, is at least as available overseas as here. And when it comes to jazz, Germany and Japan each have far more CDs in that genre than the U.S. does.

The second or third issue of *CDI* should be available on newsstands for \$6.98 by the time you read this; it is imported by Phi-Ba Project, P.O. Box 22014, Milwaukie, Ore. 97222. The company also plans a version for classical music, to be followed by a version on PC-compatible floppy disks (4.5 megabytes' worth).

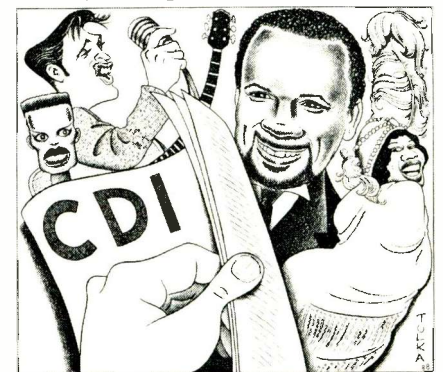

Falling Dollar, Rising Price

Japanese audio makers have been trying to hold the line on prices despite the rising yen and falling dollar. To accomplish this, they've had to cut their profits and, in some cases, to cut back on product features. Tape makers, however, have

no features to eliminate. So a number of Japanese suppliers have announced price rises of 15% to 20% on their audio tapes. This has proved to be the precursor of a rise in prices for Japanese components too, probably to be followed by rising prices for audio imports from Europe.

AN AUDIOPHILE RECEIVER THAT'S A VIDEOPHILE DREAM.

Selected as one of the
"Best Products Of The Year"

by **Video
Review**

The first A/V receiver with built in MTS tuning, Dolby Surround Sound, and Universal Programmable Remote Control.

The new ONKYO TX-SV7M can function as the heart of both a superb home audio system and an unparalleled video theater. It combines the ONKYO reputation for excellence in receiver performance with today's most demanded video capabilities.

The TX-SV7M has built-in stereo MTS television reception and tuning. That means any TV can become a stereo TV merely by connecting it to the TX-SV7M via conventional antenna or cable converter.

Full Dolby Surround Sound with 90 watts per channel for front speakers and 20 watts per channel for the rear is



supplied by four high quality amplifier sections which can also deliver 100 watts per

channel in stereo mode.

Finally, our new audio/video receiver comes with the RC-AV7M Universal Programmable Remote Control, which assures full system remote control capability with multiple brands of equipment.

No other receiver on the market offers the outstanding performance and remarkable feature combinations the TX-SV7M does. It truly is an audiophile receiver that's a videophile dream.



For complete information on the new ONKYO TX-SV7M, write to us for a free brochure or visit your Onkyo dealer.

Artistry in Sound

ONKYO®

200 Williams Drive, Ramsey, N.J. 07446 201-825-7950

*Dolby is a trademark of Dolby Labs, Inc.

Enter No. 25 on Reader Service Card

WHEN YOU WISH UPON A CAR

Now Here's My Plan . . .

It's finally dawned on me that installing state-of-the-art stereo in a 1975 Saab is rather a dim proposition. The old Model 99 (long since superseded in Saab's line) never had a radio slot or any decent places to put front speakers. Since I bought mine without an air conditioner, I spend my summers with the windows and moon roof open; as a result, sonic subtleties tend to get swallowed up by road noise.

By the time you read this, I'll probably have replaced that old Model 99 with something quieter, newer, and air-conditioned. It's not yet definite what I'll get (the leading contenders are a Ford Taurus, a newer Saab, or a slightly used Merkur Scorpio), but I've already started to scheme about a new stereo system for it. Based on my experiences with the Saab, I know pretty much what I want from the sound system in my new car. Getting it all, however, may prove to be another story.

For one thing, I am no longer so gung-ho for perfect speaker placement that I'm willing to Swiss-cheese my (presumably) valuable new car the way I did my old one. Since my new car will have come from the factory with speaker mounts, I'll try them first; any new speaker holes will be cut only after I've carefully experimented with surface-mounted speakers held on by tape. That should be no problem, as I finally have an installer who'll go along with me on this. In my new system, I hope to get good forward-stage imaging without resorting to a center channel; I don't mind adding complications to improve the sound, but I do mind it if it's done to cure problems that should not exist in the first place.

I'll want a subwoofer that can go down really low, yet I don't want to sacrifice cargo space. This means a woofer system that will neither fill up the trunk with its enclosure nor, if I get the Saab or Merkur hatchbacks, keep me from removing the rear deck and folding down the rear seats when wagon capabilities are called for. To get good bass and good frontal imaging, I'd like to use a constant-bass crossover system, which adds

low bass whether I've set the fader to favor the front speakers or the rear ones; if I'm unable to install such a crossover, I'll hook the subwoofer to the front speakers.

The front and rear speakers will be equalized independently. I suspect the final equalization will not be flat, but will have enhanced bass (to overcome road rumble) and a gently sloping treble. I don't want a user-adjustable equalizer in my dash unless I can find a way to build my own. If I could, I'd build myself an equalizer with unusual features: A mild bass boost/cut control (maybe +6 to -9 dB), a very gentle midrange adjustment (± 5 dB, perhaps?), a steep high-cut filter with

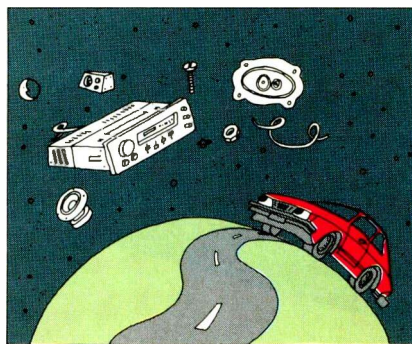

a variable turnover frequency, and maybe a control that gently slopes the frequency response without bending it, like the "Tilt" found on some Quad preamps. Instead of graphic sliders, I'd want rotating knobs with pointers I could feel; for the "Tilt" control, I'd want a tilting horizontal bar.

I think I'd like a surround decoder to add spaciousness, although a simple delay line to the rear might do as well. I'd like to try Audio Control's Epicenter bass enhancer, which is a 12-V adaptation of their Phase Coupled Activator. A gentle compander would be good, to add a little life to AM broadcasts and, more urgently, to compress the dynamic range of CDs and certain tapes when road noise makes it necessary.

I'd love to have a gadget that would adjust the sound according to the ambient noise level; ideally, as I've mentioned before, a rise in ambient noise would cause simultaneous but modest increases in

sound level, compression, and bass boost. In practice, I'd settle for a device that simply raised and lowered volume; such gadgets are available separately in Europe, but in this country they exist only as circuits in head units or equalizers.

All these items will probably be mounted on an amplifier rack which is likely to be mounted in the trunk. The board will be made readily removable (though I don't yet know how) so I can swap components in and out for tests and maximize cargo space when I need it. The board will probably have a surrounding metal screen so it won't be seen when I open the trunk, and so cargo won't butt up against it and cut off its ventilation. I hope to have one small amp (20 watts or so per channel) permanently mounted in the car for use when the amp rack has been removed.

The new system will have both tape and CD, but I haven't yet decided between a dash-mounted CD player and a trunk-mounted changer. All dash-mounted equipment will be in removable Bensi boxes, wherever possible, partly so I can take it with me when I park, but mainly so I can interchange equipment quickly for tests. If possible, there will also be a shelf to hold any dual-chassis units that I may have to test (such units will not fit in Bensi boxes). The console will also hold a selector switch for fast comparison between my reference head unit and whatever I'm testing.

Since I don't drive often enough to keep my battery fully charged at all times, I'll also want to add a voltmeter and ammeter, if the car does not already have them, to keep tabs on the car's electrical fitness.

If all works out as planned, the result will sound like a showpiece system but won't look like one. A concealed system will keep the car's appearance unimpaired and won't advertise its existence to potential thieves. (Guess it will be time to get a car alarm too—a new car not only looks more likely than an old one to have stereo gear worth stealing, but is more worth stealing for itself.)

So much for preliminary plans. Stay tuned, and we'll see how the reality develops.

MATRIX
801

WE'LL CHANGE YOUR IDEAS **S E R I E S 2**

B&W's Model 801 – the recording industry's Reference Standard Monitor – was the inspiration for Innovation. Dramatic developments in technology and enclosure design have lit the fuse. B&W's Matrix 801 Series 2 personifies the state-of-the-art ten years on. This magnificent successor sets the new standard for professional and home user alike. With no commercial compromise. Rich in Matrix technology, 801 Series 2 registers accurately even beyond audibility. Phenomenal sound. Clean and utterly uncoloured. Outstanding imagery with tight unbooming bass. An instrument destined to occupy a special place in world esteem.



The **MATRIX**
Revolution

B&W Loudspeakers of America, P.O. Box 653, Buffalo, New York 14240 (416) 297-0595
Enter No. 7 on Reader Service Card

BERT WHYTE

FIRST-STRING INSTRUMENTS

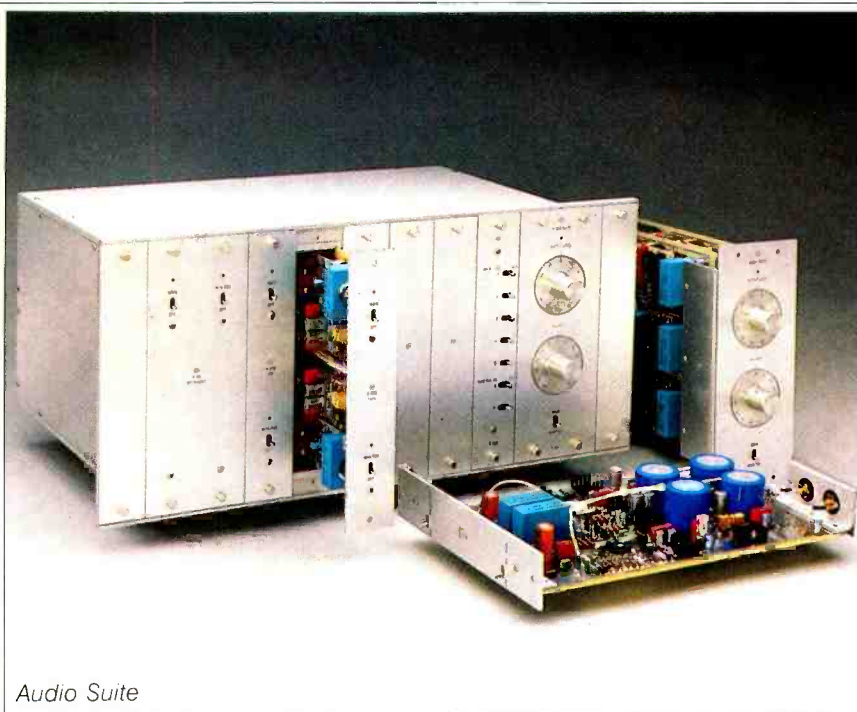

Audio Suite

In every product category, there is always a small group of items considered outstanding for their high quality, and sometimes one product is incontestably the very best, the exemplar that sets the standards by which all similar products must be judged. I freely admit that some of the differences in quality among products of such high pedigree are indeed subtle. Nonetheless, for some months now I have been evaluating the performance of the new audio equipment from Cello, Ltd., and I can say without reservation that the sonic sophistication, advanced circuit topology, and uncompromised construction found in this line surpass anything I've ever encountered. Yes, this is certainly a strong statement. What follows will, I hope, convey why I formed this opinion.

As you probably know, some time ago Mark Levinson founded Cello, Ltd., located in New Haven, Conn. He is president and CEO; his vice president of engineering is the remarkable Tom Colangelo, who was with Mark in his original company. Tom is a brilliant and innovative engineer who, over the years, has given the audio world some landmark designs which have established new standards of sonic excellence. Tom has designed the Cello

components in keeping with Mark's basic philosophy. It has three main elements: The Audio Palette, an elaborate control/equalizer system; the Audio Suite, an advanced mainframe-type preamplifier using modular components, and the Performance Amplifier, a monoblock unit, each section of which has a separate power supply.

The Audio Suite is rack-mountable, measuring 19 inches wide, 9 inches high, and 12 inches deep. It is of heavy aluminum bar and plate construction, precisely assembled with machine screws. This construction method is costly, but it offers great rigidity, especially compared to the usual sheet-metal construction of most conventional preamps. The mainframe has an electrical input for d.c. and an elaborate signal bus system. It has 10 "bays," each of which can be covered by a metal dress plate when not in use. By removing the dress plates, various modules can be installed. The unique method of securing the modules ensures electronic integrity: Removing a plate on the lower back portion of the mainframe reveals a Delrin plate with 10 vertical holes at the rear of each bay. After a module is inserted in the bay, screws are threaded through the Delrin, then through threaded, quarter-

inch square-section, solid copper bus bars, and thence into threaded holes in the module itself. There are two ground buses, one +30 V and one -30 V, and six audio buses. The audio buses can be used in various ways, depending on module function. Three stereo buses can be used or, in professional recording applications, two stereo buses plus two mono cue buses. Due to the bus system, there is no conventional wiring in the Audio Suite. The master power supply provides ± 30 V at 8 amperes regulated d.c. A special trip loop provides protection against over-voltages and short circuits. The Master Supply can simultaneously feed the Audio Suite and the Audio Palette; it can (and should) be located a considerable distance from these units. Since the Master Supply provides double regulation, a special advantage accrues: The second regulator doesn't have to deal with significant ripple voltage and ripple current.

The Audio Suite's modular design provides great flexibility so that facilities can be tailored to individual needs. Since each module has a considerable amount of internal volume, a large number of parts can be accommodated; such space also permits the use of larger film capacitors. The Audio Suite I have been using has the P101 moving-coil phono module, which has a great many polycarbonate capacitors, highly refined circuit topology, and separate power regulators for each channel. Uniquely, for reduction of hum and noise, the entire module is enclosed in a mu-metal case. The line section in this Audio Suite is a P200 module, which has switchable options for grounding, input impedance, and gain (with a total of 24 dB available). I use the P200 for CD and R-DAT playback. Both the P101 MC phono module and the P200 line-stage module have small toggle switches which will provide output to the main output or monitor. Another module in the Suite I have been using is the B200. It provides five stereo pairs of RCA inputs, with toggle switches making pairs four and five capable of monitor output. This module is connected via a resistor through the audio buses to the P301 summing amplifier output module. The P301 has a calibrated output level and balance control and a toggle switch for

WE'LL CHANGE YOUR IDEAS

B&W
CONCEPT 90
B&W

B&W's Concept 90 demonstrates the shape of audio art for the rest of this century. Challenges the view that only a sizeable, intrusive enclosure could produce sound of true monitor quality. Concept 90 is B&W Matrix technology miniaturised. The result CM1 and CM2. Loudspeakers whose mighty performance is at home in limited rooms. Whose appearance is perfectly attuned to design-conscious living. CM1's presumptuously massive voice completely belies its diminutive size. CM2. A further dimension giving supreme power and bass extension. Altogether a superlative omnidirectional pattern of sound radiation. The perfect exposition of the state of B&W art.



The **MATRIX**
Revolution

B&W Loudspeakers of America, P.O. Box 653, Buffalo, New York 14240 (416) 297-0595

Enter No. 8 on Reader Service Card

The incredibly complex Audio Palette, with its nearly 6,000 parts, is an engineering tour de force.

main out or monitor; record outputs are available on the rear of the module, and output impedance is 5 kilohms. The "P" modules are equipped with push/pull Class-A circuitry. In addition to the double regulation afforded by the Master Supply, they also have separate regulators for each channel providing ± 25 V d.c.

All modules may be mixed, due to the common bus/summing amplifier approach. In professional applications, this has many advantages. The Audio Suite operates in a balanced input/output configuration. Special Swiss-made, three-pin Fischer connectors are used with "Cello Strings," which are interconnect cables of Litz construction using three-conductor, oxygen-free copper wire and Teflon dielectric. XLR connectors can be fitted for professional use. The "P" modules are fitted for Fischer plug balanced inputs, and the P301 module is similarly equipped for balanced output. For connection to unbalanced consumer components, various adaptors are available. The Audio Suite has delay circuits to avoid on/off switching thumps.

Future modules for the Audio Suite will include A/D and D/A converters, an FM tuner, power amplifiers, special-purpose remotely controllable modules, and others. Without question, the Audio Suite is a unique preamp that offers freedom from obsolescence and delivers awesome performance.

The Cello Audio Palette is a similarly unusual component, of a design heretofore unavailable to audiophiles. Measuring 19 inches wide, 7 inches high, and 12 inches deep, it is an incredibly complex equalizer and control unit and an engineering tour de force. There are nearly 6,000 parts in an Audio Palette, including 48 discrete Class-A amplifiers. All of these components and parts are on 55 circuit boards mounted in seven levels! Although this complexity flies in the face of "less is more," I can assure you that the Audio Palette is sonically transparent; in fact, the complexity is necessary for optimizing each stage for best performance. A large number of high current stages are used to reduce noise and distortion when driving low-impedance filter, interstage, and output loads.

Filter characteristics have been optimized for time-delay aberrations; thus,

the equalization is virtually free of ringing and phase-shift errors. The filters were designed by Richard S. Burwen, a brilliant engineer who is preeminent in the field of filter design and equalization. In his design for the Palette, he employed minimum-phase, 6-dB/octave roll-off filters, with slight modifications at the 15-Hz and 25-kHz extremes. The filters overlap rather broadly, except for those which are centered at 500 Hz and 2 kHz. This clever design affords easy-to-effect



changes, and even very small adjustments are quite perceptible. Filter center frequencies are at 15, 120, and 500 Hz and at 2, 5, and 25 kHz, adjustable via 59-position controls.

The Audio Palette uses the same bar and plate construction as the Audio Suite. As noted, it too is powered from the Master Supply, with double-regulated ± 30 V d.c., although there is further internal regulation. The Palette also operates in a balanced input/output configuration with Cello Strings and three-pin Fischer connectors.

The Palette's 12 controls are all made of milled brass and are calibrated in steps. The top row has left and right input level controls, then a phase reversal switch, and then a three-position "Equalization" switch. The latter can put the Palette into the "Out" mode, with no equalization and with unity gain, or into the "In" mode, which activates the EQ and balance controls. There is also a "Blend" position on this switch, which puts the unit into mono below 40 Hz. "Output Level," at the far right of the top row, is really something special—a 59-position rotary control with stereo tracking within 0.02 dB in increments of 1 dB! Each element of the control is custom-made with platinum/palladium alloy contacts (the

same as are used in helicopter rotors) which ensure practically unlimited duty cycling, and with gold-plated circuit boards.

The Palette offers a total of 26 dB of gain from input to output, so direct drive of the Palette is possible from Compact Disc players or R-DAT recorders, AM/FM tuners, and analog tape recorders. A power amplifier card will be forthcoming, and speaker barrier-strip terminals are already on the rear of the Palette. For those who have limited space or who prefer a small audio system of ultra-high quality, this is the answer.

The Palette is designed to be inserted between the Audio Suite and the Performance Amplifier in balanced configuration, with the Audio Suite's output level control set to "0" and its balance control in the center position. In this mode, the Palette's "Output Level" serves as the master level control for the entire system, controlling input level adjustment and balance, polarity reversal, and equalization.

The final link in the Cello system is a pair of the Performance Amplifiers, monoblock units, and their matching separate power supplies. Each chassis measures 17½ inches wide, 7¾ inches high, and 17 inches deep; in the aggregate, they weigh over 250 pounds. The amplifier's output power transistors are mounted on electrically conductive heat-sinks, forming "tunnels" through which air is forced by two ultra-quiet fans which do not intrude even on triple pianissimo passages of music. Because insulators are not used, the power devices work more efficiently.

Cello points out that conventional amplifiers use capacitive-input power supplies which waste most of the a.c. cycle and need large transformers to supply high peak currents. In addition, capacitive-input supplies are extremely sensitive to a.c. line fluctuations. In contrast, Cello tells me, the Performance Amplifier's power supply has dual-choke inputs, which utilize the entire a.c. waveform, affording a high power factor and more efficient use of the a.c. line current. Other benefits of dual-choke input include additional filtering and energy storage, less stress on capacitors, and better balance of charging currents, which helps to

THE ONKYO INTEGRA DX-530

Because digital and analog shouldn't mix

The primary objection many audiophiles find with the compact disc format is a harshness and stridency in the sound that tends to obscure the real world dynamics of the music. Onkyo was the first CD player designer to address this problem by developing our patented Opto-Coupling modules.

The Integra DX-530 is the newest ONKYO CD player to incorporate our exclusive Opto-Coupling technology, which prevents the leakage of Digital Signal Interference into the analog domain. By using fiber optics instead of conventional printed circuit wiring, the DX-530 ensures correct D/A conversion, and provides superb CD sound at an affordable price.

Complete programmability is enhanced by ONKYO's exclusive Random Music Calendar, a unique display which clearly shows programmed tracks in correct playback order. A 40 key wireless remote duplicates every control function, including motorized analog output level. Audition the Integra DX-530 at your ONKYO dealer, or write to ONKYO for a detailed brochure.



Artistry in Sound

ONKYO

200 Williams Drive, Ramsey, N.J. 07446 · (201) 825-7950

Enter No. 35 on Reader Service Card

Soundcraftsmen



S-E-P-A-R-A-T-E-S...

GUARANTEED TO ENHANCE AND IMPROVE YOUR STEREO SYSTEM'S SOUND...

Preamplifiers



PRO-CONTROL FOUR Preamplifier, with digital CMOS switching. Ten total inputs, 5 tape monitors, 2 signal processing loops. Direct mode, Auto-Bridge circuitry, Bass and Treble Controls.
19" W x 3 1/2" H x 11" D, 15 lbs. **\$699**



DX4200 Preamplifier/Equalizer, with Compact Disc Player and Video/Audio Inputs. Phono preamp has Variable Cartridge Loading (50-800 pF, 100/47,000 ohm); phono level controls for adjustable ± 20 dB gain; MC variable reluctance or MM cartridge inputs; 3-way Tape Dubbing; 2 external Signal-Processor Loops; conventional line outputs plus separate Autobridge Line Outputs for Mono Bridging of Most Amps; EQ S/N 114 dB; Passive-Coil filters with 15 dB boost or cut for each octave, max 22 dB; Differential Comparator circuitry for True **0.1 dB** Unity-Gain EQ balancing; includes Frequency Spectrum Analyzer test record and instant reset Comptone Charts.
19" W x 5 1/4" H x 11" D, 20 lbs. **\$699**

DX4000 Preamplifier. Same as DX4200 without phono cartridge matching controls and Equalizer, but with 3 external loops.
19" W x 3 1/2" H x 11" D, 15 lbs. **\$439**



DX3000 Preamplifier, Inputs for CD player, Video/Audio, Tuner, Phono, Two Tape Decks with dubbing, Bass and Treble controls, and signal processor loop. THD -0.01% , S/N 95 dB.
19" W x 2 3/4" H x 10" D, 10 lbs. **\$329**

Power Amplifiers



PCR800 Power Amplifier, MOSFET stereo, 205 watts per channel continuous RMS 20-20,000 Hz into 8 ohms $<0.05\%$ THD; TIM unmeasurable; S/N 105dB.
8 1/2" W x 5" H x 12" D, 22 lbs. **\$499**



PRO-REFERENCE TWO, Studio Monitor quality MOSFET Stereo Amplifier. LED Meters monitor output of each channel in dB from -40 dB to $+3$ dB (200 Watts per channel into 8 ohms). True Clipping indicators, switching for two pairs of speakers. **Power Output:** 100 W/ch into 8 ohms, 190 W/ch into 4 ohms continuous RMS, 20-20kHz at $<0.05\%$ THD. S/N >105 dB.
19" W x 5 1/4" H x 10 1/2" D, 30 lbs. **\$699**
PRO-REFERENCE ONE, Same as above except no meters and no speaker switching, 28 lbs. **\$599**

Power Amplifiers



PRO-POWER FOUR, MOSFET stereo power amp **300** Continuous RMS Watts per channel @ 4 ohms, 205 Continuous RMS Watts per channel @ 8 ohms, 20-20kHz, **450** Watts RMS @ 2 ohms, **900** Watts RMS @ 4 ohms Bridged. THD $<0.05\%$, Hum and Noise: -105 dB, Front Panel switching for 2 pair of speaker systems. 40-LED 0-1600 Watt Power Meters.
19" W x 5 1/4" H x 11" D, 30 lbs. **\$799**

PRO-POWER THREE MOSFET stereo power amplifier, same as Pro-Power Four, except no 40-LED power meters. 30 lbs. **\$699**



PRO-POWER EIGHT MOSFET stereo power amp **600** watts per channel continuous RMS power into 4 ohms; 375 watts per channel continuous RMS power into 8 ohms, 20-20,000 Hz with no more than 0.05% THD; 900 watts per channel RMS into 2 ohms; Freq. resp. 20-20,000 Hz ± 0.1 dB; S/N -105 dB; slew rate 50V/m.sec; TIM unmeasurable; IM 0.05%.
19" W x 5 1/4" H x 16 1/2" D, 67 lbs. **\$1,499**

PM840 Power Amplifier, MOSFET stereo, features no-current-limiting power supply, **300** w/p/c RMS into 4 ohms; 450 w/p/c RMS into 2 ohms; 205 w/p/c into 8 ohms @ $<0.05\%$ THD; Freq. resp. 20 to 20,000 Hz ± 0.1 dB; S/N >105 dB; slew rate 50 V/microsec; TIM unmeasurable; damping factor 200.
8 1/2" W x 5" H x 12" D, 22 lbs. **\$549**



A5002 Power Amplifier, Class-H Vari-Proportional circuitry and Autobuffer for continuous operation into 2 ohms. Features auto crossover protection circuit for output protection without current limiting; 40-LED 0-1,000 Watt power output Meters; Front-Panel switching for 2 pairs of speakers; True Clipping indicators; Input Level controls. Output power 250 W/ch into 8 ohms, 375 W into 4 ohms continuous RMS, 20-20,000 Hz at $<0.09\%$ THD; S/N >105 dB; slew rate >50 V/microsec; TIM $<0.02\%$.
19" W x 7" H x 12" D, 50 lbs. **\$949**

A5001 Power Amplifier, Same as A5002 except no Meters and no Input Level controls. 50 lbs. **\$799**

Tuners



T6200 AM/FM Stereo Digital Tuner Digital quartz PLL tuner with 16 Station presets, 5-digit Station Readout, Auto-Scan tuning, active High Blend filter. Broad-Band AM switch, 19" rack-mount front panel, IHF sens 1.6 μ V; S/N 75 dB; distortion 0.08%.
19" W x 2 3/4" H x 12" D, 10 lbs. **\$299**

COMPACT DISC Player



NEW CD750 COMPACT DISC PLAYER with our exclusive Made-in-U.S.A. **"DIFFERENTIAL/COMPANDER"** circuitry. This newly developed circuit was designed by Soundcraftsmen to provide the utmost flexibility for the Compact Disc Format... High Dynamic Range for serious listening pleasure... or Optional Dynamic Compression/Expansion for background listening, for recording cassettes where the recorder is incapable of recording a 95 dB Dynamic Range, or for recording cassettes for playback on Car Stereos... Another Innovative Feature is our **"SPECTRAL GRADIENT"** circuit. This variable control enhances the listenability of Discs with hard or harsh high frequency characteristics. Both of these circuits are completely bypassable. The **CD750** has all the most desired features, plus many additional advanced Hi-Tech features such as Indexing, Digital Filter, All-Metal Chassis, Audible Scan, Random, Passage-Repeat, 3-Beam Laser, Wireless full function infrared Remote Control, Over-Sampling, complete Multi-Function Fluorescent Display, variable volume control Headphone Jack, Gold-Plated output jacks, **RACK-MOUNT FRONT PANEL**, and Jitter-Shock-Mounted Super-Safe Disc-handling
9" W x 3 1/4" H x 12" D, 16 lbs. **\$599**

Signal Processors



AE2000 Real Time Analyzer/Equalizer, World's most accurate (**0.1dB**) Real-Time Analyzer/Equalizer. The first and only analyzer with Two independent real-time analysis systems, (a Direct **10C-LED** display with **2dB** readout and a **0.1dB** readout Differential/Comparator) Pink-noise generator, 10-octave Real-Time display with Adjustable Decay rate, μ c. preamp. input for analysis for any Signal Processor, Autoscan mode.
19" W x 5 1/4" H x 11" D, 21 lbs. **\$799**



DC4415 Third-Octave Equalizer, stereo with 21 controls/channel. Center frequencies 40, 50, 63, 80, 100, 125, 160, 200, 250, 315, 400, 500, 630, 800, 1,000, 1,500, 2,500, 4,000, 6,300, 10,000, $\pm 5,000$ Hz; Features EQ defeat; Infrasonic filter; Tape Monitor and Tape Record; Differential/Comparator[®] circuitry for Unity Gain setting to within **0.1dB** accuracy for highest Dynamic Range capability. THD and IMD 0.01% at 2 V; S/N 114dB at full output; input imp 47,000 ohms.
19" W x 5 1/4" H x 11" D, 16 lbs. **\$699**

DC2215 Differential/Comparator[®] Equalizer, Stereo 10-band, with Differential/Comparator[®] True-Unity-Gain circuitry for Input-to-Output balancing accuracy to within **0.1dB**. Equalizer filter circuits use precision wire-wound Passive-Coil inductors for high gain, low noise and distortion.
19" W x 5 1/4" H x 11" D, 17 lbs. **\$449**

DC2214 Differential Comparator Equalizer. Same as DC 2215 except equalizer filter circuits have op-amp synthesized inductors. THD and IMD $<0.01\%$ at 2 V; S/N ratio 106 dB at 10 V; boost/cut range ± 12 dB.
19" W x 3 1/2" H x 9" D, 13 lbs. **\$299**

MADE IN
U.S.A.

Soundcraftsmen

**NOW CELEBRATING OUR 19th YEAR
OF MANUFACTURING STEREO
COMPONENTS FOR THE
SERIOUS AUDIOPHILE,
RIGHT HERE IN
SANTA ANA,
CA!**

**OUR 19-INCH
RACK-MOUNT
professional quality
separates offer you
many choices of the
finest American quality
separate components,
to add to your present
system, or to start a new
system. From our 410-watt
amplifiers at \$499, to our
\$1,499 Pro Power Eight, incredi-
bly powerful at 900 watts RMS
per channel into 2 ohms, and over
3,000 watts of instantaneous peak
reserve power into 2 ohms!
Plus a selection of 4 Preamp Control
Centers, 4 Signal Processors, a 16-
station-preset AM-FM Tuner, and
a new Rack-Mount Compact Disc Player
with our unique Differential/Compan-
der and Spectral Gradient control circuits...**



STEP UP to a new "HIGH" in Audio Reproduction...

Soundcraftsmen introduces the all new **PRO-CONTROL FOUR**, featuring digital **CMOS** switching. Soundcraftsmen's new switching technique provides the utmost in versatility plus the least distortion and noise. This **NEW** digital electronic switching completely eliminates the signal distortion and noise that is caused by mechanical switching. The **PRO-CONTROL FOUR** is the most flexible, simple to operate, control center/preamplifier ever designed.

A special "direct" mode bypasses both tone controls, as well as all signal processing circuitry, to create the ultimate pure signal path, a "straight wire with gain." Our exclusive "Auto-Bridging" circuit provides all the necessary processing for mono-bridging of two stereo amplifiers, tripling the output power.

Five tape monitor circuits for audio tape decks and/or VCR's provide the highest degree of recording/dubbing flexibility to be found anywhere. Three additional inputs are provided for compact disc player, tuner and phonograph. Two more loops are provided for signal processors, (such as equalizer, noise reduction, range expander, etc.) and may be individually switched into the signal monitoring path and/or recording path.

STEP UP to a new "high" in audio reproduction with the **PROCONTROL FOUR**, our technologically advanced digital **CMOS** control center and discrete phono preamplifier!

FREE!

16-PAGE, FULL-LINE, FULL-COLOR BROCHURE, AND \$19.95 SYSTEM-EVALUATION KIT: 12" LP Spectrum Analysis Test Record, 2-sets of Computone Charts, 1-Connector Cable for comparison test, 1-instruction folder for use with your present stereo system. **JUST WRITE TO US OR CIRCLE READER SERVICE CARD for FREE SPECIAL OFFER DETAILS.**

Enter No. 30 on Reader Service Card

Thanks to its unbelievably clean response, the Cello system displays incredible openness, spaciousness, and sonic transparency.

maintain dynamic balance of the ground point. The Performance Amplifier uses forty 250-watt bipolar power transistors per channel and, as you might imagine, this produces a whopping output current. While measurement of current of this amplifier is somewhat limited by the a.c. line, the unit is capable of 40 amperes continuous and 60 amperes on pulse, and it has a peak output of 200 amperes! With vanishingly low distortion, the Performance Amplifier is rated at 200 watts into 8 ohms and 400 watts into 4 ohms, with clipping at about 750 watts. It can drive 1-ohm loads easily at roughly 1,600 watts. Operation is Class A up to 100 watts and thereafter is Class AB. The Performance Amplifier uses balanced inputs via three-pin Fischer connectors and Cello Strings.

Well, the Cello audio system comprises a formidable group of high-tech, ultra-sophisticated components. Each is built to the highest standards of quality with the best commercially available parts and with some specialized parts made exclusively for Cello. Products of this caliber are necessarily expensive—but there is still such a thing as value for money. These three units as a package cost \$33,000. They can be bought separately and will certainly work well with other equipment, but they are made for each other and are synergistic in total performance.

The big question is, how well does this gilt-edge equipment perform? Is it worth the megabucks? In matters of sonic performance, the Cello equipment is truly incredible. I teamed the three units with two speaker systems: An updated version of the Duntech Sovereigns, which now have a new crossover permitting bi-wiring or bi-amplification, and B & W 801 Matrix units, which are just now beginning to be available in the U.S. I used Path Litz OFC speaker cables to bi-wire the Sovereigns to double outputs on the Performance Amplifier. For source material, I used a Sony CDP-705ESD CD player, connecting its coaxial digital output port to a Denon DAP-5500 digital processor/preamp. Then I ran its D/A converter output via Cello Strings into the P200 line input module on the Audio Suite. I also ran a Sony DTC-1000ES R-DAT recorder through the Denon processor and on to the Audio

Suite. I fed my Sony PCM-F1 digital processor into the high-level B200 module on the Audio Suite and did the same for my Ampex ATR-100 open-reel recorder. Phono signal was provided by a VPI HW-19 Mark 2 turntable with SME's Series V arm and a Cello Chorale MC phono cartridge. I used virtually the same setup with the 801 Matrix speakers, except that I did not use bi-wiring.

If I had to name the characteristics of the Cello electronics that immediately made me enamored of the system, they would have to be its incredible impression of openness, spaciousness, and sonic transparency. This is apparently the result of the unbelievably clean response all across the audio spectrum. The ability of the Cello equipment to cleanly delineate com-



Performance Amplifier

plex musical passages is quite extraordinary. For instance, the battle scene in Richard Strauss' "Ein Heldenleben" on the London/Cleveland Orchestra CD is a densely orchestrated section with violent dynamics, yet the musical textures were clearly revealed—even those with the most subterranean bass. In the opening passages of the fourth movement of the Shostakovich Thirteenth Symphony, also on a London CD, there is an awesome 31-Hz bass drumroll of tremendous weight. On most systems, it sounds rather muddy and overly resonant. With the Duntech Sovereign/Cello combination, the drumroll was clearly articulated—each stroke was distinct and clean. Transient response was outstanding, with piano attacks absolutely crisp and never smeared. The snare drums, rim shots, and other percussion in Tom Jung's new DMP CD of The Thom Rotella Band were razor-sharp, with the Cello system explosive in its speed and accuracy of timbre.

Speaking of Tom Jung, he uses the Cello Audio Palette extensively in his recordings and employs other Cello electronics in his custom mixing console. The Palette and Suite are also used by Polygram, Atlantic, and RCA, to name just a few record companies, and by such prestigious mastering studios as Sterling Sound and Bob Ludwig's Masterdisk.

I literally gorged myself on all my favorite music when I first set up the Cello system. I am a confirmed Mahler junkie, and hearing his profundities and heaven-storming dynamics along with his sweet lyricism was an overwhelming musical experience with this equipment.

Quite frankly, I've always been a bit down on equalizers, because most of them introduced unacceptable coloration of the music along with ringing and phase shift. However, the Audio Palette is a fascinating instrument, unlike anything I've ever used. It is indeed sonically transparent, utterly clean, and vastly useful in dealing with many of the ills and artifacts that affect recorded music. The Palette is quite efficient in taming high-frequency "glare" from early CDs and in obtaining a smoother frequency response. It is a God-given boon to vinyl records, which, because of cutting geometry and other constraints, are sometimes an affront to one's musical sensibilities. The Palette is easy to use, if you have a good ear for music—just follow your natural instincts for good sound. Many recordings will "bloom" with only the most subtle changes in equalization. Others may require more radical surgery, but it would be a rare recording that did not improve through the use of the Palette's magic knobs. It is very easy to love the Palette on short acquaintance. Play an organ recording that is deficient in the bass pedal, deftly manipulate the 15-Hz control for a few dB of boost, and your ears will appreciate the improvement. In short, the Palette can significantly expand and enhance the enjoyment of recorded music.

In spite of the potshots of those who sneer at high-end audio equipment and its big price tags, it sure is nice to know that if your ship ever comes in, such equipment is available to enrich your life. 

AWARD WINNERS

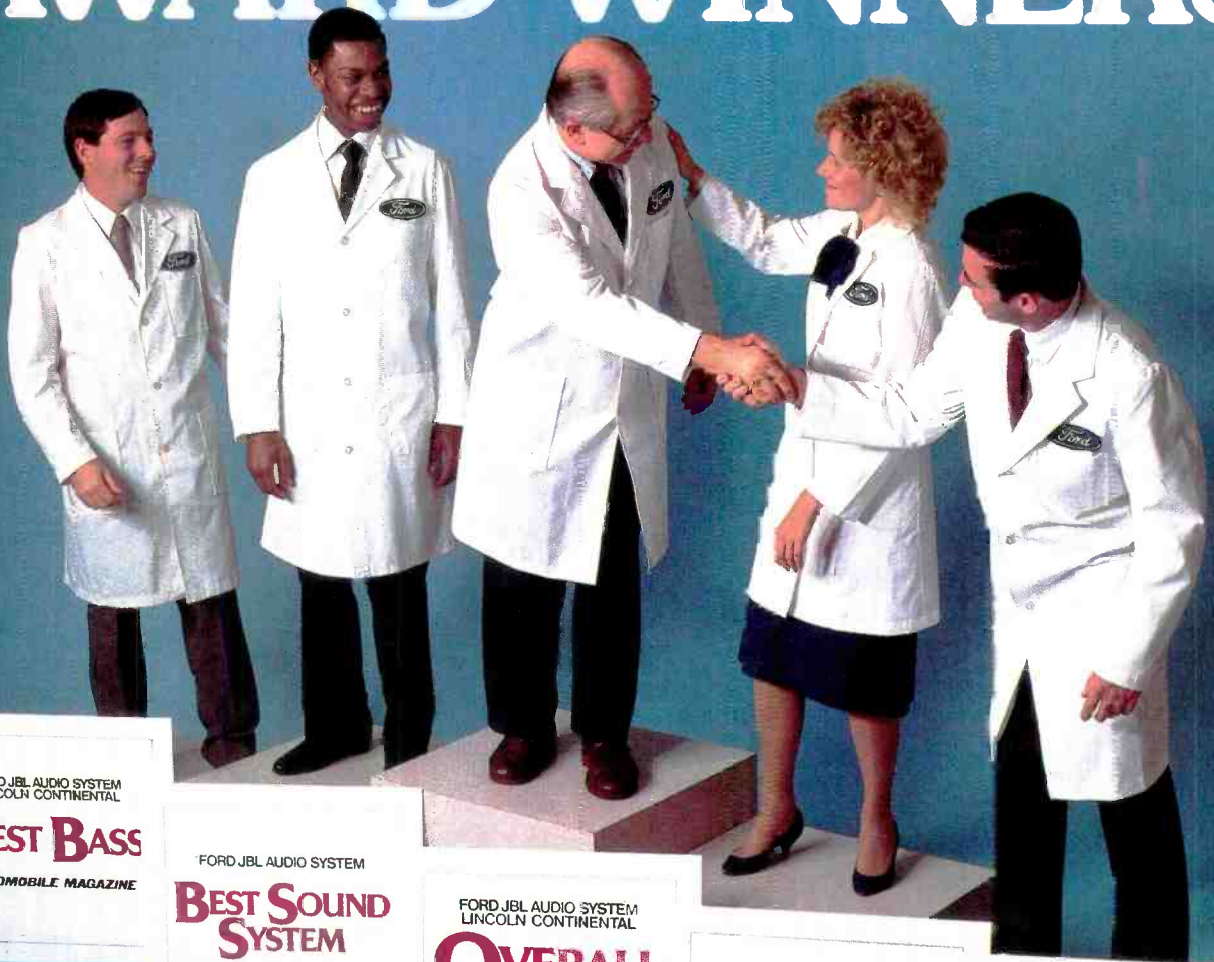

FORD JBL AUDIO SYSTEM
LINCOLN CONTINENTAL
BEST BASS
AUTOMOBILE MAGAZINE

FORD JBL AUDIO SYSTEM
BEST SOUND SYSTEM
PLAYBOY MAGAZINE

FORD JBL AUDIO SYSTEM
LINCOLN CONTINENTAL
OVERALL WINNER
AUTOMOBILE MAGAZINE

FORD AUDIO AM/FM CASSETTE
DESIGN EXCELLENCE COMMENDATION
INDUSTRIAL DESIGNERS SOCIETY OF AMERICA

PREMIUM SOUND SYSTEM
FORD TAURUS/MERCURY SABLE
BIGGEST BANG FOR THE BUCK
AUTOMOBILE MAGAZINE

The critics have spoken. They've praised Ford Audio Systems for superb performance and exacting quality. And they've honored them with impressive awards. Here's what the experts said about the Ford JBL Audio System in the 1987 Lincoln Continental:

"...transcends the normal car stereo experience and begins to enter the realm of good home equipment... the sound is exemplary... This is the first factory system we've heard that could deliver real sock 'em bass response...the Ford JBL system is simply spectacular."
Automobile Magazine

"...more expensive than concert tickets and probably better."
Playboy

"...the Ford JBL system gives the best value of the three." [in a comparison with Delco/Bose and Chrysler/Infinity systems]
Popular Mechanics

Also earning recognition was the Ford Premium Sound System in the Ford Taurus and Mercury Sable:

"Its purely technical performance is among the best...The premium sound system's modest price buys a tremendous jump in performance."
Automobile Magazine

There's good reason for the high marks given to Ford Audio Systems. Each system is designed and engineered for the specific acoustic requirements of Ford, Mercury and Lincoln vehicles, giving you true custom-tailored performance.



AUDIO SYSTEMS

"Polk Has Triumphed."

CAR STEREO REVIEW

Introducing Matthew Polk's New SDA Mobile Monitor Systems

Matthew Polk has a passion for perfection in the cars he drives, and the speakers he creates. His astonishing new SDA Mobile Monitor Speaker Systems combine the awesome sonic benefits of his revolutionary SDA True Stereo technology with the superior sound of his Grand Prix award winning Mobile Monitor loudspeakers. Car Stereo Review, the definitive authority on the state-of-the-art in autosound, raved, "It's like jumping into hyperspace."



Complete systems (front and rear speakers plus an SDA Automotive Crossover Matrix) begin under \$500.

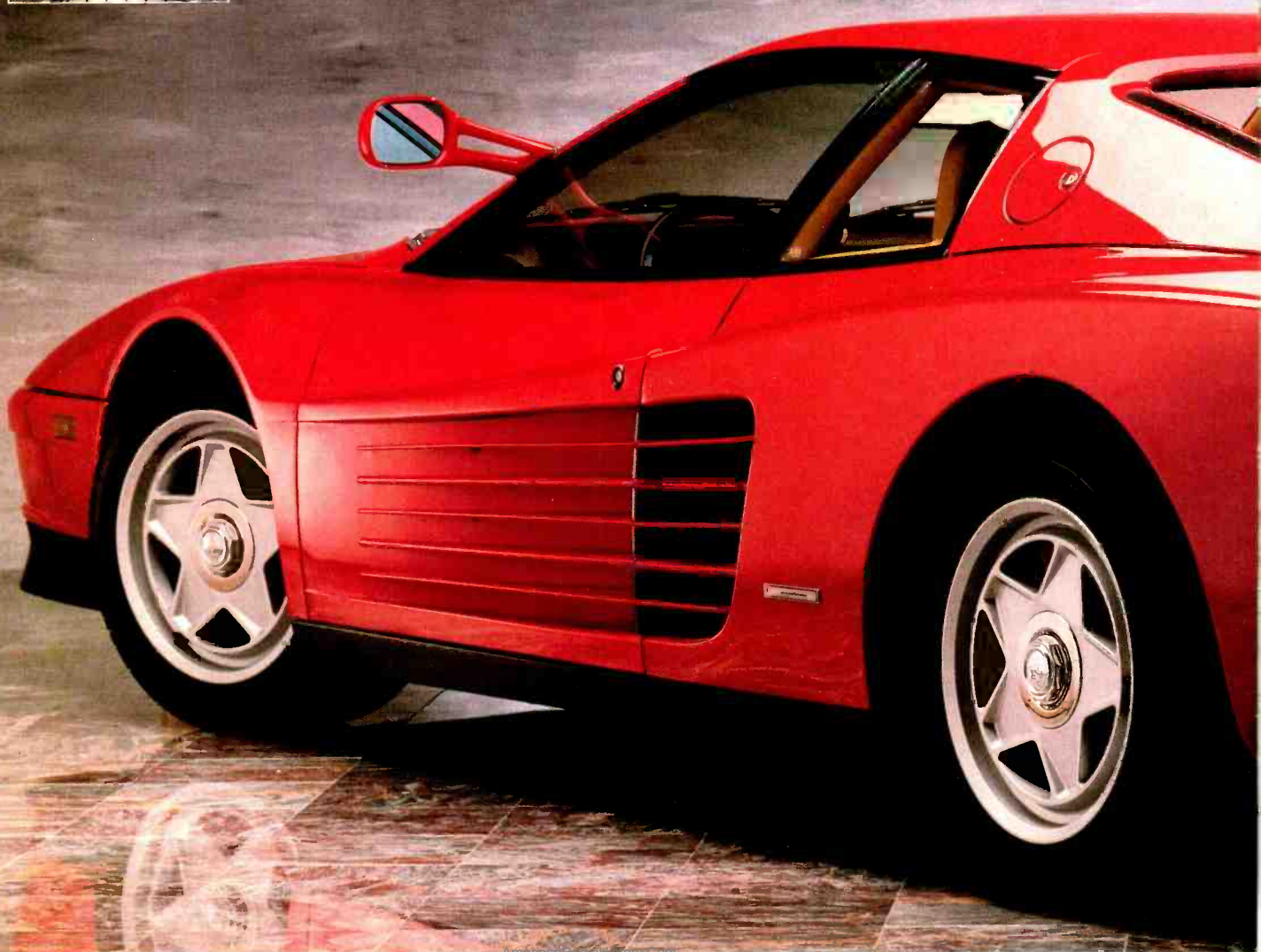

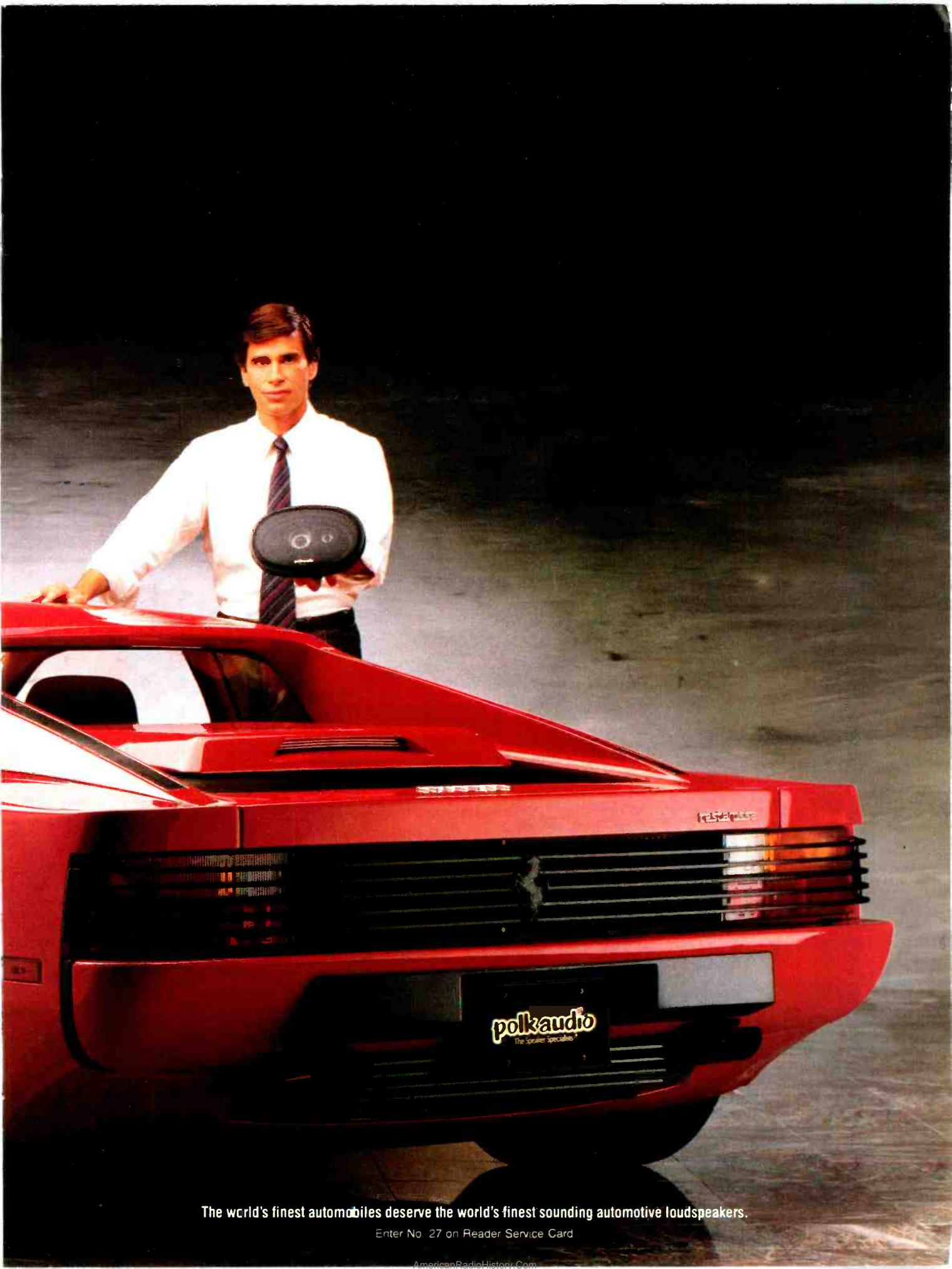

The world's finest automobiles deserve the world's finest sounding automotive loudspeakers.

Enter No. 27 on Reader Service Card



Grusin & Rosen of GRP, The Musician's Label

DAVID LANDER

It's been a busy dozen years for the men who gave GRP Records their names—Dave Grusin and Larry Rosen. It all started back in 1976 when the duo founded Grusin/Rosen Productions, after meeting and becoming friends while playing in Andy Williams' band. Originally, the partners acted as independent record producers, doing work for Columbia, RCA, Blue Note, and other labels. Their albums with vocalist Patti Austin and guitarist Earl Klugh soon caught the attention of Arista Records' Clive Davis, and he contracted with the pair to seek out and record new artists under the Arista/GRP label. Among the artists with whom Rosen and Grusin worked during this period were Angela Bofill and Dave Valentin.

When GRP's contract with Arista expired in 1982, Grusin and Rosen threw the dice and started their own record company, GRP Records. The cooperation of independent distributors, coupled with the reputation the partners had already acquired, helped them get off the ground, and financial success was quick to follow: From \$800,000 in sales in its first year, GRP Records' sales grew to \$10 million in 1986, and \$15 million is projected for fiscal 1988. There was artistic success too: In 1986, GRP garnered 10 Grammy nominations and took home one award.

Clearly, a key to GRP's success is the considerable talent the partners bring to the company. Grusin is a keyboardist, composer, and arranger who has written music for—by his count—40 to 50 movies, including *Tootsie* and *On Golden Pond*, as well as the theme music for *Baretta*, *St. Elsewhere*, and other television shows. In 1985 he won a Grammy for best instrumental arrangement (for a cut on *Harlequin*, his collaboration with Lee Ritenour). Rosen, a drummer, copped four Clio awards—an important advertising industry honor—before turning to records.

There may be no pair of producers more committed to digital technology than are Rosen and Grusin. They did their first digital recording in 1979, for Arista, and were immediately hooked by the sound quality. But recording on Thomas Stockham's Soundstream machine added some \$7,500 to \$10,000 per title to the company's costs, so the partners were ordered back to the analog domain. They returned to digital with their first GRP Records title in 1983, and remain dedicated to it—so much so that they vowed GRP would be among the first companies to release prerecorded DAT cassettes in the United States. Indeed, as this issue went to press, GRP announced the release of seven titles.

D.L.

PHOTOGRAPH: ROBERT LEWIS



Grusin with
Lee Ritenour,
a GRP guitarist.

**FOR ME, IT WAS PAINFUL
to record direct-to-disc.
Our music didn't require
the things you do with
symphony orchestras.**

—Dave Grusin

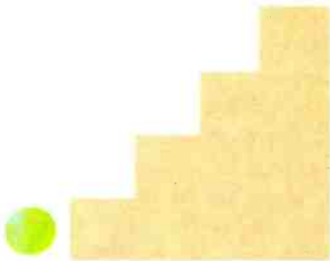

You both come from the music side of the business, yet from the first, GRP has been synonymous with high technology and sonic excellence.

Larry Rosen: We've always been interested in sound quality, even when we were recording solely on analog, because it is a big aspect of what our music is about. You're creating a picture here. Are you going to put it in a fuzzy context, or are you going to put it in as clear a light as you can? That's really what it comes down to.

Did digital recording appeal to you from the start?

L.R.: We were always aware of new technologies as they were emerging.

We heard about the Soundstream system and knew of some people who were using it. It was something we figured we ought to experiment with, so we got involved with Soundstream when we recorded Dave's record, *Mountain Dance*. Of course, it was only a two-track format, and that was limiting, in some ways, because all our records were multi-track.

Larry, you've mentioned an incident that occurred in the studio and made you a digital convert in one fell swoop. It was in 1979, I believe.

L.R.: It was when we were recording *Mountain Dance*, as a matter of fact. When you're in the studio as an engineer and you're recording multi-track analog, when you press that button to play back, there's something—as good as the quality is—there's some way that you realize what's a playback and what's live. With *Mountain Dance*, we got down the first take to the point where Dave said, "Let's hear it back." Everybody came into the studio and the system engineer pressed "Playback." Before the music started, there was conversation on the tape, and somebody said, "Hey, Larry..." I turned around. I thought it was really happening. I mean, this was the real test. It was so real. Everything about it was an exact duplication of what happened live. When we heard the first playbacks, we were just convinced that digital recording was definitely the medium of the future.

Dave, you did one of the earliest recordings with Doug Sax and Lincoln Mayorga of Sheffield Lab. How did that come about?

Dave Grusin: I've known Lincoln for

years. I knew him as a very good pianist. I knew Doug too, but it was Lincoln who came and asked me if I'd do that recording, *Discovered Again*.

What were your feelings about recording direct-to-disc?

D.G.: It drove me crazy to make the record, frankly. I didn't see any reason, from a musical standpoint, to do a whole side like a program, one thing after another with a studio band, when I knew if we stopped and worked on each tune we could really nail it. But the game was, of course, to do it top to bottom, because they didn't want to have any electronics between the music and the vinyl. Doug built a board that had nothing in it. It was just a path for everything to get to the [cutting] stylus, and all the electronics—all the equalization and everything—was in the microphones. I mean, that's their trip. For me it was painful, because the kind of music we were playing didn't require the kind of thing you might do with a symphony orchestra with all that wonderful equipment, where you really take advantage of a big acoustic hall and you get all the ambience and all the harmonic overtones—which they did; they went on to do that, of course, with the Los Angeles Philharmonic. I had Ron Carter, for instance, my bass player. Ron Carter had spent his life up to that point making the bottom notes of a bass ring. In that session, he made them ring for about half an hour; his left hand was amazing. And they didn't understand the concept of Ron's playing. They rolled all the bottom off and pushed the top. They wanted to make him sound like Ray Brown. So things like that were really in conflict. Now, when I hear the record, it sounds pretty good to me; it sounds okay. It wasn't that difficult doing the side, going from one tune to the next, but you had no control over how it was being recorded. You couldn't cue it back and say, "No, we could do that better if we did this." And digital allowed us to do that, to have our cake and eat it too, I guess.

Yet diehard analog fans are still griping about edgy, brittle highs, lack of ambience, and related sonic problems with digital.

D.G.: The real, true analog fans, I think, are used to a certain amount of distortion. No matter how quiet it is, tape running over a head just makes a certain amount of noise. They miss it when it's gone. Before digital, we fell in love with this Neve board that's all computerized—the first generation of those boards—mostly because you could mute everything except what was playing. What you did was cut down the tape noise by the number of tracks that were muted so there was nothing open

that wasn't playing. It was like noise gates. That made everything much quieter. And we did that as soon as this stuff was available. And we still do it manually. It's getting tricky now, because if you have a digital recording—I'm just finishing one now—from digital multi-track, if you start to shut the room down to keep the noise level down, you really hear the difference. You can hear it shut. And so you can't get away with that anymore. There has to be a certain amount of ambience there all the time.

L.R.: When we recorded with Sheffield, Soundstream's two-track format had a higher sampling rate than anything we deal with today. Today when you talk about recording direct to two-track, you're talking about a 44.1-kHz record frequency for digital. And there's a tendency toward harshness on the high end because it cuts off so distinctly at 20,000 cycles, whereas analog drifts off beyond that area.

D.G.: Or under it. The curve starts earlier than that, so you don't notice the cutoff.

But at least as far as editing goes, the Soundstream process wasn't very practical, was it?

L.R.: To edit *Mountain Dance*, we had to go to Salt Lake City and sit in this place with these hard disks, and it was really an involved process. I can't see studios all over the place with hard disk drives; it's just an impractical situation. But the sound quality of that first digital recording we made was exceptional. I don't think we have other systems now that equal that first Soundstream system.

Sonically speaking, how close to the Soundstream master was the CD of Mountain Dance?

D.G.: It was *really* close. For instance, Paramount licensed the title tune for a film called *Falling in Love*. I just took one of our CDs over to Paramount, and that was it; that was our source. That was the cleanest source we could have had. It was perfect. After rendering it monophonic, they just put it right onto film . . . and it was as clean as anything I've ever heard in a film.

Of the multi-track digital recorders you've used, do you have a preference?

D.G.: Well, the Mitsubishi's really comfortable; there are no dropouts, and everything has worked. I've had some great experiences with the Sony multi-track, and I've had some disastrous ones, where things were actually lost. Phil Ramone and I did some stuff for Streisand on the *Yentl* soundtrack album and recorded four singles, essentially, from those tunes. And one day in the process of checking something

out, we found that a piece of it was gone.

What did you do?

D.G.: We called a synthesizer player and replaced the string section. Luckily it was an ending; it was after the vocal was done . . . I mean, nothing is guaranteed.

Have you noticed any sonic differences among multi-track machines?

D.G.: I've never done a direct comparison of multi-track machines. I've never really sat them down next to each other. The one we're using here [Mitsubishi 850] is fast; the fast forward and rewind are fast. Most of the Mitsubishis I've used are very slow. The engineer in London figured out that the old machines ran at 43 kilometers an hour in rewind and fast forward. So you really sit there and wait for a while—longer than you're used to with analog tape.

Is analog dead in pro recording?

D.G.: No, we do a lot of things on analog multi-track. I'd like to try a project where some elements are recorded on analog and other, sweetening elements are recorded on digital, just to see what it is we're hearing.

You were the first company to make prerecorded Digital Audio Tapes available to the industry. What have you done to date in that format?

L.R.: Two years ago, we selected five titles out of our catalog and put them on DAT. We did it so there would be DAT cassettes to use for experimentation, for demonstrating DAT playback, and for our own A/B comparisons, to see what the format really sounded like.

And how does it sound?

L.R.: It sounds wonderful. Over in Ja-

pan, I sat in JVC's studio with the JVC DAT recorder and a CD player and made some comparisons. And I have to say, the DAT and the CD sounded identical. I was really curious to see what it was going to be like to take the CD through the analog output stage, go back and record onto DAT, and make an A/B comparison. I was sitting with a whole bunch of Japanese engineers, and they asked, "What do you think?" I said, "I can't hear any difference," and they said, "Well, we feel the same way. We've learned that, going through the analog electronics, we're going to lose about 5 dB in dynamic range." So from 95-dB dynamic range

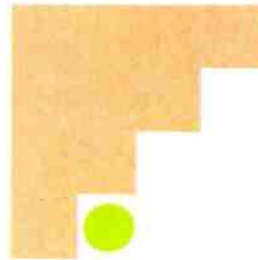

WHEN WE HEARD OUR first digital recording, we were convinced digital was the medium of the future.

—Larry Rosen

**Flautist
Dave Valentin
(standing)
and friend.**



we're talking about 90-dB dynamic range. I don't think there's an ear that's going to hear that difference.

What's the procedure for duplication?

L.R.: The high-speed duplicating systems, which are going to be needed for the mass production of software, are really in the R&D stages right now. The DATs that we made were done on a one-to-one basis in real time.

Will listeners be able to access various points on your tapes?

L.R.: Absolutely. It's all encoded, and the hardware has the memory system. You can program it any way you want. It takes like two seconds to get from song number one to song number five.

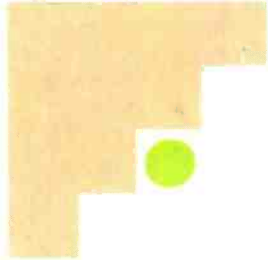

TRUE ANALOG FANS ARE used to some distortion. No matter how quiet, tape running over a head makes a certain amount of noise.

—Dave Grusin

Chick Corea's *Light Years* is now on DAT.

The longest rewind time on a two-hour DAT, I think, is 20 seconds—from the end of the tape all the way back to the beginning. Of course, anything prerecorded is not going to be in the two-hour format anyway. At most, it's probably only going to be the same length as a CD, 60 minutes or 74, whatever.

Do you have any idea what these tapes are going to cost initially?

L.R.: Real-time manufacturing costs are totally different from [the cost of] high-speed duplication. That's going to be a 300-to-1 process, so the cost for the time involved in duplicating DAT cassettes [for the mass market] is going to be cut down by a factor of 300. That'll have a tremendous impact on the actual retail cost.

And you've committed to making pre-recorded cassettes available in this country at the time DAT hardware is introduced.

L.R.: As soon as the hardware becomes available, we're going to have our software on the market. [Editor's Note: At press time, GRP's list of DAT cassettes announced for release to the public included: *Harlequin* by Dave Grusin and Lee Ritenour; *GRP Live in Session*; *Light Years* by the Chick Corea Elektric Band; Grusin's *Cinematic*; *Digital Duke* by the Duke Ellington Orchestra; GRP's *New Magic Sampler*, and *Diane Schuur and the Count Basie Orchestra*.]

Some people feel that DAT will replace CDs, render them obsolete. Others say the two formats will coexist in the marketplace. What's your prediction?

D.G.: I think it'll be exactly the same as cassettes and vinyl records. The collectibility factor is interesting: People like to have something to collect in the

disc format, whether it's 12 inches or the size of a CD. For your Walkman-type player or your car player, you'll use DAT. I think DAT and CD will coexist nicely.

The other night I turned on my television; the credits for *St. Elsewhere* were rolling by, and I noticed that Dave did the theme. I began to wonder how in the world you conceive a theme for a TV show. Dave, did you get to see any episodes of the show before you started composing?

D.G.: As a matter of fact, I did. They had two episodes in the can, I think. I don't know if they were totally edited, but I got to see *something*. Normally, that doesn't happen. By the time you're ready to write, and write to time, you usually see what it is, but if you're talking about or thinking about what a theme will be, no.

Doesn't that make things difficult?

D.G.: It's really hard for me, because most of my motivation is what a show looks like, not the subject matter. It's weird, film and music. I don't think they have much to do with each other most of the time, except by association. We've just gotten used to it. But once in a while, there are images that really suggest some kind of sonic response. For me, those are the best moments.

Do you usually get to see a movie before you sit down to compose?

D.G.: Yeah. There's frequently not very much time. What usually happens is that I get to see it early on in the editing stage, before they actually give it up and turn it over. And then, when they've finally got it down to time or close to time, I have an average of four to six weeks to actually do the writing. **The time between your seeing the first edited version and the last, that's thinking time?**

D.G.: Thinking time, that's right. It varies from a number of weeks to a number of months. It just depends on when they're willing to give it up. Now, what I like to do, way before they're ready, is just get whatever they have in whatever rough form and get it on a cassette so I can start looking at it in terms of placement, where we're going to play. The lengths of those times will all change, but maybe the concept won't be so foreign by the time I get a finished cut.

How much music goes into a film score?

D.G.: I have an average, about 45 minutes. It could be an hour and a half, sometimes 30 minutes. *On Golden Pond* had hardly enough music to make an album, so we ended up using dialog tracks to space it.

How long does it take you to write 45 minutes of music for a film?



D.G.: I usually do the actual writing in a couple of weeks.

Where do you work?

D.G.: It's hard to work here [in New York]. There's so much else going on. If I'm in New York, there's a copyist who has an extra room in his place over on 48th Street, so I'll go hide in there. In Los Angeles, I have a little rental house that I use.

When you worked with Andy Williams, you were his arranger. Where did you work when you were on the road with him?

D.G.: I seldom did any writing on the road. I did the writing before going out. He wasn't a road rat. He went out usually in the summertime. Normally he had a television show in the winter season, so he'd go out and do fair dates and concerts and things three months of the year.

L.R.: Andy's situation wasn't like a band doing one-nighters with a bus. With Andy, first of all, you flew in a plane and stayed in real nice hotels. And the gig was for a week or five days in a real nice nightclub, in one place. I had one friend with Slide Hampton's band. I went over to see him in this hotel. His room had a wire hanging from the ceiling with a bulb on it, and I was staying in a suite. I was embarrassed to even tell the guy to come over. With Andy it was kind of travelling first class. Of course, you weren't playing jazz. I mean, it was on a high musical level, I imagine. . . .

What do you mean, you imagine [laughter]?

L.R.: Well, it wasn't like playing in Count Basie's band. That would have been my choice. But it was still on a high musical level. It was better than a bar mitzvah, if you have to make comparisons.

How do you divide your responsibilities at GRP Records? I notice each of you has the title co-president, which is very egalitarian.

D.G.: Larry does everything, and I do these interviews [laughter].

L.R.: Dave's the spirit for the whole thing.

D.G.: I guess if we had an A&R department, that's where I'd be—but we don't have one. I get Larry to come in and hear mixes occasionally, but mostly he's involved on a day-to-day basis with a thousand decisions. It's lucky for me—it's probably lucky for him too—that he has the temperament he has. He really gets immersed in it, from an enjoyment standpoint as well as a business standpoint. I really think he likes the chase, probably even likes the problems, because it presents another challenge to him, another thing to solve.



You took GRP Records from ground zero to a \$10-million company in only three years. Business Week even did a story on you. How did you get so far in so short a time?

L.R.: There isn't another company marketing the same way, as far as real brand-image marketing. That, and having the individual artists as strong as they are.

Isn't the absence of strong artists the problem with many audiophile or boutique labels?

L.R.: There are all different kinds of boutique labels. Blue Note Records, at one point, had an image. They focused on a certain type of music, and their artists had a lot of longevity and a lot of substance. I feel we're a contemporary-type version of that. This isn't Be-bop Records, where you go in and try to re-create what happened at the Village Vanguard; we don't just bring a group in and have them play all day long, then create an album where we're trying to take a snapshot of what happened in a club. We're looking to build a catalog here, and we market it as a total brand image, which gives us much stronger presence in the marketplace.

Wasn't a more or less timeless catalog a key element of your marketing plan from the beginning?

L.R.: Absolutely. Our musical interest is a big part of that, and economics is the other part. The flip side of the coin is the pop marketplace—going out and trying to find the new Michael Jackson or the new Madonna. For us to compete head-to-head with the major companies, that would be ludicrous. We couldn't afford to do it, because you could spend a million dollars before

Diane Schuur is one of GRP's latest finds.

I CAN'T HEAR A DIFFERENCE between CD and DAT. There's only about a 5-dB difference in dynamic range between the two.

—Larry Rosen

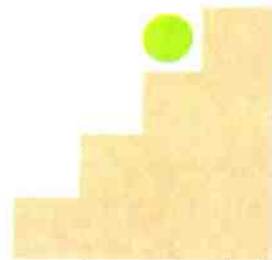

you even sold one single. Our records are constant sellers. That Glenn Miller record, for instance, will sell forever. Dave Grusin sells forever. That's a very strong base for this company. Now that we've come to a level where we have true cash flow for the company and greater exposure in the marketplace on a worldwide basis, we're shifting. We're trying to look for those artists, those productions that are going to help us stay somewhat in the same musical areas—we're still not looking for purple hair—but that are going to break through on the pop level. That would be the cream on top of what we're really creating here



DECIDING ON DAT

Witness of the Persecution

BARRY FOX

The saga of R-DAT would make a good script for a TV soap opera. So much of such little consequence happens so often that regular viewers are continually entertained, but anyone can tune in after a three-month break and pick up the threads within a few minutes. The most extraordinary thing about the DAT soap is that something so trivial, in world terms, should be exercising the minds of politicians—alongside Star Wars, nuclear disarmament, national budgets, and Third World famine.

A look at the European experience helps to put the whole silly charade into perspective. The idea of a levy or tax on tape in Europe dates back to February 1973, when Edward Lyons, a British Member of Parliament, raised the matter in a government debate. At that time, British home tapers who

wanted to stay within the copyright law could buy a license from a music-industry trade body called the Mechanical Copyright Protection Society. The license cost only a few pounds a year.

In September 1980, the licensing scheme was scrapped under pressure from the British Phonographic Industry, which is the U.K. equivalent of the RIAA. The BPI wanted a punitive tax on tape instead of a token, blanket license. But they embarked on a disastrous advertising campaign, with rich stars pleading for the tax, which lost rather than gained public support. The IFPI (International Federation of Phonogram and Videogram Producers, which has headquarters in London) further undermined the industry's case by arguing that "achieving a

Photo Collage: David Hamsley





D A T

Record-industry executives applauded Copy-code, but audio engineers, after careful listening tests, roundly criticized it.

levy of a substantial amount is probably more important than deciding how it could be distributed."

At the same time, the technically naive record industry in Europe kept talking about a spoiler which would somehow—magically—prevent the unauthorized copying of records. This idea had first been proposed by the curious little electronics company that had spun off from The Beatles' Apple empire. There were rumors in 1967 that the new *Sgt. Pepper* LP would be uncopyable. Of course, it wasn't.

Although there are several ways of preventing people from copying a disc to tape, for instance by putting an inaudible tone on the music which "beats" with the recording bias, these "single-ended" systems can always be defeated. If the tone is inaudible, it can, by definition, be filtered out without affecting the music.

In 1977, a committee under a British judge, Mr. Justice Whitford, published a report which said British copyright law was unintelligible. It also suggested that a tax might be the answer to home taping. But in July 1981, the British Government published a Green Paper (discussion document) on copyright law reform which used the record industry's own nonsensical talk about a single-ended spoiler as an excuse not to put a levy on tape. As stated in this Green Paper, if the record industry could find a technically successful system, then the Government would support it.

Soon after that, the electronics industry cut its own throat by starting to sell double-well cassette decks with high-speed dubbing facilities, and the record industry stopped talking about spoilers. So, in February 1985, the British Government did a U-turn, publishing a second Green Paper which said that a tax on tape was the only answer. In April 1986, the Government confirmed this by publishing a White Paper, intended as the basis for a full-scale reform of copyright law, which included the imposition of a tax on audio tape.

But then the record industry shot itself in the foot. In May 1986, a matter of weeks after the British Government had agreed to tax tape, the IFPI started to campaign for Copy-code, the double-ended anti-copy system devel-

oped by CBS. The IFPI asked the European Commission in Brussels, which runs the European Common Market, to make Copy-code compulsory for DAT. CBS and the IFPI demonstrated Copy-code to the Brussels bureaucrats in June 1986. In October 1986, the IFPI Board met and gave Copy-code its blessing as "the preferred copyright protection system." They also demonstrated it to officials from the British Patent Office, who advise the British Government on copyright matters.

Record-industry support for Copy-code hardened. However, the electronics industry, the audio press, and recording engineers started to worry. Was the Copy-code notch really inaudible, as CBS and the IFPI were preaching to the converted?

Inside the European Commission in Brussels, a split had developed between two departments. The department in charge of copyright wanted to introduce Copy-code as soon as possible. But another department is responsible for telecommunications, and people on that staff with an interest in audio technology were worried about Copy-code.

At the same time, news leaked out that the IFPI was working with EMI in Britain on another use of Copy-code that seemed to take its inspiration from the work of American radio pioneer Murray Crosby. A quarter-century ago, Crosby devised and patented a system for automatically logging the transmission of radio commercials. This system, called Audiocom, cut a notch out of the broadcast sound and inserted an identification code to let advertisers check whether local radio stations were broadcasting all the commercials for which they had been paid. EMI and the IFPI suggested that a digital message, like a sonic bar code, be introduced in the Copy-code notch. This would kill two birds with one stone: The notch would tell a tape deck to stop recording, and the code would be used to automate the logging of broadcast music and the payment of copyright royalties.

EMI produced a Compact Disc with music variously notched and coded. Then Gallup polled a cross-section of 50 people who owned CD players; they were given the EMI CD and asked to fill in a form saying whether they



could hear any difference between coded and uncoded music. They could, and the coding plan was quietly dropped. But the IFPI continued to press for Copy-code.

Meanwhile, under mounting pressure, the IFPI finally agreed to bring Copy-code out from behind closed doors by staging a joint demonstration with CBS. This took place in London in May 1987, a full year after the legal lobbying had begun. Although this Copy-code demonstration has been referred to as a "public" event, that description is barely accurate.

There were in fact two demonstrations, one in the large theater which is part of the Mayfair Hotel in Central London, and the other, the next day, at EMI's Abbey Road studios in North London. The majority of people invited to the demonstrations were "friendly" observers; some "unfriendly" were excluded. Only a few members of the more critical press were present, and in many cases only because they had heard about the demonstrations through the industry grapevine.

At the Mayfair Hotel, 200 record-company executives from 20 countries quite literally applauded the demonstrations and hectoring speeches from the IFPI panel; it was more like a religious service than a serious discussion, with DAT cast in the role of Devil. Although the acoustics of the theater and sound system used made serious listening virtually impossible, several audio journalists present heard the difference between coded and uncoded music. When they said so, they were given a hostile reception from the record-industry audience.

The next day, at Abbey Road, a small audience composed mainly of audio engineers was able to give Copy-code a much more thorough hearing. The system was roundly and soundly criticized.

Secondhand reports of the London demonstrations have often been based either on the Mayfair prayer meeting alone or on an "average" of the two meetings. Only those who were present at Abbey Road (or, ideally, at both meetings) are in a position to report accurately on the audio tests and reactions. Significantly, the record-industry executives who had been so noisy at the Mayfair failed to show up

the next day at Abbey Road for the serious listening tests.

In March 1987, Ian Thomas, Director General and Chief Executive of the IFPI, had explained that his Federation had adopted Copy-code on the say-so of "leading figures in the recording studio world, including George Martin and technical experts from Polygram and Philips."

George Martin is, of course, most famous for his work with The Beatles, and he is now a respected industry spokesman with his own recording studios. Martin spoke for the IFPI at the Mayfair to rally support for Copy-code. "Please vote for Copy-code," he implored. "I can promise you that every musician in the country wants it." But under questioning, Martin acknowledged that the only listening tests he had done on the system had been with encoded music provided by CBS; he had not had a chance to use an encoder for A/B tests of known material. Neither did George Martin turn up at Abbey Road the next day.

With George Martin's technical endorsement so obviously devalued, the IFPI cited Han Tendeloo, formerly of Polygram and now with Philips and Dupont Optical, as one of the "leading figures" in the audio industry who had done tests which led the IFPI to endorse Copy-code. Subsequently, Tendeloo denied this, saying that the IFPI, in endorsing the implementation of Copy-code, "did not do so on my recommendation."

Meanwhile, Philips had thrown a wrench into the works by suggesting an alternative system. News of this first broke in London in late April 1987, a few days before the Copy-code demonstrations took place. The Common Market Copyright Unit had organized a seminar in London and had asked CBS to demonstrate Copy-code. CBS had said no, so the organizers flew in Peter Plompen from Philips' headquarters in Holland. Plompen described what has become known as the "one-copy" or "no-clone" solution.

"The awesome thing about digital taping is that it isn't just taping, it's cloning," said George Martin in an IFPI handout. "However many copies you make, the product is just as good as you get in the studio." The Philips proposal addresses this concern.

Philips threw a wrench into the works by proposing an alternative to Copy-code which was called the 'one-copy' or 'no-clone' solution.

Photographs: From the Collection of Cinemabilia





Quite clearly, there is a contradiction between tax laws that legitimize home taping and Copy-code laws that try to prevent it.

D A T

Already, DAT recorders cannot dub in the digital domain from CD because of deliberate mismatching of the sampling frequencies (44.1 kHz for CD and 48 or 32 kHz for domestic DAT). Additionally, CD and DAT data streams have space for a copy-inhibit flag which would prevent digital dubbing, and all of the 15,000 CDs released worldwide have such a flag in place. Plompen's proposal would allow DAT recorders to make one digital dub from any CD, adding an extra copy-inhibit flag to the copy recording. Thus, the

first dub from a CD feed would be perfect, but thereafter, any attempt at digital dubbing (i.e., cloning) would fail. This proposal angered the IFPI because it undermined the Copy-code lobby, and Philips subsequently refused to discuss it—but by then, of course, the idea was known.

Politicians all across Europe have since found themselves getting deeper into techno-legal muddles. Clearly there is a contradiction between a tape-tax law, which in effect legitimizes home taping, and a Copy-code law, which mandates recorder circuitry that prevents home taping of some program material.

In theory, all Europe aims for unified laws. In practice, there is little chance of pan-European agreement on such a contentious issue. Tired of waiting, the British Government went it alone at the end of October 1987 and published its own Bill, or draft law, for copyright reform. There was no mention of a tax on tape and no mention of Copy-code or any other system. The Government minister responsible for the Bill, Kenneth Clarke, said he regarded the matter of a tape tax as a "dead duck." And for the first time ever for a Government minister, he used the word "tax" rather than "levy." The British Parliament is now debating the Bill, which should be law by the summer.

In Europe, despite garbled reports which suggest firm decisions already taken, the Brussels bureaucrats were, in December 1987, still undecided. They appeared unwilling to hit consumers with a tax on tape, and since the London demonstration (which was attended by representatives from Brussels), they have gone cold on Copy-code. They may well compromise by opting for the one-copy system proposed by Philips. The signs are that Japanese manufacturers would go along with this, although it is likely that a final decision in Europe will wait until the National Bureau of Standards in the U.S. has given its own independent verdict on Copy-code. The purchase of CBS Records by Sony probably comes too late to affect the issue, though Sony, ironically, now has a vested interest in copyright protection! (*Editor's Note:* Masa Namiki, general manager of Sony Corporate Communications, is quoted in Cores Publications' *Japanese Industry Newsletter* as

saying that "Sony will not attempt to force CBS Records to drop its support of an anti-taping device for DAT decks." The report also said that Sony will not require CBS Records to market DAT cassettes or CD-V discs for Sony's benefit, having found during the 20 years of the existence of CBS/Sony Records in Japan that it was important to treat the software and hardware businesses separately.—E.P.)

Meanwhile, the stop-go, on-off saga of DAT in Europe continues. The Berlin Funkausstellung, a giant consumer-electronics show held in the divided city every two years, is traditionally the time and place where major announcements are made. At the August/September 1987 show, Sony finally bit the bullet and announced plans to sell DAT in Europe beginning in October 1987. It is clear that Sony expected other Japanese companies to follow, but they did not.

Since the Berlin show, Sony has come under intense political and commercial pressure, heightened by the negotiations to buy CBS Records. After reports, denials, and denials of denials, the situation has resolved, at least temporarily, into a compromise: Sony is selling DAT machines in France and Germany only. The price of recorders in those countries has been artificially inflated to deterrent levels (equivalent to around \$2,400); what's more, both France and Germany already have a tax on tape. The logic is that the record industry cannot reasonably object to the limited sale of such a high-cost machine in countries where a tax on tape is levied.

In Britain, as in most other European countries, it is possible to buy DAT machines as "gray" imports. Taiyo Yuden, a Japanese company new to the tape business, is openly selling the oddly named That's DAT cassettes. Luxman and Akai are likely to sell small numbers of high-priced machines. JVC could be the first company to open the real floodgates, by officially launching its two-speed DAT machine. This is already being sold by Grundig in Germany.

Anyone in Europe who really wants a DAT deck can buy one. Yet with the high price being asked (up to twice the going tag in Japan), the format still remains something that far more people are writing about than using. **A**



The Moscow Sessions: From Russia with Love

Bert Whyte and Lisa Sonne

After protracted negotiations with the Russian bureaucracy, Sheffield Lab pulled off quite a coup by making the first-ever recordings of the Moscow Philharmonic Orchestra led by an American conductor. It was Sheffield's idea that the conductor, Lawrence Leighton Smith, would rec-

ord Russian music with the Moscow group and that Dmitri Kitayenko, the resident conductor of that orchestra, would record American works. After raising funds through investors and from individuals and companies in the audio industry, the Moscow Sessions took place in August 1986.



Sheffield cofounder Lincoln Mayorga was on hand to produce the sessions, along with coproducer Lisa Sonne. Also present were recording engineers Keith Johnson, who has done some remarkable work for Reference Recordings, and Stan Ricker, an old friend who worked with me on my Virgil Fox and Arthur Fiedler recordings. The Moscow Sessions were simultaneously recorded on a Studer analog tape machine (modified by John Curl) and on a JVC 900 digital recorder, the former for the LP releases and the latter for CDs. The venue was the large broadcast hall used by U.S.S.R. state television and radio. It is important to note that many broadcast halls overseas are not studios in the same sense as they are in the U.S.; many have fairly spacious acoustics and could easily qualify as concert halls. One that comes to mind is the warm, wood-paneled hall of the Danish State Radio in Copenhagen. This Russian hall is somewhat similar. Although the recording team would likely have wanted a hall that was a bit more reverberant, with proper miking it proved satisfactory.

Both Keith and Stan have told me that once the language and cultural barriers between the Russians and the Americans had been resolved, they got excellent cooperation from the engineers and technicians of the state TV and radio services. The state-owned Melodiya label, which handles all Russian recording, was heavily into multi-miking, and Keith was told that in recording the Moscow Philharmonic, Melodiya would have used 35 to 40 microphones! (Now we know why so many of the recordings put out by Melodiya sound rather "compartmentalized.") Keith brought along some microphones of his own design, and apparently the Russian engineers were very skeptical when they saw that he planned to use just eight to record the orchestra. However, after hearing playbacks of the final mike setup, they

Sheffield has achieved a quite stunning sonic picture, with a stable image and impressive stage width and depth.

were both intrigued and impressed. Keith also employed his own custom-built portable mixing console, eschewing the huge, multi-input console available in the Moscow studio.

The sessions yielded enough music for three releases, and the results are most interesting, to say the least. With Keith Johnson's relatively "purist" type of mike pickup, one can really hear the sonic qualities and musicianship of a major Russian orchestra for the first time. It is quite revelatory, with the string playing of a very high order, characterized by precision unison and ensemble work and a richly opulent tonal structure.

Sheffield has achieved a very stunning sonic picture of this great Russian orchestra. The sound is smooth and transparent yet strikingly detailed, with brazen brass and sharply accented percussion of great weight and impact. The imaging and instrumental positioning are precise and stable, stage width and depth are impressive, and there is just enough ambience to give the overall sound a lovely bloom.

As for the conducting, there are two surprises here. One is the excellence of Lawrence Leighton Smith's performances of the Russian repertoire.

Smith is the conductor of the Louisville Orchestra, a good group but certainly not a major one. Nor is Smith considered one of the "top guns" in the conducting world. Nonetheless, his performances of works by Shostakovich, Tchaikovsky, and Glinka must be rated as outstanding. The other surprise is Dmitri Kitayenko, who had *never* conducted the American music he was to record for these sessions—nor had the Moscow Orchestra ever performed them! Kitayenko certainly displayed great empathy for Copland's "Appalachian Spring," Ives' "Unanswered Question," and Barber's "First Essay for Orchestra." He even gave a very sympathetic performance of Gershwin's rarely played "Lullaby." The string tones Kitayenko drew from his orchestra in these American works were quite ravishing.

The Moscow Sessions are available on three CDs or LPs, singly or as a complete set. (Cassette releases are also planned, though at press time Sheffield was still undecided about which master to use and what duplication process to employ.) The first recording (CD-25, TLP-25) contains Glinka's "Russland and Ludmilla Overture," Mussorgsky's "Khovanshchina Prelude," and Tchaikovsky's Fifth Symphony; the second (CD-26, TLP-26) includes Barber's "First Essay for Orchestra," Piston's "Incredible Flutist (Ballet Suite)," and Shostakovich's First Symphony; the third (CD-27, TLP-27) offers Copland's "Appalachian Spring," Glazunov's "Valse de Concert in D," Griffes' "White Peacock," Gershwin's "Lullaby," Ives' "Unanswered Question," and Shostakovich's "Festive Overture." As a set, the recordings bear the numbers CD-1000 and TLP-1000.

All the recordings are very worthwhile, but if reasons of economy dictated that I choose just one, it would be CD-26. On it Smith provides a hugely dynamic, very propulsive performance



*Keith Johnson
prefers the analog
master, while
Stan Ricker would
pick the digital
one if he had
to make a choice.*

of the Shostakovich, with a sound of vivid realism. On the same disc, Kitayenko does a marvelous job with the Piston; the sound is spectacular, especially with the members of the orchestra whistling, yelling, and stamping in the "Circus" section. Kitayenko's heartfelt traversal of the Barber is also memorable, ably abetted by the Sheffield engineers' richly embroidered sonic tapestry.

The Moscow Sessions must be judged a musical, sonic, and yes, even a cultural success. *B.W.*

The Moscow Sessions are the first Sheffield Lab releases that were not recorded direct-to-disc. Instead, both a digital master and an analog master were made simultaneously, the former for CDs and the latter for LPs. As a result, listeners can now make a true comparison between analog and digital mastering.

The Los Angeles Times said the CD releases were "three of the warmest, most natural-sounding CDs imaginable." Those involved in the recording, editing, and mastering of the tapes, however, lean toward the analog results—but not without a certain amount of debate.

Producer Lincoln Mayorga, an analog advocate, felt that Sheffield had to make the recordings in both analog and digital because of the historic importance of the project. "We don't yet have the perspective of time to know which really sounds better," he says. "Additionally, we don't know yet how well the information on digital master tapes will store, whereas we have good analog master tapes that are 30 years old."

Keith Johnson, engineer and equipment designer, prefers the analog product. Ideally, he would like to pull from "the best of both mediums, to combine the warmth and inner detail of the analog and the preciseness and sharpness of the digital to achieve faithful reproduction. In the large brass

passages, like the fanfare of the Shostakovich," Johnson notes, "the digital best captured the brilliance and impact, but in the soft, subtle violin passages, like Gershwin's 'Lullaby,' the analog is by far the superior."

Stan Ricker, second engineer, also sees advantages of both media but would opt for digital if forced to choose. From a business standpoint, he cites the "crises worldwide for top-quality phonographs, the decline in vinyl quality, and the decrease in direct metal mastering facilities in the world." From an audio perspective, he favors "the speed stability, pitch accuracy, and dynamic range of digital. The hiss and pops of analog don't bother me very much, but in general the off pitch always has. There is also an increase in distortion that accompanies the decrease in radius as you play back an analog record."

Ricker points to the Glazunov "Valse" as a "good example of the strength of both areas—the introduction of the waltz is definitely more listenable on the analog, but toward the end, as the orchestra crescendos, the digital wipes out the analog with its dynamic range."

Shirley Walker, an editor who took

over for Mayorga when he had to leave on a concert tour, admits an emotional bias for analog. During the editing process, she found digital "more fatiguing for hours of listening, because the playback of the stored memory is so degraded in sound quality." The advantage of digital, she acknowledges, is that it allows one to edit within the middle of a note and change levels between cuts, which is very difficult in analog editing. "Edits have to be smoother in digital, because you hear them in a different way than analog," Walker notes. With just one exception, the takes used for the final analog and digital versions of the sessions were the same, but "about 50% of the edits are slightly different, to take advantage of the relative merits of the two formats." As Walker explains, "You know the broad areas you need to join—you just move the point at which you join them. Sometimes it's moved as much as a measure, sometimes within the space of one note."

Doug Sax, production manager of the recordings and cofounder of Sheffield, still prefers analog, but notes, "Our philosophy will continue to be to run both formats as best we can, and to decide not *before* recording but *afterwards* which is the best. I am hoping there will be a time when I clearly prefer the digital as we work on improving the technology."

At press time, Sax had not yet chosen whether the cassettes of the Moscow Sessions would be issued from the analog or the digital master, though he was leaning toward analog. Sheffield was holding off production, according to Sax, because "we are experimenting now with state-of-the-art, high-speed transfer on metal tape, with the virtue of durability, that could be sonically superior to one-on-one and sell for only a dollar or two more than the standard cassette. Since this is imminent and realizable, we would like to be the pioneers." *L.S.*

1

TANDBERG 3001 A FM TUNER

Manufacturer's Specifications

Mono Usable Sensitivity: Wide, 7.5 dBf; normal, 6.8 dBf; narrow, 8.2 dBf.

50-dB Quieting: Mono, wide, 11.25 dBf; normal, 10.3 dBf; narrow, 9.3

dBf. Stereo, wide, normal, and narrow, 32.1 dBf.

S/N: Mono, 95 dB; stereo, 82 dB; stereo at 85 dBf, 92 dB.

Muting Threshold: Variable, 11.2 to 81 dBf.

Stereo Threshold: 25.2 dBf.

Frequency Response: Mono or stereo, 30 Hz to 15 kHz, +0.2, -0.5 dB.

Mono THD: Wide, 0.03% at 100 Hz, 1 kHz, and 6 kHz; normal, 0.06% at 100 Hz and 1 kHz, 0.055% at 6 kHz; narrow, 0.12% at 100 Hz, 0.25% at 1 kHz, 0.45% at 6 kHz.

Stereo THD: Wide, 0.04% at 100 Hz and 1 kHz, 0.1% at 6 kHz; normal, 0.05% at 100 Hz and 1 kHz, 0.25% at 6 kHz; narrow, 0.08% at 100 Hz, 0.2% at 1 kHz, 1.0% at 6 kHz.

IM Distortion: Mono or stereo, wide, 0.1%, normal, 0.15%, narrow, 0.8%.

Capture Ratio: Wide, 0.4 dB; normal, 1.0 dB; narrow, 3 dB.

Adjacent-Channel Selectivity: Wide, 3 dB; normal, 12 dB; narrow, 40 dB.

Alternate-Channel Selectivity: Wide, 30 dB; normal, 90 dB; narrow, 90 dB.

Spurious-Response Rejection: 135 dB.

Image Rejection: 135 dB.

I.f. Rejection: 135 dB.

AM Rejection: Greater than 70 dB.

Separation: Wide, 60 dB at 100 Hz and 1 kHz, 50 dB at 10 kHz; normal, 60 dB at 100 Hz and 1 kHz, 45 dB at 10 kHz; narrow, 55 dB at 100 Hz and 1 kHz, 35 dB at 10 kHz.

19-kHz Suppression: 95 dB.

38-kHz Suppression: 120 dB.

Signal Meter Range: 0.3 μ V to 1 mV or 1 mV to 3 V.

Power Requirements: 115 V ($\pm 10\%$), 50/60 Hz, 34 watts.

Dimensions: 17 $\frac{1}{8}$ in. W \times 3 $\frac{1}{4}$ in. H \times 13 $\frac{3}{4}$ in. D (43.5 cm \times 8.3 cm \times 35 cm).

Weight: 15.3 lbs. (7 kg).

Price: \$1,995.

Company Address: 122 Dupont St., Plainview, N.Y. 11803.
For literature, circle No. 90



I've had the Tandberg 3001 A FM tuner sitting in my lab for nearly six months now. I've been reluctant to write this report any sooner, since that would have meant giving up this fantastic tuner and returning it to Tandberg. Those of you who have been reading my reports for some time know that I am an FM-tuner addict. Show me an outstanding unit such as the 3001 A, and it's love at first sight. I just can't bear to part with it! About the only negative thing I have to say about the Tandberg is that it gave me some worry about whether my test equipment would be good enough to accurately measure its performance.

As for the high price, that, unfortunately, goes with the territory. If you want a tuner that offers distortion lower than what you'd get from some of the best amplifiers around, plus sufficient dynamic range to handle some of today's better FM program sources (such as CDs and live, uncompressed broadcasts), I know of no other model at any price that will do the job as well as the 3001 A. Of course, at this point I should back up a bit and tell you that if all you listen to are the typical, compressed rock 'n' roll stations that clutter the FM dial in most locations, don't waste your money on this unit. But if, like me, you listen to the one or two stations in your area that take special pride in putting out the very best FM signal possible, then the Tandberg 3001 A may be just what you've been looking for—and you'll want it no matter what it costs.

The Tandberg 3001 A is an *analog* tuner. By this I mean that it does not employ frequency-synthesized tuning. The analog approach was selected by Tandberg's talented engineers not so much because they could use a familiar (and perhaps easier-to-read) dial scale and dial pointer, but rather so that they could achieve the highest possible signal-to-noise ratios—in excess of 90 dB in mono and well over 80 dB in stereo.

The front-end employs eight ganged, tuned circuits to obtain startlingly high selectivity when needed. The tuning elements are voltage-controlled capacitance diodes, and dual-gate MOS-FETs are used in the r.f. and mixer stages. In addition to the main tuning system, there is a tuning circuit that permits eight preset FM station frequencies to be stored in memory. This particular circuit is based on a voltage-synthesis principle combined with a fast analog servo loop that achieves maximum signal-to-noise ratio and frequency stability.

The i.f. filter circuits can be switched to three different bandwidths (wide, normal, and narrow). These filters consist of phase-linear block filters, plus pure LC filters, to achieve high selectivity with extremely low distortion. The special limiter circuit used in this design provides exceptionally good AM and spurious-response rejection. In addition, it ensures a constant signal output over a very wide range of input signal levels.

These days, most MPX (stereo) decoders in FM tuners and receivers consist of a single IC surrounded by a few components for 19- and 38-kHz tuned circuits. Although IC technology has certainly gotten better over the last decade, this type of design still has some inherent limitations. The Tandberg employs a decoder designed entirely with discrete components. As a result, there are none of the "beat" notes—either within the audio pass-band or outside of it—

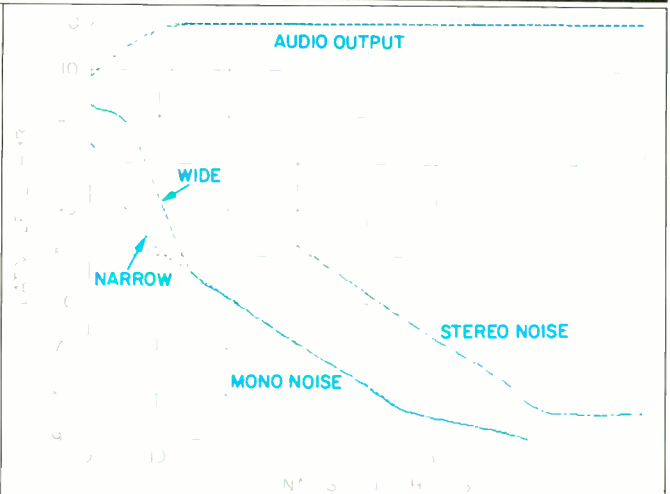

Fig. 1—Mono and stereo quieting characteristics.

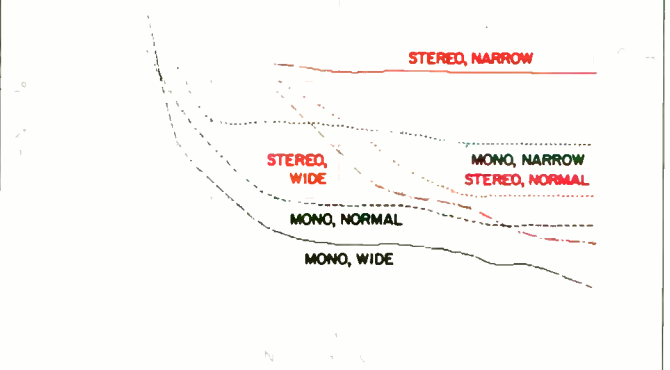

Fig. 2—THD + N vs. signal strength at 1 kHz.

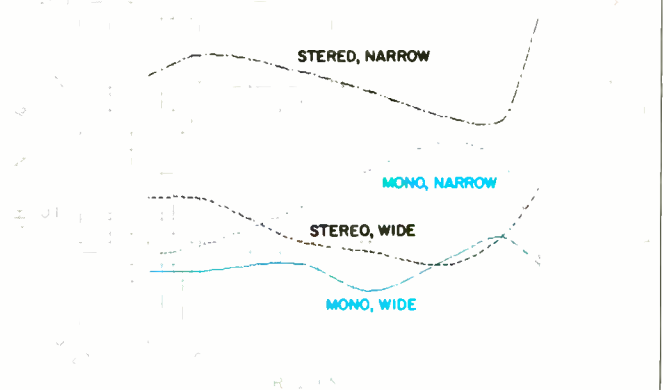
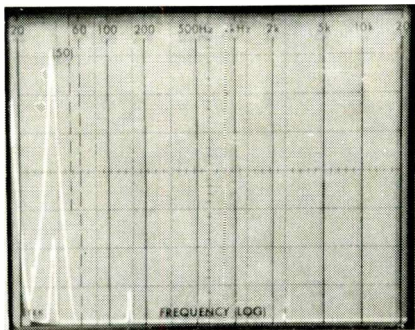

Fig. 3—THD + N vs. frequency.

The 3001 A puts out enough signal voltage so that you can switch between it and a CD player without hearing sudden changes in volume.



A

B

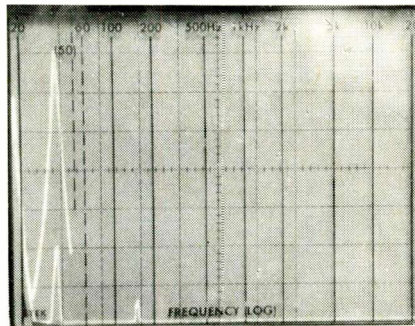

Fig. 4—Separation and crosstalk components for a 5-kHz FM modulating signal in wide (A) and narrow (B) i.f. modes.

Note the negligible third-harmonic component and the total absence of beats.

found when measuring and listening to most stereo FM tuners. Another feature of the decoder design is Tandberg's Automatic Noise Cancelling (ANC) circuit. Like the similar circuits more common in car stereos (but also found in a few home components), it offers a significant improvement in signal-to-noise ratio by reducing stereo separation as signal strength decreases. Finally, a seventh-order multiplex filter ensures accurate phase response right out to the 15-kHz limit of FM broadcasting.

The signal meter of the 3001 A operates over two ranges so that you can accurately read incoming signal levels from as low as 3 μV to as high as 3 V! An LED indicator below the meter tells you when to switch meter ranges. A second meter serves two purposes. Primarily, it acts as a precise center-of-channel tuning meter. When a preset station has been selected, however, this meter becomes a frequency indicator. The display area normally shows the number of the chosen preset, but it also shows when the storage function has been selected.

Three different muting circuits provide noise-free tuning, and the muting threshold is adjustable from about 1 μV to 3 mV. Although the tuning system is augmented by a servo type of automatic frequency control or frequency lock, this circuit is automatically deactivated whenever you touch the

tuning knob. In addition to the fixed-level output on the rear panel, the 3001 A is also equipped with variable outputs that can deliver signal levels of up to 2.5 V rms with a 100%-modulated signal. This high output level nicely matches the typical output of CD players, so you don't have to keep readjusting your volume control every time you switch from FM to CD or vice versa.

Control Layout

Eight small station-preset buttons are at the left end of the panel. Beneath them are the power switch and the level control for the variable outputs. Moving to the right, there is the display area, a button for storing presets, the dual-range signal-strength meter, the center-tune/preset-frequency meter, and the calibrated frequency scale used during manual tuning. Four tiny buttons beneath the dial scale, augmented by indicator lights, select mono or stereo and activate the ANC circuit, the servo (AFC), and the muting circuitry. A rotary knob nearby sets muting threshold, and a three-position rotary switch chooses i.f. bandwidth (wide, normal, or narrow). A large tuning knob, coupled to a flywheel, completes the front-panel layout.

The coaxial antenna connector on the rear panel is neither a standard F-type connector nor a BNC type. Fortunately, Tandberg provides a male plug to which the inner and outer conductors of a coaxial (75-ohm) antenna transmission line can be easily attached. No soldering is required. Because this tuner is sold internationally, the rear panel has a de-emphasis switch with settings for 25, 50, or 75 μS . (De-emphasis of 50 μS is used in European countries, and the 25- μS setting is for use with stations that employ Dolby FM.) In addition to the variable and fixed pairs of output jacks, a detector output jack on the rear panel delivers the signal that's available prior to multiplex circuit decoding. You might want to extract the signal at this point if you want to use Dolby decoding. Finally, two jacks can be connected to the horizontal and vertical inputs of an oscilloscope so that you can use the 'scope as a guide to minimize multipath when orienting your antenna.

Measurements

Figure 1 shows how background noise varies with input signal strength. Mono usable sensitivity in the wide i.f. mode measured an amazingly low 8.5 dBf! Even in the narrow mode, mono usable sensitivity was still as good as the figures I've obtained for most conventional frequency-synthesized tuners: Around 11.5 dBf. Stereo usable sensitivity was governed by the stereo threshold, which was set at approximately 22 dBf. In mono, 50-dB quieting required a signal input of only 12.9 dBf, regardless of bandwidth setting; in stereo, 50-dB quieting was reached with a signal input level of 32 dBf. Above 20 dBf, there was virtually no difference in the mono quieting characteristics, regardless of the bandwidth setting. Below this level, however, initial quieting was a bit steeper when the i.f. bandwidth was set to the narrow mode. This difference is plotted in Fig. 1 as well.

Maximum signal-to-noise ratio in mono measured 88 dB at 65 dBf and rose to about 90 dB at higher input signal levels. I suspect that my generator is incapable of reading above 90 dB, so Tandberg's claim of 95 dB for mono S/N

PHOTOGRAPHS OF NOTE.

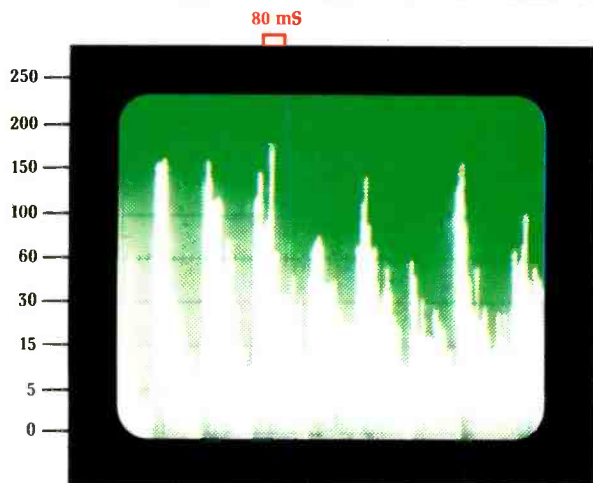

Genesis, "No Reply At All "

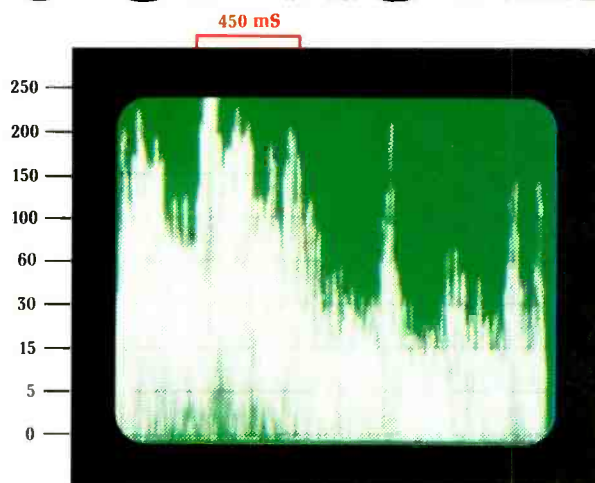

Chopin, Polonaise

These oscilloscope photos reveal the true dynamic character of music. They also show why NAD designs amplifiers to produce up to *seven times* their rated power.

Because of the incredible dynamics of today's compact disc recordings, ample "reserve" power is more important than ever for the accurate reproduction of music. That's why you should postpone buying any amplifier or receiver—in any price range—until you've auditioned the "Power Envelope" products from NAD.

THE DYNAMICS OF MUSIC. Amplifiers and receivers are rated for power output by using a test instrument to generate a steady, continuous tone. But music is anything but continuous. As you can see, in the spectrum analysis photos above, most music includes frequent furious surges that require brief bursts of power. And indeed, many amplifiers are capable of delivering bursts of high "dynamic power" for very brief periods (typically 0.02 seconds, or 20 milliseconds). But as the photographs show, the tonebursts in music can last 80 to 450 milliseconds, and sometimes longer.

THE POWER ENVELOPE. That's why every NAD amplifier and receiver, from our modest 3220PE Amplifier to our top-of-the-line Monitor Series 7600 Receiver features our exclusive "Power Envelope" technology. The Power Envelope design uses two power supplies: a low-voltage unit that operates up to the rated power level, and a high-voltage unit that is used only when a burst of power is needed.

When a musical surge occurs, a special tracking circuit *instantly* lets current flow from the high-power supply to your loudspeakers. This system allows NAD amplifiers to deliver two to seven times their rated power for bursts of 500 milliseconds or more.

With Power Envelope technology, NAD components have the musically-useful output power of much larger, much more expensive equipment. In fact, *High Fidelity* magazine tested our 75-watt-per-channel Power Envelope receiver and found it delivered dynamic peaks "the equivalent of 560 watts per channel."

Power Envelope technology is only one of the many innovative features that set NAD amplifiers and receivers apart from the rest of the crowd. If you'd like to have the whole story—including a complete explanation of our Power Envelope circuit—visit your local NAD dealer or send us the coupon below.



Left: NAD 7600 Remote Controlled Stereo Receiver bridged with NAD 2600 Power Amplifier. Rack handles are optional equipment.

Right: NAD 3220PE Integrated Stereo Amplifier.

The Power Envelope From NAD

NAD (USA) INC. | 575 UNIVERSITY AVENUE | NORWOOD, MASS. 02062

Name _____
 Address _____
 City _____ State _____ Zip _____

Mono usable sensitivity was an amazing 8.5 dBf in the wide i.f. mode and was still around 11.5 dBf in the narrow mode.

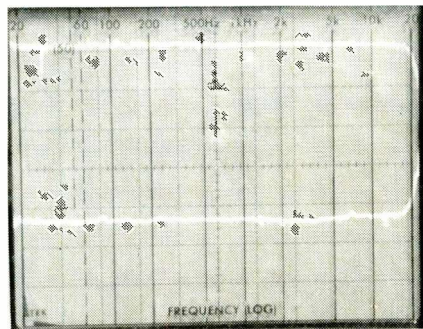

A

B

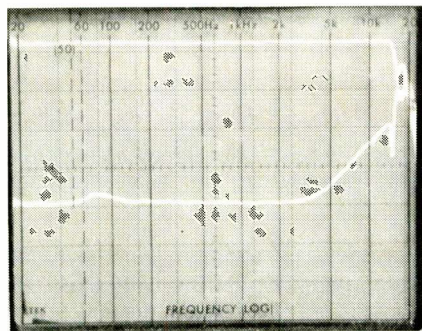

Fig. 5—Frequency response (top trace) and separation vs. frequency (bottom trace) in wide (A) and narrow (B) i.f. modes.

may well be true. In any case, these are the highest S/N readings I've ever obtained for any tuner, bar none! In stereo, S/N reached 84 dB, 2 dB higher than claimed.

Because distortion tends to rise (especially in stereo) as bandwidth is reduced, it was necessary to make three separate plots of mono THD + N versus signal strength and three more plots for stereo operation (Fig. 2). In wide-mode mono, THD + N was an incredibly low 0.025% for a 1-kHz test signal at 100% modulation and an input signal strength of 65 dBf. In wide-mode stereo, THD + N was still amazingly low—only 0.05% for a 65-dBf input signal. With stronger wide-band signals, THD + N was even lower. For example, at 80 dBf of input signal, the stereo reading was only 0.035%.

As was to be expected, normal and narrow i.f. modes yielded higher THD + N figures in both mono and stereo operation. However, even the worst-case figures for mono and stereo (0.21% and 0.7%, respectively) were still low enough so as not to seriously impair reproduction of music during subsequent listening tests.

Figure 3 shows how THD + N varies with modulating frequency. Here, only four sets of measurements were taken—two for mono and two for stereo—since, in the normal-bandwidth mode, performance fell in between the extremes

shown in the curves. In the narrow mode, THD + N for a 10-kHz modulating signal, measured without a low-pass filter in the signal path, was 0.045% in mono and 3.0% in stereo. In the wide i.f. mode, which produced the lowest distortion for the 10-kHz modulating frequency, measurements were 0.04% for mono and 0.15% for stereo.

Perhaps the most remarkable performance characteristic of the 3001 A became obvious when I made my usual spectrum analysis to see what was present at the two outputs when a 5-kHz signal was used to modulate one channel. Figures 4A and 4B seem, upon first observation, to be identical. Upon closer examination, you may notice that the level of the third-harmonic distortion component is slightly higher with the tuner in wide mode (Fig. 4A) than when it is in narrow mode (Fig. 4B). Yet no "beats" or other spurious components are seen in the region from 0 Hz to 50 kHz in this linear-sweep spectrum analysis. Clearly, the discrete-component MPX decoder circuit used by Tandberg has paid off!

When I measured stereo separation, about the only difference I could detect between wide and narrow operation was a very slight reduction at the high-frequency end of the spectrum, as shown in Figs. 5A and 5B. In the wide mode, separation measured 57 dB at mid-frequencies, decreasing slightly to 55 dB at 100 Hz and to 50 dB at 10 kHz. Even with the i.f. bandwidth set to narrow mode, separation was still greater than 45 dB at mid-frequencies and nearly 30 dB at 10 kHz.

The lowest figure for capture ratio that I was able to measure was 0.8 dB, higher than claimed by the manufacturer but still about the best I've ever seen for a tuner. Image, i.f., and spurious-response rejection all read 100 dB on my test instruments, but I hasten to add that this is the highest I am able to read, given the signal-strength ranges of my two FM signal generators.

Adjacent-channel selectivity is something I generally don't measure (the procedure is tricky and requires great care in tuning), but in light of the figures quoted by Tandberg, I couldn't resist. After several tries, I came up with a reading of 38 dB for the narrow mode (that's when it's really important) and 10 dB for the normal mode—close enough to Tandberg's claimed figures. Alternate-channel selectivity is a lot easier to measure accurately, and my figures agreed almost exactly with those claimed—except that I measured 5 dB *more* alternate-channel selectivity in narrow mode than Tandberg's spec of 90 dB.

Even when I turned up the gain on my oscilloscope and looked at the amplified distortion output on my analyzer, I was unable to detect the slightest trace of 19- or 38-kHz components at this tuner's output when it was fed with a stereo pilot signal. This suggests that Tandberg's claimed 95 dB of 19-kHz rejection and 120 dB of 38-kHz suppression may well be correct. In any case, I'm willing to take their word for it, though again, there's no way I could confirm these numbers using my best FM generator as a signal source.

Use and Listening Tests

I must confess: I think there's something wonderful about a dial scale and a rotary tuning knob. Although I deal with

One Button, One Smart System



With one button, select a music source on your Revox Wireless Remote Control from any component in your Revox audio system . . . CD, for instance.

Press the "CD" button and the Revox Timer Controller turns on all the required components. Your Revox B226 Compact Disc player fills the room with music.

Now, jump from one music source to another—CD to turntable. The Revox B203/205 Control System shuts down one source and changes over to the new one for you.

One button, one finger. It's that easy.

And smart? Try this . . . tell the B203/205 that you want to wake up to a classical music station at 7 each morning, Monday through Friday. Tell it to shut off your system at 8. Then tell it to wake you to a favorite CD on Saturday.

The B203/205 remembers it all. And a lot more.

Civilized, solid, smart. Like all Revox equipment, the B203/205 Control System is built to exacting Swiss standards of excellence. Try it, at your audio specialist in the USA. For information, call or write Studer Revox America, Inc.



B203 Timer Controller and B205 Wireless Remote Control

STUDER REVOX

1425 Elm Hill Pike, Nashville, Tennessee 37210
(615) 254-5651

Enter No. 34 on Reader Service Card

Listening with the Tandberg to the few really good FM stations in my area shows what FM can do—and what it was meant to do.

digital displays of all kinds on a daily basis (from my wrist-watch to my computer screen and my scientific calculator). I still enjoy watching a dial pointer glide smoothly across a calibrated scale. The whole arrangement sort of lets me know where I am. As the Tandberg dial pointer approaches a desired frequency and the tuning meter makes its way towards its center or perfect-tuned indication, I somehow derive a sense of satisfaction from it all.

As I indicated earlier, I've had more than the usual amount of time to listen to this unit; it's been set up as my reference tuner for several months now. In my listening area (a suburb of New York City), I was able to use the wide i.f. mode for only about six of the 50-odd stations that I am able to receive. About 40 more were handled nicely with the 3001 A set to "Normal," and another four or five, which had been all but unusable with many other tuners because of adjacent-channel interference, really benefited from the "Narrow" setting.

If you should end up buying this tuner and you own any kind of oscilloscope, I strongly recommend that you take the trouble to connect the 'scope to the 3001 A's multipath jacks. I would hope that, having spent the kind of money this tuner costs, you'd go all the way and install an outdoor antenna. But even with an indoor antenna, you'll find that orienting it with the aid of the multipath display on the 'scope will result in audible improvement. Moderate multipath dis-

tortion isn't always easy to identify as such by ear. Watching an oscilloscope while you rotate the antenna for the least possible multipath is really the best way to minimize this form of distortion.

I wish that more stations in my area were good enough to justify the purchase of a tuner such as this one. Unfortunately, there are only two or three. But listening to those few using the Tandberg 3001 A really shows what FM can do—and what it was meant to do.

One last point: If you should become as enamored of this tuner as I have, don't be discouraged by the length of its owner's manual. Though 35 pages long, it's written in no fewer than six languages, so you can thumb past the translations in Swedish, Dutch, Norwegian, French, and German to find the English paragraphs. The back page is filled with specifications, and I must say that Tandberg is one of the few companies that bother to list every last bit of technical data prescribed by the IEEE/IHF Standard for Tuner Measurement. Why shouldn't they? After all, every one of those listed specifications is about as good as it can get, given the present state of the FM art. Even more important, nearly all of those specs are actually met or exceeded. It's always been my practice to hold on to equipment until my report actually appears in print. Maybe I can get *Audio* to drag its heels a little and let me keep this tuner for another couple of months after all.

Leonard Feldman

Honesty. It's been a rare virtue in sound. Until now. *Introducing the new Design Acoustics PS•103 3-Way Loudspeaker*



While other speakers attempt to make their mark with bombast and sizzle, the Design Acoustics PS•103 loudspeaker system has been created to accurately reflect the actual sonic drama of the music. No more. And certainly no less.

Hear the original acoustic space

The PS•103 starts with smooth, uniform response for every octave of music. That's basic. Dispersion at the higher frequencies is also enhanced by a tapered, sealed, independent Point Source enclosure for the 6" mid-range and 3/4" tweeter. The result of this combination is an appropriate spaciousness to the reproduced sound... neither collapsed, nor overextended. With the PS•103, the illusion of a live performance is more accurate, making possible a more intense reaction to the music.

Bass you can feel

The illusion is enhanced by the extended bass performance from the 10" down-firing woofer, housed in its own cabinet with unique multi-element baffles that stiffen the enclosure while smoothing and extending useful sound output. You both hear and feel the deepest bass, while sensing the original room acoustics all around you.

Honestly superior

Before you settle for an artificial sounding speaker, give our spectacular honesty a chance. Audition the Design Acoustics PS•103 loudspeaker system today. Write for the names of Design Acoustics dealers in your area. Like you, they are very serious about very good sound.

DA DESIGN[®]
ACOUSTICS
An Audio-Technica Company
1225 Commerce Drive, Stow, OH 44224

When you've arrived. Proton.



Proton's AV27 audio-video system.



300 Series Remote-Controlled Components with Dynamic Power on Demand™ (top to bottom) AM-300 Stereo Amplifier, AT-300 Stereo Tuner, AD-300 Cassette Deck, 830R CD Player.

Your audio-video system should be a reflection of your lifestyle. That's why you'll want the ultimate in picture, sound and design.

Introducing Proton's new AV27 audio-video system.

At the heart of the system is our superb, remote-controlled 300 Series audio components with exclusive Dynamic Power on Demand™ (DPD™). Since its introduction, DPD has received the highest acclaim. It does what no other technological innovation has for CD, other digital recordings, or hi-fi video listening pleasure. DPD boosts the amp's output up to four times its rated power, to let you hear even the highest musical peaks clearly, without distortion.

When you put the 300 Series together with our new matching speakers, you'll have a combination that sounds as extraordinary as it

looks. And, it's the perfect complement to Proton's stunning new 27" flat screen stereo monitor/receiver.

The Proton AV27 audio-video system. Once you own it, you'll know you've arrived.

The ultimate audio/video guide is yours free for the asking.

Proton's Ultimate System Guide for Audio/Videophiles tells you everything about the innovative technology and design that go into creating the renowned Proton line.

For your copy, which includes a list of the Proton retailers near you, call **(800) 772-0172**. In California, **(800) 428-1006**.

PROTON

CLEARLY THE BEST
737 W. Artesia Blvd., Compton, CA 90220

Enter No. 28 on Reader Service Card

In the wide i.f. mode, mono usable sensitivity was an incredibly low 8.2 dBf—and in narrow mode it was even lower!

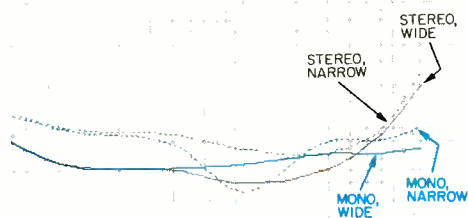
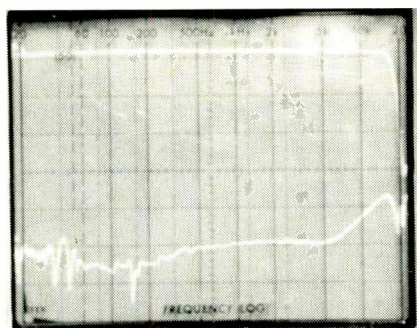
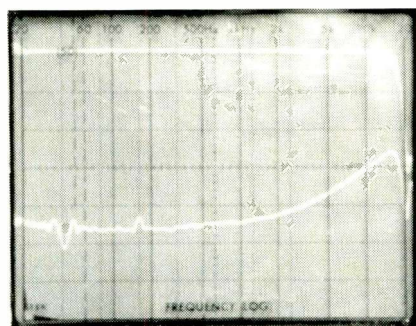

Fig. 3—THD + N vs. modulating frequency for narrow and wide i.f. modes, FM tuner section.



A



B

Fig. 4—FM frequency response (top trace) and separation vs. frequency for wide (A) and narrow (B) i.f. modes, FM tuner section.

multi-room remote systems as well. Two sets of preamp-out jacks and one set of main-amp input jacks allow connection of additional amplifiers or other audio equipment at a point beyond the receiver's tone controls and signal processors. Extra signal-processing input and output jacks are provided in addition to the two sets of tape monitor loops.

A total of 20 station frequencies can be memorized by the tuner circuitry. A switch inside the receiver allows you to tune in 25- or 50-kHz increments, if you wish, to avoid interference when receiving those cable FM transmissions that shift frequencies away from the standard 200-kHz multiples. Video signal sources can be connected to the receiver, and a video output terminal permits connection of a TV monitor. Wide-band video buffer amplifiers handle these video signals.

Control Layout

At the left edge of the R-117's all-black front panel are a power switch and a stereo phone jack. A display area near the power switch indicates tuned-to frequency, station preset number, stereo reception, signal strength, tuning mode, and "memory mode" when storing a preset station frequency. A multipath interference indicator, also found here, lights when the appropriate button is pressed—if and when multipath interference is present.

Ten numbered buttons below the display are used in tandem with an additional "shift" button to store the 20 preset stations. Nine buttons to the right of the display select desired program sources (FM, AM, tape 1 or 2, phono, CD, videodisc, and video 1 or video 2). If the "CD Straight" button (also located in this area) is pressed, the CD input is connected directly to the power amplifier section, and no other program sources can be selected. Four buttons below the program selectors and their associated indicator lights are used to choose among four possible program sources for record-output assignment: Tuner, phono, CD, and videodisc. Two additional buttons in the same row control video 2-to-1 and tape 2-to-1 dubbing.

Two speaker selector buttons are in the lower left corner of the front panel. Nearby are an "FM Muting" button, the "Multipath" button mentioned above, a two-position i.f. bandwidth selector, an "Auto Seek" button for selecting the automatic signal-seeking tuning mode, a "Memory Scan" button that lets you listen to each preset station for 5 S, the "shift" button previously mentioned, the preset "Store" button, and small rotary bass and treble control knobs. Farther to the right, along the bottom section of the panel, are a "Tone Defeat" button, a subsonic filter button, a three-position loudness compensation switch ("Off" plus two levels of compensation), a balance control, and an MM/MC phono cartridge selector. A massive volume control with an inset illuminated indicator is at the upper right corner of this feature-laden front panel.

As you might expect, the rear panel is crammed full of jacks and terminals. The FM antenna terminal is a 75-ohm coaxial type, but Luxman provides a 300-to-75-ohm matching transformer in case you prefer to use a flat-ribbon transmission line. An AM loopstick is packed separately and snaps into place in a rear-panel clamp. There are 38 audio and video input and output jacks, twin sets of speaker

Real Pride.

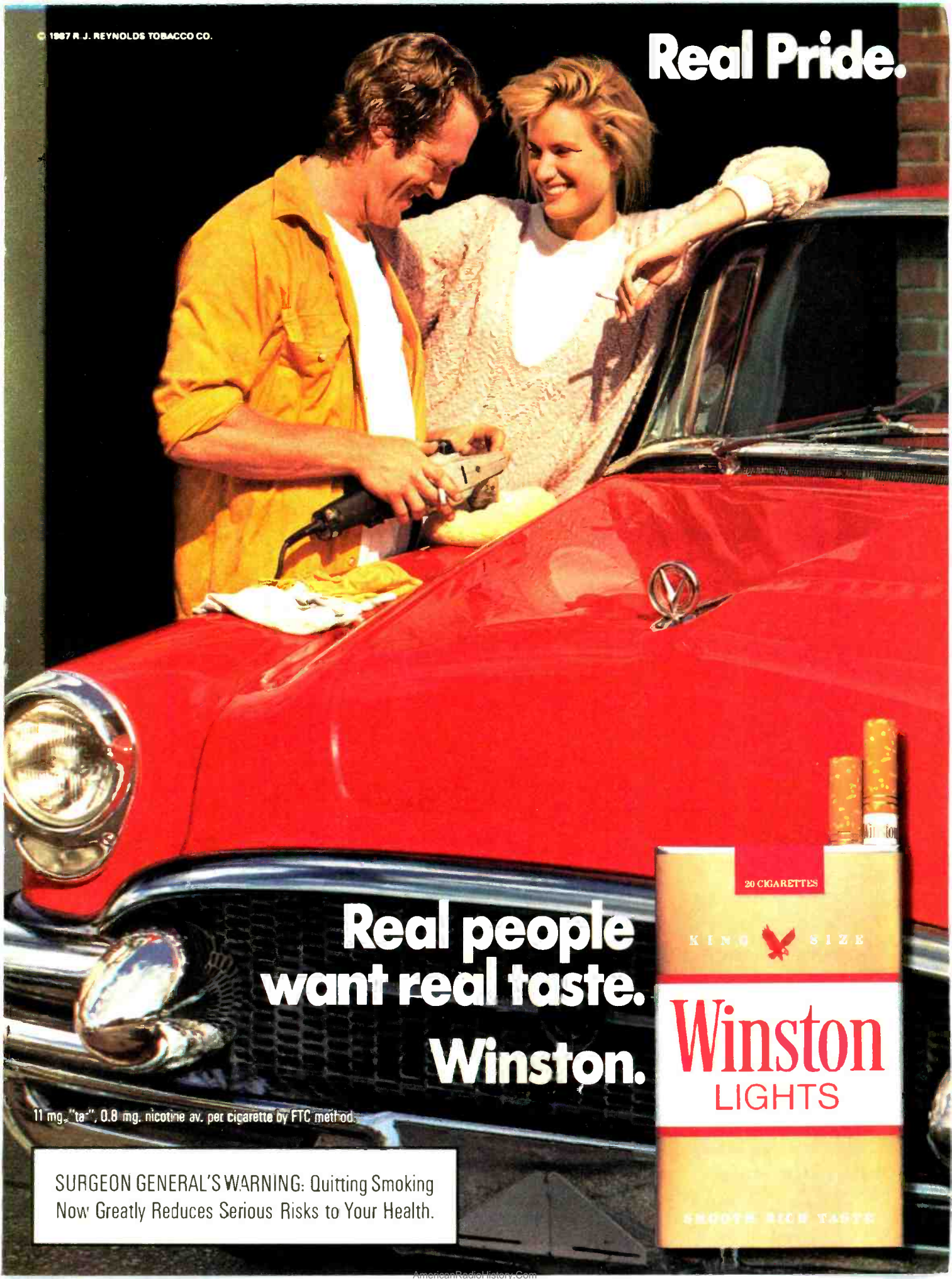

Real people want real taste. Winston.

11 mg. "tar", 0.8 mg. nicotine av. per cigarette by FTC method.

**SURGEON GENERAL'S WARNING: Quitting Smoking
Now Greatly Reduces Serious Risks to Your Health.**



Dynamic headroom was very high, allowing the amp section to deliver peaks of 450 watts into 8 ohms and 680 watts into 4 ohms!

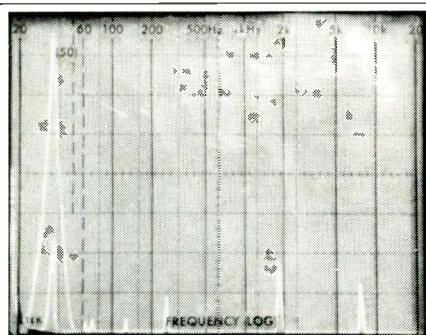

A
B

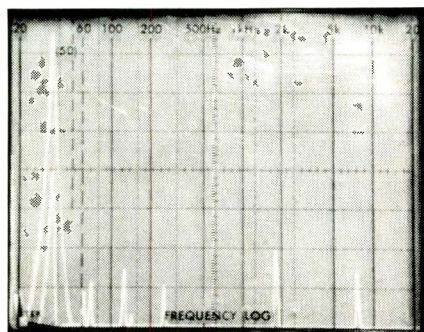

Fig. 5—Separation and crosstalk components for 5-kHz FM modulating signal, plus subcarrier and sideband components, for wide (A) and narrow (B) modes.

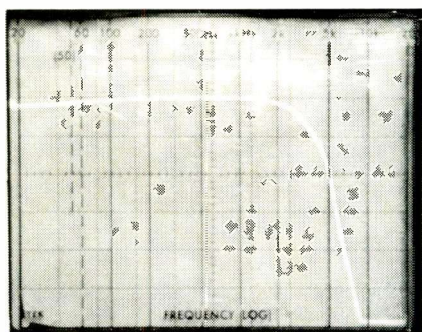

Fig. 6—AM frequency response.

output terminals, six convenience a.c. receptacles, and a chassis ground terminal. Also provided are DIN connectors for a unified remote-control system (if you use the R-117 with other Luxman components) and for an external remote sensor. A signal processor on/off switch opens the signal path so that an external device, such as a graphic equalizer, can be connected to the separate signal processor jacks.

Tuner Measurements

I could hardly believe my meters or my FM generator when I started to measure the performance of this receiver's FM tuner section. Usable FM sensitivity in mono measured an incredibly low 8.2 dBf in the wide i.f. mode—and an even lower 7.8 dBf in the narrow mode! The 50-dB quieting figure was just as impressive, measuring only 11 dBf. In FM stereo, usable sensitivity and 50-dB quieting were determined by the switching threshold rather than by actual tuner sensitivity. This threshold was set to 33 dBf in my sample, so by the time the tuner switched over to stereo, quieting had already exceeded 40 dB in the wide mode and was around 50 dB in the narrow mode. Figure 1 shows how FM mono and stereo quieting varied as a function of signal strength for the wide mode. Above 45 dBf or so, there was essentially no difference between this set's wide- and narrow-mode quieting characteristics. Maximum signal-to-noise ratio obtained for strong FM signal inputs (65 dBf or greater) measured 80 dB in mono and an almost equally high 78 dB in stereo.

Figure 2 shows how THD + N varied as a function of signal strength for a 1-kHz FM signal in mono and stereo and for narrow and wide i.f. settings. Strangely, at 65 dBf, THD + N in mono/narrow was marginally lower than in mono/wide (0.04% as against 0.05%). However, I was amazed at the fact that in stereo/wide, the lowest distortion reached with strong signals for a 1-kHz modulating signal was also only 0.04%. Even the "worst-case" 65-dBf stereo THD + N reading (0.07% in stereo/narrow) was better than what I usually read under the best conditions for an all-in-one receiver.

Figure 3 depicts THD + N as a function of modulating frequency for all four operating modes (mono wide and narrow and stereo wide and narrow). For the three test frequencies that are supposed to be reported according to the IHF/EIA Standard (100 Hz and 1 and 6 kHz), THD + N did not exceed 0.1% in any of the four operating modes and was considerably lower than that over the midrange portion of the spectrum.

Figures 4A and 4B are 'scope photos of my spectrum analysis sweeps of FM frequency response and separation. Frequency response over the entire FM broadcast range was among the best I have ever measured. Deviation was no more than ± 0.3 dB from 30 Hz to 15 kHz. In the wide i.f. mode (Fig. 4A), separation measured just over 50 dB at 1 kHz, 50 dB at 100 Hz, and 41 dB at 10 kHz. Switching to the narrow mode (Fig. 4B), mid-frequency separation decreased slightly, to 45 dB; it measured 46 dB at 100 Hz and 40 dB at 10 kHz. One nice thing about this tuner is that its narrow setting is not so narrow that it significantly increases distortion or reduces separation. By the same token, the

Not Evolutionary, Revolutionary.



Pioneer's Revolutionary Audio/Video Receiver

This is all you need to turn your existing electronic equipment into a superior A/V system. Because this revolutionary invention not only makes all of your audio and video components work better. It makes them work better...together.

For example, you'll see a better picture, due to a one-of-a-kind split-screen video enhancer that actually sharpens and focuses every video image. You'll hear a better sound too, due to three surround sound listening environments. And please, don't be

confused by what others may promise, because this machine delivers Dolby Surround® Sound, the finest in the world.

Yet even with all these dramatic improvements, your individual components have never been easier to operate. The reason: Pioneer's ultra-sophisticated 59-function system remote control.

Pioneer's Revolutionary Audio/Video Receiver. It makes all the components you already own, all together better.

 **PIONEER®**

CATCH THE SPIRIT OF A TRUE PIONEER.

©1986 Pioneer Electronics (USA) Inc., Long Beach, CA. *Pioneer's VSX5000 remote controls all Pioneer SR™ components. ©Dolby is a trademark of Dolby Labs Inc.

Enter No. 26 on Reader Service Card

I was able to use the R-117's narrow i.f. mode without giving up much separation or noticing any audible increase in distortion.

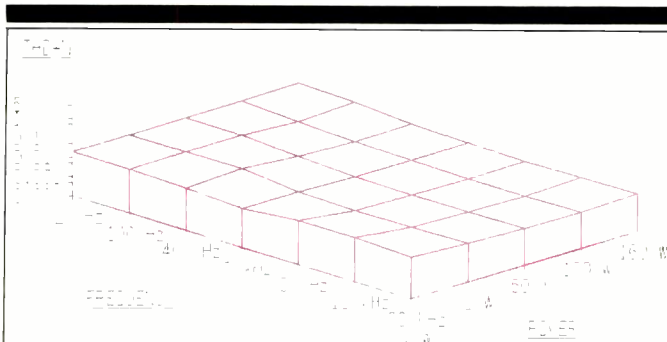

Fig. 7—THD + N vs. frequency vs. power level with 8-ohm load.

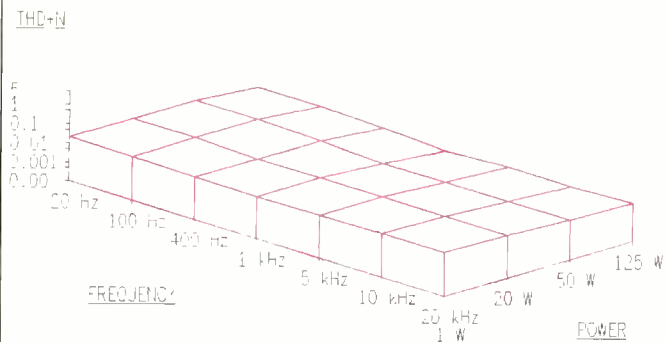

Fig. 8—Same as Fig. 7 but with 4-ohm load.

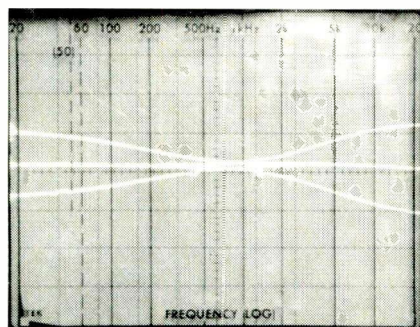

Fig. 9—Tone-control characteristics.

wide setting is not so wide that it introduces serious interference problems in crowded signal areas. In all likelihood, you will find, as I did, that you can leave the R-117 in its wide mode most of the time. This is what comes of intelligent choices of alternate-channel selectivity. I measured 52 dB in the wide mode and 80 dB in the narrow mode (against published figures of 50 and 75 dB, respectively).

As a further indication of this intelligent design, consider Figs. 5A and 5B. Here, a constant 5-kHz FM signal was used to modulate the left channel of my signal generator while the spectrum analyzer was swept linearly from 0 Hz to 50 kHz. The tall spike at the left of each photo and the shorter spike within it represent the desired 5-kHz output and the crosstalk of 5 kHz in the unmodulated channel. The only differences between results for the wide mode (Fig. 5A) and the narrow mode (Fig. 5B) are that the latter shows a slight decrease of separation and a very minor increase in harmonic distortion (represented by the height of the spikes just to the right of the 5-kHz spikes). Also evident in the narrow mode is a very slight increase in subcarrier side-band product output (represented by the two rightmost spikes in each photo).

Capture ratio in the wide i.f. mode measured 1.6 dB; in the narrow mode it was only 1.0 dB. AM rejection was superb, measuring a full 72 dB in the wide mode. Image and spurious-response rejection were both in excess of 100 dB.

In view of the better-than-average result for frequency response that I obtained for this receiver's AM section (−6 dB at 4 kHz, as shown in Fig. 6), I decided to make a few more AM measurements than I usually do. Usable sensitivity was a bit poorer than specified, 600 μ V/meter at 1 MHz. Signal-to-noise ratio, on the other hand, was better than that specified by Luxman, measuring 54 dB. THD was also much better than the published spec: my reading was 0.2% for a strong signal input with 30% modulation applied as against a claimed 0.5%. Selectivity measured 50 dB, and image rejection was about 48 dB.

Amplifier Measurements

The power amplifier section of the Luxman R-117 was as conservatively rated and designed as the tuner section. I was able to crank the amp up until it delivered 190 watts per channel of continuous power at 1 kHz into 8-ohm loads before THD reached the specified 0.03% level. With a 20-Hz signal applied, power output for rated THD was still way above the specified value of 160 watts; I measured an output of 180 watts per channel. Output was 185 watts per channel with a 20-kHz signal applied. Lowering the output to the specified 160 watts per channel, THD + N measured 0.008% at 1 kHz, 0.0085% at 20 kHz, and 0.02% at 20 Hz. SMPTE IM at rated output was only 0.015%, and CCIF (twintone) distortion was an insignificant 0.006%. Figure 7 shows how THD + N varied as a function of frequency and power output per channel into 8-ohm loads.

Although Luxman does not provide an FTC-type power output specification for 4-ohm loads, they do offer a clue as to what can be achieved by stating the expected dynamic power output. Accordingly, I simply increased input signal levels until the rated 8-ohm THD of 0.03% was reached at 4

....remarkable!



par.a.digm (par'adim) *noun: serving as an example or model of how something should be done.*

Every once in a great while a product comes along that offers performance which rises above the current variety of clever designs and marketing hype. When this occurs the new level of performance achieved can be readily heard by both the ardent audiophile and the novice listener.

Paradigm is a breakthrough loudspeaker that

provides a level of musical truth that simply must be heard.

Oh yes, the price for such glorious performance? Well . . . that's even more remarkable.

Paradigm[®]
music . . . above all.

In the U.S.: **AudioStream**, MPO Box 2410, Niagara Falls, NY 14302
In Canada: **Paradigm Electronics Inc.**, 457 Fenmar Dr., Weston, ON M9L2R6
Enter No. 4 on Reader Service Card
AmericanRadioHistory.Com

In terms of quality, the R-117 is reminiscent of the separate preamps and amps that earned Luxman its initial high marks.

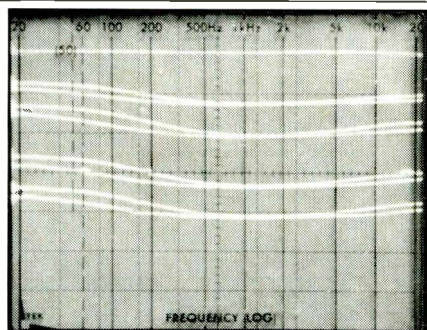

Fig. 10—Loudness-compensation characteristics. Note effects of two settings of the loudness switch.

ohms. This occurred when the amplifier was delivering 268 watts per channel at 1 kHz, 240 watts per channel at 20 Hz, and 248 watts per channel at 20 kHz. The plot of Fig. 8 shows how THD + N varied as a function of frequency and power output when 4-ohm loads were connected to the receiver.

Damping factor at 8 ohms, using a 50-Hz test signal, measured 125. Dynamic headroom was very high, thanks to the special supply-switching arrangement described earlier. I measured 4.5 dB of dynamic headroom at 8 ohms, which means that for short-term signal peaks, the amplifier can deliver as much as 450 watts per channel! While there was no reference power level against which to measure dynamic headroom at 4 or 2 ohms, I determined that the amplifier could actually deliver peak power levels of 680 and 800 watts per channel with such low impedances!

Frequency response through the high-level inputs was flat to within 1.0 dB from 13 Hz to 55 kHz and extended from 7.5 Hz to 150 kHz for the -3 dB roll-off points. With the subsonic filter turned on, the -3 dB point was 19 Hz. Phono sensitivity measured 0.35 mV for the MM inputs and 17 μ V for the MC inputs; both measurements were referenced to 1 watt output with the volume control set at maximum. High-level input sensitivity was around 12 mV for 1 watt output. Phono overload measured 170 mV in the MM setting and 15 mV in the MC mode. Equalization was very accurate, deviating from the RIAA playback curve by no more than 0.5 dB at the bass end of the spectrum.

My signal-to-noise readings differed from those specified by Luxman, but I think I know the reason why. Although Luxman did use an input reference signal of 5 mV (for phono) or 0.5 V (for the high-level inputs), I suspect that their output reference was rated power (160 watts at 8 ohms), whereas I measure S/N with respect to 1 watt output. There is no direct way to correlate the two readings, since it is not possible to determine whether most of the residual

noise originates ahead of the volume control or after it. In any case, using my method, the S/N numbers are certainly nothing for Luxman to be ashamed of: 78 dB for MM phono and 80 dB for the high-level inputs. With the volume control turned down to its minimum, I measured 86 dB below 1 watt, the residual noise of the power amplifier section. That last figure can be correlated to rated output, and the calculation results in an amp-section S/N reading of 108 dB referred to full rated output.

Figure 9 shows the full boost and cut range of the bass and treble tone controls, both of which can be fully bypassed if you wish. The sweep here (as well as for Fig. 10) is logarithmic, from 20 Hz to 20 kHz. The loudness contour traces shown in Fig. 10 are a bit different from those I usually obtain; each trace (except for the top one, which corresponds to maximum volume setting) really shows two response characteristics. These correspond to the two settings of the loudness control switch. In the owner's manual, Luxman suggests that the milder setting (less bass and treble boost at each correspondingly lower volume setting) be used for moderate listening levels, while the setting that yields somewhat more boost at the frequency extremes be used only at very low listening levels. This two-position arrangement, although certainly not as effective as a continuously variable independent loudness control, is nevertheless better than a simple "on/off" type of loudness control switch.

Use and Listening Tests

I spent much of my auditioning time with this receiver listening to FM broadcasts. In my area, the FM dial is fairly densely populated, but rarely am I able to receive more than 45 or so signals with sufficient quieting to justify listening to them. In the case of the Luxman R-117, the satisfactory station count rose to 51! (I would hasten to add that in these FM listening tests, I use a rotatable multi-element outdoor antenna.) Despite the fact that I was able to listen in the wide i.f. mode during most of my tests, I found that I was able to use the narrow setting without sacrificing much separation and without noticing any audible increase in distortion.

Most of the remainder of my listening experiments were conducted using recently acquired CDs, including a couple of Delos releases featuring Haydn symphonies and concertos (D/CD 3061 and 3062). Thanks to the Luxman's excellent electronics and to Delos' superb recording techniques, the sounds of cello and piano were truly magnificent, with dynamics and transient response that were almost indistinguishable, at times, from those of a live performance. For "bigger" sound, I played the two-disc Verdi *Requiem* recently released by Telarc (CD-80152). The clarity of the solo vocalists and the chorus, and the ease with which I was able to focus on specific voices against the full force of the Atlanta Symphony Orchestra, attest to the absence of dynamic distortion, which is not easily measured on the test bench.

All in all, Luxman has come up with an all-in-one receiver which, in terms of quality, is reminiscent of the separate amplifiers and preamplifiers for which the company earned its initial high marks.

Leonard Feldman



COMPROMISING WITH YOUR TAPE IS LIKE COMPROMISING WITH ANY OTHER COMPONENT IN YOUR SYSTEM.

Even the most advanced system is only as good as the tape you put into it. That's why Maxell has created XLII-S.

Its unique Epitaxial formula combines gammaferric oxide and cobalt ferrite for superior response at all frequency levels. The resulting superfine particles offer unprecedented clarity and brilliance. And make XLII-S the perfect tape for recording your most demanding sources.

So match your tape to the other components in your system and use only XLII-S from Maxell. Anything less is just kid stuff.



maxell
The Tape That Delivers
Higher Performance.

© 1988 Maxell Corporation of America, 60 Oxford Drive, Moonachie, N.J. 07074.

Enter No. 39 on Reader Service Card
AmericanRadioHistory.com

ATHENA. The preamplifier is in many ways the most telling component in the audio chain. All too often technical absolutism results in sound quality that is sterile, unappealing, or aggressive. Yet bad lab performance almost always indicates poor sonic integrity. With Athena, Sumo demonstrates a new balance. A preamplifier that is both a stunning performer in the areas of quickness, linearity, and freedom from overload. Yet a warm, faithful, and exciting reproducer of music.

Athena represents the culmination of a major effort at Sumo. As such, it sets new standards for dynamic headroom and freedom from overload. Utilizing high voltage power supply rails, passively linearized circuitry, and a high current toroidal transformer, Athena can faithfully reproduce music at levels far in excess of the peak output of signal sources. As a result, compact discs display dynamic range without high end pain. And complex passages come through intact and unstrained.

Sonic purity in Athena is enhanced both by careful component selection and the exclusive use of pure Class A circuitry. Low noise 1% metal film resistors and metalized polypropylene capacitors are used throughout. Components are mounted on a military grade glass epoxy printed circuit board. And all external connections are made via gold plated input and output jacks. Further, a bypass function allows the user to totally remove the high level section of the preamp from the signal path. When selected, this provides both direct line-drive for high level sources (such as a CD player), as well as direct phono out.

At various times and for various products, we hear the words powerful, impactful, detailed, delicate, accurate, transparent, smooth, natural and a variety of other flattering adjectives. But one word is repeated more frequently than all the rest, and it is that for which we have strived above all. Musical. Athena is above all gloriously musical.

As with all Sumo products, Athena is designed and manufactured in the United States. Among those select dealers stocking our products are:

GILLAM SOUND
1036 Portage Avenue
Winnipeg, Manitoba R3G 0S2
204/783-3958

HIGHER FIDELITY
1620 South Blvd., Suite 1
Charlotte, NC 28203
704/376-0350

THE NEW BALANCE.

SUMO

SUMO PRODUCTS GROUP, 21300 Superior St., Chatsworth, CA 91311 818/407-2427
SUMO CORP CANADA, 1305 Odium Dr., Vancouver, B.C. V5L 3M1 604/254-5148

Sumo
C-100

TAPE COPY

INPUT

VOLUME - BALANCE

ATHENA

STEREO
MONO
MUTE
AUTO
OFF

ADJ. BAL.
OFF

3

PARASOUND D/HX-600 CASSETTE DECK

Manufacturer's Specifications

Frequency Response: 30 Hz to 15 kHz, +2, -3 dB, with Type I tape; to 15.5 kHz with Type II tape, to 16 kHz with Type IV tape.

Harmonic Distortion: Less than 1% for 400 Hz.

Signal/Noise Ratio (Type II or IV Tape): 55 dB; 72 dB with Dolby C NR.

Crosstalk: 48 dB.

Input Sensitivity: 30 mV.

Input Impedance: 50 kilohms.

Output Level: Line, 270 mV; headphone, 30 mW.

Output Impedance: Line, 1 kilohm; headphone, 8 ohms.

Flutter: 0.12% wtd. rms.

Speed Accuracy: Within 2%.

Fast-Wind Time: 85 S for C-60.

Dimensions: 17¼ in. W x 4 in. H x 11 in. D (43.7 cm x 10.3 cm x 27.9 cm).

Weight: 12 lbs. (5.4 kg).

Price: \$360.

Company Address: 945 Front St., San Francisco, Cal. 94111.

For literature, circle No. 92



The Parasound D/HX-600 cassette deck has Dolby B and C NR, as do most decks these days, and it is one of the relatively few lower priced recorders that include Dolby HX Pro headroom extension as well. Dolby HX Professional was developed by Bang & Olufsen with assistance from Dolby Laboratories, which designed the original HX system. Quoting from a Bang & Olufsen publication:

Although the principles are similar, the aims for the two systems are different. In HX the primary aim is to allow the maximum level of high frequencies to be recorded on tape. HX Professional has the more fundamental aim of keeping the active bias constant (Active bias may be defined as the effective bias seen by each frequency in the audio spectrum.) In doing so, all parameters that are affected by a

change in bias under static conditions will be stabilized under the dynamic conditions during actual recording.

Dolby HX Professional is similar to Dolby HX in that both systems change the amplitude of the bias signal from the bias oscillator, but the reason for doing so, as well as the method of achieving this, are different. The fact that in doing so all the aims of HX are fulfilled to virtually the same extent is, in effect, a secondary benefit of HX Professional.

HX Professional has several other advantages over HX, primarily in flexibility, and in its universal application. It is a dedicated system, tailored to HX operation only, and it is fully independent of the Dolby NR module and all other electronic circuits in the recorder. It is, therefore, equally suitable for professional use (such as in studio recorders and high-speed duplication) and in high-quality cassette recorders.

The McIntosh XRT 22 Loudspeaker System delivers

The McIntosh XRT 22 is the purest expression of the loudspeakers scientist's endeavors. It is the one *right combination* of component parts that has eluded the diligent searcher for the loudspeaker bridge to the dominion of reproduced musical reality. The high-frequency radiator column is an illustration of the *right combination*. The 23 tweeter elements can reproduce 300 watts sine wave input power at 20 kHz, with the lowest measured intermodulation distortion. Because each tweeter mechanism handles a small quantity of the total power, extremely low quantities of distortion are developed. The total column radiates the energy in a half cylindrical time-coordinated sound field. The low distortion transparency of sound, coherence of sound images, definition of musical instruments, and musical balance is simply a revelation that you must experience.

Extra Realism
Extra Depth
Extra Spaciousness
Extra Smoothness



Enter No. 21 on Reader Service Card

For information on the McIntosh XRT 22 SPEAKERS and other McIntosh products write:

McINTOSH LABORATORY INC.
P.O. Box 96 EAST SIDE STATION, DEPT. A117
BINGHAMTON, NY 13904-0096

Handcrafted with pride in the United States
by dedicated, highly trained craftspeople.

Dolby C NR is no longer unusual, even on low-priced decks, but HX Pro and a "Play Trim" control are uncommon extras.

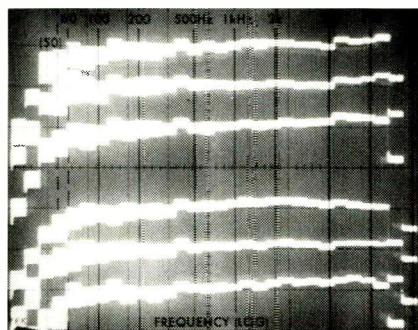

Fig. 1—Record/playback responses with Dolby C NR using "PN/Music" test signal. Upper traces are for signal at rms level equivalent to Dolby level,

using (from top) TDK AD-S, Fuji FR-II Super, and TDK MA-XG. Lower traces are for -20 dB signal using same three tapes. (Vertical scale: 5 dB/div.)

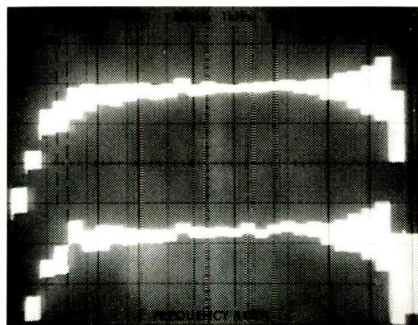

Fig. 2—Range of Play Trim effects without NR using Fuji FR-II Super tape. Top trace was recorded at -10 dB and bottom trace at -30 dB. (Vertical scale: 5 dB/div.)

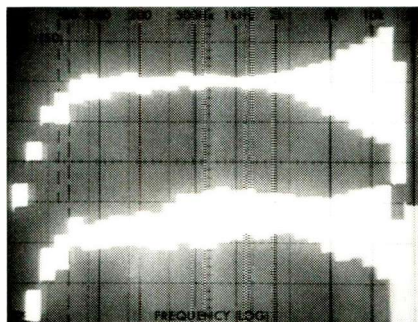

Fig. 3—Same as Fig. 2 but with Dolby C NR.

The Parasound D/HX-600 has two heads, and because such decks have difficulty in meeting the challenge of good high-frequency response, I looked forward to testing this unit. In the meantime, I discovered that it has an even more unusual feature than HX Pro, namely, a "Play Trim" control. According to Parasound, this is to ensure that the Dolby circuits are given the correct "instructions" in playback. I have written before on the grievous response deviations that can occur when switching Dolby-encoded tapes from deck to deck ("Deck-to-Deck Matching and NR: Straightening the Mirror," August 1986). Factors contributing to poor Dolby tracking when switching tapes include frequency response deviations on the tape itself, differences in Dolby calibration levels, and discrepancies in azimuth alignment.

Even without switching tapes, responses that peak or droop at the highest frequencies without Dolby NR will usually be worse with it. The deviation causes an overall level shift sensed by the NR decoder, and the peaked response ends up getting less treble reduction in playback because of this effect. Parasound states in the deck's owner's manual that the Play Trim adjustment should be made while listening for the best sound quality. There was a possibility that the control was a play-level calibration pot, but proof of that had to wait for the lab tests.

Control Layout

At the very left of the front panel, from top to bottom, are the eject and power on/off buttons and the headphone jack. The two buttons are exactly the same size, which could cause some mistakes, but I did like having the eject button at the top edge of the cassette compartment door. Unless a Dolby NR mode has been selected, the D/HX-600 does not have a pilot light per se to show that the unit is on. However, the back of the cassette well does illuminate in a soft green when power is applied.

To the right of the well is a three-digit counter and its reset button, and below them are six transport and record-control pushbuttons. All of these buttons are square and are angled out slightly from the panel, which aids a bit in visibility and actuation. The top two, "Rew" and "FFWD," have double arrows pointing in the appropriate direction. In the second row are "Stop" (with a small red square) and "Play" (with a bluish-green arrow). On the bottom are "Pause" (with a double-bar symbol) and "Rec" (with a red dot). These buttons must be pushed in for some distance to actuate their functions, but they do not latch in, which would help to remind the user what choice was made. Selecting "Pause" turns on an indicator in the meter/display panel.

To the right of the pushbuttons are vertical slider input-level controls extending nearly the full height of the panel. Because the sliders are fairly close together and the knobs have concave indentations, level adjustments up and down can be made easily for both channels with one finger. I don't know if Parasound considered that possibility, but I liked it.

Next on the front panel is the meter/display area, whose left side is occupied by four indicators that show on/off status for "Pause" (orange), "Record" (red), "Dolby B" (green), and "Dolby C" (red). The horizontal, ladder-type level meters have 12 segments for each channel; they illuminate in yellow-green from "-20" to "-1" and in or-

THE ADCOM GFP-555 PREAMPLIFIER



A remarkable combination of exceptional performance, flexibility and value.

The GFP-555's musical performance is outstanding—by any measurement or listening criterion. For example, *Stereophile** calls it "one of the most satisfying preamps around in terms of overall tonal balance . . . You can go back to it after a few weeks and still feel it to be basically right; it reveals most associated equipment as more colored than itself."

At the same time, the GFP-555 is surprisingly affordable. Again, from *Stereophile**: "It is unclear from close examination why it should cost only \$500 . . . it outperforms several competitors from the \$2500 bracket."

Here are just a few examples of how we did it. The GFP-555's gain path includes the most innovative state-of-the-art linear amplifiers ever used in high fidelity components, and is simple and direct from input to output.

The speed of the gain stages is almost fifty times faster than CD or LP signals. And the noise and distortion measurements are incredibly low. Direct coupling makes possible a frequency response from below 1 Hz to beyond 400,000 Hz.

Superb construction, incorporating regulated power supplies with large filter capacitors, provides superior performance no matter how widely the musical signal or AC line voltage may fluctuate.

As for flexibility, you can listen to any source while taping from another. There's an unusual number of inputs and outputs, plus adjustable phono gain and capacitance.

If you'd like the full story of this remarkable preamplifier and the review from *Stereophile**, please write. Of course, the fastest way to hear its demonstrably superior combination of sonic performance, flexibility and value is to visit your nearest Adcom dealer.

*Vol. 9 No. 7 (Nov. 1986)

ADCOM®

11 Elkins Road, East Brunswick, NJ 08816 201-390-1130

Distributed in Canada by PRO ACOUSTICS, INC.,
Pointe Claire, Quebec H9R 4X5

Enter No. 1 on Reader Service Card

“Play Trim” is *not* a bias control, which would affect a tape only in recording. It will have an effect on any tape played.

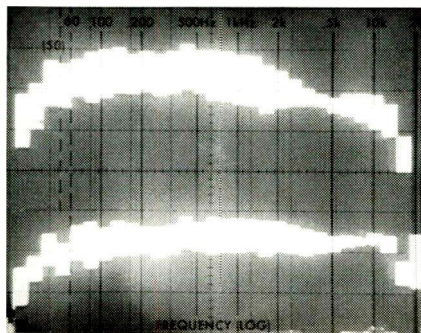

Fig. 4—Effect of Play Trim – 10 to –40 dB but without Play Trim. Bottom trace shows results with Dolby C NR. Top trace shows superimposed responses for levels from (Vertical scale: 5 dB/div.)

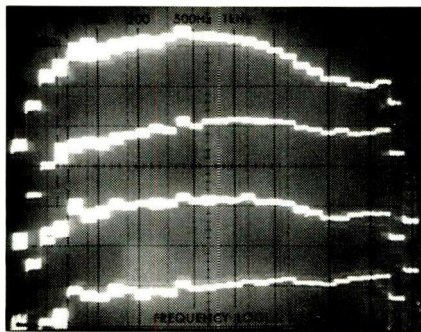

Fig. 5—Effect of Play Trim – 10 and –30 dB. Bottom two traces show playback of same tapes with Play Trim adjustment. Both –30 dB traces are shifted upward for clarity. (Vertical scale: 5 dB/div.)

ange-red from “0” to “+8.” Because of the inclusion of individual markings for +1 and –1, and for +3 and –3, there is good resolution around zero. The LEDs above zero have a hold function.

Below the display panel are vertical bar switches for “Dolby NR” (“On/Off” and “B/C”) and “Tape Selector” (“Normal,” “CrO₂,” and “Metal”). To their right is the “Play Trim” control, which has a center detent at “0.” The scale is marked “2,” “4,” “6,” “8,” and “10” on either side of zero, with “Min” next to the “10” at full counterclockwise rotation and “Max” next to the “10” at full clockwise rotation.

The back panel is very simple, with the line in/out stereo pairs the only connections to be made. I removed the top and side cover to assess internal construction. The great majority of the circuitry was on a p.c. board that was about half-chassis size. Above the main board was a smaller one, with a shield-plane below it, which was identified as being the HX Pro circuitry. Although this board was supported by

two angle brackets, it was quite springy, with just one screw to hold each bracket to the back panel. All of the parts and the few adjustments were identified. The soldering was very good, and interconnections used multi-pin plugs and sockets. The rigidity was fairly good. The transport was reasonably quiet, and its cam system for play and pause worked well. The construction was on the light side, with a medium-size capstan flywheel. The power transformer was small and was only warm, not hot, after a period of use. I did not observe a fuse, but there might have been one (or a fuse resistor) back under the HX Pro p.c. board.

Measurements

The playback response of the Parasound deck was quite good with 120- μ S equalization; all points for both channels were within 2 dB. The deviations with 70- μ S equalization varied with the test tape that I used. For reasons I never determined, there appeared to be very high skew with the BASF alignment tape but not with a couple of others I tried. I have seen cases of selective skew before, but this is the first time it appeared with the alignment test tape. There is no marking on the D/HX-600 meters for Dolby level, but playing a Dolby-level test tape resulted in a “+3” on the left-channel meter and a “+1” on the right. A flickering of this indication suggested that the level was very close to the “+1/+3” threshold. Tape play speed was 0.3% fast.

I checked the record/playback responses using my latest version of what I call “PN/Music.” Maximum levels in each $\frac{1}{3}$ -octave band are close to the maxima that I have measured from *any* of a large number of CDs. A gentle roll-off starts at about 2 kHz, reaching a shelf at around 5 kHz for levels 7 to 8 dB below the low- and mid-frequency band levels. These levels are constant out to 16 kHz, with a sharp drop above that. In playback, compensating equalization is used to make the display flat except for any response deviations. I know that some readers prefer swept-frequency responses, which *appear* to be more accurate, but which really aren’t when noise reduction is involved.

Although Parasound states in the owner’s manual that “Play Trim” would normally be kept at “0” when playing tapes made on the D/HX-600, it wasn’t so for most formulations. The record/playback responses were run using Dolby C NR. Many Type I tapes could be well matched to the deck by using the “Play Trim” control. I liked the results with TDK AD-S best of all, and that required a “–1” trim. TDK D was also very good, as were Denon DX3 and Fuji FR-I Super. Fuji FR-II Super with a “+0.3” trim was the best of many Type IIs, with Denon HD7, SKC QX, Sony UX-Pro, and TDK SA very close behind. Of the Type IVs, I liked TDK MA-XG with a “–2” trim the best. I couldn’t help but notice that many metal tapes could be well matched, which is sometimes not possible on a lower priced deck. Other good Type IVs for the D/HX-600 were BASF Metal IV, Denon HDM, Sony Metal-ES, and Triad MG-X.

Figure 1 shows the record/playback responses with Dolby C NR using the three preferred tapes. The test levels for PN/Music were set at an rms level equivalent to Dolby level (top three traces) and at 20 dB below that (bottom three traces). There is excellent flatness at both levels for all three tapes, albeit with a noticeable low-frequency roll-off

"Is the tide coming in or going out?"

"I don't know. The last thing I remember is you turning up the stereo."

That's the way it happens. The clean, clear sound of Pyle Driver® car stereo speakers surround you and transform an everyday drive into a captivating experience.

The new Pyle Driver Pounder® systems make superior sound a reality in virtually any type vehicle. Innovative features like heavy duty woofers, volume-weighted passive radiators, high fidelity, dome tweeters, and low-leakage 12 dB crossovers are computer matched and hand built into custom tuned enclosures.

That same dedication to quality is built into Pyle's new Digital Demand amplifiers. Powerful yet distortion free, Pyle Digital Demand amplifiers provide the purest sound possible.

Surround yourself with Pyle Driver® car stereo speakers and electronic components.



PYLE

For the name of the Pyle dealer nearest you write:
Pyle Industries, Inc. • Huntington, IN 46750



Many metal tapes could be well matched to this deck, and that is not always possible on units in the Parasound's price range.

Table I—Record/playback responses (–3 dB limits).

Tape	With Dolby C NR				Without NR			
	Dolby Lvl		–20 dB		Dolby Lvl		–20 dB	
	Hz	kHz	Hz	kHz	Hz	kHz	Hz	kHz
TDK AD-S	35	10.9	35	15.1	35	9.5	35	15.3
Fuji FR-II Super	34	11.4	33	15.1	34	9.7	33	15.2
TDK MA-XG	36	15.7	36	15.7	36	15.7	36	15.7

Table II—Miscellaneous record/playback characteristics with Dolby C NR.

Erasure At 100 Hz	Sep. At 1 kHz	Crosstalk At 1 kHz	10-kHz A/B Phase Error	Jitter	MPX Filter At 19.00 kHz
66 dB	62 dB	< –90 dB	0°	30°	–33.1 dB

Table III—400-Hz HDL₃ (%) vs. output level (0 dB = 200 nWb/m).

Tape	NR	Output Level					HDL ₃ = 3%
		–10	–8	–4	0	+4	
TDK AD-S	Dolby C	0.10	0.10	0.13	0.20	1.0	+5.9 dB
Fuji FR-II Super	Dolby C	0.06	0.10	0.20	0.36	1.3	+5.6 dB
TDK MA-XG	Dolby C	0.13	0.16	0.32	0.71	1.8	+4.6 dB

and a sharp cutoff at the high frequencies. Some of these same characteristics are indicated by the data for the –3 dB points listed in Table I. The results showed benefits from both Dolby HX Pro and Parasound's Play Trim. The unswitchable multiplex filter is the major contributor to the sharpness of the high-frequency cutoff.

I decided to take a closer look at Play Trim to get a better sense of its general value. Figure 2 shows the band of frequencies and range of levels affected by rotating the "Play Trim" knob from minimum to maximum. The trials were at –10 and –30 dB *without* NR. In this case, the effect is the same at both –10 and –30 dB. In Fig. 3, the same test was run, but with Dolby C NR switched in. Notice how the range of levels is increased relative to Fig. 2 at –10 dB (top traces) and the across-the-band effects that result at –30 dB (bottom traces). This proves that Play Trim does indeed precede the Dolby encoder, for more effective compensation when NR is used. Please keep in mind that this is *not* a bias control, which would affect the tape only in recording. Play Trim will have an effect on *any* tape played, no matter what deck it was recorded on.

Figure 4 shows superimposed response analyses for recording levels from –10 to –40 dB with Dolby C NR. The top trace, without Play Trim, shows responses that varied from very rolled off to fairly flat. The bottom trace shows the results from the same test but with Play Trim in use; it is a significant improvement. Figure 5 presents the playback responses from a recording made on a Nakamichi CR-7A deck at –10 and –30 dB. The top two traces do not have Play Trim, but the bottom two do, and they are much better because of it. (The –30 dB traces were purposely shifted up to allow showing all four traces in one figure.)

Table II lists a number of record/playback characteristics; they are all very good, and the data for erasure (of metal tape), separation, and crosstalk are excellent. In fact, I'm not certain how far below –90 dB the crosstalk is. The bias in the output during recording was very low.

The third-harmonic distortion of 400 Hz was measured at five signal levels for the three preferred tapes with Dolby C NR from –10 dB up to the point where HDL₃ reached 3%. The results shown in Table III are fairly good, with the low distortion at –10 dB worthy of note. Table IV gives the results of measuring HDL₃ from 50 Hz to 5 kHz at –10 dB, using TDK MA-XG tape and Dolby C NR. The low distortion at the higher frequencies is a good indication of the success of HX Pro in this area.

Table V shows the very good to excellent signal-to-noise ratios obtained with all three formulations. The best results were achieved with Fuji FR-II Super, and the other two tapes were quite close. The metal tape would be the best choice, however, for recording music having considerable high-frequency energy.

Various input and output characteristics of the Parasound deck are given in Table VI. There is nothing to fault in any of them, though some of the numbers do not agree with the specifications. The input sensitivity is a higher voltage but is still acceptable. The line output level and the output impedance are actually better than specified. I did not get the rated 30 mW across 8 ohms at the headphone output, but I would have been surprised if I had—that is a very high power level for tape-deck headphone outputs. All the phones I tried were driven to levels that were at least plenty loud—and sometimes uncomfortably so.

The level meters were 3 dB down at 12.1 Hz and at 16.0 kHz. The meter response time was very short, reaching –1 dB with a 0-dB tone burst of 3-mS duration. A full zero indication required a burst less than 20 mS long. The 20-dB decay time was 0.33 S, much less than the IEC-recommended 1.7 S. The meters gave higher indications on bursts offset in the positive direction and lower indications on bursts with negative offset. Peaks are detected best by meters which give higher readings when there is such a d.c. offset, but the meters' response should be the same for either offset polarity.

The line output's polarity was the same as the input's, both in recording and in playback. The calibration of the meter scales was excellent, with all but one bar within 0.4 dB of actual and several within 0.1 dB. At meter zero and above, there was an automatic peak hold, usually about 1 S. I felt that the hold was essential with these meters, considering their fast decay time.

The tape play speed varied regularly within ±0.03% limits, though occasionally it went to ±0.05%, which is acceptable but not very good. The play speed increased by about 0.17% when the line voltage was reduced from the reference 120 V a.c. to 110 V, and it decreased by about 0.13% when the voltage was increased to 130 V. These deviations are greater than most other decks' and could be of importance to users with unstable line voltage. Parasound specifies flutter as "0.06% nominal" and 0.12% wtd. rms. The measured flutter was a consistent 0.11% wtd. rms over the length of a C-90, with no observed basis for the "nomi-

BRYSTON

Continues to define the state-of-the art...

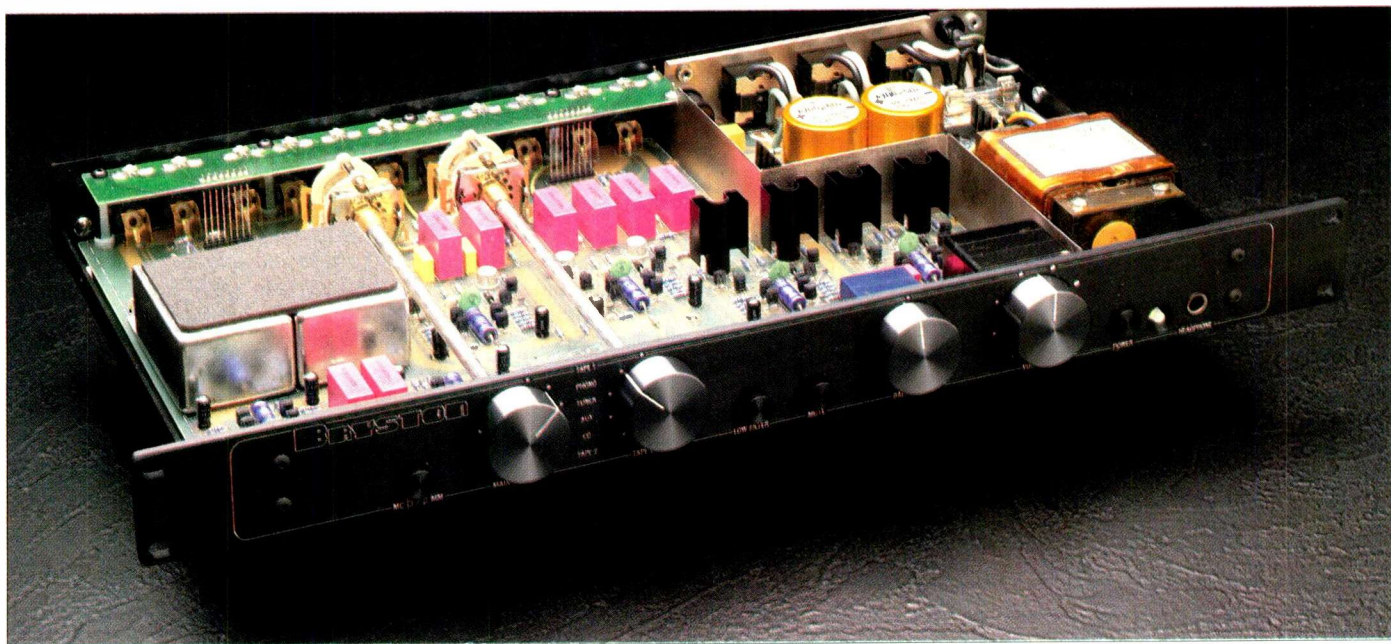

The Briston Magic

BRYSTON believes the purpose of an audio system is to create the three dimensional illusion of a live musical event in your own home.

This **sound stage** involves the placement of instruments, in space, around, behind and in front of the speaker system.

The audio system should present the instruments in their proper size, and the instruments' harmonic structure, image, tonal balance, depth, clarity and dynamic range should all sound believable.

In order to accomplish this three dimensional sound stage a significant amount of effort is required in both theory and practice when designing an audio product.

TO this end, Briston has originated and optimized the circuitry used in all its products to a degree of linearity which approaches theoretical perfection. From steady-state signals, to high, low and mid-frequency transients we understand the mechanisms and

criteria necessary for musical accuracy over the full spectrum.

We have devoted years of research to the elimination of audible problems due to phase shift, differential temperature effects, transient compression, envelope modulation, and the subtle effects group delay can have on **depth** information.

WE invite you to experience the Briston magic - a sound stage in your own home!

In Canada:

BRISTON Marketing Ltd.

57 Westmore Drive, Rexdale, Ontario M9V 3Y6
(416) 746-0300

In the United States:

BRISTON Vermont

RFD #4, Berlin, Montpelier, Vermont 05602
(802) 223-6159

Enter No. 6 on Reader Service Card

With its flat response, low distortion, and good S/N, I judge this cassette deck to be a good value.

Table IV—HDL₃ (%) vs. frequency using Dolby C NR.

Tape	Level	Frequency (Hz)						
		50	100	400	1k	2k	4k	5k
TDK MA-XG	-10 dB	0.25	0.06	0.13	0.07	0.06	0.10	0.14

Table V—Signal/noise ratios with IEC A and CCIR/ARM weightings.

Tape	IEC A Wtd. (dBA)				CCIR/ARM (dB)			
	W/Dolby C NR		Without NR		W/Dolby C NR		Without NR	
	@ DL	HD=3%	@ DL	HD=3%	@ DL	HD=3%	@ DL	HD=3%
TDK AD-S	72.3	78.2	55.1	61.0	71.5	77.4	52.2	58.1
Fuji FR-II Super	74.1	79.7	57.3	62.9	73.5	79.1	54.8	60.4
TDK MA-XG	73.3	77.9	56.3	60.9	72.4	77.0	53.4	58.0

Table VI—Input and output characteristics at 1 kHz.

Input	Level		Imp., Kilohms	Output	Level		Imp., Ohms	Clip (Re: Meter 0)
	Sens.	Overload			Open Ckt.	Loaded		
Line	95 mV	>30 V	43	Line Hphn.	513 mV	487 mV	625	+14.6 dB
					482 mV	394 mV	11.2	

nal" figure. The weighted peak figure was $\pm 0.17\%$, which further indicates just fair performance in this area.

The fast-wind time for a C-60 was 95 S, longer than specified, and it was 142 S for a C-90, which is longer than for any other deck I can recall. Time from tape run-out to stop was 5 S in fast wind and 3 S in play/record. It was possible to switch instantly between fast-wind directions. Changing to play from fast wind took less than 1 S. It was not possible to go directly from play to record mode, but many more expensive decks do not allow that either.

Use and Listening Tests

The owner's manual has limited detail but does offer helpful comments on making connections and on maintenance and trouble-shooting. Although the discussion of Dolby NR is abbreviated, it provides good suggestions on why Dolby B or C NR might be selected. As I've mentioned, a statement that the "correct setting" of "Play Trim" is at the center detent for tapes made on the D/HX-600 is really in error; the center position is only best for tapes that match the actual setup done by Parasound.

It was a simple matter to drop cassettes into the carrier and take them out again. Access for cleaning or demagnetizing was fairly good with the removable door on, and was excellent with the door off. The carrier seated tapes well, but I would have preferred greater rigidity in the support provided. In replacing the door, I found that a tricky maneuver was required: One must pull out on the door while restraining the carrier in order to get the door to slide back down over the carrier's front. The necessary procedure was not immediately obvious and is not explained in the manual.

All of the controls and switches were completely reliable throughout the testing. At times I did find the "Pause" indicator insufficiently noticeable, leading me to think the

deck was in "Stop" mode when it was not. I was favorably impressed by the smoothness of the cam actuations for "Play/Record" and "Pause." I did feel, however, that the mechanical action of the transport pushbuttons was rather stiff. I don't have a need for any of the various forms of program scan which some decks offer, but I really did miss having a simple counter-memory-zero stop from rewind mode.

Using Dolby C NR to establish a low-noise background and setting the playback volume high, I found that going into record mode generated an obvious click, going into pause caused a low-level pop, and the final stop created a soft, double clunk. In general, I could set record levels quite easily with the channel sliders and the peak-responding meter display. I did keep wishing that the meter decay time and the peak-hold time were longer.

The first listening that I did was with prerecorded cassettes from Mobile Fidelity Sound Lab, EMI, and others. Play Trim was used to considerable advantage in getting the best overall sound in the playback of Dolby B encoded tapes. I did miss deep bass from Richard Strauss' "Also Sprach Zarathustra," with Fritz Reiner leading the Chicago Symphony Orchestra (MFSL C-522), but the results were really quite good. The lack of deep bass was less apparent on *Mozart Overtures*, with Neville Marriner and the Academy of St. Martin-in-the-Fields (EMI TCC-ASD 4101). In comparisons with my more-expensive reference Nakamichi CR-7A, the D/HX-600 was not as smooth in sound, nor did it reveal as much detail. There were no indications of play skew problems as had appeared with the alignment test tape.

Most of my listening tests were done with recordings made from CDs using TDK AD-S, Fuji FR-II Super, and TDK MA-XG. Play Trim was used to match each tape in turn. As expected, the metal tape was the most forgiving when recording at higher levels. In the main, I judged the sound to be quite good overall, with accurate frequency response except at the lowest frequencies. A good example of this success and limitation was in the "March to the Scaffold" from Berlioz's "Symphonie Fantastique," with Charles Dutoit and the Montreal Symphony Orchestra (taped from a London CD, 414 203-2).

For an assessment of flutter performance, I taped a Telarc CD of Beethoven's Third Piano Concerto featuring Rudolf Serkin with Seiji Ozawa and the Boston Symphony Orchestra (CD-80063). Listening only to the playback from the Parasound deck, I heard no immediate or continual sense of unwanted flutter. However, comparing the tape playback to the CD, I detected subtle but regular and definite differences in the steadiness of the piano tones.

The D/HX-600's implementation of Dolby HX Pro is very good, with good, flat frequency response using Dolby NR. The results with metal tape at 0 dB are particularly notable. The deck also delivers low distortion across the band and good signal/noise ratios, and the unusual Play Trim feature yields important benefits. In my view, the discrepancies between my measured figures and the manufacturer's specifications are not important. For those who consider flutter critical or who desire various convenience features, the D/HX-600 will be found wanting. Overall, however, I judge it to be a good value.

Howard A. Roberson

JBL PRO SOUND COMES HOME.



Make the music happen with the speakers that made the music. JBL's "L" series home loudspeaker systems. They duplicate the renowned JBL studio monitor line depended on by top engineers and musicians in recording studios around the world. And when superstar artists tour, JBL delivers the most advanced stage of loudspeaker technology to their stage shows, too. JBL brings it all back home with the same level of sonic accuracy and true-to-source excitement. Exceptional frequency response, stereo imaging and power handling put in a professional performance every time. JBL. From in-session to in-home, no one engineers you this near to professional sound.

For more information and your nearest dealer call toll free 1-800-525-7000 Ext. 415 or write:

JBL
240 Crossways Park West
Dept. 9415
Woodbury, NY 11797

JBL

A Harman International Company

4

NEC AVD-700E DIGITAL SURROUND PROCESSOR

Manufacturer's Specifications

Signal Handling Section

Video Inputs: 1 V peak to peak, 75 ohms.

Video Outputs: 1 V peak to peak, 75 ohms.

Audio Inputs: 150 mV, 47 kilohms.

Audio Outputs: Video 1 and 2, tape out, and selector out: 150 mV, 1 kilohm. Out 1, 2 A, and 2 B: 1 V, 1 kilohm. Monitor out 1 and 2: 1 V, 150 ohms.

Decoder Section, Analog System ("By-pass" Mode)

S/N Ratio: 100 dB.

THD at 1 kHz: 0.005%.

Frequency Response: 10 Hz to 100 kHz, +0, -3 dB.

Decoder Section, Digital System

Quantization: 16 bits.

Sampling Frequency: 44.1 kHz.

Dynamic Range: 90 dB.

THD at 1 kHz: 0.02%.

Frequency Response: 10 Hz to 20 kHz, +0.5, -1 dB.

Delay Range: 1 to 92 mS in 1-mS steps.

General Specifications

Power Consumption: 120 V a.c., 60 Hz, 33 watts.

Dimensions: 16 ¹⁵/₁₆ in. W x 3 ⁹/₁₆ in. H x 14 ³/₁₆ in. D (43 cm x 9 cm x 36.1 cm).

Weight: 16.1 lbs. (7.3 kg).

Price: \$729.

Company Address: 1255 Michael Dr., Wood Dale, Ill. 60191.

For literature, circle No. 93



The NEC AVD-700E conveys its multi-function use with the "AVD" on the front panel, which stands for "Audio/Video Digital." When we add "Surround Processor," we have even more of an indication of its flexibility. A major highlight is digital processing. NEC states that the digital delay circuit is far superior to conventional analog bucket-brigade systems:

"The secret lies in the fact that NEC converts analog signals into digital signals, then processes them digitally. This produces extremely accurate sound which can be adjusted to room size for total enjoyment. The circuitry is elaborate, using a 16-bit S-RAM (Static Random Access Memory) and an address control IC."

Sensitivity and care, when applied to audio design, should channel life rather than merely reproduce sound.

R E V E A L I N G .

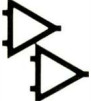

Model 3 Mono Power Amplifier

ROWLAND  RESEARCH

CRAFTED TO RECOGNIZE MUSICAL SUBTLETY

20-C Mountview Lane

Colorado Springs, Colorado 80907

303-528-8388

This unit has excellent interlocking logic among modes so that echo or mix cannot be inadvertently left in operation.

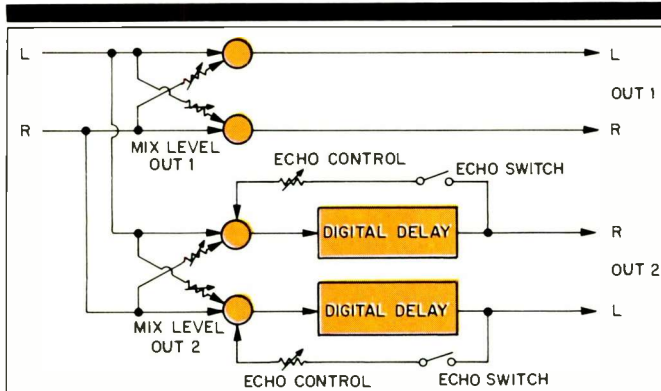

Fig. 1—Complex mixing and control system used in "Creation" surround mode. Polarity of "Mix Level Out" signals can be inverted by a front-panel switch (not shown).

This NEC unit has the expected Dolby Surround circuitry and offers three other types of surround sound as well: "Hall," "Matrix," and "Creation." The surround modes (with the exception of "Matrix," which has fixed parameters) offer various combinations of adjustable delay, echo, and cross-feeding between left and right channels, with and without phase inversion. On the sample I tested, Dolby Surround and "Hall" had 20 mS of delay and "Creation" had 30 mS of delay when the unit was first turned on. These are not default settings, however, and whatever the delays are adjusted to, those settings are automatically saved in memory for up to a week if the power is turned off. This is a good and important feature.

All of the delay times can be adjusted in 1-mS steps. The AVD-700E's Dolby Surround has a range from 15 to 30 mS, and "Hall" and "Creation" surround delays can be set anywhere from 1 to 92 mS. These are good ranges in general, but a greater maximum delay for Dolby Surround (say, 35 mS) might have been desirable.

"Hall" surround has both "Delay" and "Echo" parameters. "Echo" generates a form of reverberation from repeated, attenuated delayed signals, with knob control of echo level. In effect, the first echo level determines the time length of the reverberation heard. In "Hall" mode, the delay and echo functions cannot be switched out, but the echo control can be set at any point, including all the way off.

In "Creation" surround, there is pushbutton control for both delay and echo. Switching "Echo" off, when both echo and delay functions have been on, causes delay time to be automatically set to zero (indicated by "00" in the display). Pushing the "Delay" button will then restore the delay time to the previous setting. "Creation" surround has cross-mixing between the left and right channels, as shown in Fig. 1,

both for "Out 1" (main) and "Out 2" (surround). The level of the crossed signals can be varied, and the polarity can be switched. Volume and a number of other settings for each of the modes can be stored in memory for later recall.

The AVD-700E has five audio-only inputs; there are also five video inputs, each with companion stereo-audio inputs. These should be sufficient for the great majority of listener/viewers. Jacks on the back panel can be used to patch in a video enhancer or other device for modifying the picture output of any video source selected. An external coupling between the input-selector output and the decoder input can be removed to allow insertion of an external equalizer or other audio processor. A description of the other connections will be given later.

Control Layout

The push-on/push-off power switch is at the front panel's lower left. To its right are switches and controls for the delay, mixing, and echo circuits for the various surround modes. A large rocker bar adjusts "Delay Time"; a push on its left (" - ") reduces the delay time, and a push on its right (" + ") increases the delay. To the right of this switch is the "Delay" on/off switch, which is functional only in "Creation" surround.

Below "Delay Time" are two pushbuttons, "Out 1-Inv" and "Out 2-Inv," which function only in "Creation" surround. These switches determine whether the crossed signals between left and right are of normal or inverted polarity. Selection of the inverted signal is indicated clearly by a small, bright-red LED above each button. Below these switches are the associated "Mix Level" pots for "Out 1" and "Out 2."

To the right of those controls and pots are the "Echo" on/off switch and the "Echo Control" pot below it. As mentioned above, echo is always on in "Hall" surround, but it can be turned on and off in "Creation." When echo is on, a bright-red LED is illuminated just above the switch. The AVD-700E has excellent interlocking logic among modes so that echo or mix (crossfeed) cannot be left on inadvertently, and the LEDs always show the exact status of the system. Settings are maintained for each individual mode, so there is no need to reenter choices when returning to a prior mode.

To the right of the echo pot is "Surround Selector," which steps from one surround mode to the next. The selection made ("By-pass," "Dolby Surround," "Hall," "Matrix," or "Creation") is shown in a vertical column at the left end of a large display area dominating the center of the unit. The indicators for the surround modes are little green graphic figures: The double-D symbol for Dolby Surround, four arrows pointing outward to the corners of a square for "Hall," two crossed ellipses for "Matrix," and four crossed ellipses for "Creation."

To the right of this vertical row of indicators is the "Digital Delay" display, with "Delay Time (mSec)" for "Left" and "Right." The digits are large enough (1/4 inch high) and have sufficient brightness to be read in a typical room, but not at distances of more than 15 feet or so. This display is *not* on unless the surround mode in use has delay.

With the remote control, but not from the front panel, the left and right delay times can be set to different values. There might be a benefit from this feature in rooms where

FOR THOSE IN SEARCH OF MUSIC'S POWER AND MAJESTY.



If all you're looking for is power, it's easy enough to find. But raw power is a little like an avalanche—it tends to destroy the surrounding detail.

That's why Counterpoint created the SA-20, a hybrid amplifier capable of delivering 1000-watt peaks. It harnesses power in the most natural way possible. And captures music's majestic qualities by using the finest vacuum tube technology yet developed.

But sonic realism requires more than power. Music demands accurate preservation of sonic detail as well. Our SA-5.1 tube pre-amplifier has the uncanny ability to retain music's natural harmonic structure, elevating it—and your music—to heights you may have only dreamed of.

As you well know, rare and



beautiful things are often hard to find. So if you haven't found an SA-20 to listen to, call 800-247-6468 (in California, 619-453-9090) for the dealer nearest you.

Otherwise, you may never find what you're searching for.

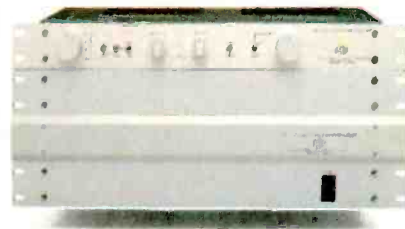

C O U N T E R P O I N T

SUPER NATURAL SOUND

Enter No. 13 on Reader Service Card

AmericanRadioHistory.Com

The "Over" lights above each input-level pot are valuable, since excessive input will cause clipping in the digital circuitry.

the surround speakers cannot be placed symmetrically relative to the listening area. NEC provides another means by which the user can benefit from different left and right delay times: There are two surround signal outputs, "Out 2 A" and "Out 2 B," each with left and right jacks. By using the two left jacks for feeding one amplifier and two speakers and the two right jacks for driving a second amplifier and speaker pair, a total of four speakers will be in use, with two sets of delay. The possibilities may have little importance to some users but could make a great deal of difference to others.

Below the left delay-time readout are green annunciators for the three selectable presets that can be put in memory with the remote control. The presets will store basic control settings, including volume, delay time, surround-sound mode, and, when in "Creation" surround, the on/off settings for the "Delay," "Echo," and "Mix Level" switches. The memory does not store input selection. Below the right delay-time readout is the remote control's sensor window.

Farther to the right is the left- and right-channel volume display for "Out 1" and "Out 2." Each of the four channel volumes is shown by a column of seven green horizontal bars. Alongside each column is a set of labels, which is convenient, although the numbers are small. From top to bottom, they are "0," "10," "20," "30," "40," "60," and "∞," with a "-dB" designation at the bottom. I should point out here that the display shows *volume-control* settings; it does *not* show input or output signal level. The volume changes in 2-dB steps over the entire range, with control provided by a front-panel rocker bar (or by the remote unit, described below). Steps of 2 dB are a bit on the coarse side for fine balancing, but two "Input Level" pots at the lower right of the front panel can be used for trimming overall levels.

To the right of the channel-volume indicators, at the right end of the display panel, are the annunciators for input selection. By using the "Input Selector" pushbutton just to the right of the display, the choice can be stepped through "CD," "Tuner," "AUX 1," "AUX 2," "Video 1," "Video 2," "Video 3," "Video 4," and "TV." The video inputs (TV is

video, not r.f.) also have associated stereo audio jacks. I should point out that there is no input for phono; this is no problem, of course, if one uses a separate preamp, but the prospective user should be aware of this lack. Below the input selector switch is the "Tape Monitor" pushbutton, which also turns on the "Tape" input indicator.

Below the tape switch is the "Sound Selector" pushbutton. When a video input has been selected, using this switch permits stepping to any of the other inputs to use a different *audio* source. Normally, all of the audio-input indicators are green and the video annunciators are red. When using "Sound Selector," the only indicator that shows red is the video input originally selected.

Near the top right corner of the front panel is a horizontal rocker-bar "Volume" control, with an upward-pointing arrow on the right end and a downward-pointing arrow on the left. Each tap of the bar adjusts volume in 2-dB steps; holding the bar in will get a series of steps. Below this bar are the "Full Mute" and "Reset" pushbuttons. When "Full Mute" is pressed, the signal is cut off and the bottom bars in the four-channel volume display flash, though the rest of the volume display remains. Another push of "Full Mute" restores all volumes to their previous levels. When "Reset" is used, all four channel volumes jump to "-40," regardless of their previous settings. This provides a handy way of starting over if you've had difficulty balancing all the levels. Once reset, however, the previous volume levels *cannot* be automatically restored.

The channel "Input Level" knobs, mentioned earlier, are on the small side, as are the other three knobs on the front panel. Above each input-level pot is a small red LED indicator with an "Over" label. This is a valuable feature, for, as NEC points out in the manual, excessive input level will cause clipping in the digital circuitry that follows.

The white printing on the black panel is very easy to read in almost any lighting, and the various lights and annunciators are a great aid when checking the status of switches and functions.

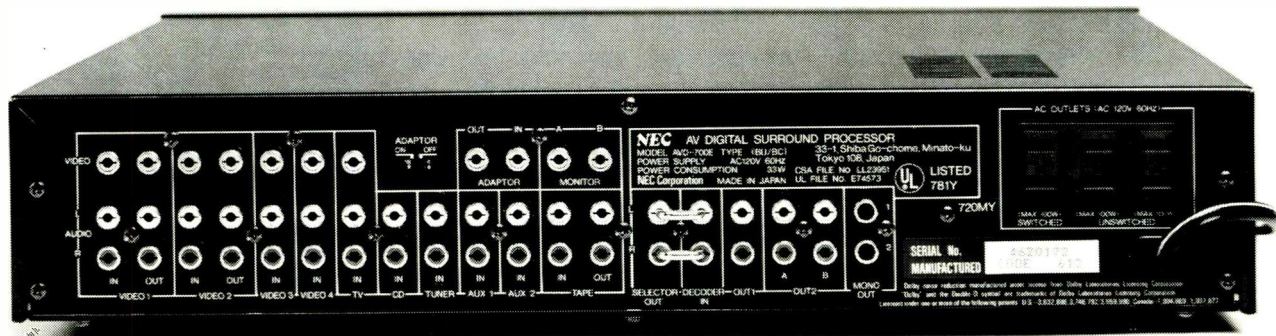

Now we do for Amadeus what we've always done for Mozart.

For years you've relied on Yamaha to faithfully reproduce the vibrancy and clarity of your music.

Now, innovative Yamaha technology does the same for your favorite movie videos as well.

Introducing the RX-1100U. The Yamaha receiver that combines our legendary audio quality with broadcast quality video. A major enhancement to our long line of successful receivers.

In fact, the RX-1100U contains so many exciting features, you might want to visit your authorized Yamaha dealer and spend a few minutes exploring them for yourself.

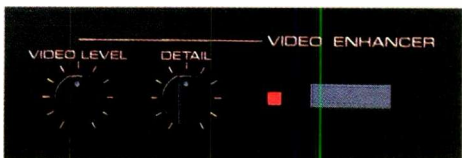

Start by playing a video cassette through the RX-1100U. And watch the results on the finest video monitor:

The powerful new video-enhancing circuitry restores clarity and sharpness to even the weakest, noisiest video signal. So any prerecorded tape looks network crisp.

Then grab a camera, shoot a few minutes of tape on your own, and use the video enhancer while making a third generation dub.

You'll have a hard time telling the dub from the original.

While you're at it, experiment with the new video Rec Out Selector feature. Use it to mix your video with different audio sources to create original music backgrounds and sound effects.

Just like a post-production shop. Next, take the most musically demanding CD, crank open the 125 watt/channel* amplifier, and listen to what's missing.

Distortion.

It's not there because the RX-1100U boasts our new Absolute Linear Amplification (ALA) circuitry.

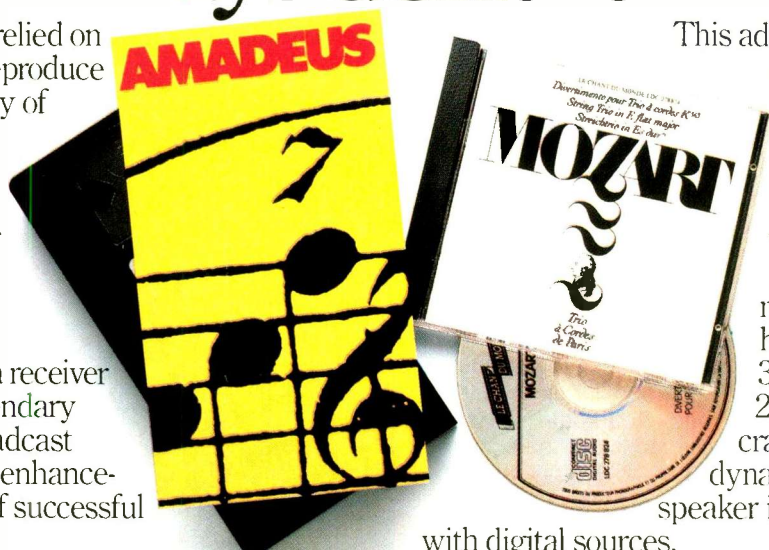

This advanced amplifier technology injects a mirror image of the output distortion back into the input stage. The distortion component drops virtually to zero.

What's more, this receiver has plenty of headroom—up to 360 watts/channel into a 2 ohm load—so it's never cramped by the wider dynamic range and varying speaker impedances associated

with digital sources.

Now, walk to the other side of the room, where you can appreciate the new RS interactive remote control to its fullest.

Notice how it packs fingertip operation of the receiver, as well as other Yamaha RS-remote CD players, cassette decks and turntables, into one slim hand-held unit that ends coffee table clutter forever.

Home entertainment has certainly changed. It had to. You started out as an audiophile and find yourself becoming a videophile as well. Or vice versa.



But you can still trust Yamaha to satisfy your needs.

Because when you want to know what's new in top performing equipment, we've always been the ones to listen to.

Now, with our RX-1100U, we're the ones to keep an eye on as well.

* 125 watts RMS per channel, both channels driven into 8 ohms, from 20 to 20,000 Hz, at no more than 0.05% Total Harmonic Distortion



YAMAHA 1887-1987

Yamaha Electronics Corporation, U.S.A. P.O. Box 6660, Buena Park, CA 90622

Remote control of delay times is not just icing on the cake, but is a great convenience in setting delays for best listening.

The aggregation of jacks on the back panel is quite impressive, maybe even a bit daunting at first. Unless stated otherwise, all of the audio jacks are in stereo pairs. Farthest to the left are jacks for five video components, with video and audio jacks for both inputs and outputs for "Video 1" and "Video 2." "Video 3," "Video 4," and "TV" have video and audio input jacks but none for output. In other words, it is not possible to dub to the "Video 3" and "Video 4" units, but there's no need or possibility of doing so with a video-disc player—or a TV monitor, for that matter.

Next are the audio input jacks for "CD," "Tuner," "AUX 1," "AUX 2," and "Tape," which also has jacks to feed out the audio of any selected audio or video input. Above the "AUX" jacks are "Adaptor Out" and "Adaptor In" jacks, with an on/off switch to their left. These jacks are for inserting a component, such as an enhancer, to modify the video output. Above the "Tape" jacks are "Monitor A" and "Monitor B" video-out jacks.

Farther to the right are the system connections. First are the "Selector Out" (audio) jacks, which are normally tied to the "Decoder In" jacks via U-type connectors. By simply pulling out these U-connectors, one can insert equalization or some other form of signal modification, if desired. Next are the main "Out 1" jacks, followed by the surround "Out 2 A" and "Out 2 B" jacks. Both "Out 2" pairs will have the same signal at all times. The last outputs are the "Mono Out 1" and "Mono Out 2" jacks that have the same full-band combined output from the main ("Out 1") left and right channels. One mono feed could be used for a center speaker and the other for a subwoofer with its own crossover and amp. Finally, in the upper right corner are three a.c. convenience outlets, one of which is switched while the other two are unswitched.

Removing the top and side cover of this large-chassis device revealed an impressive collection of circuitry on three levels of p.c. boards. The bottom layer consisted of two large boards that filled the chassis, except for the space occupied by the power transformer (just warm after hours of use). Two smaller boards were in the middle layer, one of them labelled "Video." At the top was a board one-third of chassis size made of high-quality material. The area for the digital delay was marked, as were the two D/A converters. The soldering was excellent, and the ICs on all boards were soldered in place. All of the parts were identified, which is something I always like to see, particularly when the circuitry is complex. There was a slight springiness in some of the boards, but they were well supported. Interconnections used multi-pin plugs and sockets. The construction was very rigid, with solid side rails, a cross-rail, and a cross-support/stiffener. In addition, there was a back-panel to cross-rail panel, which also served as the power supply's heat-sink.

The remote control deserves some discussion and description because of its many functions. It has a total of 42 buttons, which could have been very confusing had NEC not grouped them by function, arranged them logically, and used background and label colors to help guide the eyes and fingers. The switches are in five groups, most of which are four buttons across. Starting at the top of the unit, these groups control: (1) input selection; (2) surround-sound se-



The remote's 42 buttons are arranged in five color-coded groups, according to function.

lection; (3) delay, delay time, and echo switching; (4) volume, and (5) memory storage and recall.

There are a total of 11 "Input" buttons, for the five video inputs, the five audio inputs, and the sound selector. The labels are orange on a brownish-gray background. The "Surround" buttons have the same functions as those on the front panel, including "By-pass." The background color is the same as for the "Input" section, but the designations are white.

The "Delay," "Echo," and "Delay Time" buttons also have white labels, but most of the background is blue. This section has a total of eight buttons. "Delay" is above "Echo" at the left. To the right are six "Delay Time" buttons, three (to the right of "Delay") for "+" changes and three (to the right of "Echo") for "-" changes. The left two are for "L," the middle two for "R," and the right two for "L&R." The background here is again brownish gray, with helpful "+" and "-" labels. As mentioned earlier, the remote control provides the only means of setting different left and right delay times. Complete remote control of delay times is more than icing on the cake: It is a great convenience in getting delays correctly set for listening.

The volume-control section has "Balance," "Volume," and "Out 1/Out 2" portions, each outlined in white, plus separate "Reset" and "Full Mute" buttons. The "Balance" portion has a total of eight buttons arranged to match the relative physical location of the sound source controlled. Along the top are "Out 1L," "Out 1," and "Out 1R." Next are "Left" and "Right" in the appropriate positions. Finally, along the bottom, are "Out 2L," "Out 2," and "Out 2R." Most of this section's background is bluish-gray, but a lighter, diamond-shaped blue area connects the center top and bottom and the two middle buttons. A small, triangular arrow in the

T H E B A S I C S



style.
value.
performance.

Get Back to
the Basics

NIKKO AUDIO
The Power of Technology.

Asti Nikko Technology Corporation of America • 5830 South Triangle Drive • Commerce, CA • (213) 721-1168
Nikko Audio components are available exclusively through Authorized Nikko Audio Dealers.

Enter No. 24 on Reader Service Card

I checked the accuracy of the delay times and found all to be within 0.1 mS of the times displayed on the NEC's front panel.

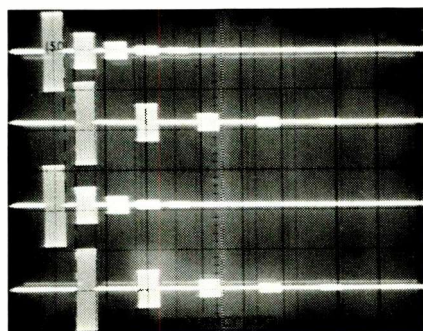

Fig. 2—Surround-channel outputs in "Creation" mode for 10-mS, 1-kHz tone-burst input. Left delay (top and third traces) is set to 15 mS, right delay (second and bottom traces) is 30 mS, and echo level is at maximum. Note that delays between bursts and successive echoes equal the delays of the initial bursts. (Horizontal scale: 20 mS/div.)

center indicates that all buttons serve to increase level. To the right of the "Balance" area is the "Volume" portion. The up and down volume buttons (for "Out 1" and "Out 2") are in line with the top and bottom "Balance" rows, respectively. The area between the buttons is blue, and arrows indicate up and down. Below the "Balance" portion is another pair of "Out 1" and "Out 2" buttons, with an arrow between them to indicate that their use will cause a reduction in volume. To the right of these buttons are "Reset" and "Full Mute." All labels in the volume-control section are white and very easily read. When I first looked at this section, I wasn't really convinced that the arrangement was the best possible. I have had to conclude, however, that some of the changes I thought of would make it much too complicated.

The bottom section of the remote unit controls the AVD-700E's memory functions. At the left is "Memo," for preparing memory to accept volume and other settings into storage. "Preset" has positions "1," "2," and "3," for storing settings after actuating "Memo" and for recalling them at any future time. This storage and recall could be a great convenience to many users, considering the possible range and complexity of volume settings and surround functions.

A small red LED at the pointing end of the control flashes whenever a command signal is being sent. This is definitely helpful, particularly as the buttons provide no audible or tactile clues on actuation.

Measurements

The frequency response of the analog section (with the AVD-700E in "By-pass" mode) was down 0.2 dB at both 20 Hz and 20 kHz. The -3 dB points were at 3.3 Hz and 89 kHz. It was difficult to check the surround outputs and be certain that there was no purposeful frequency shaping. I did find that in "Creation" surround, with echo off, the "Out 2" responses were within 0.2 dB of the 1-kHz reference level at 20 Hz and 20 kHz. The -3 dB points were at 5 Hz or so and at 21 kHz, above which there was a very sharp cutoff. In Dolby Surround, the outputs showed Dolby's specified roll-off at 7 kHz.

Harmonic distortion was 0.003% for "Out 1" (main) over most of the band from 20 Hz to 20 kHz, rising slightly to 0.005% at the lowest frequencies. Distortion was 0.03% or less over the same band for "Out 2" (surround) with 1 V out. The output residual of the 44.1-kHz sampling frequency was far down at 94 dB below 1 V. With a 1-kHz, 1-V input signal, there were side bands of 43.1 and 45.1 kHz at -95 dBV out. Changing the signal level changed the side bands by the same amount (in dB).

Audio input sensitivity was 160 mV in for 1 V at the outputs. I did not check the video input/output voltages. With the input pots at maximum and a 1-kHz test signal, the overload LEDs illuminated at 630 mV, but the output waveforms for both "Out 1" and "Out 2" ("Creation" surround) looked undistorted. At 3.2 dB higher (0.96 V), the surround outputs started to clip, showing a good margin between indicator turn-on and actual clipping. (Clipping on "Out 1" was at a much higher voltage.) The indicators had a lower threshold with higher frequencies, requiring just 0.29 V at 10 kHz for turn-on. With the continuous level of a 5-kHz signal set 1 dB above turn-on, the indicators flashed reliably, with bursts as short as 2 mS. The maximum input voltage to prevent any form of clipping in the surround channels, even with the pots turned down, was 2.8 V.

The steps of the volume control were not consistently 2 dB, but they were all 2.4 dB or less, except for one of 4.0 dB (from -8.4 to -12.4 dB), one of 2.5 dB (from -20.9 to -23.4 dB), and one of about 10 dB (the final step, from -73.6 to nearly -84 dB). Many of the steps were within ± 0.1 or ± 0.2 dB of the intended 2 dB. I had some doubts as to whether 2-dB steps would be fine enough, but these doubts lessened after listening. The four sections of the volume control ("Out 1" and "Out 2," left and right) tracked exactly over the entire range.

With "Full Mute" on or with the input pots turned to zero, the "Out 1" signal/noise ratio using a 1-V reference was greater than 100 dBA. The "Out 2" surround-sound outputs had signal/noise ratios that varied according to the mode selected and the particular adjustments made in that mode. I usually got something around 80 dBA relative to 1 V with no signal in, no muting, and the input pots at a nominal setting. "Reset" attenuated the volume of all channels by 40.1 dB, and "Full Mute" reduced the level by 70 dB.

I checked the accuracy of the delay times between "Out 1" (main) and "Out 2" (surround) relative to the front-panel indications. With a 10-kHz single-cycle burst, all of the delay times from 1 to 92 mS (1-mS steps) were within 0.1 mS of the displayed time. With the front-panel bar or the remote-

Only ComponentGuard protects product & performance



The ComponentGuard Product & Performance Guarantee Program

Serious audio and video enthusiasts choose their components on the basis of one factor alone—PERFORMANCE! And, protecting your equipment's performance is what ComponentGuard is all about.

Through a select group of audio/video specialty dealers, we offer the ComponentGuard Product & Performance Program. When you purchase a piece of high quality equipment covered by ComponentGuard, we will guarantee all of its key performance specifications, plus extend the manufacturer's original warranty, 3 additional years.

All important performance specs are protected, covering most consumer electronic products ranging from CD players and cassette decks to VCRs & MTS televisions. ComponentGuard is not available on every brand, only those that demonstrate superior quality and integrity in their manufacturing and design.

After being accepted in the ComponentGuard program, you're issued our Gold GuardCard, honored at more than 500 service centers. If you're concerned about your equipment not being up to spec during the coverage period, you can bring it in for a checkup on a periodic basis at absolutely no charge. And if the product should break (the ultimate non-performance spec), our extended warranty service plan takes over, and the equipment is repaired and tested absolutely free.

With the ComponentGuard program, your home entertainment system will always work as well as the day you bought it. That's Product & Performance Protection you can count on.



If your dealer doesn't offer ComponentGuard, call us toll free at 1-800-421-9820



COMPONENTGUARD™

Product & Performance Protection

928 Broadway New York, NY 10010
In New York, call 212-420-9820

Enter No. 12 on Reader Service Card

Because there are always a few people who will abuse a good thing, we must state the following: Program acceptance subject to approval. Certain restrictions apply. Call or write for full details.

Left and right delay can be set to different times, a benefit where speakers can't be symmetrically placed in a room.

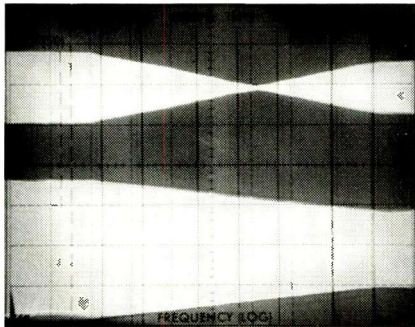

Fig. 3—Effect on 2-kHz signal amplitudes of interchannel crossfeed in "Matrix" surround mode; see text. (Horizontal scale: 0.5 S/div.)

control button held in, the delay time changed 1 mS every half-second. After 5 S of continuous actuation, a speed-up occurred; the delay time then changed at about 10 mS per second.

Next, with the AVD-700E in "Creation" surround, I used the remote control to set the left delay to 15 mS, the right delay to 30 mS, and the echo level to maximum. The mix levels were set to zero. A 1-kHz tone burst of 10-mS duration was fed to left and right inputs, and the "Out 2 A" and "Out 2 B" left and right jacks were connected to a four-channel oscilloscope. Figure 2 shows the surround outputs; note that the initial bursts are delayed as set on the front panel, and that the subsequent echoes are further delayed the same amount as the initial bursts. Each successive echo level is reduced by a little more than 6 dB; the fourth echo shown is about 26 dB down from the initial burst level. Turning down the echo level reduced the amplitude of all echoes the same amount in dB.

With the same signal applied to both channels, both left and right input levels added to the levels of all four delayed channels in "Hall" mode. The same thing happened in "Creation" surround when there was mixing; the extent of this addition, from zero to full, then varied with the setting of the "Out 2" mixing pot. If "Out 2-Inv" was used, however, increasing the setting of the pot decreased the burst and echo levels—to zero, if the pot was turned up all of the way and left and right input levels were exactly the same. I should note here that the mono outputs are affected similarly by the settings of the "Out 1" mixing pot and inversion switch.

In "Matrix," there is no delay or echo, as I mentioned before. The levels in the surround channels are determined

by the configuration of the matrix used by NEC and by the amplitudes and relative phase of the incoming stereo signal. The phasing of the crossfeed between channels affects the amplitudes of signals common to both channels, as shown in Fig. 3. At the start of the sweep, signal was fed only to the right channel, but the "Matrix" crossfeed produced half as much output from the left channel as from the right. Left-channel input was then raised smoothly from zero so that it matched the right-channel input just before the end of the sweep. Due to phase cancellation, the left-channel output initially decreased as its input level was raised; then it began rising as the input signal became stronger than the reverse-phased crossfeed. Phase cancellations also caused some reduction in right-channel output as left-channel input increased, but the difference between the traces shows that the "Matrix" crossfeeds are not symmetrical.

Use and Listening Tests

The owner's manual has good front- and rear-panel and interconnection illustrations. The diagrams showing loud-speaker positioning are helpful in a general sense. The manual has very little supportive text, however, to give the user the guidance needed on the acoustical effects to be expected from various combinations of speaker locations and orientations. In fact, nothing at all is said about what delays would be appropriate for particular rooms or listening positions. There are good instructions on how to use the remote unit and the front-panel switches and controls.

The guidelines for "Creation" surround are quite good, but the manual should encourage the listener to experiment with speaker placement. The discussion of Dolby Surround includes the suggestion that one use different left and right delays and connect the two "Out 2" left outputs to drive the mid speakers and the two right outputs to drive the rear speakers. This is a great idea, and it's valid for "Creation" surround as well, if no cross-mixing is used.

Equipment used in my listening evaluation included Yamaha amplifiers and an AM/FM tuner, an Akai VHS VCR for playing videocassettes and decoding MTS stereo TV broadcasts, a Magnavox CD player, and JBL, Dynaco, and Ramsa speakers.

The first sources I tried were movies of various types and ages. Among these was a cable-TV broadcast of *Top Gun*, whose soundtrack I received in simulcast over FM radio. I used "Sound Selector" to get video from the VCR output and audio from my tuner. The film credits stated that Dolby Surround was used. I didn't like the story or the acting very much, but the music and the sound effects were fascinating at times. Dolby Surround was definitely the best choice for really good dialog centering. "Matrix" was quite good for speech, and it was better than Dolby Surround for the pop/rock numbers on the soundtrack and for the jet flyovers. "Hall" and "Creation" surround delivered disembodied voices; decreasing the echo and bringing up the center speaker was not a good overall remedy. The subwoofer added solid rumble to the sound of the aircraft in all of the modes.

I also watched a broadcast of *Dracula*, the movie with Frank Langella. The storm scene near the beginning was better in "Matrix" than in Dolby Surround, but I preferred the



The System...

The components you see were designed for the perfectionist who desires remote accessibility and uncompromised performance.

They are not inexpensive.

They are the finest we can make...

which means they are the finest *you* can own.

Each epitomizes its genre.

Each attains the pinnacle of perfection.

If you are in a position to invest in the finest in music reproduction,

consider the Nakamichi Series-7 System...

PA-7 STASIS Power Amplifier, ST-7 AM/FM-Stereo Tuner, CR-7A Discrete Head Cassette Deck, OMS-7AII CD Player, and the CA-7A Control Amplifier...arguably, the most sophisticated preamplifier conceived by man.

You may audition Nakamichi Series-7 Components at your nearby Nakamichi dealer.



Nakamichi U.S.A. Corporation 19701 South Vermont Ave., Torrance, CA 90502 1-800-421-2313, CA 1-800-223-1521
*STASIS is a trademark of Threshold Corporation.

This unit's flexibility, sound quality, and well thought-out switching capability make it a very appealing component.

latter mode for most of the scenes in which dialog predominated. I tried watching an old *Lassie* movie—or maybe it was part of the weekly series. In any event, although it was monaural, I liked the results better with the use of the AVD-700E and Dolby Surround than without. I did feel that the background music was better with "Matrix." Pushing "By-pass" caused a definite loss of realism even with this mono program material.

During the course of the above listening, I tried various levels for the four surround speakers that were driven from "Out 2 A" and "Out 2 B." At the start, the levels of the four speakers, which were placed, roughly, in the four corners of the room, had been equal. I concluded fairly soon that the results were much better when I reduced the level of the two front speakers to a fraction of that for the two in the rear. This situation held true for the remaining listening. (I will say more about delay setting and level balancing shortly.)

Next, I tried videocassettes of movies with Dolby Surround encoding. Once again, Dolby Surround was best for dialog centering, although there were many places in *F/X* where "Matrix" or "Hall" delivered much better sound effects in this thriller. "Matrix" was preferred over "Hall" because the latter was not good for dialog. I experimented further with surround speaker levels and delays while watching and listening to *Return of the Jedi*. "Matrix" was a good choice after the rear speaker levels were boosted, but Dolby Surround was favored after using different left and right delays going to two sets of repositioned surround speakers. With some trimming of individual speaker levels, the effects were most satisfying.

Stereo TV has not yet lived up to its promise, but it's still pleasurable to hear. In fact, although the dialog (which is always in the center) may appear to be nothing special, switching to "By-pass," with its loss of the stereo spread and surround of background music and sound effects, is more than obvious. *Beauty and the Beast*, on CBS, was best with Dolby Surround, but "Matrix" was not far behind. I came to similar conclusions while tuned in to the syndicated program *Star Trek: The Next Generation*. Although it was possible to use "Hall" or "Creation" surround, the higher center-speaker level required to help the dialog ruined the surround sound.

When I switched from channel to channel, the sudden opening of the sound stage when I came to a station broadcasting in stereo was ear-catching. MTV seemed best to me with "Hall" or "Creation" surround, but *not* if there was a solo vocalist in the center of the picture. If so, my preference switched to "Matrix" or possibly to Dolby Surround. PBS's *Mystery* was judged best with Dolby Surround.

When I first noticed that NEC recommended "Matrix" surround for sporting events, my reaction was, "Who cares?" Nonetheless, I watched a Celtics basketball game (easy for a fan like me to do), a college football game (Penn State's nice), and an NFL game (the Patriots won). Because the announcers are usually not on screen, it is not essential that their voices have up-front presence. "Matrix" surround was definitely best, producing a vague sense of "being there" without losing the voices. I had thought that listening to games with surround sound wasn't worth it, but I've changed my mind.

For listening to music via the AVD-700E, all of my sources were CDs. The first one I tried was *The Organs at First Congregational Church, Los Angeles*, which has Bach works performed by Michael Murray (Telarc CD-80088). Dolby Surround and "Matrix" were unsatisfactory. "Hall" was better, particularly with adjustments of echo level and delay times. My own preference was for "Creation" surround, with adjustments of echo level and delay. I also tried combinations of crossfeeding for both the main and the surround channels. I ended up with a version that was little different from what I'd gotten without crossfeeding, but I thought it was worth it. I put the settings into memory for later use.

Another CD I tried was of Brahms' "Piano Concerto No. 2" played by Vladimir Ashkenazy, with Bernard Haitink and the Vienna Philharmonic (London 410 199-2). At times I felt that there was some validity to each of the surround modes, with the exception of Dolby Surround. "Hall" was quite satisfying, but I did prefer a modified "Creation." After I had completed the adjustments to my best satisfaction, I placed the settings in another preset.

Brothers in Arms by Dire Straits was at least acceptable in all four of the surround modes. For some vocals, the choice was between Dolby Surround and "Matrix," but at other times I felt no need to have that much vocal presence. I did not feel much need to get exact settings for levels or delays with this or with other pop/rock CDs.

Conclusions

In general, it was easy to use the remote control to do anything that was desired. Because of the front panel's little illuminated figures and bright status lights, it was simple to keep track of what I had selected. The flashing bars when full mute was used were helpful many times. It was difficult, however, to see from my listening position what the delay settings were. I concluded that this was not significant because the delay times were adjusted for the best listening, not for the "best numbers." It was a little bit of a fuss to move back and forth to adjust echo and crossfeed levels, but how nice to have the option! A change of mode or delay time gets a momentary full mute on all channels, and that was a bit distracting as I tried to assess various changes.

The remote is very flexible in its control of volume for both main and surround outputs. I did find that the 2-dB steps were sometimes larger than I wanted, especially when I was doing overall left-to-right balancing. I hit the single 4-dB step a couple of times, and that really was too much. The 2-dB steps were not obvious when I was changing single-speaker levels. Being able to put settings into memory is an emphatic plus for the AVD-700E.

The flexibility of this NEC processor with all types of audio sources and the quality of the resulting sound make it a very appealing component. With its well thought-out control of many audio and video inputs, the AVD-700E also offers a switching capability that more and more listener/viewers have a definite need for. This is not a low-priced unit, and the addition of a surround processor requires expenditures for other speakers and an amplifier or two. The sonic rewards are considerable, however, and the NEC AVD-700E delivers good value for its cost. *Howard A. Roberson*



You probably already have most of what you need to build your own home video theater. A TV set, a VCR and a pair of speakers.

Then, you need to add a second pair of speakers and a Sherwood stereo receiver with built-in surround-sound. Those are the basics that let you enjoy the dramatic realism of four-corner stereo that wraps all around, just like it does in a movie theater.

You see, most Sherwood receivers have the unique ability to "read" the rear channel information present in most stereo programs, including stereo cable and broadcast TV, as well as video tapes you buy or rent that were made from films originally shown in theaters. Even with mono video, you can enjoy stereo—or even surround sound—thanks to Sherwood's built-in stereo synthesizer.

To complete your theater, you may wish to add a Sherwood CD player, Sherwood tape deck and Sherwood turntable.

Now, you've got it all. A complete surround-sound home theater. From Sherwood, the people who more than 30 years ago made the tuner for the very first FM stereo broadcast ever.

©1988 Inkel Corporation. 13845 Artesia Blvd. Cerritos, CA 90701



YOUR CONTROL CENTER

 **Sherwood**
LIVE PERFORMANCE SOUND™

Floor Plan For Your Own Surround Sound Home Theater.

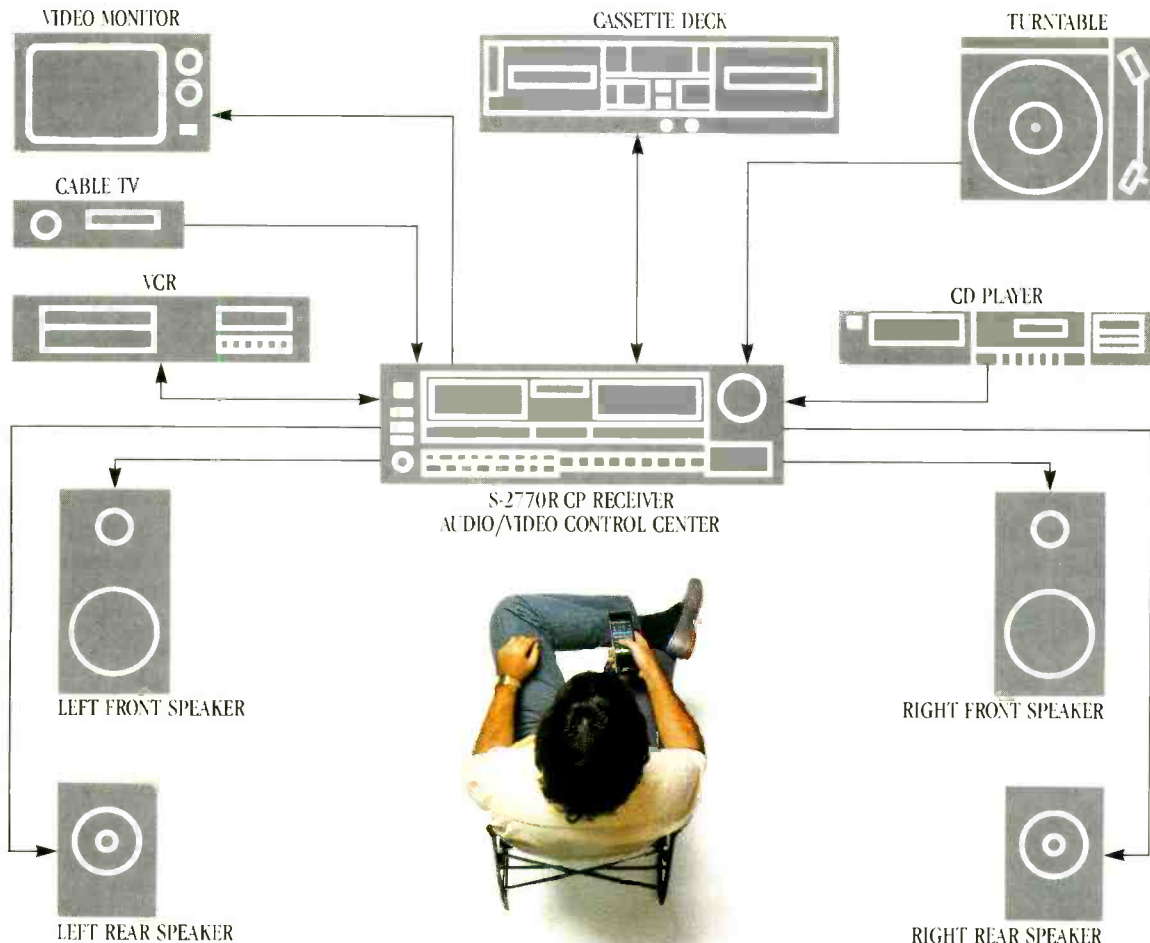

Enter No. 31 on Reader Service Card

NEW RECORDING ARTISTS

The Classical Quartet: Resisting Instruments of Change

Leopold Mozart, father of Wolfgang Amadeus and one of the most important music theory teachers of his time, would be gratified to learn that professional musicians continue to pore over his treatises. "He tells you how to play dots, wedges and slurs, how to play a passage of sixteenth notes," remarks violinist Nancy Wilson. "He's very precise."

Wilson is a member of the Classical Quartet, the first string quartet in this country to play the works of Haydn, W.A. Mozart and Beethoven on instruments of their time. For her and other contemporary musicians who have pioneered the art of performing on period instruments, writings like those of the elder Mozart are important keys to technique.

The Classical Quartet's first recording of Mozart's G-major string quartet, K. 387, and B-flat major quartet, K. 458, was recently released on CD by Titanic Records. Along with Wilson, the ensemble includes Linda Quan, violist David Miller and cellist Loretta O'Sullivan.

All four were influenced by Albert Fuller who, in addition to teaching stylistic performance of Baroque music on modern instruments at Juilliard (where Wilson, Quan and Miller studied), founded a summer festival called Aston Magna in Great Barrington, Massachusetts; it was there that his students began experimenting with earlier instruments.

"We took these same instruments we were using for Bach and Vivaldi and tried out our favorite Haydn and Mozart quartets," Miller recounts. "They sounded very different than what we were used to—because, I think, we were starting to get the composer's message more directly, not translated into a different medium, which is what a modern instrument had become."

During the Baroque and early Classical periods, there was little change in the violin, the viola and cello. In

the 1820s, however, the decade of Beethoven's death, a number of alterations were made to existing string instruments.

While the bodies went unchanged, necks and bows were lengthened to produce the wider dynamic range necessary for larger concert halls and the sustained tones used in Romantic music. Inside the instruments, the supporting elements known as bass



The Classical Quartet: (clockwise from top) David Miller, Linda Quan, Loretta O'Sullivan, Nancy Wilson

bar and sound post were strengthened, and chin rests were added. Later, the cello was given an end pin to anchor it firmly to the floor; prior to that time, performers gripped the instrument between their calves.

The strings themselves changed over the years as well. Originally wound from the intestines of sheep, metal was added, first copper and silver, later aluminum and steel.

Members of the Classical Quartet feel these evolutionary steps toward musical modernism also resulted in diminished clarity, and they are convinced the revised instruments are unable to produce subtle nuances that are critical to performances of 18th

and early 19th century works for strings. So they returned to instruments of the time and have resurrected what could be learned about the period's performance techniques. This even extends to playing at a slightly lower pitch, with A tuned to about 430 Hz rather than the modern standard of 440.

"If everything is going right, the cello is a little bit lighter-sounding, a little less muddy, and I think the ensemble sounds more unified than a modern quartet," Loretta O'Sullivan explains. To David Miller's ears, combining period instruments with what he and his fellow players have been able to glean was the accepted style of the time results in performances that sound "fresher, newer, clearer and cleaner."

In addition to treatises on technique, members of the Classical Quartet have found that period instruments themselves serve as a guide to playing in ways that seem natural and musically convincing. "By experimentation, you come up with a style that works," notes Miller. "Some problems just clear up by playing on this instrument with this bow," O'Sullivan adds. "There are certain things I might have struggled with on a modern cello that now become much clearer."

If so many who have heard them perform delight in their sound, the members of the Classical Quartet seem equally enchanted by the process that led them to it. "Being in a field like this opens up your ears and gets you into a more experimental frame of mind," enthuses Wilson. "There's room for lots of creativity."

"In new music, most of the time you have the composer there," comments Quan, who also performs contemporary works. "You can say, 'What do you mean by this dot?' We do the same thing: 'Haydn, what did you mean by this?' He doesn't answer, so we have to figure it out."



*there are **Threshold** components
and there is everything else*

Threshold uses imaginative and unique circuit concepts to reach levels of performance that will impress the most critical music listener. The sonic purity and sculptured elegance of these sophisticated instruments await your appreciation at select dealerships.

For a list of Authorized Threshold Dealers and color brochures detailing Threshold optically biased STASIS power amplifiers and high accuracy FET preamplifiers write:

Threshold Corporation
1945 industrial drive
auburn california 95603



Threshold

more than audio excellence

Threshold products are engineered by Nelson Pass, styled by Rene Besne, and handcrafted under their supervision in the U.S.A.

SWEET LITTLE SIXTY



Hail! Hail! Rock 'n' Roll: Chuck Berry
MCA 6217, LP (original motion picture
 soundtrack).

Sound: A Performance: A

After the recent Carl Perkins/Roy Orbison/Johnny Cash/Jerry Lee Lewis reunion album, *Class of '55*, proved less than transcendent, I didn't set my sights too high for the Chuck Berry 60th-birthday concert put together by Keith Richards. What with those two plus Eric Clapton, Linda Ronstadt, Etta James, Robert Cray, Julian Lennon, and who-all-else bumping around in that St. Louis theater on October 16, 1986, I figured the stage was set—literally—for an all-star let down.

I was wrong. Twice. Once when I saw the Taylor Hackford film of the concert, and then again when I reviewed the soundtrack album. Sheesh, what a band! I'm gonna pick up Mary Lou, hop into the ol' T-bird, and go see 'em again the next time they're in town.

Producer Richards made a triple play on this one, first in keeping the superstar backup band from the self-congratulatory posturing that's usual at gigs like this, and second and third by having the show recorded impeccably and then mixed superbly—vocals and instruments are balanced as well as on any record I've ever heard. Though the legendary Berry's vocals aren't what they used to be, they still mean business; I've heard decidedly authentic Chicago blues heroes with no more beautiful angry sadness. And Berry certainly outshines Julian Lennon, whose thin, overwhelmed voice almost ruins "Johnny B. Goode."

With all great records, you get one or two Crackerjack surprises. Here, it's Berry's longtime sideman (and rumored collaborator) Johnnie Johnson, who gives us a socking barrelhouse piano solo on "Wee Wee Hours." And the MVP award goes to the great Etta James, whose lead vocals on "Rock

and Roll Music" chills as it climbs the ladder.

It would have been impossible to go wrong with the song selection: "Maybellene" (a great kick-off), "Sweet Little Sixteen," "Memphis, Tennessee," "Back in the U.S.A." (with a growly Rondstadt sadly strained over too much of the song's range), "Roll Over Beethoven," and more. One cut included here didn't appear in the film: "Around and Around," recorded live at the show. "I'm Through with Love" was recorded during rehearsals.

As if there were any doubt, this new album proves that one of the great old men of rock 'n' roll has absolutely still got it.

Frank Lovece

Gematria: Peter Himmelman
Island 90663-2, CD; **90663-1**, LP.

Sound: B+ Performance: A-

Peter Himmelman's intensity is the hallmark of *Gematria*. His songs are songs of heartache and caution, but they are fueled by hope, not despair. Himmelman and his band play with real confidence and sinew, and that is a must for the slow tempos at which many of these songs are delivered. With practice, any fool can play fast. To play slowly—convincingly—is much tougher, since it is so much harder to hide flaws.

One element that adds cohesion to *Gematria* is how well prepared for recording Peter and his band obviously were, for the album was recorded live, in the studio, in just three days in May 1987. The only overdubs on *Gematria* are a couple of guitar solos and some backing vocals.

Picking favorites here is somewhat misleading, for there is consistent quality throughout the set. Every song is engaging and catchy and poetic. "Waning Moon" is clearly a standout, with a chorus that can haunt your dreams. I wish Elvis Presley were still around to try "Burning Shame," a thumping cut reminiscent of "Suspicious Minds." "Salt and Ashes" and "Wrapped Up in Cellophane" are ballads of yearning and heartbreak. "The Trees are Testifying" builds steadily to a furiously paced, U2 type of loping main figure. "You Bought It" is an all-stops-out rocker, and "1000 Years" closes the set with a Dylanesque rumi-

Photograph: Frank Driggs Collection

COMPACT DISCLOSURES

Masterpieces of Note

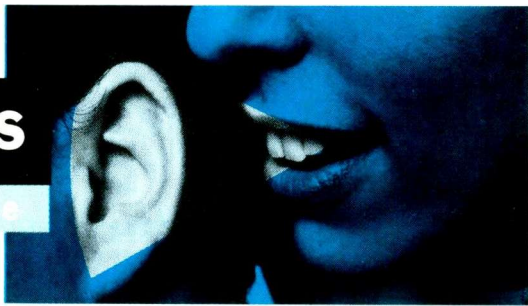

MILES AND TRANE LICK THEIR CHOPS...

SAKAMOTO GETS OCCIDENT INSURANCE...

CHICAGO RESURFACES...

TONY TERRY TUNES INTO TOMORROW.



MILES DAVIS AND JOHN COLTRANE. When they talk, you'd better listen—or miss out on one of the most exciting jazz experiences around. "Miles And Coltrane" eavesdrops on a series of their most inspired talks in a Jazz Masterpieces release of boldly innovative, trend-setting jams recorded in the '50s. Now digitally remastered, Miles and Trane speak out on CD this month.

Unpronounceable as his first name may be, RYUICHI (Rew-ee-chee) SAKAMOTO is one of the most listenable musicians ever to come out of the Orient. Ex-magician of the now-defunct Yellow Magic Orchestra, Sakamoto also scored Bertolucci's "The Last Emperor" and "Merry Christmas, Mr. Lawrence." His aptly titled "Neo Geo" combines Western rock rhythms with Eastern instruments and a synthesizer that defies geographical boundaries. A cross-cultural breakthrough, "Neo Geo," bows onto CD this March.

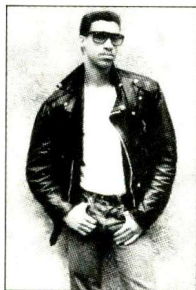
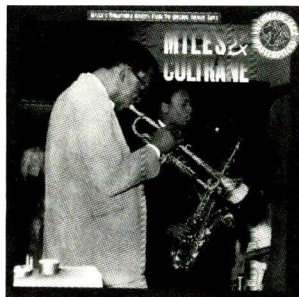

TONY TERRY hasn't played Carnegie Hall yet, but he's already led the kind of life that's the stuff of R&B legends. A gospel singer from the age of eight (professionally from eleven on), songwriter for the likes of George Clinton, and veteran of several New York stage musicals, Terry got his big break in a chance meeting with hit producer, Ted Currier. Shortly thereafter, "She's Fly," his first single, flew to the upper reaches of Black charts. His first LP, "Forever Yours," blends high-energy dance music, timeless love balladry and what you might call pop hip hop. Tony Terry tunes into CD this March.



Old joke: This tourist asks a New Yorker how to get to Carnegie Hall. "Practice, practice, practice," answers the Manhattanite. In 1971, CHICAGO capped almost three solid years of on-the-road "practice" with a sensational five-day appearance at the fabled Hall. Featuring Chicago classics like "Colour My World," "25 Or 6 To 4," "Questions 67 And 68," and the marathon Vietnam protest anthem, "It Better End Soon," this historic live recording has been digitally remastered for a CD debut this month.

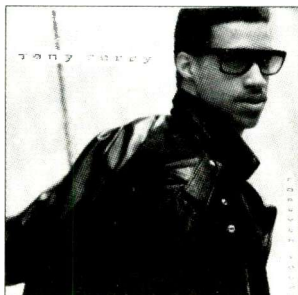
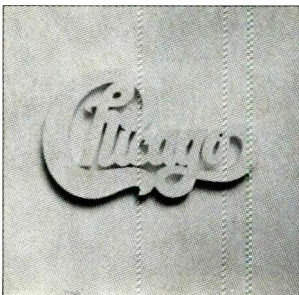
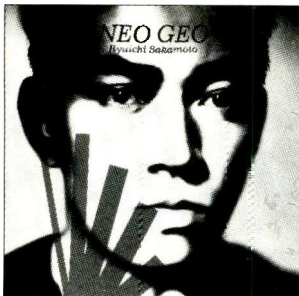

OTHER MARCH CD RELEASES!

- TIM BERNE "Sanctified Dreams"
- MIDNIGHT OIL "Diesel And Dust"
- TOTO "The Seventh One"
- THE GODFATHERS "Birth, School, Work, Death"



CBS is a trademark of CBS Inc. © 1988 CBS Records Inc. For an IBM computer diskette containing the complete catalog of CBS Compact Discs, send \$2 for postage and handling to: CBS/CD, Box 257, Garwood, NJ 07027.

Enter No. 11 on Reader Service Card

Peter Himmelman's voice is excellently rendered, allowing his substantial lyrics to come through with fine clarity.



nation about just what all this will mean a long time from now.

The CD's sound is very good—crisp and beautifully defined even in the fierce passages. Himmelman's voice is rendered excellently, allowing his substantial lyrics to come through with fine clarity. The LP, naturally, does not match the CD's crispness, but it is closer than most. It has very good sound for vinyl.

Gematria is Peter Himmelman's second album. His first, *This Father's Day*, was a fine, intriguing debut. Now he has blossomed into a real contender.

Michael Tearson

Kick: INXS

Atlantic 81796-2, CD; 81796-1, LP

Sound: A

Performance: B+

INXS (pronounced in-ex-cess) has gotten well past the point of being the sum of its influences. With the help of producer Chris Thomas and mixer Bob Clearmountain, this album finds the band defining some original musical territory. Songwriter/guitarist/key-boardist Andrew Farriss has fused technology with crunch-rock, and, together with singer Michael Hutchence (who cowrites most of the songs) and the rest of the band, has made INXS Australia's premier rock export.

Kick is the group's most consistent album to date, with a host of tracks ("Guns in the Sky," "Mystify," and "Never Tear Us Apart," to name a few) which are far better than the single "New Sensation." There have been comparisons to Robert Plant, Mick Jagger, and Billy Squier, and these may continue, but primarily from accountants—INXS is headed toward multi-platinum country.

As Thomas and Clearmountain are probably the two finest rock producers alive, it's no wonder that the LP and the CD both sound pretty incredible. The CD has a bit of brightness that's missing from the vinyl incarnation of *Kick* (no surprise there). This is most apparent on the drum kit (snare, mostly) and the vocals—the guitar sound is quite topky enough in both formats. For

those with programmable CD players, resequencing is a must: The tracking order places some of the best songs last, and who's got the patience to wait 35 minutes to hear "Tiny Daggers"? Not us. *Jon & Sally Tiven*

Vital Idol: Billy Idol

Chrysalis OV 41620, LP

Sound: A-

Performance: C

Give Billy Idol and producer Keith Forsey credit for a new variation on the old "greatest hits" theme: An all-remix dance album. Yes, give them credit. Don't, however, give them your cash. Unhappily, the theory is much more interesting than the end result, which tries to improve on perfectly okay source material by synthesizing its soul and then tranquilizing its vocals. Not only do too many cooks spoil the broth, it seems, but so does overcooking.

Given that, the most fascinatingly awful thing about these supposed dance mixes is how tepid they are. On the remix of "White Wedding"—previously a bouncy sneer of a song—Idol's newly up-front voice neither rips nor roars but rather tiptoes through the lyrics. Do you remember the way he originally sang that ironic, climactic line toward the end of the song: "Nice day to [pause, then spit out] start again"? Now imagine it sung by a librarian.

Vital Idol has some interesting sounds, and the selection of songs is all right (though I would have preferred



INXS



The Quietspeakers

Revox speakers play to the civilized ear. And they speak most distinctly where the civilized ear does its listening.

We make speakers that make beautiful music—absolutely clear, richly detailed music. At low listening levels, where other speakers are at a loss, the sound from Revox speakers is always precise, focused, vividly present. These speakers impress with their fineness, their ability to reveal music's quiet subtleties, its lucid stillness.

If you never listen loud, you need to be listening to the Quietspeakers.

From Revox of Switzerland. At your audio specialist in the USA.

STUDER REVOX

STUDER REVOX AMERICA, INC.
1425 Elm Hill Pike, Nashville, TN 37210
(615) 254-5651

Enter No. 36 on Reader Service Card

Playing guitar, keyboards, and bass, Tony MacAlpine is marching aggressively toward the top of the molten-metal heap.

"Rebel Yell," or anything else, in place of Tommy James and The Shondells' "Mony Mony," which was silly even in 1968 and makes Idol's bubblegum tendencies embarrassingly obvious). Yet often, promising starts lead straight to Computerland: "Hot in the City" opens with a rollicking Philly road-

house piano and rockabilly overdubs; then, abracadabra, it turns into A Flock of Seagulls. "Flesh for Fantasy" starts out fighting, punching out a sassy, hot-thumb bass line, and then devolves into what sounds like a wino R2D2 mumbling to himself. The album also succumbs to the annoying and in-

creasingly widespread habit of naming the remixes, with Idol (or somebody) coining the likes of "Exterminator Mix," "Mother of Mercy Mix," and "Rub a Dub Dub Mix." Let us interpret them, okay? And lemme tell you something else: Idol's so-called "Uptown Mix" of "Dancing with Myself"—supposed to be funky, right?—never gets an inch past midtown.

The somnambulistic, lounge-lizard way in which Idol recites his old material is the biggest surprise of all. I hate to say this, but judging from his approach, I can prophesy his future. It's on a double bill with Engelbert Humperdinck.

Frank Lovece

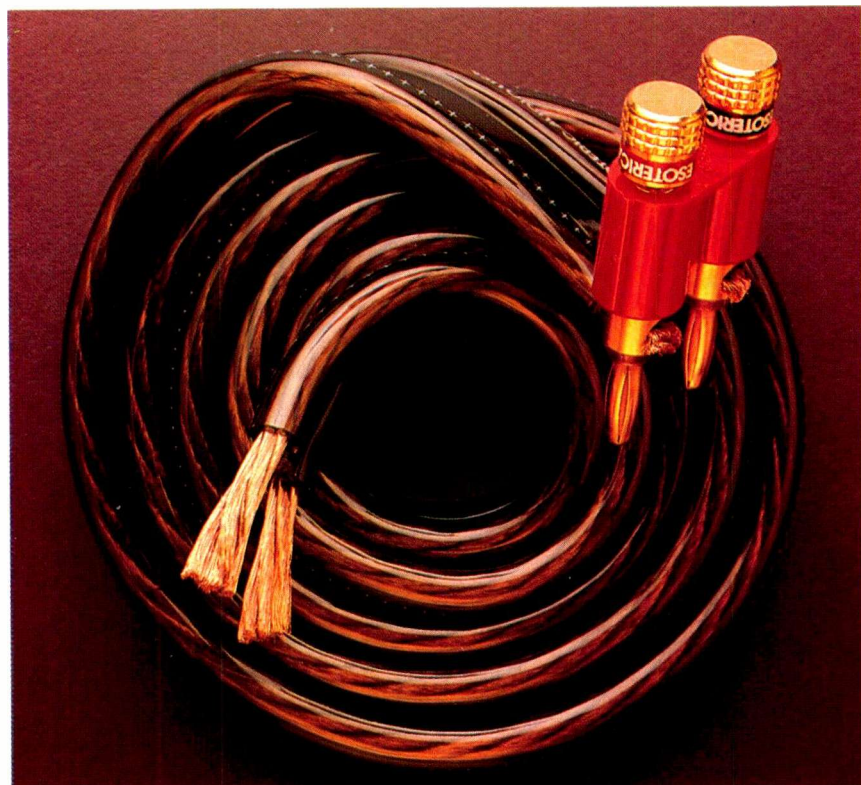

Copyright 1987 Esoteric Audio USA

LISTENING DEVICE

Before you listen to the speakers in your system, your speakers must listen to your system.

And then deliver.

So why deprive your speakers and, ultimately, yourself of all your system is capable of?

Treat your speakers to Esoteric Audio speaker cables and enjoy listening to the difference.

Your speakers will thank you.

And they will reward you.

Ask your dealer for more details about Esoteric Audio speaker cable systems or simply send \$2.00 for our latest color brochure.

Dealer inquiries invited.

ESOTERIC AUDIOUSA

RR 3 Box 262
Winder, Georgia 30680

Enter No. 17 on Reader Service Card



Maximum Security: Tony MacAlpine
Squawk 832 249 1, LP.

Sound: B+ Performance: A-

On his first major-label release, Tony MacAlpine assaults Mount Van Halen in an aggressive march toward the top of the molten-metal guitar heap. Playing guitar, keyboards, and bass, the classically trained MacAlpine machine-guns his way through scorches like the baroque-gone-mad of "Autumn Lords," the speed demonry of "Hundreds of Thousands" (of notes), the rough-edged, Malmsteenesque fury of "The Time and the Test," and a mean duel with Night Ranger axeman



Why is it that the simplest ideas are always the hardest to explain?

Ivor S Tiefenbrun had already turned the hi-fi industry on its head once before. You'd think they'd have been ready for him this time.

With the Linn LP12 turntable he'd set a new standard for the industry to strive for.

No longer were they **flummoxed** by the idea that listening is the only way to judge a turntable.

No longer was Ivor shunned at the annual American trade shows.

They wined him. They dined him. They called him the Analogue Guru of Glasgow.

But no one could understand a word he was saying. Needless to say, the **confusion** was entirely mutual.

From Ivor's point of view there were two main **enigmas**.

Why was it that Americans were buying loudspeakers without direct listening comparisons? And, why do they change the rules of ice hockey after every inning?

Realising that it would be easier to solve, he started with the first **question** first.

Ivor knew that, to change this situation, he would have to bring the industry on board with him.

So he told them a wee bit about his Isobarik DMS loudspeakers and asked them to have a listen.

But they were too **baffled** by the Isobarik's radical design to sit down and listen. No one could understand why there was a second bass unit hidden inside the cabinet.

Which certainly didn't stop them from questioning it.

In fact, they had a field day. Some people even took them apart and tried to put them together again. Which was an unmitigated disaster since, in order to work, they must be kept airtight.

But it was a good lesson learned.

When the Sara 9 loudspeakers were introduced few people bothered to try and carve them up.

Instead they contented themselves with plotting frequency response graphs.

These graphs confirmed Ivor's earlier **hypothesis**.

Namely, if you feed a signal into a loudspeaker, it will produce a sound.

THIRTEEN YEARS AGO THIS MAN CREATED A LOUDSPEAKER IN HIS OWN IMAGE.

The one drawback these graphs have is that reading them gives you absolutely **no clue** as to what the sound actually sounds like.

Only one research method exists for doing this. In Scotland we call it 'listening.' Ivor begged them to try it. His critics found this suggestion highly irregular.

Ivor knew that if he wanted them to understand his feelings of anguish and **frustration** he would have to 'speak their language.'

"Having people misunderstand your life's work is like watching your favourite linebacker miss the convert in the bottom of the ninth when the bases are loaded."

IT BECAME THE MOST MISUNDERSTOOD PRODUCT IN THE INDUSTRY.

To which everyone nodded politely before asking to see how the new Nexus loudspeaker performed in **anechoic** conditions.

Exasperated, Ivor explained the acid test he applies when comparing loudspeakers.

(The steps outlined in the next three paragraphs are perfectly safe and may be conducted in a softly lit room.)

Only one pair of loudspeakers should be in the room at the one time. Otherwise, when one pair plays, the other

pair will vibrate and the sound will be **distorted**.

Once everything is set up, sit down.

Listen.

Consider the performance of the loudspeaker. This may be done over a cup of coffee, or, if you prefer, tea.

Musical qualities are the only sensible criteria for judging hi-fi.

So, ask yourself qualitative questions like, do all the musicians seem to be playing together? Are the bassline and melody easy to follow?

Anyone can hear the difference between good and bad hi-fi. All you have to do is listen.

This fundamental belief is at the root of everything we do. And it governs the design of all our turntables, tonearms, cartridges, amplifiers and loudspeakers.

Equipment comparisons, using a single set of speakers, (see paragraph 28) are a matter of course at all our dealers. And have been ever since the dawn of Linn. No gimmicks. No obligations. Just a straightforward listen.

These days it seems incredible that anyone ever questioned something so overwhelmingly obvious.

But, as Ivor often says, "When you

have more than three bases to run on the seventh down you

can't afford to risk a penalty

for **frotting**."



LINN

HIGH FIDELITY
YOU'VE NEVER HEARD IT
SO GOOD.

Now I get it. Please tell me where my nearest Linn dealer is (try p114).

I **understood** the part about Isobariks but not the part about your new factory. Please send me your newsletter.

I found the chapter on anechoics most fascinating. Please send me product literature on the entire Linn range.

I can't quite work out what to do with this coupon. What do I fill in if I never want to hear from you again?

Name _____

Address _____

Foreigner delivers good, recycled rock, competently performed; the CD's sound is also good but has a slightly veiled quality.

Jeff Watson on "The King's Cup." (Dokken's George Lynch also makes two guest appearances.) For a change of pace, there's a piano solo (Chopin's "Etude No. 4, Op. 10") and "Porcelain Doll," variations based on the Largo movement of Chopin's "Sonata No. 3, Op. 58."

MacAlpine's sound is fuller and denser than on his *Edge of Insanity* debut (Shrapnel SH-1021), and his playing is impeccable. However, some of the excitement is missing (the *Edge* sessions were enhanced by interplay with wizards Billy Sheehan and Steve Smith), and there is a sameness to the

compositions which begins to wear thin by the end of the record. Nevertheless, the intelligence and talent displayed in MacAlpine's all-instrumental metal/classical fusion make *Maximum Security* a serious contender on a battlefield where, in the right hands, speed is the ultimate weapon.

Michael Wright

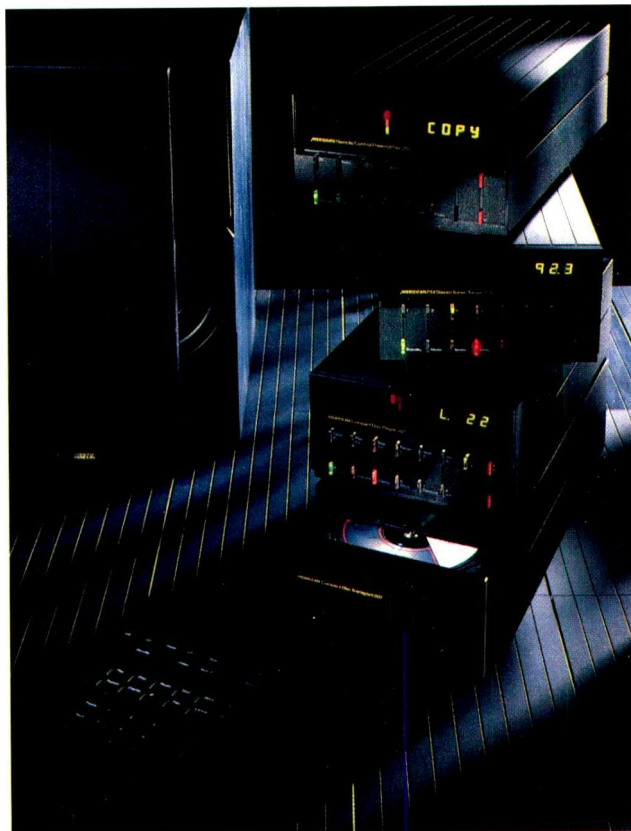

Digital High Fidelity Systems including Compact Disc, FM Stereo Radio, Amplifiers, Active Loudspeakers, Full Remote Control and Multi Room distribution systems

BOOTHROYD STUART
MERIDIAN

Exclusive U.S. Distributor **MADRIGAL AUDIO LABORATORIES**
P.O. Box 781, Middletown, CT 06457 ITT TLX 4942158

Inside Information: Foreigner
Atlantic 81808-2, CD.

If you follow commercial rock at all, you're no stranger to Foreigner. The band was formed in 1976 with the clear objective of becoming a supergroup. Four aspiring supergroupers—Mick Jones of Spooky Tooth, Lou Gramm of Black Sheep, Rick Wills of Roxy Music and Small Faces, and the free-floating Dennis Elliott—joined to form the Foreigner rock constellation as we now know it.

From the outset, the band was polished, rocked with authority, and shot hit singles at the charts like popcorn exploding out of hot oil ("Feels Like the First Time," "Cold as Ice," "Hot-Blooded"). *Inside Information* is more of the same. Gramm's unmistakable voice and Jones' on-the-money guitar give the band a particular flavor that distinguishes it—though only slightly—from the many similar groups that lack the star-power underpinning.

The sound of this analog-to-digital Compact Disc is quite good, although there is a slightly veiled quality that holds back the real power of some of the cuts. The material is good, recycled rock, competently performed, with the ratio of rockers to slow ballads about four to one. Except for the title song, which hints at intrigue, espionage, and power struggles, the only topics open to discussion on this recording are the absence and presence of love and/or sex.

The chart hits here are "Say You Will," "Heart Turns to Stone," and "Can't Wait," as the special sticker affixed to the Compact Disc shrink wrap declares. These cuts sound more than a little like the band's past hits.

With the familiar, *déjà vu* quality of *Inside Information*, Foreigner once again proves itself a native of the well-travelled American pop chart.

Paulette Weiss

Digital Discrimination.

BECAUSE ALL CD'S ARE NOT CREATED EQUAL, THE NEW CARVER DTL-200 COMPACT DISC PLAYER IS INTRIGUINGLY DIFFERENT.

The Carver DTL-200 answers the audiophile's demand for a CD Player which provides not only the greater dynamic range and richer bass expected from compact disc technology, but also the musicality, spectral balance and spatial qualities of well executed analog high fidelity recordings.

The new remote control Carver DTL-200 represents the next logical evolutionary step towards marrying the awesome technology of digital playback with Bob Carver's commitment to the re-creation of the live performance. It embodies the latest digital/analog conversion circuitry with oversampling, sophisticated laser system and a wealth of operating features. And it possesses unique Carver circuitry that solves real-world sonic problems associated with commercial CDs.

TIME DOMAIN CORRECTION. The Carver DTL-200 incorporates an important new computer logic innovation that monitors the incoming digital signal for imperfections and "glitches" caused in recording and production. Such errors are immune to conventional error-correction processes because they are actually data anomalies. Yet they can add overall harmonic distortion and cause audible changes in sound quality.

The DTL-200's Time Domain Correction circuit constantly performs a complex, 25-bit digital calculation on passing data. This high-speed error correction algorithm, in conjunction with a 121-pole digital filter, terminates distortion-causing high harmonics as they occur in the bit stream. The result is frequency response within 1/1000 of a dB of the original, with significant reduction of distortion to less than 0.007%.

PLUS THE DIGITAL TIME LENS. On top of this unerring ability to produce natural, real-sounding music from the CD's digital bits, the Carver DTL-200 has the remarkable Digital Time Lens circuit to insure your listening enjoyment.

When Bob Carver obtained his first compact disc player, he was surprised at the sound derived from most of the compact discs he purchased. The three-dimensional musical perspective which his analog system provided in lush abundance on phono discs evaporated into a flat, brittle wasteland. After exten-

sive testing, Bob uncovered two fundamental flaws in almost all compact discs: 1) An unpleasant, harsh spectral energy balance. The overall octave-to-octave energy balance was shifted on the CD towards more midrange above 400 Hz; 2) The amount of L-R signal (which carries the spacial detail of the music) on the CD was inexplicably, but substantially, reduced when compared with the amount of L-R signal found on the corresponding analog disc. The difference is obvious in these two oscilloscope photos.

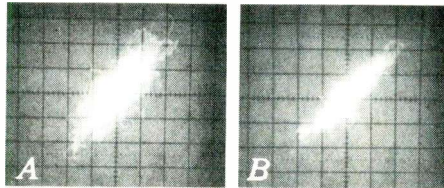

A. Lissajous pattern showing spatial detail (L-R) (L+R) ratio from an LP record.
B. The same instant of music but taken from the CD version. Note the decreased (L-R) content, as shown by the narrowed trace.

Carver's circuitry corrects the ratio of L-R to L+R by performing one extra, but important mathematical operation on the signal stream that all other CD players fail to perform. This final operation makes all the difference.

The result is a natural sound with more of the three-dimensional information that places us in the same space with performers. You won't need the Digital Time Lens on all CDs. But it is there when you need it.

In the beginning, Carver hoped, indeed he expected, that once recording artists and engineers became more experienced with CD technology

fewer and fewer CDs would require the Digital Time Lens. But both laboratory and listening tests reveal that the majority of even the most recently released CDs benefit significantly from the Digital Time Lens.

PACKED WITH USEFUL FEATURES. The Carver DTL-200 makes enjoying Compact Discs a simple exercise in button pushing from your favorite listening chair. You can program any combination of up to twelve tracks from a single CD, repeat a specific track or a whole Compact Disc for uninterrupted enjoyment.

Along with the ability to skip forward or backwards song-by-song, a touch of a key allows you to audibly review a disc backwards or forwards at many times normal speed. An A-B Specific Phrase Repeat lets you carefully analyze one section of a performance or simply provide a point of reference in a long, un-indexed symphonic movement.

All functions are displayed on an easy-to-read but subtle LCD display including programming sequence, current selection number, individual and total playing times plus indexing cues.

HEAR THE CARVER DIGITAL DIFFERENCE. Just as all CD's are not created equal, neither are Compact Disc Players. Of all the models currently available, only the new DTL-200 (and DTL-50) have the innovative and exacting Bob Carver touches that can substantially enhance your enjoyment of the digital medium.

Audition the new DTL-200 today at your Carver dealer, using a variety of discs. You will be surprised at how audibly it can improve on what is already the best playback medium ever offered.

SPECIFICATIONS. Frequency Response: 5Hz-20kHz @ 0dB, ±0.2dB. Total Harmonic Distortion: 0.007% S/N: 100db. Channel Separation: 90dB • 1 kHz. Dynamic Range: 96dB Wow & Flutter: unmeasurable. Programming: 12-track remote and manual



CARVER

PO Box 1237, Lynnwood, WA 98046

POWERFUL

MUSICAL

ACCURATE

Enter No. 10 on Reader Service Card

Distributed in Canada by: evolution technology

TOO COOL FOR COMFORT



Brasil: The Manhattan Transfer
Atlantic 81803-2, CD.

The Manhattan Transfer is as smooth and professional a music machine as you're going to find in the business. They have fueled their latest album with some of the most prominent names in Brazilian pop—along with some American pros—to turn out a long, gleaming roadster of a recording ready to make major inroads on Latin terrain.

Some of those prominent names include Milton Nascimento and Djavan, the twin kings of modern Brazilian pop; studio percussionist Paulinho Da Costa; guitarists Oscar Castro-Neves and Toninho Horta, and the instrumental group Uakti. There's even American sax man Stan Getz, who, with the Gilbertos (Astrud and Joao) and Antonio Carlos Jobim, jazzed up the sensual samba sound and brought it to these shores as the Bossa Nova.

The sound of this analog-to-digital effort is superb. Studio expertise shows from the first moments of the first cut, "Soul Food to Go," where percussion snaps out crisp and full, and synthesizers flow liquid and shining

from the speakers. Special effects abound and are perfectly mirrored on this Compact Disc: A pinpoint of sound swells into a full, electronically enhanced vocal chorale on "So You Say"; distant birdcalls and waterfall sounds open "Metropolis"; electronic voice processing makes a moment of backup vocalise sound like tiny alien creatures with adenoid problems.

Musically too, this disc is luscious. The quartet's harmonies are impeccable, a carefully controlled blend of four individual human instruments. The instrumentals are splendid, an artful landscape of easy, swinging American pop, unique Latin percussion, and authentic, sensual Latin rhythms both white-sand hot and jungle-waterfall cool. The lyrics are intelligent and filled with striking imagery. The album's pacing is masterful; the mix of uptempo tunes, ballads, straight Brazilian material, and familiar American pop modes could not have been better done.

So why isn't *Brasil* one of my favorite albums in the universe? I think it has something to do with style versus soul. Although The Manhattan Transfer consistently produces great-sounding, quality work (love their Sara Lee blue-

berry muffin gig), I have always perceived them as too cold and . . . well, too shrill. Most of the material they take for a spin here lacks the smoldering core characteristic of authentic Brazilian music (or great jazz, rock, or classical music, for that matter). Djavan does provide some vocal heat on "Capim," and, as if by osmosis, The Transfer picks it up for the backup they provide on the cut. However, the group cannot carry it over to the other eight selections on this Compact Disc.

Brasil has all the polished surface style and quality of a Rolls-Royce, but the engine is pure Chevrolet.

Paulette Weiss

Spontaneous Combustion: Barney Kessel

Contemporary C-14033, LP.

Sound: B+ Performance: A

Strollin': Gene Bertoncini and Michael Moore

Stash ST-272, LP.

Sound: B+ Performance: A

Even if you don't remember the good ol' days when cats would sit down and improvise around standards, you can still enjoy the experience with Barney Kessel's *Spontaneous Combustion* and Gene Bertoncini and Michael Moore's *Strollin'*.

Kessel's digitally recorded album (done in two nights!) burns with the cool flame that accompanies jazz when the song's melody controls the improvisation. His mellow hollow-body electric guitar slips smoothly in and out of original songs (notably "Moonlight Walk" and "Starfire") and traditional tunes ("Round Midnight" and "Get Me to the Church on Time"), occasionally bursting into very hot ornamentation. Partners in jam are the excellent Monty Alexander Trio. Expect your head and shoulders to bob from beginning to end.

Strollin' teams Gene Bertoncini's clean classical guitar with Michael Moore's nimbly plucked and bowed bass for refined romps through standards such as the title cut, "Sweet Georgia Brown," and "Limehouse Blues." Bertoncini picks up the electric for fluid riffing on Carlos Jobim's "Wave" and some nicely double-stopped blues on "Lil' Suzi/Blue

Deceptive Engineering

Obvious but *very* deceptive...

You'll probably notice our 50-watt RX-533 offers obvious features such as Digital AM/FM cassette/radio with Dolby® B & C noise reduction, 24-preset stations, preset scan, tape program search, separate bass & treble tone controls, etc., and of course, it's **removable!**

But you'll probably overlook the not-so-visible but specially engineered features such as FM optimizer II circuitry designed for superior FM reception and built-in Automatic Radio Monitor for filling the void with music while you are fidgeting with your tape. Special cassette features such as "Auto Azimuth Correction System" rotates the tape head 180 degrees whenever tape direction changes to keep perfect azimuth alignment, Keyoff Pinch Roller Release minimizes wear and tear of tape pinch roller and DC servo motor accurately controls tape movement thus minimizing wow and flutter.

Plus pre-amp outputs and CD/AUX input capability designed for flexible system expansion, two-tone illuminated control panel guarantees easy viewing and identification and replaceable Lithium back-up battery helps protect and store information in the microprocessor.

Though not in plain view, these state-of-the-art engineering innovations are obviously what you have come to expect from a company with over 11 years of manufacturing experience.

Cooustic... a sound investment.



cooustic®

4260 Charter Street
Vernon, CA 90058-2596
(213) 582-2832



© Cooustic 1987

® Dolby is a registered trademark of Dolby Laboratories.

Enter No. 14 on Reader Service Card

Though *Collaboration* does favor a lush, light pop feel, both players burn through plenty of bluesy improvisational passages.

Monk," a cut that shows the influence of Bertoni's mentor Johnny Smith. Most curious are the variations on the baroque "Prelude" combined with "Alone Together" (check out Moore's arco technique), and a similar treatment of Puccini's "Un Bel Di" and "Poor Butterfly." Tight, creative arrangements and impressive playing await you. *Michael Wright*

Collaboration: George Benson and Earl Klugh
Warner Bros. 25580-2, CD.

Sound: A — Performance: B +

No surprises with this *Collaboration* between George Benson and Earl Klugh—just lots of swinging, mellow pop/jazz guitar. What's particularly nice are the tonal colors achieved through contrasting Benson's smooth, nimble electric guitar lines with Klugh's crisp, finger-style classical approach.

Even though the material favors a lush, light pop feel, both players burn



Earl Klugh and George Benson

through plenty of often bluesy improvisational passages, most notably on "Mt. Airy Road," "Since You're Gone," and the very tasty title cut. Most of the time, one player takes the solo while the other provides accompaniment, but occasionally Benson and Klugh get some serious interplay together, as on "Dreamin'." A syrupy "Love Theme

from 'Romeo & Juliet' " mars the program slightly, but even that is saved by a Benson rave-up in the middle.

In quiet passages, the CD lets some tape noise through, but otherwise this effort from Benson and Klugh displays an impressive balance between controlled pop and spicy jazz.

Michael Wright

Are you killing your records with a blunt instrument?

Protect your valuable record collection. Replace your phono cartridge or stylus today. Send for our free brochure.

Shure Brothers, Inc., 222 Hartrey Ave., Evanston, IL 60202-3696.
 (312) 866-2553.

SHURE®

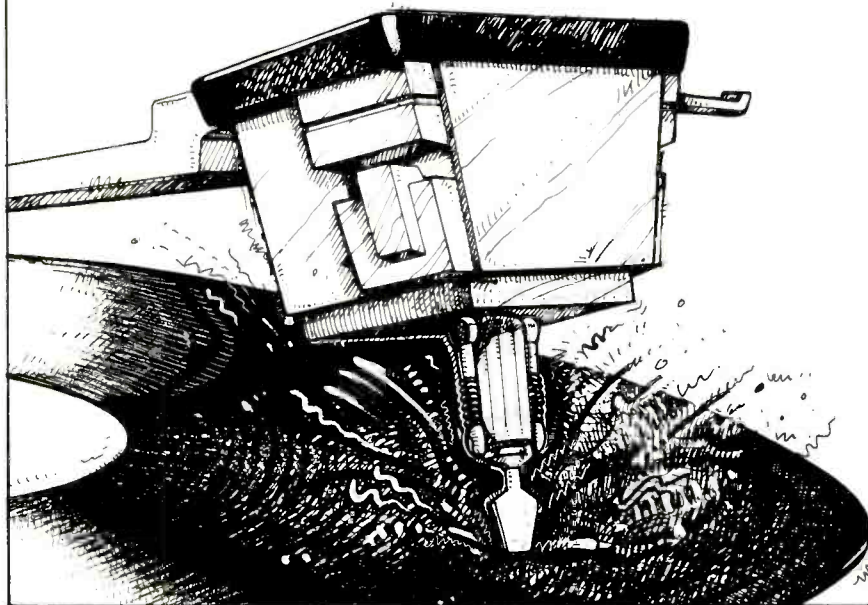

Enter No. 32 on Reader Service Card

Audio BOUND VOLUMES BACK ISSUES BINDERS/SLIPCASES



BOUND VOLUMES Great Reading, Great Price!

A ready reference for audiophiles! A full year of AUDIO is carefully hard-bound for easy reference. Complete volumes for the years 1979 through 1984 are available. Only \$24.95 including shipping and handling.

TO ORDER: Indicate year(s) requested and send check or money order, NO CREDIT CARDS, to: AUDIO Magazine, 1515 Broadway, New York, NY 10036, Attn: Bound Volume Dept. Allow 4 weeks for delivery.

BACK ISSUES

Single-copy back issues of AUDIO from 1983 through current issue are available. (Note: April, August, and October 1983 are unavailable.) \$5.00 per issue postpaid.



BINDERS/SLIPCASES



Maintain your AUDIO collection in these top-quality binders or slipcases. Binders,

\$9.00 each; 3/\$26.00; 6/\$50.00. Slipcases, \$7.65 each; 3/\$22.00; 6/\$40.00. Include \$2.50 per order for postage and handling.

TO ORDER: Indicate issue/binder/slipcase. Include proper amount for postage and handling. Please add your applicable sales tax. Allow 6-8 weeks for delivery. Make check/money orders payable to: Audio Magazine, P.O. Box 765, Holmes, PA 19043. DIRECT TOLL-FREE ORDER NUMBER: 1-800-345-8112. Use your Visa, Mastercard or American Express card. \$10.00 MINIMUM CREDIT CARD ORDER.

ORIGINAL MASTER RECORDINGS

**Our Second
Decade Of
Leadership
& Innovation
In the Pursuit
Of Audio
Excellence
Begins With
These
Benchmark
Performances
Delivered
With
Tomorrow's
Technology**

FREE CATALOG

Share in the celebration of these Benchmark Performances and our Second Decade of Audio Excellence with a free & complete Original Master Recording Catalog of Ultradiscs, Compact Discs, Audiophile LP's and Audiophile Cassettes. Choose from a broad selection of historic and history making performances by: The Beatles, Sinatra, The Rolling Stones, The Grateful Dead, Billie Holiday, The Beach Boys, Miles Davis, Arthur Fiedler & The Boston Pops, and more! Write or call Toll Free 800-423-5759

THE MELODIYA CATALOG

Timeless classics performed by the greatest artists of the Soviet Union. Mastered directly from the original master tapes at Melodiya recording studios throughout the USSR, Mobile Fidelity has the exclusive privilege of bringing these rare treasures to the American Public. Performances include: Popular Symphonic Pieces by Soviet Composers - Ermler/ Bolshoi Theatre Orchestra, Gilels: Schubert & Schumann, Arensky: Symphonies Nos. 1 & 2 - Svetlanov/USSR Symphony Orchestra.



24k GOLD ULTRADISC

Years of research and development have resulted in the most advanced compact disc in the music industry today! Capable of generating music far above current audio standards, ULTRADISC is setting new highs in listening pleasure. Increased lifespan, no sonic gaps to fill artificially, higher engraving and reading capabilities produce better overall quality for your software investment. Performances by Pink Floyd, Joe Jackson, Supertramp, Huey Lewis, Jethro Tull & more.



JAZZ CLASSICS

This series ushers in a new era in the appreciation of jazz. New digital transfer technology techniques were used to revitalize the sound from the direct-cut 78 RPM discs covering the vintage jazz years from 1917 to 1947. Never before have these classic "Live in the Studio" performances been reproduced with such spectacular clarity and accuracy. Performances by Louis Armstrong, Bessie Smith, Bix Beiderbecke, Jelly Roll Morton, Johnny Dodds and more.

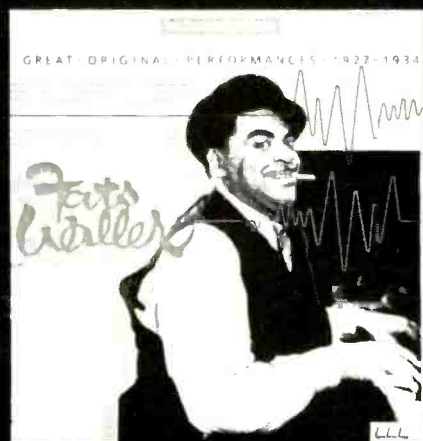

THE STATE OF THE ART IN THE ART OF SOUND
Enter No. 22 on Reader Service Card

1260 Holm Road, Petaluma, CA 94952
707-778-0134

1-800-423-5759 Except in CA, AK, HI

The clavichord forces Keith Jarrett to come up with melodic and rhythmic ideas that work—and he does indeed deliver.



Book of Ways: Keith Jarrett
ECM 1344/45, LP

Sound: B+ Performance: A-

Not content to stay in his place as a virtuoso jazz pianist, Keith Jarrett once again flaunts his artistry on *Book of Ways*, a two-record set of clavichord

improvisations. He must think that everything he touches will be golden. To be fair, *Book of Ways* is pretty good.

With Keith Jarrett playing, you know this isn't going to be jazz à la Bach. Although Jarrett uses the baroque phrasing that's intrinsic to the instrument, only rarely does he allow it to

dominate the music. Jarrett elicits a range of effects, from the guitar-picking filigree of "Book of Ways 17" to the microtonal bends of the Asian-inspired "Book of Ways 8."

I guess it would be hip to ask whether Jarrett makes the clavichord swing or not. He doesn't, but that's not what *Book of Ways* is about. It's about Keith Jarrett channelling his roving, improvisational mind into an instrument that forces him to come up with melodic and rhythmic ideas that work. There's no sustain pedal to rest on and no surging, resonant overtones to transmute repeated phrases. And indeed, Jarrett does come through with a well-spring of ideas. Angry, pounding strings are plucked on the Bartók-like "Book of Ways 10." "Book of Ways 6" generates a sort of jazzy minimalism, with repeated rhythmic phrases punched out by Jarrett with a honky-tonk abandon.

ECM has done a remarkable recording job, getting just enough resonance to make the clavichord breathe while tracking every last one of Jarrett's grunts.

For those waiting for Jarrett to record more jazz piano, the wait may be long. His next album will be Bach's *Well-Tempered Clavier, Book One*.

John Diliberto

The new SP11 Mark II from Audio Research: setting the standard, again.



A classic reborn.

Traditional wisdom holds that you don't tamper with success. But at Audio Research, the working philosophy has always been to make important progress in music reproduction available to those music lovers who care to hear the difference. So, two years after the introduction of the original SP11 preamplifier, Audio Research announces the heir to its acclaimed reference standard: the new SP11 Mark II.

New clarity, dynamics, realism.

The new Mark II offers startling improvements in musical realism compared to the standard-setting original. First, there is a soundstage that extends even further beyond the speakers, laterally and front-to-back. Within this stage, instruments and voices are focused more precisely

than ever before, with an uncanny rendition of proper size and location. Bass response is both deeper and more detailed, for a more dynamic foundation beneath the musical program. And, overall, you'll hear a breathtaking new clarity that simply lets a recorded musical performance through as never before—while telling you more about the quality of the transcription medium as well. The new SP11 Mark II is truly the most revealing, yet "invisible" preamplifier ever from Audio Research. And, we think you'll agree, one of the best values in high-end audio. Again. Audition it soon at your authorized Audio Research dealer.

Inside: Paul Horn
Rykodisc RCD 10040, CD

Rykodisc's reissue of Paul Horn's recording inside the Taj Mahal sounds amazingly fresh, despite its age. A technical virtuoso performance in itself, the restoration for Compact Disc allows the imagination and beauty of the performance to sparkle in the digital light. Horn recorded other albums in unusual places, such as the Great Pyramid, but *Inside* was the first of its type. Horn's work on this album would go on to influence The Blues Project (which used an EchoPlex for tape-delay effects in "Electric Flute Thing") and David Crosby (who used overdubbing and tape delay on a multi-track

HIGH DEFINITION® MUSIC REPRODUCTION EQUIPMENT



Enter No. 3 on Reader Service Card

The Best isn't hard to find

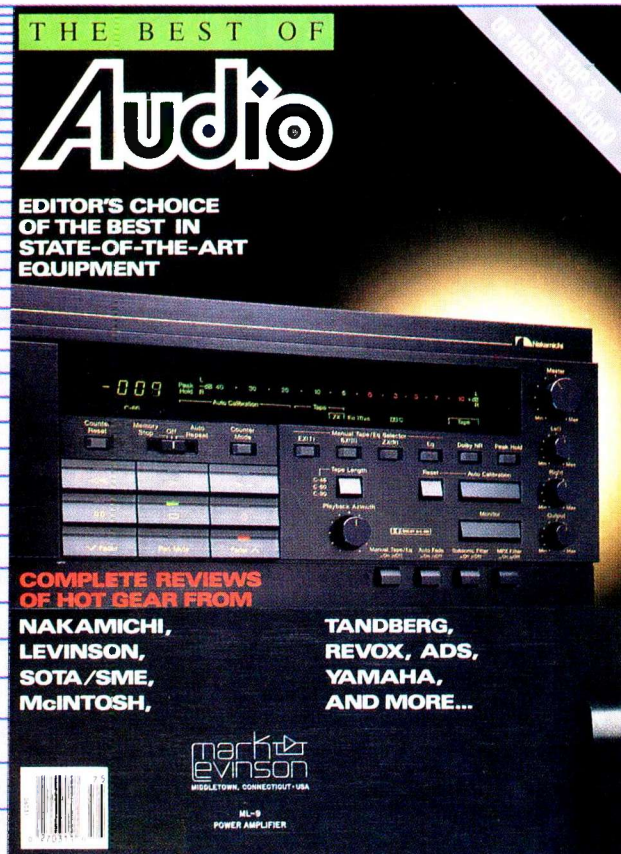

when you know where to look.

The Best of everything. That's what THE BEST OF AUDIO is all about.

Editor-in-Chief Gene Pitts and his team have gone through a complete analysis of the past year of AUDIO, selecting what meets their standards as the Best. And "Best" doesn't just mean price. It's what counts most to you: *performance*.

So THE BEST OF AUDIO is, in one convenient source, *the* state-of-the-art reference. The one that keeps you on top of the ever-changing audio market. If you're serious about sound—you can't afford to be without it.

Now, take advantage of the opportunity to get the Best in two easily available ways: by phone or at your

newsstand, on sale November 18.

THERE ARE TWO CONVENIENT WAYS TO BUY THE BEST OF AUDIO:

1. Order today by calling Toll-Free 1-800-345-8112.

2. Or, buy it at your newsstand, available November 18.

—The price is just \$3.95.—

Find out what AUDIO has selected as the Best in:

- CD Players
- Amplifiers
- Preamplifiers
- Tuners
- Receivers
- Tonearms
- Cartridges
- Turntables
- Cassette Decks
- Speakers

A lot of painstaking care has gone into restoring Paul Horn's 20-year-old recording, resulting in a thoroughly enjoyable CD.

recorder to create the beautiful vocal solo on "I'd Swear There Was Somebody Here" on *If I Could Only Remember My Name*).

What endeared *Inside* to so many of us, back in the '60s, was the skillful way that Paul Horn interacted with the acoustics of the Taj Mahal. Along with

the exquisite quality of its reverberant sound, the building has so many echo paths that a performer can generate rhythmic patterns, harmonies, and even short passages of counterpoint, though to do so requires a keen ear and agility at improvisation. Horn "plays" the acoustics of the Taj Mahal

as if it were a gigantic flute orchestra. He mixes Western styles with Hindu chant, and the disc even includes some vocal improvisations by a guard, who also knows the acoustics well.

For this Compact Disc reissue, mastering engineer Toby Mountain wished to eliminate the pre-Dolby analog tape hiss, but he couldn't do so with standard equipment. So he went to Sonic Solutions. The company, a spinoff from Lucasfilms' Droidworks, has developed a digital noise-removal process that doesn't affect the sound adversely. After digitizing music and storing it on hard disks, they extract a sample of the noise and define its parameters carefully. Usually the silent spots between or within tracks are sufficient. After defining the nature of the noise, the engineers write a computer program to remove just that portion of the data. The computation process takes about 10 to 15 times the normal playback time. As with traditional noise-reduction procedures, the Sonic Solutions approach requires many attempts, because every improvement in noise level results in a loss of quality somewhere else.

Mountain also had to touch up several places where dropouts and other defects occurred in the old analog tape. For example, some flute attacks had been obscured by analog dropouts, so he used his digital editing console to clone a good attack with similar characteristics and replaced the faulty one with the clone. This process, the digital audio equivalent of "cut and paste" in word processing, is one of the genuine benefits of digital editing. Another problem resulted from the analog editing techniques of the time. The practice was to cut the tape at the earliest possible moment at the end of each track—as soon as the ambient information disappeared into the noise. At the beginning of the next track, the editor cut the tape at the latest possible moment and inserted a precisely timed length of leader tape between cuts. On CD, we can hear those sudden jumps in noise level, so Mountain adjusted the contours of the fade-ins and fade-outs to make them sound acceptable. All of this painstaking care in restoring Paul Horn's 20-year-old recording results in a thoroughly enjoyable CD.

Steve Birchall

CARNEGIE ONE

Generator	Moving Coil
Stator	Coreless Armature Wound in a Figure 9
Antilever	Micro Edge Line Contact 5 x 75 microns
Body	Layered (Beryllium, with a Carbon Fiber Core, enclosed in Aluminum)
Tracking Force	Machined Aluminum Alloy
Output Voltage	1.7g recommended
Channel Separation	> .28 mv/NAB (1kHz 5cm/sec.)
Weight	> 30dB
	6.7 grams

Made in Switzerland

CARNEGIE ONE

Clearly . . .
The best seat in the house!

The Carnegie One is designed by, and manufactured exclusively for
Madrigal Audio Laboratories, PO Box 781, Middletown, CT 06457/ITT TIX 4942158

CLASSIFIED ADVERTISING RATES

BUSINESS ADS—\$1.85 per word, MINIMUM charge PER AD, PER INSERTION \$45. All centered or spaced lines \$16.

NON BUSINESS ADS—\$1.30 per word, MINIMUM charge PER AD, PER INSERTION \$30. All centered or spaced lines at \$13.

ALL LINE ADS—First line set in bold face type at no extra charge. Additional words set in bold face at \$2.00 extra per word. One point ruled box is \$15.

CLASSIFIED LINE ADS ARE PAYABLE IN ADVANCE BY CHECK OR MONEY ORDER ONLY. (Sorry, we cannot accept credit cards or bill for line advertising.) **ALL LINE ORDERS** should be mailed to:

AUDIO MAGAZINE
P.O. Box 9125
Dept. 346V
Stamford, CT 06925

ORDERS WILL NOT BE PROCESSED WITHOUT ACCOMPANYING CHECK OR MONEY ORDER FOR FULL AMOUNT.

CLOSING DATE—First of month two months preceding the cover date. If the first of the month falls on a weekend or holiday, the closing date is the last business day preceding the first. **ADS RECEIVED AFTER THE CLOSING DATE WILL BE HELD FOR THE NEXT ISSUE UNLESS OTHERWISE STATED.**

FREQUENCY DISCOUNTS—3 times less 5%, 6 times less 15%, 12 times less 20%. These discounts apply to line ads only. Ads submitted for a three-time frequency are unchangeable. Frequency discounts not fulfilled will be short-rated accordingly. Agency discounts do not apply to line advertising.

BLIND ADS—Audio box numbers may be used at \$8 extra for handling and postage.

GENERAL INFORMATION—Ad copy must be type-written or printed legibly. The publisher in his sole discretion reserves the right to reject any ad copy he deems inappropriate. **ALL ADVERTISERS MUST SUPPLY:** Complete name, Company name, Full street address (P.O. Box numbers are insufficient) and telephone number. Classified LINE ADS are not acknowledged and do not carry Reader Service Card Numbers. **AGENCY DISCOUNTS** do not apply to line advertising. **FREQUENCY DISCOUNTS** not fulfilled will be short rated accordingly. Only those advertisers who have prepaid for their entire contract time will be **RATE PROTECTED** for the duration of that contract, in the event of a rate increase.

CLASSIFIED DISPLAY RATES

1 col x 1 inch	\$316
1 col x 2 inches	\$498
1 col x 3 inches	\$713
2 cols. x 1 inch	\$567
2 cols. x 2 inches	\$958

One column width is 2 1/8". Two columns wide is 4 1/4". For larger display ad rates and 6, 12, 18 and 24 times frequency rates call (212) 719-6338.

DISPLAY ADVERTISERS should make space reservation on or before the closing date. Ad material (film or velox) may follow by the tenth. **DISPLAY ADVERTISERS MUST SUPPLY COMPLETE FILM NEGATIVE READY FOR PRINTING OR VELOX. PRODUCTION CHARGES WILL BE ASSESSED ON ANY AD REQUIRING ADDITIONAL PREPARATION.**

ALL DISPLAY CORRESPONDENCE should be sent to:

Carol A. Berman, AUDIO MAGAZINE,
1515 Broadway, New York, NY 10036

FOR ADDITIONAL INFORMATION: CLASSIFIED LINE ADS: Carol A. Berman—(212) 719-6345. **CLASSIFIED DISPLAY ADS:** Carol A. Berman—(212) 719-6338

ANNOUNCEMENTS

STEREO EXCHANGE . . . AMERICA'S LARGEST hi-end used inventory . . . Now we **BUY & SELL by PHONE ALL OVER THE WORLD!** Here's a **SMALL SAMPLE** of our kind of items . . . and prices. **SPEAKERS:** Acoustat 4 \$750, Allison CD9 \$750, Altec 19 \$1100, Apogee Scintilla \$2400, Bowers Active 1 (new) \$1695, Dahlquist DQ-10 \$600, DBX Soundfield 1A \$1500, Energy Pro 22 \$475, ESB 7-06 \$2000, Fried Studio IV \$600, JBL L86 \$325, Magnepan Tympani IV \$1995, Meridian M3 \$750, Meridian M10 \$1500. **TUNERS:** Cambridge T75 \$225, Dynaco FM3 \$75, Kenwood KT8005 \$100, McIntosh MR78 \$1200, NAD 4155 \$265, Onkyo T9090 \$425, Tandberg 3001A \$1095. **SIGNAL PROCESSORS:** ADS Model 10 \$350, Audio Pulse Model 1 \$150, RG Model 20 \$225, Sansui SE88 \$225, Sound Concepts SD550 \$250. **TURNTABLES:** AR AT1100 \$325, Ariston RD90 Alphason HR100S \$1295, B&O Beogram 5500 \$295, Connoisseur BD2A \$79, Denon DP62L \$360, Goldmund Studetto \$1195, JVC QL50 \$125, Linn LP12 \$595, Maple Knoll Athena \$400, Nakamichi Dragon CT \$995, Nakamichi TX-1000 \$3795, Onkyo CP1046FB \$80, Oracis Alexandria \$595, Pink Triangle \$350, STD 3055 (new) \$260, Thorens 125 MKII \$160. **TOEARMS:** Alphason Delta \$260, Fidelity Research FR64S \$300, Helius Aurum \$175, Helius Scorpio \$110, Koetsu SA1100D II \$395, Linn Ittok \$360, Lustre 801 \$125, Souther SLA3 \$325. **CARTRIDGES:** Dynavector Karat 23RS \$150, Grado 8MX \$95, Koetsu Blackgoldline \$425, Monster Alpha 1 \$125. **PRE-AMPS:** Acoustat TNP \$200, Audio Research SP9 \$1350, Berning TF10AH \$995, Carver C2 \$260, Conrad Johnson Premier 2 \$950, Citation XXP \$1595, Jadis JP-80 \$2995, Krell KRS-1A \$6495, McIntosh C27 \$600, Perreux SM2 (new) \$650, PS IVH \$350, Spectral DMC5 \$950, Theta \$295, Threshold Fet I Series II \$1195, Yamaha C4 \$275. **POWER AMPS:** Accuphase P600 \$1995, Apt 1 \$395, Audio Research D250 II \$3495, Berning EA2100 \$1700, Electrocompanet Signature \$900, Leach 101 \$375, Levinson No. 20 \$8000 pr, McIntosh MC2120 \$795, Tandberg TPA3003 \$450, Theta Mono Amps \$795. **PHONE OR WRITE: STEREO EXCHANGE, 687A BROADWAY, NYC, NY 10012. 1-800-833-0071, 1-212-505-1111.**

THE AUDIOPHILE NETWORK

Databoard system for the Computer using Audiophile and music lover. Call in with your modem anytime. (818) 988-0452. For further information write to: TAN 14155 Kittridge St., Van Nuys, CA 91405.

ANNOUNCEMENTS

ANNOUNCING MODIFICATIONS TO B&K AMPS AND PREAMPS: Most sonic improvement for \$\$ invested!! Improved detailing, depth of soundstage, increased transparency, deeper & tighter bass! State-of-the-art Technology!!! We pay shipping. **SOUND UNLIMITED**, 169 Church St., Bristol, CT 06010, Est. 1959. (203) 584-0131.

MC VISA AMEXP ACCEPTED

CLASSIC AUDIO INTRODUCES A NEW AMPLIFIER developed by George Kaye former Chief Engineer of New York Audio Laboratories and inventor of NYAL's Moscode Amplifier, Minuet in A and Super it.

The amplifier, a "Limited Edition", is a dual mono design conservatively rated at 60 Watts per channel utilizing 6550 output tubes and McIntosh output transformers. A unique feature is FET Tube driver circuits that achieve very low noise and distortion with only 8 db of negative feedback.

Suggested Retail: \$1660. Classic Audio, LTD., POB 176CAI, Walton, N.Y. 13856. 607-865-7200 8AM-5PM Mon.-Fri.

FOR SALE

AAA★ATTENTION! HI-FI HOTLINE!

**OUTSTANDING PRICES ★ VISA-MC ★ CALL US
LARGE SELECTION ★ US WARRANTY TRADES
MID-FI TO HIGH-END ★ SERVICE ★ ADVANCE.** Many products to choose from (414) 658-3111
GREAT PRICES-QUALITY AUDIO!

AA#1 RATING !!

Our **WONDER CAPS®** and **WONDER SOLDER™** have been rated **BEST** in the world by reviewers and professional experts. What do they say? Write TRT, Box 4271, Berkeley, CA 94704.

For Purists Only

Listen.



Convergent Audio Technology
Technology Serving Music

24 Falcon Drive • West Henrietta, NY 14586
716-359-2700

The Most Knowledgeable Audio Dealership

Many audiophiles who want high quality audio systems are misled by well meaning—but misinformed—salesmen, magazines, and friends whose understanding of sound reproduction is superficial or incomplete. As a result, many expensive "mistakes" are made.

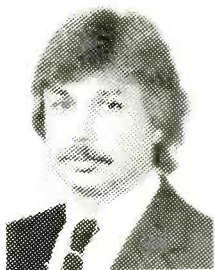

During the past 10 years, Gala Sound has distinguished itself as the preeminent high end audio dealership in the United States.

Founded by pianist-acoustician James Gala, audiophiles, musicians, and recording engineers throughout the U.S., Europe, and South America, rely on Gala Sound for audio systems tailored to their specific needs, listening environments and budgets. These systems are second to none.

If you're serious about sound, you can own the finest: a definitive audio system from Gala Sound. Phone (do not write) Jim Gala at (716) 461-3000.

**KRELL • THRESHOLD • APOGEE • KEF • B & W • ACOUSTAT
MERIDIAN • REVOX • BRYSTON • BELLES RESEARCH • NAKAMICHI**

GALA SOUND

3122 Monroe Avenue, Rochester, New York 14618 • (716) 461-3000

FOR SALE

AAAAAUDIO CLASSICS Equipment. AMPLIFIERS: Accuphase P266 Amplifier (\$2800) \$1250; Acoustat TNT200 (\$1249) \$750; Hafler DH120 (\$375) \$225; DH200 (\$430) \$250; DH200 12V (\$430) \$250; DC220 (\$499) New \$400; McIntosh MC250 \$275; MC502 (\$1200) \$675; MC2250 (\$2495) \$1700; MC2500 (\$3495) \$2600; MC7270 (\$2295) \$1750; NYAL Moscode Type II (\$1600) \$1000; Perreux PMF1050 (\$1050) \$625. **CARTRIDGES:** Accuphase AC2 NEW (\$675) \$400; AC3 NEW (\$550) \$330; Apature Koce (\$200) \$150; Audioquest MC3 NEW \$150. **CASSETTE DECKS:** Tandburg TCD310 MKII \$200. **CD PLAYERS:** McIntosh MC7005 (\$1599) \$1335. **CROSS-OVERS:** Accuphase F15 NEW (\$2200) \$1200. **DIGITAL DELAYS:** Sound Concepts SD55OR (\$789) \$350. **EQUALIZERS:** Accuphase G18 NEW (\$3300) \$2800; Hafler DH160 (\$375) \$225; McIntosh MQ101 (\$250) \$125; MQ102 (\$75) \$60; MQ104 (\$500) \$125; MQ107 (\$650) \$375. **EXPANDERS:** RG Dynamics Pro 20 (\$449) \$125. **HEAD AMPS:** Hafler DH102 or DH112 (\$75) \$45. **INTEGRATED AMPLIFIERS:** Accuphase E204 NEW (\$1200) \$730; E302 NEW (\$2300) \$1450; Kenwood LO1A (\$1500) \$665; McIntosh MA230 (\$399) \$300; MA5100 (\$449) \$350; MA6200 (\$1795) \$1150. **PREAMPLIFIERS:** Accuphase C200L New (\$3000) \$1450; C222 NEW (\$2200) \$1250; C270 NEW (\$5000) \$3400; C280 NEW (\$6900) \$3500; Hafler DC110 (\$450) \$265; Klyne SK5 (\$3000) \$2000; McIntosh C24 (\$249) \$200; C28 (\$649) \$450; C34V (\$2195) \$1725; C504 (\$1090) \$675; NYAL Minuet in A (\$995) \$675; PS Audio 4 (\$550) \$300. **RECEIVERS:** McIntosh MAC1700 (\$599) \$400; MAC4200 (\$2890) \$2150. **SPEAKERS:** Acoustat Model One (\$1299) \$779; Model One Wooler Cube (\$254) \$150; B&W DM6 (\$1390) \$600; KEF 102 (\$790) \$500; McIntosh ML1W \$250; ML2C (\$1200) \$600; ML2MW \$350; ML4U (\$2400) \$1100; XD717 (\$1598) \$1075; XR5-19 \$900; XR6W \$375; Snell Type 1 (\$1600) \$900. **SPEAKER SWITCHING:** McIntosh P349 \$500. **TUNERS:** Hafler DC330 (\$385) \$235; Marantz 10 \$850; McIntosh MR7082 (\$1499) \$1100; Perreux TU1 (\$650) \$400; Yamaha T520 (\$249) \$150. **TUNER PREAMPS:** McIntosh MX113 (\$1099) \$600. **TURNABLES:** AR ES1 with Premier MMT Arm (\$665) \$325; Thorns TD320 (\$549) \$415; TD321 (\$450) \$338. **NOISE REDUCTION:** Phase Linear 1000 (\$349) \$110. **TEST EQUIPMENT:** Audio Control SA3050 Spectrum Analyzer (\$895) \$790; Crown 2000 Watt Load Box \$500; Military Tube Tester \$165. **AUDIO CLASSICS—The SAFE, EASY, FAST way to Buy, Sell or Trade Your Precision Audio Components. FREE Catalogue. Layaway Program. Mastercard & Visa. 8AM-5PM EST Mon-Fri. By Appointment Only. Audio Classics, Lower Level, US Post Office Bldg., POB 176AAA, Walton, NY 13856. 607-865-7200.**
—Audio Advertiser Since 1979—

FOR SALE

AUDIO DESIGNS SPECIALIZES IN THE FINEST PREVIOUSLY OWNED AUDIO COMPONENTS PLUS CUSTOM TERMINATION BY ESOTERIC AUDIO. CALL OR WRITE: AUDIO DESIGNS, 5115 RED FOX, BRIGHTON, MI. 48116 (313) 229-5190.

FOR SALE

BEAT THE PRICE FIXERS WITH low discount prices and full U.S.A. manufacturers warranties on: Nakamichi, Revox, Carver, Bang & Olufsen, ADS, Kyocera, HK, Crown, Hafler, B&W, NAD, Tandberg, Polk, Island Audio, Inc., 1122 Riverside Drive, Holly Hill, FL 32017. (904) 253-3456.

Aural Symphonics, B&K, BEL, Cardas, Chesky, Clearaudio, Convergent Audio Technology, Eminent Technology, Magnum Dynalab, Mapienol, Meos, MFA, Morrison, Quicksilver, Reference Recordings, Sheffield, Souther, Straight Wire, Superphon, VPI and others. Audio Abode, Dallas, TX (214) 369-2092

The Best Deserves the Best



SME Series V
"The Best Tonearm in the World."

Talisman Virtuoso DTi

... "The best high output MC on the market and one of the best cartridges available regardless of type or price."

—Stereophile Magazine Vol. 9, #4

Sumiko

P.O. Box 5046, Berkeley, CA 94705
415-843-4500

It should come as no surprise that these two thoroughbreds work so well together. When we saw **SME's** remarkable achievement of rigidity, non-resonance and neutrality, we set about creating a phono cartridge designed to the same parameters.

Separately, each is recognized as the state-of-the-art in its genre. And, of course, the **SME V** will bring out the best in whichever phono cartridge you decide to use, just as the **Virtuoso** will perform superbly in other tonearms.

Together they are the single most faithful instrument for reproducing recorded music. Once you've listened to this combination, we think you'll agree. Call us at (415) 843-4500 and we'll rush literature to you and give the name of an audio specialist who can demonstrate **our best playing your best.**

FOR SALE

AAA-AUDIO ELITE IN WISCONSIN!!!

DENON, VANDERSTEEN, HAFLER, PS AUDIO, ACOUSTAT, YAMAHA B&K, JSE, CONRAD-JOHNSON, B&W, BOSTON ACOUSTICS, PROTON, CARVER, ONKYO, ADS, VPI, JBL, DCM, MIRAGE, SOTA, SPECTRUM, SONOGRAPH, AR, CANTON, COUNTERPOINT, GENESIS, FRIED, NITTY GRITTY, SUMIKO, THORENS, KEF, ADCOM, SUPERPHONE, SNELL, KYOCERA, M&K, HARMAN KARDON, INFINITY, BOSE, KLIPSCH, SPECTUM, UPI, JBL, MIRAGE, HK, BOSE, DAHLQUIST, SONOGRAPHY, WHY CALL US LAST? 414-727-0071. WE HAVE THE LOWEST PRICES!!!

CALL US WE CARE!!!

AAA-CALL US LAST! LUXMAN, DENON, AR, YAMAHA, CARVER, BOSTON ACOUSTICS, ADCOM, PS AUDIO, HAFLER, ADS, VANDERSTEEN, B & K, B & W, ONKYO, KEF, PROTON, SNELL, DCM, COUNTERPOINT, ACOUSTAT, JSE, SPICA, SUPERPHONE, M & K, CONRAD-JOHNSON, INFINITY, BOSE, KLIPSCH, SPECTUM, UPI, JBL, MIRAGE, HK, BOSE, DAHLQUIST, SONOGRAPHY. **WHY CALL US LAST? 414-727-0071. WE HAVE THE LOWEST PRICES!!!**

AAA-CARVER, DENON, YAMAHA, BOSTON ACOUSTICS, LUXMAN, AR ADCOM, PS AUDIO, HAFLER, ADS, VANDERSTEEN, B & K, B & W, ONKYO, KEF, PROTON, SNELL, DCM, COUNTERPOINT, ACOUSTAT, JSE, SPICA, SUPERPHONE, M & K, CONRAD-JOHNSON, INFINITY, BOSE, KLIPSCH, SPECTUM, UPI, JBL, MIRAGE, HK, BOSE, DAHLQUIST, SONOGRAPH, PLUS A LARGE SELECTION OF OTHERS 414-727-0071.

AAA J.S. AUDIO OFFERS AN EXTENSIVE product selection of **HOME AUDIO, CAR STEREO**, esoteric and the new **DIGITAL DISC PLAYERS AT EXTREMELY COMPETITIVE PRICES.** We provide ten years of audio sales experience, candid honest advice and full warantee on all products we sell. For pricing and stock information call: 301-890-3232 or write to: J.S. AUDIO, One Childress Court, Burtonsville, MD 20866. We honor Visa MC and COD Monday thru Friday 11AM-7PM, Saturday 11AM-4PM.

◆◆◆**AAA—LOWEST PRICES-QUALITY AUDIO**◆◆◆
DENON, HAFLER, CARVER, ADCOM, NAD, YAMAHA, PS AUDIO, VANDERSTEEN, B&K, KEF, POLK, B&W, BOSTON ACOUSTICS, PROTON, A.R., LUXMAN, COUNTERPOINT, SONOGRAPH, SPECTRUM, SNELL, THORENS, SUPERPHONE, CANTON, D.C.M., FRIED, GENESIS, MIRAGE, NITTY GRITTY, SOTA, SUMIKO, V.P.I., ONKYO, JBL, HK, ADS, M&K, ACOUSTAT, JSE, CONRAD-JOHNSON, PROTON, INFINITY, BOSE, HARMAN KARDON, DBX, KLIPSCH, THIEL, B&O, NAKAMICHI PLUS MANY OTHERS. AUDIO ENTERPRISES. (414) 722-6889.

◆◆◆ **MAKE US AN OFFER** ◆◆◆

AAA—LOW PRICES—HIGH END EQUIPMENT!!!
DENON, BOSTON ACOUSTICS, PS AUDIO, HAFLER, YAMAHA B&K, CARVER, AR, COUNTERPOINT, SUPERPHONE, LUXMAN, THORENS, M&K, SNELL, SPECTRUM, ACOUSTAT, ADS, VPI, CONRAD JOHNSON, APOGEE, B&W, JSE, SOTA, JBL, DCM, MIRAGE, ONKYO, PROTON, H.K., KEF, INFINITY, KLIPSCH and any others you desire. AUDIO ELITE. (414) 725-4431, Menasha, Wisconsin.
OUR PRICES CAN'T BE BEAT!!!

AAA—NOW IT'S TIME TO

CALL US!

YAMAHA—DENON—ADCOM—B&K—A.D.S.—BOSTON ACOUSTICS—HAFLER—JBL—B&W—PS AUDIO—VANDERSTEEN—PROTON—ACOUSTAT and many other lines

HI-FI HOTLINE

We have such a large selection we can't print them all. SO CALL 414-658-3111.

LOWEST PRICES ANYWHERE!!!

ALABAMA-WEST GEORGIA

Aragon, Audioquest, Beard, Carnegie, Creek, Garrott, Grado, Hafler, KEF, Kindel, Klipsch, Melos, Merlin, MIT, Music Reference, NAD, Premier, Promethean, Quad, RAM, Soundstream, Souther, SME, Spectrum, Thorens, Tube Traps, VPI, Well Tempered, Zapco, and more. AC-CURATE AUDIO, 110 E. Samford Ave., Auburn, AL 36830. (205)-826-1960.

ACTIVE ELECTRONIC CROSSOVERS

MODEL 120 CABINET & NEW 120-R "RACK AND PANEL" DESIGNS

Made to order in Butterworth bi-amp, tri-amp, or quad-amp configurations with optional level controls, subsonic filters, or summers. Filters, regulated power supplies, equalizers, are also available.

New catalog and price sheet. Free!

DeCoursey Eng. Lab.

11828 Jefferson Bl. Culver City, CA 90230
PHONE (213) 397-9668

FOR SALE

—AAA-QUALITY AUDIO-LOW PRICES—

ADCOM • CARVER • DENON • NAD • YAMAHA • PS AUDIO • THIEL • AR • KEF • JSE • DCM • COUNTERPOINT • LUXMAN • M&K • SOTA • SNELL • SPECTRUM • SUPERPHONE • THORENS • VANDERSTEEN • VPI • HAFLER • POLK • BOSTON ACOUSTICS • B&K • HARMAN KARDON • ONKYO • B&W • PROTON • KLIPSCH • INFINITY • B&O • NAKAMICHI • DBX • BOSE • ADS • JBL • PLUS MANY OTHERS. AUDIO ENTERPRISES (414) 722-6889.

—THOUSANDS OF SATISFIED CUSTOMERS—

BEST TRADES OFFERED. We buy, sell, trade, consign most high-end products. Audio Doctor, 1518 W. Commercial, Buffalo, MO 65622. 417-345-7245. COD-VISA-MC. Newsletter.

The Best Price on Sound Advice



At SOUND STAGE you can talk to a knowledgeable salesperson who will advise you on the best audio or video equipment that meets your needs and budget. From our large selection you can compare performance specifications and prices.

ALL SOUND STAGE equipment includes:

- 30-day best price protection
- free 3-year warranty with parts & labor
- free delivery

PLEASE, NO MAIL ORDER

NAD	CARVER	DENON	BANG & OLUFSEN
ADS	ALPINE	ENERGY	DBX SOUNDFIELD
CWD	GRADO	ELITE	AUDIO CONTROL
DCM	PULSAR	SIGNET	MONSTER CABLE
NEC	KLOSS	UNGO BCX	
M&K	AMBRIA	TALISMAN	

Call for store hours

(718) 961-9888

173 Broadway

NYC, NY 10007

[NW corner of

8 way & Cortlandt

Enter on Cortlandt

One flight up

OR

184-10 Horace Harding Expwy

Fresh Meadow NY 11365 (Ext 25 L1E)



FOR SALE

B&K AMPLIFIERS, PREAMPLIFIERS. High-performance electronics you can afford. AUDIO NEXUS, NJ (201) 277-0333

THE FULL-RANGE RIBBON EXPERIENCE



- ▲ CALIPER
- ▲ DUETTA
- SCINTILLA
- ▲ DIVA
- ▲ Nominal Impedance 4 ohms

Dubier/Tesky Photography

APOGEE ACOUSTICS, INC.

35 YORK INDUSTRIAL PARK
RANDOLPH, MA 02368
928121 APOGEE RAND

Four Ways Monster Lets You Hear All the Music

Most audiophiles and critics believe quality audio interconnect cables are essential for superior sound reproduction. Many consider Monster Cable Interlinks to be the very finest available.

With good reason. Bandwidth Balanced® construction. MicroFiber™ dielectrics. And Duraflex® insulation.

Each one a Monster—and industry—first. Each one ready to let you hear all your music. Audition them now at your nearest Monster dealer. And in your own sound system at home.

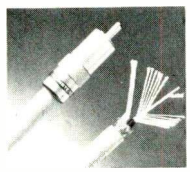

Interlink® M1000: The Sonic Reference Standard

M1000 employs Bandwidth Balanced phase-compensated windings and MicroFiber insulation to

transparently transfer the most subtle nuances and dynamic musical passages with unprecedented sonic clarity. Comes complete with patented M Terminator™ locking connectors. Quite simply, the very best.

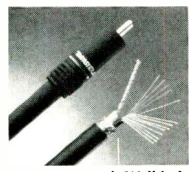

Interlink Reference A: The Audiophile Favorite

Our most popular interconnect, Reference A sets a performance standard by which other interconnects are

compared. Well balanced and incredibly natural, with accurate recreation of depth, ambience, and soundstage.

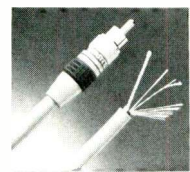

Interlink 500: Big Performance In A Small Package

Extended dynamic range, lower noise, and extreme clarity are just part of the sensational sonic

performance you enjoy with Interlink 500. Now add compact size, increased versatility, a moderate price, and Interlink 500 is a sure winner.

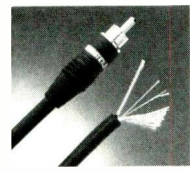

Interlink 400: Price/Performance Breakthrough

Monster technology and a high-performance sound more expensive cables can't match.

We invite you to compare Interlink 400 with any of the competition. Rated "best buy" by audio magazines.

Connect all your components with Interlink by Monster Cable. And bring out the best in your sound system

Monster Cable, 101 Townsend St.
San Francisco, CA 94107 Tel: 415 777-1355
Telex: 470584 MCSYUI Fax: 415 896-1745

MONSTER CABLE®
Advancing the Art of Listening

Wall-To-Wall Control.

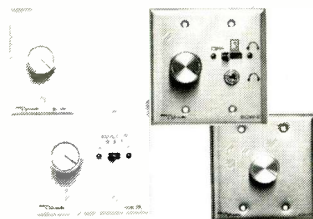

Our fine line of wall-mounted stereo volume controls allow you to adjust the volume from any room in your house.

We feature units with a headphone jack for private listening, or an A-B switch that enables you to select either one of two amplifiers as the sound source.

So switch the volume control from your amplifier to your wall. And take control of your sound environment.

Niles Audio Corporation.
The Control Connection To Your
Sights And Sounds.



P.O. Box 160818, Miami, FL 33116
(305) 238-4373

Niles Audio Corporation, Inc. ©1987

FOR SALE

ABSOLUTELY THE BIGGEST SELECTION IN THE SOUTHEAST! Acoustat, Adcom, AKG, AR, Aragon, Ariston, AudioSource, B&W, Belles, Beyer, Chicago Speaker Stand, Conrad-Johnson, Cramolin (professional packs), Dalquist, Discwasher Classics, ESB, Esoteric Audio, Grado, Grado Signature, Hafler, JPW, Koss, Magnum Dynalab, May Audio, Mod Squad, Monster, Niles, Proton Video, QED, Rata, Rotel, Sennheiser, Shure, Shure Ultra, Sonographe, Souther, Sumiko, Sumo, Syrinx, Systemdek, Target, Teac, Terk, Torumat, Tweek, Vampire, Van den Hul, VPI, Wharfedale, WBT, Zeta and much, much more! Come and see us! **HIGHER FIDELITY**, 1620 SOUTH BLVD., CHARLOTTE, N.C. 28203—800-438-6040 USA—800-221-7267 N.C.—704-376-0350 in Charlotte, N.C. area. Ask for Cal.

CARVER, NAKAMICHI, BANG & OLUFSEN, A.D.S., CROWN, REVOX, TANDBERG, HAFLER, ADCOM, MISSION, N.A.D., HARMAN KARDON, KYOCERA, YAMAHA, LUXMAN, DENON, KLIPSCH, B & W, KEF, D.C.M., E-V, J.B.L., INFINITY, D.B.X., AKG, AND OTHER QUALITY COMPONENTS. BEST PRICES—PROFESSIONAL CONSULTATION. ALL PRODUCTS COVERED BY MANUFACTURERS' U.S.A. WARRANTY. AMERISOUND SALES, INC., JACKSONVILLE, FLORIDA 32241 EAST: (904) 262-4000 WEST: (818) 243-1168.

Adcom Modifications from **D.R.H. WAVETRACE TECHNOLOGIES**. Through the use of F.E.T.'s and our proprietary circuit design we'll transform your **535, 545, and 555** into sonic gems. Ask about our **MONEY BACK GUARANTEE!** Also, **FULLY MODIFIED GFA-555's—\$995.00**. Call or write **D.R.H.** 2275 East Bay Drive, #1205C, Clearwater, FL 34624 813-536-2904

AUDIO BEST: LA, ORANGE, SAN BERNARDINO, CALIFORNIA. DEMONSTRATES PREAMP BEST BUYS: CONRAD-JOHNSON, AUDIBLE ILLUSIONS MOTIF PS, ADCOM, SUPERPHON, B&K, MOSCODE, MUSIC REFERENCE, CD BEST BUYS: SONOGRAPH, PS, AUDIOQUEST. ALSO, ACOUSTAT, PALANTIR, VORTEX, SPICA, SPECTRUM, RAUNA, SOUNDLAB, VELODYNE, WELL-TEMPERED-LAB, VPI, MAPLENOLL, SYSTEM-DECK, MAGNUM, PREMIERE, GRADO, ALPHASON, GARROTT, VDHUL, FOSGATE, TEAC, MIT, MONSTER, RANDALL, STRAIGHTWIRE. (714) 861-5413, appointment.

BRING THE FEELING OF A live musical performance into your home by adding a high quality, low priced subwoofer to your audio system. Free brochure. **NOSC**, Box 13023, Akron, OH 44313.

CABLE TV CONVERTERS. Scientific Atlanta, Jerrold, Oak, Zenith, Hamlin. Many others New **VIDEO HOPPER** "The Copy Killer". Visa, M/C & Amex. **1-800-826-7623**. B&B Inc., 10517 Upton Circle, Bloomington, MN, 55431.

FOR SALE

BLANCO ELECTRONIC SERVICES, 2702-A Pleasant Ave., Wellsburg, WV 26070 304-737-1001. **AUTHORIZED BOZAK DEALER** Used vintage equipment bought, sold, traded, Repairs, modifications, consultation. Tubes available. Catalog.

PLAY WITH THE BEST



"Of all the CD mats and damper discs we have tried, the best by far is the one from The Mod Squad."
J. Peter Moncreiff



"The Mod Squad 650 CD player is significantly more open and dynamic than any other CD player I have heard to date. It delivers the dynamic range that CD has promised since it first appeared but has never quite made good on."
Anthony H. Cordesman

The Mod Squad offers a unique portfolio of products and services. Call today (619) 436-7666 and ask what we can do for your system, or request a list of full-time dealers.

In Canada: May Audio Marketing, Longueuil
In France & The Netherlands: Audio Quartet, Nice
In Hong Kong: Sound Chamber
In Italy: P.F.A., Pisa
In Singapore & Malaysia:
Advanced Acoustics, Singapore

*The
Mod Squad*

In South Africa: Phonovox, Johannesburg
In Switzerland: Ensemble, Basel
In Taiwan: Sound Ray Electronics, Taipei
In Thailand: Audio Com., Bangkok
In United Kingdom:
Moth Group, Bedford

Department A • 542 Coast Highway 101 • Leucadia, CA 92024 • (619) 436-7666

FOR SALE

BOOKS FOR SALE. Rock, Pop, Jazz, Blues, Price Guides, Discographies, Biographies, more. Hundreds of titles. Free Catalog. Music Book Enz., Box 60, Randolph, Massachusetts 02368.

B&O RIBBON MICROPHONES. TWO MODEL 53'S. EXCELLENT CONDITION. BAFFLE & TWO CUSTOM BRACKETS. ASKING \$525. PHONE 604-384-6090.

CALL TOLL FREE! 1-800-826-0520 FOR: NAD, PROTON, H.K., HAFLER, B&W, TANDBERG, AUDIOCONTROL, DAHLQUIST, dbx, NITTY-GRITTY, 3D, CWD, REVOLVER, STAX, M&K, BELLES, MOSCODE, FRIED, AUDIOQUEST, THORENS, MONSTER, SNELL, ORACLE PRO-AC, GRACE, GRADO, DCM, TALISMAN, TIPTOES. FREE CATALOG. SOUND SELLER, 1706 MAIN ST., MARINETTE, WI 54143. (715) 735-9002.

CASH for your USED AUDIO EQUIPMENT. WE BUY by PHONE. CALL FOR the HIGHEST QUOTE. (215) 886-1650. The Stereo Trading Outlet, 320 Old York Road, Jenkintown, Pa 19046.

CONVERGENT AUDIO TECH. SL-1 TUBE PRE-AMP SAN DIEGO AREA music lovers will want to audition this "marvelous C.A.T.": other high value select components, including Wingate, Merlin, Vortex. Audio Archives, 619-455-6326.

COUNTERPOINT ELECTRONICS

Can make a significant improvement in the reproduction of music in most audio systems. We offer a full line of Counterpoint components starting at only \$595. Demonstrations by appointment. Visa and MasterCard. **WORLDWIDE EXPORTING.** Free delivery to ALL zip codes. OXFORD AUDIO CONSULTANTS, INC., Box 145, Oxford, OH 45056-0145, 513-523-3333, TLX427791.

DB-1B ALPS VOLUME CONTROL (80 DB) NOW available. Also: DB-1 to DB-1A, DB-1A to DB-1B. Power Amplifier update: DB-6 to DB-6A. Warranty extensions. DB SYSTEMS, Rindge, NH 03461. (603) 899-5121.

DIRECT-TO-TAPE RECORDINGS—Real-Time Duplicated Tapes. Also compact discs (classical/jazz)—excellent prices: ORFEO, CHANDOS, TELARC, DELOS, CAPRICCIO, DMP, GRP, ACCENT, other labels. Send \$1 for CATALOG and NEWSLETTER. Direct-to-Tape Recording, 14-R Station Avenue, Haddon Heights, NJ 08035.

ELECTRONIC CROSSOVERS, SUBSONIC FILTERS. For mono or stereo subwoofers, bi-amping, tri-amping, etc. Free flyer w/reviews. ACE AUDIO CO., #532-5th Street, East Northport, NY 11731-2399.



Brown Electronic Labs

2530 Berryessa Rd., Suite 126, San Jose, CA 95132

FOR SALE

ELECTROSTATICS—\$398/PAIR. EPI Stat 450s (see February AUDIO review). \$700 retail; 5-year warranty. UPS shipping extra. Sound Values, POB 551, Dublin, OH 43017. VISA MC: 1-800-HIFIKIT.

EXCEPTIONAL AUDIO REPRODUCTION SYSTEMS AD- COM, ALPHASON, AR, ARCAM, AUDIOQUEST, AUDIOSOURCE, AUDIRE, BRITISH (MUSICAL) FIDELITY, CHICAGO, CREEK, DUAL, GRACE, GRADO & SIGNATURE, GOLDRING, FRIED, HEYBROOK, KENWOOD BASIC, KYOCERA, LINN, LOGIC, MAS, MORDAUNT-SHORT, NITTY GRITTY, PREMIER, QED, RATA, REGA, ROTEL, SHINON, SPECTRUM, SPENDOR, SUPERPHON, SUPLEX, TALISMAN, TARGET along with LAST, LIVEWIRE and others. EARS, P.O. BOX 658-U, W. COVINA, CA 91790. 818 961-6158 EVENINGS, WEEKENDS. MC/VISA. MANY MONTHLY SPECIALS. PREPAID SHIPPING-SEND STAMP!!

GET LOW PRICES ON ALL TYPES of audio equipment—including high-end and even esoteric products not normally discounted. Now we can **SAVE YOU MONEY** on the equipment you really want. Extensive selection—no need to settle for second choice. Thousands of satisfied customers nationwide. **FAST DELIVERY** available. All products feature USA manufacturer's warranty. Call us for price quotes or friendly, expert advice. Catalog \$1. Member BBB and Chamber of Commerce. Est 1979.

THE AUDIO ADVISOR, INC.,
225 Oakes SW, Grand Rapids, MI 49503. (616) 451-3868.
AMEX/DISCOVER/MC/OPTIMA/VISA.

PRESS COMMENT ON VMPS

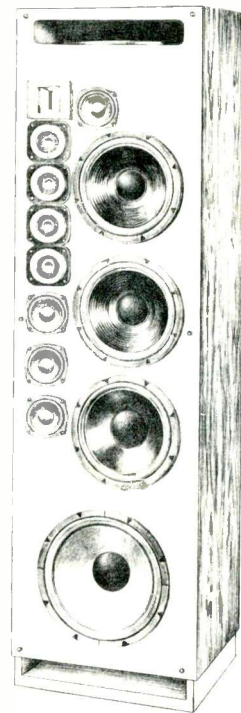

The VMPS Super Tower IIa/R Special Edition, \$1499/ea kit, \$1938/ea assem in oak, walnut, or sat in black. 76"x21 1/2"x17" (HxWxD), 300lbs.

In **The Best of Audio 88**, critic Anthony Cordesman offers "My Personal Honor Roll" a "brief list of more affordable reference speakers." Twenty top models are described; two are from VMPS. Mr. Cordesman comments: "The VMPS Tower II (\$1199/pr) [has] extraordinary power handling and bass capability. An unquestioned 'best buy' for lovers of organ, rock, large bands, full orchestra and grand opera. The VMPS Super Tower/R (\$1938/pr) [is] a bigger, smoother version of the Tower II, with a larger array of drivers [and] more open sound stage and depth, overall integration is excellent, bass relatively flat to 22Hz, and the speaker has tremendous power handling capability." (**A Search for the Ultimate Speaker System**, Nov 87)

VMPS manufactures two bookshelf, four floor-standing, and three subwoofer systems with the lowest total harmonic distortion, widest dynamic range, and greatest bass extension for size of any production loudspeakers. New for 1988 is the updated **Special Edition** of the Super Tower IIa/R featuring inverted harddome, woven fiberglass Superdome tweeters from France, all IAR Wondercap crossovers, Powerline II internal wiring, and the single amp conversion kit with biamp option. VMPS also distributes John Curls's **Vendetta Research** TPC 1 electronic crossover (\$449), SCP1 preamp (\$949), and the new MC to line level SCP 2 preamp (\$1895) with RIAA equalization and 300mV output.

Hear VMPS at the dealers listed below, or write us for brochures and test reports.

VMPS AUDIO PRODUCTS

div Itone Audio

3412 Enc Ct El Sobrante Ca 94803 (415) 222-4276

Hear VMPS at The Listening Studio, Boston, Par Troy Sound, Parsippany NJ, Dynamic Sound Washington DC, Audio by Caruso, Miami Fl, Arthur Morgan, Lake Mary Fl, Mountaineer Telephone, Beckley WV, Encore Audio, Lees Summit Mo, The Long Ear Coeur d'Alene Id, Ultimate Sound, Mesa Az, Reference Sound, Eagle Rock Ca, Efficient Stereo, Torrance Ca, Sounds Unique, San Jose Ca, Ultimate Sound, San Francisco Ca, Custom Audio, Novato Ca, Sound Impression, Cotati Ca, Itone Audio, El Sobrante Ca

One-Year, 6-Issues; Charter Subscription \$30.00

PSSST... WHAT DO THE ABSOLUTE SOUND AND STEREOPHILE HAVE IN COMMON?

COMPETITION... STARTING NEXT MONTH!

high end
Post Office 5826
Scottsdale, AZ 85261-5826
(602) 860-6044

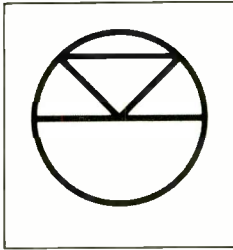

LINN HIGH FIDELITY Authorized Dealers

- ALABAMA**
Audiom, Homewood • Campbell Audio, Huntsville
- CALIFORNIA**
Audio Basics, Claremont • Musical Images, Fresno • Havens & Hardesty, Hgin Beach • Christopher Hansen, Los Angeles • Gene Rubin Audio, Monterey Park • Audible Difference, Palo Alto • Keith Yates Audio, Sacramento • Stereo Design, San Diego • Access to Music, San Francisco • The Audio Shoppe, Santa Monica • Systems Design, Sherman Oaks
- COLORADO**
Hi-Fi Shop, Colorado Springs • Audio Alternative, Denver • Audio Alternative, Ft Collins
- CONN.**
Carston Stereo, Danbury
- FLORIDA**
Sound Components, Coral Gables • Audio Visions, Tampa
- GEORGIA**
Music Audio, Atlanta • Sounds of Distinction, Atlanta
- HAWAII**
Audio Shoppe, Honolulu
- ILLINOIS**
Audio Musicale, Belleville • Glenn Poor's Audio, Champaign • Media Room, Chicago • Pro Musica, Chicago • Victors Stereo, Chicago • Glen Poo's, Normal • Sundown Audio, Normal • Sound Choice, Lisle • Absolute Audio Sys, Roundford • Sundown One, Springfield
- INDIANA**
Audiotrend, Evansville • Higher Fidelity, Ft Wayne • Audio Workshop, Indianapolis • Ovation Audio, Indianapolis
- KANSAS**
Golden Stereo, Overland Park
- KENTUCKY**
Ovation Audio, Lexington • Audio Video by Design, Louisville
- LOUISIANA**
Wilson Audio, New Orleans
- MASS.**
Tweeter, Etc., Danvers • Natural Sound, Framingham • MusicFirst West, Hatfield
- MICHIGAN**
Absolute Sound, Ann Arbor • Jemstone Audio, E. Lansing • Classic Stereo, Grand Rapids • Classic Stereo, Kalamazoo • Dr. Goodyears, Mt. Pleasant • Absolute Sound, Royal Oak
- MINNESOTA**
Audio Perfection, Minneapolis • Exclusive Sound, St. Cloud
- MISSOURI**
Superior Audio Radio, Columbia • Sound Room, Chesterfield • Sound Room, Cleve Coeur
- NEBRASKA**
Sound Environment, Lincoln • Sound Environment, Omaha
- NEW JERSEY**
Professional Audio Conslt, Milburn • CSA Audio, Upper Montclair
- NEW MEXICO**
Sound Ideas, Albuquerque • Ovation, Santa Fe
- NEW YORK**
Ears Nova, Great Neck • Innovative Audio, Brooklyn • Sound by Singer, New York • Sound Concept, Rochester
- N. CAROLINA**
Audio Salon, Charlotte • Stereo Sound, Chapel Hill • Stereo Sound Greensboro • Stereo Sound, Raleigh • Stereo Sound, Winston-Salem
- OHIO**
Audible Elegance, Cincinnati • Custom Stereo, Columbus • Stereo Showcase, Dayton • Audio Encounters, Dublin • Oxford Audio, Oxford • Hoffman's Stereo, Warrensville Hts
- OKLAHOMA**
Audio Dimensions, Oklahoma City
- OREGON**
Hawthorne Stereo, Portland • Northwest Audio Labx, Corvallis
- PENN.**
Audio Gallery, Pittsburgh • Community Audio, Philadelphia
- PUERTO RICO**
Precision Audio, Rio Piedras
- RHODE ISLAND**
Soundings, Middletown
- S. CAROLINA**
British American Sound, Charleston
- S. DAKOTA**
Western Stereo, Sioux Falls
- TENNESSEE**
Opus 2, Memphis • Audio Systems, Nashville
- TEXAS**
High Bias, Austin • Audio Concepts, Dallas • Audio Concepts, Houston • Concert Sound, San Antonio
- VIRGINIA**
High-C Stereo, Leesburg • Digital Sound, Virginia Beach
- WASHINGTON**
Definitive Audio, Seattle • Advanced Audio Systems, Tacoma
- WISCONSIN**
Specialized Sound, Madison • Audio Emporium, Milwaukee • Audiophile's, Verona
- CANADA**
Audio Corner, Barrie • Boutique of Sound, Calgary • L Audiophile, Chicoutimi • Globe Audio, Hamilton • K & A, Kelowna • Musiquaite Hi-Fi, Laval • London Audio, London • Martin Sound, Mississauga • Audio Club, Montreal • Opus Audio, Montreal • Studio 1006, Montreal • Dewar's, Ottawa • Audio Room, Peterborough • Sound Advice, Pine Falls • C.O.R.A., Quebec City • Harmony Audio, Regina • Better Music, Saint Katherine • Total Audio Plus, Saskatoon • Sounds Superior, Sault Saint Marie • Stereo Factory, Thornhill • Frons Hi-Fi, Thunder Bay • Audio Gallery, Toronto • Music Works, Vancouver • Sound Plus, Vancouver • Sound Hounds, Victoria • Sound Stage Fine Audio, Waterloo • Whitty Audio, Whitty • Better Audio, Windsor • Creative Audio, Winnipeg

STEREO • VIDEO CAR STEREO

Lowest prices on over 150 brands
PLEASE CALL OR WRITE FOR CATALOG

800 / 233-8375

9-6 M-Th / 9-3 Friday (Pacific Time)

ALDIO UNLIMITED

1203A Adams Avenue / La Grande, OR 97850
(503) 963-5731

FOR SALE

FRIED SPEAKERS & KITS

State-of-the-art! Amazing performance price. FREE shipping. Knowledgeable, friendly service. Audire, Chesky, CWD, Grato, Monster, PS, Quad, Sony-ES, Sota, Spica, Thorens, more. READ BROTHERS STEREO, 593 King Street, Charleston, South Carolina 29403. (803) 723-7276.

GOLDMAN-MARK LEVINSON. Goldman Studietto with T5 arm: \$2850, Levinson ML7A: \$3500. Meridian M3 speakers: \$800. Meridian Pro CD: \$700. Less than 50 hours on all equipment. Call Rob 213-838-2678.

HAFLER PREAMPS, POWER-AMPS, TUNERS & ACCESSORIES. MOST MODELS IN STOCK. CALL TOLL-FREE 1-800-222-3465 FOR ORDERING & PRICES. WE CAN'T BE BEAT! HCM AUDIO, 1600BB MANGROVE, CHICO, CA 95926. (916) 345-1341. VISA MC/AMEX.

HAFLER—XL-280 KITS & NEW PRICES!

Hafler's bold new amplifier, the XL-280, is so accurate that it can be directly compared with the ultimate reference—a straight wire with gain. We are stocking: XL-280K \$525, XL-280 \$600, DH-100K \$200, DH-100 \$250, DH-110K \$375, DH-110 \$450, DH-120K \$325, DH-120 \$375, DH-220K \$400, DH-220 \$500, DH-330K \$325, DH-330 \$385, DH-500K \$725, DH-500 \$850. Export units and accessories in stock. Three year warranty on assembled units (no suffix). Visa and MasterCard. WORLDWIDE EXPORTING. Free delivery to ALL zip codes. OXFORD AUDIO CONSULTANTS, INC., Box 145, Oxford, OH 45056-0145. 513-523-3333. TLX427791.

KINDEL PHANTOM SPEAKERS. NEUTRAL, MUSICAL, DARK OAK, BROWN GRILL, 40x18x6. MINT (BUYING HOUSE—NEED \$), CURRENT LIST \$1895, SELL \$895. 215-622-6587.

FOR SALE

JBL DD-55000 EVEREST: \$7400/PAIR, REVOX B-226 SIGNATURE BLACK, LIMITED EDITION CD PLAYER WITH B-208 REMOTE: \$1295, DBX 5BX-DS 5-BAND EXPANDER: \$1120, MICRO SEIKI DOX-1000: \$650. ALL FACTORY SEALED CARTONS, FULL WARRANTY. JOHN, PO BOX 34773, LOS ANGELES, CALIFORNIA 90034 (213) 837-2731.

J.B.L.—HARTSFIELD, OLYMPUS & PARAGON—All models custom made of premium wood & finishes—Components-&Kits shipped world wide. San Francisco's Pioneer since 1947. AES Charter Member. Hal Cox. MC & VISA. (415) 388-5711. San Francisco Area. Catalogue \$5; 164 Tamalpais Ave., Mill Valley, CA 94941.

JEMSTONE AUDIO serving Lansing and Southern Michigan. **PREMIUM EQUIPMENT/NICE PEOPLE.** New! Aragon, Melner, FRIED, Linn, Luxman, Meridian, Sumo, AR, Pulsar Video, Shure HTS. **NEWSLETTER! JEMSTONE AUDIO,** 325 Grove Street, East Lansing, Michigan 48823. (517) 332-1230 (**ELECTRONICALLY 517-332-1322**).

CARVER, NAKAMICHI, BANG & OLUFSEN, A.D.S., CROWN, REVOX, TANDBERG, HAFLER, ADCOM, MISION, N.A.D., HARMAN/KARDON, KYOCERA, YAMAHA, LUXMAN, DENON, KLIPSCH, B & W, KEF, D.C.M., E-V, J.B.L., INFINITY, D.B.X., AKG, AND OTHER QUALITY COMPONENTS. BEST PRICES—PROFESSIONAL CONSULTATION. ALL PRODUCTS COVERED BY MANUFACTURERS' U.S.A. WARRANTY. AMERISOUND SALES, INC., JACKSONVILLE, FLORIDA 32241. EAST: (904) 262-4000 WEST: (818) 243-1168.

LINN—OHIO, KENTUCKY & INDIANA

Hear Linn products in your home!! Some restrictions may apply. Please call us for details. OXFORD AUDIO CONSULTANTS, INC., Box 145, Oxford, OH 45056-0145. 513-523-3333.

MCINTOSH, MARANTZ (USA), conrad-johnson, Audio Research, Krell and other Precision Audio Components Bought-Sold-Traded. **FREE** Catalogue. See our list at the beginning of the classifieds. **Audio Classics,** Lower Level, US Post Office Bldg., POB 176MM, Walton, NY 13856. 607-865-7200. 8AM-5PM EST Mon.-Fri. By Appointment Only.

—Audio Advertiser Since 1979—

MCINTOSH

WANTED: MCINTOSH, MARANTZ, AUDIO RESEARCH, DYNACO, LEVINSON, KRELL, ALTEC, JBL, TANNAY, C.J. SEQUERRA, WESTERN ELECTRIC, TUBE & SOLID STATE, BUY-SELL-TRADE, MAURY CORB, (713) 728-4343, 11122 ATWELL, HOUSTON, TX 77096.

DIMENSIONAL PURITY

VANDERSTEEN AUDIO



MODEL 2C

Vandersteen Audio was founded in 1977 with the commitment to offer always the finest in music reproduction for the dollar. Toward this goal there will always be a high degree of pride, love, and personal satisfaction involved in each piece before it leaves our facilities. Your Vandersteen dealer shares in this commitment, and has been carefully selected for his ability to deal with the complex task of assembling a musically satisfying system. Although sometimes hard to find, he is well worth seeking out.

Write or call for a brochure and the name of your nearest dealer.

VANDERSTEEN AUDIO
116 WEST FOURTH STREET
HANFORD, CALIFORNIA 93230 USA
(209) 582-0324

FOR SALE

MARANTZ, MCINTOSH, OTHER CLASSIC and hi end tube equipment needed at top offers. Also want Paticians, Hartsfields, Jannoys, Jensens and better prewar radios! McIntosh C20: \$250, C22, 2505: \$395, 5100: \$300, MR71 just aligned: \$395, MR65: \$295, AE2 (2) + 20W2 (2) offers, Paragon 12 b.o. Cotter preamp in teak cab: \$1075, Berning original handmade preamp (rare): \$495, Leak pt. 1 and 250 amp: \$325, D23X over \$350, ADS10: \$400, Audio Authority 3.01 comparator: \$300, Dynavector diamond D23 mint: \$150, Marantz 7 mod 10B: \$650, SLT12 table: \$195, 20, 120, 150 and 2130 scope tuners. Theta amps pr.: \$700, Bedini-Strelloff 200 200: \$495, Rappaport class A amp: \$795, Tech EPA500 arm: \$350, R.G. Sign. expander: \$350. More under "Loudspeakers", N.Y.S.I. noon till 3pm (718) 377-7282.

MCINTOSH MC-60 \$750pr, MC-250 \$299, MX-112 \$450, MC-225 \$300, 1700 \$300, 1900 \$400, MX-110 s \$250-400, RCA shaded dogs & Mercury Living Presence COMPLETE UNIQUE collection \$30,000, Crown SL "C" phono modules \$100, Nakamichi 680 w dolby C \$650, Hi-Com-II \$300, ADS-10 perfect \$570, Phase 1000 \$165, 400 \$350, Sansui TU-9900 \$225, demo: AU-G55X \$200, Harman-Kardon demo: HK65C table \$325, Lux C120A preamp \$200, R.C.A. ribbon microphones: 77DX \$475, BK-11A \$190, Handpicked tubes 1963 vintage many types, Boothroyd-Stuart Meridian amplifier system \$450, Onkyo sealed TX-35 \$175, Sony LC90-FeCr \$11, LC60-FeCr \$6, LC90-SLH \$9, LC60-SLH \$4.50 elcaset tape, Teac AL-700 elcaset recorders originally \$1,100, factory sealed \$269, RX-10DBX DBX sealed \$200, remotes \$50, QUAD: Panasonic SH-3433 \$300, EV 7445 encoder \$475, Pioneer RTU44 recorder w remote \$1,250, Sony TC854-4S w selsync, new capstan motor!, remote \$1,200, Ortofon transformers STM-72 \$25, T-10 \$60, Mitsubishi DA-RB \$150, 900 prerecorded rtr \$7, 1/2 track \$18, Require collections pre-recorded openreel, McIntosh, Marantz (tube) units, Sony, Teac, Advent Dolby units, oddball pieces, accessories. Desire pre-eminent consignment items. Money back guaranty. Mail-order Specialist! Shipping worldwide. Martin Gasman 779 Worcester Street, Wellesley, Mass. 02181. Telephone: 617-CEL-TICS, 617-235-8427.31

NITTY GRITTY RECORD CLEANING MACHINES & SUPPLIES. MOST ITEMS IN STOCK. CALL TOLL-FREE FOR ORDERING & PRICES 1-800-222-3465. HCM AUDIO, 1600BB MANGROVE, CHICO, CA 95926. (916) 345-1341. VISA MC AMEX.

NORTHERN CALIFORNIA! IN THE BEAUTIFUL NORTH VALLEY YOU CAN FIND ACOUSTAT • B&O • B&W • BOSE • BOSTON ACOUSTICS • HAFLER • HARMAN KARDON • KLIPSCH • NAD • SONY & MORE. APPOINTMENTS WELCOME. GOLDEN EAR HI-FI. CHICO, CA. (916) 345-1762.

CALL US LAST

WE WILL BEAT ANY PRICE PRINTED IN THIS MAGAZINE ON AUDIO & CAR STEREO

The SOUND Approach
6067 Jericho Tpke., Commack, NY 11725
FAST DELIVERY (516) 499-7680
FULL WARRANTY

FOR SALE

MUSIC BY THE SEA

Southern California's premier audio salon offering music lovers exceptional products: ROWLAND RESEARCH • SOTA • MOD SQUAD • ET 2 • VIRTUOSO • SME • VANDERSTEEN • MIT • COUNTERPOINT • VAN DEN HUL • B&K • SPICA • ORACLE • WELL TEMPERED LAB • STAX • RAUNA • NITTY GRITTY • AUDIOQUEST • GRADO • HARMAN KARDON • SUPERPHON • MIRAGE • KOETSU • STRAIGHTWIRE • MAGNUM • VACCUM TUBE LOGIC • TUBE TRAPS • POLYPHASORS • Custom cables, expert turntable set-up, in-home auditions, system installation and a 2 week satisfaction guarantee. **MUSIC BY THE SEA (619) 436-7692; 542 North Highway 101, Leucadia, California 92024. Open Tuesday-Saturday 11-6 pm. Call for your MUSICAL NOTES newsletter.**

PASSIVE PREAMPS AT WHOLESALE PRICES. Factory direct. Beats the Mod Squad line drive. 2 week money back guarantee. Standard and custom models available from \$40 Write for details: Electronic Visionary Systems, 2531 Regent St. #17, Berkeley, Ca. 94704.

CARVER, NAKAMICHI, BANG & OLUFSEN, A.D.S., CROWN, REVOX, TANDBERG, HAFLER, ADCOM, MISSION, N.A.D., HARMAN KARDON, KYOCERA, YAMAHA, LUXMAN, DENON, KLIPSCH, B & W, KEF, D.C.M., E-V, J.B.L., INFINITY, D.B.X., AKG, AND OTHER QUALITY COMPONENTS. BEST PRICES—PROFESSIONAL CONSULTATION. ALL PRODUCTS COVERED BY MANUFACTURERS' U.S.A. WARRANTY. AMERISOUND SALES, INC., JACKSONVILLE, FLORIDA 32241. EAST: (904) 262-4000 WEST: (818) 243-1168.

- Acoustal • Arogon
- Boston/Acoustics
- B&W • Camber
- Carver • Celestion
- CWD • Dahlquist
- Dual • Hafler
- Infinity • Koetsu
- Krell • Madrigal
- Magnum • Meitner
- Meridian • MIT
- NAD • Onkyo
- Ortofon • Revox
- Rotel • SME
- Snell • Sony
- SOTA • Sumiko
- Velocityne

Quality Components
Qualified Sales
and Service

Sound & Music

351 Pleasant St., Northampton, MA 01060 (413)584-9547

FOR SALE

MONSTER CABLE PRODUCTS AT LOW PRICES! CALL TOLL-FREE FOR ORDERING & PRICES 1-800-222-3465. HCM AUDIO: (916) 345-1341. VISA/MC/AMEX.

AudioVisions

*the best in audio technology,
combined with old-fashioned hospitality*

• ON LONG ISLAND •

for music lovers who seek out excellence

electronics

- Audio Research • Bryston
Denon • Klyne • Magnum
Meridian • N.A.D. • Threshold

loudspeakers

- M & K • Mariah • Martin Logan
Paradigm • Thiel • Vandersteen

analogue and c.d. sources

- Adcom • Carnegie • Dual • Dynavector
Eminent Technology • Grado • Meridian 207
Oracle • Shinon • SME • Sonographe • SOTA
Sumiko • Thorens • Virtuoso • van den Hul

cables

- Audioquest • M.I.T. • Monster • Straight Wire

Service Throughout Metro N.Y.

Since 1981, AudioVisions has been setting new standards for service. Music lovers have willingly travelled hundreds of miles to come to our store. Why? Visit with us, and find out.

Appointments Are Requested

You don't want to be rushed. You and your audio consultant should be talking in depth with each other. When you're ready to audition equipment in the store, you'll want a really meaningful demonstration, with great attention paid to details. (Even the choice of cables can make a big difference.) *An honest, thorough demonstration takes time. We'll guarantee you that time.* Please just call us in advance.

Four Large Demo Rooms

Well travelled audio experts have told us that our demo facilities are among the very best in the country. Make an appointment to visit us, and see if you don't agree.

1067 MONTAUK HIGHWAY, WEST BABYLON
NEW YORK 11704 (516) 661-3355

AudioVisions

SOUND INVESTMENTS



From vibration absorbing record clamps to the extremely effective AQ Sorbothane Isolation Feet, AudioQuest has the right accessory to make your music system sound more like music.



Products that bring your system to life!

P. O. Box 3060 San Clemente, CA 92672 USA Tel: 714-498-2770 Fax: 714-498-5112 Tlx: 205864

DAT·PCM·CD

Audio Gallery has an excellent selection of these hard to find, high-end components, new and used.
MICRO SEIKI TURNTABLES, SAEC TONEARMS, HIGHPHONIC CARTRIDGES
 Turntable Systems from \$500 to \$15,000. CALL FOR A FREE LIST!
Audio Gallery • 2718 Wilshire, Santa Monica, CA 90403 • (213) 829-3429

FOR SALE

1988 HIGH END HI-FI SHOW IN SANTA MONICA APRIL 8, 9, 10. \$10.00 AT THE DOOR OR ADVANCE TICKETS AT \$7.95. CALL STEREOPHILE AT 505-982-2366; MAIL POB 5529, SANTA FE, NM 87502—CHECK, VISA, MC.

AUDIOPHILE ACCESSORIES

1. Audioquest (AQ) CD Stabilizer Rings
 Trial Kit: 15 Rings w/locator 19.95
 25 Rings w/locator 29.95
 Set of 50 Rings 49.95
2. AQ Automatic Tonearm Lifter 39.95
3. AQ Super Reflex Clamp (Delrin) 39.95
4. AQ Sorbothane Record Mat 31.95
5. AQ Carbon Fiber Record Brush 7.95
6. AQ Wonder Solder (1.5 oz) 9.99
7. AQ Sorbothane Isolation Feet (ea) 9.00
 Set of 4 35.94
8. AQ Sorbothane Tube Damper Rings (ea) 2.50
9. AR ES-1 Turntable W/AR Tonearm 399.95*
 AR ES-1 Turntable W/MMT Tonearm 549.95*
 CALL
10. ASC Tube Traps CALL
11. Rolltop CD Storage Cabinet (Teak)
 Holds 60 CD's 29.95
CLOSEOUT!
12. Chicago Speaker Stands w/spikes
 RJ-10 10", For Heavy Speakers 71.95**
 Hercules 15" 109.95*
 — For Spendor SP-1 or Equivalent.
 Hercules 25" 119.95*
 — For Spica, Proac, SL-6 or SL-6D0
13. Datagard 6 outlet electrical strip:
 3 stage spike/noise protection 39.95
 Deluxe 7 stage spike/noise filter 69.95
14. DB Cartridge Alignment Protractor 24.50
15. Grado Phono Cartridges XTE-1 15.00
 Sig MCX 255.00
 Sig BMX 169.00
 Sig MCX Stylus 169.95
 Sig BMX Stylus 94.95
16. Interconnect Cables: Distech, FMS!
 Livewire, MIT, Monster, VandenHul CALL
 14.95
17. LAST Record Preservative 14.95
 LAST Stylus Cleaner w/stylus brush 6.95
18. Magnavox CDB471 *CD PLAYER* 179.95**
 CDB472 219.95**
 CDB473 269.95**
 Magnavox CDB650 **Top Model** 349.95**
19. Mod Squad CD Damper 23.50
20. Monster Cable X-terminators (pr) 24.95
21. RAM/GoldAero Premium Grade Tubes CALL
22. RCA Connectors: Tiffany, WBT CALL
23. Sonex Acoustic Room Treatment CALL
24. Sound Anchors: State-of-the-Art Stands
 For Vandersteen IIC Loudspeakers 239.95
 Quad Stand from ARCICI 149.95*
25. SUMIKO TWEAK 14.99
26. Sumiko FB-1 Fluxbuster MC Demag 209.95
27. Tip Toes:
 For Electronics (1/2") 4.50
 For Loudspeakers (1 1/2") 6.50
 For Loudspeakers (Deluxe!) 8.95
 For Vandersteen, Hercules, Quad,
 & Sound Anchor Speaker Stands 8.50
 For Sota or VPI Tables 8.95
29. Turntable/CD Wall Shelves:
 Target TT-1 Turntable Wall Shelf 99.95**
 QED WF-1 CD Wall Shelf 99.95**
 VPI HW-5db "Magic Brick" 34.50
30. VPI HW-16.5 Record Cleaning Machine CALL
31. VPI Record Cleaning Solution: 1 gal. 19.95
32. SHIPPING CHARGES (48 STATES, UPS, INSURED)
 Accessories One Item 3.95
 Each Additional Item 1.25
 *Stands/Turntables 12.95
 **Electronics 8.95

CHARGE IT! (616) 451-3868
 AMEX/DISCOVER/MC/OPTIMA/VISA
 prices subject to change without notice



225 OAKES SW • GRAND RAPIDS, MI 49503

FOR SALE

Philadelphia Audiophiles

We proudly represent:

- | | | |
|-------------------|----------------|----------------|
| Acoustic Research | Infinite Slope | Pioneer Elite |
| Adcom | Kimber Cable | PS Audio |
| Alphason | Kindel | QED/Target |
| Arcam | Kinergetics | Rega Planar |
| Ariston | Lazarus | Rogers |
| Audible Illusions | Linn Sondek | Rotel |
| B&K Components | Magnavox CD | Royd Audio |
| Celestion | Maplenoll | Snell |
| Counterpoint | Micro Seiki | Soundcraftsman |
| Creek | Mission | Stax |
| Eagle Amps | NAD | Straightwire |
| Electrocompaniet | Naim Audio | Superphon |
| Golding | Parasound | Systemdek |

Plus 15 brands of cartridges and more!

SOUND SERVICE CO.

8010 Bustleton Ave. Philadelphia, PA 19152
 (215) 725-1177-78 Bank Cards Accepted

PS-AUDIO—SUPERB!

Fast, FREE shipping! Knowledgeable, friendly service! Audire, CWD, Fried, Grado, Mirage, Monster Cable, Quad, SME, Sony-ES, Sota, Spica, Straightwire, Superphon, Talisman, Thorens, more. READ BROTHERS STEREO, 593 King Street, Charleston, South Carolina 29403, (803) 723-7276.

SIDEREALKAP

THE SIDEREALKAP WAS DESIGNED FROM ITS INCEPTION TO BE THE FINEST SOUNDING CAPACITOR AVAILABLE FOR AUDIO TODAY.
 FIND OUT WHAT THE MUSIC LOVER'S CAPACITOR DOESN'T SOUND LIKE. CALL (619) 722-7707, OR WRITE TO: SIDEREAL AKUSTIC, 1969 OUTRIGGER WAY, OCEANSIDE, CA 92054.
 FREE LITERATURE AND PRICE INFORMATION UPON REQUEST.
 DEALER INQUIRIES INVITED.

FOR SALE

SALE, SALE—INCREDIBLE SALE

This is just the thing you need to perk up those mid-winter blues—a sale on selected product by Acoustat, Audionics, Counterpoint, Dynaco, Grace, Haller, Linn, Naim, Rogers, Walker and more. Call or write for details. Free delivery. OXFORD AUDIO CONSULTANTS, INC., Box 145, Oxford, OH 45056-0145, 513-523-3333. TLX427791.

SPECTRAL IS AT GOODWINS

Goodwins Music System is proud to offer the complete line of Spectral components for the music connoisseur. The DMC-6 and DMC-10 delta preamps are all on display for your musical enjoyment. The DMA-50 and the long awaited DMA-200 power amps also await your attention. The DMA-200 has the sonic purity of the DMA-50 coupled with seemingly limitless currently capability—a true tour de force. The latest product from Spectral is the SDR-1000 CD player, already considered a milestone by those who have heard it. In our opinion, Spectral represents enduring value with respect to its state of the art performance, quality of build, and proven reliability. Spectral has an eleven year history of standing solidly behind their electronics. And the integrity of the people at Spectral is clearly reflected in these exquisite products. We are very comfortable with and enthusiastic about these superb products. Please come share our excitement!
 Goodwins Music Systems 16 Eliot St.
 Harvard Square
 617-492-1140
 M-F 11-8 Sat 10-6 Cambridge, MA 02138

STEREO DESIGN FOR THE HOME, a 25 year old hard-cover book looks at "State of the Art" installations in 1962. \$5.00 including shipping & handling. Collectors Item. AUDIO CLASSICS, POB 176SD, Walton, NY 13856. 607-865-7200, 8AM-5PM EST Mon.-Fri.

—Audio Advertiser Since 1979—

STRAIGHTWIRE SPEAKER & INTERCONNECT CABLES IN STOCK. WE SHIP ANYWHERE! CALL TOLL-FREE FOR ORDERING AND PRICES 1-800-222-3465. HCM AUDIO: (916) 345-1341. VISA/MC/AMEX.

LOUDSPEAKERS

ABLE TO USE A SCREWDRIVER? OVER 30 PROVEN SPEAKERKITS FOR HOME, CAR, SUBWOOFER & PRO. JBL, B&W, AUDAX, SEAS, VIFA, MOREL; 24DB ELECTRONIC CROSSOVER; FFT SOFTWARE, 34 PAGE CATALOG, \$2. GOLD SOUND, BOX 141A, ENGLEWOOD, CO 80151.

AUDIO CONCEPTS INC., Speaker Building headquarters. AC kits compete with the finest in the world. Finest drivers, (Focal, Dynaudio, AC, Seas), AC Acoustic foam, Wonder Caps and much more! For catalog call toll free: 1-800-346-9183. 1631 Caledonia St., La Crosse WI. 54602.

SHURE • ORTOFON • TALISMAN

We Are Proud To Offer
 A LARGE SELECTION OF:

NEEDLES CARTRIDGES

TOLL FREE

(800) 342-9969



High Quality Turntables
 & Accessories in Stock...

M&Y CO.

8344 Melrose
 Los Angeles

Featuring

- ORTOFON
- SHURE
- GRADO
- DYNAVECTOR
- AUDIO TECHNICA
- PICKERING
- SIGNET
- GRACE
- TALISMAN
- STANTON
- PREMIER
- AUDIOQUEST
- CARNEQUE ONE
- THORENS
- AR
- MICRO SEIKI
- AND MANY MORE...

SIGNET • MONSTER CABLE • GRACE

L LOUDSPEAKERS

ABSOLUTELY UNPARALLELED IN EXCELLENCE: Audition these remarkable, patented JSE Infinite Slope loudspeakers in your own home on our minimum 7 Day—**NO RISK AUDITIONING** Policy. We pay shipping. Authorized JSE: Fried, Spectrum, Counterpoint, Superhph, Kinergetics, B&K, Hafler, Magnum Dynalab, Thorens, Audioquest, Apature. **PARASOUND** dealers, **SOUND UNLIMITED**, 169 Church St., Bristol, Conn. 06010. Est 1959. (203) 584-0131.
MC/VISA AMEXP ACCEPTED

A&S SPEAKERS offers the widest selection of high-end speaker kits, drivers and systems from Europe's and America's most respected manufacturers. Audax, Dynaudio, Scan-Speak, Focal, Peerless, VMPS, Morel, Eminence, Peerless, Jordan, others. Write, call or come in for free 1988 catalog. **A&S SPEAKERS**, 3170 23rd St., San Francisco, CA 94110. (415) 641-4573.

BEVERIDGE 2 (orig) powered: \$2200. 2 SW oak: \$2000. model 3 (orig \$6m): \$1500. CM2 eq: \$100. Dayton Wright XG10III w/woofers (orig \$5400): \$1600. Synthese (Belgian orig \$2900): \$1200—very unused! Strathern ribbon 6 element system w/\$600 R&B tweeters and honeycomb woofers. 8 enclosures: \$1100. RJR DR1 electrostatics (orig \$3400) w/powered woofer: \$1000. Empire Grenadier 8000 w/marble: \$475. Stacked Quad E SL's mint: \$1395 or b.o. JBL Paragon system: \$3200. Metrogon: \$1400. (718) 377-7282 noon-3pm.

B&W 802F WALNUT. S/N 3535.3536. EXCELLENT & BEAUTIFUL. \$1250 PLUS SHIPPING. B&W 80xF HOODS, BROWN, EXCELLENT. \$130 PLUS SHIPPING. PETER 914-429-8572

CARVER, NAKAMICHI, BANG & OLUFSEN, A.D.S., CROWN, REVOX, TANDBERG, HAFLER, ADCOM, MISION, N.A.D. HARMAN/KARDON, KYOCERA, YAMAHA, LUXMAN, DENON, KLIPSCH, B & W, KEF, D.C.M., E-V, J.B.L., INFINITY, D.B.X., AKG AND OTHER QUALITY COMPONENTS. BEST PRICES—PROFESSIONAL CONSULTATION. ALL PRODUCTS COVERED BY MANUFACTURERS' U.S.A. WARRANTY. AMERISOUND SALES, INC., JACKSONVILLE, FLORIDA 32241. EAST: (904) 262-4000 WEST: (818) 243-1168.

DB SYSTEMS ELECTRONIC CROSSOVERS—6 to 36 dB per octave. NEW 36 dB In Phase, Snell type crossovers. Main St., Rindge, NH 03461 (603) 899-5121.

FIND OUT WHY AUDIO CONCEPTS INC. sells more high-end speaker kits than anyone in the country. Call Toll Free: 1-800-346-9183.

FRIED LOUDSPEAKERS: Legendary, Fantastic. AUDIO NEXUS has them all. NJ (201) 277-0333.

"GOLDSTANDS"

FULLY ASSEMBLED SPEAKER STANDS Very Effective. Superior Quality, many models, angles, straights, spikes, sand-filled, custom stands readily available. Fast delivery and remember completely assembled. Free catalog. Goldstands, 229 Nassau Rd., Huntington, NY 11743. (516) 427-4813.

JBL, ALTEC, ELECTRO-VOICE speaker components and systems. JBL Studio Monitors, Altec 19 kits, UREI, Carver, Crown QSC professional amps. JBL 2235H's \$170.24. 12ga. speaker cable 500' \$115. Low prices! Rick Marder, AH Co. 201-561-8123.

JSE INFINITE SLOPE LOUDSPEAKERS: 10-Day, moneyback, home auditions. Free shipping. AUDIO NEXUS, NJ (201) 277-0333.

LEGACY LOUDSPEAKERS BY REEL TO REAL DESIGNS combine Edge-of-the-Art design with Old World Craftsmanship. A marriage of the finest speaker components from England, France, Denmark and the United States. "... exceptional value" says The Sensible Sound. "... a world class speaker" E.H., South Carolina. "... the best speaker enclosures I've heard" I.M., Massachusetts. Exquisite cabinetry. Quality assured by a ten year warranty. Auditioned in the only relevant environment—YOUR HOME. Retail or factory direct. From \$496/pr shipping prepaid. RTRD, 2105 Claremont, Springfield, IL 62703. (217) 529-8793.

FM ACCESSORIES

MAGNUM/DYNALAB FM SIGNAL BOOSTER

Signal Sleuth 105 FM 99.00-(orig. 190.00)
Signal Sleuth 2002 (mobile) 99.00-(orig. 190.00)

MAGNUM/DYNALAB FM ANTENNAS

ST-2 Omni-directional — 69.00
SR-100 Silver Ribbon tuneable — 17.00

TERK AMPLIFIED ANTENNA 69.00

MAGNAVOX CD PLAYER SALE
CDB 650 — CALL CDB 465 — 219.00



(914) 666-0550

PO. Box 673
Bedford Hills, New York 10507-0673

LOUDSPEAKERS

GUSS 3-D SPEAKER SYSTEMS

"State of the speaker builder's art... the loudspeaker equivalent of the Holy Grail..." (Review). From \$3000. Demonstrator models, 50% discount. (212) 582-8871.

LEGACY-1 LOUDSPEAKERS BY REEL TO REAL DESIGNS: Probably the most accurate speaker system you'll ever own. Samarium Cobalt leaf tweeter hands off to a 30mm European dome. Vocals are recreated by the most remarkable cone driver anywhere. A multi-chambered, slot-loaded dual woofer configuration extends bass response to 16 Hz. Biampable through Tiffany gold binding posts and high definition cable. Elegant 43" tower design. Ten year warranty. \$1496/pr shipped prepaid. Ten day home trial. RTRD, 2105 Claremont, Springfield, IL 62703. (217) 529-8793.

motif mc seven

A dual-monaural f.e.t. preamplifier designed and manufactured by conrad-johnson design, inc.

For information, write:

conrad-johnson design, inc.
2800R Dorr Ave.
Fairfax, VA
22031

703-698-8581



GRAB LAST MONSTER COILS

YOUR SEARCH IS OVER!

We specialize in hard to find phono cartridges and original replacement styli.

(800) 221-0906

CALL TOLL-FREE FOR FREE PRICE QUOTES AND VISA/MC ORDERS N.Y. STATE (516) 599-1112

SEND SELF ADDRESSED STAMPED ENVELOPE FOR OUR FREE CATALOG.

LYLE CARTRIDGES

Dept. A, Box 158
Valley Stream, N.Y. 11582

Phones Open Mon-Sat 9 am-8 pm

ortofon **SHURE** stanton

Dynavector Bang & Olufsen PICKERING

C&A AUDIO

NY & NJ's Authorized Dealer of Highest Quality Audio

193 Bellevue Ave. 201-744-0600 Upper Montclair, NJ 07043

LOUDSPEAKERS

LOUDSPEAKER COMPONENTS-KITS. Dynaudio, Morel, Eclipse, Focal, Peerless, Eton, Vifa, more! Crossover parts—design books also. Catalog \$1. Meniscus, 3275W Gladiola, Wyoming, Michigan 49509. (616) 534-9121.

SUPER OFFER premium blanks as low as 24¢ each!

Here's a first for audiophiles, as of right now, you can buy branded, high quality, bulk-packed audio cassettes *directly from the manufacturer at factory-direct prices!*

Call Greencorp toll-free today and we'll ship your tapes U.P.S. tomorrow. (Call for other sizes and quantity rates.)

**Duplicator Quality,
Music-Grade XDS Cassettes**
(price each in quantities shown)

	25	100
C10-C12	34	.24
C30-C32	35	.25
C45-C47	37	.28
C60-C62	39	.30
C90-C92	45	.36

**CD Quality, High Bias, Chromium
Dioxide Cassettes**

C60	.60	.48
C90	.82	.69

**Norelco-type library boxes:
clear top or all-clear**

.15 .13

Self-adhesive, white cassette labels
\$3.00 per 100

**TELEPHONE ORDERS:
TOLL FREE (800) 972-0707
In Florida (305) 925-0707**

SATISFACTION GUARANTEED! If not satisfied for any reason, return the cassettes for a full refund

- Minimum order \$10.00 Shipping extra, U.P.S. is 8% (min \$3)
- We gladly accept company or personal checks, or charges to Visa, Mastercard or American Express

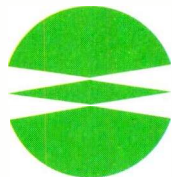

GREENCORP

U.S. Sales Office: 3505 S. Ocean Drive,
Hollywood, FL 33019.

LOUDSPEAKERS

SPEAKER BUILDER

The world's only magazine for people who love building all kinds of loudspeakers—from bookshelf kits to electrostatics to horns. A rich mix of how-to-do-it and theory. Only \$35 for 2 years (12 issues), 1 year for \$20.

SPEAKER BUILDER

Box 494, Dept. A82, Peterborough, NH 03458 USA
(Outside USA add \$4/year postage. US \$ only.)

VANDERSTEEN LOUDSPEAKERS; PUT A LEGEND in your livingroom. AUDIO NEXUS, NJ (201) 277-0333.

AUTO SOUND

CARVER, NAKAMICHI, BANG & OLUFSEN, A.D.S., CROWN, REVOX, TANDBERG, HAFLER, ADCOM, MISION, N.A.D., HARMAN KARDON, KYOCERA, YAMAHA, LUXMAN, DENON, KLIPSCH, B & W, KEF, D.C.M., E-V, J.B.L., INFINITY, D.B.X., AKG, AND OTHER QUALITY COMPONENTS. BEST PRICES—PROFESSIONAL CONSULTATION. ALL PRODUCTS COVERED BY MANUFACTURERS' U.S.A. WARRANTY. AMERISOUND SALES, INC., JACKSONVILLE, FLORIDA 32241. EAST: (904) 262-4000 WEST: (818) 243-1168.

CD PLAYERS

COMPACT DIGITAL PLAYERS!

Knowledgeable service! Finest brands: Sony-ES, more. Also, Audire, CWD, Monster, PS, Quad, Spica, more. READ BROTHERS STEREO, 593 King Street, Charleston, South Carolina 29403. (803) 723-7276.

J.S. AUDIO OFFERS Compact Disc Players from the inexpensive to the esoteric, plus a complete selection of audio components at competitive prices. For more information Mon. thru Sat. please call 301-890-3232. J.S. Audio, One Childress Court, Burtonsville, MD 20866. We honor Visa & M/C.

MAGNAVOX

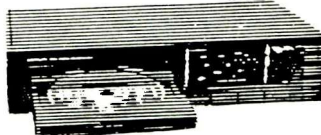

**You'll Love Q Audio For
Prices & Delivery On
Compact Disc Players Starting @**

\$149.88

CD8 470 \$149.88. Call for best price on 471-472-473-650 and all latest models.

All models new. Mail order only. We will not be undersold.

We carry all models of Magnavox & Philips CD Players.



95 VASSAR ST.
CAMBRIDGE, MA
02139

617
547-2727

COMPACT DISCS



COMPACT DISCS AND ACCESSORIES

Call for FREE catalog. Requests welcome 24 hours a day. Retailer prices available

CT call
1-452-0203

1-800-ALL DISC

41 Monroe Turnpike, Trumbull, CT 06611

COMPACT DISCS—AT LOW WAREHOUSE PRICES. Now in our 5th year. Free catalog. Oz Warehouse, 1575P Hwy 29, Lawrenceville, GA 30244. (404) 962-6180.

PREVIOUSLY-OWNED COMPACT DISCS! Buy, Sell, Trade. Free Catalog, Information. The CD LINK, P.O. Draw 5596, Greenville, SC 29606.

WE'RE MUSIC TO YOUR EARS

- Free Catalog of CD's
 - Same day shipping if you order before 12:00n EDT.
 - \$1⁰⁰ DISCOUNT per disc on orders of 10 or more.
 - \$2⁵⁰ for UPS Cont. U.S. shipments.
- Call Toll Free to order:
USA 1-800-232-3687
NYS 1-800-537-7303**

P O Box 616, Clifton Park, NY 12065
518-664-2550



REFERENCE RECORDINGS

"THREE-WAY MIRROR" sees itself in your future! Airtio Moreira, Flora Purim and the late, great Joe Farrell make jazz of many colors, with Mark Egan on electric bass, guitarist Jose Neto and others. Hear Airtio. THE Brazilian percussionist, as a straight-ahead jazz drummer. Hear Flora Purim caress four new tunes with her legendary voice. Hear echoes of "Dafo's" in more of Airtio's atmospheric jungle music. Hear Joe Farrell's flute and saxes embroider all this in his last recording session, engineered, naturally, by Prof. Johnson (RR-24), "NOJIMA PLAYS LISZT," and how! Japan's foremost pianist in his first American recording will take your breath away. Power, accuracy, poetry; he has it all, and more. The demonic Liszt Sonata, Mephisto Waltz and others are brought to life in full-blooded Prof. Johnson sonics (RR-25). Both new titles available on Digital Master compact disc or Pure Analogue 33-1 3 rpm LP (\$16.98 each) postpaid. Visa/MC welcome. Free catalogue/reviews. Dealer inquiries invited. REFERENCE RECORDINGS, Box 77225X, San Francisco CA 94107. (415) 355-1892.

PARTS & ACCESSORIES

ELECTRON TUBE SALES 6DJ8 6AN8A 6CA7 6L6GC 6550A EL34 KT77 KT88 EF86 Same day shipping from stock Industrial Tube Distributors since 1947. 4000 Types in stock. A R S Electronics, 7110 DeCelis Place, Van Nuys, Ca. 91406. 1-800-422-4250.

MARANTZ, MCINTOSH, A.R.C., BEVERIDGE, other classic and contemporary tube gear. Call w/your best offer! Also need Patricians, Hartsfields, Jensens, Jannoys and better prewar radios. N.Y.S.I. (718) 377-7282 noon-3pm.

SALE! MOGAMI NEGLX CABLE: 2534 interconnect \$.50; 2513 speaker \$2.00; Gold Aero exceptional tubes 25% off present inventory. Martin Gasman 779 Worcester Street, Wellesley, Mass. 02181. Telephone: 617-CEL-TICS. 617-235-8427.

TUBES & ACCESSORIES WITH ADVICE on tubes, mods., system design, new & used components. Amperex, EE, GE, Gold Lion, Mullard, Sylvania, Tungstram. Exclusive US rep. Siemens/Telefunken. Great prices. Consultant/supplier to manufacturers, dealers, clubs, individuals. Douglas Kent Smith Consulting, 240 W. Pike St., Canonsburg, PA 15317-1163. (412) 746-1210.

PARTS & ACCESSORIES

BRISSON/MIT CABLES, customized ATHENA PolyPhasors, MI-330/Shotgun custom interconnects, tonearm sets, WBT locking RCA, and Camac terminations for Goldmund and Levinson. Brisson hookup wire for audio constructors, MIT wiring harness & extensive mods for INFINITY RS-1, custom threaded Tiptoes for any component, ASC Tube Traps, Chateauroux & Wonder Caps & solder, Resistas, connectors, etc., \$1.00 catalog, Michael Percy, Box 526, Inverness, CA 94937. 415 669-7181.

AUDIOPHILE RECORDS

AUDIOPHILE WAREHOUSE LIQUIDATION! Direct-to-Disc, Halfspeed Masters & Quix II Recordings. Approximately 2500 available! Great Titles—Great Prices! First Come—First Served! Call for Price List. The Elusive Disc, (213) 388-7176.

BLANK TAPE

3.95 SHIPPING ANY SIZE ORDER, UPS 1-800-245-6000

TDK	T/120/1750	HG	MAXELL
MAX 90	5.79	TDK MAXELL 3.79 4.79	SONY UX3 90 1.99
MAX 90	3.48	TDK HDPRO 7.49	SONY UX55-90 2.49
MAG 90	2.95	MAXELL GOLD 5.59	SONY UXJ-PRD 90 2.89
HXS 90	2.99	KONICA 3.49	SONY ES-90 3.99
SAR 90	2.09	FUJISONY 3.79 4.79	JVC G1-90 7.9
AD90	1.99	FUJISONY 3.79 4.79	JVC G1-90 7.9
SA 90	1.59	BASF CSE 100 1.99	UR 120 1.99
SA-60	1.59		UR 90 99
ADS 90	1.69		UR 60 89
D-90	99		KL135-90B 6.99
D-40	89		UD35-90 4.99
FR100	1.69		BASF METAL 120 4.99
JVC M2B 90 1.38	JVC ME 90 2.89	FUJIMETAL 120 2.99	

TAPE WORLD

WE WILL BEAT ANY PRICE OF THE TOTAL ORDER INCLUDING ALL SHIPPING & HANDLING CHARGES BY 11%
3.95 SHIPPING ANY SIZE ORDER (C.O.D. ADD 1.95)
ALL TAPES HAVE U.S. WARRANTIES

VISA, MC NO EXTRA CHARGE

M-F 8:30-5:00
412/283-8821
800/245-6000

TAPE WORLD 200 SPRING ST BUTLER PA 16001
TRIAD, AND KONICA CALL

WANTED TO BUY

ALWAYS PAYING TOP \$\$ FOR MCINTOSH, M. LEVINSON, KRELL, ARC, C. JOHNSON, AND SIMILAR HIGH QUALITY PRODUCTS. CALL OR WRITE: JOHN WOLFF, 5115 RED FOX, BRIGHTON, MI. 48116. (313) 229-5190.

AUDIO CLASSICS the SAFE, EASY, FAST way to Buy, Sell and Trade Your Used Equipment. 8AM-5PM EST Mon-Fri. By Appointment Only. **Audio Classics**, Lower Level, US Post Office Bldg., POB 176AAA, Walton, NY 13856. 607-865-7200.

—Audio Advertiser Since 1979—

IT'S WORTH IT CALLING ME! McIntosh, Marantz Tube components, Western Electric, Altec, JBL, Jensen, Tannoy Lan-Gevin Trusonic Raw speaker, Tube etc., top cash. Henry Chang, 309 E. Garvey Ave., Monterey Park, CA 91754. (818) 571-6274 LAX.

MCINTOSH, MARANTZ TUBE, MCINTOSH S.S. equipment, Western Electric, Tubes, Speakers, etc. TOP CASH. Scott Dowling, 9908 Daines Drive, Temple City, CA 91780. (818) 286-9122, evenings weekends.

MCINTOSH, MARANTZ TUBE COMPONENTS, Western Electric, Altec, Tannoy, JBL, Jensen, other collectibles. John Conrad, 1178 Blackbird Street, El Cajon, CA 92020. (619) 449-9155.

TOP PAYING FOR MCINTOSH, MARANTZ TUBE AMP McIntosh Solid state, Western Electric, JBL, Altec, Tannoy Speakers & Horn, EMT Turntable, SME Arm, Torch Fire & Co., Temma—(516) 997-7633. (516) 496-2973.

WELL-KNOWN TOP PRICES BUYER: McIntosh, Marantz, ARC, Quad, Western Electric, tube equipments, Early speaker systems, units, by Tannoy, EV, JBL, Altec, Jensen, W.E. Brand new tubes: ECC82 83 EL-34, KT66 88, 6L6, 6550, David Yo, PO Box 832 Monterey Park, CA 91754. Tel: 818 576-2642.

BUSINESS OPPORTUNITIES

ATTN: AUDIO DEALERS, COTTY Headphones, 24 models, and Opto solar battery rechargers. Create your profits! Yuhan's, 285 Sobrante Way, Suite M., Sunnyvale, CA 94086. Ph. (408) 749-8280 Fax. (408) 749-8259.

GET PAID for reading books! Write: Ace-NN, 161 Lincolnway, North Aurora, IL 60542.

INTRODUCING MUSIC RIBBON 32 SPEAKER CABLE (9 Ga. at \$5.00/FT.)

FLAT Low Inductance Design with Polypropylene encapsulated OFC Conductors. Produces the most accurate amplitude and phase response resulting in superior dimensionality, resolution and focus. Color choices of tan or white to suit any decor. AVAILABLE as MUSIC RIBBON 16 (12 Ga. @ \$2.50/FT.)

STRAIGHT WIRE

1909 HARRISON ST., SUITE 208 • HOLLYWOOD, FL 33020 • (305) 925-2470

TURNTABLES

SOTA SAPPHIRE & STAR SAPPHIRE TURNTABLES: Beautiful craftsmanship, unsurpassed sonics. AUDIO NEXUS, NJ (201) 277-0333.

SERVICES

AUDIO PULSE SERVICE. Factory trained technicians. New Digital Time-Delay Systems with power amplifiers available. White Labs, 10528 Lower Azusa Rd., Suite 192A, El Monte, CA 91731. (818) 446-5346.

PUBLICATIONS

"THE AUDIO CRITIC" IS BACK!

After an absence of more than six and a half years, the toughest, most original and most serious critical journal in audio is back in business again. The Fall 1987 issue of THE AUDIO CRITIC discloses surprising information, unavailable elsewhere, on amplifiers, phono technology, speakers, etc. The Winter 1987-88 issue, heavy on speakers and CD players, is coming soon. Subscriptions are now being taken for four issues a year, starting with No. 10 (Fall 1987). Send \$22 (no Canadian dollars, \$10 extra for overseas delivery) to THE AUDIO CRITIC, 800 GRAMATAN AVENUE, MOUNT VERNON, NEW YORK 10552.

MISCELLANEOUS

NEW IDEA? Innovation Center in Washington, D.C. will assist you through Research and Development! Free Kit—1-800-257-7880.

SOTA's Reflex Clamp is Here!



Ready to Hear LP Perfection?

SOTA's new record clamp combines simplicity of use, elegance, and unequalled performance. True Reflex action. Rigid, massive, yet decoupled during play. The ideal match for the SOTA Supermat.

Capture part of the SOTA achievement. Experience how perfect an LP can sound! Warning: Both may be addictive!

SOTA
industries

P.O. Box 7075, Berkeley, CA 94707

Improve the sound of any speaker.

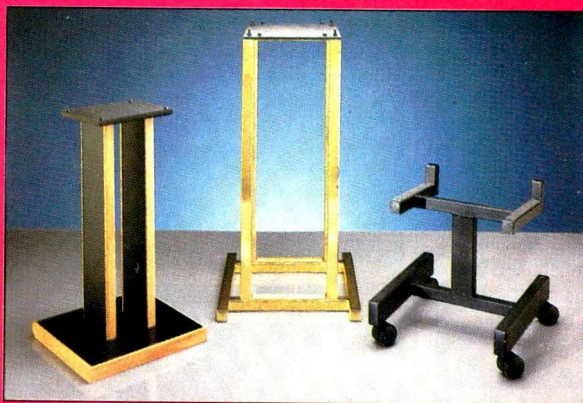

Yes, your speakers can sound as if they cost twice as much. Chicago Speaker Stands' are rigid and spiked to prevent the movement that causes smearing and blurring of the musical event. Chicago Speaker Stands must be heard. Over 25 Models. Prices start at under \$40 per pair.

Chicago Speaker Stand

American quality and technology made in the USA

312-745-5500

800-882-2256

TAPE DECKS/EQUALIZERS/HEADPHONES AMPLIFIERS/COLOR TELEVISIONS/VIDEO PROCESSORS/COMPUTER FURNITURE/CAR STEREO RADAR/ALARM HOME SECURITY/PERSONAL PORTABLES/CLOCKS

J&R MUSIC WORLD

Koss JCK/200 \$1177
"Kordless Stereophones"
 • The ultimate in convenience and sound for the true music lover
 • Closed ear design • Digital ready driver • Includes transmitter, wireless stereophones & AC adaptor • List \$150

JVC XL-7000B \$399.95
Multi-Disc CD Changer
 • Your digital jukebox • 6 disc magazine and single disc tray
 • Program up to 15 of your favorite selections from 7 discs • Wireless remote • Digital filter • Large LED display • Black • List \$600

Toshiba DX-900 VHS CALL
PCM Digital Hi-Fi Stereo VCR
 • Digital special effects • Picture-in-picture • Avanced heads • Hi-Fi stereo cable ready tuner • 37 function wireless remote • On screen display • PCM digital audio recording • Black • List \$299

Teac W-770 \$269.95
3-Head Hi-Fi Pro Cassette Deck
 • Dolby B/C noise reduction • Hi-Fi Pro dynamic expansion system • True tape monitoring • Bias free tuning • Programmable music search • Black finish • List \$469

Shure V15 Type V-MR \$129.95
MicroRidge Phono Cartridge
 • Micro ridge stylus tip • Excellent modularity • Dynamic compliance • Side guard stylus protection • Dual-point alignment gauge • List \$275

JVC RX-950VBK CALL
High Power A/V Receiver
 • Features 120 watts per channel plus 7-band equalizer with spectrum analyzer display • 3-video inputs for complete outboard • Wireless remote • Black finish • List \$749

Teac W-990RX CALL
Double Reverse Cassette Deck
 • Dolby B & C and C • Cobalt random tape heads • Record • Random program outboard system • Auto tape select • Wireless remote • List \$799

Technics SL-M3 \$399.95
Quartz Linear Tracking Turntable
 • Quartz direct drive • Linear pitch control • Computer controlled titanium linear tracking tonearm • Access 2 Mount carriage • Front panel operation • Wood base • List \$499

Technics RS-1506 \$1199.95
Pro Real-To-Real Tape Recorder
 • Three motor direct drive system • Inbuilt capstan loop system • 4 track 2 channel record/playback • Additional 2 track 2 channel playback head • Quartz locked capstan motor • List \$1999

dbx 224X-DS \$179.95
Type II Noise Reduction
 • Rack mountable NR system which affects only the recorded signal • Dynamic range • 40dB min. noise reduction • Switch switching with encoding and monitoring • List \$299

dbx 14/10 \$699.95
Audio Equalizer/Analyzer
 • Automatic computerized equalizer analysis sound spectrum • Fast or slow speed • Microprocessor controlled 14 band EQ • Memories 10 different room settings • List \$1299

SAE EG-10 \$99.95
3-Band Parametric Equalizer
 • Separate level, frequency and slope controls • Wide and high frequency ranges • Tape monitor • More controls for less money • Black finish • List \$210

AudioSource \$249.95
EQ-One II Equalizer/Spectrum Analyzer
 • Automatic 120 channel equalizer with 12-28 range • Real-time analyzer with pink noise generator • Includes colorized microphone • Subsonic filter • List \$429

Beyerdynamic \$159.95
Audiophile Stereo Headphones
 • Open style headphone with an ultra wide frequency response of 5.5kHz • Unique moving coil assembly • Exceptional transient response • List \$185

MAIL ORDER

CHADWICK MODIFICATIONS

Our speaker cables and interconnects bring the music back to you!

- Upgrades for Thorens turntables & Grado cartridges
- Corktone Platter Mat, F-1 Dustcover Weight and more
- Complete catalog \$3.00, refundable with purchase.

1925 Massachusetts Avenue, Cambridge, MA (617)354-8933

ABARGAIN: NAMIKI DIR FNDR \$95; TECHNICS STYLUS GUAGE \$68, 305CMCK2 \$205, 100CMK4 (BEST P MOUNT AVAIL) \$259, EPA500 \$295, EPA250 \$275, STAX PRO LAMBDA (#3) \$759, PRO LAMBDA (#1) \$450, SIGMA SRD7 \$450, LAMBDA SRD7 \$335; GRACE 747 \$199, 707IIB \$179, F9E (Super) \$189, F9E(S) RUBY \$249, F9E(S) STYLUS \$105, RUBY STYLUS \$189; DENON 103D \$189, DL303 \$210, DL305 \$350, DL304 \$245, DYN-AVECTOR 23RS(MR) \$249, 17DS(MR) \$450; KOETSU BLACK \$525; F.R.1MK3F \$189, FR45 \$199; SIGNET XK50 \$199; ORSONIC HEADSHELL \$29; WORLD'S BEST GERMAN ZEISS BINOCULARS AT UNRESISTABLE PRICES; SEND SASE: BOX 3334, RIDGEWOOD, NY 11386; ALL UNSOLD. (212) 619-2888 DAY; (718) 366-0360 EVE.

BEST PRICES SME V \$1399 SMEIV \$850 Formula V \$179 Rega RB250 \$125 Koetsu Black \$465 Mayware MC-7/3 \$165 MC-2V \$99 MC-3L/2 \$99 Celestion SL600 \$975 Wharfedale 708 \$399 Rogers LS3/5A \$399. Catalogue \$1 bill. STEREO: P.O. Box 774, London, NW7 3ST, England. Prices include Airmail delivery.

CARVER, NAKAMICHI, BANG & OLUFSEN, A.D.S., CROWN, REVOX, TANDBERG, HAFNER, ADCOM, MISSION, N.A.D., HARMAN/KARDON, KYOCERA, YAMAHA, LUXMAN, DENON, KLIPSCH, B & W, KEF, D.C.M., E.V, J.B.L., INFINITY, D.B.X., AKG, AND OTHER QUALITY COMPONENTS. BEST PRICES—PROFESSIONAL CONSULTATION. ALL PRODUCTS COVERED BY MANUFACTURERS' U.S.A. WARRANTY. AMERISOUND SALES, INC., JACKSONVILLE, FLORIDA 32241. EAST: (904) 262-4000 WEST: (818) 243-1168.

THE BEST RECORD RACK IN AMERICA Stackable, portable, oak units hold LPs, CDs and tapes. Free Mailorder Brochure. (please mention Audio). Per Madson Design: (415) 928-4509, P.O. Box 330101, San Francisco, CA 94133.

SINGERS! REMOVE VOCALS FROM RECORDS AND CDs!



SING WITH THE WORLD'S BEST BANDS!

An Unlimited supply of Backgrounds from standard stereo records! Record with your voice or perform live with the backgrounds. Used in Professional Performance yet connects easily to a home component stereo. This unique product is manufactured and sold Exclusively by LT Sound - Not sold through dealers. Call or write for a Free Brochure and Demo Record.

LT Sound, Dept. AU-3, 7980 LT Parkway Lithonia, GA 30058 (404) 482-4724
 Manufactured and Sold Exclusively by LT Sound
24 HOUR PHONE DEMO LINE: (404) 482-2485

Polkaudio
 The Speaker Specialists®

Where to buy Polk Speakers

- AUTHORIZED DEALER LIST**
- CANADA** Call Evolution Technology, Toronto for nearest dealer 1-800-263-8399
- AK Anchorage:** Shmick's Fairbanks; Hoffs
 - AL Birmingham:** Audition; Dobson; International Audio • Huntsville: Sound Distributors
 - Mobile:** Hi Fi Zone • Montgomery: The Record Shop • Tuscaloosa: Kinard Stereo & TV
 - AR Little Rock:** Lesure Electronics • Searcy: Soliman
 - AZ Flagstaff:** Sound Pro • Mesa: Hi Fi Sales • Tucson: Audio Emporium • Yuma: Warehouse Stereo
 - CA Campbell:** Sound Goods • Canoga Park: Stereo • Chino: Sounds By Dave • Corona: Del Mar: Pacific Coast Audio Video • Davis: World Electronics • Eureka: Eureka Audio Video • Fresno: Bananas Hi Fi • Mill Valley: World of Sound • Mountain View: Sound Goods • Nap: Futuretron • Orange: Absolute Audio • Penngrove: California Stereo • Redondo: Systems Design • Sacramento: World Electronics • Santa Cruz: Sound Wave • San Diego: Sound Company • San Francisco: Stereo Store, World of Sound • San Gabriel: Audio Concepts • Santa Barbara: Creative Stereo • Santa Maria: Creative Stereo • Santa Monica: Stereo Garage • Sherman Oaks: Systems Design • Stockton: Guskins Camera • Thousand Oaks: Creative Stereo • Ukiah: Music Hut • Ventura: Creative Stereo • Walnut: High Fidelity Shoppe
 - CO Boulder:** Soundtrack • Waplesboro: Stereo • Colorado Springs: Sunshine Audio • Denver & Suburbs: Soundtrack • Pueblo: Sunshine Audio
 - CT Avon:** Hi Fi Stereo House • Danbury: Carlson's Fairfield: Audio Design • Greenwich: Al Franklin's Hartford: Al Franklin's • New Haven: Audio City • Newington: Hi Fi Stereo House • New London: Roberts • Norwalk: Audiotronics
 - DE Wilmington:** Bryn Mawr Stereo
 - DC Myer: Great**
 - FL Daytona Beach:** Stereovides • Ft. Myers: Stereo Garage • Ft. Lauderdale: MS Design • Ft. Pierce: Sound Shack • Ft. Walton Beach: Audio International • Jacksonville & Suburbs: Audio Tech • Key West: Audio International • Lakeland: Sound Factory • Merritt Island: Southern Audio • Miami: Electronic Equipment Co. • Sound • Tampa: Audio Video • Orlando & Suburbs: Audio Spectrum • Pensacola: Fidler Hi Fi • St. Petersburg: Cooper Lot Stereo • Sound Advice • Tallahassee: Stereo • Tampa: Audio Video • Sound Advice • W. Palm Beach: Electronic Connection
 - GA Atlanta & Suburbs:** Hi Fi Buys • Augusta: Stereo City • Macon: Gacon Music • Savannah: Audio Warehouse • Valdosta: Stereo Connection
 - HI Honolulu:** Honolulu Audio Video
 - IL Danverport:** Gregg Music • Des Moines: Audio • Dodge City: Sound World • Iowa City: Hawkeye Audio • Mason City: Sound World • Waterloo: Team
 - ID Boise:** Stereo Shoppe • Sandpoint: Electric Hi-Fi Falls: Audio Warehouse
 - IL Altan:** Reliable Stereo • Aurora: Stereo Systems • Bloomington: Alan's Creative Stereo • Buffalo Grove: Columbia • Carbondale: Owen Stereo • Dhampaignan: Good Vibes • Decatur: J.R. Lloyd's • DeKalb: Audio Plus • Hoffman Estates: Simply Stereo • Highland Park: Columbia • Joliet: Stereo Systems • Kaneake: Barnett Entertainment • Lansing: Audio Clinic • MORTIS: Barretts Entertainment • Naperville: Stereo Systems • Normal: Sundown One • Orland Park: Sim-St. Charles: Team Electronics • Rockford: Columbia • Shamburg: Hi Fi Hutch • Springfield: Sundown One • Spring Valley: Audio Labs • Sterling: Midwest Hi Fi • Vernon Hills: Alan's • Villa Park: Hi Fi Hutch • Waukegan: Alan's
 - IN Evansville:** Ristley's • Ft. Wayne: Classic Stereo • Indianapolis: Ovalton • Lafayette: Grand Video • Marion: Classic Stereo • Michigan City: Audio Connection • Murcra: Classic Stereo • South Bend: Classic Stereo • Terre Haute: Hooper
 - KS Junction City:** Audio Junction • Overland Park: Audio Electronics • Wichita: Audio Visions • Topeka: Nelsons
 - KY Bowling Green:** Audio Center • Campbellville: Crippock's Home Entertainment • Louisville: Stereo Shoppe • Ovation Audio • Louisville: Audio Video Buy Design • Owensboro: Paducah: Ristley's
 - LA Alexandria:** Simpsons Electronics • LA Alexandria: Simpsons Electronics • Lafayette: Sound Effects • Lake Charles: Classic Audio Systems • Metairie & New Orleans: Alternan Audio • Delouaas: Sound Electronics • West Monroe: Audio Tech
 - MA Boston:** Waltham Camera & Stereo • Fitchburg: Fitchburg Music • N. Dartmouth: Creative Sound Systems • Worcester: O'Connell • Frederick: Evergreen
 - ME Bangor:** Sound Source • Camden: Harbor Audio • Portland: New England Music
 - MD Annapolis:** Spackways • Baltimore: O'Connell • Frederick: Evergreen • Rockville: Myer Echo
 - MI Ann Arbor:** Absolute Sound • Birmingham: Almas Hi Fi • Dearborn: Almas • Farmington Hills: Almas Hi Fi • Flint: Stereo Center • Grand Rapids: Classic Stereo • Iron Mountain: Sound North • Kalamazoo: Classic Stereo • Royal Oak: Absolute Sound • Southfield: Rompage
 - MI Duluth:** Mel's TV & Audio • Mankato: Audio King • Minneapolis & Suburbs: Audio King • Minnetonka: Audio King • Rochester: Audio King • St. Paul: Audio King
 - MO Cape Girardeau:** Stereo One • Columbia: Johnson Audio • St. Louis: Sound Central
 - MS Columbus:** Audio Advantage • Gulfport: Empress • Hattisburg: McElrath TV • Jackson: Maud • Pascagoula: Empress • Tupelo: Audio Advantage
 - MT Bozeman:** Thrifty Ear • Great Falls: Rocky Mountain Hi Fi • Missoula: Aspen Stereo
 - NC Asheville:** Mr. Todd's Stereo Video • Boone: Hollins • Chapel Hill: Stereo Sound • Charlotte: Audio Video Systems • Greensboro: Stereo Sound • Jacksonville: Home System Electronics • Kingston: Stereo Concepts • Moorehead City: Anderson Audio • New Bern: Anderson Audio • Pineville: Stereo Video • Raleigh: Audio Buys • Stereo • Rocky Mount: Microwave Audio • Wilmington: Atlantic Audio • Winston-Salem: Stereo Sound
 - ND Bismarck:** Pacific Sound
 - NE Kearney:** Midwest Audio • Lincoln: Stereo West • Norfolk: Mid City Stereo • Omaha: Stereo West • York: Midwest Audio
 - NH Concord:** Audio of New England • Exeter: AudioSound & SoundSystems • Laconia: Lakeside Stereo • New London: North Star Salem: Guomos
 - NJ East Brunswick:** Atlantic Stereo • Franklin Lakes: Jankovics • Lakehurst: Maple Shade • Bryn Mawr Stereo • Montclair: Perdue Radio • Raritan: AC Audio • Ridgewood: Sound Board • Shrewsbury: Monmouth Audio • Springfield: Hi-Fi Stereo Camera • West Caldwell: Perdue Radio
 - NM Alamogordo:** D&K Electronics • Albuquerque: West Coast Sound • Santa Fe: Hi-Fi Stereo
 - NV Las Vegas:** Upper Ear • Reno: The Audio Authority
 - NY Albany:** Clark Music • Balavia: Unicorn • Buffalo: Spakker Shop • Corning: Chemung • Jamestown: Stereo One • Manhasset: Audio Breakthroughs • Massena: Hi Fi Shop • Newburgh: Audio Expression • New York City: Audio Breakthroughs • Electronic Warehouse • Rochester: JB Stereo • Saratoga: Sterling • Syracuse: Clark Music • Vastal: Hart Electronics
 - OH Akron:** Audio Craft • Canton: Belden Audio • Cleveland & Suburbs: Audio Craft • Cincinnati: Audio Warehouse • Columbus: Lab • Dayton: Stereo Showcase • Findlay: Audio Craft • Lima: Classic Stereo • Toledo: Audio Store
 - OK Lawton:** Hi Fi Shop • Oklahoma City: Audio Dimensions • Shawnee: Rave Sounds • Stillwater: Carlines • Tulsa: Audio 3224
 - OR Beaverton:** Stereo Superstores • Bend: Stereo Video • Warhouse • Medford: Fidelity • Grants Pass: Shekells • Medford: Shekells • Portland: Stereo Superstores
 - PA Allentown:** Bryn Mawr Stereo • Altoona: Audio • Dodge City: Sound World • Bryn Mawr: Bryn Mawr Stereo • Camp Hill: Bryn Mawr Stereo • Erie: Studio One • Johnstown: Gary's Entertainment • Kingston: Hi-Fi Stereo • Lancaster: Stereo Concepts
 - Longhorne:** Bryn Mawr • Montgomeryville: Bryn Mawr • Natrona Heights: Stereo Land • Philadelphia & Suburbs: Bryn Mawr Stereo • Phoenix: Audio Warehouse • Quakertown: Bryn Mawr Stereo • Reading: G'n T Stereo • Selingsgrove: Stereo Shoppe • State College: Paul & Tony's Stereo • Williamsport: Robert Audio
 - Puerto Rico** Rico Piedras: Precision Audio RI Kingston: You R Eye & Ear • N. Providence: Eastern Audio
 - SC Anderson:** Team Bookshelves • Charleston: Audio Warehouse • Greenville: Mitchell's Stereo • Greenwood: Stereo Shop • Spartanburg: Stereo Shop
 - TN Chattanooga:** R&R TV • Cookeville: Lindsey Ward • Jackson: New Wave Electronics • Johnson City: Mr. Todd's Stereo Video • Kingsport: Mr. Todd's Stereo Video • Knoxville: Lindsey Ward • McMinnville: Lindsey Ward • Memphis: New Wave Electronics • Nashville: Hi Fi Buys • TX Abilene: Sound Effects • Arlington: Stereo Idea • Austin: Audio Video • College Station: Audio Video • Corpus Christi: Tape Town • El Paso: SoundQuest • Ft. Worth: Sound Effects • Houston: Stereo • Madison: Stereo Idea • Laredo: Metra International • Longview: Audio Techniques • Lubbock: Electronics Supercenter • San Angelo: Stereo • San Antonio: Bill's Stereo • San Marcos: Discovery Audio Video • Sherman: Worldwide Stereo • Temple: Audio Tech • Texarkana: Sound Towne • Waco: Audio Tech
 - UT Logan store:** Stokes Brothers • Salt Lake City: Broadway Music
 - VA Bristol:** Mr. Todd's Stereo Video • Charlottesville: Sound World • Falls Church: Myer Echo • Franklin: Audio Showroom • Leesburg: Evergreen Audio • Richmond: Gary's Stereo • Roanoke: Happers • Virginia Beach: Sound World • Falls Church: Hi-Fi
 - VT Essex Junction:** Creative Sound
 - WA Bellingham:** QC Stereo • Cheilan: Music Store • Oak Harbor: QC Stereo Center • Richland: Sound World • Spokane: Eric Tractral • Fair St.
 - WI Appleton:** Sound World • Eau Claire: EMF Audio Systems • Green Bay: World of Sound • Madison: Falls Church: Happy Medium • Marinette: Sound Seller • Milwaukee: Audio Emporium • Wausau: Sound World
 - WV Barboursville:** Beckley, Charleston, Huntington, Pied Piper • Piedmont: Sound Gallery • Wheeling: Stereo Lab
 - WY Cheyenne:** Electronics Unlimited • Sheridan: Star Video

ALL PRODUCTS CARRY MANUFACTURERS WARRANTIES

HOW TO ORDER BY MAIL

SEND MONEY ORDER, CREDITED OR CASHIER'S CHECK, MASTERCARD, VISA OR AMEX (INCLUDE CARD NUMBER, EXPIRATION DATE AND SIGNATURE) TO: J&R MUSIC WORLD, 98-50 BUELLING MIDTOWN EXPRESSWAY, MASPEL, NY 11378. **CASH:** AMERICAN DO NOT SEND CASH! Personal and business checks must clear our Authorization Center before processing. \$25 Minimum Order. Shipping handling & insurance charge is 1% of total order with a \$3.00 flat rate (Canada) Orders Add 15% Shipping with a \$9.95 minimum charge. Payment by all pre-authorized money orders, checks, MONEY, MO & B, NEW YORK STATE'S PLATE, MO, 6453, TAX. ALL MERCHANDISE IS SHIPPED BRAND NEW, FACTORY FRESH, AND 100% GUARANTEED NOT RESPONSIBLE FOR TIPOGRAPHIC ERRORS.

800-221-8180
 In New York, Alaska and Canada CALL: (718) 417-3737
 150 Queens-Midtown Expressway, Dept. AMO388, Maspeth, NY 11378

OUR NEW SPEAKERS KEEP ROCK GROUPS FROM BREAKING UP.

They'll also keep jazz trios, classical quartets, and the Mormon Tabernacle Choir together.

Because in our AT Series Loudspeakers we've virtually eliminated audible levels of distortion (also known as break-up).

Meaning, you'll hear the music and nothing but the music.

Unless, of course, you're listening to the news.

Either way, you'll hear the brilliance of our new dome tweeters. Which not only play clean, but loud.

Our AT dome tweeters have their highs and lows. High power handling and high frequency response with very low distortion.

In fact, a pair of AT-15s can reach 127 decibels. As loud as a live concert.

With smooth frequency response over a wider listening area, precise stereo imaging, and no compression of dynamic range.

What's more, our new woofers are ribbed for durability and have magnets that weigh as much as 7 pounds.

All of which can change the course of musical history.

Because with Cerwin-Vega AT Series Loudspeakers, even the Beatles won't break up.



This is about 25% of a Cerwin-Vega woofer. Funny, most woofers are about 25% of a Cerwin-Vega woofer.

 **Cerwin-Vega!**



For more information, please write or call:

*Cerwin-Vega: 555 E. Easy Street, Simi Valley, CA 93065 805-584-9332
Cerwin-Vega Canada: 2360 Midland Av. Unit 21, Scarborough, Ontario M1S 4A9
Cerwin-Vega Europe: Gryderupvej 12, P.O. Box 40, DK-9610 Norager, Denmark*

Enter No. 37 on Reader Service Card

LIFE IS FULL OF COMPROMISES, BUT YOU DON'T HAVE TO LISTEN TO THEM.

And that's just what you do with most compact disc players. You end up listening to the machine and not the music.

That's why Marantz designed the uncompromising CD-94.

The elastomer suspended aluminum transport and tracking system, along with the die cast non-magnetic main chassis, eliminate acoustic feedback.

A radial tracking, single beam laser reads the disc and eliminates the inaccuracies inherent in more conventional systems.

A 16 bit dual digital to analog converter and quadruple oversampling

digital filter guarantee perfect frequency and phase response within the compact disc's bandwidth.

The musical information is then fed through a high quality analog stage that utilizes ceramic damped capacitors and custom components linked by oxygen free copper wire.

All this to ensure that the soundstage accurately preserves the depth, presence and purity of the original performance.

The Marantz CD-94 fully programmable compact disc player. Expensive. But to the audio purist, compromise is just too high a price to pay.

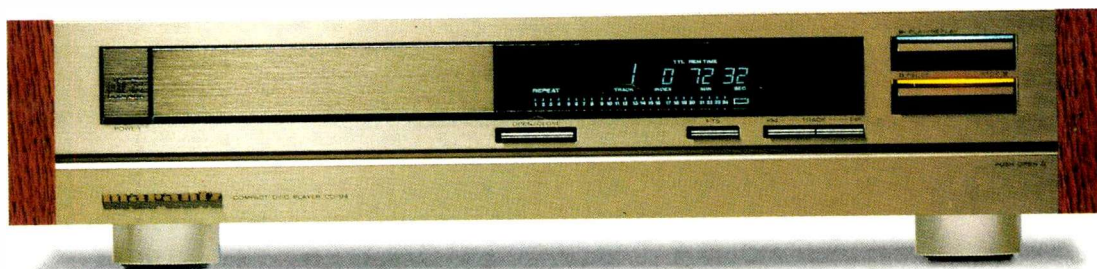

marantz
HIGH FIDELITY

Marantz Company, Inc., 20525 Nordhoff Street, Post Office Box 2577, Chatsworth, CA 91313-2577
Phone: 818-998-9333 Fax: 818-998-5475

For more technical information, call or write Marantz for the brochure, "The 94 Series, A Technical Narrative."