

# Audio

SEPTEMBER 1984 • \$2.00

RECORDING HISTORY  
TAPE COMES OF AGE

HOW IMPORTANT IS  
TAPE AZIMUTH?

REVOX CD PLAYER  
WORTH THE WAIT



**TESTED:**  
**AUDIO-TECHNICA AT160ML**  
**HOT NEW STYLUS SHAPE**





LIGHTS: 10 mg. "tar", 0.8 mg. nicotine, KING: 17 mg. "tar", 1.3 mg. nicotine, av. per cigarette by FTC method.



*You've got what it takes.*

# *Salem Spirit*

*Share the spirit.  
Share the refreshment.*



Warning: The Surgeon General Has Determined That Cigarette Smoking Is Dangerous to Your Health.



# Acoustic Research introduces three essentials for the ultimate system.

**1.** Our new line of nine different computer-designed speakers, ranging from the economical, space-saving AR8B bookshelf model to the awesome AR9LS with its Dual Dome™ mid-high range driver and thunderous Bass Contour Chamber.

**2.** A new three-point suspension turntable whose predecessor was a legend among audiophiles ten years ago. So much of a legend we decided to bring it back in a totally updated version—re-designed from the dustcover on down. With your choice of universal tone arm mounting platform, or AR's own new medium mass straight arm.

**3.** Our new AR compact remote control unit employing ultra-sophisticated microcircuitry. From wherever you sit or stand, you can control stereo balance and work a wide range of functions on your amp for maximum convenience and ideal sonic performance.

**AR**

Hear what you've been missing.

TELEDYNE ACOUSTIC RESEARCH  
10 American Drive, Norwood, MA 02062, USA.



# Audio

SEPTEMBER 1984

VOL. 68, NO. 9

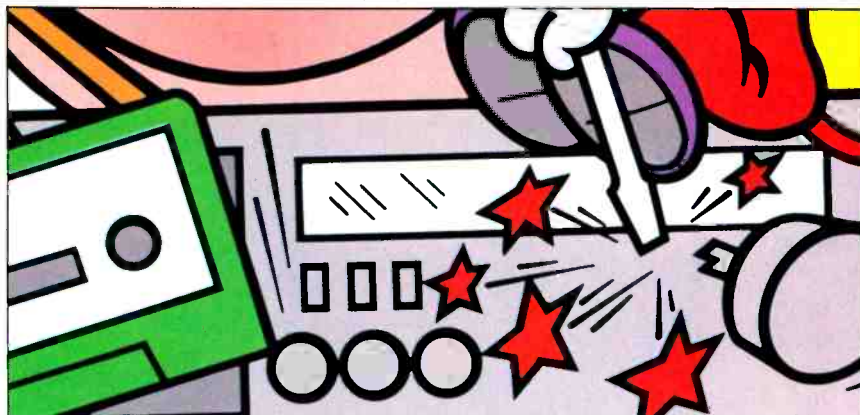

See page 40.



See page 47.

## FEATURES

HISTORY OF MAGNETIC RECORDING: PART II	ROBERT ANGUS	33
HOW IMPORTANT IS TAPE AZIMUTH?	HERMAN BURSTEIN	40
TAPE TEST FOLLOW-UP	HOWARD A. ROBERSON	47

## EQUIPMENT PROFILES

REVOX B225 COMPACT DISC PLAYER	LEONARD FELDMAN	50
TANDBERG TCD 3014 CASSETTE DECK	HOWARD A. ROBERSON	58
NAKAMICHI TD-800 CAR STEREO	LEONARD FELDMAN	64
DEPT. OF AMPLIFICATION: PERREAUX PREAMP		70
AUDIO-TECHNICA AT160ML CARTRIDGE	GEORGE SHELLENBERGER	72
AURICLE: YAMAHA NS-2000 LOUDSPEAKER	ANTHONY H. CORDESMAN	78

## MUSIC REVIEWS

ROCK/POP RECORDINGS	Michael Tearson, Jon & Sally Tiven	82
COMPACT DISCS		86
AUDIOPHILE RECORDINGS		94
CLASSICAL RECORDINGS	Edward Tatnall Canby	100

## DEPARTMENTS

AUDIO ETC	Edward Tatnall Canby	6
DIGITAL DOMAIN	Ken Pohimann	12
SPECTRUM	Ivan Berger	14
ROADSIGNS	Ivan Berger	18
BEHIND THE SCENES	Bert Whyte	22
TAPE GUIDE	Herman Burstein	27
AUDIOCLINIC	Joseph Giovanelli	28
WHAT'S NEW		30

The Cover Equipment: Revox B225 Compact Disc player.  
The Cover Photographer: Steven Dolce.

Audio Publishing, Editorial and Advertising Production Offices,  
1515 Broadway, New York, N.Y. 10036.

Subscription Inquiries, (800) 525-9511; in Colorado (303) 447-9330.

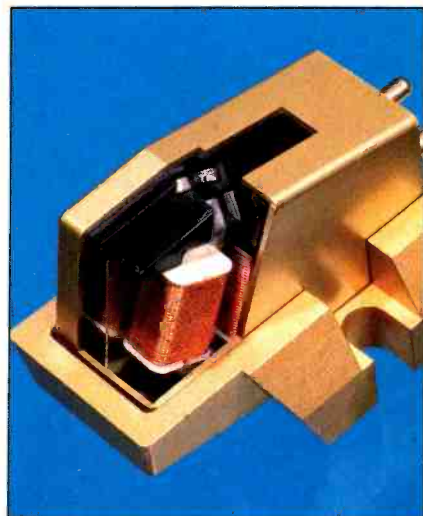

See page 72.



See page 6.



# Is your luxury car wealthier than you are?

At Subaru, we don't think an exorbitant price tag should stand between you and a luxury car.

That's why our luxury cars are not only impeccably engineered, and elegantly appointed, they're beautifully affordable.

Presenting the GL-10 Four Door Sedan and Two Door Hardtop.

## A luxury car at a Subaru price.

Our luxury cars are sensibly priced because they're equipped with luxuries you want, and not loaded down with garish ones you don't need.



Standard appointments include air conditioning, plush velour interior, power windows and steering, electronically tuned AM/FM six speaker sound system, sun roof, even a fold down arm rest in the back seat. And the GL-10's black exterior trim gives them the look of luxury cars priced much higher.

Nowhere do we allow extravagance to overshadow intelligence. Our digital dashboard makes information clearly visible, yet beautiful to look at. It even comes with an on board trip computer. Everywhere you look, superb styling is complemented by superb engineering.

## Superb engineering is a necessity. Not a luxury.

The GL-10's, like every Subaru, are equipped with road holding front wheel drive. A necessity many luxury cars don't even offer as an option.

Our exceptional design and engineering have contributed to the long Subaru record of durability and reliability.

And that makes our luxury cars even less expensive to own in the long run. Which in this day and age may be the greatest luxury of all.

**SUBARU**  
Inexpensive. And  
built to stay that way.





# PRECEDENT

Never, in the history of audio, has response to a tuner equalled the acclaim received by the CARVER TX-11 FM Stereo Tuner with the Asymmetrical Charge Coupled FM Stereo Detector.

"Breakthrough in FM tuner performance: Carver TX-11"

"The significance of its design can only be fully appreciated by setting up the unit, tuning to the weakest, most unacceptable stereo signals you can find, then pushing those two magic buttons."

"Separation was still there; only the background noise had been diminished, and with it, much of the sibilance and hiss edginess so characteristic of multipath interference."

"A tuner which long-suffering fringe area residents and those plagued by multi-path distortion and interference have probably been praying for." *Leonard Feldman Audio* (December, 1982)

"It is by a wide margin the best tuner we have tested to date."

"What distinguishes the TX-11 is its ability to pull clean noise-free sound out of weak or multi-path ridden signals that would have you lunging for the mono switch on any other tuner we know of." *High Fidelity* (January, 1983)

"...enjoy the music and forget about noise and distortion."

"under conditions of weak signal stereo reception the effectiveness is almost magical." *Ovation* (December 1982)

"A major advance... "Its noise reduction for stereo reception ranged from appreciable to tremendous." "It makes the majority of stereo signals sound virtually as quiet as mono signals, yet it does not dilute the stereo effect." *Julian D. Hirsch, Stereo Review* (December, 1982)

Audition this superlative instrument incorporating Bob Carver's latest circuit refinements at your authorized CARVER dealer.

*And Now...*

If you have substantially invested in another stereo FM tuner—or perhaps in a receiver—you will appreciate the CARVER TX-11.

The TX-11 embodies Asymmetrical Charge-Coupled technology in a sophisticated add-on high fidelity component.

For a 20 dB improvement of the stereo quieting (that's 10 times quieter!) and a 10dB improvement in multipath noise reduction, simply connect the CARVER TX-11 between your FM stereo tuner and the pre-amplifier or through the tape monitor/external processor loop of present system. Hear fully separated stereo FM reception with space, depth and ambience—only hiss, noise and distortion is eliminated.



**CARVER** CORPORATION P.O. Box 1237, Lynnwood, WA 98036  
POWERFUL MUSICAL ACCURATE

Distributed in Canada by Evolution Audio, Ltd.

Enter No. 10 on Reader Service Card

## Audio

Eugene Pitts III  
Editor

Art Director: Cathy Cacchione  
Assistant Art Director: Linda Zerella

Technical Editor: Ivan Berger  
Managing Editor: Kay Blumenthal  
Assistant Editor: Andrea Lynne Hecker

Associate Editors:  
Edward Tatnall Canby, Bert Whyte, B. V. Pisha

Senior Editors:  
Leonard Feldman, Richard C. Heyser,  
Howard A. Roberson

Editor-At-Large: David Lander

Contributing Editors/Artist:  
Herman Burstein, David L. Clark,  
Anthony H. Cordesman, Ted Costa, John Diliberto,  
John M. Eargle, Joseph Giovannelli,  
Laurence L. Greenhill, Bascom H. King,  
Edward M. Long, C. G. McProud,  
Peter W. Mitchell, Jon Sank, Donald Spoto,  
Michael Tearson, Jon & Sally Tiven, Paulette Weiss

General Manager: Mary Anne Holley  
Production Assistant: Patti Burns  
Special Projects Coordinator: Karyn L. Popke  
Ad Coordinator: Ruth M. Linehan

Roman Beyer  
Publisher

### ADVERTISING

Advertising Director: Stephen Goldberg  
(212) 719-6335  
Eastern Ad Manager: Stephen W. Witthoft  
(212) 719-6337  
Account Managers: Susan L. Newkirk  
(212) 719-6346  
Lesa Rader  
(212) 719-6291  
Western Ad Manager: William J. Curtis  
Regional Ad Manager: Joy Aronson  
(213) 827-8655  
Classified Ad Manager: Laura J. LoVecchio  
(212) 719-6338

### OPERATIONS

Circulation Director: Leon Rosenfield  
Marketing Services Director: Glenda Bradshaw  
Production Director: David Rose

### CBS MAGAZINES EXECUTIVE STAFF

President: Peter G. Diamandis  
Sr. V.P.: George H. Allen  
Sr. V.P./Adv.: Michael J. O'Neill  
V.P., Finance & Admin.: Robert J. Granata  
V.P., Circulation: Robert F. Spillane  
V.P., Mfg. & Distribution: Murray Romer

**AUDIO** (ISSN 0004-752X, Dewey Decimal Number 621.381 or 778.5) is published monthly by CBS Magazines, A Division of CBS Inc., at 1515 Broadway, New York, N.Y. 10036. Printed in U.S.A. at Nashville, Tenn. Distributed by CBS Magazine Marketing. Second class postage paid at New York, N.Y. 10001 and additional mailing offices. Subscriptions in the U.S.: \$15.94 for one year, \$27.94 for two years, \$37.94 for three years; for other countries, add \$6.00 per year.

**AUDIO** is a registered trademark of CBS Inc. ©1984, CBS Magazines, A Division of CBS Inc. All rights reserved.

Editorial contributions are welcomed but should be accompanied by return postage. Submissions will be handled with reasonable care, but the Editor assumes no responsibility for safety or return of manuscripts, photographs, or artwork. The Publisher, in his sole discretion, reserves the right to reject any ad copy he deems inappropriate.

**AUDIO** Publishing, Editorial and Advertising Production offices, 1515 Broadway, New York, N.Y. 10036. Subscription offices, P.O. Box 5318, 1255 Portland Place, Boulder, Colo. 80322; (800) 525-9511, (303) 447-9330 in Colorado. Postmaster: Send change of address to P.O. Box 5316, 1255 Portland Place, Boulder, Colo. 80322.



# ARTISTRY IN

# HIGH FIDELITY



The hk690i is Harman Kardon's unique expression of ultimate artistry in high fidelity. In it are found the same control of technique, mastery of detail and creative excellence inherent in every great and enduring work of art.

The hk690i receiver is exemplary of the technological strokes of genius created and perfected by Harman Kardon throughout its more than 30 year history. 45 Amps of High Instantaneous Current Capability allows the hk690i to develop up to 150 Watts per channel into 2 Ohms under peak conditions. An Ultrawideband Frequency Response of 0.2Hz to 150kHz delivers extremely fast and accurate transient response. Low Negative Feedback results in the virtual elimination of TIM distortion. An exclusive Sample-And-Hold Multiplex Decoder decreases high frequency switching noise while eliminating the need for much of the filtering normally required in FM processing. And, the use of Discrete Components demonstrates Harman Kardon's inherent technical integrity.

With this dedication, Harman Kardon stands ready to deliver the ultimate in high fidelity listening pleasure with every model in their entire product line.

Harman Kardon... Dedicated to mastering the fine art of high fidelity.



**SPECIFICATIONS**  Power Output, (FTC) RMS, per channel, both channels driven into 8 Ohms, 20-20,000Hz: 60 Watts per channel @ < .06% THD  4 Ohms, 1kHz, IHF Signal (Dynamic Power): 120 Watts  2 Ohms, 1kHz, IHF Signal (Dynamic Power): 150 Watts  Negative Feedback (overall): 12dB  HCC (High Instantaneous Current Capability): 45 Amps  Power Bandwidth, at half-rated output, 8 Ohms: <10Hz-100kHz  Frequency Response, at 1 Watt output, +0/- 3dB: 0.2Hz-150kHz  TIM: Immeasurable  Slew Rate: 200V/ $\mu$ sec  Usable FM Sensitivity: mono (dB/ $\mu$ V-75 Ohms): 10.8dB/0.95 $\mu$ V  Stereo Separation: 1kHz, 65dB/100% mod: 55dB  FM THD: mono 1kHz, 100% mod: 0.06%; stereo: 0.08%

## harman/kardon

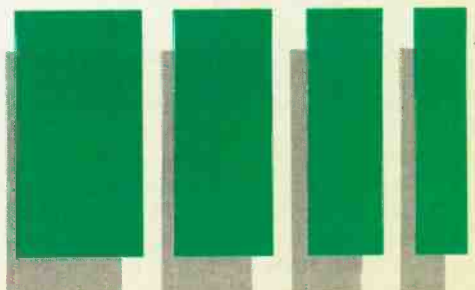

240 Crossways Park West, Woodbury, NY 11797; In Canada, Gould Marketing, Montreal. For more information call toll-free 1-(800) 633-2252 ext. 250.



## THE PEELED EYE

**O**f the many gaudy mail-order catalogs that come my way each week, with such prosaic names as Bean's, Brent's, Breck's, Burpee's, Brookstone's and on through the alphabet, there is one that really hits my fancy—*The Sharper Image*. Now there's a name to conjure with! This outfit sells high-tech consumer stuff, at appropriate prices. For instance, I recently bought, elsewhere, the most convenient bathroom scale I've ever used; it reads the same as the one in my doctor's office and cost me \$10. *The Sharper Image* has a scale with "four separate computer memory banks" to remember your weight last week and last month; it costs \$119, but I'll hand it to them: For an added ten bucks you can have an all-mechanical model straight from West Germany. That's sharp thinking for you.

I've been bothered and fascinated for a long time by this matter of the sharper image. Mostly, we don't have it, or we have lost it. But, with all this present convergence of video, audio and the personal computer into ever more compact and more elaborate consumer entertainment centers, it has been borne in on me that we in audio have had a sharper image all along, since Major Armstrong's FM sound back in the '30s and '40s. The Sharper Audio Image. High Fidelity! Could there be a more exact description?

The more you delve into technical specs, the closer is the relationship between a sharp *visible* image and an accurate *audio* image. In both cases this is a matter of faithfulness to some sort of original (even in the case of the eyes), in terms of lack of distortion, absence of "noise," i.e., meaningless and unwanted extraneous signals—and, most of all, a matter of sharply defined detail. In visible imaging we call this resolution, resolving power, but we can apply the same to an audio signal. For when you come down to it every sort of "fuzziness," of poor resolution, is actually a distortion, a blurring of the message, a reduction of its information content, whether to the ear or to the eye.

True, much "noise" is technically not a part of our signal at all, hence the feasibility of noise reduction. But, in the end, even noise is distortion, interfering with what we hear or see.

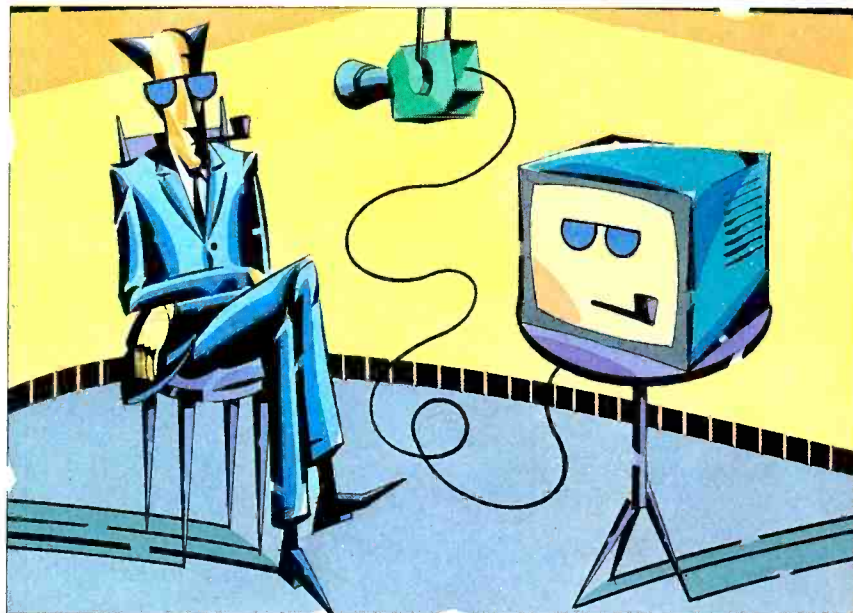

Illustration: Philip Anderson

These matters are very quickly coming to a lot of heads today in the ferment of change. Suddenly, here and there, sharpness becomes crucial where before it hasn't much mattered. And at the same time, in other areas, the steady trend towards ever greater fuzziness, the decidedly Unsharp Image, goes relentlessly onward. As we know from TV experience, there are ways to get around a lack of sharpness, using artistic ingenuity. Not everyone is bothered by faulty video resolution in the TV soaps and the "interview" shows—they are mostly close-up. Easy way out, and quite okay—who's complaining? Nor is the still-present TV sound incompatible—it, too, is "close-up," that is, mostly simple speech, not requiring super-hi-fi for its message. And, we can always use, and do use, lip reading.

But in the new "third world" of the personal computer the resolving power suddenly gets important—especially where the "ordinary" TV tube is used. How well can you read the facts and figures on the screen? How small can the letters and words be, and how many can appear at a time? TV tubes are just fine for large blocks of color and great big words that sell their own message—in monosyllables. But when your computer speaks in big monosyllables it's not giving you what you want for your money, as thousands have

discovered. So we have the "monitor" tube, with improved resolution. You can read words on it, whole pages of them.

You think that hasn't had any effect on the general public? It's *having* it, every minute of the present day, as inevitably as the thousands of babies born in the same time, so many per minute, year in and year out.

I went to a cheapie movie last week, or rather, watched it via public TV, projection style. The film was extraordinarily fuzzy but it didn't matter much. On the other hand, at the end, I was jolted to discover that I could not read a single word of the credits that rolled by. Just a lot of blurred and meaningless lines. People do not usually fuss when they don't see sharp credits; they are mainly *pro forma*. But when the same thing happens on a cheap computer, as are now selling in the millions—what then? The sharpness idea is contagious! The fire will spread. All it will take, for the setting, is a few major advertising campaigns for the new "Sharper TV"—when and if. This is surely already in the works.

Once again, and as never before, the medium is the message. A sharper video image opens new "program" techniques, more detailed pictures, faster action, greater clarity in the plot line. If and when practical. It should be, in Phase Three of the marriage of

# AUDIOPHILE FILE™ XL-S

## COMPACT DISC COMPATIBLE

Maxell introduces the new XL-S audio cassettes; a series of ferric oxide tapes which deliver a level of performance that can capture the sound nuances found on Compact Discs more faithfully than other ferric oxide cassettes on the market.

There are a number of areas where this achievement is apparent.

### GREATER DYNAMIC RANGE.

Through a new formulation of our magnetic particles, we were able to reduce the perceived residual AC bias noise level by 1 dB in the critical 2 kHz to 10 kHz mid-frequency range. And simultaneously increase sensitivity and maximum output levels by as much as 2 dB.

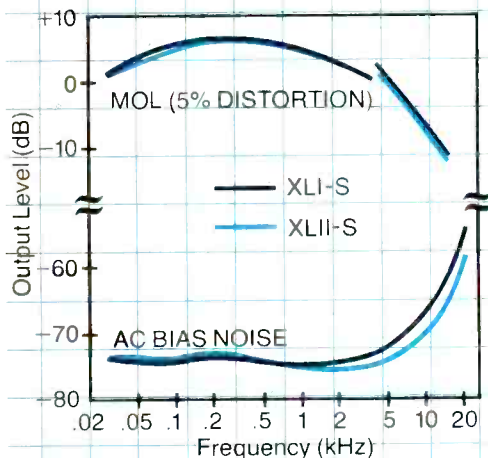

As a result, the dynamic range of each tape has been significantly expanded. So you get a

better signal to noise ratio and a fuller impact of the dynamic transients exclusively inherent to digital CD recordings.

### LOWER DISTORTION.

The newly formulated particles also contribute considerably to XL-S's low output fluctuation, as well as its virtual distortion-free reproduction, especially in the critical mid-range frequencies. This, in turn, accounts for our XL-S tape's enhanced sound clarity.

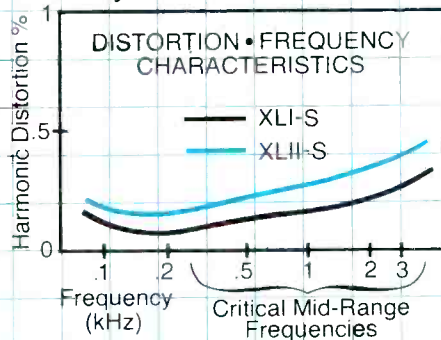

### IMPROVED MAGNETIC PARTICLES.

Our refined particle crystallization process is the basis for all of these accomplishments. Maxell engineers are now able to produce a more compact needle-shaped Epitaxial magnetic particle of extremely high uniformity.

This allows us to create a greater ratio of total surface area to unit weight of magnetic particles.

As a result, our XL-S

tapes now have the ability to record more information per unit area than ever before.

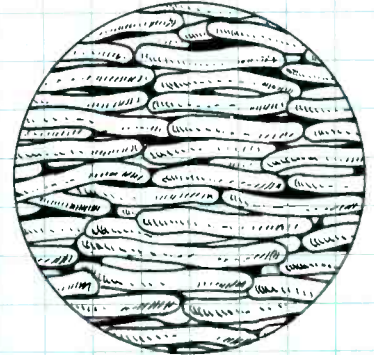

PACKING DENSITY OF UNIFORM PARTICLES.

Which is why Maxell high bias XLII-S and normal bias XLI-S are unsurpassed at reproducing the sound qualities found on today's finest recordings. Regardless of whether your frame of reference is analog or digital audio discs.

For technical specifications on the XL-S series, write to: Audiophile File, Maxell Corp. of America, 60 Oxford Drive, Moonachie, New Jersey 07074.



IT'S WORTH IT.

© 1984 Maxell Corporation of America, 60 Oxford Drive, Moonachie, N.J. 07074



A sharper video image opens new "program" techniques, more detailed pictures, faster action and greater clarity.

audio and video with, er, a third party, the computer. (Three-way marriage? We'd better find a better, if duller, term to protect the moral sense.

Then there is that indefinable and powerful compatibility which must always exist between media in a dual format, involving sight and sound together. On traditional TV we have had

lo-fi, the fuzzy image, in equal terms for both picture and sound and the combo has been a vast success. But lately people are discovering—and business is advertising—the virtues of improved TV sound. The most unsettling and miraculous development in this area is surely the new videocassette sound from Sony and its parallel in VHS. Sud-

denly—from the bottom straight to the top! Imagine it, hi-fi reproduction from videocassettes that rates well above everything in our hi-fi audio except the topmost digital—is *that* unsettling! And already this sound is being relentlessly plugged, the surest way to bring it to the notice of the many Mr. and Mrs. John Q. Publics in all their multitudinous clones. Does it now behoove the lowly TV tube, what with these mounting pressures, to produce a Sharper Image? And what about the TV source, the present broadcast system? It's already edging into stereo—what, then, of the proposed doubling of lines, for a really "hi-fi" picture and yet with compatibility, even so, for the lingering old-style tubes? First we hike up one side of the dual message, then the other.

So, you see, the pressure for a Sharper Image mounts in many directions. The video biz is indeed finally beginning to catch up with us in the concept of high fidelity. The new video is not going to burst into bloom, as the seed catalogs say, until, in my Phase Three, the tubeless video picture really takes over. But that, too, is coming on strong, and sooner than most of us could have guessed. (I've decided to wait for a word processor until I can have it with a *big*, flat screen not more than an inch or two deep. IBM is talking in these terms, as are others; little screens are already on the market.)

In digital, the Sharper Image is rampant and on an unheard-of scale. How many billion bits can we now process per second? John Q. and his wife are already impressed, since they owe so much to the new electronics that can process so much in so little time. One of my favorite historical memories, speaking of bits, goes back, in mind at least, to the early transatlantic cables. Did you know that, to their dismay, the first operators found that the on-off digital-style telegraph code was rendered so fuzzy after a few thousand miles that at first only a word or so a minute could be transmitted? Like an ordinary light bulb that took about 30 seconds to fade on and then off again.

It remains to be pointed out that, with all of this potent movement towards sharpness and better resolution in both audio and video messages, there still is a much longer tradition of precisely the opposite—a steady, enduring

Only one factory in the world completely handcrafts audio components.

# Perreaux of New Zealand

Custom crafted from the cutting, drilling and anodizing of the rigid aluminum chassis, to the testing, matching and soldering of the transistors. Built by hand in a single factory.



C & M Stereo Unlimited  
Fairfield, California 94533  
(707) 422-3340



*Soundcraftsmen* presents...

**410 watts—MOSFET—** **\$449.<sup>00</sup>**  
**205 watts per channel**

**@ 8 ohms, 20 Hz—20 KHz, less than 0.05% THD...**

**THE WORLD'S SMALLEST, LIGHTEST,  
MOST POWERFUL CONTINUOUS POWER  
STEREO AMPLIFIER!**

**"PHASE-CONTROL-REGULATION"®**

Soundcraftsmen's research into Digital Audio Technology has resulted in a major advance in amplifier design—Phase Control Regulation.® The world's first PCR amplifier, the PCR800, sets continuous performance and reliability standards never before possible in audiophile equipment.



For the **ULTIMATE** in Stereo Amplification. Add a **SECOND PCR800** to your Soundcraftsmen DX-series Preamp and your PCR800 for...

**555 WATTS** per channel @ 8 ohms!

Full FTC Specifications, 20Hz-20KHz < 0.05%THD



*Soundcraftsmen*

**AMERICA'S LEADER IN AMPLIFIER,  
PREAMPLIFIER, EQUALIZER  
AND ANALYZER TECHNOLOGY...**

**DIGITAL QUARTZ AM-FM-FM STEREO TUNER...**

AM-FM-FM Stereo Tuner with 7 AM, 7 FM Station Presets, Automatic or Manual Scanning, Active High Blend Circuitry...

**WORLD'S MOST VERSATILE PREAMPLIFIERS...**

Featuring -97dB Phone S/N, Adjustable Phono Capacitance and Impedance, Moving Coil Inputs, Phono Input Level Controls, Exclusive AutoBridge® circuit for Mono Operation of Stereo Amplifiers @ TRIPLE POWER OUTPUT, Push-Button Patch Bay with Two External Processor Loops, Digital and Video/Audio Inputs, 10-octave EQ, Precision Passive Coil EQ Circuitry and Differential/Comparator® for Highest Gain, Lowest Distortion and No "Clipping" of Wide Dynamic-Range Material. 12" LP Analyzer Test Record and Charts with EQ's...

**REAL-TIME SCAN-ANALYZER/EQUALIZERS AND  
EQUALIZERS, ACCURACY TO 0.1dB...**

REVOLUTIONARY Differential/Comparator® circuitry makes possible Accuracy to 0.1dB! Automatic or Manual Octave Scanning for Fast, Accurate Analyzing and Equalizing. Precision Passive Coil Filters for Highest Gain, Lowest Distortion, Scan-Alyzer Models. With and Without Built-in Equalizers. No Calibrated Microphone necessary. 12" LP Analyzer Test Record and Charts with EQ's...

**REVOLUTIONARY CLASS "H" AND  
MOSFET AMPLIFIERS, 125 TO 555 WATTS P/C...**

The most advanced Stereo and Professional Amplifier Models, featuring Class H Dual Signal-Tracking Power Supply, Auto-Buffer® for Continuous 2-Ohm Operation, No Current-Limiting, Power MOSFET circuitry for Highest Reliability, Calibrated LED meters, A, B, and AB Speaker Switching...

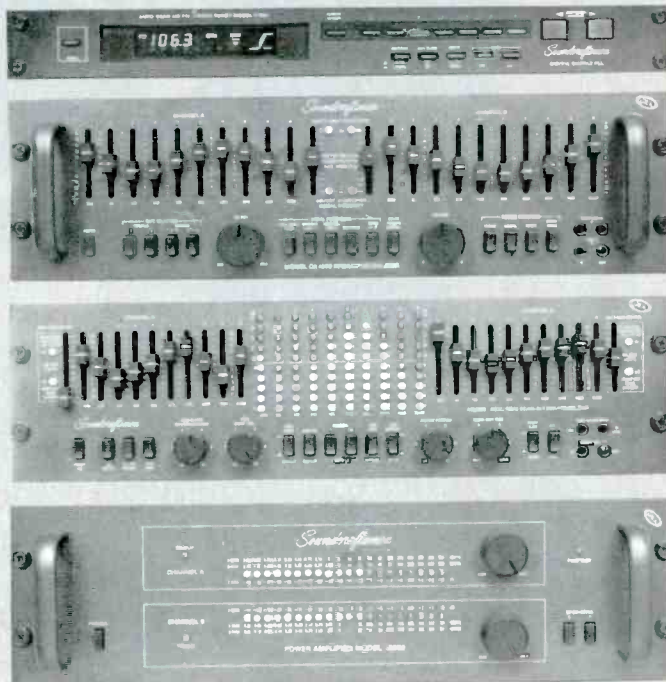

**FREE!**

**16-PAGE FULL-COLOR BROCHURE, \$19.95 EQ-EVALUATION KIT, includes 1-12" LP Frequency Spectrum Analysis Test Record, 2-sets of Computone Charts, 1-Connector Cable for comparison test, 1-instruction folder for use with your present stereo system, JUST WRITE TO US OR CIRCLE READER SERVICE CARD # 30 for FREE SPECIAL OFFER DETAILS.**

2200 So. Ritchey, Santa Ana, California 92705, U.S.A./Telephone (714) 556-6191/U.S. Telex/TWX 910-595-2524 • International Telex: 910-595-2524/Answer-back Code SDCRFTSMN SNA

Enter No. 30 on Reader Service Card



In some areas, we progress to sharper images. In others, we have progressed to bigger and fuzzier ones, due to business economizing.

trend away from sharpness and towards a lower resolution. Mostly, this is due to business economizing, but that aspect is, in the end, surprisingly unimportant. Public acceptance is what counts.

Have you ever looked at the celebrated landscape photographs of the middle and late 19th century, taken

with big cameras which used huge glass plates, often the cumbersome "wet plate" prepared in a portable dark-room on the spot? The lenses of those days were imperfect, with much blur and distortion out at the edges, but the main body of the picture had a sharpness, especially in an original print, that is hard to believe. As late as 1929, I

took B/W stereo pictures on glass plates (dry process!) that to this day, when magnified in the viewer, astonish.

In 1933, I acquired the original Ciné-Kodak Eight, to my mind the best-made home-movie camera ever produced. It had a little button of an f/4.5 lens and an imprint so tiny on the film you could not read it with the naked eye—but you should see the detail in a five-foot-square projection!

You will find this same acute sharpness in every direction in those earlier years. I think, for instance, of my ancestors' cut glass, as compared to the similar pressed glass, same patterns, we find in today's supermarkets.

And it's the same with an original reproduction proof—cold type, that is letters and words produced via the photographic medium, has a fuzzy edge when compared with a proof made from "real" poured-metal type.

In these and other areas we have progressed to bigger and fuzzier and we still progress. Super-8 color movies are too fuzzy for me. Zoom lenses, lots of light, blurred details. Instant still pictures are the same. *Not sharp.* And now—all hail the disc camera! To my mind this is the worst compromise we've ever indulged in, for sharpness, and yet the system is a success. Like TV, the disc pictures are mostly close-up, nearby people and babies and dogs—not landscapes. The Unsharp Image is a part of this medium and determines its content—or is it the other way around?

To my perverse mind, sharper is always going to be better. And that applies to audio as it does to photography. But the commercial question as to *which* sharpness, in *which* usage, will lead to raging success with the public is one that, as speakers say, we must address with care. You bet. As always, the canny guy who picks the right Sharper Image is going to clean up. Ditto the outfit that chooses the most suitable fuzziness—whether in sound or sight. Some of those who do this last trick are among the canniest of all. Like Kodak, for instance, if in a negative way. But don't think that the Fuzzier Image is necessarily the way to success! It all depends. In any case, we in audio hi-fi proved long ago that our own Sharper Image was the right way to go. And still is.



**"Worth the price to anyone who can appreciate them."** Sound Canada

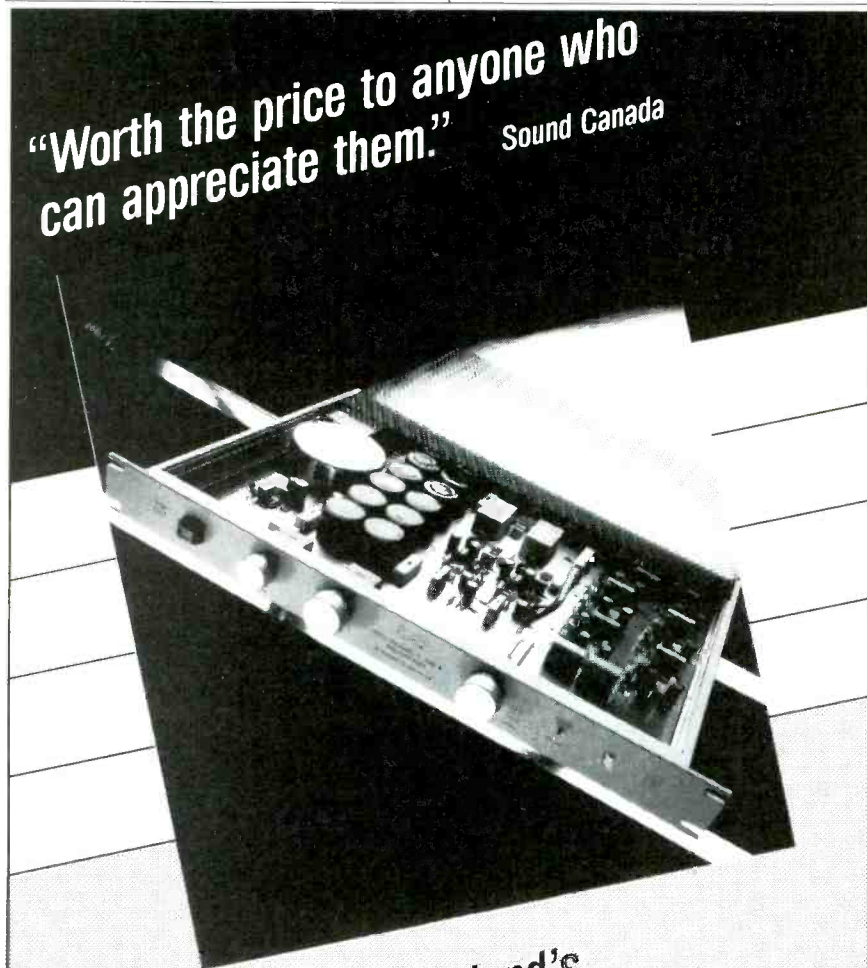

**Perreaux of New Zealand's SM-2 preamplifier. At only \$1290, it's worth it.**



**Listen Up**  
 Denver, Co 80209  
 (303) 778-0780  
 Boulder, Co 80302  
 (303) 444-0479

# Save up to \$25 during the Shure 60th Anniversary Rebate Sale.

Buy a genuine Shure cartridge or replacement stylus between September 1 and October 31, 1984 and get a hefty cash rebate direct from our factory. Just supply the information requested below, mail it to Shure and earn up to a \$25 rebate on a quality phono cartridge—up to \$10 on a stylus.

A Shure cartridge is the best investment you can make to improve the sound of your system. And a Shure replacement stylus will reduce record wear, extending record life. Remember, with Shure, you're getting 60 years of audio experience. Get all the details on this offer at a Shure dealer near you or write Shure Rebate Offer, 222 Hartrey Ave., Evanston, IL 60204.

Save \$10 to \$25 on a quality Shure phono cartridge.

Cartridge	Your rebate
V15 Type V-MR	\$25
V15 Type V-B	\$20
ML140HE	\$15
ML120HE	\$15
M110HE	\$10

Save up to \$10 on a genuine Shure replacement stylus.

Stylus model	Compatible with this Shure cartridge	Your rebate
VN5MR	Upgrade for V15 Type V	\$10
VN5HE	Replacement for V15 Type V	\$10
VN45HE	Replacement for V15 Type IV	\$ 5
N97HE	Upgrade for M97ED Replacement for M97HE	\$ 5
N95HE	Upgrade for M95ED Replacement for M95HE	\$ 5
N95ED	Replacement for M95ED	\$ 5
N91ED	Upgrade for M91E Replacement for M91ED	\$ 5

**Earn up to a \$25 rebate during the Shure 60th Anniversary cartridge and stylus sale.**

To receive your rebate on selected Shure phono cartridges and replacement styli, send: (1) your dated sales receipt (non-returnable), (2) the complete outer carton from your Shure cartridge or stylus, and (3) this completed request to: Shure Rebate Offer—Dept. 63, 222 Hartrey Avenue, Evanston, Illinois 60204.

Name \_\_\_\_\_

Address \_\_\_\_\_

City \_\_\_\_\_

State \_\_\_\_\_

Zip \_\_\_\_\_

Phone (Area Code) \_\_\_\_\_

(Number) \_\_\_\_\_

Offer valid only on purchase made between September 1, 1984 and October 31, 1984. All requests must be postmarked by November 15, 1984. Limit of one rebate per household, and/or consumer regardless of number of Shure cartridges or styli purchased. This is a consumer rebate offer only. Shure dealers, companies and employees of Shure and their advertising agencies, distributors and retailers are not eligible. This offer may not be used in conjunction with any other rebate from Shure. Shure is not responsible for late, lost or misdirected mail. Offer good only on purchases made in U.S.A. Void where taxed or prohibited by law. Allow 6-8 weeks for delivery of check.

# SHURE®

You'll hear more from us.

A 9/84



## BIT BY BIT

In essence, the task of recording and reproducing music can be simply summarized—we want to form a representation of the music. Obviously, the closer our representation is to the original, the better. Unfortunately, reality is stubborn in its ability to defy recreation, and we are left with a challenging endeavor as we attempt to create an approximation of the original event. The essential problem lies in the complexity of even the simplest acoustic waveform and the dual nature of the information it carries. No matter which recording system we employ, our task is the same: To completely characterize an acoustic event, we must store both correlated time and amplitude information. Thus, a vinyl LP has a groove, the length of which implicitly encodes time, and lateral variations which encode amplitude. In a digital system, both time (implicitly again) and amplitude are stored as discrete pieces of binary information.

We've discussed sampling, a method of periodically taking a measurement. Of course, taking a measurement is meaningful only if both the time and value of the measurement are stored. Thus, sampling represents the time of the measurement, quantization represents the value of the measurement or, in the case of audio, the amplitude of the waveform. Sampling and quantization are thus the twin pillars of digital audio. Together, at least in theory, they can completely characterize any acoustic event.

Of course, as I've mentioned, reality isn't prone to duplication, thus our goal is one of approximation. Both sampling and quantization become variables which determine the accuracy of our approximation. An originally analog waveform may be mapped into a series of pulses; the amplitude of each will yield a number which represents the analog value at that instant. It is apparent that the greater the rate of the sampling, the better the representation of the waveform. Nonintuitively, the sampling of a bandlimited signal is a lossless process; so long as we sample at twice the highest throughput frequency, sampling is a perfect technique. But the choosing of the amplitude value is a different story. An analog waveform has an infinite number of amplitude values whereas we can only

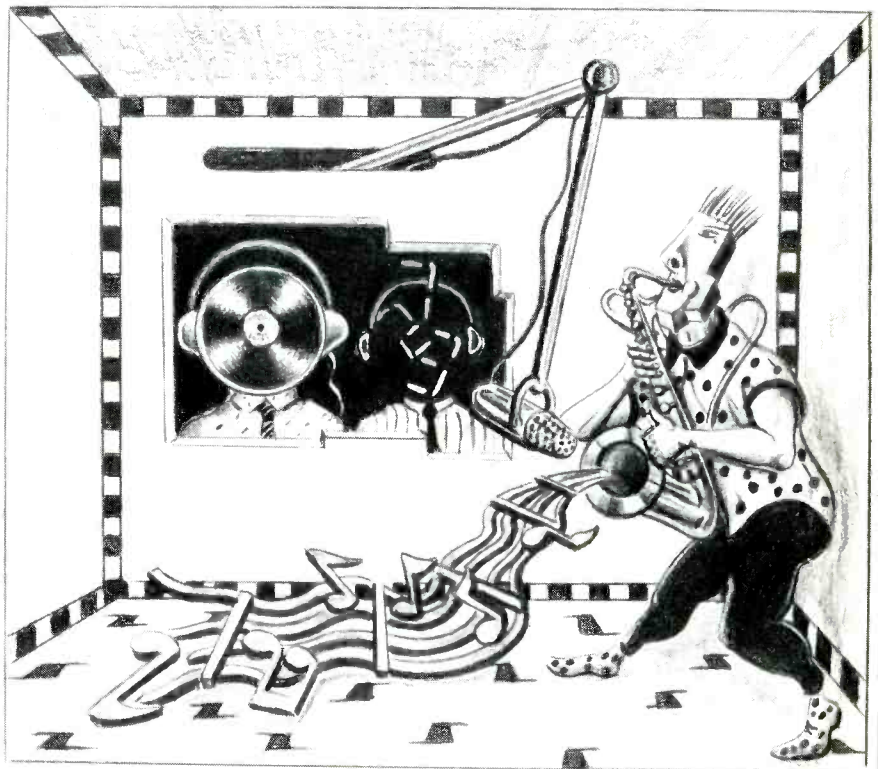

Illustration: George Blume

choose from a finite number of increments, so our chosen value will be only an approximation to the actual. In other words, there is an error.

Let's use an example to illustrate that, yes, even digital has error, and differentiate this error from the one inherent in an analog system. Suppose that I've connected two voltmeters, one analog and one digital, to my recording console, and, at the instant of the last cannon shot in the "1812 Overture," I read both meters, reading the voltage corresponding to the acoustic input signal. Given a good meter face and a sharp eye, I read the analog needle as showing 1.278 V. My digital meter, a rather cheap model, has only two digits and thus I read 1.3 V. If I pay a little more for a three-digit meter, I might read 1.28 V, and a four-digit meter would give 1.278 V. Now, both types of meters are always in error. The analog meter errs because of the ballistics of the mechanism and my difficulty in reading the meter. Even under ideal conditions, at some point, any analog measuring capacity is lost in the device's own noise. With the digital meter, the nature of the error is

different. My accuracy is limited by the resolution of the meter, that is, by the number of digits displayed. The more digits, the greater our accuracy, but the last digit will always round off relative to the actual value (1.278 was rounded to 1.3). Under the best conditions the last digit would be completely accurate (1.300 shown as 1.3) and under the worst conditions the rounding off will be one half increment away (1.250 rounded off to 1.2 or 1.3). The philosophical question of which is better, analog or digital, has already been decided in the marketplace—at least as far as voltmeters are concerned. For equal or less cost, we can build digital meters with greater resolution, ease of use, and reliability. A digital readout is an inherently more robust kind of measurement; we gain more information about an analog event when it is characterized in terms of digital data. The analog voltmeter has gone the way of the slide rule.

Back to audio digitization: Quantization is the technique of incrementing an analog event to form a discrete number. In terms of the quantizing hardware, the number of increments is

Number 7 in a Series

## Controlling The Cantilever

In your stereo phono cartridge, the stylus which traces the groove is attached to a small arm, or cantilever, which transmits the stylus motion to the actual sensing mechanism. The mounting of this cantilever is critical to the proper operation of the entire cartridge.

### Easy Does It

While the cantilever should move readily as the stylus moves (high compliance) it must also have the proper restoring force to bring it back to a central position when there is no groove modulation. It should also have no tendency to vibrate more easily at one frequency than another (resonance), particularly at audible frequencies. With the small masses involved, this can be a particular problem at very high frequencies, resulting in peaked response.

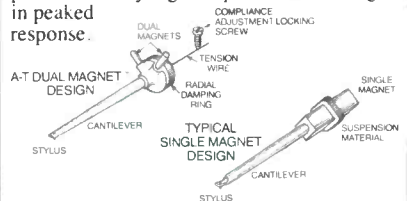

### Equal Opportunity Damping

In most stereo cartridges, control of cantilever motion is supplied by an elastic material surrounding the fulcrum. With Audio-Technica Dual Magnet cartridges, this is a radial damping ring which responds equally to motion in every plane. Thus damping is uniform regardless of relative channel signal strength or phase.

### Hand Tuning

This radial damping ring is slightly compressed during cartridge construction to a specific value which is hand-tuned for each stylus assembly. Thus compliance and resonance control can be optimized, eliminating potential unit-to-unit variations common to less sophisticated designs. Output is unusually smooth, even well beyond the highest audible frequencies.

### A Perfect Match

The exact compliance value for each cartridge model depends on its intended use. For instance, an inexpensive cartridge meant for low-cost players should have relatively low compliance to assure proper tracking. For a top quality turntable, however, much higher compliance will take full advantage of the improved tone arm quality. Our hand tuning assures exact adjustment to the ideal value for each specific model during cartridge production.

One of our most important design features is the use of two magnets. We'll tell you why in our next column.

Good listening.

*Jon R. Kelly*

Jon R. Kelly, President  
Audio-Technica U.S., Inc.  
1221 Commerce Dr., Stow, OH 44224



**audio-technica®**

The World's Favorite Phono Cartridge

determined by the length of the data word, in bits; just as the number of digits in our voltmeter determined our resolution, the number of bits in our digitization equipment determines resolution. As we will see in a future column, that decision (primarily an economic one) takes place in the design of the analog-to-digital converter. An eight-bit byte would accommodate  $2^8 = 256$  increments, a 16-bit byte would map  $2^{16} = 65,536$  increments. The more bits the better, but there will always be an error associated with quantization because the limited number of amplitude choices contained in the binary word can never completely map an infinite number of analog possibilities. No matter how many increments are available, there can always be an analog amplitude in between. At some point, the quantization error becomes audibly indistinguishable, but exactly what word length provides that luxury still isn't clear.

Word length determines the resolution of our digitizing system, and hence provides an important specification to measure the system's performance. Sometimes our chosen increment will be exactly at the analog value; usually it won't be quite exact. At worst, the analog level we desire to encode will be one half increment away, that is, there will be an error of one half the least significant bit of the quantization word. For example, suppose the binary word 011000 maps the analog increment of 1.20 V, and 011001 maps 1.30 V, and the actual analog value at sample time is unfortunately 1.25 V. Since 011000 and  $\frac{1}{2}$  isn't available, I would have to round up to 011001 or down to 011000, either way, I would be in error by one half of an increment magnitude. In characterizing digital hardware performance we may formulate a ratio of the total number of increments covered by our quantization scheme to the maximum incremental error. This ratio of maximum expressible amplitude to error determines the signal-to-noise ratio of the digitization system. For example, a 16-bit system would yield a S/N ratio of  $65,536 \div 0.5 = 131,072$ ; in terms of a more familiar dB measurement, this is about 98 dB. The S/N relationship can be conveniently expressed in terms of word length as  $S/N (dB) = 6.02n + 1.76$  where "n" is the

number of bits. Using the formula, a 16-bit system again works out to 98 dB, whereas a 14-bit system is slightly inferior at 86 dB. [Editor's Note: The common approximation is to multiply the bits by 6, yielding 96 dB for 16 bits and 84 dB for 14.—I.B.] In a later column we'll see that a digital S/N specification is a slightly different animal than an analog S/N specification.

Quantization is more than just word length, it is also a question of hardware design. There are many techniques available to accomplish quantization and different strategies determine how the analog signal is mapped onto the increments; we could use techniques such as linear or nonlinear distribution, monotonic or magnitude-and-sign, or many-to-one or one-to-many. Those algorithm decisions influence the efficiency of the available bits as well as the relative effects of the error. For example, a linear quantizer produces a relatively high error with low-level signals which span only a few increments. A nonlinear system such as a floating-point converter could be used to amplify low-level signals to utilize the fullest possible incremental span; while that improves overall S/N ratio, the noise modulation byproduct is undesirable and requires special masking.

Sampling and quantizing are, therefore, the two fundamental design criteria for a digitization system. Sample rate determines bandlimiting and thus frequency response, and word length determines S/N ratio. Although band-limited sampling is a lossless process, quantizing is one of approximation. Incidentally, quantization error is akin to noise—fortunately, with 14 or 16 bits it exists below most analog noise floors, and its effects can be further masked in the recording chain with a purposefully introduced noise called dither which makes quantization noise perceptually benign. In general, a word length of 14 or 16 bits with a sample rate of 44.1 kHz or 48 kHz yields remarkable fidelity, comparable to, or better than, the best analog systems. And that statement isn't meant to disparage the quality of analog audio—rather, it pays dear tribute to analog recording. It required an extremely sophisticated digital system, capable of processing 1.5 million bits per second, to rival Edison's wiggling groove. **A**



## DOWN THE AISLE

### Audio Visions

Pundits began talking of "the marriage of audio and video" as soon as audio output jacks reappeared on the back of some TV sets. (Such jacks had been available on some TVs, such as Conracs, back in the '50s, and on Heathkits ever since.) But it took more than sound-output jacks, LaserVision discs with hi-fi



sound, or even Hi-Fi VCRs to make the marriage a reality. Now, with stereo sound soon to be available in normal TV broadcasting, the two media are at least necking in the corner—or so it would appear from some of the items I saw at the Summer Consumer Electronics Show in Chicago.

Stereo TV is hardly catching the industry flat-footed. In the past year or two, most companies have equipped at least their top-end sets for plug-in stereo-sound adaptors, and now will offer the adaptors as well as sets with stereo decoding built in—for example, Fisher, GE, Magnavox, Mitsubishi, Panasonic, Pioneer, RCA, Sanyo, Sony, Toshiba, Zenith . . . even NAD, whose 20-inch MR20, with built-in decoder, is their first TV. I also noticed audio/video component systems from NEC, Fisher, JVC and Pioneer; all had lasers, one way or another: CD players in the NEC, Fisher and JVC, a LaserVision video disc player in the Pioneer.



A few of the new stereo-equipped sets had other features worth noting. Pioneer's SD-25 monitor, for instance, has space for any two of three optional modules which add UHF/VHF (non cable-ready) tuning, RGB computergraphics input, or sing-along (*karaoke*) capability. The remote control facilities include sharpness, color, tint, contrast and brightness.

NAD's premiere set featured three video inputs (one on the front panel), an r.f. video game/computer input (also in front), and remote-switchable r.f. inputs for use with premium cable services. Sony had a 26-inch table model. And Toshiba showed a prototype digital set, the CZ-2094, with such features as picture-in-picture superimposition, freeze-framing of the inset picture, and RGB computer inputs; the price is expected to be just under \$1,200.

I saw no sign of a universal TV-stereo decoder for use with older sets lacking multiplex-out jacks. Technics, however, had one new AM/FM/TV-sound receiver, the SA-850, with



stereo decoding built in, and three other models (the SA-550, SA-450 and SA-350) with monophonic TV-band reception plus jacks for an optional decoder. The tuners cover just the VHF band—no UHF or cable channels. Sorry, MTV fans.

So far, there seem to be no videocassette decks with stereo TV decoders, though Sony's Beta Hi-Fi models have jacks for the MLV-1100 multichannel sound adaptor (\$200). Sony also issued a fat catalog of Beta Hi-Fi software, and announced a new high-speed Beta Hi-Fi duplicator, the Sprinter, which should fatten it still further. Sprinter uses contact printing, allowing two-hour programs to be duplicated in 1½ minutes. Sony and Toshiba both announced low-priced Hi-Fi decks, for \$800 and \$850,



respectively. Sony also showed a "Hi-Fi-ready" deck, the SL-HFR30, which accepts an external Beta Hi-Fi adaptor; Aiwa announced a Hi-Fi-ready portable a few months back!

Meanwhile, the VHS camp mounted its own Hi-Fi counterattack, with models announced by Akai, NEC, Panasonic, GE, RCA, Sharp and Hitachi. Panasonic's PV-9600 portable was the smallest Hi-Fi-model.

Pioneer introduced 8-inch LaserVision discs. The first ones announced were 20-minute music videos selling for \$10.99. But 40-minute discs, costing about \$5 more, will be available for use with Pioneer's home *karaoke* module mentioned above and with their 60-videodisc jukebox, which also has *karaoke* facilities (mike inputs, a mixer and reverb).

The better to hear all this, several speaker manufacturers (B&W, Boston Acoustics, Pioneer, Polk and Proton) offered magnetically shielded models which could be snuggled up against a color set without affecting its picture, and NAD showed an



experimental, self-powered one. Naiad showed a small amplifier for video use, with tone controls and several high-level (but no phono) inputs.

The number of audio signal processors for video use is beginning to catch up with the number of pure video ones. From ADC, there's a video sound processor with volume expansion, DNR noise reduction and stereo synthesis. Three new

# Tandberg's advanced engineering offers less.



Tandberg's dedicated staff of audiophile engineers long ago decided that ideally there should be nothing between the listener and the music . . . no IM, no THD, no TID . . . no audible distortion of any kind.

However, in the real world of audio electronics, "nothing" wasn't easy to come by; virtually every aspect of the signal path, and the circuitry that supports it, required reevaluation. Tandberg embarked on a 5-year research project to systematically localize and eliminate every source of audible distortion, however subtle.

## In Pursuit of Nothing

The practical result of our concentrated research effort is the remarkable TPA 3006A Power Amplifier. Breaking new ground, and old rules, the TPA 3006A employs unique *zero feedback* MOSFET output stages. This is a difficult design topology, but the only one guaranteed to eliminate the audible time domain distortions undetected by conventional test methods. Available power output is 150 watts per channel into 8 ohms and 235 watts per channel into 4 ohms, with less than 0.02% THD/IM.

And, although MOSFETs have been used before, our constant-source impedance driver stage design is specifically engineered, for the first time, to take full advantage of these remarkable output devices.

The voltage and current limiting protection circuits of conventional amplifier designs also proved to be major obstacles to full fidelity. Tandberg's MOSFET configuration eliminates the need for all such circuit limitations; the MOSFET stages themselves are maintained at full linearity

by a unique Voltage Comparator Circuit. The TPA 3006A, therefore, has an output-current capacity exceeding 25 amperes per channel, supported by a massive, tightly regulated toroidal transformer power supply with over 30,000 microfarads of filter/storage capacitance.

Damaging DC is kept from the output signal path via our (patented) Thermic Servo Loop system that monitors the amplifier's output, automatically and instantaneously rebiasing the amplifier as necessary . . . but, unlike other designs, with no connection whatsoever to the musical signal.

Once the major areas of power amplifier distortion were eliminated, Tandberg engineers were free to pursue the much more subtle, less definable sources of sound degradation.

## Further technical nuances

Tandberg's pursuit of absolute fidelity led to the use of carefully chosen, costly high tolerance components: 1% metal-film resistors for their stability and low noise; plus sonically superior polypropylene capacitors (instead of electrolytic and ceramic types) are used in all audio stages. And, all audio stages employ discrete (no ICs!)

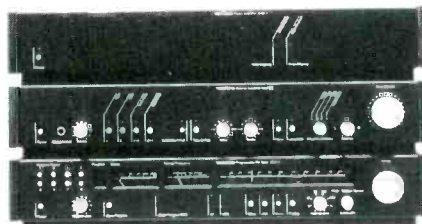

# TANDBERG

circuitry for maximum headroom and minimum distortion.

Tandberg has even reevaluated circuit board design. The lowest possible noise levels and totally identical performance between channels could be realized only when there is symmetrical parts layout and the reverse side of the circuit boards copper-plated to form a shielding ground plane; all housed in an unusually compact, nonmagnetic, anodized extruded-aluminum chassis.

## Compact & Cost Effective

Never before has a power amplifier of this degree of performance been compact enough to match our TCA 3002A Preamplifier and the world-famous TPT 3001A Programmable Tuner.

It should be evident that in the TPA 3006A, Tandberg has mounted an all out assault on audible distortion, breaking new ground in those areas that elude conventional measurements . . . and designers.

The final proof, of course, is in the sound. Audition the TPA 3006A at your Tandberg dealer . . . and hear why our engineers feel that they have achieved a quality of music reproduction comparable to the most costly esoteric units, in a compact, cost-effective design that is unobtrusive in any room setting.

For a Technical Paper on the remarkable TPA 3006A Power Amplifier and a beautiful color poster showing the complete Tandberg family of purist audio components, send \$2 for postage and handling to: Tandberg of America, Dept. AM, One Labriola Court, P O Box 58, Armonk, N. Y. 10504.



# Great Lies of Hi-Fi

## #1

### “Spend Most of Your Money on Speakers”

It is a common misconception that the most important component in a hi-fi system is the loudspeaker. Nothing could be further from the truth!

The performance of any loudspeaker is limited by the performance of every component that comes before it in the reproduction chain. Often, improving the speaker serves only to more clearly reveal faults that exist earlier in the system.

Or, more simply put, if you don't get the information off the record at the turntable, no component further down the chain can recreate that missing information. This is the reason that a moderately priced system with a Linn Sondek LP12 turntable, Linn Basik LVX arm, inexpensive integrated amp, and bookshelf speakers will sound better than an expensive system with a lesser turntable.



Whether you have an expensive hi-fi or a moderately priced system, replacing your existing turntable with a Linn will result in a larger audible improvement than any other change you could make, regardless of cost! This may sound like a pretty bold claim; don't take our word for it, visit a Linn/Naim dealer and hear it for yourself.

Distributed in the U.S. by:

# audiophile systems LTD.

6842 Hawthorn Park Drive  
Indianapolis, Indiana 46220

Enter No. 4 on Reader Service Card

If you've ever wanted headphones you could sit in, The Acoustic Chair may be just your cup of tea.



enhancers from dbx include an expander, an impact restorer (which expands transient attacks), and a bass enhancer (not a subharmonic synthesizer, as you'd expect from dbx, but an expander that operates only below 250 Hz), each priced at \$149.00. Pioneer introduced a surround-sound processor, the SP-101, which also includes a bass synthesizer; at least 57 movies now on LaserVision discs have soundtracks which Pioneer says will benefit from the surround treatment, and there should be at least as many videotapes which will.

Sansui now has a combination audio/video processor, the AV-77. It includes facilities for two-way videotape dubbing, as well as audio/

video recording from a TV tuner, audio component or video camera. The jacks for the camera, the second VCR and a microphone are on the front panel. Audio processing facilities include dbx noise reduction and stereo synthesis, while video processing includes sharpness, detail, hue, solarization, fading in and out of both picture and sound, and vertical and horizontal picture "wipes."

Akai's AV-U8 combines an integrated amplifier (20 watts per channel) with an audio/video switcher and a 4-inch, black-and-white monitor screen. The latter allows you to monitor a video dubbing while you watch something else on your main TV screen.

#### Audio Armchair

Over the years, hi-fi buffs have mounted loudspeakers in walls, ceilings, chests, and even in armchairs. For the audiophiles who must have high-level sound agitating their pinnae, hi-fi headphones have been one answer, but they can grow uncomfortable over long periods; so a British sound engineer, Stephen Court, has developed what could well be the ultimate in listening comfort.

The Acoustic Chair, as he calls it, looks like any other plush, high-backed winged armchair, but each wing has three loudspeakers buried inside the framework to handle middle- and high-frequency sounds. The lower and bass frequencies are reproduced by four bass units, mounted in a chamber under the seat and connected to hidden vents in the backrest.

The upper bass and mid-range are handled by roll-surround, stiff-cone drivers in the wings, all aligned for phase accuracy with the HF units. Crossover networks are in the bass chamber, with input terminals beneath the chair. The impedance is 8 ohms.

The performance of this chair is



sonically impressive, as a deafening undistorted level can reach the ears from an 8-watt input. It is important to know that only a small amount of sound leaks into the room, certainly not enough to disturb other people there. The vents at top and bottom allow the low frequencies to be heard by ear and felt by bone conduction.

This form of "easy listening" must be paid for: I have heard whispered prices, according to finish, of around £860 to £1,000 sterling (about \$1,186 to \$1,380).  
*Donald Aldous*



# TO MAKE A CASSETTE TAPE SOUND LIKE MUSIC, YOU'VE GOT TO KNOW WHAT MUSIC SOUNDS LIKE.

Think about it. What other tape manufacturer also builds professional recording equipment including 24-track and digital studio tape recorders? What other tape manufacturer has 72 years of experience as a major record company? Other tape manufacturers may talk about "digital ready," but do you know Denon developed the digital recording process in 1972?

It is this unique combination of technical and musical expertise that led Denon to use Dynamic Distortion Testing to optimize DX cassette tape performance in the presence of real musical signals, not mere laboratory test tones. The result is the most *musical* of all cassette tape. Denon DX-Cassette tape. When we claim it's better, we say it with music.



# DENON

D E S I G N I N T E G R I T Y

Nippon Columbia Co., Ltd., No. 14-14, 4-Chome, Akasaka, Minato-Ku, Tokyo 107, Japan

Denon America, Inc., 27 Law Drive, Fairfield, N.J. 07006 201-575-7810  
Queon Imports, 3950 Griffith St., Montreal, Quebec H4T 1A7, Canada, 514-735-4338

Enter No. 12 on Reader Service Card

AmericanRadioHistory.com



IVAN BERGER

## FROM DISC TO DISC

**F**or 50 or 60 years now, we've been able to tune in music in our cars. But being able to play the music of our choice there is a much newer development.

Probably the first attempt at bringing this convenience to a mass market was Chrysler's Highway Hi-Fi, of 1956. It played, of all things, phonograph records; the obvious problems of vibration and the need for a special small-diameter, 16 $\frac{2}{3}$ -rpm recordings killed that pretty quickly. Judging from our photo files, Norelco had something similar; but we lack details. Chrysler made another try, with a 45-rpm, 14-record changer, in 1960.

Open-reel tape was never a contender—too hard to thread while driving. But tape cartridges and cassettes were another story. Three such systems burst upon us in the '60s: The short-lived, four-track tape cartridge (descendants of which still survive in broadcast studios); the 8-track cartridge which became, for quite a while, the U.S. mobile-music standard, and the Compact Cassette.

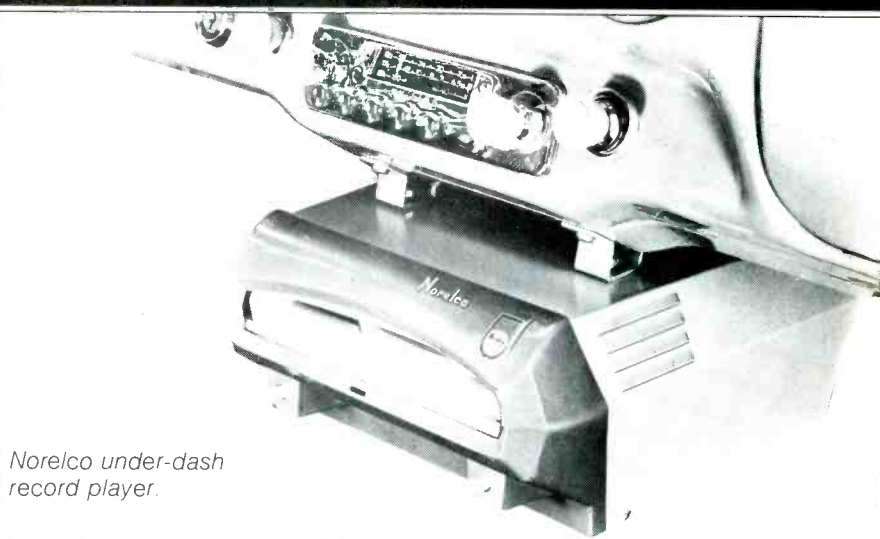

*Norelco under-dash record player.*

tape speed (3 $\frac{3}{4}$  versus 1 $\frac{1}{8}$  ips) gave them better fidelity than cassette. There were problems, to be sure: The cartridges were bulky (about four to six times as big as cassette, if memory serves); the tape was a bit more prone to jam or develop flutter; the three track-changing interruptions played

Only it wasn't. With chrome tape and Dolby NR, the cassette first matched and then surpassed 8-track's fidelity. For those who demanded endless music, auto-reverse players and recorders came to be. And recording your own tapes at home was far easier with the cassette, which had a third as many mandatory interruptions. Further, the large numbers of monophonic but stereo-compatible cassette portables gave owners of in-dash cassette units a way to play their tapes that 8-track users couldn't match.

It took a while before 8-track makers even tried to respond to cassette's advances in fidelity. And by the time they did, it was too late—those who cared about sound were already into cassette—and those still into 8-track were, almost by definition, ones who didn't care that much. The 8-track recorders with Dolby NR and other advances failed to sell. Eight-track had become, irredeemably, the low-priced spread.

By the time you read this, it may be possible to buy a CD unit for your car. A disc player? Isn't that where we came in? *A*



*The 3M-Wollensak 8075 8-track recorder offered decent quality and Dolby NR—but cassette had already won the battle.*

The cassette showed up in cars almost as soon as it was invented—but that was thanks to a "Car-Mount," designed to hold a portable Carry-Corder under the dash. The system was bulky, low-powered (it apparently used the Carry-Corder's meager amp and speaker) and, of course, monophonic. Soon, however, in-dash and under-dash stereo cassette units were available; they sold fairly well in Europe, but not here.

In this country, the lead had gone to the cartridge tape systems. They had been stereo from the outset, and their endless-loop design meant they didn't need to be ejected and flipped over halfway through—a convenience for the driver. What's more, their higher

hob with classical-music continuity, and the lack of a true fast-forward mode (or any rewind whatsoever) made it very inconvenient to find any particular song or section of the tape. But once Detroit started offering in-dash, 8-track stereos, it looked as if that was the ball game.

*An early 8-track player, designed for under-dash use.*



Welcome to the golden age of Luxman



Luxman's special champagne gold series: The L-400, K-220, T-240, L-210, K-240, L-430.

Believing that form follows function, Luxman creates a special champagne gold series of sophisticated audio components. Inside, precise hand-crafted electronics. Outside, elegant, classic design. With pure, clear sound to match. See and hear how over 50 years of refinements and innovations, now backed by The Alpine Touch, ushers in the golden age of Luxman. Start by calling 1-800-257-4631.

*The  
Touch  
of  
Luxury*  
**LUXMAN**  
HIGH FIDELITY SYSTEMS

Luxman/Division of Alpine Electronics of America, 19145 Gramercy Pl., Torrance, CA 90501

Enter No. 3 on Reader Service Card



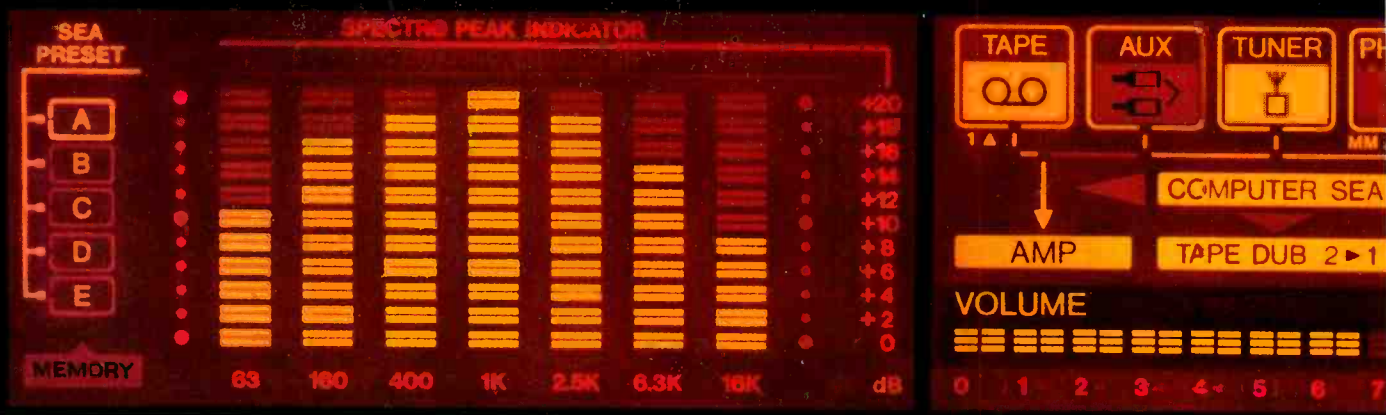

# THE ULTIMATE MACHINE

**JVC'S NEW R-X500B RECEIVER IS A SUPERB EXAMPLE OF HOW FAR JVC WILL GO TO BRING YOU THE ULTIMATE IN SOUND.**

Some hi-fi equipment delivers slightly higher fidelity. Especially when it's designed by JVC®. In fact, JVC's entire line

remote equalization and unheard-of-refinements, it is virtually without equal.

**ADVANTAGE: A POWER AMP WITH INCREDIBLE POWERS**

The R-X500B boasts two of the highest refinements in power amp technology available today—Dynamic Super A and Gm Driver. Dynamic Super A improves



of high fidelity components is known throughout the world for technological brilliance and painstaking craftsmanship.

The R-X500B receiver is a case in point. With the technology of JVC's power amp, equalizer and tuner, plus

performance in two significant ways. One, it renders music reproduction silky and pure by eliminating offensive switching distortion. Two, it capably controls speaker motion by forming an ideal interface between the amplifier and the speaker.

**HIGH FIDELITY**



JVC's newest technology, Gm Driver, improves actual in-use performance at all listening levels, high and low, by driving the power stage at a constant voltage.

**ADVANTAGE: AN EQUALIZER WITH A GRAPHIC DIFFERENCE**

Since 1966, when JVC pioneered equalizers for home use, we have remained in the very forefront of equalizer technology.

The computer controlled graphic equalizer in the R-X500B is a superb example of engineering to achieve an end. It combines unequalled versatility with automatic capabilities, while maintaining sonic integrity.

Five equalized responses can be memorized for instant recall at a touch.



And an infrared wireless remote control makes it possible to adjust equalization from your armchair without sacrificing sound quality.

In a further refinement, JVC engineers opted for an LSI to handle electronic switching for both channels at

seven different control frequencies. The result—electrical loss and tonal

degradation never enter the picture.

**ADVANTAGE: A TUNER AS SMART AS A COMPUTER**

The R-X500B puts an advanced microcomputer in charge of the digital synthesizer tuner and references it to the accuracy of a quartz oscillator, making it highly versatile and easy to use. The microcomputer lets you preset 15 AM and 15 FM frequencies, scan them all for 5 seconds each, read out aerial signal strength in 5dB increments, plus much more.

SPECIFICATIONS	
<b>AMPLIFIER SECTION</b>	
Output Power	
100 Watts per channel, min. RMS, both channels driven into 8 ohms, from 20Hz to 20kHz, with no more than 0.007% total harmonic distortion.	
Signal-to-Noise Ratio ('66IHF/DIN)	
Phono—80dB/66dB	
Video/Aux/DAD/Tape—100dB/67dB	
RIAA Phono Equalization	
± 0.5dB (20Hz -20kHz)	
<b>S.E.A. SECTION</b>	
Centre Frequencies—63, 160, 400, 1k, 2.5k, 6.3k, 16kHz	
Control Range—± 10dB	
<b>FM TUNER SECTION ('78 IHF)</b>	
50dB Quieting Sensitivity	
Mono—14.8dBf Stereo—38.3 dBf	
Signal to Noise Ratio (IHF-A Weighted)	
Mono/Stereo—82dB/73dB	

**ADVANTAGE: JVC**

It is the attention to engineering detail and craftsmanship evident in the R-X500B which separates every JVC hi-fi component from all others. JVC makes changes in design for the sake of improvement. Not just for the sake of change. And the result is the difference between excellent and average. See, and hear, this difference at your nearest JVC dealer.





CD player prices have been dramatically reduced. There are several in the \$400 to \$500 range, which may mean "under \$300" at retail.

CD-player-only unit, both covered in depth in the July *Audio*.

Fujitsu is planning a car CD player and was showing a prototype—but no production schedule was given.

Pioneer is well along with its plans to introduce a car CD player in January of 1985. Their two-unit approach couples a small operating module which fits

into almost any dashboard with a hide-away processing module which can be located under a seat, for example. This CDX-1 car CD player also has a door-less loading slot, and its anti-vibration design is said to eliminate tracking errors, obviously of importance in a car CD player. Equally important is a sensor which can detect an excessive rise

in ambient temperature, whereupon playback is automatically disengaged. No price set as yet.

Finally, I must report on a most unusual new CD player from Technics. How about a CD *changer* that can currently play 51 CDs, and is ultimately expandable to play 251! This is the Technics SL-P15. The unit performs up to all the usual CD player parameters and is equipped with wireless remote control.

Technics has a number of new technologies at work here, but essentially the CDs are loaded into a 50-selection magazine, and a playing mechanism, whose remote ancestor may have been a vertical-play Seeburg jukebox, does the job. Special interfaces and extra magazines are needed for playback of the group of 251 CDs.

All these discs can be programmed in any sequence; you can play record 3, band 2, then shift to record 104, band 5, and then on to record 14, band 1, and so on, ad infinitum. The mind boggles! One shudders at the thought that some of these wall-to-wall background music freaks could program music for every minute of the day for more than ten days! Yike!

Needless to say, commercial broadcast interests see the possibility of a machine like the SL-P15 replacing their poor-sounding tape-cartridge carousels. The SL-P15 will probably be available in the fall, at a price of \$1,500.

(*Editor's Note:* Magnavox, Hitachi, and Sony all have changers in the works as well, but so far none from these three are being offered in the U.S. In Japan, Sony's unit is being sold through a second party to the *karaoke* sing-along club and bar market—*E.P.*)

Two popular CDs used to demonstrate the qualities of the various players were Telarc's Sampler Volumes I and II (CD-80101 and CD-80102). Volume I starts out with a rip-snortin' version of John Williams' "Superman" theme, while Volume II begins with a rousing rendition of Arnaud's "Olympic Fanfare." The two discs contain 38 selections and most positively demonstrate the musical and sonic virtues of the Telarc CDs.

Next month, in Part II of the 1984 SCES roundup, a look at some interesting new audio electronics, loudspeakers, and assorted devices. **A**

**"For the person seeking a power amplifier that has no compromises, and will drive anything but a truck."**

Andrew Marshall  
Audio Ideas, Canada

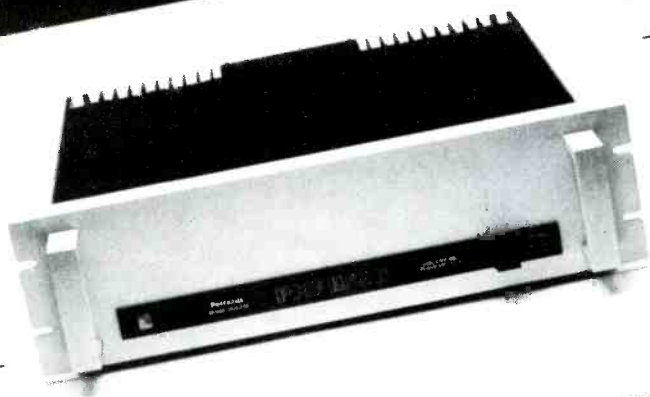

**Perreaux of New Zealand's 1150B power amplifier... unexcelled drive and sound quality for only \$1150.**



**Alterman's Audio**  
Meatree, Louisiana, 70002  
(504) 834-7772



# Winston. America's Best.

Excellence.  
The best live up to it.



17 mg. "tar", 1.3 mg. nicotine av. per cigarette by FTC method.

Warning: The Surgeon General Has Determined  
That Cigarette Smoking Is Dangerous to Your Health.



# FOREVER IS A LONG TIME



## Presenting High Bias II and the Ultimate Tape Guarantee.

Memorex presents High Bias II, a tape so extraordinary, we're going to guarantee it forever.

### We'll guarantee life-like sound.

Extraordinarily flat frequency response at zero dB recording levels, combined with remarkably low noise levels, means music is captured live. Then Permapass, our unique oxide-bonding process, locks each oxide particle—each musical detail—onto the tape. So music stays live. Not just the 1st play. Or the 1000th. But forever.

### We'll guarantee the cassette.

We've engineered every facet of our transport mechanism to protect the tape. Our waved-wafer improves tape-wind. Silicone-treated rollers insure precise alignment and smooth, safe tape movement. To protect the tape and mechanism, we've surrounded them with a remarkable cassette housing made rigid and strong by a mold design unique to Memorex.

### We'll guarantee them forever.

If you ever become dissatisfied with Memorex High Bias II, for any reason, simply mail the tape back and we'll replace it free.

YOU'LL FOREVER WONDER,

IS IT LIVE,  
OR IS IT  
MEMOREX.





## Automatic Sensitivity Adjustment

*Q. My cassette deck has a micro-processor which, according to the manufacturer, automatically sets the bias, equalization, and sensitivity levels. Does this also set the Dolby level?—William H. White, Fullerton, Cal.*

*A. Yes. If the deck has been correctly adjusted at the factory with respect to Dolby reference level, the automatic sensitivity adjustment performed by the microprocessor makes any required change, for the particular tape that is being recorded.*

Tape sensitivity refers to the amount of signal output delivered by the tape for a given signal input to it. For the Dolby noise-reduction system to work properly, the level of the signal presented to the encoding (treble-boost) system must match the level presented to the decoding (complementary treble-cut) system. If a tape has high sensitivity, which signifies a relatively high signal output—or a lower signal input required for a given signal output—allowance for this must be made in recording; the signal output in playback will thereby match the signal input in recording.

## Belt Source

*Q. I own an open-reel tape deck which is about six or seven years old. It is now inoperable because the drive belt has stretched with age. I have tried electronics parts stores and wholesale houses in search of a replacement belt, but it appears that my belt is different enough from anything currently available that nothing will work. I have been told that the manufacturer of my deck has suspended all U.S. operations. Do you know how I can get a new belt?—Al Beckett, Oklahoma City, Okla.*

*A. Try Projector-Recorder Belt Corp., Department SR, 147 Whitewater St., Whitewater, Wisc. 53190.*

## Cassette vs. Open-Reel Decks

*Q. I am no longer satisfied with my present cassette deck and am trying to decide whether to trade up to a better one or to buy an open-reel deck. Open-reel looks attractive to me for several reasons: I can buy 10½ inch reels of unspliced tape used only once from a local radio station for only \$1.00 apiece. I could record much more ma-*

*terial on a (10½-inch) reel even at the high speed of 7½ ips. I am concerned with the limits of dynamic range of cassette, inasmuch as phono records are improving and my collection contains more and more discs made from digital and half-speed masters. I would like your opinion on cassette versus open-reel.—Chris Sellers, Ames, Iowa*

*A. As cassette decks and tapes have steadily improved, it has become increasingly difficult for most persons to detect a significant difference between a fine cassette unit and a fine open-reel one. Metal-particle (Type IV) tape has further decreased the difference; at the same time, improvements in the other kinds of tape—ferric oxide (Type I), chromium dioxide or ferricobalt (Type II), and ferrichrome (Type III)—have left them a scant distance behind metal tape. Important increases in signal-to-noise ratio—owing chiefly to dbx (about 30 dB) and Dolby C (about 20 dB) noise reduction—have made cassette a truly high-fidelity medium. Such improvements permit the recordist to sacrifice a few dB of S/N by recording at a slightly lower level, thereby avoiding tape saturation and consequent distortion and loss of high treble.*

The consensus seems to be that unless you're directly taping live material, you can do about as well with cassette as with open-reel. On the other hand, the advent of improved recorded material, in particular the Compact Disc, presents a new challenge to tape recording, so that the superiority of open-reel, particularly at speeds of 7½ and 15 ips, may again become evident—at least for a while, until cassette catches up again.

As you recognize, open-reel, particularly if you have a deck that takes 10½-inch reels (some cannot accept reels larger than 7 inches), will afford you longer recording and playback time per reel. Further, editing is easier with open-reel than with cassette.

Perhaps the most audible inferiority of cassette with respect to open-reel, particularly if open-reel is operated at 7½ ips or more, lies in the area of azimuth alignment. The faster speed of open-reel causes a given degree of azimuth misalignment to have less adverse effect on treble response. True, the wider track of open-reel is disad-

vantageous with respect to the azimuth problem, but this disadvantage is substantially overcome by the faster speed. On the other hand, cassette deck manufacturers—at least those making quality units—are paying closer and more effective attention to accurate azimuth alignment.

In view of all the factors you have mentioned, I slightly incline toward open-reel in your particular case. But I think you should do some careful listening to both cassette and open-reel decks before you make your decision.

## Service Problem

*Q. About two months ago I took my open-reel tape deck to be cleaned and serviced. When it came back it was worse than it had ever been; it wouldn't run in fast forward and it wouldn't rewind without spilling tape all over the place; in operating mode it would drag as it came to the end of a reel. When I brought in the deck, the only problem was the drag. I wish to take my deck back, but I am afraid that the shop may mess it up even more. Where can I get my deck fixed properly?—George Pruitt, Pemberton, N.J.*

*A. The Tape Guide cannot recommend specific service shops. Try to obtain the name of an authorized service shop in your area from the deck manufacturer, from a local audio dealer, or from the yellow pages of your telephone book.*

Whatever service shop you decide on, be sure to do two things: (1) Demonstrate the problem you have so that you and the shop agree as to what it is, and so that it is clear that all else is working well. (2) When you pick up the deck, have the shop demonstrate that the problem has been fixed and that all else is working properly. Service shops are not always eager to do so, but unless they are you probably shouldn't engage their services.

If a great deal of time hasn't passed since your deck was serviced, I think you might give that service shop a chance to correct its work, provided it is willing to do so at no or minimal cost to you. **A**

**If you have a problem or question on tape recording, write to Mr. Herman Burstein at AUDIO, 1515 Broadway, New York, N.Y. 10036. All letters are answered. Please enclose a stamped, self-addressed envelope.**



## Protection-Circuit Problem

*Q. I have a receiver which I purchased some time ago. Every once in a while a relay will click and the sound disappears from my loudspeakers. However, the signal is still present at the input of my tape recorder. Sometimes, the relay will again click and the sound returns. At other times, I can bring the operation back to normal by a sharp rap on the side of the unit. Does this sound like some kind of protection-circuit problem?—Robert W. Thompson, Glendale Heights, Ill.*

*A.* The relay is part of a protection circuit. You may be driving your amp beyond its limits, thereby activating the protection circuit (and the relay) when the temperature on the heat-sink rises to an appropriate point. The fact that the tape recorder is still fed by its correct signal is at least partial proof that your protection circuit is triggering.

Sometimes these circuits will "take off"—even when the receiver is not being overdriven or when there is no signal fed into it. This may represent a malfunction of the protection system. It may also signify there is a lack of good ventilation around the equipment, which would result in a gradual rise in heat-sink temperature. This, in turn, would trigger the protection circuit.

## Using Timers

*Q. How safe are timers when used with a stereo system? I have always understood that such timers have the same effect as pulling the a.c. power cord out of the wall outlet with the system turned on.—Rocky Ciesick, Panama City, Fla.*

*A.* Cutting off the power has virtually the same effect whether it's done by pulling the plug, shutting off the system's master switch, or interposing an external switch, such as a timer. The more components switched on or off at once, the bigger the surge on the a.c. line. Therefore, it might be more advisable to use the timer to turn on only the components which need to be on at that time—for example, just the tuner and the tape deck, when you are taping programs off the air.

The only problems I have found with using timers occur when using mechanically controlled tape decks or tape decks and phonographs with idler-wheel drive systems. Mechanical-

ly controlled tape decks use your finger pressure on the "Play" key to push the pinch roller against the capstan. On such decks, the roller must be left in position for the period between set-up and timer actuation, which can permanently flatten the roller at that point. (This does not happen on solenoid-operated decks, whose pinch rollers are moved into position electrically.) In some decks and turntables, transport drive idlers will also be engaged under pressure, again possibly producing flat spots. Flat spots on the pinch roller or drive idlers cause wow and, sometimes, physically noisy operation.

In general, if a tape deck has a timer-recording switch or switch position, it is safe to use it with a timer. All other components are also safe, except for idler-driven phonographs (which are becoming less and less common).

## Stylus Life

*Q. How many hours can a stylus play records before you must replace it?—Robert Hirose, Los Angeles, Cal.*

*A.* Stylus life varies markedly, depending on such factors as stylus shape, tracking force, anti-skating force, the overall loudness of the discs being played, and the amount of foreign matter the stylus encounters in its travels. There are also variations in the durability of the individual gems from which styli are ground. Use the manufacturer's recommendations as your guide, and have your stylus checked from time to time (especially when it nears or passes the end of its rated life) on a stereo microscope (one with independent left and right optical systems). Good stereo microscopes are expensive, but many dealers have them.

If the tonearm is handled carelessly, so that the stylus is dropped onto a disc or the turntable, the stylus may need replacement after virtually no playing time at all.

## Muting Again

*In the October 1983 "Audioclinic," you fielded a question concerning the -20 dB muting switch found on many amplifiers and receivers. The owner's manual supplied with my receiver stated the following about this switch:*

*1. It extends the useful range of the volume control. With high-output signal*

*sources, with efficient speakers or with sensitive headphones, you may find that the sound is too loud over most of the range of the volume control, i.e., you are restricted to using only settings near the lower end of the control range. By engaging the low-level switch, you can use the full range of the volume control for normal listening.*

*2. It provides optimum signal-to-noise ratio for low-level listening in quiet environments. For example, if you are listening to soft music late at night and the surroundings are quiet, the low-level switch minimizes the already low residual of the preamplifier and tone control circuits.*

*3. It provides a convenient, temporary cut in volume (as your response in Audio stated).—Joe Mazzini, Montgomery Creek, Cal.*

## Digital Turntables

*Q. Are there such things as digital turntables? If not, why are more and more phonograph records being digitally recorded if they are just to be played back on analog or conventional phonographs?—William Scaramazca, Swedesboro, N.J.*

*A.* The phonograph is an analog system, and even digitally recorded master tapes must be converted to analog form for phonograph disc mastering. But studios are making more and more of their masters digitally, both in preparation for the release of these recordings in such digital formats as the Compact Disc and to get better quality in their LP releases. Digital masters have less noise and distortion and more extended high- and low-frequency response than analog masters, and they are not gradually degraded by constant recopying in the process of converting multi-track originals to two-track stereo releases. (There are, however, some who feel that digital recordings sound harsher.)

The Compact Disc player might be considered the "digital turntable" you asked about. But it, of course, plays only digital CDs—some of which were made from analog masters. A

**If you have a problem or question about audio, write to Mr. Joseph Giovanelli at AUDIO Magazine, 1515 Broadway, New York, N.Y. 10036. All letters are answered. Please enclose a stamped, self-addressed envelope.**

# ULTRX

## MOST PEOPLE WOULD CALL IT OVERKILL.

The new ULTRX™ R100 receiver isn't for everybody.

You don't really need 100 watts per channel\* of virtually distortionless power. Unless you like listening to today's ultra-high quality recordings at "live concert" sound levels.

And a remote-controlled digital tuner with 20-station memory is probably more than enough—unless you're a dedicated FM listener with wide-ranging tastes.

Likewise, most people could get along without the built-in dbx and DNR noise reduction systems.

of noise in CD digital recordings. With the dbx, any cassette deck can make virtually noise-free recordings, while the DNR "cleans up" existing noisy signals.

Unless you're a nut about *video* sound quality, too, you won't have much use for the TV/VCR inputs and stereo synthesizer circuit.

The R100 is packed with features that are best appreciated by an audio perfectionist. It may be the best-equipped receiver ever built.

Get an ULTRX dealer to put an R100 (or one of our other new receivers) through its paces for you.

Some people might call it overkill. But you'll call it overwhelming.

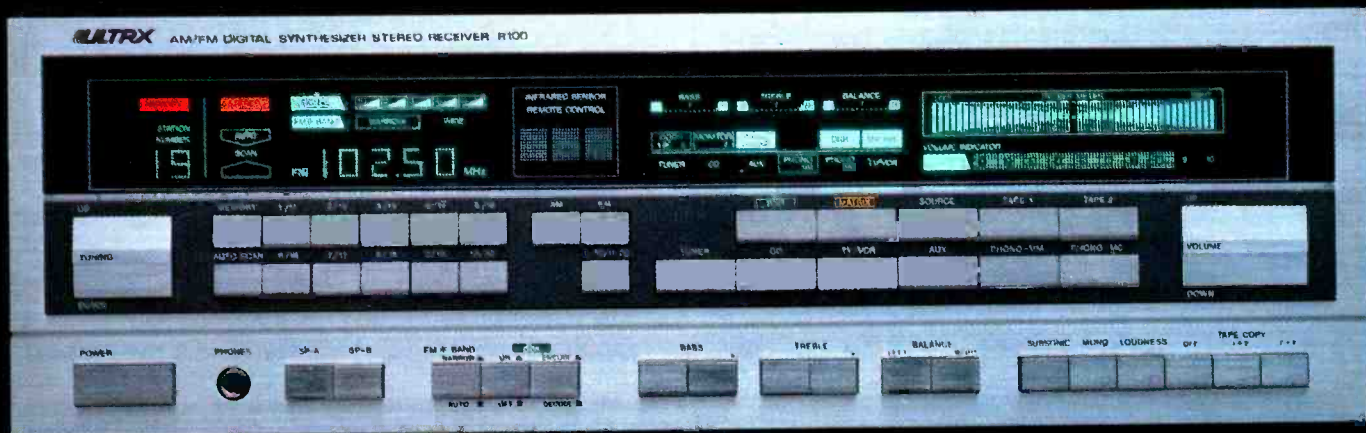

Beyond the Ordinary.

\*Minimum Continuous Average Power per channel, both channels driven into 8 ohms, from 20-20,000Hz, with no more than 0.009% Total Harmonic Distortion.

©1984 ULTRX dbx is a trademark of dbx, Inc.

Enter No. 26 on Reader Service Card





### Fried Loudspeaker

The Fried A/3 bookshelf loudspeaker replaces the A/2, which was introduced in 1981. Among its new features are a polypropylene bass-mid driver with ventilated voice-coil, a new dome tweeter, and a new crossover network in which the drivers are connected in series rather than in parallel. According to Fried, series networks provide more homogenous, smooth and dynamic sound, and better stereo imaging. Price: \$580.00 per pair. For literature, circle No. 102



### Linear Power Crossover

The XO1 active stereo crossover, from Linear Power, can be set to any of 19 frequencies (between 74 Hz and 17 kHz) by plugging in an IC-sized

frequency module. A remote frequency selector, the XO-controller (shown at right in the photo) is available to installers, allowing them to check the

effects of different crossover frequencies by turning a switch while sitting in the car. Price: XO1, \$149.95. For literature, circle No. 100

### Koss A/3 Portable Radio/Cassette

The Koss Music Box personal portable stereo line now includes a cassette player with Dolby B NR and an AM/FM tuner pack. The 10½-ounce player features the SafeLite, a yellow LED which warns

when sound pressure through the headphones reaches 95 dB SPL. The SafeLite is calibrated for Koss's Sound Partner folding headphones, which come with the system. Price: \$129.95. For literature, circle No. 101



### Yamaha Headphones

Now you can wear a Porsche: Yamaha's new YHL-006 headphones were styled by the Porsche Design group. They curl up into a palm-sized package for carrying or storage, and their diaphragms are in



unique, ball-shaped enclosures which sit on the ear and are held in place by a flexible headband. The "Y" cord has a 3.5-mm mini plug; a ¼-inch plug adaptor and a case are provided. Price: \$40.00. For literature, circle No. 103

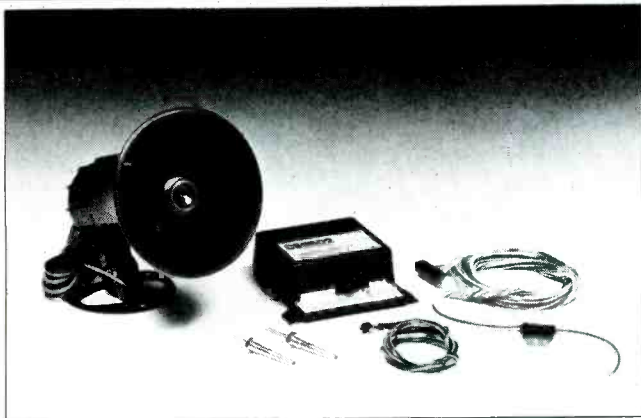

### Crimestopper Car Alarm

The Crimestopper CS9502 alarm is a keyless system which arms itself through the car's ignition system (thus qualifying for insurance discounts on cars with passively-armed systems). The system can also be overridden to allow valet parking; in this mode, a chirp reminds the user to

re-arm the system later. An LED status indicator shows the arming mode and indicates when intrusion has been attempted. A backup battery circuit triggers the alarm (a 110-dB siren) when the car battery is disconnected. Price: \$149.95, plus installation.

For literature, circle No. 104



### Aiwa Beta Hi-Fi VCR

The V-5 Beta Hi-Fi videocassette recorder, from Aiwa, is a portable with an unusual configuration. Unlike most portables, this one has its tuner, timer and power supply built in, making it heavier than most portables, but still, at 13.7 pounds, it's probably the lightest tuner/timer/VCR. As a portable, it records sound monophonically; the Beta

Hi-Fi stereo signals are provided by the amplifier/adaptor unit shown beneath the VCR. The amp section delivers 5 watts per channel into 8 ohms, from 20 Hz to 20 kHz, at 5% THD or less; there is also a preamp output for use with external sound systems. Price: \$950.00, including amplifier/adaptor and wired remote control.

For literature, circle No. 106

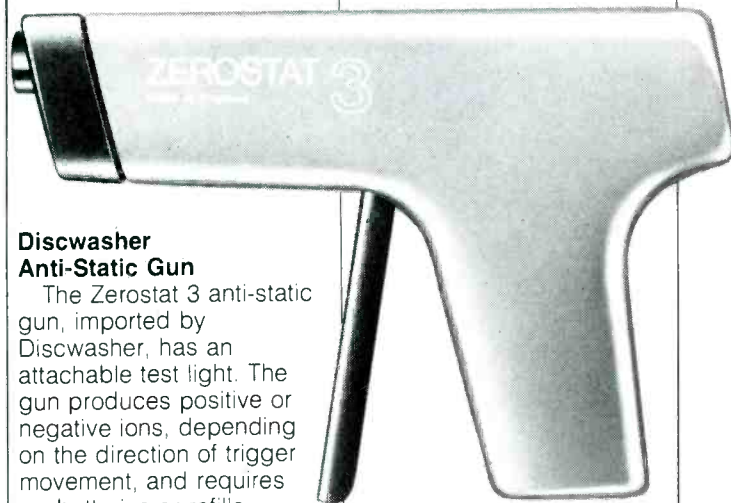

### Discwasher Anti-Static Gun

The Zerostat 3 anti-static gun, imported by Discwasher, has an attachable test light. The gun produces positive or negative ions, depending on the direction of trigger movement, and requires no batteries or refills. Price: \$23.00.

For literature, circle No. 105

### Pioneer System

The Pioneer SC-5 offers more opportunity for personal involvement than the average one-brand system. In addition to the usual components (a digital tuner, front-loading turntable, dual cassette deck, seven-band equalizer and three-way speakers), it has a built-in mixer, handling up to five inputs,

with pan-pots to locate sources in either channel or between them. Microphone and headphone jacks (and a c. convenience outlets) are accessible on the front of the rack. The system also features cassette storage drawers, the usual record-storage space, and a digital timer. Price: \$2,199.95.

For literature, circle No. 107





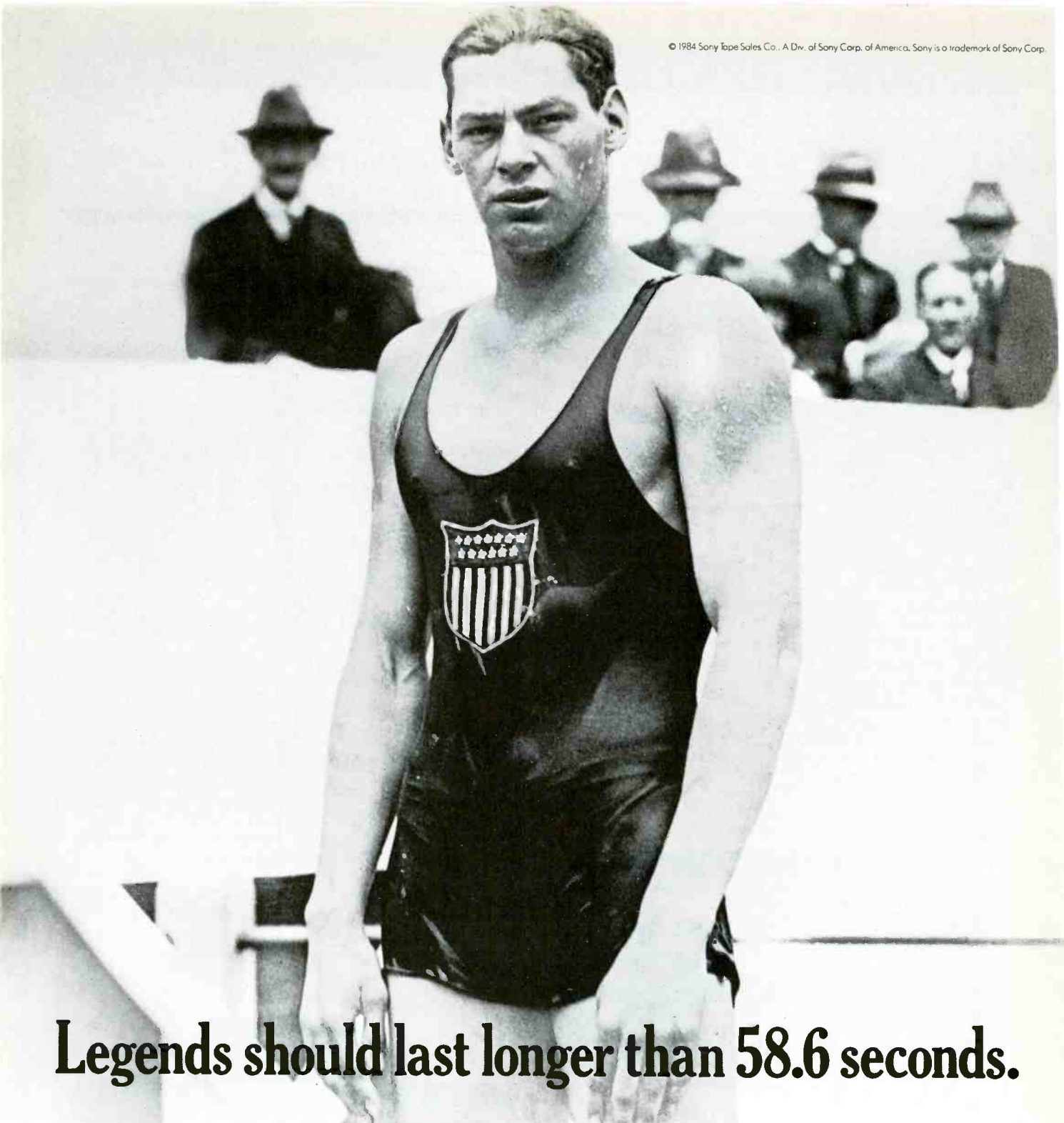

# Legends should last longer than 58.6 seconds.

The legendary Johnny Weissmuller. A record-breaking 58.6 seconds for the 100-meter Freestyle at the 1928 Olympics. All told, 5 gold medals and 5 Olympic records at the '24 and '28 Olympic Games.

Unfortunately, you couldn't capture the Weissmuller legend on Sony Tape back then. But new legends will be made and new records set this summer in Los Angeles. Capture them on Sony Tape. And let the legends live on.



For \$1.00 rebate on T-120 and L-750, see participating retailer.

## Sony Tape. The Perfect Blank.

Enter No. 32 on Reader Service Card

# HISTORY OF MAGNETIC RECORDING



## ROBERT ANGUS

In 1947, while John Mullin was proving the worth of the Magnephon tape recorder he had brought back from Germany, a research team at Bell Laboratories (consisting of physicists John Bardeen, Walter Brattain and William Shockley) was developing a device which would revolutionize tape recording along with just about every other aspect of electronics—the transistor. Manufacturers of magnetic recording equipment didn't pay much attention—they were too busy developing wire and tape. Magnecord, which had been organized in 1946 to produce wire recorders (first for broadcast use and almost immediately for public consumption) abandoned that format in favor of tape in the fall of 1948. Magnecord's PT-6 quickly became the workhorse of recording studios and radio stations, as well as finding favor among hi-fi buffs.

One day the following year, David Apps of General Motors Laboratories approached Magnecord with an unusual request: Could the company build a tape recorder which could capture sound stereophonically? GM had been using a PT-6 to analyze automobile noise, but the results were unsatisfactory because they lacked spatial perspective. Perhaps a stereo unit might solve the problem. Magnecord quickly modified a PT-6, installing two record/play heads 1-5/16 inch apart along the tape path. The upper one recorded left-channel sound, the lower one the right. Having made its first stereo recorder, Magnecord made two

more for display at the 1949 Audio Fair in New York.

The musical applications of the stereo recorder were obvious to Magnecord's engineering-oriented management team, so in 1950 they hired a musical coordinator, a young recording engineer and audiophile named Bert Whyte. Whyte's first chore was to use the stereo machine to record as many different types of music as possible. A highly personable and persuasive man, the Chicago-based Whyte proceeded to talk just about every musical agglomeration that blew through the Windy City into letting him show them what stereo sound could do for their music. Benny Goodman, Lionel Hampton, Jimmy McPartland, the U.S. Navy Band, Woody Herman, and the Chicago Symphony all passed before Whyte's Magnecord for a series of recordings, many of which still exist. None, however, has ever been released commercially because of union problems and the fact that they were recorded as experiments.

Talking Woody Herman and Goodman into letting him record was child's play compared to Whyte's next challenge, explaining stereo to James Caesar Petrillo, then president of the American Federation of Musicians. Six years earlier, Petrillo had brought all commercial recording in America to a screeching halt while he held out for a recording trust fund for his members. The major record companies, who had been bloodied in that battle, weren't about to tangle with Mr. Petrillo again.

**Magnetic recording was known before the turn of the century and recording on tape has its 50th anniversary this year. But it was only after WW II that tape recording truly came of age—thanks to important developments like polyester backing for tape, stereo recording, the Philips cassette, chrome particles, video recording, noise reduction, etc.**



# MAGNETIC RECORDING



Norelco 2500 cassette player

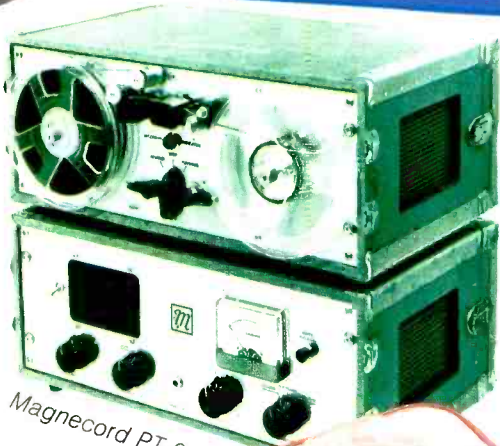

Magnecord PT-6



Norelco open-reel



Scotch 111 "Living Letter"

Whyte and Magnecord, on the other hand, had nothing to lose. So he made an appointment to see the union leader, bringing with him a tape he'd made of a Leopold Stokowski concert in Urbana, Ill. "He sat there and listened," Whyte remembers, "and as he listened, I could see his face clouding up. When the tape ended, he scowled and said to me, 'Of course, you realize that we'll have to work out a pay scale for stereophonic recordings. Since there are two channels on the tape, I'd consider that two recording sessions. Each man in the group would have to be paid twice.'"

Whyte realized that stereo would never go anywhere under that arrangement. The record companies simply wouldn't sit for it. "Yes, Mr. Petrillo," Whyte replied, "but don't you see? If stereo catches on, everything will have to be rerecorded since there are no stereo recordings now." Petrillo thought that over, considering the increased work for his members—and the jump in record company contributions to his new trust fund. The scowl gradually faded into a benign smile. "Yeah," he answered, and the meeting was over.

Halfway around the world, something was happening that would alter the tape scene just as profoundly as had any of the previous developments. In the fall of 1945, a handful of Japanese engineers had leased some space in a burned-out Tokyo department store to start a company. They weren't sure exactly what they were going to do, but one thing was certain: It would be different from the things other companies were doing. Their first efforts were handmade pieces of broadcasting equipment to be used by the government radio network, NHK.

One day in 1948, the company president, Masaru Ibuka, was delivering a piece of equipment to the NHK studios when he happened to see a device on the desk of

officers who oversaw NHK operations. It was a tape recorder. Suddenly Ibuka knew what the company was going to make.

It took the company which was to become Sony two years to do so, partly because nobody in Japan knew how to make recording tape. Ibuka and his associates experimented first with cellophane as a base, but found it stretched under tension and expanded in humid weather. Next, they tried paper. The results were better, but the paper tore every time the tape caught in the transport. "It was a blessing in disguise," Sony's Board Chairman, Akio Morita, whose cousin supplied the paper, recalled recently. "We had to take painstaking care in designing and manufacturing all of the parts along the tape path, to be sure the tape wouldn't snag." Old-timers say that at first the paper was laid out on the floor of Sony's "new" factory, a warehouse in the Shinagawa district of Tokyo. Workers then ran back and forth along its edges, spraying on the magnetic powder and binder with an airbrush.

Morita today admits that those first tapes weren't very good, particularly when compared to 3M's product. But they improved, and by late 1949 Sony had a prototype tape recorder. Early in 1950, the first Sony recorders went on sale in Japan. They cost \$400, a lordly sum in postwar Japan, weighed over 100 pounds and were about the size of a small steamer trunk.

Back in the United States, some visionaries were talking about the day when tape might replace the ubiquitous long-playing record. Recording Associates, as early as 1950, published a catalogue of recorded music on tape, and other entrepreneurs talked confidently of putting the major record companies out of business. The record companies responded initially by ignoring the whole thing.

As a result, companies who wanted to offer music on tape either had to record their own or acquire recordings from European sources who hadn't been able to make deals with the independent U.S. labels. The result generally was music of less than compelling interest performed by artists nobody'd ever heard of. One of the first to record specifically for tape—and to observe professional quality standards—was





Chet Smiley with several Ampex open-reel machines.



Bert Whyte



James C. Petrillo

Chet Smiley of Livingston Audio Products. Smiley packed up a stereo Mag-necord in 1951 and flew to Florence, Italy, to record a number of classical performances at the May Festival. To these he added organist Hack Swain in a number of programs of old favorites and finally the *piece de resistance*—Lenny Herman and the Mightiest Little Band in the Land, then performing at the Hotel New Yorker.

Then, in 1954, the dam broke, with RCA Victor the first major label to produce its own prerecorded open-reel tapes. In quick succession came Vox Productions, Mercury Records (for whom Whyte had been consulting) and Westminster. The tapes' cost was high—\$12.95 for a half-hour stereo program, at a time when discs cost \$4 and frequently contained 50 percent more music.

Everybody loved tape's high-fidelity sound—and the fact that, in the early 1950s at least, it was the only way of hearing true stereo. But cost was an important consideration. So was convenience. Together, those two factors spawned a number of unlikely products, beginning with a device which fit on top of conventional professional turntables, converting them into tape decks. The three-wheeled unit, made by Presto, included takeup and feed tape reels, a playback head assembly and a capstan wheel driven by the turntable spindle. Then there was the Garrard cartridge, two full-sized reels of tape sealed inside a plastic shell. The British record changer manufacturer had visions of producing a tape transport which would hold and drop these cartridges in sequence for automatic play. Midway through the 1960s, Sony would offer a machine which changed conventional tape reels automatically. If you wanted one with your name engraved on a silver plaque on the chassis, it would have cost you \$995.

Primitive as the Garrard cartridge was, it was the first step toward what would be the biggest revolution of all in audio recording, Philips's development of the Compact Cassette. But first came the RCA cartridge, an oversized precursor of the Philips cassette, which used standard quarter-inch-wide tape at a speed of  $3\frac{3}{4}$  inches per second. Then came a short-lived square cartridge developed by Columbia Records and 3M (the takeup reel was inside the player). And then, in 1963 and 1964, the Compact Cas-sette. All were attempts to get over the public's fear of tape handling and threading, and were designed to make tape players more compact, efforts which would pay off some 15 years later in the video era.

Video, in fact, was only being hinted at in tape recording circles during the 1950s. In fact, Bing Crosby Enterprises had shown a black-and-white open-reel video recorder as early as 1951 and on January 4, 1927, a Russian immigrant to Britain, Boris Rtcheouloff, had applied for a patent based on Poulsen's invention, describing a system for recording pictures and sound on wire or "a travelling strip of magnetic material." The Rtcheouloff application even goes so far as to describe a rudimentary video camera.

It wasn't until 1956 that video recording became a reality at the professional level, with the Ampex VRX-1000. It was first used by CBS for "Douglas Edwards and the News," on November 30. Shortly thereafter, NBC became the first network to broadcast an entire program recorded on videotape, "The Jonathan Winters Show." And just after the New Year, 3M would begin marketing reels of videotape at \$307 each.

The first hint of video recording for the home also came in 1956, when RCA announced that it was working on

what it called a See-Hear video tape player, which would enable homeowners to play prerecorded programs through their television sets. Like other RCA pronouncements on video, this one wasn't followed up with actual products.

Beginning in 1954, with the first use of Bell Telephone Laboratories' transistor in a consumer product—this one a radio, manufactured in Texas for Regency—the move toward complete elimination of vacuum tubes in recording devices began. That same year, and not coincidentally, Sony produced the first Japanese-made transistors, under license from Bell. It would take 10 years before transistors completely displaced tubes in tape equipment, but the handwriting clearly was on the wall, and it said "Solid State."

By the early 1960s, the sale of open-reel tape recorders was booming, along with other audio products. Consumers, unaware of the changes taking place beneath the surface, were



Wollensak Model 1515s, c. 1974, left, and c. 1954.



## MAGNETIC RECORDING

*Du Pont chemist Dr. Paul Arthur, Jr., inventor of chromium dioxide, six grams of which are needed for a C90 cassette.*

For the first year or two, purchasers of Norelco Carry-Corders got a single blank tape (later three) with their machines. The manufacturer felt that since the units would be used for dictation, there really was no need to supply blank cassettes in quantity.

The Dutch hadn't counted on the cussedness of people. Nobody ever accused those first cassette recorders (\$199 at first, later \$149, and about the size—but not the weight—of two bricks side by side) of being high-fidelity instruments. But almost from the first, people began recording music on them to play back where their home stereo systems couldn't go. Accordingly, the need for blank tape arose almost at once—and the leading tape brands of the day (Ampex, Reeves Soundcraft, Audio Devices, BASF and Scotch) attempted to meet it. By 1966, Maxell was producing Japan's first cassette tapes.

The cassette might have remained in that rough-and-ready state if it weren't for a development taking place in, of all places, India. There, a young engineering graduate of Stanford University and Cambridge was finishing out a tour of duty with the Peace Corps. Ray Dolby (formerly a member of Ampex's first video-recorder design team) was a music lover who was intrigued by the problem of noise in tape recording, which seemed to be inherent. The nights in India were long, and Dolby had lots of time to think about the persistent hiss he heard in the quiet passages of his favorite tapes. Then he hit on the idea of breaking up the frequency spectrum during recording, with certain frequencies and certain volume levels of the signals recorded at higher levels than other combinations. Then, during playback, these signals would be suppressed by exactly the same amount, along with the accompanying background noise or hiss. Dolby's invention found immediate application in professional recording, where Decca Records in England bought every unit he could produce during his first five months in business.

What turned the cassette into a high-fidelity recording medium, however, was the development of a low-cost version of the system Decca was using,

one which could be built into home recording equipment. The idea came from Henry Kloss, then president of KLH. The recorder in which he planned to use it was an open-reel model, but when Kloss moved on to establish Advent, he took the idea of a low-cost Dolby noise-reduction circuit with him and applied it to that company's first cassette deck.

During this period, Dolby appeared before the Audio Engineering Society to describe his system, and mentioned casually that there was no reason why the circuit KLH was using couldn't be reduced to an integrated-circuit chip and incorporated in every cassette recorder. In 1973, Signetics produced such a chip. Harman-Kardon then beat Advent to the punch by using the new chip to upgrade a cassette deck it had just introduced.

The coming of cassette helped bring Scotch 111 and the other first-generation red-oxide tapes to the end of their

paying as much as \$399 for so-called professional models from Concertone or Bell Sound Systems. You could buy a do-it-yourself kit from Eico for \$300 or pay \$200 for the Wollensak 1515, a recorder which was fast becoming the Coke bottle of the tape field. Not a thing of beauty, the mono version went on sale in 1954. With very minor changes in its cosmetics and profile (but significant improvements in its interior, including a stereo version in 1963), it lasted until 1978, when the last ones were made for schools.

But the days of the home open-reel boom were numbered. In Holland, Philips had developed a compact dictating system which it would introduce in Europe during 1963 and in the United States the following year. Also in 1963, the first video recorder intended for the home made a fleeting appearance in the basement of the Cinerama Theatre on Broadway, in New York.

Of these, the one producing the greatest impact initially was Philips' Carry-Corder. Over the next 20 years, it would spell the end of open-reel tape recording in the home, open the whole new field of portability and spur the development of new types of tape better suited to the Compact Cassette's peculiar requirements.



*An original Philips "Carry-corder" (Photo; Courtesy C.G. Nijsen, Philips and J.A.E.S.)*

Ampex Model 200, right, c. 1948, was followed by the Model 300 a year later.

Ray Dolby



long careers. At 3M and at Philips, work had begun on a new tape particle, pure metal, rather than the oxides which had been used for 30 years. The chemists and engineers were trying to do the same thing that Dolby did, improving the signal-to-noise ratio of tape recordings by making backgrounds quieter. "We all knew that it was the ferrite bits in the oxides which did all the work," 3M technical manager Del Eilers says now, "that the oxidized bits caused all the noise because no signal was recorded there. So we figured that if we could coat a tape with particles of pure iron, we could dramatically reduce residual noise levels, while doing something dramatic about frequency response and other characteristics." The catch was that pure iron filings or powder proved highly unstable. Exposed to oxygen in the air, they would immediately oxidize, sometimes with explosive results.

There is no evidence that anyone was ever killed or injured in these explosions, but both Philips and 3M experienced them, and there was apparently some damage to equipment. So the idea of metal tape was put on the back burner.

Meanwhile, E.I. du Pont de Nemours & Co. had patented a process for producing chromium dioxide, a product not found in nature. The trouble was that, at first, nobody seemed to know what to do with it. The scientists at du Pont thought that because of its high coercivity, it might have an application in magnetic recording. Accordingly, in 1969, the company sent a marketing/engineering team to New York to explain to the tape industry how chromium dioxide could be used to make superior audio recordings, particularly in cassette recorders designed specifically to accept it, as well as in video applications. Interest was high, and du Pont signed licensing agreements with BASF, making it the exclusive manu-

facture in Europe, and with Sony, which had all rights to the product in Japan. That meant that any Japanese tape manufacturer wishing to produce chrome tape would have to talk to Sony first. If they produced the tape commercially, they would have to pay Sony royalties as well.

The predictable result was a race to develop a chrome substitute. The first step in that direction came in the early 1970s when Pfizer Inc. developed 2228, a high-quality gamma ferric-oxide particle which could be mass-produced. Previously, some tape makers had formulated their own particles from raw materials supplied by chemical companies like Pfizer, while in other cases, small firms, many engaged in producing paint pigments (as was Pfizer), purchased finished particles.

In any case, the development of 2228, which was nothing more than a very good quality ferric-oxide particle, made it possible for almost anybody to go into the tape business and produce a high-quality coating. It was compatible with the ferric-oxide tapes which had been produced during the 1950s and 1960s in terms of signal biasing and equalization, but it offered much better uniformity and particle size ratio. It could also be combined with cobalt particles to achieve even better frequency response and signal-to-noise ratio—but only when biased and equalized at a level somewhat higher than previously used and specified by Philips in its patent licensing agree-

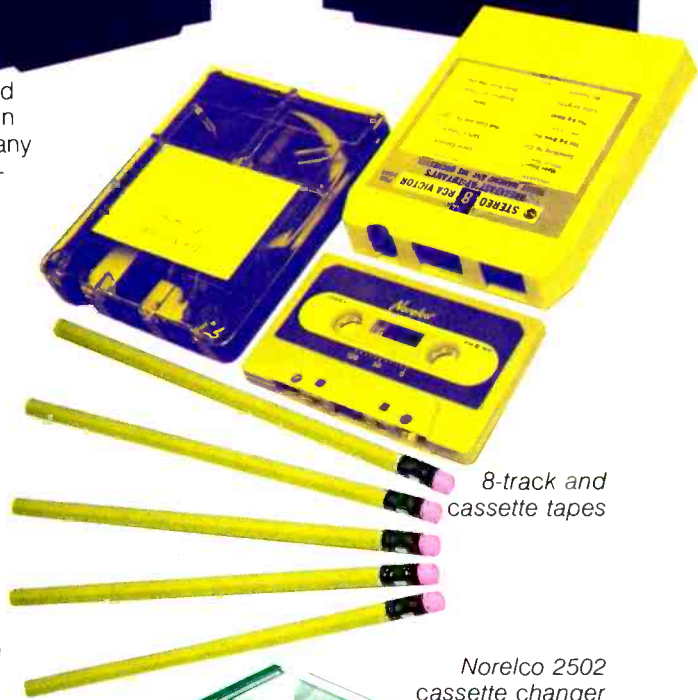

8-track and cassette tapes

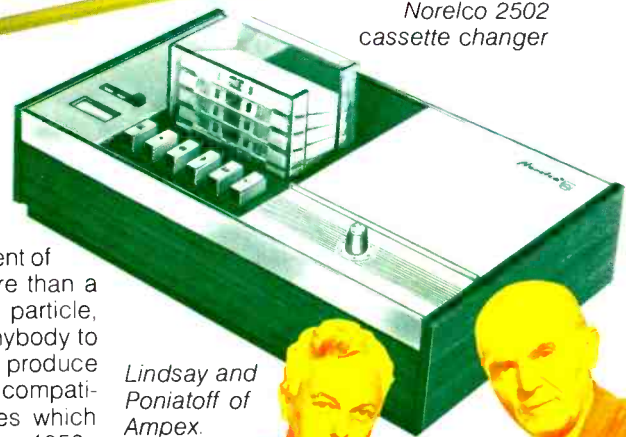

Norelco 2502 cassette changer

Lindsay and Poniatoff of Ampex.





## MAGNETIC RECORDING



Sony VP-1100 U-Matic, c. Oct. 1971

ments. Since its introduction, virtually every improvement in ferric oxide tape has involved the use of 2228 or an equivalent as a basic building block.

Indeed, du Pont had run afoul of the Philips patents when it first tried to use chrome for cassette recording. So after protracted negotiations, the Dutch company amended its standards to permit biasing and equalization for chrome. As it happened, these specifications worked equally well for cobalt-enhanced 2228 particles, and soon every Japanese tape manufacturer other than Sony was offering its own version of chrome-biased ferric-oxide tape. By 1976, it had become necessary for companies like Maxell to clearly identify each tape's bias and equalization characteristics on the cassette or package.

By far the most bizarre event of that decade of change was the announcement, late in 1963, by a previously unheard-of British electronics firm, Telcan Ltd., that it had developed a home video recorder which could sell for the incredibly low price of \$94. It used half-inch tape at a voracious rate—an 11½-inch reel provided only 11 minutes of playing time. The day of Telcan's demonstration was a cold and wintry one; the pictures reaching the black-and-white monitor in the basement of the Cinerama theatre from local TV stations were smeary, unclear and unacceptable. So were the recordings the Telcan unit made of them and played back to the assembled press corps. Sniffed the highly respected *Television Digest* in its report, "Telcan't."

Telcan didn't go away immediately, but neither did recorders appear in stores. Instead, the company reorganized and talked about a kit version for



Sony SL-6300 Betamax, c. May 1975

\$164 (it never appeared, either), while other kitchen inventors offered working models of their own so-called brute-force recorders.

The whole idea might have died there. Instead, Ampex, Panasonic and Sony, using the helical scan recording idea advanced nearly 40 years earlier by Boris Rtcheouloff, introduced black-and-white video recorders designed for home use and priced between \$1,000 and \$1,200, or about three times the cost of the best audio cassette deck at the time. These recorders provided much better results than Telcan's, but they had their own problems. One was that tapes recorded on one machine might not play back on another unit, even if both were the same brand. Another was that the Ampex, at least, was a service technician's nightmare. Once something went wrong with it, it usually went into the closet and was forgotten.

Akio Morita believed that it was Sony's task not only to develop and produce products which were revolutionary, but also to teach people how to use them. Accordingly, Sony bought television time in New York to explain to viewers who didn't know that they needed home VCRs what the recorders were for and how easy they were to use. The commercials zeroed in on the

time-shifting feature, which Morita has always felt was the most important. They didn't sell many recorders—all three models disappeared within a year or two—but they did raise consciousness when it came to video recording and to Sony.

Sony's first real video recorder hit was the introduction of U-Matic recorders in 1970, in conjunction with a number of other Japanese manufacturers who had agreed in advance on a single format. This time, recordings were fully interchangeable from one ma-

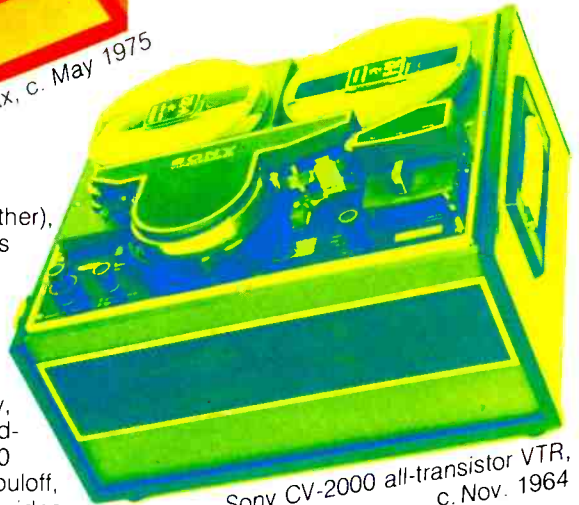

Sony CV-2000 all-transistor VTR, c. Nov. 1964

chine to another and from one brand to another. The recordings were in color this time, and the tape was protected by a cassette-type shell. However, the manufacturers made no real effort to sell U-Matic as a home medium; instead, the recorders were sold to educational and industrial users, to cable television systems and even to local broadcasters.

Two years later, home viewers got their chance, with a console called Cartrivision. It contained a 25-inch color TV set in addition to the cartridge video recorder, at a cost of \$2,400. Very few people had that kind of money, and many of those who did had no use for another 25-inch receiver. Besides, the sets didn't always work, and very few programs were available for the system.

Home video finally became a reality in 1975, when Sony introduced the Betamax. Panasonic and JVC followed up quickly with VHS machines early in

The Crosby Enterprises VTR used high tape speed past fixed heads, but was abandoned when Ampex showed its unit in 1956. First use of Ampex's VRX-1000 was for "Douglas Edwards and the News" in November 1956.

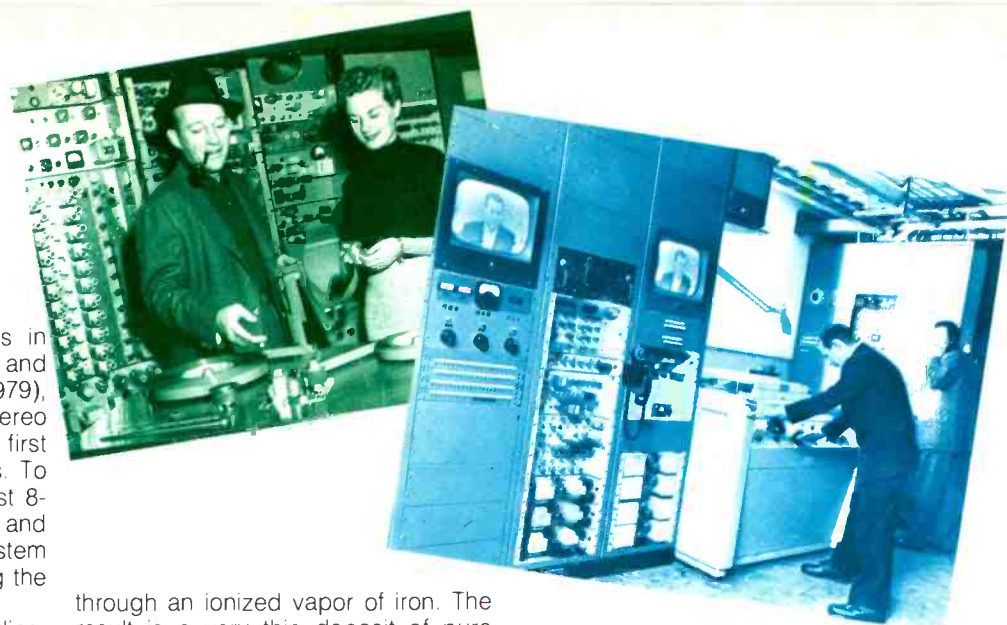

1976. Since then, improvements in these systems have come thick and fast—the first portable VCRs (1979), the first VCRs with high fidelity stereo sound (1982) and, in 1983, the first one-piece Beta camera-recorders. To them were added in 1984 the first 8-mm camera-recorders from Kodak and the first really compact VHS-system camera-recorders from JVC, using the ultra-small VHS-C videocassette.

Like the story of video recording, that of recording tape remains unfinished as these lines are written. As home video developed, recorder manufacturers found that the high-bias audio chrome and cobalt-absorbed ferric-oxide tapes, which began appearing around 1970, were ideal for recording video as well.

In 1979, 3M's technicians finally found a way of producing metal-particle tape without explosions, and without the tape oxidizing the first time the user took it out of the box. The secret: Allow the thin surface skin to oxidize just enough to protect the rest of the metal coating underneath and combine traces of other metals with iron to inhibit oxidation. 3M contacted a number of recorder manufacturers before going public with its tape. Of the lot, Tandberg was the first to develop a recorder designed to take full advantage of the ultra-high-bias tape.

3M thought it had stolen a march on other tape manufacturers. It was aware, of course, of Philips research on metal particles, but it believed that the Dutch had not yet solved the stabilization problem. The company was astounded, therefore, when a Japanese maker, Kanto Denko, not previously involved in tape manufacture at all, announced that it had a metal particle, and proceeded to sell it to any Japanese manufacturer who cared to buy.

Metal particle tape has yet to find a niche in video recording, though the recent introduction of an 8-mm recorder-camera designed to use it suggests that it is about to do so. In the meantime, there is another form of metal tape which has been used for several years in the manufacture of microcassettes. "We originally called it metal-plated," a 3M technician told me, "when we began research on it back in 1963." He explained that the process involves passing a charged plastic film

through an ionized vapor of iron. The result is a very thin deposit of pure metal on the surface of the film. The coating is much thinner than one of metal particles, but it's also more even, with virtually no gaps or dropouts. Panasonic patented a process which works in the early 1980s and labelled the result Angrom. Indications are that we'll be hearing more about both types in the years to come.

And what about the Compact Cassette, which for practical purposes buried the open-reel home recorder in the early 1970s? Well, you can mark 1984 down as the year in which it finally surpassed the long-playing record in terms of prerecorded sales, due in no small part to another idea of Sony Chairman Akio Morita. Back in 1980, Morita reasoned that what the world needed was a very compact, very lightweight high-fidelity cassette tape player that could be enjoyed through high-quality, comfortable headphones. Virtually everybody at Sony tried to talk him out of it. For one thing, they pointed out, nobody had ever heard of a portable player without a loudspeaker. And if you put in a speaker that sounded like anything, the unit would be

heavy. No record function? Likewise unheard of. Morita stuck to his guns (after all, he was the chairman of the board). He even had a name for the new player: Walkman. Some of his associates cringed. It would never play in America, they said, and persuaded him to let the players be introduced under another name there. Within 18 months, everybody had forgotten the first name (Soundabout); the Sony Walkman was the hit of three continents and the Sony headquarters building in Shinagawa had a museum in the basement containing blatant copies by several dozen competitors.

The magnetic recording industry entered a new era—or at least the audio portion of it did—in 1978 when Sony introduced the first PCM digital recorder. Since then, PCM units have come down in price, size and complexity to the point where virtually any audiophile can afford one, alongside his hi-fi video recorder and professional-quality Compact Cassette deck. In the 1980s, it's virtually an embarrassment of riches for the tape-oriented audiophile. **A**

The Ampex VRX-1000 included three items basic to all current VTRs: Spinning heads, FM recording of the video signal, and time-base error correction. The design team included Fred Pfost, Shelby Henderson, Ray Dolby, Alex Maxey, team leader Charles Ginsberg, and Charles Anderson.

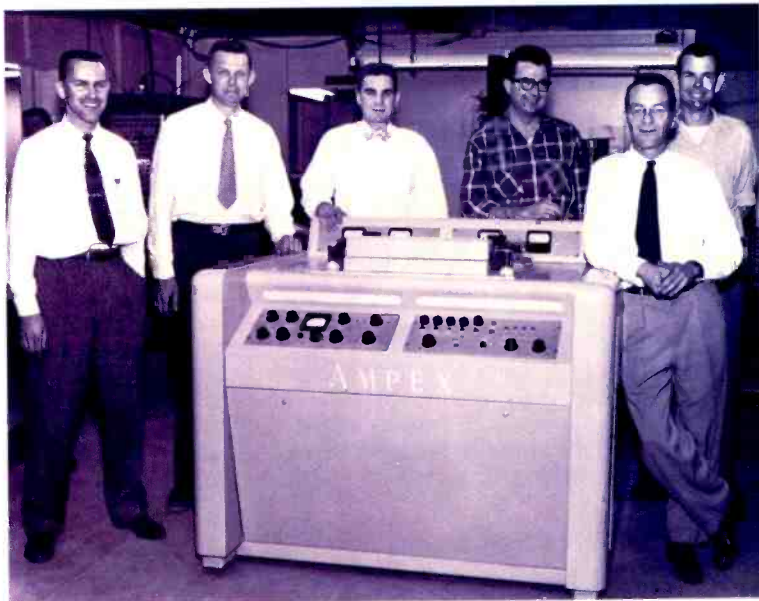



A  
An error of 20', or one third of a degree, (see text).

# How Important Is Tape Azimuth?

D  
HERMAN BURSTEIN

**N**ot least among the factors that enable a cassette system to maintain essentially flat response out to 15 kHz or more is accurate azimuth alignment of its record and playback head or heads. A considerable number of queries received by my "Tape Guide" column grow out of the problem of achieving and maintaining such accuracy.

Azimuth refers to the orientation of the head gap with respect to the direction of tape motion. To simplify discussion, we'll temporarily assume that a tape head has but one gap (rather than the two needed for stereo). In the *absolute* sense, correct azimuth alignment denotes that the gap of a tape head is perfectly perpendicular to the direction in which the tape moves, as in Fig. 1. If not, we can say there is absolute azimuth error, depicted by the angle in Fig. 2; for clarity, the angle is greatly exaggerated.

Absolute azimuth error may be caused by the head being mounted with its gap slantwise to the tape path or by the tape skewing with respect to the gap when in motion, as in Fig. 3. Such error tends to produce increasing loss of signal as frequency rises

(Fig. 4); we can call this azimuth loss. The loss occurs not on the tape but in playback.

Whether azimuth loss does occur depends on *relative* azimuth error—on the azimuth of the playback head relative to the azimuth of the record head. For compatibility among tape decks, it is desirable that both heads be correctly aligned in the absolute sense, as in Fig. 1; therefore, both will then have the same azimuth, so that relative azimuth error is nonexistent.

However, if absolute azimuth error does exist, but is the same in both the record and playback heads, the errors cancel; there will be no relative azimuth error and no azimuth loss.

Thus, it is advantageous to have a two-head deck, so that the same head is used for record and playback. Even though the head may not be in absolute azimuth alignment, the errors in record and playback will tend to cancel, and there tends to be little or no azimuth loss when playing a tape recorded with that head. (The possibility of some azimuth loss, usually slight, still exists because, depending on the quality of the cassette and of the deck, the tape might skew differently in re-

ording than in playback, resulting in relative azimuth error.)

Significant azimuth loss can more easily happen with a three-head deck, one which employs separate heads for record and playback. Such loss occurs still more easily when different decks are used to record and playback, as with borrowed, traded, and commercially prerecorded cassettes and those tapes recorded on a formerly owned deck.

In sum, it is relative azimuth error which concerns us (although this does not diminish the importance of absolute azimuth alignment to insure compatibility among decks). Hereafter I will simply say azimuth error to denote relative error. Also for simplicity, I will assume that azimuth is absolutely correct in recording, with error occurring only in playback; after all, it isn't until playback that the consequence of azimuth error was manifest.

## Azimuth Loss and Tape Format

We have already noted that azimuth loss increases as frequency rises. The loss also increases as tape speed is reduced. (Both causes of increased loss are really different sides of the

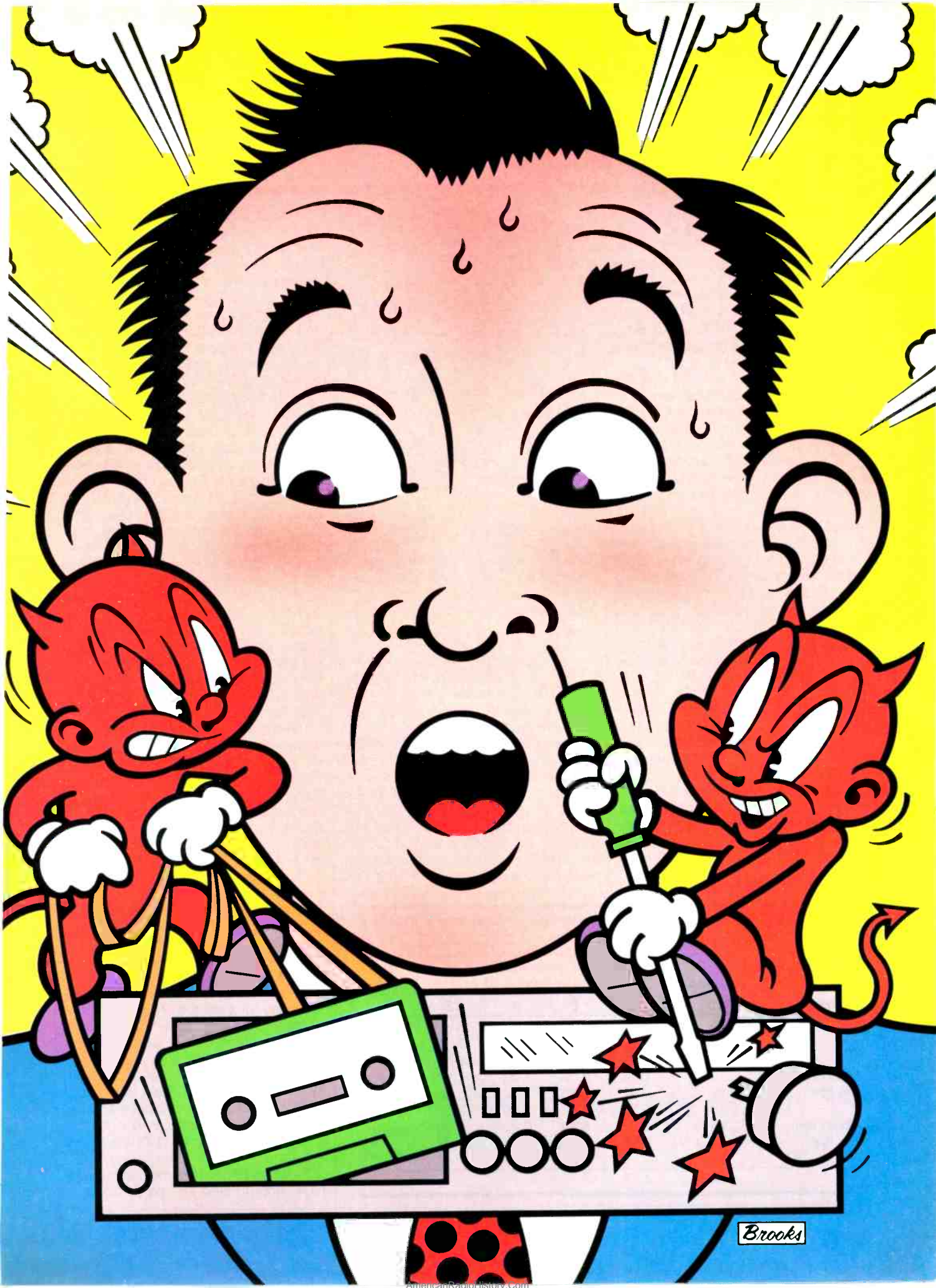

Brooks





same coin: The loss increases as the wavelength decreases—and wavelength, which is speed divided by frequency, grows shorter as frequency rises or as speed drops.) Because of this, the azimuth problem is more acute at the cassette speed of 1 7/8 ips than at the speeds of 3 3/4 and 7 1/2 ips commonly used in home open-reel decks.

On the other hand, azimuth loss decreases as track width is narrowed. So the cassette's narrower track (0.024 inch, versus 0.043 inch on four-track open-reel tape) partially offsets the effect of its lower speed as compared to open-reel tape (Table I). But the azimuth problem still remains greater for cassette systems.

Azimuth error angles of less than 1° can produce disastrous treble loss. Therefore, since the angles we deal with are very small, they are usually not stated in degrees but in minutes (60ths of a degree)—for example, 12' instead of 0.2°.

From Table I, we see that an azimuth error of only 12' (0.2°) produces a possibly acceptable loss of 3.07 dB at 10 kHz and a truly unacceptable loss of 7.77 dB at 15 kHz. Greater azimuth errors produce losses far out of keeping with the concept of high fidelity. (It should be recognized that the losses in Table I are additional to treble losses caused by other factors in a tape system, such as tape saturation, electrical characteristics of tape heads, insufficiently narrow gap in the playback head, improper equalization in recording or playback, tape properties, etc.)

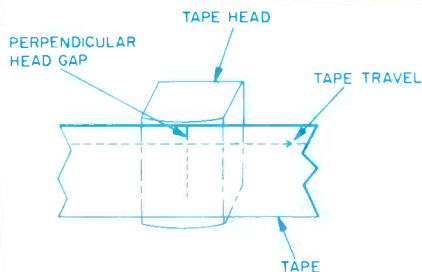

Fig. 1—Correct absolute azimuth.

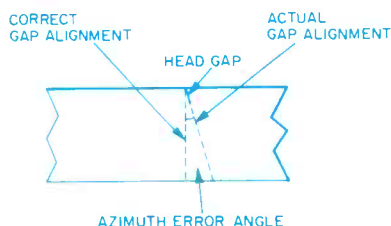

Fig. 2—Absolute azimuth error (exaggerated, for clarity) due to head misalignment.

For a cassette system to maintain fairly good response out to 15 kHz, Table I indicates that the azimuth error angle,  $\alpha$ , must be kept under 9'; for good response out to 20 kHz,  $\alpha = 6'$  is at the edge of acceptability. Preferably,  $\alpha$  should be kept to no more than about 3', which produces a loss of less than 1 dB at 20 kHz.

It may be of interest to visualize how small the values of  $\alpha$  under discussion are, and thus appreciate the care that must be exercised by deck and cas-

sette makers and by others in dealing with the azimuth problem. To do so, the following takes only a few moments. Assume a gross, totally unacceptable error of 20' (or one-third degree). On an 8 1/2 x 11-inch sheet of blank paper, draw a light, thin vertical line down the middle from top to bottom, with Points A and B respectively designating top and bottom of the line. One-sixteenth inch to the right of Point B, mark Point C. Connect Points A and C with a light, thin line. Lines AB and AC will now form an angle of 20'. Darken line AC for 1-13/16 inch, starting from the top, and designate the bottom of the darkened line as Point D. If AB corresponds to tape width (0.150 inch), AD corresponds to the upper gap of the head of a cassette deck (0.024-inch long). Although we know that AD deviates from vertical, our eye cannot detect the deviation. Clearly, azimuth alignment by eye is out of the question. (On the other hand, some people can do a fairly good job of aligning the playback head by ear, using a tape containing program material or using an azimuth alignment tape containing a high frequency.)

It is clear from Table I that open-reel tape, with its higher speeds, can tolerate greater azimuth error than cassette, despite the cassette's narrower track. This is especially true of 7 1/2-ips open-reel format. For example, Table I shows that an azimuth error angle of 6' is at the edge of acceptability (down 3 dB at 20 kHz) for cassette, while with 7 1/2-ips open-reel tape, a 12' error is within the edge. Looking at Table I from another point of view, we see that, for a given azimuth error, 7 1/2-ips open-reel tape suffers much less treble loss than the 1 7/8-ips cassette.

At 3 3/4 ips, however, the azimuth problem is only slightly less for open-reel than for cassette. The advantage of faster speed is nearly cancelled by the disadvantage of greater track width. Hence 6' azimuth error is approximately at the edge of acceptability for both formats; Table I shows that such error produces a loss of 3.07 dB at 20 kHz for cassette, and a loss of 2.42 dB at 20 kHz for 3.75-ips open-reel tape.

In the past, a few cassette decks have incorporated 3 3/4 ips as an extra

Table I—Playback loss (in dB) due to azimuth error in common home tape systems.

Format	Frequency (kHz)	Azimuth Error, $\alpha$ (Minutes of Arc)				
		3	6	9	12	15
Cassette	10	0.18	0.73	1.67	3.07	5.03
	15	0.40	1.67	3.97	7.77	14.64
	20	0.73	3.07	7.77	18.65	$\infty$
Open-reel, 3 3/4 ips	10	0.14	0.58	1.33	2.42	3.93
	15	0.32	1.33	3.12	5.95	10.47
	20	0.58	2.42	5.95	12.05	$\infty$
Open-reel, 7 1/2 ips	10	0.04	0.14	0.32	0.58	0.91
	15	0.08	0.32	0.74	1.33	2.11
	20	0.14	0.58	1.33	2.42	3.93



speed for improved fidelity. One of the improvements is greatly reduced azimuth loss. For example, an azimuth error of 9' produces only 1.67 dB of loss at 20 kHz with a tape speed of 3¾ ips, compared with 7.77 dB of loss at 1⅞ ips. For cassette, the edge of acceptability goes from about 6' at 1⅞ ips to about 12' at 3¾ ips.

The azimuth problem becomes all the more pronounced in two slow-speed tape systems, not yet discussed here, that have become part of the audio scene—1⅞-ips open-reel and 15/16-ips cassette. To illustrate, assume an azimuth error of 6', which is at or within the edge of acceptability for other systems discussed thus far. This would produce losses of 2.42 and 5.95 dB respectively at 10 and 15 kHz in a 1⅞-ips open-reel system, and of 3.07 and 7.77 dB in a 15/16-ips cassette system. Such losses are unacceptable for high fidelity.

### General Principles

If we stay within the area of "moderate" losses—say, not exceeding about 10 or 12 dB—we may infer from Table I and other data that square-law principles apply (in approximate fashion) to azimuth loss. Azimuth loss increases roughly as the square of any increase in angle of azimuth error, frequency or track width, and as the square of any decrease in tape speed. In other words, if you double the azimuth error angle, the recorded frequency or the track width, the loss in output will quadruple; if you double the tape speed, the azimuth loss will diminish to one-fourth of its original value.

In the area above "moderate" azimuth losses (say above 10 or 12 dB), the square-law principles give way to losses that move precipitously toward infinite as azimuth error increases, frequency rises, tape speed declines, and track width increases.

The table and other data also show that maximum acceptable azimuth error tends to decrease in proportion to any decrease in tape speed or increase in track width. To illustrate, maximum acceptable azimuth error tends to be halved if tape speed is halved or if track width is doubled.

### The Colinearity Problem

For simplicity, Figs. 1, 2, and 3 show

only one head gap. But cassette tape heads ordinarily have two, one for each stereo channel. Each gap is about 0.024 inch long, and the two are spaced about 0.011 inch apart. Ideally, they should be colinear, that is, both in the same straight line, so that if one is correctly aligned for azimuth the other is too.

However, depending on the quality of the head, the gaps may depart from colinearity, as shown in Fig. 5 (greatly exaggerated, there, for clarity). In such circumstances, the optimum alignment is that yielding equal azimuth loss in each channel.

### Calculating Azimuth Loss

When azimuth error is stated (in an equipment review or elsewhere), it is given either as an angle ( $\alpha$ ) or as phase shift (P) at a specified frequency. If one has a pocket calculator with trigonometric and logarithmic functions, the following equations enable one to readily translate  $\alpha$  into azimuth loss or P into  $\alpha$ .

$$L = 20 \log \frac{\sin(180T)}{\pi T} \quad (1)$$

where

- L = Relative level in dB,
- T =  $(\tan \alpha \times F \times W) \div S$ ,
- $\alpha$  = Azimuth error angle, in degrees,
- F = Frequency in Hz,
- S = Tape speed in ips, and
- W = Track width in inches.

(Common track widths are 0.043 inch for quarter-track open-reel, 0.024 inch for stereo cassette. The 180 and  $\pi$  factors convert degrees into radians, the "20 log" term converts the answer to dB.)

To illustrate, assume that azimuth error  $\alpha = 0.1^\circ$  (or 6'), and we wish to know the azimuth loss at 15,000 Hz for cassette. In this case,  $F = 15,000$ ,  $W = 0.024$ ,  $\tan \alpha = 0.0017453$ , and  $S = 1.875$ . Therefore,  $T = (0.0017453 \times 15,000 \times 0.024) \div 1.875 = 0.3351032$ , so that

$$\begin{aligned} L &= 20 \log \frac{\sin(180 \times 0.3351032)}{3.1415927 \times 0.3351032} \\ &= 20 \log \frac{0.8687921}{1.0527576} \\ &= 20 \log 0.8252536 \\ &= -1.67 \text{ dB.} \end{aligned}$$

(Note that the answer appears as a negative, signifying a signal loss.)

To convert phase error into azimuth error requires a different formula:

$$\alpha = \arcsin \frac{P \times S}{360 \times D \times F} \quad (2)$$

where

- $\alpha$  = Azimuth error angle in degrees,
- P = Phase error in degrees,
- S = Tape speed in inches per second,
- D = Distance between track centerlines, and
- F = Frequency in Hz.

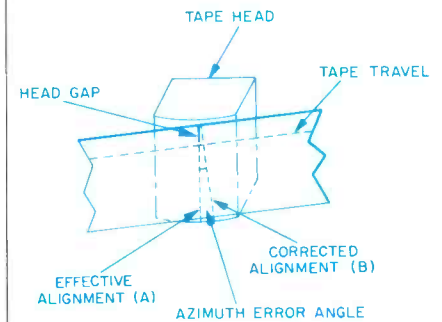

Fig. 3—Tape skew can effectively misalign a head positioned properly with relation to the tape deck. The effective alignment that results (A) is at an angle to the tape; repositioning the head produces corrected alignment (B).

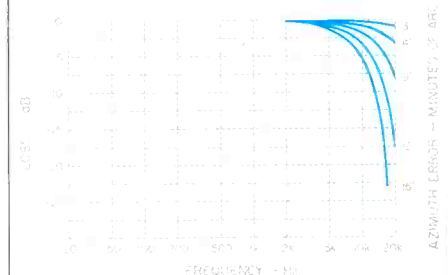

Fig. 4—Loss vs. frequency, as a function of azimuth error, for cassette tape.

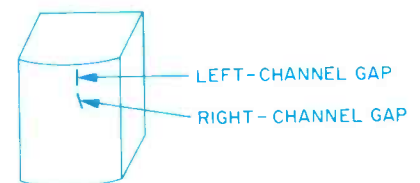

Fig. 5—Noncolinear head gaps (greatly exaggerated).





# Compatibility in Tape Decks

HOWARD A. ROBERSON

It would seem that if the same alignment tape were used to adjust the playback heads on several three-head tape decks, and then each record head was adjusted for an exact match to its respective playback head, the recorded flux would have the same orientation to the tape on each deck. We might further conclude that a tape made with flat response on one deck could be replayed with flat response on a second deck.

Unfortunately, the situation is more complex than indicated. To get data on what really happens, I used a BASF Type II Alignment Tape to adjust the playback heads of three decks, all with separate record and playback head gaps. Two of these, the Nakamichi 582 and Tandberg TCD 3014, had separate record and playback head assemblies. The third, an Aiwa AD-M700, had a single head with separate record and playback gaps. In the Aiwa deck, therefore, the position of the record-head azimuth was automatically determined by the playback alignment with the test tape.

In the first tests, I made a recording of pink noise on the Tandberg TCD 3014 using Maxell XL II-S at 20 dB below Dolby level after the record head had been adjusted for the best response. The playback on the TCD 3014 was displayed and stored with a  $\frac{1}{3}$ -octave real-time analyzer (Fig. 1, top). This same tape was then played back on the Nakamichi 582 (middle) and the Aiwa AD-M700 (bottom). All of the playback responses are quite flat over most of the range, but there are differences. The response on the Tandberg, which recorded the tape (top), is the flattest—as would be expected. The Nakamichi 582 playback (middle), however, displays a rising output above 2 kHz or so, which raises a question I'll answer a bit later. The response on the Aiwa AD-M700 deck would be considered disappointing, particularly in comparison with the other two decks. Immediately, it might be concluded that there was considerable alignment error, even though the AD-M700's head had been adjusted using the same test tape.

The second set of tests used the

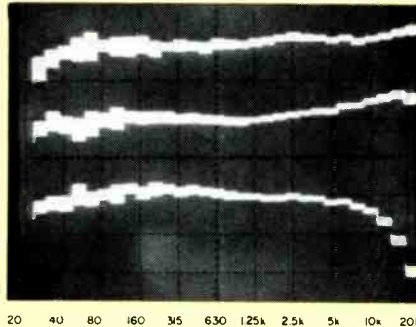

Fig. 1—Playback responses with recording made on Tandberg TCD 3014 cassette deck. Top, Tandberg; middle, Nakamichi 582; bottom, Aiwa AD-M700. (Vertical scale: 5 dB/div.)

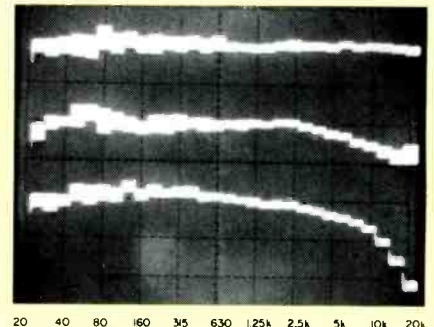

Fig. 2—Playback responses with recording made on Nakamichi 582. Top, Nakamichi; middle, Tandberg TCD 3014; bottom, Aiwa AD-M700. (Vertical scale: 5 dB/div.)

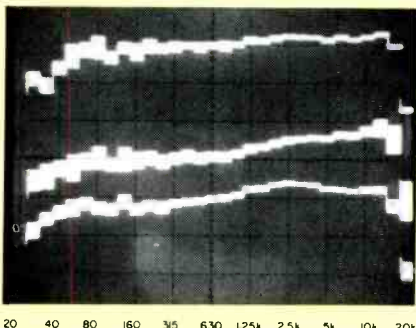

Fig. 3—Playback responses with recording made on Aiwa AD-M700. Top, Aiwa; middle, Nakamichi 582; bottom, Tandberg TCD 3014. (Vertical scale: 5 dB/div.)

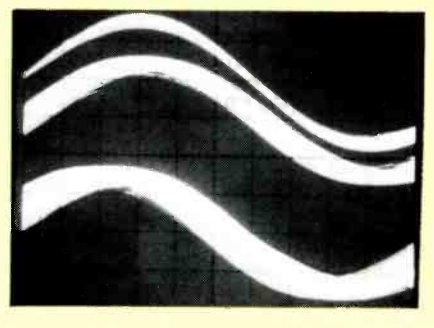

Fig. 4—Misalignment and jitter with 5-kHz test tone. Top, playback of reference track A on recording Nakamichi 582; middle, playback of trace B of 582, illustrating relative jitter; bottom, playback of same tape on Tandberg TCD 3014, showing alignment shift and jitter of track B relative to track A of TCD 3014. See text. (Horizontal scale: 30°/div.)

Nakamichi 582 as the recording deck, with a change to TDK SA-X tape, just to see if the tape skewing characteristics of a different cassette would affect the results. Figure 2 shows the very flat response at -20 dB with playback on the 582 deck (top). With playback on the Tandberg TCD 3014 (middle), however, the high-frequency rolloff is quite evident. The drooping response with the Aiwa deck is quite similar to that in the earlier figure, with a dB or so more rolloff.

Before drawing any conclusions, I ran a similar test set using the Aiwa AD-M700 as the recording deck, using XLII-S. The response in playback on the Aiwa deck is quite flat overall. The 8-dB drop at 20 kHz is a characteristic

of this medium-performance deck. Playing this tape, the response on the Nakamichi 582 (middle) showed a rise above 1 kHz, while that on the Tandberg TCD 3014 (bottom) showed closer correspondence to the Aiwa deck results. Note that there is some vertical broadening of the 12.5-, 16- and 20-kHz filter-level indications for both the 582 and the TCD 3014—especially the 582. A separate check showed that the effect was caused by slight skewing of the tape on the Aiwa during recording. Because of the very short distance between the record and playback gaps of the Aiwa combination head, there were no skew-caused level variations in its playback.

An examination of the responses in



Figs. 1 to 3 along with some analysis, including reference to past experience, led me to these conclusions:

(1) The playback equalization of the Nakamichi 582 is relatively elevated at the higher frequencies compared to that of the Tandberg TCD 3014;

(2) The playback equalization and/or head response of the Aiwa AD-M700 rolls off compared to both of the other decks;

(3) The Aiwa deck uses "extra" record equalization to compensate for the roll-off in playback, and

(4) The alignment match between decks adjusted with the same alignment tape was fairly good, despite the equalization-caused response differences which might make things appear otherwise.

In confirmation of what some readers are already thinking, I must state that the playback equalization (70  $\mu$ S for Type II), as given mathematically in international standards, is not followed exactly by the great majority of manufacturers. I won't take up space here to discuss the whole issue, but it can be noted that the Nakamichi playback is close to that for an ideal head, while the Tandberg's is closer to that for the IEC reference playback head.

Figures 1 and 2 reflect this relationship, with the Nakamichi recording rolled off on the Tandberg, and the Tandberg recording boosted on the Nakamichi. These response differences relate to equalization and *not* to azimuth error. Figure 4 illustrates what azimuth error might be found between these two decks. I recorded a 5-kHz tone on the Nakamichi 582, both tracks. In the playback, track A (top) was the 'scope sweep reference, and the broadening of the track B trace (middle) shows the jitter of B versus A. There was some amplitude variation on both tracks. The average position of its trace shows that B lags A by about 6° at 5 kHz, with 30° of total jitter. The phase error of 6° is equivalent to an alignment error of less than 1 minute of arc. The bottom trace is that of track-B playback of the same tape on the TCD 3014, with the 'scope locked to its track A. Here the jitter is higher, and B leads A by 20°, still just 2 minutes of alignment difference. So, a final word: Align heads carefully, but be aware of possible equalization discrepancies between decks.

(The distance between centerlines of the stereo tracks is 0.035 inch for cassette and 0.125 for quarter-track open-reel.)

To illustrate, an *Audio* review of a top-notch cassette deck stated that phase error measured 15° at a test frequency of 12,500 Hz. Thus  $P = 15$ ,  $S = 1.875$ ,  $D = 0.035$ ,  $F = 12,500$ , so that

$$\alpha = \arcsin \frac{15 \times 1.875}{360 \times 0.035 \times 12,500}$$

$$= \arcsin 0.0001786$$

$$= 0.0102 \text{ degrees (or 0.61 minutes)}$$

So small an azimuth error would cause very minute azimuth loss, for example merely 0.03 dB loss at 20,000 Hz.

#### How Azimuth Loss Occurs

Assume that a sine-wave signal is recorded at 1 7/8 ips on cassette tape. The recorded signal is equivalent to a series of bar magnets end to end, as in Fig. 6—north poles adjacent to north poles, and south poles to south poles. Each bar represents a half wavelength, and its poles correspond to the positive and negative peaks of the half wavelength. The higher the frequency, the shorter are the bar magnets because more of them must fit into each inch of tape. At the upper end of the treble range, say above 10,000 Hz, they become extremely short, on the order of less than 0.0001 inch. (At 10,000 Hz, a half-wavelength =  $1.875/20,000 = 0.0000938$  inch.)

At any given instant of playback, each edge of the head's gap contacts a given intensity and polarity of magnetic field produced by the bar magnets. Because the two gap edges contact different parts of a bar or of adjacent bars, most of the time each edge is at a different field intensity. Therefore most of the time a magnetic potential exists between the two edges. The potential constantly changes in intensity and polarity as the gap traverses the bar magnets, and the *changing* potential induces a voltage in the coil of the playback head.

As frequency rises and the bars become shorter, the difference in field intensity and polarity at the two edges of the gap increases, thereby increasing head output. Maximum output oc-

curs when the distance between gap edges equals a half wavelength (one bar), with one gap edge contacting a north pole while the other contacts a south pole, resulting in maximum potential across the gap. Output falls rapidly as frequency increases further, reaching zero when an entire wavelength equals the distance across the head gap, since the potential will then always be equal at each gap edge. Hence, the importance of a very narrow playback gap for extended high-frequency response.

The greater the field intensity seen by each gap edge, the greater can be the magnetic potential between edges at various instants, and the greater can be the changes in potential, thus increasing head output. Contrariwise, if anything reduces the field intensity seen by the gap edges, this reduces head output.

Azimuth error performs such a reduction. When there is no azimuth error, in playback all parts of the left edge are in contact with the same polarity and intensity of magnetic field. That is, the upper and lower sections of the edge see the same field intensity as the center of the edge. But azimuth error tilts the edge with respect to the magnetic bar, so that the central, upper, and lower sections contact different magnetic intensities, which partially cancel each other. The same is true, of course, for the right edge.

To help visualize this, assume that the center of a gap edge is at the north pole of a bar magnet and thus sees maximum field intensity. But if the edge tilts, its top and bottom sections are no longer at the north pole and therefore are at points of reduced intensity. Accordingly the intensity seen by the edge as a whole is reduced.

This process doesn't work in reverse; that is, tilting the gap edge doesn't increase the field intensity seen by it. To illustrate, assume that the center of the edge is at the middle of a bar, where intensity is minimum. Now the top and bottom of the edge do see higher intensities than does the center of the edge. But the top and bottom incline in opposite directions, toward opposite polarities, so that these higher intensities cancel each other and leave the edge as a whole at minimum intensity.



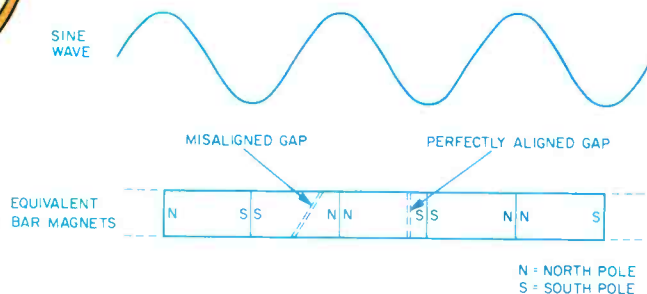

Fig. 6—How azimuth loss occurs: Recorded signals are essentially bar magnets of varying length. Head output depends on the difference in

magnetic field bridged by the head gap—a difference greatly reduced when the gap is tilted to bridge areas of different flux.

Considering how short are the bar magnets at high frequencies, very slight gap tilt (azimuth error) will cause the top and bottom of a gap edge to ride very different field intensities, with substantial cancelling effect. To illustrate, assume a cassette player with an azimuth error of 9°, tilting the top of an edge to the left and the bottom to the right. Therefore the bottom of the edge is displaced 0.000063 inch to the right with respect to the top of the edge. (Displacement =  $\sin \alpha \times \text{gap length} = 0.002618 \times 0.024 \text{ inch} = 0.000063 \text{ inch}$ .) Next assume a frequency of 15,000 Hz, so that a half-wavelength, or one magnetic bar, =  $1.875/30,000 = 0.000063 \text{ inch}$ . Now assume that the center of the gap edge contacts a bar's north pole, where field intensity is maximum. Because the tilted edge in our example spans an entire magnetic bar, the top and bottom of the edge must be at midpoints of magnetic bars, where field intensity is minimal. Thus, the field intensity seen by the gap edge as a whole is quite substantially reduced.

At lower frequencies, where the recorded magnetic bars are longer, a given gap tilt causes the top and bottom of a gap edge to be displaced only a fraction of a bar relative to the center of the edge. Therefore the cancelling effect on field intensity seen by the edge is reduced, and azimuth loss is less.

The above discussion paves the way to our understanding why, for a given azimuth error and tape speed, the azimuth loss increases with track width. As the track width, and therefore gap height, is increased, the top and bot-

tom of the tilted gap edge are displaced a greater distance along the tape path from the center of the gap. To illustrate: We noted earlier that at 1.875 ips an azimuth error of 9° results in a displacement of the edge bottom relative to the edge top of 0.000063 inch when track width is 0.024 inch (cassette). When track width is 0.043 inch (open-reel), the displacement increases to 0.00011 inch. As already noted, the greater the displacement, the greater is the reduction in field intensity seen by the gap edge as a whole, increasing azimuth loss.

### Minimizing Azimuth Error

From the foregoing it is obvious that great care must be exercised by all parties to the tape recording process in order to minimize azimuth error.

The cassette deck manufacturer must pay close attention to proper azimuth alignment of the head or heads used for recording and playback. This requires an accurate test tape on which a high frequency, such as 10,000 Hz, has been recorded with the gap of the record head (in the deck that produces the tape) exactly at a 90° angle relative to the direction of tape travel. The playback or record-playback head of the deck being aligned is then oriented for maximum output from the test tape. If the deck being aligned has a separate record head, it is adjusted, while recording and monitoring a high-frequency signal, for maximum output from the previously aligned playback head.

If head gaps are not colinear, so that correct alignment of one gap necessitates azimuth error of the other, an op-

timum position has to be found that achieves equal azimuth loss in both stereo channels. If there are separate heads for record and playback, optimization becomes more complex. And it is even more complex in the case of reversible decks which use heads with four gaps.

Production of an accurate azimuth alignment tape is not an easy matter and requires precise laboratory procedures. Even for test tapes made by companies of high reputation, it has been noted that somewhat different results may be obtained from tapes of different companies. However, these differences tend to be slight and are becoming slighter as new azimuth alignment tapes appear.

Care must be exercised by the deck manufacturer to properly adjust tape tension and thereby minimize tape slewing (a change in the angle of the tape with respect to the head). Toward the same end, the cassette deck must be designed so that the cassette is uniformly and securely locked in place.

Equal care applies to the cassette itself. It may appear to be a disarmingly simple affair but it is really a very sophisticated device that must be built with a high degree of precision in order to operate properly. Guides must be accurate and true, and the tape must be slit very accurately, in order to minimize slewing.

Reverse cassette operation presents an extra azimuth problem because the tape tends to slew differently when running from left to right than from right to left. One solution is to use a head with two gaps instead of four and rotate the heads 180°, with a separate azimuth adjustment (a stop screw) for each direction. Another solution is to turn the cassette over, as one turns the page of this magazine, so that the tape always runs in the same direction with respect to the heads. A third solution, used in the Nakamichi Dragon, is to continuously adjust the playback head azimuth during operation. This is achieved by dividing the gap for one of the playback tracks into two sections; as a tape is played, the phase difference between gap sections is constantly monitored, and azimuth is adjusted by a motor to minimize the phase difference and thereby minimize azimuth loss.



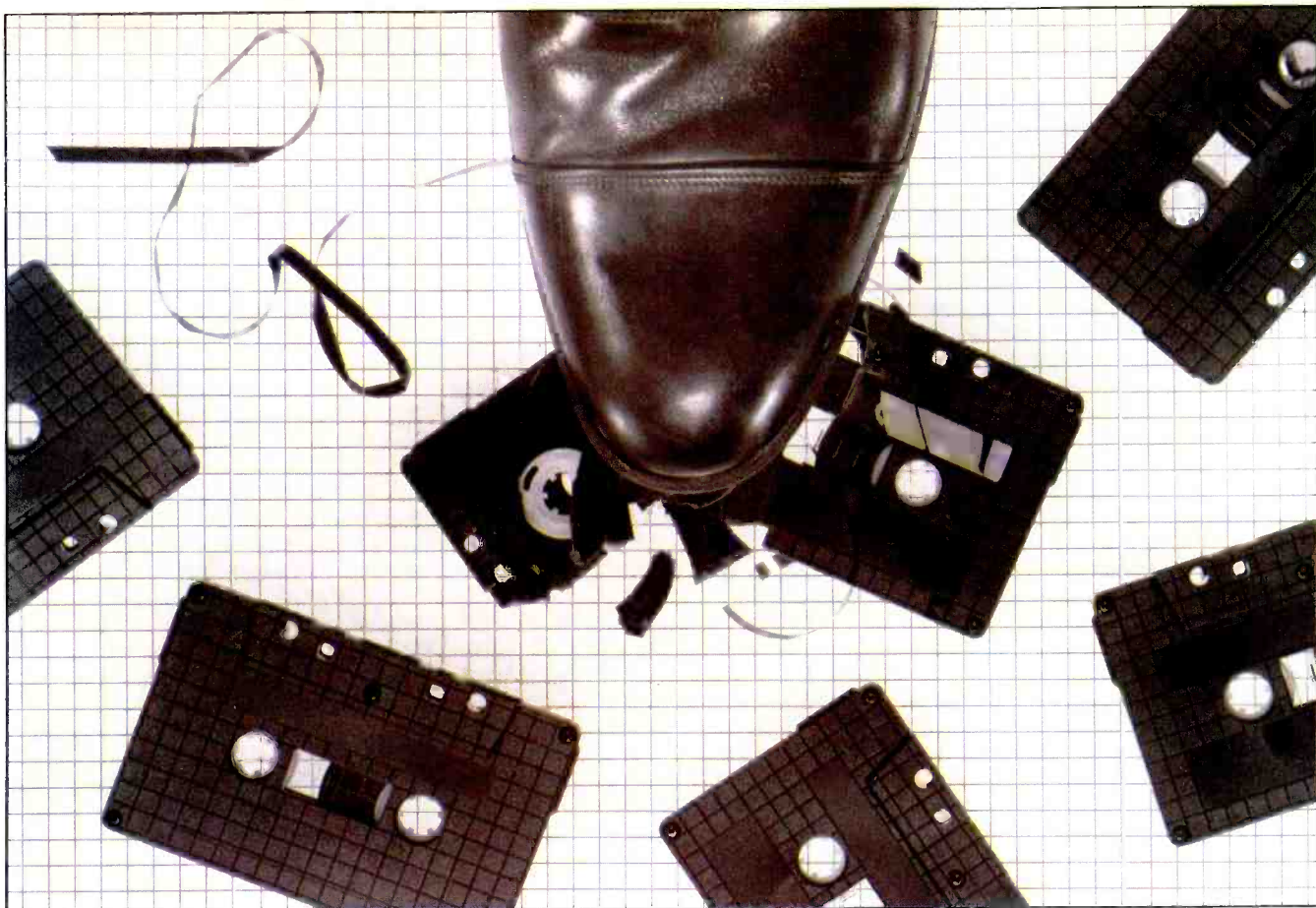

Photograph: Robert Lewis

# CASSETTE TEST UPDATE: 12 FORMULATIONS

HOWARD A. ROBERSON

**W**ith the continuing introduction and updating of cassette tape formulations, it was just about inevitable that some manufacturer would deliver samples after the deadline for our "Mass Tape Test" (September 1983). Konica and TDK had that distinction, but the omission is being corrected here. There are two Konica Type I formulations, designated ML and GM-I, a Type II tape called GM-II and a Type IV, Metal. TDK introduced a new metal particle formulation, designated HX-S, which is unique in that it

is designed to use Type II bias. The manufacturer claims greatly improved high-frequency MOLs, which normally aren't very good for Type II tapes.

This follow-up will also cover retesting of Radio Shack (Realistic) and Swire formulations. Radio Shack specifically questioned the results presented for their Supertape Hi-Bias tape, but provided samples for their entire cassette line. Retesting was conducted on the three formulations covered before, and the same tests were run on Realistic Low Noise, which had

not been evaluated. Swire also felt that the results indicated the samples of their tapes were not representative and provided new samples for retest.

## Test Methods

A brief word is in order to describe the evaluation leading to the results in the Table, response plots, and commentary that follow. All of the tests were made on a Nakamichi 582 deck. The bias for each tape was adjusted for best response at 20 dB below Dolby level, after adjusting the record



# Most of the tapes showed little or no skew and were consistent in sensitivity, bias requirements and output level.

head for alignment with the playback head for that particular sample. The bias level was metered and referenced to the bias that secured best response with the IEC reference tape for the tape type under consideration. The record sensitivity was checked against the same reference tape. Because the frequency responses at -20 dB were so similar, they were not plotted. Those at 0 dB, or Dolby level, were, however, as they showed the limitations from high-frequency saturation.

The MRLs (maximum record levels) at a limit of 3% third-harmonic distortion were measured at 100 and 400 Hz and at 1 and 2 kHz. The 3% THD limit for higher frequencies was established using twin-tone IM techniques. The signal-to-noise ratio was measured with both IEC A and CCIR/ARM weightings, using the level for 3% distortion at 400 Hz as the reference. (The Table of results does not list the CCIR/ARM figures, as they were consistently just about 2.6 dB less than the dBA results.) Modulation noise was measured by recording a 1-kHz tone at +3 dB, notching out the tone in playback with a very narrow filter, and measuring the output noise after a bandpass filter of 500 to 1,500 Hz was inserted.

The output-level stability, dropouts and flutter were all measured on the playback of a recorded 3-kHz tone. The stability was examined with a 2-S/division sweep on a spectrum analyzer

tuned to 3 kHz, while the dropout check used a sweep rate of 0.05 S per division.

## Measurements

Table I lists the results of the evaluation of the 12 formulations. The arrangement is exactly the same as used in the earlier article, facilitating any comparisons that might be desired. Each of the 0-dB response plots has a 3% MRL curve added to help visualize the significance of the figures in the Table.

The brief comments below on each of the formulations are arranged alphabetically by brand within tape type. Most of the tapes showed little or no skew and had consistent sensitivity and bias. The output-level stability was usually quite good, and most of the samples showed average flutter.

## Type I Tapes

*Konica ML:* Overall, the results would be classified as typical for a Type I tape. The analyzer display in the dropout test showed some roughness, but dropouts close to audibility were quite infrequent.

*Konica GM-I:* This is one of the better tapes in this category, with good MRLs, nice responses, high consistency, no skew, low noise, very good output-level stability and no dropouts, even of a minor nature.

*Realistic Low Noise:* This is a non-pre-

mium tape with low MRLs and higher noise than most Type I tapes. The consistency was quite good in most respects, but one of the samples which showed a little skew also had some output-level wandering (0.35 dB) and higher than average flutter.

*Realistic Supertape Gold:* Tests of the newer samples revealed that a good Type I tape had become better, with higher MRLs, lower noise, and improved output-level stability. Flutter was slightly better than average.

*Swire Laser XL:* The new samples evidenced general improvements. Especially worthwhile was the over 5-dB increase in MRLs from 100 to 2,000 Hz. Bias and sensitivity were much closer to the IEC reference tape. The samples had noticeable skew, however, and the output-level stability was just fair.

*Swire Laser UHDI:* The earlier tests of this formulation had shown an unusual distortion spectrum under some conditions, but the new samples did not have any such characteristic. The MRLs were fairly good across the band, and there was a slight improvement in the signal-to-noise ratio. The samples were very consistent, including their lack of skew.

## Type II Tapes

*Konica GM-II:* This is a good Type II tape, with good MRLs, low noise, no dropouts and excellent output-level stability. The samples had excellent

## TABLE I

BRAND	DESIGNATION	TYPE	MAXIMUM RECORD LEVEL dB re: 400-Hz Dolby Level						S/N RATIO dBA	RESPONSE AT -3 dB (kHz)		MOD NOISE dB	BIAS dB	SENS dB
			HDL <sub>3</sub> = 3%				TTIM = 3%			0 dB Level	-20 dB Level			
			100	400	1k	2k	5k	10k						
Konica	ML	I	+ 3.6	+ 4.4	+ 5.1	+4.0	-3.8	-10.0	56.1	9.1	23.6	-44.6	-2.2	+0.4
Konica	GM-I	I	+ 4.4	+ 5.8	+ 7.1	+4.5	-1.2	- 7.5	58.4	10.5	23.4	-47.5	+0.3	-0.2
Realistic	Low Noise	I	+ 1.2	+ 2.3	+ 3.0	+1.9	-4.3	-10.3	52.7	9.0	22.9	-45.1	-2.1	+0.2
Realistic	Supertape Gold	I	+ 6.0	+ 6.6	+ 6.7	+4.6	-1.3	- 7.6	57.5	10.1	23.9	-47.5	-1.2	+1.0
Swire	Laser UHDI	I	+ 3.7	+ 5.0	+ 6.4	+3.2	-2.3	- 8.4	55.2	10.1	23.3	-48.3	-0.7	-0.3
Swire	Laser XL	I	+ 2.6	+ 3.9	+ 5.3	+3.3	-2.0	- 8.6	53.7	10.1	23.5	-47.1	-0.9	-0.5
Konica	GM-II	II	+ 4.3	+ 5.9	+ 6.7	+3.5	-4.5	-10.6	60.9	9.8	22.6	-49.2	-0.3	+1.0
Realistic	Supertape Hi-Bias	II	+ 4.4	+ 5.4	+ 5.7	+2.1	-5.1	-10.4	59.7	9.6	23.4	-47.1	+0.2	+0.8
Swire	Laser UHDIi	II	+ 0.6	+ 1.9	+ 3.0	+2.1	-6.2	-11.1	57.0	9.3	23.9	-51.4	-0.1	-0.1
TDK	HX-S	II	12.0	25.8	+ 7.8	+8.7	+8.9	+ 7.0	- 1.7	- 6.4	60.6	-47.4	0.0	+3.5
Konica	Metal	IV	+ 6.8	+ 8.6	+10.1	+6.8	-0.5	- 5.9	61.2	12.9	25.1	-50.0	+0.1	-0.3
Realistic	Supertape Metal	IV	+ 9.0	+10.9	+11.4	+7.3	0.0	- 6.2	64.3	13.5	24.7	-49.9	+0.3	+1.5

# As these tests demonstrate, you can expect continuing improvements and new names. Isn't it nice to have so many quality tapes?

## TYPE I

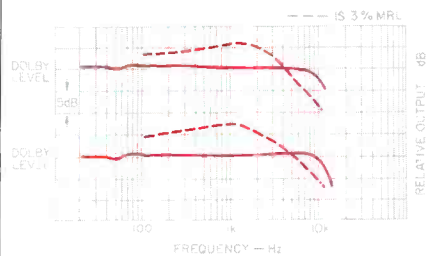

**Konica ML (top) and GM-I**

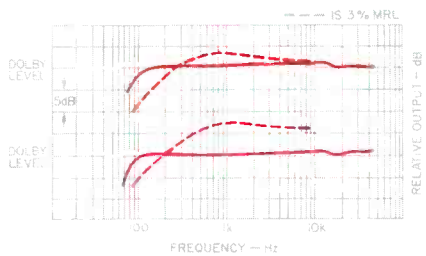

**Realistic Low Noise (top) and Supertape Gold**

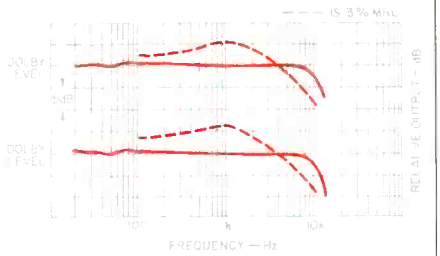

**Swire Laser XL (top) and Laser UHDI**

## TYPE II

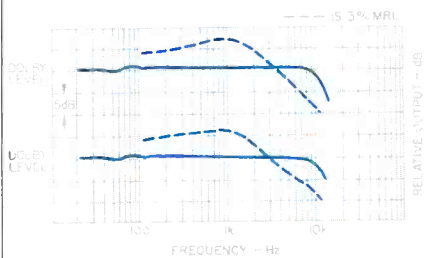

**Konica GM-II (top) and Realistic Supertape Hi-Bias**

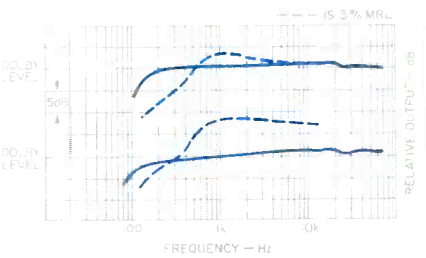

**Swire Laser UHDI (top) and TDK HX-S**

## TYPE IV

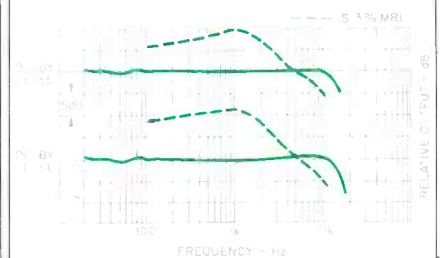

**Konica Metal (top) and Realistic Supertape Metal**

consistency of sensitivity, bias needs and lack of skew.

**Realistic Supertape Hi-Bias:** It was quickly apparent that results with the new samples were better than first reported. A reassessment of the earlier samples revealed that a reference-level error of 2 dB had been introduced inadvertently while doing low- and mid-frequency MRL tests with this formulation only. The new samples provided even better results, with good MRLs and low noise, as shown in Table 1. There was little measured skew, also an improvement over the earlier report.

**Swire Laser UHDI:** The new samples of this tape were somewhat different from those tested before: Poorer low-frequency MRLs, better high-frequency MRLs, a lower signal-to-noise ratio and lower modulation noise. Overall, it remained one of the poorer Type II tapes.

**TDK HX-S:** The test results listed in the

Table demonstrate that this formulation takes its place as the highest performing of all Type IIs, with the most extended responses at both 0 and -20 dB and the highest MRLs overall. The signal-to-noise ratio is very good, but not outstanding, and the modulation noise is a little high. The required bias was to the IEC reference, but the sensitivity was at +3.5 dB—not a problem if one compensates for it. There was outstanding consistency among all samples, including both sides.

### Type IV Tapes

**Konica Metal:** This is a typical metal tape, showing extended responses, high MRLs and low noise. The consistency from sample to sample was very good, including no skew. The dropout display was a bit rough, but none of them got to the audibility threshold.

**Realistic Supertape Metal:** These new samples were in improved boxes with

shrink-wrap, a change from the Radio Shack practice of using simple label seals. More important, however, was the increase in MRLs across the band, making this one of the better metal tapes. Its consistency remained one of the best for this tape type, and the low price adds to its appeal.

The evaluation of these 12 formulations demonstrated that the user can expect to see continuing improvements in products from tape manufacturers. TDK HX-S is an unusual addition to the tapes available, and for some decks, the lower bias requirements of this excellent formulation will be beneficial. And there will be new names appearing on those boxes as other firms hope for success in this competitive market. Perhaps this will increase confusion about *what* choice to make, but isn't it nice to have a number of quality formulations to choose from?



# 1

## REVOX B225 COMPACT DISC PLAYER

### Manufacturer's Specifications

**Frequency Response:** 20 Hz to 20 kHz,  $\pm 0.6$  dB.

**Signal-to-Noise Ratio:** Greater than 96 dB, 20 Hz to 20 kHz, unwt'd.

**Total Harmonic Distortion:** Less than 0.006%, 20 Hz to 20 kHz.

**Channel Separation:** More than 90 dB, 20 Hz to 20 kHz.

**Output Level:** 2.0 V, fixed; 0 to 2.0 V, variable.

**Headphone Level:** 13 volts p-p, 35 mW into 600 ohms.

**Number of Programmable Selections:** 19.

**Search Time For Any Location:** Less than 4 S.

**Wow and Flutter:** Below measurable limits.

**Power Consumption:** 40 watts maximum.

**Dimensions:** 17.75 in. (45.0 cm) W  $\times$  4.25 in. (10.9 cm) H  $\times$  13.0 in. (33.2 cm) D.

**Price:** \$1,150.00.

**Company Address:** 1425 Elm Hill Pike, Nashville, Tenn. 37210.

For literature, circle No. 90

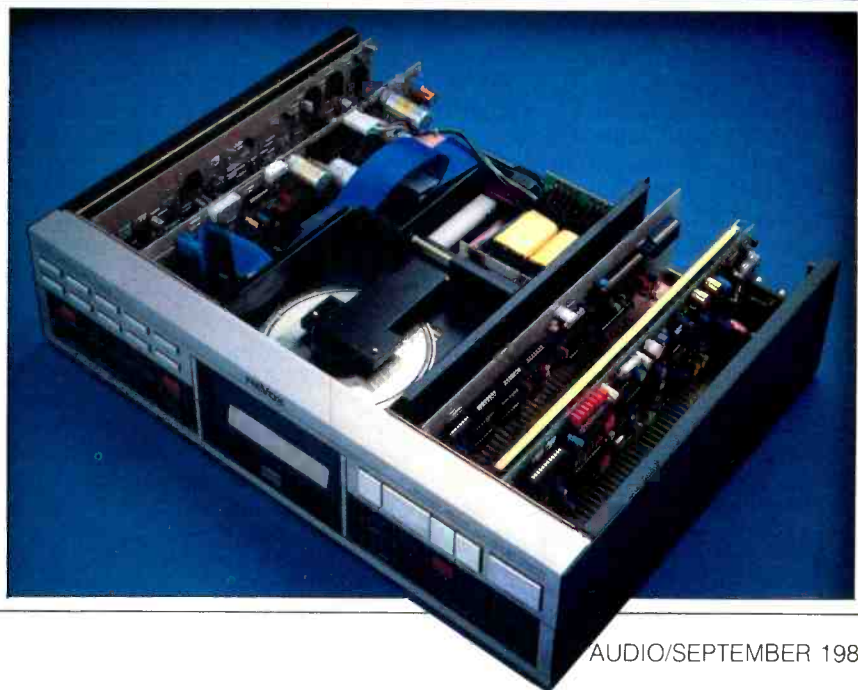
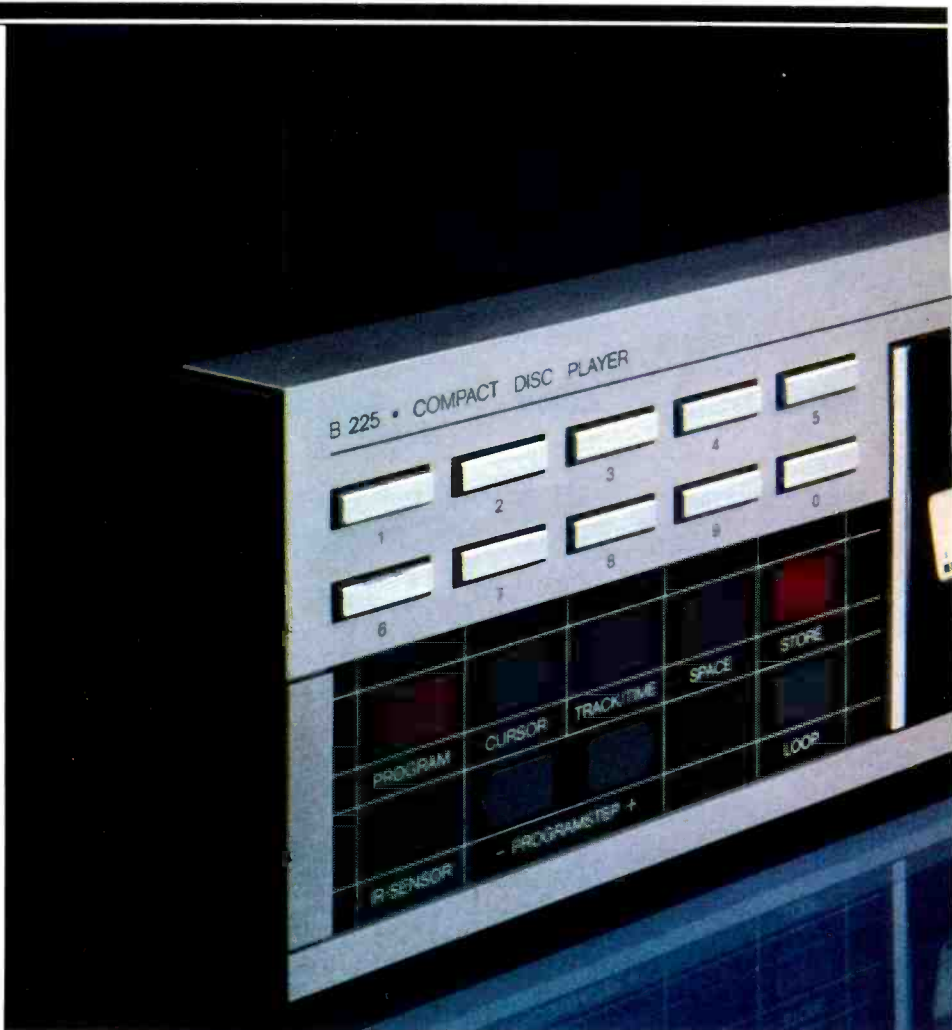

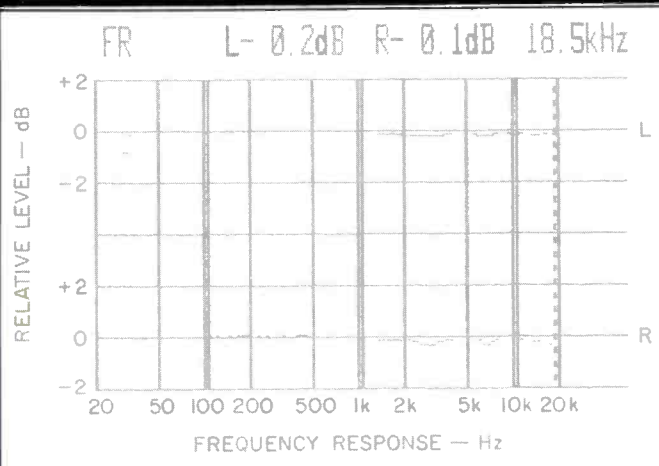
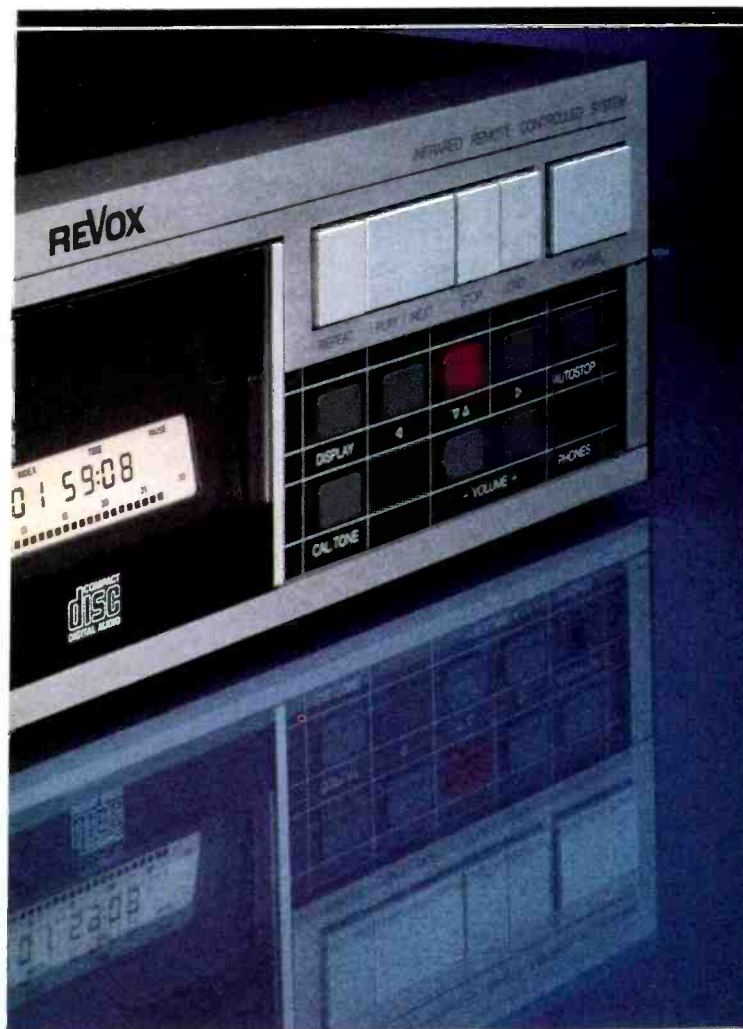

**Fig. 1—Frequency response, left (top) and right channels, at 0-dB level.**

end the other way. Program memory is nonvolatile, so it will retain its contents even if you shut the B225 off or accidentally unplug it.

The three functions which Revox calls "special program steps" are even more unusual. Entering the "Loop" command as a program step makes the program repeat endlessly until stopped. (If pressed in normal play mode, the "Loop" button repeats the entire CD.) The program can pause automatically after any selection, until the pause key is pressed—and can also output the 1-kHz calibration tone to remind you that the program has paused. The player can even be set to turn itself completely off at the program's end! Even handier, perhaps, the program can be "paged" through for checking and then modified without erasing it or starting over.

On the technical side, the B225 follows the Philips system of four-time oversampling (at 176.4 kHz—see April, 1984 *Audio*), with both digital and analog filters, using digital filters specially designed for Revox by Dr. Roger Lagadec.

**Control Layout**

The first thing I noticed was the panel's logical layout. Often-used controls occupy the right third of the panel, while programming controls are grouped to the left. In the center is the disc drawer, with a multifunction display on its front surface.

The controls at the right include the "Power" switch, and a group of four keys: "Repeat," "Play/Next" (to start play or, if playing, move to the next track or next programmed step), "Stop," and "Load" (to open and close the drawer). Below are five more buttons: "Display" (which switches the display between time elapsed in the current selection and time elapsed since the beginning of the disc), keys to skip back or ahead and to pause or restart play, and an "Autostop"

It comes as no surprise to me that this first Compact Disc player to be built by Studer-Revox is one of the most sophisticated, rugged, yet easy-to-use units of its kind that I have ever tested. After all, Studer and Revox tape equipment is used in broadcast and recording studios throughout the world, and Revox products (the brand name used on Studer's consumer products) are regarded by many to have the same attributes as the company's professional components. What *did* surprise me was the suggested retail price of the unit. I had fully expected the Revox CD player to be among the world's most expensive as well as among the world's best. While it certainly lived up to the latter expectation, its price was no higher than that on some of the first-generation CD players which offered only a fraction of this unit's versatility.

The B225's programming facilities are unusually elaborate, and some are unique. Programs can be up to 19 steps long. Notice I said "steps," not "selections"—each step can include any number of consecutive selections, in their original order. Selections can be programmed by track number or by time from the beginning of the disc—or you can program the start of a selection one way and program its



I had expected Revox's CD player to be among the world's most expensive as well as among the world's best. But its price is not that high.

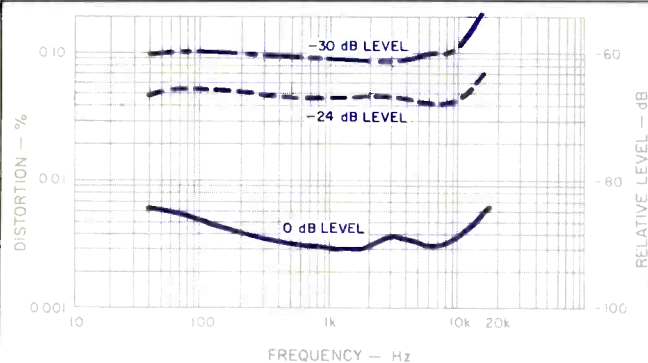

**Fig. 2—THD vs. frequency at levels of (from top to bottom) -30, -24 and 0 dB.**

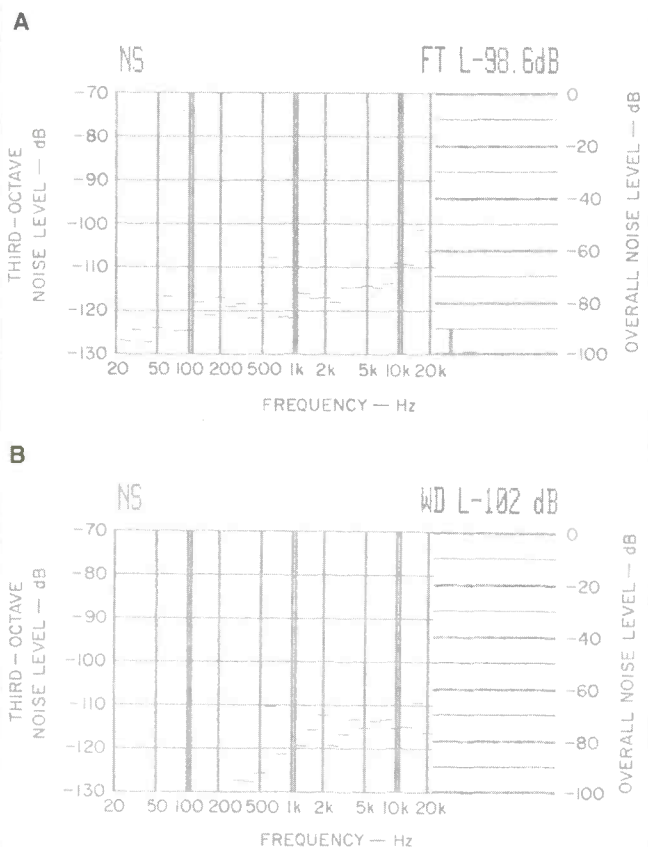

**Fig. 3—S/N analysis, both unweighted (A) and A-weighted (B).**

key (which makes the player pause at the end of each selection or program step, resuming when the pause key is pressed). At the bottom of this section are the "Cal. Tone" button (which sends a 1-kHz tone to the output jacks, at the maximum level possible from a CD, for adjusting tape-recorder levels) and the up/down "Volume" buttons (which control the adjacent headphone jack and the variable-level outputs on the rear panel).

The B225's display offers a wealth of useful information. In normal (nonprogrammed) play, it shows track and index number, time since the beginning of the current track (or since the start of the disc), and shows whether the "Pause," "Autostop" or "Loop" modes have been activated. If the player finds index signals on the disc, the word "Index" comes on the display, with the current index number just beneath it; there is no way of accessing selections by index number, though.

In programmed play, the display shows the word "Step" to indicate the programmed mode and shows the number of the step being executed. The next field of the display shows the track number or timing that started the selection, with the following field showing the track number or timing (if any) programmed as the selection's end point.

One display function remains the same in both programmed and normal play. When the disc is first loaded, a horizontal line of square bars appears along the bottom of the display, indicating how many selections (up to 30) are on the disc. These bars disappear, one by one, as the tracks they designate are played.

Several of the controls in the programming area at the left can be used for normal play as well. The 10 numbered buttons at the top of this section can be used for direct access to any given track in normal play, as well as for programming track number or selection time (from the beginning of the disc). The "Loop" button at the bottom left repeats the entire CD in normal play, or the entire program during programmed play. The others are for programming only. Pressing "Program" puts the B225 in program-entry mode, which can be done even while a disc is playing in normal mode. The "Store" button enters commands in memory. The "Track/Time" button switches selection start or end-point entry and display between track-number and elapsed-time modes. Start and end points can also be marked while the disc is playing, by pressing the "Mark" button as the desired points come by. Two additional buttons allow you to "page" through a previously entered program, forward or backward, to check or edit it. A "Cursor" key is used to move from field to field of the display when editing a program, or to switch, in elapsed-time programming, from minutes to seconds.

A sensor at the lower left of the panel receives infrared signals from Revox's optional B201 wireless remote-control unit (\$125); a light behind the sensor panel blinks to acknowledge commands. The B201 commands the B225's "Play/Next," "Stop," skip-ahead, skip-back, and pause functions, plus direct numerical track entry. The B201 can also be used with Revox's B251 amplifier, B261 tuner, B710 Mk II cassette deck, and the B791 and B795 turntables. To keep the button count down to a reasonable number (381), the remote does not provide separate buttons for the CD-

The B225's 20 programming steps can cover more than 20 tracks: Each step can include any number of consecutive selections.

player functions, but requires that a "\*" key be pressed concurrently with each button when commanding the B225. If the remote is to be used only with the CD player, it can be modified so that the "\*" key need not be pressed.

The rear panel of the B225 is equipped with fixed- and variable-level output-jack pairs, a power-cord receptacle and a multi-pin remote socket for connecting a wired remote control. Connecting such a remote automatically disables the infrared receiver.

Reading about all the B225's controls may perhaps intimidate you a bit—when I first read the owner's manual, before actually using the deck, I figured I'd need several hours to master everything. In fact, once I started dealing with this magnificent product, I was able to use and program it almost immediately—that's how well the panel is laid out, and how succinctly and clearly the controls are labelled.

### Measurements

After marvelling at the extraordinary flexibility of this beautifully crafted machine, I got down to measuring its actual performance. As I have found again and again over the years, Revox's published specifications were unusually conservative. Figure 1 shows a plot of frequency response for both the left and right channels of the B225. The vertical scale is 2 dB per division, and the sweep, from left to right, extends from 20 Hz to 20 kHz. Frequency response was extremely flat, deviating by no more than  $\pm 0.2$  dB. Harmonic distortion for maximum output varied from 0.003% to around 0.006%, depending upon the test frequency being measured. A plot of THD versus frequency up to around 10 kHz, at various recorded levels, is shown in Fig. 2.

Unweighted S/N measured 98.6 dB (Fig. 3A) while, with A-weighting, it increased to 102 dB (Fig. 3B). At maximum recorded level, IM distortion measured 0.0055%, increasing to 0.065% at  $-20$  dB recorded level. Linearity was accurate to within 0.2 dB down to  $-80$  dB. Stereo separation (Fig. 4) ranged from 80 dB at the low and high frequency extremes to around 89 dB at mid-frequencies.

Reproduction of a 1-kHz, digitally generated square-wave signal is shown in Fig. 5. The reproduced waveform is typical of that obtained with CD players that use digital filtering ahead of their D/A converters, as this one does. (The filters used here are Revox's own design.) Playback of a digitally generated unit-pulse signal was also typical of players using this type of filtering (Fig. 6). The scope photo of Fig. 7 shows negligible phase shift between a left-channel, 200-Hz test signal and a right-channel, 2-kHz one. It should be noted that the B225 has two independent D/A conversion circuits, which eliminate one source of time delay or phase differential between channels.

### Use and Listening Tests

In their white paper on the technology of the B225, Revox claims the unit "doesn't mistrack, even in very stressful situations," thanks to its pivoting-arm laser assembly. As to error-correction, the paper claims that "The B225 plays all damaged records. It is the only CD player capable of this." The only restriction cited is that "Discs in very bad shape (broken, pierced, scratched all over the surface) will still be perfectly reproduced, but cannot be programmed."

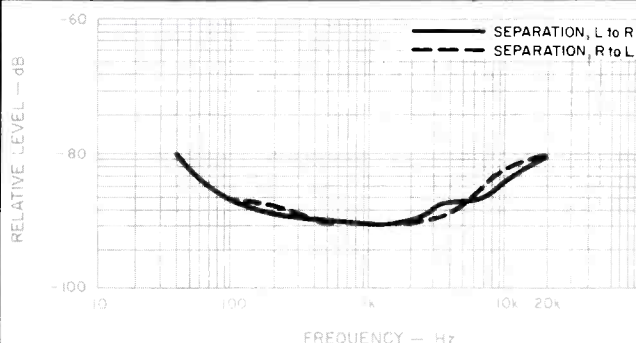

Fig. 4—Separation vs. frequency.

Fig. 5—Square-wave reproduction, 1 kHz.

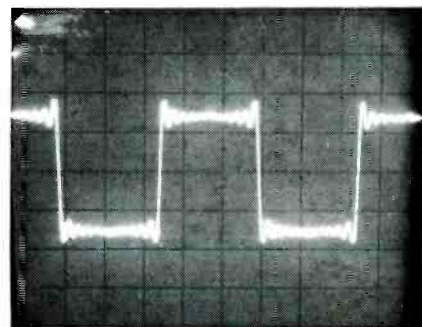

Fig. 6—Single-pulse test.

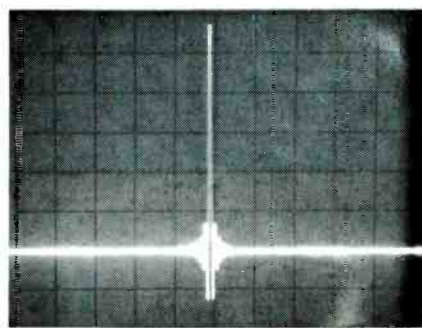
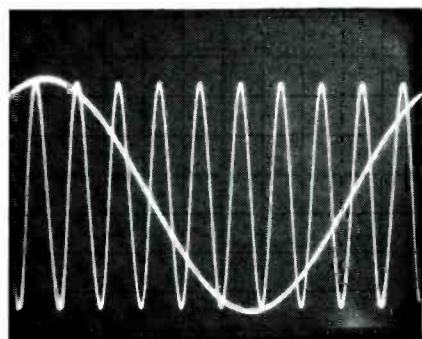

Fig. 7—Two-tone phase test (200 Hz left channel, 2 kHz right).





Revox claims the B225 can play even the most badly damaged Compact Discs. The only restriction is in programming.

Well, I wasn't about to break, pierce, or scratch all over their surfaces any of my favorite musical CDs to prove the point, and I suspect that even at Revox, copywriters can get to be a bit over-enthusiastic. This much I can say, with certainty, however. The Revox B225 had no trouble whatsoever playing through (and ignoring) all of the defects built into my special Philips test disc. That means that it was able to correct for dropouts extending to 900 microns in length, simulated dust or dirt spots 900 microns in diameter, and a long, semi-opaque simulated fingerprint smudge. I must also confess that I was a bit more brutal than usual in my "tapping tests" along the sides and top of this rugged unit, yet still I failed to cause any mistracking during these "shock tests."

If you are looking for a CD player that doesn't occupy very much space on your shelf or table top, this is probably not the unit for you. There are CD players around that are much smaller in size and lighter in weight. If, however, you are looking for a CD player that is more versatile in its programming capabilities than just about any other player available, you would do well to consider the long-awaited Revox B225 very seriously. I have been an admirer of Revox and Studer products for many years and have been privileged to visit the Studer factories in Switzerland and Germany and to meet and talk with the company's legendary founder, Dr. Willi Studer. Having had the pleasure of listening to Dr.

Studer explain his philosophy of product design and quality, I expected nothing less than sonic and mechanical perfection from the company's first CD player.

I was not disappointed in the least. Sound quality was beyond reproach. I know that in the past I have repeatedly stressed that there is little audible difference between one CD player and the next. Nevertheless, I felt that the Revox B225 sounded cleaner; instruments seemed better defined during ensemble playing and in orchestral works. Stereo imaging was magnificent when I played some of my most recent CD acquisitions. I wondered whether my positive reaction to the sound of this player was purely psychological (stemming from my admiration for the engineering and layout of the instrument) or whether it was, in fact, the result of an audible difference between this CD player and others I have tested. I suppose I will never really know. The ease with which complex programming could be accomplished on this superbly engineered machine seemed a fitting accompaniment to the high technology involved in the actual playing and tracking of CDs. All in all, the Revox B225 is a superb instrument. I simply can't find anything to criticize, nor can I think of a single feature or control that I would have arranged differently. As is usual with Revox where new designs are concerned, it took the company quite a long time to come up with their first CD player. But it was certainly worth waiting for!

*Leonard Feldman*



“The construction of the GFP-1A is, to put it mildly, robust... The cabinet and chassis are made of steel... everything is on a single large circuit board, with an open, uncluttered parts layout and a minimum of point-to-point wiring. All of this indicates probable long-term reliability. Both on the test bench and as part of a hi-fi system, the Adcom GFP-1A left nothing to be desired. It has all the flexibility one could ever want combined with smooth, silent and bug-free operation. An excellent preamplifier at a very reasonable price”

*Julian Hirsch in Stereo Review*

“The GFP-1A gives us just about everything—in features, technology, and performance—that we’ve ever really wanted in a preamplifier. That response and distortion measurements are beyond reproach goes without saying... and the feel and appearance of the controls further inspire confidence. Had we not been delighted by what we heard through the GFP-1A, we would have been astonished. But the only real surprise was the price... which was modest relative to some of the high-tech preamplifiers to which its performance invites comparison.”

*High Fidelity*

**Now, if you still want to pay more than \$375 for a high-performance preamplifier, that's up to you.**

**ADCOM®**

11 Elkins Road, East Brunswick, New Jersey 08816

Enter No. 1 on Reader Service Card

# Would you pay an extra quarter for a record that would last forever?

**We're serious.**

**Records treated with LAST  
do not wear out.**

Remarkable as this may seem, LAST preservative is a unique chemical formula which enables the record vinyl to withstand repeated plays without wear... by preventing the microscopic "shock-wave" fracturing that occurs every time you play your favorite record. Lab tests prove it, and your ears prove it, too.

**You get "brand new" sound  
every time, even after 200  
plays.**

Instead of hearing the "pops" and "clicks" getting worse every time you play your record, you'll hear the "brand new" sound every time. What's more, LAST improves the contact between the stylus and the groove, so you hear better sound starting with the *first* play.



NEW RECORD, UNPLAYED



NEW RECORD, UNTREATED,  
PLAYED 50 TIMES



NEW RECORD, TREATED WITH  
LAST, PLAYED 200 TIMES

**Stop cheating yourself!**

You've probably got albums you're afraid to play, or maybe you've even gone to the trouble and expense of recording some of your albums, all because you want to protect them.

Aren't you worth a quarter? That's all it costs for one 30-second application of LAST, and you'll enjoy "brand-new" sound for 200 plays.

Find out more about the LAST System of record and stylus care products: LAST Record Preservative, STYLAST Stylus Treatment, Stylus Cleaner, LAST Power Cleaner, LAST Record Cleaner.

Ask your dealer or call Toll-Free:

**800-223-LAST**  
(in California 800-222-LAST)

**LAST**<sup>®</sup>

POST OFFICE BOX 41  
2015 RESEARCH DRIVE  
LIVERMORE, CA 94550

**we keep your records sounding brand new**

Enter No. 16 on Reader Service Card





Nakamichi Sound Research Center Concert Hall

This is Nakamichi

## Nakamichi—The *first* name in cassette recording

In 1973 we shocked the world by introducing the Nakamichi 1000—the first “Discrete 3-Head” cassette deck—the first cassette recorder that *outperformed* the open-reel decks of its day.

In the past decade, Nakamichi has shattered one technological barrier after another with such innovations as NAAC, our Auto Azimuth Correction system, UDAR, our unique *Unidirectional Auto Reverse*

mechanism, and our exclusive Asymmetrical Dual-Capstan Diffused-Resonance transport, quite simply, the world's most *precise* tape drive.

As impressive as these technological breakthroughs are, they are merely means to an end—*sound purity!* Hearing is believing. Listen to *any* of our decks and you'll be convinced that Nakamichi Sound is in a class by itself—pure, clean,

transparent, utterly refreshing, and quite unlike ordinary cassette sound.

Nakamichi Sound characterizes our entire line from the inexpensive BX-1 to the exotic DRAGON. When you pay less for a Nakamichi deck, you get fewer features—not inferior sound! Each Nakamichi design must pass the *ultimate* test—critical live vs. recorded listening in our Sound Research Center Concert Hall.



### **DRAGON** Auto Reverse Cassette Deck

The world's first Discrete 3-Head Dual-Capstan Direct-Drive Auto-Reverse Cassette Deck. Nakamichi's unique Auto Azimuth Correction system—NAAC—guarantees 20-22,000 Hz response in *both* playback directions!



### **ZX-9** Discrete 3-Head Cassette Deck

The *perfectionist's* cassette recorder. Azimuth, bias, and sensitivity calibration controls for perfect recording on virtually any tape and our unique SLT direct-drive motor for flutter-free reproduction.



### **RX-505** Unidirectional Auto-Reverse Discrete 3-Head Cassette Deck

Our exclusive UDAR mechanism combines unidirectional performance with auto-reverse convenience. Discrete 3-Head recording and playback on both sides! The 2-Head RX-303 and RX-202 offer UDAR performance and many unique features.



### **LX-5** Discrete 3-Head Cassette Deck

Revel in the aesthetic luxury of the LX-5 and companion 2-Head LX-3. Tap the right panel to reveal the hidden controls, then sit back and enjoy the unique purity of Nakamichi Sound. A feast for the eyes and ears!



### **BX-150** 2-Head Cassette Deck

Designed for those who appreciate simple virtuosity, the BX-150 and BX-100 demonstrate the sound purity that can be realized at an economical price. Compare them with decks costing much more. You'll be surprised!



### **BX-1** 2-Head Cassette Deck

Think you can't afford Nakamichi Sound? Think again! The remarkable BX-1 costs less than \$300, but outperforms decks at twice the price. Hearing is believing so audition one now and convince yourself!



Nakamichi U.S.A. Corporation 19701 South Vermont Ave., Torrance, CA 90502 (213) 538-8150  
In Canada: W. Carsen Co., Ltd., 25 Scarsdale Road, Don Mills, Ontario M3B 3G7



## 2

## TANDBERG TCD 3014 CASSETTE DECK

### Manufacturer's Specifications

**Frequency Response:** 18 Hz to 20 kHz; to 23 kHz with metal tape.

**Harmonic Distortion:** 1%.

**Signal/Noise Ratio:** 74 dBA with Dolby C NR.

**Separation:** 40 dB.

**Crosstalk:** -60 dB.

**Erase:** 80 dB.

**Input Sensitivity:** Line, 10 to 100 mV, adjustable.

**Output Level:** Fixed output, 700 mV; variable output, 0 to 4 V.

**Flutter:** 0.09% wtd. rms;  $\pm 0.12\%$  wtd. peak.

**Dimensions:** 17 $\frac{1}{8}$  in. (435 mm) W  $\times$  6-9/16 in. (166 mm) H  $\times$  13 $\frac{3}{4}$  in. (350 mm) D.

**Weight:** 21.6 lbs. (9.8 kg).

**Price:** \$1,395.00.

**Company Address:** Labriola Court, Armonk, N.Y. 10504.

For literature, circle No. 91



The TCD 3014 is Tandberg's newest cassette deck and the latest addition to their 3000 series. The deck features advanced design, using discrete components instead of ICs wherever possible, phase-compensated amplifiers and high-grade capacitors. It has separate record and playback heads for best performance and monitoring while recording. To maximize performance with any tape, adjustments for bias, sensitivity and record-head azimuth can be made with controls on the TCD 3014's front panel.

The peak-reading meters are equalized to give better

indication of maximum allowable levels before tape saturation. The TCD 3014 features Tandberg's patented Dyneq system (which automatically varies record EQ for best high-frequency recording) and Actilinear II (which increases the headroom of the record amplifier). This deck also includes both Dolby B and Dolby C NR.

The transport is built on a heavy aluminum baseplate for rigid and stable support of the four-motor, closed-loop, dual-capstan drive. The two reel-hub motors are slaved to provide constant tape speed, even in fast wind and cue and

review modes. The two capstan flywheels are not identical, to minimize resonances, and are belt-driven by the capstan motor. The fourth motor shifts the head assembly and performs other functions in a nonshock fashion, replacing the usual solenoid. A built-in microprocessor controls the normal transport operations as well as a number of memory and auto-wind functions. It also calibrates individual tapes for exact indications of elapsed time, even in fast forward and rewind. An optional, infrared remote control costs \$150.

The TCD 3014's front panel is dominated by the projecting cassette compartment. Turning on the power (at the lower left) illuminates the meters (at the upper right) brightly, while the counter display (upper left) shows "0000" after warming up for a few seconds. A red light above the "Release" button (furthest left of the six large, round transport-control buttons) shows that the transport is unlocked, for easy insertion of a cassette. In all other modes, including stop, the tape is snugly held in place until "Release" is pressed again.

The play and fast-wind functions require only a touch of the appropriate buttons. Recording can be initiated from either play or stop mode, but only if the "Rec. Preset" lever (just beneath the "Record" button) is switched on—a nice touch that helps prevent inadvertent erasures. The recording indicator, just above the button, flashes when the preset is on and glows when the deck is recording. The 3014 is unusual in that it not only allows punch-in recording but also can be switched back into play mode without stopping the tape—a definite nicety. Another nice touch is that the recording indicator will not light or flash if the cassette's erase-prevention tabs have been removed, showing immediately that the tape cannot be recorded unless the holes are covered again.

The "Memory" ("Stop/Off/Repeat") switch works with the "Set" button just below "Release." With the "Memory" switch at "Stop," the "Set" button resets the counter to zero, to mark the automatic stop or rewind point. And with the "Memory" switch at "Repeat," the "Set" button records the displayed counter setting as the automatic start point.

Pressing "Stop" and "Set" together switches the counter readout between conventional counting and elapsed-time display. The time display is calibrated to match C-90 tapes, but pressing both "Release" and "Set" recalibrates it for the tape length actually in use. The calibration includes automatic rewinding to the beginning, playing two short sections of tape, and rewinding back to the start of the tape again—accomplished in about 20 S plus any rewind time needed. I liked the combination of memory and counter features, especially the elapsed-time readout, which keeps its calibration even in fast winds.

The fast winds have constant tape speed for controlled tape tension. The winding speed is 60 times play speed, so that 1 S of wind equals 1 minute of play anywhere along the tape. Winding speeds are reduced by holding the corresponding button in, and the tape can be shuttled back and forth easily by rocking between the two fast-wind buttons; the tape stops if both are released at once.

The cue and review modes, at 20 times normal speed, are locked in by touching the "Play" button while holding either fast-wind button down. Here, too, the tape can be shuttled.

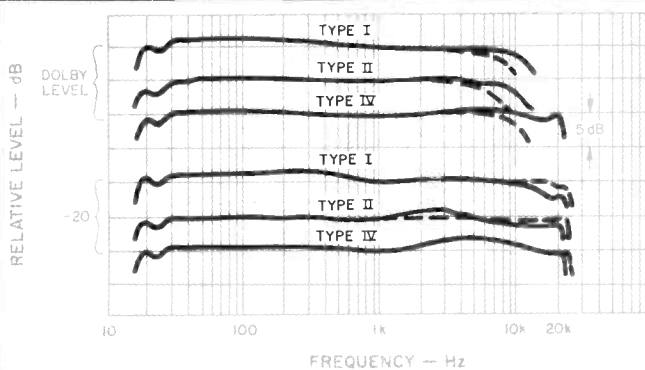

**Fig. 1—Frequency responses with (solid lines) and without (dashed lines) Dolby C**

**NR, using Type I (XL I-S), Type II (XL II-S) and Type IV (MX) tapes, all from Maxell.**

Pressing the "Stop" button during a fast wind starts the auto search function, which skips ahead or back for up to nine selections, depending on how many times the "Stop" button is pressed.

Input levels are set by a large-knobbed "Master Control" and a center-detented "Balance" pot. I prefer this arrangement to the usual separate channel pots, particularly when they are the dual-concentric type with high friction. The 3014's master pot has the added conveniences of an adjustable reference-level indicator with detent and accurate decibel scaling (relative to 12 o'clock) around its periphery.

At the top of this panel section are the brightly illuminated, peak-responding level meters, which have white scales below zero (250 nWb/m, about 2 dB above Dolby level) and red above that. Each meter has a second scale, for Type IV (metal) tapes, just below the first one. Its zero is 6 dB above Dolby level—at 400 nWb/m. The white meter needles are easily seen against the meter faces. The infrared receptor for the remote control is to the right of the meters.

Along the bottom of the panel, to the left of the "Balance" pot, are the switch for "Dolby NR" selection, the "Output" level pot, and a rotary "Monitor/Test" switch. This has the usual source and tape positions, plus positions for 15-kHz and 315-Hz test signals. These signals are used when making record-head azimuth, bias, and tape-sensitivity ("Record Current") adjustments. The controls for these adjustments are to the left of the cassette well.

The 15-kHz test tone is used for azimuth adjustment, which is gauged by reading playback-head output on the meters while turning the "Azimuth" knob. When the meters peak, the record head is properly aligned to the playback head for that tape, even if the tape has some skew. Tandberg recommends doing this for every recording.

For other recording adjustments, the azimuth is set and the tape type is selected by using the three-position toggle switch above the "Azimuth" control. These steps must be taken before the bias and sensitivity controls are adjusted. This must be done with a small screwdriver, as these controls are recessed behind the panel. Bias is correctly set



The 3014 not only allows punch-in recording, but can be switched back into play mode without stopping the tape—a nicety.

**Table I—Record/playback responses (−3 dB limits).**

Tape Type	With Dolby C NR				Without NR			
	Dolby Lvl		−20 dB		Dolby Lvl		−20 dB	
	Hz	kHz	Hz	kHz	Hz	kHz	Hz	kHz
Maxell XL I-S	17.0	13.9	17.0	23.6	17.0	10.2	17.0	25.2
Maxell XL II-S	18.3	11.8	17.0	22.5	18.4	7.7	17.0	24.7
Maxell MX	17.4	22.0	17.1	24.0	17.4	11.3	17.1	25.1

**Table II—Miscellaneous record/playback characteristics.**

Erasure At 100 Hz	Sep. At 1 kHz	Crosstalk At 1 kHz	10-kHz A B Phase Error*		MPX Filter At 19.00 kHz
56 dB	56 dB	−105 dB	20°	25°	−30.3 dB

\*After record-head adjustment.

**Table III—400-Hz HDL<sub>3</sub> (%) vs. record level (0 dB = 200 nWb/m).**

Tape Type	NR	Record Level						HDL <sub>3</sub> = 3%
		−10	−8	−4	0	+4	+8	
Maxell XL I-S	Dolby C	0.14	0.20	0.36	0.60	1.3	+7.0 dB	
Maxell XL II-S	Dolby C	0.09	0.17	0.40	1.1		+3.7 dB	
Maxell MX	Dolby C	0.04	0.04	0.11	0.40	1.1	+8.0 dB	

when the output-meter readings for both the 15-kHz and 315-Hz test tones are equal. Record current is correctly matched to the tape's sensitivity when the meters read zero for the 315-Hz tone. These adjustments assure the best performance possible and good Dolby-NR tracking. Individual bias and sensitivity pots are provided for each channel and for each of three tape types.

The headphone jack is right under the "Azimuth" knob, a position that might lead to an inadvertent azimuth error when attempting to change listening level (though I must say I didn't do that during testing). The "Timer" switch ("Play/Off/Record") also seemed somewhat out of place to me, being below the "Stop" button on the right side of the panel.

There are the expected pairs of phono jacks on the back panel, but with a difference: The inputs have adjustable sensitivity from 10 to 100 mV, and there are two sets of outputs. One set has a fixed level of 700 mV for meter zero, while the other is controlled by the front-panel pot, anywhere from 0 to 4 V for the same meter reading. These features add greatly to the deck's flexibility in interfacing with other equipment. The deck has automatic sensing to set EQ in playback, but there is a little pushbutton switch on the back panel to get 70 μS for older Type II tapes which lack sensing holes. The multiplex filter switch is also back here, which could be inconvenient for those who record from FM units with poor pilot-tone suppression.

The top and side cover has pads on its inside surface to clamp and steady the three vertical p.c. boards (which appeared to be for the microprocessor and the Dolby NR circuitry). One of the two horizontal mother boards has power-supply, bias and motor-control circuits, while the other holds amplifier circuitry. Adjustments are labelled with

parts numbers and function. The soldering is excellent, and intercard connections are made with multi-conductor cabling. The parts quality is also excellent, and the capacitors are the highest quality I have yet seen in a deck. I was impressed by the rugged transport support from a solid die-casting and the rigid U-channel box chassis, quite amenable to the use of the optional rack adaptors.

**Measurements**

The playback responses were within ±1 dB for both equalizations, one of the best results I have ever measured. Playback-level readings for such standard flux levels as 200 nWb/m were pretty accurate. The range of the record-current and bias-current adjustments was well beyond that required by any present-day tapes, and excellent performance could be secured from many of them. I did, however, use the supplied tapes (Maxell XL I-S, XL II-S, and MX) in my lab tests.

Swept-frequency responses were run with and without Dolby C NR for the usual three tape types both at Dolby level and 20 dB below that. As Fig. 1 and Table I show, the responses at −20 dB were well extended and flat within ±1.5 dB from 20 Hz to 20 kHz for most cases, including those with Dolby C NR. The benefits of Dolby C NR at higher levels are evident for all three tape types.

Table II lists some measured record/playback properties. At 100 Hz, erasure of metal tape was just fairly good (56 dB)—but it was an outstanding 94 dB at 1 kHz. Crosstalk was so low (−105 dB) that it was nearly impossible to measure. The tests of third-harmonic distortion versus level (Table III) showed that the Tandberg deck utilizes metal tape's potential very well. The low-distortion results are reflected in the signal-to-noise ratios given in Table IV, all excellent, although the Type II figures seem relatively low. Table V lists the HDL<sub>3</sub> figures for MX tape with Dolby C NR from 30 Hz to 6 kHz at −10 dB. The distortion is certainly

The controls for bias and sensitivity are recessed behind the panel, so a small screwdriver must be used to make these adjustments.



# Polk's True Stereo SDA Speakers Sound

**"Spectacular"**

*Stereo Review Magazine*

**"Astounding"**

*High Fidelity Magazine*

The Nation's Top Audio Experts Agree:  
Polk SDAs Always Sound Better Than Conventional Speakers

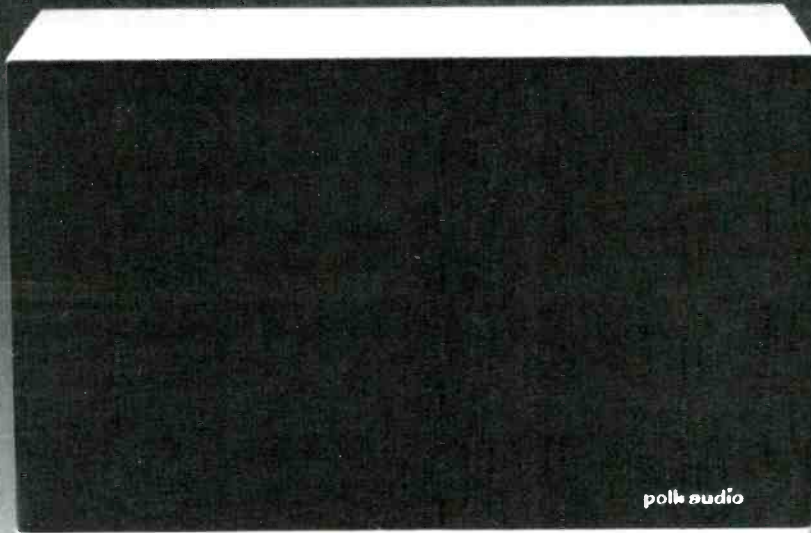

Introducing the New  
Polk SDA Compact  
Reference System  
\$395.

The Newest "Mind-Boggling" SDA  
Fits Beautifully on Your Bookshelf!

Polk's AudioVidex® Grand Prix Award winning SDA technology has been called the most important fundamental advance in loudspeaker design since stereo itself. In fact, Polk SDAs are the world's 1st and only True Stereo loudspeakers. Stereo Review said, "The result is always better than that achieved by conventional loudspeakers." High Fidelity agreed, "An amazing experience. . . . Mind Boggling . . . Astounding . . . Fabbergasting . . . We have yet to hear any stereo program that doesn't benefit." Now the dramatic audible benefits of Polk's exclusive True Stereo SDA technology are available in an elegant new loudspeaker which is ideal for bookshelf placement, the SDA Compact Reference System.

**SDA** TRUE-STEREO  
LOUDSPEAKERS

Hear the Remarkable Sonic Benefits Now!

"You owe it to yourself" . . . *High Fidelity Magazine*

The experts agree that Polk SDA loudspeakers always sound better than conventional speakers. Listeners' jaws drop in amazement when they hear the huge, lifelike, three-dimensional image produced by the SDAs. Visit your nearest Polk dealer and hear them for yourself. Write us or use the reader service card for the name of your nearest Polk dealer and information on all three SDAs (\$395.00 to \$850.00 ea.), the Polk Monitors (\$79.95 to \$460.00 ea.), and the Polk Mobile Monitors (\$39.95 to \$139.95 ea.). There is a Polk loudspeaker which is the perfect choice to fulfill your sonic needs. Happy listening!

Polk Audio, Inc., 1915 Annapolis Road  
Baltimore, MD 21230

**polkaudio**  
The Speaker Specialists®

Digital Disc Ready!

In Baltimore at Sound Scope  
403 West Coldspring Lane

Enter No. 23 on Reader Service Card

AmericanRadioHistory.com



I particularly liked the elapsed-time counter, the record preset switch, and the smooth high-speed winding.

low in mid-band, and the rises at the frequency extremes are quite moderate. It does appear that Dyneq and Actilinear II do provide benefits.

Various input and output characteristics are listed in Table VI. The line-input levels shown are for the maximum and minimum sensitivity settings of the level-set pots on the rear panel. The line-output figures listed are both for meter zero: The 4.3-V figure was the maximum from the variable output, which could be set at any value down to zero, while the 720-mV figure is from the fixed-level output. A very high level was delivered to all headphones tried. The master input-level pot sections tracked within 1 dB over a 65-dB range, outstanding performance. The output-level pot tracked better than most, both channels within 1 dB of each other for 50 dB of attenuation. The deck's input and output polarity were the same in both "Source" and "Tape." Checks of the nondefeatable subsonic filter indicated a response down 3 dB at 16 Hz, -10 dB at 10 Hz, and -20 dB at 6 Hz—useful to remove record-warp contributions. Bias in the output was quite low during recording. The waveforms for the 315-Hz (304-Hz actual) and 15-kHz (14.6-kHz actual) test tones were fine for their intended purposes.

The peak-responding meters are truly that, for they reach full deflection, within 1 dB, with a 2-mS tone burst and rise the correct 6 dB when the tone burst is offset so its peak (or bottom) value, rather than its middle value, corresponds to 0 V. Very few recorder meters show such peak levels correctly. The meters also had a good 20-dB decay time of 1.9 S. The meter-scale calibration was very close relative to zero, with most points within 0.2 dB. In "Release" mode, the meter frequency response was 3 dB down at 19 Hz and 45.6 kHz. In "Stop" (or play or record modes), the response showed the effect of record equalization—about 3 dB of boost at the lowest frequencies, increasing to 7 dB at 15 kHz.

The playback of a recorded 3-kHz tone showed barely measurable speed variations when line voltage varied anywhere from 110 to 130 V. The record/playback flutter was very low: 0.035% wtd. rms and  $\pm 0.05\%$  wtd. peak. Tape play-speed deviations over time stayed within  $\pm 0.01\%$ . Wind/rewind was smooth but fast, taking just 38 S for a C-60 (one way) and ending with a nonshock stop. Tape slack was taken up before tape drive began. All changes in mode required 1 S or less.

### Use and Listening Tests

The owner's manual provides good basic instruction, but it would benefit from greater detail. On the other hand, there is a quick-reference guide card, with the microprocessor functions covered on one side and record-optimization adjustments on the other—a handy reminder to keep next to this Tandberg deck.

Tape loading is simple—just push the cassette in. Removal is just as simple, but the deck must be in "Release." Access for cleaning or demagnetizing the tape path is excellent, and a push-in dust cover helps keep dirt out of the tape well when the deck is not in use.

I particularly liked the 3014's elapsed-time counter, the record preset and the smooth, high-speed winding. With some practice, most of the special button pushing, such as "Record" plus "Stop" for record-mute, seemed quite logi-

**Table IV—Signal/noise ratios with IEC A and CCIR/ARM weightings.**

Tape Type	IEC A Wtd. (dBA)				CCIR/ARM (dB)			
	W/Dolby C NR		Without NR		W/Dolby C NR		Without NR	
	@ DL	HD=3%	@ DL	HD=3%	@ DL	HD=3%	@ DL	HD=3%
Maxell XL I-S	65.8	72.5	51.1	57.3	67.6	74.3	49.2	55.4
Maxell XL II-S	67.2	70.7	53.4	56.0	69.5	73.0	51.4	54.0
Maxell MX	67.1	74.6	53.0	59.5	70.1	77.6	51.8	58.3

**Table V—HDL<sub>3</sub> (%) vs. frequency at 10 dB below Dolby level.**

Tape Type	NR	Frequency (Hz)							
		30	50	100	400	1k	2k	4k	6k
Maxell MX	Dolby C	0.22	0.08	0.09	0.04	0.03	0.08	0.16	0.47

**Table VI—Input and output characteristics at 1 kHz.**

Input	Level		Imp., Kilohms	Output	Level		Imp., Ohms	Clip (Re: Meter 0)
	Sens.	Overload			Open Ckt.	Loaded		
Line	8.8 mV	530 mV	155	Line	4.3 V	4.3 V	102	+17.3
	83.0 mV	5.5 V			720 mV	687 mV		
				Hdphn.	4.2 V	2.2 V	45	

cal. Going into "Record" and back to "Stop" generated soft clicks which were just out of the tape noise with Dolby C NR. Setting levels was very easy with the meters, thanks to their excellent dynamic response and their high visibility under any lighting condition. I decided there was validity in the Tandberg approach of having the meters display the input level during recording even with the output monitor set for "Tape." With level-monitoring of the source signal, there is better indication of momentary peaks that might be reaching the tape saturation level.

The wireless remote control worked very well, and it was not necessary to point it exactly at the receptor window on the deck. Its range appeared to be at least 30 feet.

Sometimes during the listening tests, I felt that I could pin down specific differences between the sounds of source and playback, but when the in/out levels were very closely matched, it became difficult to tell. Discs for the tests included the dbx-encoded Nautilus release of Tim Weisberg's *Tip of the Weisberg* and the Mobile Fidelity release of the Beethoven Ninth Symphony recorded for London by Sir Georg Solti and the Chicago Symphony Orchestra and Chorus. It was easy to relax and enjoy the Tandberg deck. The sound was detailed, but also sweet.

The 3014 does not have a sophisticated music-selection programming mode, but it has many other features for the serious user: A rugged transport for long-term reliability, elapsed-time metering, fast winding with low tension, excellent level metering, and facilities to match any tape that might be used. These and other niceties, in combination with its excellent performance, make the Tandberg TCD 3014 worthy of consideration by critical users, including comparison to other decks costing much more.

Howard A. Roberson



# CAMEL LIGHTS

## It's a whole new world.

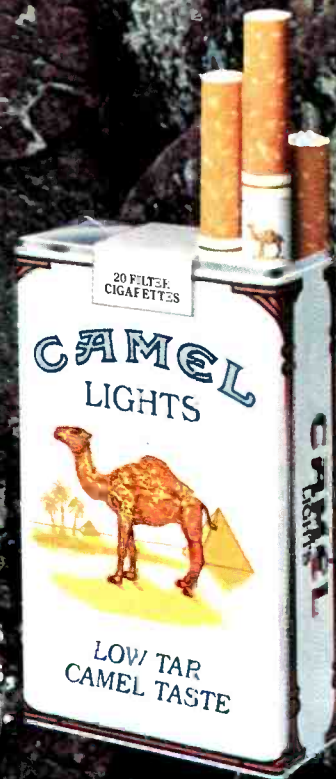

Today's  
Camel Lights,  
unexpectedly mild.

Warning: The Surgeon General Has Determined  
That Cigarette Smoking Is Dangerous to Your Health.

9 mg. "tar", 0.8 mg. nicotine av. per cigarette by FTC method.



3

## NAKAMICHI TD-800 CAR STEREO

### Manufacturer's Specifications

#### FM Tuner Section

**Usable Sensitivity:** 20 dBf.

**50-dB Quieting Sensitivity:** Mono, 26 dBf.

**S/N Ratio:** Mono, 65 dB.

**THD:** Mono, 0.08% at 1 kHz; stereo, 0.13% at 1 kHz.

**Frequency Response:** 30 Hz to 15 kHz,  $\pm 3$  dB.

**Alternate-Channel Selectivity:** 60 dB.

**Capture Ratio:** 1.5 dB.

**Image Rejection:** 65 dB.

**I.f. Rejection:** 80 dB.

**Stereo Separation:** 35 dB at 1 kHz.

#### AM Tuner Section

**Sensitivity:** 36  $\mu$ V.

**Selectivity:** 20 dB.

**Image Rejection:** 50 dB.

**THD:** 2.0%.

#### Preamplifier Section

**Frequency Response:** 10 Hz to 50 kHz,  $\pm 1.0$  dB.

**Output Level:** 1.1 V.

**Output Impedance:** 870 ohms.

**THD:** Less than 0.005%.

**Tone Control Range:** Bass,  $\pm 18$  dB at 40 Hz; midrange,  $\pm 10$  dB at 200 Hz; treble,  $\pm 12$  dB at 20 kHz.

#### General Specifications

**Dimensions:** Main unit, 7-1/16 in. (17.9 cm) W  $\times$  2-1/16 in. (5.2 cm) H  $\times$  7-3/16 in. (18.3 cm) D; Additional electronics enclosure, 7-1/8 in. (18.1 cm) W  $\times$  2 in. (5.1 cm) H  $\times$  5-1/4 in. (13.3 cm) D; Azimuth Fine Tuning Control, 2-11/16 in. (6.8 cm) W  $\times$  2-1/2 in. (6.4 cm) H  $\times$  2-13/16 in. (7.1 cm) D.

**Weight:** Main unit, 5-1/2 lbs. (2.5 kg); additional enclosure, 1 lb. 12 oz. (0.80 kg); azimuth control unit, 2 oz. (57 g).

**Power Requirements:** 13.2 V d.c. (10.8 to 15.6 V allowable), 3 A maximum; negative ground.

**Price:** \$890.00.

**Company Address:** 19701 South Vermont Ave., Torrance, Cal. 90502. For literature, circle No. 92



Since it comes from Nakamichi, I expected this car stereo's cassette mechanism to be superb; what I didn't expect was that its frequency-synthesized tuner section would be equally so. Nor did I expect so many features and so rugged a transport as I found in this small package—or, rather, set of packages, since the TD-800 is a three-piece unit. Beside the main chassis, with the tape transport and controls, there's a remotely situated azimuth control (in a small enclosure, which can be removed for installing the control in the dash) and a hide-away box which holds the

tuner circuitry, the antenna input, and other overflow components.

The azimuth adjustment is in recognition of the fact that tapes played on any car stereo (save for the one or two models which record) will have been recorded on other machines. Since there is no way of knowing that recorder's azimuth alignments, the TD-800 lets the user adjust azimuth for optimum high-frequency playback response from each recorded tape. A lovely idea—I wonder why no one else ever came up with it.

The TD-800's second unusual feature is its slide-out tape-transport mechanism, shared with the TD-1200. This saves space while allowing the use of a high-inertia flywheel and a Nakamichi-developed linear torque motor. When the tape ends or the ignition is shut off, the pinch roller releases and the drawer unlocks, but does not move out; if the ignition is turned on again and the tape hasn't ended, play resumes.

### Control and Panel Layout

On both control shafts, two concentric ring controls surround a triple-duty knob. On the left, these are "Bass," "Treble" and a "Volume" knob which also turns the tuner on or off, if pushed, and becomes a mid-bass tone control (centered at 200 Hz) when pulled. All three tone controls have center click-stops. On the right, the outermost control selects "AM," normal FM, "Hi-Blend" or "Mono"; it surrounds the front/rear "Fader." Twisting the center knob a little tunes up or down the dial until you release it; pushing the knob triggers the auto-seek circuits, which find the next station up the dial, and pulling the knob engages the "Balance" control.

The nosepiece (the front of the tape drawer) holds the five preset tuning buttons and their indicator LEDs (when a preset is selected, its LED glows brighter), the nicely out-of-the-way "Memory" button, the station display and stereo-FM light, and the tape controls and indicators. These include the large tape-play button and the smaller buttons for fast-forward, rewind and stop/eject. At the top of this panel section lie the "EQ" ("70/120") button, the tape motion and "Repeat" indicators, and the "NR" button (which cycles, push by push, through Dolby B, Dolby C and off). The Dolby B NR works on FM too—and the station memory records whether you want it on or off for any preset station. Below the "NR" switch is the "Auto Repeat" button, which automatically rewinds and replays the tape.

The azimuth control has 31 click-stop settings, each of which alters the angle of the playback head by about 2.6 minutes of arc. To set it, you adjust it slowly while listening for maximum treble from your tape. It may help to temporarily boost the treble control while doing this.

### Tuner Measurements

In mono, FM usable sensitivity measured a very low 12 dBf, far better than the 20 dBf Nakamichi claims. Only a 17.5-dBf signal was required for 50-dB quieting, well below the claimed 26 dBf.

In stereo, usable sensitivity measured 13 dBf, almost as low as in mono, because the automatic high-blend circuit cuts stereo signals almost down to mono to minimize noise. This accounts for the unusual shape of the stereo noise versus input curve (Fig. 1): As signal strength decreases, noise begins to rise, then starts decreasing, as the auto blend takes over. Strong-signal (65-dBf) S/N was nearly as high for stereo (68 dB) as for mono (70 dB).

Figure 1 also shows that distortion at 1 kHz is very low for strong signals, both in mono (0.064%) and in stereo (0.08%)—expected in top-quality home tuners, but rare in car units. Figure 2 shows that distortion is not only low at mid-frequencies but remains relatively low at the frequency extremes.

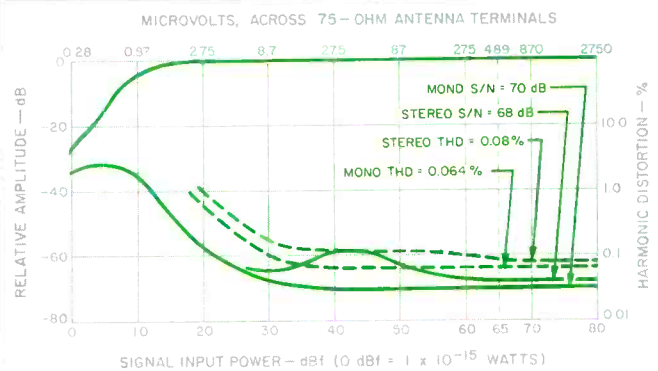

Fig. 1—Mono and stereo quieting and distortion characteristics, FM section.

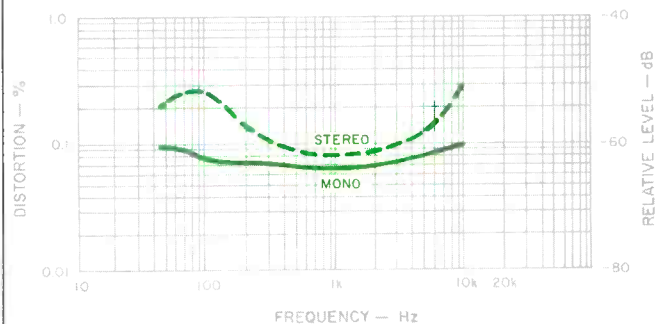
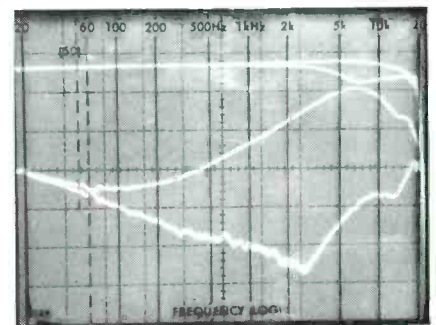

Fig. 2—THD vs. frequency, FM tuner section.

Fig. 3—FM frequency response and separation. From top to bottom: Response without high-blend and with high-blend, separation with high-blend and without high-blend.



A spectrum analysis of tuner frequency response versus stereo separation (Fig. 3) shows that, with the high-blend off, the separation (lower curve) was 46 dB at 1 kHz, 36 dB at 100 Hz, and 32 dB at 10 kHz. As you would expect, with high-blend on, separation decreases as frequency rises, reducing to around 22 dB at 1 kHz and to about 10 dB at 10 kHz, with a slight frequency-response aberration at the treble end. Figure 4 shows crosstalk and distortion products for a 5-kHz modulating signal. Capture ratio measured 1.5 dB. Selectivity and image rejection both measured 65 dB, SCA rejection was 68 dB, and i.f. rejection measured 85 dB.

I would not characterize the AM tuner frequency response



# DIGITAL DYNAMITE FROM TDK.



TDK enters the digital recording era with a BANG! Introducing our exclusive HX-S metal-particle formulation for Type II (High-Bias) recordings. It delivers everything promised by metal tape—on any cassette deck with a Type II switch.

High frequency saturation ceases to be a problem since TDK HX-S is capable of an MOL of +4 dB at 10 kHz.

HX-S also delivers exceptional high-end response. Plus a wider dynamic range. With further improvements in overall sensitivity of up to 1.5 dB.

These superior recording characteristics make HX-S perfect for capturing high-powered, treble-intensive digital source material with optimum results.

And TDK makes sure the performance never fizzles, with our specially engineered, trouble-free Laboratory Standard cassette mechanism for durability and reliability. Plus the assurance of our Lifetime Warranty.

So before you try any other cassette, pick up TDK HX-S, the first metal particle formulation for Type II (High-Bias) and digitally-sourced recordings.

It's absolutely digital dynamite.

 **TDK**  
THE MACHINE FOR YOUR MACHINE.

Nakamichi may bill the TD-800 as a unique tape player, and it is. But its FM performance is uniquely good, as well.

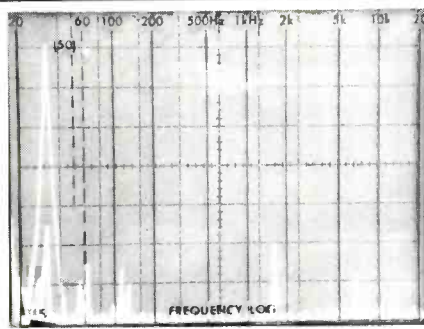

**Fig. 4—** FM stereo crosstalk and distortion components for a 5-kHz signal (with linear sweep, 5 kHz/div., ignore frequency notations on 'scope face).

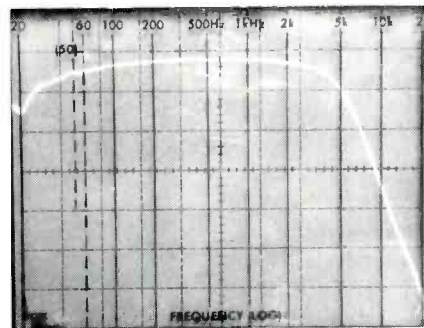

**Fig. 5—** AM frequency response.

(Fig. 5) as "high fidelity," but it is far better than that of most home tuners and receivers. It's a good compromise between reasonable response and overly wide AM bandwidth, which can cause whistles and noise.

### Tape Player Measurements

Nakamichi's concern for correct azimuth is shown by the automatic adjustment in the Dragon home deck and TD-1200 car player. In the TD-800, azimuth adjustment is manual, but still easy when listening to any recording with good treble content. I was impressed by the difference it made. With the azimuth control deliberately misadjusted (by just one click stop!), frequency response (Fig. 6A) was down 10 dB at 20 kHz. With the control at its optimum setting (which was at the midpoint of the control, I am happy to say, for my test tape), response (Fig. 6B) was down only 0.6 dB at 20 kHz, and substantially flat beyond that!

Since azimuth misadjustment also causes phase errors that increase with frequency, I compared the phase of the left and right playback channels, for test signals of 2.8, 5.7, 11.8 and 15.8 kHz. Figure 7 shows phase error with the azimuth control deliberately misadjusted by one click stop, yielding an error of  $-176^\circ$  at 15.8 kHz; a one-click misadjustment in the opposite direction changed the error to  $+108^\circ$ . This wide error range is for a total playback-head swing of only about 5.6 minutes of arc, less than  $0.1^\circ$ . With the control optimized for this tape (Fig. 8), phase error at 15.8 kHz becomes a negligible  $4^\circ$ !

Wow and flutter measured only 0.045%, wtd. rms (Fig. 9). The chief wow component, 8 Hz, contributed 0.024% to the overall figure.

Tape speed was off by approximately 0.279%. Altering

the d.c. supply voltage to the TD-800 from 12.0 to 14.0 V, I observed virtually no shift in speed.

While S/N for a tape player depends on the tape used, I still wanted to see what difference Dolby B and C NR made for each major tape type. With a Type I tape (TDK AD-X), A-weighted S/N (relative to 200 nWb/m recorded level) measured 56.0 dB without NR, 65.5 dB with Dolby B, and 70.5 dB with Dolby C NR. With a Type II tape (Maxell XL IIS), the figures were 59 dB without NR, 67.5 dB with Dolby B, and 73.5 dB with Dolby C NR. With a metal tape (Maxell MX), the figures were 58, 66.5 and 73.0 dB, respectively.

Output levels of the preamp section were 1.34 V for an FM signal at 100% modulation and 1.1 V for a cassette with a mid-frequency signal at a level of 200 nWb/m. Figure 10 shows the action of the three tone controls.

### Use and Listening Tests

In my own listening tests, with the unit connected to my laboratory reference amp and speakers, I found the 200-Hz mid-bass control particularly effective in filling out program material which lacked solid upper bass or, combined with

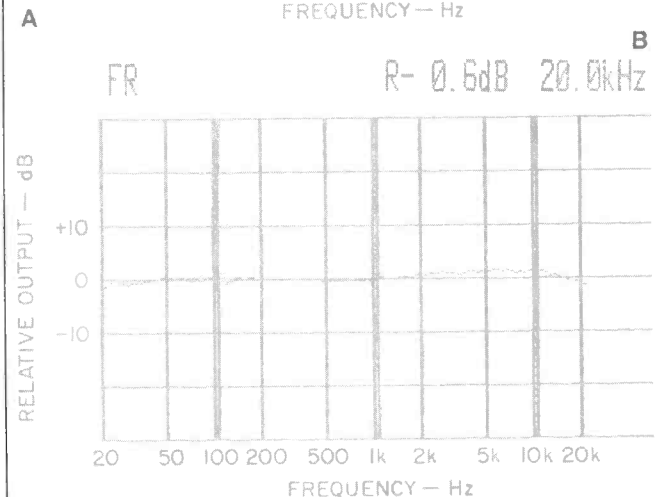
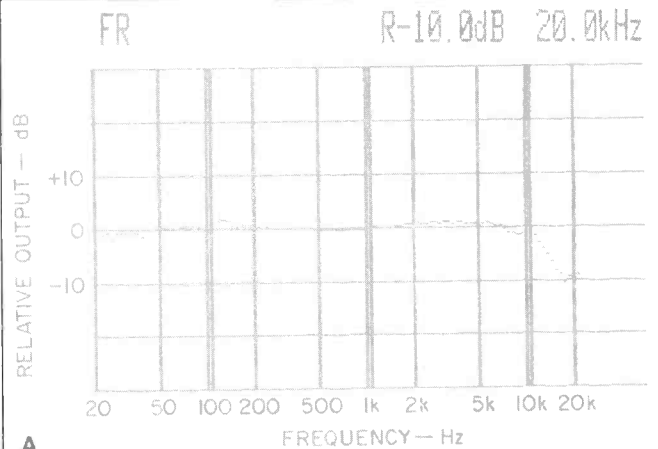
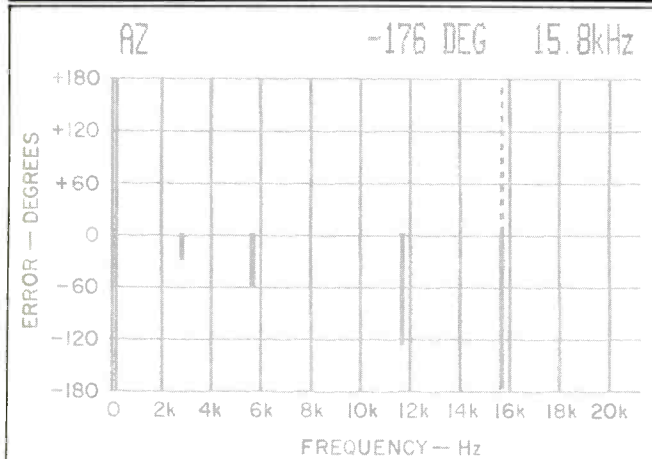

**Fig. 6—** Frequency response with azimuth misadjusted by one click

stop, or 2.6 minutes of arc (A), and when properly adjusted (B).



On the road, I consistently picked up many more stations, far more clearly with the Nakamichi than with my reference system.



**Fig. 7—How phase error between channels increases with frequency with azimuth misadjusted by one click stop. Test signals shown are 2.8, 5.7, 11.8 and 15.8 kHz.**

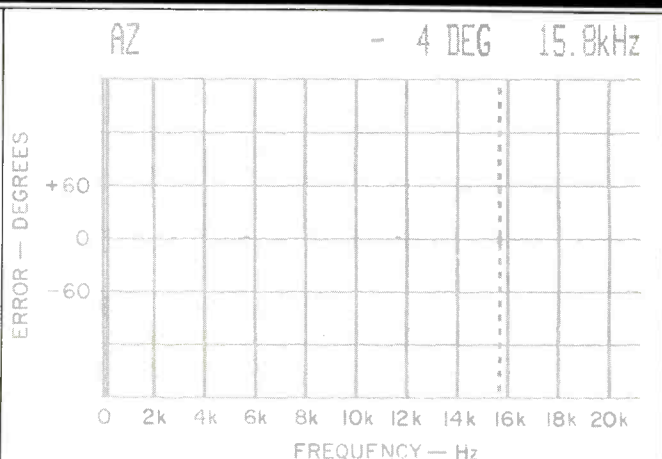

**Fig. 8—Same test signals as Fig. 7 with azimuth control setting optimized for the test tape.**

moderate use of the regular bass control, in producing a loudness-compensation curve for low-level listening.

The Nakamichi TD-800 is, without a doubt, one of the finest tuner/tape deck combinations ever offered to the music-loving driver. That little azimuth control makes such a difference in tape reproduction that you may well wonder how you ever got along without it—and wish you had it in your expensive home deck.

As to FM performance, while I cannot tell you how the TD-800 deals with such on-the-road problems as multipath and signal fading, I can tell that, given a signal of even moderate strength, the tuner performed beautifully when in a fixed location. Had I not known otherwise, I would have guessed, just from listening, that it was a top-quality home tuner and not the little package that it is.

*Leonard Feldman*

### Behind the Wheel

Installing the TD-800 is complex, but the pieces are small enough and the cables long enough to give the installer some flexibility, and the instructions are excellent. The main unit is fairly large, however, and will not fit every car's dash.

The slide-out transport will make loading harder in those few installations where the deck slants up or some projection overhangs the drawer. But it also frees up panel space for the many controls, makes head-cleaning easy, eliminates the need to eject the tape when the deck shuts off, and will simplify untangling tape snarls, if there are any. I'd prefer a stronger spring to move the drawer out or an easier way to grip it, however.

The TD-800's panel looks daunting, but its layout is basically conventional. The tape play button moves at an odd angle, but is nicely big. The mid-bass control is hard to engage and has an oversoft detent, but the manual implies it's mainly meant for "set it and forget it" acoustic compensation. The LED indicators for tape EQ and Dolby NR setting were invisible by day, alas.

At night, the tape-EQ and sometimes other LEDs glowed

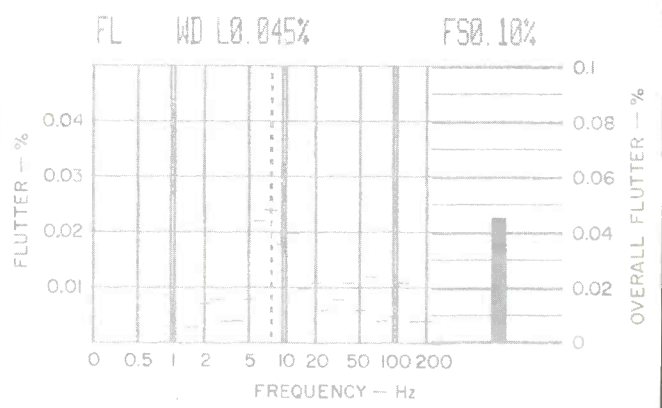

**Fig. 9—Wow-and-flutter analysis.**

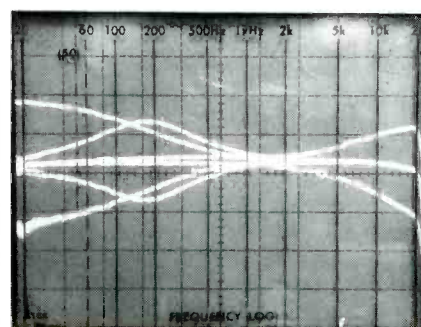

**Fig. 10—Tone control characteristics; note mid-bass control.**

How? With ceramics technology—Kyocera's innovative method of ensuring steady laser tracking—immune to vibrations. The bottom line: total purity of sound.

Why ceramics? They're rigid and inert, so they provide uncommon stability and resistance to mechanical vibrations from audio feedback. They're non-ferrous, so there are no chassis eddy currents to cause electrical hum.

The handsome ceramic-compound resin base of the DA-910 CD player is actually the

chassis—supporting and housing all components and isolating vibration. Resonance from the cabinetry is almost non-existent.

But Kyocera doesn't stop there. Digital audio's technical requirements demand unprecedented circuit capability so we use fine ceramics throughout to further conquer vibration. For example, all discrete hi tolerance audio components and the 3rd order Bessel analog filters are ceramic encased.

There are other material differences. Instead of an ordinary laminated E frame, we use a solid ferrite cutlass core power

transformer to cut eddy currents, minimize flux leakage and improve voltage regulation. And instead of ferrous

metals, we use 100% aluminum and zinc chassis construction including a diecast laser head and a precision disc drive mechanism.

### What else does the DA-910 offer?

- Infrared wireless remote control system.
  - Three separate power supplies to allow complete isolation to critical circuits.
  - Direct coupling (audio stages) for excellent low frequency response.
  - Floating horizontal motorized disc loading to further improve stability and accuracy from external feedback.
  - Separate digital to analog conversion for left and right channels.
  - 176.4 KHz quadruple over-sampling technology.
  - Quality digital and improved analog filtering for superior phase distortion performance.
  - Full feature programmable keyboard entry. Even before Kyocera added ceramics, the DA-910 CD player provided remarkable purity. With ceramics, the results are truly astounding. Put it to the test at a selected Kyocera dealer now.
- Kyocera International, Inc., 7 Powder Horn Drive, Warren, New Jersey 07060, (201) 560-0060

**The new Kyocera DA-910 Remote Control Compact Disc Player.**

# Stops vibration in its track.

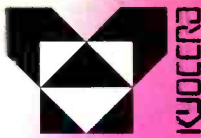

## BETTER SOUND BASED ON CERAMICS.

Enter No. 40 on Reader Service Card



Revox B225

For those who waited.  
And those who wish  
they had.



All Compact Disc players are *not* created equal. This much, at least, has emerged from all the hype and hoopla.

Some CD players are built better than others. Some have more sophisticated programming features. Some are easier to use. And, yes, some *do* sound significantly better than others.

The new B225, from Revox of Switzerland, excels on all counts. For those who have postponed their purchase, patience has been rewarded. For those who didn't wait, the B225 is the logical upgrading route.

First, the B225 is designed for unexcelled CD reproduction. By using oversampling (176.4 kHz) in conjunction with digital filtering, the B225 guarantees optimum sound resolution and true phase response.

For your convenience, the B225 offers programming of nearly every conceivable combination of start, stop, pause, and loop functions, in any sequence, and using mixed combinations of track numbers and times. Cueing time is always less than 3 seconds, and a single infrared remote transmitter (optional) operates the B225 as well as all other components in the Revox 200 audio system.

Finally, the B225 is a product of refined Swiss design and meticulous craftsmanship. Behind its faceplate of functional elegance, you'll find the B225 is an audio component built in quiet defiance of planned obsolescence.

Without question, the definitive CD player has now arrived. For those who waited (and those who didn't), now is the time to see an authorized Revox dealer.

**STUDER REVOX**

1425 Elm Hill Pike, Nashville, TN 37210/(615) 254-5651

The TD-800 is, without a doubt, one of the finest tuner/tape deck combinations ever offered to music-loving drivers.

even when the unit was off, a nice touch; with the tuner on, more LEDs visually locate the preset buttons and show which has been selected. It was too easy, especially in the dark, to confuse the fast-forward and rewind buttons, but indicator LEDs made it clear what the deck was actually doing.

The azimuth control proved its worth when I randomly tested 16 tapes and found their proper azimuth settings ranging from +6 to -11 (including an 8-click variation between sides of one tape). But I probably wouldn't be able to use it much while driving, except with badly misaligned tapes. I also found it useful in rolling off the highs on very hissy tapes, since it works more steeply (Fig. 7A) than the treble control.

On the road, tape performance was exceptional. I heard no flutter on bumpy roads, and the sound was clear and clean, even with metal tapes recorded to their limit.

The real eye-opener was FM performance. According to the specs, the TD-800 should be no match for my reference system's tuner; in practice, the 800 runs rings around it. On the highway, I consistently picked up many more stations, far more clearly, with the Nakamichi. (In one far-fringe location, the TD-800 picked up 14 stations well, 12 stations fairly well, and eight stations poorly, while my reference system got two good, three fair, and three poor ones.) In high-multipath city driving, both units were pretty good; the TD-800's manual mono setting helped more, here, than its manual high-blend control. On AM, the TD-800 picked up very few more stations than my reference unit, but sounded substantially clearer on the strong ones.

Nakamichi may bill the TD-800 as a unique tape player, which it is. But as an FM tuner it is, while not technically unique, still uniquely good. Overall, sound clarity proved to be the unit's major virtue—not just in tape playback (where the azimuth control system had led me to expect it) but in FM and AM as well.

*Ivan Berger*

#### Department of Further Amplification

The Perreaux preamp, tested in our July issue, was in a seriously underbiased condition—0.4 mA instead of the specified 18 mA. This may well have affected the listening tests and possibly several of the measurements. Where and how this underbiasing occurred, neither the maker, the importer nor *Audio's* office staff and reviewer know. Graciously, the importer has offered to take the lumps for the condition of the preamp, since they provided no schematic which would have disclosed the proper level. Not providing details of the circuitry is understandable since many of the Perreaux techniques are proprietary. On the other hand, *Audio* might well have asked about such a peculiar situation in a preamp we otherwise saw as a good attempt at state of the art. Our sample seemed in good working order when tested.

The results of the repeat listening tests and measurements will appear together with some comments about preamp design criteria and testing by Peter Perreaux. Specifically addressed will be the RIAA circuitry, correlation of sonic attributes such as "air," "space," and the stereo stage with square-wave response and phase testing, and, finally, the SM2's grounding techniques and goals.—E.P.

To avoid turntable rumble, hum and howling, stability is all. Steadiness of the needle in the groove—and in the platter rotation.

Kyocera's solution: It starts with ceramics. This unique material provides uncommon stability and isolation of mechanical and electrical feedback. The result is a performance that is virtually free of vibration and resonance.

A rigid ceramic-compound resin forms the subchassis of the PL-701. To further eliminate vibration, this subchassis is suspended by three springs within a sturdy wood base. The base has four adjustable shock-mounted

feet. This dual-isolation foundation supports the platter and arm. For even greater stability and uniform rotation, the platter weighs in at 3.3 lbs. Add an advanced two-motor belt drive system to eliminate motor vibration and you have a turntable that is truly—

**Other features:**

- Straight aluminum tubular low mass tonearm with removable carbon fiber shell.
  - Micro-computer electronic sensing non-friction tonearm control.
  - Stabilizer (.7 lb) with built-in two-speed stroboscope.
  - Wow and flutter of 0.03%.
  - Signal-to-noise ratio of 70 dB (DIN-B)
  - Tinted dust cover and convenient soft-touch front panel controls.
- Performance says it all. Put it to the test at a selected Kyocera dealer now.
- Kyocera International, Inc., 7 Powder Horn Drive, Warren New Jersey 07060, (201) 560 0060

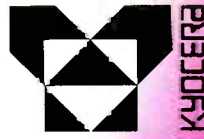

# Steady as a rock.

**The new Kyocera PL-701  
Full Automatic  
Belt Drive Turntable**

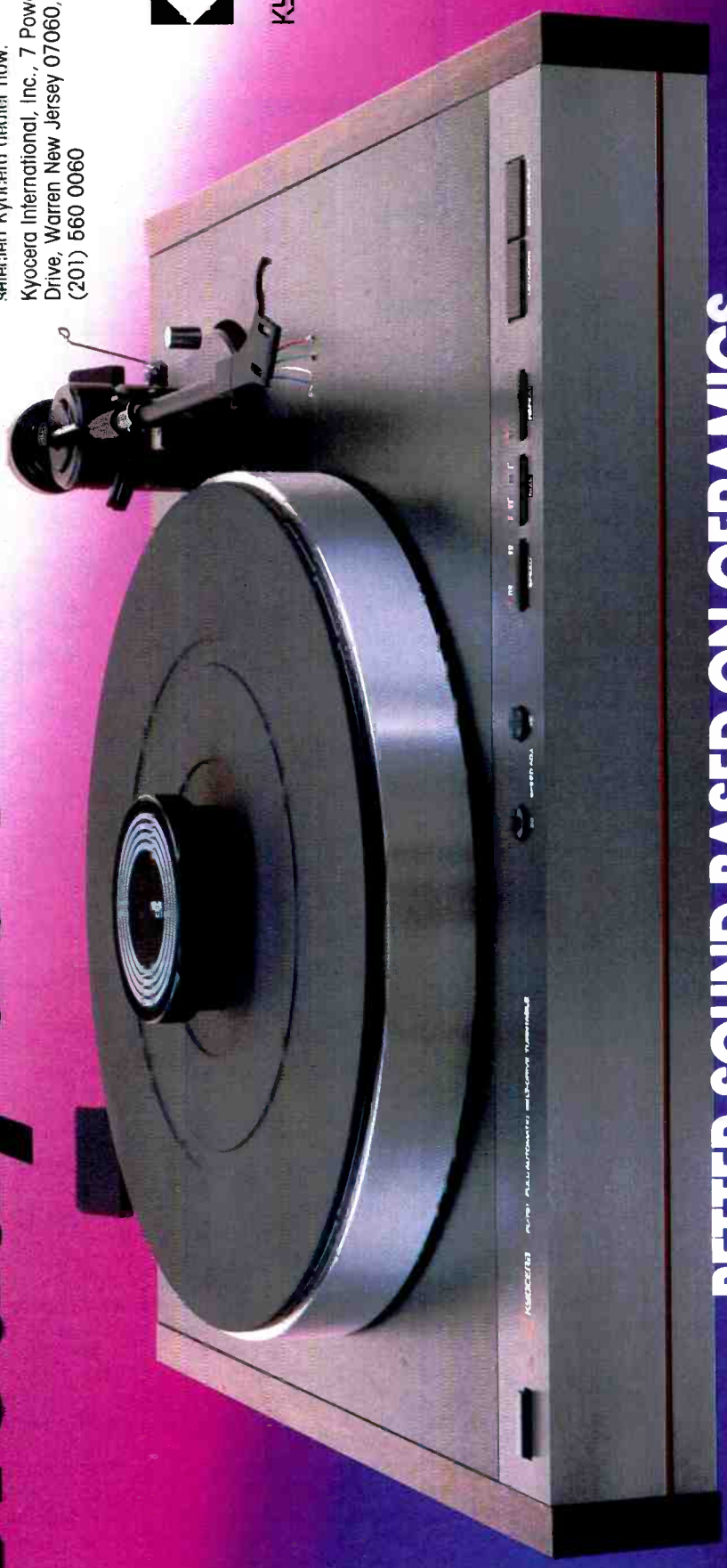

**BETTER SOUND BASED ON CERAMICS.**

Enter No. 41 on Reader Service Card



## 4

## AUDIO-TECHNICA AT160ML CARTRIDGE

### Manufacturer's Specifications

**Type:** Moving magnet.

**Stylus:** MicroLine, nude-mounted, grain-oriented, square diamond.

**Frequency Response:** 5 Hz to 35 kHz.

**Channel Balance:** Within 0.5 dB.

**Separation:** 31 dB at 1 kHz, 21 dB at 10 kHz.

**Recommended Vertical Tracking Force Range:** 0.08 to 1.8 grams.

**Tracking Ability:** 90 microns at center vertical tracking force (VTF), 100 microns at upper VTF.

**Output:** 5 mV at 1 kHz and 5 cm/S.

**Recommended Load Impedance:** 47 kilohms and 100 to 200 pF.

**Vertical Tracking Angle:** 20° (IEC/DIN standard).

**Cartridge Weight:** 8.1 grams.

**Price:** \$275.00.

**Company Address:** 1221 Commerce Dr., Stow, Ohio 44224.

For literature, circle No. 93

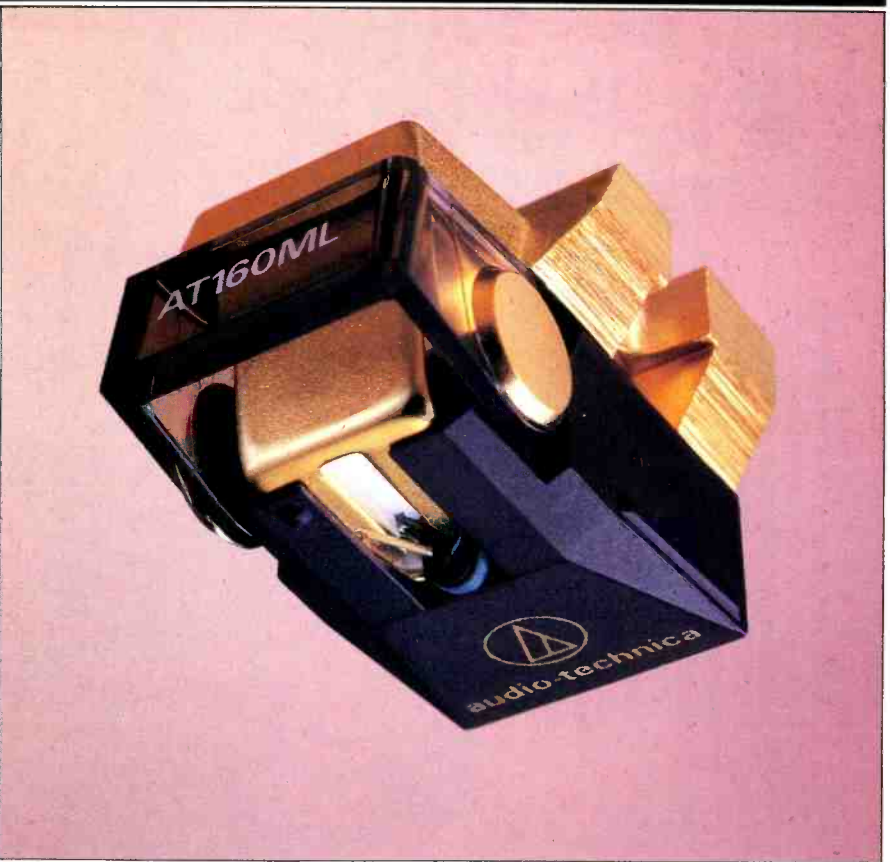

The AT160ML cartridge, introduced in early 1984, succeeds the AT155LC as the top of Audio-Technica's moving-magnet line. While the 155 remains in the line, the 160 sports several important developments—reduced cantilever mass, the new MicroLine stylus shape, and an improved stylus guard. The cartridge comes in an attractive plastic case with a universal headshell and an assortment of accessories. The case itself will display and store two cartridges in universal shells. The case's back can be removed for access to the accessories, which include an overhang gauge, a left/right inclination gauge, two brushes (the usual stylus brush and a special one to reach the recessed contacts in a universal tonearm mount), an Allen wrench for unlocking the headshell azimuth adjuster, a flat-bladed screwdriver, and the usual mounting hardware. All in all, this is an unusually complete and very well thought-out set of accessories, which nicely complements a top-of-the-line phono cartridge.

The AT160ML is one of the first cartridges on the market to use the new MicroLine stylus design (see Fig. 1). To produce this radically new tip shape, the square, grain-aligned diamond stylus is cut away at the edges of the

normal contact area to form a microscopic ridge, which rides at 90° to the record groove. This shape allows more vertical contact than is possible with almost every other design, and only one or two other designs compare in this regard. In addition, since the front and back sides of the ridge are parallel, the shape of the footprint area contacting the record groove wall does not broaden as the stylus tip wears. It also appears likely that discs will be worn at a slower rate, particularly discs which are hard to track because of their high velocities. Further, not only will new records be tracked better, but older discs, ones with moderate amounts of wear confined to specific levels of the groove wall, will be reproduced better. While it might fairly be said that all of these benefits could be claimed by the successively more radical generations of stylus tips, there can only be one "Best Tracking Cartridge" at each point in time. Certainly, Audio-Technica's AT160ML is an extremely strong contender for that crown at present.

The cantilever is 0.3 mm in diameter and, like its predecessor in the AT155LC, it is made of beryllium, one of the lightest and stiffest metals. In the AT160ML, it is gold-plated, as part of an effort to flatten frequency response by control-

The key is Kyocera ceramics technology—a superior new way to virtually eliminate mechanical and electrical vibrations that impede dynamic performance.

It starts with a handsome ceramic-compound resin base (actually the chassis) that supports all components. Because ceramics are rigid and inert, they provide vibration-free stability immune from volume and frequency irregularities. Because ceramics are non-ferrous, there are no eddy currents—so there's no electrical hum. Result: a chassis with practically no mechanical and electrical impurities.

**The new Kyocera A-910 Integrated Amplifier.**

# Pure power without bad vibes.

In addition, fine ceramics encapsulate critical components throughout the circuitry to further isolate vibration. Kyocera also uses a heavy duty cutlass core power transformer to reduce eddy currents, minimize flux leakage and improve voltage regulation.

There are many other features that distinguish this extraordinary integrated amp:

- Rated a full 150 watts per channel into 8 OHMS at 0.02% THD from 20-20,000 HZ.
- New MM/MC equalizer with ultra low noise and input impedance transistors.
- Heavy duty high speed 80 MHz power amplifier design incorporating parallel triple push pull final stages with MOS FET drivers.
- Single stage push pull amplifier circuitry for improved signal to noise ratio and wide band frequency response.

**Kyocera's matching PLL Quartz synthesized AM/FM Stereo T-910 Tuner.**

- Non-ferrous ceramic-compound resin base with adjustable feet.
- Fluorescent digital display (low noise type).
- Dynamic noise reduction circuitry for improved weak signal reception.
- Programmable 16 station pre-selects.
- Narrow or wide IF bandwidth programmable selection.
- Two FM antenna—programmable selected.
- Multiplex decoder with pilot and birdie noise cancelling circuit.

Performance says it all. Put it to the test at a selected Kyocera audio dealer now.

Kyocera International, Inc., 7 Powder Horn Drive, Warren New Jersey 07060, (201) 560-0060

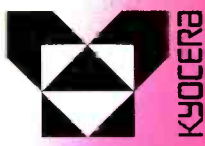

**BETTER SOUND BASED ON CERAMICS.**

Enter No. 42 on Reader Service Card



**The AT160ML's new stylus tip, dubbed the MicroLine, offers better vertical contact with the groove throughout the stylus life.**

ling and reducing resonances. Audio-Technica uses what they term a Vector-Aligned Dual Magnet system, which positions two tiny cylindrical magnets in the shape of a "V" to match the angles of the left and right groove walls on a stereo record. These magnets are arranged between the laminated pole pieces, which are para-toroidally wound to reduce sensitivity to hum. Immediately to the rear of the magnet and pole-piece assembly, and located at the fulcrum, is the radial damping ring, which AT tells us is individually hand-tuned. Such hand-tuning, incidentally, can do a good deal for a cartridge's response. In a cheaply made cartridge, hand-tuning can bring the unit within spec; in high-end cartridges like the AT160ML, hand-tuning will bring the response within very fine tolerance.

**Measurements**

After measuring an inductance of 565 mH and a resistance of 760 ohms, I mounted the AT160ML in the tonearm of the recently introduced AR Turntable and aligned it using Telarc's Omnidisc. The AT160ML weighs 8.1 grams, which is at the heavy end of the range for today's cartridges, and what with the additional weight from screws, nuts, and so forth, I found that the AR's counterweight was not heavy enough to balance the cartridge. I therefore machined an additional mass for the arm and proceeded with the tests.

As is the practice of this magazine's reviewers, measurements are made on both channels to assure accuracy, but only the left channel is reported unless there is significant variation. During the test period, temperature was  $70^{\circ} \pm 2^{\circ}$  and the relative humidity ranged from 50% to 70%. The following records were used in making the measurements reported here: CBS STR-100 and STR-112; JVC TRS-1007;

Deutsches HiFi No. 2, and Shure Brothers TTR-103, TTR-110, TTR-115, and TTR-117.

The tracking force found to be optimum was 1.5 grams, and the anti-skating force was set to 1.8 grams, again the optimum setting. The load resistance was 47 kilohms and the total load capacitance was 200 pF. As one might expect with a relatively heavy cartridge such as this one, the low-frequency arm-cartridge resonance (12-dB rise of 6.5 Hz) was at a lower frequency than one would optimally prefer. This is within the warp-wow frequency region and should be of concern to those who play significant numbers of warped discs. The peak would be lowered by use of a tonearm with a well-engineered decoupled counterweight.

The AT160ML's frequency response (see Fig. 3) was within 1.5 dB from 40 Hz to 20 kHz, using the CBS STR-100 test record. Using the JVC TRS-1007 test record, the channel-to-channel separation at midrange frequencies was a bit over 30 dB, decreasing smoothly to about 23 dB at 10 kHz, and to 15 dB at 20 kHz.

Static vertical compliance was  $42 \times 10^{-6}$  cm/dyne, while dynamic vertical compliance was  $9.2 \times 10^{-6}$  cm/dyne. The lateral compliance was found to be  $8 \times 10^{-6}$  cm/dyne. The vertical tracking angle was found to be approximately  $20^{\circ}$ , using an optical readout system. Output was found to be 5.3 and 5.8 mV (1.50 and 1.64 mV/cm/S) for the left and right channels respectively, for a channel balance within 0.22 dB.

Figure 4 shows the square-wave response as obtained with the CBS STR-112 test record. An expanded scope trace revealed the rise time to be 18  $\mu$ S with the normal load of 47 kilohms and 200 pF. Increasing the capacitive load to 700 pF increased the rise time to 22  $\mu$ S; 700 pF is probably outside any real-world conditions. The cartridge is well damped, showing only one cycle of sonic-region oscillation during square-wave tests, the last half cycle being rather small. This is followed by ultrasonic oscillations at a frequency of about 37 kHz, which are on the test record, probably as a result of cutterhead assembly ringing.

Using the 3.54 cm/S,  $45^{\circ}$ , 1-kHz signals from the CBS STR-100 test record, the total harmonic distortion was found to be 1.3%. IM distortion, using CBS STR-112 (400/4000 Hz, 4-to-1), was: Lateral (+9 dB), left 0.9%, right 1%; vertical (+6 dB), left 1%, right 1.2%.

Tests of tracking ability showed that the AT160ML is outstanding in its ability to handle highly modulated discs. The cartridge easily tracked the highest vertical and horizontal 300-Hz bands of the Deutsches HiFi No. 2 test record. The recorded levels from the correction table are 55.4 microns (0.00554 cm) at 10.32 cm/S at +5.86 dB, and 114 microns (0.0114 cm) at 21.5 cm/S at 12.10 dB, respectively. The cartridge was also able to track the highest (+18 dB) 300-Hz lateral and highest (+12 dB) 300-Hz vertical bands of the CBS STR-112; the +18 dB band approximates the highest levels found on commercial recordings. With Shure's TTR-103, some slight mistracking was evident on the highest level of side 1, band 8, which is composed of 1 and 1.5 kHz, mixed at equal levels and recorded at 40 cm/S peak velocity. The AT160ML successfully tracked this disc's previous band, which was recorded at 31.7 cm/S peak velocity. The cartridge also tracked all bands of Shure's

**Fig. 1—Drawing of a MicroLine stylus. Note how the shape is an attempt to contact the maximum vertical distance of the groove wall.**

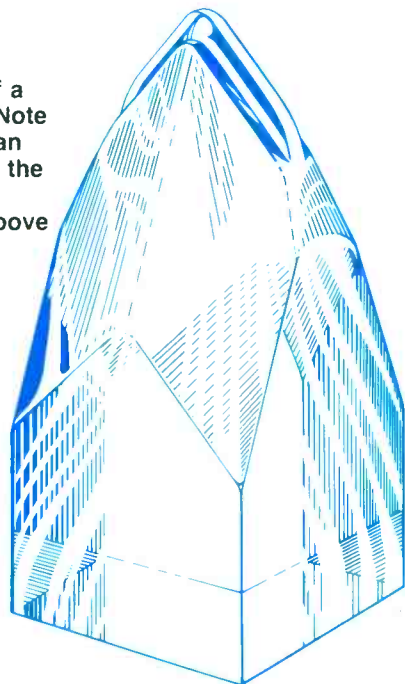

# TO CREATE A BETTER DISC PLAYER, WE TURNED TO A HIGHER INTELLIGENCE.

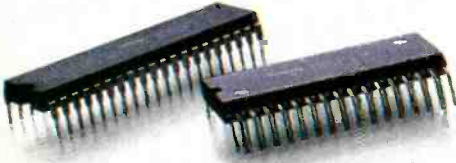

Yamaha's proprietary LSI technology provides audibly superior playback and added programming power.

Introducing the CD-2 compact disc player. And the brains that set it

above all other compact disc players.

We're referring, of course, to our proprietary LSIs (Large Scale Integrated circuits). And the approach they use to process digital signals.

Most CD players convert the digitized signals at a standard sampling rate of 44.1kHz. So they are forced to use a very sharp 50db/octave analog filter to cut off the unwanted frequencies above 20kHz generated by the 44.1kHz carrier signal.

This process creates phase anomalies which degrade the harmonic structure of your music. You hear this as a loss of dimensionality.

So we came up with an intelligent solution. Our YM-2201 LSI. It doubles the sampling rate to 88.2kHz and uses an on-chip digital filter.

This over-sampling eliminates phase distortion and



Cordless infra-red remote control is standard equipment.

maintains the harmonic integrity of your source. With no loss of dimensionality. You can actually hear a more natural, spacious sound from your discs.

A related benefit of our proprietary LSI technology is user convenience. You can choose from three different playback modes. Program the random-access memory system in moments. And search for selections (or individual passages within a selection) at the touch of a button.

You also get wireless infra-red remote control. Our 3-beam laser with LSI-based servo-control for extraordinary tracking accuracy. And a sleek, component-sized package.

What's more, if you don't require the CD-2's random access programming, or a remote, you can enjoy all this sound-improving technology in the CD-X1. At an even lower price. (CD-2, \$599\*; CD-X1, \$499\*)

So visit your Yamaha dealer today. And hear for yourself why our CD-2 is the most intelligent way there is to listen to compact discs.



To match your decor and other components, the CD-2 is available in silver and black (both standard component size).

\*Suggested U.S.A. retail prices



Yamaha Electronics Corporation, USA, P.O. Box 6660, Buena Park, CA 90622





Frequency response was within 1.5 dB from 40 Hz to 20 kHz, while separation was above 30 dB through the midrange frequencies.

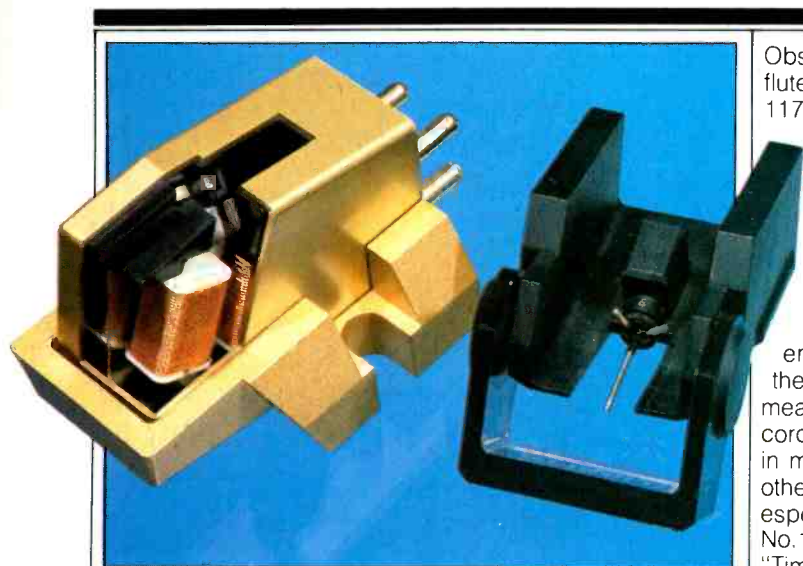

**Fig. 2—**This large-scale model shows how the coils in the AT160ML are arranged.

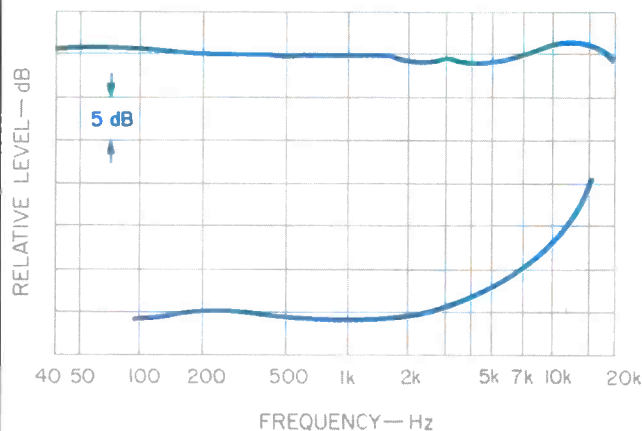

**Fig. 3—**Frequency response from CBS STR-100 and separation from JVC TRS-1007.

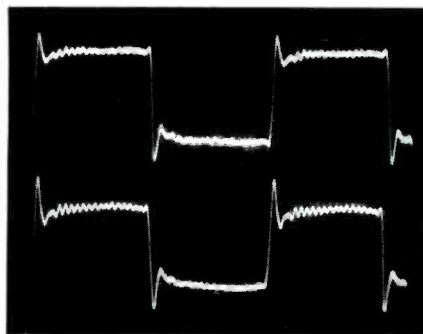

**Fig. 4—**Response to 1-kHz square wave from CBS STR-112.

Obstacle Course Era IV (TTR-115) except for level 5 of the flute and harp test. Shure's Era V Obstacle Course (TTR-117) contains a complex signal composed of 200 Hz, 2.1 kHz, and 17 kHz; all six bands on this disc were tracked without audible mistracking or waveform distortion being visible on the 'scope. An X/Y plot revealed good linearity and phasing between the two channels.

### Use and Listening Tests

The Audio-Technica AT160ML was used to audition several digitally mastered and direct-to-disc recordings, using the same AR Tonearm and AR Turntable with which the measurements are performed. In addition to the three recordings from Delos and the Mobile Fidelity disc mentioned in my March 1984 review of the Micro-Acoustics 630, two other sampler discs were used for auditioning and are to be especially recommended. These are Opus 3's Test Record No. 1, "Depth of Image" (79-00) and Test Record No. 2, "Timbre" (80-00). (Available from Scandinavian Sounds, P.O. Box 3656, San Clemente, Cal. 92672.) These recordings contain superbly recorded music and require no instruments for the evaluation of one's system. (*Editor's Note:* We have been using this disc pair around the office for some months, principally to check loudspeaker voicings as a preliminary to full-scale reviews. Frankly, we're in love with them. They contain virtually every sort of music one might wish—vocal, organ, piano, guitar, violin, both solo and in groups. I can't think of any cut that isn't acoustic, rather than electric, and natural, rather than colored.—E.P.)

As its uniform frequency response would suggest, the AT160ML presented a neutral, unrestrained sound over a wide range of recorded material. This included the broad variety of types presented by the Opus 3 records, particularly the massed choirs, plucked strings, and percussive sounds, such as drums and finger-cymbals. Highs were unrestrained and possessed a sheen, but not to the point of excessive brightness. The midrange was natural, and the bass was solid. With the misshapen discs I use to test for warp-handling ability, a small amount of warp modulation of sustained mid-frequency notes was heard. This check of arm-cartridge interaction with record warp is worst-case testing, since there seldom is a need or desire to play such severely warped discs and a good decoupled tonearm can reduce such modulation to inaudibility.

The imaging of the AT160ML was good. The left-to-right stereo stage was stable, with individual instruments and soloists maintaining their positions. Front-to-back imaging was similarly good, particularly with the Gitarrkvartetten handling of J. S. Bach's "Invention No. 14" on the Opus 3 "Depth of Image" disc.

To sum up, then, the Audio-Technica AT160ML is not an inexpensive cartridge since it lists at \$275, but it is reasonably priced considering its level of performance. One particular appeal will be to those who wish to upgrade to a cartridge possessing one of the newest and best-tracking stylus shapes. The AT160ML is also a cartridge with good linear frequency response, excellent separation, and superior tracking ability. In short, it's a strong contender for state-of-the-art.

*George Shellenberger*

# B & W DIGITAL MONITORS



## LISTEN AND YOU'LL SEE

The new DM110 and DM220 are built to the same exacting standards as the monitors we supply to major digital recording studios throughout the world. They are, happily, much more affordable. At around \$300 for the DM110, and \$500 for the

DM220, you now have a perfect excuse to upgrade your equipment to digital standard.

Ask to hear them soon. Close your eyes and listen. Then you'll see



AS USED BY DIGITAL STUDIOS WORLDWIDE. AND SOON, WE HOPE, BY YOU

Anglo American Audio, P.O. Box 653, Buffalo, NY 14240 416-438-1012

"See Page 112 for your local B & W dealer."

Enter No. 9 on Reader Service Card



## YAMAHA NS-2000 LOUDSPEAKER

**Company Address:** 6600 Orange-  
thorpe Ave., Buena Park, Cal.  
90620.

For literature, circle No. 94

The Yamaha NS-2000 speaker system is definitely a high-end product. It costs \$2,900 per pair, and combines a greatly improved form of the beryllium dome midrange and tweeter technology which Yamaha pioneered in the NS-1000 with a true all-carbon-fiber woofer cone. These drivers are placed in the most solidly built enclosure that I have ever encountered in a box speaker. Each unit weighs 103 pounds, although it measures only  $17\frac{7}{8} \times 29\frac{5}{8} \times 15\frac{7}{8}$  inches.

The main change in the new beryllium drivers is greatly improved dispersion. The 13-inch carbon-fiber woofer is made of formed sheets to allow Yamaha to avoid any blend of the carbon and other materials, and this woofer is said to have very similar sound propagation properties to the beryllium  $3\frac{1}{2}$ -inch midrange dome and  $1\text{-}3/16$ -inch tweeter. All drivers have comparatively high flux and seem to be very well made, indeed.

Careful attention is paid to minimize cabinet and mounting diffraction effects. The crossover is a fairly complex 12 dB/octave system, operating at nominal frequencies of 500 Hz and 6 kHz, and uses good components. Separate level adjustments are provided for the midrange and tweeter.

The cabinet finish is superb, as well as being nonresonant. The speaker does, however, need a custom-made stand to raise its tweeter to ear height. Suitable speaker stands are available from the Chicago Speaker Stand Co. (4701 W. Armitage Ave., Chicago, Ill. 60631) for \$75 and raise the units 8 inches off the ground. The speaker connections are the clip-in types.

The sound of the speaker is highly dependent on adjustment of the midrange and treble controls. I found it excessively bright until the treble control was set below 10 o'clock and the



midrange control below 11 o'clock. It is also essential to keep each speaker about 18 inches from the rear wall and 24 inches from either side wall to get the flattest response in most rooms, as well as to use stands to raise the speaker so the tweeter is ear height. Keeping the backs parallel to the wall seems to provide better imaging and sound-stage depth than a toed-in (drivers pointed toward the listening position) placement.

As is the case with most acoustic-suspension designs, the NS-2000 provides its best bass response and control with the high damping factor and low impedance drive capability of the better transistor amps. For example, the Robertson Forty Ten and Sixty Ten did notably better in controlling the bass than the Conrad-Johnson Premier Four or Audio Research D-160B.

Even with such amplifiers, there is limited deep bass below 50 Hz. The mid- and upper-bass, however, is excellent. The NS-2000 is fast, flat, detailed, and well controlled to any power level a sane listener could desire. This is not an organ buff's speaker, but no drummer, pianist or bass player is likely to criticize its performance. This is saying quite a bit, even given the demanding competition in the NS-2000's price range.

The midrange is equally clean, but not as flat, and there are some slight sonic problems around the crossover frequency of 500 Hz. The NS-2000 lacks its usual coherence at this point. There also is a slight upward tilt in the upper midrange which cannot be eliminated by the midrange or treble controls. The speaker's specifications indicate that this is around 2 kHz, but it sounds slightly higher. The blend between midrange and tweeter is excellent, and considerably better than in most high-end speakers.

The NS-2000s have a musically natural midrange and treble, with a slight tinge of brightness. This is not noticeable on good, well-balanced recordings—in fact, it helps create the impression of "life," that one is sitting near the performance. It can, however, be slightly hard when the material is bright or miked too close. The upper strings and female voice can be particularly revealing in this regard.

The NS-2000s are not the ideal speakers for a phono cartridge with a rising high end or for hard transistor electronics. A flat or slightly downward sloping cartridge is preferable. The speed and detail of the Yamaha NS-2000s make them a good match with tube electronics or those transistor electronics which are detailed and mu-

**HEAR ALL OF THE MUSIC AND NONE OF THE TAPE**



# SWITCH TO BASF CHROME AUDIO TAPE



## THE WORLD'S QUIETEST TAPE

If you won't settle for anything less than pure music, accept nothing less than BASF Pure Chrome audio tape. Unlike ferric oxide tapes, BASF Pure Chrome is made of perfectly shaped chromium dioxide particles. And the exclusive Chrome formulation delivers the lowest background noise of any tape in the world, as well as outstanding sensitivity in the critical high frequency range. And this extraordinary tape is designed especially for the Type II Chrome Bias position. So make sure you're hearing all of the music and none of the tape. Make the switch today to the world's quietest tape. BASF Chrome.



Enter No. 7 on Reader Service Card



# Shift to high performance car audio with the KICKER II™

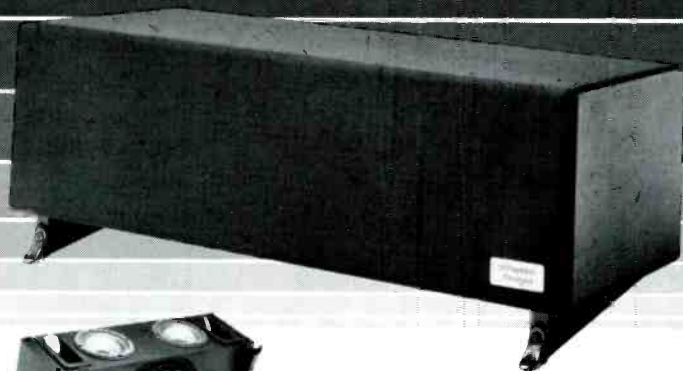

The KICKER II™... massive sound, full of definition and clarity, in a self-contained stereo speaker system designed to fit in the rear of your fastback or hatchback.

- 100 watts/channel maximum amplifier power
- Beautifully-detailed cabinet installs with just two screws.

Available nationwide at better car audio specialists. Suggested list price \$250.00



stillwater  
designs..

Stillwater Designs 1212 South Main Stillwater, OK 74074 (405) 624-0451

Enter No. 33 on Reader Service Card

# Music in the round. With B.E.S. speakers, center stage is everywhere.

The computer-designed diaphragm of every B.E.S. speaker radiates sound in a near-perfect spherical pattern, not in a narrow beam like ordinary cone-and-box speakers.

So wherever you decide to place your B.E.S. speakers—and wherever you sit—the musical image is three-dimensional and lifelike, as in a concert hall.

Suddenly, center stage is wherever you are.

 B.E.S.

Music in the round.™



SM 275

© 1984 by B.E.S., 345 Fischer Street, Costa Mesa, Ca 92626 • (714) 549-3833

Enter No. 8 on Reader Service Card

Yamaha's NS-2000 speakers clearly merit, if not demand, excellent high-end components.

sical, rather than those which are aggressive and bright.

They worked very well with the new Hafler and PS Audio equipment and the "softer" tube electronics—such as the Conrad-Johnson or earlier Audio Research products. You may, therefore, have to make some minor trade-offs between the merits of transistors for the bass and tubes for the mid-range and treble.

Imaging and sound-stage depth are very good, but not excellent. The NS-2000s offer a wide, stable sound stage, good dispersion over a wide range of listening positions, and considerable depth. They do not, however, match the ability of the Quad ESL-63s or Thiel CS-3s to both place an instrument in a precise and stable manner and then give it the harmonic detail or air that make it sound natural.

The Yamaha NS-2000s do, however, have outstanding dynamics and power handling, which helps them provide very good sound with piano and percussive instruments. They outperform the Quads and Thiels in this respect, although the difference between them and the Thiels is limited. Further, the Yamahas are much less sensitive than the Quads and other dipole speakers to rear wall conditions, and this helps eliminate bass anomalies and center-fill problems.

Whether they are the best pair of near-\$3,000 speakers in the world is impossible to answer. They are a definite design success, and a considerable advance over the NS-1000M, which was the first speaker to prove to me that Japan could also make great loudspeakers. The NS-2000s clearly merit, if not demand, excellent high-end components.

Much will depend on your preferred listening position and style. I would describe these speakers as putting you close to the music in a modern hall: They are accurate, detailed, and musically natural, with good staging and the ability to disappear behind the music.

Put it this way: They are good enough, even at their high price, to be worth extended auditioning with the proper matching components. I even felt it was well worth lugging 206 pounds of speakers into my living room. A very good listen!

*Anthony H. Cordesman*

# Experts Experience Superb Sound of Ohm Walsh 4

## Experience the Innovation

"As close to genuine innovation as anything we have seen in this broad class of (dynamic) speakers, is the cylindrical diaphragm devised by the late Lincoln Walsh (1903-1971). It resembles a megaphone standing on its wide end—a huge inverted ice cream cone, if you will—with the voice-coil perched at the apex.

Why this design? For one thing, it produces uniform power dispersion omnidirectionally, a technique that is credited with achieving excellent phase linearity and sonic 'coherence,' contributing both to clarity and to a good stereo image."

— Norman Eisenberg, *Ovation*

"Ohm claims that the Walsh driver does not operate as a piston—the usual design goal for a conventional speaker—but rather as a transmission line that progressively delays the propagation of different frequencies so that a coherent cylindrical sound field is radiated. Some years ago, when we tested the original, Ohm F speakers, we were able to verify that claim to our satisfaction. Although the Walsh 4 is a modified form of that system, it retains many of its qualities, with the added advantages of a reasonably high sensitivity, non-critical room placement, and a much lower price."

— Julian Hirsch, *Stereo Review*



with apparent ease even the most hair-raising sonic peaks contained on the new laser disks."

— Hans Fantel, *The New York Times*

## Experience the Sound

"Listening to a pair of (Walsh) 4s reproducing music is the real clincher. You are hardly into a recording before you sense that you are listening to a performance rather than to one being reproduced by machinery. This impression—which one may get from a few other top-quality speakers—does not lessen with prolonged listening. The full musical spectrum is easily spanned with authority and fine tonal balance. Detailing of inner instrumental choirs is excellent, and so too are the fuller splashes of massed ensemble effects. Titanic dynamic impact comes across when required, yet there there is no tonal dropout of the subtle nuances of chamber music. Transients come across properly crisp and forceful, but not 'over-etched' to the point of unnaturalness."

— Norman Eisenberg, *Ovation*

"The Ohm Walsh 4 is as smooth and natural sounding as its excellent frequency-response measurement suggests. It provides a full stereo stage of sound at almost any position in the room, including a distinct quality of depth resulting (presumably) from sound reflections off the rear and side walls.

Ohm makes much of the imaging qualities of this speaker, and it certainly lives up to those claims. A demo record produced by Ohm provides convincing evidence that the Walsh 4, playing a variety of commercial music recordings, is capable of generating distinct spatial images that are apparent from almost any position in the room. For example, Leroy Anderson's musical typewriter moves with the impressive smoothness between the speakers, with not a trace of the vague, uncertain, or erratic position shifts that we observed with some other speakers.

In case I have not made the point sufficiently clear, this is a superb-sounding speaker—not inexpensive by any means, but worth every cent of its price.

— Julian Hirsch, *Stereo Review*

## Experience the Power

"(Ohm) has now at last gone all the way with the new Ohm Walsh 4, which boasts all the notable virtues of the earlier model but extends the bass to 32 Hertz. This allows it to conjure up with almost tactile impact the deep shudder of a low C played on an organ pedal or the wallop of a bass drum. With a stupendous power capacity of 500 watts, the Ohm Walsh 4 accommodates

For information on Ohm Walsh speakers, and details on how you can buy directly from Ohm, write or call toll free, today.

1 (800) 221-6984

241 Taaffe Place, Dept. A9  
Brooklyn, New York 11205

**Ohm Acoustics Corp.**

We make loudspeakers correctly.



Specifications	Ohm Walsh 1	Ohm Walsh 2	Ohm Walsh 4
Frequency Response	48 Hz to 18kHz ±4dB	45Hz to 16kHz ± 4dB	32Hz to 17kHz ± 4dB
Weight	24 lbs.	29 lbs.	63 lbs.
Sensitivity	87dB at 1 meter with a 2.83 volt input	87dB at 1 meter with a 2.83 volt input and all controls at maximum	87dB at 1 meter with a 2.83 volt input and all controls at maximum
Finish	Genuine walnut veneer	Genuine wood veneer, walnut and oak standard. Scandinavian rosewood and black or white lacquer on oak finishes available on special order.	Genuine wood veneer, walnut and oak Scandinavian rosewood and black or white lacquer on oak finishes available on special order.
Inputs	Press connectors accepting "banana plugs" or bare wire up to 12 gauge	Press connectors accepting "banana plugs" or bare wire up to 12 gauge	Press connectors accepting "banana plugs" or bare wire up to 12 gauge
Controls	None	2 — low and high frequency each with 3 positions	3 — low, high and perspective each with 3 positions
Power requirement on Music	20 watts minimum/90 watts maximum	30 watts minimum/120 watts maximum	50 watts minimum/500 watts maximum
Impedance	8 ohms	4 ohms	8 ohms
Price per Pair	Under \$595	Under \$995 Depending on finish	Under \$1895 Depending on finish



# ROCK/POP RECORDINGS

MICHAEL TEARSON  
JON & SALLY TIVEN

## FIRE THE BOSS

**Born in the U.S.A.:** Bruce Springsteen and the E-Street Band  
**Columbia QC38653.**

Sound: B— Performance: C

Bruce Springsteen has come to the point in his career most artists eventually reach, and his coming to grips with his situation has produced a simply mediocre piece of work. Most of those idols Springsteen revered have either passed on or have been dwarfed by Bruce's fame. Bruce is alone on his mountaintop, seemingly flanked only by yes-men, stacks of records, and the E-Street Band. Unfortunately, Mr. Springsteen isn't exactly the deepest of thinkers and, having shed most of his influences, his recent introspections result in an album of relatively little consequence.

From the title track—yet another rewrite of "Cadillac Ranch" with an additional debt to Keith Richards—to the pseudo-moderne synths of the single "Dancing in the Dark," Springsteen shows himself to be anything but The Boss. His bravado of old is replaced by a desperation without reason, a nostalgia that reads more like a reactionary streak than common sense. The Great White Hope of '70s rock has become a has-been. In refusing to move forward with musical trends, Bruce Springsteen displays an alienation from his first love—the world of rock 'n' roll.

Some of this is due to Springsteen's own mid-career crisis. How long can you go on singing about cars, girls, the road, the night, and the glories of rock 'n' roll once you pass 30? But no, Bruce's shrine is his record collection, and there are no greater glories than to try to rekindle some quasi Woody Guthrie "We Are the Common People" stance. The record sounds pompous, as if it *should* mean something, but, upon close inspection, it resembles warmed-over Meatloaf. The new Bob Dylan has turned into the New Elvis—flanked by his impenetrable Jersey Mafia, and no signals get through that aren't specially groomed. These tracks were originally intended for release before *Nebraska*—an album of infinitely more power and honesty than *Born in the U.S.A.*—and it's easy to see why

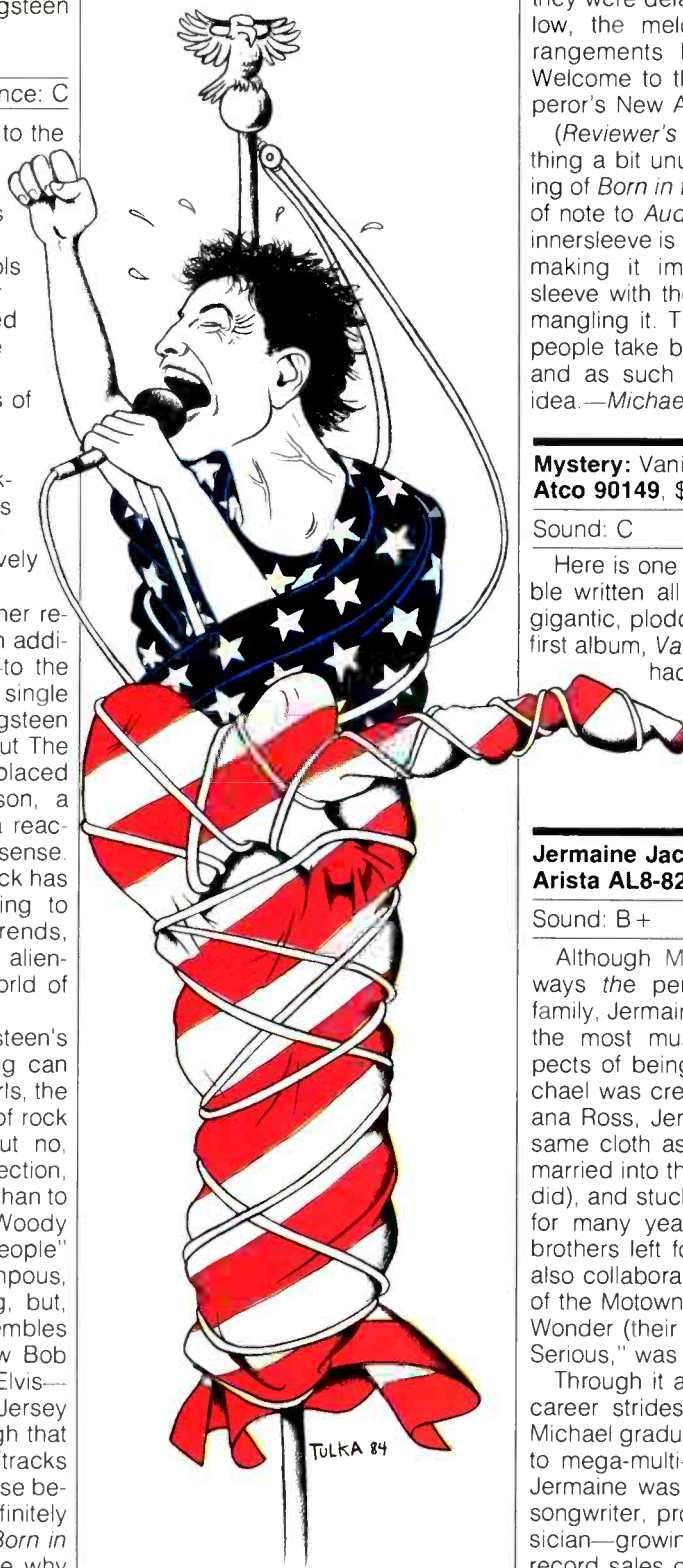

Illustration: Rick Tulka

they were delayed. The words are hollow, the melodies retreads, the arrangements border on self-parody. Welcome to the unveiling of The Emperor's New Album. *Jon & Sally Tiven*

(*Reviewer's Note:* There is something a bit unusual about the packaging of *Born in the U.S.A.* which may be of note to *Audio* readers. The album's innersleeve is 1/4-inch wider than usual, making it impossible to insert the sleeve with the open side out without mangling it. This may well help some people take better care of the album, and as such it is a fine, off-the-wall idea.—*Michael Tearson*)

**Mystery:** Vanilla Fudge  
**Atco 90149, \$8.98.**

Sound: C Performance: D—

Here is one reunion that has inevitably written all over it. *Mystery* is one gigantic, plodding turkey. So was their first album, *Vanilla Fudge*, but that one had the innocence of youth going for it. As a wise man sang, "The original is still the greatest."  
*Michael Tearson*

**Jermaine Jackson**  
**Arista AL8-8203, \$8.98.**

Sound: B+ Performance: B+

Although Michael Jackson was always *the* performer in the Jackson family, Jermaine embodied the spirit of the most musically adventurous aspects of being a Motown artist. If Michael was created in the image of Diana Ross, Jermaine was cut from the same cloth as Marvin Gaye. He even married into the Gordy clan (as Marvin did), and stuck with the Motown family for many years after the rest of his brothers left for greener pastures. He also collaborated with many members of the Motown stable, including Stevie Wonder (their joint venture, "Let's Get Serious," was quite compelling).

Through it all Jermaine made minor career strides while younger brother Michael graduated from platinum sales to mega-multi-platinum. All the while, Jermaine was learning his trade as a songwriter, producer, singer, and musician—growing as an artist even if his record sales didn't reflect it. When he

# Sherwood announces the latest thing in second generation CD audio technology: Affordability



The compact disc just may be the most heart-stopping concept in sound since stereo. But the most heart-stopping feature of compact disc players has been their price. Now, with Sherwood's new CDP-100, you can relax about money and really get excited about sound.

#### **A tradition of affordable excellence.**

Sherwood is well-known for high-quality audio products at affordable prices. And our new CD player is no exception. While others were still on first generation models, we combined advanced second-generation performance with a no-nonsense array of useful, features. And we did it in a way that not only makes sense, but saves you dollars as well.

**Three laser beams for better tracking.** Most CD players use only one laser beam. Sherwood put a **three-beam** laser into the CDP-100, because a three-beam system virtually eliminates distortion caused by spurious data from adjacent tracks.

#### **Two filters, not one.**

All CD's require filters, because the decoding of digital

sound generates a sampling frequency which must be filtered out, or distortions will be heard.

Other CD players use one very steep analog filter; this can cause phase distortion. Sherwood's answer is to use a digital filter to double the sampling frequency, then use a more gentle type of analog filter for reduced phase distortion. The result: better sound at less cost.

#### **Easy-to-use functional controls.**

Inserting a disc is easy, thanks to a "smart" motorized drawer under microprocessor operation. (It even knows if you accidentally put the disc in upside down.)

You can easily access any selection, and there's a two-speed fast forward and backward, so you can listen while you quickly locate the spot you want to hear. You can even set the CDP-100 to repeat the entire disc for continuous music.

Find out how advanced, easy to use, and affordable Sherwood's new CDP-100 really is at your nearest Sherwood dealer. To find him, call (800) 841-1412 during west coast business hours.



# Sherwood

**Quality and Innovation You Can Afford**

17107 Kingsview Avenue, Carson, CA 90746. In Canada: The Pringle Group, Don Mills, Ontario

Enter No. 27 on Reader Service Card



Jermaine Jackson



All in all, a very impressive album from a very talented man. Jermaine Jackson will obviously grow more as a writer in the future.

finally cut his ties with Motown, his bid for stellar sales was this record which, in many ways, is the culmination of his woodshedding. Jermaine produced most of it (with help from Michael Omartian and arranger Michael Sembello), wrote little of it, and sang his arse off on it. Although it seems to have been created in a spirit-of-*Thriller* atmosphere, Jermaine manages to come off as his own man. His debt to Marvin as a singer is acknowledged in the liner notes and in the grooves as well—the cool timbre and attack ring that familiar emotional bell. The songs and production style aren't quite as personalized as the vocalizing—Jermaine is aiming at a wider audience than was Mr. Gaye—but he knows well that one needs several "Ain't Nothing Like the Real Thing's" to legitimize his *What's Goin' On*. His album is humbler than *Thriller*, but its high moments (such as "Dynamite" and "Tell Me I'm Not Dreaming") easily equal anything on *Thriller*. And brother Michael's duet with Jermaine is more adventurous, phrasing-wise, than one would expect. All in all, a very impressive album from a very talented man. Jermaine will obviously grow more as a writer and auteur in the future, and his approach can only improve as he takes a firmer grip on his artistic direction.

Jon & Sally Tiven

**24 Original Classics:** The Everly Brothers  
**Arista AL9-8207**, two-record set, \$9.98.

**24 Original Classics:** Dion and The Belmonts  
**Arista AL9-8206**, two-record set, \$9.98.

Sound: C+ Performance: A

Both of these sets are "best of" collections, gathered from the full span of two illustrious careers, and include selections from all of the record companies the artists recorded for. It's the

first time either artist has enjoyed such complete coverage. Both sets do what retrospectives are supposed to do and so often don't: They cover the whole range of an artist's career and give it perspective.

The Everly Brothers are an act I hold especially dear, and their collection is

Dion

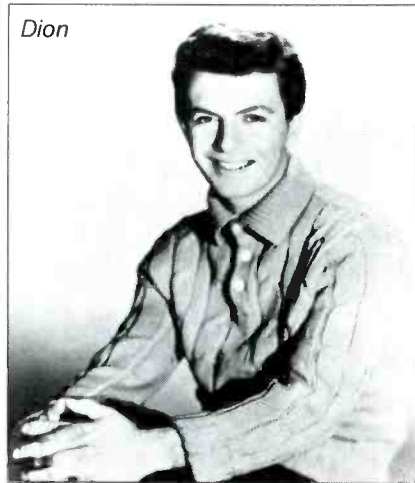

as good as anyone could hope for. Sides one and two cover the brilliant early years on Cadence, while three and four cover the Warner Bros. years with one early 1970s RCA track. From the raw energy of youth to the recorded polish of accomplished studio work, *24 Original Classics* shows the full range of Don and Phil Everly, from rockers through some of the most sublime ballads ever. It is all here.

The Dion set is similar in execution with two sides covering the early years on Laurie, 1958 to 1963. These include the Dion and The Belmonts hits, Dion's subsequent solo successes plus The Belmonts' 1961 hit, "Tell Me Why." Side three covers Dion's tenure at Columbia, where Mitchell Cohen's notes point out he was handled as poorly and inappropriately as Aretha Franklin was at the same time and by the same label. Side four begins with Dion's 1968 comeback smash, "Abraham, Martin and John" and its wonderful flip side, "Daddy Rollin' (In Your Arms)," and continues through his Warner Bros. years, concluding with a track licensed from Lifesong.

Sound on both sets is surprisingly good on the early songs with little noise and unexpected clarity that wavers only on the Columbia side of

the Dion set. The Everly Brothers' Cadence material receives its best reproduction in several reissue attempts.

To say I prefer the Everly Brothers collection only reveals my own preferences. Both acts are important ones in the history of rock 'n' roll, and each deserves this attention. Your favorite song by The Everly Brothers or Dion is almost certainly included as well as some excellent stuff you may have forgotten or never knew before.

Michael Tearson

**Going for Broke:** Eddy Grant  
**Portrait FR 39261.**

Sound: B Performance: B+

After the 1983 breakaway summer success of "Electric Avenue" from his *Killer on the Rampage* album, Eddy Grant is back with more music ideal for warm weather. Standouts on *Going for Broke* include "Boys in the Street," "Telepathy," and "Romancing the Stone," which was omitted from the

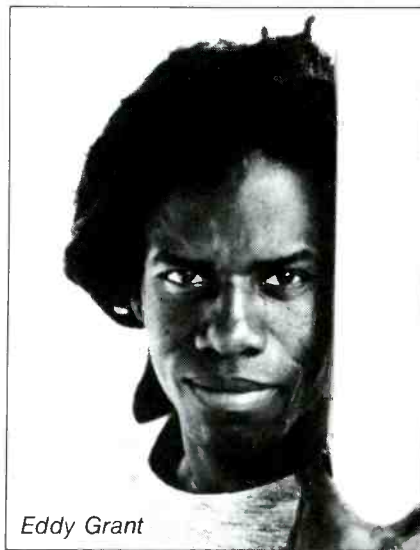

soundtrack of the hit movie at the last possible moment before release. Each side includes a slow song to help the pacing.

Eddy plays all of the instruments except the horns, but the album feels much livelier than your usual one-man band. Part of the "why" is that Grant uses only a little synthetic percussion so that a true "live" feeling is still there. *Going for Broke* is a good solid album.

Michael Tearson



**Sansui's all new Intelligent Super Compo system with compact disc player.**

It's pure digital dynamite! Sansui's IS-110 Intelligent Super Compo system is the ultimate in musical magnificence.

Never has a Hi-Fi system been more convenient to use and more appealing to the ear. That's because here at Sansui we've never lost our touch for uncomplicated pleasure or uncompromising sound.

It's all made possible by ingenious micro-computer circuits that permit each separate component of a unit to operate interactively with each other. With Sansui's exclusive Compu-Select One-touch Simul-switching, you can go from turntable-to tape deck-to compact disc at the touch of a single button. And with exclusive Compu-Edit you can make perfect cassette recordings from your records.

But what's magic to your fingers without magic to your

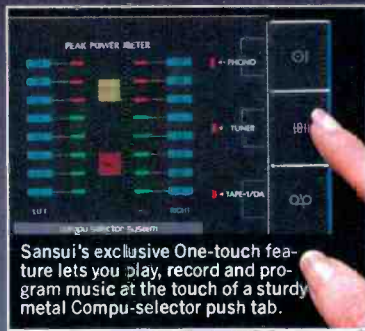

Sansui's exclusive One-touch feature lets you play, record and program music at the touch of a sturdy metal Compu-selector push tab.

ears? Our easy-to-use compact digital disc player gives you a clarity of sound that brings music all the way to life. It offers you a new world of solid musical purity that never diminishes—even after thousands of plays. And consistent ultra-fidelity sound is assured by Sansui's exclusive 3-beam semiconductor laser and digital filter.

You can select a beautifully matched Sansui Intelligent Super Compo system with unmatched sound. Or create your own from a fantastic selection of intelligently designed turntables—with the latest in P-mount cartridge mounting capabilities; tuners; integrated amplifiers; cassette decks—several with Dolby "C" noise reduction; equalizers; and sensational sounding speakers.

No matter what you choose, it will be the most intelligent choice you can make for pure sound quality and convenience. So see your nearest Sansui dealer today.

SANSUI ELECTRONICS CORPORATION, Lyndhurst, NJ 07071  
Carson, CA 90746; Sansui Electric Co., Ltd., Tokyo, Japan

# SOUNDSATIONAL.



*Putting More Pleasure in Sound.*

\*Dolby is a registered trademark of Dolby Laboratories, Inc.

Enter No. 25 on Reader Service Card



## WIZARD AT SUNSET AND VINE

**Growing Up In Hollywood Town:** Amanda McBroom and Lincoln Mayorga.

Sheffield Lab CD-13.

**West of Oz:** Amanda McBroom and Lincoln Mayorga.

Sheffield Lab CD-15.

As virtually every audiophile knows, in 1970 Sheffield Lab resurrected an old technique, direct-to-disc recording. By combining this with the sophisticated devices of modern disc-cutting technology, Sheffield created a recording medium of the highest fidelity. Using a brilliantly conceived microphone setup with proprietary tube microphones, their first direct-to-disc recording, *Lincoln Mayorga and Distinguished Colleagues*, was a sonic blockbuster that became an instant hit as a demonstration disc.

In the intervening years, Sheffield has built up a small, but very impressive catalog of direct-to-disc recordings and a well-deserved international reputation for sound of the highest fidelity. Sheffield's co-owners, Doug Sax and Lincoln Mayorga, have steadfastly continued to record in the direct-to-disc medium, but in virtually all of their recordings, they have been wise enough to record two-channel, stereo analog tape reference masters at the same time. In the last few years, some of their productions have been recorded digitally as well. The use of digital recording by Sheffield Lab may seem surprising in view of the fact that Doug Sax has become one of the most outspoken critics of digital recording. (See the interview with him in the January, 1984 issue of *Audio*.) Whatever his antipathy to digital recording, you can be sure Doug felt it was prudent to make digital reference recordings as a hedge towards future developments.

Needless to say, the analog and digital tape masters that he had made were a great asset with the advent of the Compact Digital Disc. No matter what reservations Doug might have about CDs, he could hardly have been expected to ignore their strictly business aspects. With the superior sound of his Sheffield Lab recordings, it was an obvious move for them to produce Compact Discs. By the time you read this, 11 Sheffield Lab recordings will have been issued on Compact Disc.

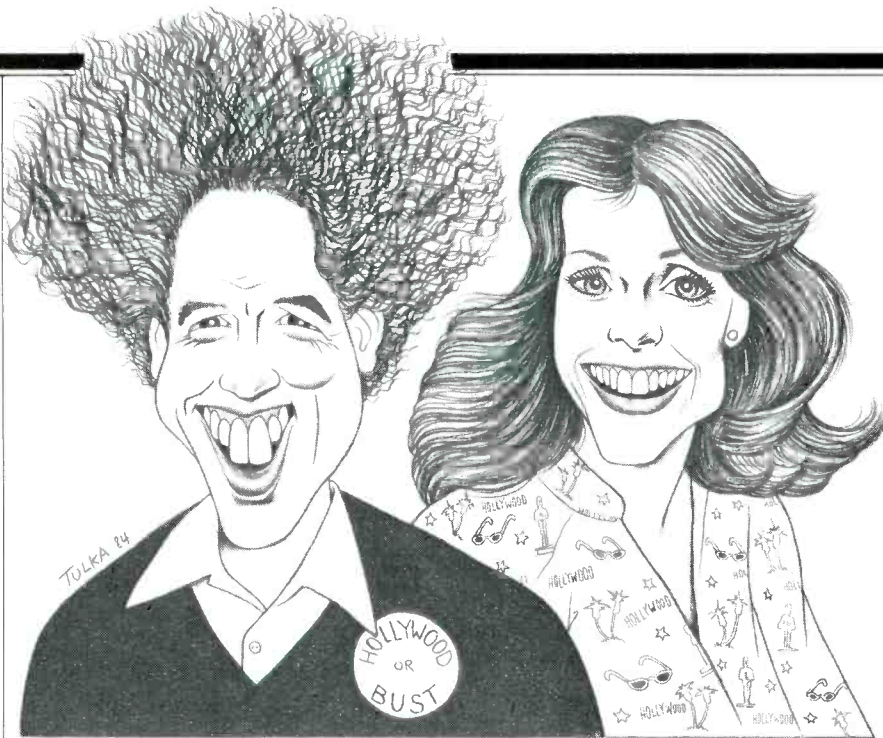

Illustration: Rick Tuika

I received advance CDs of *Growing Up in Hollywood Town*, and *West of Oz*, featuring one of Sheffield's most famous artists, the multi-talented Amanda McBroom. In the direct-to-disc format, both of these recordings are much favored by audiophiles for demonstration and test purposes. This is especially true of the "Amanda" cut on the *Growing Up* album, where there are interesting percussion effects including two bass drum thwacks of great impact and very heavy Fender and synthesizer bass.

I want to state straight away that these first Sheffield Lab Compact Discs are superb, and among the best I have heard thus far.

I was most interested in making a comparison between the original direct-to-disc recordings and their CD counterparts. The *Growing Up In Hollywood Town* CD was derived from an analog master tape and had the obvious advantages of noiseless surfaces. The lovely, clear, clean voice of Amanda McBroom was beautifully reproduced from the CD and the direct-to-disc recording. Technically, there was little to choose between them. In fact, the CD and the direct-to-disc album sounded remarkably similar. However, careful auditioning did show points of superiority in the sound of the direct-to-disc recording. The transient attack on

piano, cymbals, guitars and drums was much sharper, faster, and more cleanly delineated than on the CD. The aforementioned big bass drum thwacks in the "Amanda" cut had a decidedly lower extension in bass response and more impact. This is understandable since a good, properly adjusted Neumann or Ortofon cutter-head has better low-frequency response than a typical analog tape machine.

When the *West of Oz* album was recorded direct-to-disc, the simultaneous reference tape was digitally recorded. In this case, the sound of the CD and the direct-to-disc recording are almost identical. In matters of transient attack, the digital sound of the CD and the DD album are equally matched. In terms of bass response, a digital recorder can equal or surpass the performance of a disc cutter-head. Thus, the bass response of the CD and DD recording is just about equal. As for the attenuation of reverberant information, which some people allege is a fault of the digital recording process, at least in this particular comparison, I could not perceive any difference. Just as a point of reference, I used both a Magnavox CD100 player (as a representative player of the European oversampling decoding technique) and a Technics SL-P10 player (typical of

# THIS MONTH'S BIG EVENTS ON CBS COMPACT DISCS.



## SEPTEMBER

**MILES DAVIS**  
DECOY

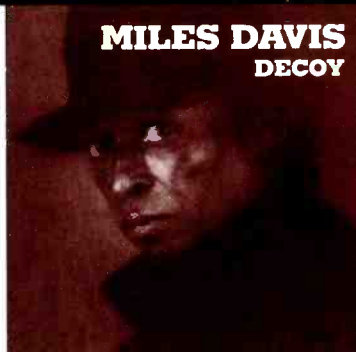

**BRASS IN BERLIN**  
CANADIAN BRASS & BERLIN  
PHILHARMONIC BRASS  
Bach, Pachelbel, Gabrieli, Albinoni



**SCANDAL**  
FEATURING PATTY SMYTH

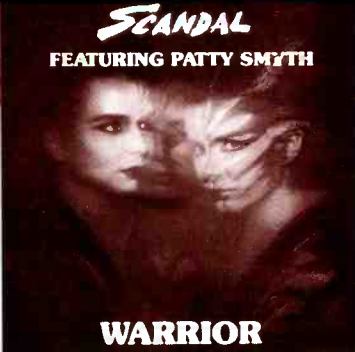

**7**

**WARRIOR**

**11**

**NENA**



99 LUFTBALLONS

**13**

**14**

**RAMPAL**  
J. S. BACH  
THREE FLUTE CONCERTOS  
Sinfonia from Cantata No. 209  
ARS REDIVIVA OF PRAGUE  
MUNCLINGER



**19**

**JUST RELEASED!**

THE PSYCHEDELIC FURS "Mirror Moves"  
ELVIS COSTELLO "My Aim Is True"  
THE DAVE BRUBECK QUARTET "Time Out"  
HEART "Passionworks"  
MOZART: Piano Conc. No. 26 "Coronation";  
Rondos / Perchia; English Chamber Orch.  
HAYDN: Three Favorite Concertos  
Yo-Yo Ma; Wynton Marsalis; Cho-Liang Lin

**BRUCE  
SPRINGSTEEN**  
BORN  
IN THE U.S.A.

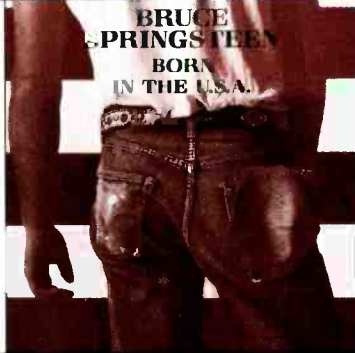

**21**

Enjoy today's revolution in sound with CBS Compact Discs. Our rapidly-growing catalog features over 160 titles by superstar artists in all categories of music. Ask for a free copy wherever Compact Discs are sold.

COMPACT  
disc  
DIGITAL AUDIO

"CBS" is a trademark of CBS Inc. © 1984 CBS Inc.

Enter No. 11 on Reader Service Card



# Virtuoso

## THE NEW AIWA AD-F990 3-HEAD CASSETTE DECK: PERFORMANCE READY FOR THE DIGITAL AGE.

At Aiwa, we believe being the best means taking the lead, not following. That's why our engineers developed the AD-F990: the first fully automated cassette deck designed to meet the demands of the compact digital disc.

### 20-21000Hz FLAT

### FREQUENCY RESPONSE!

Listen to the AD-F990 and you'll be stunned. Dolby HX Professional and Aiwa's exclusive amorphous combination head have extended performance parameters so far that the AD-F990 can faithfully reproduce digitally recorded programs without compromise...or effort.

### A TRIUMPH IN HUMAN

### ENGINEERING

To perfectly integrate man and machine, the Aiwa AD-F990 presents its controls on a unique "keyboard." That's new! So is our Auto Record Level Control, Auto NR Detector, Auto Demagnetizing, Auto Tape Selector, Digital Time Remaining Display that shows all tape operation modes, and a fluorescent display for all functions.

The Aiwa AD-F990: the top of our new line of "digital-ready" cassette decks. The sound of the future, today.

**AIWA**  
SIMPLY ADVANCED



Enter No. 2 on Reader Service Card

AIWA AMERICA INC., 35 Oxford Drive, Moonachie, New Jersey 07074. In Canada, Shriro (Canada) Ltd.

The recordings on this Dylan CD are flat and characterless, with little or no sense of depth. The instruments tend to lose their individuality.



Japanese 16-bit, linear decoding). For playback of the direct-to-disc recordings, I used a Sota Star Sapphire vacuum turntable with Sumiko's "The Arm," the really excellent Alpha I phono cartridge, and the superb, but much more expensive, Kiseki Agaat Ruby phono cartridge.

Viewing these Sheffield Lab CDs strictly on their own merits, they are both a sonic and musical delight. Amanda McBroom is a remarkable performer. The beautiful quality of her voice is aided by her great projection, deft delivery, sense of timing and masterful phrasing. She is also well represented as a composer on these two CDs. On *Growing Up In Hollywood Town*, she very expressively sings the plaintive and poignant "The Portrait"; her most famous piece, "The Rose," and the audiophile's delight, "Amanda." On *West of Oz* she sings the up-tempo "Not Gonna Say I'm Sorry" and the saucy and impudent, "Reynosa." She is equally effective in other composer's songs, whether the mood be rock 'em-sock 'em, or tender and lyrical. We must not forget Lincoln Mayorga's fine piano contributions and orchestral arrangements here.

The utterly clean, dynamically exciting sounds we have come to expect from Sheffield Lab recordings has been most successfully transferred to these CDs.

When I engineered the direct-to-disc recordings of classical music for Crystal Clear, I also recorded analog or digital, and, in some cases, made both types of reference tapes. I can only hope that if these recordings are eventually transferred to CD, they will fare as well as these fine examples from Sheffield Lab. *Bert Whyte*

#### **Bob Dylan's Greatest Hits CBS CK 9463.**

The digital medium can do just so much to improve upon older analog recordings. The digitalized version of *Bob Dylan's Greatest Hits* only serves to point up the shortcomings of the technology applied to these recordings back in the '60s.

Although the musical material here is treasurable both for its entertainment value and for its place in the history of modern popular music, the recordings

themselves are flat and characterless.

They have little or no sense of depth, and in the few cases where instruments are massed in any number, they tend to lose their individuality. This is most noticeable in the classic "Subterranean Homesick Blues," in which Dylan's snappy vocal compendium of social ills and foibles careens headlong over a great marsh of sound from which occasionally emerges his clean spunky harmonica or a clear electric guitar riff. Keep in mind, this is not a complaint about the arrangement—a jangly, energetic flight of early electric Dylan which would be grand to hear decently reproduced exactly as it was played in 1965.

Much of this album is early acoustic Dylan, the Hibbing minstrel, his guitar and harmonica captured flat and unaccompanied on tape. Some of the tape hiss has been cleaned up (although some is still audible, as on "Blowin' in the Wind"), and it is good to have a CD of this stuff instead of the beaten-up, candle-wax marred vinyl grooves many of us have been hauling around in our collection since our folkie days.

I have a few complaints about the packaging, though. These are indeed some of Bob Dylan's greatest hits, but this collection is by no means comprehensive. Originally put together way back in 1967, this album represents only his acoustic folk period ("Blowin' in the Wind," "It Ain't Me Babe") and his early transition into folk-rock ("Mr. Tambourine Man") and electric instrumentation ("Subterranean Homesick Blues," "Like a Rolling Stone"). The front-cover art, picked up from the analog disc jacket, mis-sequences a few of the cuts. CBS might have taken the time to correct this ancient error. CBS also chose to provide zilch in the recording information department. Even minimal information on which album each selection was taken from and the year of each song's original recording have been neglected. Of course, there is no indication of the musicians and producers involved either. This is pretty sloppy packaging, and it insures that the *Bob Dylan's Greatest Hits* CD

is for the hard-core Dylan fan or pop historian cum collector only.

*Paulette Weiss*

#### **Tchaikovsky: Symphony No. 4.** The Cleveland Orchestra, Lorin Maazel. Telarc CD-80047.

Lorin Maazel made recordings of the six Tchaikovsky symphonies with the Vienna Philharmonic Orchestra for London/Decca some years ago that established him as one of the premier interpreters of Tchaikovsky's music.

His reading of Tchaikovsky's Fourth Symphony, on this Telarc CD, reveals little change from his London recordings. Tempos are a shade faster, and the boisterous finale is even more brilliant and exciting. Otherwise, his performance is as refined and neatly structured as before, including his very lyrical second movement. The Vienna Philharmonic had a somewhat warmer sound than the Cleveland Orchestra has here, but the Clevelanders excel in their precision and execution in ensemble playing. Their superiority is clearly evident in the way they traverse the difficulties of the pizzicato section in the third movement.

Recorded in Masonic Auditorium in Cleveland, Telarc has given us a full-bodied, highly detailed sound with warmly spacious acoustics. A good sense of depth is apparent, as are excellent inner balances. The frequent trumpet fanfares and answering French horn fanfares of the first and fourth movements are particularly brilliant and well projected. String tone is



John Williams gives a virtuoso performance. The overall sound is clean but marred by wiry strings and an over-isolated guitar.



John Williams

smooth. The explosive opening of the fourth movement shows off the power and impact of the bass drum. In the opinion of many, this is one of Telarc's best recordings. I would have to concur.

*Bert Whyte*

**The World of the Harp.** Susann McDonald playing the concert, Paraguayan, and Irish harps.

**Delos D/CD 3005.**

Seventeen works, most of them fairly short, are on this disc. As its name implies, this release is something of a guidebook to the instrument and its unique colors. While not as demanding as the piano, the harp has never really been well served by the LP, with its inherent noise level and low-frequency aberrations. On CD there is none of that, and the music seems to float out of the loudspeakers with no effort at all. Amazingly, one can almost imagine the harp right in the listening room.

There isn't much substance to the solo literature for the harp, most of it having been written by harp virtuosos. Generally, the transcriptions fare better. Taken altogether, there is almost too much richness of sound to be taken in one sitting. Things are bound to cloy, no matter how fine the player may be.

The brief excursions to Paraguay and Ireland are a good tonic.

*John M. Eargle*

Susan McDonald



**Rodrigo: Concierto de Aranjuez; Villa-Lobos: Concerto for Guitar.** The English Chamber Orchestra, Daniel Barenboim; John Williams, guitar.

**CBS MK 33208.**

On this CD we have the well-known "Concierto de Aranjuez" of Rodrigo, with the haunting second-movement adagio that is so famous in its own right, along with the rarely performed "Concerto for Guitar" by Villa-Lobos.

John Williams gives us a virtuoso performance of these works, and his fingering and clean, articulate touch are something to marvel at. Daniel Barenboim and the English Chamber Orchestra furnish a well-played, entirely sympathetic accompaniment to Mr. Williams' guitar. The overall sound is quite clean, but is flawed by the wiry sound of the high strings. Also, while the sound of John Williams' guitar is clean and resonant, it is recorded as if it were in an isolation booth. The surrounding orchestra is heard with a nice spacious ambience, but the guitar appears to be in a different and rather dry-sounding acoustic space. One appreciates that the output of an acoustic guitar is low, and could easily be swamped by the weight of the orchestral sound, but this problem can and has been solved in other recordings of these works, without recourse to such extreme isolation of the guitar as heard here.

*Bert Whyte*

**Rise:** Herb Alpert  
**A&M CD 3714.**

Although Herb Alpert, head honcho of A&M Records, long ago left the Tijuana Brass behind, perhaps in some picturesque cantina to drown their sorrows in tequila, he still retains an affectionate "south of the border" quality in

his music. On *Rise*, his 1979 A&M release, he lifts his trumpet in tribute to Spain and Mexico on Rodrigo's "Aranjuez," Sinfield and Brooker's "Angelina," and on Alpert's own "1980."

Now Alpert is a naturalized citizen of the recording studio: Here he is very much at home and shows no hesitation in using every one of its rich resources. *Rise* contains eight selections featuring massive and intricate instrumentation, with additional audio and musical wizardry provided by a host of established music business names.

All cuts here were originally recorded digitally, then transferred to analog for editing, and once again digitized for this format. The results are quite impressive. With coproducer Randy Badazz and associate producer Andy Armer, Alpert goes for the big effect, laying on banks and banks of instruments to showcase his Latin-flavored horn. A magnificent sense of aural space is created here, though it is an artificial space, not one which reflects the actual location of instruments in an orchestra. Alpert's horn is almost always the center of attention, although the mix often places it in the background. As though from a distance, Alpert's trumpet or flügelhorn shines through the masses of sound, floating in a bright pool of reverb at the center of great swirling clouds of instrumentation.

The production and arrangements are extremely lavish. For the precise musical accent, Alpert and cohorts choose any instrument that might best serve their purposes, whether it is a slide steel guitar, a marimba, or even a balalaika. The variety of sounds elicited from excellent musicians like Tom

Herb Alpert

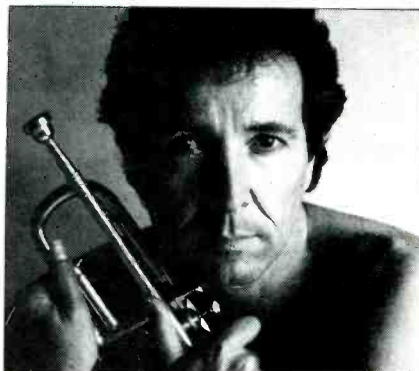



# Perfect bass... Perfect treble... Perfect sound forever...

**Introducing Rotel.** Audio components with extraordinary features, yet surprisingly affordable. An incorporation of superb quality and elegant, modern design has been achieved only through painstaking research and development...in both the engineering laboratory and listening room. In the interest of audio signal purity, Rotel has dispensed with all tone controls and extra switching. Instead, there is a high standard of precision and enhanced sensitivity within...eliminating the necessity for manual adjustments. Rotel audio com-

ponents are highly refined, and provide perfect reproduction of your favourite music, as originally recorded by professional sound engineers. This high performance and outstanding quality is the product of a perfect marriage...prestigious British design, coupled with advanced Japanese technology. If you want to achieve the ultimate in sound quality at an affordable price...don't settle on anything less than perfection... The Rotel Revolution...built better to sound better.

**ROTEL**

P.O. Box 653, Buffalo N.Y. 14240 U.S.A. Enter No. 24 on Reader Service Card



# THE MOST BEAUTIFUL SOUND NEXT TO SILENCE NOW REALIZED ON ECM COMPACT DISCS

**Available from  
ECM Records  
on compact disc:**

**Chick Corea**  
*Children's Songs\** 2-25005

**Chick Corea and  
Gary Burton**  
*In Concert, Zürich,  
October 28, 1979* 2-1182

**Charlie Haden**  
*The Ballad Of The  
Fallen* 2-23749

**Keith Jarrett**  
*The Köln Concert* 2-1064  
*My Song* 2-1115  
*Changes* 2-25007

**Pat Metheny**  
*80/81* 2-1180  
*Offramp* 2-1216

**Pat Metheny &  
Lyle Mays**  
*As Falls Wichita, So  
Falls Wichita Falls* 2-1190

**Oregon**  
*Oregon* 2-23796

**Steve Reich**  
*Music For  
18 Musicians* 2-1129

\*Contains "Addendum,"  
written for piano (Corea),  
violin (Ida Kavafian) and  
cello (Fred Sherry).  
Available only on CD format.

## ECM

Manufactured and Distributed by Warner Bros. Records Inc.  
© 1984 ECM Records GmbH

Enter No. 39 on Reader Service Card

*Under Cover* shows what a hot little CD can do to capture the spirit of sleazy rock 'n' roll at its best.



**Under Cover: The Rolling Stones  
Rolling Stone CP35-3087.**

The Rolling Stones like their rock 'n' roll lowdown and dirty, and in many ways their production values consciously reflect this. Stones albums have plenty of muddy instrumental stretches; the guitars of Keith Richards, Ron Woods and, very occasionally, of Mick Jagger himself often blend in murky interchanges, which are further muddled by the use of fuzztone and the boys' raucous, uninhibited vocal choruses.

So why bother with a CD? Although *Under Cover* is no exception to The Stones' pattern, it shows off what a hot little CD can do to capture the spirit of sleazy rock 'n' roll at its best. The clarity of this analog-to-digital master recording reaffirms that The Stones and their producers, Chris Kimsey and the Glimmer Twins (actually Mick and Keith), have consciously opted for this swampy sound. When aural clarity is deemed necessary, significant effects or passages cut through the murk like a hungry 'gator razoring through the bayou.

Special percussion and electronic touches punctuate these 10 selections with eye-opening impact. For instance, the title cut, The Stones' most political song in many years, explodes out of the CD silence with a clear burst of simulated machine-gun fire. "Under Cover's" follow-up percussion (the "thunk" of claves in the right channel, Charlie Watts' speeding-train drum and cymbal figure in the phantom center), its big rich bass and sweep of electronic wash, the odd tin-roof drum rumble in the left channel, and Mick's voice entering at mid-ground center are all reproduced faithfully. Their

widely disparate textures are almost physically palpable on this digital recording. The now-notorious "She Was Hot" contains healthy doses of fuzz-tone guitar and other aural obfuscation, yet when Mick's voice, sinister and sensuous, half-whispers "she was hot" in both left and right channels with an upfront hissing intimacy, it becomes very clear that these producers knew just what they were doing.

This is a hard-driving album, and though it doesn't push the outer reaches of the CD's ability to handle high-end frequencies, it certainly gives the low end a workout. Most of these cuts have a good, thumping rock-dance beat, with lots of drums, including big, bottom-heavy babies that appear with liver-quivering presence in "Too Tough" and "Tie You Up (The Pain of Love)." Bill Wyman's bass gets its low licks in too, loping along on "Under Cover" and "Feel on Baby." No distortion here, no matter what the volume level. The high end gets a bit of mild exercise from the hot horn of the backup group, CHOPS, on "Too Much Blood," and The Stones' occasional screams and glass-shattering falsettos pierce the murk with nerve-tingling precision.

My reviewer's copy of *Under Cover* is a Japanese import, featuring an album-jacket booklet with full information on the disc. The U.S. release is now available, presumably minus the translation into Japanese. Get it. *Under Cover* is a powerful Stones album, carrying their two-decade-old obsession with sex and violence into the '80s. It is excellently produced and engineered, and the digital mastering process allows the listener to wallow in the aural and moral muck The Rolling Stones choose to play in. *Paulette Weiss*

Scott, Joe Sample, and Michel Colombier tests the CD's full-range accuracy of reproduction. From crisp bongos to delicately chiming triangles, from full orchestral strings to synthesized bass bottoms, these arrangements clearly display the superiority of digital technology over analog. The total lack of distortion, even at very high volume levels, is extraordinary. One particularly impressive effect is a short run of ear-testing-type high notes on "Angelina," a gentle little "south of the border" tune. These piercingly high notes, produced either on the slidesteel or on a synthesizer, are just within the range of the human ear, and they add an almost subliminal musical dimension to an otherwise unremarkable piece of music.

The material on *Rise* goes from grandiose Spanish-style epics, like "1980," to the light funk of "Street Life." Despite all the lavish instrumentation and the constantly shifting patterns within each arrangement, this is generally very easy stuff to listen to, featuring pretty, almost bland melodies, which are not at all as taxing as you might expect from the complexity of their underpinnings. It's a case of the parts being greater than the whole.

If you'd like to blast your guests out of their seats and straight into the bullring with a powerful brass fanfare, then crank up your volume control knob and let 'em have "1980" full force. Otherwise, just pass around the tequila and salt and put *Rise* on for background atmosphere. *Paulette Weiss*

**Ravel: String Quartet; Bartok: String Quartet No. 3.** Sequoia String Quartet. Delos D/CD 3004.

The lushness of both playing and recording here benefit the Ravel quartet. By comparison, the same soft-edged sound takes away some of the essential incisiveness of the Bartok. Yet both works are superbly played by the Sequoia String Quartet, who, in the several years since this digital recording first appeared, have grown in musical stature.

For most listeners, a bonus in this recording will be the total lack of edginess in the pickup of the ensemble. The mellow B & K omni microphones saw to that. *John M. Eargle*



## KNIGHT TIME'S THE RIGHT TIME

**Sir John—a Lot of Merrie Eng-  
landes:** John Renbourn  
**Lost Lake Arts LL-0084, \$9.98.**

Sound: A Performance: A+

Windham Hill Records established their Lost Lake Arts subsidiary to bring back into circulation gems that have become otherwise unavailable. John Renbourn's 1968 masterpiece, *Sir John*, is the fourth in the series. He was then a member of Pentangle, that seminal fusion of English traditional folk song with jazz ideas greatly influenced by Charles Mingus.

*Sir John* is entirely instrumental and unbelievably beautiful. Selections range from Booker T and The MGs' "Sweet Potato" and Charles Lloyd's "Transfusion" to William Byrd's "The Earle of Salisbury," which dates from Elizabethan times, and the traditional, "The Trees They Do Grow High." The rest is original material which falls within these wide parameters.

Renbourn's stunning acoustic guitar is properly the center of the sound. He is joined, as occasion warrants, by Ray Warleigh on flute and fellow Pentanglean Terry Cox on African drums, finger cymbals and glockenspiel. On "Morgana," the lengthiest piece here, the ensemble is augmented by David Monroe on recorders and Roderick Skeaping on bass viol for a medieval fantasia.

*Sir John* has been a treasured companion for the 16 years since its original issue and a perennial on my "desert island collection of records I would never do without. The reissue is definite cause for celebration. With the brilliant job the sonically concerned folk at Windham Hill have done remastering the record, the reissue is clearly superior to the original. It is fun listening technically to the mallet striking the glockenspiel in "The Earle of Salisbury," the wind in the recorders in "Morgana," the thump of hand on drum in the finale, "Seven Up."

Best of all, Renbourn's guitar has splendid detail. He is a wonderful guitarist who plays as fast as anyone, but he's also one of those rare musicians who know how to play slowly, intricately, and precisely.

Congratulations and thanks to Windham Hill for *Sir John a Lot of*. This is what recorded sound on vinyl is sup-

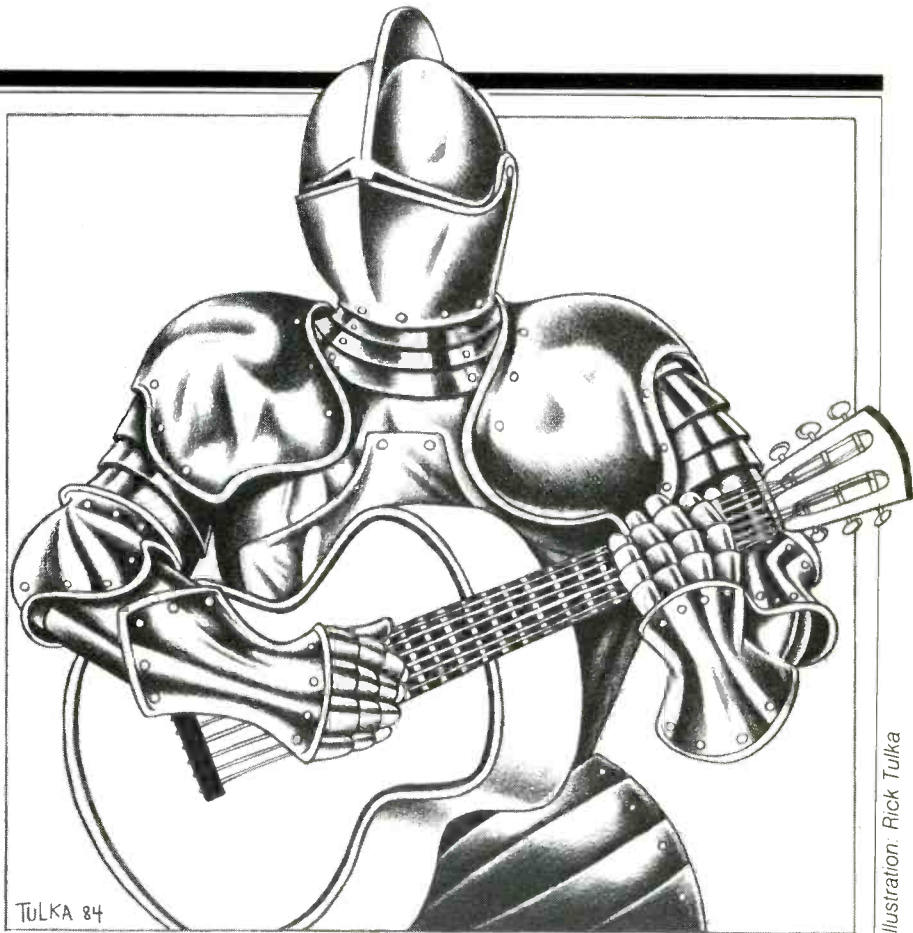

Illustration: Rick Tulka

posed to sound like. My sources tell me that they also have the rights to Renbourn's companion album, *The Lady and the Unicorn*. I hope release of that gem will follow as soon as possible.

Michael Tearson

**Norman Mackenzie at Trinity Cathedral.** Norman Mackenzie, organ.  
**Direct-to-Tape DTR-8215**, PCM digital cassette (Beta and VHS), \$29.50.

**Ron Thomas: Digital Demo for Bob.** **Direct-to-Tape DTR-8217**, PCM digital cassette (Beta and VHS), \$25.00. (Both also available on open reel, cassette and Beta Hi-Fi Audio from DTR, 14-D Station Avenue, Haddon Heights, N.J. 08035.)

Direct-to-Tape Recording Company specializes in recorded tape in a variety of formats, including Sony's PCM-F1 Beta. Currently, all of their recording is done digitally, so creating clones of the edited master in Beta F-1 format is as simple as making a cassette in your own home. Recently, I have had the

pleasure of listening to a couple of DTR's Beta format recordings.

Norman Mackenzie presents a program of organ music from Trinity Cathedral in Trenton, N.J. The organ, originally a Möller, but now the product of several rebuildings, is thoroughly in the French style, with its gutsy trompettes and varied mutation stops. The program consists of early works by de Grigny and Soler, continuing into more modern times with works by French organ masters Gigout and Duruflé. Mackenzie's playing is accurate and has plenty of the panache which this music needs. The recording is a model of its kind—absolutely stunning! The organ is heard fairly close in, but there is enough reverberation to envelop the sound to the required degree. The French-style chorus reeds, heard with no trace of break-up or time-base distortion, have the impact of the real thing. This recording will measure your system, both as regards dynamic range and low-frequency extension. Recommended without question.

The Bob referred to in Ron Thomas'



## Technics Linear Tracking and Quartz Drive. If your next turntable gives you less, you're settling for less of a turntable.

To create a turntable with either linear tracking or quartz drive is an achievement in itself. But to create a turntable with both linear tracking and quartz drive is pure Technics.

A Technics turntable with linear tracking gives you a tonearm that moves straight across the record. The way the record was originally cut. So you get none of the distortion or tracking error that are so common with conventional turntables.

Quartz drive is the most accurate drive system in the world. That means the wow and flutter that plagues conventional turntables is inaudible.

So Technics turntables, with both linear tracking and quartz drive, deliver performance few turntables anywhere can match.

The new Technics SL-J2 offers completely automatic operation: automatic speed selection, automatic disc size selection, automatic start, stop, return and more. There are front-panel controls. Including a digital display of the track number you're listening to. And all of this technology has been placed in a turntable about the size of a record jacket.

Technics turntables also feature the innovative P-Mount plug-in cartridge system. For optimum tonearm/cartridge performance and ease of cartridge installation.

So why settle for less. Explore the entire line of Technics turntables at a dealer near you.

**Technics**  
The science of sound

Enter No. 36 on Reader Service Card



# A clear challenge from PDMagnetics to the readers of Audio.

**Introducing the 500 CROLYN® HG Audio Cassette. Clear sound, clear shell...clearly superior.**

The new 500 CROLYN® High Grade cassette will exceed even *your* high standards. We engineered it for you, the audiophile. We want to hear from you. We challenge you to compare it with the likes of XL-IIS and SA-X. Hear the difference genuine chromium dioxide tape makes versus cobalt-iron oxide imitations or other "chrome equivalent" tapes. Also, ask about 1100 Metal HG and Tri-Oxide Ferro HG.

Buy a 500 CROLYN® HG cassette. Use it—test it—under *your* standards. Send us your comments (plus outer wrapper and sales receipt). We'll send you a 500 CROLYN® HG Cassette FREE! We're betting you will agree with our results.\*

Only the people who invented the compact cassette (Philips, the "P" in our name), and chromium dioxide (Du Pont, the "D" in our name), could bring you a tape this great.

#### Rating vs. Leading Premium Cassettes

	500 CROLYN® HG
Tape Background Noise	SUPERIOR
S/N, Low Frequency	SUPERIOR
S/N High Frequency	EQUAL
Dynamic Range	SUPERIOR
Frequency Response	EQUAL
Shell Quality	EQUAL
Overall Listening Quality	SUPERIOR

Specific test results available on request. For free cassette offer, technical information or the PDMagnetics dealer serving your area, write us at address below.

## PDMagnetics

A legacy of quality from Philips and Du Pont.



\*Offer expires December 31, 1984

©1984 PDMagnetics 600 Heron Drive, Pureland Industrial Complex, Bridgeport, NJ 08014  
Enter No. 22 on Reader Service Card

AmericanRadioHistory.com

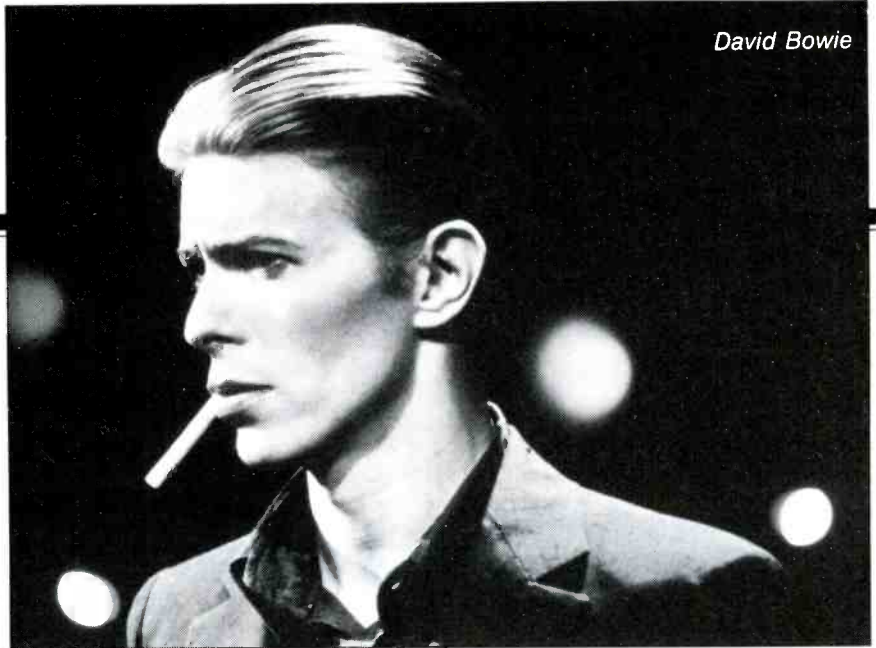

*Digital Demo for Bob* refers to Bob Sellman, who is the engineer and producer for the company. While agreeing that the sound of Thomas' bluesy piano is quite natural, I must confess that I am not taken by the program of his own compositions. Again, as with the organ, it is a revelation to hear the piano with not a trace of distortion or wow.

How do these recordings differ from Compact Discs? Not at all, I would say. The digital standard employed in the F-1 system is virtually the same as that used in the CD, so, minor player differences aside, these recordings sound very much as though they would if they were available on CD. The fact is that a great deal of the Direct-to-Tape catalog, because of its specialized nature, will never see the light of day in CD form.

Only the packaging is less than fully professional. Notes are minimal and are the product of a difficult-to-read dot-matrix printer. It could simply be that, with so few orders in the F-1 format, the company has not been able to justify anything better.

Most of the DTR catalog is classical, with an emphasis on Baroque forms. There is lots of organ music, with lutes, recorders, and harpsichords not far behind. The pop/jazz portion of the catalog is presently quite small.

If you are a tape enthusiast and appreciate the benefits of Dolby or dbx noise reduction, you should certainly contact DTR and ask for a copy of their current catalog. *John M. Eargle*

**Let's Dance:** David Bowie  
**Mobile Fidelity MFSL 1-083, \$15.98.**

Sound: B- Performance: B+

Months after its chart domination is over, David Bowie's *Let's Dance* is now available in audiophile format, which throws a whole new light on the record. Is a dance record worthy of this sort of treatment? Is the recording of a high enough quality to make a high-grade mastering/pressing job noticeably better? And how good an album was this in the first place?

Last question first—this was a number one album because a couple of the tracks captured the mood of the nation/world at the time of its release,

because Bowie once again was in vogue, and because he was on a label that was willing to go out on a limb to make him happen. As everyone (ABC, most notably) was being successful mimicking him, it was of the utmost importance that Bowie reestablish his presence, thus a massive promotion and tour, unlike anything Bowie'd done in years, coincided with this record. But after all the dust has settled in the grooves, *Let's Dance* is not a great album as such, what with only two of the five new Bowie songs worthy of a second listen ("China Girl" was on an Iggy LP, "Cat People" appeared on the soundtrack of the movie of the same name in a superior form, and "Criminal World" is a cover tune). The two tunes that rate, "Modern Love" and the title track, are meritorious more for their incessant dance groove (courtesy Nile Rodgers, who produced) than for content. So this come-back album for the thin white duke could have stood a little more weight, and in retrospect its success is more remarkable than its music.

As for the sonic quality, the richness of the gated reverb on the snare is mighty pleasing, but overall this pressing seems a little top-heavy. The recording was made more with radio and the dance floor in mind than the home listener. Perhaps the best test of this master recording would be in Studio 54, but they wouldn't allow us to use their premises as a listening room. Suffice to say that this has more dynamic range than the conventional pressing, but it still could use a bit more low end. Either way, we're not talking about an earthshaking classic—perhaps purchasing the 12-inch versions of "Let's

Dance" and "Modern Love" would prove to be of ultimately greater sonic worth (wider grooves, less chaff) to the diehard Bowie audiophile.

*Jon & Sally Tiven*

#### Moby Grape

**San Francisco Sound SFS 04830-PB**, digital, boxed-set, \$50.00; **SFS 04830-3**, vinyl LP, \$9.98; **SFS 04830-PD**, picture disc, \$20.00. (Available from San Francisco Sound, P.O. Box 4011, Malibu, Cal. 90265.)

What a visual stunner this rainbow-boxed set of brightly colored picture discs is! These six pretty babies, each differently hued, are 12-inch, 33 $\frac{1}{3}$ -rpm singles containing one cut per side. A brightly colored picture disc as well as a standard black-vinyl LP are also available.

The sound within is a technicolored spectacular as well; all is digitally recorded, and the aural fidelity is remarkable. The dynamic range is impressive. Aural textures are exquisite; a brush stroked over a cymbal stands out in sandy, grainy contrast to the smooth metallic ping of that same instrument tapped by a wooden drumstick. The lowest bass run is solid, with no distortion, and the highest scream of an electric guitar is reproduced with piercing accuracy. Presencing and spatial relationships are also handled beautifully.

But, is this carefully numbered, limited-edition set one for your collection, despite the hefty price tag? Nope; the pot o' gold at the end of this particular rainbow turns out to contain sheer dross. The music, so stunningly presented visually, is colorless, trite, repe-



Although the musicians on Moby Grape still have great chops, they have nothing but their own brand-new material to work with.

titious, and hardly worth your time and money.

Another blight on the rainbow is the excessive amount of surface noise on the standard LP, audibly present despite the proud claim on the shrink-wrap label of "finest quality vinyl for absolute fidelity." As for the picture discs, forget about actually putting

these colorful cuties on your turntable if good sound is important to you; these surfaces play with all the quiet dignity of an IRT express roaring into Penn Station at rush hour.

As for packaging, there are no cardboard or foam reinforcements between the six discs in the box to prevent warping, an oversight in view of the

obvious care taken in producing the set. Otherwise, the box is quite sturdy and each disc is well-protected by a heavy, clear-vinyl sleeve.

Although technically the instrumentalists still have great chops—the guitar work shines as brilliantly as in the old days—they have nothing but their own brand-new material to work with. And it sounds time-worn and dull. "Silver Wheels," for instance, is an attractive enough country-rock tune with some lovely guitar interplay, but by now this road has been too often travelled by the likes of Poco, The New Raiders of the Purple Sage, and early Eagles. Moby Grape's attempts at rock and boogie tunes—"Suzzam," "Too Old to Boogie," "Think It Over"—run a handful of repetitious riffs into the ground and go nowhere. There are a few special effects ("Queen of the Crow") and some interesting monochromatic twists ("Sitting and Watching"), but, in general, there's little here to justify the physical extravagance of this presentation.

The Grape has had bad fortune before in its balance of talent and packaging. Their first LP, released in 1967, was also called *Moby Grape*. It featured their classic three-guitar lineup, tight vocal harmonies, and well-structured songs that ventured into the blues, psychedelia, and early country-rock. Unfortunately, the hype Columbia Records saddled them with at that time weighed the Grape down and limited their fame to the San Francisco area.

The original band—Jerry Miller, Peter Lewis and Skip Spence on guitars, Bob Mosley on bass, and Don Stevenson on drums—broke up and reformed several times over the past 17 years. The albums they produced were of little consequence despite their "legendary" reputation. The present lineup substitutes Grisha Dimant for long gone Skip Spence and adds Richard Dean on keyboards and Lorenzo Biancalana on vocals. However, nothing they do can lift the Grape out of the pits.

Moby Grape was an innovative band in the '60s. Unfortunately, yesterday's fresh fruit is today's fuzzy green thing jammed in the back of the refrigerator. This collection is for avid collectors and die-hard Moby Grape fans only.

Paulette Weiss

# PALM READINGS

Perfect sound could lie in the palm of your hand, with the new, affordable AudioSource RTA-ONE Real-Time Analyzer. Whether adjusting your home stereo equalizer, or setting up a 10,000-watt auditorium sound system, the RTA-ONE allows instantaneous frequency-response analysis of the system.

The easily readable screen features red and green LEDs which display the relative level of each octave frequency band in the audible range. The RTA-ONE incorporates a built-in electret condenser microphone, professionally-calibrated controls, and is encased in a rugged metal housing. An optional Pink Noise Generator, Remote Microphone, AC Adapter, and Carrying Case are available.

The RTA-ONE is the perfect measurement device to help you achieve optimal sound, wherever you go, at a price that is a revelation to behold.

## AudioSource

1185 Chess Drive, Foster City, CA 94404 • (415) 574-7585



**UNDER \$200.00**



# For the best possible sound, all you need are the Basics.

Kenwood Basic components.

They give you all the audio technology you need. Whether you're looking for full-size components, or record-jacket size components like our HD (High Density) series.

Both offer you pure sound and high power at easy-to-handle prices.

Both provide perfectly matched components that provide the ultimate in individual performance, too.

And both give you patented features that are uniquely Kenwood.

For example, Sigma Drive, the ingenious amp-to-speaker negative feedback device that insures sonic clarity.

Or, Dynamic Linear Drive (DLD): super-efficient, dual-output amplifier technology that produces power, purity and a dynamic range wide enough for Kenwood's amazing full and jacket-size CD players.

Look into the remarkable, digital-ready Basic components.

Whatever size you choose, you'll find everything you need for the best possible sound.

**KENWOOD**  
*Shaping the future of sound.*

Enter No. 14 on Reader Service Card



EDWARD TATNALL CANBY

## IN THE BEGINNING

**Dvořák: "New World" Symphony.**  
The Chicago Symphony Orchestra, Sir Georg Solti.  
London 410 116-1, digital, \$11.98.

I cringe to think of the opening impact of this recording in its CD form! Even the LP's beginning is likely to jolt you. It begins (as Dvořák intended) so softly and gently that you will reach for your volume control, bemused: Is something wrong with the LP? Why so faint? Then, *wham*, comes the loud music, and down goes the volume control again. The LP surfaces are so quiet, especially in the usually audible low-bass rumble, that its impact is not too different from CD's. The whole dynamic range of the music is there.

Dvořák and a zillion others wrote for live performance in numerous Carnegie Halls. The live volume was absolute and preset. If the violins played so you could scarcely hear them for audience coughs and rustles and creaks, at least you *knew* they were exactly as soft as they sounded, no more, no less. Not so in recording! I suggest that, at least for CD, some sort of predetermined level information be put on each disc to avoid jarring.

This "New World" is super-high-tech, both in the recording and, curiously, in the playing. The performance is hard virtuoso, faultlessly accurate, ruthlessly loud and forceful in the big places. I like it for its nowness, its 1980s modernity—this is no sonic nos-

Sir Georg Solti

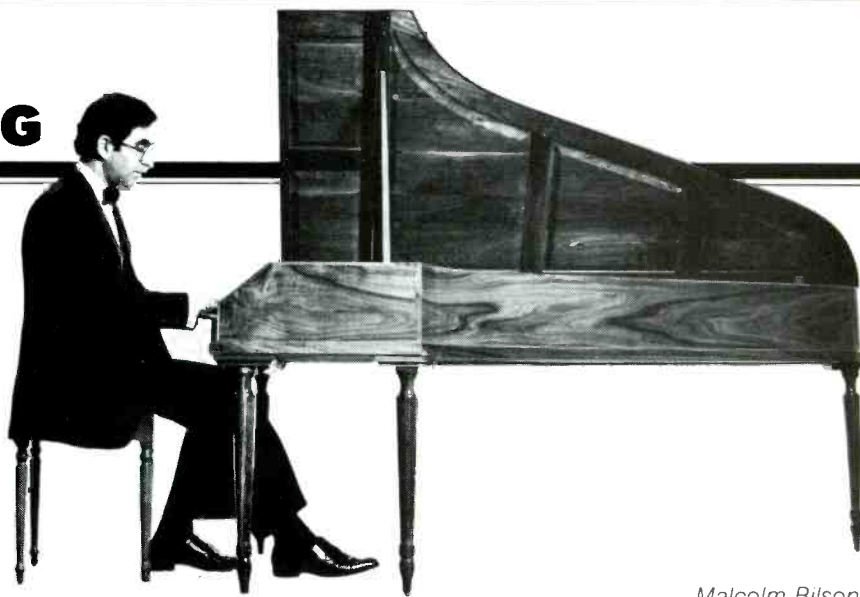
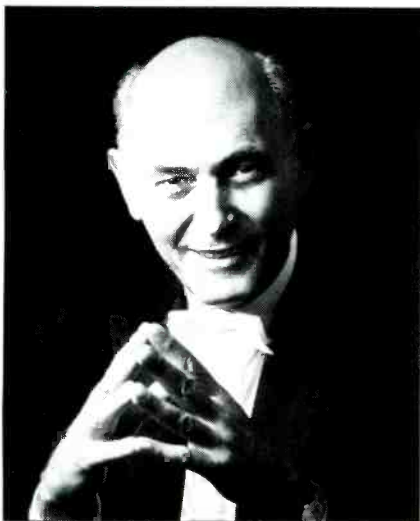

Malcolm Bilson

algia voyage back to the '90s of the old century! Far from it. Even the soft parts are on the taut side, if beautifully played in every detail. Very cool, in every sense, old and recent.

The sound of London's Orchestra Hall has a faintly metallic ring to it, not to my liking though it suits the hard performance. Why? I wasn't there, can't say. I expect that a Romantic work like this could, even in that same hall, have a velvety ambience.

Yes, there are new levels of sheer *fi* to be heard on this and similar recent digital recordings, whether via CD or LP. It shows—you will notice it instantly. I interpret the difference as simply an even cleaner sound than all the clean sounds of the past—what else? Clear overtones and instrumental color; more significantly, ultra-clean quick transients, razor-fast and sharp. You can hear these differences on most older equipment—it's all relative. Improve just one part of the audio chain and all the rest seems to improve too. Most of the time, anyway.

**Mozart: Music for Two Fortepianos.**  
Sonata in D, K. 448; Fugue in C Minor, K. 426; Larghetto and Allegro in E Flat. Malcolm Bilson and Robert Levin.

Nonesuch 78023, \$8.98.

The fortepiano is so named for convenience today, to distinguish it from the pianoforte, our modern instrument out of the late 19th century; it is the piano from its beginnings through the first part of the 19th century and the early Romantic period. The modern redevelopment of this old instrument (in a variety of forms) followed straight af-

ter the earlier revival, first, of the harpsichord and, later of the "Baroque" or "Classic" organ. All of these were put into operation for the music originally intended to be heard on them in one of two forms: The original old instruments, restored, or, alternatively, modern "exact" copies, rigorously derived from older models.

It is a pair of these last that we have here, and the usual special question arises concerning any stringed instrument—*is this the way the old ones sounded when they were new?* Not so easy to say! As much tinkering can be done with an old piano as with any vintage amplifier, including, of course, the temptation to add modern "improvements." They do sneak in, inevitably, and why not? Do we have to make all the mistakes our forebears made, when we now can do better? Or can we?

Certainly the sound of these two new fortepianos (modelled on specific old ones) is nearer to what Mozart presumably heard than to the sound of any modern pair of pianos. But there isn't that much difference here. These two instruments sound in the treble very much like a modern instrument, only a little brighter; and the metallic, clanky bass of the old fortepianos, harpsichord-like, is minimized.

That, for my ear, is a shame—but am I right? I love the older bass sound, the harpsichordish twang, as I have heard it in many recordings of restored old instruments and even in a live example, on which I myself did a bit of playing. There is another recording of the two-piano Mozart "Sonata in D," featured here, which was played on two original instruments in Vienna, supposedly restored. The sound is utterly

## The Gold Seal of Quality.

unlike that of these modern copies and, again, for my ear much more interesting. Am I crazy?

The problem is—are even the restored pianos just “old pianos” and sounding that way? Are the creaks and groans and clanks, the tinny highs and brassy bass, merely symptoms of age, just as they might be in a well-worn, old-timey jazz upright, the sort that sounds as if it had thumb tacks in its hammers? Who knows? I don't. I just enjoy that noise a lot.

The modern fortepianos are relatively colorless and cool. Perhaps that is right. At least there is no overwhelming big blur, as too often occurs via the contemporary piano, or that artificially “little” sound that so many pianists produce in an attempt to put Mozart in his place. There is heft here, and energy, and clarity too. As for performance, these two pianists race like the wind and I don't like it much. Why such a hurry? The music gets to be mechanical sounding, especially in the difficult “Fugue in C Minor,” which sounds like the “Grosse Fuge” of Beethoven, all harsh and rattlingly loud.

**Brahms: Hungarian Dances.** Royal Philharmonic Orchestra, Walter Weller. London Jubilee 411 703-1 LJ, \$6.98.

The steady spate of lower-priced reissues, always improved in quality and, “now more than ever,” currently huge, is due perhaps to the appearance of the expensive CD and all the varieties of digital recording. London's Jubilee label should offer many nice goodies for just over half the cost of a disc on the parent's digital label. This one, however, is strictly so-so—not because of age or recording quality but because of the strangely distant and confused mike pickup and the interpretation of the dances.

We all know how the so-called “Hungarian” music of the 19th century, actually derived from gypsy café music, tends to start slow and then increasingly speed up. Okay—but this conductor whips up such a speed that the music, especially in a confusing reverb, is simply unintelligible, the details smeared and the fine points lost in the shuffle. It seems to be worst in the very familiar dances, four or five of 21. The others fare little better.



## The Standard to Match.

The gold seal on every CBS Masterworks recording is your assurance of our commitment to quality. It symbolizes the exacting standards we maintain in bringing you recordings of the highest caliber.

Consider these details:

- All CBS Masterworks records are pressed from a special vinyl compound and are 15% heavier than standard imported discs.
- Discs are protected by an anti-static inner sleeve and sturdy album jacket, enclosed in a poly bag to prevent warpage caused by shrink wrap.
- Cassettes are reproduced on chrome tape and include complete liner notes.
- CBS Masterworks, the domestic pioneer in Compact Discs, now has over 75 titles available.

Equally, the gold seal represents the unparalleled quality of the artists on the CBS Masterworks roster. From definitive performances by world-renowned artists and maestros to the excitement of discovering today's brightest new talent, you'll experience it all on CBS Masterworks.

**CBS Masterworks Records, Cassettes and CDs.**

**The New Gold Standard  
In Recorded Classical Music.**

M  
A  
S  
T  
E  
R  
W  
O  
R  
K  
S





# McINTOSH... *the tradition for EXCELLENCE*



In 1884 artisans, following an exact and demanding design, created this piano (S/N #51908). Master craftspeople, using common and ordinary materials in an uncommon fashion, created the unique instrument that is... Steinway. Today, 100 years later, this superb musical instrument, when combined with hands of talent, continues to produce concert hall performances. Here, truly, is an expression of superior technology, performance capability, and lasting value.

Since its beginning in 1949, the McIntosh tradition for Excellence and technological leadership and more than thirty-five years of lived history provide the theoretical and practical background for years of dedicated research and exploration that has produced the XR 1051 'Xtra Real' loudspeaker.

The McIntosh XR 1051 is the finest expression in the loudspeaker scientist's repertoire. It is imbued with the McIntosh tradition for Excellence in technologically superior design, a significant advance in low distortion performance, in depth and spaciousness of stereo imaging, a cabinet finish that is the pride of the cabinet craftperson's art, lasting long-term value, and best of all, 'Xtra Real' music.

**XR1051**  
**XTRA REAL LOUDSPEAKERS**  
Suggested Retail Price \$1199 each

**For Detailed Information on McIntosh Products Write:**  
**McINTOSH LABORATORY INC.**  
**EAST SIDE STATION, A54 P.O. BOX 96**  
**BINGHAMTON, NY 13904-0096** Enter No. 18 on Reader Service Card



Maestro Cleve is a knowledgeable Mozart conductor, with an excellent sense for phrasing and rhythm in this not-so-simple music.

**Mozart: Symphony in E Flat, K. 161a; Piano Concerto No. 17 in G, K. 453.**  
Midsummer Mozart Festival Orchestra, George Cleve; Lilian Kallir, piano.  
**Sonic Arts LS 40, digital, \$17.98.**

This digitally recorded series, recorded "live in concert," has some intriguing aspects that brought me back for a third time, after trying two earlier releases, one of which was quite acceptable, the other full of almost unbelievable faux pas, both musical and in the technical production.

Aside from the deliberately intended audience noises, which will surely annoy some listeners (after the umpteenth playing!), this one comes through very acceptably, if with some musical reservations. Lilian Kallir is an assured and highly competent Mozart player with a fine sense of proportion and style and so you are assured of the best in the piano solo. George Cleve is a knowledgeable Mozart conductor, too, with an excellent sense for phrasing and rhythm in this not-so-simple music (Mozart may "sound easy" but it isn't!). Thus, in interpretation, you will not find any better Mozart, and much that's worse, even among Great Performers.

The one musical weakness in this series is in the string department—particularly noticeable in a one-time "live" recording. Maestro Cleve keeps these players on a stylistically good track but he cannot make them into a viable ensemble. There are entirely too many sour notes, blurred fast passages, just plain incompetent performing, concert or no. I have heard plenty of "festival orchestras" of this sort, not to mention more permanent playing organizations, enough of them to know that there are hundreds and hundreds that do a better, more accurate job in a live performance.

Frankly, I am not one to go along with the current reaction towards "live" recordings, though they can often be superb if all goes ideally well. It seems to me that the idea, right now, is a bit suspect, though understandably so. It isn't exactly a coincidence that the

"live" digital recording requires no expensive digital editing, or at least a minimum at beginnings and endings; there are no time-consuming retakes, no hours and hours of studio or hall time, etc. In "live" recording we take what gets played—once—and that's it. Very economical, you must admit. Es-

pecially when the resulting LP sells for \$17.98. (Telarc has reduced its similar digital-LP price to \$12.98.)

You'll find nine other current LP versions of this Mozart piano concerto and two of the little symphony in E Flat, usually known as K. 184 but in the revised "K." listings as K. 161a.

## Better sound from every record you own, with the new Signet TK10ML!

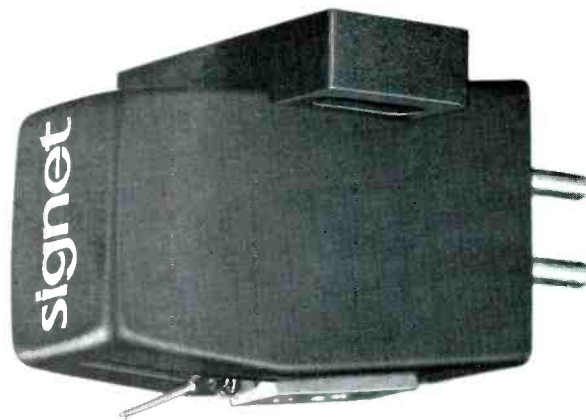

### It's something you can't get with any other technology.

Until you hear the Signet TK10ML, you may not fully appreciate how superb today's analog recordings can be. And how much may be lost by going all-digital.

The single most significant advance in the Signet TK10ML is its unique new *MicroLine*™ stylus... with the longest, narrowest "footprint" ever achieved! Its scanning radius is a mere 2.5 microns, half that of the best ellipticals, while its vertical contact footprint is three times longer than the elliptical. The Signet *MicroLine* stylus tracks very high frequencies better—at lower groove pressure—than any other design.

Even with repeated playings, the *MicroLine* stylus maintains its shape, without "spreading" like all other tips.

So grooves sound new, long after other styli are threatening irreparable damage to your record collection.

Each Signet TK10ML *MicroLine* stylus is created from a whole, natural octahedral diamond, oriented for longest life, and with a square shank to precisely fit the laser-cut hole in our unique, ultra-rigid low-mass boron cantilever. You get perfect alignment. Period.

But the proof of quality is in the playing. With the new Signet TK10ML, older records literally come back to life. New records transcend the limits of ordinary technology. Your entire system gets a new lease on life.

Visit your Signet dealer. Peek into his microscope to see this fantastic stylus. Then get the real proof. Listen.

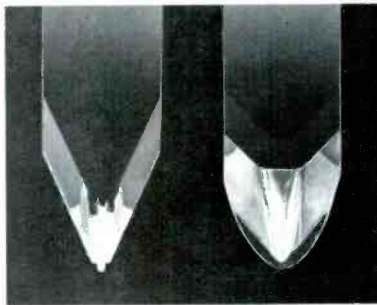

**signet**

SIGNET, 4701 HUDSON DRIVE, STOW, OHIO 44224

Enter No. 29 on Reader Service Card



## CLASSIFIED ADVERTISING RATES

**BUSINESS ADS**—\$1.40 per word, MINIMUM charge PER AD, PER INSERTION \$33.00. All centered or spaced lines \$11.00.

**NON BUSINESS ADS**—95¢ per word, MINIMUM charge PER AD, PER INSERTION \$17.00. All centered or spaced lines at \$9.00.

**ALL LINE ADS**—First line set in bold face type at no extra charge. Additional words set in bold face at \$1.65 extra per word. One point ruled box is \$12.00.

**CLASSIFIED LINE ADS ARE PAYABLE IN ADVANCE BY CHECK OR MONEY ORDER ONLY.** (Sorry, we cannot accept credit cards or bill for line advertising.) **ALL LINE ORDERS** should be mailed to:

AUDIO/CBS Magazines  
P.O. Box 9125  
Dept. 346V  
Stamford, CT 06925

**ORDERS WILL NOT BE PROCESSED WITHOUT ACCOMPANYING CHECK OR MONEY ORDER FOR FULL AMOUNT.**

**CLOSING DATE**—First of month two months preceding the cover date. If the first of the month falls on a weekend or holiday, the closing date is the last business day preceding the first. **ADS RECEIVED AFTER THE CLOSING DATE WILL BE HELD FOR THE NEXT ISSUE UNLESS OTHERWISE STATED.**

**FREQUENCY DISCOUNTS**—3 times less 5%, 6 times less 15%, 12 times less 20%. These discounts apply to line ads only. Ads submitted for a three time frequency are unchangeable. Frequency discounts not fulfilled will be short rated accordingly. Agency discounts do not apply to line advertising.

**BLIND ADS**—Audio box numbers may be used at \$6.00 extra for handling and postage.

**GENERAL INFORMATION**—Ad copy must be type-written or printed legibly. The publisher in his sole discretion reserves the right to reject any ad copy he deems inappropriate. **ALL ADVERTISERS MUST SUPPLY:** Complete name, Company name, Full street address (P.O. Box numbers are insufficient) and telephone number. Classified LINE ADS are not acknowledged and do not carry Reader Service Card Numbers. **AGENCY DISCOUNTS** do not apply to line advertising. **FREQUENCY DISCOUNTS** not fulfilled will be short rated accordingly. Only those advertisers who have prepaid for their entire contract time will be **RATE PROTECTED** for the duration of that contract, in the event of a rate increase.

### CLASSIFIED DISPLAY RATES

1 col x 1 inch	\$275.
1 col x 2 inches	\$435.
1 col x 3 inches	\$622.
2 cols. x 1 inch	\$495.
2 cols. x 2 inches	\$836.

One column width is 2 1/8". Two columns wide is 4 1/4". For larger display ad rates and 6, 12, 18 and 24 times frequency rates call (212) 719-6338.

**DISPLAY ADVERTISERS** should make space reservation on or before the closing date. Ad material (film or velox) may follow by the 10th. **DISPLAY ADVERTISERS MUST SUPPLY COMPLETE FILM NEGATIVE READY FOR PRINTING OR VELOX.** PRODUCTION CHARGES WILL BE ASSESSED ON ANY AD REQUIRING ADDITIONAL PREPARATION.

**ALL DISPLAY CORRESPONDENCE** should be sent to:

Laura J. Lo Vecchio  
AUDIO MAGAZINE  
1515 Broadway  
New York, NY 10036

**FOR ANY ADDITIONAL INFORMATION** contact Laura directly at (212) 719-6338

**ATTENTION ADVERTISERS!  
SEE CLASSIFIED RATE BOX  
ON PAGE 104 FOR NEW  
RATES EFFECTIVE OCTOBER  
1984 ISSUE.**

## AUTHORIZED DEALERS

### NATIONAL

**ABBIE'S AUDIO OFFERS EXCEPTIONAL PRODUCTS,** Berning, NOVA, Robertson, Precision Fidelity, B&K, Goetz Systems, JSE Infinite Slope, Spica, M&K, Melos Audio, VPI, AR Tables, Pink Triangle, Sonographe, Souther, Nitty Gritty, Talisman, Audioquest, Premier, Sumiko, Monster Cable, Grace, Creek, Beard, and more. Free newsletter, 302 E. High St. Waynesburg, PA 15370 (412) 852-1134.

**ACOUSTAT IN WISCONSIN!!!**  
AUDIO ELITE, Menasha, WI, 414-725-4431

## AUTHORIZED DEALERS

### NATIONAL

# A BRAND NEW WONDER CAP!!

**A TOTALLY NEW DESIGN** from IAR research. It's bigger, it's far better—and it costs **LESS!** How much better does it really sound, compared to our old Wonder Cap? Excited users have said: **SPECTACULAR! UNBELIEVABLE!** What will you say when you hear the **NEW IAR Wonder Caps™** in your own electronics and speakers? Write for **FREE** application notes and order forms.

IAR/TRT  
VISTA, CA 92083

**ATTENTION: BERNING, ALPHA, SOTA, DENON CARTRIDGES, DYNAVECTOR, FULTON, STAX, KOETSU, LINN, AR TURNTABLE, ROBERTSON, AUDIBLE ILLUSIONS, WALKER, ALPHASON, ZETA, GOETZ, PRECISION FIDELITY, MUSIC & SOUND, LAST, BRB, OTHERS.** 713-728-4343. MAURY CORB.

**DEMO & CLOSE-OUT SPECIALS:** Bedim, Belles, Denon, Helius, Naim, Supex, 3D, Audio Connection 201-239-1799.

# THE BOOK ON DIGITAL BY THE PEOPLE BEST QUALIFIED TO WRITE IT.

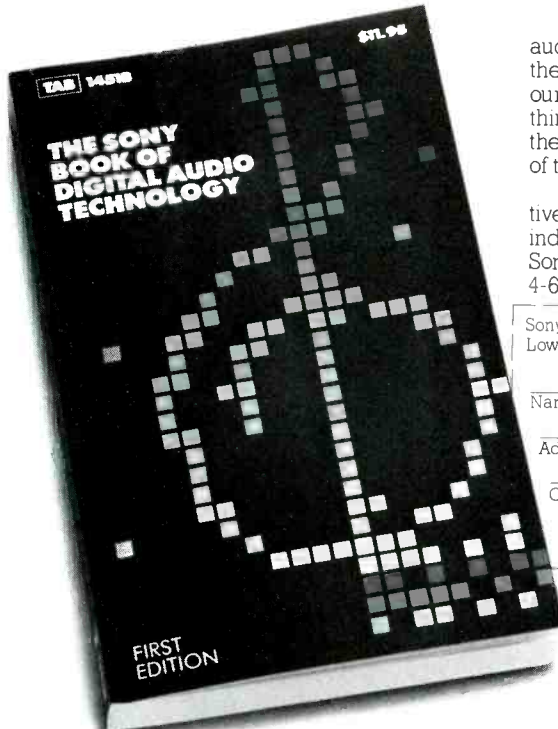

When it comes to digital audio, Sony wrote the book on the subject. Over 300 pages by our project engineers on everything from PCM processors to the development and operation of the Compact Disc Player.

For your copy of the definitive reference book for the industry send \$11.95\* payable to Sony Special Products. Allow 4-6 weeks for delivery.

Sony Digital Book, P.O. Box 166,  
Lowell, MA 01853

Name \_\_\_\_\_ AM 9/84  
Address \_\_\_\_\_  
City \_\_\_\_\_  
State \_\_\_\_\_ Zip \_\_\_\_\_

**SONY**  
THE LEADER IN DIGITAL AUDIO

\*Outside U.S.A. add \$3.00 ©1984 Sony Corporation of America. Sony is a registered trademark of the Sony Corporation.

**AUTHORIZED DEALERS**

**NATIONAL**

**ACES OVER EIGHTS SYSTEM**

(UNDER \$8200)

- Turntable: Linn Sondek Lp-12
- Tonearm: Syrinx PU-3
- Cartridge: Talisman S
- Preamp: Counterpoint SA-5
- Headamplifier: Counterpoint SA-6
- Tuner: Adcom GFT-1A
- Amplifier: Krell KSA-50
- Speakers: Symdex Simga/Omega

**SOUND BY SINGER**

227 Lexington Avenue  
New York, NY 10016  
(212) 683-0925

EXPANDING TO NEW LOCATION!  
CALL FOR DETAILS

**ACOUSTAT AND PS AUDIO—SUPERB!**

Free shipping! Fast service! Also Nakamichi, Thorens, Talisman, Proton, Hafler, Adcom, Mitsubishi, Carver, digital discs and players. READ BROTHERS STEREO, 593 King Street, Charleston, South Carolina 29403. (803) 723-7276.

**APPALLING? ISN'T IT?**

How many esoteric audio products look and feel as if they were made by orangutans with screwdrivers. If you are fed up with sacrificing reliability, aesthetics and quality of construction to obtain purer sound, don't despair!

There are many high end audio components built by small yet solid professional companies which not only express the utmost in musicality but also reflect the highest level of design integrity, craftsmanship and quality control. At Sound by Singer we select and blend only such components into systems designed to extract the most music from your audio dollars.

- ACOUSTAT • ADCOM • AKROYD • APOGEE • AUDIO DESIGN • AUDIOQUEST • AUDIO NOTE • AUDIO INTERFACE • AUDIO VOIS • BERNING • BEVERIDGE • COUNTERPOINT • CWD • DYNAVECTOR • FUSELIER • GRACE • GRADO • ITC • KISEIKI • KLOSS • KRELL • LINN SONDEK • LIVE WIRE • MICRO SEIKI • MONSTER CABLE • NAD • NAIM AUDIO • NITTY GRITTY • NOVAK • PIONEER VIDEO • PRECISION FIDELITY • PROTON • RANDALL RESEARCH • RAUNA • REGA • ROBERTSON • SNELL ACOUSTICS • STAX • SUPEX • SYMDEX • SYRINX • TALISMAN • THRESHOLD

**SOUND BY SINGER**

227 Lexington Avenue  
New York, NY 10016  
(212) 683-0925

WE SHIP ANYWHERE  
WATCH FOR NEW LOCATION!  
165 EAST 33RD ST., NYC 10016  
CALL FOR DETAILS

**ELECTRO-VOICE AUTHORIZED DEALER**—Speaker components stocked (including 30" woofer) for high performance systems. Interface 1, 2, 3, plus stage, studio, PA speakers. Low prices. Rick Marder (201) 561-8123.

- Luxman
- Harmon Kardon
- Tandberg
- Boston Acoustics
- Audio Control
- Sherwood
- Hitachi
- Denon
- Revox
- Onkyo
- Ortofon
- Hafler
- Thorens

**Get It Free!**

- ADS
- AIWA
- Grace
- M&K
- B&O
- SME
- & Many More

We Deliver FREE  
Anywhere in the  
Continental USA!

**the SOUND Approach**

6067 Jericho Tpke., Commack, NY 11725  
Charge it...Call 516-499-7680

**AUTHORIZED DEALERS**

**NATIONAL**

**AUDIOPHILE START UP SYSTEM**

(\$700)

- Turntable: NAD 5025
- Receiver: NAD 7150
- Speakers: PARADIGM 5's

**SOUND BY SINGER**

227 Lexington Avenue  
New York, NY 10016  
(212) 683-0925

EXPANDING TO NEW LOCATION!  
CALL FOR DETAILS

CALL TOLL FREE 1-800-826-0520 FOR ACOUSTAT, DAHLQUIST, NAD, CARVER, HAFLER, DENON, dbx, THORENS, B&W, PROTON, TANDBERG, BELLES, 3D, GRACE, GRADO, PERREAUX, SNELL, VSP, ORACLE, M&K, SUMIKO, PYRAMID, NITTY GRITTY, TALISMAN, STAX, DYNAVECTOR, AUDIOQUEST, CWD, ASTATIC, DCM, SOTA, THE SOUND SELLER, 1706 MAIN ST., MARINETTE, WI 54143 (715) 735-9002.

**DEALERS, REPS AND AUDIOPHILES WANTED**

ATHENA is introducing a new line of audio products. Defined Operation electronic components and Bruce Brisson designed passive components utilize proprietary technologies for a unique level of performance. Call (415) 334-3320 for dealer information or send an SASE and \$5.00 for each of four White Papers.

**OHM WALSH 4 SIMPLY SUPERB.** Incredible, Imaging, you listen to the music, not the speaker. Treat yourself with some of the finest sound to be had outside a concert hall. AUDIO CENTER, 4815 Gratiot, Saginaw, Michigan 48603 (517) 790-7444.

**Audiophile's Corner**

**THE INCREDIBLE TRANSFORMATION**

**Interlink Reference<sup>®</sup> from Monster Cable**

Improves your sound system like no other component that you can add. Featuring Monster's "bandwidth balanced™" system of three "wire networks", Interlink Reference gets the maximum sound out of all your components. Available for audition at:  
ESOTERIC AUDIO, 27861 Orchard Lake Rd.  
Farmington Hills, MI (313) 553-8240



*You've been reading a lot about the superiority of tube amplification lately. Isn't it time you checked into it? The unique design of the Counterpoint SA-3 Preamp offers the sonic verity of tubes in a gorgeous slimline chassis. You owe it to yourself to audition the Counterpoint SA-3 and our other fine products at your dealer.*

**COUNTERPOINT**

(619) 453-9090

P.O. Box 12294, La Jolla, CA 92037

**Amazingly Affordable**

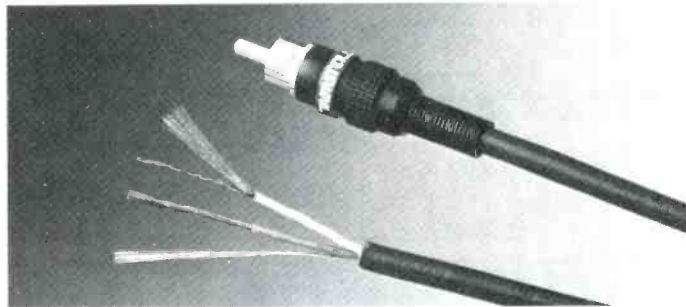

**A New Cable Technology Delivers High Performance at Low Cost**

Interlink 4 offers Monster Cable's exclusive "bandwidth balanced" technology\* and performance in a low cost, high performance cable. Based on the same technology used in Monster Cable's highly acclaimed Interlink Reference, Interlink 4 uses a special construction of dual multiple gauged wire inner conductors to accurately transfer both highs and lows with equal clarity and definition.

**Why "Bandwidth Balanced?"**

Unlike a conventional "coaxial cable" Interlink 4 incorporates 2 inner conductors plus a shield to accurately

control the magnetic behavior of the audio signals as they are transmitted through the wire. In addition each inner conductor utilizes 2 wire networks, one for the bass and one for the highs, to maintain proper balance in both phase and amplitude.

**The Result?**

Superb music reproduction. Powerful, dynamic, and natural. A high performance audiophile cable at a very non audiophile price. Available in various lengths from 1/2 meter to 20 ft. pairs as well as custom terminated lengths.

\* patent pending

**interlink 4**  
by MONSTER CABLE USA

**"Phase Aligned" High Resolution Interconnect**

Monster Cable Co., 101 Townsend St., San Francisco, CA USA 94107, 415/777-1355 telex: 470584 MCSYU1



# MUSIC, NOT JUST SOUND.

Our equipment is designed to reveal the full range of music. Hear it all at Chestnut Hill Audio: Accuphase, Acoustic Electronics, Amber, Apature, Apogee, Audio Pro, Audioquest, B&K Components, Berning, CWD, Counterpoint, DB, Denon, Duntech, Dynavector, EMT, Entec, Euphonic, Fourier, Grace, Haller, Janis, Koetsu, Kiseki, Krell, LAST, Linn, Sondek, Live Wire, Mark Levinson, J. A. Michell, Monster Cable, Music Reference, NAD, Naim, Oracle, Origin, Pioneer Video, Proton, Pyramid, Quad RGR, Rogers, Signet, Sony, Souther, Spectral, Spondor, Symdex, Syrinx, Talisman, Tandberg, Thorens, 3D Acoustics, VPI, VSP Labs, Vandersteen, Zeta. We are located at 311 Cherry Street, Philadelphia, Pa. 19106 (215) 923-3035

## CHESTNUT HILL AUDIO LTD.

### AUTHORIZED DEALERS

#### NATIONAL

#### "LEVEL II"—HALF-PRICE GRACE OR SECOND-RATE GRACE?

**EVERYBODY LOVES A BARGAIN.** But if you're considering a Grace "level II" cartridge as a lower cost alternative to a Grace F-9 series cartridge, you may be getting less than you bargained for.

As the only authorized importer of Grace products to the U.S., we were offered the Grace "level II" series two years ago. We rejected this series because technical evaluation showed that the motor mechanism and body of the "level II" were identical to those used in the old F-8 series, the only differences being the type of cantilevers and stylus available. The F-9 series, on the other hand, has a motor mechanism and body far advanced from the F-8 or "level II."

The "level II" cartridges are not updates of the F-9 series. "level II" cartridges should cost less than F-9s—they're worth less.

Several "mail-order discount" type outfits are offering "level II" cartridges for sale. The public should be aware that these cartridges are not imported by Sumiko, Inc., are not quality controlled by us, and are not covered by our warranty. The companies that sell you these goods claim to provide warranty on defective units. We have no way of knowing how valid these claims are, nor does the consumer have any assurance that these companies will still be in business when service is necessary. Warranty repairs may be available only in Japan for cartridges obtained from these sources.

To be sure your Grace products are coming from an authorized Sumiko dealer, please contact us and we will be glad to provide you with the name of your nearest dealer.

**SUMIKO, INC., P.O. BOX 5046,  
BERKELEY, CA 94705  
(415) 843-4500**

### AUTHORIZED DEALERS

#### NATIONAL

#### SPENDORS ARE SPLENDID!

Spondor loudspeakers are revered for their legendary performance and appreciated for their value pricing. Here are some examples: LS3/5A \$450.00\*, BC-1 \$775.00\*, SP-1 \$900.00\* (\*per pair; stands are extra). FREE SHIPPING in US and PR. WORLDWIDE EXPORTING. Visa and MasterCard. OXFORD AUDIO CONSULTANTS, INC., Box 145, Oxford, OH 45056-0145, 513-523-3333, TLX427791.

#### —EXCEPTIONAL AUDIO REPRODUCTION SYSTEMS—

REGA, HEYBROOK, AR, THORENS, DUAL turntables; ZETA, REGA, PREMIER, LOGIC, HELIUS tonearms; ADCOM, ARCAM, AUDIRE, CREEK, COUNTERPOINT, KENWOOD BASIC, KYOCERA, ROTEL, SHERWOOD, VSP LABS electronics; FRIED, HEYBROOK, MORDAUNT-SHORT, MAS, REGA loudspeakers. TALISMAN, SUPEX, PROMETHEAN, PREMIER, REGA, GRADO & SIGNATURE, ARCAM cartridges; AUDIOQUEST, DECCA, NITTY GRITTY, THE PIG and other accessories. EARS, P.O. BOX 658-U, W. COVINA, CA 91790, 818-961-6158. EVENINGS, WEEKENDS. MC/VISA. MANY MONTHLY specials! (SEND STAMP).

#### OXFORD AUDIO CONSULTANTS, INC.

For nearly ten years, we have been serving the audio cognoscenti, from our pastoral setting here in Oxford, Ohio, with excellent services, superb products and succinct, expert advice. We reach customers not only in Ohio, Kentucky and Indiana but throughout the United States, Puerto Rico and in countries all over the world. OAC specializes in accurate high quality audio components. Our product lines include AKG, AR, AUDIONICS, DENNESEN, GRACE, HAFNER, JANIS, LINN, NAIM, SPENDOR, TALISMAN, VANDERSTEEN AND WALKER. Demonstrations are given by appointment. Most orders are shipped by the next business day. We pay for shipping and insurance on orders shipped to the fifty states, Puerto Rico and APO/FPO. Our extensive export facility ships worldwide. OXFORD AUDIO CONSULTANTS, INC., Box 145, Oxford, OH 45056-0145, 513-523-3333, TLX427791.

### AUTHORIZED DEALERS

#### NATIONAL

**LINN & NAIM—NEW ARM, CARTRIDGE & MORE**  
Hopefully we will have these NEW products by the time you read this: Basik Plus arm, Karma cartridge, Naim Hi-Cap Power Supply. Hear all of the Linn/Naim components in our SINGLE SPEAKER DEMONSTRATION ROOM. FREE SHIPPING to all fifty states and APO/FPO. WORLDWIDE EXPORTING. Visa and MasterCard. OXFORD AUDIO CONSULTANTS, INC., Box 145, Oxford, OH 45056-0145, 513-523-3333, TLX427791.

**MONSTER CABLE AT LOWEST, LOWEST PRICES,** cut to any length. We Carry All Monster Cable accessories. Haller, Precision Fidelity, Thorens, C.J. Walker, Systemdek, DCM, Alpha 1, Grado, Jensen, Maxell UDXL2C90 \$2.19 each, UDXL2C90S \$2.59 each, Minimum of 12. Call or Write for other Great Prices. \$4.00 Shipping Charge. MC/Visa. Trolley Stereo 364 Trapelo Rd. Belmont, Ma. 02178, (617) 484-7847

#### MIDDLE ATLANTIC

**ADIRONDACK MUSIC** can put the excitement back in your stereo system—with a JBL subwoofer. Even the best systems often can't deliver the bottom octave—but a JBL subwoofer gives it to you with the punch and power of the original performance. The improvement is little short of amazing. Adirondack Music, Commercial Drive in New Hartford, NY.

#### ORPHEUS AUDIO—LONG ISLAND

AR (turntable), Grace, Haller, Kyocera, NAD, Orpheus loudspeakers, Sumiko, Vandersteen. **ORPHEUS AUDIO**, Locust Valley, NY (516) 676-5082.

#### AUDIO CONNECTION

in Northern New Jersey

**TURNABLES:** AR, GOLDMUND, HK, HEYBROOK, VPI  
**TO NEARMS:** E.T. (air), Goldmund/Lurne Souther  
**CARTRIDGES:** Alpha 1, Argon, Decca VdHul, Grado, Promethean, EMT VdHul & Type III, Win  
**ELECTRONICS:** Tube—Audible Illusions, Berning, Quicksilver (we stock replacement tubes) Solid State—Electrocompaniet, HK, FM Acoustics, Magnum, PS Audio  
**SPEAKERS:** Fuselier, Goetz, Heybrook, Kindel, Rauna, Spondor, Spica, 3D Acoustics, Vandersteen  
**ACCESSORIES:** Goldmund Clamp/Mat, LAST, LiveWire, Randall, Kimber, NG, Torumat, VPI  
201-239-1799  
615 Bloomfield Ave, Verona, NJ 07044

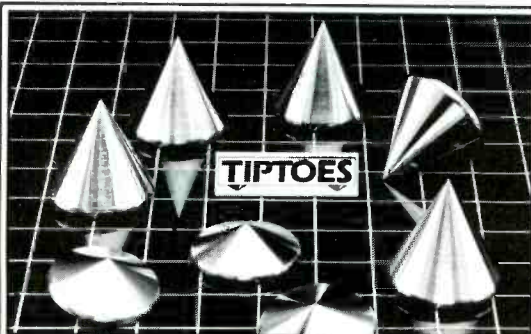

"The use of Tiptoes will increase the clarity, inner resolution and detail, and dynamic range of almost any audiophile system."

\$ENSIBLE SOUND

### TIPTOES

The perfect platforms for high quality components. Put your system on our TPTOES and you'll hear more clarity, better resolution, greater dynamic range. We guarantee it!

*The Mod Squad*

542 Coast Highway 101 • Leucadia, CA 92024 • (619) 436-7666

#### ARIZONA

Sound of DLM, Mesa  
Wilson Audio, Tucson

#### CALIFORNIA

Absolute Audio, Santa Ana & Woodland Hills  
Accurate Audio, Pasadena & Santa Monica  
Alta Buena Stereo, Grass Valley  
Ametron, Hollywood  
Audio Ecstasy, San Luis Obispo  
Audio One, West Hollywood  
Audio Today, Westminster  
Dimensions in Stereo, Torrance  
GNP, Pasadena  
Monterey Stereo, Monterey

Music by Design, Sausalito  
Music By The Sea, Leucadia  
North County Stereo, Encinitas  
Optimal Enchantment, Santa Monica  
Paul Seydor Audio, Los Angeles  
Shelley's Stereo, Santa Monica  
Sound Center, Woodland Hills  
Stereo Unlimited, San Diego  
Systems Design Group, Redondo Beach

#### FLORIDA

Audio By Canuso, Miami  
**LOUISIANA**  
Wilson Audio, New Orleans  
**MASSACHUSETTS**  
Audio Vision, Lexington  
Scientific Stereo, Sunderland

#### MICHIGAN

Audio Custom, Birmingham  
Audio Threshold, Mt. Clemens  
Classic Audio, Grand Rapids

#### MINNESOTA

Audio Perfection, Minneapolis  
Novatronics, New Brighton

#### NEBRASKA

Audio Additives, Omaha

#### NEW JERSEY

Audio Connection, Verona  
Professional Audio Consultants,  
Millburn

#### NEW MEXICO

Crosby's Camera & Stereo Center,  
Hobbs

#### NEW YORK

Aurico Sound, New York  
Eardrum, Nanuet  
JSG Audio, Binghamton  
Lyric Stereo Hi-Fi, New York & White Plains  
Sound Systems, Nesconset  
Stereo Emporium, Buffalo  
Stereo Exchange, New York  
Village Multitrack, Rochester  
**NORTH CAROLINA**  
Taylor House, Denver  
**OHIO**  
Play It Again Sam, Lakewood

#### OKLAHOMA

Audio Dimensions, Oklahoma City  
Youngblood Sound, Oklahoma City  
**OREGON**  
Corner Audio Store, Aloha  
**PENNSYLVANIA**  
Chestnut Hill Audio, Philadelphia  
**TEXAS**  
Arnold & Morgan Music, Dallas & Garland  
Audio Pro/Philes, Houston  
Audio Source, San Antonio  
Esoteric Audio Systems, Dallas  
Hillcrest High Fidelity, Dallas

**IN CANADA:** Distributed by MAY AUDIO MARKETING, Longueuil, Que.





# Randall Research Cable Systems

... the indispensable component

17925-a sky park circle

irvine, ca 92714

714/261-9141

## • SUMMER SPECIAL •

### OVER 50% EQUIVALENT SAVINGS!

The performance of systems costing over \$12,000 is available now at AudioVisions at a special package price of \$5,185 until September 25. LISTEN... ENJOY... AND THEN, COMPARE!

The new ORACLE "Alexandria" Mark II (\$1,050 complete with Oracle's revised auto-lift "Prelude" tonearm) extracts more information from the groove, more accurately, than tables selling for much, much more. (For those who haven't yet heard the news, please note that the Mark II designation identifies a unique, ingenious current storage bank and, also, new, improved suspension components: See our ad in the July Audio for further information.)

Your choice of two exceptional \$325 moving coil cartridges: Either the AUDIOQUEST "1.1" medium output, or the new ADCOM "XC/Micro-Ridge II" high output.

The LUXMAN TX-101 tuner, with 16 f.m. presets plus 8 a.m. presets, offers excellent reception and musical quality that is outstanding for \$350.

In addition to outstanding sonic performance, BRYSTON electronics offer RELIABILITY that is unmatched in the entire audio industry. In the 1B preamp (\$735), R.I.A.A. (phono) equalization is accomplished via a unique division of the equalization curve into two sections, each handled by a separate discrete circuit. When testing the 1B for Audio magazine, Len Feldman became "frustrated" because he could not measure ANY distortion! Meanwhile, Sound Canada magazine praised the 1B's "clarity and definition and sense of space." Bryston's 3B amplifier has two power supplies (totally separate for left and right channels), each of which is at least as large if not larger than the single power supplies in other amplifiers, and can deliver huge amounts of output current (12 amperes per channel CONTINUOUSLY, 36 amperes per channel short duration). For \$925, this kind of quality (most of the 3B's componentry exceeds even military specifications by a wide margin) is, truly, unique.

The leading high-end audio publications are now describing the THIEL model C33 loudspeakers (\$1,950/pair) as "SUPERB!" and "FANTASTIC!" We, ourselves, have had a few words to say about the C33, and we've been saying them for about a year now (well in advance of all the magazines). If you haven't yet heard the C33, we have a very rare treat waiting for you.

**CABLES:** Yes, they are very important, especially with sophisticated components such as the above. We believe that when you are given a price for a system, the price should be for the COMPLETE system. Thus, our package price includes, from MONSTER CABLE, the following—2 pair of 1 meter "REFERENCE" interconnects, 40 feet of "POWERLINE II" speaker cable, 2 pair of "EXTERMINATORS" (bananas), and 8 gold spade connectors—\$326 total.

**ALSO INCLUDED:** A few other items, such as, delivery and set-up (2 hours time, certain other limitations) anywhere in the metro New York area. (To assure optimal location of speakers in your listening room, set-ups are personally supervised by one of the AudioVisions owners.) The AudioVisions "Courtesy Card" (non-transferrable) has already saved some of our customers hundreds of dollars—and the card's benefits are LIFETIME benefits. Lastly, the MOST IMPORTANT ITEM OF THEM ALL: the expertise, dedication, and technical support services of the AudioVisions staff (when visiting us, ask to see our new service lab with over \$20,000 of test equipment).

1067 MONTAUK HIGHWAY, WEST BABYLON  
NEW YORK (516) 661-3355

**AudioVisions**

## AUTHORIZED DEALERS

### SOUTHWEST

#### GENE RUBIN AUDIO—LOS ANGELES

Linn Sondek	Naim Audio	Isobariks
Thorens	Conrad-Johnson	Acoustat
C.J. Walker	Creek	Spendor
Acoustic Research	NAD	Celestion
Dual	Precision Fidelity	PS Audio

Pre-paid shipping, (818) 571-1299, (Pac. time)

**ATTENTION ADVERTISERS!  
SEE CLASSIFIED RATE BOX  
ON PAGE 104 FOR NEW  
RATES EFFECTIVE OCTOBER  
1984 ISSUE.**

### MIDWEST

**ANY STEREO SYSTEM**, no matter how good, can benefit from a JBL subwoofer. These are the best subwoofers we've heard; they reproduce the lowest octave with clarity and depth. And the midrange of the stereo speakers is cleaner too. Hear how a JBL subwoofer will improve your system, at Meyer Television and Audio in Edwardsville, IL (618) 656-4620.

**AUDIO EMPORIUM**, representing hi-fi's best values. Free Catalog, 6914 W. Brown Deer Rd., Milwaukee, WI. 53223. 414-354-5082. **AD**

**B&B APPLIANCE** will HELP your stereo system reach new lows—with a JBL subwoofer. The JBL B460 and B380 will let you hear all the low bass that's in today's best recordings—and when you hear it, you won't want to live without it. Hear these remarkable JBL subwoofers at B&B Appliance in Middleburg Heights, OH (216) 842-5600, and in Cleveland (216) 261-5600.



### REMOVES VOCALS FROM RECORDS!

Our VOCAL ELIMINATOR can remove most or virtually all of a lead vocal from a standard stereo record and leave most of the background untouched! Record with your voice or perform live with the backgrounds. Used in Professional Performance yet connects easily to a home component stereo system. Not an equalizer! We can prove it works over the phone. Write or call for a free brochure and demo record.

Write to: **LT Sound, Dept. AU, PO Box 338**  
Stone Mountain, GA 30086  
In Georgia Call (404)493-1258  
**TOLL FREE: 1-800-241-3005 — Ext. 43**

## AUTHORIZED DEALERS

### MIDWEST

**DIGITAL SIGHTS AND SOUNDS** features new lows in audio—the best subwoofers we've ever heard. And they're from JBL! The JBL B380 and B460 bring you the bottom octave that's missing in just about all full-range systems. You owe it to yourself to hear what we're talking about. Digital Sights & Sounds, 783 Bethel Rd., Olentangy Plaza, Columbus, OH.

**GOURLEY PRO AUDIO** now has the world's best subwoofers—from JBL! The JBL B380 and B460 bring you the bottom octave that's missing from most full-range systems. Today's best recordings really benefit from a JBL subwoofer—the difference is dramatic! Hear JBL at Gourley Pro Audio, 400 N. Main, Sioux Falls, SD.

**IN BLOOMINGTON, THE PLACE TO GO** to add new lows to your stereo system is American Audio-Video. We feature the best subwoofers you'll find—and they're from JBL! We think that only JBL can reproduce both the power and the subtlety of the low bass on today's best recordings. Come in and hear what we mean. American Audio-Video, Bloomington, IN. (812) 334-1905.

**PARAGON SOUND** can help you find the missing octave—the low bass that adds drama and impact to your music. Come in and listen to a JBL subwoofer system, the best we know of. Today's best recordings have plenty of low frequency content, and a JBL subwoofer will let you hear all of it. Paragon Sound, Toledo, OH (419) 882-1010.

**QUITE A CHALLENGE**, but there is a way to add the lowest octave to your stereo system. Hear a JBL subwoofer, and you'll be amazed at the clarity and power it adds to even the best full-range systems. Once you hear it, you won't want to be without it. Come to Stereo Center, Flint, MI (313) 239-9474.

**RED BARON'S INC. IS PROUD** to feature JBL subwoofers, the very best. The JBL B460 and B380 reproduce the lowest octave with clarity and depth, and they reach the volume levels that make such bass stunning in its impact. After you hear what a JBL subwoofer can do for your favorite state-of-the-art recordings, you'll wonder how you lived without it. Red Baron's in Wichita, KS (316) 684-6572.

**SO YOU THOUGHT SUBWOOFERS** were only for reproducing cannon shots? When you hear the JBL subwoofers, you'll find out how much one of them can add to any good recording. In fact, when you hear what really good bass actually sounds like, you'll wonder how you ever got along without one... even if you don't like cannon. Sound World in Appleton, WI (414) 733-8539 and in Green Bay (414) 499-4519.

**AUDIO ELITE HAS ACOUSTAT!!!**  
AUDIO ELITE, Menasha, WI. 414-725-4431

### NORTHWEST

**DEEP BASS THAT'S REALLY** crisp and clean? You bet. when you have a JBL subwoofer. Audition the JBL B380 at the Sound Wave in Pocatello and you'll hear how much bass there really is in today's best recordings. Only JBL can give you the bottom octave with such clarity and power. Hear it at the Sound Wave, 416 S. 5th Ave., Pocatello, ID.

## KIMBER KABLE

HIGH PERFORMANCE  
SPEAKER WIRE

Strong in the West, headin' East.

**ASK YOUR DEALER**

Manufactured by:

RKB Industrial, Inc.  
2058 Harrison Blvd.  
Ogden, Utah 84401  
(801) 621-5530

## AUTHORIZED DEALERS

### NORTHWEST

**MARK'S CUSTOM STEREO** now features the world's best subwoofers—JBL! That's right—JBL! The JBL B460 and B380 restore the bottom octave that's missing from most stereo systems—and once you've heard true deep bass, you won't want to live without it. We wouldn't. Hear it all at Mark's Custom Stereo, Ontario, OR (503) 889-8855.

**ROCKY MOUNTAIN HI-FI WANTS** to help you find the missing octave in your stereo system—the lowest octave. Most full-range systems simply can't reach that low. But a JBL subwoofer can. These are the best subwoofers we've ever heard, and adding one to your system will make a dramatic difference. Rocky Mountain Hi-Fi in Great Falls, MT (406) 761-8683.

**THE SOUND TRACK NOW OFFERS** the world's best subwoofers—JBL! That's right, JBL. The B380 and B460 reproduce the lowest octave, the one missing from most systems. From thunderous crescendos to delicately played tympans, a JBL subwoofer brings out the best in your best recordings. The Sound Track, Boise, ID (208) 375-5530.

### WEST

**FIDELITY SOUND OF ORANGE** wants you to hear low frequency sound so good you won't believe it's from a speaker system. But it is—and from a JBL subwoofer system. There's really no other way we know of to get true deep bass. The JBL subwoofers are the best around. Hear them at Fidelity Sound, Orange, CA (714) 997-3030.

**GRAMOPHONE SHOP, INC.** now offers the world's best subwoofers—and they're from JBL! That's right—JBL's subwoofers deliver the truest low bass reproduction we've heard. Today's best recordings demand these systems, and so will you when you hear them. Come in now—the Gramophone Shop in Denver (303) 744-1283.

**HARMONY STEREO CAN SHOW YOU** how to take your stereo system to new lows—with a JBL subwoofer. Today's top recordings have lots of good low frequency information, and it takes a JBL subwoofer to let you hear it as it ought to be heard. So for clean, powerful bass, hear JBL at Harmony Stereo in San Francisco (415) 661-2525.

**KUSTOM HI-FI IN BURLINGAME** wants to introduce you to the best in low frequency reproduction—a JBL subwoofer. From cannon to contrabassoon, a JBL subwoofer gives you all the power—and the detail—that's present in the lowest octaves. We wouldn't live without it. And we think you'll feel the same way. Kustom Hi-Fi, 220 California Drive in Burlingame, CA.

**LISTEN UP BRINGS NEW LOWS** to the mile-high city—subwoofers from JBL! JBL makes the best low frequency loudspeakers around, and the B380 and B460 subwoofers are what you need to hear the bottom octave that's missing from just about all full-range systems. Hear what we're talking about at 685 S. Pearl St. in Denver.

## AUTHORIZED DEALERS

### WEST

**MATEO HI-FIDELITY** is now featuring the ultimate low in stereo sound—a JBL subwoofer system. JBL makes the best low frequency loudspeakers in the world, subwoofers that cleanly reproduce the bottom octave that's missing from most stereo systems. Today's best recordings demand equipment of this caliber. Mateo Hi-Fidelity, San Mateo, CA (415) 573-6506.

**NO QUALITY STEREO SYSTEM** should be without a JBL subwoofer. Come to Sunnyvale Electronics and hear what these spectacular speakers can do for you. With a JBL subwoofer, you'll hear the lowest octave, and hear it cleanly and crisply. Sunnyvale Electronics in Sunnyvale, CA (408) 736-1323.

**PERFECTION** in audio reproduction is hard to find... but you should listen to a JBL subwoofer system. With today's fine signal sources, you'll hear the lowest octave the way it should be heard. A JBL subwoofer will improve any stereo system. Hear what it can do at Serra Stereo in Colma, CA (415) 992-5018.

**STEREO SHOWCASE NOW FEATURES** an indispensable part of the ultimate stereo system—a JBL subwoofer. JBL makes the best low frequency loudspeakers we know of, and you won't believe how good the sound is until you've heard one. The impact is stunning. Hear for yourself at Stereo Showcase in Vallejo, CA (707) 552-1515, and in Sacramento (916) 483-5141.

**THRIFTY ELECTRONICS CAN SHOW** you how to take your stereo system to new lows—with a JBL subwoofer. The JBL subwoofers will reproduce the bottom octave of music, the octave that's missing from even the best full-range systems. JBL brings it to you cleanly and powerfully. Hear JBL at Thrifty Electronics in Van Nuys, CA (818) 786-1610, (819) 873-2976.

**UNLESS YOU HAVE A JBL SUBWOOFER**, you're probably missing out on hearing the lowest octave. From cannon to contrabassoon, there is a lot of music down there, and it takes a JBL subwoofer to reproduce it with the clarity and power of the original performance. Hear JBL at Metro Stereo, Fresno, CA (209) 221-0500. Also in Visalia.

**WOODEN SHIP STEREO OF AUBURN** wants to introduce you to the best low frequency reproduction you're likely to hear—a JBL subwoofer. That's right—JBL makes a superb subwoofer system that lets you hear the bottom octave that's missing from most setups. Hear what JBL can do for you at Wooden Ship Stereo in Auburn, CA (916) 823-1493.

**YOU WON'T BELIEVE THE DIFFERENCE** a JBL subwoofer can make in even the best stereo systems. For the first time, you'll hear the bottom octave the way it was intended to be heard. No boom, no mud, just clean, deep bass. Hear it at Speaker Works, 211 E. Katella in Orange, CA, or 16460 Whittier Blvd. in Whittier.

TAPE WORLD TOLL FREE 1-800-245-6000						
TOK	MARKELL	TOK	1120/1750	5.99	SCOTCH 1120/1750	6.49
MA/90	4.29	XL1500	2.79	TOR.	1120/1750HG	7.69
SAX.90	2.99	UDX1190	2.25	MARKELL	1120/1750	5.99
ADK.90	2.59	UDX1160	2.19	MARKELL	1120/1750GX	7.69
SA.90	1.99	UD90	.99	KODAK	1120/1750	5.99
SA.60	1.89	UD50	.89	FUJII	1120/1750	6.49
AD.90	1.89	LN90	1.29	SONY	1120/1750	6.49
AD.60	1.49	LN60	1.10	SONY	UCX5 90	2.49
D.90	1.10	XL3500	6.49	SONY	HI90	1.19
D.60	.99	UD3590	4.99	FUJII	FR190	2.29

WE WILL BEAT ANY COMPETITOR'S PRICE OF THE TOTAL ORDER, INCLUDING ALL SHIPPING AND HANDLING CHARGES BY 1%.

3.75 Shipping any size order in US. VISA, MC no extra charge. COD Add 1.65. Minimum COD order \$8.00. PA add Sales Tax. All orders shipped within 48 hours. MT 8:30-1:00

323 Brown Avenue Box 341 Butler, PA 16001 412-283-8621

# ANNOUNCING A MAJOR DESIGN ADVANCE FROM VMPS

After driver selection, crossover design is the most critical element determining loudspeaker performance. For the past ten years we at VMPS have advocated correct relative driver polarity and phase coherent filter networks as essentials for system minimum phase response, the prerequisite for true waveform fidelity in any transducer. First order, 6dB/octave crossovers in VMPS speakers maintain phase coherence, prevent time delay and insertion losses, and in conjunction with drive elements specially designed to complement such a slope, have contributed to our worldwide reputation for unmatched low distortion, linearity, tremendous dynamic range and outstanding bass response.

The first order filter network has a drawback: response outside the driver passband is rolled off very gradually, and driver crossmodulation can become an audible phenomenon even in the best of such designs. To rectify this problem without sacrificing the virtues of the first-order network, VMPS introduces—for the first time in commercially available five- and six-way speaker systems—**Quasi Second Order (QSO)** filter networks in our five floorstanding systems (**MiniTower II**, \$309ea kit, \$439ea assem, **Tower I**, \$419ea kit, \$599ea assem, **Super Tower/R**, \$679ea kit, \$969ea assem; **Super Tower IIa/R**, \$999-1199ea kit, \$1499-1699ea assem, and the fabulous **Widerange Ribbon**, \$5995 complete, \$7500 in the Special Edition with all Wondercaps™ and Randall Research internal wiring) and three bookshelf systems (**404b**, \$129ea, **606c**, \$199ea, **808c**, \$289ea). The QSO circuit dramatically reduces driver interference effects, resulting in an amazingly spacious, unboxy sonic presentation (something all enclosed speaker systems must strive for) and even lower THD and IM products. We believe the naturalness and fidelity of these speakers to be unsurpassed by any competitor regardless of size or price, setting new high standards for sound quality per dollar.

Hear the new QSO series at the dealers listed below (and don't forget our new **Subwoofer**, \$250ea kit, \$375ea assem, and **Electronic Crossovers**, \$250 and \$395 ea) or write us for brochures and test reports. Kits include fully assembled cabinets and prices include **free shipping** in USA.

## VMPS AUDIO PRODUCTS

div Itone Audio  
1016 Contra Costa Dr., El Cerrito,  
CA 94530 415-526-7084

Hear VMPS at: The Listening Studio, Boston; Cuomo's, Salem NH; Mike Hilliard, Shreveport La; Audio Labs, Des Moines Ia; Efficient Stereo, Woodland Hills CA; The Long Ear, Big Bear Lake Ca; Sounds Unique, San Jose Ca; A-Vidd Electronics, Long Beach Ca; Itone Audio, El Cerrito Ca; Leisure Electronics, Chugiak Ak; Arthur Morgan (rep), Altamonte Springs Fl.

Note: VMPS speakers delivered after 6/1/84 are equipped with our new **Son of Superdome** softdome tweeter, a slightly less elaborate version of our **Superdome** tweeter still available as an extra cost option. Superdome and Son of Superdome feature ferrofluid cooling, two-layer voicecoils, very high power handling, and the finest sonics of any driver of its type. Son of Superdome is supplied at no increase in price. Owners wishing to update to QSO filters or either of the new tweeters can do so at low cost; contact us for details.

## SYSTEMDEK IIX

The **SYSTEMDEK IIX** represents the ultimate value/performance combination in turntables available today. This is accomplished by including such features as: oil-pump bearing, glass platter, lamb's wool record mat, 24 pole synchronous motor, belt drive, interchangeable arm board, real-wood base built about a steel frame and a unique 3-point hung suspension which allows quick and easy adjustment, even while a record is playing! All this at a surprisingly affordable price.

The **SYSTEMDEK IIX** is available: without tonearm, fitted with a Profile II (as shown); or Profile IIS tonearm.

Please write for further information.

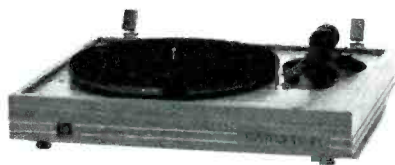

DISTRIBUTED BY:

**PRO-ACOUSTICS INC.**

IN CANADA:

16877 Hymus Blvd  
Kirkland, Quebec  
H9H 3L4

IN USA:

Waterfront Plaza  
Newport, Vermont  
05855



**COMPACT DISC CENTER** (518) 664-2550  
 P.O. BOX 616  
 CLIFTON PARK, NY 12065  
 QUALITY. AT AFFORDABLE PRICES. • FREE CATALOGUE  
 LARGE SELECTION  
 1-3 per disc \$16.99  
 4-9 \$15.99  
 OVER 10 \$14.99

## Sidereal Akustic™

Finally, a full range dynamic loudspeaker with speed and accuracy beyond even the finest electrostatics. Without the size, complexity or sonic drawbacks of these systems.

Designed from its inception to provide an essentially flawless recreation of the original sound field, the Sidereal Akustic Model Four Loudspeaker System is startling in its life-like, three dimensional realism.

Sidereal Akustic invites you to audition the Model Four Loudspeaker System in your Dealer's listening room.

### Sidereal Akustic.. Audio Systems Inc.

4035 Oceanside Blvd. Unit G-57  
 Oceanside, CA 92054 (619) 726-3150

## AMPS/PREAMPS

### A REAL AMPLIFIER

If we were to look at what's going on today in the audio world, we would immediately have to recognize the fact that no amplifier, advertised today, is truly just that, an amplifier. By this we mean a device which does only one thing, and that is, amplify the music signal! FAITHFULLY!. By today's accepted standards, an amplifier has become something, that has very distinct characteristics, which come along with the amplification, thus altering the sound. In fact, today, that's become EXPECTED of an amplifier.

Well, ACOUSTIC ELECTRONICS has on the market today, a device, which we call a **AMPLIFIED IMAGE REPRODUCER**, which is a **REAL AMPLIFIER**.

The AR 2.2, as confirmed by today's leading audio experts and reviewers, is truly a Real Amplifier in the sense that you **FINALLY** hear only the music, amplified as it was intended at the moment of recording. No misleading qualities of its own, no anomalies which confuse, compress, rearrange or otherwise **INTERFERE** with the job at hand; amplification of music signal! Impossible you say!!! Well, find an authorized dealer and listen, for the first time, to the **MUSIC**. It'll be a new experience for you, a true awakening to what's being done in audio **TODAY!** (linear amplification). And dealers, who are currently selling the usual high-end "break throughs", are invited to discover one that's **REAL**. All inquiries welcome: Acoustic Electronics, P.O. Box 13, Highlands, NJ 07732.

**A HIGH END PREAMP** for \$495? The Counterpoint SA-7 is the audiophiles' choice. Hear it at Musical Images in Fresno. (209) 226-1770. **AD**

**AMPLIFIERS**—Electron Kinetics Eagle 7A (#44), mint \$2,200; ARC D-75, near mint, \$500, (214) 573-4678 or (214) 783-0661 after 6 p.m. CST.

**AUDIO RESEARCH D-50F1b POWERAMP** \$450, SP-3 preamp \$350, EC-3An 3-way adjustable crossover (Mint) \$450, McIntosh 225 poweramps (Pair) \$200ea. Harman-Kardon Citation 12 poweramp \$175. Jeff 517-669-8089. 6-10pm est.

## AMPS/PREAMPS

### ATTENTION DYNA AND HAFLER OWNERS

We build new circuits into most Dyna and Hafler units. We transform Dyna ST-80, ST-120, ST-150, ST-300, ST-400, ST-416, SCA-50, and SCA-80Q amplifiers into modern POWER MOS-FET amps with new PC cards, precision parts, and low inductance power supplies. We install five new PC cards in Hafler DH-200 and DH-220 amplifiers with ground plane output networks for much improved transient performance. We install new circuits in DH-101, PAT-5, PAT-4, and PAS-3X preamplifiers with exact RIAA equalization, matched precision parts, precision controls, and complete freedom from transient and digital overload. Audiogram said we make the world's best tuner in the FM-5 chassis. Our \$99 phono cartridge has a satisfaction guarantee or your money back. Call or write for free catalog and sample copy of our monthly newsletter, Audio Basics. We ship worldwide and have new 120 and 240 volt equipment available.

**JENSENS STEREO SHOP**  
 2202 RIVER HILLS DRIVE  
 BURNSVILLE, MINN. 55337, (612) 890-3517

**AUDIO PERFECTION IN MINNEAPOLIS** presents Counterpoint. Hear what music sounds like without Solid State devices. (612) 866-0083. **AD**

**AUDIO RESEARCH SP6A PREAMPLIFIER**—\$795; Audio Research D350 Amplifier \$1295. 509-627-2638. West Coast. Eves. or Early AM.

**AUDIO RESEARCH SP6A PREAMP**—\$350.00. Hafler DH500 - \$400.00. (308) 237-7993.

## BIG TEN SYSTEM

(UNDER \$10,000)

Turntable: Linn Sondek Lp-12  
 Tonearm: Syrinx PU-3  
 Cartridge: Kiseiki Blue  
 Tuner: Adcom GFT-1A  
 Preamp: Krell PAM 1-A  
 Amp: Krell KSA-100  
 Speakers: Snell Type A's

## SOUND BY SINGER

227 Lexington Avenue  
 New York, NY 10016  
 (212) 683-0925

EXPANDING TO NEW LOCATION!  
 CALL FOR DETAILS

**BRB SYSTEMS**—delivers performance without the hype and high prices! Model 200 Power Amps 100w/ch \$395. Model 120's 60w ch \$250. Full 3 year warranty, 30 day return policy. COD, checks or M.O. P.O. Box 391202, Mt. View, CA. 94039.

**CROWN DC300A**, NEVER USED, perfect condition \$900. W.E. Brennan, 3560 Admiralty Bay, Anchorage, AK 99515.

### DOES YOUR HAFLER HAVE LIPS?

Ours do! Imagine an extremely wide bandwidth, ultra low impedance power supply. A power supply that sounds far better than most dual mono designs, because of it's very low terminal impedance. Imagine it all fits on a 4 x 2 1/4 PCB and fits neatly into Hafler preamps and others requiring ± 12v to ± 24v at 200ma. You've just imagined a LIPS. Musical Concepts, 1060 Fifth Plaza, Florissant MO 63031, 314-831-1822.

**DYNA PAT-5 PREAMP WITH WOOD CASE**. Old Van Alstine modification. Takes moving coils straight in. \$130. (915) 658-5945.

**FM ACOUSTICS' 240 PREAMPLIFIER**: Should one spend \$3995 on a preamp? Fine music knows no price. Audio Connection 201-239-1799. **AD**

**FUTTERMAN OTL AMPLIFIERS & MOSCODO** hybrid high power amplifiers at Landes Audio (201) 674-4000. **AD**

### HAFLER IN THE SOUTH!

In stock, the superb Hafler pre-amps, amplifiers, tuner and equalizer. Immediate, FREE shipping. Also Acoustat, Adcom, Audire, Carver, Conrad-Johnson, Fried, Klipsch, Mirage, Nakamichi, PS, Proton, SAE, Talisman, Thorens, Vandersteen, digital discs and players. READ BROTHERS STEREO, 593 King Street, Charleston, South Carolina 29403 (803) 723-7276. **AD**

# THE MOST TRUSTED AUDIO DEALERSHIP

Located in Rochester, New York and established by pianist James Gala, **GALA SOUND** sells musically accurate and correctly engineered audio components.

Audiophiles, musical institutions, and recording studios interested in achieving the highest level of sound reproduction rely on **GALA SOUND** for definitive audio systems designed for their specific needs and listening environments.

We deliver and install state-of-the-art audio systems anywhere in the Continental U.S. with a minimum purchase of \$7,000. For lesser amounts, we ship you the audio components of your choice the day you order.

Phone — please do not write — Mr. Gala at (716) 461-3000. If Music is significant in your life, you deserve an audio system from **GALA SOUND**.



James Gala

MARK LEVINSON • THRESHOLD • McINTOSH  
 KEF • B & W • QUAD • MAGNEPLANAR • ACOUSTAT • POLK  
 ORACLE • THORENS • NAKAMICHI • KYOCERA • NAD  
 BANG & OLUFSEN • LUXMAN • BRYSTON • GRACE

# GALA SOUND

650 Monroe Avenue, Rochester, N.Y. 14607  
 (716) 461-3000

## AMPS/PREAMPS

### HAFLE—QUALITY AUDIO, MODEST PRICES

We stock all of the following components: DH-100K \$149.95, DH-100A \$199.95, DH-110K \$324.95, DH-110A \$399.95, DH-112 \$74.95, DH-160K \$299.95, DH-160A \$399.95, DH-220K \$349.95, DH-220KE \$359.95, DH-220A \$449.95, DH-220AE \$459.95, DH-330K \$374.95, DH-330A \$449.95, DH-500K \$599.95, DH-500KE \$619.95, DH-500A \$749.95, DH-500AE \$769.95. Accessories too! Three year warranty on assembled units. FREE SHIPPING to all fifty states, PR and APO/FPO. WORLDWIDE EXPORTING. Visa and MasterCard honored. OXFORD AUDIO CONSULTANTS, INC., Box 145, Oxford, OH 45056-0145, 513-523-3333, TLX427791. **AD**

**HARMAN/KARDON, NAKAMICHI, TANDBERG, CROWN, REVOX, HAFLE, CARVER, NAD, DBX, ELECTRO-VOICE AND OTHER QUALITY COMPONENTS. BEST PRICES-PROFESSIONAL CONSULTATION. AMERISOUND SALES, INC., P.O. BOX 24009, JACKSONVILLE, FL. 32241. EAST: (904) 262-4000, WEST: (818) 840-0878.**

**MARK LEVINSON IN PITTSBURGH.** Hear these superb electronics now on display at BETTER SOUND CONCEPTS, 400 South Craig St., Pittsburgh, PA 15213. (412) 687-3737.

**MARK 9 POWER AMPLIFIERS, 250 watt amp using six 6550A outputs tubes and a regulated power supply. \$795.00 kit - \$975.00 wired. Write for brochure. AUDIO CLASSICS/ATLANTA, PO BOX 690, ROSWELL GA 30077.**

## MAVRICK/SPATIAL

Another preamplifier . . . absolutely not. This one sonically surpasses the performance of ANY production preamplifier in the World. We guarantee it will or we'll buy it back! Proper explanations of the unique circuitry and construction techniques are best accomplished via phone. Call:

## AUDIO ONE

8788 Sunset Boulevard.  
West Hollywood, California 90069  
**213/855-0500** **AD**

**MCINTOSH MC-275,** and New York Audio Labs **FUTTERMAN** OTL-3's (pair) high-power tube amps. Absolutely superb. 406-222-7404 late eves, early morns.

**MITSUBISHI DA-A15DC 150 w/ch power amplifier;** dual-monaural, direct-coupled circuitry; perfect, \$195, 215-345-4567.

**NAD 1020, \$125;** Signet TK7LCA, new stylus, \$75. Both excellent condition. 303-565-2190 evenings MST. **AD**

## AMPS/PREAMPS

**MITCHELL COTTER MK2L, MC pickup transformer** mint \$400 nego. New \$750. (812) 254-1461.

**\$\$\$ MONEY BACK GUARANTEE \$\$\$** You must agree that the \$200 Phoenix P-10-MMA or P-10-MCA (for moving coil) sounds better than your present phono Preamp or return within 30 days for full refund. M/C, Visa, & C.O.D. call (203) 643-4484. Free shipping in U.S. PHOENIX SYSTEMS INC-A, Manchester, CT 06040.

### MUSICAL CONCEPTS PRESENTS THE M-110 GOLD

Our newly revised M-110 mod will raise great excitement among serious audiophiles, but the M-110 Gold is something else. It's the ultimate expression of the design, with Teflon RIAA capacitors and the LIPS power supply included. This ravishing musical experience will be available in kit (\$325) or installed (\$425). Limited quantities. Musical Concepts, 1060 Fifth Plaza, Florissant, MO 63031, 314-831-1822

**PS AUDIO'S INCREDIBLE PSIV CHALLENGES** any pre-amplifier. Audio Nexus, NJ, (201) 464-8238, (201) 730-2409.

### SYMMETRY AS-1 MC AMPLIFIER

SYMMETRY HAS A VERY FEW superb moving coil head-amps in an extra special Consumer Electronics Show rack-mount chassis. Available factory direct at \$450. (415) 334-3320.

**THRESHOLD FET ONE \$1450.** Threshold series II amp \$2500. 918-582-8944 after 6 p.m. Oklahoma.

## TUNERS

**HARMAN/KARDON, NAKAMICHI, TANDBERG, CROWN, REVOX, HAFLE, CARVER, NAD, DBX, ELECTRO-VOICE AND OTHER QUALITY COMPONENTS. BEST PRICES-PROFESSIONAL CONSULTATION. AMERISOUND SALES, INC., P.O. BOX 24009, JACKSONVILLE, FL. 32241. EAST: (904) 262-4000, WEST: (818) 840-0878.**

## LOUDSPEAKERS

**A&S OFFERS THE WIDEST SELECTION** of high-end speaker kits and raw drivers from the world's finest manufacturers including Dynaudio, Fried, Audax, Falcon-Acoustics, SEAS, Peerless, Morel, Dalesford/Cambridge, Jordan, Philips, JVC, Siare and Pinfold. Custom auto speaker systems and separates are also available. Free catalog. A&S SPEAKERS, Box 7462A, Denver, CO 80207, (303) 399-8609.

**BEVERIDGE SYSTEM 5** full range electrostatics available in N.J. Landes Audio (201)-674-4000. **AD**

## BOSTON AREA'S FINEST

Conrad Johnson  
Souther  
Pro Ac  
Duntech  
Vandersteen  
Infinity RS 1  
Sumiko  
Stax  
V.P.I.

Spica  
Perreaux  
Electrocompaniet  
Counterpoint  
Acoustic Electronics  
Futterman  
Accuphase  
Koetsu  
and many others

LEASING OF FINE PRODUCTS NOW AVAILABLE



**40 Mass. Ave.  
Lexington, MA 02173  
617 863-5221**



**ALL DISC MUSIC, INC.**

FOR COMPACT DISCS  
AND ACCESSORIES  
CALL US TOLL FREE!

**1-800-ALL-DISC**

IN CONNECTICUT **1-452-0203**

CALL FOR A FREE CATALOG TODAY!!!

 **plateau**  
SPEAKER STANDS

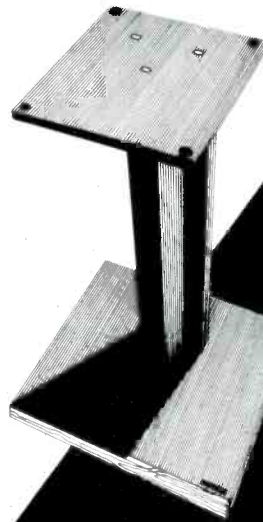

Plateau speaker stands provide an easy and inexpensive way to dramatically improve the performance of your audio system. Designed to acoustically decouple and position the speaker, Plateau provides tighter bass, more focused mid-range and precise stereo imaging. For more information and the name of your nearest Plateau dealer, please write:

Canada  
Naiad Products Inc  
Box 1840  
Branford, Ontario  
N3T 5W4

United States  
Naiad Products Inc  
Box 1250 Falls Sta.  
Niagara Falls, N.Y.  
14303-0260

## THE PEOPLE TO LISTEN TO:

knowledge, individual attention plus the names you want most in audio/video.

•ACOUSTAT•ACOUSTIC ELECTRONICS•AUDIO RESEARCH•B&O•DENON  
•Boston Acoustics•ADS•COUNTERPOINT•CARVER•DUNTECH•HAFLE  
•Discrete Technology•KYOCERA•JENSEN VIDEO•PS AUDIO•Alphason  
•Koetsu•Dahlquist•GRADO•LINN SONDEK•PROAC•SONOGRAPHIE  
•REGA•NAD•Signet•THIEL•Naim•Koetsu•Grace

**CSA**  
**AUDIO/VIDEO**  
**201/744-0600**  
upper montclair nj

**AUTHORIZED DEALER**

## Fanfare FOR THE UNCOMMON MAN

This is the only loudspeaker available at under \$600 that has: true acoustical alignment of its drivers, phase coherent crossover, open air tweeter mount, imported polypropylene drivers, Wonder Caps, Livewire BC-1, and gold plated, 5-way binding posts. The result is MUSIC at a price the common man can afford. Write for literature and the location of the dealer nearest you.

4650 ARROW HWY #F4, MONTCLAIR, CA 91763 • 714/624-4020







Authorized Dealers

- ALABAMA: Litus Audio, Birmingham, AL
ALASKA: Shmek's Audio, 405 E. Northern Lights Blvd, Anchorage, AK
ARIZONA: Wilson Audio Ltd., Tucson, AZ
CALIFORNIA: Christopher Hansen, Los Angeles, CA
COLORADO: Boulder Sound Gallery, Denver, CO
CONNECTICUT: Tweeter Etc., New Haven, CT
DISTRICT OF COLUMBIA: Myer Emco, Washington, DC
FLORIDA: Market Place Electric, Orlando, FL
GEORGIA: Georgia Music, Macon, GA
HAWAII: Hilo Audio Inc., Hilo, HI
ILLINOIS: Audio Dimensions, Moline, IL
INDIANA: Mark Ark Audio, Mishawaka, IN
IOWA: Audio Labs, Des Moines, IA
KANSAS: Custom Sound, Wichita, KS
LOUISIANA: Patu Kadat Home & Commercial, Baton Rouge, LA
MAINE: New England Music Co., Portland, ME
MARYLAND: Myer Emco, Rockville, MD
MASSACHUSETTS: Sound & Music, Northampton, MA
MICHIGAN: Atlas Hi-Fi Stereo, Dearborn, MI
MINNESOTA: Jensen's Stereo Shop, Burnsville, MN
MISSOURI: Johnson's Audio, Columbia, MO
MONTANA: Rocky Mountain Hi-Fi, Great Falls, MT
NEBRASKA: Sound Dimensions, Lincoln, NE
NEVADA: The Upper Ear, Las Vegas, NV
NEW HAMPSHIRE: Camera Shop of Hanover, Hanover, NH
NEW JERSEY: Stuarts Audio, Westfield, NJ
NEW MEXICO: Litus Audio, Albuquerque, NM
NEW YORK: The Audio World, Huntington, NY
PENNSYLVANIA: Video Sound Gallery, Pittsburgh, PA
SOUTH CAROLINA: Myer Emco, Washington, DC
TENNESSEE: Modern Music Audio, Memphis, TN
TEXAS: Audio Works, Nacogdoches, TX
VERMONT: H-Fidelity Inc., Austin, TX
VIRGINIA: Myer Emco, Falls Church, VA
WASHINGTON: Sound Audio, Seattle, WA
WISCONSIN: Wisconsin Rapids, WI
ALBERTA: Audio Ark, Edmonton, AB
BRITISH COLUMBIA: Sound Hounds, Victoria, BC
ONTARIO: Anderson Sound, Hamilton, ON
QUEBEC: Perigny Haette-Fidette, St-Jovite, QC
SASKATCHEWAN: Dales Electronics Ltd., Kerrobert, SK

LOUDSPEAKERS

AEOLIAN LOUDSPEAKERS LTD. offers systems and drivers delivering incomparably low distortion and high resolution. Avoid disappointments and costly upgrades—get the sound you want by starting with the finest: our exclusive high-powered modified Jordan Module and Shackman Electrostatics, and Focal drive units. Box 1005, W. Newbury, MA 01985, (617) 363-5495.

ATC LOUDSPEAKER TECHNOLOGY of England - A no compromise approach to loudspeaker design. Finest materials; superb naturalness; awesome dynamic capabilities. Europe's finest studio monitors. Serious inquiries only. Audio Ecstasy, 360 East Ave., Rochester, NY 14604, (716) 423-9919. AD

ATTENTION QUALITY SPEAKER BUYER. In the performing world, entertainers strive to achieve their pinnacle of success, a true testament to their star quality. In this world of entertainers there are stars and then there are superstars. Performers who can elicit deep emotions from their audience. They have the ability to soothe, inspire, to be dynamic, exciting, charismatic and most of all to stand heads and tails above their peers, to these superstars, give them a standing ovation. Now Greg Acoustics proudly presents to you: The music enthusiast our superstar line-up of loudspeakers. More info, write P.O. Box 29105, Baltimore, Maryland 21205.

AUDIO NEXUS HAS JSE INFINITE SLOPE LOUDSPEAKERS. Come Listen. NJ (201) 464-8238, (201) 730-2409.

AWESOME!

ECHOLON AUDIO IS PROUD TO INTRODUCE THE ECLIPSE SERIES LOUDSPEAKER. A DIGITAL READY, STATE OF THE ART SYSTEM THAT OVERSHADOWS THE REST. HIGH POWER HANDLING—YET HIGHLY EFFICIENT. COMPUTER DESIGNED AND TESTED FOR EXTREMELY ACCURATE PERFORMANCE. COME UP TO OUR LEVEL OF LISTENING PLEASURE. WRITE: ECHOLON AUDIO, P.O. BOX 8086, GADSDEN, ALABAMA 35902-8086.

CONSTRUCT STATE-OF-THE-ART LOUDSPEAKERS at far less cost than you've ever dreamed! Dynaudio, Strathern, Seas, Peerless, Morel etc. Capacitors, coils including IAR WCB Ultracaps™. Acoustic foam for cost-effective room treatment, cabinet dampening. Shadow Electronic crossovers. Full line definitive, esoteric speaker kits. Beautiful oak, walnut cabinetry. Thousands of satisfied customers because of our products, informed assistance, fast service, and guaranteed lowest prices. Catalog \$2.00 refundable (608) 781-2110 MC/Visa AUDIO CONCEPTS, 1631 Caledonia St., LaCrosse, WI 54603.

ELECTRO-VOICE AUTHORIZED DEALER—Speaker components stocked (including 30" woofer) for high performance systems. Interface 1, 2, 3, plus stage, studio, PA speakers. Low prices. Rick Marder (201) 561-8123. AD

FRIED LOUDSPEAKERS IN NEW JERSEY!! AUDIO NEXUS has them all. (201) 464-8238, (201) 730-2409. AD

LOUDSPEAKERS

FRIED SPEAKERS & KITS

State-of-the-art sound. Try our prices! Free shipping. Also Nakamichi, Hafler, Carver, Mitsubishi, Adcom, digital discs and players. READ BROTHERS STEREO, 593 King Street, Charleston, South Carolina 29403. (803) 723-7276. AD

HARMAN/KARDON, NAKAMICHI, TANDBERG, CROWN, REVOX, HAFLE, CARVER, NAD, DBX, ELECTRO-VOICE AND OTHER QUALITY COMPONENTS. BEST PRICES-PROFESSIONAL CONSULTATION. AMERISOUND SALES, INC., P.O. BOX 24009, JACKSONVILLE, FL 32241. EAST: (904) 262-4000; WEST: (818) 840-0878.

B&W 801F SPEAKERS like new. SANSUI AUD11-2 AMP. 215-567-4626, eves.

INFINITY RS1 SPEAKER SYSTEM—Immaculate, \$2,900.00. (308) 237-7993.

JANSZEN 134AOW ELECTROSTATIC TWEETER/MID-RANGES \$300pr., Bozak Symphony 4000's with Bozak cones Philips domes \$550pr., Jeff 517-669-8089 6-10pm est.

J. B. L. SPEAKERS AND COMPONENTS used - bought, sold, and traded 1-313-229-5191 eves. aft. 7 EST

MARTIN LOGAN ELECTROSTATIC SPEAKERS \$2800. 918-582-8944. After 6-p.m. Oklahoma.

NEW YORK ACOUSTICS introduces phase-aligned, digital-ready speakers and kits with unsurpassed performance at bargain prices. Finest European drivers, Modified Leaf Tweeters, Strathearns, premium crossover parts and more. Catalog \$2.00. New York Acoustics, 578 Nepperhan Avenue, Yonkers, N.Y. 10701 (914) 476-4900.

ONE PAIR OHM LOUDSPEAKERS model "H". Very good condition. \$400.00. 404-321-4299 after 5 p.m. EST.

ORPHEUS MODEL 8 LOUDSPEAKER—At \$1150/pair, it is setting the competition on its ear! Find out why! AUDIO ADVOCATE. Short Hills, NJ (201) 467-8988. AD

ONE STEP UP SYSTEM

(UNDER \$1200)

- Turntable: Rega 2
Receiver: NAD 7120
Speakers: Snell Type K's

SOUND BY SINGER

227 Lexington Avenue, New York, NY 10016

(212) 683-0925

EXPANDING TO NEW LOCATION! CALL FOR DETAILS

SNELL TYPE A Improved Walnut Cabinet \$1200. 212-570-6754. Eves.

Prompt Insured Shipments GUARANTEED SAVINGS "Why Settle For Less When You Can Own The Best"
• Professional Advice • FREE Delivery & Set Up
• Relaxed 'NO RUSH' Showroom • Financing Available
• Trade-ins Accepted • Custom Installation & Repairs
FEATUREING OVER 60 BRANDS INCLUDING:
• ADS • Advent • Aiwa • AKG • Alpine • Amber • AR • Audio Control • Audio Source • Blaupunkt • Bose • Boston • Celestion • Concord • DBX • Denon • Dual • Dynavector • Energy Loudspeaker • Grace • Grado • Harman/Kardon • Hitachi • JBL • Kyocera • Mitsubishi • Onkyo • Ortofon • Phase Linear • Proton • Pyramid • Robertson Audio • SAE • Sequera • Sherwood • Signet • SoundCraftsmen • Sony • Sound Dynamics • Tandberg • Thorens • C.J. Walker • And More...
CAR STEREO
• ADS • Alpine • Alphasonik • Alttec • Blaupunkt • Clarion/Audia • Concord • JVC • AFS/KRIKET • Phillips • Sherwood • Sony • Ungobox • And More...
Call or Write Harold Minto, Proprietor

performance audio/video

36S South Bayview Ave. (Corner Atlantic Ave.) • Freeport, Long Island, New York 11520

Tel. (516) 378-4389

Just 35 min. from Manhattan by car or railroad.

Showroom Hours: Mon.-Fri. 12 noon to 7 p.m. Sat. 11 a.m. to 6 p.m.

MC VISA AMEX

Retail Mailorder Export

## LOUDSPEAKERS

**TANGENT RS-4'S**—Best sounding mid priced speaker in America at a new low price. Landes Audio (201) 674-4000. **AD**

### TWEETER OF THE MONTH CLUB!

High frequency masterpieces from all over the world, picked at the point of perfection and delivered to your door. A gift to delight the audio gourmet. **WHERE ELSE BUT . . . MADISOUND** Box 4283, Madison, Wisconsin 53711 608-767-2673.

### VANDERSTEEN 2C

With the Orpheus SW12 subwoofer—an awesome combination! **ORPHEUS AUDIO**, Locust Valley, NY (516) 676-5082. **AD**

**YOU'VE HEARD ABOUT THEM**, now audition, the new **DUNTECH PCL-3's** with the Acoustic Electronics RP-1 **SUBWOOFER**—Awesome Match-up for an incredible price! Where else but **CSA AUDIO!** 201-744-0600.

**WALL MOUNTING WONDERS!! DUNTECH PCL-3's**. Hearing them is believing them. Only at **CSA AUDIO** 201-744-0600.

### VANDERSTEEN 2C—DIMENSIONAL PURITY

With recent improvements in driver technology, this classic is even more analytical and revealing! **IN STOCK** at \$1125.00. Stands extra. **FREE SHIPPING** to all fifty states, PR and APO/FPO. **WORLDWIDE EXPORTING**. Visa and MasterCard. **OXFORD AUDIO CONSULTANTS, INC.**, Box 145, Oxford, OH 45056-0145, 513-523-3333, TLX427791. **AD**

**ATTENTION ADVERTISERS!**  
**SEE CLASSIFIED RATE BOX**  
**ON PAGE 104 FOR NEW**  
**RATES EFFECTIVE OCTOBER**  
**1984 ISSUE.**

## TURNTABLES

### BEST SOUND PER DOLLAR SYSTEM

(UNDER \$2100)

Turntable: **Rega Planar 3**  
Cartridge: **Dynavector 10X3**  
Receiver: **NAD 7150**  
Speakers: **Snell Type E's**

### SOUND BY SINGER

227 Lexington Avenue  
New York, NY 10016  
(212) 683-0925

EXPANDING TO NEW LOCATION!  
CALL FOR DETAILS

### MERRILL TURNTABLE

**FEATURES:** Beautiful solid oak base. A tunable, three-point Constant Resonance Suspension System. A subchassis designed to absorb tonearm release energy. Optional, outer periphery record clamp. Price \$600. For more information contact **UNDERGROUND SOUND**, 2125 Central Ave., Memphis, TN 38104 (901) 272-1275.

**"NEW" AR TURNTABLE IMPROVEMENT:** Dramatically improve the performance of your new AR: **ALL ALUMINUM ARMBOARDS:** \$20.00 (Stock arm or Premier MMT) All other arms: \$25.00; **TABLE MATS:** Music Mat: \$28.00 Oracle Mat: \$42.50; **RECORD CLAMPS:** Souther Clamp: \$10.00 ADC/Orsonic: \$27.50. Shipping: \$3.00/item. Call for details on more extensive modifications. Audio Advisor, Inc. Box 6202 Grand Rapids, MI 49506, 616-451-3868. **AD**

# MOREL INTEGRA

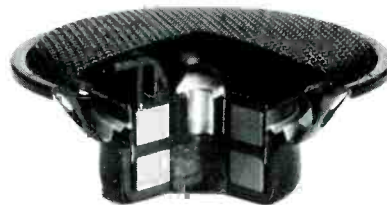

MOREL'S "INTEGRA" AUTO FIDELITY loudspeakers provide the perfect solution to high-quality sound reproduction in the car. Morel's system differs from conventional coaxial systems which use two separate drivers that have to be mounted mechanically together. The "Integra" concept is based on a two-way coaxial system consisting of two magnets - one for the dome tweeter and one for the woofer - integrated on a single axis. Similar in their high power-handling and excellent sound to the Morel driver units for home loudspeakers, the Morel Integra auto fidelity loudspeakers are durable and rugged enough for use in any type of vehicle.

### INTEGRA - 1

Integrated 2-way 6" / Dome Tweeter (Adapted for bi-amp)

Power Handling Capacity . . . . . 100 Watts RMS  
Frequency Response . . . . . 45-25000 Hz  
Woofer Type . . . . . 6" Dia., 3" Aluminum voice coil  
Tweeter Type . . . . . Soft dome, Aluminum voice coil  
Ferrofluid Cooling/Damping . . . . . Yes  
Impedance . . . . . 4 ohms  
Sensitivity 1W/1M . . . . . 91 db  
Magnetic Structure Weight . . . . . 2.3 lbs./1.05 Kgs.  
Dimensions . . . . . 160mm/6 1/4" Dia., 67mm/2 3/4" Depth  
Mounting Depth . . . . . 53mm/2 1/8"  
Net Weight . . . . . 2.85 lbs./1.3 Kgs.  
Front Grill . . . . . Integral metal grill

### INTEGRA-2

Integrated 2-way 8" / Dome Tweeter (Adapted for bi-amp)

Power Handling Capacity . . . . . 120 Watts RMS  
Frequency Response . . . . . 35-25000 Hz  
Woofer Type . . . . . 8" Dia., 3" Aluminum voice coil  
Tweeter Type . . . . . Soft dome, Aluminum voice coil  
Ferrofluid Cooling/Damping . . . . . Yes  
Impedance . . . . . 4 ohms  
Sensitivity 1W/1M . . . . . 92 db  
Magnetic Structure Weight . . . . . 2.3 lbs./1.05 Kgs.  
Dimensions . . . . . 220mm/8 3/4" Dia., 75mm/3" Depth  
Mounting Depth . . . . . 57mm/2 1/4"  
Net Weight . . . . . 3.3 lbs./1.5 Kgs.  
Front Grill . . . . . Integral metal grill

Please write for details:



**morel acoustic usa**

414 harvard street, brookline, mass. 02146  
u.s.a. tel. (617) 277-6663

**morel acoustic ltd**

industrial area b, p.o.b. 140, ness ziona  
70 451 israel. tel. 054-70796, telex 361951

## Introducing Straightwire II™ COMPUTER-CONTROLLED PREAMPLIFIER

The Straightwire II™ preamplifier by VSP LABS is an ALL OUT ASSAULT in preamp design. With a computer-controlled front end for automatic muting and DC offset sensing, moving coil as well as moving magnet capability, and RIAA phase accuracy that other preamplifiers only approach, the Straightwire II™ preamp sets a standard in musical accuracy that is a benchmark others will try to emulate in years to come. Audition the Straightwire II™ with our TransMos amplifiers and hear VSP electronics bring your system to life!

For complete specifications and reviews of our TransMos, Gold Edition TransMos, and the Straightwire II™ Preamplifier, plus the location of the dealer nearest you, call (313) 769-5522. Or write:

VSP Labs, Dept. A9,  
670 Airport Blvd.,  
Ann Arbor, MI 48104



Only the music remains.





## TURNTABLES

**ATTRACTIVE PRICES:** DYNAVECTOR, DENON CARTRIDGES, KOETSU, LINN, STAX, FULTON, ALPHASON, BERNING, AUDIBLE ILLUSIONS, BRB, SOTA, AR TURNTABLE, WALKER, GOETZ, ROBERTSON, FR, ETC. COD, SHIPPING 713-728-4343. MAURY CORB, 11122 ATWELL, HOUSTON, TEXAS 77096. **AD**

**HARMAN/KARDON, NAKAMICHI, TANDBERG, CROWN, REVOX, HAFLER, CARVER, NAD, DBX, ELECTRO-VOICE AND OTHER QUALITY COMPONENTS. BEST PRICES-PROFESSIONAL CONSULTATION. AMERISOUND SALES, INC., P.O. BOX 24009; JACKSONVILLE, FL. 32241. EAST: (904) 262-4000; WEST: (818) 840-0878.**

# DALLAS

AR	Nitty Gritty
Acoustat	Onkyo
Audible Illusions	PS Audio
Audio Source	ProAc
Audioquest	Randall Research
Belles	Reference Recordings
CJ Walker	Robertson
Conrad-Johnson	Sheffield
Electrocompaniet	SOTA
Grace	Sonographe
Grado	Souther
Harman-Kardon	Spica
Kimber Kable	Sumiko Products
Live Wire	Talisman
Magnepan	Thiel
MAS	Threshold
Monster Cable	VPI

**Omni Sound**  
4833 Keller Springs Rd.  
Dallas, Texas 75248  
(214) 931-6664

## LEGENDS ARE MEANT TO BE HEARD



For more than a decade, Rogers has combined a classic approach to loudspeaker design with the latest advances in technology.

To actually hear what has been accomplished, take the time for a serious demonstration. Legends are meant to be heard.

For the name of your nearest authorized dealer please write:

# Rogers

BRITISH HIGH-FIDELITY

U.S.A.  
Naiad Products Inc  
Box 1250 Falls Sta.  
Niagara Falls, N.Y.  
14303-0260

CANADA  
Naiad Products Inc  
Box 1840  
Brantford, Ont.  
N3T 5W4

## RECEIVERS

### LUCKY 16 SYSTEM

(ABOUT \$1650)

Turntable: Rega 2  
Cartridge: Adcom GFCE +1  
Receiver: NAD 7150  
Speakers: Snell Type J's

### SOUND BY SINGER

227 Lexington Avenue  
New York, NY 10016  
(212) 683-0925

EXPANDING TO NEW LOCATION!  
CALL FOR DETAILS

**HARMAN/KARDON, NAKAMICHI, TANDBERG, CROWN, REVOX, HAFLER, CARVER, NAD, DBX, ELECTRO-VOICE AND OTHER QUALITY COMPONENTS. BEST PRICES-PROFESSIONAL CONSULTATION. AMERISOUND SALES, INC., P.O. BOX 24009; JACKSONVILLE, FL. 32241. EAST: (904) 262-4000; WEST: (818) 840-0878.**

## TAPE RECORDERS

**HARMAN/KARDON, NAKAMICHI, TANDBERG, CROWN, REVOX, HAFLER, CARVER, NAD, DBX, ELECTRO-VOICE AND OTHER QUALITY COMPONENTS. BEST PRICES-PROFESSIONAL CONSULTATION. AMERISOUND SALES, INC., P.O. BOX 24009; JACKSONVILLE, FL. 32241. EAST: (904) 262-4000; WEST: (818) 840-0878.**

## MULTI COMPONENTS

### DEEP SIX SYSTEM

(ABOUT \$6000)

Turntable: Linn Sondek Lp-12  
Cartridge: Talisman S  
Tonearm: Linn Basik LV-X  
Tuner: Adcom GFT1-A  
Preamp: Acoustat TNP  
Amplifier: Acoustat TNT-200  
Speakers: Acoustat 2+2

### SOUND BY SINGER

227 Lexington Avenue  
New York, NY 10016  
(212) 683-0925

WATCH FOR NEW LOCATION!  
165 E. 33RD ST, NYC 10016  
CALL FOR DETAILS

AD

## Listen...



### Before You Buy!

- Time Delay
- Reverberation
- Crossovers
- Noise Reduction
- Compressor/Limiters
- Expanders
- Spectrum Analyzers
- Parametric EQ

Don't have regrets about paying too much for a lesser product. In demos and comparisons, we'll show you why we're Better! Our Factory Direct sales allow us to produce a Superior product and offer it to you at a Lower price... Call or write for a free full-length Demo Album and 24 page brochure. Write to: **LT Sound, Dept. A-3, P.O. Box 338 Stone Mountain, GA 30086**  
In Georgia Call (404)493-1258

**TOLL FREE: 1-800-241-3005 - Ext. 18**

## MULTI COMPONENTS

### AAAA-STEREO SHOWCASE-DAYTON, OHIO

We offer the following—Linn Sondek LP-12, Linn Loudspeakers, Naim Audio, Heybrook Speakers, and turntable, Creek Audio, Audioquest and Cart-A-Lign. Discover the HI-FI Hierarchy, and single speaker demonstrations at Stereo Showcase. Stereo Showcase, P.O. Box 652, Dayton, Ohio 45409 (513) 299-2811. **AD**

**ACOUSTAT MODEL 3**—895.00/pr Teak with white Grille. Hafler DH200A 285.00. Mike 918-481-5162.

**AUDIO ECSTASY** offers the finest audio values: ATC, JSE, Spica, Entec, VSP, B&K, Counterpoint, VPI, AR, Zeta, Goldbug, Kimber, Apature, and more. 360 East Ave., Rochester, NY 14604, (716) 423-9919. **AD**

**HARMAN/KARDON, NAKAMICHI, TANDBERG, CROWN, REVOX, HAFLER, CARVER, NAD, DBX, ELECTRO-VOICE AND OTHER QUALITY COMPONENTS. BEST PRICES-PROFESSIONAL CONSULTATION. AMERISOUND SALES, INC., P.O. BOX 24009; JACKSONVILLE, FL. 32241. EAST: (904) 262-4000; WEST: (818) 840-0878.**

**JBL HARTSFIELD CABINETS** w/o speakers, good condition, \$100 ea, Phase Linear 700B \$425, Phase 400 \$300, 305-776-4915.

## MORE WITH FOUR SYSTEM

(UNDER \$4300)

Turntable: Linn Sondek Lp-12  
Tonearm: Linn Basik LV-X  
Cartridge: Audioquest 404  
Tuner: Adcom GFT1-A  
Preamp: Counterpoint SA-7  
Amplifier: Robertson 2140  
Speakers: Fuselier 3.3

### SOUND BY SINGER

227 Lexington Avenue  
New York, NY 10016  
(212) 683-0925

WATCH FOR NEW LOCATION!  
165 E. 33RD ST, NYC 10016  
CALL FOR DETAILS

AD

**RELAXED, UNPRESSURED LISTENING** and consultation from the alternative stereo marketplace. Quality brands, competitive prices, full service, home trials, trade-ins AT 150% value and more. Community Audio, 318 W. Duval, Phila. PA 19144 (215) 843-9918.

**THORENS TD125/SME-3009II** with Ortofon SL15E-2 moving coil and STM-72 transformer \$425. Teac 6010 new heads, remote, 7" \$350. Jeff 517-669-8089 6-10pm est.

**UNITY MODEL 7 SPEAKERS**, \$650. Precision Fidelity M7A, \$325 Van Alstine Superpas pre-amp \$125. (313) 335-9526 Alt. 6PM EDT.

**ACOUSTAT 2+2 SPEAKERS, NEW** and Sony Cassette Deck. (215) 567-4626. Eve Wkd.



**BENNETT SOUND CORPORATION**

*The first wholly new technology in loudspeaker systems in fifty years.*

P.O. BOX 565  
RESEDA, CA 91335  
(818)345-1608



**MULTI COMPONENTS**

**START WITH SEPARATES SYSTEM 1**  
(UNDER \$2700)

- Turntable: Rega Planar 3
- Cartridge: Dynavector DV-10X3
- Preamp: Adcom GFP-1A
- Tuner: Adcom GFT1-A
- Amplifier: Adcom GFA-2
- Speakers: Snell Type E's

**SOUND BY SINGER**

227 Lexington Avenue  
New York, NY 10016  
(212) 683-0925  
WATCH FOR NEW LOCATION!  
165 E.33RD ST, NYC 10016  
CALL FOR DETAILS

AD

**CARTRIDGES/TONEARMS**

DIAMOND NEEDLES and STEREO CARTRIDGES at DISCOUNT PRICES for SHURE, PICKERING, STANTON, EMPIRE, GRADO, AUDIO TECHNICA, ORTOFON, MICRO-ACOUSTICS, SONUS, ADC and LAST, send S.A.S.E free catalog. LYLE CARTRIDGES, Dept. A, Box 69, Brooklyn, NY 11218. For fast COD service Toll Free 800-221-0906. N.Y. State (718) 871-3303. 9AM - 8PM except Sunday. VISA/MC

AD

FOR SALE: M&K MODIFIED RABCO TONEARM, \$400. E. Kantor, 12365 Montsouris, St. Louis MO 63141 (314) 878-5950.

GOLDMUND STUDIETTO W/LURNE arm & Decca VDHubl cartridge: a standard by which to judge all others! Audio Connection in NJ 201-239-1799.

AD

**SIMPLY... THE WORLD'S ONLY PURELY MECHANICAL LINEAR ARM.**

THE SOUTHER SLA-3



THE LEADER IN LINEAR PHONO TRACKING™ Dealer inquiries invited. (617) 828-5050

SOUTHER ENGINEERING CORPORATION  
429 M York Street, Canton, Massachusetts 02021

**FOR THE SILENCE OF SPACE, THE THUNDER OF THE PLANETS...**



Listen to the BPA-100B High Technology, High Definition Amplifiers. • Meets all the design criteria of Ottala and Cherry. • Features nested multiple feedback loops, wide bandwidth and high slew rate with a dominant pole frequency of 15KHz, resulting in constant feedback and zero phaseshift from DC to 20 KHz. • A fully regulated power supply yields true DC coupling and incredibly solid bass. No protection circuitry within the signal path, yet fully protected. 100 w/ch. into 8 ohms, 175 w/ch. into 4 ohms and 350 w into 8 ohms in the built-in bridge-mono mode. • Coming soon: Model LCA-10 preamplifier.

Spectrascan, Inc. 5923 N. Nevada Ave., Colorado Springs, Colorado 80907,  
(303) 599-9254 Dealer and representative inquiries invited.

**CARTRIDGES/TONEARMS**

**EMINENT TECHNOLOGY**

Straight line tracking/frictionless air bearing tonearm. Now our sole arm recommendation, just rated Class 1A by IAR, the AB1 extracts the most subtle nuances that you have NEVER heard from your discs before. Performance easily worth twice its price: \$600!

**AUDIO ONE**

8788 Sunset Boulevard.  
West Hollywood, California 90069  
**213/855-0500**

AD

TALISMAN CARTRIDGES AND PREMIER MMT TONEARMS: Sonic sorcery for audiophiles. Audio Nexus, NJ, (201) 464-8238, (201) 730-2409.

**WHAT IS A GRACE "LEVEL II"?**

EVERYBODY LOVES A BARGAIN. But if you're considering a Grace "level II" cartridge as a lower cost alternative to a Grace F-9 series cartridge, you may be getting less than you bargained for.

As the only authorized importer of Grace products to the U.S., we were offered the Grace "level II" series two years ago. We rejected this series because technical evaluation showed that the motor mechanism and body of the "level II" were identical to those used in the old F-8 series, the only differences being the type of cantilevers and stylus available. The F-9 series, on the other hand, has a motor mechanism and body far advanced from the F-8 or "level II."

The "level II" cartridges are not updates of the F-9 series. "level II" cartridges should cost less than F-9s—they're worth less.

Several "mail-order discount" type outfits are offering "level II" cartridges for sale. The public should be aware that these cartridges are not imported by Sumiko, Inc., are not quality controlled by us, and are not covered by our warranty. The companies that sell you these goods claim to provide warranty on defective units. We have no way of knowing how valid these claims are, nor does the consumer have any assurance that these companies will still be in business when service is necessary. Warranty repairs may be available only in Japan for cartridges obtained from these sources.

To be sure your Grace products are coming from an authorized Sumiko dealer, please contact us and we will be glad to provide you with the name of your nearest dealer.

SUMIKO, INC., P.O. BOX 5046,  
BERKELEY, CA 94705  
(415) 843-4500

AUDIO TAPES		VIDEO TAPES	
SONY	1.98	MAXELL	\$ 5.88
UCX 90	2.48	T120	7.48
UCXS 90	.98	T120 HGX	8.98
HF 90		T120 HGX GOLD	6.58
TDK	1.98	L750	
SA 90	1.08	SONY	5.48
D 90		L500	4.98
MAXELL	\$1.98	L750 after rebate	5.38
XL-II 90	1.18	L500UHG	6.78
LN 90	6.18	L750UHG	6.78
XL 135-90B	4.48	L830	4.98
UD 35-90		T120 after rebate	4.98
		L830 UHG	8.48
		Discwasher	KODAK
		Accessories: CALL!	T120
			T120 HGX
			L750
			5.98
			7.48
			5.98

Hi-Fi, Video, TV: Most Brands — CALL!

**INTERNATIONAL DIST. SALES**  
240 Ivory St., Braintree, MA 02184  
800-225-8656 ORDERS ONLY 10am-6pm EDT M-F  
Add \$3.50 shipping on all orders up to \$70.00. Shipping 5% of total order over \$70.00. MC/VISA, no cash discount — call. No C.O.D. Shipping charges for USA. Foreign shipments call. \$20.00 minimum order. Personal checks, money orders or certified checks accepted. 14 days clearing interval on personal checks.  
MASS ORDERS (617) 848-4008 **IDS**

**EXTRAORDINARY**  
loudspeakers from

**EUPHONIC AUDIO**

RRI Box 266 New Egypt, N.J. 08533 201-929-2613

LABOR DAY WEEKEND SEPT 1 & 2

**GRAND OPENING**  
AUDIO & VIDEO

*Sale*



Highly critical shoppers give us rave reviews for our showstopping array of audio, video, car stereos and car alarms. Plus, they applaud our first-rate service and impeccable advice.

Shop SOUND STAGE for:

- knowledgeable service
- 30-day price guarantee
- super selection in stock
- extended warranties
- prompt, free delivery
- free repair pick up
- authorized dealership

For a personal appointment call: 212 961-9888 or just stop in. Sorry, no mail orders accepted.

In New York City we are an authorized dealer for all these products:

ADS	ALPINE	DENON	KLOSS	THE UNGO BOX
FAS	GRACE	CARYER	PROTON	AUDIOCONTROL
BES	AMBER	LUXMAN	CLIFFORD	BANG & OLUFSEN
NAD	ADCOM	ALLISON	AUDIO-PRO	DACCORD LOCKS
DCW	SIGNET	PYRAMID	SOMAGRAPHE	AUDIBLE ILLUSIONS
STAY	POSTEK	TALISMAN	3D ACOUSTICS	BOSTON ACOUSTICS
GRADO	MITACH	CJ WALKER	BETTER DYNAMIC	CHAPMAN SECURITY

Please visit our stores at:  
178 Broadway  
New York City, NY 10007  
(Corner of B'way & Cortland in the Wall St. area.)  
(OR)  
184-10 Horace Harding Express  
Fresh Meadows, NY 11365  
Exit 25 L.I.E., Utopia Plaza  
(Three blocks from Bloomingdale's.)





## CARTRIDGES/TONEARMS

**YOU'VE HEARD ABOUT IT! YOU'VE SEEN THE REVIEWS! THE PROMETHEAN GREEN** moving flux cartridge—the product of 7 years of exhaustive research—is the **MOST** accurate pick-up available for under \$400! This hand built design **MUST** be heard! No gimmicks, no tricks, just solid engineering for the most cost-effective listening possible! 3.5mv output, 5 grams weight. \$175. VISA/MC/AMEX The Audio Advisor Inc., (616) 451-3868 Box 6202 Grand Rapids MI 49506. **AD**

## TUBE EQUIPMENT

**ATTENTION WANTED:** MCINTOSH, MARANTZ, ARC, DYNACO, QUAD, LEAK, WESTERN ELECTRIC, LEVINSON, TANNY, THORENS, JBL, AMPLIFIERS, SPEAKERS, ETC. 713-728-4343, MAURY CORB.

**DYNACO OWNERS:** 60,000-lb buyout of Dyna's remaining inventory! Tubes, transistors, circuit boards, sheet metal, manuals . . . more. **FREE BARGAIN CATALOG.** SCC, Box 551(AM), Dublin, OH 43017. (614) 889-2117. VISA/MC/COD.

## The Revelation Basic®



## Superphon

1840 W. 11TH • EUGENE, OR 97402

Phone: (503) 345-4226

AVAILABLE FACTORY DIRECT!

Immediate Delivery

\$399.00



## TUBE EQUIPMENT

### GENELEX GOLD LION POWER TUBES

KT88—\$68 MATCHED PAIR  
KT77—\$58 MATCHED PAIR  
KT66—\$56 MATCHED PAIR  
INDIA REFERENCE TUBES—  
ECC83—\$12 ECC82 or 81—\$8  
**SOUND GOODS—2627 SOUTH BASCOM,**  
CAMPBELL, CA 95008  
408-559-1920 **AD**

**MCINTOSH SOLID STATE**—bought, sold, and traded. 1-313-229-5191 aft. 7 EST

**MULLARD (BRITISH) TUBES:** 12AT7/ECC81, \$4.95; 12AU7A/ECC82, \$4.95; 12AX7/ECC83, \$4.95; 12AX7A/7025, \$6.45; 6L6GC, \$9.95; EL34/6CA7, \$8.00; 6BQ5/EL84, \$5.95; GE: 8417, \$11.60; 6FQ7, \$4.85. \$2.00 SHIPPING. SCC, BOX 551 (AM), DUBLIN, OH 43017. (614) 889-2117. VISA/MC/COD.

**TUBE SPECIALS!** Premium quality Tungstam 12AX7, \$2.99 each; Amperex (British) EL34/6CA7 (tall slender style), \$19.95/matched pair. Complete kits: Dyna Mk4 40W mono power amp, \$199.00; Dyna PAS-3X stereo preamp, \$149.00. **FREE BARGAIN CATALOG.** SCC, Box 551(AM), Dublin, OH 43017. (614) 889-2117. VISA/MC/COD.

**WHOEVER SAID THAT TUBE ELECTRONICS** had to be ugly or unreliable hasn't seen Counterpoint! The Audio Doctor, Buffalo, MO. (417) 345-7245 **AD**

## PARTS/ACCESSORIES

**DB SYSTEMS OFFERS PRECISION ELECTRONICS AND AUDIOPHILE ACCESSORIES.** Five year warranty. Write for our complete product list. DB SYSTEMS, Main Street, Rindge, NH 03461 (603) 899-5121.

**GOLD LION, "INDIA", TELEFUNKEN TUBES.** Cramolin, Furman Sound, Hartley, Kimber Kable, LAST, Precision Fidelity, Sheffield, SONEX, VPI. VECTOR ELECTRONICS, 2030 NW Marshall #104, Portland, OR 97209. 503-227-5641. VISA MASTERCARD, AMERICAN EXPRESS.

## PARTS/ACCESSORIES

**LOW DCR AIR CORE INDUCTORS** ARE OUR ONLY PRODUCT! Wide selection of coils wound with twelve and sixteen gauge wire! Custom orders welcome! Lowest prices! Rush C.O.D. orders accommodated! Free Information! Wilsons, 2111-M 30th street, Suite 1138, Boulder, Colorado 80301, (303) 530-1067 evenings

**ELECTRONIC CROSSOVERS:** 6, 12, 18dB/octave. Kits from \$106.50. Transient-Perfect Crossover, \$175. Free folder. ACE AUDIO CO., 532-5th St., E. Northport, NY 11731-2399. (516) 757-8990.

### MERRILL AR MODIFICATIONS

**TONEARM REPLACEMENT SUBCHASSIS KIT** for old AR \$85.00—Subchassis for AR-XE \$95.00. Platter Coating \$10.00. Replacement Spindle \$25.00. Spring Kit \$8.00. High Torque Motor \$45.00. Platter Balancing Service \$10.00. Replacement inner and outer platter, \$135.00 for all AR-XA, AR-XB, and AR-XE turntables. UNDERGROUND SOUND, 2125 Central Ave., Memphis, TN 38104. (901) 272-1275.

**PETERSON PRESENTS EMERALD™**—a new, air-dielectric, symmetrical, twinaxial Interconnect and Tonearm Cable System of incomparable transparency and musicality. No price increase. Peterson Interconnects have been setting performance and quality standards since 1979, and EMERALD™ continues that tradition. See your dealer or contact us for information and no-risk trial terms. PETERSON AUDIO, Dept. AM, 13665 SW Garrett Court, Tigard, OR 97223. (503) 639-2401. Dealer inquiries invited.

## RANDALL RESEARCH

**Cable Systems:** Serious about your system? You need to wire it totally with Randall Cables. All other cables lack the clarity, impact, musical timbre, smoothness, localization and phase coherence of the Randalls. Typically, you receive ten times the sonic improvement per dollar compared to changing electronics. Just rated world's best by English Hi-Fi News. Free Shipping (US). Call for prices.

## AUDIO ONE

8788 Sunset Boulevard  
West Hollywood, California 90069

213/855-0500 **AD**

**SUBSONIC FILTERS,** 18 or 24dB/octave (from \$98.50) remove unwanted noise/thumps from passband. Free flyer w/reviews. ACE AUDIO CO., #532-5th St., East Northport, NY 11731-2399. (516) 757-8990.

**TOPLESS!!!! (ALSO MEANS UNSURPASSED).** SWL, Inc. offers Quicksilver cable (our teflon & silver coated copper combination) and our highest quality gold RCA plugs. We also offer discount pricing on many cartridges, tonearms, tape decks, personal/business computers. Please send SASE for catalog or call 409-763-6061. Stephen Worsham Labs, Inc. P.O. Box 959, Galveston, TX 77553.

**SPEAKER STANDS**—Solid Oak and Walnut. Bring your sound off the ground and into the room for better listening with these beautiful pedestal type stands. These are solid woods throughout. Available in Oiled Oak - \$39.95/pair or Oiled Walnut - \$49.95/pair. Money back guarantee. Check or Money order to CDS Woods, Box 17175, Colo. Spgs., Co. 80935.

**THE ULTIMATE RCA-TYPE PHONO PLUG.** Five part construction, teflon dielectric, ground compression ring gives positive strain relief, well-anchored center pin, 14K gold plate. DBP-13PX (2) price per pair (red/white) \$14.95. Include \$2.50 handling under \$45.00. For complete information write: DB SYSTEMS, Main St., Rindge, NH 03461 (603) 899-5121. Enclose \$1.00 for color photograph.

## PRERECORDED TAPE

**LISTEN TO "ANDOR"**, science fiction book. Three hours. Two cassettes. Sharp suedene carrying case. Send \$12.00. STORYTELLER, 4300 Laurel Hill Road, Raleigh, NC 27612.

**LIVE OPERA TAPES, CASSETTES, DISCS, INCREDIBLE SELECTION.** FREE CATALOGUE. LIVE OPERA, BOX 3141, STEINWAY STATION, L.I.C. N.Y. 11103

# aq audioquest

The AudioQuest stable of products includes the famous AQ series of moving coil cartridges with hollow sapphire cantilevers. The AQ404, AQ606 and AQ808 are high output models designed to feed a normal phono input. The AQ505, AQ707 and AQ909 are low output models requiring an extra gain stage. The new AQ1.1 is a medium output model designed for the new generation of "high gain" preamps. We also make the remarkably inexpensive GroovDancer MC+ high output moving coil and the GroovDancer IM+ induced magnet cartridge. The AQ Shadow tonearm along with the AQ 317/LW and AQ 407/LW all come with LiveWire headshell leads and a LiveWire tonearm cable. Whether you are spending \$325, \$575 or \$825 these arms will let you hear what your cartridge is supposed to sound like instead of the harshness and resonance-induced mistracking so common in other arms. Don't forget the superb LiveWire interconnecting and speaker cables, the only good looking sound paneling, AudioQuiet One and Two, the AQ record brush and AQ stylus cleaner. The latest AQ product is an extremely effective record mat which supports and damps for the least colored sound possible.

AT AUDIOQUEST WE TALK MERIT — NOT MARKETING!

3857 birch street, #610

newport beach, california 92660

714 / 720-1995

# LIVE WIRE™

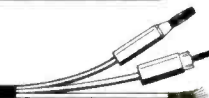

## CD PLAYERS

### COMPACT DIGITAL DISCS AND PLAYERS!

In stock! Many titles. Fast, FREE shipping. Also: Mitsubishi, Klipsch, Nakamichi, more (see our Hafler ad.) READ BROTHERS STEREO 593 King Street, Charleston, South Carolina 29403. (803) 723-7276. AD

HARMAN/KARDON, NAKAMICHI, TANDBERG, CROWN, REVOX, HAFLER, CARVER, NAD, DBX, ELECTRO-VOICE AND OTHER QUALITY COMPONENTS. BEST PRICES-PROFESSIONAL CONSULTATION. AMERISOUND SALES, INC.; P.O. BOX 24009; JACKSONVILLE, FL. 32241. EAST: (904) 262-4000; WEST: (818) 840-0878.

## BLANK TAPE

**AMPEX PROFESSIONAL SERIES AUDIO TAPE SALE** High quality open reel 1800' or 2400' on 7" reels, used once. Case of 40, \$45.00. 10 1/2" x 3600' and cassettes available. Master Card/Visa. Valtech Electronics, Box 6-A, Richboro, PA 18954 (215) 322-4866.

**SURPLUS AMPEX 671 SCOTCH 24 00'** box of 62, \$56. SCOTCH 3600' box of 30, 75. COD or check. CK Ltd., P.O. Box 527, Cottontdale, Florida 32433

## COMPACT DISCS

**COMPACT DIGITAL DISCS** exclusively—from stock—classical, opera, jazz, film—catalog \$1.00, refundable with order—Ethel Enterprises, P.O. Box 3301, Dept. A, Falls Church, VA 22043

### COMPACT DISC

SPECIALS-SPECIALS-SPECIALS-SPECIALS for September, 1984

TELARC compact disc—\$16.00 each  
DELOS compact disc—\$16.00 each  
DENON compact disc—\$16.00 each  
SHEFFIELD compact disc—\$16.00 each

We specialize in import labels like Yupiteru, Teichiku, Pierre Verany, Harmonia Mundi, and many more. Quantity savings order 10 - pay \$14.95 each. Send \$1.00 for complete catalog. Supersound Records, P.O. Box 7082, Forest Park, IL. 60130. Phone (312) 366-1300 1pm-5pm. Ask for Alice.

**COMPACT DISC TRADE-IN!!!** We credit \$5 for each non-defective compact disc you send to us. Ask us about our collection of used CD's.

**COMPACT DISCS—1300 TITLES—LISTED NOW!** Immediate delivery! Classics—Pop—Jazz!—FREE Catalog available. Phone or mail orders—Master Card & Visa. LAURY'S RECORDS, 9800 North Milwaukee, Des Plaines, IL, 60016 (312) 296-0420

## DIGITAL COMPACT DISCLUB

Join and get **SUPER SELECTION, SUPER LOW PRICES, TRADE IN PRIVILEGES.** Free updated quarterly catalog with 1000 titles. Send \$1.00 (Refundable with membership) for DETAILS TO SOUNDPRO DISCLUB-A, P.O. Box 645, Carmel, Ind. 46032

## JAZZ CDs

**RECORDED TOTALLY DIGITAL.** Free catalog DMP, Box 2317, NY, NY 10185.

## RECORDS

**RARE OUT OF PRINT RECORDS:** Warehouse stock reasonable prices. Catalog \$2., Melody House Records, Box 607, Ansonia Station, New York, NY 10023.

**THE ROLLING STONES**—Terrific savings on the new Mobile Fidelity 10 record set. Order now for lowest price anywhere.

Call or write for our free newsletter of audiophile recordings and Japanese imports. The largest selection anywhere at discount prices. Supersound Records, P.O. Box 7082-A, Forest Park, IL 60130, (312) 366-1300.



**Move up to PS AUDIO**  
Look and listen for yourself—it will be obvious why no one has even come close to our level of price, performance and enjoyment. A leading innovator for almost a decade, PS Audio continues to set the pace. Write for our free 20-page brochure  
PS Audio, 3130 Skyway Dr. 301  
Santa Maria, CA  
93455

## RECORDS

**WE BUY AND SELL LIKE NEW LPS,** Prerecorded reel tapes and cassettes. Thousands in stock. Catalog \$2.50. Protect your Lps Poly, Paper, Cardboard jackets Low Prices. Free Catalog, House Of Records, Hillburn, New York 10931.

## AUDIOPHILE RECORDS

**AUDIOPHILE RECORDINGS, CD'S, ACCESSORIES** lowest price available on MFSL, Telarc, Mastersound, Japanese, Fresh Aire, Nautilus, Sheffield, over 400 CD's, catalog \$1.00, 20% discount first order, Record Rack, 818 GB Plaza, Green Bay, Wisconsin 54304

**MOBILE FIDELITY,** out of print, unopened-mint Steely Dan-Katy Lied, Crusaders, Al Jarreau, Zubin Metha, Manhattan Transfer, Little Feat, Al Stewart-Yoc, Steve Miller, Mystic Moods, Joe Sample, Poco, more. Offers (602) 935-5291.

**MOBILE FIDELITY SOUND LABS - Beatles Box -** long out of print! Available now! \$350 + \$8 freight. Laury's Records, 9800 North Milwaukee Ave. Des Plaines, IL. 60091, 312 296-0422.

### REFERENCE RECORDINGS

DAFOS has all the critics reaching for superlatives: "If there is any single argument against the headstrong dash toward digital recording, it rests in the vaults of RR on a large metal reel. It is Keith Johnson's master tape of DAFOS." — Al Fasolt, *Fanfare*. "... puts to shame the cannon blasts from Telarc and every other percussive effect I know of. To do anything more powerful will require a nuclear detonation." — HP, *The Absolute Sound*. "You really don't want to live another day on earth without listening to this record." — Peter Moncrieff, *IAR*. Obtain your copy of this 45 rpm audiophile percussive extravaganza featuring Mickey Hart, Airto and Flora Purim at your local RR dealer or directly from Reference Recordings, Box 77225X, San Francisco, CA 94107. DAFOS, RR-12, \$16.98 postpaid in US. Visa/MC welcome. Call free: 800-621-0854 Ext. 107, or 408-745-7159. Dealer inquiries invited!

## Announcing a new level of Audio Sophistication in Fort Worth

**Home and Office**—Acoustat, Celestion, Harmon/Kardon, Stax, Dynavector, Sumiko, Quad, Kef, Micro-Seiki, Proton, Monster Cable, Entec, Kimber Kable, Precision Fidelity, Sonographe, SOTA, Goldring, Talisman, Supex  
**Car**—Proton, Sony, Pioneer, Toby, Rockford-Fosgate, Hirschmann



### POWER BASE ELECTRONICS

6743 Camp Bowie Boulevard  
Fort Worth, Texas 76116  
817-731-7457 Store Hours 10-6  
VISA—MasterCard—American Express

## AUDIOPHILE RECORDS

### REFERENCE RECORDINGS

**BIG BAND BASH!** You asked for it and here it is! "Your Friendly Neighborhood Big Band" features current concert jazz with vocalist Mavis Rivers and her son Matt Catingub's 20-piece band. Concert hall ambience, natural balances and Prof. Johnson's patented punch give big band lovers the thrill of the real thing! Not a rehash of tired 1940's dance tunes, RR-14 features dynamic new charts of standards and original material. 45 rpm audiophile pressing available directly from Reference Recordings, Box 77225X, San Francisco CA 94107, 408-745-7159, \$16.98 postpaid in US. Visa/MC welcome. Call free: 800-621-0854 Ext. 107, or 408-745-7159. Dealer inquiries invited!

"SPECIALS": **MOBILE FIDELITY "NATALIE COLE,"** \$9.95; **SONIC ARTS DIRECT-DISCS, PIANO/CLASSICAL (3 DIFFERENT)** \$5.99 EACH; **HEAD FIRST DIGITALLY MASTERED/AUDIOPHILE JAZZ, "ALLEN VIZZUTTI" (TRUMPETER EXTRAORDINAIRE) OR "MIKE METHENY" (FLUGELHORN),** \$5.99 (LP OR DOLBY CASSETTE); **A-T TOSHIBA/EMI JAPANESE DIRECT-DISC (6 DIFFERENT AVAILABLE),** \$5.99 EACH. VISA/MC/COD. SCC, BOX 551, DUBLIN, OH 43017 (614) 889-2117.

**NY METRO AREA**

ADS, AGI, APT, Astratic, Audio Control, Audi-  
onics, Audio Pro, Audio Research, Audio Tech-  
nology, Beyer, Blaupunkt, B&O, Burwen, B&W Carver,  
CAT, Catter, CWD, Danquist, B&O, Denon, Dynavector, Ev,  
Fidelity Research, Grace, Grado, Halter, Jans, KEF, Koetsu Linn  
Sondek, Live Wire, Lustre, Nakamichi, Pyramid, Quad, Queen Labs  
Revox, RG Dynamics, RGR, RH Labs, Rogers, Snell, Stax, Symmetry,  
Tandberg, 3D Acoustics, VPI, Yamaha

**Audiocom**  
high technology audio

SERVICE ON PREMISES • CUSTOM INSTALLATIONS  
THREE LISTENING ROOMS ON TWO LEVELS  
LARGE INVENTORY • PROMPT DELIVERY  
INFORMATION LINE 203-637-3621

177 Sound Beach Avenue, Old Greenwich, CT 06830  
Major credit cards honored. Open 10 AM-6 PM Mon-Sat.



## GREENFIELD EQUIPMENT

Audio components and systems dedicated to the presentation of the art form, THE MUSIC.

Accuphase • Adcom • Ariston • Audio Interface • Beveridge • Berning • Classe Audio • Clear Audio  
 Counterpoint • DB Systems • Discotech • Dynavector • Electrocompaniet • Electron Kinetics  
 Entec • Estoric Audio Research • Grace • Halfer • ISOS • Kiseki • Kimber Kable • Klyne • Koetsu  
 Lustre • Micro Seiki • Orsonic • Ortofon • Precision Fidelity • Profile • Sideraal Akustik • SME  
 Snell • Souther • Spica • Stax • Supex • Thorens • Tiffany • Triad • VPI • VSP Labs

Call or write for information - Complete shipping and export facilities available - Auditions by appointment

7805 Greenfield Street • River Forest, Illinois 60305 • (312) 771-4660

### WANTED TO BUY

**BIG REWARD !!** All Mac equip., JBL spkrs. and electronics, Altec Acousta-voicette, MXR ETC 31 band equalizers, Thorens TD 125, SME 3009-3, JBL speaker cabinet blueprints. 1-313-229-5191 aft. 7 EST

**MCINTOSH, MARANTZ TUBE COMPONENTS**, Western Electric, Hartfields, Patricians. John Conrad 1178 Blackbird El Cajon, Ca. 92020 (619) 449-9155

**MCINTOSH, MARANTZ TUBE EQUIPMENT**, Thorens TD-124, Western Electric, Altec/JBL/EV/Tannoy/Stephens raw speakers, Tubes, etc. Top cash. Scott Dowling, 9908 Daines Dr., Temple City, CA 91780 (818) 286-9122. Week-ends and after 6PM (PST) M-F

**MCINTOSH, MARANTZ, LEAK, TUBE AMPS**. Thorens TD-124, Garrard 301. Old Tannoy Monitor Speakers, Western Electric Equip (Tubes, Mixers, Consoles, Amps, Tweeters, Horns, Speakers, Etc.) Tel: 818/576-2642 David Yo, POB 832, Monterey-pk, Ca. 91754.

**QUADRAPHONIC OPEN REEL TAPES**, Q-8's, records, select equipment, Michael Robin, 120 Atlanta Place, Pittsburgh, PA 15228. 412-341-1686

## In New England...



The knowledge, creativity and dependability you expect from a dealer who represents these manufacturers.

Acoustat	Kiseki
ADS	Magnepan
Alpha	Mission
Audio Interface	NAD
Audio Pro	Nakamichi
Audioquest	Niles
Bang & Olufsen	Nitty Gntty
Boston Acoustics	Oracle
Bryston	Plexus
Carver	Proton
Counterpoint	Pyramid
C J Walker	Robertson
Dennessen	Signet
Denon	SOTA
Dynavector	Stax
Energy	Sumiko
ESB	Tandberg
Grace	Threshold
Halfer	Vandersteen
KEF	VPI
Keith Monks	Wooden Images

5 listening rooms... New England's largest Audiophile record dealer... Keith Monks record cleaning... In-store service... All shipments pre-paid and insured in the continental U.S.

# 5 TAKE AUDIO

105 Whitney Ave., New Haven, CT  
 (203) 777-1750  
 Mon., Tue., Wed., Fri. 10-6, Thurs. 10-8, Sat. 10-5

### WANTED TO BUY

**THE AUDIO CRITIC**, Vol. 2, No. 1, THE ABSOLUTE SOUND, Nos. 1-10, E. Kantor, 12365 Montsourir, St. Louis, MO 63141 (314) 878-5950.

**WANTED: KLH TABLE RADIO**. Prompt payment for either FM or AM/FM model in good condition. (415) 397-2718 or (415) 458-3940.

### PLANS & KITS

**ATTENTION! SPEAKER KITS**, Audax, Becker, Dynaudio, Eclipse, Focal, Peerless, Morel, Vifa, SIARE, and more. 1984 catalog, 25c. Meniscus Systems, 3275W Gladiola, Wyoming, Michigan 49509.

**CURRENT-MIRROR PRE-PREAMP KIT**. Price reduced 36% to \$45 plus \$4 shipping. Kit includes chassis and hardware plus assembled and tested circuit board. SASE must accompany inquiries. Custom Components, Box 33193, Decatur, GA 30033.

**GRAPHIC EQUALIZER KITS**, 12-24 BANDS/CHANNEL \$89-200. NOISE FILTER/EXPANDER \$120. SUBSONIC FILTERS, OTHERS: SSS, 856U LYNNROSE, SANTA ROSA, CA 95404. (707) 546-3895.

### SERVICES

**AUDIO PULSE SERVICE**. Factory trained technicians. Write us about Model One update kits. White Labs, 10528 Lower Azusa Rd., Suite 192A, El Monte, CA 91731. (818) 446-5346.

**AUDIO PULSE SPECIALISTS**. Repairs—Modifications—Updates—Sales. WALT'S AUDIO SERVICE, 111 East Rialto Ave., Rialto, Calif. 92376. (714) 875-0776.

**PRECISION AUDIO SERVICE**. Japanese and Domestic Amplifiers, Preamps, Electronic Accessories, etc. Matched transistors, metal film resistors, quality capacitors used in repairs. Current and vintage tube equipment restored. Low overhead, reasonable rates. All work guaranteed. B.S.E.E. on staff. 212-526-8430, Jamaica, NY

## TEST RECORDS

**SEVEN STEPS TO BETTER LISTENING, FROM CBS TECHNOLOGY CENTER**, is a high-precision test record for the novice. Set up your hi-fi system and tune it to the specific acoustics of your listening room. Make certain your equipment functions properly. Includes 16-page booklet by AUDIO's Edward Tatnall Canby which shows you how to perform the following "ears only" tests: Proper identification of left and right channels, phasing, loudspeaker balance, tone control settings, elimination of buzzes and rattles, proper adjustment of vertical and lateral-tracking forces, and much more. Send \$6.98 in check or money order in U.S. funds only; payment must accompany order. Allow four to six weeks for delivery. **AUDIO TEST RECORD**, P.O. Box 182101, Dept. 406, Cincinnati, OH 45218

### TEST RECORDS FROM CBS TECHNOLOGY CENTER

**STR 100 PHONO CARTRIDGE TEST RECORD**, includes sweep frequency with sync for recorder; spot frequency; separation; compliance; vertical- and lateral-tracking; tonarm resonance, and more. \$10.00 each.

**STR 112 PHONO CARTRIDGE TEST RECORD**, includes square wave, graduated-tracking, and IM bands. \$15.00 each.

**STR 120 PHONO CARTRIDGE TEST RECORD**, includes ultra-sonic test tones, high-level low-frequency glide tones, standard-level and silent bands, and can be used with a graphic level recorder. \$15.00 each.

**STR 130 RIAA FREQUENCY RESPONSE TEST RECORD**, provides accurate means of calibrating professional recording equipment. Can be used with a graphic level recorder or, without automatic equipment, with the spot frequency bands. \$15.00 each.

**STR 140 PINK NOISE ACOUSTICAL TEST RECORD**, is designed for acoustical testing of loudspeakers in ordinary rooms and whole systems, and for psychoacoustic tests. Includes spot frequency tones with voice announcements and glide-tones in 1/2 octave bands from 30 Hz to 15 kHz synced for a graphic recorder. \$15.00

**SQT 1100 QUADRAPHONIC TEST RECORD**, the standard test disc for SQ decoding adjustment, has test bands for pickup measurements, setup of decoders, channel identification and balance. \$15.00 each.

Payment must accompany order and be either a check or money order in U.S. funds. Allow four to six weeks for delivery.

STR 100 Stereo Frequency Record \$10.00  
 STR 112 Square Wave, Tracking and IM Disc \$15.00

STR 120 Wide-Range Cartridge Disc \$15.00  
 STR 130 RIAA Frequency Response Disc \$15.00  
 STR 140 Pink Noise Disc \$15.00

SQT 1100 Quadraphonic Test Disc \$15.00  
**AUDIO TEST RECORDS**, P.O. Box 182101, Dept. 406, Cincinnati, OH 45218

## THE NEW TECHNOLOGY

Tube Quality—  
 Transistor Prices

New from Kinergetics.  
 The KBA-100 Amplifier \$795.00.  
 The KPA-1 Preamplifier \$775.00.

Hear them now at selected audio dealers.

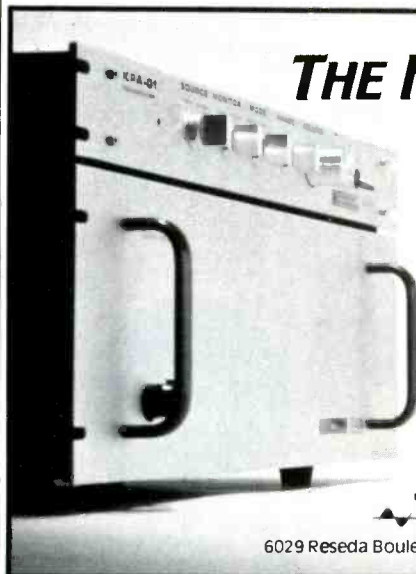

UNDER LICENSE BY ASR

**K KINERGETICS INCORPORATED**

6029 Reseda Boulevard • Tarzana, California 91356 • (818) 345-2851

## RADIO PROGRAMS

**OLDTIME RADIO** . . . Classic broadcasts on high quality tapes. Free catalogue. Carl A. Froelich, 2 Heritage Farm, New Freedom, PA 71349.

**OLD TIME RADIO**—Original broadcasts on quality tapes. For free catalog send SASE to: Triple Trivia Studios, PO Box 29073A, Chicago, IL 60629.

## HELP WANTED

### PROGRAMMER—AUDIOPHILE WANTED

Major east coast manufacturer of high quality loudspeaker systems is expanding engineering staff. Require person with high level of interest in audio to do programming, process control programming and assist in product design. Knowledge of PASCAL and understanding of A.D. D/A conversion helpful. Send resume c/o AUDIO MAGAZINE, Classified Box #984, 1515 Broadway, New York, NY 10036

## PUBLICATIONS

**ARE YOU INTERESTED IN QUALITY, USED STEREO EQUIPMENT?** Send for the **PLAY IT AGAIN SAM** newsletter—hundreds of listings—items for sale—items sought—published 6 times per year. \$8. 1-year subscription. Send today to **PLAY IT AGAIN SAM**, 12611 Madison Avenue, Lakewood, Ohio 44107. (216) 228-0040. Master Charge and Visa accepted.

## MISCELLANEOUS

**CLOCKS:** The absolute finest ships bell and mantel clocks. Discounted "high-end" send \$3 for catalog. San Joaquin Clockworks P.O. Box 60322 Dept.-A, Bakersfield, CA 93386

**INVENTIONS, IDEAS, NEW PRODUCTS WANTED!** Industry presentation/national exposition. 1-800-528-6050. X831.

# USED!

HARMANKARDON Citation 16 \$449 NAKAMICHI 550 \$449  
 HARMANKARDON Citation 11 \$129 TECHNICS RS1 500 \$799  
 REVOX B795 \$199 HARMANKARDON Citation 15 \$149  
 AUDIO RESEARCH SP6A \$679 McIntOSH C27 Call  
 AUDIO RESEARCH SP6B \$749 McIntOSH MR67 \$199  
 AUDIO RESEARCH DI00 \$449 JANIS W2 \$399  
 ALTEC 729A Acoustivoicette EO \$499 Bryston 2B \$249  
 TECHNICS SL-1100A \$279 YAMAHA CA600 \$169  
 CELESTION SL-600 demo \$1199 YAMAHA CA600 \$169  
 LUXMAN T-4 \$229 SPECTROACOUSTICS 217 \$89  
 TEAC 3340S \$849 KLARK TECHNIC DN15 preamp/eq \$699  
 LUXMAN PD272 \$159 SOUND CONCEPTS SD550R \$349  
 REVOX B760 \$749 COTTER BI/Technics SP10 Mk II \$499  
 REVOX B710 \$799 MARK LEVINSON JC-2 \$499  
 YAMAHA CT800 \$179 AUDIO RESEARCH D-100 \$499  
 ACOUSTAT 3M \$999 BOSE 901 Series I \$469  
 PIONEER RT707 \$399 POLK AUDIO Mon. Jr. & LF14 \$399  
 PIONEER TX6200 \$79 DYNACO Stereo 70 \$159  
 DYNACO PAS-3 \$89 KLH TNE-7000A \$249  
 DYNACO MK3 pr. \$250 PYRAMID T-9 demo \$349  
 STAX SR44 Cali STAX SR5 System Cali  
 QUAD ESL \$799 FISHER HiCom II \$129  
 B & W 801f demo \$1999 CELESTION SL6 new \$549  
 KLH 9 \$499 SONY PS-B80 w/Sony MC cart. \$699  
 LINN Sara PMS \$699 SHAHINIAN Obelisk \$549  
 FRIED A3 demo \$389 FRIED O2 demo \$289  
 DCM Time Base pr. \$449 McIntOSH MC2120 \$899



95 Vassar St.  
Cambridge, MA 02139

617-547-2727

## MAIL ORDER/USED EQUIP.

**AAAAAAA SAVINGS TO 90% ON CARTRIDGES.** Mostly discontinued ADC, Adcom, Grace, Shure and 8 other brands. Send stamp for list. ACS, 2313 Brentwood, Olympia, WA 98503.

**AAAA Rated HIGH-END Japanese Audio specialists.** Our equipment comes direct from Japan in unopened cartons at **TREMENDOUS SAVINGS.** Cartridges: we list 100 with prices. Tonearms: we list 45. Accessories: 100! Absolutely the best selection at the lowest prices. **NAKAMICHI DRAGON, 1000ZXL, RX-505;** Sony 701ES, PCM-F1; Yamaha R-100, T-70; **STAX Pro Set;** lowest prices, in stock! **DYNAVECTOR 17DII, \$199! 23R GOLDBUG** Mr. Briar, \$580! **ACCUPHASE AC-2 \$260! AC-3, \$230!** Micro, Fidelity Research, SAEC, NEC, Esprit, Lux, Audiocraft, High-Phonic: many items not available anywhere else. Our full catalog \$3. Japanese Stereo 930 North Lacienege Boulevard, Los Angeles 90069, (213) 652-3337 (Tuesday through Saturday) or in Japan 1-14-32-210 Jingu-mae, Shibuya-ku 150, Tokyo.

**A BETTER SYSTEM?** People who know stereo buy their sound direct. Now you can buy the finest in high fidelity components, including esoterics and autotune, at unheard of prices. **DIRECT SOUND MARKETING** provides sensible expert advice, in-house service facilities, and factory fresh components on an in-stock basis. Discover America's best kept audio secret. Send \$1.00 for our informative catalogue to **DIRECT SOUND MARKETING**, Dept. A, 3095 Bolling Way N.E., Atlanta GA 30305 or call 404-233-9500. MC/VISA and AMEX accepted.

### CAUTION! NAKAMICHI BUYERS!

Nakamichi goods not designed for sale in the United States are being sold by unauthorized dealers. **NAKAMICHI U.S.A. CANNOT BEAR ANY RESPONSIBILITY FOR SALES OR WARRANTY SERVICING OF UNITS NOT COVERED BY OUR APPLICABLE WARRANTY.** For the name of your nearest authorized Nakamichi dealer, call 1-800-421-2313. In Calif., call 800-223-1521.

## MAIL ORDER/USED EQUIP.

**GRACE BY MAIL-ORDER? PLEASE READ THIS EVERYBODY LOVES A BARGAIN.** But if you're considering a Grace "level II" cartridge as a lower cost alternative to a Grace F-9 series cartridge, you may be getting less than you bargained for.

As the only authorized importer of Grace products to the U.S., we were offered the Grace "level II" series two years ago. We rejected this series because technical evaluation showed that the motor mechanism and body of the "level II" were identical to those used in the old F-8 series, the only differences being the type of cantilevers and styli available. The F-9 series, on the other hand, has a motor mechanism and body far advanced from the F-8 or "level II."

The "level II" cartridges are not updates of the F-9 series. "level II" cartridges should cost less than F-9s—they're worth less.

Several "mail-order discount" type outfits are offering "level II" cartridges for sale. The public should be aware that these cartridges are not imported by Sumiko, Inc., are not quality controlled by us, and are not covered by our warranty. The companies that sell you these goods claim to provide warranty on defective units. We have no way of knowing how valid these claims are, nor does the consumer have any assurance that these companies will still be in business when service is necessary. Warranty repairs may be available only in Japan for cartridges obtained from these sources.

To be sure your Grace products are coming from an authorized Sumiko dealer, please contact us and we will be glad to provide you with the name of your nearest dealer.

**SUMIKO, INC., P.O. BOX 5046,  
BERKELEY, CA 94705  
(415) 843-4500**



**ZETA**

probably the best tonearm in the world?

'the Zeta is the best sounding arm I've tried. . . capable of bringing a whole new dimension to disc reproduction.' — HIFI ANSWERS.

'more dramatic in resolution, dynamic range enhanced, general sharpening of instrumental positions.' — HIFI NEWS.

'bass was exceptionally good, deep, powerful, tight & articulate. . . treble was sweet & transparent.' — HIFI CHOICE.



**GOLDBUG**

hand building sweeter MC cartridges

REFERENCE MONITOR INT. INC. 6074 CORTE DEL CEDRO, CARLSBAD, CA 92008



**1-800-431-3232**  
Specializing only in  
cartridges + stylus + rmc's + headphones

**audiofon**

B&O • audio-technica • AKG • Ortofon  
Dynavector • Grace • PICKERING • Stanton  
ADC • SIGNET • SHURE • Sennheiser  
We quote pro advice + lowest price  
24 Hr. Shipments on all our equipment  
COD's are Okay, call us, don't delay  
P.O. Box 37, Brooklyn, NY 11204 (212) 438-6400

**MAIL ORDER/USED EQUIP.**

**AFFORDABLE AUDIOPHILE COMPONENTS!** Great prices on wide selection of "Best Buy" high-end audio components. Large selection of audiophile accessories and record cleaning products. Call or write for prices and list of monthly specials. HCM AUDIO, 1600 B Mangrove, Chico, CA 95926 (916) 345-1341

**AD INDEX**

**MAIL ORDER/USED EQUIP.**

**ABARGAIN:** STAX SIGMA \$210, LAMBDA \$162, SRX/MK3 \$130, SRD-7 \$68, PROF. LAMBDA & AMP \$509; SUPEX 901E SUPER \$120; GRACE F9E \$99, F9E STYLUS \$55; RUBY STYLUS \$110, F9E RUBY \$160, 70711(B) \$130, 747 \$149; ACCUPHASE AC-2 \$265, AC-3 \$229; TECHNICS EPC205CIV \$150, EPA500 \$255, EPA250 \$250, TECHNICS STYLUS GAUGE \$49; DENON 103D \$165; DYNAVECTOR 23RS \$175, 17DII \$189, 17DS \$359, 10x3 \$75, DV501 \$289, DVGA SILVERFORMER \$255; FIDELITY RESEARCH 64SS \$375, 64FX \$295; MAYWARE FORMULA IV \$75; INTERCOMPONETS: BEN-SEI 3' \$35, 6' \$49; ALL UNUSED, BOX 273179 BOCA RATON, FL., 33427 (305) 487-1048; BOX 6312, L.I.C., N.Y. 11106 (212) 784-2939; WANTED LEICA & ROLLIE-FLEX TLR CAMERAS.

**A-TRONIX SYSTEMS UNLIMITED "2001" TOMORROWS TRONIX TODAY! "SUPERB COMPONENTS" (ESOTERIC) / BEST PRICES! ADS, TANDBERG, S.A.E., HARMAN/KARDON, ONKYO, AIWA, THORENS, BOSTON ACOUSTICS, INFINITY, PYRAMID, DAHLQUIST, MICRO SEIKO, GRACE, GRADO, SONUS, MORE! PROFESSIONAL CONSULTATION WITH FRIENDLY AUDIO VIDEO SPECIALISTS; BUSINESS, HOME, CUSTOM INSTALLATIONS U.S.A. WARRANTIES, PROMPT SHIPPING 1800 S. ROBERTSON BLVD., BUILDING 6, SUITE #246, LOS ANGELES, CA 90035, (213) 273-5667.**

**20% TO 40% SAVINGS:** NAKAMICHI, B&W, KOETSU, Denon, Tascam, NAD, Etc. VISA/MC, COD. AudioWorkShop 1-206-323-4987.

**AUDIO DISCOUNTS OFFERS THE FINEST** lines of audio components (INCLUDING THE ESOTERIC) at DISCOUNT PRICES. If you're in the market for speakers, receivers, cassette decks, to the best in separate components including amps, pre-amps, turntables, cartridges etc. or a new CAR STEREO our knowledgeable sales staff will be glad to assist you. For more information Monday thru Saturday PLEASE CALL 301-593-8833 or write to **AUDIO DISCOUNTS**, 1026 McCeney Avenue, Silver Spring, MD 20901. We honor VISA-MC and COD for your convenience. **AD**

**HIGH-END AND ULTRA-END** discounted up to 50%! How? Our offices in Tokyo make us uniquely different. All equipment imported directly; sealed cartons, warranties, absolutely lowest prices anywhere. We recommend: Accuphase AC-2, \$260! Dynavector 23R \$135, DV-17DII \$199! Sony PCM-F1, \$1,250! Nakamichi Dragon, 1000ZXL, RX505: excellent discounts. New Yamaha CD-1A, \$1,295 (exclusively ours); R-100 \$595, T-1000 \$265; Stax Lambda \$155, Pro, call! Grace Ruby \$130! Micro's newest air-bearing turntable \$1,775! Fidelity-Research FR-66fx \$495! Goldbug \$585! Tremendous (high-end) selection! Catalog \$3 Japanese Stereo, 930 North Lacienea Blvd., Los Angeles, CA 90069 (213) 652-3337 or 1-14-32-210 Jingu-mae, Shibuya-ku, Tokyo.

**INTERSONICS—YOU'VE HEARD OF US:** direct-export specialists: Japanese high-end/esoteric audio components, accessories, parts, Japanese pressings, OEM sourcing, more. Serving audiophiles and dealer/distributors with exceptional volume pricing, prompt delivery, responsible backup. An AMERICAN enterprise: INTERSONICS, PO Box 113, Toyohashi 440, JAPAN.

**NAKAMICHI NAKAMICHI SHAMEFULLY LOW PRICES:** Products Designed Especially For USA And Overseas Use. The More Information You Have The Better You Can Make Your Decision. Extremely Long Insured USA Warranties. Service Available Nationwide. Thousands of Satisfied Customers Worldwide. AudioWorkShop 1-206-323-4987.

**THEY DON'T DISCOUNT IT? WE DO!** Get LOW PRICES on ALL types of audio equipment—including high-end and even esoteric products not normally discounted! Now we can save you money on the equipment you REALLY WANT. Extensive selection—no need to settle for second choice. Thousands of satisfied customers nationwide. Call us for price quotes or friendly, expert advice. Catalog \$1. 616-451-3868. VISA/MC/AMEX. THE AUDIO ADVISOR INC., BOX 6202, GRAND RAPIDS, MI 49506.

**ATTENTION ADVERTISERS! SEE CLASSIFIED RATE BOX ON PAGE 104 FOR NEW RATES EFFECTIVE OCTOBER 1984 ISSUE.**

Firm (Reader Serv. No.)	Page
Acoustic Research	1
Adcom (1)	54
Aiwa (2)	88
Alpine Luxman (3)	19
Audiophile (4)	16
Audio Source (5)	98
Audio-Technica (6)	13
BASF (7)	79
B.E.S. (8)	80
B&W Loudspeakers (9)	77
Camel	63
Carver (10)	4
CBS Masterworks (17)	101
CBS Records (11)	87
Denon (12)	17
Discwasher	Cover IV
Harman/Kardon	5
JVC (13)	20 & 21
Kenwood (14)	99
Kyocera (40,41,42)	69, 71, 73
Last Factory (16)	55
Maxell	7
McIntosh (18)	102
Memorex (19)	26
Nakamichi	56 & 57
Ohm (20)	81
Onkyo (21)	Cover III
PDMagnetics (22)	96
Perreux (43,44,45)	8, 10, 24
Polk (23)	61
Rotel (24)	91
Salem	Cover II
Sansui (25)	85
Sanyo (26)	29
Sherwood (27)	83
Shure Brothers (28)	11
Signet (29)	103
Sony (32)	32
Soundcraftsmen (30)	9
Stillwater (33)	80
Studer Revox (34)	70
Subaru	3
Tandberg (35)	15
Technics (36)	95
TDK (37)	66
Toshiba (38)	23
Warner (39)	92
Winston	25
Yamaha	75

CALL TOLL FREE 800-221-8180  
IN NEW YORK CALL (212) 737-6600

**J&R MUSIC WORLD**

**THIS MONTH'S SUPER SPECIALS HEADPHONES RECEIVERS**

TECHNICS SA850 \$219.95  
TECHNICS SA150 \$159.95  
TECHNICS SA550 \$199.95  
AKAI AA425 \$179.95  
AKAI AA435 \$179.95  
AKAI AA445 \$179.95  
SANSUI Z2000X \$199.95  
SANSUI Z2000X \$199.95

**COMPACT DISC PLAYERS**

TECHNICS SLPT \$179.95  
TECHNICS SA550 \$199.95  
TECHNICS SA550 \$199.95  
SANSUI CD 200 \$199.95

**TURNABLES**

TECHNICS SL5 \$179.95  
TECHNICS SL200 \$199.95  
TECHNICS SL200 \$199.95  
TECHNICS SL200 \$199.95

**CARTRIDGES**

SHURE V15 \$149.95  
SHURE M110HE \$149.95  
AUDIO TECHNICA AT152LP \$149.95  
AUDIO TECHNICA AT152LP \$149.95  
MICRO ACOUSTICS \$149.95

**CASSETTE DECKS**

TEAC V500X \$149.95  
TEAC V500X \$149.95  
TECHNICS PSB2B \$149.95  
AKAI CB200 \$149.95  
AKAI CB200 \$149.95

**STEREO-TO-GO**

SONY WMF10 Mini \$149.95  
SONY WMF10 Mini \$149.95  
SONY WMF10 Mini \$149.95  
SONY WMF10 Mini \$149.95

**SOUND ENHANCERS**

AUDIO CONTROL C101 \$149.95  
AUDIO SOURCE \$149.95  
ADC \$149.95  
NUMARK \$149.95  
NUMARK \$149.95  
TECHNICS \$149.95  
TECHNICS \$149.95

**VIDEO TAPE**

ANY BRAND 1500 \$6.99  
ANY BRAND 1750 \$6.99  
ANY BRAND 1750 \$6.99  
ANY BRAND 1750 \$6.99  
ANY BRAND High Grade 1500 \$6.99  
ANY BRAND High Grade 1750 \$6.99  
ANY BRAND High Grade 1750 \$6.99

**SUPER SPECIALS**

MAXELL T-120 \$10.99  
MAXELL T-120 \$10.99  
MAXELL T-120 \$10.99  
MAXELL T-120 \$10.99  
MAXELL T-120 \$10.99

**23 PARK ROW, DEPT. A9, NYC, N.Y. 10038**

HOW TO ORDER BY MAIL: FOR PROMPT AND COURTEOUS SHIPMENT SEND MONEY ORDER CERTIFIED CHECK CASHIER'S CHECK MASTERCARD VISA (include card number) OR CREDIT CARD (expiration date and signature) I DO NOT SEND CASH. PERSONAL AND BUSINESS CHECKS MUST CLEAR OUR BANK BEFORE PROCESSING. \$25 MINIMUM ORDER. INTERBANK NO. DEPOSIT ON DATE AND SIGNATURE. \$3.95 PER ORDER. \$3.95 PER ORDER. SHIPPING AND INSURANCE CHARGE IS 5% OF TOTAL ORDER. NEW YORK RESIDENTS PLEASE ADD SALES TAX. ALL MERCHANDISE SHIPPED BRAND NEW. FAST TOGETHER FREIGHT. 100% GUARANTEED. WE ARE NOT RESPONSIBLE FOR ANY TYPOGRAPHICAL ERRORS. WRITE OR CALL FOR FREE 288 PAGE AUDIO VIDEO COMPUTER CATALOG

**Electrified**  
**Discounters**

**203-937-0106**

**Lowest Possible Prices !!**

**AUDIO VIDEO CAR PRODUCT COMPUTERS — (HARDWARE - SOFTWARE) VIDEO GAMES TELEPHONES MORE**

**FULL WARRANTY — FAST DELIVERY**

**SEND FOR CATALOG**

MasterCard 996 ORANGE AVE. WEST HAVEN, CT. 06516 VISA



The **only** compact disc player with separate power supplies for each critical performance function.

# The Onkyo Integra DX-300

**Servo Control Delta Power Supply**  
Powers the **FOUR** DC and DC Servo motors and control circuitry, ensuring smooth and stable transport action. This design provides accurate disc rotation with positive disc handling and loading.

**Analog Domain Delta Power Supply**  
The important analog circuits benefit from the clean DC source, ensuring that the analog audio output retains the full dynamic range capabilities of the digital compact disc.

**Digital Domain Delta Power Supply**  
Provides the digital microprocessors and Digital/Analog conversion circuitry with a rock-steady DC supply. This ensures that transient voltage spikes and modulation noise cannot interrupt the digital data bit stream.



**Display Delta Power Supply**  
Energizes the incandescent, fluorescent, and LED components of the front display panel, with constant illumination.

The parameters of the Digital Audio Disc system provide for incredible audio performance, with wide dynamic range and ultra low distortion. Because Compact Disc players deal with purely digital audio signals it is commonly believed that no differences in sound quality exist between various CD players. However, much of the circuitry is devoted to the musical information after conversion to analog form. The Onkyo DX-300 Compact Disc Player employs separate Delta Power Supplies for each critical performance function to ensure that no extraneous noise or distortion affects the musical performance.

The Delta Power Supply, developed by Onkyo and used in our state-of-the-art amplifiers, pre-amplifiers, and other audio components, eliminates the low-level transient modulation noise caused by the interaction of musical signals with frequency components at or near the line charging frequency. This expands the available dynamic range a full 20 db over conventional analog power supplies, and provides a supply source with a dynamic range wide enough to match that of the digital audio source.

Onkyo's patented Delta Power Supplies, coupled with a highly sophisticated laser

tracking system and the most demanded convenience features, ensures that superb audio fidelity will always be realized. As the name "Integra" suggests, the DX-300 gives the listener a sound that's as close as possible to the original, with all the integrity of the live performance retained.

Artistry in Sound

## ONKYO

200 Williams Drive  
Ramsey, New Jersey 07446

Enter No. 21 on Reader Service Card



New Technologies  
can't replace  
what you already own.

New technologies will provide many advances in recorded music, but nothing can replace your favorite records.

Protect them as people have been doing for well over a decade...with Discwasher record care products.

The Discwasher® D4+™ Record Care System safely cleans records without reducing their dynamics and fidelity. The highly active D4+ fluid is able to lift and suspend contaminants on the record surface to be removed by the directional fibers of the D4 pad; and the D4+ System cleans



records without leaving behind residues which can affect a record's sound.

But total care doesn't stop with a clean record surface. A diamond stylus, contaminated with vinyl stabilizers and dirt, can actually reduce the life of your records by two-thirds.

The Discwasher® SC-2™ Stylus Care System, with its exclusive nylon-fibered brush and scientifically safe fluid, effectively loosens and wipes away abrasive stylus contamination for longer record life.

Protect your records with Discwasher® care.

**discwasher**

1407 NORTH PROVIDENCE ROAD, P.O. BOX 6021, DEPT. AU, COLUMBIA, MO 65205 USA  
A DIVISION OF JENSEN an ESMARK Company