

Audio

JUNE 1983 • \$1.75 • (F) 06030

AMP SHOWDOWN
SONY VS. DENON

FIRST TEST PHASE LINEAR COMPACT DISC PLAYER

BUILD A POOR-MAN'S WOW & FLUTTER METER



**COMPONENT
WITH
ITION TV**

**AFTSMEN
ANALYZER-
ER**



Anyway you look at the NEC PJ-4000EN, it's the best looking rear-screen Video Projector around. Its slim 22" depth means that it will look better in your home. Its new dual-pattern screen gathers and disperses light more evenly so more members of the audience can get a better look at the PJ-4000EN's brilliant picture, wherever they're sitting or standing. (Its 120 degree horizontal viewing angle is the industry's widest; its 36 degree vertical viewing angle, the tallest.)

A full complement of High Video Fidelity features including 134-channel frequency synthesized tuning; two sets of video and

dual-channel audio inputs/outputs, simulated stereo from mono, etc., lets you take full advantage of the PJ-4000EN's outstanding performance.

The PJ-4000EN truly lives up to the "Best in Class" reputation established by the other models in the NEC Large Screen Video line-up. The NEC PJ-6000EN (60" diagonal) one-piece

front screen Projection TV offers greater resolution at a larger picture size than even its most esteemed competitor. The PJ-1000EN (100" diagonal) is the genuine giant screen two-piece Video Projector, not a smaller screen home unit with adapter lenses.

Whether it's picture quality, styling or features—no matter how you look at it, NEC is the one to watch.

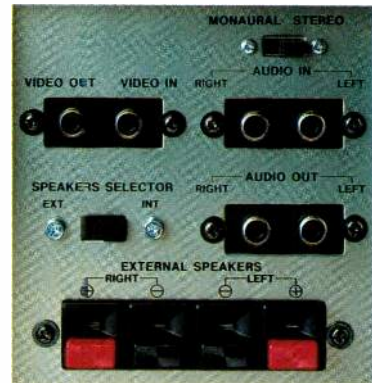

THE REAR

A glance at this rear panel indicates that the PJ-4000EN has the flexibility of a genuine video component.



REMOTE

A wireless full-function remote puts you in control.

THE PJ-6000EN AND PJ-1000EN VIDEO PROJECTORS.

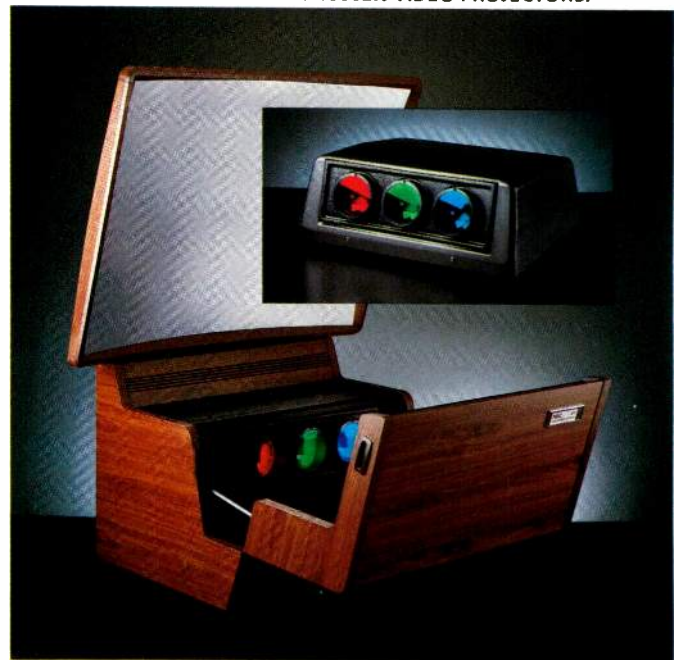

NEC
THE ONE TO WATCH

THE FRONT

NEC's dual-pattern screen design gathers more light and spreads it more evenly over wider viewing angles.



THE SIDE

Measuring a mere 22" deep, the PJ-4000EN takes up little more room than a conventional console TV.

**THE BEST-LOOKING
PROJECTION TV.
FROM ALL ANGLES.**

Audio

JUNE 1983

VOL. 67, NO. 6

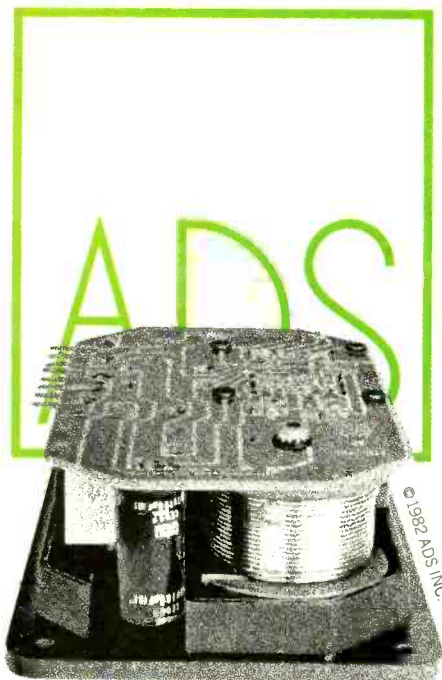

The crossover network. A great place to hide.

You don't usually see crossovers in loudspeaker ads.

Because the crossover is the most embarrassing part of most loudspeaker systems; an electronic 'kludge' buried deep in the cabinet. Designed to cover up the deficiencies of mediocre drivers. Or, just to save money so that the speaker can be sold at a particular price.

The ADS crossover, above, is a different breed altogether.

All its components are computer grade, and mounted on a 'military spec' epoxy printed circuit board. Chokes are wound with wire imported from one country on ferrite cores imported from another.

It's one of the reasons an ADS speaker sounds better, and tighter in the low end. It is an elegant solution, in every way.

We bring it to your attention because it is one of many fastidious details which are part of every piece of equipment (regardless of price) which carries the ADS name.

Watch this space for more interesting facts. Or contact us.

Write Analog & Digital Systems, Inc., 221 Progress Way, Wilmington, MA 01887. Call 800-824-7888 (in California, 800-852-7777) Operator 483.

Or best of all, see an ADS dealer. We can only tell you how well they're made. He can show you how much better they sound.

ADS. Audio apart.



See page 72.

FEATURES

BATTLE OF THE AMPS	Leonard Feldman	56
BUILD A POOR-MAN'S WOW & FLUTTER METER	M. J. Salvati	64
ONE-BRAND SYSTEM REVIEW: SANYO PRO-PONENT A/V SYSTEM	Leonard Feldman	72

EQUIPMENT PROFILES

PHASE LINEAR 9500 COMPACT DISC PLAYER	Leonard Feldman	76
SOTA SAPPHIRE TURNTABLE	Edward M. Long	80
MAGNAVOX FD1000SL COMPACT DISC PLAYER	Leonard Feldman	86
SOUNDCRAFTSMEN AE2000 ANALYZER-EQUALIZER	Howard A. Roberson	90

MUSIC REVIEWS

ROCK/POP RECORDINGS	Michael Tearson, Jon & Sally Tiven	20
AUDIOPHILE RECORDINGS		28
CLASSICAL RECORDINGS	Edward Tatnall Canby	34

DEPARTMENTS

SPECTRUM	Ivan Berger	9
ROADSIGNS	Ivan Berger	10
TAPE GUIDE	Herman Burstein	14
AUDIOCLINIC	Joseph Giovanelli	16
BEHIND THE SCENES	Bert Whyte	36
VIDEO SCENES	Bert Whyte	40
AUDIO ETC	Edward Tatnall Canby	44
SIGNALS & NOISE		50
CLASSIFIED ADVERTISING		95
ADVERTISING INDEX		112

See page 40.

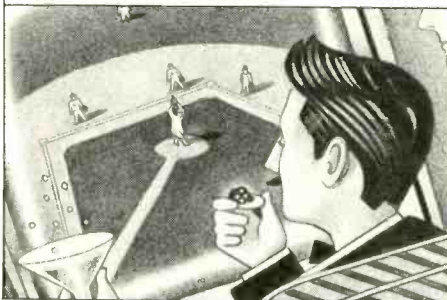

The Cover Equipment: Phase Linear 9500 Compact Disc player.
The Cover Photographer: Carl Zapp.

Audio Publishing, Editorial and Advertising Production Offices,
1515 Broadway, New York, N.Y. 10036.

Subscription Inquiries, (800) 525-9511;
in Colorado (303) 447-9330.



HOW CAN SANSUI CLAIM THE D-970 IMPROVES EVERY TAPE YOU'LL EVER MAKE? SIMPLE. ITS HI-TECH FEATURES INCLUDE COMPU-TREC.

Sansui's remarkably innovative approach to microcomputer technology is the reason Sansui cassette decks have an unfair advantage over other cassette decks.

Sansui's new top-of-the-line D-970 full-logic cassette deck proves it conclusively.

Compu-Trec fine tunes for best performance.

With its Compu-Trec microcomputer system, the D-970 automatically fine tunes itself for correct bias, recording level and equalization, for optimum high level performance from any tape on the market. And it does it in less than five seconds. That's faster than any other deck.

Sansui's hi-tech features put more pleasure in recording.

As the most advanced deck Sansui has ever produced, the D-970 is packed

with features and refinements that let you transfer every nuance of sound onto tape—and actually monitor it while you're recording. The unique combination of the precision,

tape; a 4-digit counter that's also a timer and a real-time clock; 12 LED peak meters; and audio record mute. Sansui has made high-performance recording completely effortless.

Great Sansui decks with the uncommon in common.

There's a lot of the precision and operating convenience of the D-970 in every cassette deck Sansui makes. So regardless

which you choose, you're assured superb recordings every time—automatically.

Audition them all at your Sansui audio specialist, or write for full details today.



coreless FG-servo direct-drive capstan motor and the Dyna-Scrape filter with Hold-Back Tension servo, glides the tape smoothly over the three high-performance heads.

The result is 0.025% wow and flutter—less than the most expensive deck in the world. And Dolby C/B noise reduction is responsible for a superb 81dB signal-to-noise ratio. There's also a Dual Memory for repeat play on any section of



SANSUI ELECTRONICS CORPORATION
 Lyndhurst, NJ 07071; Garden, CA 90248
 Sansui Electric Co., Ltd., Tokyo, Japan
 W. Carson Co., Ltd., Don Mills, Ont.,
 Canada M3B 3G7

Dolby is a registered trademark of Dolby Laboratories

Putting more pleasure in sound



Enter No. 3 on Reader Service Card

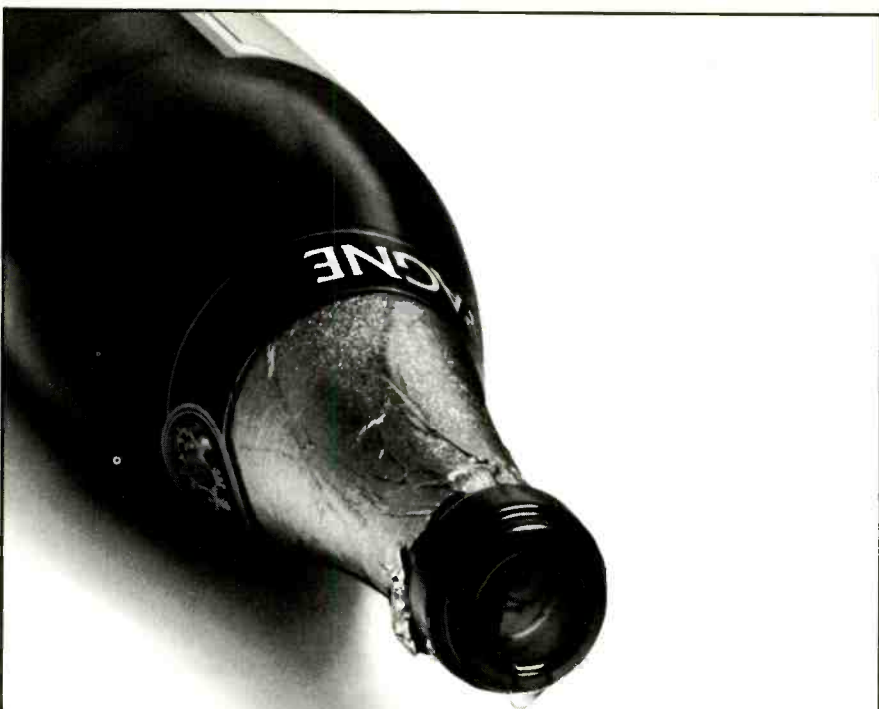

No hangover!

Hangover—a rather loose term to describe the stored energy resonance in a loudspeaker, the principal cause of coloration that immediately tells you you're listening to a loudspeaker.

Take it away and there's a new world—the loudspeakers have nothing more to say—instead there's just the orchestra and the magic of the music.

If music is an important part of your life, then a pair of ESL-63 loudspeakers could be the best investment you've ever made.



Perhaps even something

to celebrate about.

For further details and the name and address of your nearest QUAD ESL-63 retailer, write: QUAD, 425 Sherman Avenue, Palo Alto, CA 94306.

In Canada: May Audio Marketing Ltee, Ltd., Longueuil, Quebec J4G 1P8

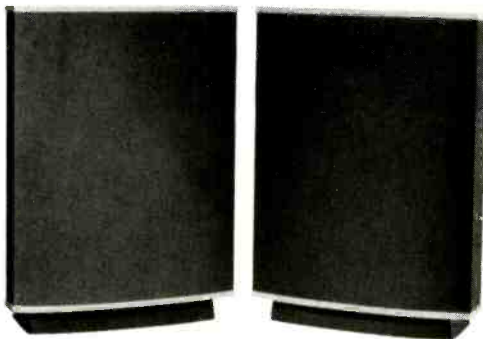

QUAD 
for the closest approach
to the original sound

© 1982 QUAD

Audio

Eugene Pitts III
Editor

Art Director: Cathy Cacchione

Technical Editor: Ivan Berger
Assistant Editor: Kay Blumenthal
Editorial Assistant: Andrea Lynne Hecker

Associate Editors:
Edward Tatnall Canby, Bert Whyte

Senior Editors:
Richard C. Heyser, B. V. Pisha,
Howard A. Roberson

Contributing Editors/Artists:
Herman Burstein,
Ted Costa, John Diliberto,
Leonard Feldman, Joseph Giovanelli,
David Lander, Edward M. Long,
C. G. McProud, Jon Sank, Donald Spoto,
Michael Tearson, Jon & Sally Tiven,
Linda Zerella

General Manager: Mary Anne Holley
Production Manager: Elaine S. Geiger

Charles M. Stentiford
Vice President/Executive Publisher
Marlene F. Jensen
Publisher

ADVERTISING

Advertising Director: Roman Beyer
(212) 719-6335

Eastern Ad Manager: Stephen W. Witthoft
(212) 719-6337

Western Ad Manager: William J. Curtis
Account Manager: Stephen Moser
(213) 487-5880

Classified Ad Manager: Laura J. LoVecchio
(212) 719-6338

OPERATIONS

V.P./General Manager: Robert F. Spillane
Group Business Manager: John J. Miller
Associate Business Manager: James Slockbower
Advertising Promotion Director: John Brown
Advertising Research Director: Perry Grayson
Production Director: Karen L. Rosen

CBS CONSUMER PUBLISHING EXECUTIVE STAFF

President: Robert J. Kretling
Sr. V.P.: George H. Allen
V.P., Group Publisher: Peter G. Diamandis
V.P., Finance & Admin.: Robert J. Granata
V.P., Editorial: Harold Hayes
V.P., Group Publisher: Patrick M. Linskey
V.P., Group Publisher: Michael J. O'Neill
V.P., General Manager: Thomas M. Kenney

Thomas O. Ryder
V.P., Group Publisher

AUDIO (ISSN 0004-752X, Dewey Decimal Number 621.381 or 778.5) is published monthly by CBS Publications, The Consumer Publishing Division of CBS Inc., at 1515 Broadway, New York, N.Y. 10036. Printed in U.S.A. at Nashville, Tenn. Second class postage paid at New York, N.Y. 10001 and additional mailing offices. Subscriptions in the U.S., \$15.94 for one year, \$27.94 for two years, \$37.94 for three years; other countries, add \$6.00 per year.

AUDIO is a registered trademark of CBS Inc. ©1983, CBS Publications, The Consumer Publishing Division of CBS Inc. All rights reserved.

Editorial contributions are welcomed but should be accompanied by return postage. Submissions will be handled with reasonable care, but the publisher assumes no responsibility for safety or return of manuscripts, photographs, or artwork. The Publisher, in her sole discretion, reserves the right to reject any ad copy she deems inappropriate.

AUDIO Publishing, Editorial and Advertising Production offices, 1515 Broadway, New York, N.Y. 10036. Subscription offices, P.O. Box 5318, 1255 Portland Place, Boulder, Colo. 80322; (800) 525-9511, (303) 447-9330 in Colorado. Postmaster: Send change of address to P.O. Box 5316, 1255 Portland Place, Boulder, Colo. 80322.



The Nakamichi DRAGON The Most Incredible Creature Of The Decade

Dragon—the first deck to reproduce every cassette with exquisite clarity and definition. Dragon's revolutionary NAAC (Nakamichi Auto Azimuth Correction) system determines the actual recorded azimuth and continuously manipulates the playback head into perfect alignment *without* special test tones—*automatically*—on every cassette. Restored are the missing highs that have made pre-recorded cassettes (and many home-recorded ones!) inferior to phonograph records. Gone is the dullness caused by noise-reduction systems that don't receive all the high-frequency energy that was recorded. Move into the future with a deck that's already there!

Dragon—Nakamichi's first auto-reverse deck. Not until we created NAAC to correct the playback-azimuth error that occurs when tape is reproduced in the reverse direction would we put our name on an auto-reverse deck.

Dragon—the world's first deck to reproduce in *both* directions with equal perfection, the first auto-reverse deck to employ Asymmetrical Dual Capstans, each directly driven by its own Super Linear Torque DD Motor electronically locked to a precision quartz-crystal reference for amazingly low flutter.

Dragon—with a full complement of "traditional" Nakamichi features and such new innovations as switchable subsonic filters to prevent tape overload when recording a warped record and an Auto Fec Pause that triggers automatically whenever a 10-second program break is detected!

Dragon—another Nakamichi miracle! See it now at your Nakamichi dealer.



Nakamichi U.S.A. Corporation, 1101 Colorado Avenue, Santa Monica, CA 90401



Warning: The Surgeon General Has Determined
That Cigarette Smoking Is Dangerous to Your Health.

8 mg. "tar", 0.7 mg. nicotine av. per cigarette, "TC Report DEC. '81.

CAMEL

Where a man belongs.

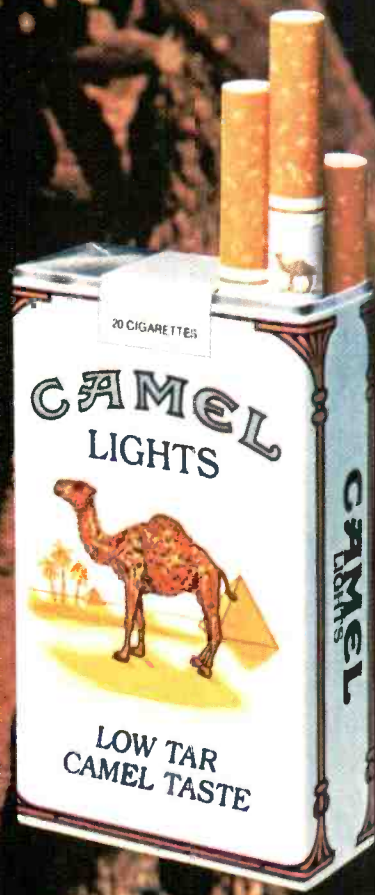

8 mg tar.

Camel Lights.
Low tar. Camel taste.

6

Sixth in a series of how Delco Electronics and Bose technology contribute to your enjoyment of driving.

Deceptive... isn't it.

The control panel of this Electronically Tuned Receiver (ETR) is simple—and deceptive. Simple so that the receiver is easy to operate. Deceptive because a very sophisticated technology lies behind it. A technology that produces high fidelity reception from the Delco-GM/Bose Music System under conditions that are even difficult for ordinary radio reception.

The key to this technology is Delco Electronic's own custom integrated circuits. These circuits respond automatically to changing reception conditions and program requirements. So you can enjoy music and driving more.

When you visit your GM dealer* you will understand why Len Feldman wrote in *Popular Science*: "It's as good as or better than the best home systems I've heard."

*Available as a factory-installed option on Cadillac Seville and Eldorado, Buick Riviera, Oldsmobile Toronado, and Corvette by Chevrolet.

Delco  **BOSE**

Sound so real it will change how you feel about driving.



DIALING FOR DIGITS

supplied WDHA) are showing up, too.

Can you hear the difference over radio? So far, I've only managed to catch CD records via cheap portable or table radios, which don't show off the difference—when I'm listening to my home system, there's no CD to be heard. But E.P. reports:

"I've listened to broadcasts of Compact Discs over three systems—a personal portable during my commute on a bus, a mini-system with \$500 car speakers, and over my 'good' system, which includes Stax Earspeakers. Each time, the improvement and difference were clearly audible; it sounds something like the sudden inclusion of a noise-reduction system. And, best of all, it made each of the systems sound better, a lot better, though it was clearly best on the big system."

Says Robert Linder, General Manager of WDHA-FM, "Rock stations compress a lot, as you know. But with CD, when the compression brings up the soft passages, the noise doesn't come up with it."

Why compress? "Because most listeners are in loud ambient environments, such as the car, the office or the street. There's also the competitive situation, where stations are judged by volume as to how strong they are. At least ours is tastefully done, if compression can be tasteful. We use state-of-the-art equipment, and use it conservatively. But you can't sound too much different from your competition. I'd like to see a system that lets stations broadcast compressed sound for the car and so on, but let living-room listeners expand it back again."

Record Time: Free Program

I feel no guilt in taping my own records for use in my car (or for use in my Walkman, before it walked). They're my records, and since many are long out of print, I couldn't buy new copies—tape or disc—in any case. (There's an argument against tape royalties, come to think of it: If royalties were charged on blank tapes, the fees I paid would not go to those past recording artists whose work I am taping, but to those current ones whose work, by and large, I do not tape.)

Taping classical works is easy. You just note the time per side, or add up the times for the two (or three, at most) bands on that side. But pop records, with 10 or so short cuts per side, are different. You can either add up a host of times like "2:38" and "4:27," or just record until the tape runs out, erase the partially recorded cut at the tape's end, and start the second side with it.

Computer to the rescue. I've written a record-timing program in BASIC, which adds up the times and either tells you how long a tape to use or (if you've already selected the tape) tells you to start the second side of the tape when you have all the cuts the current side can hold. It also adds four seconds to the time of every cut, to allow for the band between selections. If you want a copy of RECTIME/BAS, send a self-addressed, stamped envelope to me; mark your outer envelope "RECTIME."

If you've written any programs you'd like to share with fellow *Audio* readers (about 10% of our readers own computers), please send them in. If the program is long and resides on a machine that I have access to (currently TRS-80 I and III, Apple II and Atari 800 with disc, TRS-80 Color Computer and Sinclair/Timex ZX81 with cassette), I'd appreciate getting it on the appropriate magnetic media—which will be returned, naturally.

```

140 PRINT "Total so far = ";MS;" ";SS
150 IF MS>VAL(C$)/2 GOSUB 230
160 IF I=1 GOTO 180
170 IF C$="" AND MS>30 PRINT:PRINT "too big f
(reset Z:see L1.165)
180 IF C$="" AND MS>45 PRINT:PRINT "too big f
190 GOTO 60
200 INPUT "Want another (Y/N)";W$
210 IF W$="Y" THEN 30
220 END
230 "INT CHR$(7);
"this cut won't fit! Start
"ide = ";M;" ";S
Beep
Sta

```



Illustration: Philip Anderson

CD on FM

If you want to hear Compact Discs in your living room, you may be able to do it at no cost—via FM. Here in New York, at least three stations are playing CDs—WQXR-FM and WNCN (both classical), and WNEW-FM (album-oriented rock). Across the river in New Jersey, WDHA-FM was apparently the first in this area to broadcast CD (last January 30). The first station in the country to do so was WFMT, Chicago.

Meanwhile, more and more FM stations around the country are getting CD players—mainly classical and AOR stations, since that's what most CD software is. Sony is working out promotional deals with stations around the country, and other brands such as Denon (which supplied the WNCN unit) and Kyocera (which

IEEE Conference

The IEEE (Institute of Electrical and Electronics Engineers) will hold its 1983 International Conference on Consumer Electronics from June 8-10 at the Ramada O'Hare Inn, in Des Plaines, Ill. The papers to be given cover a wide range of consumer electronics. Most are on TV and video, and a few are on computer topics. Audio will get its heaviest coverage on the morning of Friday, June 10, in a session on DAD/PCM audio. Half of the papers given in the

Thursday morning session on "IC and Component Technologies" are audio-related, too.

Preregistration costs \$35 for IEEE members, \$45 for nonmembers; write Charles Marik, Motorola Corporate Research, 1299 East Algonquin Rd., Schaumburg, Ill. 60196. At the door, admission will be \$10 higher in both categories. If you're interested in the Wednesday keynote luncheon (\$12 extra) or the lake cruise that night (\$25), mention them while preregistering.

TRAFFIC JAM

Once upon a time, you could have put all the car stereo news from CES into one page of this magazine, with space at the bottom for some jokes, like *Reader's Digest*. Now, even a column the length of this one cannot hold it all. Hence, Round Two of our CES once-over-lightly—including a few items not seen at the Show.

There was some increased emphasis on theft protection. Sony probably had the best such idea, in their XRM-

In equalizers, Panasonic has a simpler anti-theft idea, a plain cover which conceals their CY-SG50 booster/equalizer. Called The Composer, this seven-band unit has unusual and realistic equalizing capabilities: It has the usual octave spacing only on its lower five bands (60/125/250/500/1k), with the higher bands at 3.5 and 10 kHz. And the 125- and 250-Hz bands, where most cars have pronounced resonances, have 18 dB of cut and no

and automatic equalization, similar to dbx's 20/20 home unit. A built-in microphone samples the system's frequency response in "Auto EQ" mode, and four different curves can be set in memory. In "AVC" mode, the same mike reads ambient low-frequency levels, and adjusts system volume to compensate—no more having to fiddle with the volume as you slow down, speed up, or stop to ask directions. I'd like to see a remote microphone on the

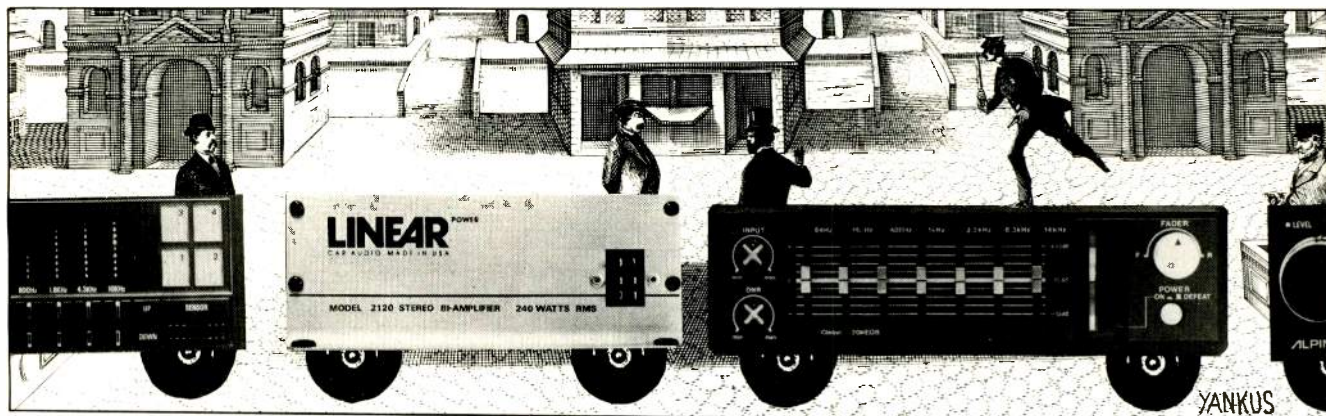

10 Music Shuttle (\$380). Its tape transport is removable for security (leaving the radio functions in the dash). Once removed, it can be plugged into an accessory battery pack and headphone interface (supplied), to become a Walkman-type portable. The Shuttle's components are available separately, in case you lose the portable part or want another in-dash unit for your second car. Audiobahn had a somewhat similar idea in their Carport AB-500, with the difference that the entire unit comes out of the dash to plug into a "boom-box" portable unit.

Nakamichi's new TD-1200 in-dash unit also has a theft-deterrence device: Each unit has an individual lock code burned into its memory. If you activate the lock system before turning the set off, it won't power up again until you key in the code on its station-preset buttons. Unfortunately, those thieves who don't read hi-fi magazines won't know a stolen 1200 is worthless until they've ripped it off. Perhaps the set should bear a sticker saying why it wouldn't work if stolen, and offering a no-questions-asked reward if returned to a Nakamichi dealer. That way, stolen units might at least get returned.

boost, with the usual ± 12 dB boost and cut on all the other bands. A suggested curve is marked on the front panel. This model has two "25 watt/channel" amps, delivering a still-respectable 12.5 watts per channel at 1% distortion; the similar CY-SG100 has four such amps, plus Panasonic's Ambience sound circuit (now available in a portable, too) on the front speakers and the option of feeding only bass (below 125 or 350 Hz) to the rear speakers.

Several other equalizers with deliberately asymmetric band spacing were on display. The Rockford-Fosgate equalizers have always had this: Their three-band 2100-252 IIR, for instance, has a bass band with variable (30 to 45-Hz) center frequency and up to 18 dB of boost with no cut, followed by a mid-bass control at 175 Hz with no boost but up (down?) to 12 dB of cut, followed by a high band with a 6 dB per octave rise and high frequencies switchable from 3 to 10 kHz. The BGW (formerly Spectron) three-band equalizer has bands at 60 and 180 Hz and 16 kHz.

Alpine's seven-band Model 3015 (\$400) has even band spacing—but it also has a built-in spectrum analyzer

3015, so one could automatically equalize for different listening positions; oddly, that feature is available on the French Sofare S-Tronic Mk3 EQ (not sold here), although it only has the automatic level control.

Metrosound introduced a nonautomatic equalizer/booster with all-electronic, pushbutton controls instead of sliders (a feature introduced last year by Kenwood) and DNR noise reduction. Clarion's new 200EQB2 EQ/booster with DNR has sliders, but its DNR control is variable—a first, I think, in auto audio.

AUM Audio's AA-9PC nine-band equalizer has one feature you don't see often in mobile components, an RIAA input. It's for use with turntables like the Technics linear-trackers and some Sharp models, which can also operate on 12 V d.c. (But not while the car's in motion.)

Zapco has a four-band "paragraphic" equalizer, with built-in amplitude controls and plug-in modules to control the Q (bandwidth) and center frequency of each band; a plug-in with variable Q and frequency controls is in the works to make it a true parametric. The \$500 unit also has a built-in electronic crossover and a mono bass

"Panasonic's Composer is a seven-band equalizer and booster, with spacing of the bands tailored to the car's special needs."

switch for feeding dual or single subwoofers.

Crossovers are also being built into a growing number of amplifiers. Rockford-Fosgate's Power 6, MGT's Model 2180, Linear Power's 2120, and three models from AUM Audio all have this feature.

More important new ground was broken by Visonik, whose Alphasonik A265 is probably the first Class-A mobile amp. It delivers 65 watts per channel in stereo mode, 130 watts when bridged for mono. Proton introduced two amplifiers with "Soft Clipping," like sister company NAD's, for more appar-

ent headroom. The Proton P240 has switchable Soft Clipping, and delivers 50 watts per channel stereo, 100 watts when bridged to mono. The P222 has full-time Soft Clip, and delivers 22 watts per channel.

Nakamichi introduced its first mobile amplifier, the PA-300, rated 70 watts per channel. BGW offered 50 and 75 watt/channel models with turn-on and turn-off delays to avoid thumps.

Nakamichi, Polk and Boston Acoustics have all joined the ranks of mobile speaker manufacturers. Nakamichi's is a three-way system on a unified mounting plate, with the asymmetrically-sloped crossovers housed separately "to avoid sonic degradation due to magnetic leakage." Boston's new 700 is a two-way system on a plate; Polk offers both a plate and separates.

Bose has updated their 1401 Direct Reflecting system. The Series II version's new features include remote-sensing turn-on switching (so the active equalizer and 4 x 25-watt booster can be concealed), circuit protection (which cuts out only the channels requiring it and restores sound once the problem's gone), and features for easier installation. The stereo sound field is much like that of the Delco/GM/Bose system, giving a sense of stereo throughout the car. Also like that system, its stereo balance control affects only high frequencies, shifting the apparent stereo source without affecting overall bass response or volume level.

The Sound Series 2000 from Philips is wider than most rear-deck speaker systems. Each unit contains three driver modules, side by side: Two low-frequency drivers with square 5-inch flat polymer diaphragms (claimed to reach 20 Hz), plus tilt-up end units with dome tweeter and midrange drivers.

Getting back to in-dash units for a second, Panasonic showed the CQ-S788, with a Daily Priority Station feature which automatically switches to pre-designated stations at preset times so you won't miss favorite shows. Kenwood has broken Pioneer's record for the greatest number of station pre-selects: 24 (6 AM and 18 FM) to Pioneer's 15 (5 AM and 10 FM). Both should mainly interest metropolitan-area listeners with eclectic tastes, or long-distance travellers who regularly cover the same routes.

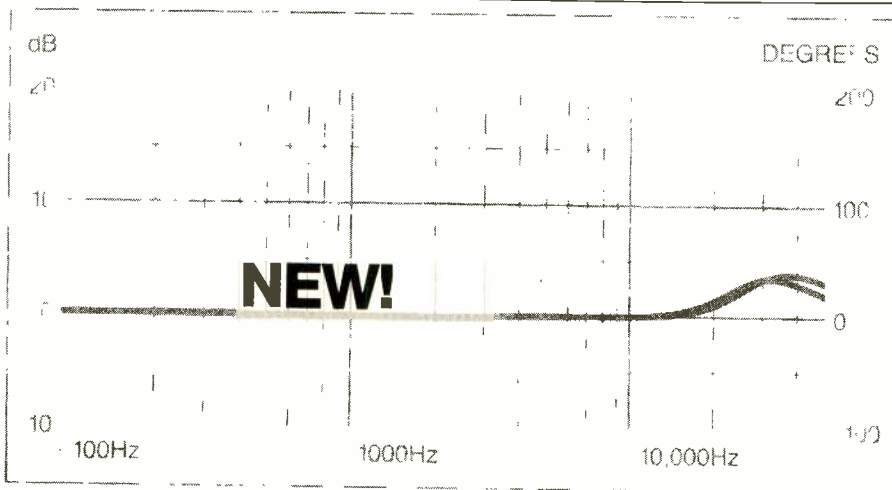

Every so often, a new development contributes so decisively to performance, that it re-defines the state-of-the-art. Such a development has taken place in the laboratories and listening rooms of Ortofon in Denmark.

A dramatic new way of evaluating performance has led to a design concept called Ortophase® and a new Ortofon moving coil cartridge. The MC2000 is the first cartridge ever designed that takes into account the critical role of both amplitude *and* phase response in the performance of phono cartridges.

The result? We make only a modest claim for the new Ortofon MC2000. Spectacular.

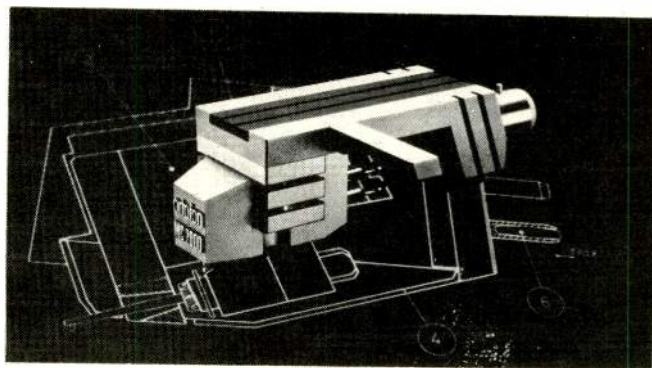

Write to us for complete information. See and hear the Ortophase-designed MC2000 at your Ortofon dealer now.

ortofon

122 Dupont Street, Plainview, New York 11803

THE TOGETHER SEPARATES

Tandberg TIA-3012 Innovations And Specifications

All discrete
selected components

Moving-coil and
moving-magnet inputs

No electrolytic or ceramic
capacitors from phono in
to speaker out (cleaner
sound path)

Separate "listen/record"
input selector switches

Minimum phase shift
for superior imaging

High-speed design (1,000
volt/micro-second slew rate)

Tone control circuits with
variable turnovers utilizing
1% calibrated resistors

Dedicated digital input
(no capacitors through entire
circuit) capable of 20-volt
input without overload

MOSFET output devices
with no current or
voltage limiting

Toroidal power
transformer

Thermic servo-
loop biasing
(maintains
stability
without
affecting
musical
signals)

Main remote
speaker
switching
with gold-
plated relays,
heavy duty
wiring, five-way
binding post

Unit constructed of extruded
aluminum profiles for
strength and heat dissipation

100 watts RMS/channel,
8 ohms, 20 Hz to 20 kHz,
less than 0.02 THD and IM

**Tandberg introduces
the latest addition to its
continuing 3000 Series of
components, based on fifty
years of engineering excel-
lence and innovation.**

The TIA-3012 integrated
amplifier matches other
components in the Tandberg
3000 Series in its dedication
to musical excellence, flexi-
bility, quality, and value.

TANDBERG®

Labriola Court
Armonk, New York 10504
(914) 273-9150

All these qualities are
available in a series of
components endowed with
European styling and simple,
straightforward operation.

The TIA-3012, in com-
bination with either of our
highly acclaimed 3000
Series tuners and a pair
of rosewood side panels,
forms the world's finest
receiver, with built-in
flexibility without loss
of investment.

**Get together with the
TIA-3012 at your local
authorized Tandberg dealer.**



**TIA-3012 Integrated Amplifier with
TPT-3011 FM Tuner and Rosewood Side Panels**

TAPE GUIDE

HERMAN BURSTEIN

Too Much High End

Q. Some time ago I sent my tape deck to a company to have it tuned up and indicated that I would like to see the high end brighter. Now the highs seem unnaturally bright. I plan to have a local shop readjust the deck. Please tell me what adjustments are involved so that I may speak intelligently with the shop personnel.—Joseph Lacerenza, New Rochelle, N.Y.

A. To brighten the response of your deck, the company may have done one or more of the following: (1) decreased the amount of bias used in recording; (2) increased the treble boost employed in recording; (3) modified the playback equalization.

Your deck should be aligned with respect to the tape that you plan to use in the future. First, playback equalization should be adjusted for flat response when playing a test tape. Then bias and recording equalization should be adjusted for the optimal combina-

tion of low distortion and flat response on a record-playback basis; or in your case, perhaps with a slight high-frequency emphasis.

Disc-Dubbing at Half Speed

Q. I propose to play a digitally mastered phono disc at half speed (16 $\frac{2}{3}$ rpm), dub it onto my cassette deck at 1 $\frac{7}{8}$ ips, and play the tape at 3 $\frac{3}{4}$ ips. What changes are necessary in the phono playback and tape record equalization curves? Please provide me with new time constants.—Ralph Morgan, Wahiawa, Hawaii

A. From the tape side, I see no merit in recording a cassette at half speed. Frequency problems in tape recording are functions of recorded wave length; if you halve both the frequency and the tape speed, this will not change. You may even add a problem, because wow and flutter tend to be greater at 1 $\frac{7}{8}$ ips than at 3 $\frac{3}{4}$ ips. [On the phono side, you may solve high-frequency

tracking problems, but you'll raise the frequency of any rumble, wow and flutter in your turntable, and of your arm/cartridge resonance.—I.B.]

If you insist on going ahead, do not change the 3 $\frac{3}{4}$ ips playback equalization; keep that standard. Since record equalization is not standard, but is adjusted so that tapes made on that machine will have standard playback characteristics, it is impossible to tell you in advance specifically what changes to make in that. As a starter, lower the frequency at which your 1 $\frac{7}{8}$ ips record-EQ treble boost begins.

The RIAA phono playback curve has maximum bass boost at 50 Hz (a 3,180- μ S time constant), declining towards 500 Hz (318 μ S), plus a treble cut commencing at 2,122 Hz (75 μ S). If all frequencies are halved by playing a disc at half speed, the turnover frequencies must also be halved, by doubling the respective time constants to 6,360, 636 and 150 μ S.

THE IMF ELECTRONICS HPCM

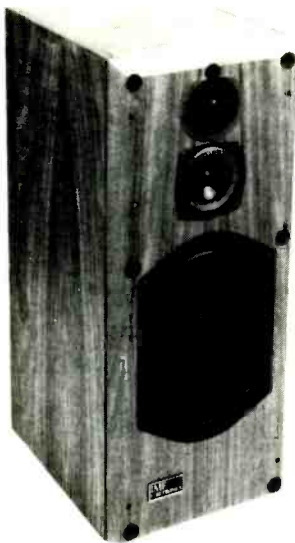

The IMF Electronics HPCM does not refer to some exotic new type of Pulse Code Modulation, but designates our new High Performance Control Monitor loudspeaker. However, the allusion to PCM is entirely appropriate since digital sound was a vital tool in the development of our HPCM loudspeaker.

Our design goal was a compact loudspeaker that could cope with the extended frequency response, high power-handling requirements, and wide dynamic range of digital recording. In short, we wanted a compact version of our IMF Electronics Reference Standard Professional Monitor Mark VII.

In fact, the HPCM uses the same 1 $\frac{3}{4}$ inch x 8 $\frac{1}{4}$ inch, high stiffness/low mass, styrene/fibreglass woofer of the Mark VII, which affords true piston-action bass response, and a polymer-cone mid-range and chemical dome tweeter, both of which are damped with Ferro-fluid. These drivers are mounted in an inline configuration in a 26.8 inch H x 14.8 inch D x 11.6 inch W sealed enclosure. The enclosure is constructed of epoxy-impregnated heavy particle board. This extremely rigid and virtually inert material along with heavy internal damping in the enclosure, minimizes resonant colorations. The edges of the enclosure are beveled to attenuate diffraction radiation. The in-line drivers and a third-order crossover network maintains phase integrity and affords precise and stable stereo imaging.

The minus 3 dB point of the HPCM is 37 Hz, and this provides exceptional extended bass reproduction from the new CD digital discs now on the market. The HPCM gives the smooth, clean, highly-detailed sound at high power levels that characterizes the IMF Electronics Reference Standard Professional Monitor Mark VII in a compact, no-compromise, cost effective system. Audition the remarkable IMF Electronics High Performance Control Monitor at selected dealers.

Dealers are welcome to audition this and other new models from IMF Electronics at the Summer International Consumer Electronics Show, June 5th thru the 9th at the Beverly Suite Conrad-Hilton Hotel, Chicago, Illinois.

IMF ELECTRONICS, INC. 5226 State Street Saginaw, Michigan 48603 Tel (517) 790-2121 Telex 227461

IMF ELECTRONICS LTD Richardson Street Buckinghamshire England HP11 2SB Tel (0494) 35576 Telex 83545



Recording vs. Playback Levels

Q. When recording, I keep the peaks within -3 to 0 dB on the record level meter. However, during playback the meter goes well into the red above 0 dB. Although no distortion is noticeable during playback, I am concerned about the discrepancy between the meter readings in recording and in playback.—Robert Rigsby, Richmond, Va.

A. As long as you hear no distortion, there appears to be nothing to worry about. Some brands and types of tape are "hotter" than others; that is, they have a relatively high output for a given input. The manufacturer of the cassette deck cannot foresee which tape you will be using. If your tape has higher than average output, this can drive the meter into the red during playback.

Your meter might be miscalibrated with respect to output readings. Some decks have an internal control for adjusting playback calibration so that the

meter gives about the same reading in playback as in recording. If your deck contains such a control, a competent technician can easily adjust it for the tape of your choice.

Reducing Only Noise?

Q. Can any noise-reducing unit operate without losing a lot of sound?—August Yirsa, Brookfield, Ill.

A. When using Dolby NR, there may occasionally be some loss of the very low frequencies—say, below about 30 Hz or so, according to some reports. When using Dolby or dbx NR, there may be some loss of the very high frequencies—say, above 15 kHz or so. But all this tends to vary among decks.

Dynamic-filter noise reducers (such as the Burwen or DNR systems), or autocorrelators, can also cut high frequencies, depending on the setting of their sensitivity controls. For the best compromise between noise reduction and high-frequency loss, these sys-

tems should be readjusted with each change of program material.

Dying Left Channel

Q. When I turn on my cassette deck and begin recording, everything is fine, but after about 45 minutes nothing at all works on the left channel. If I turn off the power for a few minutes, everything is okay again. What could be the problem?—Julio Poma, Bronx, N.Y.

A. There may be a poor solder joint in the power supply to the left channel. As temperature varies according to whether the cassette deck is on or off, the joint may cause the connection to be complete or incomplete. Another possibility is a faulty switch or component which doesn't work properly when it's warmed up. **A**

If you have a problem or question on tape recording, write to Mr. Herman Burstein at AUDIO, 1515 Broadway, New York, N.Y. 10036. All letters are answered. Please enclose a stamped, self-addressed envelope.

Don't buy this tuner.

(Until you've heard others at twice the price.)



Sonic performance is the best reason for selecting any audio component. And when it comes to tuners, performance is relatively easy to evaluate.

A tuner either brings stations in clearly, or it doesn't. Especially the weak and distant stations that on some tuners come in noisily or not at all.

The music, of course, must sound clean and accurate. And two (or more) tuners should be auditioned under identical conditions.

Then you want to compare features: such as the tuning system, programming flexibility, signal displays and signal-enhancement controls.

Now, it's time to consider price. Our new GFT-2 is less than \$250. But we suggest you ask your dealer to compare it with other tuners priced up to \$500 or more.

When you've done all that, you'll no longer need our advice. You'll know exactly which tuner to buy.

The new Adcom GFT-2.

- Quartz-referenced digitally-synthesized tuning (accuracy: 0.000025%)
- Dual-gate MOSFET RF amplifier
- Double-tuned quadrature detector
- Storage for seven AM and seven FM stations
- 5-stage LED signal-quality display
- Manual and automatic scan.

For further information or the location of the ADCOM dealer nearest you, please write to:

ADCOM®

11 Elkins Road, East Brunswick, NJ 08816

Unusual FM Reception Problem

Q. I have three high-quality FM tuners. All perform well in my living room and equally well in my basement, except that each produces a loud hiss when receiving WNYC there. None of the tuners does this when receiving WNYC in the living room. All three tuners, when in use, are fed from the same Yagi antenna. I tried a good distribution preamplifier and a splitter.

The basement tuner sits on a shelf above the top of the stone foundation. The only electrical devices reasonably nearby are a refrigerator and the furnace. I turned both of them off, but the hiss persisted. I've also installed a line filter between the tuner and the wall outlet.

This is not a matter of incomplete tuner limiting. The signal strength meters show that the levels are far above those required for total limiting. The condition is far worse when I use a distribution amplifier than when I use a simple splitter. And opening a knife switch in the portion of 300-ohm lead-in going to the downstairs tuner, so that there is a 1/8-inch gap, diminishes the hiss drastically—though not enough to make acceptable recordings.—Morton N. Wekstein, Bronxville, N.Y.

A. The answer most likely lies in the 300-ohm lead-in you are using, or its routing to the basement. Perhaps it is wrapped around ductwork or pipes, fastened to a metal support column, or run through ductwork. Such situations cause signal losses and reflections.

If such routing cannot be avoided, I suggest that you use a 75-ohm coaxial system. That should solve the problem. If signal losses are too great overall because of long cable runs, balun and splitters, you will need to try a mast-mounted amplifier, not as a distribution amplifier but as a means of obtaining more signal. This amplifier must, however, have a better noise figure than the tuners have. If it does not have a better noise figure, reception will again be degraded, especially weak-signal reception. The coaxial system will necessitate a complete rewiring of the installation, including the living room—even though reception in this room was always good.

Signal losses are not the only cause of hiss; multipath problems will also cause it. Such added signal reflections

can be introduced by metal objects in contact with 300-ohm lead-in as well as those introduced into the antenna from surrounding buildings and/or terrain.

Mono Speaker, Stereo Amp

Q. What's the best way to connect a single speaker to a stereo amplifier or receiver without losing fidelity or damaging the equipment? Would the same connections be used for tube and solid-state gear?—Name withheld

A. With either type of amp, just connect your speaker to one channel's output terminals, rotate the balance control all the way to that side, and use only that channel's input. Set the mode switch to stereo so no signal feeds the unused channel.

Third-Lug Theme

Q. I notice that all volume controls have three terminal lugs. What is the purpose of the third one?—Robert Ades, Los Angeles, Cal.

A. A volume control, or potentiometer, consists of a resistor with fixed contacts at each end and a sliding contact between them. The signal is usually placed across the entire resistance of the volume control, and the output taken between the center terminal lug and one end.

Nickel-Cadmium vs. Alkaline Batteries

Q. I am considering buying a set of rechargeable nickel-cadmium batteries to be used in a portable stereo system, but a friend tells me they do not provide full power for nearly as long a time as alkalines. I know nickel-cadmiums would pay for themselves in time, but since they supply 1.2 instead of 1.5 volts, does this affect the play speed? Which type is the better choice?—Steve Kuske, Goodhue, Minn.

A. It's true that nickel-cadmium batteries do not provide as much voltage initially as alkaline batteries and that they won't supply their full voltage for as long as alkalines will. However, alkaline cells will gradually fall off in voltage over their lives, while nickel-cadmium types will tend to maintain their operating voltage during much of their discharge cycle. Thus, if such batteries perform well for a specific application, their performance can be relied

on until the charge has been virtually exhausted.

Once alkaline cells have been exhausted, they must be discarded; no attempt should be made to recharge them. The nickel-cadmium cells can be recharged a number of times. (In fact, they can be cycled a lot more often than is true of dry, lead-acid cells.)

The lower voltage produced by a battery of nickel-cadmium cells will seldom affect the performance of the equipment in which they are installed. Even tape speed will not be adversely affected because of the recorder's speed-controlling system and because it probably was designed to allow for low-battery operation.

If you plan to use a portable stereo system over extended periods, you definitely should consider using rechargeable cells. Keep two sets on hand, one under charge and the other in use. Should you be away from power lines and should one set of cells run down, the recharged set will be immediately available.

Equipment Compatibility

Q. I once read an article which spoke of "equipment compatibility," claiming it would be unwise to purchase a music source capable of producing more signal than would drive the amplifier to full output. My power amplifier's manual states that "a 1-volt signal will drive each amplifier channel to its full output." I note that many tape decks have outputs of 1.5 volts, 1.8 volts, etc. Would they be incompatible with my present power amp?—Samuel J. Neiditch, Highland, Cal.

A. If you're speaking of an integrated amplifier with a volume control, no problem; just turn down the volume control. If you're using a power amp with the tape deck (which is unusual), there will only be a problem if the amp lacks an input level control and the deck has no control for output level. Gross mismatches (such as a 10-to-1 mismatch) can cause problems with distortion or noise, but not the sort of mismatch you're discussing here. 

If you have a problem or question about audio, write to Mr. Joseph Giovanelli at AUDIO Magazine, 1515 Broadway, New York, N.Y. 10036. All letters are answered. Please enclose a stamped, self-addressed envelope.

DIGITAL/DYNAMIC RESERVE™

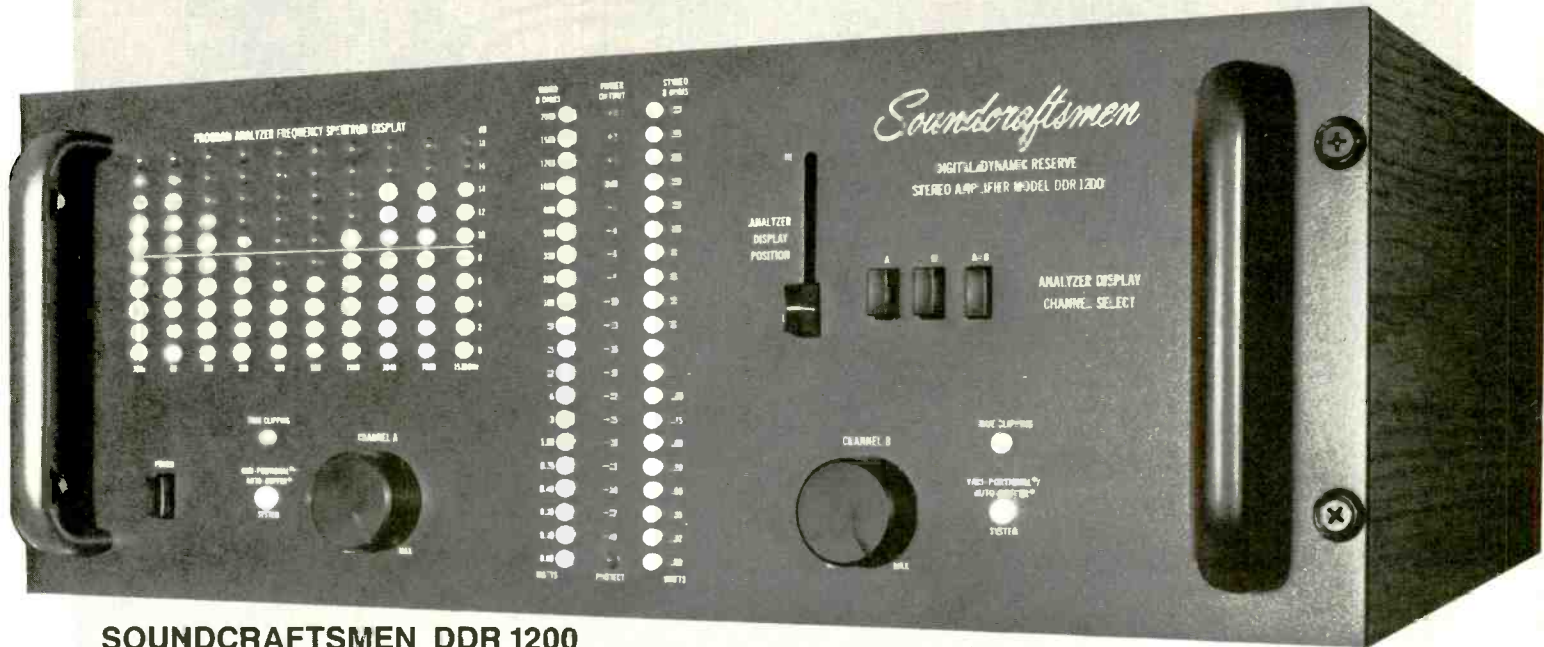

SOUNDCRAFTSMEN DDR 1200 DIGITAL/DYNAMIC RESERVE™ STEREO POWER AMPLIFIER



POWER! Lots of clean, pure power... the ONE ESSENTIAL REQUIREMENT for the reproduction of the magnificent new Digital Recordings. With 30dB greater dynamic range, the new Digital Audio Discs demand up to ONE THOUSAND TIMES more power than conventional records, even at moderate listening levels!

The DDR 1200 can deliver over ONE THOUSAND WATTS of total power (see specifications) to reproduce digital dynamic musical "peaks" with a degree of sonic effortlessness unheard-of in conventional amplifiers.

And, unlike the "lightweights," the DDR 1200 will produce its rated power hour after hour without overheating or breakdown!

Need even more power for low-efficiency loudspeakers or multi-speaker installations? The DDR 1200 converts to a 750-watt mono amplifier with the flip of a switch!

The DDR 1200 is the world's only stereo amplifier capable of analyzing the other components in the music system! Its 100-LED Frequency Spectrum Display lets you see, in Real Time, exactly how your phono cartridge, tape deck and other program sources are performing. A specially-recorded Frequency Spectrum Analysis 12" LP Test Record is included with the DDR 1200.

If Digital Audio is in your future, a Soundcraftsmen amplifier should be in your present!

Soundcraftsmen DDR 1200 . . . \$1199 . . . Other models from \$649.

SPECIFICATIONS: 250 watts per channel @ 8 ohms, minimum RMS, with no more than .09% total harmonic distortion, 20Hz to 20kHz. 375 watts per channel @ 4 ohms, 750 watts @ 8 ohms mono mode. 1200 watts total dynamic reserve power.

CONVENTIONAL RECORD

Oscilloscope photo shows music playing at normal listening level. Only 1 watt of power is required for average level, but 16 watts are needed to produce "peaks."

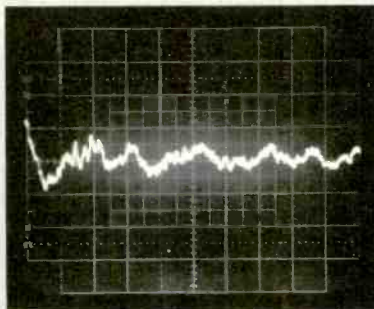

DIGITAL AUDIO DISC

Oscilloscope photo shows same music playing at same normal listening level. Again only 1 watt is required for average level, but 500 watts are needed to produce the... "digital/dynamic peaks" without distortion!

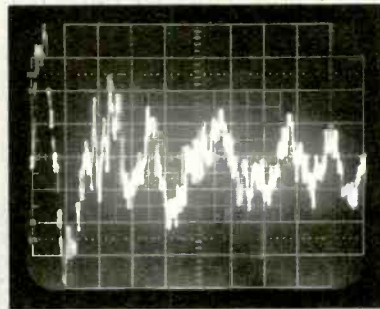

The World's Finest Stereo Components
Are Still... **MADE IN U.S.A.!**

Soundcraftsmen

FREE!

FREE! \$19.95 EQ EVALUATION KIT, including 12" LP Frequency Spectrum Analysis Test Record, 2 sets of Computone Charts, Connector Cable, complete instructions. **JUST WRITE TO US OR CIRCLE Reader Service Card #30.** We'll send Free Special Offer Details and 15-page full-color brochure featuring "WHYS AND HOWS OF EQUALIZATION."



2200 So. Ritchey, Santa Ana, California 92705, U.S.A./Telephone (714) 556-6191/U.S. Telex/TWX 910 595 2524 • International Telex: 910 595 2524/Answer-back Code SNDCRFTSMN SNA

Enter No. 30 on Reader Service Card

ABERCROMBIE & FITCH



MEET MITSUBISHI MONTERO,
THE URBAN GORILLA.

Behold: a rugged off-road 4-wheel drive beast that acts civilized on the road.

Shift our new Montero into 2-wheel drive and it cruises around town like a sporty car. It's roomy, seats four comfortably. And it's loaded with creature comforts.

But more about the beauty later. First, let's examine the beast.

WHERE DOES A GORILLA GO? JUST ABOUT ANYWHERE IT WANTS TO.

Mud, snow, hills or gullies. You name it, the Montero tames it.



In its 4-wheel drive mode, there's a low gear that will haul you up a hill. And a high gear for quick and nimble going in sticky snow or loose dirt.

Super low gearing provides Montero with super climbing ability. And its wide track, allows it to traverse steep terrain.

Town or country, this animal goes just about anywhere.

YOU NEED A GORILLA BECAUSE IT'S A JUNGLE OUT THERE.

From steel top to solid box-type frame and protective steel skid plates, the Montero is well built, like a gorilla.

Gutsy 2.6 liter, 105 horsepower MCA-Jet engine is the biggest 4-cylinder power-plant we offer. So it won't back down in the backwoods.

Yet, it's smooth and quiet in the concrete jungles. Because unique Dual Engine Stabilizers reduce vibrations.

Beefy independent front suspension with torsion bars smooths out unbeaten paths. Or roads that have gone to potholes.

And the power-assisted front discs will stop a gorilla in its tracks.



GOT THINGS TO CARRY? GET A GORILLA.

Fold down the rear seat and the Montero becomes a beast of burden. Sporty front bucket seats recline, and the passenger seat tilts forward for easy rear seat access. Cargo tie-downs come standard, to secure everything you need to go on a

camping trip. Or haul everything back from a shopping spree.



EVERY GIRL NEEDS A GORILLA.

Although it manhandles most anything, the Montero is easily woman handled, thanks to variable assist power steering.

Easy to see out of. Thanks to a high top and tinted glass.

Easy to shift. Thanks to a sporty 5-speed manual overdrive transmission.

Easy to ride in. Thanks to a driver's seat that "floats" on a shock absorber.

And it's easy to look at. Thanks to a nifty two-tone paint job and 15-inch stylish spoke-type wheels with all terrain radial tires.

And it's all standard. Thanks to Mitsubishi.



CIVILIZED INSTRUMENTATION.

ALL THESE STANDARD FEATURES MAKE IT QUITE AN ANIMAL.

Every gorilla comes loaded with standard features like: 2.6 liter, 105 horsepower MCA-Jet engine.

5-speed manual overdrive transmission.

Independent front suspension with torsion bars.

Variable assist power steering.

Manual free-wheeling hubs.

Protective skid plates.

Driver's suspension seat.

15" styled spoke-type wheels with all terrain radial tires.

4-passenger seating plus big cargo area.

Plus dozens more standard features for only \$9,229*.

YOU CAN EVEN BEEF UP A GORILLA.

We offer the Sport Option Group with limited slip differential, automatic free-wheeling hubs, headlamp washers, rear wiper/washer, accent stripe and an AM/FM/MPX cassette radio with four speakers. That's a lot of gorilla for only \$721* more. You might say you'll go ape over it.

For your nearest dealer, call (800) 447-4700.

*Manufacturer's suggested retail price. Actual prices set by dealers. Taxes, license, freight, options and other dealer charges extra. Prices may change without notice.
Limited availability in California until September, 1983.



**ACHIEVE MITSUBISHI
MONTERO. IT TAKES
YOU WHERE YOU'VE
NEVER BEEN BEFORE.**

MICHAEL TEARSON
JON & SALLY TIVEN

ROWLAND ON RYE

Too-Rye-Ay: Dexys Midnight Runners
Polygram SRM 1-4069, \$8.98.

Sound: B Performance: B+

Too-Rye-Ay is one of the most eclectic records to receive the big radio and MTV push. Although it may not be what you'd term revolutionary music—reactionary might be more applicable—it's a certainty that nothing along the same lines is being recorded these days. What it comes down to is Kevin Rowland, a Celtic lad stylistically in debt to the Martin Scorsese school of ethnic sensibility, drawing heavily from '60s soul records and his own traditional Irish music. He comes up with a sound, devoid of electric guitars, driven by horns, accordions, banjos and fiddles that's unlike the music usually associated with these instruments. Rowland also has a peculiar voice that's rather high and clear, whereas the singers he seems hooked on are midrangey and gruff. This unlikely combination of roots, instrumentation and voicings produces a fairly distinc-

tive sound which has actually gotten onto many radio stations via the infectious hook of "Come On Eileen"—a major accomplishment these days, when every record heard on the FM dial seems to resemble Journey's.

Of course, part of this success is due to the mild resemblance Kevin Rowland's music bears to early Springsteen (*The Wild, Innocent, & E-Street* period), and how certain people in radio are paranoid about missing out on the next Bruce. The similarities are only superficial, heightened by the fact that everything else around sounds like it was manufactured at the same heavy-metal plant.

The production on *Too-Rye-Ay* is minimal; none of the instruments are enhanced by the recording, and the drums are thin. But for an American debut, the record is fairly interesting and distinctive. Only time will tell whether Rowland becomes an artist with major impact or, like Graham Parker, just another singer/songwriter in the shadow of the Asbury Park.

Jon & Sally Tiven

On My Own Two Feet: Paul Barrère
Mirage/Atlantic 90070-1, \$8.98.

Sound: C Performance: B-

Paul Barrère's songwriting blossomed under Lowell George's shadow in Little Feat as Paul gradually became an adept songsmith with an uncommonly bent wit. Here he emerges as his own man but is still heir apparent to the Little Feat style, if not its sound. The similarities are unavoidable even though Barrère employs bigger sounds than the old group did. The playing throughout is excellent, and several members of The Dixie Dregs figure prominently. The songs are cheery fun if light, but Jeff Glixman's pedestrian production might act as a dampener in that respect. For all the obvious energy that has gone into *On My Own Two Feet*, the raw sound is remarkably lifeless.

Little Feat fans and fetishists are sure to like Paul Barrère's long-awaited solo album, probably a lot.

Michael Tearson

In Cold Blood: Johnny Thunders
New Rose NR350, two discs, \$10.98.

Too Much Junkie Business: Johnny Thunders

ROIR A118, cassette, \$7.98 (611 Broadway, New York, N.Y. 10012).

Sound: B- Performance: B

Johnny Thunders is one of the more amusing cult figures in rock, if only due to his deliberate attempt to remain a semi-obscure legend: No one could accidentally make records (and tapes) this trashy and yet display so much talent. All his records are characterized by inexcusable playing, whiny singing, and a lack of any real production. Despite all this, Thunders' songwriting talent and semi-lovable personality shine through. The guy certainly knows how to handicap himself.

He hasn't been able to get a real record contract, so these are released through a small French label (New Rose) and an American cassette-only company that caters to the tastes of New Wave refugees. Many of the same songs are featured on both. Although the French issue is the more logical—two records, one studio and one live



Illustration: Rick Tulka

HEAR ALL OF THE MUSIC AND NONE OF THE TAPE...



SWITCH TO BASF CHROME AUDIO TAPE

THE WORLD'S QUIETEST TAPE

If you won't settle for anything less than pure music, accept nothing less than BASF Pure Chrome audio tape. Unlike ferric oxide tapes, BASF Pure Chrome is made of perfectly shaped chromium dioxide particles. And that exclusive Chrome formulation delivers the lowest background noise of any tape in the world, as well as outstanding sensitivity in the critical high frequency range. And this extraordinary tape is designed especially for the Type II Chrome Bias position. So make sure you're hearing all of the music and none of the tape. Make the switch today to the world's quietest tape. BASF Chrome.

 **BASF**
Chrome Audio & Video Tapes

Enter No. 17 on Reader Service Card

"Johnny Thunders is an ex-New York Doll who seems to be finding out the hard way that it takes more than heart to get across."

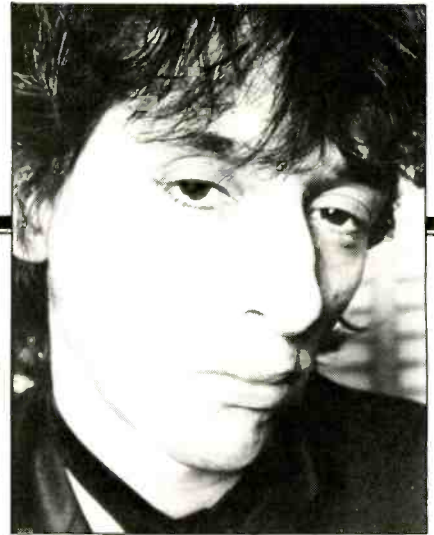

Johnny Thunders

from Cambridge, Mass.—the cassette has a charm all its own. *Too Much Junkie Business* features 15 songs with narration in between by Johnny Thunders. Two of the best studio tracks here didn't make it onto *In Cold Blood* ("Who Do Voodoo" and "King of the Gypsies"). The live tracks on both

packages feature less than great sound. True fans should get The Heartbreakers' *Live in London* album recorded seven years ago but only recently made available. The cassette includes more vintage Heartbreaker material, while the New Rose edition duplicates cuts (who needs a studio

and a live version of "Green Onions"?). But those who are addicted to vinyl, as opposed to magnetic tape, will probably opt for *In Cold Blood* despite this disclaimer.

If Johnny Thunders surrounded himself with musicians of at least a marginally talented calibre, he might be able to get away with this kind of performance and become, say, the next Patti Smith. On his *So Alone* album (where he was aided and abetted by Sex Pistols, The Only Ones, and a Pretender), the presentation was far more coherent than that found here. This ex-New York Doll seems to be finding out the hard way that it takes more than heart and soul to get across to the public. Unfortunately, his recordings show him as his own worst enemy—but in some kooky way, they're still all right. You figure it out. *Jon & Sally Tiven*

The New CD Series Controlled Directionality Speakers



From the excited engineers at Electro-Voice

EV engineers are very excited about our new CD Series speakers and the new technology they represent.

Years ago we solved the key problems of frequency response and optimized low-frequency performance of small enclosures. EV has been manufacturing high quality speakers for decades offering both the superior engineering and high efficiency that have been EV bywords.

But actual listener position always determined the quality of sound because speaker component dispersion angles varied somewhat with frequency.

Always, that is, until now.

The new CD Series speakers from Electro-Voice feature wide dispersion (100°) of full frequency sound.* We call this advancement "Controlled Directionality". Now, every seat can be "the best seat in the house".

The CD Series offers you the best whether you're a technical expert or a sophisticated listener seeking no-apologies reproduction.

Send for the free packet of detailed information about the two models in the CD Series and soon you'll be just as excited as we are!

Please write to: Thomas W. Zoss, Electro-Voice, Inc., 600 Cecil Street, Buchanan, MI 49107.

CD Series type 35 and 35i specifications

Axial Frequency Response:	Essentially flat from 40-30,000 Hz
Sound Pressure Level:	92dB 1 watt, 1 meter, anechoic
Suggested Amplifier Power Ratings:	Minimum: 3 watts Typical: 10-15 watts Maximum: 400 watts
Time Coherency:	Within .15 milliseconds
Dispersion Angle Acoustic Coverage:	Zone: *Held to 100° by Direktor™ geometry within the critical 500-12,000 Hz range
Crossover Frequencies:	1500 and 8000 Hz
Impedance:	Nominal: 6 ohms Minimum: 5 ohms

EV Electro-Voice®
a gulton company

Enter No. 18 on Reader Service Card

Love Over and Over: Kate and Anna McGarrigle

Polydor 810-042-1 Y-1, \$8.98.

Sound: C— Performance: A

Love Over and Over is a lovely and very satisfying album by the Canadian McGarrigle sisters. They write genuine songs of the heart that are emotional and blessed with glowing warmth, grace, and wit.

In addition to their new songs are two somewhat older, glorious ones. Kate's "The Work Song" was a highlight of Maria Muldaur's 1973 solo debut album. Its melodic ties to Stephen Foster are emphasized here in a beautiful performance. Anna has translated (loosely) Bob Seger's "You'll Accompany Me" into French and dressed it up with fiddle and accordion.

The arranging throughout the album is excellent, laced with gentle surprises. It is too bad the album is

N a k a m i c h i

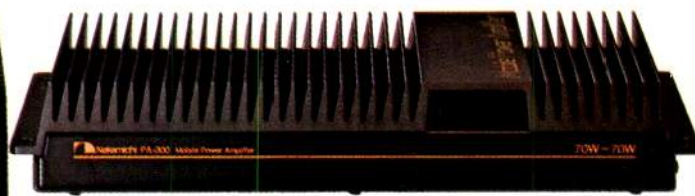
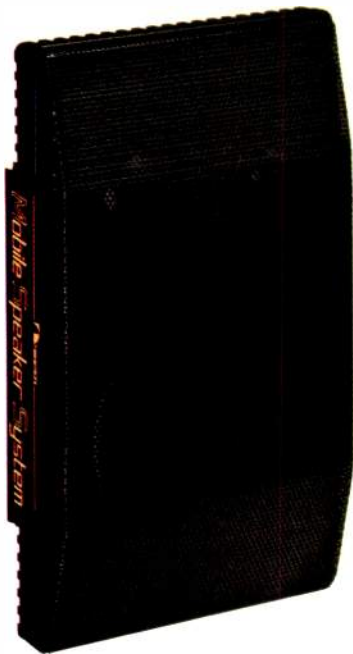

PA-300 Mobile Power Amplifier



TD-1200
Mobile Tuner
Cassette Deck



SP-400 3-Way Mobile Speaker System

Take Nakamichi Sound With You

Imagine listening to music in *your* car with the same fidelity you enjoy at home! Impossible? No longer! Nakamichi Sound has taken to the road!

Only the acknowledged leader in *home*-stereo equipment could have created the remarkable Nakamichi Mobile Sound System—a system so unique, so revolutionary, that it defies comparison! Imagine auto equipment that not only *rivals* the finest home componentry but *outperforms* most of it!

Imagine an auto-reversing cassette deck that reproduces equally well in *both* directions—one that reaches *beyond* the audio spectrum to 22 kHz! Imagine a cassette player that senses when the music has stopped and fast winds to the end of side for quick reversal.

Imagine NAAC—the unique Nakamichi Auto Azimuth Correction system that, from the program material itself, automatically aligns the playback head to *each* tape to extract the last iota of performance. Imagine a *car* deck that has *less* flutter than a home deck—one with a choice of equalization and Dolby* B- or C-type noise reduction—one that achieves 70-dB dynamic range!

Imagine a *mobile* power amp that delivers 70 watts per channel with *less* distortion than a home amplifier—a *mobile* quartz-PLL synthesized FM/AM tuner with the signal-pulling power, selectivity, and immunity to multipath that brings *home* reception into your car! And, imagine a three-way *mobile* loudspeaker system that recreates a sound field of such breadth and clarity that you think you're in your listening room!

Imagine no more! The system you've been dreaming about is waiting for you at your Nakamichi Mobile Sound System dealer. Take your favorite cassettes along and ask for a demonstration. Or, write for more information to Nakamichi U.S.A. Corporation, 1101 Colorado Avenue, Santa Monica, CA 90401.

*TM Dolby Laboratories Licensing Corporation



Investment Protection:
Engraved on your key is a unique personal code that "unlocks" your system and brings it to life. Without the code, your system is absolutely inoperable and of no use to anyone.



BLESSED



CARVER M-1.5t
MAGNETIC FIELD POWER
AMPLIFIER

"...the equal of any power amplifier in transparency, focus and smoothness and, of course, far ahead of any other we tested in sheer gut-shaking power and dynamic range. We especially enjoy hearing spatial detail, instrumental definition and completely natural dynamics on familiar records to a degree we did not know was extractable from the grooves when we listened through lesser amplifiers. At this level of sonic performance, the astoundingly small size and cool operation of the M-1.5t become the icing on the cake, rather than the main attraction."

Peter Aczel *The Audio Critic*
Winter 1982-83

Recent advances in analog and digital disc recording technology have made source material with full, real-life dynamic range a reality.

But, if you want to hear this improvement in sound quality, your high fidelity system must include an amplifier *fully* capable of reproducing *all* of the music...the CARVER M-1.5t Magnetic Field Power Amplifier.

350 watts rms/chan. into 8 ohms, 20-20 kHz with less than 0.1% THD. And most importantly, the rating that is musically significant: 600 watts/chan. Long-Time-Period Reserve Power with 750 watts/chan. Dynamic Headroom. Weight: 16 lbs.

The CARVER M-1.5t...carefully and specifically designed for those who seek highest fidelity and musical purity.

For more information write to:

CARVER
Powerful • Musical • Accurate

P.O. Box 664 14304 N.E. 193rd Pl.
Woodinville, WA 98072

pressed so badly that it very nearly undoes all the fine efforts. Surface noise is prevalent and so are distorted voices, but often delicate percussion and piano parts are undamaged. Something has gone very wrong here technically. I should note that I checked three copies to ascertain that the problems were not isolated.

Still, despite the technical problems, *Love Over and Over* is a highly recommended album of sensitive and mature songs. *Michael Tearson*

Another Page: Christopher Cross
Warner Bros. 23757-1, \$8.98.

Sound: B+ Performance: B+

As thoroughly as Christopher Cross first album saturated America, it's hard to believe this is just his second record. With this state-of-the-genre L.A. pop album of mellow rocking sounds, he proves he is not just another one-shot wonder.

Production and sonic values are squeaky clean and clear on the Quix II vinyl review copies. Musicianship is of the usual high level of the L.A. studio Who's Who playing on the album.

Cross is a class act. His songs have lovely, full melodies that grow on you. *Another Page* makes excellent, non-irritating listening. *Michael Tearson*

No Man's Land: Lene Lovich
Stiff/Epic Are 38399.

Sound: B Performance: B

Lene Lovich and her partner Les Chappell have kept something of a low profile since the last Lovich album in 1980 and the last EP in '81. With *No Man's Land*, she retains her squeaky gypsy-queen vocal persona plus the Balkan rhythms and melodic ideas that make her best work, like "Lucky Number" or "New Toy," so diverting.

Lene's peculiar voice can start to wear on some ears by the end of an album, but when the songs are strong on their own, as they are for much of *No Man's Land*, everything is peachy. New standouts include "Blue Hotel," "Maria" and "Sister Video." The lead track, "It's You, Only You (Mein Schmerz)," tries hard but in the end is just too precious.



Lene Lovich

For an album recorded in no fewer than seven studios, Lene and Les have gotten a nice consistent sheen on the production. Their music's quirks provide it its abundant character. As you get used to the territory, *No Man's Land* emerges as a fine, warm album that gets better and better.

Michael Tearson

Win This Record : David Lindley & El Rayo-X
Electra Asylum 9 60178-1, \$8.98.

Sound: B Performance: A

Win This Record sounds like a musical Siamese twin to Lindley's first solo album, *El Rayo-X*, one of the highlights of 1981's releases. Not that this is a second-string batch of Lindley magic, mind you, but an identical sounding style which differs from its predecessor only in the increased percentage of featured guitar work by the other player, Bernie Larsen, and the larger contribution of originals by the group's mastermind.

Lindley's guitar trademarks are all over these tracks—soaring lap steel parts, Mexican-flavored figures, percussive finger-picking rhythm parts, and major-scale solos. Exceptional in composition and execution, his instrumental sections always manage to take off. He's simply one of the best guitarists, for both originality and sheer chops, now on vinyl.

As for the band, whose other core members are Jorge Calderón on bass and Ian Wallace on drums, it seems to be of one musical mind, judging from the homogenous body of outstanding tracks. Most of the tunes are calypso or reggae in feel as the band leader seems to be heavily into Caribbean and Mexican stylings. There's a considerable amount of unison and harmony singing, and "Let the Girl Go Home" and "Brother John" suggest

Virtuoso

**THE NEW AIWA AD-F990
3-HEAD CASSETTE DECK:
PERFORMANCE READY FOR
THE DIGITAL AGE.**

At Aiwa, we believe being the best means taking the lead, not following. That's why our engineers developed the AD-F990: the first fully automated cassette deck designed to meet the demands of the compact digital disc.

**20-21000Hz FLAT
FREQUENCY RESPONSE!**

Listen to the AD-F990 and you'll be stunned. Dolby HX Professional and Aiwa's exclusive amorphous combination head have extended performance parameters so far that the AD-F990 can faithfully reproduce digitally recorded programs without compromise...or effort.

**A TRIUMPH IN HUMAN
ENGINEERING**

To perfectly integrate man and machine, the Aiwa AD-F990 presents its controls on a unique "keyboard." That's new! So is our Auto Record Level Control, Auto NR Detector, Auto Demagnetizing, Auto Tape Selector, Digital Time Remaining Display that shows all tape operation modes, and a fluorescent display for all functions.

The Aiwa AD-F990: the top of our new line of "digital-ready" cassette decks. The sound of the future, today.



AIWA®
SIMPLY ADVANCED



AIWA AMERICA INC., 35 Oxford Drive, Moonachie, New Jersey 07074. In Canada, Shriro (Canada) Ltd.

Enter No. 22 on Reader Service Card

"David Lindley is growing as a songwriter and as a musical force who can stand on his own two feet."

that Lindley loves a sing-along. The latter tune gets a four-star treatment whose end product is a masterpiece of simplicity. The arrangement of guitar and percussion instrumentals makes for development within the song which is perfectly suited to Lindley's adenoïdal voice. Although it's hard to choose

favorites on an album that's as consistently uplifting as this, "Talk to the Lawyer," penned by Lindley, doesn't sound far from what pop radio might choose as a single.

More than anything else, *Win This Record* proves that Lindley's first record wasn't a fluke. Although *Win*

doesn't quite surpass it, this album does demonstrate that the man best known as Jackson Browne's guitar player is now growing as a songwriter and musical force who can stand on his own two feet. *Jon & Sally Tiven*

THE TURNTABLE THAT BEAT THE COMPACT DISC

In a recent test done by **Popular Hi-Fi**, all four reviewers chose the Linn Sondek LP12 Turntable over the Compact Digital Disc.

"The Compact Disc Player sounds impressive at first, probably due to its relative absence of surface noise but once the music starts there is something which tells you immediately that it is wrong." — Chris Thomas

"All the key musical elements were there, but the subtle nuances of the music — delicate cymbal playing, intricate guitar work and so on — were missing which made the overall presentation of the music less convincing and involving than that provided by the analogue front end." — Simon Davies

"... although it was better than we had anticipated, it still was far behind our reference Linn/Ittok/Asak T combination in pure sound quality." — Chris Frankland

"In my view it still has some way to go before it is as good as the best analogue disc playing systems." — Jonathan Kettle

For a complete reprint of the review, and other information on the turntable that beat the compact disc, circle the reader service number listed below.



For further information contact:

AUDIOPHILE SYSTEMS LTD., 6842 HAWTHORN PARK DR., INDIANAPOLIS, INDIANA USA 46220
ALDBURN ELECTRONICS LTD., 50 ROLARK DR., SCARBOROUGH, ONTARIO, CANADA M1R 4G2

Quartet: Ultravox
Chrysalis B6V, digitally mastered, \$6.98.

Sound: A — Performance: A —

Chrysalis inaugurates its new distribution deal with CBS with this lovely new album from Ultravox at a special low price. The group's cool, archly romantic music has something of an updated Moody Blues feel minus the constant philosophizing and most of the pomposity.



Ultravox

A big part of the story here is the wonderful production by George Martin with Geoff Emerick as engineer. Both, of course, have done lots of highly distinguished work, topped by their efforts on many of The Beatles records. More recently Emerick produced Elvis Costello's *Imperial Bedroom*. Their work here is of equal distinction. *Quartet* has brilliant sound with uncommon clarity and separation.

Ultravox is a major group in much of the world outside of North America. They are truly a class and a classy act which deserves a serious listen here, too. Their smooth, modern music wears well through repeated play.

Michael Tearson



Here's a little competition for a lot of speaker systems.

As you can see, the Triad is very small, even when you add up its three pieces.

The subwoofer is about the size of two shoe boxes ($8\frac{1}{2} \times 13\frac{1}{4} \times 8$). Each satellite is less than one shoe box ($8\frac{1}{2} \times 5\frac{5}{8} \times 5$).

So much for their physical size. It's the astonishing dimensions of their sonic performance that's really significant. And interesting.

For example, frequency response extends from 24 to 21,000 Hz, ± 3 dB! Power handling is 25 watts continuous, 250 watts peak. And that's for each channel.

Triad accomplished this with a mix of good design and considerable innovation. All acoustically valid. The 6½-inch woofer is self-powered, with a sophisticated signal-conditioning amplifier. The input signal and the cone excursion are electronically monitored for optimum performance within the woofer's designated operating range.

The end result: low-frequency performance you'd expect from a woofer twice that of the Triad's, and an enclosure ten times larger.

Precise stereo imaging is achieved by the special

low-diffraction, phase-aligned configuration of the mid and high-frequency drivers.

One last important point. The original Triad system was recommended primarily for use at moderate listening levels and in modest-size rooms. The new model does not have these limitations.

You can now consider the Triad for just about any home condition—especially where the speakers should be inconspicuous. Or very portable. (A special carrying case is available.)

But first things first. You'll want to hear what the Triad sounds like to your ears. To do that, just call our toll-free number, 800-525-4018, and ask for the name of the dealer nearest you. Or write for our literature to: Acoustic Design Group, 620 East Bleeker St., P.O. Box G-3, Aspen, CO 81612.

You're in for a big surprise.



ONE WONDERFUL WURLITZER

Illustration: Rick Tulka

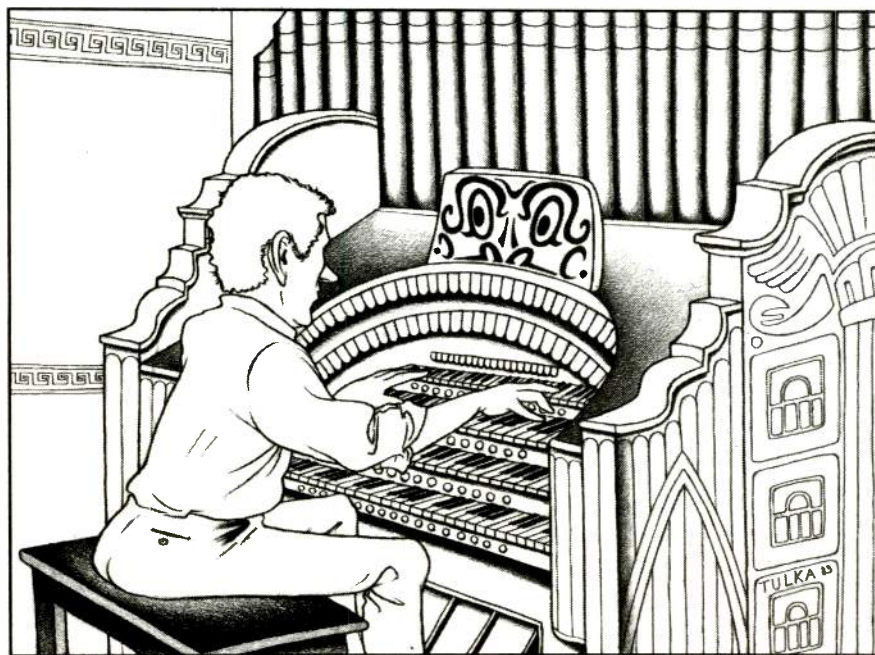

The Road to Wichita: Billy Nalle
WTO 1959, \$9.00 (Billy Nalle Music, 400 West Central Ave. 2205, Wichita, Kans. 67203).

The time was, many years ago, when theater-organ records were the ones to test your system with; they were the audiophile albums of the late '50s and early '60s. There were three prominent organists in those days: Billy Nalle, with his jazz approach to the instrument; George Wright, with his pop, somewhat gimmicked approach, and Ashley Miller, who played more in the main-line tradition.

In the last decade, the theater organ has waned in popularity, mainly because of shifts in the general taste, but the instrument maintains a cult following. One of the finest examples of a theater organ was the Wurlitzer originally installed in the New York Paramount Theater. The instrument was removed in 1964 when the building was gutted to make room for a large office complex. Through the personal and financial intervention of Richard Simon-ton, the organ was kept intact and stored for almost 10 years prior to finding a home in the Wichita Convention Center. In this environment, and with much refurbishing, the instrument speaks out more freely than it ever did

in the padded confines of the old Paramount; the sound is rich and, rare for a theater organ, cohesive. In the mid-'70s, Nalle moved to Wichita to become organist in residence for the Wurlitzer. Appropriately, this album is dedicated to the memory of Simon-ton.

The unusual thing about Nalle's playing is that he avoids the typical clichés. His textures are lean, allowing musical details to come through, and his rhythmic drive and control are remarkable. In his hands, the instrument sounds more like an ensemble of jazz musicians than the cumbersome monster it usually is.

Nalle offers a variety of pop songs, old and new. The sound is just a little distant for my tastes, but it probably reflects accurately what you might hear in the hall. Like most theater organs, this one hisses, the result of minute leaks in the high-pressure wind supply. The pressing quality is moderate to good. *John M. Eargle*

Wolftracks: John Kay & Steppenwolf
Nautilus NR-53, \$15.98.

Sound: A- Performance: C-

It's admirable that Nautilus has the initiative to issue rock albums that haven't been available before—ideally,

the job of an audiophile label should go beyond reissuing last year's top 20 albums. The digital recording makes something of a difference, but it's unfortunate that Nautilus picked a record as lackluster as *Wolftracks* to kick off the series. John Kay was never much of a singer, although he had his hey-day for a while toward the end of the '60s ("Born To Be Wild"). The other members of the original Steppenwolf have long gone on to greener pastures. Self-produced, the record features original material with the exception of Argent's "Hold Your Head Up" which doesn't stand up to the earlier version. Hopefully, the second record in Nautilus' all-new rock audiophile series (which allegedly will be a reunion of Spirit) will be more valid musically.

Jon & Sally Tiven

The King Crimson Collection: King Crimson

EG Editions/Jem EGKC 1-10, half-speed mastered; 10 discs, \$89.80; \$8.98 each.

Sound: B Performance: B

In doing a half-speed mastering job on the recorded works of King Crimson, the status of the group is raised from cult classicists to prog-rock gods. There is still some question, however, as to how important this group was to the development of contemporary music. Certainly the alumni of the group went on to form alliances such as Foreigner, ELP and Asia, but is being the progenitor for future bombast a legit excuse for instant canonization? The question arises, is the purpose of this collection to boost Robert Fripp's standing in the rock community, or to meet some demand of the general public anxious to get their hands on early recordings by John Wetton?

Taking these albums as a whole, one must have the patience to sort through the self-indulgent passages in order to get to anything vital. For every "Cat Food" or "20th Century Schizoid Man," there is a "Happy Family" or ten, and the presence of all these "name" performers doesn't make the random rambling of Fripp & Co. any more appealing. As for the half-speed mastering job that supposedly is the reason these hard-to-find albums were reissued, the

A progress report from Dolby Laboratories

Dolby® Noise Reduction in 1983

■ Only two years after its introduction, more than 4 million listeners are enjoying the benefits of Dolby C-type noise reduction in their stereo cassette recorders. Thanks to its unique combination of dual-level processing and the proven sliding-band principle, Dolby C provides ample noise reduction to satisfy even the most critical listener, along with a freedom from side-effects conventional companders can't match.

■ But the rapid acceptance of Dolby C is not all that's happening. Now that low-voltage Dolby B ICs are available, more than 20 personal portable cassette models with Dolby B-type noise reduction are either on the market or in the final development stages. In addition, 20% of all VHS video cassette recorders now being built are equipped with Dolby B, including the many stereo models.

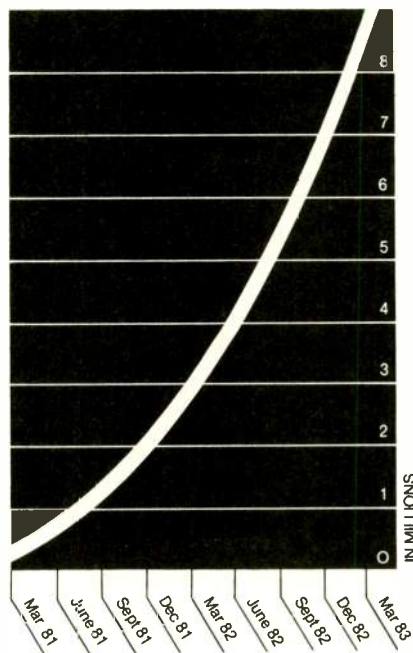

Number of Dolby C-type noise reduction circuits in use.

■ There is also progress with software. Hundreds of pre-recorded VHS cassettes encoded with Dolby B are now available, among which are many feature films originally released in Dolby Stereo. And thanks to Dolby HX Professional, improved audio cassettes, duplicated at high speed with significantly better high frequency response, are on the way.

■ In 1983, confidence in the familiar Dolby trademarks is higher than ever before. There are probably none others as closely associated with quality sound throughout the world.

Dolby Laboratories Licensing Corporation, 731 Sansome Street, San Francisco, CA 94111, Telephone 415-392-0300. Telex 34409. "Dolby" and the double-D symbol are trademarks of Dolby Laboratories Licensing Corporation. S83/3992/4968

 **Dolby®**

original recording jobs done on the first five King Crimson albums were so un-stupendous that double-speed mastering could have done the job as effectively. Anyway, it sounds like some of these were not made from first generation tapes. Fortunately, the \$8.98 price tag is more in line with the sonic value

here, for their interest in sonic excellence was certainly at the low end of the industry standard.

It all comes down to how much of a Fripp fan you are, because the soon-to-be-stellar sidemen aren't doing diddley. And Fripp, for all his pretentious conceptual idiocy, happens to

have a great deal in the way of guitar technique and can be engaging despite himself. On *Red*, in particular, he played some disturbingly innovative stuff, and even on the early albums he didn't have much trouble moving his fingers around.

Though Fripp was not a tremendous influence on the future of music, he just managed to surround himself with individuals who were very good and who would eventually make their own mark. The closest he has come to being an event unto himself was when, for a brief moment, he guested on Bowie and Blondie records.

These 10 records (which, by the way, come in paper rather than plastic sleeves) seem to indicate that EG wants them kept in print rather than that American audiences are clamoring for them. The music sounds dated and primitive, but when it was released it seemed far-out and futuristic. Such is the benefit of time and perspective upon the works of artists who juggle talent with self-hype. *Jon & Sally Tiven*

Attention: All Record Owners

HOW TO PREVENT WARPING YOUR MOST PRIZED RECORDINGS

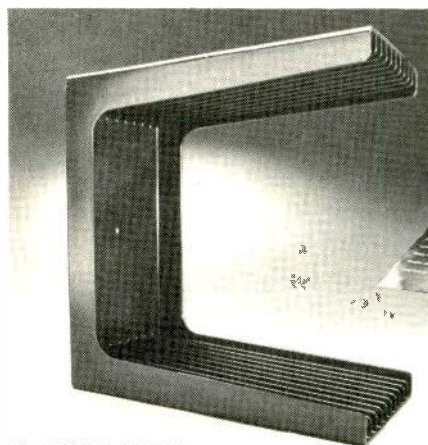

The **SOUND SAFE** System protects your valuable investment in records; audiophile, collector's items or just plain favorites. Even videodiscs. If your discs are not stored in a totally vertical position (upright without leaning), the forces of gravity can cause warpage. Warped records, as you've no doubt sadly experienced, dramatically reduce the reproduction potential of your stereo system. **SOUND SAFE's** exclusive inner-divider structure prevents your records from tilting and from excessive pressure by adjacent discs.

SOUND SAFE EXCLUSIVES

- EACH SOUND SAFE PROTECTS UP TO 20 DISCS
- SOUND SAFE CAN STAND ALONE ON A TABLE OR BE PLACED SIDE BY SIDE ON SHELVES
- MADE OF SUPER STRONG HIGH IMPACT STYRENE
- SLEEK STYLING AND RICH BLACK COLORING COMPLEMENT ANY ENVIRONMENT
- THE PERFECT GIFT FOR ANYONE WHO COLLECTS OR OWNS RECORDS OR VIDEODISCS
- SOUND SAFE MODULES CAN FORM THE BASIS FOR YOUR OWN INDIVIDUAL FILING SYSTEM
- NOT AVAILABLE IN STORES (THE SOUND SAFE IS EXCLUSIVELY AVAILABLE FROM THE QUALITY CONNECTION)

FREE BONUS!!!

"How To Care For Your Most Prized Recordings." A Quality Connection Data Report Free with each **SOUND SAFE**

INTRODUCING
SOUND SAFE™
THE VERTICAL DISC STORAGE SYSTEM

IT SAFEGUARDS YOUR RECORDS TOTALLY VERTICAL—PROTECTING AGAINST WARPAGE

IT'S A CUSTOM FILING SYSTEM FOR RECORDS AND LASER VIDEODISCS

Dimensions:

Height—12¾" Depth—12½"
Width—6" Weight—2 lbs. 3½ oz. each

HOW TO ORDER

- PRICES: **\$12.99** for one SOUND SAFE.
- 2-9 SOUND SAFES **\$11.99** each
- 10-49 SOUND SAFES **\$10.99** each
- 50 or more SOUND SAFES **\$9.99** each

SHIPPING & HANDLING: (USA)

- 1 SOUND SAFE \$2.50
- 2 SOUND SAFES \$3.50 Total
- 3 or more sound safes
- Call our toll-free number for exact rates.

Please allow 3-4 weeks delivery. California residents add 6% sales tax. All orders shipped UPS.

CREDIT CARD HOLDERS CALL TOLL-FREE 24 HOURS A DAY!

VISA • MASTERCARD • AMERICAN EXPRESS
Monday-Friday 9:00 AM-5:00 PM (PST)

800-423-0688

If busy, after hours, 24 hours on weekends or if you live in California call:

800-228-2028

(Ext-128)

Or simply send your check or money order (including shipping and handling charges) to the address below.



THE QUALITY CONNECTION

DEPT A, 18653 Ventura Blvd., Suite 314,
Tarzana, Calif. 91356 (213) 882-3542

©1983, THE QUALITY CONNECTION

Mozart: Symphonies No. 40 & 41.

The Chicago Symphony Orchestra,
James Levine

RCA ARC1-4413, \$8.98.

Levine does something in these two performances that we are not used to: He takes all the repeats. The result is 35 minutes on one side and 37 on the other! RCA's disc-cutting engineers have accomplished this feat better than I would have ever thought possible. But even then, they had to cut some bass and finish the sides much closer to the label than is normal. I would credit their Zuma variable-pitch and depth computer for accomplishing much of this. When time comes to release this album in the digital Compact Disc format, it may just barely be made to squeeze into that medium.

Unfortunately, the music is not well served by either the technology or by the approach Levine has taken. The playing sounds pushed, and, in combination with the many repeats, this makes for some tiresome moments. An example is the second movement of the 40th Symphony which, at 15:02 minutes, is twice as long as we are used to and seems almost endless. The finale to the 41st runs 11:02 min-

"Though recorded in 1959, Previn's jazz version of *West Side Story* is a prime example of what can be done with an old master."

Some Girls: The Rolling Stones
Mobile Fidelity MFSL 1-087, \$15.98.

Sound: A Performance: A

The Rolling Stones seem to revel in messiness. If rock 'n' roll is kept alive by imperfect records, these geezers

are undoubtedly the masters of the form: When a track is too tight, they manage to throw in a guitar figure which messes the rhythm up a bit. Between Mick Jagger's never-spot-on vocal and Charlie's vague approximation of the tempo, humanity is not only preserved on Stones records, it is *embod-*

André Previn

utes and is rushed in the process.

The combination of reduced transfer level and the close spacing of grooves has resulted in a pressing quality not up to Europadisk's normal standards.

The competition with this coupling of Symphonies is fierce, and two recent acquisitions point it up well. Schwarz and the Los Angeles Chamber Orchestra abound in the briskness which it seems Levine was looking for, while Kubelik and the Bavarian Radio Symphony score higher in their emphasis on these Symphonies' lyrical elements.

John M. Eargle

West Side Story: André Previn and His Pals Shelly Manne & Red Mitchell
Mobile Fidelity MFSL 1-095, \$17.00.

What well-known classical conductor was a jazz near-great during the '50's? The answer, of course, is André Previn. He abandoned his career as Hollywood *wunderkind* to become a conductor, and while we have gained his remarkable insights into English orchestral music, we have lost the freshness and invention of his jazz piano style.

Previn's collaborators on *West Side Story* are Shelly Manne on drums and Red Mitchell on bass. The recording was made in 1959; but for a minute amount of tape hiss, you would never know it. The sound is clean as can be, and it stands as a prime example of an excellent old master tape given the benefits of up-to-date stereo disc transfer and superb processing.

The eight cuts on this disc are varied in style and never for a moment dull. Only one of them, "America," doesn't seem to work; it lacks the Latin rhythmic drive it needs to make good musical sense.

Congratulations to Mobile Fidelity for dressing up this old masterpiece for our enjoyment.

John M. Eargle

If you love music, make it LAST

Only LAST offers a formula that will actually preserve your discs, and another that will actually protect your stylus—plus the most effective record and stylus cleaners in the world. LAST products, formulated for record archives, are now available to everyone.

LAST record preservative actually penetrates the record groove to a depth of ten molecular layers, protecting the groove from the constant, complex movements of the stylus—for 200 plays!

LAST power cleaner cleans records like no other product on the market. It even removes mold release—the potentially damaging material left in the groove by the manufacturing process.

STYLAST stylus treatment is molecularly engineered to lower friction by filling in the hollows on the surface of every diamond, reduce vibration effects by creating a liquid cushion for the moving stylus . . . and protect the elastomer holding the cantilever to the cartridge and the adhesive holding the diamond to the cantilever.

LAST stylus cleaner removes the most tenacious accumulations on the stylus while protecting the adhesive holding the diamond tip and the cantilever suspension.

Of course, you love music. That's why you should make it LAST. LAST is at finer dealers everywhere.

LAST

LAST • 122 Dupont Street, Plainview, New York 11803 • Tel. 516-349-9180

Audio®

BACK ISSUES/ BOUND EDITIONS/ BINDERS



BOUND ISSUES

A ready reference for audiophiles! A full year of AUDIO is carefully hard-bound for easy reference. Complete volumes for the years '77, '79, '80, '81 and '82 are available. **\$40.00 each plus \$2.50 for postage and handling.**

BACK ISSUES

Single copy back issues of AUDIO for 1981 and 1982 are available. (NOTE: Jan-Aug '81 issues are in limited supply.) **\$5.00 per issue postpaid.**



BINDERS/ SLIPCASES

Maintain your AUDIO collection in these top quality binders or slipcases. **Binders \$9.00 each, 3/\$26.00, 6/\$50.00. Slipcases \$7.65 each, 3/\$22.00, 6/\$40.00. \$2.50 per order handling and postage.**

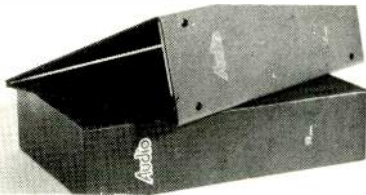

TO ORDER Indicate issue/book/binder/slipcase. Include proper amount for postage and handling. California residents must include 6% sales tax. Allow 4 weeks for delivery. **\$15.00 MINIMUM CREDIT CARD ORDER.** Make checks/money orders payable to: **Old Del Mar Emporium (ODME), P.O. Box 1621, Spring Valley, CA 92077. FOR CREDIT CARD ORDERS CALL TOLL FREE 1-800-854-2003 EXT. 835 in CALIF. CALL 1-800-522-1500 EXT. 835.**

"On *Some Girls*, Mobile Fidelity has once again done a fine job, with all the individual guitar figures articulated."

ied by them. It is for this reason that you wouldn't think they'd lend themselves to the audiophile format; the assumption would be that records this sloppy are made for radio or parties, but not simply listening to in your living room.

Granted, *Some Girls* is not exactly Ravel or Beethoven, yet it translates extremely well to a listener's record when all the original frequencies and separation are preserved. It also happens to be the last really well-made Stones album (all we've seen since are greatest hits, live versions, and out-takes from these sessions), and there's no mistaking The Stones' excitement when they first record with a new band. The addition of Ron Wood and Ian McLagan made for new textures that had only been hinted at when Woody



Keith Richards & Mick Jagger

was a temporary sub in the band, and after much touring the guitars and keyboards had time to gel. On this pressing particularly, you can hear the guitar figures individually articulated. In retrospect, Ron Wood delivered some very nice figures, despite accusations that he was just Keith Richards' alter ego. This disc also had strong production, and some credit should go to Chris Kimsey, who engineered and mixed. This pressing seems to favor the high-end extremes less, and in giving a more objective view of *Some Girls*, makes it more "Respectable."

Once again Mobile Fidelity has done a fine job, not that they were given the proverbial sow's ear from which to make a silk purse. However, the idea of making a Stones LP into a high-fidelity work is not far from the notion of making a full-length feature movie out of a newspaper comics section. Then again, *Superman* and *Annie* seemed to find their audience easily enough, and surely *Some Girls* will too.

Jon & Sally Tiven

The Advent Market Survey.

For three and a half years Advent has been developing a loudspeaker unlike anything we've ever produced. We need some information regarding speaker/room interface to finalize the design. If you will send us this survey, we will send you technical data on this new Advent 6003. In addition, we will send a coupon good for \$50.00 off on the purchase of a pair of these new Advent loudspeakers. Please fill out the survey and send to the address below.

NAME _____

ADDRESS _____

CITY _____ STATE _____ ZIP _____

What model Advents do you own? _____

What year did you purchase them? _____

What room are they in? _____

How large is the room? Floor area _____ x _____

Ceiling ht. _____

Additional comments are welcome.

ADVENT 4138 N. United Parkway
Schiller Park, Illinois 60176



... at home, in your car, in your car... Walkman. You'll not only hear the music... you'll feel it. You may not find these super cassettes at your local stores, but they're always available from The Quality Connection, 24 hrs. a day, 7 days a week. Order now for fastest delivery.

A SAMPLE OF OUR LATEST SELECTIONS AVAILABLE IMMEDIATELY!

- MF C-074 **CHRISTOPHER CROSS** "CHRISTOPHER CROSS"
 - MF C-084 **ALAN PARSONS PROJECT** "I ROBOT"
 - DL C-3015 **EUGENE ORMANDY - PHILADELPHIA ORCHESTRA** "TCHAIKOVSKY SYMPHONY #6"
 - MF C-086 **FRANK SINATRA** "NICE 'N' EASY"
 - DL C-3007 **LOS ANGELES CHAMBER ORCHESTRA** "VIVALDI: THE FOUR SEASONS"
 - MF C-047 **THE BEATLES** "MAGICAL MYSTERY TOUR"
 - MF C-510 **SIR GEORG SOLTI - LONDON SYMPHONY ORCHESTRA** "HOLST: THE PLANETS"
 - DL C-3017 **Y CHAMBER SYMPHONY OF NEW YORK** "BEETHOVEN SYMPHONY #6"
 - MF C-088 **CROSBY, STILLS, NASH & YOUNG** "DEJA VU"
 - MF C-017 **PINK FLOYD** "THE DARK SIDE OF THE MOON"
 - DL C-3010 **LOS ANGELES CHAMBER ORCHESTRA** "WATER MUSIC OF HANDEL"
 - MF C-049 **KENNY ROGERS** "KENNY ROGERS GREATEST HITS"
 - MF C-005 **SUPERTRAMP** "CRIME OF THE CENTURY"
 - DL C-3012 **LOS ANGELES CHAMBER ORCHESTRA** "MOZART SYMPHONY #40"
 - MF C-060 **THE ROLLING STONES** "STICKY FINGERS"
 - MF C-008 **ZUBIN MEHTA - LOS ANGELES PHILHARMONIC** "STAR WARS/CLOSE ENCOUNTERS SUITE"
 - DL C-3011 **LOS ANGELES CHAMBER ORCHESTRA** "DVORAK SERENADE OP 22"
 - MF C-042 **THE MOODY BLUES** "DAYS OF FUTURE PASSED"
 - MF C-033 **STEELY DAN** "AJA"
- AND MANY MORE. WRITE US FOR A COMPLETE LISTING.

IT'S IMPOSSIBLE FOR YOU TO MAKE A CASSETTE THAT SOUNDS AS SPECTACULAR AS THESE!

Forget everything you've ever heard about pre-recorded cassettes.

EXCLUSIVE PRE-RECORDED CASSETTES

Until quite recently, pre-recorded cassettes have done nothing to complement the sonic capabilities of your tape deck, automobile cassette system or portable player. They've been mass-produced, excessively noisy and sonically lifeless. They virtually waste the high fidelity potential of your stereo system.

Many of you have been forced to make your own cassette transfers from your favorite popular and audiophile recordings. You have probably improved the sound quality to a more acceptable degree. Perhaps you're "almost" satisfied. Or just more frustrated. We've got the answer.

DIRECT FROM THE ORIGINAL MASTER TAPE

The Quality Connection is proud to announce the immediate availability of the most spectacular pre-recorded cassettes you've ever heard. They are limited edition, custom cassettes created by two of the most respected companies on the audiophile scene... Delos Recording and Mobile Fidelity Sound Lab. You can order them now by mail or use our toll-free telephone numbers.

These mega cassettes are recorded directly from the original stereo master recording tape in "real time." They aren't high-speed duplicated like conventional cassettes. Every subtlety of the artist's original performance is meticulously captured. Nothing is lost. You'll hear Frank Sinatra, The Beatles, The Philadelphia Orchestra with Eugene Ormandy, Christopher Cross, Steely Dan, The Rolling Stones and countless others as they were meant to be heard.

YOU CAN'T MAKE... OR BUY... A MORE INCREDIBLE CASSETTE

We challenge you. It doesn't matter how expensive or extensive your stereo system may be. You won't be able to come close to

matching the startling dynamic range, frequency response, signal-to-noise ratio or dramatically reduced background noise levels of these cassettes. Remember, these tapes are created directly from the original master tape source... a magnetic medium. When you attempt to transfer sonic information from a phonograph record (a mechanical medium), you must deal with the potential fidelity weaknesses of every component of your playback system.

The Quality Connection will not compromise its quality standards. We sincerely believe that the Original Master Recording™ High Fidelity Cassettes by Mobile Fidelity Sound Lab... and the Digital Professional Reference Cassettes™ by Delos Recording... are the finest pre-recorded cassettes money can buy. Mobile Fidelity Sound Lab's cassettes are recorded on pure chromium dioxide tape, while Delos utilizes metal particle tape. Both include Dolby B noise reduction. For a more complete technical breakdown of these cassettes, please circle the reader response card in the back of this magazine.

FREE BONUSES WITH YOUR ORDER

If you order one of our cassettes this month, we'll send you The Quality Connection Data Report entitled "How To Care For Your Prized Pre-Recorded Cassettes." PLUS you'll start receiving our monthly newsbulletin, ON THE QC, detailing the latest new audiophile cassette and album releases available from The Quality Connection. It's our way of saying thank you.

DON'T TAKE OUR WORD FOR IT... JUDGE FOR YOURSELF.

Let your ears be the final judge. Order at least one of these sensational cassettes today by mail or phone. We'll rush it to your home or office. Put it on your own stereo

HOW TO ORDER

Prices: Original Master Recording High Fidelity Cassettes (MF prefix) are \$17.99 each. Digital Reference Professional Cassettes (DL prefix) are \$18.99 each.

Shipping & Handling: If your order is:
 (USA & Canada) Under \$20 . . . Add \$2.50
 \$20-\$40 . . . Add \$4.00
 (Foreign orders Double these Rates) \$41-\$75 . . . Add \$5.50
 Over \$75 . . . Add \$7.00

California residents: Please add 6 1/2% sales tax. All orders shipped UPS. Please allow 3-4 weeks for delivery.

CREDIT CARD ORDERS CALL TOLL-FREE 24 HOURS A DAY!

Visa - MasterCard
 - American Express

800-423-0688

(MONDAY - FRIDAY, 9AM - 5PM PST)

If busy, after hours, 24 hours on weekends or if you live in California, call:

800-228-2028 (Extension 228)

Or simply send your check or money order to the address below (including shipping and handling charges). To speed processing of your personal checks, please include your phone number and drivers license number.



THE QUALITY CONNECTION

Dept. SR 18653 Ventura Blvd., Suite 314. Tarzana, California 91356 (213) 882-3542

EDWARD TATNALL CANBY

FRONT AND CENTENARY



Stravinsky Celebration. New England Conservatory.

NEC 120, \$9.98. (Available from Golden Crest, P.O. Box 2859, Huntington Station, N.Y. 11746.)

This is an excellent live recording which celebrates the centennial of Stravinsky's birth. My only complaint is that it should be more adventurous—i.e., two discs. So much in this student/faculty series of concerts is necessarily omitted. It is important that we keep our ears tuned to the remarkable things that can be done today with our professional recording equipment, outside of the general run of record releases, actively inside the large and varied world of music and musical sound. I would hate to have missed this one.

The music spans Stravinsky's whole long career, to his very last little piece, and is performed by all the major departments of the Conservatory, the chorus under Lorna Cooke deVaron, the orchestra under Eiji Oue and so on. What makes things interesting, of course, is the enthusiasm of advanced student performers, young enough so that they understand and love the music as too few senior orchestral players do. And also the direction of experienced faculty members. All this communicates—and there is an audience (deftly managed in the editing) of more students and friends, families, obvi-

ously highly interested. If you want live on tape, this is it.

I particularly enjoyed the Dumbarton Oaks Concerto of 1938, very Bach-like, wonderfully tuneful and genial for Stravinsky. I heard one of the early performances at Dumbarton Oaks itself in Washington, D.C. during the war. Also the set of Russian church anthems, in that marvelously rounded style with the big basses and ornate sound that you will also find in Rachmaninoff, Tchaikovsky and many others. But perhaps best of all was the segment of that familiar warhorse, "Firebird" (the Firebird Suite), done in an absolutely hair-raising manner, so modern sounding you wouldn't believe. Just as the old-line conductors used to bring out the Romantic aspects of this early work, so the youth of today emphasizes the genuine modern—zowie! We should have the rest.

Indeed, what is noticeable throughout the disc is the easy domination of brass and percussion over the formerly dominant strings (at least as recorded). The strings seem to me rather weak and fussy; the brass is all brassy confidence. That's good for today's listening tastes.

Excellent clean sound, in a rather dead acoustic (I think Boston's Jordan Hall, with audience), giving a very clinical and sharply detailed effect, clearly just right for this composer's often dry and rhythmic music.

The Odessa Balalaikas

Nonesuch D 79034, digital disc, or cassette (D 4-79034), \$11.98 each.

What struck me first, listening to this quite charming disc (and cassette) was that the Russians are entirely free from the uncomfortable trichotomy in our music, between "classical," pop and folk. The modern balalaika, revived in the 19th century from a cruder folk instrument, is definitely poised right between these three and suffers no problems at all. Whereas we are always offending somebody in two wrong corners of our triangle—whether it's classical-pop, pop-folk, folk-classic! One listen to this balalaika music and you'll see what I mean. It just flows, easily, tunefully and effortlessly. Who cares what corner it does or doesn't inhabit?

An apt analogy because the balalaika is itself triangular, the only such instrument of its sort. It comes in a whole family, low bass through treble, and that is what we have here, sounding indeed like a considerable orchestra, not merely a quintet. This instrument is also remarkable in that its technique includes the strummed note, like the old-fashioned uke hereabouts, but richer and easier.

Curiously, this band was formed on our West Coast by four very un-Russians; they became so adept that in the end they attracted two genyooine Russians, one of whom plays, the other does the arranging. So now they are authentic. The superb Russian-style contralto who sings one number on each side is named Linda O'Brien. I found this recording very pleasing and utterly musical and so will you.

Haydn: The Six Last Sonatas. Glenn Gould, piano.

CBS 36947, digital.

Glenn Gould stands unique in music history as the first major pianist to give up the live concert entirely in favor of recording. Even some engineers have doubts about that, but all of us in the field owe him a lot of gratitude. Yes, he was an eccentric—and maybe better eccentricity on tape, invisible (though only too audible at times!), than on the stage. But the real boost he gave was to the *validity of recording itself*, dis-

tinct from the concert. That is what mattered. Beethoven was even more eccentric, remember.

Absolutely no question, Gould thrived musically in his solitude, if recording can ever be called that. He grew and grew—he became one of the greatest sheer interpreters of the old classics, as is clear when one traverses his successive recordings, from powerful to far more than that. He re-did the Bach *Goldberg Variations*, his first famous recording, for this very reason; he knew he had much new and more profound thinking to get down on tape.

So—those who think the Haydn piano sonatas are nice, tinny little pieces had better consider this release. Pianists, of course, but also piano teachers who assign these works to their thousands of students! Not to mention those of us who have listened to Haydn, on records or elsewhere, or even played them, more or less, ourselves. Absolutely breathtaking, is all I

Glenn
Gould

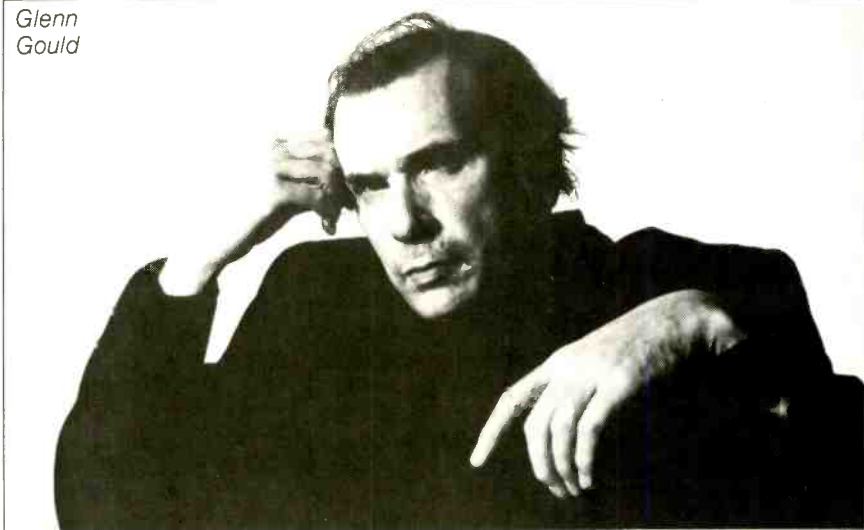

can say. I could use all the publicity words—stupendous, acclaimed, and so on, but I'll leave it simply that I was stunned. That is the sound of Glenn Gould in recording.

The actual sound, by the way, is clearly digital but a bit in the familiar Columbia-CBS style, rather dry, a trace steely. Not at all unpleasant, it is a perfectly good top-quality alternative.

ARM YOURSELF FOR A MUSICAL ATTACK.



The new 4BX with Impact Restoration.

The clash of a cymbal. The blast of a sax.

The new 4BX with Impact Restoration releases these musical attacks, adding punch and clarity to sounds otherwise dulled in the recording process. These musical transients are an essential part of music anticipation—the pleasure of knowing, but not knowing precisely, what will happen next.

The 4BX also incorporates our most advanced multi-band dynamic range expander, bringing out all the drama of the loudest and softest sounds. Music takes on a new presence, a new “liveness,” like you’ve never heard before.

The 4BX’s unique remote Logicontrol lets you adjust volume, expansion, transition levels and Impact Restoration—all by push button—from anywhere in the room.

So if you’re missing the drums in the distance, and the call of the bugles, don’t surrender. Arm yourself for surprise attacks with the new 4BX.

For our full line brochure, call or write:
dbx, Incorporated, 71 Chapel Street,
Newton, MA 02195. (617) 964-3210.

dbx[®]

Music can't live without us.

BERT WHYTE

SPEAKERS OF THE HOUSE

For several months now, I have been evaluating two interesting new loudspeakers, the Meridian M10 and the Acoustat Model Eight.

The Meridian is manufactured by Boothroyd Stuart, Ltd. of Huntingdon, England. In recent years, Meridian has specialized in what they call "interactive" loudspeaker systems. Simply put, this is a design wherein the driver elements are combined with dedicated amplifiers and crossovers, integrated in a common enclosure.

The M10 is the most advanced and most powerful of Meridian's line of interactive loudspeakers. One of the goals of the design is to create a virtual point source of sound, with symmetrical horizontal and vertical dispersion. To this end, a unique enclosure is employed. On the front of the loudspeaker, 5-inch cone midrange drivers are mounted above and below a 2-inch dome tweeter. These drivers are in a heavily damped enclosure isolated from the woofers. The cabinet's width is just slightly larger than the 5-inch midrange units, thus presenting a very narrow frontal area said to reduce diffraction distortion. On each side of this cabinet are mounted two directly driven, 5-inch bass drivers; a flat-diaphragm, 8 x 12-inch passive radiator is mounted behind the virtual source. This slim enclosure is integrated into the top portion of a pedestal of the same width. Contained within the lower part of the pedestal are two 75-watt amplifiers for the bass system, another 75-watt amplifier for the midrange drivers, a 35-watt amplifier for the dome

Meridian M10s

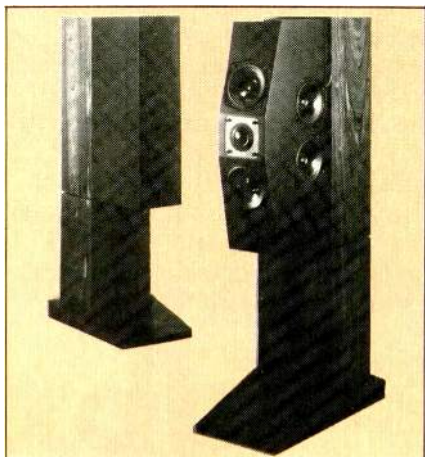

tweeter, an electronic crossover, and two power supplies. Quite an assemblage—and in spite of the close proximity of the various elements, very little heat is generated.

The M10 is thus a tri-amplified system, and Meridian points out that the amplifiers and crossover are configured to match the characteristics of the drivers. Crossover from the bass section is at an unusually low 190 Hz, and a time-delay-compensated, fourth-order crossover directs high frequencies to the tweeter from 2 kHz on up.

Meridian claims an overall frequency response of -3 dB at 33 Hz and 24 kHz, with THD of the entire electronic system typically less than 0.01%. This slim pedestal design stands 39 inches high, with the upper enclosure 18 inches deep.

Since the M10 is an active system, the only other electronic component necessary is a preamplifier. Meridian recommends their own Model 101, but any high-quality preamplifier can be used. Each M10 is supplied with frequency-compensation plugs which can be inserted in the rear of the enclosure to tailor high-frequency response for variations in room acoustics.

To evaluate the Meridian M10, I teamed it up with a Levinson ML6A preamplifier which superbly complemented the fine performance of this unusual loudspeaker. With 270 watts of tri-amplified power per side, the M10s gave an impressive performance with large-scale symphonic works. I had the pleasure of a visit from Bob Stuart, the astute young designer of the M10, and we listened to digital discs on a prototype Sony CDP-101 digital audio disc player. It was obvious that the M10 could handle the great dynamic range of a number of recordings at high output levels, certainly approaching the 110 dB on program peaks claimed by Meridian. Bass response was very firm and solid: Bass drums had plenty of punch and weight, and contrabass had a most satisfying clean resonant "thrum." Only the extreme low organ pedals of Virgil Fox recordings indicated the need for a good subwoofer. Transient response of the M10 is exemplary. On the M & K *Hot Six* drum recording, high percussion of cymbals and bells was very accurate, while the rim shots were positively

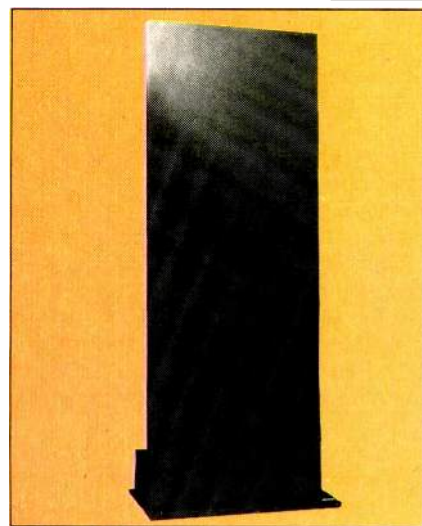

Acoustat Model Eight

explosive in their projection. Given the proper source material, high-frequency response of the M10 was very smooth, although there was a slight tendency to brightness. Judicious use of the frequency contouring plugs would be indicated in some rooms. As expected, because of the point-source emphasis in the design, imaging and depth projection were extraordinarily good. The image focus and instrument localization have to be considered among the top three or four loudspeakers which excel in this parameter. The overall sound of the M10 is accurate, very musical, and not fatiguing. A pair of M10s costs \$4,450, but it must be remembered that this includes 270 watts of tri-amplification per side.

Acoustat now proudly proclaims that their line of electrostatic loudspeakers puts them in the category of the world's 10 best-selling loudspeakers. I have no reason to doubt this, as their speakers have garnered much acclaim and steadily increasing sales in the relatively short span of the company's existence.

Some months ago, Acoustat updated their speakers and added several new models. The Model Eight, their state-of-the-art "flagship" electrostatic loudspeaker, costs \$4,750 per pair. It is an imposing monolith, standing 7 feet, 10 inches high, 36 inches wide, 4 inches deep and weighing 220 pounds!

The Model Eight is, in essence, two Model Four speakers stacked in a single unit. As with all current Acoustat ES

MICHELOB



Some things speak for themselves

"Quite obviously, a speaker of such imposing size as Acoustat's Model Eight should be used in rooms of appropriate dimensions."

loudspeakers, the Model Eight's signal-carrying wire grids are made of high-purity copper, utilizing 47 strands of 40-gauge wire. This is claimed to produce high output with less mid-range coloration. The wire grids are strung on a very rigid honeycomb plastic form, with the 0.0005-inch-thick,

conductive mylar diaphragm sandwiched between the grids. Each panel of the Model Eight is equipped with a high-frequency balance control for frequencies above 10 kHz, and the system's frequency response is rated as 24 Hz to 20 kHz, ± 2 dB.

Each Model Eight panel is also

equipped with two Acoustat MK-121 input "biformers," since each side is meant to be driven by both channels of a stereo amplifier. (The MK-121 is said to permit a largely resistive load of 6 ohms.) The Model Eight requires a lot of amplifier power. I have used two Acoustat Trans Nova 200 watt/channel units very successfully, with the amplifiers providing a very clean, highly detailed sound with plenty of punch. I currently use a Levinson ML-3 amplifier on each panel of the Model Eight. The huge voltage and current capabilities of the ML-3 amps provide a sound of unparalleled power and refinement.

Obviously, a speaker of such imposing size should be used in rooms of appropriate dimensions. Acoustat recommends rooms on the order of 20 x 30 feet, and their specification for sound pressure level is 125 dB at 25 feet in a room this size! However, an LEDE (live end-dead end) room can be much smaller since, with the absorption, the speaker is essentially in an "infinite" room. That is how I have the Model Eights set up, and it works perfectly, with excellent directivity and a large soundstage. Imaging is quite good, but not on the order of a B & W 801. On the other hand, depth perception is excellent. In spite of the speaker's height, I do not get disparate or elongated images or the sense of an orchestra performing above my head.

As to performance, the Model Eight has to be deemed one of the world's great loudspeakers. Transient response on everything from percussion to piano has a "right now" immediacy. When fed signals from master analog tapes (and some digital tapes, too), string sound can be ultra-smooth and of ravishing tonal beauty. With 23 square feet of radiating diaphragm driven by two Levinson ML-3 amplifiers, bass response is awesome in its output, clarity and visceral impact. Even with the Virgil Fox organ recordings, no subwoofer is necessary. In large-scale orchestral works like those of Mahler, Bruckner and Stravinsky, the dynamic range capability is enormous. No question whatever that digital sound can be handled. Given a recording of the requisite high quality, the Acoustat Model Eight can furnish some of the most accurate, wonderfully musical sound extant. 

Why in the world do we need another line of turntables?

With Linn Sondek, Oracle, Pink Triangle and other high quality units already on the U.S. market, why do we need still another line of turntables?

Just listen to an Ariston in comparison tests and you'll have the answer. Ariston turntables prove that there will always be a need for such components—as long as music lovers can hear as well as listen.

Do the sensible thing. Audition an Ariston before you invest in any turntable.

For complete information, write to us at 122 Dupont Street, in Plainview, New York 11803.



Ariston RD1[®] Superior, shown here with SME 3009R tonearm

WHY PUT TWO FILTERS INTO ONE GREAT COMPACT DISC PLAYER?

Kyocera goes to double lengths to make sure there's no distortion in its DA-01 Compact Disc Player. It's got both digital and analog filters—so nobody hears distortion.

The advantage of digital and analog filtering systems.

Modern technology has made analog filters pretty effective. But there can be a problem— analog filters by themselves render limited performance. By combining an analog filter with a digital filter, and precisely applying both types in just the right way, the limitations found with analog filters are not there anymore. Thanks to the unique use of these filters, and an impressive array of very advanced circuitry, the Kyocera CD Player provides accurate, crystal-clear, life-like sound.

The awesome specs that only digital can provide.

Needless to say, the Kyocera DA-01 comes through with some specs that are mind-boggling: A full 90 dB dynamic range... flat frequency response from 20-20,000 Hz... quiet 90 dB S/N ratio... and total isolation 90 dB channel separation.

And, just in case you didn't realize it, with the fabulous disc player system, as provided in Kyocera's DA-01 Player, there is no contact between disc and playback head. No ticks, clicks, pops, scratches or record wear. And the DA-01 plugs right into your present audio system—Kyocera or others—just like a conventional turntable.

Easy to use, but total control of every function.

The DA-01 is easier to use than a modern cassette deck—slide the compact disc into the disc compartment, shut the door and hit the play button. With the DA-01's feather-touch controls, you can play the whole thing (60 minutes a side)...repeat a track...scan...pause...skip...advance...index...and program up to 24 different segments with an electronic memory. A functional LED digital panel tells you program running time and just where the optical scanner is on the disc.

Admittedly, our DA-01's are carried only by selected dealers. If you have trouble finding one, contact: Kyocera International, Inc., 7 Powder Horn Drive, Warren, NJ 07060 (201) 560-0060.

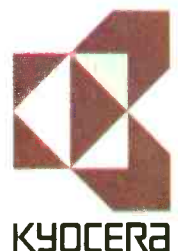

BERT WHYTE

THE CAVIAR SYNDROME

Why is it that if products are of very high quality, or are very expensive, or are rather exotic, so many people seem to resent these products and delight in putting them down? I guess it can be charged to a petty streak in human nature. I call it the caviar syndrome: You hear people say, "I've never tasted it, but I'm sure I wouldn't like it." Or those who derisively sneer at a gleaming new Mercedes and state that "My Chevy gets me from point A to B, and that's all I need."

It would seem that projection TV falls into this category. Yes, it is expensive, and you always hear those well-worn clichés, "It's too big," "It takes up too much space," or "The screen isn't bright enough." All complaints duly noted, but isn't it interesting that when the World Series or the Super Bowl is going to be broadcast, the neighbors call up to ask if they can see the game on your big screen?

There is no doubt that complaints about the size of projection TV systems, their limited screen brightness, and restricted viewing angles were perfectly valid in the early models. However, there has been considerable progress in correcting these shortcomings, and current models are quite sophisticated. A case in point is NEC's PJ-4000EN rear-projection TV.

This unit has a 40-inch screen, yet it is only 22 inches deep, about the same as a conventional 25-inch TV set. Height is 48-5/16 inches and it is 37 inches wide. A large unit to be sure, but not overwhelming. This rear-projection system uses three in-line Schmidt-type CRT lenses plus an ultrafast f/1.0 projection lens. This gives an exceptional 150 foot-lambert screen brightness, which is just about the same as a good quality 25-inch TV set. In addition, the PJ-4000EN has a horizontal viewing angle of $\pm 60^\circ$ and a $\pm 18^\circ$ vertical angle. Thus, fairly large groups can view the 40-inch screen; in earlier units, off-axis light fall-off restricted viewing angles. Granted, a 40-inch screen doesn't approach the 6-foot monsters usually found in two-piece projection TVs, but it appears that 40 to 50-inch screens are the best compromise, furnishing quite a large screen with high brightness levels, wide viewing angles and good resolu-

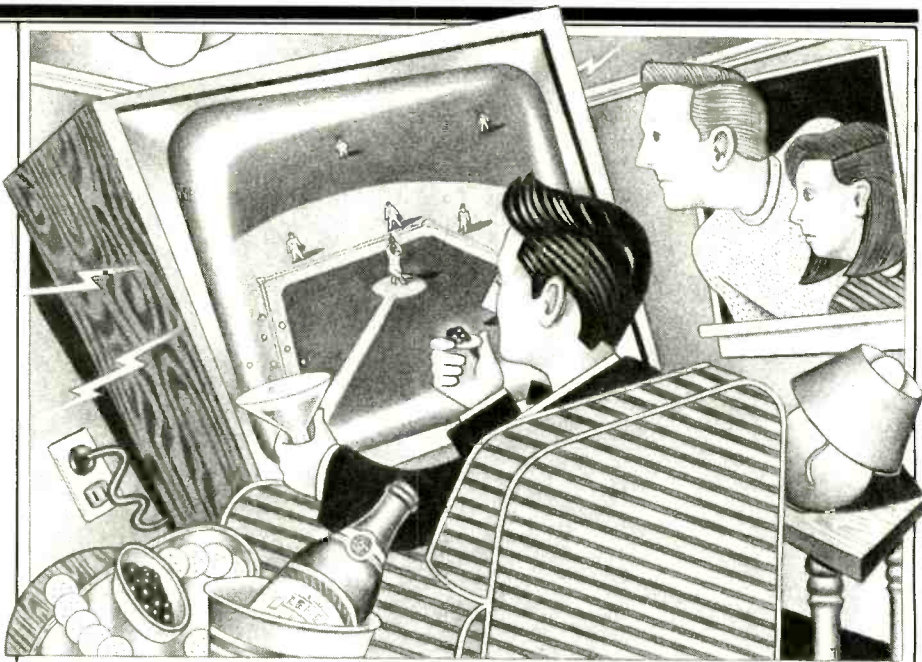

Illustration: Michael Emerson

tion. The PJ-4000EN offers many other features and amenities. It has phase-locked loop electronic tuning, wireless infrared remote, 134-channel CATV capability, and input/output channels for VCR, videodisc, video games, etc. The unit has a 10-watt stereo amplifier and two speakers for stereo sound. The NEC PJ-4000EN is the embodiment of a new breed of video projectors that may change the minds of those hide-bound people mentioned earlier. No price is listed as yet, but my guess is that it will run about \$2,300 to \$2,400.

NEC also is making news with their TC-100E, a CCD (charge-coupled device) color video camera. Such CCD image sensors are most likely the wave of the future and will replace tube-type color pickups when costs can be brought down. The NEC CCD has more than 200,000 separate light-sensing elements packed onto a chip less than a centimeter square. The CCD affords higher resolution (250 TV lines horizontally and 450 vertically), is relatively insensitive to vibration, has improved color accuracy, and eliminates such things as color shifts, spot burning and "blooming." Of course, since the CCD obviates the need for a pickup tube, the overall camera weight can be reduced. In fact, the TC-100E weighs just 5 pounds.

One of the biggest advantages of the CCD is its high sensitivity. Com-

bined with a fast, f/1.4 6 \times power-zoom lens on the TC-100E, NEC claims it will record as low as 50 lux; in practical terms, this means shooting indoors at night under normal room lighting without supplementary lights. Still another plus is that there is instant-on—the CCD image sensor and the electronic viewfinder are activated one second after this camera is switched on.

Speaking of the viewfinder, the TC-100E's is a 1.5-inch miniature CRT; it is detachable from the camera and can be used up to 19 feet away with an optional extension cord. Other features of the TC-100E include an automatic white balance control and an automatic-iris exposure control. Audio is recorded through an omnidirectional electret condenser microphone. The CCD concept is an important advance in video camera technology, and the NEC TC-100E appears to incorporate a successful application of this new device. Price of the camera has not been established.

Video recording enthusiasts who subscribe to a cable service and who happen to prefer the Beta format will welcome a new Betamax VCR from Sony. The Model SL-5101 is the first Betamax VCR that is cable ready and permits direct recording of non-scrambled programs without a converter box. However, its "105-channel" tuner only has the usual 14 preset tuning

LIGHTS: 9 mg. "tar", 0.8 mg. nicotine, LIGHTS 100's: 10 mg. "tar", 0.8 mg. nicotine, av. per cigaret e by FTC method.

© 1983 R.J. REYNOLDS TOBACCO CO.

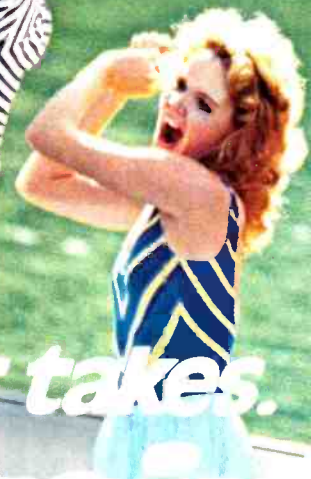

You've got what it takes.

Salem Spirit



*Share the spirit.
Share the refreshment.*

Warning: The Surgeon General Has Determined That Cigarette Smoking Is Dangerous to Your Health.



AUDIO and VIDEO

ALL THE TOP BRANDS FOR THE SAME PRICE DEALERS PAY

- ★ SAME DAY SHIPPING
- ★ NO-LEMON GUARANTEE
- ★ NO DEPOSIT

CALL OR WRITE FOR OUR FREE BOOKLET "ULTRA HI-FI DIGITAL at HALF THE COST"

9-9 DAILY-TIL 5PM ON SATURDAY
1-301-488-9600



INTERNATIONAL HI-FI DISTRIBUTORS, INC.
MORAVIA CENTER INDUSTRIAL PARK
BALTIMORE, MD. 21206

Enter No. 28 on Reader Service Card

FOR INFORMATION AND ORDERING: (800) 221-8180
IN NEW YORK CALL: (212) 732-8600

DEALERS/INSTITUTIONAL INQUIRIES CALL: (800) 221-3191

J&R MUSIC WORLD

THIS MONTH'S SUPER SPECIALS!

AUDIO	STEREO-TO-GO
HI FI	SONY WM-5 Stereo, Cass. \$84.95
TECHNICS SA-410 Receiver, 45W \$189.95	SONY WM-7A II Cass. Stereo \$124.95
TECHNICS SL-50 Turntable \$80.95	SANYO MC-2 Cass. Stereo \$85
TECHNICS SL-4 Turntable \$189.95	SANYO MC-2 (AM) FM/Cass/Stereo \$29.95
TECHNICS RM-205 Cass Deck \$119.95	SANYO MC-8 Cass Stereo \$64.95
TECHNICS RM-225 Cass Deck \$139.95	SANYO MC-32 (AM) FM/Cass \$64.95
TECHNICS RM-255 Cass Deck \$149.95	AWA HES-00 FM/Cass/Stereo/Rock \$129
PIONEER PL-4 Turntable \$84.95	TOHOKU KT-5 FM/Cass/Stereo \$65
PIONEER SL-303 New Receiver \$289.95	TOHOKU KT-5 (AM) FM/Cass/Stereo \$68
PIONEER PL-400 Turntable \$134.95	PARSONS PC-200 Cass Stereo, CD \$124.95
PIONEER CT-4 Cass Deck \$184.95	JVC CX-1 Cass Stereo \$79
SANSUI 2-5000 Receiver/70W \$129.95	JVC CX-2 Cass/FM Stereo \$99
AKAI CSF-12 Cass Deck \$219.95	JVC PC-11 Portable Stereo \$46
AKAI CSF-31 Cass Deck \$219.95	
SONY STR-VX33 Receiver/40W \$239	VIDEO GAMES
SONY PSR-800 Turntable \$189.95	COLLECTION VIDEO GAME \$179.95
TEAC V2-4X Cass Deck \$39	ATARI VIDEO GAME (CX-200) \$49.95
TEAC V66-C Cass Deck \$189.95	ATARI VIDEO GAME (CX-500) \$49.95
MARANTZ SR-620 Receiver/65W \$299.95	MATTEL INTELLIVISION II \$149.95
WHEATGARD FM-400 Electric Antenna \$4.95	VECTREX VIDEO GAME \$49.95
TECHNICS SF-1 MCRO Speakers \$134.95/PAIR	DOYSEY VIDEO GAME \$119.95
PIONEER PS-10 MCRO Speakers \$169.95/PAIR	COLLEO EXPANSION MOD 1 (also use of Atari games on Commodore) \$59.95
HEADPHONES	COMPUTERS/PRINTERS/TYPENITERS
KOSS PRO 4-AAA \$47.95	COMMODORE VIC-20 \$40
SHURE SR-710 \$48.95	COMMODORE 64 \$399.95
SONY MDR 80-T MCRO \$59.95	ATARI 1300XL \$40
CARTRIDGES	ATARI 800 disk RAM \$238.95
SHURE V-15 Type V \$54.95	ATARI 800 10K disk RAM \$269.95
SHURE M71E \$48.95	TEXAS INSTRUMENTS T99/41160 \$269.95
SHURE M911B \$57.95	TEXAS SINGLE-ARM (2K RAM) \$499
STANTON 6811B \$57.95	MULTI-ARM MPF-8 (disk, COIL) \$349
PICKERING XCV-3000 \$179.95	SHARP PC-1500 (3K RAM) \$399.95
AUDIO TAPES	TI PHA-4100 11" Color Monitor \$299
MAXELL UD-XL of UD-XL C-90 \$2.49	SMITH CORONA Letter Quality Printer \$499
MAXELL UD-XL of UD-XL C-90 \$2.79	SMITH CORONA Letter Quality Printer \$499
MAXELL XLII of XLII C-90 \$3.49	ULTRASONIC TYPEWRITER \$439.95
MAXELL UD-C90 \$4.79	
MAXELL MX-90 Metal \$4.79	
MAXELL UD 35-90 \$4.99	
TDK SA C-90 \$4.99	
TDK SA C-90 \$4.99	
TDK MC C-90 Metal \$4.17	
TDK D C-90 \$4.59	
TDK AD C-90 \$4.99	
TDK SA-90 \$4.99	
TDK MD-101 Head Demagnetizer \$12.99	
TDK MD-101 Head Demagnetizer \$12.99	
SONY MC C-90 (MCRO) \$1.99	
SONY MC C-90 (MCRO) \$1.99	
BASE PRO 850 of PRO II-90 \$2.49	
SCOTT'S MASTER II C-90 \$2.79	

5% DISCOUNT ON 100 OR MORE ASSORTED TAPES MINIMUM ORDER 12 TAPES

HOW TO ORDER BY MAIL: FOR PROMPT AND COURTEOUS SHIPMENT, SEND MONEY ORDER, CERTIFIED CHECK, CASHIER'S CHECK, MASTERCHARGE, VISA, BRITISH CASH, PERSONAL AND BUSINESS NO. PROVISION DATE AND SIGNATURE. DO NOT SEND CASH, PERSONAL AND BUSINESS CHECKS. MUST CLEAR OUR BANK BEFORE PROCESSING. CREDIT CARD ONLY. CREDITORS ORDERS CONTINENTAL U.S., ALASKA, HAWAII, PUERTO RICO, AND CANADA ONLY. CREDITORS ORDERS ADD 10% SHIPPING WITH A 7.95 MINIMUM CHARGE. FOR PAYMENTS BY AIR, PLEASE DOUBLE THESE CHARGES. SURETY, INC. C.O.D.'S. NEW YORK STATE RESIDENTS PLEASE ADD SALES TAX. ALL MERCHANDISE SHIPPED BRAND NEW, FACTORY FRESH AND 100% GUARANTEED.

23 PARK ROW, DEPT. A6, NYC, NY 10038
SEND FOR FREE 240 PAGE AUDIO/VIDEO CATALOG

Enter No. 29 on Reader Service Card

slots; the difference is that these can be tuned to cable as well as broadcast channels. The Express Tuning System can be used to select any 14 channels, in any sequence, from VHF (channels 2 through 13), UHF (14 through 83), cable midband (A through I), and cable superband (J through W). With no converter box required, it is possible to record one non-scrambled program while watching another.

In other respects, the SL-5101 is like its sister model, the SL-5100. It features front loading, a wireless infrared remote control, a 7-day/1-event programmable timer, full-logic microprocessor controls, and 5-hour recording capability. Additionally, the SL-5101 has extra audio and video line inputs and outputs, and as an interesting extra, a PCM switch for use with either of Sony's two digital processors. This new Betamax SL-5101 is priced at \$669.95.

The next item may raise some eyebrows. American Audio Corporation of San Francisco has introduced what they claim is the "world's first in-dash

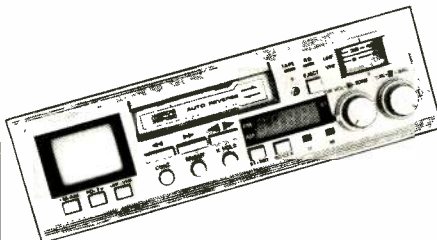

American Audio's ET-9000TV combines TV with AM/FM radio and cassette.

car video system," their Model ET-9000TV. An in-dash TV set? The mind boggles, and recoils in horror at what highway carnage could result from such a device. Not to worry, folks. The system is to be installed so that the TV screen, though not the TV sound, is inoperative when the car ignition switch is on. However, if the system is mounted in the rear passenger section, the TV could operate while the car is moving.

Actually, the ET-9000TV is a very elaborate entertainment package. On one chassis is an auto-reverse stereo cassette player, an electronic-tuning AM/FM/MPX radio, and, of course, the 2-inch monochrome TV, with all-channel vernier VHF/UHF tuner and controls for contrast, brightness and vertical

"American Audio's in-dash car video system may raise some eyebrows, but its TV screen is inoperative when the car's ignition is on."



Sony's cable-ready SL-5101 also offers 14-channel Express Tuning.

hold. The cassette deck is controlled by microprocessor chip. The audio tuner has a digital frequency display, along with stereo tone and balance controls. There is a 25-watt stereo amplifier and even a digital quartz clock.

Although something like this may have limited appeal, it would furnish TV programs when you are on a beach or at picnic grounds. If you want to be the first in your carpool with the ET-9000TV, it will set you back \$1,495.

Finally, in the realm of the far-out, Telefunken has announced they will demonstrate the first PCM receiver for Direct Satellite Broadcasting at the Internationale Funkausstellung to be held in Berlin this September. It is claimed the unit will have pushbutton selection of 16 stereo programs, which can be received with "digital audio quality." The receiver will operate in the region from southern Sweden to southern Italy. I hope they are not going to short-change the U.S. Supposedly, AT&T and CBS are still very hot on the idea of Direct Satellite Broadcasting—maybe at the June 1984 Consumer Electronics Show?

Flash: Video Recording Standard Reached

It was announced in Tokyo on March 28th that approximately 120 companies have agreed to use quarter-inch videocassette tape in the next generation of VCRs and video cameras. Accord was reached on specifications for audio- and videocassettes, one specific method of video recording, and the tracking method. It is expected that the new format will not be offered to consumers for at least a year, and that the agreement will likely reduce competition among the three current half-inch tape formats of VHS, Beta, and V-2000.

TEST-DRIVE IT BRISKLY. BUT DO IT LEISURELY.



PONTIAC 2000

When you take one for a spin, take your time. There's a lot this car wants to tell you.

Pontiac 2000 is an energetic, state of the art, front-wheel-drive compact.

Its performance, fit and finish are impressive, to say the least.

An overhead cam 4-cylinder engine with electronic fuel injection and a 5-speed manual gearbox are standard.

It's available in sedan, coupe, hatchback or wagon.

As you can see, Pontiac 2000 is quite good looking. As your test drive will prove, it's also fun to drive. Leisurely or briskly.

And as your Pontiac dealer will show you, it's very easy to own.

What a car!

Some Pontiacs are equipped with engines produced by other GM divisions, subsidiaries, or affiliated companies worldwide. See your Pontiac dealer for details.



PONTIAC  **WE BUILD EXCITEMENT**

EDWARD TATNALL CANBY

GEARING UP

Softgear. That's an emergency or ad hoc name I'm using to cover all the input, for entertainment and/or instruction, which goes into our hardware, our hard gear, and thereby causes it to make noise and maybe produce pictures. A big order and we need a new name.

In times of really fundamental long-range change in, say, the things we deal in (not trying to give them any name!), the fundamental terms themselves go haywire, right along with the status quo when it stops being "quo." I don't think a lot of you out there really believe it yet (because you haven't seen or heard), but this is indeed such a time. Terms get thrown about so fast you can't keep up with them. We latch frantically onto every tricky word that comes along and apply these as fast as we can to our own special bailliwicks, just to show how up-to-date we are. Software, my eye! I'm already sick and tired of calling things like Beethoven by the name of software. Makes me think of a soft-boiled egg. Better a hard nut for him (and a hard one to crack for some of us) than a soft egg.

Besides, software increasingly belongs to developing computer technology, where indeed it must have first appeared. It goes legitimately with bits, addresses, bytes, nand and nor, and the rest of the new logic that builds around the technical instructions which tell a computer, any sort, what to do and in what sequence with what checks and balances. That is the new and stable use of software as a term, and already it should not be mentioned elsewhere except in analogy—"like software." Or if you wish, in metaphor, as the case may be. (Remember from your English class that an analogy says "like" something or "as," whereas a metaphor just calls it that.) Beethoven is *like* a soft-boiled egg? Thanks, but no.

True, we have a legitimate edge into real software, if you insist. Anything from a phono stylus to a microphone, not to mention a digital signal, does instruct a computer for us if we have a few convenient chips located in our front ends. But this is splitting microhairs—what we really mean is the body of actual entertainment, or educational instruction, or what have you, that is recorded or broadcast so that we may



Illustration: Philip Anderson

consume it in our, er, homes (meaning, of course, our cars, RVs, boats, cycles, skates, beauty parlors, supermarkets, saunas, whirlpools—whatever happened to the living room?).

You see what I mean. In times of change, terminology just bogs down, or boggles the mind. So—*softgear*. Strictly weaseling on my part, but at least it sets ours apart from the legitimate computer world.

I am more and more taken up these days, in my mind, with this *softgear*. You might say I am even worried. Because though we look very hard at our new hardware and we are breaking our worldwide necks to develop more of it every day, we act as if *softgear* is just *softgear* and won't really matter very much, just so it's there. That's the way everybody acts, except one very vital force in business, the consumer, because he doesn't know the difference—yet.

Ha! The marketplace, as the marketers call it. That's him & her. Ho! The inventory, as the wholesalers might have it. That's also him & her. And then there is that magic, mystic term, sales. The very embodiment of him & her and we never use it in the singular—a sale is something else again, but sales are just the beginning of what really mat-

ters—USE. That, alas, is where the cookie so often crumbles . . .

Hardware is a nice old term that we can freely use since it long antedates computer science. For maybe a couple of centuries it has been one of those curious one-sided designations, minus any opposite, which serve comfortably, decade after decade, without causing the slightest ripple of confusion. There were hardware stores (but no software) back in the pioneer days, along with dry goods emporia (no wet goods), greengrocers (no white or red grocers), blacksmiths (but, yes, whitesmiths or tinsmiths), and more. If the computer people have appropriated hardware for themselves, so may we. Leave the wet goods to the skin-diving and aqualung types, who really need the term. Neither do we need grocer, nor smith, unless for that overworked personality, the tunesmith. But hardware—yes. And *softgear*—yes.

Sorry, they do not match. But neither do binaural, for headphone listening, and stereo for two-eyed separate-photo photography, an exact analog. These should properly be binaural and binocular, but there we get mixed up with a prior usage for, shall I say, telescope, and a quite accurate one at that. In juggling our terminology we have to

AUDIOPHILE FILE™ XL-S

GREATER DYNAMIC RANGE

Maxell XL I-S and XL II-S are the ultimate ferric oxide cassette tapes. Precision engineered to bring you a significant improvement in dynamic range.

XL I-S provides exceptionally smooth linear performance characteristics with high resolution of sound and lower distortion.

While XL II-S has a greater saturation resistance in higher frequencies resulting in an excellent signal to noise ratio.

How did we achieve this?

IMPROVED EPITAXIAL PARTICLES.

Maxell engineers have managed to improve the Epitaxial magnetic particles used on both tapes.

By developing a crystallization process that produces a more compact, smoother cobalt ferrite layer on the gamma ferric oxide core, they've been able to pack the particles more densely and with greater uniformity on the tape surface.

This increases maximum output level and reduces AC bias noise which in turn expands the dynamic range.

IMPROVED EPITAXIAL PARTICLE CHARACTERISTICS:

MORE UNIFORM COBALT-FERRITE LAYER

SMOOTHER PARTICLE SURFACE

GAMMA-FERRIC OXIDE
COATING THICKNESS: 10-11A (1A = 1/10,000,000 mm)

470A

↑
↓

Enter No. 27 on Reader Service Card

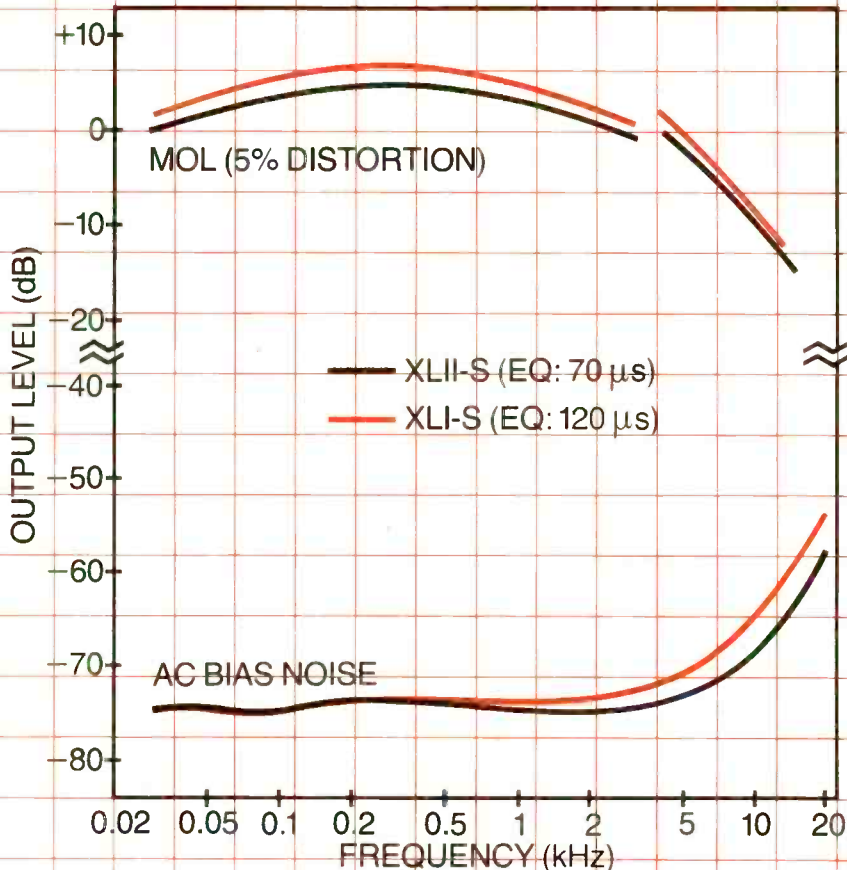

So you get a better signal to noise ratio, greater resolution of sound and higher output levels.

Of course, greater dynamic range isn't the only reason to buy Maxell high bias XL II-S or our normal bias equivalent XL I-S.

Both tapes have more precise tape travel and greatly reduced distortion levels.

You'll see both these improvements covered in detail in future Audiophile

Files. In the meantime, we suggest you listen to them.

For technical specification sheets on the XL-S series, write to:

Audiophile File, Maxell Corporation of America, 60 Oxford Drive, Moonachie, New Jersey 07074.



IT'S WORTH IT.

©1988 Maxell Corporation of America, 60 Oxford Drive, Moonachie, N.J. 07074

Retailers—put

Audio[®]

on your
counter...

and welcome a
great new
sales partner!

We've got a plan to help
build your sales...and ours.

You're invited to join AUDIO's Retailer
Sales Plan. Simply offer everyone's
favorite audiophile magazine in our
handy display rack and you:

- chalk up 100% profit on every
issue sold.



- build traffic as your customers
come back for issue after
issue of AUDIO.
- generate more interest in the
accessories and equipment
you carry.
- make more sales now!

For details, write to us on your letterhead.

**Contact: Mary Lombardo
AUDIO**

1515 Broadway, New York, NY 10036

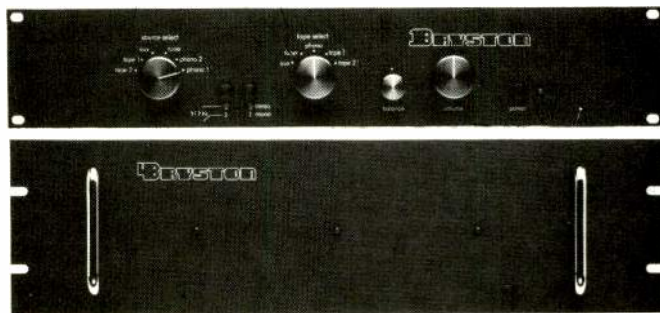

the perfect combination...

The musical accuracy of Bryston components is a revelation. Every note emerges with perfect clarity from a background of silence, then vanishes. The progression of musical events seems real, tangible, almost visual in its presentation....

Bryston believes there is a need for reference standards of musical accuracy. That is why we designed our Models 2B, 3B and 4B power amplifiers, and our Model 1B preamplifier. Their only reason for existing is to provide the most faithful electronic rendition of a musical signal possible within the bounds of available technology. Write to us and we'll tell you how we do it, and where you can listen to our perfect combination.

IN THE UNITED STATES:

BRYSTON VERMONT
RFD#4, Berlin, Montpelier, Vermont 05602
(802) 223-6159

IN CANADA:

BRYSTON MARKETING LTD
57 Westmore Dr., Rexdale Ont., Canada M9V 3Y6
(416) 746-0300

take practical account of the competition, linguistically speaking. Or the regulations that apply. The ad people have no trouble with all this—they sometimes just don't call it anything, and substitute adjectives. Those boxes you see with RICHER, FLUFFIER, SMOOTHER on them and nothing else. Dodge a lot of problems in that fashion. But we haven't reached that stage quite yet.

You can look back and see how terminology has jumped the rails in many a past time of rapid change. What's your field? Electronics? In times past your field was an expanse of agricultural land newly bounded in by fencing, where once the land was open and unfettered for all the people. That was a terrible time of change, particularly in England, and it wasn't that far back. Queen Elizabeth knew all about it. Revolution was in the air and there was violence everywhere, as the fences went up. No wonder that, in changed circumstances, "field" is still a very strong term today and the skirmishes around the fences still are plenty sharp. Right? You can even apply this to a magnetic field, which is by definition a matter of force, within an area yet extending its influence outwards

If you think I am straying from the point, you are quite right; it is deliberate. If we ourselves are thrashing about from hither to yon trying to decide what will be the big thing this year and next and what shall we call it—then I figure my writing should accurately reflect that situation. A kind of internal drama, like the "smellies" we often hear about (but never smell) or the earthquake movie. These approaches are not too farfetched. Awhile back I got a fancy catalog of roses from a nursery; it took me quite awhile to realize that the faint scent of roses I kept noticing came from the paper.

So the thing that we must understand about softgear is its extraordinarily precise demands on us, the incredible exactitude with which it must be shaped and honed to fit its own hardware, if we are to profit by both.

Every tiny change in hardware, in its shape, its parameters, the specs of its performance, its means of distribution, above all the way it operates in use,

"In times of change, terminology just bogs down, or boggles the mind. So, *softgear*—which at least sets us apart from the computer world."

directly affects the softgear that will make it go in the marketplace and in the, er, home, such as home is. It's like the environment. You kill off some itty-bitty fish in a little old stream and next thing you know the lions and tigers in Africa are dying and the dinosaurs are back. We *all* should be worrying about softw—whoops, I mean softgear—even more than the environmentalists, because this is our environment, it is what counts.

And yet—what do we see? Compatibility is the name of our wishful thinking! What do you do when you finally develop a videocassette, that is, a means for recording and reproducing signals in the video medium? You just handily turn over your old stocks of entertainment, which will do just fine. What happens when a compact digital audio disc comes along? Why what else—transfer the old recordings straight to the new medium and the problem is no more. Compatibility, you bet. But viability? Does anyone truly know—yet?

Strange—so strange—that whereas the audio disc has been a solid and at times brilliant success for almost a hundred years, the videodisc, its precise counterpart and with immense advantages technically, and admirable features (build a home library of entertainment, great classics, etc. at your finger tips . . .), is oddly sluggish and doesn't seem to want to get started in any big way. While at the same time people keep right on buying that alternative video product, the VCR, because it works and has found its place—unforeseen as that may have been, at the beginning.

I've always suspected that, like the audio cassette (a late but great starter), the videocassette was a lucky strike, even if Sony, that clever outfit, may have had some sneaky and very correct ideas as to what it might do best, back some 10 years ago. You remember? The vast "TV cartridge" marathon involved six or seven revolutionary and wholly incompatible systems, so great did the potential seem to be at that time—and every one died a ghastly corporate death, to the tune of literally billions in losses, except the relatively old-fashioned tape videocassette, an adaptation of professional video recording already in existence,

Revox B791

The Straight Line on Precision Engineering

First, a few words about our straight line tracking system – Linatrack®. Under the guidance of a sensitive infrared-interrupt servo circuit, Linatrack® guides the ultra-short (1¾" long) low mass tonearm straight across the radius of the disc, thus eliminating tracking error. Linatrack® mounts most popular cartridges, and the entire tonearm module swings aside for quick record changing.

Next, the heart of the B791: precision engineering. A quartz-regulated Hall-effect direct-drive motor assures absolute speed stability with no cogging effects. Even the vari-speed is quartz-locked, with an LED display to show the nominal speed and exact percentage of deviation.



The Revox B791 is solid, substantial, and meticulously assembled. It is designed for maximum user convenience, sonic accuracy, and exceptional longevity. It is not inexpensive.

That's the straight line. Hear the full sound of your nearest Revox dealer.

STUDER REVOX

1425 Elm Hill Pike, Nashville, TN 37210 / (615) 254-5651

Enter No. 24 on Reader Service Card

FREE

McIntosh

STEREO CATALOG and FM DIRECTORY

Get all the newest and latest information on the new McIntosh stereo equipment in the McIntosh catalog. In addition you will receive an FM station directory that covers all of North America.

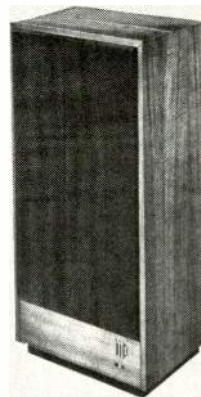
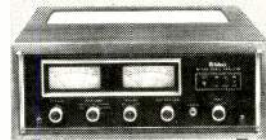
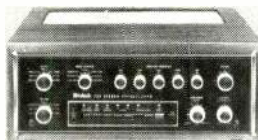

SEND TODAY!

McIntosh Laboratory Inc.
East Side Station P.O. Box 96
Binghamton, N.Y. 13904-0096

A

NAME _____

ADDRESS _____

CITY _____ STATE _____ ZIP _____

If you are in a hurry for your catalog please send the coupon to McIntosh. For non rush service send the Reader Service Card to the magazine.

Enter No. 40 on Reader Service Card

"Every tiny change in hardware, in its shape, its parameters, etc. directly affects the softgear that will make it go in the marketplace."

the least revolutionary of all the systems and, you might say, the tamest. Of course! It took off because suddenly there was an absolutely unforeseen area of *softgear* that the others hadn't thought about. You recorded right off your TV, and you didn't do it to build up a grrreat classic library but mainly so

you could look at it later on and erase it when you felt like something else. If I dare say so, even CBS didn't think of *that*, with its admirable EVR video system, which could not record.

What we must do with our new hardware, our new systems, is to probe and feel and experiment, gingerly, careful-

ly, until we begin to sense an area for softgear breakthrough. If we have any sense, that is how we go at it. Compatibility—just use the old softgear all over again? That is merely a temporary little bridge, useful for a time, which gives us leeway to work on the far side—like those wooden planks and ramps they put down for pedestrians when a new building is going up. Yes, you can throw in all the old (and new) softgear you have on hand, compatibly, and for awhile everybody is happy. But not for long. *Never* for very long.

If you do not find the key to the new softgear demands, and satisfy those changed demands, you are a dead duck. Speaking of ducks, it is like closing your eyes and shooting a shotgun blast in the general direction of a flock of those birds. You are bound to hit at least a few, though which ones you cannot know—and, just maybe, one of these will turn out to be the duck that lays the golden egg.

Indeed, the contours of a successful softgear are astonishingly subtle, and it is agony to look ahead and try to see their future shape. Practically nobody ever does. Most success is accidental—with a few remarkable exceptions and those almost always on the artistic side. Those early film producers and actors, for instance, who understood the power of the silent film and the means whereby it could convey sense even without sound. And again some of the same—Buster Keaton, Harold Lloyd, Chaplin—who sensed further that this medium needed longer films, not only funnier but deeper, more involving. Can you credit this to engineering or to business? It was the non-technical minds who saw ahead, though they were intimate with the hardware aspect, knew exactly what it could do and, more important, what it might do.

The true engineers make these things possible and they work towards still better hardware in the indicated directions. But, after all, Edison invented only a dictating machine, not a phonograph. And a moving picture, not a film. It is the softgear, every time, that does it. Right now, I can't see we're thinking beyond the compatible bridge in any of our directions.

Well, give us time. Long rows to hoe in a very big field. 

A LASER MONITOR FOR THE PRIVILEGED FEW.

The new Celestion SL-6 is like no other loudspeaker in the world.

Designed with a laser, a computer and a blank sheet of paper by a new generation of engineering talent, it began with something never seen before. The microscopic vibrations of drivers in action, frozen in time. Scanned and plotted in exquisite three-dimensional detail by the laser-computer system we call ULTRA.TM*

With the knowledge ULTRA gave us, we could discard the misconceptions and guesswork of conventional speaker design. The results: Two radically different transducers with precise, perfect-piston response. A crossover network of unique simplicity, because the drivers are so perfectly matched. And an enclosure of incredible rigidity.

What's more, the SL-6 is the first compact loudspeaker of studio monitor quality. Smaller than many "bookshelf" units.

Conventional driver

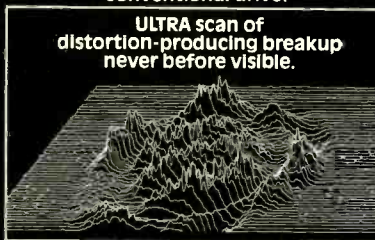

© 1982 Celestion Industries, Inc.

yet effortlessly handling up to 200 watts per channel.

There is much more to tell. But the most eloquent way to hear it is musically, from the SL-6 itself.

SL-6 driver

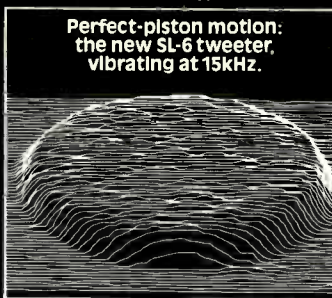

But first, a word of caution: only a limited number are planned for production. Which means its pleasures are limited to a privileged few. That select group of music lovers with the sensory and, yes, the financial resources to appreciate it. If the idea of being among them intrigues you, write or call for more information.

*Ultra-accurate Laser Topographic Response Analysis.



celestion  speakers

AND PROFESSIONAL DRIVERS.

You'll know...in an instant

Celestion Industries, Inc., Kuniholm Drive, Box 521, Holliston, MA 01746 (617) 429-6706. In Canada, Rocelco, Toronto

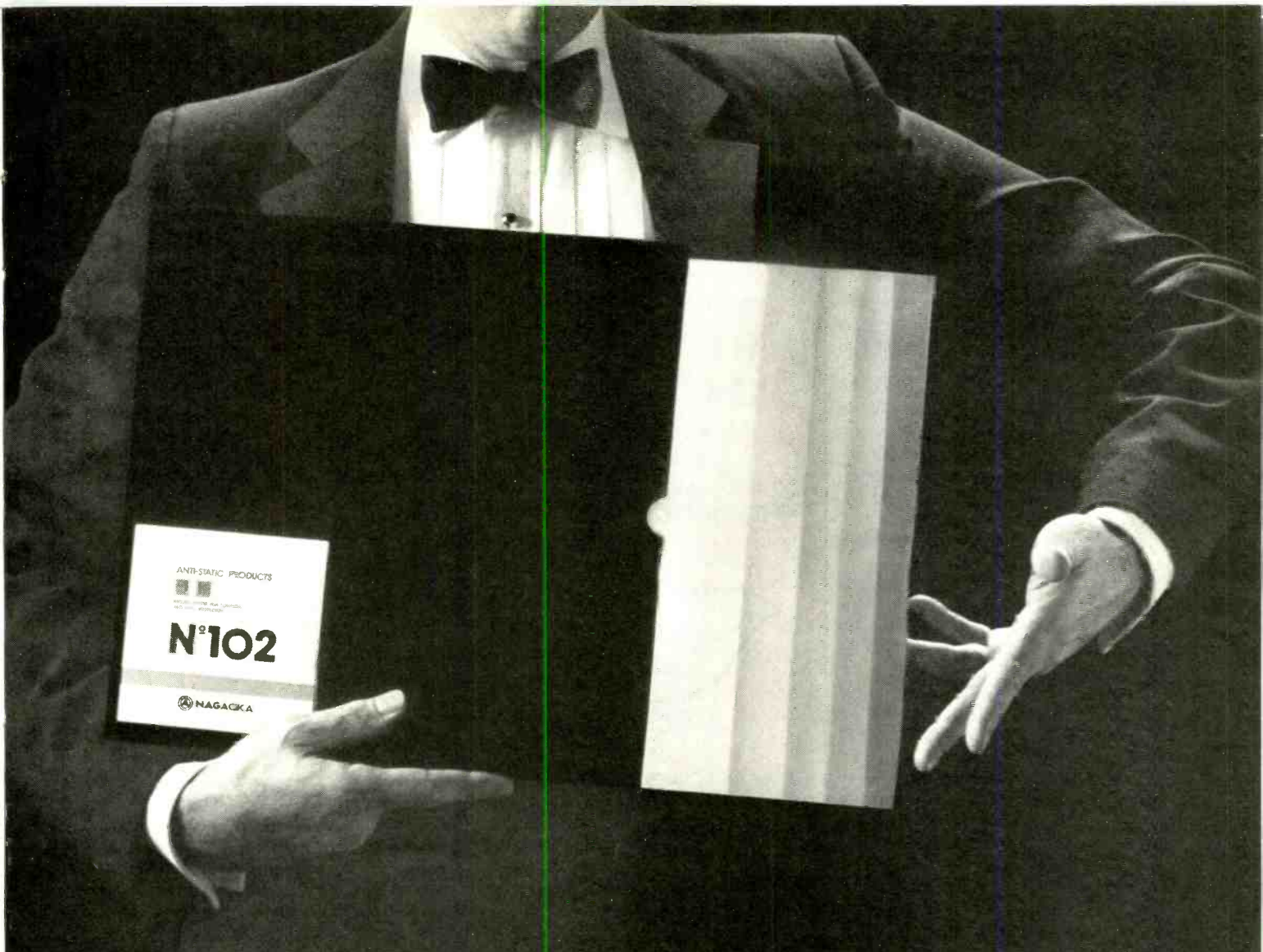

NOTHING UP OUR SLEEVES.

**NO DIRT.
NO LINT.
NO TEARING.
NO SCRATCHING.
NOTHING.**

Serious record collectors know that the inner sleeves provided with most records often do damage rather than offer protection. They disintegrate over time, generating and depositing lint on record surfaces. They create static, which causes "clicks and pops" in addition to attracting dust like a magnet.

In short, paper inner sleeves are good for one thing—throwing away.

Nagaoka No. 102 Anti-static Record Sleeves are the sure way to keep your records mint. Each sleeve is subjected to a special static prevention process and therefore is not susceptible to the generation of static electricity created by the friction between the record and the sleeve itself.

Nagaoka Anti-static Record Sleeves will not deteriorate over time and therefore cannot scratch valuable records with self-generated dust.

Nagaoka Anti-static Record Sleeves are designed to last for the life of your records—a life which will be greatly extended through their use.

Japan leads the world in the production of Hi-Fi equipment. Nagaoka leads Japan in the production of accessories.

How will Nagaoka fare in the United States? One thing's for sure: we're not starting from scratch.



NAGAOKA

Take Care.

Cover Competition

Dear Editor:

Couldn't help but notice your March 1983 cover reference to the NAD 4150 tuner, "Better Than Carver's?"

Well, I'm happy that you hold my tuner as the benchmark, worldwide gold standard of tuners against which all others are judged, but also couldn't help but notice that the cover question went unanswered inside the magazine. I've had lots of phone calls about this. So, to help me and to serve the readers of *Audio*, let's take a look.

Len Feldman tested both tuners and measured the data as reported in *Audio*. The data presented in the accompanying chart includes everything that was reported for both tuners.

Inspection of Len Feldman's test results shows that the Carver TX-11 is better (with eight wins, four losses, and two ties) than the NAD 4150 (with four wins, eight losses, and two ties).

But the reality is that my chart of Len's numbers proves only one thing: Both tuners are state-of-the-art. Except for one very important exception—the single reason that I invented my special circuits. And that reason is related to only a single number. Look at the 50 dB stereo quieting sensitivity: NAD, 25.0 μV versus Carver, 6.9 μV . It is this number that defines, more than any other, what my tuner is all about.

Inspect Len Feldman's quieting and distortion graphs for the NAD 4150 (from the March 1983 issue) against those for the Carver TX-11 (December 1982 issue). They are virtually identical, i.e., they are both superb. But wait! As soon as one pushes, in Len Feld-

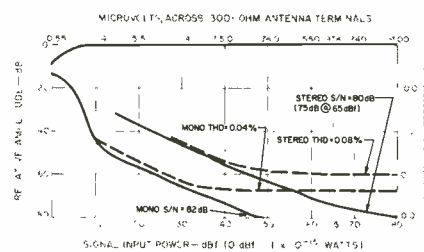

NAD 4150 tuner, FM mono and stereo quieting and distortion characteristics.

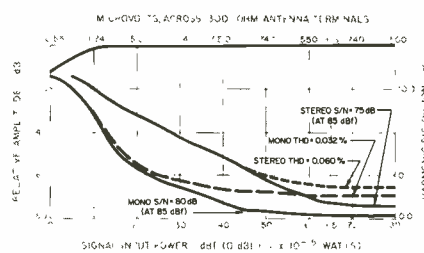

Carver TX-11 tuner, FM mono and stereo quieting and distortion characteristics, wide-band mode, without use of special circuits.

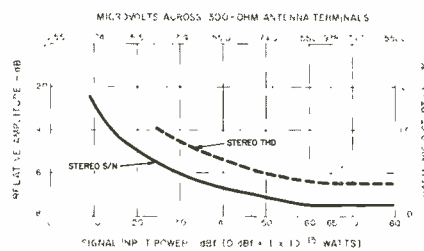

Carver TX-11, stereo quieting and distortion, wide-band mode, with noise- and multipath-reduction circuits activated.

man's words, "those two magic buttons" on my tuner, an amazing thing happens! Next look at Len's quieting and distortion curves for the TX-11 with the magic buttons pushed in. The noise dropped 20 dB at 25 dB! That's 10 times less noise! And 10 times more station pulling power. And five times less multipath-induced interference.

That's what my tuner is all about. No other tuner in the whole wide world even comes close.

In closing, I wish to compliment Larry Shutz, a very talented and disciplined designer, for his excellent work on the NAD tuner—and for that, my sincerest admiration.

Bob Carver
President, Carver Corp.
Woodinville, Wash.

Satellite to Audio

Dear Editor:

Thank you for the article "WFMT: Satellite Superstation" which appeared in your February 1983 issue. It made very interesting reading for those of us who are involved in satellite audio.

One correction I would like to make concerns the list of other satellite audio services which are piggybacked with WGN-TV. While it is true that the Moody Bible Institute of Chicago operates an audio service by this means, it is not radio station WMBI-FM, but rather the Moody Broadcasting Network (MBN) which is distributed via satellite to affiliate radio stations and cable systems. MBN is a long-form, national program service which can be segmented for local radio service use. There is no reference to local news, weather, etc. on MBN.

Wayne Shepherd
Satellite Program Manager
Moody Broadcasting Network
Chicago, Ill.

Will the Real Superstation Please Stand Up?

Dear Editor:

I wish to bring to your attention two minor errors in a basically excellent article regarding WFMT in your February 1983 issue.

The first error is listing KTVU in Oakland as being the third superstation carried via satellite. While it's true that KTVU had been called a superstation, it has not been on satellite for over a

Specification

	NAD 4150		Carver TX-11	
Fifty-dB Quieting, Stereo	25 μV		6.89 μV	BEST
Sensitivity, Mono	1.2 μV	BEST	2.05 μV	
S/N, Mono	82 dB	BEST	80 dB	
S/N, Stereo	75 dB		75 dB	TIE
THD, 1 kHz, Mono	0.04%		0.032%	BEST
THD, 1 kHz, Stereo	0.08%		0.06%	BEST
Frequency Response Deviation	-0.1 dB	BEST	-2 dB	
Separation at 65 dB				
Mid-Band	51 dB		52 dB	BEST
Extremes	49 dB	BEST	42 dB	
19- & 38-kHz Rejection	71 dB		>75 dB	BEST
Selectivity	79 dB		88 dB	BEST
AM Rejection	70 dB		≥ 100 dB	BEST
Spurious, I.f., Image Rejection	≥ 100 dB		≥ 100 dB	TIE
Capture Ratio	1.5 dB		1.0 dB	BEST

Will KEF's new Standard Series Loudspeakers meet the standards of the British Hi-Fi reviewers?

Here's what the British Hi-Fi press said about the original Standard Series:

CARLTON

"As we have come to expect from KEF, the construction and finish are exemplary."

"...very precise and detailed... quite good depth discrimination."

"...output well in excess of what people would tolerate in their home."

"This well made and most reasonably priced loudspeaker offers very good performance, with minimal coloration, good efficiency and excellent power handling. Clearly, it earns a definite recommendation."

*HI-FI NEWS & RECORD REVIEW
1982*

"Sensitivity noticeably above average... bass performance easily the best we have heard from the models in this group (Standard Series)... well worth auditioning as a possible upgrade investment for a medium-priced audio system."

*GRAMOPHONE
November, 1981*

CODA

"It looks like you're getting a lot for your money, and looks don't deceive in this case."

"The Coda is very, very good. Far better in fact than its price tag would suggest."

"...a very solid and life-like representation of the signal it's presented with."

"The Coda is a remarkably articulate, musical loudspeaker. Developed and

musically refined far beyond its price level, it can only be strongly recommended."

*PRACTICAL HI-FI
January, 1982*

"The Coda has a very good performance, which many vastly more expensive speakers might envy."

*HI-FI NEWS & RECORD REVIEW
December, 1982*

"...a good match for any domestic amplifier at this budget end of the market; a very pleasing design which looks like a genuine bargain."

*GRAMOPHONE
November, 1982*

Hear the new, significantly improved Standard Series today at your KEF dealer and judge for yourself.



KEF
The Speaker Engineers

For people with higher standards.

KEF, 425 Sherman Avenue, Palo Alto, California 94306

Enter No. 38 on Reader Service Card

Where to reserve seventh row, center. Forever.

year. Actually, the third superstation is WOR-TV from New York City.

The second error concerns the number of transponders the author states are in the Satcom satellites. The correct figure is 24, not 12. The original Western Union (Westar) satellites had only 12, and RCA does designate their transponders as broadcasting 12 vertical and 12 horizontal modes—but the series of RCA Satcom satellites have had and will have 24 transponders.

Melvyn E. Shlank
Orange, Conn.

Igor, Come Here!

Dear Editor:

In these uncertain times, when standards have come to mean so little and brand names have come to stand only for high prices, not quality, it has been comforting to know that one man and one line of components have made a stand for quality and fidelity, much as a beacon of light cuts through the darkness. Yes! Professor I. Lirpa has shown us the way. But if *Audio* is not to cover the achievements of this inventive genius, then surely all is lost. For years I have counted on *Audio*'s coverage of Prof. Lirpa's unique and unsurpassed equipment. His shower microphone has proved to give the cleanest sound available. Lirpa's 5-kg tonearm has been shown to be the undisputed master of the warped disc, and any other disc with which it should happen to come in contact. How can *Audio* call itself the authoritative publication while leaving out the one man and one line of components worthy of our continued admiration? The world will little note nor long remember what *Audio* says, but the words and deeds of Prof. Lirpa will live forever, or at least until tax time, whichever comes first. Bring back Prof. Lirpa! Such remarkable genius as his must not be hidden in some small, not quite inconspicuous classified ad (April 1982, pg. 76). Return him to his rightful full-page editorial glory, where he and his talents can be exposed for what they truly are.

Ms. April Fieldsday
Miami, Fla.

Editor's Note: Lirpa has not lapsed. The Professor spent considerable time developing the ultimate one-brand system, which was subject to our careful scrutiny in the April issue.—E.P.

- ARIZONA
Audio Emporium—Tucson
HiFi Sales Company—Mesa
- ARKANSAS
Walloch's—Little Rock
- CALIFORNIA
Audio Services—North Hollywood
Eber Electronics—San Francisco
House of Music—San Francisco
Pacific Stereo—Los Angeles
Pacific Stereo—San Diego
Pacific Stereo—Berkeley
Paris Audio—Santa Monica
Roger Sound Labs—Van Nuys
Sherman Oaks Camera—
Sherman Oaks
The Good Guys—San Francisco
Tokyo Electronics—San Francisco
- CONNECTICUT
Take Five Audio—New Haven
- COLORADO
Listen Up—Denver
- FLORIDA
Hoyt HiFi—Jacksonville
Marc's Electronics—Melbourne
Sound Advice—Miami
Sound Components—Coral Gables
- GEORGIA
Back Door Stereo—Atlanta
- ILLINOIS
Audio Dimensions—Moline
Audio Enterprises—Chicago Heights
Good Vibes Sound—Champaign
Mills Recording—Chicago
Pacific Stereo—Chicago
Paul Heath Audio—Chicago
Stereo Systems—Aurora
United Audio—Chicago
- IOWA
The Audio Room—Cedar Rapids
- KANSAS
Red Baron's Entertainment
Center—Wichita
- KENTUCKY
Stereo Shoppe—Lexington
- LOUISIANA
Alterman Audio—New Orleans
- MAINE
New England Music—Portland
- MARYLAND
Audio Buys—Gaithersburg
Gramophone Ltd.—Baltimore
High Fidelity Center—Baltimore
Professional Products—Bethesda
- MASSACHUSETTS
Audio Studio Stereo Lab—Brookline
HiFi Listening Shop—Marlboro
Q Audio—Cambridge
Sound & Music—Northampton
- MICHIGAN
Peerless Electronics—Detroit
Stereo Shoppe—Lansing
- MINNESOTA
Sound Center—Minneapolis
- MISSOURI
Sound Enterprise Stereo—
Kansas City
- MONTANA
Rocky Mountain HiFi—Great Falls
- NEBRASKA
Stereo West—Omaha
- NEVADA
Q Audio—Reno
The Upper Ear—Las Vegas
- NEW JERSEY
The Audio Lab—New Brunswick
- NEW YORK
Charos Custom Sound—Southampton
Gordon Electronics—Syracuse
Grand Central Radio—NYC
Lyric HiFi—NYC/White Plains
Park Avenue Audio—NYC
Sound Chamber—Rochester
Stereo Chamber—Buffalo
- NORTH CAROLINA
Sound Ideas—Raleigh
- OHIO
Golden Gramophone—Akron
Phil Reddish Audio—Cleveland
Stereo Lab—Cincinnati/Columbus
- OKLAHOMA
The Turntable—Enid
- OREGON
Chelsea Audio—Beaverton
Fred's Sound of Music—Gresham
- PENNSYLVANIA
Chestnut Hill Audio—Philadelphia
D.S. Audio—West Reading
Opus One—Pittsburgh
Sassafras Audio—Montgomeryville
Stereo Barn—Ephrata
The Sound Store—Pittsburgh
- SOUTH CAROLINA
Read Brothers—Charleston
- TENNESSEE
Audio Systems—Nashville
Sound Concepts—Johnson City
- TEXAS
Electronic Service Center—Odessa
Marvin's Electronics—Ft. Worth
Pacific Stereo—Dallas
Pacific Stereo—Houston
Recorder Center—Dallas
Sheffield Audio—Houston
Sound Climax—Dallas
Stereo International—San Antonio
- UTAH
HiFi Shop—Ogden
Standard Audio—Salt Lake City
- VIRGINIA
Audio Center—Roanoke
Sound World—Virginia Beach
- WASHINGTON
Magnolia HiFi—Seattle
Pacific Stereo—Seattle
- WEST VIRGINIA
Sound Investments—Morgantown
- WISCONSIN
American TV—Madison
Sound Stage—Milwaukee
Specialized Sound System—Madison

SONY
THE ONE AND ONLY.

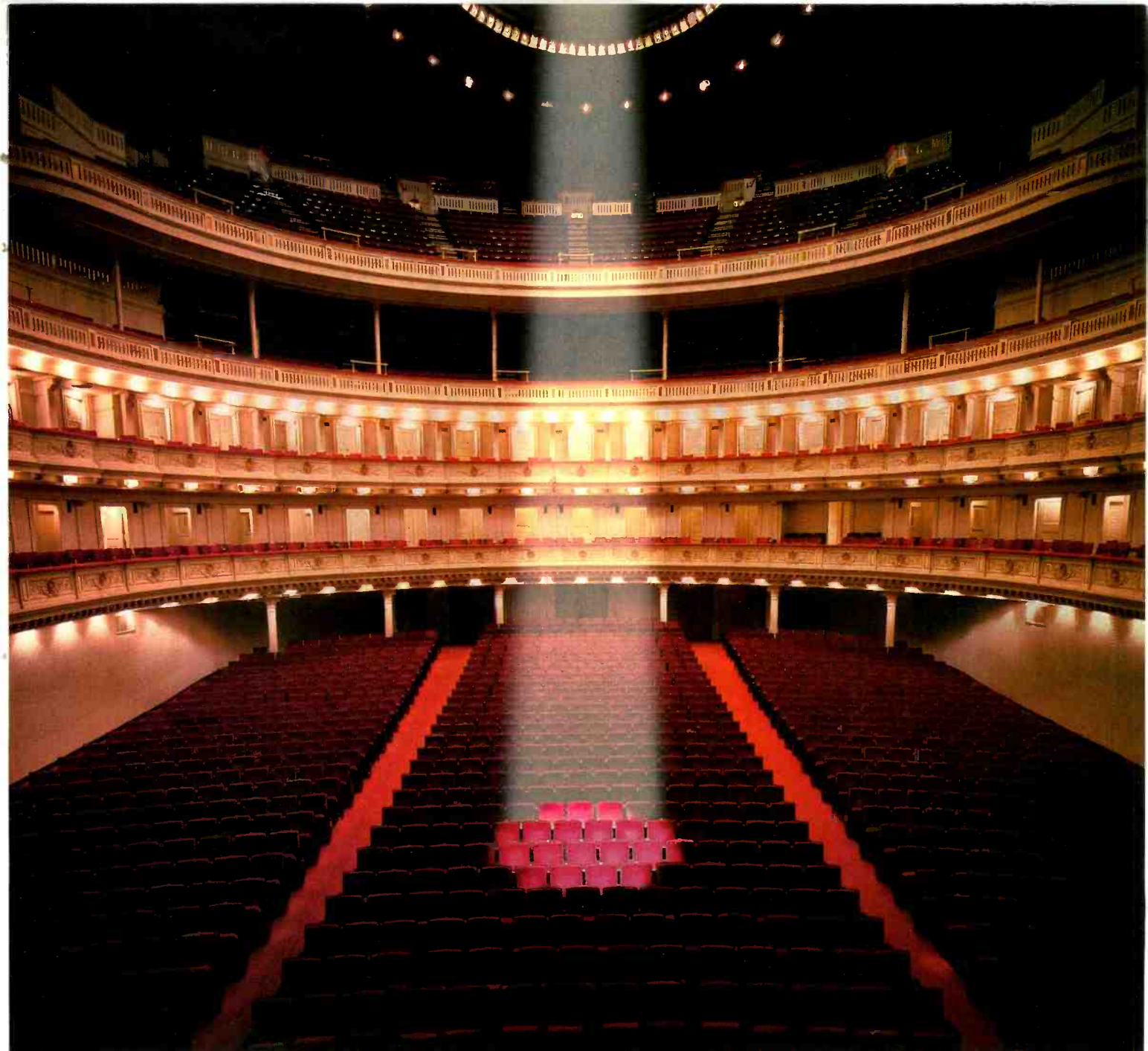

Sony creates seventh row, center. Forever.

INTRODUCING THE SONY COMPACT DISC PLAYER

The inventor of digital audio processing is pleased to raise the curtain on the CDP-101. Hailed by the discriminating ears at *High Fidelity* as "the most fundamental change in audio technology in more than eighty years."

There are compelling reasons for such applause.

The CDP-101, based on the world's first compact disc system co-developed by Sony and Philips of Holland, offers concert-hall freedom from distortion, wow, flutter, and other sonic gremlins. Plus an awesome dynamic range exceeding 90dB. To bring you the full

beauty of Mahler or the Moody Blues as never before.

This highest of fidelity remains faithful, too. Because the digital discs are read by laser beam, there's none of the physical wear inevitable with tape or vinyl. While the CDP-101 ingeniously ignores scratches, dust, and fingerprints.

Equally ingenious, an infrared remote control even lets you select tracks without budging from your armchair. Yet for all its sophistication, the CDP-101 is thoroughly compatible with whatever sound system you now own.

We suggest you hear the CDP-101

soon. For a sound you can't believe, from the audio innovator you assuredly can.

SONY
THE ONE AND ONLY.



You Don't Become A Digital Audio Expert Overnight.

Most of the companies now introducing digital audio players were just recently introduced to digital audio themselves.

Such is not the case with Mitsubishi. We've been at the leading edge of digital

audio research since the early 70's, when our involvement in satellite communication equipment and computers showed that pulse-coded modulation would bring about a revolution in recorded music.

1972 Mitsubishi begins pioneering research in digital audio recording, culminating in this, our latest 32-channel professional recorder.

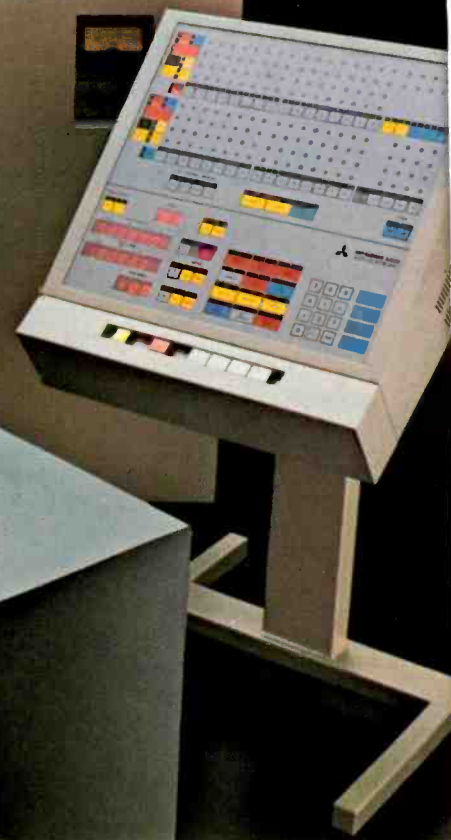

1983 Mitsubishi introduces its digital audio player for the consumer.

Our technological focus back then was on professional recorders, which could immediately apply the superiority of digital sound to the recording of conventional analog records.

The 32-channel X-800 model shown (rear) is the most sophisticated audio recorder ever engineered. Taking over where the last generation of analog recorders left off.

And now the digital sound revolution has come full circle, from our pioneering work in digital tape recording to our new digital disc player. Taking over where the last generation of analog record players left off.

INTRODUCING THE MITSUBISHI DIGITAL AUDIO DISC PLAYER.

Analog record players attempt, with varying success, to play back a mechanical, physical likeness of the music's continuously changing waveforms in grooves on the record.

The Mitsubishi DP-101 digital disc player does the infinitely more exacting job of reading music that has been digitally encoded in microscopic "pits" on a Compact Disc.

The code represents over 44,000 measurements a second of the musical waveforms. The pits, and their dimensions, represent the digital data.

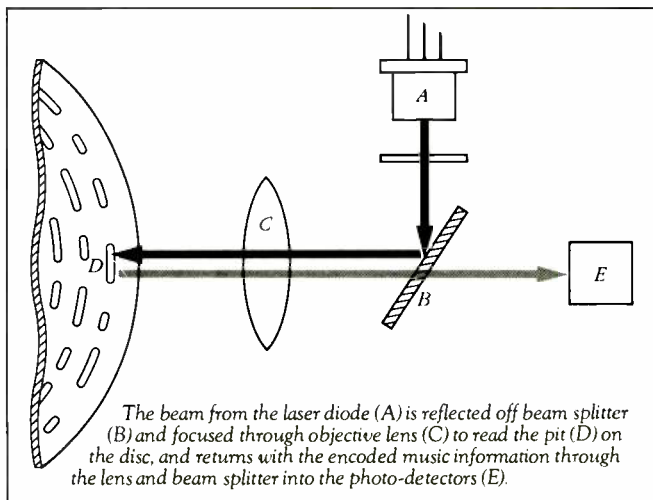

The music encoded in the pits is read, not by a mechanical stylus, but by a laser beam. This allows for a reproduction accuracy that the stylus, restricted by the laws of physics, can't match.

It's this esoteric laser technology that is the

heart of the system, and Mitsubishi's long experience in semiconductor lasers for fiber-optical communications enables us to maximize performance of this key element to our own rigorous standards.

HEAR NOTHING. AND EVERYTHING.

Nothing bad. No noise, no wow, no flutter, no rumble. No pops, clicks or surface noise.

Everything good. From complete silence, the music emerges in its full power and range, every detail etched in great relief. Music utterly uncompromised by the undesirable.

Nothing ever sounded so good before.

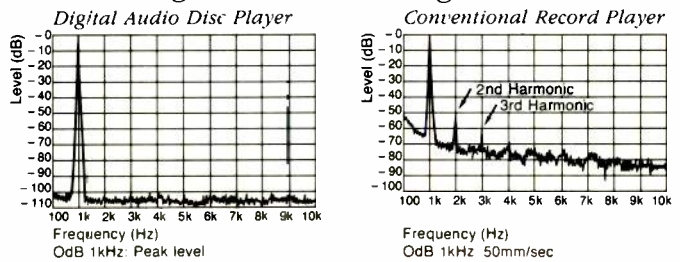

Better sound is easy to see.

As if to validate the evidence of your ears, the specs are spectacular.

Distortion, as shown, 0.008% (compared to analog's 0.5 to 1.5%). Dynamic range, 90 dB (compared to 60-70 dB). Channel separation 80 to 90 dB (clearly separate from analog's 20-50). And an exquisitely flat frequency response within 0.5 dB from 2Hz to 20kHz.

Yet this astonishingly complex machine is easier to operate than an audio tape cassette player.

It features a full-function remote control unit. And extensive programming controls enable you to play any part of the disc, in any sequence you choose. No other digital player we know of can offer you more flexibility.

Nor can they offer you the unique feature located just below those programming controls. One that insures the excellence of all that lies within.

It's stamped into the metal.

The name Mitsubishi.

MITSUBISHI

Even If You Can't Have The Best Of Everything,
You Can Have The Best Of Something.

Mitsubishi Electric Sales America, Incorporated, 3030 Victoria Street, Rancho Dominguez California 90221. Specifications are subject to change without notice.

BATTLE OF THE AMPS

by LEONARD FELDMAN
Photograph by ROBERT LEWIS

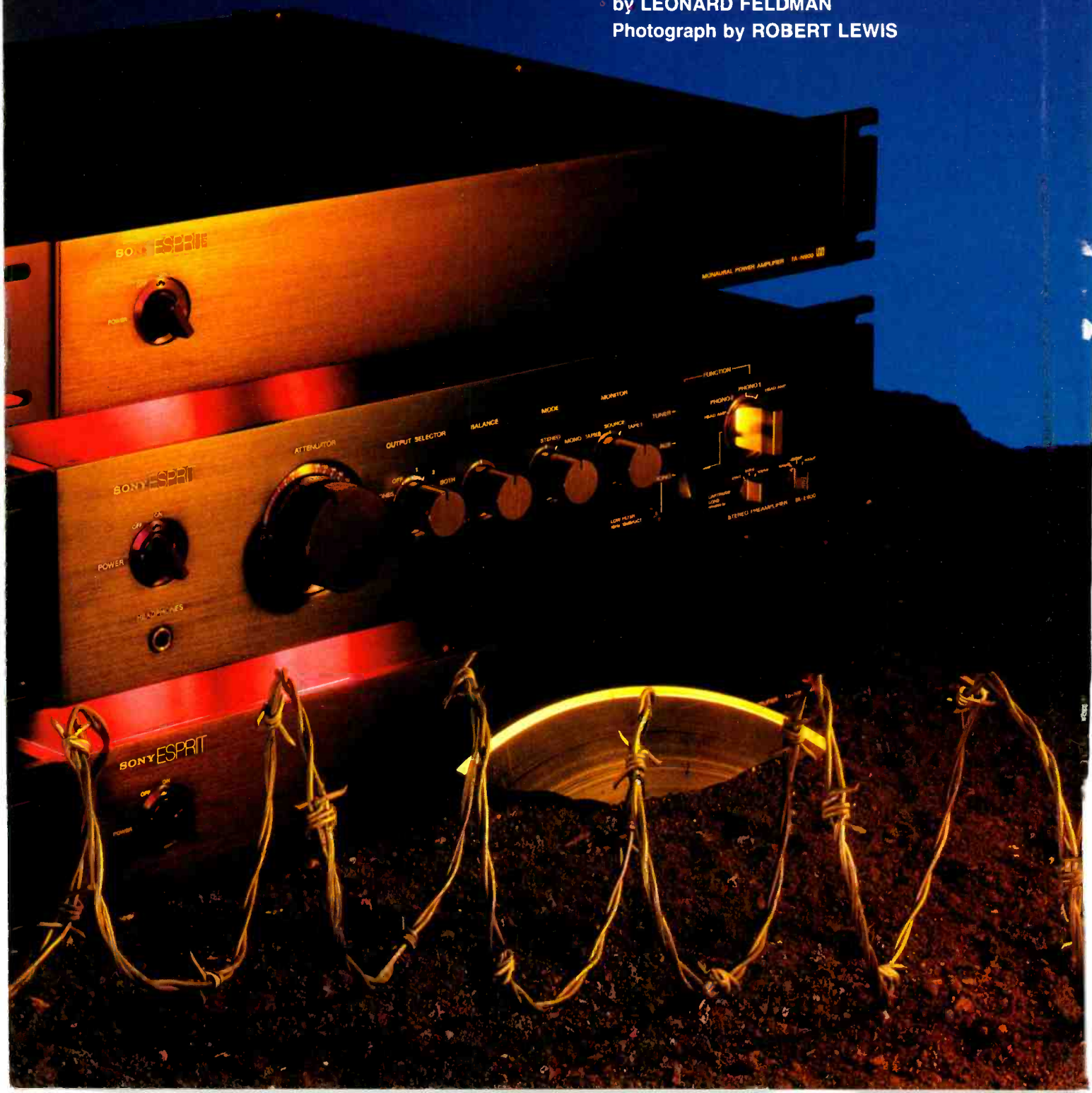

High-end audio holds a very special place in Japan and constitutes a larger percentage of the market than it does in this country. While some U.S.-made gear is very hot there, Japanese manufacturers often consider this area to be one where their prestige is at stake. A fair amount of this Japanese-produced high-end gear never makes it to the States; when it does, many of these "all out" products reach substantially fewer dealers. It is also apparent that different design approaches are used

in these state-of-the-art attempts, for different and much less cost-effective features are often found in them. Indeed, such products are sometimes highly impractical for mass production since they embody design philosophies radically different from those found in mid-level gear. This is not merely because of combining sophisticated designs with relatively small sales. Why put 150 pounds of sand-casting and 20 coats of hand-rubbed lacquer into a turntable with a production run of 100?

The answer I've always received is, "That's what we thought was needed to make it correctly." Whatever your feelings about this approach to hi-fi manufacture, we think it deserves this closer look.—E.P.

Most large Japanese manufacturers of audio equipment have a few high-end, high-performance products which have been designed without regard to price or number of units that are expected to be sold. Call them "im-

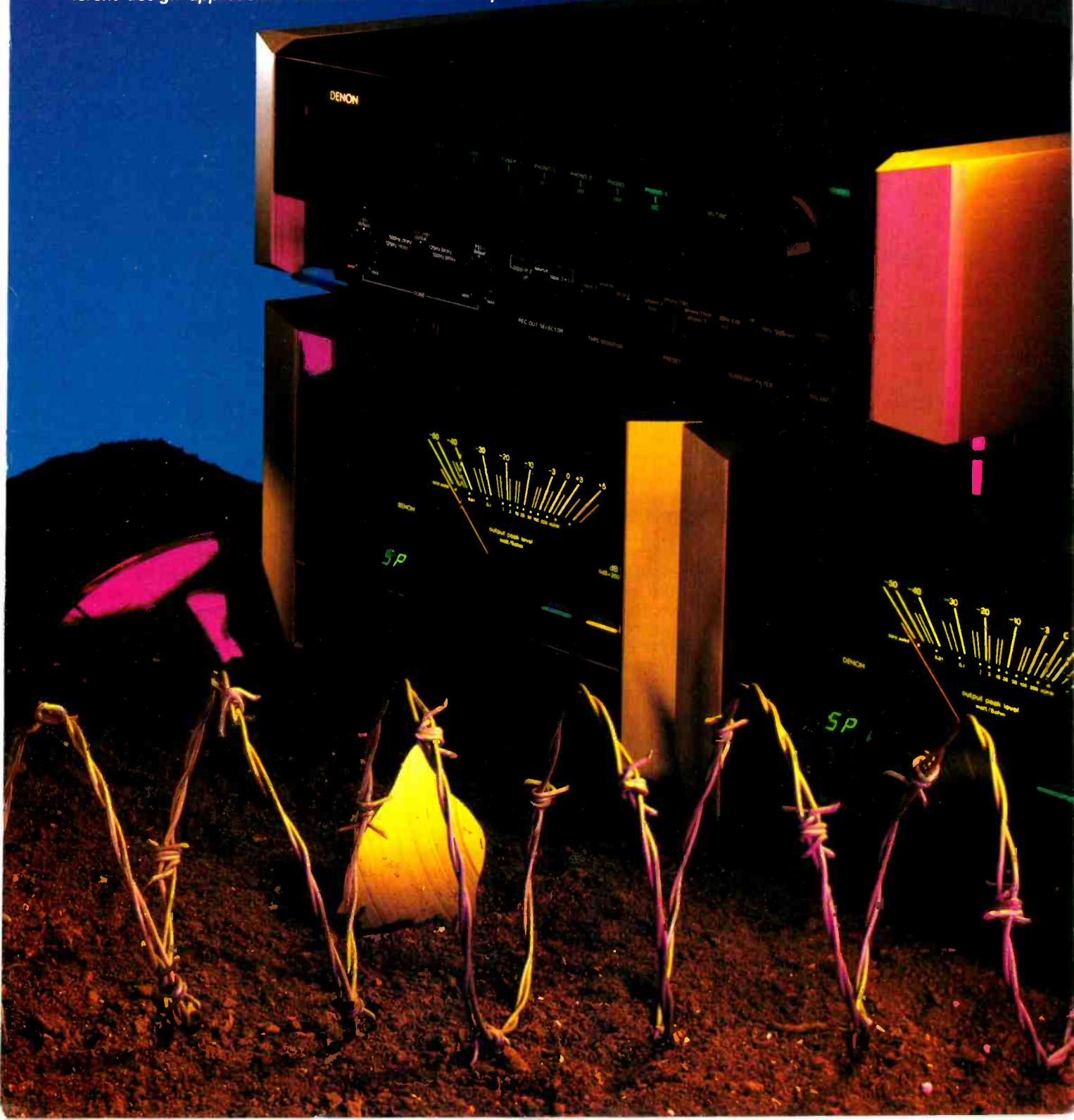

Sony's specs on THD and IM distortion are more conservative than Denon's, but both test much better than claims.

Photographs: CBS Studio



Denon PRA-6000 preamplifier and POA-8000 power amps

age builders," "showpieces" or whatever you like, these no-holds-barred products represent the closest thing to true state-of-the-art and perfection that the top engineers of these companies are able to create. Analogies with other categories of equipment (such as motor cars or sailboats) generally aren't applicable when it comes to these top-of-the-line audio products, although one statement often attributed to yacht and Rolls Royce salesmen does apply here, "If you have to ask how much it costs, you can't afford it!"

The Editor of *Audio* and I decided that it might be interesting (and a great deal of fun, besides) to pit one such top system against another; not so much for the purpose of coming up with a clear sonic "winner," but rather to present the points of view of two top design teams and to explore the differences in philosophy inherent in the designs of two obviously superior audio electronics systems. We chose for these comparisons Denon's top stereo preamplifier, Model PRA-6000, operating with a pair of Denon POA-8000 monaural power amplifiers as one of the systems. The other system consisted of a Sony TA-E900 stereo preamplifier and a pair of Sony TA-N900 monaural power amplifiers, all three of which are part of Sony's "Esprit" line of audio components.

Denon Preamplifier Layout

The PRA-6000 preamplifier/control unit's dark front panel is elegantly offset by a pair of gold-colored metal end blocks, tapered to form a pleasing frame for the unit. Only the most-often-used controls are normally visible and accessible. These include the power on/off switch, seven program selector pushbutton switches with indicator lights above them, a muting on/off switch, a master volume control, and a small pushbutton which releases a door on the lower portion of the panel, exposing the remaining controls. When this last button is pushed, the door not only opens, but slides under the chassis, out of view. Program sources activated by the pushbutton selectors include "Phono-1" (MC or MM), "Phono-2" (MM), "Phono-3" (MC), "Tuner," "DAD," and "AUX." The "DAD" input is designed for connection of a digital audio disc player and is able to handle the extremes of dynamic range inherent in that program source.

Secondary controls normally hidden by the lower door on the panel include a treble and bass control, a tone control turnover switch (which selects various turnover-frequency combinations of 125 and 500 Hz for bass and 2 and 8 kHz for treble), a record-out selector, a "Tape Monitor" switch, a "Preset" priority switch (needed, due to the

electronic input switching, to select which program source will switch in when power is first applied), a "Subsonic Filter" switch with settings for 16- or 20-Hz cutoff, and a channel "Balance" control. The "Rec Out" selector has settings for "Source," "Copy Tape-1 to 2" and "Copy Tape-2 to 1." When in the off position, the tape-out jacks are disconnected from the circuit completely, even if tape decks are plugged in. The "Tape Monitor" switch has settings for "Source," "Tape-1" or "Tape-2." It is interesting to note that while many high-end preamplifiers (including the Sony unit which will be described shortly) do not include tone controls of any sort, Denon has not only included bass and treble controls, but has incorporated a rather elaborate turnover control to go along with them.

The rear panel of the Denon PRA-6000 has the usual array of input and output jacks, two grounding terminals, and three switched and two unswitched a.c. outlets. Two sets of output jacks are wired in parallel, should you wish to feed signals to more than the usual pair of power amplifier channels. Of particular interest is a slide switch which converts the "Phono-1" inputs from MM to MC. With three separate sets of phono inputs, a user could conceivably hook up two MM cartridges plus an MC cartridge or two MC cartridges plus an MM pickup. All of this, of course, in addition to the connection facilities for a Compact Disc player.

Sony Preamplifier Layout

The Sony TA-E900 is configured for standard 19-inch rack mounting. Below its power on/off switch is a stereo headphone jack, allowing you to listen to program sources via headphones even if you don't own the companion power amplifiers and appropriate loudspeakers. A large, calibrated knob adjusts master volume of the system, and the "Output Selector" alongside selects headphone or either or both of the output pairs on the rear panel, or disables output altogether. This switch therefore enables you to feed either or both of two power amplifiers connected to the preamp. A stereo "Balance" control comes next, and to its right is a "Mode" switch with mono and stereo settings. A tape "Monitor" switch se-

lects "Source," "Tape 1" or "Tape 2." A "Low Filter" switch, operable only when in the "Phono" selection mode, is located near the two-part program-selection system. A three-position toggle switch selects "Phono," "AUX" or "Tuner." When this switch is in the "Phono" position, a secondary rotary switch is used to choose "Phono 1" or "Phono 2" inputs and to decide whether or not either of these inputs shall be routed through a pre-preamp for moving-coil signal amplification. Cartridge load resistance and capacitance for the "Phono 2" inputs can be varied (25/50/100 ohms or 100/200/400 pF) by two small switches at the lower right corner of the front panel.

Instead of the usual connection jacks on the rear panel, designers of the TA-E900 elected to have input and output jacks accessible from the preamp's top surface, so that the jacks mount directly to the epoxy-encapsulated p.c. board, eliminating internal signal cables. The jack panel surface is recessed below the top of the unit, so cables running out to the back are actually below the top surface, permitting you to mount another component above the preamp without crushing the cables. Two convenience a.c. outlets are found on the rear panel. Each of the outlets (switched and unswitched) is rated at 450 watts.

Denon Power Amplifier Layout

The Denon POA-8000 monaural amplifiers feature the same tapered, gold-color metal ends as the PRA-6000 preamplifier. The black front panel is dominated by a huge meter section, calibrated in dB and watts, with fast-acting meter movement displaying peak power levels. An LED illuminates when rated output is exceeded. Two additional indicator lights near the lower right of the panel illuminate when power is applied and when a subsonic filter switch (on the rear panel) is turned on. A speaker selector switch and a meter illumination on/off switch are also located in this region of the panel. A digital display located at the lower left, near the power switch, serves three purposes: It counts down after turn-on, from 7 to 1, after which muting is turned off and amplifier operation begins; it shows which speaker has been selected, and it displays various alpha-



Sony Esprit TA-E900 preamplifier



Sony TA-N900 power amps

numeric codes when trouble occurs in the amplifier (e.g., "E-3" means trouble in the main amplification circuit, "E-0" means temperature inside the unit is excessive, etc.).

Facilities on the rear panel include an input jack, an input level control, a subsonic filter on/off switch, a grounding terminal, and two pairs of speaker terminals. Covers or caps are provided for the speaker terminals after connections have been made, since the voltage corresponding to 320-watts output (the "music power" or "peak power" rating of this amplifier) is enough to give you a hefty electrical shock if you happen to touch the terminals while maximum power is being delivered.

Sony Power Amplifier Layout

The only control on the rack-mounted front panel of the Sony Esprit TA-N900 amplifier is a power on/off switch, augmented by a power-on indicator light. The rear panel is equipped with a ground terminal, two input terminals (one of which is for direct d.c. connection, while the other includes an isolating input coupling capacitor), a pair of loudspeaker terminals, and a loudspeaker impedance switch with settings for 2-, 4-, or 8/16-ohm speaker systems. A built-in cooling fan exhausts internally generated heat via a ventilation grid occupying about half the width of the TA-N900's rear panel.

While some will choose the Sony amps for their light weight and small size, some will prefer the look of the Denons.

MANUFACTURER'S SPECIFICATIONS

Specification	PREAMPLIFIERS	
	Denon PRA-6000	Sony TA-E900
Frequency Response		
MM Phono	RIAA, ± 0.2 dB	RIAA, ± 0.2 dB
MC Phono	RIAA, ± 0.2 dB	RIAA, ± 0.2 dB
High Level	2 Hz-300 kHz, ± 0.3 dB	0 Hz-300 kHz, +0, -1 dB
Phono Overload at 1 kHz,		
MM/MC	380 mV/19 mV	180 mV/15 mV
Harmonic Distortion	0.002% at 8-V out	0.005% at 8-V out
IM Distortion	0.002%	0.005%
Rated Output	1.5 V	1.5 V
Input Sensitivity		
Phono, MM/MC	2.5 mV/125 μ V	2.5 mV/200 or 35 μ V
High Level	150 mV	150 mV
S/N Ratio		
Phono, MM/MC	86 dB/76 dB	80 dB/70 dB (IHF)
High Level	100 dB	115 dB (IHF)
Low-Filter Response	16 Hz, 12 dB/oct.; 20 Hz, 6 dB/oct.	15 Hz, 12 dB/oct.
Tone Control Turnovers	2 kHz, 125 Hz/ 8 kHz, 125 Hz; 2 kHz, 500 Hz/ 8 kHz, 500 Hz	Not Applicable
Tone Control Range,		
20 Hz to 20 kHz	± 0.5 , ± 1.0 , ± 2.0 , ± 4.0 , ± 8.0 dB	Not Applicable
Power Consumption	90 watts	27 watts
Dimensions	18 in. W \times 5.25 in. H \times 15.4 in. D	19 in. W \times 4.25 in. H \times 18 in. D
Weight	31.5 lbs.	28.6 lbs.
Price	\$3,000.00	\$3,200.00

Preamplifier Circuit Highlights

The Denon PRA-6000 preamplifier employs non-negative feedback circuitry. Balanced circuitry with slew rates approaching 500 V/ μ S is used in all amplification stages. The equalizer/preamplifier section uses an RC load-impedance circuit of the current-amplification type, with no negative feedback. The MC pre-preamp has a non-negative feedback circuit with balanced power supplies. Switching from MM to MC (in the Phono 1 circuitry) is accomplished electronically.

The pre-preamplifier of the Sony TA-E900 employs a common-base, complementary push-pull amplifier in cascode connection. The equalizer, input buffer, and flat amplifiers which follow are made up of a bootstrapped cascode differential amplifier, a cascode differential amplifier, a cascode mirror-load circuit, and an output stage made up of a Darlington emitter-follower, single-ended push-pull circuit. The equalizer amplifier is of the non-feedback type. Two regulated power supplies are used for each channel.

Amplifier Circuit Highlights

The Denon POA-8000 is a Class-A monaural amp which does not use conventional negative feedback for distortion reduction. Instead of overall loop feedback, a distortion elimination circuit is built into each stage of the amplifier. The power stage is a three-level Darlington design which employs six series-connected high-speed transistors, each with a dissipation capacity of 150 watts. The p.c. board of the power transistor section is made of a glass-epoxy resin coated with oxygen-free copper, 150-microns thick. A toroidal power transformer is used in the highly stable power supply. A block diagram of the POA-8000's circuitry is reproduced in Fig. 1.

The Sony TA-N900 amplifier also operates in pure Class A. Pre-power stages consist of a bootstrapped, double-cascode, FET differential-input stage with current-mirror output; a bootstrapped cascode inverting amplifier, and an emitter-follower, single-ended push-pull driver stage. Double-diffused power MOS-FETs are used in the power output stage. A distortion reduction circuit operates by controlling gate bias in order to improve pow-

Specification	POWER AMPLIFIERS	
	Denon POA-8000	Sony TA-N900
Rated Output, 8 ohms,		
20 Hz to 20 kHz	200 watts	200 watts
Rated Harmonic Distortion	0.003%	0.05%
SMPTE-IM Distortion	0.003%	0.05% (4 ohms, 0.1%)
Input Sensitivity for Rated Output	1 V (8 ohms)	1.7 V (4 ohms, 1.2 V)
Damping Factor, 8 ohms	80	50
Frequency Response	1 Hz-200 kHz, +0, -1.0 dB	0 Hz-100 kHz, +0, -3 dB
S/N Ratio	120 dB (A-weighted)	110 dB (IHF)
Subsonic Filter	16 Hz, 6 dB/oct.	Not Applicable
Slew Rate	± 380 V/ μ S	150 V/ μ S
Power Consumption		
Idling	160 watts	175 watts
Maximum	820 watts	Not Available
Dimensions	12.2 in. W \times 7.4 in. H \times 18.2 in. D	18 $\frac{7}{8}$ in. W \times 3 $\frac{1}{8}$ in. H \times 17 $\frac{1}{8}$ in. D
Weight	48.4 lbs.	23.13 lbs.
Price per Channel	\$2,600.00	\$1,750.00

Company Addresses: Denon, 27 Law Dr., Fairfield, N.J. 07006. For literature, circle No. 99. Sony Esprit, Sony Dr., Park Ridge, N.J. 07656. For literature, circle No. 100.

er stage linearity. A high-efficiency cooling system accounts for the relatively compact size of the TA-N900. It consists of a heat pipe, heat-sinks, and a crossflow fan driven by an extremely quiet linear-torque brushless and slotless motor—the same type as that used in Sony turntables and tape decks. The system draws in cooling air from the bottom of the amplifier, exhausting it from the rear via a ventilation grid. The power stage uses no negative feedback loops and is a pure-complementary, single-ended push-pull output operated in Class A. A "pulse-locked" power supply is used in the amplifier. Partial block diagrams of the TA-N900 circuitry are reproduced in Fig. 2.

Preampifier Measurements

Phono (MM) input sensitivity for both preamplifiers was identical, at 0.9 mV, referred to 0.5-V output. Measured from a 50-ohm source impedance, it appeared as though the Denon unit's pre-preamplifier offered more gain from input to main preamp output than the Sony unit; sensitivity measured 50 μ V for the Denon and 312 μ V for the Sony model. With an ultra-low terminating impedance of 4 ohms, however, sensitivity of the Sony's MC input came very close to that of the Denon unit, measuring 55 μ V for the same referenced output. As for RIAA equalization, both preamplifiers offered accuracies within 0.1 dB of the prescribed playback curves throughout the audio band, as shown in Figs. 3 and 4. Note that the vertical sensitivity of these displays has been expanded to 2 dB per division, rather than the usual 10 dB per division. The Sony response curve (Fig. 4) exhibits a slight tendency to rise in the superaudible region (around 30 to 40 kHz), but even this slight rise did not deviate from flat response by more than 0.25 dB.

Phono overload for the MM inputs (using a 1-kHz test signal) measured a very high 400 mV for the Denon and a more than adequate 225 mV in the case of the Sony preamplifier. Switching to the MC input mode, overload occurred at an input level of 23 mV for the Denon unit, while the Sony preamplifier was only able to handle 5.5 mV before overload was noted. I suspect that some of the higher output moving-

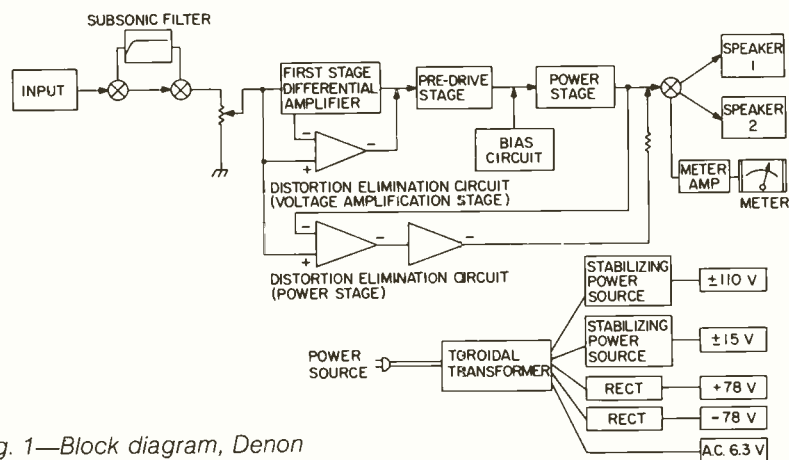

Fig. 1—Block diagram, Denon POA-8000 power amplifier.

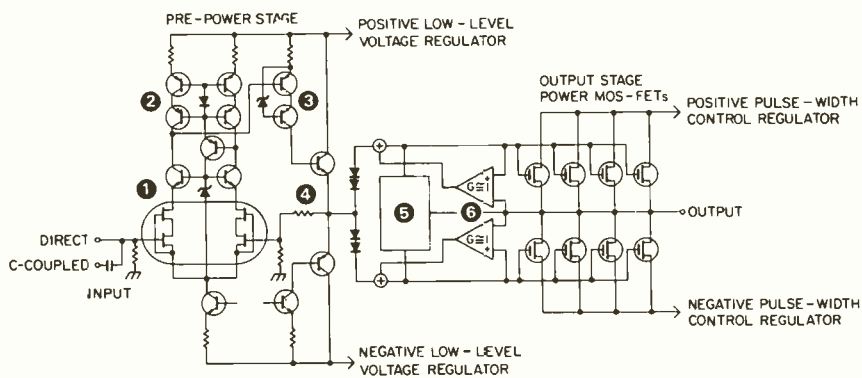

Fig. 2A—Partial schematic of Sony Esprit TA-N900 amplification stages. Legend: (1) Bootstrapped double cascode FET differential amp, (2) cascode current-mirror load, (3) bootstrapped cascode FET differential amp, (4) emitter-follower SEPP output, (5) peak current (PC) limiter, and (6) distortion-reduction circuit.

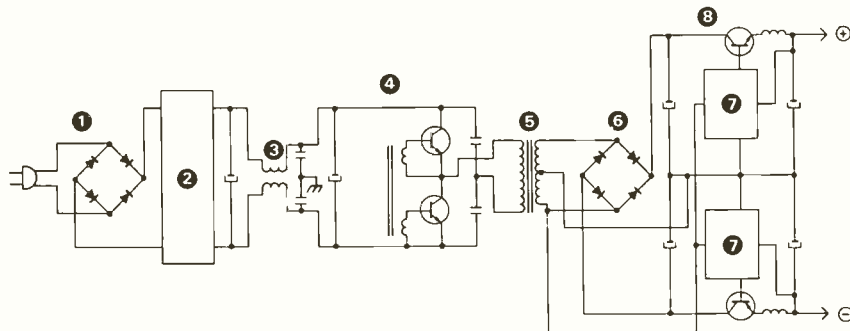

Fig. 2B—Partial schematic of Sony Esprit TA-N900 pulse-width power supply. Legend: (1) Primary rectifier, (2) current surge suppression circuit, (3) line filter, (4) 20-kHz power oscillator, (5) converter transformer, (6) secondary rectifier, (7) pulse-width control circuit, and (8) pulse-width control voltage regulator.

consider each of these systems to be a superb example of the audio art and the audio science.

Fig. 3—RIAA response curves, Denon PRA-6000 preamplifier with cursor set to 7.80 kHz (A) and 29 Hz (B). Note expanded vertical scale of 2 dB/division.

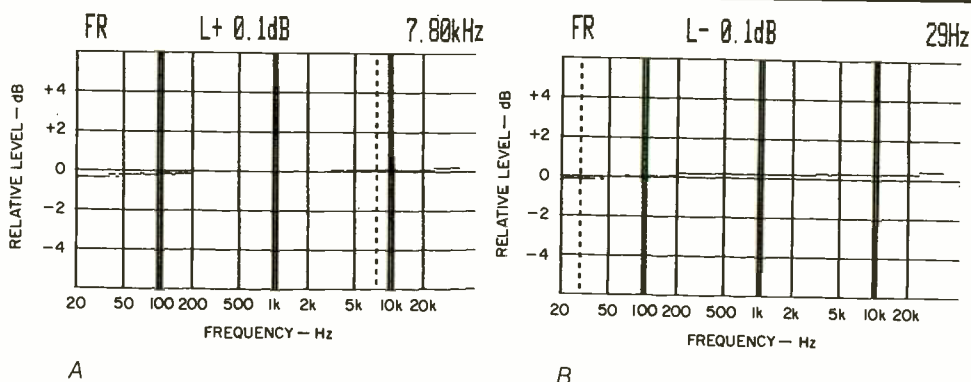
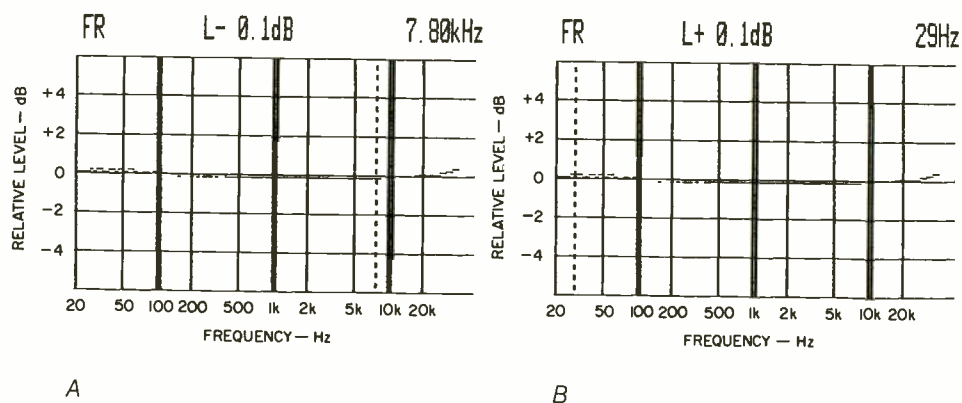

Fig. 4—RIAA response curves, Sony Esprit TA-E900 preamplifier with cursor set to 7.80 kHz (A) and 29 Hz (B). Vertical scale has again been expanded to 2 dB/division.



coil cartridges now available might cause a problem when operated into this MC input, although when using a favorite MC cartridge (custom-produced by Bang & Olufsen) I encountered no difficulties with either preamp during the listening tests.

The Sony preamp does not incorporate tone control circuitry, as mentioned earlier. Figure 5 shows the boost and cut characteristics of the tone controls provided in the Denon unit. Note that it is possible to select either of two turnover points in the bass region for use with either of the two turnover settings available for the treble control.

Turning to distortion measurements, THD was so low on both preamps that all I could read was the residual distortion of the signal generators and test equipment (around 0.002% at mid-frequencies, rising to around 0.003% at the frequency extremes). The SMPTE-IM distortion measured around 0.0015% for both units, a coincidence

which leads me to believe that here, too, I was reading residual instrument IM and not any distortion products produced by the units themselves. It almost goes without saying that the 80 dB dynamic range of the spectrum analyzer prevented my seeing any IHF-IM distortion products at levels below clipping for either preamp. The dynamic range of 80 dB corresponds to a distortion level of 0.01%, so the best I can say is that any and all forms of IM distortion which might have been produced from twin-tone test signals were well below this figure.

The frequency response of the Sony unit's high-level section surpassed that of the Denon. It extended out to 1.25 MHz (yes, that's MHz) for a -1.0 dB roll-off and still further out to 1.5 MHz for the cutoff point of -3 dB. The Denon unit was down 1.0 dB at 160 kHz and -3 dB at 200 kHz. Obviously, the bandwidth of both units is more than any of us needs.

Coincidentally, signal-to-noise ratio

for the MM phono inputs of both units was precisely the same: 89 dB below 0.5-V output, referred to 5-mV input. That's about as high an S/N figure as I have ever measured for any phono preamp input, using the new IHF/EIA input and output reference values. As for S/N of the MC input, the Denon unit exhibited an incredibly high 85 dB, while the Sony unit managed a respectable 74 dB. For the high-level inputs, the Sony unit did a bit better than the Denon, measuring 94 dB (referred to 0.5-V output and input) against 90 dB for the Denon preamp. All signal-to-noise measurements are A-weighted.

Power Amplifier Measurements

Sony's claims regarding harmonic and IM distortion for their Class-A TA-N900 are considerably more conservative than those made by Denon for their POA-8000. Both amplifiers did considerably better than the claimed figures at rated output levels and be-

low. At mid-frequencies, the Denon unit reached clipping levels at a power output of 231 watts (8-ohm load), while the Sony unit began to clip when power output reached 262 watts (8 ohm-load). Neither of these amplifiers lists 4-ohm power ratings, but I measured them at that impedance anyway, after first throwing the Sony's impedance switch to the appropriate position. The Sony amp delivered 240 watts under these conditions, for a THD level of 0.1%; the Denon unit produced 220 watts at the lower impedance before THD rose above the nominal 0.003% rating. Real clipping at 4 ohms occurred at a considerably higher power output level—more like 250 watts.

The Denon unit exhibited marginally higher dynamic headroom than the Sony amp, 1.4 against 1.02 dB. Damping factors were very close to published figures, 75 for the Denon amplifier and 52 for the Sony. The CCIF-IM distortion figures were 0.0033% for the Denon amplifier and 0.0167% for the Sony. I was able to detect a bit of IHF-IM distortion for the Sony amp using spectrum analysis and mathematical summation of observed components of distortion in the audio band. The results of my calculations showed that the Sony was producing all of 0.03% IHF IM at rated output. Frequency re-

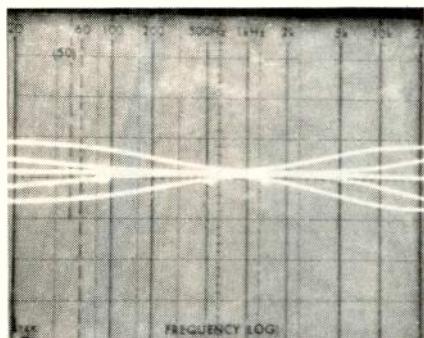

Fig. 5—Tone control characteristics, Denon PRA-6000 preamplifier.

sponse for both units extended well out beyond 100 kHz for the -1 dB roll-off point. Input sensitivity for rated output was 1.1 V for the Denon unit and 1.65 V for the Sony TA-N900. Input sensitivity decreased to 1.2 V for the Sony amp when the load impedance (and the impedance switch setting) was changed to 4 ohms. Both amplifiers retained stability when 2- μ F nonpolarized capacitors were shunted across the load resistors used in the bench tests.

Signal-to-noise ratios for the amplifiers measured 94 dB for the Denon unit and 95 dB for the Sony, both referred to 1-watt output. Since the Sony amplifier is not equipped with an input-level control, I had to interpolate to obtain its S/N figure: There was no way to establish standard input level (0.5 V) while at the same time adjusting output for the standard 1-watt level at which these measurements are supposed to be made.

Listening Tests— The Moment of Truth

With amplifiers and preamplifiers such as these, what possible program sources could I use to identify subtle differences, if any, between the two systems? Why, Compact Discs, of course! Happily, I was in the process of testing my very first DAD player when I first auditioned the Sony Esprit system, and by the time I measured and listened to the Denon components, I already owned my very own digital disc player. So, although the listening tests were not blind A-B, at least the program material used in both cases was identical—and superb. So, too, was the quality of sound delivered by both systems. (I told you at the outset not to expect a clear winner, so don't look so disappointed!)

Were there any other physical differences between these two superb systems that are worth noting? Yes, there were. The Sony amplifiers are more compact and much lighter in weight, but that is accomplished in part by the incorporation of forced air cooling. And, as with any forced air cooling system, if you listen carefully (especially when there is no surface noise or tape hiss to mask it) you can hear the fan when it operates. Unlike some public-address amplifiers which feature fans that only turn on when things get

too hot, the cooling system in the Sony TA-N900 operates continuously, however quietly. If the amps are at some distance from you, no problem. If you're right on top of them, you will hear the fan motor during ultra-quiet passages of music. The solution, of course, is to get the amps out of the listening room altogether.

That's not necessary with the Denon system, where larger heat-sinks and a generally larger and heavier construction obviate the need for a forced air cooling system. Indeed, this is a good thing because the Denon units, with their attractive solid-aluminum side panels, are worth showing off. All three components are truly beautiful looking as well as beautiful sounding—and that's not easy to achieve with a three-piece electronic preamplification and amplification system.

If you were considering these two systems for possible purchase, one of the determining factors might be your attitude regarding the need for tone controls. If you feel they are superfluous or even detrimental, as so many audio purists seem to believe, then you would obviously lean towards the Sony system. If you feel that tone controls, if executed with care and used in moderation, can prove to be an asset—especially when program material itself or room acoustics need some measure of tonal compensation—then you will want to look carefully at the Denon trio.

As for my listening tests, using the finest program material on Compact Discs that I was able to obtain, I could detect no difference in quality between the Sony and Denon systems—again, bearing in mind that I was unable to conduct instantaneous A-B comparisons. More important, I consider each of these systems to be a superb example of the audio art and science. If nothing else, the tests proved to me that a company that makes most of its sales in mid-priced components, such as Sony, can turn out products to delight the most esoteric of audiophiles. Similarly, a company like Denon, whose high-end electronic products are perhaps not as well known in this country as are its turntables (which are acclaimed even by the high-end audio fraternity here) can turn out amplifiers and preamplifiers whose performance is second to none. 

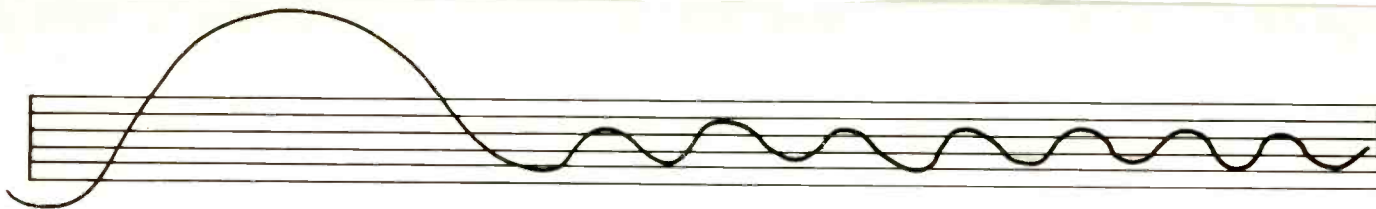

BUILD A POOR-MAN'S WOW & FLUTTER METER

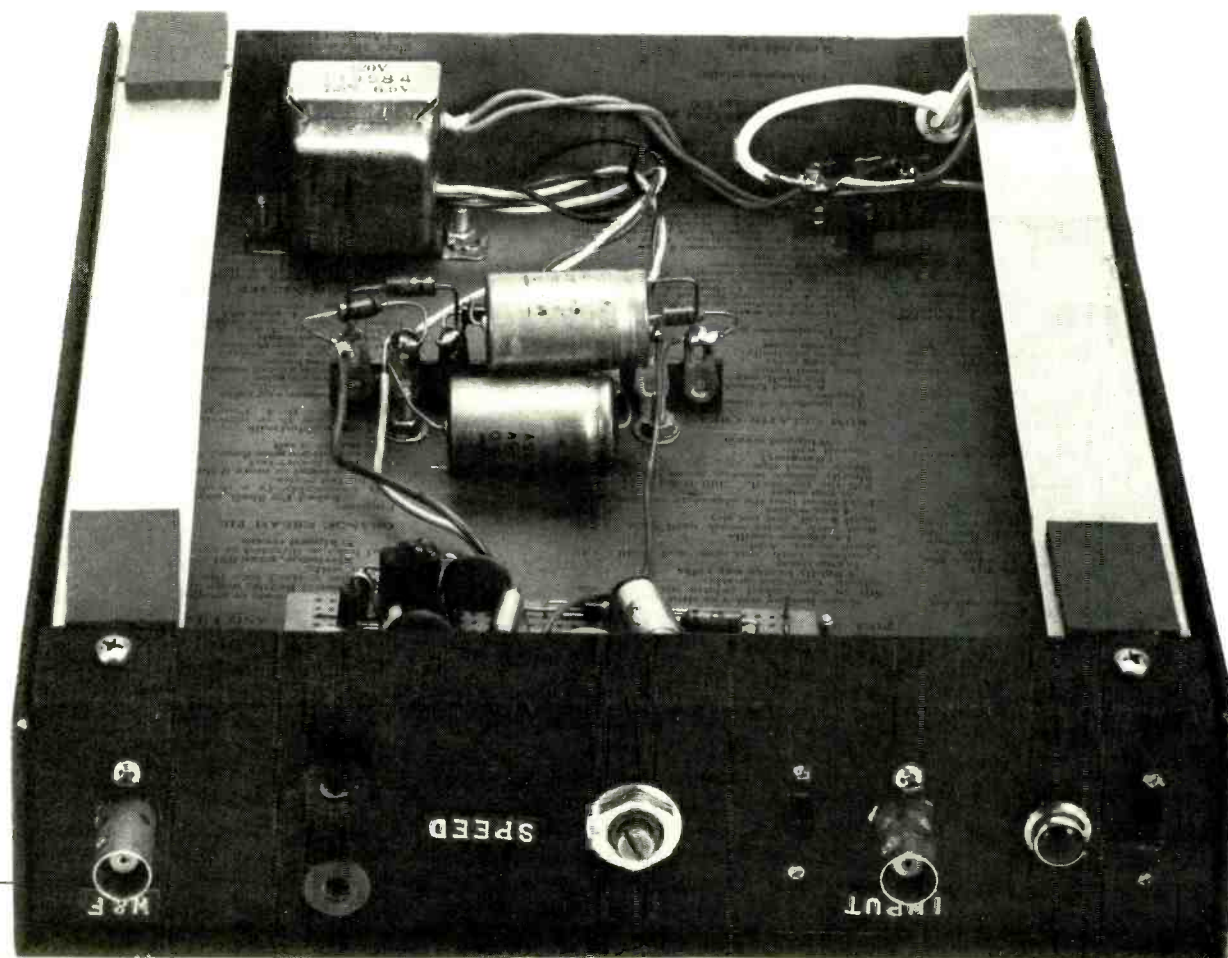
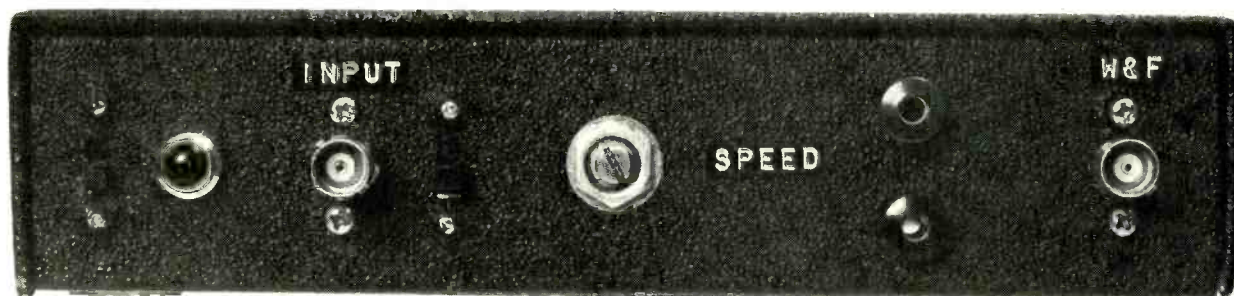

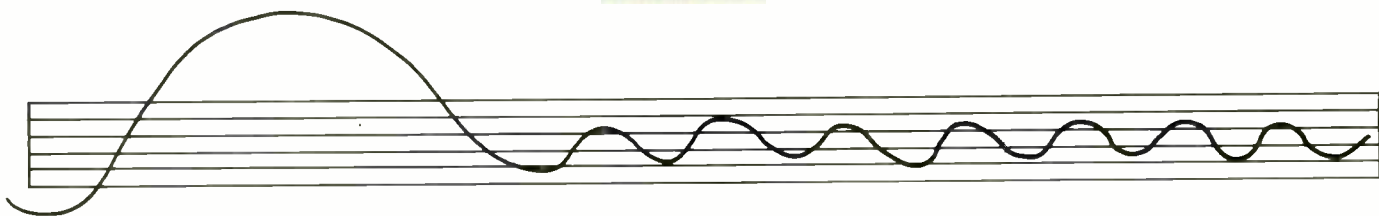

M. J. SALVATI

This article describes the construction and operation of a low-cost device capable of measuring turntable or recorder speed accuracy and wow and flutter. Cost is kept as low as possible by utilizing the audiophile's own d.c. and a.c. voltmeters to read out speed accuracy and wow and flutter, respectively. However, instructions are given for internal metering, if desired. While this device does not have the same accuracy and features as commercial instruments selling for \$500 to \$1,000, it certainly will check the specs of medium- and low-cost recorders and will indicate serious deficiencies in top-of-the-line machines. Full specifications for the meter are given in Table I.

Theory of Operation

The output of a turntable or tape machine is fed to a frequency discriminator whose output contains a.c. and d.c. error-signal components representing wow and flutter and speed error, respectively. These error signals are individually processed by the two signal channels, and read out by means of a.c. and d.c. voltmeters connected to the unit. The schematic of the basic device is shown in Fig. 1.

Frequency Discriminator. Op-amp IC1 is a unity-gain buffer that provides a high input impedance for the unit. It drives the input of phase-locked loop IC2. As long as the input signal is above 10 mV and within $\pm 30\%$ of the 3,150- or 3,000-Hz test frequency, the IC's d.c. output level is directly proportional to the frequency of the input signal. As the input frequency shifts (due to recorder speed variations), the d.c. output voltage of IC2 also shifts. Capacitor C5 and resistors R3 and R4 determine the center frequency of the discriminator.

Speed Channel. The error-signal output voltage at pin 7 of IC2 is referenced to its pin 6 voltage, so a differential amplifier (IC3B) with a voltage gain of $75\times$ amplifies the error signal and converts it to a ground-referenced signal. A filter with a very long time constant (resistor R21 and capacitor C13) removes the rapid variations (wow and flutter), so the d.c. voltage appearing at the output of buffer IC5

represents only the (relatively) constant speed error. A d.c. voltmeter connected to jacks J3A and J3B will therefore indicate speed accuracy (or "drift," as it is sometimes called). Because of the drive capability of IC5, even a low-impedance voltmeter can be used for readout.

Wow and Flutter Channel. The error-signal voltage at pin 7 of IC2 is also applied to a 200-Hz low-pass filter. This second filter and amplifier chain removes the test frequency, sets the upper frequency limit of the wow and flutter signal passband, and amplifies the signal to the extent necessary to establish the 1 V per 1% scale factor. Op-amp IC3A uses a small amount of gain ($1.7\times$) to produce a sharp corner despite the use of only two filter sections (R7, R8, C6 and C7). The following op-amp (IC4) provides a voltage gain of $44\times$, so the total voltage gain for this channel is $75\times$. Since this gain is the same as that of the speed channel, it means that when the "Speed" output is calibrated (via pot R17 across the output of IC2), the "W & F" output is calibrated simultaneously.

The input coupling to op-amp IC4 is capacitive, to remove the d.c. component from this channel. The output signal of IC4 is applied to the "W & F" jacks (J2A and J2B) via another low-pass filter (R13 and C11), which provides an additional 10 dB reduction of the 3,150/3,000-Hz test frequency.

Internal Metering. Meter M1 (see Fig. 2A) has a zero-center scale, so it is not

necessary to switch polarity as tape speed drifts from faster to slower than normal. For wow and flutter measurements, a high-pass filter and precision rectifier are combined to drive meter M2. Op-amp IC8 is configured as a maximally-flat, two-pole filter whose corner frequency is 0.5 Hz. This establishes the low-frequency limit of the 0.5 to 200-Hz standard wow and flutter passband, and also provides some amplification before the wow and flutter signal is applied to the precision rectifier (IC9), which converts it to a unipolar voltage. The "W & F" percentage switch (S4) selects the resistors that establish the scale factors for meter M2.

Construction Notes

There is nothing especially critical about layout beyond the common-sense precaution of not routing the power-switch leads near the "Input" connector and its switch.

With the exception of the power transformer, rectifiers and filter capacitors, nearly all of the basic-unit components are mounted on a single piece of Veroboard® or equivalent perfboard. Furthermore, if you obtain compact filter capacitors, there is no reason why all power-supply components other than the transformer cannot be mounted on the same board. However, if you opt for internal wow and flutter metering (Fig. 2B), it might be more convenient to build the additional circuitry on a separate board.

Choice of Parts. There is considerable latitude in the ratings for many of the parts listed in Tables II and III. Where space permits, the alternate choices are given in the parts lists, with the preferred part listed first. For example, the low-power (100 mA, TO-92 case) versions of the three-terminal plastic voltage regulators will do nicely for IC6 and IC7, although any of the equivalent higher-power versions listed work just as well. Similarly, any capacitors having a voltage rating of over 20 V can be used (except for C15 and C16). The most important consideration with capacitors is to locate the ceramic disc bypass capacitors physically close to the associated ICs, and capacitor C16 close to IC7. Where no type of capacitor is specified, you can use paper, polyester, mylar, or ceramic.

Table I—Specifications

Operating Frequency: 3,000 or 3,150 Hz.
Input Level: 10 mV to 20 V.
Input Impedance: 100 kilohms.
Speed Readout Ratio: 1 V d.c. per 1% speed error.
Speed Accuracy Ranges: Depends on d.c. voltmeter used; $\pm 5\%$ for internal metering.
Wow and Flutter Frequency Range: 0.5 to 200 Hz.
Wow and Flutter Readout: 1 V a.c. per 1% wow and flutter.
Wow and Flutter Ranges: Depends on a.c. voltmeter used; 0.2%, 1%, 5% for internal metering.

Table II—Basic Unit Parts List

IC1, IC4, IC5—LF351 or LF13741 FET op-amps.
 IC2—NE565 or LM565 PLL.
 IC3— μ A747 or LM747 in 14-pin package.
 IC6—78L15, 7815, or LM340T-15 positive regulator.
 IC7—79L15, 7915, or LM320T-15 negative regulator.
 J1—Phono jack.
 J2, J3—Pairs (red/black) banana jacks.
 S1—SPST toggle or slide switch.
 S2—SPDT toggle or slide switch.
 S3—DPDT toggle or slide switch.
 T1—16 to 18-V, 0.25-A power transformer (Mouser 41FJ300 or Digi-Key T102).
 D1, D2—6.0-V, 500-mW zener diodes.
 D3—LED.
 D4, D5—100-PIV, 1-A silicon rectifier diodes.
 C1, C2, C8, C9, C11, C12, C14—0.022- μ F, 25-V ceramic disc capacitors.
 C3—0.1- μ F, 25-V capacitor.
 C4—0.001- μ F, 25-V capacitor.
 C5, C6, C7—0.01- μ F, \pm 10% styrene or silver-mica capacitors.

C10, C13, C17—0.22- μ F, 25-V capacitors.
 C15, C16—220- μ F, 35- or 50-V electrolytic capacitors.
 C18—2.2- μ F, 25-V tantalum electrolytic capacitor.
 R1—100-kilohm, $\frac{1}{4}$ -W carbon-film resistor.
 R2, R13—4.7-kilohm, $\frac{1}{4}$ -W carbon-film resistors.
 R3—10-kilohm, 15-turn trim pot (Weston 830P or Spectrol 43P).
 R4—5.6-kilohm, $\frac{1}{4}$ -W, 5% carbon-film resistor.
 R5—560-ohm, $\frac{1}{2}$ -W resistor.
 R6—13-kilohm, $\frac{1}{4}$ -W, 5% carbon-film resistor.
 R7, R8—120-kilohm, $\frac{1}{4}$ -W, 5% carbon-film resistors.
 R9—430-ohm, $\frac{1}{2}$ -W resistor.
 R10—9.1-kilohm, $\frac{1}{4}$ -W, 5% carbon-film resistor.
 R11, R21—4.7-megohm, $\frac{1}{4}$ -W carbon-film resistors.
 R12, R20—10-kilohm, single-turn trim pots.
 R14—43-kilohm, $\frac{1}{4}$ -W, 5% carbon-film resistor.
 R15—1-kilohm, $\frac{1}{4}$ -W, 5% carbon-film resistor.
 R16, R18—10-kilohm, $\frac{1}{4}$ -W, 5% carbon film resistors.
 R17—47-kilohm, single-turn trim pot.
 R19, R22—750-kilohm, $\frac{1}{4}$ -W, 5% carbon-film resistors.
 7 x 5 x 3-inch aluminum box (Mouser LMB TF-782).

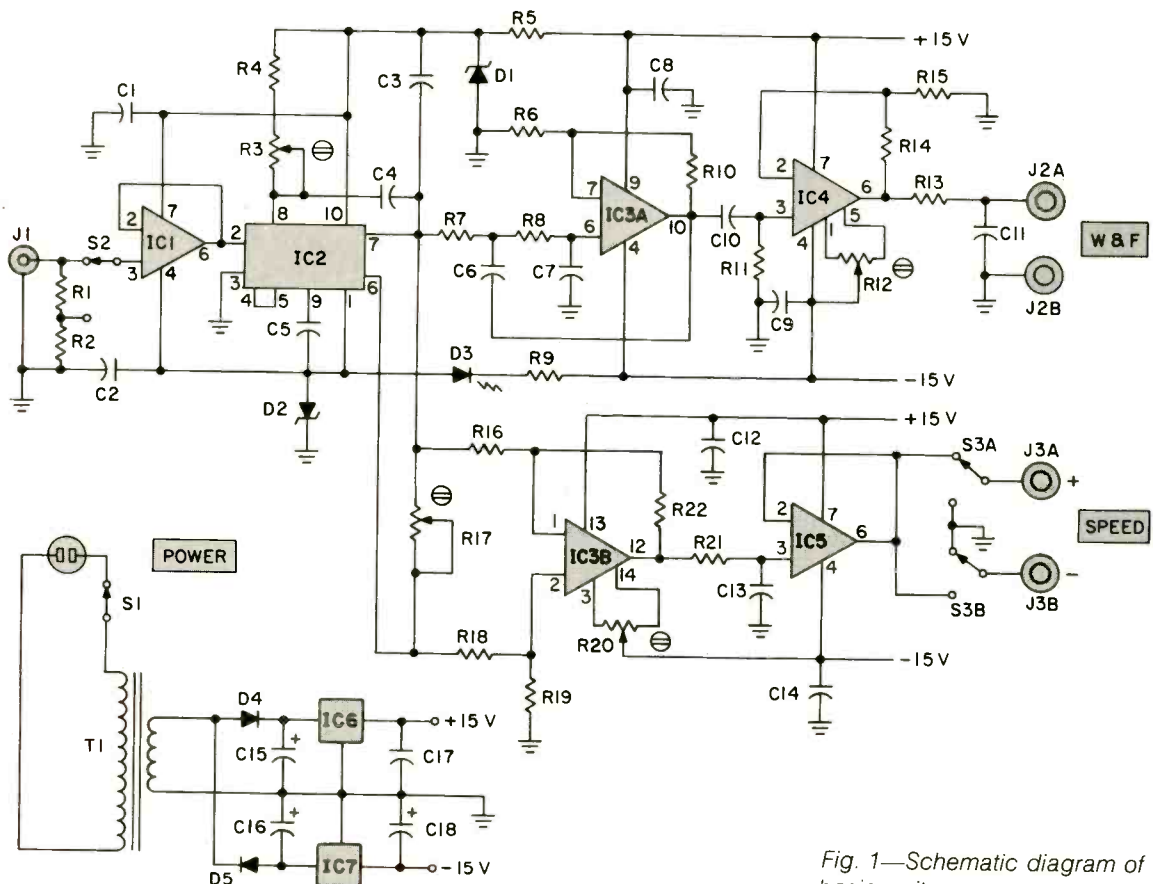
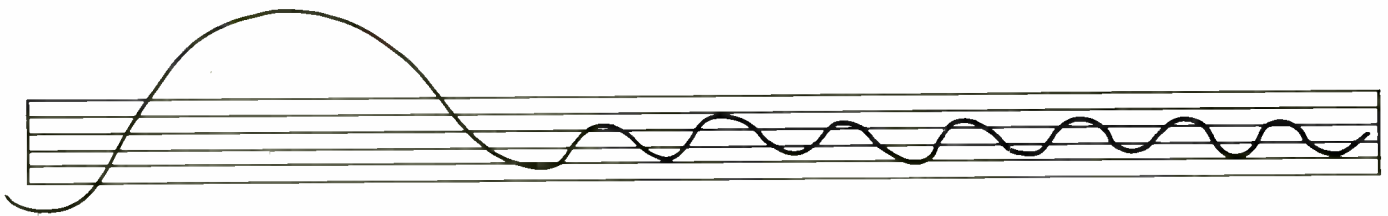

Fig. 1—Schematic diagram of basic unit.



The input and output connectors specified are the most typical for their application. They can (and should) be changed to other types more suited to your own tastes and/or test equipment. (I certainly did this in my prototype!)

Options and Modifications. The circuit shown in Fig. 1 was designed to interface with as wide a variety of test equipment and tape machines as possible. In most cases, you can save a little time, effort and money by eliminating the features not necessary to your setup.

If all your tape machines have at least one output jack apiece whose normal output level is in the range of 10 mV to 1 V rms, you can eliminate S2 and the 4.7-kilohm resistor. Connect the "Input" jack (J1) directly to pin 3 of IC1, and resistor R1 from there to ground.

If you are using an external d.c. voltmeter to read out speed, and that voltmeter has its own polarity ("+/−") switch, you can eliminate S3. Simply connect the red (+) "Speed" jack to pin 6 of IC5, and the black (−) jack to ground.

If you plan to use internal metering

for speed readout, eliminate the "Speed" jacks and switch S3, and add the parts shown in Fig. 2A. Resistor R23 then connects directly to pin 6 of IC5, and the meter "−" terminal connects to ground.

Using your a.c. voltmeter to read out wow and flutter is both convenient and cost efficient. However, many a.c. voltmeters lack full response down to the 0.5 Hz commonly used as the lower limit measured by commercial wow and flutter meters. Therefore, you may want to build a low-frequency a.c. voltmeter into this device. A suggested circuit, which consists of a 0.5-Hz high-pass filter, precision full-wave rectifier and metering, is shown in Fig. 2B. This circuit provides full-scale wow and flutter ranges of 0.2%, 1%, and 5%. Since multi-scale meters are rarely available as stock items, you will have to use a 0-50 scale microammeter and add the 0-0.2 and 0-1 scales with dry-transfer lettering. The decade zeros of the existing scale graduations can either be erased or painted over with white enamel.

A list of additional and alternate parts needed for internal metering is given in Table III. Note that some of

these parts (mostly capacitors) are used *in place of* their equivalents in the Basic Unit Parts List. After you have decided what (if any) options or modifications you want in your unit, carefully go through both parts lists to select only those parts you will actually use.

Packaging. This depends on the degree of complexity selected. The unit I built is housed in a custom-made box. The recommended standard-size aluminum case for the basic unit is 7 × 5 × 3 inches, with a 5 × 3 end used as the front panel. A suggested layout is shown in Fig. 3A. If you use internal metering, a larger case is necessary to accommodate the meters. For both internal speed and wow and flutter metering using the recommended 4-inch meters, a 10 × 6 × 3½-inch case is ideal. The suggested layout shown in Fig. 3B uses one 10 × 6 face for the front panel.

Parts Availability. All of the ICs, resistors, and capacitors are available from consumer-oriented mail-order houses such as Digi-Key and Jameco Electronics. The meters, power transformer, case, and many of the other parts are available from Mouser Electronics. Order their catalogs first to check prices and availability. (Digi-Key, Box 677, Thief River Falls, Minn. 56701; Jameco Electronics, 1355 Shoreway Rd., Belmont, Cal. 94002, \$10 minimum order; and Mouser Electronics, 11433 Woodside Ave., Santee, Cal. 92071, \$20 minimum.)

Adjustments

To adjust this device, an audio oscillator, a.c. voltmeter, d.c. voltmeter, and frequency counter are needed. Before energizing the circuit, set all pots (R12, R17 and R20) to mid-rotation. Proceed as follows:

1. Plug in the power cord and flip the power switch on. The LED should illuminate.
2. Check the output voltages at IC6 and IC7. They should be +15 and −15 V respectively.
3. Check the voltages at pins 7 and 4 of IC1. They should be +6 and −6 V respectively.
4. Check the voltage at pin 6 of IC2. It should be approximately +4.5 V.

After making these checks, go on to the calibration adjustments, but wait until the wow and flutter meter and test

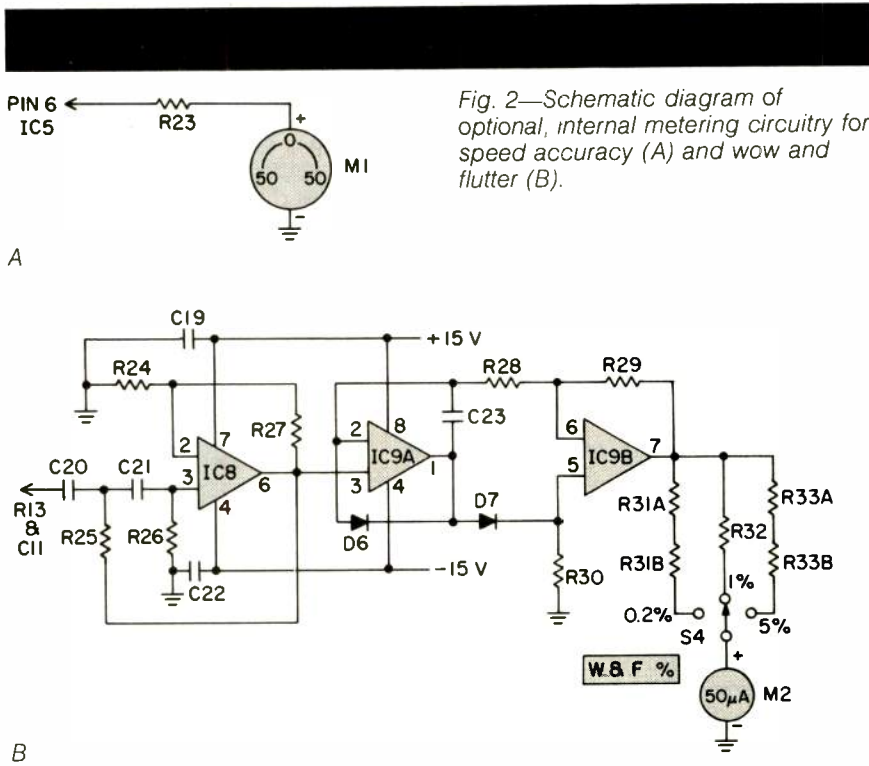

Fig. 2—Schematic diagram of optional, internal metering circuitry for speed accuracy (A) and wow and flutter (B).

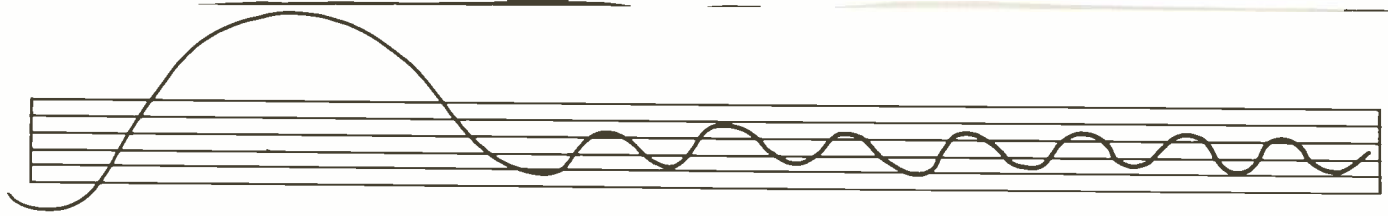

Table III—Options Parts List

- IC8—LF351 or LF13741 FET op-amp.
- IC9—LF353, LM1458, RC4558, TL072, or TL082 dual op-amp.
- S4—1-pole, 3-position rotary switch.
- M1—50-0-50 μ A microammeter (Mouser 39LK416).
- M2—0-50 μ A microammeter (Mouser 39LK414).
- D6, D7—1N914 or 1N4148 silicon signal diodes.
- C19, C22—0.022- μ F, 25-V ceramic disc capacitors.
- C20, C21—0.22- μ F, \pm 10% capacitors (Panasonic M1224).
- C23—100-pF ceramic disc or mica capacitor.
- R23—100-kilohm, $\frac{1}{4}$ -W, 5% carbon-film resistor.
- R24—13-kilohm, $\frac{1}{4}$ -W, 5% carbon-film resistor.
- R25, R26—1.5-megohm, $\frac{1}{4}$ -W, 5% carbon-film resistors.
- R27—9.1-kilohm, $\frac{1}{4}$ -W, 5% carbon-film resistor.
- R28, R29—10-kilohm, $\frac{1}{4}$ -W, 5% carbon-film resistors.
- R30—4.7-kilohm, $\frac{1}{4}$ -W carbon-film resistor.
- R31—5.3-kilohm (5.1 kilohms and 200 ohms), $\frac{1}{4}$ -W, 5% resistor.
- R32—33-kilohm, $\frac{1}{4}$ -W, 5% resistor.
- R33—168.5-kilohm (160 kilohms and 8.2 kilohms), $\frac{1}{4}$ -W, 5% resistor.
- 10 \times 6 \times 3 $\frac{1}{2}$ -inch aluminum case (Mouser LMB TF-784).

equipment have been warmed up for at least 20 minutes. Do the calibration procedures in the order given, since later adjustments depend on the preceding ones.

D.c. Balance. To adjust the d.c. balance of IC4, connect a d.c. voltmeter across the "W & F" jacks (J2A and J2B). Then, carefully adjust pot R12 for an output voltage of zero, \pm 0.1 V.

To adjust the d.c. balance of the speed channel, proceed as follows:

1. Connect the d.c. voltmeter across the "Speed" jacks (J3A and J3B).
2. Either connect a jumper from pin 6 to pin 7 of IC2 (best way) or rotate pot R17 so it has zero resistance.
3. Carefully adjust pot R20 for an indication of zero, \pm 0.1 V.
4. Remove the jumper or restore pot R17 to mid-rotation.

Calibration. The procedure given here will adjust for a scale factor of 1 V d.c. per 1% frequency error at the "Speed" jacks, and a 1-V a.c. output per 1% wow and flutter at the "W & F" jacks, based on the newer standard test frequency of 3,150 Hz. However, the 3,000-Hz figures will be given in parentheses, in case your test tapes use this frequency. After determining which frequency applies, proceed as follows:

1. Connect an oscillator whose frequency can be accurately set (either by dial calibration or by a

counter) to "Input" jack J1. Set the oscillator output to around 100 mV rms, and the oscillator frequency to 3,150 (3,000) Hz.

2. Set the range switch of the d.c. voltmeter (connected to the "Speed" jacks) to 5 V and its polarity switch (or S3) to positive. If the prior adjustments were properly made, this voltmeter should indicate 0 V with exactly 3,150-Hz (3,000-Hz) input.
3. Change the oscillator frequency to exactly 3,276 (3,120) Hz, as indicated on the frequency counter or dial. Adjust trim pot R17 for a d.c. voltmeter indication of exactly 4.0 V.

Center-Frequency Adjustment. Pot R3 allows the center frequency to be set to either of the standard test frequencies (3,150 or 3,000 Hz). Again, the procedures given here are for 3,150 Hz, with figures for 3,000 Hz in parentheses. To adjust R3, proceed as follows:

1. Connect a frequency-stable oscillator to "Input" jack J1. Set the oscillator output level to around 100 mV rms.
2. Connect a d.c. voltmeter to "Speed" jacks J3A and J3B.
3. Carefully adjust the oscillator frequency (with a frequency counter) to 3,150 (3,000) Hz, \pm 2 Hz. Then adjust trimmer R3 for zero d.c. output at the "Speed" jacks.
4. When you have done this, recheck

the frequency counter display to make sure that the input frequency is exactly 3,150 (3,000) Hz. Readjust the oscillator frequency if necessary, and readjust trim pot R3 for exactly zero d.c. output. The accuracy of your speed-error measurements depends on how carefully this adjustment is made. *Note:* If you do not have a frequency counter, pot R3 can be set well enough for wow and flutter measurements by using the dial calibrations of the oscillator. However, this alternative is not accurate enough for reliable speed measurements.

Operation

There are two ways to use this device to check tape machines. The simplest method is with your own oscillator as the signal source. This permits an overall check of wow and flutter; record and playback performance is measured as a whole. The second method uses a prerecorded test tape to check playback only for wow and

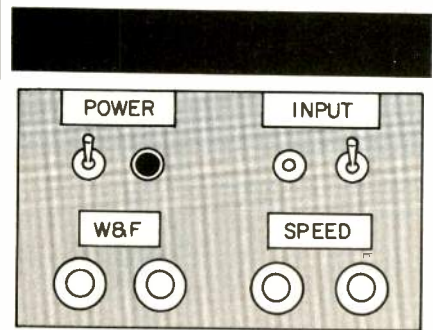

A

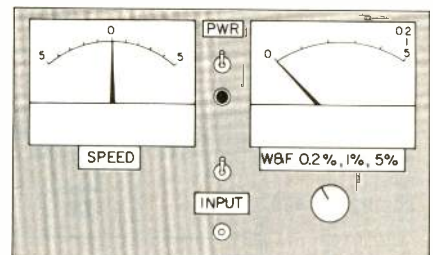

B

Fig. 3—Suggested panel layouts of basic unit (A) and unit with full internal metering (B).

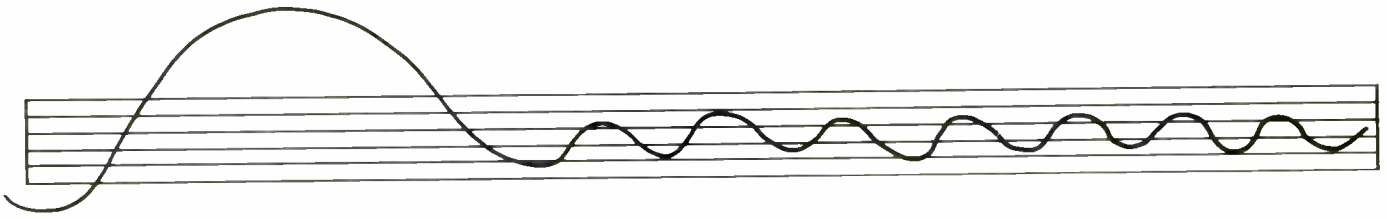

flutter and speed accuracy. Turntables use this second method with a test disc such as the CBS STR-151. For an overall measurement:

1. Connect an a.c. voltmeter with good low-frequency response to the "W & F" jacks.
2. Connect a stable audio oscillator to the tape machine's input connector. Set the oscillator output to whatever level the tape machine requires for recording. Set the oscillator frequency to the same test frequency (3,150 or 3,000 Hz) as that for which your device was previously calibrated.
3. Allow the equipment to warm up for a few minutes, then record 10 to 15 minutes of test signal on a blank tape. Do this near the middle of the tape reel or cassette for best results.
4. Disconnect the oscillator from the tape machine. Connect the tape machine's output to "Input" jack J1.
5. Play back the recorded test signal, and set "Input" level switch S1 to match the tape machine's output level.

The a.c. voltmeter will indicate total wow and flutter. A fairly steady meter indication means that the output is mainly high-frequency components (flutter). A widely varying indication means that low-frequency components

(wow) predominate. However, this is just a generalization, since the damping and ballistics of the a.c. voltmeter affect the amount of pointer movement for any given amount of wow.

Overall wow and flutter measurements will vary considerably from the playback-only wow and flutter specifications listed by most manufacturers. When the tape is recorded and played back on the same machine, the same cyclic speed variations occur in playback and recording, and can either add or subtract, depending on their phase. With test tapes recorded on a different machine of lower wow and flutter, this is less of a problem. In my experience, multiplying the overall measurements by 0.6 or so yields a figure that is *roughly* comparable to playback-only specifications; some testers recommend a figure of 0.7. It also helps, even with commercial test tapes, to make multiple readings and average them.

Wow and flutter test tapes are available from several sources. Standard Tape Laboratory (26120 Eden Landing Rd. #5, Hayward, Cal. 94545) has open-reel and cassette tapes at \$40 to \$50 for home formats, higher prices for half-inch, 1-inch or higher-speed tapes. LC Engineering Laboratories (9451 North Kostner Ave., Skokie, Ill. 60076) has open-reel, cassette and

microcassette wow and flutter tapes, at \$19 to \$34.

To check speed accuracy and/or playback-only wow and flutter, proceed as follows:

1. Connect an a.c. voltmeter with good low-frequency response to the "W & F" jacks and a d.c. voltmeter to the "Speed" jacks.
2. Turn on the device, the voltmeters, and tape machine. Allow everything to warm up for 20 minutes.
3. Connect the "Input" jack to the tape machine's output jack. Set the "Input" level switch to match the tape machine's output level.
4. Play the test tape in the tape machine. The d.c. voltmeter will indicate speed error at the rate of 1 V (meter indication) per 1% speed error. Positive voltage means the tape machine is fast; negative voltage means the machine is slow. *Note:* if wow is severe, the d.c. readings will also fluctuate slowly.

The a.c. voltmeter will indicate wow and flutter of the playback section alone. Again, a steady meter reading indicates mainly high-frequency speed variation (flutter); if the reading fluctuates, low-frequency components (wow) predominate. The damping and ballistics of the particular a.c. voltmeter used will affect the speed and degree of observed variation for any given amount of wow.

If we made them look like other loudspeakers... that's all they would sound like.

New PS-8 and PS-10 Point Source Loudspeaker Systems

DA DESIGN ACOUSTICS
An Audio-Technica Company

MORE THUNDER FROM THE THE PERFORMANCE WORLD



MARK OF EXCELLENCE

USA-1 TAKING CHARGE

CAMARO · CELEBRITY · CAVALIER · CHEVETTE · CITATION · MALIBU · MONTE CARLO · CAPRICE · CCAVETTE

CHEVY THAT TOOK BY STORM.

INTRODUCING THE NEW 5-SPEED, 5-LITER Z28.

It's been quite a year for Camaro Z28. First, it became Motor Trend magazine's 1982 "Car of the Year." Then, the official Indianapolis 500 Pace Car.

And now, it looks like the competition is in for some more rough weather. With the introduction of the new 5-speed, 5-liter Camaro Z28.

More power and more gears than last year. To take you from zero to 50 MPH with lightning-like response.

And that, of course, is in addition to all of the advanced engineering features that helped make Camaro the hottest-selling 2 + 2 sport coupe on the road today.* Like road-hugging Ground Effects technology. A cockpit designed with the latest advances in ergonomics. And a shape so sleek, only its shadow can match it.

The new 5-speed, 5-liter Camaro Z28. It's going to be nearly impossible for the competition to steal any of its thunder.

Some Chevrolets are equipped with engines produced by other GM divisions, subsidiaries, or affiliated companies worldwide. See your dealer for details.

*Source: Ward's Automotive Reports, Specialty Subcompact Segment, October, 1982.

Let's get it together... buckle up.



Chevrolet

SANYO PRO-PONENT AUDIO/VIDEO SYSTEM



Photograph: Susanne Buckler

Sanyo is a sufficiently broad-based company to offer just about every type of consumer electronic product currently sold to the public. It's no wonder, then, they have come up with a "total" audio/video package that can be easily assembled and installed to form the basis of a complete home entertainment center. As complete as this system is—what with its stereo audio component system and rack, matching speaker systems, plus a superb color video monitor, video tuner/control center and video rack—Sanyo wisely chose to offer each of its elements separately. While this didn't allow the designers to provide any interactive features, such as those we have seen on some one-brand audio systems, the trade-off of flexibility in customer options makes up for that omission. After all, the video monitor and TV control center would

certainly be a welcome addition for those who already own a high-quality audio component system, while those who own a good color set or even a TV monitor should have the option of being able to add just an audio component system, with or without speakers, and, for that matter, with or without a video tuner-control center.

For those who do choose to go Sanyo all the way, for both video and audio components, the facilities offered by the Pro-Ponent System (as Sanyo calls the total combination) are truly complete. Before detailing the important features of each of the audio and video components, let me state that I was very favorably impressed with the styling. The tuner, integrated amplifier and cassette deck all have cleverly designed, swing-down hinged doors with slots or openings that permit you to operate major controls or

observe needed indicators even with the doors closed. Preset buttons on the tuner are still accessible, as are program selector buttons on the amplifier; metering LEDs are visible in the cassette deck, even with these doors in their closed positions.

The P-33 turntable and cartridge combination offers the first linear-tracking turntable I have encountered in a one-brand system. It is fitted with a nonreplaceable cartridge whose stylus is user replaceable. Although selected speed is indicated by a digital readout, this readout does not convey accuracy of speed, for which strobe markings are supplied both on the rim of the turntable and on a small printed card which fits on the spindle. A speed control fine-tunes the 33 $\frac{1}{3}$ or 45 rpm speeds. I found the tracking of the low-mass arm to be quite good and was rather amazed, in fact, that a linear-

ONE-BRAND SYSTEM RATINGS

Manufacturer: Sanyo

Model: Pro-Ponent System

Company Address: 1200 West Artesia Blvd., Compton, Cal. 90220.

Cabinet Dimensions: Audio cabinet, 16 in. W x 34¾ in. H x 15½ in. D; video cabinet, same but 22 in. W.

Separate Component Prices: System 33 audio components (A-33 amplifier, T-33 tuner, P-33 turntable and cartridge, and D-33 cassette deck), \$599.95; S-33 loudspeakers, \$199.95 per pair; APB-33 speaker stands, \$59.95; AF-33 audio rack, \$199.95; AVM-195 color monitor, \$599.95; AVT-95 video control system, \$399.95; AVF-90 video rack, \$199.95.

System Price: \$2,259.65. For literature, circle No. 98.

AUDIO COMPONENTS

Component & Specification	Claimed	Measured	Rating
<i>Power Amp Section (A-33)</i>			
Power/Channel, watts	25.0	30.0	♪♪♪
Rated THD, %	0.09	0.07	♪♪♪
<i>Preamp/Control Section (A-33)</i>			
Freq. Response, Phono, ±dB	RIAA, ±0.2 dB	RIAA, +0, -0.2 dB	♪♪♪♪
Phono S/N, dB	90†	78	♪♪♪
<i>FM Tuner Section (T-33)</i>			
50 dB Quieting, Stereo, dB	39.2	40.0	♪
S/N, Stereo, dB	70.0	71.0	♪♪
THD, Stereo, 1 kHz, %	0.30	0.13	♪♪♪
Separation, 1 kHz, dB	45	40	♪♪
Alt. Channel Selectivity, dB	65	68	♪♪
<i>Turntable/Cartridge Section (P-33)</i>			
Frequency Resp., Hz-kHz, ±dB	20-20	47-18.5	♪
Separation, 1 kHz, dB	20	23	♪♪
Rumble, DIN B, dB	78	75	♪♪♪
Wow & Flutter, % wtd. rms	0.04	0.05	♪♪
<i>Cassette Recorder Section (D-33)</i>			
Freq. Resp., Hz-kHz, ±3 dB			
Normal Tape	20-13	37-16.5	♪
Chrome Tape	20-17	35-20	♪♪
Metal Tape	20-19	20-20	♪♪
S/N, Best Tape, dB (with NR)	77	78.4	♪♪
Wow & Flutter, % wtd. rms	0.04	0.06	♪♪

†Not measured according to IHF/EIA Standards; see text.

VIDEO COMPONENTS

Component & Specification	Claimed	Measured††	Rating
<i>Video Control System (AVT-95)</i>			
Number of Video Inputs	3	3	♪♪
Number of TV Channels	82, +23 Cable	Confirmed	♪♪
Remote Control	Full-Function	Confirmed	♪♪
<i>Video Monitor (AVM-195)</i>			
Maximum Usable Luminance	NA	152 Foot-Lamberts	♪
Horizontal-Line Resolution	360 Lines	360 Lines	♪♪
Black-Level Retention	NA	90%	♪
Frequency Response	NA	To 4.2 MHz	♪♪
Interlace	NA	50/50	♪♪
Transient Response	NA	Good	♪

††Supplied by CBS Technology Center.

Rating System

♪ = Poor; ♪♪ = Good; ♪♪♪ = Very Good; ♪♪♪♪ = Excellent; ♪♪♪♪♪ = Superb.

General Comments

Integrated Amplifier: Sound quality quite good at moderate listening levels. Because of rather limited power, it would be wise to choose very efficient speakers for this amp, unless you stay with the S-33 speakers Sanyo offers for this system. Excellent phono preamp section with very accurate RIAA equalization. **Tuner:** Very cleverly designed in terms of physical layout and ease of use and tuning. Only moderately sensitive, however, and an outdoor FM antenna is suggested. **Turntable & Cartridge:** Cartridge cannot be replaced by one of your own choice, and present cartridge exhibits unusual bass "bump" with the radial tracking tonearm in which it is mounted. Some listeners may actually find this extra bass appealing. Tracking ability was excellent and rumble was low. **Cassette Deck:** High-end response better than claimed when using premium tapes, but bass response rolled off with all but metal tape. Dolby tracking was excellent, and presence of Dolby C NR adds value to this deck. **Video Control Center:** Well designed, both in terms of a TV tuner and in terms of its flexibility as a video control center. Adequate number of video and audio inputs for most home entertainment systems. **Color Monitor:** Provides a far better picture than is available from even the most expensive all-in-one TV sets. When used with the System 33 audio components, the internally supplied amplifiers are bypassed. (But even without them, the AVM-195 is fairly priced for the quality of picture it delivers.) **Overall Comment:** Audio components don't particularly take advantage of the fact that they are sold as a system (no interactive features), but all components worked well together and integrated nicely with the video components. **Overall Rating:** Audio, ♪♪♪; video, ♪♪.

"The amplifier exceeded its power rating, delivering 30 watts per channel, but with today's program sources, choose high-efficiency speakers."

tracking tonearm could be incorporated in an audio component package in this price range. I was disappointed with the frequency response of the system. Though excellent at the high end, it exhibited a very steep rise at around 25 Hz, which I could only attribute to tonearm/cartridge resonance. I'm all for getting tonearm resonance up and out of the warp-wow region, but 25 Hz—that's a bit high!

The A-33 integrated amplifier incorporates features usually found only on higher powered, more expensive models. Included, for example, is a record-out selector switch, allowing you to record one program source while listening to another. A subsonic filter and loudness control are included, as are the usual bass and treble tone controls and a not-so-usual microphone input, with its own level control for mixing in live mike sounds with other program sources.

The amplifier met its basic published specifications, with the exception of phono signal-to-noise. Sanyo's specification cannot be compared with my measured results since the company is still referencing this measurement to some undefined (but high) input level and to rated output. Still, my IHF/EIA reading of 78 dB (A-weighted) is certainly acceptable for a system of this type. The amplifier exceeded its power rating, delivering 30 watts per channel at mid-band, but with today's dynamic program sources, you can't expect to reproduce lifelike sound levels with this amp unless you choose high-efficiency speakers to go with it. I did not audition Sanyo's S-33 speakers, but would guess that they are probably high enough in efficiency to compensate for the relatively low power output of this otherwise fine amplifier.

Like so many recently designed tuners, the T-33 offered by Sanyo employs precise frequency-synthesized tuning, eight preset buttons for selecting favorite stations, "Up" and "Down" buttons for manual tuning, and a digital readout of frequencies to which the tuner is set. While not one of the most sensitive AM/FM tuners I have tested, it did exhibit low distortion in both mono and stereo, adequate stereo separation and reasonable selectivity for most metropolitan locations. Signal-strength LEDs, and indicators to tell you which

of your preset stations you are tuned to, embellish an otherwise simple, straightforward and very good-looking front-panel layout.

The two-head D-33 cassette deck exhibited excellent signal-to-noise capabilities, thanks to the incorporation of Dolby C noise reduction. Again, this feature is rarely found on low-cost decks and, more important, calibration of Dolby B and C NR was excellent. As is often the case with lower cost decks, however, "0 dB" has been set 3 dB below actual Dolby level (200 nWb/m), which gives the user the feeling that there's more headroom in this deck than there actually is. For superb recordings, I recommend metal tape, though for noncritical, casually made recordings, any premium ferric-oxide or high-bias tape will do nicely. Although wow and flutter was not quite as good as the 0.04% claimed by Sanyo, the 0.06% reading is better than I would have expected from even the most expensive cassette decks just a few years ago.

The AVT-95 video control system is styled like an audio component. Visible on its front panel are a stereo headphone jack, pushbutton selectors for the one r.f. and three audio/video inputs, a remote-control sensor and a digital channel display, plus pushbuttons for up/down channel scanning and volume control and a power switch. Hidden behind a flip-down panel are still more controls—mono/stereo selection for each input source; a normal/CATV mode selector for the 105-channel, cable-ready tuner; an up/down fine-tuning button; a "sound expander" switch (which produces a synthesized "stereo" effect), and controls for bass, treble, stereo balance and headphone level.

The remote control (included with the unit) repeats the power, volume and channel-scan buttons, and adds a few controls of its own. These include a 10-key, numerical keypad for direct-access channel selection, an audio-mute switch, and a timer button which shuts the system off after 30, 60 or 90 minutes, depending on whether it's pressed once, twice or three times.

The rear panel holds all the connections. In addition to the 75-ohm "F" connector for the r.f. input, there are three sets of video and stereo audio

inputs and two pairs of outputs—one to feed a VCR for recording and one for connection to the monitor. The audio outputs to the VCR are unaffected by the volume control, like tape outputs in audio systems.

The monitor tested was the Model AVM-195, with a 19-inch screen and built-in, 5-watt audio amplifiers. However, since I was testing the video components as part of a total audio/video system, I used only the external audio components for the listening tests.

Because my lab is not (yet) equipped with video test equipment, the two video components which form a part of the Pro-Ponent System were first sent to the CBS Technology Center in Stamford, Conn. That facility has just about the most sophisticated and complete video testing facilities in the country, and the data shown in the expanded ratings chart was supplied by them. I did, however, use the AVM-195 color monitor and the AVT-95 video control system in my lab and listening room, hooking them up with the rest of the Sanyo components.

Since the video component measurements may be unfamiliar to readers of *Audio*, some explanations may be in order. Maximum usable luminance is the maximum brightness that can be obtained from the picture tube of a TV monitor (or, for that matter, a TV receiver) before the picture begins to "bloom" or become defocused. The 152 foot-lamberts measured for the AVM-195 monitor is an excellent result and more than adequate for comfortable viewing in a well-lit room. Horizontal-line resolution is a measure of how much detail you will be able to see in a TV picture. Typically, most complete TV receivers offer horizontal-line resolution in the range from 250 to 300 lines. The 360-line resolution offered by the Sanyo monitor means that the resolution or detail of the reproduced picture will be much closer to the maximum that can be obtained with the NTSC transmission system used in the U.S. and Japan. Watching a picture reproduced on this monitor, you will probably take back all the derogatory remarks you've made over the years regarding our inferior television system. I know I did!

Black-level retention is the ability to

"The video monitor's 360-line resolution is very close to the maximum obtainable with the NTSC transmission used here."

You never forget your first Girl.

maintain a good, black background in the presence of bright portions of a video scene. I measured 90% for the Sanyo monitor, a good score though not absolutely perfect. It's a lot better, though, than you are likely to get with an ordinary TV receiver. Video frequency response is directly related to the earlier-mentioned horizontal-line resolution. It is measured by using a video test signal consisting of bursts of frequencies, ranging from 0.5 to 4.2 MHz. What appears on the screen are groups of vertical lines, each group more closely spaced than the previous one. If the right-most group can be identified as individual lines rather than as a continuous blur or as gray, then the system's response extends all the way out to 4.2 MHz and picture resolution will be as good as it can be. Such was the case with the Sanyo AVM-195 monitor.

Interlace describes the positioning of two successive "fields" which make up a single "frame" in a video picture. In the U.S. NTSC system, there are 30 frames per second and 60 fields. The lines of two successive fields are supposed to be displaced slightly from each other, so that the 262 lines of the one field of a given frame fit precisely between the 263 lines of that frame's other field. Thus, the two fields make up a single picture or frame containing 525 lines. If lines of the second field fall on top of lines of the first field (or are not evenly spaced between them), the picture loses vertical detail or resolution, and a viewer is more apt to see the picture as distinct lines when sitting close to the screen. The best rating for interlace would therefore be 50/50, which means that alternate field lines are exactly centered with respect to the previous field lines. And it is that 50/50 condition that CBS Technology Center measured for the Sanyo AVM-195 monitor.

Specific comments concerning both the Pro-Ponent audio and video components will be found within the ratings chart. In summing up this complete home entertainment system, I feel that the audio components were, on the whole, well designed and nice to look at, while the video components were truly outstanding; hence the separate overall ratings for the two halves of this system.

Leonard Feldman

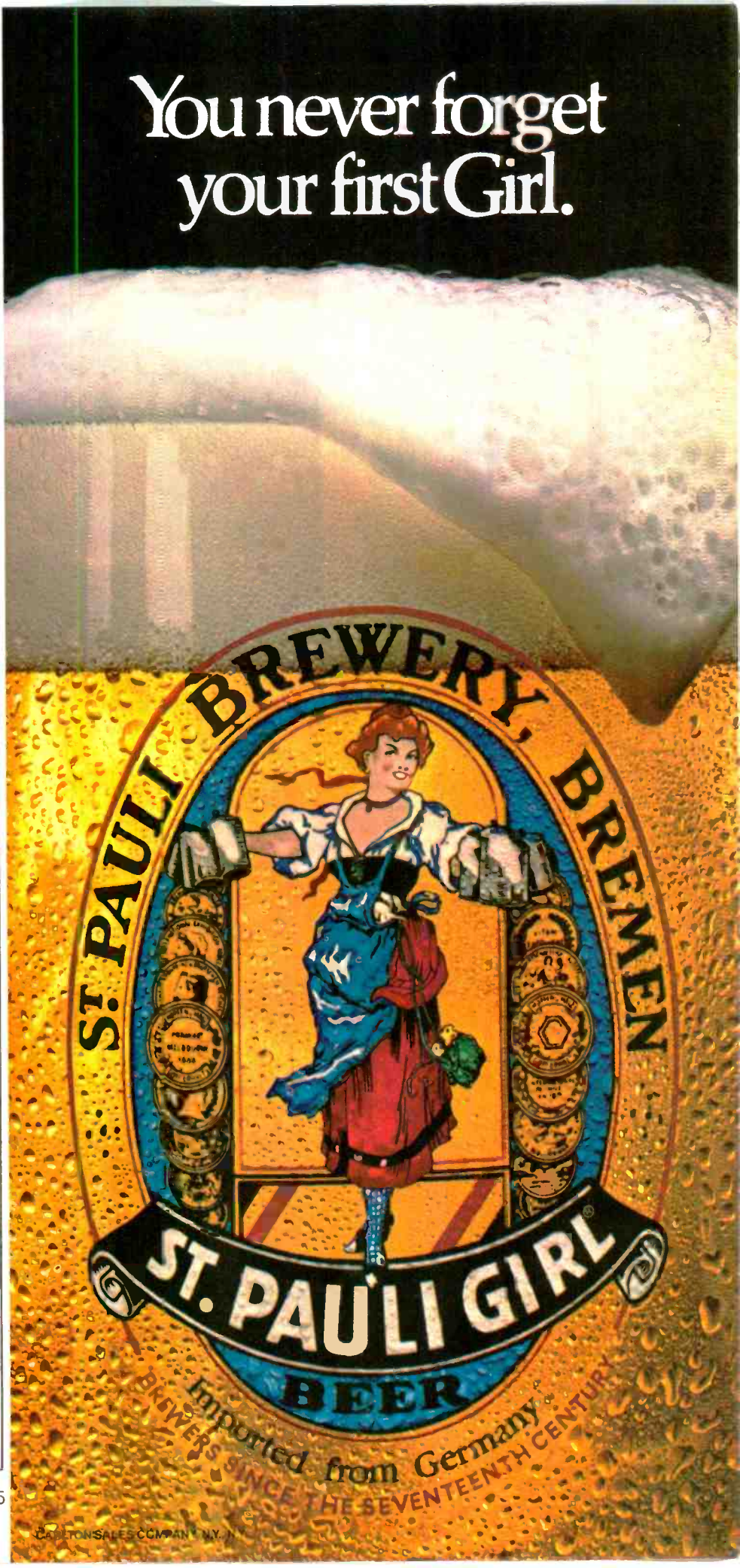

1

**PHASE
LINEAR
9500
COMPACT
DISC
PLAYER**

Manufacturer's Specifications

Frequency Response: 20 Hz to 20 kHz, ± 0.5 dB.

Dynamic Range: More than 90 dB.

S/N Ratio: More than 90 dB.

Channel Separation: 90 dB.

Harmonic Distortion: Less than 0.005%.

Wow and Flutter: Unmeasurable.

Line Output Level: 0 to 2.0 V, variable.

Output Impedance: Less than 100 ohms.

Power Consumption: 30 watts.

Dimensions: 16.93 in. (43 cm) W \times 5.2 in. (13.2 cm) H \times 12.6 in. (32 cm) D.

Weight: 17.6 lbs. (8 kg).

Price: \$995.00.

Company Address: 4136 North United Pkwy., Schiller Park, Ill. 60176.

For literature, circle No. 90



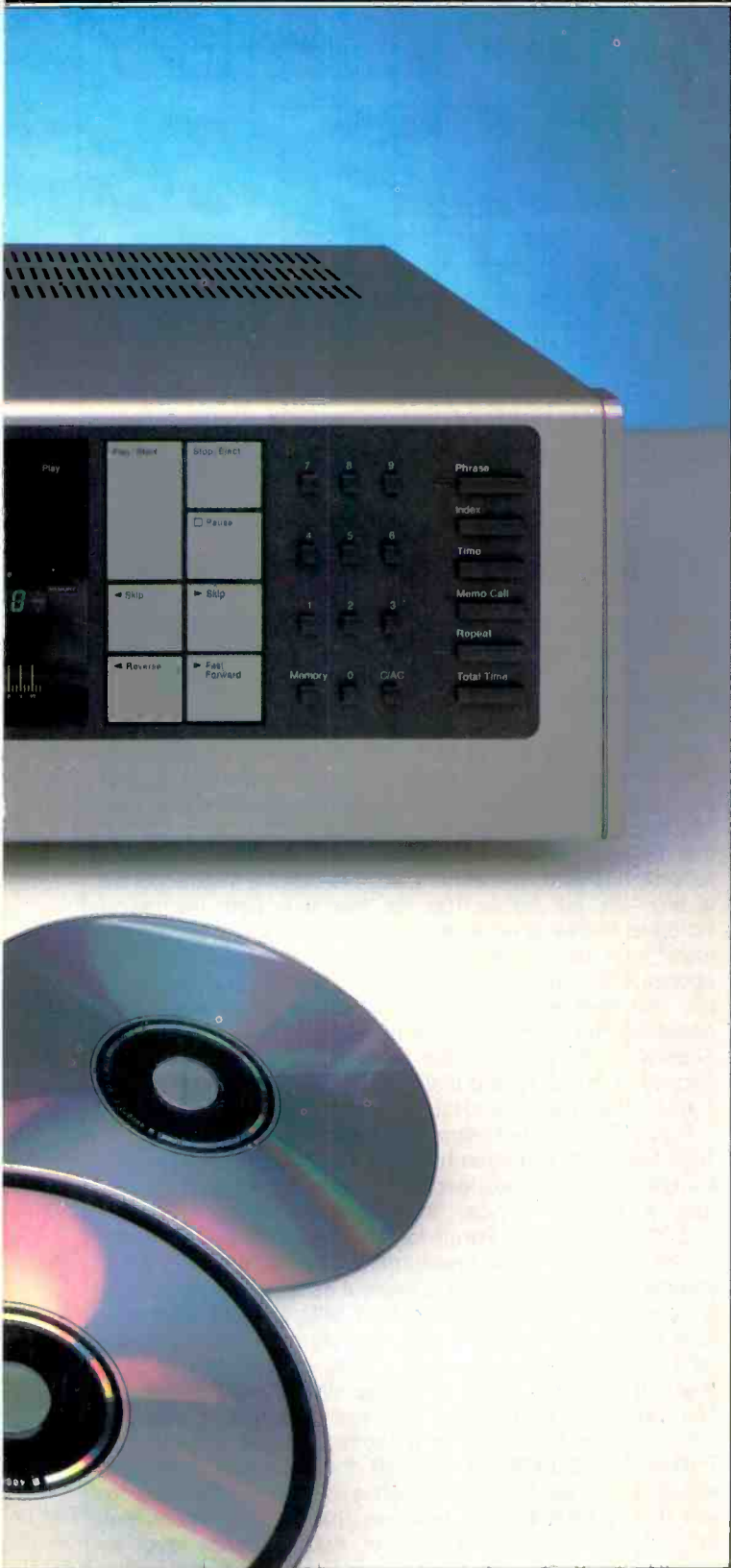

Although Phase Linear admits to having their Model 9500 CD player manufactured off-shore, they are the first U.S.-based and U.S.-owned company to introduce a digital audio disc player for the now-standard Compact Discs developed jointly by Philips and Sony. Representatives of Phase Linear, now an Esmark Company (which also owns Jensen Sound Laboratories and recently acquired the Advent name as well), tell me that some of the unusual user-features found on the front panel of the 9500, as well as some of its internal engineering, were designed here and "contracted out" for manufacture abroad.

The Phase Linear 9500 is configured more like the Technics, Sharp and Hitachi units than like the Sony CDP-101. That is, it features a swing-down hinged door which, when opened, discloses a narrow slot into which a Compact Disc is placed, label facing outward. On the Phase Linear, though, it is then necessary to push the disc down until it is fully inside the door and then to manually close the door, much as one would with a front-loading cassette compartment. I suspect that some users may actually prefer manual control over their discs rather than the automatic loading found on other CD players, which seem to swallow the disc once it is inserted in the slot and then close the door by means of a motor.

A display area to the right of the disc compartment door provides a wealth of information concerning the disc being played. A ruler-like scale with a moving LED behind it tells approximately how far into a record the laser pickup has progressed. A digital readout displays time into the given track being played or total time from the start of a disc, depending upon whether or not the "Total Time" touch button, located elsewhere, is depressed. Surrounding this time display are tiny LED indicators which illuminate when total time is being displayed, when the memorized programmed selections are being played in selected order, and when a separate "Index" button is touched. (More about the "Index" function in a moment.) A separate digital display shows the current track being played or selected. Three more indicator lights along the top of the display area show whether the player is in "Stand By," "Pause," or "Play" mode.

Basic operation of the 9500 is handled by seven large touch-pads, the largest of which is labelled "Play/Start." A "Stop/Eject" control terminates play if a disc is playing or, pressed a second time, opens the disc door and ejects the disc from the door slot enough so that it can be removed. The "Pause" control interrupts play but keeps the laser pickup precisely at the point of interruption. Touching "Pause" again causes play to resume. Forward and reverse "Skip" controls, when touched, move the laser to the start of the next or previous selection on a disc. "Fast Forward" and "Reverse" controls, when held in their depressed positions, move the laser pickup rapidly in either direction while the track and time display follow the movement, allowing you to start playing at any predetermined track or time into a track.

To the right of these large touch pads are smaller keys numbered from 0 to 9. These are used with the "Memory" and "C/AC" (Clear/All Clear) keys for preprogramming a sequence of selections in any order that you choose. Some

“The Phase Linear 9500 has some of the most innovative convenience features found on any Compact Disc player.”

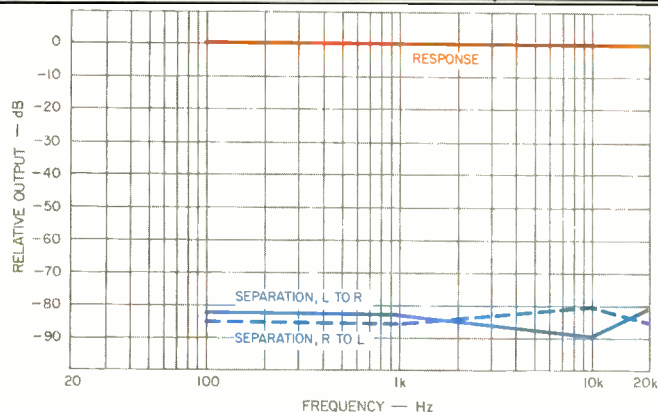

Fig. 1—Frequency response and stereo separation.

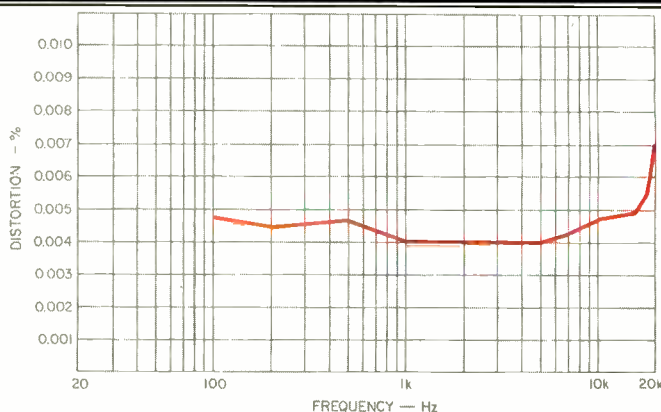

Fig. 2—Harmonic distortion vs. frequency.

of the most innovative convenience features I have yet encountered on any CD player are activated by the last series of touch buttons, located at the extreme right of the front panel. When touched once, the uppermost of these, labelled “Phrase,” sets a “mark” for the particular location being played. If the “Phrase” button is touched a second time, a second mark is set, and the unit repeatedly plays the section between the two marks, over and over, until the order is cancelled with the all-clear button. This proved to be extremely useful in my study of the player when I wanted to hear a musical phrase (or section of a test tone) again and again for careful analysis and study.

The second button in this row of switches is identified as “Index.” While my present collection of CDs could not be used to check out this feature, I understand that in the future, some Compact Discs—particularly classical works which have very long selections, such as complete movements, as single “track” numbers—may have additional “index” codes within each track. These codes would be listed on the record jacket and could be accessed for listening to a particular portion of a long movement or track. If discs encoded with index points are played, and if these points are called up by the user, the track display continues to show the selected track, while the time display switches from a “minutes: seconds” arrangement to a two-digit representation of the “Index” number called for.

The third button in this group is labelled “Time” and may be used to access any point in a given track. The user first punches in the track number on the numeric keyboard, then punches in the time, in minutes and seconds. After that, the “Time” button is depressed to let the microprocessor know that you not only want a given track but a given time into that track. Then you either press “Play” or, if you want to program several such access points in sequence, “Memory.”

A “Memo Call” button, when depressed, reviews all of the track numbers you have programmed into memory by flashing each of them on the track display for a couple of seconds. A “Repeat” button is used for playing any given track over and over again. The last button in this group is the

“Total Time” button whose function I have already mentioned.

The rear panel of the Model 9500 is equipped with the usual left and right output jacks and an output level control.

Measurements

Figure 1 is a point-by-point plot of the playback frequency response (upper curve) and channel separation capability for the Phase Linear CD player. You may recall that my test disc, supplied by Sony, does not include frequencies below 100 Hz; hence the abrupt termination of the graph plots at that frequency. As I have mentioned in other CD player reports, however, I have no reason to believe that response is any less flat below 100 Hz than it is over the range included in this special test disc. If my digital-readout dB meter can be trusted, maximum departure from flat response in the range covered was no greater than 0.2 dB at any test frequency, and, at most of the spot-frequencies observed, the error was either nonexistent or read +0.1 dB. Separation, depicted by the lower curve in Fig. 1, ranged from 81 to 90 dB for the test frequencies available (100 Hz, 1 kHz, 10 kHz and 20 kHz).

Figure 2 is a plot of harmonic distortion versus frequency. Total harmonic distortion hovered around the 0.004% point for most of the test frequencies included in the test disc, and reached a “high” (if I can, in all conscience, use that term) of 0.007% at 20 kHz. Purely for statistical interest, this is the lowest distortion I have measured for any CD player to date, though it is only of academic interest as far as sound quality is concerned. It would make little difference in what you hear even if the harmonic distortion were 10 times greater. As I have pointed out in other tests of CD players, with digital audio, THD tends to rise as signal levels decrease. That being the case, I also checked distortion at levels of -10, -20 and -60 dB for a 1-kHz test tone. At -10 dB, THD rose to 0.008%. At -20 dB, the distortion reached a still-inaudible level of 0.023%, while at -60 dB, the reading was 0.18%. Bear in mind, however, that 0.18% is equivalent to -55 dB below reference level. And reference level, in

“THD hovered around 0.004% for most test frequencies. The ‘high’ (if I can call it that) was 0.007%, at 20 kHz.”

this case, is already at -60 dB. What I suspect, therefore (and oscilloscope observations confirmed my suspicions), is that the distortion analyzer was reading quantization noise rather than actual harmonic distortion during the -60 dB tests.

These decreasing-amplitude 1-kHz test tones were used to check linearity of the system as well, and perfect linearity was observed down to 60 dB below maximum levels. At -80 dB, an error of 1.7 dB was noted; at -90 dB I was too involved in the noise floor of the system to really judge linearity with any degree of precision.

SMPTE IM measured 0.0085% at 0 dB (maximum) level, increasing to 0.02% when I played the next track with a test tone of 400 Hz + 7 kHz, recorded 10 dB lower. For the twin-tone IM test tones, I recorded a reading of 0.0018% CCIF IM at 0 dB recording level and 0.002% at -10 dB level.

Signal-to-noise ratio measured an incredible 96.7 dB, unweighted, and if I added an A-weighting network to the measurement system, it increased to 100.5 dB. These numbers are higher than those recorded for any CD player to date.

De-emphasis was as accurate as my measurement system could detect—to within 0.1 dB—for the 1-, 5-, and 16-kHz test tones used to check this characteristic.

Use and Listening Tests

My collection of Compact Discs has grown somewhat since I last tested a CD player, but not by very much. I now own a grand total of an even dozen discs (11 if you exclude the test disc). Two of my most recent acquisitions are a London recording of Stravinsky's *Rite of Spring*, with Antal Dorati conducting the Detroit Symphony, and a Deutsche Grammophon recording of Mahler's First Symphony, with Claudio Abbado conducting the Chicago Symphony Orchestra. If you are familiar with either of these selections, I

need not tell you that the dynamics and transients contained in them are awesome, to say the least. For the first time, I felt the total excitement and involvement in the music that I had previously experienced only when hearing these works performed in live concert.

But you don't have to be a classical music buff to derive excitement and pleasure from digital discs. At a recent seminar which I gave at an audio dealer in Danbury, Connecticut, I happened to play some cuts (we need a new term here, for sure!) from the digital disc version of Billy Joel's *The Stranger*. By a happy coincidence, one of the sales people at that store had a copy of the analog LP version of the same record. Both discs had been made from digital master tapes. We did our best to synchronize the LP with the CD version. The fact that the surface noise on the LP totally disappeared when I switched to the CD version was just a small part of the total difference. Played alone, the LP sounded fine. Played against the CD, all of us were suddenly aware of how much the LP version had been compressed. As one seminar attendee put it, the Billy Joel LP sounded "squashed," while the CD edition sounded open, "real."

That's been my experience with every CD player I've tested. Add to this wonderful sound the complete versatility and ease of operation found in the Phase Linear 9500, and you have an outstanding product. It seems very appropriate for the reincarnated company, under its new ownership, to be among the first American firms to deliver a CD player. Their latest line of amplifiers was specifically designed to handle the extremes of dynamic range encountered during the playing of digital discs. The 9500 used with, say, their new DRS 900 power amplifier (which I hope to review in a future issue) should make an unbeatable combination that won't place any limitations on the inherent capabilities of the Compact Disc system.

Leonard Feldman

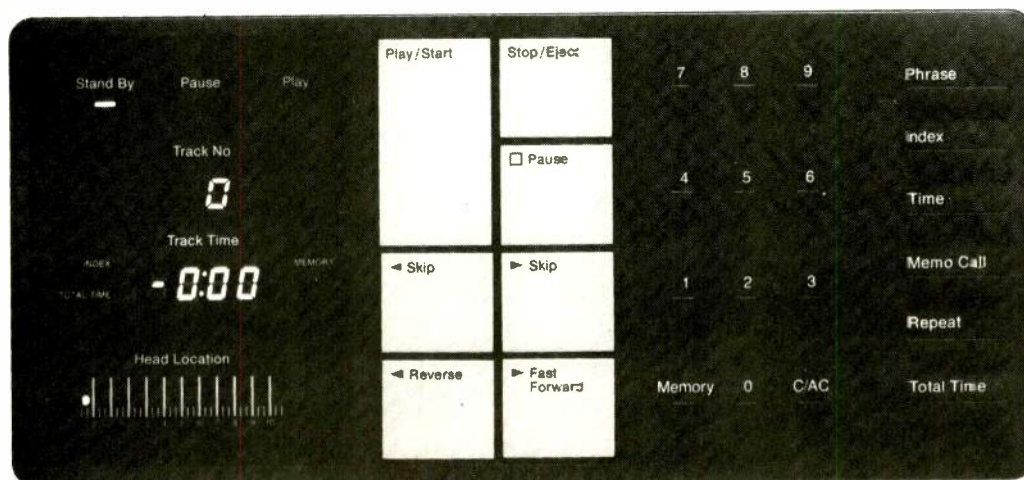

The 9500's display/control panel includes four basic sections: Operating status lights, basic function pushbuttons, memory programming, and memory or time-track readout controls.

2

SOTA SAPPHIRE TURNTABLE

Manufacturer's Specifications

Speeds: 33 $\frac{1}{3}$ and 45 rpm, electronic switching and fine adjust.

Motor Type: Brushless d.c. servo.

Drive Type: Belt.

Platter: 11.2 lb., cast alloy with damping.

Suspension: 20-lb. subassembly, 4-point system.

Rumble: -60 dB unwt'd.

Wow and Flutter: 0.04% wtd. rms.

Suspension Frequency: 2.55 Hz.

Weight: 44 lb. (20 kg).

Dimensions: 7 $\frac{1}{2}$ in. (19.05 cm) H (to top of dust cover) x 20 $\frac{1}{4}$ in. (51.4 cm) W x 16 $\frac{1}{2}$ in. (41.9 cm) D.

Price: \$750.00.

Company Address: P.O. Box 7075, Berkeley, Cal. 94707.

For literature, circle No. 91



SOTA, located in Oakland, Cal., is the only company in the U.S.A. presently making turntables. This is an amazing fact since, in past years, some of the finest turntables in the world were made in this country. All of the turntables sold here in the past few years have been imported, even those of audiophile quality. Rather than merely copying some previously successful turntable, Rod Herman, a mechanical design engineer and British expatriate, and David Fletcher, a physicist formerly with the University of California, have taken a fresh look at the functions a turntable is meant to perform and come up with a design which has many unique features. They have called their turntable the Sapphire, after the material used for the precision-ground thrust plate upon which the main bearing turns.

SOTA stands for "State of the Art," and the Sapphire turntable is designed and manufactured with state-of-the-art goals in mind. SOTA also makes the lower cost GEM turntables for Sumiko of Berkeley, Cal. The GEM-707 at \$725 and the GEM-747 at \$800 have many of the same design features as the SOTA Sapphire.

The objective technical measurements and subjective listening evaluations of the Sapphire turntable were made using the Sumiko MDC-800 tonearm and the Talisman S moving-coil phono cartridge. Comparisons between this combination and my present reference system were made by a listening panel. My practice is to make the technical measurements prior to the listening tests to insure that the turntable, tonearm and cartridge are functioning at their best and that no hidden defects, which could have been corrected, can invalidate these results. During the playing of each selection, members of the listening panel are asked to make notes, which will be discussed and compared later. There is no talking during the playing of selections, and the panel members are asked not to make any outward reactions which might be distracting.

After the listening tests, I try to correlate the comments of the listening panel with the technical measurements. During the technical evaluations, many measurements are made which never appear in the published report. They are necessary, however, to assure that nothing has been over-

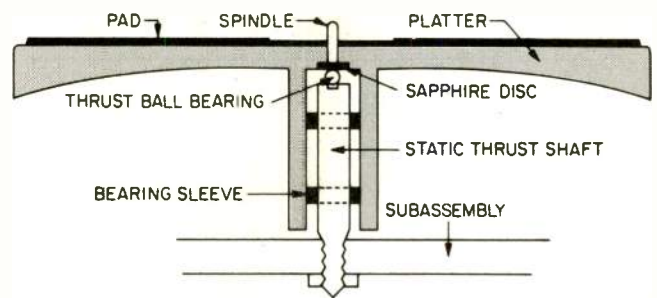

Fig. 1—Side-view drawing showing details of bearing and thrust disc. Note that bearing is at the platter's center of gravity.

looked which might affect performance and to provide insights which help in correlating the subjective judgments of the panel members. In this report, the comments made by members of the listening panel and the technical data are presented together and correlated where possible.

The "turntable that Newton would have built," as SOTA describes the Sapphire, incorporates many ingenious features. The main bearing, instead of being at the bottom of a bearing well as with other turntables, is up at the center of gravity in the middle of the turntable platter. Figure 1 shows the bearing container (it would be silly to call it a well), which is an integral part of the platter and rotates with it. Also shown in Fig. 1 are the two matched, sintered, bronze bearing sleeves; the sapphire thrust plate, and the thrust ball bearing attached to the static (non-moving), 0.55-inch diameter thrust shaft. This design prevents any tendency to wobble, because both the 11-pound mass of the aluminum platter and the belt which drives the platter at the rim are directly in line with the main bearing. The drawing also shows that most of the platter's mass is near the rim, providing a flywheel effect which improves speed stability. The platter is not removable and is shipped from the factory with transit screws which lift it to release the sapphire thrust plate from contact with the thrust shaft's ball-bearing tip. Note in the drawing that the platter pad, which is permanently attached, extends higher than the center and edge of the platter and allows the record to fit snugly so that unwanted mechanical energy may be dissipated. SOTA warns against the use of heavy record clamps and recommends only light, friction-lock clamps such as the Sumiko BA-20 stabilizer clamp I used.

The subchassis, upon which the turntable bearing and tonearm are mounted, hangs by four springs from the turntable base plate. Winding the springs in clockwise and counterclockwise pairs, and mounting them diagonally from each other, effectively cancels the tendency for rotational motion when the springs are flexed. The springs are matched by the factory to resonate with the mass of the turntable at 2.5 Hz. Since the Sapphire is shipped without an arm, the mass of the tonearm is unknown but is taken into

MEASURED DATA

Specification	Measured	Comment
Speed Stability	±0.18%	Excellent
Wow		
DIN unwdt.	0.24%	Very Good
DIN wtd.	0.11%	Very Good
Flutter		
DIN unwdt.	0.13%	Excellent
DIN wtd.	0.03%	Excellent
W&F		
DIN unwdt.	0.27%	Very Good
DIN wtd.	0.12%	Very Good
Drift		
Short-term	+0.32% to -0.27%	Very Good
Long-term	±0.10%	Excellent
Rumble		
Unwdt.	-65.2 dB	Excellent
Wtd.	-84.5 dB	Excellent
Suspension Resonance	2.67 Hz	Well Damped

"The Sapphire provides isolation from outside mechanical energy better than any turntable I have seen so far."

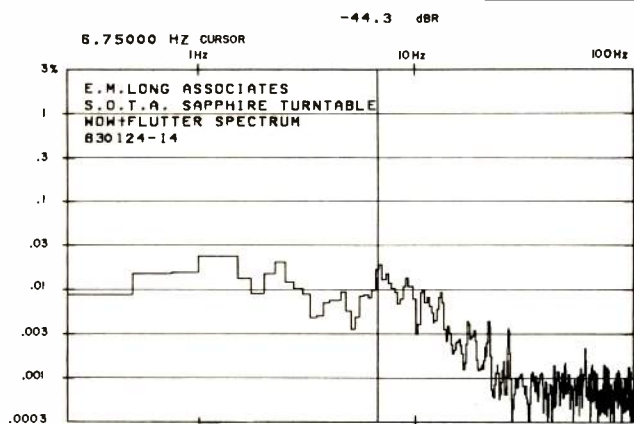

Fig. 2—Computer plot of wow and flutter spectrum, from 0 to 100 Hz. Frequency components are evenly distributed and very low in level, both excellent.

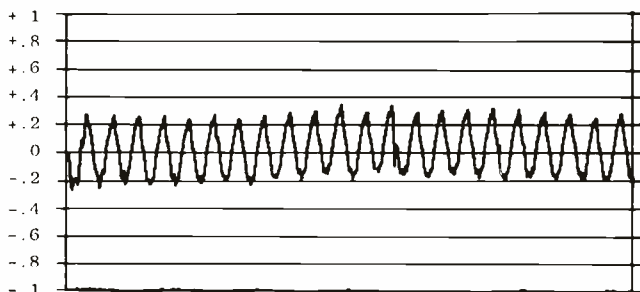

Fig. 3—Speed drift over a 41-S period. The variation at 5.6 Hz is related to one revolution at 33 1/3 rpm. The drift varies between +0.32% and -0.27%.

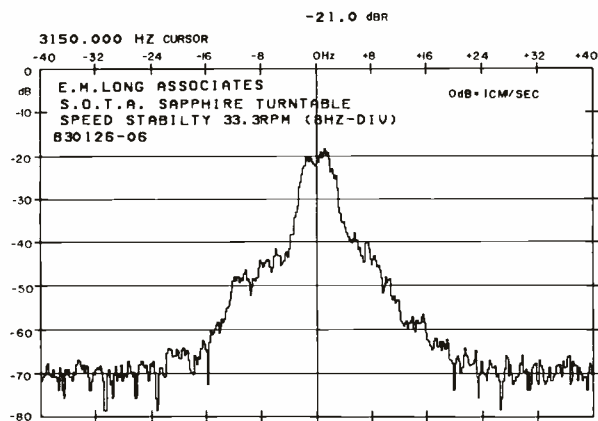

Fig. 4—Speed stability referenced to 3,150-Hz tone on B & K 2010 test record. The variation is very tight compared to most turntables.

consideration: A 2.5-pound bag of shot is supplied, and the turntable is set up and balanced with this in place on the tonearm mounting board. After the tonearm is mounted, some of the shot is poured into a well near the tonearm until the total mass of the tonearm and the shot equals 2.5 pounds. When this is done, the turntable is rebalanced. By this technique, arms of up to 2.5 pounds can be used with the Sapphire while still maintaining the 2.5-Hz resonance without any adjustment of the springs. The base, from which the subchassis is suspended, has over twice the mass of the subchassis and platter. I think this is very sensible since suspending a heavy subchassis from something light and flimsy, which itself is susceptible to environmental vibration, is no solution to, and indeed often only compounds, the isolation problem. The SOTA Sapphire turntable provides speeds of 33 1/3 and 45 rpm with pitch controls for each speed. The standard base is ash finished in oak, while an optional base of koa wood is \$100 more.

Measurements

Some of the data in this report appear different from those in my previous reports because a digital plotter was used instead of the usual photo of the display screen. The digital plotter is connected via the IEEE-488 buss to a Nicolet 660A-2D dual channel fast fourier transform analyzer (FFT), a Nicolet Explorer III dual-channel digital-storage oscilloscope, and a computer controller. After each test, the data, which have been analyzed and stored by the appropriate instrument, are transferred to the plotter. I hope this data format provides greater clarity than the photos used previously.

Speed accuracy and stability are very important aspects of turntable performance. While the simple wow and flutter numbers shown in the "Measured Data" table are quite good, the data shown in Fig. 2 are even more revealing of performance. This shows that the wow and flutter spectrum is well distributed, with no prominent component which would tend to add coloration to the sound. The listening panel made favorable comments about the clarity of the reproduction from the SOTA turntable, and lack of flutter seems to be a major reason for this impression.

Figure 3 is a 41-second recording of the variation in the 3,150-Hz wow and flutter test tone of the B & K 2010 test record. The output is taken from the drift output of the wow and flutter meter. At precisely 3,150 Hz, the d.c. output is 0 V. If the tone increases in frequency, the d.c. voltage goes positive, which indicates that the turntable speed has increased; the d.c. output voltage goes negative for a decrease in speed. The variation shown occurs at exactly one revolution of the platter at 33 1/3 rpm. The short-term drift is from +0.32% to -0.27%. A very slight average drift can be seen over the 41-second period, but it is well within 0.1%. Figure 4 shows the same data in another form, which indicates how accurately the speed is maintained in terms of the same 3,150-Hz tone. In this case, the major spectral components, down to about 20 dB below the average, indicate that the speed variation is about $\pm 0.18\%$. Bear in mind that all these tests include the speed stability problems inherent in any test record. The data presented in Figs. 3 and 4 show that the SOTA Sapphire turntable has excel-

“The listening panel commented favorably about the clarity of reproduction. The lack of flutter seems a major reason for this.”

lent speed accuracy and stability, and the comments made by the listening panel with respect to the clarity and definition of the sound reproduction attest to this. In fact, comparisons between the SOTA and the reference turntable, in this regard, caused the panel much difficulty; the conclusion was that comments about the performance of each turntable, when playing even difficult program material such as piano, left no clear winner between the two.

Figure 5 shows the rumble spectrum of the SOTA Sapphire turntable. In this case, 0 dB is referenced to 10 cm/S, which is the standard level for rumble measurements. The main component of rumble at 10 Hz is due to the natural resonance of the tonearm mass reacting with compliance of the cartridge. The level of this component is 36.8 dB below the 10 cm/S reference and is very good. The rumble spectrum is very smooth, with no components which would tend to color the background noise. The component at about 23 Hz is an artifact of the B & K 2010 test record. The “Measured Data” table shows the unweighted rumble is -65.2 dB, which is better than the 60 dB minimum claimed, while the weighted rumble is -84.5 dB. When playing copies of identical records simultaneously on both the SOTA and the reference turntable, no difference in level or coloration of the background noise could be distinguished between the two.

In the past few years, a great deal of attention has been directed to the problem of energy control and dissipation in phono sound reproduction. The problem can be divided into at least three separate areas: Energy internal to the disc caused by the playing of the record by the phono stylus, external mechanical vibrations transmitted through the suspension, and acoustical energy transmitted through the air. These three forms of energy are picked up by the stylus and added to the desired signal. The quality of the sound reproduction is improved if they are reduced.

Figure 6 shows the average level of spectral components caused by a series of mechanical impulses to the edge of a stationary record while the phono stylus is resting in a groove. These mechanical impulses cause energy to be released in the record. The mechanical energy versus time is displayed in Fig. 7. The higher frequency energy lasts for only about 30 mS, but the low-frequency energy at about 60 Hz lasts for over 200 mS. This indicates that the SOTA turntable mat (which, by the way, is nonremovable) is quite effective in damping high-frequency energy but is less effective at lower frequencies. The greatest energy level is at 62.5 Hz and 162.5 Hz but is at least 30.7 dB down from the 0 dB = 1 cm/S reference level. There is, however, a broad band of energy from about 880 to 1,350 Hz—which could be the reason that all of the panel members commented that the sound reproduction, particularly brass and strings, was brighter and sharper from the SOTA than from the reference turntable.

One of the requirements for a good turntable is that it be well isolated from external mechanical forces which could interfere with sound reproduction. To be state of the art, it is not enough that a turntable be isolated from forces which could cause catastrophic interference effects; its suspension system must provide a high degree of isolation from any intrusion of outside mechanical influences into the reproduced sound. The SOTA Sapphire provides this type of

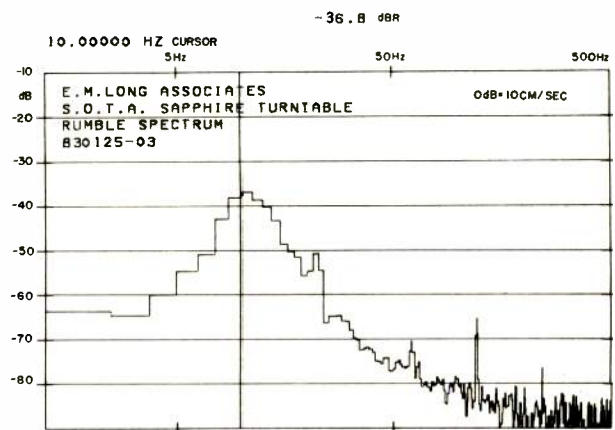

Fig. 5—Rumble spectrum. Main output is from tonearm/cartridge resonance at 10 Hz.

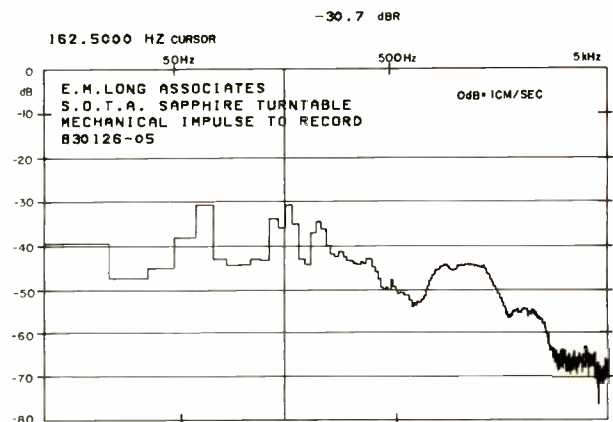

Fig. 6—Spectrum (to 5 kHz) of vibrations caused by mechanical shock to edge of record, with stylus resting in groove. The damping of internal energy is very good, with the major components at 62.5 and 162.5 Hz.

isolation better than any turntable I have seen or tested so far. Figures 8 and 9 display the spectrum and the output versus time from an external mechanical shock applied to the extremely massive test stand upon which the SOTA turntable was mounted during the laboratory tests. The spectrum information of Fig. 8 shows that the level of any individual frequency component is greater than 30 dB below the 1 cm/S reference level. The output versus time response of Fig. 9 indicates that the higher frequency components are greatly diminished within the first 200 mS and that the resonant frequency of the turntable mechanical suspension is 2.67 Hz, extremely close to the 2.55-Hz specified.

Figure 10 shows the spectrum due to the presence of a sound pressure level of 100 dB at the surface of the turntable platter. The stylus is once again stationary in a groove

"The rumble spectrum is very smooth, with no components which would tend to color the background noise."

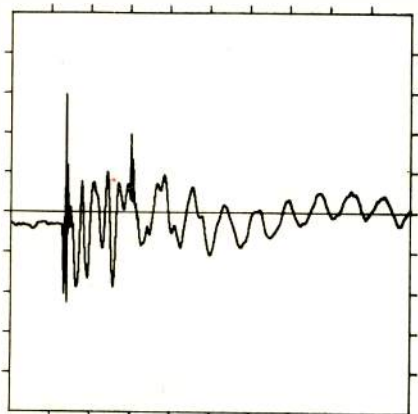

Fig. 7—Output vs. time response of the impulse of Fig. 6. The spectrum of

Fig. 6 was derived from this using a fast fourier transform analyzer.

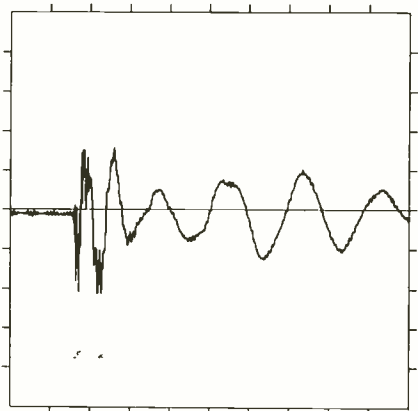

Fig. 9—Output vs. time response of the impulse of Fig. 8. The low-frequency oscillation is at 2.67 Hz and is due to the

mass of the turntable and the compliance of the springs. The period of measurement is 2.05 S.

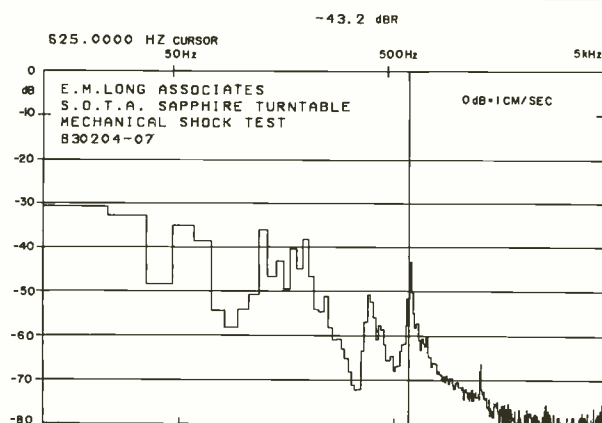

Fig. 8—Spectrum (to 5 kHz) of vibrations caused by mechanical shock to massive platform on which the

turntable rested. The turntable exhibits excellent isolation from external shock.

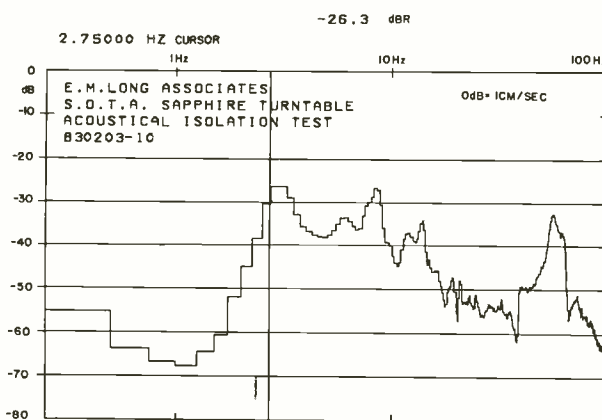

Fig. 10—Spectrum (to 100 Hz) of vibrations from a 100 dB acoustic field at the cartridge position. Cartridge is resting in a

groove near the middle of a record. Isolation from the acoustic field is excellent.

near the middle of the record. The major output is near the suspension resonance, but it is 26.3 dB below the 1 cm/S reference, which is very low. The next highest output is, as might be expected, at the tonearm/cartridge resonance of 10 Hz. There is output of significance at about 60 to 65 Hz, but even this is at -34 dB.

Use and Listening Tests

The overall impression of the listening panel was corroborated by the measurements very well. The comments were mostly directed toward a very slight brightness or sharpness in the sound when compared with the reference turntable. The data in Fig. 8, which shows the effect of the energy stored in the disc itself, reveal that the energy between 880 and 1,350 Hz is not dissipated very quickly (even though it is at a low level) and therefore does tend to color the sound

and add a bit of brightness. This brightness was only noticeable when recordings of strings or brass were played simultaneously on the SOTA and the reference turntables, and the two discs are directly compared by switching between them. In fact, the listening panel had great difficulty in discerning any difference between the turntables on most program material. The deep bass was solid, the upper bass was well defined, the quality of male voice was very good, and the stability and clarity of the stereo image were good on both. The point which put the SOTA Sapphire turntable ahead of the reference turntable was its stability and isolation from environmentally induced mechanical or acoustical energy which could affect the sound. I feel that the SOTA Sapphire turntable is excellent at any price. At its present, reasonable price, it is an exceptional value.

Edward M. Long

You'll be sold on our DRS 900 amplifier after just one peak.

Our new DRS™ 900 amplifier will bring you as close as you can get to concert hall sound without buying a ticket. How? Power and lots of it. And after all, who knows more about high power amplifiers than Phase Linear? We became known for them back in the days when everyone's idea of good stereo was loud stereo. If you could blow the windows out of your home, you had a good stereo. And nothing could blow out windows like an amplifier from Phase Linear. Well, the volume era is over. The quest for purity is on. The trouble is, you just can't

get pure sound reproduction out of a low power amplifier. You need lots of power... power for purity. Advances in recording technology like direct-to-disc and digital audio disc recordings require enormous amounts of peak power. Without it, the amplifier simply clips the peaks leaving you without the full musical experience. For example, accurately reproducing the final cannon shot from a digitally recorded version of

Tchaikovsky's 1812 Overture can require 900 watts of peak power! And that's at reasonable volume levels. That much power is needed because the dynamic range (the ratio of the loudest note to the residual noise) of a digital audio disc is about four times that of a conventional record.

get pure sound reproduction out of a low power amplifier. You need lots of power... power for

purity. Advances in recording technology like direct-to-disc and digital audio disc recordings require enormous amounts of peak power. Without it, the amplifier simply clips the peaks leaving you without the full musical experience. For example, accurately reproducing the final cannon shot from a digitally recorded version of

Our DRS 900 handled the previously mentioned cannon shot. No clipping, no distortion. Yet, the DRS 900 is conservatively rated at 150 watts per channel RMS (see specifications). You see, efficient power is the key. The DRS 900 has a dual voltage power supply. It operates at an efficient 150 watt capability. Then, when the music approaches a peak requiring more dynamic headroom (more power to keep it from clipping), the

secondary supply kicks in, instantly providing up to 900 watts of peak power per channel. A conventional 150 watt amplifier has a peak power rating of just about 300 watts. Keep that in mind the next time you're comparing amplifiers. Don't go by RMS alone. You have to compare dynamic headroom, too. When you do, you'll be sold on our DRS 900.

See the entire line of Phase Linear audio

components at your Phase Linear Dealer, today. For the address of the dealer nearest you, call us toll

free at (800) 323-4815. In Illinois call (800) 942-

DRS 900 SPECIFICATIONS
150 Watts per channel continuous output power, minimum RMS into 8 ohms, with no more than .015% total harmonic distortion, 20-20kHz. 900 Watts peak per channel momentary output power into 8 ohms with no more than .02% THD, 20-20kHz.

8833. Or write us at 4134 N. United Parkway, Schiller Park, IL 60176. Oh, and remember to give us your address so we can send you a copy of "The Phase Linear Report: Power for Purity." It's an exciting analysis of audio amplification in the eighties. We think it should be required reading for anyone serious about audio.



phase linear
Power for Purity™

Enter No. 19 on Reader Service Card

3

MAGNAVOX FD1000SL COMPACT DISC PLAYER

Manufacturer's Specifications

Frequency Response: 20 Hz to 20 kHz, ± 0.3 dB.

Dynamic Range: Greater than 90 dB.

S/N Ratio: Greater than 90 dB (20 Hz to 20 kHz).

Channel Separation: 86 dB (20 Hz to 20 kHz); 90 dB at 1 kHz.

Total Harmonic Distortion Plus Noise: Less than 0.005%.

Wow and Flutter: Unmeasurable, quartz-crystal precision.

Line Output Level: 2 V rms.

Power Consumption: 20 watts.

Dimensions: 12.6 in. (32 cm) W \times 2.87 in. (7.3 cm) H \times 10.51 in. (26.7 cm) D.

Weight: 11 lbs. (5 kg).

Price: \$800.00.

Company Address: c/o NAP Consumer Electronics Corp., P.O. Box 6950, Knoxville, Tenn.

For literature, circle No. 92



Billed as the smallest Compact Disc player in the world, this attractively styled unit is also the lowest priced of three models to be offered by Magnavox. Magnavox, as you probably know, is a wholly owned subsidiary of North American Philips. And North American Philips, in turn, is owned by Philips of Holland, to whom must go the primary credit for the development of the CD format, which has already become an international standard. Although credit for the disc and player is generally shared by Philips and Sony, the truth

is that Sony's primary contribution was in the area of the error-correction systems that were ultimately adopted. It was Philips which began work on the digital disc idea way back in 1969 and 10 years later showed the first working system to the European press.

The unit I tested, in fact, bore the model number CD-100, suggesting that it was actually a sample of the Philips model being sold in Europe, with its power supply modified for use in the U.S. We are told, however, that the configuration and

all of the features of this model are otherwise identical to the Magnavox FD1000SL, which will be the American designation for this truly compact Compact Disc player.

Magnavox maintains there are subtle differences in the quality of sound reproduction between various manufacturers' CD players, and they attribute this to technical differences in the way the players reproduce sound. The main difference is in the signal-conversion process from digital back to analog. All of the units I have tested to date (with the exception of the Phase Linear Model 9500) use straight 16-bit D/A converters with steep analog filters. Some listeners maintain that the use of a sharp cutoff filter results in considerable phase shift in the 20-kHz region; they perceive this as detrimental to proper stereo imaging and reproduction of transients.

The Magnavox player incorporates three techniques that are said to provide the effectiveness of a pure 16-bit system, but which require a simpler digital-to-analog converter with simpler filters. First, "oversampling" is used. This has the effect of reducing noise in the audio band by an additional 6 dB. The technique involves sampling the digital signal at four times the normal rate, thereby distributing the noise over a broader spectrum. Secondly, digital filtering is used to remove ultrasonic components while maintaining phase linearity up to 20 kHz. Finally, noise shaping is used to reduce noise in the audio band by an additional 7 dB while increasing noise outside the audio band. The unwanted high-frequency noise is then eliminated with simple analog filters.

Unlike any of the CD players I have previously tested, the FD1000SL is a top-loading unit. Depressing a designated area on the see-through hinged door on the player's top surface causes that door to pop open. The Compact Disc is simply placed on the exposed center spindle, and the door is closed manually. All remaining controls and displays are on the gently sloping front surface. A power on-off pushbutton is at the extreme left. A display area labelled "Track Program Selector" occupies the same left-to-right length of the sloped surface as does the disc-loading door on the top surface, making for an extremely pleasing and integrated look. When power is first applied, a bank of green LEDs, numbered from 1 to 15, illuminates. If the "Play" button to the right of the display area is then depressed, disc playing will commence from the first track and an additional row of LEDs below the "program" LED bank will display the current track being played. "Pause" and "Stop" buttons are located alongside the "Play" touch button. An additional LED lights up in the display area when the "Pause" button is activated. Touching the "Pause" button a second time causes play to resume and extinguishes the "Pause" LED.

In addition to this straightforward approach to the playing of Compact Discs, the FD1000SL offers several other options, including programming of desired selections on a disc in any given order. Four tiny touch buttons further to the right are identified as "Select," "Store," "Cancel" and "Repeat." Pressing the "Repeat" button causes the entire disc to be played over and over again until the button is depressed a second time or until "Stop" is depressed. While in the repeat mode, another LED in the display area lights up to indicate that fact. The three remaining buttons in this area



Booklet, demo disc and cleaning cloth packed with the player.

provide the user with two different methods of programming. The "Select" button, when depressed, moves the "track" LED in the display, one track at a time, to any desired track from 1 to 15. When the desired track you want to hear first is indicated, touching the "Store" button places that track number in "memory." By repeating this sequence of operations, a method referred to in the owner's manual as "Add-In Programming," you can program in as many tracks as you like, in any order you choose.

An alternate method of programming, called "Take-Out Programming," is used if you want to hear most, but not all, of the selections contained on a particular disc. In that case, the "Select" button is used to bring the moving LED to the track that you *don't* want to hear, and the "Cancel" button is then touched. Upon completing this routine, the appropriate LED in the upper bank of "Track Program Selector" LEDs is extinguished, indicating that that particular track will be skipped when it is reached. The procedure is repeated until all undesired tracks have been selected. If the "Play" button is then depressed, disc play will commence and will proceed in order, from track to track, skipping only those tracks that you have "cancelled."

The remaining two touch buttons on the sloped front panel are "Search" buttons that are used to advance the laser rapidly in either forward or reverse direction. Although there is no sound heard when using the "Search" buttons, the current track being scanned at any instant by the laser pickup is indicated by an appropriate LED in the display. If you should inadvertently hold down a forward or reverse search button so that the laser reaches the end (or the beginning) of the disc, an "Error" light will come on.

In this Magnavox player, the emphasis is clearly on purity of sound reproduction and ease of programmability. Certain features I have encountered on other CD players have been omitted, however. For example, no time indications are provided, either as to time remaining on a disc or time into a given track being played. No doubt some of Magnavox's more expensive models to be offered in the future will incorporate additional features.

"In this Magnavox player, the emphasis is clearly on purity of sound reproduction and ease of programmability."

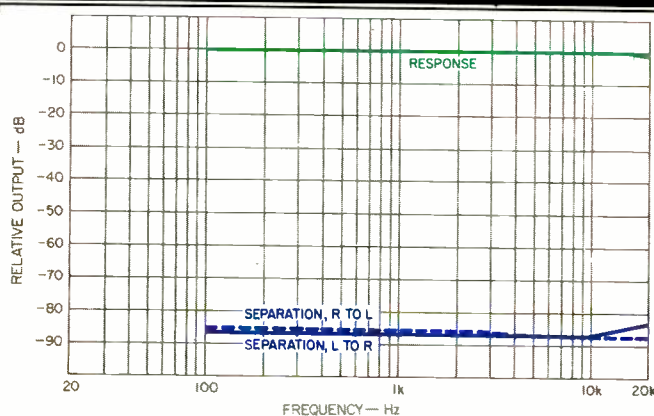

Fig. 1—Frequency response and stereo separation.

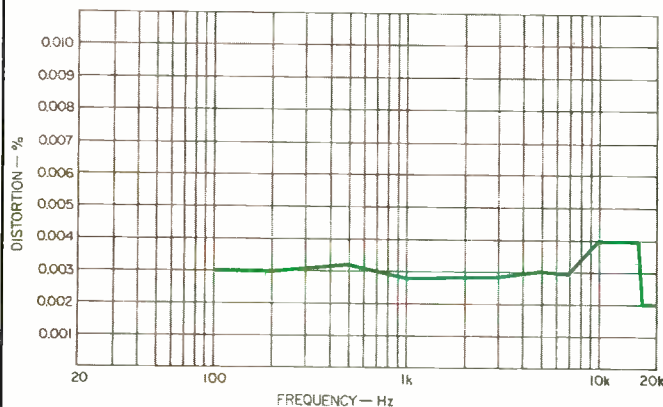

Fig. 2—Harmonic distortion vs. frequency.

Measurements

A point-by-point plot of frequency response (upper curve) and channel separation capability for the Magnavox FD1000SL is shown in Fig. 1. Maximum departure from flat response in the range covered by the test disc (100 Hz to 20 kHz) was never greater than 0.2 dB, and even that deviation was noted only for the 18- and 20-kHz test signals. Separation, represented by the lower curves in Fig. 1, ranged from 83 to 87 dB for left-to-right channel crosstalk and from 86 to 87 dB for right-to-left channel crosstalk.

Harmonic distortion versus frequency at 0 dB is shown in Fig. 2; readings ranged from 0.002% to 0.004%. At the -10 dB level of the 1-kHz test tone on the disc, THD rose to a still completely insignificant 0.0085%. At -20 dB level, THD increased somewhat further to 0.023%.

Decreasing-amplitude 1-kHz test tones were also used to check linearity of the playback system. Absolutely perfect linearity was noted from 0 dB level all the way down to -60 dB. At -80 dB, linearity seemed to be off by 1.0 dB, and at

-90 dB I read an output of -88 dB, which may well have been residual noise in my test setup rather than actual departure from true signal linearity.

Signal-to-noise ratio measured 92.5 dB, unweighted, increasing to 99.5 dB when an A-weighting filter was inserted in series with the measuring instrument. At 0 dB recording level, SMPTE IM measured 0.0056%, increasing to 0.013% at -10 dB level. Measurements for CCIF (twin tone) IM were 0.0010% and 0.0025% at 0 and -10 dB record levels, respectively. De-emphasis was accurate to within 0.1 dB at the three test frequencies of 1, 5, and 10 kHz included in the test disc.

Use and Listening Tests

Happily, my collection of CD records is growing by leaps and bounds. I now own more than a dozen of these amazing little discs, and I am pleased to report they are getting better and better, musically speaking. Someone out there must be listening to those of us who have suggested that new mixing techniques and approaches (or are they really "old techniques" after all?) are going to be needed if the Compact Disc's potential is to be realized. Two recent acquisitions are from RealTime Records (Miller & Kreisel Sound Corp.). One is from their "Digital Masterpiece Series," Zoltan Rozsnyai conducting The Philharmonica Hungarica in selections by Brahms, Berlioz, Chabrier, Rossini, Bizet, Dvorak, Dukas and Liszt. The other, *Real Hot Jazz*, features jazz-band music by the likes of Don Menza, Jack Sheldon, John Dentz and Freddie Hubbard and their assorted musical aggregations. If you want to know how totally thrilling digital disc reproduction can be, drop either of these (depending upon your musical taste) into any CD player and you'll be an immediate convert.

Could I hear a "difference" between the sound produced by the Magnavox unit and my own reference CD player? Frankly, no! The new discs sounded absolutely superb on both. This is not to say that you won't be able to detect some subtle differences if you listen long enough. All I'm saying is the CD experience is so overwhelming compared to any analog listening I've done over the years, that straining to pick out hitherto undetectable flaws seems a pointless exercise to me. I prefer to enjoy the music—as I've never enjoyed it before—and to thank the people at Philips (and, yes, those at Sony, too) for bringing this miracle to us during our lifetimes.

This much I will say: The earliest CDs in my collection, and those that were produced from less-than-excellent analog master tapes, point up their failings on any type of CD player, while the most recent Compact Discs sound good on both the Magnavox and my reference player. In that connection, the Philips unit I received for testing was magnificently packaged. Included with it was a Philips Compact Disc containing 14 cuts, eight of them pop music, the rest in the classical domain. This disc, too, offered a superb example of how CDs should be engineered. Magnavox would be wise to offer their version of the player packaged just as it was by Philips, including this magnificent sampler. As for the Magnavox CD player, its small size, excellent design in terms of ergonomic factors and its relatively low price make it a sure winner.

Leonard Feldman



* in-no-vā-tion

(a new idea, method or device)

At JVC, innovation is a philosophy that has always been translated into improved *performance*. Some of the most important improvements—innovations you may take for granted—were introduced by JVC. The list includes the world's first metal-capable cassette deck, quartz-servo controlled turntables, and fine-ceramic speaker diaphragms.

More recently, we've refined the Super-A amp circuitry we originated; it reduces six different kinds of distortion down to imperceptible.

You're also invited to consider the Jewel-Lock head assembly, as found in our auto-reverse cassette decks. It sets the standard for the next generation of audio, because it maintains peak performance in both directions of tape travel, while accomplishing reverse action silently and in no more than .4 seconds.

Now imagine a speaker system with a frequency response range from 35 Hz to 100,000 Hz. With a ribbon tweeter element weighing just 22 milligrams. The only word for its output: *pure*. The only

name on its enclosure: JVC.

The list goes on. There's the JVC turntable with a computer controlled linear tracking tonearm, and a double-servo quartz-control system that's a work of science *and* a work of art.

So is the JVC computer-controlled synthesizer tuner with four tuning modes and a highly obedient mind of its own.

But perhaps the best suggestion of all is to check it all out. Drop in at a JVC listening room.

And listen to the sound of innovation.

JVC®

JVC COMPANY OF AMERICA
High Fidelity Division
41 Slater Drive, Elmwood Park, N.J. 07407
JVC CANADA INC., Scarborough, ONT.

Enter No. 11 on Reader Service Card

4

SOUNDCRAFTSMEN AE2000 ANALYZER- EQUALIZER

Manufacturer's Specifications Equalizer Section

Harmonic Distortion: 0.01%.

IM Distortion: 0.01%.

S/N Ratio: 114 dB at maximum output.

Filter-Band Control Range: ± 15 dB.

Unity-Gain Control Range: 18 dB.

Filter Type: Passive wirewound coil inductors.

Analyzer Section

Differential/Comparator® Accuracy: 0.1 dB.

Input Impedance: High level, 47 kilohms; mike, 2 kilohms.

Maximum Gain: High level, 30 dB; mike, 80 dB.

Frequency Response: 20 Hz to 20 kHz, ± 0.1 dB.

Filter Centers: 30 Hz, 60 Hz, 120 Hz, 240 Hz, 480 Hz, 960 Hz, 1.92 kHz, 3.84 kHz, 7.68 kHz, and 15.36 kHz.

General Specifications

Dimensions: 19 in. (490 mm) W \times 5¼ in. (135 mm) H \times 11¼ in. (290 mm) D.

Weight: 28 lbs. (12.7 kg).

Price: \$699.00.

Company Address: 2200 South Ritchey, Santa Ana, Cal. 92705.

For literature, circle No. 93

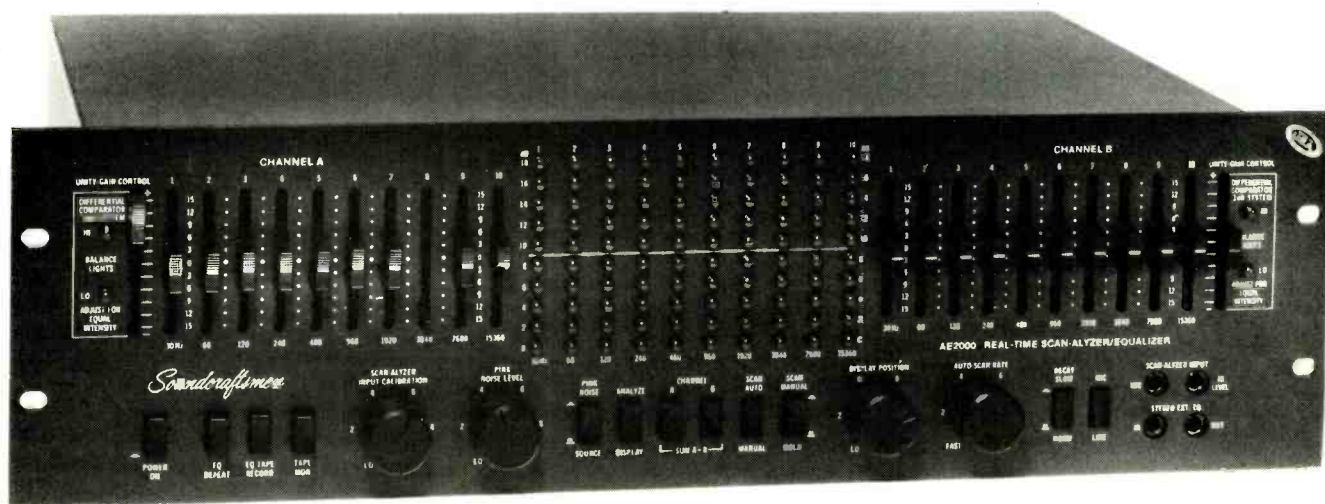

The Soundcraftsmen AE2000 combines a real-time analyzer, a graphic equalizer, a pink-noise source, and Soundcraftsmen's excellent level comparator scheme to make what they call a Real-Time Scan-Analyzer/Equalizer. The RTA display dominates the center of the front panel, with a column of 10 LEDs for each of the 10 filter bands, which are octave-spaced from 30 Hz to 15.36 kHz. The vertical col-

umns have 2 dB steps, from 0 to 18 dB. There is a horizontal white line between "8" and "10," which makes for a good level reference; it is aligned with the center position of the filter sliders.

Each of the filter controls has a range of ± 15 dB. The associated unity-gain sliders, one for each stereo channel, have a range of 18 dB for adjusting the equalized-signal

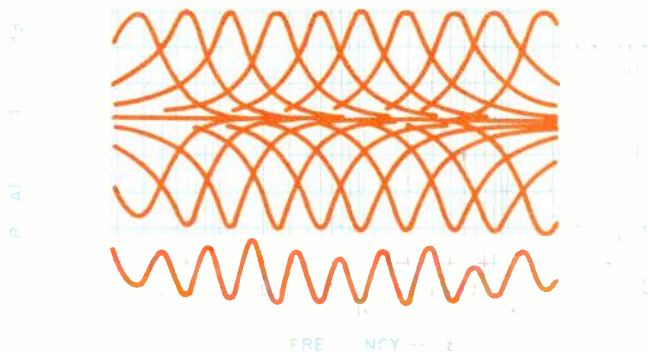

Fig. 1—Swept-frequency responses of each filter section at maximum

boost and maximum cut, and with all sections at maximum cut.

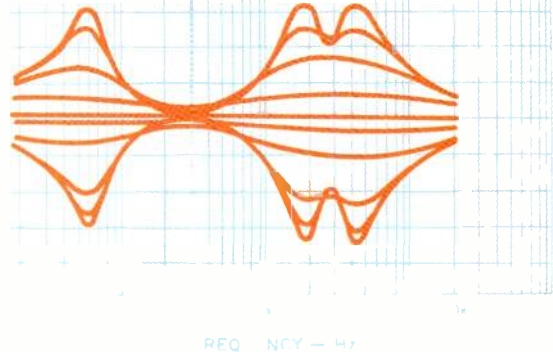

Fig. 2—Swept-frequency responses with 60-, 1,920- and 3,840-Hz filters set successively for 3 dB

steps from -15 to +15 dB. Note that +12 and +15 dB curves overlap completely.

gain to 0 dB, matching the EQ-out gain. Two LED balance lights adjacent to each unity-gain slider show how to adjust that slider to restore unity gain. The indicators provide definite and accurate (to 0.1 dB) feedback to the user when any gain adjustments are needed. The scheme is an excellent one, and Soundcraftsmen has interfaced it with the RTA for fast and accurate sound-system equalization.

The Scan-Alyzer is a special function of the RTA, which normally shows the levels in all 10 bands simultaneously, although rapid scanning is actually taking place. A switch from "Display" to "Analyze" changes the RTA to one that steps from filter to filter, either with a push of "Scan Manual" or with an adjustable stepping rate in "Scan Auto." The output of the internal pink-noise generator is bandpass-filtered to the same octave as the RTA, and the filtering is stepped in synchronization in either scan mode. The sound-system output is fed into the "Scan-Alyzer Input" phone jacks, "Mic" or "Hi Level." The "Pink Noise Level" pot is used to set a good level for equalizing—well above background noise, without being excessively loud. The "Scan-Alyzer Input Calibration" pot is adjusted for balance, using the comparator LEDs, in "Display" mode. Then, a switch to "Analyze," and the balance in each octave band is examined and adjusted in turn, while stepping manually or with "Scan Auto." Each stereo channel is selected in turn for this equalization. The equalizing is much more accurate than with other units because the adjustments are made with the aid of the high-accuracy comparator, not by trying to read the imprecise indications of an RTA display.

There are also rotary controls for "Auto-Scan Rate" (from about 1 second for all 10 bands to about 10 seconds per band) and for "Display Position," which is operational in all RTA modes.

To the right of these knobs are pushbuttons marked "Decay Slow/Norm" (for the display) and "Mic/Line" plus jacks for the "Mic" and "Hi Level" Scan-Alyzer inputs and "In" and "Out" jacks for Scan-Alyzing with an external equalizer. The "Mic/Line" description does not tell the whole

story: For Scan-Alyzer use, the switch is left in "Mic" position, and the signal to be analyzed is fed into the "Mic" or "Hi Level" phone jack. For RTA use, the switch selects between the front-panel "Mic" input and the rear-panel line outputs. With the "Pink Noise/Source" switch in "Source" position, the "Line" setting will display the equalized signal; one must press "EQ Defeat" to see the unequalized signal that is coming in via the rear line inputs.

That "EQ Defeat" switch is grouped with the "EQ Tape Record" and "Tape Mon" buttons, at the far bottom left. These three are not pushed in during normal equalizer operation. The power switch is to their left.

Eight phone jacks on the rear panel provide in/out connections for a preamp/receiver (or perhaps a mixing board) and a tape recorder. Adaptors to phono jacks are provided.

Removal of the heavy steel top and side cover revealed three large p.c. boards with quality components and very good soldering. Intercard connections were made with wire-wrap. None of the parts were identified. All of the DIP ICs were mounted in sockets, and the single fuse was in a clip. Cabling used twisted wires without an outside shield. The inductors used in the filters appeared to be well made. The box chassis was fairly heavy and rigid, but some sections of the cards were a bit springy.

Equalizer Section Measurements

With all of the sliders set in their center detents, the frequency responses were flat within ± 0.5 dB from 20 Hz to 20 kHz with EQ, and within ± 0.2 dB with EQ defeated. During this test, the balance lights indicated the discrepancies with EQ at the ends of the band, and a touch of the sliders to match the two LEDs reduced the deviation with EQ to less than 0.1 dB. The 3 dB down points were at 0.8 Hz and 112 kHz with EQ, and at 0.8 Hz and 290 kHz without.

Figure 1 shows the swept-frequency response plots of each filter section at maximum boost and cut and with all filter sections at maximum cut. (The response with all sections at maximum boost was pretty much a mirror image of

"Equalizing with the AE2000 is more accurate than with other units, because adjustments are made with the high-accuracy comparator."

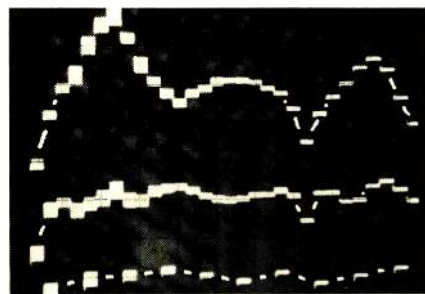

Fig. 3—System equalization test. Simulated room response curve (top), response after analysis and equalization using Scan-Alyzer (middle; top and middle curves shown

with 1/3-octave resolution), and equalized response with octave-band resolution (bottom).

the maximum-cut plot.) The spacing of the filters was even, and the filter shapes were quite consistent, reflected in the constant level of the crossovers of the individual filter responses. The measured center frequencies of the filters were all within 5.3% of the specification, and the average discrepancy was an excellent 2.7%. The maximum boosts were 15.6 dB or more, with the exception of the 30-Hz filter which was very close to the 15 dB spec with 14.6 dB of boost. The maximum cuts were 15.1 dB or more for all filters in a static test, although the swept response showed less cut than that with the 30-Hz filter. As the discrepancy was considered unimportant, it was not investigated further.

Figure 2 shows the swept responses obtained with three filters set at maximum cut and then shifted in steps of 3 dB for each successive sweep until reaching maximum boost. As with most graphic equalizers, the steps close to zero (center detent) change signal level throughout the band, and the response deviations do not match the scale values. This is especially true at maximum boost: The +12 and +15 responses were exactly the same, as shown.

With the 480-Hz filter, a one-octave bandwidth was reached with a boost of 11.2 dB, higher than most such equalizers. This signifies that the filters are on the broad side, but also that one can therefore add more boost than usual before the onset of ringing. The practical limit to minimize the possibility of ringing was a boost of 9.1 dB, at which point Q was 1.0, and the bandwidth was 1.4 octaves.

The unity-gain slider had a range from -14 to +6 dB, with 0 dB gain at the center detent. With all sliders in detent, the change in gain with EQ out was less than 0.1 dB. Level matching with the Soundcraftsmen comparator was within ±0.1 dB across the entire band at any level above 60 mV. The maximum input/output levels were 9.2 V from 20 Hz to 20 kHz, open-circuit, dropping to 8.5 V at the frequency extremes with a 10-kilohm load. The input impedance was 27 kilohms over most of the band, dropping to a somewhat low 12.8 kilohms at 20 kHz. (This would not be a problem for

most of the latest equipment, but units with source impedances of 1.7 kilohms or higher would have a drop of 1 dB or more at 20 kHz.) The AE2000 had a desirably low output impedance of 550 ohms or less.

The harmonic distortion at 2 V was a very low 0.0025% over much of the band, rising slightly at the low-frequency end and rising to 0.032% at 20 kHz. The distortion figures at 20 kHz for the left channel were somewhat higher, and it was noted that there was some positive-going slew-rate limiting at 2 V and 24.1 kHz. The right channel showed slight indications of such limiting at 2 V, but not until 90 kHz. Replacing one of the DIP ICs would probably get the left channel to match the right. With all sliders in detent, the signal-to-noise ratio was 94.3 dBA relative to 1 V, 88.3 dBA relative to the EIA standard reference of 0.5 V. The ratio was 113.6 dBA relative to the maximum output of 9.2 V, which is certainly very close to the specification of 114 dBA, but maximum output is an unrealistic reference. With various combinations of slider positions, it appeared that figures of about 5 dB less would be more likely (for all references) in normal use.

Analyzer Section Measurements

The center frequencies of all of the RTA filters were within 5% of specification, with the exception that those for 30 and 120 Hz were about 7% high, still quite good. The peak responses of the filters were very close, with a total spread of 1.0 dB. At the center of the immediately adjacent bands, the filter responses were down about 7.5 dB. They were down a little over 14 dB in the center of the second bands over, at which point the final 6 dB/octave slopes were well established. These are expected results from fairly high-Q, single-tuned circuits. Although it would be desirable to have more rejection of adjacent-band energy, the design is quite adequate for the intended purpose. The 2 dB steps of the vertical columns were accurate, with a total error spread of 0.6 dB over the range of 18 dB. For a 10 dB change, the display required about 30 mS to reach full indication in "Normal." In "Slow" about 40 mS was required at the lowest frequencies, but only 15 mS or so at higher frequencies. The big difference was in decay time, with 0.55 S for "Normal" and 8 S for "Slow."

The high-level input sensitivity for an RTA display and functioning of the Scan-Alyzer was 16 mV to 1.6 V, depending upon the pot settings. The mike input sensitivity showed the same 40 dB range, but from 50 μV to 5 mV. Operation was generally more satisfactory with levels three to five times higher than the minimum figures given. The input impedances were 2.2 kilohms across the band for mike and 27 kilohms for high level, with an unimportant reduction to 22 kilohms at 15.36 kHz. The pink-noise output could be set anywhere from 30 μV to 380 mV, with a minimum of 20 mV required for a good RTA display. The spectrum was fairly flat for most of the pot rotation, but there were some variations. These deviations were judged quite unimportant, because the Scan-Alyzer matches levels band by band, deviated or not. In other words, the comparator measures only relative level differences between the pink noise and the system output in each band. If the pink-noise signal were 2 dB low in the 7.68-kHz band, for instance, it would lower the

"With the sliders centered, response was flat within ± 0.2 dB; but using the LEDs, a touch of the sliders reduced deviation to less than 0.1 dB."

input 2 dB on both sides of the comparator, cancelling out that difference; only the variations due to the system's response would register on the Scan-Alyzer LEDs.

Band-limiting of the pink-noise output is an essential element in the Scan-Alyzer method of equalizing band by band. The pink-noise outputs in the "Analyze" mode are peaked at the center frequency of the band under test, rolling off above and below that point.

Use and Listening Tests

The AE2000 was supplied with the Soundcraftsmen test record, which includes useful bands of noise, and "Computone" charts which can be cut to match equalizer settings, serving as a form of memory. The owner's manual has some good material, including cautions on excessive boost at 30 Hz, but it is lacking in a number of areas where the non-professional needs guidance. I would also recommend a lower level than -3 for recording pink noise on a tape deck: Many cassette decks will have high-frequency roll-off at that level.

Soundcraftsmen does not supply a test microphone with the AE2000, but they have a valid point that inexpensive microphones normally included with RTAs are not that good. The manual does have good instructions on how to use a separate microphone to get good results with reference to its response curve. There is no discussion of directivity, however, so let me remind the reader that most microphones will have a response peak at the high end when they are pointed directly at a loudspeaker in a typical listening room. A mike's normal response would be approached more closely with its axis perhaps as much as 70° or more away from the speaker.

As expected, some familiarization time was required to utilize the Scan-Alyzer efficiently. Sometimes I used "Scan Auto," setting the stepping rate to match my adjustment speed. Other times it seemed easier to step manually, for then I was absolutely certain which slider to adjust. It was always easy to match the brightness of the balance LEDs, and the required slider positions were very definite.

Figure 3 shows the results of running one test with a simulated system response (top). There is a very large peak around 100 Hz, a deep crossover notch at 3 kHz, and poor tweeter response. The middle trace shows the response after using the Scan-Alyzer to set up the AE2000's octave-spaced sliders. No reference was made to the third-octave display when this was being done, and I was quite surprised myself at how flat it was even with the third-octave resolution. The bottom trace is the resulting response on an octave-band basis.

In "Norm" the display was fairly good for music monitoring, while "Slow" was better for looking at the results of Scan-Alyzer equalizing. The LEDs were bright enough for easy use under most any lighting situation. The unit had very low noise and distortion, though some attention was in order for the left channel.

The combination of an equalizer and a matching RTA is a good one, in general, but Soundcraftsmen has done something quite synergistic with the use of their excellent comparator scheme to ensure speedy and accurate equalizing. The price is very reasonable for what the AE2000 can do.

Howard A. Roberson

HEYBROOK MADE FOR MUSIC



They possess that effortless sound quality which at first was almost impossible to believe... The design as a whole is a success because coloration is remarkably low. Just listen to them and you will forget all about size and costs.

Practical Hi-Fi, Nov. 1980

HB2

In short I find the speaker very musical. It is exciting to listen to... It is exciting because it relates aspects of rhythm and tempo for instance that other more expensive designs destroy... And it is impressively powerful.

Popular Hi-Fi, Jan. 1983

HB3



The turntable proved to be quite a revelation with bass becoming a more coherent musical instrument, rather than a loose vibration under the rest of the music. All instruments, in fact, become more separated taking a stable position between and around the speakers. The Heybrook TT-2 turntable must be highly recommended for the price.

What Hi-Fi, Jan. 1982

TT2

By any standards these new HB-1's are marvelous, and their smooth, seamless response and open tonal balance will win many friends... If you are in the market for speakers up to \$339 a pair, do hear these new Heybrooks, I am sure you will be as impressed as I am.

Hi-Fi Answers, April, 1983

(our newest product) **HB1**



Audition the entire Heybrook line at these select dealers:

Audio Breakthroughs
Manhasset, NY
(516) 627-7333

Audio Connection
Verona, NJ
(201) 239-1799

A.C.S. Limited
Berkeley, CA
(415) 841-4192

Audic 2000 Electronics
Fort Lauderdale, FL
(305) 962-5300

Community Audio
Philadelphia, PA
(215) 843-9918

Hi-Fi Gallery
Indianapolis, IN
(317) 253-5141

Music One
Greenville, MS
(601) 335-0380

Stereo Shop
Martinez, GA
(404) 863-9143

See us at the Chicago Consumer Electronics Show
Conrad Hilton Hotel Suites 764 & 766

imported and distributed by
D'Ascanio Audio

11450 Overseas Highway
Marathon, FL 33050
Tel.: 305-743-7130

Use Your Convenient
MasterCard • Visa
American Express
Diners Club Card

COD orders accepted
Money orders accepted
Allow 4 weeks clearance on
any personal check



LABELLE Camera & Stereo OF MAINE



155 Main Street, Biddeford, Maine 04005

Prices and products in this advertisement supercede all previous ads.

FOR MAIL ORDERS
CALL TOLL FREE:

1-800-341-0783

In Maine, Alaska and
Hawaii, Call 1-207-283-1401
Call For Shipping
And Handling On Mail Orders

SONY Walkman 4
Cassette
Stereo
\$54.95
Complete Set

- Sony Walkman 5 \$84.95
- Sony Walkman 7 \$129.95
- Sony Professional! WD6 \$229.95

SONY FM Stereo
Cassette
FM-1
\$89.95
Complete Set

- Sony FM-2 \$129.95
- Sony WA-33 \$119.95
- Sony WA-55 \$129.95

TOSHIBA FM Stereo
Cassette
KT-S3
\$59.95
Complete Set

- Toshiba KTR-2 \$89.95
- Toshiba KT-V51 \$89.95

SANYO AM/FM
Stereo
Cassette
MG-31
\$49.95

- Sanyo MG-7 \$24.95
- Sanyo MG-100 \$99.95
- Sanyo MG-1 \$59.95

AIWA AM/FM Stereo
Cassette
W/Recording &
Auto Reverse
HS-J2
\$129.95
Complete Set

- AIWA HS-P02 \$109.95

AM/FM STEREO RECEIVERS

PIONEER

SX5	\$149.95
SX202	\$119.95
SX303	\$159.95
SX6	\$199.95
SX7	\$329.95
SX8	\$489.95

Technics

SA110	\$109.95
SA210	\$139.95
SA310	\$179.95
SA410	\$199.95
SA610	Call
SA810	Call
SA828	\$519.95

SONY

STR-UX1	CALL
STR-UX22	FOR
STR-UX33	BEST
STR-UX4	PRICES
STR-UX5	

SPEAKERS

Call For
Lowest Prices
On Speakers

PIONEER
ARIES 50
3 way
100 Watts Total
\$119.95
pair

48'S
3 way
\$279.95
pair

CERWIN-VEGA
u-123 3 way
120 Watts Total
\$258.95
pair

CASSETTE DECKS

PIONEER

CT-4	\$109.95
CT-5	\$139.95
CT-6R	\$179.95
CT-7R	\$249.95
CT-8R	\$369.95
CT-9R	\$430.95

SONY

TC-FX33	CALL
TC-FX44	FOR
TC-FX66	PRICES
TC-FX77	
TC-FX5000R	
TC-FX1010	
TC-K 555	
TC-K 777	

Technics

RSM205	\$99.95
RSM224	\$119.95
RSM226	\$139.95
RSM255X	\$239.95
RSM228X	Ca
RSM258R	\$259.95
RSM235X	Ca
RSM275X	\$369.95

SHERWOOD

S9200	\$169.95
S9300	\$199.95
S9400	\$249.95
S9600	Call

J.V.C.

CALL
FOR
LATEST
MODELS
AND
BEST
PRICES!

Sansui

Z-3000	CALL
Z-5000	FOR
Z-7000	BEST
Z-9000	PRICES
AUD-9	
AUD-7	

Sansui

D-55MS	CALL
D-77FS	FOR
D-77RS	PRICES
D-99DS	
D-370	
D-370	
D-770	
DW-9	

J.V.C.

CALL
FOR
LATEST
MODELS
AND
BEST
PRICES!

marantz

SD225	\$119.95
SD320	\$169.95
SD420	\$219.95
SD3510	\$189.95
SD5010	\$229.95
SD9000G	\$369.95

AKAI

AA-R22	\$169.95
AA-R42	\$289.95
AA-R32	\$229.95

marantz

SR1000	\$149.95
SR2000	\$179.95
SR520	\$219.95
SR220	\$119.95
SR620	\$279.95
SR-7100DC	\$349.95
SR-8100DC	\$409.95

NIKKO

NR-320	CALL
NR-520	FOR
NR-700	LATEST
NR-800	MODELS
NR-1000	AND
ALPHA220	BEST
ALPHA440	PRICES!

TEAC

V-33	\$109.95
V-44C	\$129.95
V-66C	\$147.95
V-80	\$237.95
V-4RX	\$252.95
V-2RX	\$309.95
V-1RX	\$375.95
V-3RX	\$419.95
V-90R	\$319.95
V-95RX	\$389.95

AKAI

CS-F12	\$109.95
CS-F14	\$129.95
CS-F21	\$165.95
CS-F31	\$209.95
GX-F51	\$245.95
GX-F71	\$297.95
GX-F91	\$487.95
CS-F39R	\$259.95
GX-F44R	\$327.95
GX-F66RC	\$384.95

BLANK TAPES

TDK SA-C90	\$2.45 ea
MAXELL	
UDXL11C90	\$2.49 ea
TDK-T120	\$9.95 ea
MAXELL T120	\$9.95 ea
SONY L750	\$8.95 ea
SONY L830	\$11.95 ea
SONY L500	\$7.95 ea

We carry Maxell, Tok, Sony, Scotch, Fuj, Memorex, Best, Ampex, Jvc, Panasonic.
Minimum Order: 10 Tapes

TURNTABLES

SONY

PS-LX1	CALL
PS-LX 3	FOR
PS-LX 4	LATEST
PS-LX 5	MODELS
PS-FL1	LOWEST
PS-FL 3	PRICES
PS-FL 5	

TURNTABLES

JVC

CALL
FOR
LATEST
MODELS
AND
BEST
PRICES!

TURNTABLES

AKAI

AP-B110	\$74.75
AP-D210	\$94.70
AP-Q310	\$109.75
AP-Q41	\$158.90
AP-L45	\$199.95
AP-L95	\$389.95

TURNTABLES

PIONEER

PL-2	\$64.90
PL-4	\$88.90
PL-5	\$94.90
PL-7	\$109.90
PLL-800	\$259.90
PLL-44F	\$169.90
PLL-88F	\$259.90

TURNTABLES

Technics

SLB10	\$62.90
SLB20	\$74.90
SLB30	\$88.90
SLD30	\$99.95
SLQ20	\$111.90
SLQ30	\$129.95
SL-10	\$399.90
SL-15	\$549.90
SL-QL1	\$248.90
SL-1200MKII	\$289.90

AM/FM CASSETTE CAR STEREO IN DASH

PIONEER

KP1500	\$69.95
KP5500	\$119.95
KP7500	\$169.95
UKP5200	\$139.95
UKP5600	\$159.95
KE-5100	\$179.95
KE-6100	\$219.95
UKE-3100	\$179.95
UKE-7100	\$249.95

JENSEN

RE-530	\$309.95
RE-520	\$259.95
RE-518	\$239.95
RE-512	\$219.95
RE-508	\$179.95
R210	\$119.95
R200	\$89.95
JR-115	\$139.95
JR-110	\$119.95

SONY

XR-15	CALL
XR-25	FOR
XR-35	PRICES
XR-50	
XR-55	
XR-70	
XR-75	
XR-77	

CONCORD

HPL-101	\$149.95
HPL-112	\$179.90
HPL-118	\$249.90
HPL-118F	\$279.95
HPL-119	\$319.50
HPL-121	\$249.95
HPL-122	\$299.95

MITSUBISHI CAR AUDIO

CZ747	\$259.95
RX735	\$209.90
CV725	\$129.95
RX707	\$154.95
RX726	\$129.95
RX723	\$99.95
RX909	\$209.90
RX791	\$219.95

PANASONIC

CQS818	\$234.95
CQS958	\$349.95
CQS768	\$219.95
CQS747	\$189.95
CQS788	\$219.95
CQS903	\$289.95
CYSG100	\$169.95

Clarion

5100R	\$119.95
5150R	\$129.95
5300R	\$139.95
5550R	\$139.95
5700R	\$179.95
7500R	\$189.95
5500R	\$139.95
5900R	\$209.95
9300T	\$239.95

marantz

CAR-312	\$124.95
CAR-320	\$139.95
CAR-322	\$179.95
CAR-340	\$199.95
CAR-302	\$179.95
CAR-310	\$149.95

SANYO

FTC-1	49.95
FTC-28	69.95
FTC-8	109.95
FTC-120	199.95
FTX-140	229.95
FTX-160	249.95
FTC-180	289.95

BLAUPUNKT

CR-2002	169.95
CR-2001	199.95
CR-5000	289.95
CR-2010	249.95
CR-3001H	339.95
CR-3003	264.95
Berlin	919.95
BEA 55	79.95
BEA 150	119.95

CRAIG

T-531	129.90
R-230	239.95
T-624	79.95
T-691	149.95
T-560	139.95
T-140	89.95
T-690	119.95
T-530	129.95
T-400	69.95
W-460	249.95

ADC EQUALIZERS

ADC SS10	\$149.95
ADC SS20	\$209.95
ADC SS30	\$269.95
ADC SS5	\$69.95
ADC SAI	\$119.95

35mm CAMERAS

Famous Maker
80-200mm Macro Zoom

\$69.95

35mm CAMERAS

Canon

AE 1 with 50mm 1.8 FD Lens	\$179.95
AE 1 PROGRAM w/50mm 1.8 FD Lens	\$219.95
A1 w/50mm 1.8 FD Lens	\$259.95
SURE-SHOT 35M w/Case	\$109.95
CASES FOR CANON	\$15.95

MINOLTA

XGM w/50mm f2	\$169.95
X700 w/50mm f2	\$219.95
XG-1 w/50mm f2	\$149.95
CASES FOR MINOLTA	\$15.95

PENTAX

K1000 w/50mm f2	\$119.95
ME SUPER w/50mm f2	\$159.95
ME F w/50mm f2	\$119.95
CASES FOR PENTAX	\$15.95

NIKON

FE w/50mm 1.8E	\$239.95
FM2 w/50mm 1.8E	\$234.95
F3 Body Only	\$369.95
CASES FOR NIKON	\$15.95

SEND \$2 FOR YOUR COPY OF LABELLE'S COMPLETE CATALOGUE!

Name _____

Address _____

City _____

State _____ Zip _____

LaBELLE 155 MAIN STREET
BIDDEFORD, ME 04005

30 day return policy: All returns must be phoned in for prior authorization. All products must be returned in original factory packaging, clean and unscratched. Do not write, tape, or deface manufacturer's original cartons. Please include blank warranty cards.

Open Mon. thru Fri. and Sunday, 9 a.m.-8 p.m. Closed Saturday • All Merchandise Is New And Guaranteed • Quantities are limited

These products are for mail & phone orders only • Please call and reserve if you plan to buy and pick up at store

CLASSIFIED ADVERTISING RATES

BUSINESS ADS—\$1.00 per word, minimum charge \$7.00 per line for spaced ads specifying five or less words per line. First line set in bold face type at no extra charge. Additional words set in bold face type \$1.10 extra per word. One point ruled box, extra charge \$9.00. **ORDERS WILL NOT BE PROCESSED WITHOUT ACCOMPANYING CHECK OR MONEY ORDER FOR FULL AMOUNT**

NON-BUSINESS ADS—70¢ per word, minimum charge \$5.00 per line for spaced ads specifying five or less words per line. First line set in bold face type at no extra charge. Additional words set in bold face type \$1.10 extra per word. One point ruled box, extra charge \$9.00. **ORDERS WILL NOT BE PROCESSED WITHOUT ACCOMPANYING CHECK OR MONEY ORDER FOR FULL AMOUNT.**

FREQUENCY DISCOUNTS—3 times less 5%, 6 times less 15%, 12 times less 20%. These discounts apply to line ads only. Ads submitted for a three time frequency are unchangeable. Frequency discounts not fulfilled will be short rated accordingly.

Classified ads are payable in advance **BY CHECK OR MONEY ORDER ONLY**. (Sorry, we cannot accept credit cards or bill for line adv.). All orders should be mailed to:

AUDIO MAGAZINE
P.O. Box 1790V
Greenwich, CT 06836

DEADLINE—1st of month two months preceding the cover date. If the first of the month falls on a weekend or holiday, the closing date is the last business day preceding the weekend or holiday.

ADS RECEIVED AFTER THE CLOSING DATE WILL BE HELD FOR THE NEXT ISSUE UNLESS OTHERWISE STATED.

BLIND ADS—Audio box numbers may be used at \$5.00 extra for handling and postage.

GENERAL INFORMATION—Ad copy must be typewritten or printed legibly. The publisher, in her sole discretion, reserves the right to reject any ad copy she deems inappropriate. **ALL ADVERTISERS MUST SUPPLY:** Complete name, Company name, Full Street address (P.O. Box numbers are insufficient) and telephone number. Classified **LINE ADS** are not acknowledged and do not carry Reader Service Card Numbers. **AGENCY DISCOUNTS** do not apply to line advertising. **FREQUENCY DISCOUNTS** not fulfilled will be short rated accordingly. Only those advertisers who have prepaid for their entire contract time will be **RATE PROTECTED** for the duration of that contract, in the event of a rate increase. For any additional information contact Laura J. Lo Vecchio, Classified Adv. Mgr., 1515 Broadway, New York, NY 10036 ... Direct Dial (212) 719-6338.

CLASSIFIED DISPLAY RATES	
1 col x 1"	\$195.
1 col x 2"	\$350.
1 col x 3"	\$450.
2 col x 1"	\$390.
2 col x 2"	\$700.

For larger display ads and frequency discounts call (212) 719-6338.

DISPLAY ADVERTISERS MUST SUPPLY COMPLETE FILM NEGATIVE READY FOR PRINTING OR VELOX. PRODUCTION CHARGES WILL BE ASSESSED ON ANY AD REQUIRING ADDITIONAL PREPARATION.

DISPLAY ADVERTISERS must make a space reservation on or before the closing date. Ad material (film or velox) may follow by the 10th.

FOR SALE

HOW TO ANSWER BOX NUMBER ADS
When replying to an Audio Box Number Ad, please use this address Box No. ___ c/o Audio, 1515 Broadway, New York, N.Y. 10036

1-313-553-9248. **AB SONICS FOR KEF**, CJ Walker, Linn, Pink Triangle, Michell Gyrodec, Rogers, and other British components! Write or call for free catalog and info. AB Sonics, 28140 Kendallwood Dr., Farmington Hills, Mich 48018. We now carry the full line of Unity Audio speakers.

1-602-245-0192—**ARIZONA AUDIOPHILES**—Demo & used equipment clearance—Ross 1A speakers, Revox Amplifier, Tandberg preamp, Luxman tuner, B & O, Rega turntables **ESOTERIC AUDIO**

250 WATT DALE RESISTORS 4-OHM Non-Ind gold finned \$20., 212-996-2252

1-313-471-3076 OR 1-313-553-0508—**B&K IMPORTS**—Favorable terms for ALL audiophiles! Broad range of products imported and domestic. Free shipping—Visa, MasterCard, Checks, C.O.D.—Ask for our catalog! 24160 Twin Valley Ct., Farmington, MI 48024. British Audio mags old and new

AAAAAN ORACLE DELPHI \$760, 616-874-8369 evenings

FOR SALE

1-800-245-6000
TAPE WORLD

JVC: T-120	8.09
TDK: MA-90	4.49
TDK: SAX-90	3.19
TDK: ADX-90	2.99
TDK: SA-90	2.25
TDK: SA-60	1.89
TDK: AD-90	1.89
TDK: AD-60	1.49
TDK: D-90	1.29
TDK: D-60	1.15
MAXELL, TDK: T-120, L-750 Hi-Grade	11.49
MAXELL, TDK: T-120, L-750	8.49
MAXELL: XLI or IIS-90	3.59
MAXELL: UDXL I or IIC-90	2.59
MAXELL: UDXL I or IIC-60	2.29
MAXELL: UD-90	2.19
MAXELL: XL I 35-90B	6.49
MAXELL: UD35-90	5.39
SONY: UCXS-90	2.99
TDK: HD-01 (Head Demag.)	13.99
WE WILL HONOR ANY COMPETITORS PRICE OF THE TOTAL ORDER. \$3.75 Shipping any size order in US. VISA, MC no extra charge. COD add \$1.50. Minimum COD order \$40.00. PA ad Sales Tax. Allow 2 weeks for delivery.	
323 Brown Ave., Box 361, Butler, PA 16001 412-283-8621	

HERE'S WHAT HAPPENS WHEN YOU GIVE THE WORLD'S FINEST AUDIO ENGINEERS CARTE BLANCHE.

The team of engineers that developed Sony Esprit was not asked to work within the narrow confines of a budget.

Nor were they asked to adhere to the compromising deadlines of some production timetable. Or to the arbitrary figures of a spec sheet.

They were asked, quite simply, to develop components that would approach, to the closest possible degree, perfect sound.

There is no gimmickry in Esprit components; only those technological improvements that contribute to sound quality were considered meaningful.

There are no question marks either. For the Esprit engineers fully research their equipment before production. Not afterward.

For more information write Sony Esprit, 2300 Peachford Rd., NE, Suite 1150, Atlanta, Georgia 30338.

SONY ESPRIT.



ALTERMAN AUDIO
3213 17th Street
Metairie, LA 70002
(504) 834-7772

D S AUDIO
545 Penn Avenue
West Reading, PA 19611
(215) 376-4917

PARIS AUDIO
12401 Wilshire Blvd.
Los Angeles, CA 90025
(213) 820-2578

PARK AVENUE AUDIO
425 Park Avenue South
New York, NY 10016
(212) 685-8101

PROFESSIONAL PRODUCTS
AUDIO CENTER
4964 Fairmont Avenue
Bethesda, MD 20014
(301) 657-2141

RECORDER CENTER
2003 North Henderson
Dallas, TX 75206
(214) 826-8700

THREE PHASE AUDIO
104 Foreman Drive
Lafayette, LA 70503
(318) 981-4951

© 1982 Sony Corp. of America. Sony and Sony Esprit are registered trademarks of the Sony Corp.

FOR SALE

2 WORLD-CLASS TABLES; 1 COMPANY

The SOTA Sapphire establishes new standards, both sonic and set-up, for all audiophile turntables. How amazing—one year later, this American firm then, adds a Vacuum Hold-Down STAR and a vacuum kit for all Sapphires. How refreshing that an American company now makes the 2 best tables in the world—bar none! NEW in Washington D.C. area, EXCALIBUR. 703-765-1823.

AAA-TOP PRICES PAID for Audio Research, Marantz, McIntosh, and Western Electric Equipment, AudioWorkShop (206)323-4987

FOR SALE

AAAA—CANADIAN AUDIOPHILES

Cartridges, tonearms, transformers, headphones, loudspeakers, interconnects, accessories and much more. All available at lowest possible prices. Write for free brochure and price list. ESOTERIC AUDIO - 107—2929 Nootka St., Vancouver, B.C., CANADA. V5M-4K4. Free shipping throughout Canada.

ABARGAIN: Perreux 2150B hybrid Class A power amplifier. 200/200. Mint. \$1095 or B.O. (617) 491-2216 evenings.

FOR SALE

#1 AGAIN!

Conrad-Johnson's new preamp, the Premier Three, redefines the state-of-the-art in preamplifiers. If you want the best, it's here. \$2850. Combine this with the Premier One amplifier at \$4350, and you will have the finest electronics on earth.

DCM Time Windows: a classic that remains in a class by itself. \$747.

In stock: Perreux's incomparable preamp with enough gain for MC cartridges (\$990) and their incredible 2150B amplifier (200 wpc, \$1450) that will drive Acoustat lovers (and others) into ecstasy. Haller's new DH-100 preamp.

No one appreciates the value of the dollar more than we do. That's why we are dedicated to serving you with the finest advisory staff in the business. Call us anytime and hear the difference.

We proudly represent:

PS AUDIO	HAFLER	KRELL
NAD	PERREUX	DENON
AMBER	GNP	BOSTON ACOUSTICS
ADS	DCM	TANDBERG
DENNESSEN	SPICA	NITTY GRITTY
GRACE	ROGERS	AUDIOSOURCE
VPI	STAX	AUDIOQUEST
MARCOF	CJ WALKER	DYNAVECTOR

Please call or write for information. Friendly, expert consultation. Fast, free, same-day shipping. MC VISA/AMEX.

REFERENCE AUDIO SYSTEMS

18214 DALTON AVENUE
GARDENA, CA 90248
(213) 398-4205

AAA-ASTOUNDING CARTRIDGES: Finest in the World at Shamefully Low Prices. Accuphase, Denon, Dynavector, Grace F9E's, F9E Ruby's, Koetsu, etc. NEW, 100% Quality Control. Warranties, COD Available. No Price List. "We Will Not Be Undersold". AudioWorkShop (206) 323-4987 24hrs.

AAA AUDIO DISCOUNTS OFFERS THE FINEST

lines of audio components (INCLUDING THE ESOTERIC) at DISCOUNT PRICES. If you're in the market for speakers, receivers, cassette decks, to the best in separate components including amps, pre-amps, turntables, cartridges etc. or a new CAR STEREO our knowledgeable sales staff will be glad to assist you. For more information Monday thru Saturday PLEASE CALL 301-593-8224—301-593-8244 or write to AUDIO DISCOUNTS, 1026 McConeny Avenue, Silver Spring, MD 20901. We honor VISA-MC and COD for your convenience.

AAAUDIOPHILE SPEAKER BUILDER? JORDAN MODULES exclusive importer. STRATHEARN midribbon, Polypropylene Drivers, EMIT Tweeters, Domes, IBM Computerized Designs, Capacitors, Low DC Coils, Crossovers. (Dealers inquire on letterhead) CATALOG \$2.00 U.S. Soundbox. 841A-A S. American Street, Philadelphia, 19147

ABARGAIN: Supex SDX2000 \$299., 901E + Super \$130., 901E + Super \$120.; Grace F9E \$115., F9E Ruby \$165., Rubystylus \$115., F11L \$179.; Accuphase AC-2 \$285.; Technics 205CMKIII \$130., Technics Electronic stylus gauge \$56.; Denon 103D \$165.; Dynavector DV-23R \$180.; Koetsu Black \$475., SA-1100DMKII \$485.; Linn Ittok \$445.; Fidelity Research FR64fx \$415.; Signet SK50 \$230.; Stax headphones; All unused/warranty; Won't be undersold: (212) 784-2939 evenings; (305) 487-1048 evenings.

HIGH END PARTS

Corning ¼W, ±1% Metal Film Resistors, ea.	25¢
(E24 range, 108 values: 10 ohm-1 meg.)	
Neglex/Mogami signal cable, ft.	60¢
Gold on brass, 8mm RCA plugs, ea.	\$3.25
Mogami Speaker wire, ft.	\$2.00
Wire Termination kits, set of 2, ea.	\$1.50
Telefunken ECC83/12AX7, ea.	\$8.50
GE, 6L6GC, Matched pair	\$18.50

All prices postpaid, Quantity discounts available, Ask for our parts flyer, MC & Visa welcome.

OLD COLONY SOUND LAB
Box 243A Peterborough, NH 03458

VANDERSTEEN AUDIO DIMENSIONAL PURITY

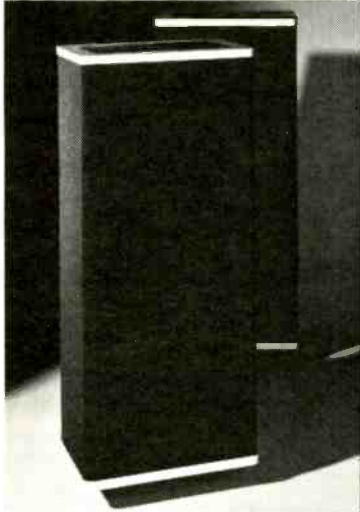

MODEL 2C

Vandersteen Audio was founded in 1977 with the commitment to offer always the finest in music reproduction for the dollar. Toward this goal there will always be a high degree of pride, love, and personal satisfaction involved in each piece before it leaves our facilities. Your Vandersteen dealer shares in this commitment, and has been carefully selected for his ability to deal with the complex task of assembling a musically satisfying system. Although sometimes hard to find, he is well worth seeking out.

Write or call for a brochure and the name of your nearest dealer.

VANDERSTEEN AUDIO
116 WEST FOURTH STREET
HANFORD, CALIFORNIA 93230 USA
(209) 582-0324

COMPARE
OURS
TO
THEIRS!

INTRODUCING THE
TRANS
By: **VSP labs**
MOS
POWER AMPLIFIER
ONLY THE
MUSIC
REMAINS

670 AIRPORT BLVD.
ANN ARBOR, MI. 48104
(313) 769-5522

FOR SALE

A BETTER WAY TO BUY YOUR AUDIO AND VIDEO COMPONENTS. Consider the following—DIRECT SOUND MARKETING can provide you with virtually any brand of audio or video components (including the esoterics) at extremely competitive pricing, on an in-stock basis. Moreover, we maintain a complete service facility to handle any service problems. So, if you're looking for a price, selection, fast shipments, in-house service and competent advice we have it all, and more. Before you buy anything please call us at (404) 233-9500 for more information.

Or write to DIRECT SOUND MARKETING, 3095 Bolling Way N.E., Atlanta, GA 30305. For your convenience use your Mastercard, Visa, or Amex for fastest service. Sales tax is charged to Georgia residents only.

ABSOLUTE AUDIO: AMBER, ASTATIC, ORACLE, CONRAD JOHNSON (INCLUDING PREMIERS), DYNAVECTOR, MISSION, NAD, OHM, RGR, SNEEL, THIEL, VPI, WALKER, ETC. Audio File, 1202 South Congress, Austin, Texas 78704, (512) 443-9295

ABSOLUTELY THE BEST? low direct Tax free price, reviewed November 82 Gramophone "indeed the combination of Mayware MKIV tonearm \$125 and MC-2V 'Vital' stylus \$79 + T-24 transformer reproduced my sequence of Test records with unusual accuracy and tonal naturalness. World's best loudspeaker manufacturer says "combination performs extremely well and cures mistracking which occurred with SME." Just released "The Cartridge" \$159 VISA/MC accepted info \$1 bill. Mayware P.O. Box 58, Edgware, Middx. England.

ACCURATE AFFORDABLE AUDIOPHILE EQUIPMENT at very low prices! Specialists in CARTRIDGE-TONEARMS-TURNABLES. Great selection of cost-effective components for audiophiles on a budget. Call or write for prices and specials. HCM AUDIO, 1363-G Longfellow Ave., Chico, CA 95926 (916) 343-0558

ACCURATE, QUALITY HOME/CAR AUDIO AFFORDABLY PRICED!! Denco Audio, P.O. Box 6104-U, El Monte, CA 91734. (213) 961-6158 evenings, weekends. STAMP BRINGS SPECIALS SHEET. M/C, VISA ACCEPTED!

ACOUSTAT IN WISCONSIN!!!
AUDIO ELITE, Menasha, WI, 414-725-4431

ACOUSTAT PRODUCTS AVAILABLE AT
GENE RUBIN AUDIO (213) 571-1299 (PAC)

ACOUSTAT SPEAKERS—SUPERB!
Free Shipping! Fast Service! READ BROS STEREO, 593 King Street, Charleston, SC 29403, (803) 723-7276. Also Sony digital (disc and PCM-F1).

ACOUSTECH III AMPLIFIER, IV pre-amp, both \$200. AMPLEX 755 tape deck, \$125. All are original mint, complete with factory manuals and schematics. Wayne (312) 739-0061

ACOUSTIC RESEARCH D40, NEW, \$1,200.00
Koss Model 1, Preowned, Exc., Pair \$600.00
Nakamichi 700 ZXL, Demo \$1,600.00
Imperial Sound, 918-622-6111, Visa MC

CROWN BEST QUALITY AMPLIFIERS, TUNERS, PRE-AMPLIFIERS. PROFESSIONAL CONSULTATION—BEST PRICES. EAST: (904) 262-4000; WEST: (213) 840-0878.

ADCOM SUBWOOFER WITH CROSSOVER \$115. Post-paid U.S.A. call for other low prices. Tarzana stereo center, 19012 Ventura B1, Tarzana Calif. 91356, (213) 343-6103

KIMBER KABLE

HIGH PERFORMANCE
SPEAKER WIRE

Strong in the West, headin' East.

ASK YOUR DEALER

Manufactured by:

RKB Industrial, Inc.
2058 Harrison Blvd.
Ogden, Utah 84401
(801) 621-5530

FOR SALE

ADVICE TO ANXIOUS TURNTABLE OWNERS
Banish audio anxiety by getting a SOTA Sapphire or SOTA STAR Vacuum turntable. Not only will you have "freedom from worry" about set-up, isolation, and feedback—rest assured there is no better sounding turntable on the market. In Los Angeles, PAUL SEYDOR AUDIO, (213) 826-5580.

ELECTRO-VOICE INTERFACE AND CD SERIES QUALITY SPEAKER SYSTEMS. PROFESSIONAL CONSULTATION—BEST PRICES. EAST: (904) 262-4000; WEST: (213) 840-0878

AFFORDABLE AUDIO—FREE SHIPPING
Esoteric Audio Research, Conrad Johnson, Hafler, Audire, Spica, Vandersteen, DCM, Quad 63's \$2695, Precision Fidelity, Walker, MAS Arm, Spondors, Kycocera, Micro Seiki, Linn Products, Dynavector, PS Audio, Janis, etc. Perfectionist Audio, 1610 James, North Mankato, Minnesota 56001, Daytime: 507-625-7068, Evenings: 507-345-7186

HAFLER, REVOX, TANBERG, CARVER, DBX AND OTHER QUALITY COMPONENTS. PROFESSIONAL CONSULTATION—BEST PRICES. EAST: (904) 262-4000; WEST: (213) 840 0878.

HARMAN-KARDON SEPARATES, RECEIVERS, CASSETTE DECKS, TURNTABLES, PROFESSIONAL CONSULTATION—BEST PRICES. EAST: (904) 262-4000; WEST: (213) 840-0878.

ALL CLASSIC QUAD ELS OWNERS. Hard to believe QUADS can be improved? The "KOVAL QUAD MOD" has been unbelievably successful in satisfying the most ardent QUAD lover. No risk 30 day trial \$140/pr. For info send SASE to John Koval, Linear Acoustics Labs, 11521 Cielo Pl., Santa Ana, CA 92705, 714-838-6555

ALL DALESFORD: 10" D 100/250; 5 1/4" D 30 110; D 10 R Dome. \$99.50 per side (x 2 for pair). Others charge \$124 to \$140. VERY limited supply—order now! L.R. Co. (503) 779-6643. Evenings, west coast.

ALLISON I SPEAKERS AND ALLISON SUBWOOFER. 215-LO7-4626 EVES.

ALL NEW ITEMS: AC-2 \$300; DL-103D \$175; FR-1mk.3F \$150; ASAK \$300; ROGERS LS3/5A \$500; CELESTION SL-6 \$600; QUAD ESL-63 \$2500; AMPLIWIRE II \$1100; NAKAMICHI DRAGON \$1500. ALSO NAKAMICHI SYSTEM ONE RACK-MOUNTED 620 POWER AMP/630 PRE-AMP TUNER/TIMER AND EXTRA PANELS \$1500. NAKAMICHI 700II (20 HOURS USE) \$800. CALL KEVIN @ 212-807-8746 OR 212-685-1954 (LEAVE NAME & NUMBER)

ALL LS3/5A OWNERS, A SEALED PAIR of Satterberg woofers \$450. Out of print direct discs, reasonable. 206-747-2894

ALMOST A MIRACLE, "SCORPIO!" A medium mass, high performance tonearm from Helius for only \$239.00. For dealer list, contact IAI, 723 Bound Brook Road, Dunellen, New Jersey 08812 or call 201-968-8771.

Quality Tapes

BELOW WHOLESALE SPECIALS

	TDK	DISCWASHER
SAX C-90	3.19	D C-60 1.15
SA C-90	2.15	LX 35-90 5.25
SA C-60	1.85	LX 35-90B 5.85
MA C-90	4.35	SA 35-90 9.49
AD C-90	1.85	T-120 8.45
AD C-60	1.45	T-160 15.49
ADX C-90	3.15	MAR 90 6.39
D C-90	1.29	

	MAXELL	SONY
UDXL 11 C-90	2.59	XL1 35-90B 6.45
UDXL 11 C-60	2.37	XL 11 35-90 11.49
XL 11 SC-90	3.59	T-120 8.45
UD C-90	2.15	HGX T-120 10.95
UD 35-90	5.35	MX C-90 4.89
		FR 11 C-90 2.75
		METAL C-90 4.45
		T-120 9.95
		T-120 HG 13.49
		UCXS C-90 2.95
		L-750 8.95
		L-500 6.95
		L-750 HG 10.95

TO ORDER BY PHONE CALL 212-434-3617 OR ORDER BY MAIL - ON ORDERS UP TO \$70 ADD \$3.50 SHIPPING - OVER \$70 ADD 5% OF TOTAL ORDER - OUTSIDE U.S. ZONES DOUBLE ABOVE - OUTSIDE USA WRITE FOR SHIPPING CHARGES - MASTERCARD/ VISA ORDERS ADD 3% EXTRA FOR HANDLING - PRICES SUBJECT TO CHANGE

QUALITY TAPES

864 East 7th Street, Dept A6, Brooklyn, NY 11230

TECHNICAL WIZARDRY

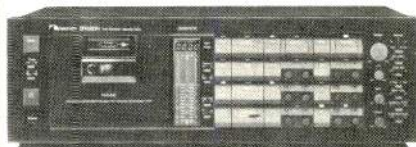

Monster Cable and the Nakamichi Dragon

Nakamichi is a world leader when it comes to tape deck technology.

Their newest masterpiece, the Dragon, with NAAC (Nakamichi Auto Azimuth Correction), represents a giant leap forward in cassette deck design and sonic accuracy.

Accurate music reproduction is first priority at Nakamichi. Monster Cable is a world leader when it comes to high performance cable and connector technology.

The Monster's latest creation, Interlink Reference, with "Bandwidth Balanced" technology, achieves a new level of sophistication and performance.

Accurate music reproduction is also first priority at Monster Cable.

That's why Nakamichi recommends the use of high quality interconnect cables, such as the Interlink series, with all their tape decks. Natural sounding midranges, clean highs, and powerful bass.

All from using the correct wire. Whether you are hooking up a tuner, pre-amp, or tape deck; use Interlink to maximize the performance of your sound system.

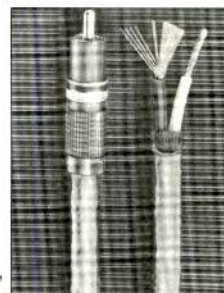

interlink™

SERIES by MONSTER CABLE®

Monster Cable Co. 101 Townsend St.
San Francisco CA USA 94107
(415) 777-1355 telex: 470584 MCSYUI

FOR SALE

AMBER Preamp/amp \$650 Call Terry 402-391-3842

AMERICAN INTERNATIONAL offers a wide variety of affordable audio and video components. Choose from Advent, Aiwa, Akai, Audio Control, Carver, DCM, Dynavector, Fisher, Grace, Grado, JVC, Klipsch, Koss, Luxman, Marantz, Mitsubishi, Perreux, Revox, Sony, Stax, Teac, 3-D, Walker and many more. Free shipping, double-insurance, free brochure explaining how to buy audio and video, trade-in's accepted, nation-wide financing (pending), service facilities, extended warranties and dedicated personnel. M/C, VISA, AMEX welcomed. All, and only, from AMERICAN INTERNATIONAL ("The Source"), 745 Alexander Road, Princeton, NJ 08540; 1-609-452-7500; Call now for your free brochure.

"AN AMERICAN MASTERPIECE" is how we at AUDIO ELITE view the SOTA Sapphire, simply the world's best turntable. Construction is fantastic. Isolation—unbeatable. Sound—BREATHTAKING!! Truly the Elite table at Audio Elite, Menasha, WI 414-725-4431.

ROGERS SPEAKERS Hearing is believing. Audio Den, Smith Haven Plaza, 2021, Nesconset Hway, Lake Grove, NY (516) 360 1990

Eliminate Your "Patchcord Headaches"

If you have more components than places to hook them up, we have a switching system for you. For complete information on switch boxes for your tape decks, signal processors, and speakers, WRITE OR CALL TODAY.



Dept. A, P.O. Box 160818
Miami, Florida 33116 (305) 238-4373
DEALERS: SEE US AT BOOTH 3520 SCES

FOR SALE

AMAZING? ISN'T IT

The amount of nonsense that gets thrown around in the audio world. If you are sick of being treated like a 5-year-old child by shoe salesmen masquerading as audio experts, you owe it to yourself to give us a call. Our opinions are based on a solid foundation of experience with the components we sell as well as those sold by our competitors. Most importantly we don't simply sell the finest audio equipment available, we arrange it in complementary systems designed to extract the greatest benefit from your audio dollars chosen from among the following lines we represent:

ACOUSTAT • ADCOM • ASTATIC • AUDIONOTE • AUDIO DESIGN • AUDIO INTERFACE • AUDIO RESEARCH • AUDIONOTE IO TYPE II • BEARD • BERNING • BRB SYSTEMS • COUNTERPOINT • DCM • DYNAVECTOR • FOSTEX • FUSILIER • GRACE • HAFLE • ITC • JANSZEN • LINN SONDEK • LIVEWIRE • MICRO-SEIKI • MONSTER CABLE • MORDAUNT-SHORT • NAD • NITTY GRITTY • PINK TRIANGLE • PRECISION FIDELITY • PREMIER • QUICKSILVER • REGA • ROGERS • SNELL ACOUSTICS • STAX • SUMIKO PHONO AMP • SUPEX • 3D ACOUSTICS • THRESHOLD •

SOUND BY SINGER

227 Lexington Avenue
New York, NY 10016
(212) 683-0925
We ship anywhere!!

APT/HOLMAN PLUS—Own the best value in audio today. The Apt/Holman Preamp is the most cost effective and best sounding preamplifier on the market. Destined to be a classic! PLUS quality control to assure optimum performance. Shipping anywhere in the continental U.S. DESIGNATRON'S STEREO STORES, INC., 260 Old Country Road, Hicksville, NY 11801 (516) 822-5277.

ARC D52B \$600 1-503-938-3085 NIGHTS

THE MICHELL GYRODEC geometrically and technically correct. Alternative Audio, 5207 Holston Drive, Knoxville TN (615) 974 9655

FOR SALE

A&S OFFERS HIGH-END SPEAKER KITS, auto speaker systems and raw drivers from the world's finest manufacturers. Meeting the needs of beginners and audiophiles, we carry Audax, Dynaudio, Dalesford, Jordan, Peerless, JVC, SEAS, Pyle, Seymour, Becker. Featuring the "Bill Reed" Signature kit and Dynaudio's "Authentic Fidelity" kits. Free price list. A&S SPEAKERS, Box 7462A, Denver, CO 80207. (303) 399-8609.

A SUBWOOFER CAN EXTEND THE BASS RESPONSE of your stereo system. Our Dual Driver Complimentary Symmetry Subwoofer lowers distortion and improves transient response for tight, solid and accurate bass. The Bass Amplifier has over 25 Amps of output current capability for the high current headroom subwoofers need. Our products are simple to assemble kits and provide high performance at modest cost. No soldering is needed. All electronics are fully assembled and tested using high quality components. Call or write today. SONTEK, Dept 116, 332 E. Hope St., Mesa AZ 85201. (602) 969-1419.

THE MICHELL GYRODEC setting higher standards of sonic excellence. Audio Excellence, 425, Washington St., San Francisco CA (415) 433 1335

At last, available to you now!

WONDER CAPS

You will not believe the sonic improvement that Wonder Caps™ make to every audio component in your system! See our advertisement in October Audio, p.114. Write for FREE application suggestions and order forms.

IAR Dept. WCB
2449 Dwight Way, Berkeley CA 94704

ATTENTION ACOUSTAT OWNERS!

Can you name three ways to dramatically improve the performance of your loudspeakers? EPIK can, and if you want to know too, call or write EPIK AUDIO. (312) 894-0294, 653 Overland Trail, Roselle, IL 60172.

ATTENTION EVERYBODY!!!

ACOUSTAT	COUNTERPOINT	KYOCERA
ACOUSTIC ELECTRONICS	CJ WALKER	LINN SONDEK
AUDIO QUEST	DAHLQUIST	MUSIC REFERENCE
ADS	DCM	NAD
AUDIO RESEARCH	DRONON	ORACLE
B&O	DYNAVECTOR	PETERSON
BOSTON ACOUSTICS	HAFLE	ALPHASON
CARVER	KISEKI	GRACE
VPI	HELIUS	SIGNET
QUICKSILVER	PENTAGRAM	RGR

CSA AUDIO

193 Bellevue Ave, Montclair, NJ 07043
The audio professionals since 1972! Complete customer satisfaction. VISA, Mastercard accepted!
201-744-0600
SERIOUS INQUIRIES BY PHONE. NO MAIL!!!

AUDIO PULSE SERVICE. Factory trained technicians. Write us about Model One update kits. White Labs, 10528 Lower Azusa Rd., Suite 192A, El Monte, CA 91731. (213) 446-5346.



Money back guaranteed.

HELP INSURE PROPER TRACKING WITH THE V-1000 ALBUM CLAMP/INDICATOR. ELIMINATE CRITICAL HARMONIC FREQUENCIES.

The V-1000 album clamp is to be used while playing your 33 1/3's to help guard against record warpage and unwanted resonance.

This unit also doubles as a level indicator. Simply place it over your turntable spindle and adjust its level accordingly. The cost - \$34. - Prepaid shipping.

The V-1000 is a "must" for the stereo addict.

Send check or money order to:
THE JANATKA ENGINEERING CORP.
P. O. Box 83 - Oakville, CT 06779

Please allow 3-4 weeks for delivery.

Do Your Friends Believe . . .

- The more drivers the better?
- The more strands the better?
- The lighter the tracking force the better?
- Weighted rumble figures?
- Lots of watts?

If you've risen above the petty mythology of mass-fi and just want good sound and the best value — then AudioQuest products are for you.

audioquest

Premium quality high and low output moving coils with hollow sapphire cantilevers.

GroovDancer

High output moving coils & induced magnet cartridges.

LIVE WIRE™

Pure copper & litz speaker cables.
True litz interconnecting cables & tone arms cables.

For more information please write AUDIOQUEST
3857 Birch Street, #610, Newport Beach, CA 92660

FOR SALE

ATTENTION DYNA AND HAFLER OWNERS:
 Frank Van Alstine can rebuild most Dyna units and Hafler DH-200 amps with all new internal circuits. We transform Dyna St-80, St-120, St-150, St-300, St-400, St-416, SCA=80Q, and Hafler DH-200 amps into state of the art quality rugged POWER MOS-FET amps with new PC cards, precision parts, mos-fet output circuits, huge low inductance power supplies, shielded ground plain construction, totally free of transient distortion. We install new circuits in PAT-5, PAT-4 and PAS-3 preamps, complete with precision controls, exact RIAA equalization, matched precision parts, and achieve complete freedom from transient overload, even on Digital source material. *Audiogram* says our complete new circuits for the FM-5 & AF-6 make the world's best sounding FM tuner. We offer a 30 day satisfaction guarantee or your money back on our \$99 super phono cartridge. Why pay for expensive new equipment when we can make your Dyna units better than new, for much less than new prices? We ship worldwide and have new 120 volt and 240 volt equipment available. Write or call us for our descriptive catalogue.

JENSENS STEREO SHOP
 2202 RIVER HILLS DRIVE
 BURNSVILLE, MINN. 55337, (612) 890-3517

ATTENTION: SOTA SAPPHIRE OWNERS
 SOTA Industries now offers a VACUUM PLATTER Kit to upgrade all Sapphire turntables. Performance equal to the SOTA STAR Sapphire. Write for full information: P.O. Box 7075, Berkeley, CA 94707, or contact your dealer.

ATTENTION WANTED: MCINTOSH (SOLID STATE & TUBE), MARANTZ, ARC, WESTERN ELECTRIC, BERNING, ETC. TUBE EQUIPMENT. 713-728-4343. MAURY CORB, 11122 ATWELL HOUSTON, TEXAS 77096

ATTENTION WANTED: MCINTOSH, MARANTZ, WESTERN ELECTRIC, ARC, BERNING, ETC. TUBE EQUIPMENT. (713) 728-4343. MAURY CORB 11122 ATWELL, HOUSTON, TEXAS 77096

ATTRACTIVE PRICES: DYNAVECTOR, GRACE, DENON CARTRIDGES, FULTON, LINN, KOETSU, ACCUPHASE, FR, STAX, SOTA SAPPHIRE, QUAD 63, WALKER, BRB SYSTEMS. COD SHIPPING, SASE QUOTES, (713) 728-4343. MAURY CORB 11122 ATWELL, HOUSTON, TEXAS 77096

AUDIO DOCTOR IS IOWA'S HIGH END
 The SOTA Sapphire is so musical and fully isolated—it's the only table you can dance to without destroying records. After comparing SOTA to the Linn, we can't keep Sapphires in stock. Call about our conclusions: (319) 386-8794, Davenport.

AUDIO ELITE HAS ACOUSTAT!
 AUDIO ELITE, Menasha, WI, 414-725-4431

AUDIO RESEARCH D90B, Mint, wonder caps, latest wiring, \$1300. (212) 454-3205

CALL ME.



BOB HEENAN at
Q AUDIO For

- | | | |
|----------------|---------------|---------------|
| ACOUSTAT | GRACE | PS AUDIO |
| ADCOM | GRADO | PYRAMID |
| AUDIO TECHNICA | HAFLER | SONY CD |
| BERNING | JANIS | SOTA SAPPHIRE |
| BRB SYSTEMS | KRELL | SOUTHER |
| CRAMOLIN | KISEKI | STAX |
| DECCA | KYOCERA | SUPEX |
| DENNESEN | MONSTER CABLE | CJ WALKER |
| DYNAVECTOR | MOREL | NITTY GRITTY |

Your TradeIns Are Worth More!

95 Vassar Street
 Cambridge, Ma 02139
 617-547-2727



FOR SALE

“The Perreaux SM-2 is the best preamp I've ever heard, regardless of price.”

Quote by Ralph Tarnofsky
Professional Audio Consultants
 Milburr, NJ
 201-467-1950



AUDIO CONNECTION

IN NORTHERN NEW JERSEY

- TURNTABLES:** Denon, Heybrook, Linn, VPI
ARMS: Helius, Linn, Lurne, Souther SLA-3
CARTRIDGES: Argent, Audioquest, Grado, Promethean, Win
ELECTRONICS: Beard (tube), Bedini, Electrocompaniet, Magnum, Naim, PS Audio
SPEAKERS: Fuselier, Heybrook, Kindel, Linn, Rogers, Spectrum, Spica, Vandersteen & more
ACCESSORIES: Audiophile Discs, Clearing Machines, Last, Littile, LiveWire, JGA Interconnects
 —201-239-1799—

615 Bloomfield Ave, Verona, NJ 07044
 We offer single-speaker demonstration and request that you schedule an appointment.

AUDIO HOUSE—FLINT MICHIGAN

- | | | |
|-------------|----------------|---------------|
| Acoustat | Conrad-Johnson | SOTA Sapphire |
| Rogers | Belles Reserch | Audio Pro |
| Spectrum | Citation | Nitty Gritty |
| Leach LSR&D | Revox | Systemdek |
- 4304 Brayan, Swartz Creek, Michigan, 48473
 313-655-8639 by appointment

AUDIO INTERFACE, low impedance moving coil transformer—\$175.00—see recent review in Audio—(901) 767-2990-days (901) 323-5566-evenings

AUDIONICS CC-2—\$290., Mark 614-422-7407

AUDIONICS CC2—\$399, Composer—\$600. Call Shane 402-483-4511

AUDIOPHILE START UP SYSTEM

(ABOUT \$700)

- Turntable: NAD 5025
 Cartridge: ASTATIC IM-10E
 Receiver: NAD 7120
 Speakers: 3D ACOUSTICS "THE CUBE"

SOUND BY SINGER

227 Lexington Avenue
 New York, NY 10016
 (212) 683-0925



FOR SALE

AUDIO RESEARCH D79, Linn Sondek w/fac. Nirvana, Ittok (latest), Koetsu Black (latest and American Import) Cotter M2L \$2150. for all. Respond c/o Audio Box 683.

AUDIO RESEARCH D-76—\$695, SP3A—\$425 Call Shane 402-483-4511

AUDIO RESEARCH SP-6E, \$1500 or best offer. 217-367-2840.

AUDIO RESEARCH SP-6B—D90. Both excellent with new factory tubes and adjusted by ARC. (201)762-4943.

AUDITION VAN ALSTINE'S Transcendence amp and preamp in your home, by his Eastern Representative Call for appointment (516) 277-5336 ask for Tom.

We have the superb **MICHELL GYRODEC** on demonstration. Audio Alternative, 1124 E. Elizabeth, Ft. Collins, CO (303) 221 2268

B-1 COTTER TABLE WITH FR66S ARM and Koetsu rosewood—Will separate; JBL 660 integ-amp—FR64ss; Teac X-7R, Cotter L transformer—All items must be sold—Best offers. Serious inquiries only, please. Leave message 212-427-2203 anytime.

ROGERS SPEAKERS A reference standard, Chestnut Hill Audio, 311 Cherry St, Philadelphia, PA (215) 923 3035

DIAMOND NEEDLES and **STEREO CARTRIDGES** at DISCOUNT PRICES for SHURE, PICKERING, STANTON, EMPIRE, GRADO, AUDIO TECHNICA, ORTOFON, MICRO-ACOUSTICS, SONUS and ADC. send S.A.S.E free catalog. LYLE CARTRIDGES, Dept. A., Box 69, Brooklyn, NY 11218. For fast COD service Toll Free 800-221-0906. N.Y. State (212) 871-3303. 9AM - 8PM except Sunday.

LEGENDS AS USUAL.

These highly respected names can be found at Chestnut Hill Audio Acoustat, Adcom, Amber, Apature, Apres, Audio Pro, B&W, Berning, Cabasse, Cotter, Dahlquist, Dayton Wright, Dennesen, Denon, Discwasher, Dynavector, Fidelity Research, Fourier, Gilmore, Grace, Grado, Hafler, Impulse, Janis, Kenwood, Purist, Leach, Marcol, Mariah, Monster Cable, Mordaunt-Short, NAD, Oracle, PS Audio, Quad, R G R, Rogers, Signet, Spondor, Stax, Symmetry, Tandberg, Theta, 3D Acoustics, Thorens, Threshold, VPI, Vandersteen, 311 Cherry Street, Philadelphia, Pa 19106 (215) 923-3035

CHESTNUT HILL AUDIO LTD.

MARIAH ACOUSTICS

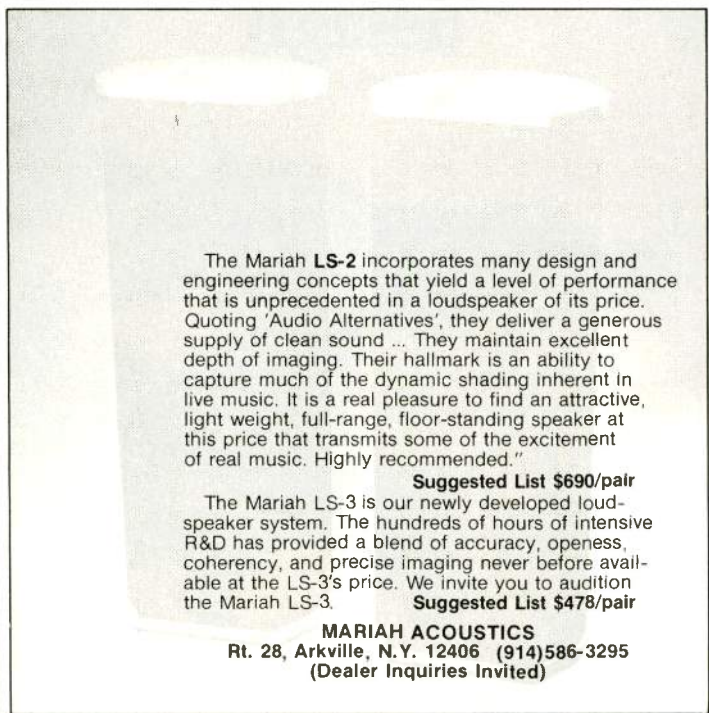

The Mariah **LS-2** incorporates many design and engineering concepts that yield a level of performance that is unprecedented in a loudspeaker of its price. Quoting 'Audio Alternatives', they deliver a generous supply of clean sound ... They maintain excellent depth of imaging. Their hallmark is an ability to capture much of the dynamic shading inherent in live music. It is a real pleasure to find an attractive, light weight, full-range, floor-standing speaker at this price that transmits some of the excitement of real music. Highly recommended."

Suggested List \$690/pair

The Mariah **LS-3** is our newly developed loudspeaker system. The hundreds of hours of intensive R&D has provided a blend of accuracy, openness, coherency, and precise imaging never before available at the **LS-3's** price. We invite you to audition the Mariah **LS-3**.

Suggested List \$478/pair

MARIAH ACOUSTICS
Rt. 28, Arkville, N.Y. 12406 (914) 586-3295
(Dealer Inquiries Invited)

FOR SALE

AVAILABLE IMMEDIATELY FROM LARGE INVENTORY WONDER CAP®

polypropylenes and Siemens polystyrenes, including RIAA valves, at **low prices**. Mod kits too. Premium-quality vacuum tubes, EAR 509 poweramps, Entec's fabulous Keith Johnson designed active subwoofer, and Strathern ribbon drivers all available at best prices around. Write for free info and application notes.
TWO JEFFREYS AUDIO
527 W. Butler Dr., Phoenix, AZ 85021

BANG & OLUFSEN PLUS—Finally, audiophile sound quality coupled with elegant styling. Made in Denmark, you can have European craftsmanship at very affordable prices. Now available—B&O's newest products in stock! **PLUS** quality control to assure optimum performance. Shipping anywhere in the continental U.S., DESIGNATRON'S STEREO STORES INC., 260 Old Country Road, Hicksville, NY 11801, (516) 822-5277.

BEARD TUBE ELECTRONICS, PINK TRIANGLE TURNTABLES, AND HELIUS TONEARMS are now available from your audio specialist. For information, contact IAI, 723 Bound Brook Road, Dunellen, New Jersey 08812 or call 201-968-8771.

BEDINI—back & better than ever! Hear the new DE electronics: Audio Connection 201-239-1799

BERNING EA-230 NEW: \$730; Grace G-747 mint: \$170. Boxed. (804) 232-5072.

B&W 802F LOUDSPEAKERS. One year old. New (\$2500) Will sell for \$1700. Call Ken nights at 608-244-3551

FOR SALE

BEST SOUND PER DOLLAR SYSTEM

(UNDER 2000)

Turntable: **REGA PLANAR 3**
Cartridge: **PREMIERE LMX**
Receiver: **NAD 7150**
Speakers: **SNELL TYPE E'S**

SOUND BY SINGER

227 Lexington Avenue
New York, NY 10016
(212) 683-0925

BEST SOUND HIGHEST QUALITY EXCEPTIONAL VALUE = **BEARD AUDIO SYSTEMS**

Tube pre and power amps distributed by IAI, 723 Bound Brook Road, Dunellen, New Jersey 08812 or call 201-968-8771.

BEST TRADES OFFERED. Trade for Acoustat, Berning, Belles, Bedini, Classe, Counterpoint, Perreaux, Music Reference, Ruana, Pyramid, PS, Quicksilver, Oracle, Quad, Sota, Rega, Thiel, Audioquest, Nitty Gritty, etc. **AUDIO DOCTOR**, 5731 North Pine St., Davenport, Iowa 52806, 319-386-8794

BEST USED EQUIPMENT. Free shipping. Snell A's \$1550. Acoustat II \$695. Acoustat 2 + 2 \$1550. Acoustat III \$1095. Hafler 500A \$475. ARC D90B \$1295. Hafler 101 \$95. McIntosh 240 \$425. Marantz 8B \$450. Apt Holman pre \$395. MAC 2505 \$395. Watson Seven, Counterpoint SA-2 \$695. Nikko Gamma V \$325. Theta 550, Luxman T-2 \$150., Tandberg, 10XD 550, Counterpoint TT 175., Nakamichi 581 475, and more. **AUDIO DOCTOR**, 5731 North Pine St., Davenport Iowa 52806, 319-386-8794

BOSTON ACOUSTICS PLUS—Dollar for dollar, one of the most exceptional speaker lines to come along in years. Boston Acoustics delivers unbelievable performance at very reasonable prices. All models in stock. **DESIGNATRON'S STEREO STORES, INC.** 260 Old Country Road, Hicksville, NY 11801 (516) 822-5277.

CABLE TV DESCRAMBLERS AND CONVERTERS. Plans and parts. Build or buy. For information send \$2.00. C&D Electronics, Inc., P.O. Box 21, Jenison, MI 49428.

CALL HI FI BUYS (ATLANTA) for Acutex, Adcom, Aiwa, Apt, AR, B&O, Carver, DCM, Dynavector, Hafler, Harman Kardon, Kenwood, Linn, Mirage SM-1, Mission, Mitsubishi, NAD, Nakamichi, Onkyo, Oracle, RGR, Sony, Thorens, 3-D Acoustics, Vandersteen, and more. Free shipping, fully insured, in the Continental U.S. Just call 404-261-4434 for more information.

THE IMPOSSIBLE TAKES A LITTLE LONGER. TATE II SURROUND STEREO SYSTEM



UNPARALLELED ABILITY TO TRANSPORT YOU TO THE LIVE PERFORMANCE.

INCORPORATING MORE THAN 10 YEARS RESEARCH AND 5-PATENTS (OTHERS PENDING) THE MODEL 101A CAN VIRTUALLY RECREATE A MUSICAL EVENT IN ITS NATURAL PERSPECTIVE FROM ANY GOOD TWO CHANNEL STEREO OR VIDEO SOURCE MATERIAL. DIMENSION AND SPACIOUSNESS ARE INCREDIBLE. REACHING BEYOND THE WALLS IN ALL DIRECTIONS SOUNDS ARE SUSPENDED IN SPACE ALL AROUND THE LISTENER. EVEN UP AND DOWN WITH IMAGING AND OPENNESS NEVER HEARD BEFORE. NOTHING ARTIFICIAL HAS BEEN ADDED OR TAKEN AWAY FROM THE ORIGINAL SIGNAL. NO AUDIBLE DISTORTION, NOISE, OR CHANGE IN TONAL BALANCE. INTRODUCTORY PRICE \$474.95. WRITE OR CALL 602-445-6999 FOR FREE INFORMATION.

FOSGATE RESEARCH INC.
714 CLUBHOUSE DR. PRESCOTT, ARIZONA 86301

FOR SALE

CASSETTE DECK OWNERS—High quality blank recording tape at super low prices. Will send information and free sample cassette. Write: AUDIOTECH, P.O. Box 3360, Escondido, CA 92025

BOB CARVER PHASE LINEAR 4000 PREAMP MINT CONDITION, BOXED, \$350. 1-806-372-9608.

CROWN BEST QUALITY AMPLIFIERS, TUNERS, PRE-AMPLIFIERS. PROFESSIONAL CONSULTATION—BEST PRICES. EAST: (904) 262-4000; WEST: (213) 840-0878.

CONRAD JOHNSON PV2AR TUBE PREAMP, latest, mint. Near wholesale! (203) 762-5621.

HAFLER, REVOX, TANBERG, CARVER, DBX AND OTHER QUALITY COMPONENTS. PROFESSIONAL CONSULTATION—BEST PRICES. EAST: (904) 262-4000; WEST: (213) 840-0878.

CONRAD JOHNSON PV3 KIT \$299, (Dealer Assembled \$329). This is the best value in audio! Order from the complete Conrad Johnson line along with PS Audio, Infinity, Stax, Pyramid, Boston Acoustics, Grado and the incredible VSP Trans Mos Amp state of the art 150 watts/channel for \$825. Also, Used Equipment: such as Stax DA 80M for \$295. Trades Welcome! Threshold Audio 409 S. 22nd Street, Heath, Ohio 43055, #614-522-3520.

ROGERS MONITORS The masters of imaging. The Sound Chamber, 2584, Ridge Road West, Rochester, NY (716) 225 8660 and 2930, Monroe Ave, (716) 381 9348

COMPACT DISC PLAYERS: SONY, KYOCERA and more in stock and on display \$800.00 and up. Good selection of CD's at fair prices. Catalog \$3.00. Q Audio, 95 Vassar St., Cambridge, MA 02139 617-547-2727.

ROGERS. No magic or mystique, just music. All new speakers on demonstration. Custom Stereo, 1391 S. Hamilton Road, Columbus OH (614) 235 3531

CROWN D-60 POWER AMPLIFIER with walnut cabinet, \$175. 312-343-8553

CROWN SL-1 PREAMPLIFIER—\$299, DL2—\$1,800 Call Shane 402-483-4511

THE MICHELL GYRODEC musically and aesthetically stunning. Audio by Caruso, 13831 S. Dixie Hwy, Miami, FL (305) 253 4433

ELECTRO-VOICE INTERFACE AND CD SERIES QUALITY SPEAKER SYSTEMS. PROFESSIONAL CONSULTATION—BEST PRICES. EAST: (904) 262-4000; WEST: (213) 840-0878.

Why is **AUDIO TREND** the only **THE ARM** dealer in Texas? Because superb audio components deserve careful matching and dedicated set-up. Hear David Fletcher's **THE ARM**, along with the finest associated gear, in a relaxed, friendly atmosphere. **AUDIO TREND**, 10968 Westheimer, Houston, TX 77042

SUPERTUNE YOUR HAFLER!

We improve the best! Using state of the art techniques and the finest quality parts: Wonder-Caps®, computer-grade electrolytics, and polypropylene caps — the best becomes even better!

- Improved dynamic range
- Finer focus and imaging
- Enhanced definition

MODIFICATION PRICES

DH200 / DH220 \$250.
DH500 \$300.

One year limited parts and labor warranty
Call or write for more information

RP Marketing LTD
N 4514 Isernhart Rd
Spokane, WA 99216
(509) 926-6336

FOR SALE

“The Perreaux preamp is destined to be a classic...incredibly high signal acceptance...uncanny resolution of detail...obviously built to last.”



THE MICHELL GYRODEC already becoming a legend. Chestnut Hill Audio 311 Cherry St., Philadelphia, PA (215) 923 3035

DB SYSTEMS AUDIOPHILE ACCESSORIES INCLUDE: DBP-2JAU Switch Box with gold jacks \$54.95, DBP-6 Phono Equalization Kit or DBP-6MC Resistive Loading Kit \$34.95, DBP-10 Phono Alignment Protractor \$21.95, DBP-12 Audio Cable—10 meter, 400 pF \$65.95, DBP-CK Cramolin Audio Kit \$14.95. **GOLD PLATED CONNECTORS** (eight pack) DBP-13J (1/4") Phono Jacks \$12.95, DBP-13JR (3/8") Phono Jacks \$15.95, DBP-13P Phono Plugs \$7.95, DBP-14 Spade Lugs \$5.95 DBP-9AU Banana Plugs \$14.95, DBP-9J Dual Banana Jacks (two pack) \$15.95. For complete information write: DB SYSTEMS, Main St., Rindge Ctr., NH 03461 (603) 899-5121. Orders under \$45 add \$2.50 Handling. Dealer inquiries invited.

DCM TIME WINDOW SPEAKERS \$440.—Mint, Thorens TD-125 Turntable, Audiocraft arm, Satin Cart \$350. Decca Cart \$50. Various Cart \$50. 212-465-4717

DENON HA-1000 HEADAMP, mint \$225 or B/O. DB 4A headamp and power supply, mint \$100 or B/O. 217-367-2840 evenings.

FOR SALE

Quote by Gene Halaburt
Hillcrest HiFi
Dallas, Texas
214-528-0774

THE MICHELL GYRODEC a step ahead in the art of disc reproduction. Audio Consultants, 1014 Davis St., Evanston, IL (312) 864 9565

DEDICATED TO AFFORDABLE STATE OF THE ART
The NEW RGR MODEL FOUR-1 High Gain Pre-amp is the world's only FULL FEATURE pre-amp offering its level of quality and performance WITH enough gain to accommodate moving coil cartridges directly! THE RGR MODEL FIVE High Current Power Amplifier boasts an astounding 50 amperes of current output per channel, allowing its 110 watts/channel the ability to "keep on going" when other amps "run out of gas"! For more info, call or write RGR 6440 N. Ridgeway Av. Lincolnwood, IL 60645 312-673-9320.

DESIGNATRON invites you to audition the remarkable new **PREMIER LMX** moving coil phono cartridge. Dynamic, accurate, transparent, detailed, and affordable. Now playing at **DESIGNATRON's**, 260 Old Country Rd., Hicksville, NY 11801. **DESIGNATRON's** North Country Rd., Setauket, NY 11733.

DYNAVECTOR TONEARM DV—501. New—Never Used \$250.00 with DV17D cartridge \$500.00 cartridge played approximately one hour. (505) 299-5909. Ask for Jeff.

GALA SOUND



A NEW STANDARD OF EXCELLENCE

Many serious listeners have been misled by certain well intentioned but musically and technically incompetent "audiophile" publications.

Thousands of dollars have been spent on poorly engineered products acclaimed in these publications whose expertise lies in journalism, not audio. The goal of improved reproduction of music is not well served in this manner.

Pianist James Gala has established a unique audio salon in Rochester, New York.

GALA SOUND sells correctly engineered and musically accurate audio components. We are involved in the recording—both analog and digital—of philharmonic orchestras, have a continuing dialogue with the world's preeminent audio engineers, and Mr. Gala performs in concert regularly.

We fly our customers round trip at our expense from anywhere in the continental U.S. to our store for the selection of an audio system of \$5,000 or more.

Phone (716) 461-3000 today and ask for Mr. Gala. If music is important in your life, then you deserve a stereo system from **GALA SOUND**.

650 MONROE AVE.

ROCHESTER, NEW YORK 14607

GALA SOUND

FOR SALE

EFRM

Would you believe?

- Hartley Polymer Drivers?
 - Transient speed 5 times conventional systems?
 - Complete phase coherency?
 - 25 Hz—45 kHz frequency response?
- Call or write for more information. EPIK AUDIO, 653 Overland Trail, Roselle, IL 60172 (312-894-0294).

ELECTRONIC X-OVERS: 6, 12 AND 18DB/OCTAVE. Kits from \$106.50. Also Transient-Perfect Crossover model 6000-6, \$175.00. Filters. Free folder w/reviews. ACE AUDIO CO. #532-5th Street, E. Northport NY 11731-2399. (516) 757-8990.

ENTEC—Entertainment Technologies endeavors to provide the audiophile, and professional, with equipment that reflects the classic values of integrity and common sense. Properly chosen audio equipment involves a pride of ownership that we, at ENTEC, respectfully cater to. Our Seismic Generator gives the solid foundation for listening pleasure that only complete speaker accuracy can assure. This bass reproducing system will work so well, and give such true bass expression to a wide variety of speakers, that you can experience a remarkable improvement by the simple addition of the Seismic Generator.

BEARD ELECTRONICS in NJ at Audio Connection

SPEAKERS KITS OR ASSEMBLED



Highly refined, factory priced, speaker systems for the audio purist. The affordable alternative for those seeking the best. For brochure, call or write us.
Chicago Speakerworks inc
5700 N. Western, Chicago, Ill. 60659
Phone (312) 769-5640

- ACOUSTIC ELECT • B&W • THE DAVID BERNING CO. • CRAMOLIN • DENON
- DYNAVECTOR • ELITE FURNITURE
- ENERGY LOUDSPEAKERS • FULTON
- GOLDMUND • GRACE • GRADO • HÄFLER
- HILL PLASMATRONICS • JANIS • KEITH MONKS • KINDEL • KOETSU • KYOCERA
- LAST • LINN SONDEK • LIVE WIRE
- LUSTRE • MARCOF • MEGASONICS
- MONSTER CABLE • MUSIC REFERENCE
- NAD • NAKAMICHI • NITTY GRITTY
- PENTAGRAM • PLATTER MATTER • PSE
- POLK AUDIO • PRECISION FIDELITY
- PROMETHEAN • PROTON • P.S. AUDIO
- PYRAMID • QUICKSILVER AUDIO • SIGNET
- SNELL ACOUSTICS • SPICA • STAX • SUMO ELECTRIC • SUPEX • TANDBERG • THETA ELECTRONICS • VPI • C.J. WALKER

the listening room

590 Central Park Avenue
Scarsdale, N.Y. 10583

Mon, Thurs, 10-9 PM
Tues, Wed, Fri, 10-7 PM/Sat 10-6 PM

Credit Cards Accepted
We ship FREE Anywhere in the Continental U.S.A.

914-472-4558

FOR SALE

ENTEC is currently expanding to broaden our dealer network, and will soon have dealers from coast to coast. We welcome all inquiries, so call or write today for more details. ENTEC 1016 Morse Ave. #12, Sunnyvale, Ca. 94086 (408) 745-0377.

H&B AUDIO CONSULTANTS is southwestern Michigan's newest audiophile oriented facility. We have selected only the finest products, many which have never been available in this area. You are invited to select from our product lines which include Astatic, Belles Research, Berning, Counterpoint, Daybreak, Fuselier, Live Wire, Megacable, Mirage, Musical Concepts, QLN, Sota, Sound Lab, Spica, and more. Hours by appointment. (616)-965-1816 or (616)-962-3910

5 YEARS AND GROWING STRONG! featuring the renowned Strathearn ribbon, available with solid hardwood frames, crossovers, complete systems, Dynaudio, Dalesford, Panasonic leads, Wonder caps, Wesco, Shadow Engineering electronics. A full line of esoteric but affordable kits, AC acoustic foam for cost effective room treatment. Guaranteed lowest prices, instant shipping, technical assistance. MC/Visa. Noon to 6:00m-f. 608-781-2110 Detailed catalogue \$2. **AUDIO CONCEPTS** P.O. Box 212 La-Crosse, Wi. 54601

FOR OVERSEAS USE & EXPORTS We supply Stereo equipments & Appliances 110-220V, 50/60 Hz. Best prices, Prompt delivery, Contact: Roma Entp., P.O.B.41127, Cincinnati, Oh-45241, (513) 769-5363

FREE CATALOG—CAR STEREO, Speakers, Equalizers, CB, Police-Fire scanners, Radar Detectors, Telephones J&M Electronics, 409 Cayuga St., Joliet, IL 60432

FREE SALE FLYER

Many bargains in NEW and USED equipment.
AUDIOPHILE'S SOUND STUDIO
330 Westgate Mall
Madison, WI 53711
(608) 273-3211

GRACE—RUBY CANTILEVER FOR F9 SERIES
We offer the Grace 747, 707MK2, 704, F11L, F9E and RUBY. Visa and MC. FREE SHIPPING IN US AND PR. OXFORD AUDIO CONSULTANTS, INC., Box 145, Oxford, OH 45056-0145, 513-523-3333, TLX427791.

FOR SALE

FREE SPEAKER CATALOG!

Woofers, mids, tweeters, hardware, crossovers, grille cloth, plans, kits, information, much more. Discount Prices! UNIVERSAL SOUND, Dept. AO, 2253 Ringling Blvd., Sarasota, Fla. 33577 (813) 953-5363.

FREE SPEAKERKIT CATALOG 17 proven designs. Also, 200 drivers' specifications, JBL + polypropylene Thiele data, \$3. GOLD SOUND, Box 141A, Englewood, CO 80151. (303) 789-5310.

FRIED SPEAKERS & KITS

State-of-the-art sound. Try our prices! Fast, free shipping. READ BROS. STEREO, 593 King St., Charleston, S.C. 29403. (803) 723-7276. Also Hafler, NAD, Carver, Nakamichi, Sony digital (disc and PCM-F1).

GARLAND WELCOMES SOTA

We rarely rush to endorse new products, especially turntables. With this noteworthy exception! With great pleasure, we throw our full support to the SOTA Sapphire and SOTA Star Sapphire. Both set new standards for performance, sound, and value. "American turntable" and "world-class" are a rare combination. NOT ANY MORE!! San Jose, CA **GARLAND AUDIO**, (408) 244-6724.

GAS GRANDSON \$200, MARANTZ Model 16—Model 7T—\$399 both Call Shane 402-483-4511

GENE RUBIN AUDIO—LOS ANGELES

NAIM AUDIO	LINN SONDEK	ISOBARIKS
PS AUDIO	THORENS	ACOUSTAT
NAD	CJ WALKER	THIEL
KYOCERA	LS3/5A	SPENDOR

Prepaid shipping (213) 571-1299 (Pacific Time)

GENUINE GOLD LION TUBES—WEST COAST DISTRIBUTOR. Hand built—Individually tested with Specification Sheet. The Worlds Finest Sounding Output Tubes. Shipped Prepaid U.P.S. KT88 . . . (Replaces 6550) . . . \$38 ea. MATCHED PRS. KT77 . . . (Replaces EL34/6CA7) . . . \$30 ea. **ADD \$10** ECC83 . . . (12AX7 INDIA), \$12 ea. M/C, VISA, MONEY ORDER. SOUND GOODS-2627 So. BASCOM, CAMPBELL, CA. 95008. (408) 559-1920

GOLD CONNECTORS, CRAMOLIN, other goodies. Details, SASE. Reference Audio, 368. Rindge NH 03461

GRACE F9E's and F9E Rubys's, New With Warranties. "We Will Not Be Under Sold". (206) 323-4987

MUSIC MAT

THE AUDIOPHILE'S CHOICE

Dramatically reduces the effects of:
• Turntable Rumble • Acoustic Feedback • Vinyl Echo •
The results—more detail—more music.

WHY SETTLE FOR ANYTHING LESS?

FOR INFORMATION WRITE
Ionian Distribution,
111 Queen Street East, Suite 302a
Toronto M5C 1S2 Canada.

STATE OF THE ART RIBBON MID RANGE

As Manufactured by Strathearn

ABSOLUTE SOUND'S REFERENCE MIDRANGE
UNSURPASSED CLARITY

SPACIOUS STEREO IMAGING

System Power Rating 100 Watt Max.

Sensitivity 86 dB / Watt Mean at 1 meter

Dim. 25 1/8 X 5 1/8 inches

Also available with:

Advanced flat honeycomb bass drivers, fast leaf tweeters
Recommendation for true State of the Art system,
offering savings with no quality sacrificed

EXCLUSIVE NORTH AMERICAN IMPORTER

VARIS AUDIO

CALL (201) 671-3074



FOR SALE

HAFLER DH-220K, DH-110K \$550.00 BOTH, DH-355 \$325.00pr, FUMIG C-1000, M-1000 \$550.00 both, HARMAN-KARDON CD-401 \$585.00, CD-301 \$435.00, HK-580i \$390.00, HK-680i \$500.00, RADIO SHACK MODEL 3 COMPUTER, 48K, TWO DRIVES \$1725.00, SONY PCM-F1 \$1450.00, TC-K555 3 head cassette \$350.00, 203-777-1476

HAFLER ELECTRONICS & SPEAKERS

We are now stocking: DH-101K \$199.95, DH-101A \$299.95, DH-102 \$55.00, DH-110K \$299.95, DH-110A \$399.95, DH-112 \$74.95, DH-160K \$299.95, DH-160A \$399.95, DH-220K \$349.95, DH-220A \$449.95, DH-220KE \$359.95, DH-220AE \$459.95, DH-355 \$400.00 per pair (speakers), DH-500K \$599.95, DH-500A \$749.95, DH-500KE \$619.95, DH-500AE \$769.95. 101, 200 and 220 accessories. FREE SHIPPING IN US AND PR. WORLD-WIDE EXPORTING. Visa and MC. OXFORD AUDIO CONSULTANTS, INC., Box 145, Oxford, OH 45056-0145, 513-523-3333, TLX427791.

HAFLER FM DIGITAL TUNER DH330 at Q AUDIO NOW. New DH100 preamp coming soon at \$150.00. All other products on display and always in stock. Kits, factory and Q-built. Trades taken. Good pricing. Authorized dealer. 95 Vassar St., Cambridge, MA 02139. 617-547-2727.

HAFLER IN THE SOUTH

In stock, the superb Halfer DH-110 pre-amp and DH-220 & DH-500 amplifiers. Immediate, FREE shipping. Also Fried, Carver, Acoustat, NAD, Nakamichi, Audire, PS, Vandersteen, Klipsch, Sony digital (disc and PCM-F1). READ BROTHERS STEREO, 593 King Street, Charleston, South Carolina 29403, (803) 723-7276.

HAFLER IN THE WEST! ALL MODELS ALWAYS IN STOCK! REFERENCE AUDIO SYSTEMS. (213) 398-4205.

HAFLER, REVOX, TANBERG, CARVER, DBX AND OTHER QUALITY COMPONENTS. PROFESSIONAL CONSULTATION—BEST PRICES. EAST: (904) 262-4000; WEST: (213) 840-0878.

FOR SALE

"The Perreaux is the most non-fatiguing preamp of solid-state accuracy I've ever heard."

Quote by Mark Pinkerton
Pinkerton Audio
Carmichael, Cal.
916-485-5725

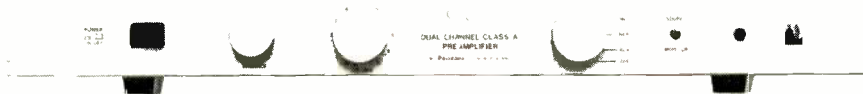

HAFLER PLUS—The new Halfer DH220 power amplifier—replacing the DH 200, reinforces David Halfer's commitment to quality in every product he designs. We carry the full Halfer line, available in either kit or factory assembled. Own some of the finest audio equipment! Now at extra savings! **PLUS-FREE** shipping anywhere in the continental U.S., DESIGNATRON'S STEREO STORES, INC., 260 Old Country Road, Hicksville, NY 11801, (516) 822-5277.

H&B AUDIO CONSULTANTS is southwestern Michigan's newest audiophile oriented facility. We have selected only the finest products, many which have never been available in this area. You are invited to select from our product lines which include Astatic, Belles Research, Berring, Counterpoint, Daybreak, Fuselier, Live Wire, Megacable, Mirage, Musical Concepts, QLN, Sota, Sound Lab, Spica, and more. Hours by appointment. (616)-965-1816 or (616)-962-3910

HARMAN-KARDON SEPARATES, RECEIVERS, CASSETTE DECKS, TURNTABLES, PROFESSIONAL CONSULTATION—BEST PRICES. EAST: (904) 262-4000; WEST: (213) 840-0878.

HEYBROOK TT2 TURNTABLE & HEYBROOK LOUD-SPEAKERS available at Audio Connection, 201-239-1799

HEYBROOK HB-1 \$339. PAIR

The affordable link for the demanding audiophile on a budget. By appointment: ACS Limited, 2232 Ward Street, Berkeley, CA 94705. (415) 841-4192.

HEYBROOK HB-2 \$489. PAIR

A classic design with uncompromising performance and compact dimensions. By appointment: Community Audio, 318 West Duval Street, Philadelphia, PA 19144. (215) 843-9918.

HEYBROOK HB-3 SERIES II \$989. PAIR

A monitor quality loudspeaker with all the impact and excitement of the original performance. Available at: Audio 2000, 2137 Sterling Road, Fort Lauderdale, FL 33312. (305) 962-5300.

HEYBROOK IN GEORGIA

Hear them at: Stereo Shop 4319 Columbia Road, Martinez, GA 30907 (404) 863-9143

HEYBROOK IN INDIANA

Hi-Fi Gallery, 811 Broadripple Avenue, Indianapolis, IN 46220 (317) 253-5141

COTTER SYSTEM 2



The most-exciting and long-awaited Mitchell A. Cotter System 2 audio preamplifier is now on demonstration at dealers worldwide. The completion of System 2 came with the introduction of the CM-2 Control Module, and combined with the PSC-2 Phono Signal Conditioner, NFB-2 Noise Filter Buffer and MK-2 MC Cartridge Transformer forms a "triaxial" shielded preamp of uncompromising clarity and versatility. Cabinetry of unique design as well as a rack-mount complete the System 2.



MITCHELL A. COTTER Sales Corp.
201 E. Rosemary St.
Chapel Hill, NC 27514
(919) 929-2037

AT YOUR DEALER NOW!



The Argent series of moving coil cartridges was developed to offer the audiophile a state of the art component capable of reproducing acoustical detail with astonishing accuracy and clarity.

MC110 Sapphire mounting base — Tapered titanium cantilever — Line contact nude diamond stylus

MC300 Boron cantilever — Parabolic nude diamond stylus

MC310 Aluminum cantilever — Elliptical nude diamond stylus

DIRECT SOUND CORP. 150 FIFTH AVE. SUITE 516, NEW YORK, N.Y. 10011 (212) 807-1598

FOR SALE

HEYBROOK IN MISSISSIPPI

Treat your ears. Music One, 375 Lake Street, Greenville, MS 38701 (601) 335-0380

HEYBROOK IN NEW YORK

Audition the full line at: Audio Breakthroughs, 1534 North-ern Blvd., Manhasset, N.Y. 11030 (516) 627-7333

HEYBROOK TT-2 \$500.

The turntable that has lowered the price of perfection. Available at Audio Connection, 615 Bloomfield Avenue, Verona, NJ 07044 (201) 239-1799.

ROGERS MONITORS Reference loudspeakers from a refer-ence hi fi dealer, Lyric Hi Fi, 1221, Lexington Ave., New York, NY (212) 535 5710 and 146, E. Post Road, White Plains, NY (914) 949 7500

ROGERS SPEAKERS Playing music forever. The full range on demonstration. Audio House, 4304 Brayan Dr., Swartz Creek, MI (313) 655 8639

ACTIVE ELECTRONIC CROSSOVERS

STEREO BI-AMP \$139
STEREO TRI-AMP \$230

Level controls and sub-sonic filters, summers, optional. Filters, regulated power supplies, equalizers, are also available.

Free catalog and price sheet

DeCoursey Eng. Lab.

11828 Jefferson Bl. Culver City, CA 90230
PHONE (213) 397-9668

FOR SALE

HIGH END EQUIPMENT

All kind of American, Japanese, English and German audiophile products like: Audio-Research, Audiostatic, Acous-tat, Conrad-Johnson, Esoteric A.R., EMT, Goldmund, Infin-ity, Kiseki, Krell, Koetsu, Linn, Magneplanar, Oracle, Plas-matronics, Quad, Revox, Stax, Snell, Threshold, Thorens, Vernissage, Zen and many others at lowest export prices. Ask for latest price list and details. WE SHIP WORLD-WIDE! HiFi Systems, Lengsdorfer Hauptstrabe 75, 53 Bonn 1 West-Germany, Tel. 0228-253111 or 253314, Tlx. 886646 hfss d.

HIGHEST QUALITY USED EQUIPMENT FOR SALE: McIntosh C32 preamp, \$1,000.00; B&W 801 spkrs, \$2,500.00/pr; IMF Monitor mkIV, \$2000.00/pr. Quad ESL spkrs, \$1,000.00/pr; McIntosh C28 preamp, \$300.00; Tandberg TD20A deck, \$1,000.00; JBL SG 520 preamp, \$200.00; McIntosh MR 78, \$800.00; Carver M400 amp, \$295.00; Dahlquist DQ10 spkrs, \$595.00/pr; Tandberg 10XD, \$990.00, McIntosh MR 71 tuner, \$275.00. All used equipment guaranteed 90 days parts and labor. Audio Consultants, Inc, 1014 Davis Street, Evanston, IL 60201, (312) 864-9565

ROGERS NEW SPEAKERS incredible detail and resolu-tion, Hi Fi Gallery, 811 Broadripple Ave., Indianapolis, IN (317) 253 5141

IN STOCK! Audio Research, Thorens, RGR, Halfer, On-kyo, Technics, B&W, Meridian, E.V., Vandersteen, Dyna-vector, Snell, Tascam and more . . . For information: P. K. Audio, 4773 Convention Street, Baton Rouge, LA 70806 or (504) 924-1001.

It's a crime to sell a cartridge this good for only 200 bucks! That's how we feel about the new **PREMIER LMX**. It's smooth and neutral, yet detailed and dynam-ic. In a word, unquicky. We'd love to let you hear it. Now in progress at **AUDIOVISIONS**, 1067 Montauk Hwy., West Babylon, NY 11704.

FOR SALE

JANIS WOOFERS & INTERPHASE CROSSOVER/AMP

The Janis bass systems are the finest universal subwoofer systems available. **FREE SHIPPING IN US AND PR.** Visa and MC. **WORLDWIDE EXPORTING.** OXFORD AUDIO CONSULTANTS, INC., Box 145, Oxford, OH 45056-0145, 513-523-3333, TLX427791.

J.B.L. SPEAKER SYSTEMS AND COMPONENTS

bought, sold and traded. 1-313-229-5191 or 5115 Red Fox, Brighton, MI 48116.

John Garland is moderately enthusiastic about David W. Fletcher's **THE ARM**: "Finally **GARLAND AUDIO** has found the pinnacle in tone arms—**THE ARM**, the finest, the last word." Hear why at **GARLAND AUDIO**, 325 S. Monroe Street, San Jose, CA 95128.

JRM POWER TOWER AMPS; 3BPB Electronic Cross-overs; Transparency Loudspeakers. Jerry Martin, 3716 Broadway NE, Knoxville, Tn. 37917 (615) 688-6501.

ROGERS SPEAKERS Everyones reference standard, Audio Excellence, 425 Washington St. San Francisco, CA (415) 433 1335

ROGERS SPEAKERS Your ears should be so good!! Jannen Systems, 214, W. 21st St, Hazleton, PA (717) 459 5722

"**KAIDE**", Sao Win's new MC-10, musically superb, a true reference: at Audio Connection, 201-239-1799

KENWOOD KT-917 (List \$1000) \$365; Lustré GST-1 \$143.; Quad EHT \$40.; Dalesford D50/200 Driver \$37. each; Syrxin PU-1 \$198.; Supex SDX-1000 \$199. All Un-used; Dahlquist LP1 \$175.; Dyna (Van Alstine) ST-70 \$210; ST-70 \$100.; Paragon 12A \$399.; Promethean (G2 +) \$143.; Marantz 20 tuner \$199.; Stax UA-7CF/N \$168.; Oracle (latest) \$645.; Mission 774 \$225.; Ionovac tweeters \$198. All Mint (212) 784-2939 evenings.

LAB & TEST GEAR—Ferrograph RTS-2, Audionics quad decoder, Crown IMA, BK Precision 1465 scope, Eico 902 scope, Heath 10-102 scope, Heath 1G18 sine-square gener-ator, Heath 1G37 FM stereo generator, Heath SG-8 r.f. generator, Lectrotech FC-50 freq. counter, Heath AG-9A audio generator, meters: BK Dynascan 2830, Knight 440-06235, Ohmeter M220, Heath 1M-105, Lafayette field strength, Eico capacitance, Daystrom ohms, Heath volts, Realistic SPL. \$1,000. f.o.b. Florida. Respond to **AUDIO BOX NO. 6831.**

Don't Throw Out Your Amplifier... Buy Pentagrams!



We at Pentagram have noticed that all too often high end speakers are fickle devices that must be very carefully matched to your ampli-fier. Some speakers present the amplifier with such an odd load that all but the most esoteric of amplifiers sound terrible, clip at low volumes, or still worse—blow up! The customer must revamp his system in order to accommodate his new speakers.

While the Pentagram P-10 and P-8 incorporate the latest in technology and design, they also have been designed to present the ampli-fier with a smooth, easy load. So, when you purchase Pentagrams you can keep your present equipment, or if you want to get the most of our special engineering you may use equipment as esoteric as you like. In either case you will be able to achieve the op-timum quality your equipment is capable of producing.

Changing to Pentagrams is the most significant audible improvement you can make in any system.

Amertron
Hollywood, Ca.
(213) 466-4321

Audio Analyst
Madison, WI.
(608) 241-8889

Audio Den
Lake Grove, N.Y.
(516) 360-1990

Audio Vision
Arlington, Mass.
(617) 641-0490

CSA Audio Design
Upper Montclair, N.J.
(201) 744-0600

Digital Sound
Virginia Beach, Va.
(804) 424-5850

Harmony House
New York, N.Y.
(212) 751-9188

Landes Audio
Chester, N.J.
(201) 879-6889

The Listening Room, Inc.
Scarsdale, N.Y.
(914) 472-4558

The Mountain Ear
Carbondale, Colo.
(303) 963-3269

The Stereo Lab, Inc.
New London, Conn.
(203) 447-9802

Stereo House
Los Alamos, N.M.
(505) 672-1177

Stereo Shop
Martinez, Ga.
(404) 863-9143

21st Century Audio
Philadelphia, Pa.
(215) 324-4457

Come hear the difference at your local dealer or visit us at the "Con-sumer Electronics Show" in Chicago June 5-8 in Room 626A.

Pentagram

"WE SOUND BETTER BECAUSE WE LISTEN!"



PENTAGRAM® INC.

"A Labor of Love"

207-19 35 AVENUE BAYSIDE, N.Y. 11361
(212) 746-6193 (212) 423-3923

Get it Free!

Luxman ADS M & K Halfer Tandberg Wharfedale Thorens 3-D Acoustics Audio Control NAD Ortofon AIWA Revox Kenwood Mitsubishi

Grace Denon Hitachi Onkyo SME MXR Sherwood & Many More!

We Deliver **FREE** Anywhere in the Continental USA

the SOUND Approach

6067 Jericho Tpke., Commack, N.Y.
Charge it...Call 516-499-7680 Ext-82

WE WILL NOT BE BEAT!

SUPER SELECTION • FULL WARRANTY • FAST DELIVERY
• HI-FI, HIGH END & VIDEO •

AUDIO PEOPLE

1000 Orange Ave., West Haven, CT 06618

VISA CALL (203) 934-5291 NOW! MAC

FOR SALE

LEVINSON HQD, ML-1, ML9, LNC-2, Nakamichi 682ZX, Counterpoint SA-1. (913) 764-6482

LEVINSON LNP-2 PROF PREAMP, Factory checked 3/17/83, mint cond. \$1695. Threshold 400w amp \$695. 212-465-4717

LINN/NAIM in NJ: Audio Connection, 201-239-1799

LINN PRODUCTS, MODIFICATIONS & NAIM

We are pleased to offer the complete line of Linn and Naim products: turntable, cartridges, arms, speakers, electronics, NIRVANA & VALHALLA MODIFICATIONS FOR LP12. Visa and MC. FREE SHIPPING IN US AND PR. OXFORD AUDIO CONSULTANTS, INC. Box 145, Oxford, OH 45056-0145, 513-523-3333, TLX427791.

LISTEN METRO N.Y. Audition New York Acoustics superb line of custom built speakers in your home. Featuring Strathern midrange, ultra smooth super tweeters, stunning cabinets. Choice of finish and grill covers. Prices start at \$260. per pair. Call 516-277-5336 for information and appointments

LUXMAN 5M20 POWER AMPLIFIER, \$600., 312-343-8553

MAGNAPLANER TYMPANI 1-D, white, \$900 (203) 467-0319 Evenings & Weekends

MAGNUM'S 95 FM PREAMPLIFIER—the only way to clean FM. Audio Connection, 201-239-1799

MARANTZ, McIntOSH original tube covers, cabinets, manuals. Reasonable (805) 646-5862

MC INTOSH AUDIO EQUIPMENT Bought—Sold—Traded—Evenings & Weekends, 607-865-7200. If no answer 607-865-5387 S.D.R., P.O. Box 176, Walton, NY 13856

MC INTOSH BOUGHT AND TRADED. Kenwood 917 Tuner \$295. Levinson ML1 w/latest pwr. supply \$850. Dayton Wright SPA w/latest mods. \$575. Beveridge RM1/2d \$1100. Levinson ML3 \$1900. Counterpoint SA2 \$675. Scheiber decoder b/o over \$950. Oracle Delphi \$725. B&O 1900 rec. \$300. Sumo The Power 400 w/pc \$925. Meridian 1055 \$500 pr. Thorens 124 \$125. Tech EPA 500 arm \$300. Pyramid 2 + 2w's \$1000. Several desirable MAC & Marantz pieces. More used hi-end gear every week. Yours wanted now for cash. Sound Investments (212) 377-7282. New York, 7 days. Noon till 3PM only.

McIntOSH BOUGHT, SOLD AND TRADED. 1-313-229-5191 or 5115 Red Fox, Brighton, MI 48116.

McIntOSH MC-275, MR-67, C-26. CITATION Eleven, 18. PIONEER Spec-1, CT-F1000, PL-610. SONY ST-J60. M&K Satellite's & Volkswoolfer. DYER, 717-299-4161

McIntOSH MR78—\$998, 2120—\$900 Call Terry 402-391-3842

FOR SALE

“The Perreaux's craftsmanship and attention to detail are immediately evident... listening to the Perreaux preamp and power amp was simply stunning.”

Quote by Kerry Likis
Likis Audio
1103 21st St.
Birmingham, Ala.
205-933-8135



MCINTOSH MR71 \$450, MC2100 \$475. MA230 \$285, MPI-4 \$1,000. Marantz #6 \$200, 15 \$175, 7T 160, SLT12U \$285, 22 \$140, 23 \$99. Harman Kardon Citation 1 \$150. Citation 3X \$225. Citation 11 \$175, Citation 12 \$200. Panasonic SH3433 4 channel scope \$300. Kenwood RC6060A \$200. KT7000 \$99. Teac AL700 elcaset factory sealed originally \$1,100 only \$349. Sony EL-4 elcaset factory sealed \$139. Sony Ferrichrome elcaset tape. Mullard 12AX7's \$5.95. Dahlquist DQ10's w/stands \$650. KLH 9's pairs \$1,000, \$750. Quads \$750. RCA 77DX's \$1,000. AKG 412's perfect \$1,800. Neumann KM86 \$750. MCI 8 channel \$9,000, Tandberg 9000 \$300. Ampex 350 w/console perfect condition seldom used \$1,750. ReVox A77MK3 \$650. A700 w/unused 1/2 track headblock \$2,250. Crown SS1444 \$2,000. IC150A \$225. DBX 124 \$175, 122 \$125. Advent 100A \$135. Scott 265A's \$300, 130 \$200, 4312 \$160. Stax MK3's sealed \$150, Koss ESP9B \$125. Audiophile #1 \$300. Adcom GFA1 \$250. GAS Thoebe \$300. Nakamich rack system \$1,699. 300 prerecorded r/r tapes \$6 each. some Crown, Mac, Marantz & SAE cabinets. Some Dual, ReVox, McIntosh parts. Manufacturer's original service manuals-no red tape, no minimum-fast Martin Gasman 779 Worcester St. Wellesley, MA 02181 617-CEL-TICS

ORACLE "DELPHI" OWNERS. You won't get the best sound your turntable can produce without our beefier, low ripple power supply. Improved imaging, dynamic range and instrument timbre guaranteed! THE MOD SQUAD, 144 Athena Street, Leucadia, CA 92024 (619) 436-7666.

McIntOSH MR 78 TUNER, with walnut cabinet, original packing. One year old. Excellent condition \$1050. Jerry Kaldor, 218-728-1414

MCINTOSH PLUS—McIntosh instruments are the Laboratory Reference Standard for the world. McIntosh designs their equipment for a long life with low maintenance and high quality performance. PLUS-FREE test report on your new McIntosh equipment, on request, FREE shipping anywhere in the Continental U.S., Prompt delivery, Credit cards accepted. DESIGNATRON'S STEREO STORES, INC., 260 Old Country Rd., Hicksville, N.Y. 11801 (516) 822-5277

MISSION 770'S, Linn LP-12, Grace 707, Ortofon MCII 20 latest models, each unit \$900., best offer. (215) 874-7404

mitsubishi Tuner, Preamp, Amplifier, Power meter—\$1,000 Micro Tuner, Preamp, Amplifier—\$600 Call Terry 402-391-3842

MONSTER CABLE .65¢ A FOOT CUT TO ANY LENGTH. GOLD PINS .50¢ EACH. Mariah Speakers, Precision Fidelity. Call or write for other great prices. VISA and MC. TROLLY STEREO 451 Moody St. Waltham MA. 02154 (617) 891-3337

Close-out Sale!

Fons CQ30 Mark 1
\$125 plus shipping. limited quantity

Send money order to:

Lord Brothers
P.O. Box 6430
Denver, Colo. 80206

no refunds.
90 day warranty

303-534-7590
Colorado residents add tax.

Can a cassette sound as good as a record?

The KMP-2 can dramatically close the gap.

With a good deck, top quality tape and the Kinergetics Magnetic Processor for tape decks (KMP-2), the quality will be directly comparable.

It is not an equalizer. The processing uses the same technology as that employed in the KMP-1 for magnetic cartridges.

- The KMP-2 has a suggested retail of \$110.00.
- Why not audition the KMP-2 and hear for yourself.

SEE US AT CES
Conrad Hilton,
3rd Floor



In New England...



No hyperbole — just the kind of knowledge, creativity and dependability you expect from a dealer who represents these manufacturers.

- | | |
|-------------------|---------------|
| Acoustat | LAST |
| Apt-Holman | Magnepan |
| Audel | Marcof |
| Audio Pro | M & K |
| Boston Acoustics | Monster Cable |
| Bryston | N.A.D. |
| Carver | Nakamichi |
| Dahlquist | Nitty Gritty |
| Denon | Oracle |
| D.C.M. | Proton |
| Dynavector | Pyramid |
| Fidelity Research | Signet |
| Gem | Supex |
| Grace | Threshold |
| Hafler | Vandersteen |
| Keith Monks | VPI |
| KEF | Win Labs |
| KLH | & more... |

5 listening rooms... New England's largest Audiophile record dealer... Keith Monks record cleaning... In-store service... All shipments pre-paid and insured in the continental U.S.



105 Whitney Ave., New Haven, CT
(203) 777-1750

Mon., Tue., Wed., Fri. 10-6, Thurs. 10-8, Sat. 10-5

FOR SALE

MERRILL AR MODIFICATIONS

SUB CHASSIS KIT—\$69.00 Designed to deaden the AR turntable and allow replacement of original tone arm. Consists of acoustically dead replacement sub chassis and new bearing.

SPRING KIT—\$8.00 Allows use of wide variety of tone arms, platter pads, record weights, and other accessories.

REPLACEMENT HIGH TORQUE MOTOR—\$45.00
OAK REPLACEMENT BASE—\$135.00 Beautiful solid oak base with lead lining for extra deadness.

**LEAD COATING SERVICE—\$10.00, REPLACE-
MENT SPINDLE—\$25.00**

PLATTER BALANCING SERVICE—\$10.00
GLASS & LEAD PLATTER PAD—\$35.00
Underground Sound, 2125 Central, Mphs, TN
38104, (901) 272-1275.

MOUNTAIN EAR HAS STRATHEARN RIBBONS. 303-963-3269

ROGERS SPEAKERS Legendary performance, Main Street Music, 315, E. Hyman Ave #208, Aspen, CO (303) 925 2921

FOR SALE

**MERRILL TURNTABLE—
NOW ACCEPTING ORDERS**

FEATURES: Solid oak hand-built base, lead and foam lined for deadness. Seven layer laminated plinth. One of the best looking turntables ever built. Three point energy absorbing subchassis. Three-fourth inch thick arm mounting boss (thickest of any turntable made). Four adjustable feet. Twenty-four pole synchronous motor with enough torque to handle a ten pound platter. A spindle system that will handle hundreds of pounds of weight. Two piece platter, machined out of matching aluminum. 100% balance guaranteed. Non-obsolete. New accessories can be added to the existing turntable. Comes with a 10 gauge soft vinyl dust cover. Many more features! The bottom line: Listen and compare to the high priced foreign turntables. Price: \$385.00 COMING SOON FOR THE MERRILL TURNTABLE: A subchassis tuning system; more advanced than any on the market. A unique record vacuum platter. **FOR MORE INFORMATION AND A PICTURE:** Please send a self-addressed stamped envelope to: **UNDERGROUND SOUND, 2125 Central Ave., Memphis, TN 38104**

FOR SALE

MUST LIQUIDATE MANY CROWN AMPS, preamps, equalizers, cross-overs. Most new with warranty, some used. Phone 616-641-5555

NAD 1020 and 3020A Owners!

Find out what high quality parts such as metal film resistors, polypropylene capacitors and gold plated jacks can do for the sound of your NAD. Free info with SASE. Kindel Audio, 1710 Newport Circle, Unit O, Santa Ana, CA, 92705

NAD IN PITTSBURGH—BETTER SOUND CONCEPTS
3281 W. Liberty Ave., Pgh, PA 15216, (412) 561-3312

NAKAMICHI: SHAMEFULLY LOW PRICES. New And Used. BX-2, LX-3, LX-5, ZX-7, ZX-9, Dragon. AudioWorkshop (206) 323-4987

NAKAMICHI PLUS—Featuring the incredible BX-1 cassette deck. Now you can have Nakamichi performance for under \$300. We also carry the full line of Nakamichi products. **PLUS-FREE** calibration and bias adjustment, on request, **FREE** shipping anywhere in the continental U.S. **DESIGNATRON'S STEREO STORES, INC.,** 260 Old Country Road, Hicksville, NY 11801, (516) 822-5277.

NEW 83 RAW LOUDSPEAKER CATALOG, 25c. Meniscus Systems, Dept A, 3275 Gladiola, Wyo., MI 49509

**—NEW—RG DYNAMICS' VIDEOSONIC
STEREO PHASOR**

Now, from ANY video source, RG's VC-1 delivers a quality signal worthy of being amplified through your stereo system! It's the audiophile answer to terrible video sound. Since compression is 80% of the problem, and noise is 20%, the VC-1 combines expansion with effective elimination of the hiss and noise PLUS superb synthesized stereo sound! The VC-1 is simply UNBELIEVABLE! For more info, call DSA Marketing 1-800-323-3665 (IL call 312-673-7003) 9-5pm CST

PHASE LINEAR 700 WATT AMP \$450. F.M. Acoustic 600 Lab Power Amp \$895. 212-465-4717

Park Audio

425 Park Avenue South
at 29th Street
New York, N.Y. 10016
212 685-8101/8102

**We respect our customers;
you can make your own choice from among:**

- Sony Esprit • Sony PCM-F1 • McIntosh • Nakamichi • SAE-X • Black Koetsu • Denon • Mitsubishi • Spondor • Quad • B&W • Bang & Olufsen • Tandberg 3000 Series • Kirksaeter • Obelisk* • Shahinian Acoustics • Sequerra Pyramid • Accuphase • ADS • Mordaunt Short • Signet • Supex • Benchmark

Threshold
precision crafted audio components

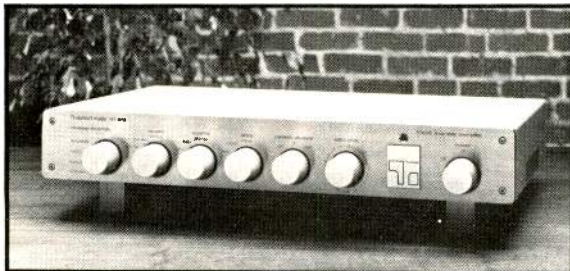

The Threshold FET one STASIS preamplifier places fewer electronic devices between the source and the listener than any other preamplifier.

Threshold considers it axiomatic, all other things being equal, that a simple audio circuit will always sound better than a complex audio circuit. The FET one approaches the theoretical limit of this ideal by using a *single* fet for the voltage gain required of each preamplifier stage.

Sophisticated peripheral control circuits assure that this single fet is always held at maximum linearity while the output topology employs, for the first time in a preamplifier, Threshold's proprietary STASIS technology.

Component parts, assembly craftsmanship and finish are maintained at the highest level, and each FET one is *individually* hand calibrated for exact phase and amplitude adherence to the RIAA characteristic.



For a full color brochure and technical specification sheet on the full Threshold line write:

Threshold Corporation
1832 tribute road suite e sacramento california 95815



**The Best
Doesn't Mean the
Most Expensive.**

Low prices on a huge selection of name brand hi-end. All units are new with full warranty. Let our experts guide you to the best sounding system for your dollar. Call for information or write for a free catalog

Nationwide Delivery
VISA MasterCard Amex

audio advisor, inc.
Box 6202 Grand Rapids, MI 49505 (616) 451-3888

A SINGER'S DREAM!

REMOVES VOCAL FROM MOST STEREO DISCS
The Thompson Vocal Eliminator can actually remove most or virtually all of a solo vocalist from a standard stereo record and yet leave most of the background music untouched! Not an equalizer! We can prove it works over the phone. Write or call for a brochure and demo record below. **COST: \$349.00**

YOU SHOULD SEE US

- For:
- Time Delay/Ambience
 - Studio Echo/Reverb
 - Tape Noise Reduction
 - Parametric Equalization
 - Electronic Crossovers
 - Compressor/Expanders
 - Mic Preamp/Mixers

We manufacture a full line of high quality audio and recording equipment. You will probably have to pay twice as much elsewhere to obtain comparable quality. Only Direct Sales make our prices and quality possible. Write or call for a 24 page brochure and demo record.

Write to: **LT Sound, Dept. AU, P.O. Box 338, Stone Mountain, GA 30085, Phone (404) 493-1258**

FOR SALE

ROGERS SPEAKERS A growing legend, all new models on demonstration. North County Stereo, 131-B El Camino Real, Encinitas, CA (619) 753 3546

ROGERS SPEAKERS Capture the magic in music. Newport Audio, 1000, N. Bristol, Newport Beach, CA (714) 851 0112

THE MICHELL GYRODEC Engineering artistry, a sonic and visual delight. Newport Audio, 1000 N. Bristol, Newport Beach, CA (714) 851 0112

THE MICHELL GYRODEC nothing beats it for isolation and beautiful styling. North County Stereo, 131-B El Camino Real, Encinitas, CA (619) 753 3546

1-601-323-0750 **FOR LOWEST PRICES:** NAKAMICHI, HK, JBL, BOSE, POLK, DBX, GRADO, and more. DYNAMIC SOUND, Box 168, Starkville, MS 39759. 1 PM-9 PM, M-F.

ORACLE PLUS—Own the finest sounding turntable in the world. The Oracle will greatly improve the total sound of your system. Plus - quality control to assure optimum performance and free shipping anywhere in the continental U.S. DESIGNATRON'S STEREO STORES, INC. 260 Old Country Road, Hicksville, NY 11801. (516) 822-5277.

OTL AMPLIFIER (c)

The OTL AMPLIFIER (c) was perfected by Julius Futterman in 1954. Now, for the first time the audiophile may listen to a tube amplifier that is not penalized by the output transformer. With a slew rate of 33 volts per microsecond and a bandwidth of 200KHZ the OTL AMPLIFIER (c) has the speed of a transistor amp and the harmonic correctness only possible with tubes. There are 8 models of the Futterman OTL AMPLIFIER from a 25 watt triode to a 250 Watt mono amplifier. For a complete technical discussion of tube electronics and technical papers on OTL AMPLIFIERS, send for our 72 page book, \$2.50 domestic, \$5 foreign. New York Audio Laboratories, Inc., 33 North Riverside Avenue, Croton-on-Hudson, NY 10520

PHONO PICKS UP RADIO SIGNALS? RELIEF is money-back guaranteed with the A2 Phono Input Filter. Simply plug in between phono cables and preamp. Does not affect sonic quality. \$17.50 (stereo pair). Audioworks, P.O. Box 1288, Traverse City, MI 49685-1288.

PINK TRIANGLE: A WELL KEPT SECRET. The best sounding turntable from England. For dealer list, contact IAI, 723 Bound Brook Road, Dunellen, New Jersey 08812 or call 201-968-8771.

PORTABLE EQUIPMENT: UHER, Sony, Sennheiser, AKG, Beyer-Dynamic. Send SASE (Specify Model), Carpenter Sound, Box 1321, Meadville, Pa. 16335-0821

POWER TO THE PEOPLE—Most complete publication available on regulated power supply construction. \$16.50. **MEGACABLE**—Our interconnect and speaker cables deliver what others only talk about. 37c SASE brings regulator/cable information. **MIDWEST AUDIOPHILE SUPPLY**, BOX #3, Emerson NE 68733, (402) 695-2509

ROGERS No magic or mystique, just music, all new speakers on demonstration, Audio Dimensions, 794 N. Woodward, Birmingham, MI (313) 642 6383



From the worlds oldest and largest speaker kit manufacturer, **SPEAKERLAB**. Save up to 30% on the speaker designs critics rave about. From tiny bookshelf speakers to slender, floor-standing models to massive folded corner horns. PLUS the latest in state-of-the-art car speakers. All in Speakerlab's 1983 catalog. Send for it today. (Allow 4 - 6 weeks for delivery. Send \$1.25 for faster, first class postage.)

speakerlab
Dept. A36, 735 N. Northlake Way
Seattle, Washington 98103

FOR SALE

"The sound of the Perreaux pre-amp is astonishing. Light years ahead of the competition...open, extended, detailed, natural...will handle any cartridge or DAD."

Quote by John Dudley
Accurate Audio
1027 No. Coast Highway
Laguna Beach, Cal.
714-494-2030



PRECISION FIDELITY ELECTRONICS AT GENE RUBIN AUDIO (213) 571-1299 (PAC)

PRIVATE STUDIO SELLING QUALITY AUDIO EQUIPMENT: amplifiers, decks, microphones, speakers, preamps, processors, turntables, etcetera. Listing available: Studio, 8608 Dairyview, Houston, TX 77072

ProAc ProAc ProAc

England's finest loudspeakers are now imported for your listening pleasure by Modern Audio Consultants. West: 2888 Bluff St., Suite 210, Boulder, CO 80301, 303-449-1440 East: 112 Swanhill Ct., Baltimore, MD 21208, 301-486-5975 New! The fantastic, tiny ProAc Tablette!

PS AUDIO COMPLETES YOUR MUSICALITY QUEST with the integrated "ELITE". Affordable, powerful, elegant and sophisticated. Hear it at Q Audio along with the new PS 2C, PS-IV and MCA-2. 95 Vassar St., Cambridge, MA 02139. Export model, too. 617-547-2727.

PS AUDIO—FANTASTIC!

In stock! Fast, free shipping. **READ BROTHERS STEREO**, 593 King Street, Charleston, South Carolina 29403. (803) 723-7276.

PS AUDIO AND REFERENCE AUDIO PRESENT the new TWO C PLUS amplifier. Incorporating innovative technology, the results are absolutely stunning. The Two C Plus exhibits a tremendous (and accurate) soundstage with superb lucidity that will bring you to tears. Your jaw will drop when you hear this latest addition to the PS Audio family. A true bargain at \$600. PS Audio's new MCA moving-coil headamp is the world's first high-impedance solid-state headamp. Featuring improved regulation, this headamp works magically with Dynavecors and Koetsus. Only \$255 with high-current power supply.

Serious audiophiles will find the new PS Audio Conductive Fiber Anti-Static Record Brush indispensable. It is the best dry-cleaning system available. Forget the liquid brush systems that turn dirt into sludge with impossible to remove residues. Special introductory price: \$12.00. Will be \$15.00 7/1/83.

Coming next month: a big surprise from PS Audio. **REFERENCE AUDIO SYSTEMS:** 18214 Dalton Avenue, Gardena, CA 90248 (213) 398-4025.

PS AUDIO'S "ELITE" INTEGRATED AMPLIFIER—the best integrated, period! Audio Connection, NJ 201-239-1799

The art of shaping sound.

Does your music sound better in the next room? Pro audio kills resonances with **SONEX** acoustic foam, and now you can too. Control acoustics and turn your room into a studio. At midrange, **SONEX** has twice the sound absorption of good carpeting for about the same cost. If your dealer doesn't have **SONEX**, send us \$40 for a sample box of four 24"x24" sheets, or write for our color brochure.



illbruck/usa
techniques with foams

3800 Washington Ave. N. Minneapolis, MN 55412

FOR SALE

Music Lovers & Audiophiles
Take Notice!
We are proud to announce the

**GRAND OPENING of
APPLE AUDIO**

featuring the finest names in audio such as
•ADS •Amber •Audio-Pro •Audio Control
•Beyer •Celestian •Dynavector •D.C.M.
•F.A.S. •Grace •H.K. •Last •Monster Cable
•Ortofon •Ungo Box •Pyramid •Sonus
•Sumiko •Sherwood •Thorens
•3D Acoustics •And More
Prompt, Courteous Service Free Shipping in the U.S.A.
Feel Free to call for information
MC/VISA 110-220 VOLTS



74-18 37th Ave.
Jackson Heights, N.Y. 11372
(212) 507-0561 Open 7 Days
Exit Broadway-Roosevelt
278

PS AUDIO = SUPERB VALUE
Gene Rubin Audio (213) 571-1299 (PAC.)

Q AUDIO TURNTABLE BARGAIN FOR JUNE, 1983:
LINN Basik LV-X on WALKER CJ55 with GRADO GTE - 1
\$595.00 set up and delivered anywhere USA. 95 Vassar
St., Cambridge, MA 02139. 617-547-2727.

QUAD 405 MODIFICATION. We've compared this beauty
with the finest amplifiers and walked away smiling. It's a
knock-out! Solid-state authority combined with tube sweet-
ness and musicality. THE MOD SQUAD, 144 Athena
Street, Leucadia, CA 92024 (619) 436-7666.

QUAD OWNERS CLUB
We are sharing info, set up, mods to make the best better.
Send for info to QUAD OWNERS CLUB, 33 North River-
side Ave., Croton-on-Hudson, NY 10520

**QUALITY JAZZ CLASSICAL RECORDINGS IN COM-
PLETE 72 PAGE CATALOG PLUS BESTSELLER SUP-
PLEMENT.** Also books, gifts, cassettes. \$1.00 (refundable)
MUSICAL CONCEPTS, Box 53 AA5, Cedarhurst, NY
11516.

FOR SALE

QUICKSILVER, PENTAGRAM, COUNTERPOINT, Preci-
sion Fidelity, David Berning, Audire, PSE, Sota, Audio-
quest, Spica, Klyne. The Mountain Ear. Evenings and
weekends, 303-963-3269

RARE PARAGON E-1 BASS AMPS \$185, VanAlstine
Dyna 120B \$265 (408) 649-1115

**CROWN BEST QUALITY AMPLIFIERS, TUNERS, PRE-
AMPLIFIERS, PROFESSIONAL CONSULTATION—BEST
PRICES.** EAST: (904) 262-4000; WEST: (213) 840-0878.

**RECORDED SOUND TURNED INTO
A LIVE PERFORMANCE**

Although disc and tape recordings fall short of this
ideal, it is now possible to overcome the loss of inner
detail and of transient information as well as other
limitations of the recording process. The PATENTED
circuitry of the ROBERT GRODINSKY SIGNATURE
ONE EXPANDER is designed to analyze and correct
for shortcomings in recordings.

The improvements in resolution of each instrument,
in the accuracy of attack, the correctness of harmonic
structure and stereo image must be heard in your own
system to be appreciated. You will hear information on
all of your records and tapes as well as FM which was
only hinted at before. Music sounding more real and
with background noise reduced.

We invite you to try the SIGNATURE ONE on our
money back offer. If you do not agree that your stereo
sound is markedly improved, return it for a full refund.
The price of \$495.00 includes shipping anywhere in
the U.S. To order or for more information, call DSA
Marketing at 1-800-323-3665 9-6 pm CST (IL call 312-
673-7003). VISA and MASTERCARD accepted.

REFERENCE RECORDINGS

RR 11, the Utah Symphony performing Berlioz' "SYM-
PHONIE FANTASTIQUE," has prompted hundreds of cus-
tomer responses like these. Thank you all! W. Peplinski,
WI.: "Very, Very Impressive!!!" J. Warren, IL.: "An incredi-
ble listening experience—Thank you. Thank you . . ." E.
Ellis, CA.: "Absolutely a fabulous recording together with a
1st class performance—this could be the best interpretation
available!" M. Meshginpoosh, OH.: "Simply put; Bravo!" To
order this special 45 rpm two record set, send \$25 to
Reference Recordings, Box 77225X, San Francisco, CA
94107. (408) 289-1462. Visa/MC welcome. Free Catalogs!
Dealer inquiries invited.

REGA PLANAR 3, with factory arm, mint condition \$350.
1-203-889-1937

FOR SALE

**REGA, HEYBROOK, SYSTEMDEK, COUNTERPOINT,
AUDIRE, HARMON KARDON, KENWOOD PURIST, KYO-
CERA, SHERWOOD, CLARKE SYSTEMS, FRIED, ROG-
ERS, SATTERBERG, ADCOM, GRACE, GRADO, LINN,
PREMIER, SUPEX plus many accessories and more . . .**
E.A.R.S., P.O. Box 658-U, W. Covina, CA 91790. M/C,
VISA, MONTHLY SPECIALS

**HAFLER, REVOX, TANBERG, CARVER, DBX AND OTH-
ER QUALITY COMPONENTS.** PROFESSIONAL CON-
SULTATION—BEST PRICES. EAST: (904) 262-4000;
WEST: (213) 840-0878.

**HARMAN-KARDON SEPARATES, RECEIVERS, CAS-
SETTE DECKS, TURNTABLES, PROFESSIONAL CON-
SULTATION—BEST PRICES.** EAST: (904) 262-4000;
WEST: (213) 840-0878.

ROGERS LS3/5A MODIFICATION. You can keep the
characteristic "Rogers" sound while cutting back on distor-
tion and beaming. Want more smoothness, tighter bass,
and a cleaner high end? Contact THE MOD SQUAD, 144
Athena Street, Leucadia, CA 92024 (619) 436-7666.

SAVE 75%, BUILD YOUR OWN SPEAKERS. Crossovers,
Woofer, Mids, Tweeters instructions. HI-FI, Pro, Auto.
Send \$2.00 for catalog-refundable. DKI Audio, Davis, IL
61019

**CROWN BEST QUALITY AMPLIFIERS, TUNERS, PRE-
AMPLIFIERS, PROFESSIONAL CONSULTATION—BEST
PRICES.** EAST: (904) 262-4000; WEST: (213) 840-0878.

SEE UNDER CATEGORY "WANTED TO BUY" David Yo

**ELECTRO-VOICE INTERFACE AND CD SERIES QUALI-
TY SPEAKER SYSTEMS.** PROFESSIONAL CON-
SULTATION—BEST PRICES. EAST: (904) 262-4000;
WEST: (213) 840-0878.

**HAFLER, REVOX, TANBERG, CARVER, DBX AND OTH-
ER QUALITY COMPONENTS.** PROFESSIONAL CON-
SULTATION—BEST PRICES. EAST: (904) 262-4000;
WEST: (213) 840-0878.

**HARMAN-KARDON SEPARATES, RECEIVERS, CAS-
SETTE DECKS, TURNTABLES, PROFESSIONAL CON-
SULTATION—BEST PRICES.** EAST: (904) 262-4000;
WEST: (213) 840-0878.

SOUTHERN LINEAR ARM—right on track!!! at Audio Con-
nection, NJ 201-239-1799

**\$5200
for a legend**



MBR ELECTRONICS
1 WORLD TRADE CENTER, SUITE 1913
NEW YORK, N.Y. 10048

**THE
SOURCE**
Direct free-port pricing

American International Audio Video
745 Alexander Rd., Princeton, N.J. 08540
1-609-452-7500

CALL OR WRITE FOR YOUR FREE BROCHURE

REFERENCE QUALITY AUDIO COMPONENTS

- Accuphase
- Adcom
- Ariston
- Audio Interface
- Beveridge
- Bipolar
- Counterpoint
- DB Systems
- D&K Imports
- Decca
- Dynavector
- Electrocompaniet
- Entec
- Estoric Audio Research
- Grace
- Hafler
- ISOS
- Kiseki
- Kimber Kable
- Klyne
- Koetsu
- Krell
- Lustre
- Nova
- Ortofon
- Orsonic
- Precision Fidelity
- Sideral Akustik
- SME
- Snell
- Souther
- Spica
- Stax
- Sumiko
- Supex
- Symmetry
- Talisman
- Thorens
- Triad
- VPI
- VPS Labs

Call for appointment and/or information or send \$2.00 (Refundable) for product brochure.

Complete Shipping and Export Facilities Available
Bank Cards Accepted

GREENFIELD EQUIPMENT
BOX 225D RIVER FOREST, IL 60305 (312) 771-4660

DISCOUNT WORLD

CAR STEREO SPECIALS

**CONCORD
HPL122
HPA25
COMPLETE \$319**

CLARION 5700R \$199
SONY XR-50 Silver . . . \$169
JENSEN R-200 \$99
PIONEER KP-1500 \$79

TDK SAC90	12.50	TDK MAC90	14.75	Maxell UDXL2C90	12.95	Maxell UDXL2SC90	13.75
Pioneer Car Stereo KP4500	119	Pioneer Car Speakers TS106	33	Jensen Car Stereo RE530	319	Jensen Car Speakers J1242	89
Pioneer Car Stereo KP5500	129	Pioneer Car Speakers TS108	39	Jensen Car Stereo RE520	269	Jensen Car Speakers J1069	45
Pioneer Car Stereo KP6500	139	Pioneer Car Speakers TS1622	40	Jensen Car Stereo RE518	259	Jensen Car Speakers J1065	69
Pioneer Car Stereo UKP4205	119	Pioneer Car Speakers TS1644	60	Jensen Car Stereo RE512	239	Jensen Car Speakers J2037	69
Pioneer Car Stereo UKP5600	169	Pioneer Car Speakers TS1688	80	Jensen Car Stereo RE508	199	Jensen Car Speakers J2033	99
Pioneer Car Stereo UKP7600	189	Pioneer Car Speakers TS411	49	Concord Car Stereo HPL101	149	Concord Car Stereo HPL115	199
Pioneer Car Stereo UK63100	169	Pioneer Car Speakers TS694	55	Concord Car Stereo HPL112	169	Concord Car Stereo HPL118	209
Pioneer Car Stereo KE5100	179	Pioneer Car Speakers TS695	89	Concord Car Stereo HPA-25	69	Concord Car Stereo HPL122	289
Pioneer Car Stereo KE6100	209	Pioneer Car Speakers TSX6	75	Clarion Car Stereo 7500R	209	Clarion Car Stereo 3150R	79
Pioneer Car Stereo UK7100	229	Pioneer Car Speakers TSX11	199	Clarion Car Stereo 5550R	149	Clarion Car Stereo 300E0B3	125
Sony Car Stereo XR15	129	Sony Car Speakers XR55	239	Clarion Car Stereo 5150R	119	Clarion Car Stereo 100E0B4	65
Sony Car Stereo XR25	149	Sony Car Stereo XR75/75B	299	Philips Car Speakers EN-8741	49	Philips Car Speakers EN-8769	129
Sony Car Speakers XS101	39	Sony Car Speakers XS102	49	Altec Car Speakers 6X9-4C	85	Altec Car Speakers SK2	69
Sony Car Speakers XS211S	39	Sony Car Speakers XS606	69	Page Alert 4444	99	AudioSafe	32
Whistler Radar Dect. 01000	189	Fox Superfox Remote	199				

DISCOUNT WORLD, P.O. BOX 191, MINEOLA, N.Y. 11501 516-294-6136
Shipping charges are \$4.00 per order to continental U.S.A. We accept money orders, cashiers or certified checks.
Personal checks - 3 weeks delay. N.Y.S. Residents add sales tax. Write for FREE catalog.

FOR SALE

SONY DIGITAL

The new CDP-101 digital audio disc player (plus the discs), and the PCM-F1 digital audio processor. In stock. Free shipping. READ BROTHERS STEREO, 593 King Street, Charleston, South Carolina 29403, (803) 723-7276.

SOTA COMES TO MUSIC CITY USA

VISION Audio, the only SOTA dealer in Tennessee, welcomes the Sapphire and the Vacuum Star Sapphire. Give us 15 minutes and we will show you what new turntable technology REALLY means. Remarkable sound, remarkably stable. In NASHVILLE, (615) 242-5810.

SOUND INVESTMENTS. Think again before selling or trading-in your better components at a big loss to local audio shops. CONSIGN your components at reasonable prices by listing with me in NYC with its large and growing audio market. I also buy audio equipment for cash and invite trades. Good prices for your less than perfect gear too! Call or write for information. H.L. Schneck, P.O. Box 153 Homecrest Sta., Brooklyn, NY 11229 or call between noon and 3pm (NY time) 212-377-7282

SOUND INVESTMENTS: TIMPANI III'B \$1200 pr. DENON-DP 7000 W/FR 12 arm on top Denon base \$625. MET. 3 \$1200 pr. MET 2+2W \$1400 pr. Mac XR7 spkrs. \$1100. KENWOOD LO7D \$1100. DENON DP 80/Cotter BI base/FR 66 arm \$1400. MARANTZ mod. 19 rec. w/case \$600. Mac MP14 scope b.o. Prices reduced on items in Feb. Audio ad pg. 73. Call noon to 3 p.m. (N.Y. time) 212-377-7282

SOUND LAB ELECTROSTATICS R1 with custom subwoofers \$1700., Threshold Stasis II \$1450, Bryston 3B \$650. 312-894-0294

SPECIAL SALE SPECIAL SALE

on the following. NEW: Audio Master MLS1 \$250. Audionics Composer \$1000. Dynaco MKIII Modified (pair) \$700. Grace 704 \$225. Hafler DH102 \$55. LenteK Prepreamplifier \$120. Linn Basik LV-V \$99. Rega P2 (marred cover) \$350. Rega P3 Blank \$350. Rogers A100 \$800. DEMONSTRATION: Denon DA307 \$140. Denon HA1000 \$250. Hafler DH101AP Modified \$275. Hafler DH200A \$300. Linn Prepreamplifier \$175. Rogers A75S2 \$375. Spendor SA1 Rosewood \$400. Theta 1A \$800. Theta OPT (pair) \$1000. USED: Audionics Revox RVR/RVP \$200. Denon AU320 \$75. Dynaco tube electronics. Harmon Kardon HK701 \$175. All sales final. Free shipping in continental US. OXFORD AUDIO CONSULTANTS, Box 145, Oxford, OH 45056, 513-523-3333.

FOR SALE

SPENDOR BC-1, Janszen Electrostatic Tweeters, REGA-3 Turntable, ACE-BSP Preamp, (412) 327-7193

SPENDORS ARE SPLENDID

Excellent loudspeakers, reasonably priced: SA1, SA2, SA3, BC1, LS3/5a and Prelude. Visa and MC. FREE SHIPPING IN US AND PR. WORLDWIDE EXPORTING. OXFORD AUDIO CONSULTANTS, INC., Box 145, Oxford, OH 45056-0145, 513-523-3333, TLX427791.

ROGERS FABULOUS new speakers, from \$450 to \$6,600/pr. The Sound Mill, 115, Main St., Mount Kisco, NY (914) 241 1230

ROGERS MONITORS By far the best value in British speakers. The Sounding Board, 75, Franklin Ave., Ridge-wood, NJ (201) 445 5006.

ROGERS . . . Our favorite speakers. Shimeks, 505, W. 6th Ave., Anchorage, AK (907) 277 3223

ROGERS SPEAKERS Amazing clarity and incredible imaging. Soundscape, 406, W. Coldspring, Baltimore, MD (301) 889 1134

ROGERS STUDIO ONE: exquisite tonal quality + precise image + tremendous dynamics = a Winner. Sound Components, 2710 Ponce de Leon Blvd., Coral Gables, FL (305) 446 1659

START WITH SEPARATES SYSTEM 1

(About \$2600)

Turntable: REGA PLANAR 3
Cartridge: ADCOM HCE-1
Preamp: ADCOM GFP-1
Tuner: ADCOM GFT-1A
Amplifier: ADCOM GFA-2
Speakers: SNELL TYPE E'S

SOUND BY SINGER

227 Lexington Avenue
New York, NY 10016
(212) 683-0925

THE MICHELL GYRODEC for music lovers only. Sounds, 502, Kaaahi St., Honolulu HI (808) 847 0104

ERROR-FREE LINEAR TRACKING

The Souther Linear Arm, the only purely mechanical linear-tracking tonearm is now available in an improved, production model. The new unit features a 1.1 gram tonearm/headshell fitted to our quartz track system. The tonearm fits most turntables and will extract superior sound from any cartridge. Our EQUI-MASS™ configuration ensures perfect tracking of warps and permits an ultra-low moving mass. Available at selected dealers or direct for immediate delivery. \$700.00 ppd. Literature available—Dealer inquiries invited.



SOUTHER ENGINEERING CORPORATION
429A York St., Canton, MA 02021 (617) 828-5050 —PATENTED—MADE IN USA



Sidereal Akustic™

The Sidereal Akustic Model Four Loudspeaker System utilizes a lightweight ribbon tweeter instead of the usual dome. This decision was based on the fact that flexure ripples which are transmitted from a dome's periphery to its center cannot be terminated as with a cone or ribbon. The dome is therefore a potentially resonant device. The coil of a ribbon transducer is etched on the diaphragm itself, the diaphragm is therefore subject to uniform drive power over its entire surface. This provides superb sound reproduction with less distortion and better phase response. Also, the impedance is flat over a wide frequency range and this maintains a constant damping factor even at high frequencies.

To create a whole loudspeaker system capable of reproducing sound with a high degree of fidelity to the original, Sidereal Akustic has carefully integrated the individual components into a fully coherent, synergistic design. Write or call for free literature and information.

See us at the summer C. E. S. at Conrad Hilton Room 637.

Dealer inquiries invited.
(619) 726-3150

Sidereal Akustic.. Audio Systems Inc.

• 4035 Oceanside Blvd., Unit G-57 • Oceanside, CA 92054 •

It's not the Ruby we put on the Grace.



It's the Grace we put in the Ruby.

Grace's F-9E Ruby is a revolution in fixed-coil cartridges. The new solid ruby cantilever gives the legendary F-9E the transient quickness previously associated with only the finest moving coil designs. Ruby exhibits much less resonance and flexion than common metal cantilevers, assuring a virtually perfect one-to-one energy transfer between stylus and magnet. It took Grace to combine this technology with the proven musical superiority of the F-9E.

Listeners are already calling the F-9E Ruby the world's finest sounding cartridge that doesn't need a step-up. We agree. We think you'll agree after you visit your Grace dealer and listen to the F-9E Ruby.

Note: Owners of Grace F-9E and F-9L cartridges may update with the RS-9 Ruby replacement stylus.

P.O. Box 5046, Berkeley, California 94705

FOR SALE

THE MICHELL GYRODEC musically neutral, superior isolation, engineered to perfection, beautiful and affordable. The Sound Mill, 115, Main Street, Mount Kisco, NY (914) 241 1230

STOP DAMAGE TO YOUR STEREO, TV, Computer and VCR's caused by AC power failures, with our model TW-1. For information, write: Custom Electronics, 3401 Elgin Drive, Decatur, GA 30032

STRAIGHT-LINE TONE ARM, OPTO Electronics, low mass Plexiglas \$800., M&K arm OPTO update \$200. AU-DIOETC, 613 S. 8th, La Crosse, WI 54601, (608) 782-5845 eves.

SUBSONIC FILTER KIT \$50

Rejects subsonic and most audible low frequency noises: warps, rumble, often even acoustic feedback. Kit instructions: \$2.50 (refundable); kit \$50; assembled: \$85 postpaid. Free catalog. SSS, 856A Lynnrose Ct., Santa Rosa, CA 95404

SURROUND EFFECTS

FROM YOUR STEREO MOVIES on Laserdisc, CED, VCR! Rear channel gives experience of Stereo Theater Sound in your home. Free information. Surround Decoder \$99. Cinema Box, RT. 3, Box 163, Prairieville, LA 70769

SWL'S QUICKSILVER INTERCONNECT CABLE.

Fine strand silver coated copper cable with teflon dielectric and outer jacket with machined gold plate RCA's. Available in 1/2, 1, & 2 meter stereo sets (\$25, \$30, \$45 respectively. Add \$3.00 S&H. TX res. add 5% sales tax). Custom lengths, connectors, bulk cable, speaker cable. 33-50% off all Japan MC cart., arms, transformers. Dealer inquiries invited. Send SASE for catalog. VISA & MC by phone. STEPHEN WORSHAM LABS 3720 Maplewood Dr., Dallas, TX 75205, Ph. 409-763-6061.

SYMDEX LOUSPEAKERS

We are pleased to introduce the further improved Symdex Sigma and the new companion subwoofer, a three-way system of unparalleled accuracy and low coloration. This reference system, which sets new standards for definition and transparency, is a result of thorough optimization of all design factors plus construction and components of a quality never before used in loudspeakers. The sonic results of this effort have been described by listeners as a redefinition of the state of the art of dynamic loudspeakers.

For further information, contact: Symdex Audio Systems, Inc., P.O. Box 8037, Boston, MA 02114, 617-938-8180.

Current Symdex owners note that factory updates are available.

VANDERSTEEN IN NJ only at Audio Connection, Verona

spendor

BBC Specification LS3/5A

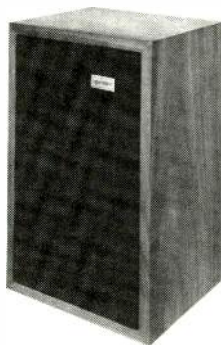

BEFORE SPENDOR WAS ESTABLISHED, WHILE SPENCER HUGHES WAS STILL WITH THE BBC RESEARCH DEPT., HE DEVELOPED THE BASIC DESIGN FOR THE LS3/5A. IN COMMON WITH OTHER CURRENT SPENDOR DESIGNS, THE LS3/5A IS USED EXTENSIVELY THROUGHOUT BRITISH BROADCASTING. THE LS3/5A WILL PROVIDE THE FINEST REPRODUCTION OBTAINABLE FROM A LOUSPEAKER OF ITS COMPACT DIMENSIONS, FOR LESS THAN \$500 THE PAIR.

RCS Audio International, Inc.
1055 Thomas Jefferson Street, N.W.
Washington, D.C. 20007

FOR SALE

THRESHOLD AUDIO is offering Conrad Johnson, VSP, Pyramid, PS Audio, Grado, Sony, Marantz, Infinity, Stax, VPI, YSL and more. Prepaid shipping. Trade-ins Welcome! Stax DA-80M, retail \$1500, sell \$295. 409 South 22nd Street, Newark, Ohio 43055, (614) 522-3762, or 3520.

THE FINEST WISCONSIN—ACOUSTAT!

Just one of the fine lines AUDIO ELITE represents is ACOUSTAT. We have their superb electronics and their reference loudspeakers. AUDIO ELITE takes the time to properly set-up these respectable speakers so you can hear why the ACOUSTATS are one of the finest sounding loudspeakers anywhere. Come and listen to the entire ACOUSTAT line. AUDIO ELITE, 221 Main St., Menasha, WI 54952, 414-725-4431.

WALKER CJ55 & LINN BASIC LV-V

This is a most agreeable, attractively priced, complete disc system. Visa & MC. FREE SHIPPING IN US AND PR. WORLDWIDE EXPORTING. OXFORD AUDIO CONSULTANTS, INC., Box 145, Oxford, OH 45056-0145, 513-523-3333, TLX427791.

THIRSTY EAR—Nakamichi, NAD, harman/kardon,

Apt Holman, Tandberg, Thorens, Bang & Olufsen, Dahlquist, Polk Audio, Dynavector, Adcom, Mordaunt-Short, Conrad-Johnson. THIRSTY EAR, 9 East Main, Bozeman, MT 59715, (406) 586-8578

THE MICHELL GYRODEC Redefining the state of the art. Stereo Horizons, 3760-11 Sports Arena Blvd., San Diego, CA (619) 223 2424

THE MONOLITH LOUSPEAKER

It redefines the state of the art for affordable loudspeakers. Its clarity, transient response, imaging, and cabinet construction are virtually second to none. You have been waiting for this one for a long, long time. Literature \$3. Monoith, P.O. Box 222, W. Springfield, Massachusetts 01090

THE SOUNDING BOARD (NJ) KNOWS TURNTABLES

Does your turntable have the shakes or jitters? Does it cry "TILT" when you start to boggie? Audition the very musical and very well-isolated American SOTA Sapphire, which sounds as well as it performs. Compare in Ridgewood, (201) 445-5006.

TWEETER OF THE MONTH CLUB!

High frequency masterpieces from all over the world, picked at the point of perfection and delivered to your door. A gift to delight the audio gourmet. WHERE ELSE BUT... MADISOUND Box 4283, Madison, Wisconsin 53711 608-767-2673

TELEFUNKEN, AMPPEREX, GENALEX and other top quality audio tubes available. Contact S.J. Wallace, 1203 Success St., Pittsburgh, PA 15212.

FOR SALE

WIN LABS STRAIN GUAGE CARTRIDGE, w/power supply. \$125. SME S/2 tonearm, DKL modified, \$100. Infinity "Black Widow" tonearm, needs wiring harness, \$75. ESS Heil AMT I Towers, excellent, \$500/pr. Ten foot transmission line subwoofers, two Kef B200's in each; homely, but DEEP, TIGHT BASS. \$700/pr. Call evenings (703) 560-6598.

VTA ADJUSTMENT FOR YOUR TONE ARM. SUMIKO'S new vertical tracking angle adjustment devices allow you to dial in correct VTA during play. VTA-7 for GRACE G-707/G-747; VTA-U for most other separate tone arms. Now at your GRACE dealer or call 415/843-4500 for nearest location.

TELEQUEST CATALOG

Filled with over 350 exciting state-of-the-art electronic products. Latest in high-tech engineering and design. To order dial toll free 1-800-327-TELE. Or send \$4.95 plus \$1.40 for shipping and handling (Fla residents include 5% sales tax) to: TeleQuest: 3015 North Ocean Blvd., Fort Lauderdale, Florida 33308

TEACS: A-4300SX with remote control, \$425; A-2300SX, \$295; Burwen DNF1201A, \$165; Onkyo T-4090 tuner, \$190; Carver C-9, \$175. All mint. Norman Tetenand, 20 White Birch Lane, Commack, N.Y. 11725.

25% TO 60% SAVINGS on Prestige Audio products from Europe and Japan. Our prices often better than other overseas suppliers. Products not sold in U.S. available. Ship worldwide. For information and price list send \$1 to: Audiophile Exports Co., 507 Dragon Seed Building, 39 Queens Road Central, Hong Kong. Run by audiophiles.

VANDERSTEEN-DIMENSIONAL PURITY

We offer the remarkable 2C's at \$990 per pair (stands \$75). Visa and MC. FREE SHIPPING IN US AND PR. WORLDWIDE EXPORTING. OXFORD AUDIO CONSULTANTS, INC., Box 145, Oxford, OH 45056-0145, 513-523-3333, TLX427791.

HARMAN-KARDON SEPARATES, RECEIVERS, CASSETTE DECKS, TURNTABLES, PROFESSIONAL CONSULTATION—BEST PRICES. EAST: (904) 262-4000; WEST: (213) 840-0878.

ROGERS MONITORS All new models available at Victors Stereo, 8, E Erie St., Chicago IL (312) 642 6349 and 5701. Dempster, Morton Grove, (312) 966 5590

HAFLER, REVOX, TANBERG, CARVER, DBX AND OTHER QUALITY COMPONENTS. PROFESSIONAL CONSULTATION—BEST PRICES. EAST: (904) 262-4000; WEST: (213) 840-0878.

THORENS TD126SME--\$795, TD160IIB--\$225 Call Shane 402-483-4511

Houston and the Gulf Coast

Mark Levinson/Spectral/Bryston/Ling/Acoustat/Magnepan/Dahlquist/Nakamichi Klipsch/Apt-Holman/Pyramid/Stax/Boston/DCM/Hafner/NAD/Rega/Amber NAIM Audio/Meridian/Adcom/Fidelity Research/Thorens/Grace/Chapman

AudioConcepts

2200 SW Freeway at Greenbriar Houston, Texas 77098 713/527-0774
Credit Cards Accepted Freight Prepaid in Continental USA

NY METRO AREA

ADS, AGI, APT, Astatic, Audio Control, Audionics, Audio Pro, Audio Research, Audio Technology, Beyer, Blaupunkt, B&O, Burwen, B&W, Carver, CAT, Cotler, CWD, Dahlquist, DCM, Denon, Dynavector, E.V. Fidelity Research, Grace, Grado, Haller, Janis KEF, Koetsu, Linn, Sonotek, Live Wire, Lustr, Nakamichi, Pyramid, Quad, Queen Labs, Revox, RG Dynamics, RGR, RH Labs, Rogers, Snell, Stax, Symmetry, Tandberg, 3D Acoustics, VPI, Yamaha

Audiocom
high technology audio

SERVICE ON PREMISES • CUSTOM INSTALLATIONS
THREE LISTENING ROOMS ON TWO LEVELS
LARGE INVENTORY • PROMPT DELIVERY
INFORMATION LINE 203-637-3621

177 Sound Beach Avenue, Old Greenwich, CT 06830
Major credit cards honored. Open 10 AM-6 PM Mon-Sat.

FOR SALE

THRESHOLD S/150 STASIS POWER AMP. Latest. Near wholesale! (203) 762-5621.

THRESHOLD STASIS 1 POWER AMPS. Only 160 units built and only 30 units in the U.S.A. Threshold 800S power amplifier, only 12 built. Joe Sammut, P.O. Box 214615, Sacramento, Ca., 95821, 916-726-2263

THRESHOLD STASIS II, Mint, \$1,300. 817-573-4097

TIME DELAY, SOUND CONCEPTS SD550, \$350. DBX-3BX Dynamic Range Expander \$350. 212-465-4717

TUBES—ALL TYPES, DISCOUNT PRICES. Many Oldies and hard to find types. SASE for list. Antique Radio & Tube Co., Dept. 601, 1725 W. University Temple, Arizona 85281

THIEL LOUDSPEAKERS AT GENE RUBIN AUDIO (213) 571-1299 (PAC)

RECORDS

ALL AUDIOPHILE ALBUMS 5—50% OFF! Over 500 titles, including new compact digital discs. Save on accessories too! FREE catalog: FOR THE RECORD... Box 21201-G, Columbus, Ohio 43221.

AUDIOPHILE RECORD GALLERY discounts on ultra sound direct disc, half mastered, digital, Japanese Imports, more! We specialize! Only the finest fidelity recordings. Catalog \$1.00 P.O. Box 1073, Vienna, VA 22180

"KAMIKAZE SALE"

of imports from Japan. Until 7:00 PM June 30, \$11.50 will buy almost any single Japanese LP (exceptions: CBS/EPIC and albums list priced over 2500 Yen)

You can select from anyone's list of Japanese imports or our own 1983 catalogs:

Pop/Rock (4500 listings) send \$ 5.00
Jazz (3500 listings) send \$ 4.00
Complete (with Soundtrack, Blues etc) \$10.00

Expect a 6-8 week wait. Send us your want list now! Orders must be received by June 30. Check, Visa, MC, AmEx, C.O.D. (add \$2.00). Domestic shipping: \$1/album up to \$5. SUPERSOUND RECORD SERVICE, box 82-A, Forest Park, IL 60130, (312) 366-1300

QUADRAPHONIC RECORDS and Q8s! Really! The fabulous Fosgate Research Tate II Surround Stereo System; our price only \$439.95. Hard-to-find ambisonic UHJ recordings. Free catalog. QUAD Incorporated Enterprises, Box 19, Capron, VA 23829.

SHEFFIELD MISSING LINC, Sealed—Best offer—201-366-9836

SHEFFIELD S-9 PLAYED ONCE IMMAC \$500. New Maryoga Voi-3, Houston Lab-2, James Lab-3, Brahms Lab-4, Grusin Lab-5. *Umbrella* Rough Trade, Nexus. *Crystal Clear* Dentie, San Fran, Byrd. *Mobile Fidelity* Steely Dan, Supertramp, Star Wars, Power & Majesty. *M&K Blu* 1&2. *All new*. Others. Make offer. SAE 5000, Dahlquist MX-1, other stuff. Write for listing. P.O. Box 48, Cook, Mn 55723 or 218 666 5203 p.m.

IF YOU CARE ENOUGH TO HEAR THE VERY BEST—



MODEL BPA—100B

LISTEN TO THE **SPECTRASCAN** BPA-100B (BASIC) AND BPA-100M (METERED) HIGH TECHNOLOGY, HIGH DEFINITION AMPLIFIERS • MEETS ALL DESIGN CRITERIA OF OTALA AND CHERRY • NESTED MULTIPLE FEEDBACK LOOPS. WIDE BANDWIDTH, HIGH SLEW RATE • 15KHZ DOMINANT POLE. CONSTANT FEEDBACK, ZERO PHASE-SHIFT AND HIGH DAMPING FACTOR FROM DC TO 20KHZ • REGULATED POWER SUPPLY FOR TRUE DC COUPLING AND INCREDIBLY SOLID BASS • FULL PROTECTION CIRCUITRY. ACTS ON POWER SUPPLY. NOT AMPLIFIERS • 100 W/CH, 8 OHMS • 175 W/CH, 4 OHMS • 350 W, 8 OHMS, BRIDGE/MONO

• COMING SOON: TWO PREAMPLIFIERS. (MODELS LCA-10 AND LCA-20) ONE 150 W/CH AMPLIFIER (MODEL BPA-200B) AND A PAIR OF SPEAKERS (ASHLEY-100L). WRITE OR CALL FOR BROCHURES AND PRICES.

SPECTRASCAN INC

5923 N. NEVADA AVE.
COLORADO SPRINGS COLO. 80907
303-599-9254

DEALER AND REPRESENTATIVE INQUIRIES INVITED

RECORDS

PROTECT YOUR LPS POLY SLEEVES for jackets 13c. Poly lined paper 15c. Square bottom inner sleeves 8c. White jackets 35c. Postage \$2.50. House of Records, Hillburn, NY 10931

MFSL 001 and 003 "Mystic Moods". Sealed \$150 for Both; E.L. Harris MFSL-015 "Quarter Moon" sealed \$55. Call Steve Stone 617-782-1247

THOUSANDS OF LIKE NEW LP's and prerecorded tapes. Catalogue—\$2.50. House of Records, Hillburn, New York 10931.

TELARC RECORDS, ALL MINT \$9. each, plus shipping, \$11. if sealed. (212) 454-3205

SPEAKERS

ELECTRO-VOICE INTERFACE AND CD SERIES QUALITY SPEAKER SYSTEMS. PROFESSIONAL CONSULTATION—BEST PRICES. EAST: (904) 262-4000; WEST: (213) 840-0878.

BUSINESS OPPORTUNITIES

MAKE MONEY FROM HOME, excellent opportunities! Details \$1. Chamberlin, 4166 Almond Street, Riverside, CA 92501

TAPE RECORDINGS

DIRECT-TO-TAPE RECORDINGS: REAL TIME DUPLICATED REELS (2/4 track, Dolby B/C, TypeX), CASSETTES (Dolby B-C, TypeX), and DIGITAL CASSETTES from MASTER TAPES. FREE CATALOG. Direct-to-Tape, 14-R Station Ave., Haddon Heights, NJ 08035

OUR BOOKS TALK! Best sellers, classics, childrens stories, famous plays, on quality cassettes. Listen to Paul Scofield bring Dr. Zhivago to life! James Mason recreates the Lost World! For free catalog send inquiry w/#10 SASE to The House of Gifts, Dept. A300, 7235 S. Woodward-202, Woodridge, IL 60517

SERVICES

LOST AND FOUND. NATIONAL SECURITY SERVICE. Protect components, tapers, video, computers. Call 804-424-5800. SASE. "Finders", Box 2500-A, Chesapeake, VA., 23320.

RAPPAPORT REPAIRS AND MODIFICATIONS. Triode Labs, P.O. Box 7717, Ann Arbor, MI 48107. (313) 482-2686.

TAPE HEADS RELAPPED. \$20. each. E. Maher, 5 Evans Place, Orinda, CA 94563.

"... the new Astatic Cartridge (a moving flux design) sounded as good, if not better than the Dynavector Diamond."

The Audiophile Society Minutes

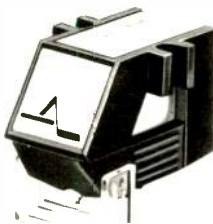

The Moving Flux Cartridge is equal or superior to the finest low output moving coils. Yet it can be directly connected to your phono section without an intervening head amp or transformer.

The Moving Flux is the only high output cartridge that directly transmits the stylus signal to the coils without the use of distortion causing pole pieces. — The same advantage the finest low output moving coils have.

Astatic's unique Moving Flux cartridge is available from North America's better audio salons.

ASTATIC Audio Division

Box 120 Conneaut, Ohio 44030

STILL LOWER LOUDSPEAKER DISTORTION

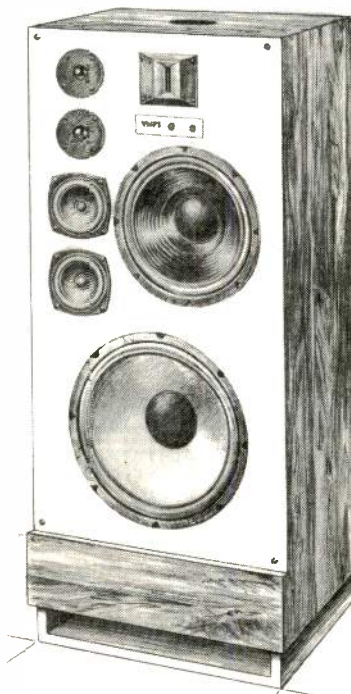

The VMPS Super Tower/R, \$6799ea kit, \$9699ea assem in rosewood or satin walnut, 50x18x18" (HxWxD), 140 lbs. Sold in mirror-image pairs. Portrait by Keith Criss, Oakland, CA. Attaboy Keith.

The VMPS Super Tower/R is a magnificent nine-driver, six-way ultra-low-distortion loudspeaker with neutrality of response, wide bandwidth, and high output level capacities to please the most demanding audiophile.

Total harmonic distortion with one Watt drive does not exceed 0.5% (22Hz-30kHz). Exclusive features such as minimum phase response, single amp or biamp operation **without** an external crossover, internal wiring with Monster Cable, mylar/polypropylene crossovers, no resonances whatsoever within the audio range, and now mirror-image, dual line-source baffle design combine to afford you, the listener, with music reproduction of astounding realism second only to our highly acclaimed, 6½ft tall Super Tower IIa/R system.

Hear the Super Tower/R at the dealers listed below, or write us for full information on all the VMPS floor-standing systems including the **Mini-Tower II** (\$309ea kit, \$439ea assem), **Tower II** (\$419ea kit, \$599ea assem), and **Super Tower IIa/R** (\$999-1199ea kit, \$1499-1699ea assem).

All prices include **free shipping** in USA and kits are supplied with cabinets fully assembled. Full reviews and test reports from Bert Whyte, B.V. Pisha, HiFi-News & Record Review, and HiFi Buyer's Guide also available on request.

VMPS AUDIO PRODUCTS

div. Itone Audio

1016 Contra Costa Drive, El Cerrito, CA 94530
(415) 526-7084

Hear VMPS at: The Listening Studio, Boston, MA; Mike Hilliard Audio, Shreveport, LA; Odin Sound, Longmont, CO; Mainline II Johnstown, PA; Wallace Brown Audio, Oklahoma City, OK; The Long Ear, Big Bear Lake, CA; Woodland Stereo, Woodland Hills, CA; Sounds Unique, San Jose, CA; The Listening Post, San Francisco, CA; Itone Audio, El Cerrito, CA; A-Vidd Electronics, Long Beach, CA.

SERVICES

AUDIO PULSE REPAIR SPECIALISTS. Modification Kits available for Model One's. WALT'S AUDIO SERVICE, 398 Granada Street, Rialto, CA 92376, (714)-875-0776.

AUDIO PULSE SERVICE. Factory trained technicians. Write us about Model One update kits. White Labs, 10528 Lower Azusa Rd., Suite 192A, El Monte, CA 91731. (213) 446-5346.

TAPE AND TAPE RECORDERS

A TRUCKLOAD AMPEX AUDIO TAPE SALE

High quality open reel 1800' or 2400' on 7" reels, used once, excellent. Case of 40, \$45.00. Cassettes available. Valtech Electronics, Box 6-A, Richboro, Pa. 18954

CROWN RECORDERS. We upgrade SX-824 with installation of DBX-150. Gives lower distortion and 90dB SN. Permits use of Crown mixer. Full tape monitor. Crown service our speciality. Ideal Acoustics, 110 Willow Road, Starkville, MS 39759. 601-324-1020 anytime.

REEL TO REEL TAPES—mostly Ampex, used once, unboxed, 1800'. 50 Reels \$48.00; Sample Reel \$2.00. Prices included shipping. Free boxes while supply lasts. COD orders accepted. Paragon Sales, Inc. P.O. Box 2022, Joliet, IL 60434, 815/725-9212.

WANTED TO BUY OR TRADE

AUDIO INTERNATIONAL COMPANY SINCE 1974. All items listed by Aberst, Corb, Yo. Highest price, Integrity. (805) 646-5862

A BETTER DEAL for your McIntosh, Marantz tube components. 713-772-4653 or 713-726-9070.

BIC TWO-SPEED CASSETTE DECK. Any model Brenner, 106 Woodgate, Rochester NY 14625

BOOK—BUILDING SPEAKER ENCLOSURES, by David Weems, Dalzell, 1729 Circo Del Cielo, El Cajon CA 92020

WANTED TO BUY OR TRADE

HEATHKIT AR-15 AM-FM radio receiver wanted. William Ziewacz, 101 Lancer, Johnstown, Pennsylvania, 15906. (814) 539-5689

I'LL BUY OR TRADE FOR CITATION'S 2, 11, 12, 14 & 15, 17, 18, IN WORKING CONDITION. I'll also buy Citation's 16, 16S, 16AS, 16A & 19 in any condition. Call collect, 504-392-7443, or 504-866-8020, or write to Doug Wilson, 341 Willowbrook Drive, Gretna, Louisiana, 70053.

MCINTOSH, MARANTZ TUBE COMPONENTS, Western Electric speakers, amps, etc. John Conrad 1178 Blackbird St. El Cajon, CA. 92020 (619) 449-9155

MCINTOSH—MARANTZ TUBE AMPS, PREAMPS—E.V. Patricians—JBL Hartfields/Paragons—Klipschorns—Borzak Concert Grands and related equipment. Kurluff Ent., 4331 Maxson Road, El Monte, CA 91732, (231) 444-7079

MCINTOSH, MARANTZ, QUAD, TUBE TYPE COMPONENTS. Western Electric Tubes, Amps, Consoles, Drivers, Tweeters, Horns, Speakers, Others. Thorens TD-124. Garrard 301. Altec 604C/E. Tannoy Monitor Speakers Tel: 213/576-2642 David Yo POB 832 Monterey Pk, Ca. 91754

MISCELLANEOUS

FIREWORKS: Largest selection available. For catalogue send 50c to Fireworks, P.O. Box 792, Tiffin, Ohio 44883 or call in Ohio 1-800-821-7901. Outside Ohio 1-800-821-2483.

FOR SALE—HiFi Stereo Mag—All back issues to #1. High Fidelity Mag—From 1953. Absolute Sound #1 to 28. Chic Mag #1 to 25. Playboy #3 to 1980. Qui #1 to 48. Best Offers—212-465-4717

INSTRUCTION & EDUCATION

YOUR OWN RADIO STATION! Licensed, unlicensed, home, church, school, business. Low cost transmitter kits. Free information. Broadcasting, Box 130-N5, Paradise, CA 95969

AD INDEX

Firm (Reader Service No.) Page

Acoustic Design Group (21)	27
Adcom (8)	15
ADS	2
Advent	32
AIWA (22)	25
Arista (6)	38
Audiophile Systems (37)	26
BASF (17)	21
Bryston Manufacturing (14)	46
Camels	6 & 7
Carver Corp.	24
Celestion (16)	48
Chevrolet	70 & 71
D'Ascanio Audio (34)	93
dbx	35
Delco/Bose	8
Denon (35)	Cover III
Design Acoustics (32)	69
Dolby Laboratories (9)	29
Electro-Voice (18)	22
IMF (7)	14
International Hifi (28)	42
International Preview Society	11
J & R Music World (29)	42
JVC (11)	89
KEF (38)	51
Kyocera (30)	39
LaBelle	94
Last Record & Stylus Care (29)	31
McIntosh (40)	47
Maxell (27)	45
Michelob	37
Mitsubishi (31, 33)	18 & 19, 54 & 55
Nagaoka (23)	49
Nakamichi (2, 15)	5, 23
NEC (1)	Cover II & 1
Ortofon (20)	12
Phase Linear (19)	85
Pontiac	43
Quad (4)	4
Quality Connection (41, 42)	30, 33
Revox (24)	47
Salems	41
Sansui (3)	3
Sony (10)	52 & 53
Soundcraftsmen (30)	17
St. Pauli Girl	75
Studer-Revox (24)	47
Tandberg (5)	11
Technics (36)	Cover IV

News from Apt Corporation

Volume 3, Number 2



Apt Holman Preamplifier two

\$ 417.00

Moving Coil Cartridge Compatibility

In this series, we will be discussing some of the areas of preamplifier performance that vitally affect high-fidelity music systems.

When moving coil cartridges were first introduced, they offered a significant advantage over conventional moving-magnet types: substantially reduced high frequency distortion. The previous moving magnet styli resonate between 10 to 15 kHz, and require a critical combination of mechanical damping in the stylus and electrical damping in the preamplifier to achieve flat audio frequency response. (Regrettably, most preamplifiers do not provide the means to compensate the electrical system precisely, resulting in sonic colorations.) While linear electrical damping is simply achieved with passive components, mechanical damping (typically supplied by an elastomer) is quite nonlinear, resulting in severe harmonic and IM distortion in the damping region at frequencies above 3 kHz. Because many moving-coil cartridges resonate at ultrasonic frequencies, they require far less damping in the audio band. The only consequence of a low mechanical damping design is an easily-compensatable frequency response rise from 10 to 20 kHz.

Oddly enough, while lower distortion damping was exploited fully in the first moving coils, the rising high-frequency response was left uncompensated by most pre-preamplifiers, with the unhappy results of unnatural sound, anomolous specifications, and, worst of all, new moving coil designs which added mechanical damping to flatten the response, but increase the distortion.

Since overall system performance may be optimized by a moving coil cartridge standard which specifies a uniform rising response and a corresponding (distortion free) electrical rolloff, the pre-preamplifier built into the Apt Holman Preamplifier 2 allows for the precise compensation via inexpensive plug-in capacitors of any present, as well as future, moving coil cartridge.

For more information, please contact your dealer or Apt Corporation. Thank you.

Apt Corporation - P.O. Box 512 - Cambridge, Massachusetts 02139 USA - (617) 492-5145

DESIGN INTEGRITY:

WHAT MAKES DENON CASSETTE DECKS UNCOMMON IS HOW MUCH THEY HAVE IN COMMON.

Denon has never built multi-thousand dollar cassette decks in order to sell unrelated inexpensive machines. Instead, Denon has concentrated its full engineering effort to produce rationally-priced cassette decks that would impress serious music lovers with their sound rather than their features. Now, the new DR-M4, DR-M3 and DR-M2 cassette decks exceed Denon's previous sonic performance levels, while adding significant technological and convenience features.

Denon's Tape Tension Servo Sensor System has been further refined to provide automatic sensing and correction of tape tension for optimum tape-to-head contact throughout the entire play of each cassette. A new SF combination head extends frequency response to 23kHz (metal) with a 70dB S/N ratio (Dolby C). A new computer controlled silent tape transport mechanism provides entirely quiet and safe tape handling. An electronic computer digital counter using a laser detector system automatically indicates tape used and tape remaining information.

The DR-M Cassette Decks feature Denon's Flat Twin direct capstan drive; non-slip clutchless, beltless, reel drive mechanisms; Dolby B & C noise reduction; direct-coupled amplifier design, and separate amp/mechanical power supplies.

The DR-M3 offers computer tape tuning for bias and sensitivity. The DR-M4 adds programmable random access, stopwatch function and dual-capstan transport. Otherwise, all the Denon DR-M Series Cassette Decks are principally the same—each offering the highest performance and quality at its price in the industry.

Denon products share more than name alone.

For the best results on the new DR-M Series, or any cassette decks, for that matter, try new Denon DX Series Cassette Tape.

Denon DR-M1 Two-Head Cassette Deck with Dolby C; Tape Tension Servo. \$299.

Denon DR-M2 Three Head Cassette Deck
with Dolby C; Tape Tension Servo; SF Combination Head.
(Side panels optional) **\$399**

Denon DR-M3 Three Head Cassette Deck
adds Computer Tuning System.
(Side panels optional) **\$499**



Denon DR-M4 Three Head Cassette Deck
adds Dual Capstan and Music Search.
(Including side panels) **\$599**

Prices for comparison

DENON

Imagine what we'll do next.

Denon America, Inc., 27 Law Drive, Fairfield, N.J. 07006
Enter No. 3E on Reader Service Card



A unique solution to a serious turntable problem: Technics introduces turntables with the P-Mount system.

Unfortunately, standard turntable design has left too much to chance in terms of cartridge mounting and performance.

Technics turntables with the patented P-Mount tonearm/cartridge system change all that. By providing complete compatibility between tonearm and cartridge to achieve the optimum tonearm resonant frequency, the level at which bass frequency interference is minimized. For the accuracy and fidelity conventional turntables can deny you.

In addition, P-Mount is a plug-in system. You'll get outstanding performance without struggling to install the cartridge. There's nothing to wire. There's no longer a headshell. There's no more fumbling to calibrate overhang or stylus position. In addition, tracking and anti-skating adjustments have been virtually eliminated.

Just plug any P-Mount cartridge into a Technics straight, low mass, high performance tonearm, and tighten one locking screw. With Technics, your records are now virtually immune to the groove wear, poor channel separation and distortion caused by improper cartridge-to-tonearm mounting.

And Technics standardized all key specifications with manufacturers of P-Mount cartridges: cartridge weight, external dimensions, connector shape, stylus position and more. So you have a wide range of cartridges to choose from.

The P-Mount plug-in cartridge system. Just one of the many advances you'll find in the new line of sophisticated Technics turntables. From belt-drive to direct-drive to quartz-locked.

The turntable revolution continues at Technics.

Technics
The science of sound

Enter No. 36 on Reader Service Card